

Airgain™



Coverage.
Performance.
Smart.

Profile Series

N2420DG3

Airgain P/N: N2420DG3-T2L-PK1-G400U
Antenna Type : dipole

**Airgain
Embedded
Antenna**

**Engineering
Data Sheet**

3611 Valley Centre Drive, Suite 150
San Diego, CA 92130 USA
Tel: +1 760 579 0200
Fax: +1 760 579 0892
Information: info@airgain.com
Sales: sales@airgain.com
Support: support@airgain.com

Revision History (Required)

Revision	Date	Note
533-02-00-001-1 Rev. 1.0	May 25, 2015	Initial Draft

Disclaimers

The information in this document is provided in connection with Airgain Antenna products and is proprietary and confidential. Airgain may make changes at any time, without notice.

Please verify with Airgain before finalizing a product design.

Contents

1. Airgain N2420DG3 Embedded Antenna.....	4
2. Features.....	4
3. Specifications and Interface.....	5
4. Radiation Patterns.....	5
5. Dimensions	7
6. ROHS.....	7
7. Mounting Guidelines	7
8. Feature and Options Information.....	10
8.1 Part Number Conventions	10
8.2 Part Number Example	10
9. Cable Data Sheet	11

Figures

Figure 1: Model N2420DG3 Embedded Antenna	4
Figure 2: Model N2420DG3 Measurement axes.....	5
Figure 3: Model N2420DG3 Measured Radiation Patterns at 2.44 GHz.....	6
Figure 4: Model N2420DG3 Measured Radiation Patterns at 5.2 GHz.....	6
Figure 5: Model N2420DG3 Embedded Antenna Dimensions	7
Figure 6: Side View of Case side wall mounting considerations for Model N2420DG3	8
Figure 7: Case top considerations when mounting Model N2420DG3 on case side wall	8
Figure 8: Side View: Clearance considerations when case top mounting Model N2420DG3.....	9
Figure 9: Top View: Case side wall mounting considerations when mounting Model N2420DG3.....	9
Figure 10: N2420DG3 with connector or stripped.....	10

1. Airgain N2420DG3 Embedded Antenna

The Model N2420DG3 Embedded Antenna provides a high efficiency, dual band embedded antenna solution for Wi-Fi and ISM band applications, such as WLAN products. As embedded antenna solutions become the focus of next generation wireless product design, the Model N2420DG3 provides the flexibility of an embedded antenna with top performance. The Model N2420DG3 Embedded Antenna is a center fed version of its predecessor, the N2420D, allowing it to fit in spaces where center feeding is better suited. It is designed to accommodate most WLAN access point applications, such as routers and gateways and can be easily integrated into an ID package design.

2. Features

The Model N2420DG3 Embedded Antenna is defined by the following features:

- IEEE 802.11 a/b/g/n/ac standards
- Dual Band operation
- Case mount
- 3.1 dBi peak gain @2.44 GHz; 2.8 dBi peak gain @ 5.2 GHz
- High efficiency
- Quick integration

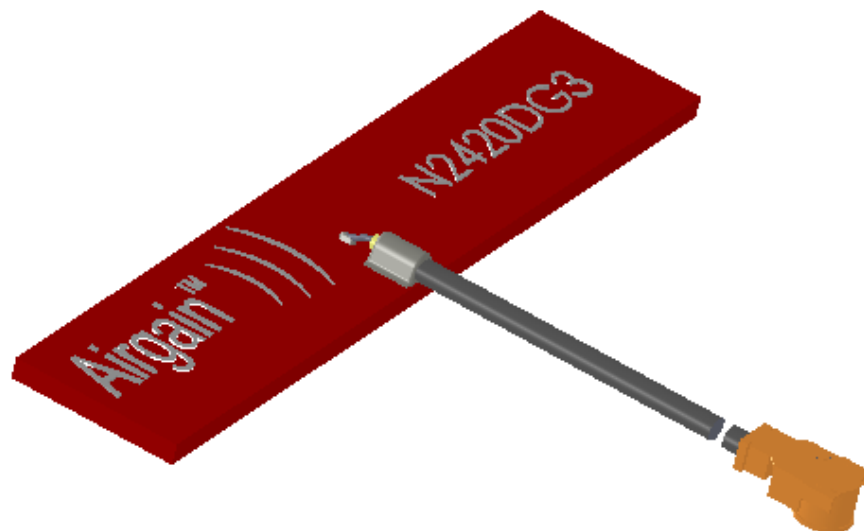

Figure 1: Model N2420DG3 Embedded Antenna

3. Specifications and Interface

Standard	IEEE 802.11n and 802.11 a/b/g/ac
Frequency range	2.4 to 2.49 GHz, 4.9 to 5.9 GHz
Peak gain	3.1 dBi @ 2.44 GHz, 2.8 dBi @ 5.2 GHz
VSWR	< 2:1
Feed impedance	50 ohms
Power handling	30 dBm
Interface	50 ohms, 1.13 mm diameter, micro coax cable (available with optional U.FL-compatible cable connector and/or cable-mounted EMI ferrites)
Antenna dimensions	40 x 8 x 1 (mm)
Weight	0.65 g (0.023 oz)
Temperature range	Operating: -40° C to +75° C (-40° F to +167° F) Storage: -40° C to +85° C (-40° F to +185° F)
Humidity range	0% to 95% non-condensing

4. Radiation Patterns

Radiation patterns for the Model N2420DG3 were taken with the antenna mounted on a 90 x 90 x 2.2 mm thick ABS Plastic Sheet and covered with a 90 x 90 x 2.2 mm thick ABS Plastic Sheet spaced 3mm above the element, using 1.6mm thick double sided tape.

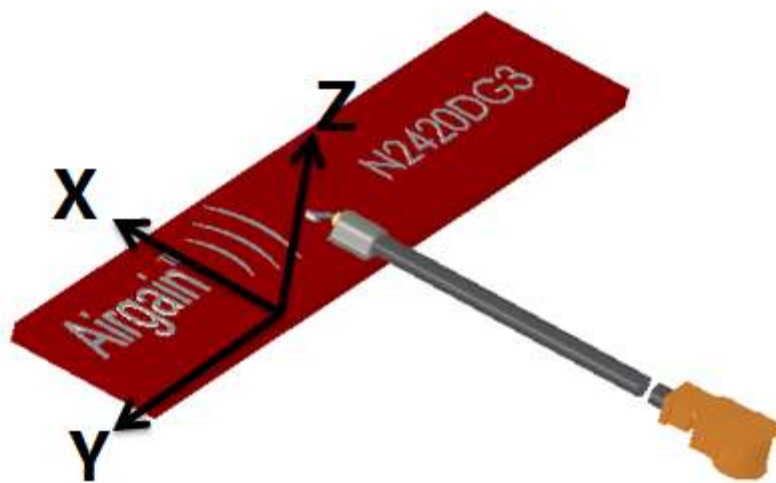

Figure 2: Model N2420DG3 Measurement axes

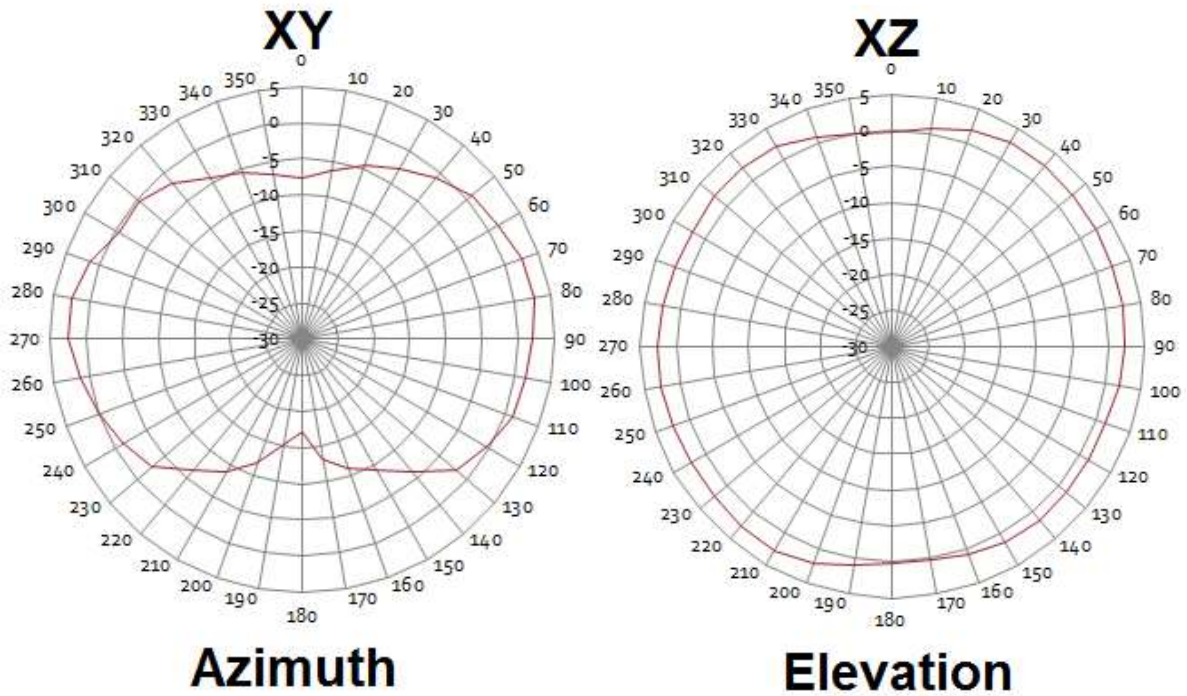

Figure 3: Model N2420DG3 Measured Radiation Patterns at 2.44 GHz

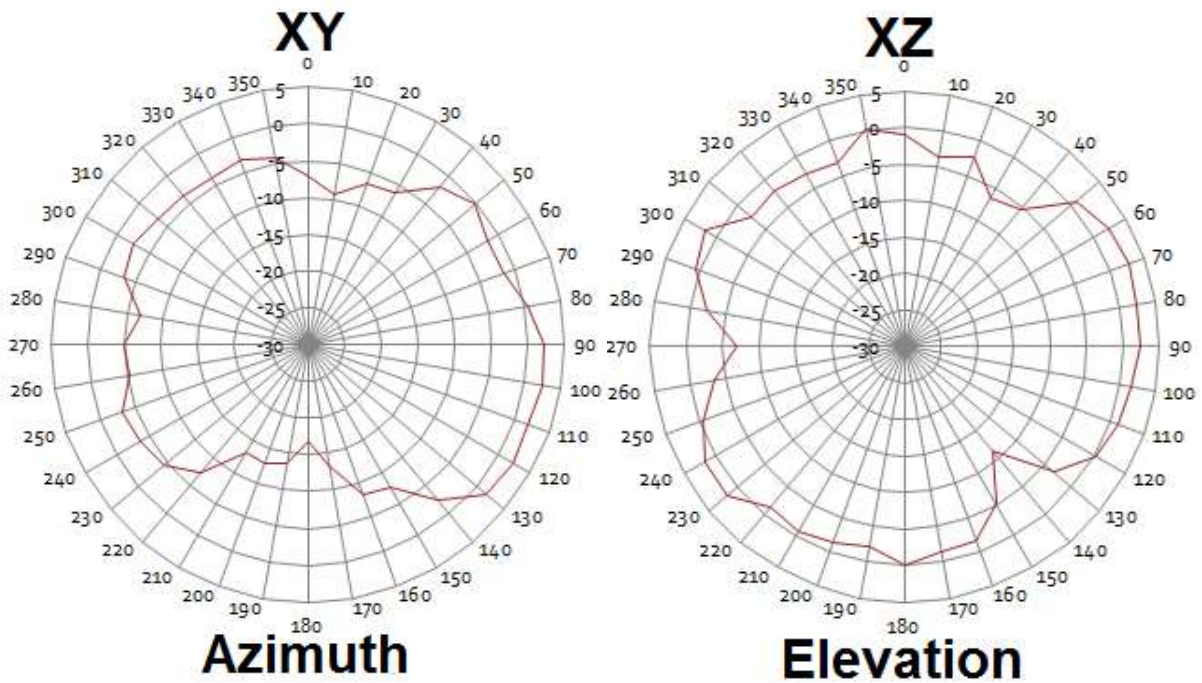

Figure 4: Model N2420DG3 Measured Radiation Patterns at 5.2 GHz

5. Dimensions

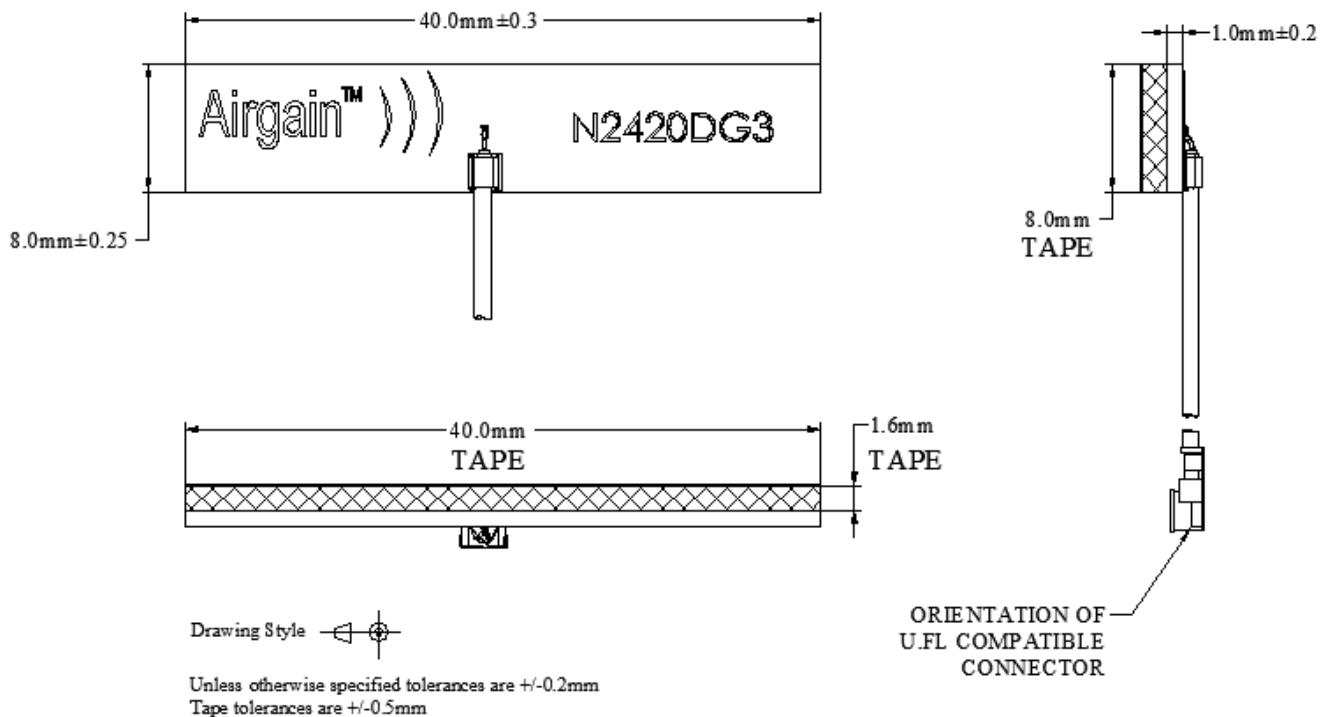

Figure 5: Model N2420DG3 Embedded Antenna Dimensions

6. ROHS

Airgain N2420DG3 embedded antennas are RoHS compliant.

7. Mounting Guidelines

The model N2420DG3 embedded antenna can be simply mounted on the interior of an ABS Plastic case using double sided adhesive tape. This can simplify the industrial design process and can also shorten the product development cycle.

The N2420DG3 is mildly loaded (detuned) if it is not properly spaced away from the ABS Plastic mounting surface. Airgain recommends mounting the N2420DG3 antenna onto a 2.2mm thick ABS Plastic case with 1.6mm double sided tape for optimum performance. Mounting the N2420DG3 to case walls of different thicknesses may be considered, but optimum separation between the N2420DG3 and the case wall would need to be determined on a case by case basis. Airgain has observed that as the case material becomes thicker, the loading effect becomes more pronounced, which is offset by a larger tape thickness.

Case Mounting the N2420DG3 using Double Sided Tape

For a case wall mount, the N2420DG3 can be mounted in an application case by using a 40mm by 8.0mm piece of double sided adhesive tape placed behind the antenna PCB, as shown in Figure 6 and Figure 9. Place the N2420DG3 on the case side wall at a height where the lowest antenna PCB edge is 5 mm above the application PCBA top plane. A space of 5mm is recommended between the PCBA edge near the N2420DG3 and the case wall mounting location. (Figure 6)

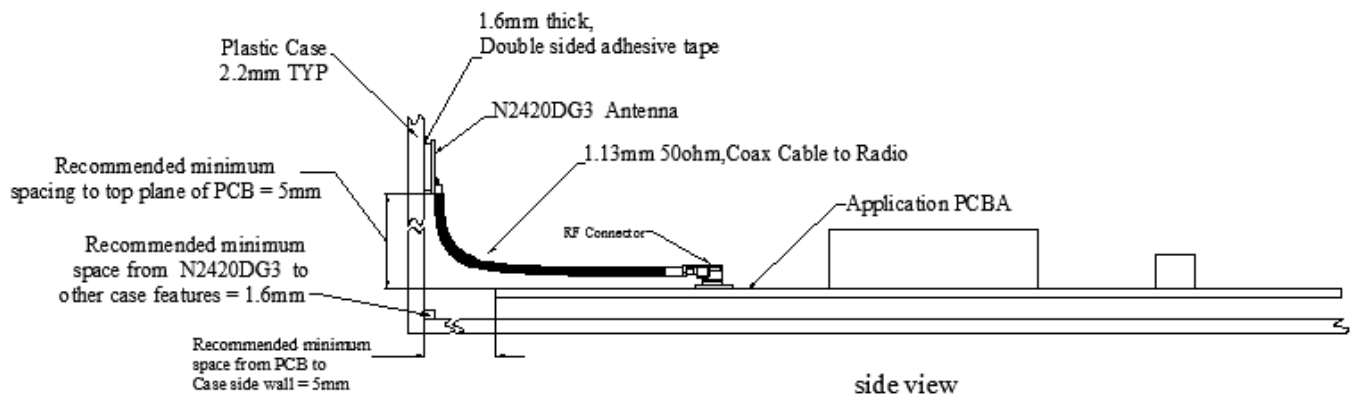

Figure 6: Side View of Case side wall mounting considerations for Model N2420DG3

For a case top location, ensure that a space of 1.6 mm minimum is maintained between any other case walls, case features, or case top, which are near the N2420DG3 antenna mounting location as shown in Figure 7 and Figure 8.

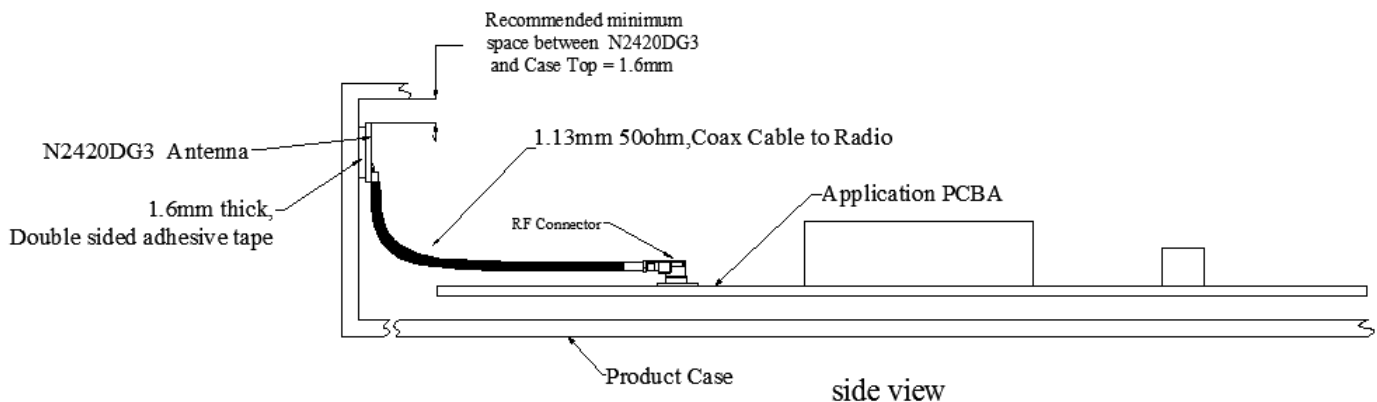

Figure 7: Case top considerations when mounting Model N2420DG3 on case side wall

In Figure 8, a tall component keepout area is defined beneath the N2420DG3 antenna. No portion of any tall components on the application PCBA should come within 5mm of the N2420DG3. This helps assure maximum antenna performance.

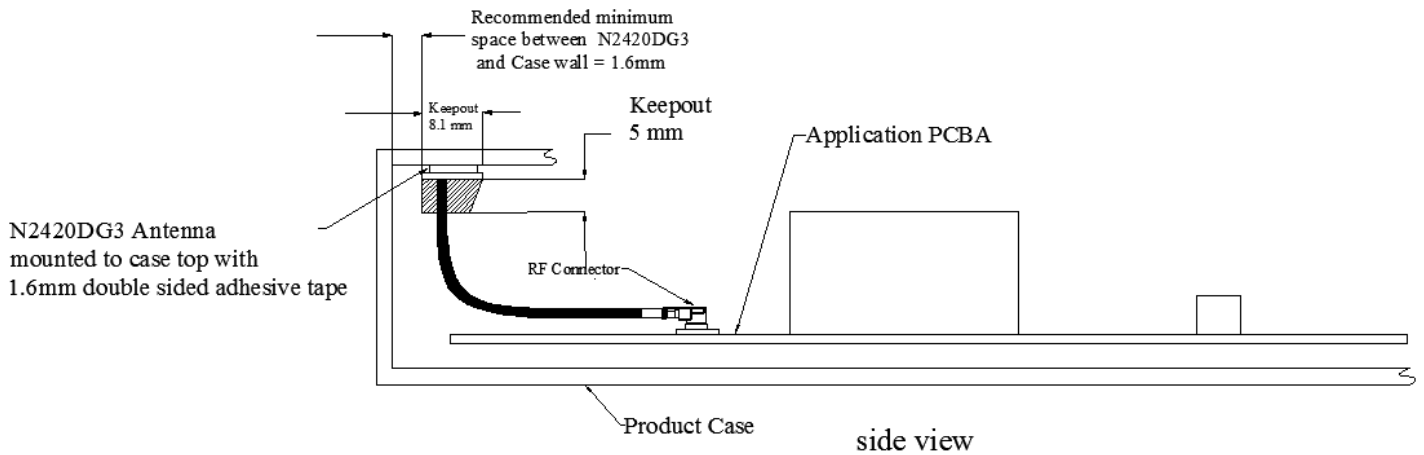

Figure 8: Side View: Clearance considerations when case top mounting Model N2420DG3

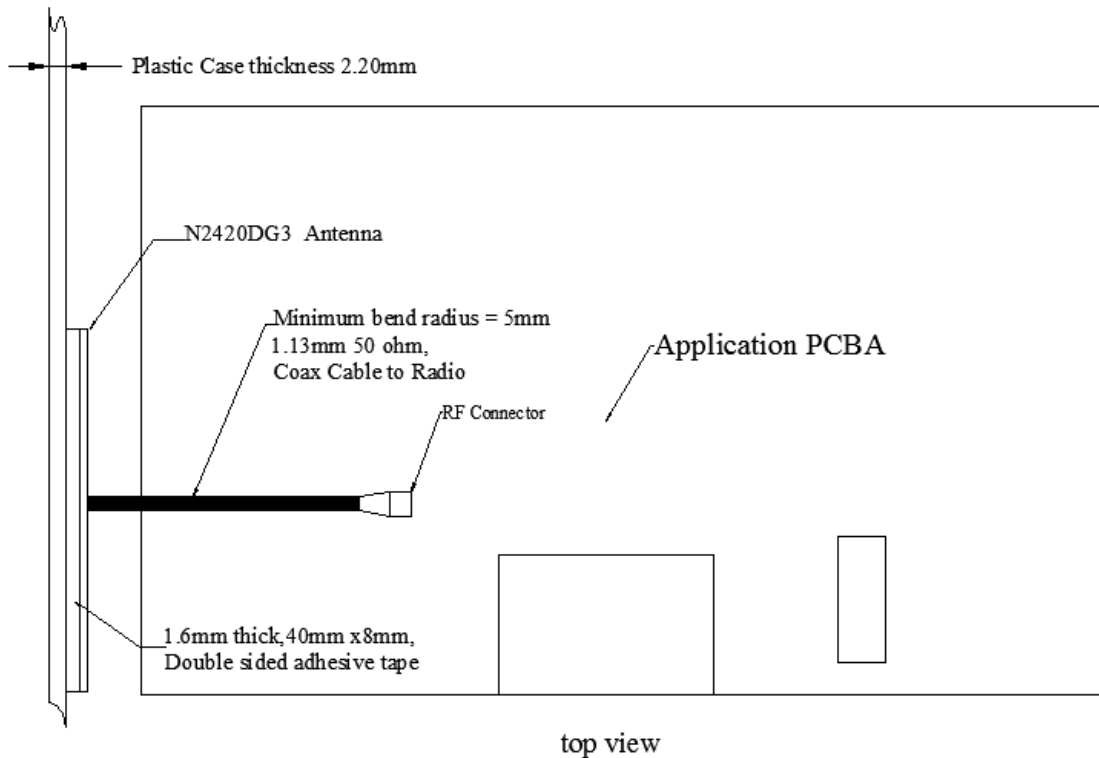

Figure 9: Top View: Case side wall mounting considerations when mounting Model N2420DG3

8. Feature and Options Information

Airgain Model N2420DG3 Series antennas are equipped with a RF cable I/O interface. Optional cable termination such as U.FL compatible micro coax connectors and cable mounted EMI ferrite cores are available. To aid mounting the N2420DG3, pre-applied double sided adhesive tape is available on the N2420DG3 –T(x) Series.

8.1 Part Number Conventions

Airgain uses a six-staged standard number system for our part numbers, which serially define the antenna type, tape type, cable type/length, and connector type/interface, as described below:

Antenna #	Tape type -XX (if required)	Packaging type -XX	Cable Assembly Type –xxxxxx		
			Cable Color –x	Cable length XXX	Connector type XX (if required)
N2420DG3	Blank = No Tape T = Tape on bottom of element T2L = 1.6mm PE Tape affixed to bottom surface of antenna with left peel flag	Blank= parts shipped in panels of 20 pieces PK1= singulated (individual) antennas	G = Grey (Standard) B = Black (Non Standard) W = White (Non Standard) A = Blue(Non Standard)	Cable length in millimeters (mm) Sample Lengths*: 65, 100, 130, 150, 190, 230, 250, 300,400	Blank = Stripped Cable U = U.FL connector C = U.FL connector plus Ferrite Core, core size: 3.5mm * 9.0mm * 1.5mm CS = stripped cable plus Ferrite Core, core size: 3.5mm * 9.0mm * 1.5mm

* Standard cable lengths listed in RF Cable Datasheet

8.2 Part Number Example

N2420DG3-T-G100U – N2420DG3 antenna with 1.6-mm double-sided adhesive tape, 100-mm cable, and U.FL-compatible connector.

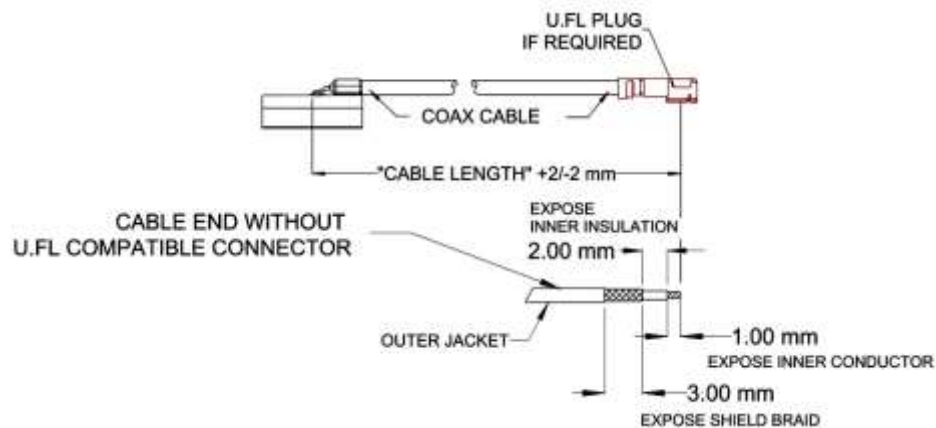
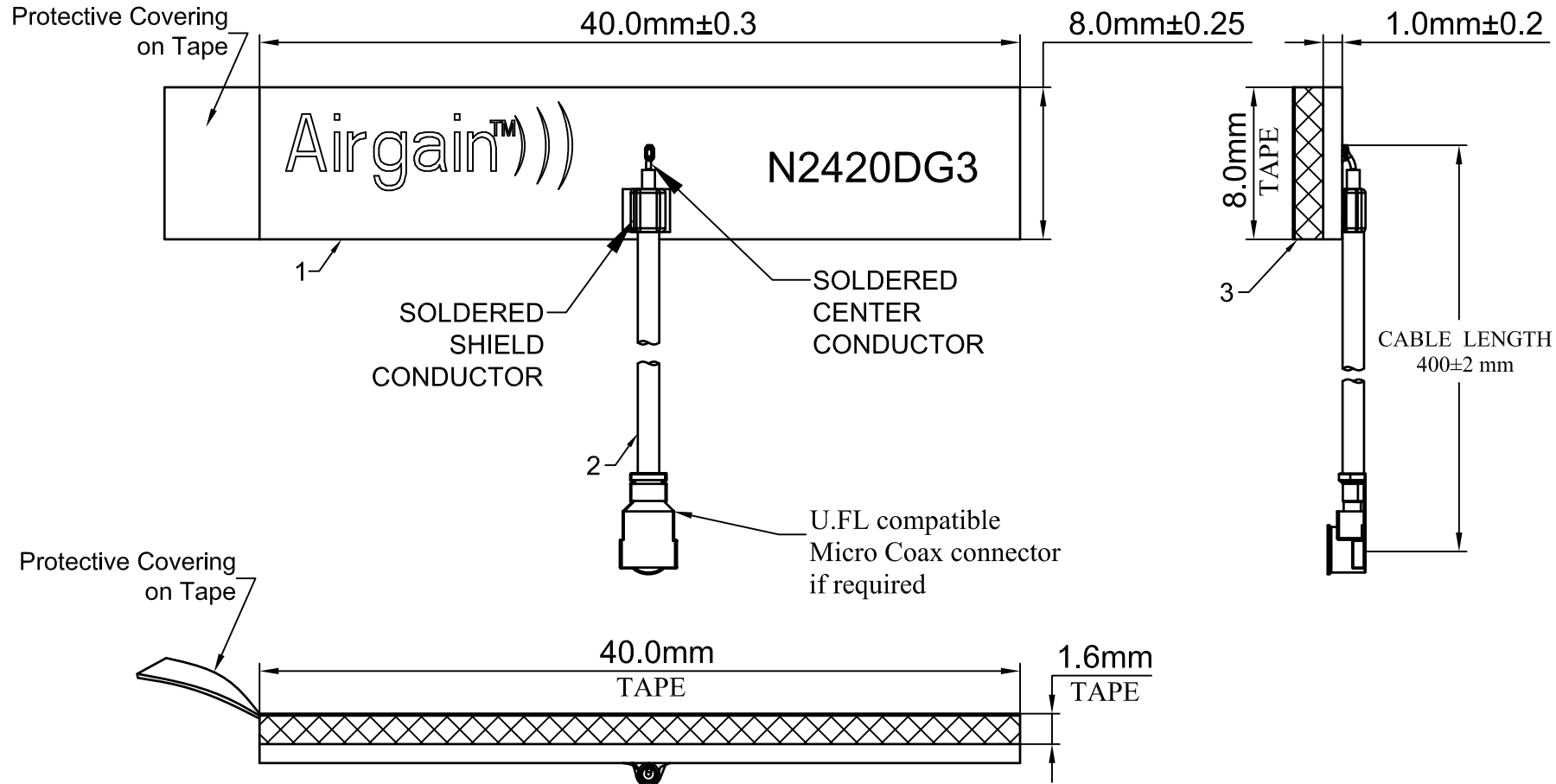

Figure 10: N2420DG3 with connector or stripped

9. Cable Data Sheet

Item	Specification	
Cable type	OD1.13	
Impedance	50 ± 3 ohms	
Inner conductor	Material	Tin-coated copper
	Conductor numbers	7
	Conductor size	0.08 mm
	Outer diameter	0.24 ± 0.02 mm
Dielectric layer	Material	FEP
	Color	Clear
	Average thickness	0.22 mm
	Diameter	0.7 ± 0.03 mm
Braid (shielding)	Material	Tin-coated copper
	Conductor size :total / O.D. of every wire(mm)	16*4/0.05 mm
	Coverage	90%± 5%
	Diameter	0.92 ± 0.05 mm
Outer cover	Material	FEP
	Color	Black / white / grey
	Average thickness	0.10 mm
	Diameter	1.13 ± 0.05 mm
VSWR testing	< 1.3@0~6GHz	
Attenuation (dB/1meter)	1GHz	≤2.2
	2GHz	≤3.1
	3GHz	≤3.8
	4GHz	≤4.4
	5GHz	≤4.9
	6GHz	≤5.4
Operating temperature	-55°C~+150°C	

REV	DESCRIPTION	BY	DATE
A	Initial Design	BWU	16/April/2018



Notes:
The processes used to assemble this antenna shall comply with the following specifications ,unless otherwise specified.

- 1.Solder:use lead free solder if applies for lead free soldering process to assemble the antenna , unless otherwise specified.
- 2.Bom:use the bom file for assembling the antenna.this table is provided for reference only.
- 3.Unless otherwise specified dimension, tolerances are +/-0.2mm
- 4.Unless otherwise specified dimension, tape tolerances are +/-0.5mm
- 5.Packaging type: break up panel packaging

ITEM#	DESIGNATOR	QUANTITY	NOTE
1	Antenna	1	
2	Coax Cable	1	Cable color is Grey
3	Tape	1	

DRAWING STYLE

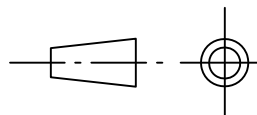

THIS DOCUMENT IS PROPRIETARY AND CONFIDENTIAL PROPERTY OF AIRGAIN INC.

BOM No. 533-06-00-001-1	3611 Valley Centre Drive, Suite 150 San Diego, CA 92130 USA		Airgain™
PCB No. 533-12-00-001-1	Project	PROFILE EMBEDDED ANTENNA	
Drawn by BWU	Date 16/April/2018	Title	N2420DG3-T2L-PK1-G400U
Checked by	Date	Size B	Number 533-14-02-015-3
Approved by	Date	Layer	Scale
		File	Sheet 1 of 1

A

B

C

D

E

F

G