



SPORTON International Inc.

No. 52, Hwa Ya 1st Rd., Kwei-Shan Hsiang, TaoYuan Hsien, Taiwan, R.O.C.
Ph: 886-3-327-3456 / FAX: 886-3-327-0973 / www.sporton.com.tw

FCC RADIO TEST REPORT

Applicant's company	Arcadyan Technology Corporation
Applicant Address	4F, No.9, Park Avenue II, Science-based Industrial Park, Hsinchu 300, Taiwan, R.O.C
FCC ID	RAX-WN8522B65M

Product Name	802.11n Dual Band WLAN Adapter
Brand Name	Arcadyan
Model Name	WN8522B 4
Test Rule Part(s)	47 CFR FCC Part 15 Subpart E § 15.407
Test Freq. Range	5150 ~ 5350MHz / 5470 ~ 5725MHz
Received Date	Feb. 25, 2010
Final Test Date	Mar. 22, 2010
Submission Type	Original Equipment
Operating Mode	Client (without radar detection function)

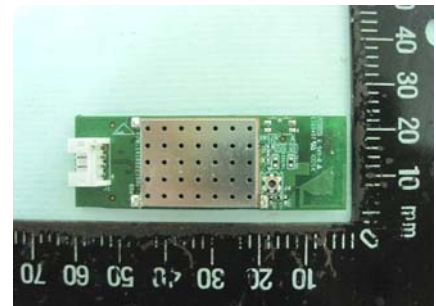

Statement

Test result included is for the IEEE 802.11n and IEEE 802.11a (5150 ~ 5350MHz / 5470 ~ 5725MHz) of the product.

The test result in this report refers exclusively to the presented test model / sample.

Without written approval of SPORTON International Inc., the test report shall not be reproduced except in full.

The measurements and test results shown in this test report were made in accordance with the procedures and found in compliance with the limit given in ANSI C63.4-2003 and 47 CFR FCC Part 15 Subpart E.

The test equipment used to perform the test is calibrated and traceable to NML/ROC.



Table of Contents

1. CERTIFICATE OF COMPLIANCE	1
2. SUMMARY OF THE TEST RESULT	2
3. GENERAL INFORMATION	3
3.1. Product Details.....	3
3.2. Accessories.....	5
3.3. Table for Filed Antenna.....	5
3.4. Table for Carrier Frequencies	6
3.5. Table for Test Modes	7
3.6. Table for Testing Locations.....	8
3.7. Table for Supporting Units	8
3.8. Table for Parameters of Test Software Setting	8
3.9. Test Configurations	9
4. TEST RESULT	11
4.1. AC Power Line Conducted Emissions Measurement.....	11
4.2. 99% Occupied Bandwidth Measurement	15
4.3. Maximum Conducted Output Power Measurement.....	21
4.4. Power Spectral Density Measurement	31
4.5. Peak Excursion Measurement.....	37
4.6. Radiated Emissions Measurement	43
4.7. Band Edge Emissions Measurement	74
4.8. Frequency Stability Measurement	85
4.9. Antenna Requirements	87
5. LIST OF MEASURING EQUIPMENTS	88
6. TEST LOCATION.....	89
7. TAF CERTIFICATE OF ACCREDITATION	90
APPENDIX A. PHOTOGRAPHS OF EUT.....	A1 ~ A3
APPENDIX B. TEST PHOTOS.....	B1 ~ B7
APPENDIX C. MAXIMUM PERMISSIBLE EXPOSURE.....	C1 ~ C3



History of This Test Report

Original Issue Date: Mar. 23, 2010

Report No.: FR022550-01AA

- No additional attachment.
- Additional attachment were issued as following record:

Attachment No.	Issue Date	Description



1. CERTIFICATE OF COMPLIANCE

Product Name : 802.11n Dual Band WLAN Adapter
Brand Name : Arcadyan
Model Name : WN8522B 4
Applicant : Arcadyan Technology Corporation
Test Rule Part(s) : 47 CFR FCC Part 15 Subpart E § 15.407

Sporton International as requested by the applicant to evaluate the EMC performance of the product sample received on Feb. 25, 2010 would like to declare that the tested sample has been evaluated and found to be in compliance with the tested rule parts. The data recorded as well as the test configuration specified is true and accurate for showing the sample's EMC nature.

Jordan Hsiao 2010.3.24

Jordan Hsiao

SPORTON INTERNATIONAL INC.

2. SUMMARY OF THE TEST RESULT

Applied Standard: 47 CFR FCC Part 15 Subpart E				
Part	Rule Section	Description of Test	Result	Under Limit
4.1	15.207	AC Power Line Conducted Emissions	Complies	11.37 dB
4.2	15.407(a)	26dB Spectrum Bandwidth	Complies	-
4.3	15.407(a)	Maximum Conducted Output Power	Complies	0.22 dB
4.4	15.407(a)	Power Spectral Density	Complies	3.23 dB
4.5	15.407(a)	Peak Excursion	Complies	6.48 dB
4.6	15.407(b)	Radiated Emissions	Complies	4.31 dB
4.7	15.407(b)	Band Edge Emissions	Complies	0.05 dB
4.8	15.407(g)	Frequency Stability	Complies	-
4.9	15.203	Antenna Requirements	Complies	-

Test Items	Uncertainty	Remark
AC Power Line Conducted Emissions	±2.3dB	Confidence levels of 95%
Maximum Conducted Output Power	±0.5dB	Confidence levels of 95%
Power Spectral Density	±0.5dB	Confidence levels of 95%
Peak Excursion	±0.5dB	Confidence levels of 95%
26dB Spectrum Bandwidth / Frequency Stability	±8.5×10 ⁻⁸	Confidence levels of 95%
Radiated Emissions (9kHz~30MHz)	±0.8dB	Confidence levels of 95%
Radiated Emissions (30MHz~1000MHz)	±1.9dB	Confidence levels of 95%
Radiated / Band Edge Emissions (1GHz~18GHz)	±1.9dB	Confidence levels of 95%
Radiated Emissions (18GHz~40GHz)	±1.9dB	Confidence levels of 95%
Temperature	±0.7°C	Confidence levels of 95%
Humidity	±3.2%	Confidence levels of 95%
DC / AC Power Source	±1.4%	Confidence levels of 95%

3. GENERAL INFORMATION

3.1. Product Details

IEEE 802.11n

Items	Description
Product Type	WLAN (2TX, 2RX)
Radio Type	Intentional Transceiver
Power Type	From Host System
Modulation	see the below table for IEEE 802.11n
Data Modulation	OFDM (BPSK / QPSK / 16QAM / 64QAM)
Data Rate (Mbps)	see the below table for IEEE 802.11n
Frequency Range	5150 ~ 5350MHz / 5470 ~ 5725MHz
Channel Number	19 for 20MHz bandwidth ; 9 for 40MHz bandwidth
Channel Band Width (99%)	MCS0 (20MHz): 17.60 MHz ; MCS0 (40MHz): 36.48 MHz
Conducted Output Power	Band 1: MCS0 (20MHz): 16.65 dBm ; MCS0 (40MHz): 16.78 dBm Band 2: MCS0 (20MHz): 16.10 dBm ; MCS0 (40MHz): 16.04 dBm Band 3: MCS0 (20MHz): 15.06 dBm ; MCS0 (40MHz): 14.85 dBm
Carrier Frequencies	Please refer to section 3.4
Antenna	Please refer to section 3.3

IEEE 802.11a

Items	Description
Product Type	WLAN (1TX, 1RX)
Radio Type	Intentional Transceiver
Power Type	From Host System
Modulation	OFDM for IEEE 802.11a
Data Modulation	OFDM (BPSK / QPSK / 16QAM / 64QAM)
Data Rate (Mbps)	OFDM (6/9/12/18/24/36/48/54)
Frequency Range	5150 ~ 5350MHz / 5470 ~ 5725MHz
Channel Number	11a: 19
Channel Band Width (99%)	11a: 17.44 MHz
Conducted Output Power	Band 1: 16.52 dBm ; Band 2: 16.84 dBm ; Band 3: 15.22 dBm
Carrier Frequencies	Please refer to section 3.4
Antenna	Please refer to section 3.3

Antenna & Band width

Antenna	Single (TX)		Two (TX)	
	20 MHz	40 MHz	20 MHz	40 MHz
IEEE 802.11a	V	X	X	X
IEEE 802.11n	X	X	V	V

IEEE 802.11n spec

MCS Index	Nss	Modulation	R	NBPS	NCBPS		NDBPS		Datarate(Mbps)			
					20MHz	40MHz	20MHz	40MHz	800nsGI		400nsGI	
									20MHz	40MHz	20MHz	40MHz
0	1	BPSK	1/2	1	52	108	26	54	6.5	13.5	7.200	15
1	1	QPSK	1/2	2	104	216	52	108	13.0	27.0	14.400	30
2	1	QPSK	3/4	2	104	216	78	162	19.5	40.5	21.700	45
3	1	16-QAM	1/2	4	208	432	104	216	26.0	54.0	28.900	60
4	1	16-QAM	3/4	4	208	432	156	324	39.0	81.0	43.300	90
5	1	64-QAM	2/3	6	312	648	208	432	52.0	108.0	57.800	120
6	1	64-QAM	3/4	6	312	648	234	486	58.5	121.5	65.000	135
7	1	64-QAM	5/6	6	312	648	260	540	65.0	135.0	72.200	150
8	2	BPSK	1/2	1	104	216	52	108	13.0	27.0	14.444	30
9	2	QPSK	1/2	2	208	432	104	216	26.0	54.0	28.889	60
10	2	QPSK	3/4	2	208	432	156	324	39.0	81.0	43.333	90
11	2	16-QAM	1/2	4	416	864	208	432	52.0	108.0	57.778	120
12	2	16-QAM	3/4	4	416	864	312	648	78.0	162.0	86.667	180
13	2	64-QAM	2/3	6	624	1296	416	864	104.0	216.0	115.556	240
14	2	64-QAM	3/4	6	624	1296	468	972	117.0	243.0	130.000	270
15	2	64-QAM	5/6	6	624	1296	520	1080	130.0	270.0	144.444	300

Symbol	Explanation
NSS	Number of spatial streams
R	Code rate
NBPS	Number of coded bits per single carrier
NCBPS	Number of coded bits per symbol
NDBPS	Number of data bits per symbol
GI	guard interval

3.2. Accessories

N/A

3.3. Table for Filed Antenna

Ant.	Brand	Model Name	Antenna Type	Connector	Gain (dBi)	Remark
1	-	-	PCB Antenna	N/A	3	TX/RX
2	-	-	PCB Antenna	N/A	3	TX/RX

Note: The EUT has two antennas.

For IEEE 802.11a/b/g Mode:

Ant. 1 can be used as transmitting/receiving antenna.

Ant. 2 can be used as receiving antenna.

For IEEE 802.11n Mode:

Ant. 1 & Ant. 2 could transmit/receive simultaneously.

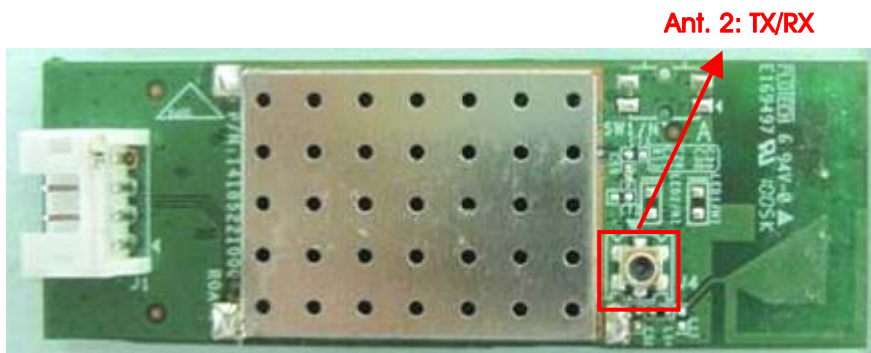
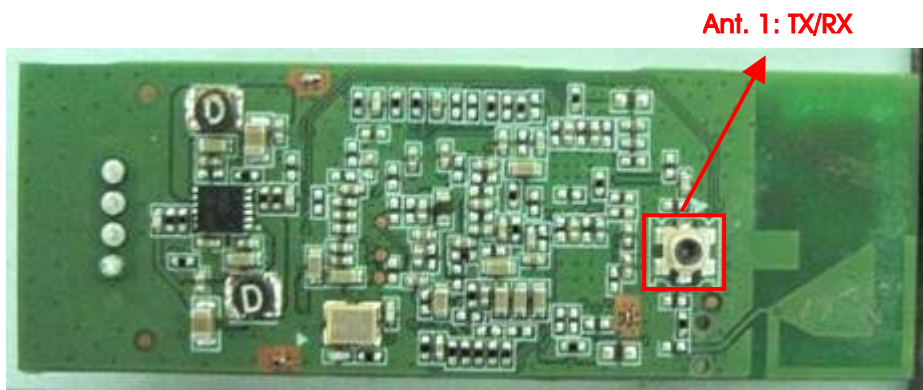

3.4. Table for Carrier Frequencies

There are two bandwidth systems for IEEE 802.11n.

For both 20MHz bandwidth systems, use Channel 36, 40, 44, 48, 52, 56, 60, 64, 100, 104, 108, 112, 116, 120, 124, 128, 132, 136, 140.

For both 40MHz bandwidth systems, use Channel 38, 46, 54, 62, 102, 110, 118, 126, 134.

Frequency Band	Channel No.	Frequency	Channel No.	Frequency
5150~5250 MHz Band 1	36	5180 MHz	44	5220 MHz
	38	5190 MHz	46	5230 MHz
	40	5200 MHz	48	5240 MHz
5250~5350 MHz Band 2	52	5260 MHz	60	5300 MHz
	54	5270 MHz	62	5310 MHz
	56	5280 MHz	64	5320 MHz
5470~5725 MHz Band 3	100	5500 MHz	120	5600 MHz
	102	5510MHz	124	5620 MHz
	104	5520 MHz	126	5630 MHz
	108	5540 MHz	128	5640 MHz
	110	5550 MHz	132	5660 MHz
	112	5560 MHz	134	5670 MHz
	116	5580 MHz	136	5680 MHz
	118	5590 MHz	140	5700 MHz

3.5. Table for Test Modes

Preliminary tests were performed in different data rate to find the worst radiated emission. The data rate shown in the table below is the worst-case rate with respect to the specific test item. Investigation has been done on all the possible configurations for searching the worst cases. The following table is a list of the test modes shown in this test report.

Test Items	Mode	Data Rate	Channel	Antenna	
AC Power Conducted Emission	Normal Link	Auto	-	-	
Max. Conducted Output Power	MCS0/20MHz	Band 1~2	6.5Mbps	36/40/48/52/60/64	1/2/1+2
		Band 3	6.5Mbps	100/116/140	1/2/1+2
	MCS0/40MHz	Band 1~2	13.5Mbps	38/46/54/62	1/2/1+2
		Band 3	13.5Mbps	102/110/134	1/2/1+2
	11a/BPSK	Band 1~2	6Mbps	36/40/48/52/60/64	1
		Band 3	6Mbps	100/116/140	1
26dB Spectrum Bandwidth 99% Occupied Bandwidth Measurement Power Spectral Density Peak Excursion	MCS0/20MHz	Band 1~2	6.5Mbps	36/40/48/52/60/64	1+2
		Band 3	6.5Mbps	100/116/140	1+2
	MCS0/40MHz	Band 1~2	13.5Mbps	38/46/54/62	1+2
		Band 3	13.5Mbps	102/110/134	1+2
	11a/BPSK	Band 1~2	6Mbps	36/40/48/52/60/64	1
		Band 3	6Mbps	100/116/140	1
Radiated Emission Below 1GHz	Normal Link	Auto	-	-	
Radiated Emission Above 1GHz	MCS0/20MHz	Band 1~2	6.5Mbps	36/40/48/52/60/64	1+2
		Band 3	6.5Mbps	100/116/140	1+2
	MCS0/40MHz	Band 1~2	13.5Mbps	38/46/54/62	1+2
		Band 3	13.5Mbps	102/110/134	1+2
	11a/BPSK	Band 1~2	6Mbps	36/40/48/52/60/64	1
		Band 3	6Mbps	100/116/140	1
Band Edge Emission	MCS0/20MHz	Band 1~2	6.5Mbps	36/40/48/52/60/64	1+2
		Band 3	6.5Mbps	100/116/140	1+2
	MCS0/40MHz	Band 1~2	13.5Mbps	38/46/54/62	1+2
		Band 3	13.5Mbps	102/110/134	1+2
	11a/BPSK	Band 1~2	6Mbps	36/40/48/52/60/64	1
		Band 3	6Mbps	100/116/140	1
Frequency Stability	Un-modulation	-	40/60	N/A	

3.6. Table for Testing Locations

Test Site No.	Site Category	Location	FCC Reg. No.	IC File No.	VCCI Reg. No
03CH03-HY	SAC	Hwa Ya	480872	IC 4086	-
CO04-HY	Conduction	Hwa Ya	480872	IC 4086	-
TH01-HY	OVEN Room	Hwa Ya	-	-	-

Open Area Test Site (OATS); Semi Anechoic Chamber (SAC); Fully Anechoic Chamber (FAC).

Please refer section 6 for Test Site Address.

3.7. Table for Supporting Units

Support Unit	Brand	Model	FCC ID
Notebook	DELL	PP25L	E2K4965AGNM
Mouse	iCooky	AMS0706W	DoC
Wireless AP	Planex	GW-AP54SGX	N/A

3.8. Table for Parameters of Test Software Setting

During testing, Channel & Power Controlling Software provided by the customer was used to control the operating channel as well as the output power level. The RF output power selection is for the setting of RF output power expected by the customer and is going to be fixed on the firmware of the final end product.

Power Parameters of IEEE 802.11n MCS0 20MHz

Test Software Version	DOS								
Frequency	5180 MHz	5200 MHz	5240 MHz	5260 MHz	5300 MHz	5320 MHz	5500 MHz	5580 MHz	5700 MHz
MCS0 20MHz	56	56	56	56	56	56	56	56	56

Power Parameters of IEEE 802.11n MCS0 40MHz

Test Software Version	DOS						
Frequency	5190 MHz	5230 MHz	5270 MHz	5310 MHz	5510 MHz	5550 MHz	5670 MHz
MCS0 40MHz	58	58	58	58	58	58	58

Power Parameters of IEEE 802.11a

Test Software Version	DOS								
Frequency	5180 MHz	5200 MHz	5240 MHz	5260 MHz	5300 MHz	5320 MHz	5500 MHz	5580 MHz	5700 MHz
IEEE 802.11a	68	68	68	68	68	68	68	68	68

During the test, "DOS" under WIN XP was executed to control the EUT continuously transmit RF signal.

3.9. Test Configurations

3.9.1. Radiation Emissions Test Configuration

Test Configuration: 9KHz~1GHz

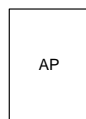
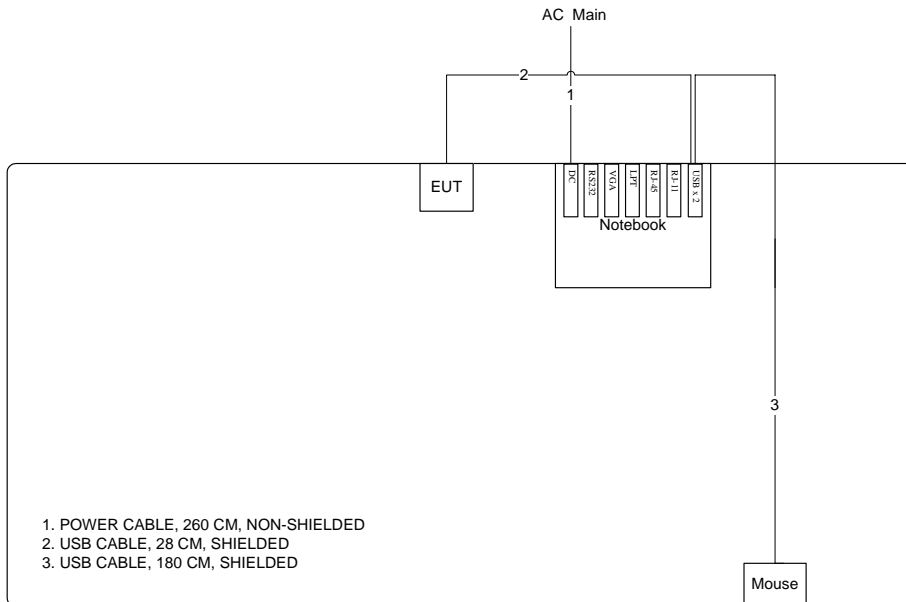

Test Configuration: above 1GHz

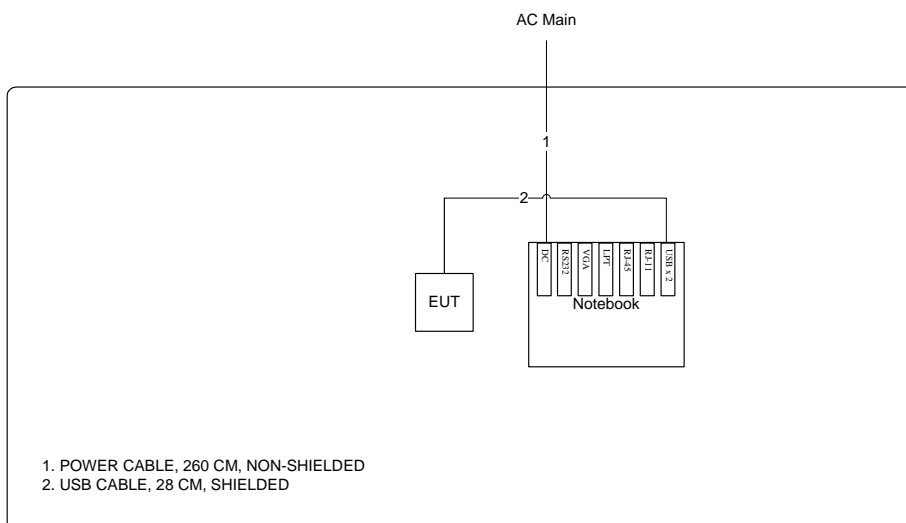

3.9.2. AC Power Line Conduction Emissions Test Configuration

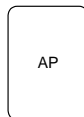
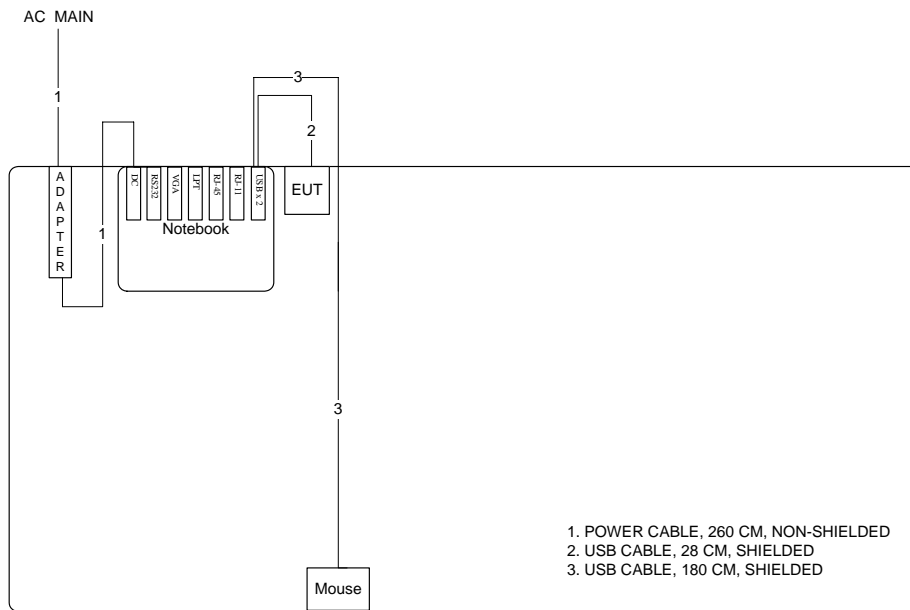

4. TEST RESULT

4.1. AC Power Line Conducted Emissions Measurement

4.1.1. Limit

For this product that is designed to connect to the AC power line, the radio frequency voltage that is conducted back onto the AC power line on any frequency or frequencies within the band 150 kHz to 30 MHz shall not exceed below limits table.

Frequency (MHz)	QP Limit (dBuV)	AV Limit (dBuV)
0.15~0.5	66~56	56~46
0.5~5	56	46
5~30	60	50

4.1.2. Measuring Instruments and Setting

Please refer to section 5 of equipments list in this report. The following table is the setting of the receiver.

Receiver Parameters	Setting
Attenuation	10 dB
Start Frequency	0.15 MHz
Stop Frequency	30 MHz
IF Bandwidth	9 KHz

4.1.3. Test Procedures

1. Configure the EUT according to ANSI C63.4. The EUT or host of EUT has to be placed 0.4 meter far from the conducting wall of the shielding room and at least 80 centimeters from any other grounded conducting surface.
2. Connect EUT or host of EUT to the power mains through a line impedance stabilization network (LISN).
3. All the support units are connected to the other LISNs. The LISN should provide 50uH/50ohms coupling impedance.
4. The frequency range from 150 KHz to 30 MHz was searched.
5. Set the test-receiver system to Peak Detect Function and Specified Bandwidth with Maximum Hold Mode.
6. The measurement has to be done between each power line and ground at the power terminal.

4.1.4. Test Setup Layout

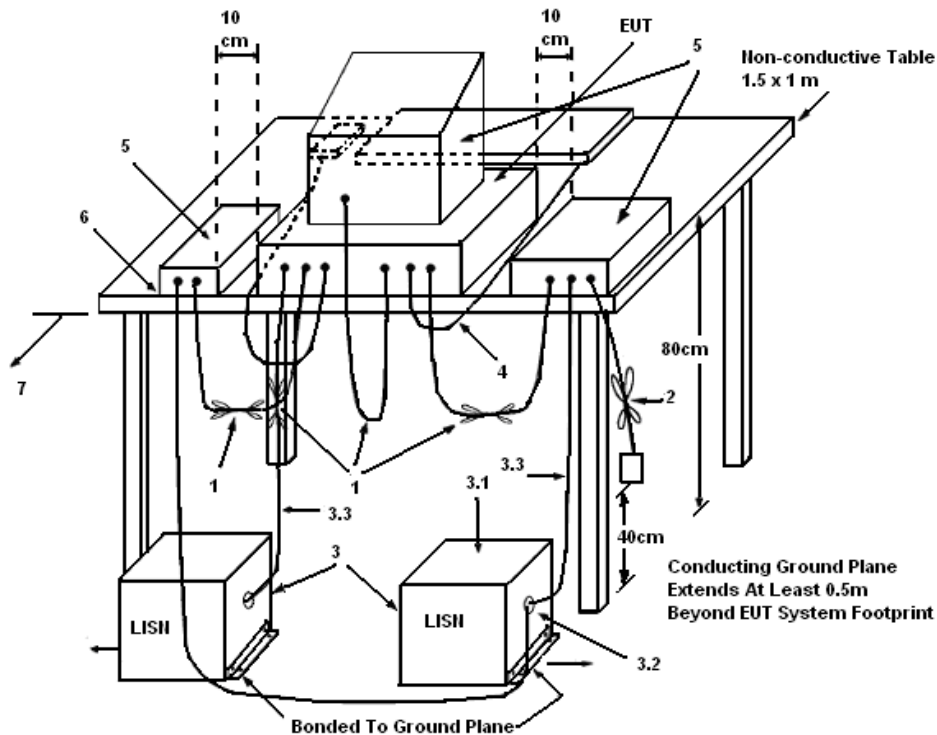

LEGEND:

- (1) Interconnecting cables that hang closer than 40 cm to the ground plane shall be folded back and forth in the center forming a bundle 30 to 40 cm long.
- (2) I/O cables that are not connected to a peripheral shall be bundled in the center. The end of the cable may be terminated, if required, using the correct terminating impedance. The overall length shall not exceed 1 m.
- (3) EUT connected to one LISN. Unused LISN measuring port connectors shall be terminated in 50 Ω . LISN can be placed on top of, or immediately beneath, reference ground plane.
 - (3.1) All other equipment powered from additional LISN(s).
 - (3.2) Multiple outlet strip can be used for multiple power cords of non-EUT equipment.
 - (3.3) LISN at least 80 cm from nearest part of EUT chassis.
- (4) Cables of hand-operated devices, such as keyboards, mice, etc., shall be placed as for normal use.
- (5) Non-EUT components of EUT system being tested.
- (6) Rear of EUT, including peripherals, shall all be aligned and flush with rear of tabletop.
- (7) Rear of tabletop shall be 40 cm removed from a vertical conducting plane that is bonded to the ground plane.

4.1.5. Test Deviation

There is no deviation with the original standard.

4.1.6. EUT Operation during Test

The EUT was placed on the test table and programmed in normal function.

4.1.7. Results of AC Power Line Conducted Emissions Measurement

Temperature	24°C	Humidity	54%
Test Engineer	Aric Li	Phase	Line
Configuration	Normal Link		

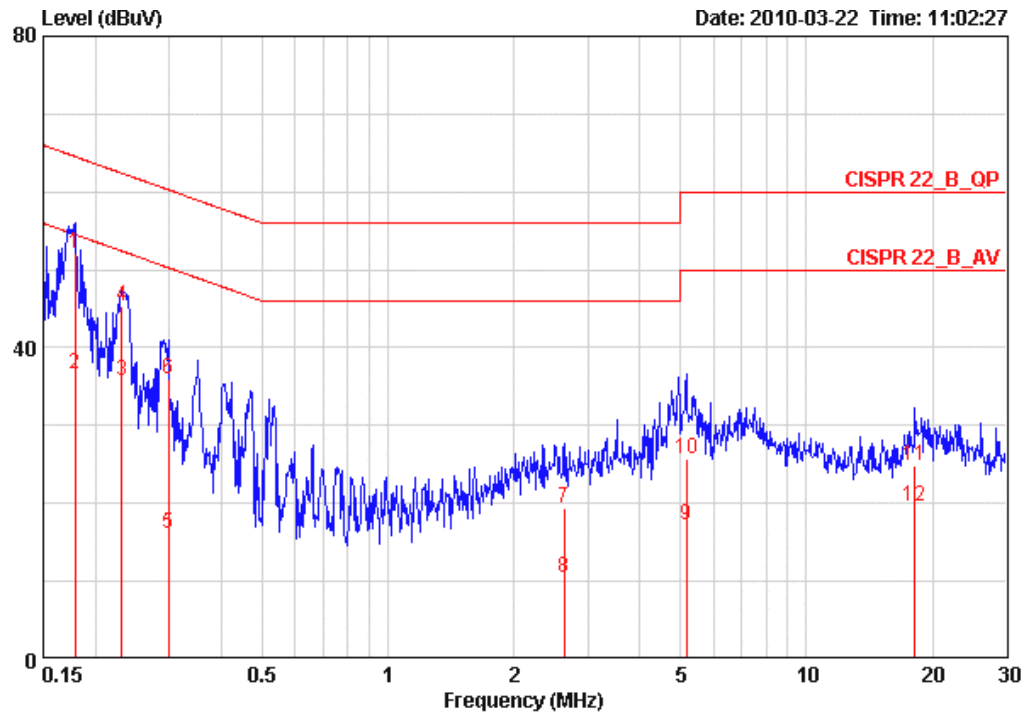

	Freq	Level	Over Limit	Limit Line	Read Level	LISN Factor	Cable Loss	Remark
	MHz	dBuV	dB	dBuV	dBuV	dB	dB	
1	0.17866	52.00	-12.55	64.55	51.74	0.06	0.20	QP
2	0.17866	36.62	-17.93	54.55	36.36	0.06	0.20	AVERAGE
3	0.23162	35.73	-16.67	52.39	35.48	0.05	0.20	AVERAGE
4	0.23162	45.33	-17.07	62.39	45.08	0.05	0.20	QP
5	0.29869	16.17	-34.11	50.28	15.93	0.04	0.20	AVERAGE
6	0.29869	35.94	-24.34	60.28	35.70	0.04	0.20	QP
7	2.636	19.34	-36.66	56.00	19.07	0.07	0.20	QP
8	2.636	10.44	-35.56	46.00	10.17	0.07	0.20	AVERAGE
9	5.166	17.26	-32.74	50.00	16.79	0.17	0.30	AVERAGE
10	5.166	25.67	-34.33	60.00	25.20	0.17	0.30	QP
11	18.135	24.95	-35.05	60.00	23.72	0.73	0.50	QP
12	18.135	19.71	-30.29	50.00	18.48	0.73	0.50	AVERAGE

Temperature	24°C	Humidity	54%
Test Engineer	Aric Li	Phase	Neutral
Configuration	Normal Link		

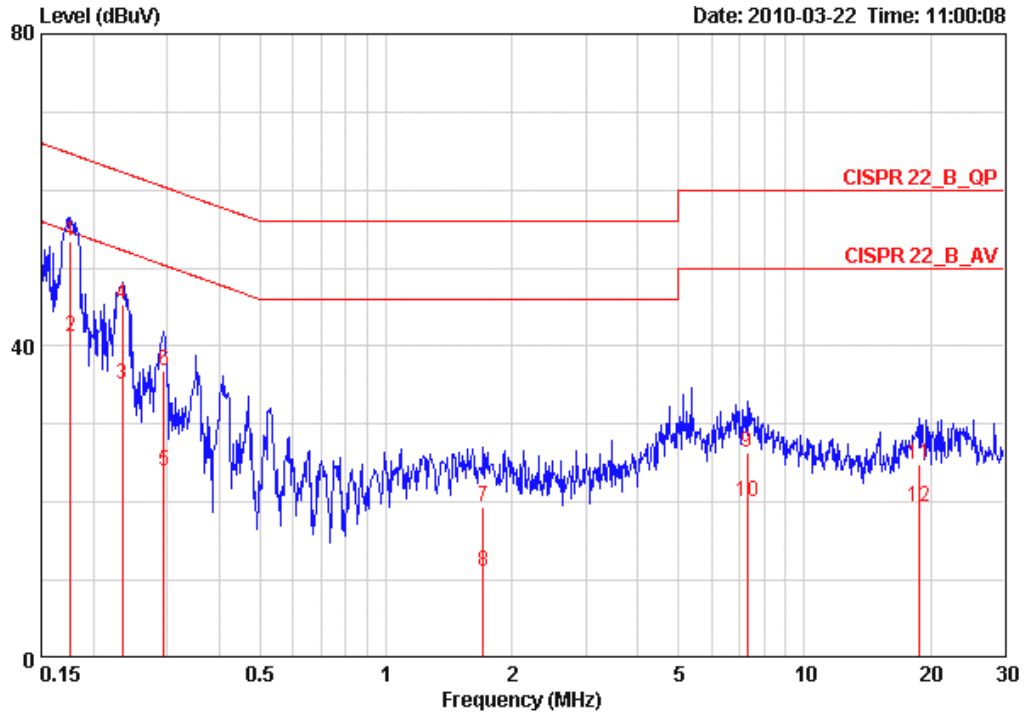

	Freq	Level	Over Limit	Limit Line	Read Level	LISN Factor	Cable Loss	Remark
	MHz	dBuV	dB	dBuV	dBuV	dB	dB	
1	0.17584	53.31	-11.37	64.68	53.02	0.09	0.20	QP
2	0.17584	41.19	-13.49	54.68	40.90	0.09	0.20	AVERAGE
3	0.23409	35.12	-17.19	52.30	34.84	0.08	0.20	AVERAGE
4	0.23409	45.32	-16.99	62.30	45.04	0.08	0.20	QP
5	0.29398	24.04	-26.37	50.41	23.77	0.07	0.20	AVERAGE
6	0.29398	36.75	-23.66	60.41	36.48	0.07	0.20	QP
7	1.707	19.30	-36.70	56.00	19.07	0.09	0.14	QP
8	1.707	11.07	-34.93	46.00	10.84	0.09	0.14	AVERAGE
9	7.290	26.31	-33.69	60.00	25.65	0.30	0.36	QP
10	7.290	20.07	-29.93	50.00	19.41	0.30	0.36	AVERAGE
11	18.820	24.81	-35.19	60.00	23.55	0.76	0.50	QP
12	18.820	19.34	-30.66	50.00	18.08	0.76	0.50	AVERAGE

Note: Level = Read Level + LISN Factor + Cable Loss.

4.2. 99% Occupied Bandwidth Measurement

4.2.1. Limit

No restriction limits. But resolution bandwidth within band edge measurement is 1% of the 99% occupied bandwidth.

4.2.2. Measuring Instruments and Setting

Please refer to section 5 of equipments list in this report. The following table is the setting of the spectrum analyzer.

Spectrum Parameters	Setting
Attenuation	Auto
Span Frequency	> 26dB Bandwidth
RB	300 kHz
VB	1000 kHz
Detector	Peak
Trace	Max Hold
Sweep Time	Auto

4.2.3. Test Procedures

1. The transmitter output (antenna port) was connected to the spectrum analyzer in peak hold mode.
2. The resolution bandwidth of 300 kHz and the video bandwidth of 1000 kHz were used.
3. Measured the spectrum width with power higher than 26dB below carrier.
4. Measuring multiple antennas, the connector is required to link with spectrum analyzer through a combiner.

4.2.4. Test Setup Layout

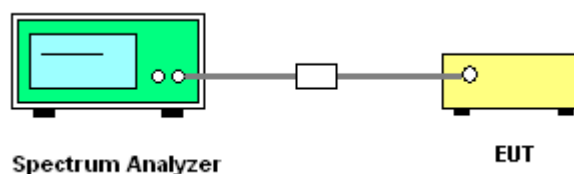

4.2.5. Test Deviation

There is no deviation with the original standard.

4.2.6. EUT Operation during Test

The EUT was programmed to be in continuously transmitting mode.

4.2.7. Test Result of 99% Occupied Bandwidth

Temperature	18°C	Humidity	60%
Test Engineer	Johnson Chang	Configurations	IEEE 802.11n

Configuration IEEE 802.11n MCS0 20MHz Ant. 1 + Ant. 2

Channel	Frequency	26dB Bandwidth (MHz)	99% Occupied Bandwidth (MHz)
36	5180 MHz	23.04	17.44
40	5200 MHz	24.96	17.44
48	5240 MHz	25.28	17.44
52	5260 MHz	25.12	17.60
60	5300 MHz	25.44	17.60
64	5320 MHz	24.96	17.44
100	5500 MHz	25.28	17.60
116	5580 MHz	25.12	17.60
140	5700 MHz	25.76	17.60

Configuration IEEE 802.11n MCS0 40MHz Ant. 1 + Ant. 2

Channel	Frequency	26dB Bandwidth (MHz)	99% Occupied Bandwidth (MHz)
38	5190 MHz	39.20	36.48
46	5230 MHz	45.28	36.48
54	5270 MHz	45.12	36.48
62	5310 MHz	45.12	36.48
102	5510MHz	39.68	36.48
110	5550 MHz	45.28	36.48
134	5670 MHz	45.28	36.48

Temperature	18°C	Humidity	60%
Test Engineer	Johnson Chang	Configurations	IEEE 802.11a

Configuration IEEE 802.11a Ant. 1 + Ant. 2

Channel	Frequency	26dB Bandwidth (MHz)	99% Occupied Bandwidth (MHz)
36	5180 MHz	26.88	17.28
40	5200 MHz	26.24	17.44
48	5240 MHz	26.08	17.28
52	5260 MHz	27.04	17.44
60	5300 MHz	26.56	17.28
64	5320 MHz	26.72	17.28
100	5500 MHz	23.36	17.28
116	5580 MHz	25.12	17.28
140	5700 MHz	26.08	17.28

Note: All the test values were listed in the report.

For plots, only the worse case of OFDM modulation was listed in the report.

26 dB Bandwidth Plot on Configuration IEEE 802.11n MCS0 20MHz Ant. 1 + Ant. 2 / 5180 MHz

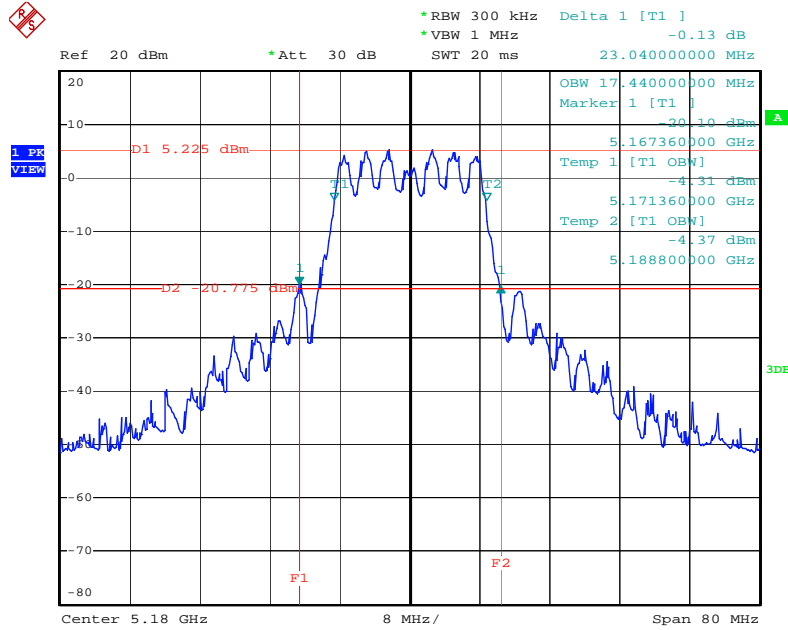

Date: 16.MAR.2010 17:16:49

26 dB Bandwidth Plot on Configuration IEEE 802.11n MCS0 20MHz Ant. 1 + Ant. 2 / 5200 MHz

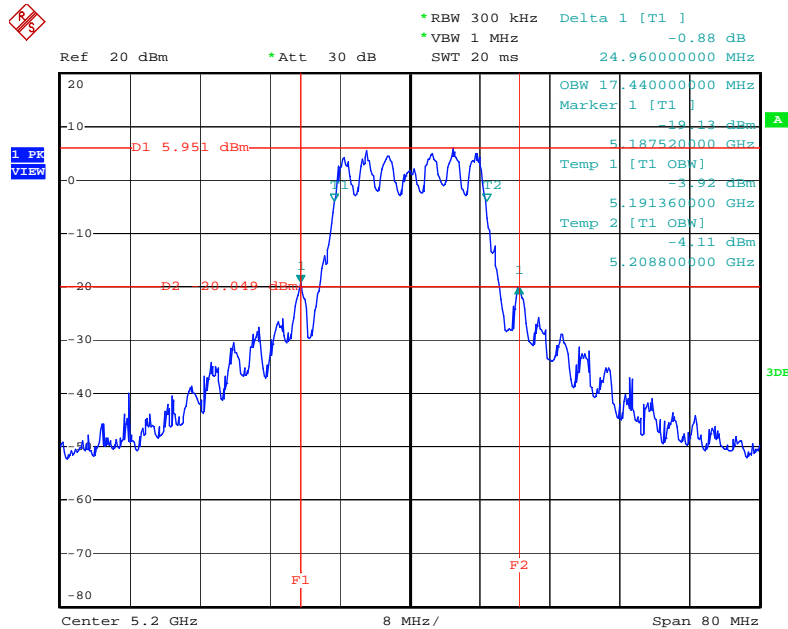

Date: 16.MAR.2010 17:18:34

26 dB Bandwidth Plot on Configuration IEEE 802.11n MCS0 20MHz Ant. 1 + Ant. 2 / 5240 MHz

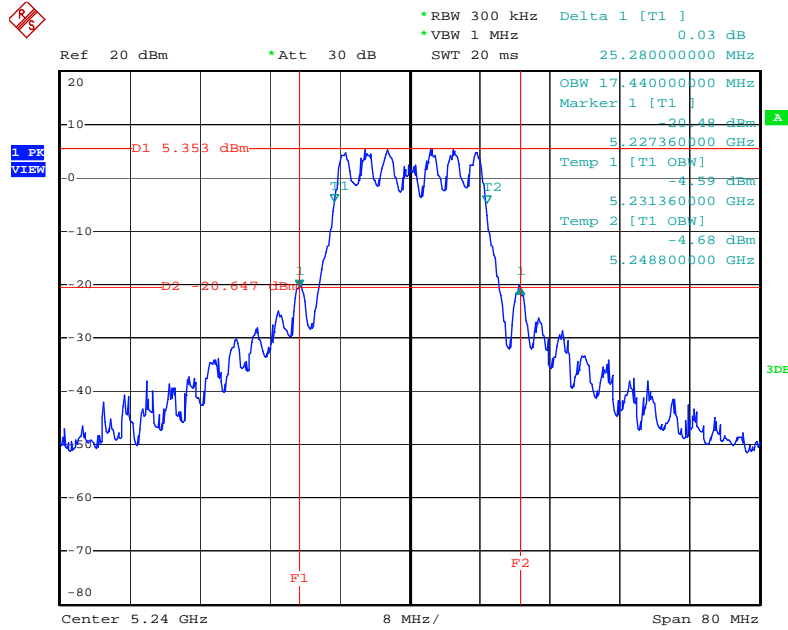

Date: 16.MAR.2010 17:19:52

26 dB Bandwidth Plot on Configuration IEEE 802.11a Ant. 1 + Ant. 2 / 5500 MHz

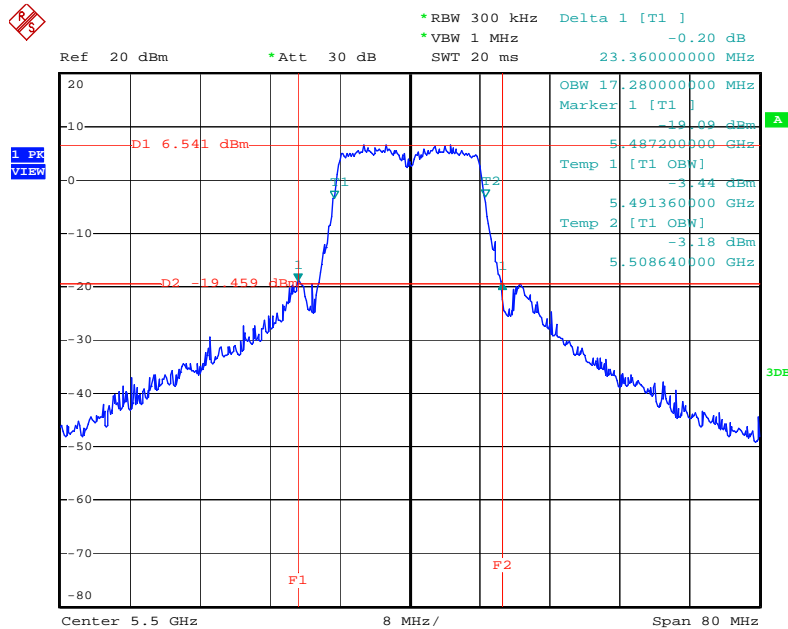

Date: 16.MAR.2010 14:50:13

26 dB Bandwidth Plot on Configuration IEEE 802.11a Ant. 1 + Ant. 2 / 5580 MHz

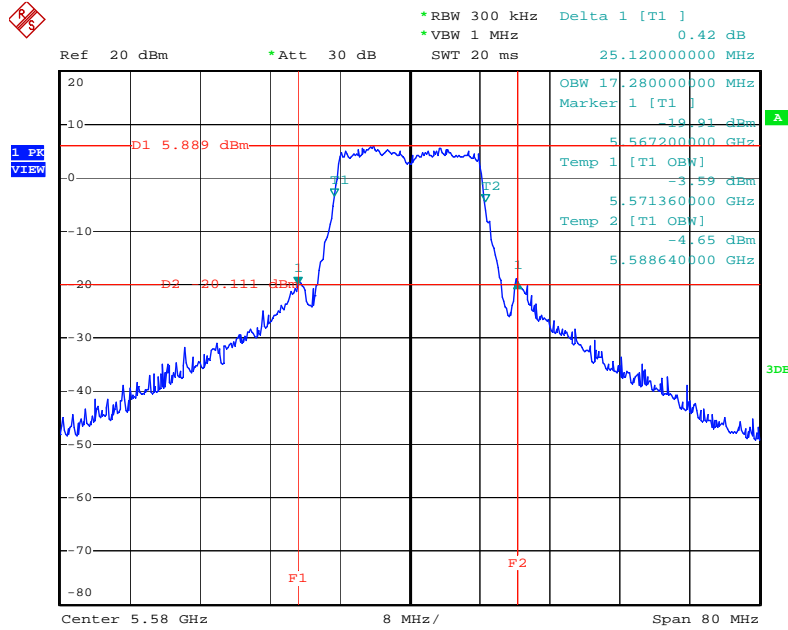

Date: 16.MAR.2010 14:47:51

26 dB Bandwidth Plot on Configuration IEEE 802.11a Ant. 1 + Ant. 2 / 5700 MHz

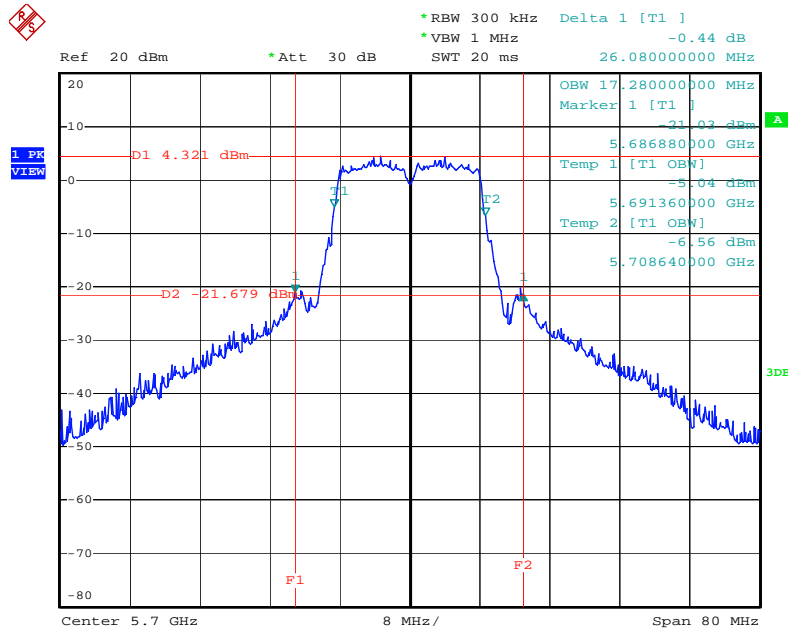

Date: 16.MAR.2010 14:45:37

4.3. Maximum Conducted Output Power Measurement

4.3.1. Limit

For the band 5.15~5.25 GHz, the maximum conducted output power over the frequency band of operation shall not exceed the lesser of 50 mW (17dBm) or $4 \text{ dBm} + 10\log B$, where B is the 26 dB emissions bandwidth in MHz. If transmitting antennas of directional gain greater than 6 dBi are used, the peak output power and power density from the intentional radiator shall be reduced by the amount in dB that the directional gain of the antenna exceeds 6 dBi.

For the 5.25-5.35 GHz and 5.470-5.725 GHz bands, the maximum conducted output power over the frequency bands of operation shall not exceed the lesser of 250 mW (24dBm) or $11 \text{ dBm} + 10\log B$. If transmitting antennas of directional gain greater than 6 dBi are used, the peak output power and power density from the intentional radiator shall be reduced by the amount in dB that the directional gain of the antenna exceeds 6 dBi.

For the band 5.725-5.825 GHz, the maximum conducted output power over the frequency band of operation shall not exceed the lesser of 1 W (30dBm) or $17 \text{ dBm} + 10\log B$. If transmitting antennas of directional gain greater than 6 dBi are used, the peak output power and power density from the intentional radiator shall be reduced by the amount in dB that the directional gain of the antenna exceeds 6 dBi. However, fixed point-to-point U-NII devices operating in this band may employ transmitting antennas with directional gain up to 23 dBi without any corresponding reduction in the transmitter peak output power and peak power spectral density. For fixed, point-to-point U-NII transmitters that employ a directional antenna gain greater than 23 dBi, a 1 dB reduction in peak transmitter power and peak power spectral density for each 1 dB of antenna gain in excess of 23 dBi would be required.

4.3.2. Measuring Instruments and Setting

Please refer to section 5 of equipments list in this report. The following table is the setting of the spectrum analyzer.

Spectrum Parameter	Setting
Attenuation	Auto
Span Frequency	Encompass the entire emissions bandwidth (EBW) of the signal
RB	1000 kHz
VB	3000 kHz
Detector	RMS
Trace	MAX HOLD
Sweep Time	Auto

4.3.3. Test Procedures

1. The transmitter output (antenna port) was connected to the spectrum analyzer.
2. Test was performed in accordance with FCC Public Notice DA 02-2138, August 30, 2002.
3. When measuring maximum conducted output power with multiple antenna systems, add every result of the values by mathematic formula.

4.3.4. Test Setup Layout

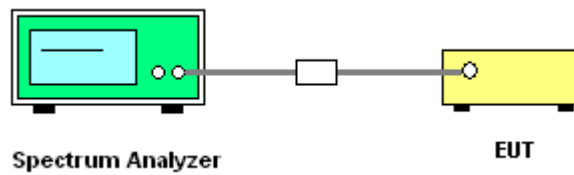

4.3.5. Test Deviation

There is no deviation with the original standard.

4.3.6. EUT Operation during Test

The EUT was programmed to be in continuously transmitting mode.

4.3.7. Test Result of Maximum Conducted Output Power

Temperature	18°C	Humidity	60%
Test Engineer	Johnson Chang	Configurations	IEEE 802.11n

Configuration IEEE 802.11n MCS0 20MHz Ant. 1

Channel	Frequency	Conducted Power (dBm)	Max. Limit (dBm)	Result
36	5180 MHz	14.15	17.00	Complies
40	5200 MHz	14.12	17.00	Complies
48	5240 MHz	13.91	17.00	Complies
52	5260 MHz	13.91	24.00	Complies
60	5300 MHz	12.66	24.00	Complies
64	5320 MHz	12.27	24.00	Complies
100	5500 MHz	12.21	24.00	Complies
116	5580 MHz	11.28	24.00	Complies
140	5700 MHz	10.94	24.00	Complies

Configuration IEEE 802.11n MCS0 20MHz Ant. 2

Channel	Frequency	Conducted Power (dBm)	Max. Limit (dBm)	Result
36	5180 MHz	12.97	17.00	Complies
40	5200 MHz	13.09	17.00	Complies
48	5240 MHz	12.83	17.00	Complies
52	5260 MHz	12.09	24.00	Complies
60	5300 MHz	11.60	24.00	Complies
64	5320 MHz	11.49	24.00	Complies
100	5500 MHz	11.89	24.00	Complies
116	5580 MHz	11.00	24.00	Complies
140	5700 MHz	10.61	24.00	Complies

Configuration IEEE 802.11n MCS0 20MHz Ant. 1 + Ant. 2

Channel	Frequency	Conducted Power (dBm)	Max. Limit (dBm)	Result
36	5180 MHz	16.61	17.00	Complies
40	5200 MHz	16.65	17.00	Complies
48	5240 MHz	16.41	17.00	Complies
52	5260 MHz	16.10	24.00	Complies
60	5300 MHz	15.17	24.00	Complies
64	5320 MHz	14.91	24.00	Complies
100	5500 MHz	15.06	24.00	Complies
116	5580 MHz	14.15	24.00	Complies
140	5700 MHz	13.79	24.00	Complies

Configuration IEEE 802.11n MCS0 40MHz Ant. 1

Channel	Frequency	Conducted Power (dBm)	Max. Limit (dBm)	Result
38	5190 MHz	14.28	17.00	Complies
46	5230 MHz	14.60	17.00	Complies
54	5270 MHz	13.94	24.00	Complies
62	5310 MHz	13.28	24.00	Complies
102	5510MHz	12.59	24.00	Complies
110	5550 MHz	12.12	24.00	Complies
134	5670 MHz	11.25	24.00	Complies

Configuration IEEE 802.11nMCS0 40MHz Ant. 2

Channel	Frequency	Conducted Power (dBm)	Max. Limit (dBm)	Result
38	5190 MHz	12.60	17.00	Complies
46	5230 MHz	12.73	17.00	Complies
54	5270 MHz	11.88	24.00	Complies
62	5310 MHz	11.43	24.00	Complies
102	5510MHz	10.92	24.00	Complies
110	5550 MHz	10.75	24.00	Complies
134	5670 MHz	10.26	24.00	Complies

Configuration IEEE 802.11n MCS0 40MHz Ant. 1 + Ant. 2

Channel	Frequency	Conducted Power (dBm)	Max. Limit (dBm)	Result
38	5190 MHz	16.53	17.00	Complies
46	5230 MHz	16.78	17.00	Complies
54	5270 MHz	16.04	24.00	Complies
62	5310 MHz	15.46	24.00	Complies
102	5510MHz	14.85	24.00	Complies
110	5550 MHz	14.50	24.00	Complies
134	5670 MHz	13.79	24.00	Complies

Temperature	18°C	Humidity	60%
Test Engineer	Johnson Chang	Configurations	IEEE 802.11a

Configuration IEEE 802.11a Ant. 1

Channel	Frequency	Conducted Power (dBm)	Max. Limit (dBm)	Result
36	5180 MHz	16.27	17.00	Complies
40	5200 MHz	16.51	17.00	Complies
48	5240 MHz	16.52	17.00	Complies
52	5260 MHz	16.84	24.00	Complies
60	5300 MHz	16.29	24.00	Complies
64	5320 MHz	15.93	24.00	Complies
100	5500 MHz	15.22	24.00	Complies
116	5580 MHz	15.09	24.00	Complies
140	5700 MHz	13.50	24.00	Complies

Note: All the test values were listed in the report.

For plots, only the worse case of OFDM modulation was listed in the report.

Conducted Output Power Plot on Configuration IEEE 802.11n MCS0 40MHz Ant. 1 / 5190 MHz

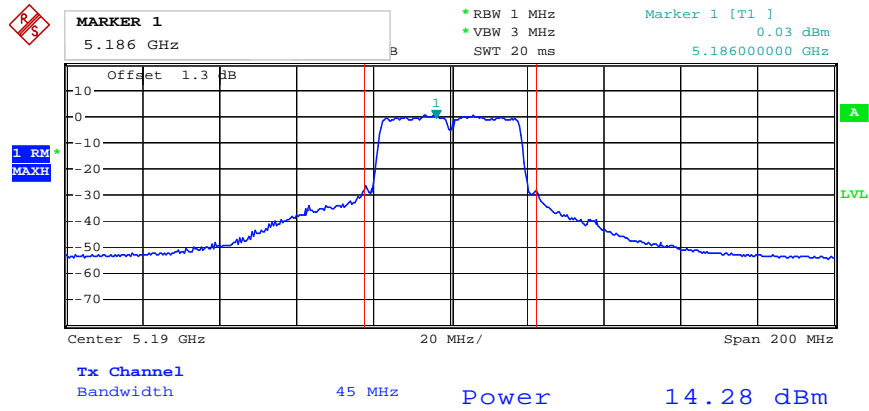

Date: 16.MAR.2010 15:20:23

Conducted Output Power Plot on Configuration IEEE 802.11n MCS0 40MHz Ant. 1 / 5230 MHz

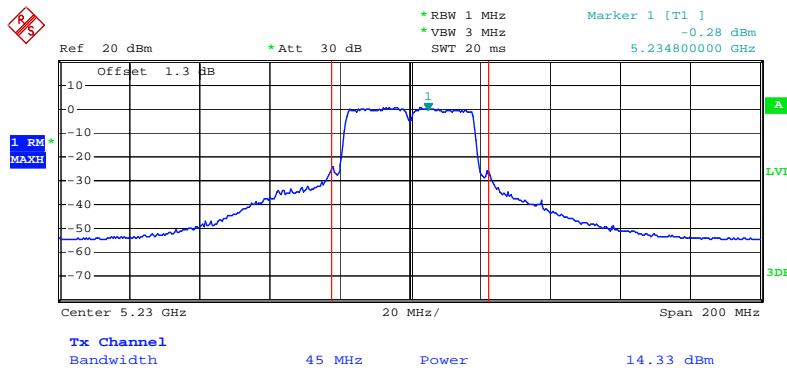

Date: 17.MAR.2010 15:42:01

Conducted Output Power Plot on Configuration IEEE 802.11n MCS0 40MHz Ant. 2 / 5190 MHz

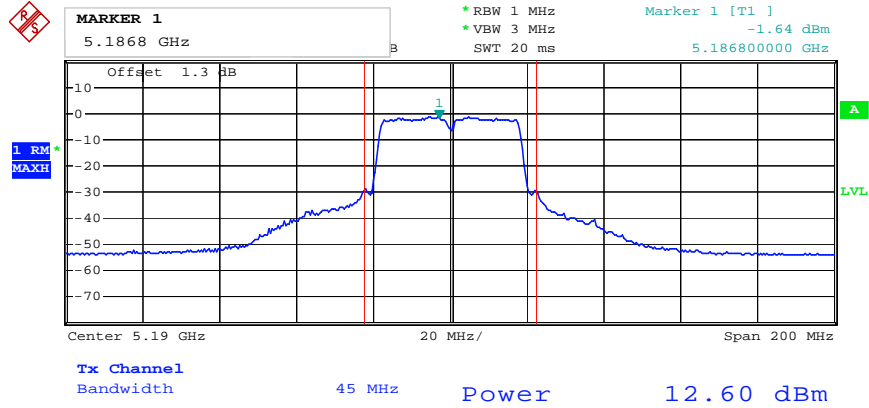

Date: 16.MAR.2010 15:21:10

Conducted Output Power Plot on Configuration IEEE 802.11n MCS0 40MHz Ant. 2 / 5230 MHz

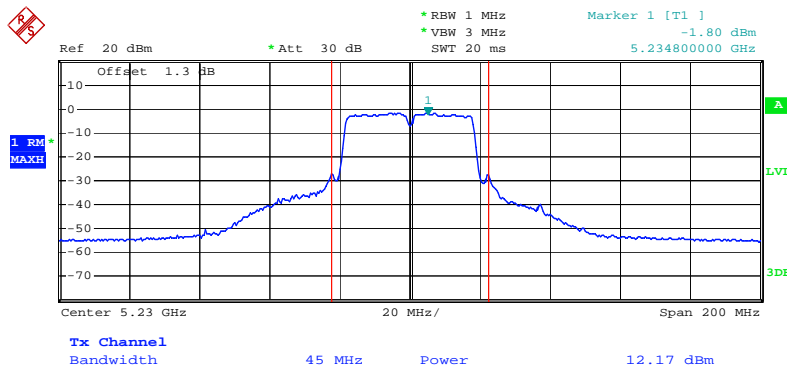

Date: 17.MAR.2010 15:41:43

Conducted Output Power Plot on Configuration IEEE 802.11a Ant. 1 / 5260 MHz

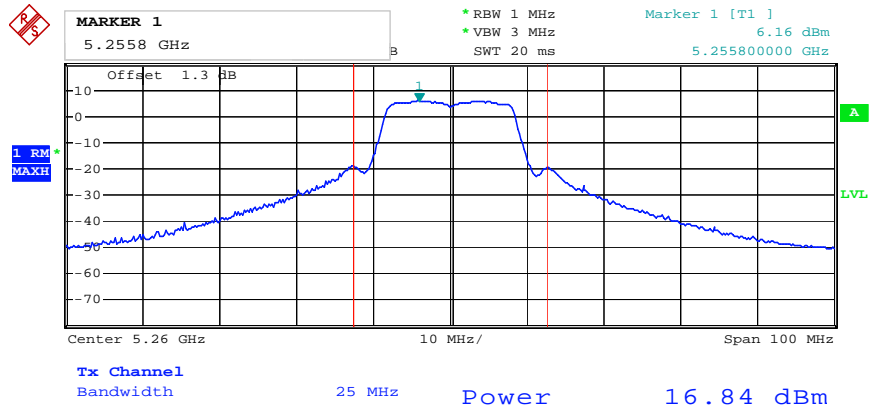

Date: 16.MAR.2010 11:54:36

Conducted Output Power Plot on Configuration IEEE 802.11a Ant. 1 / 5300 MHz

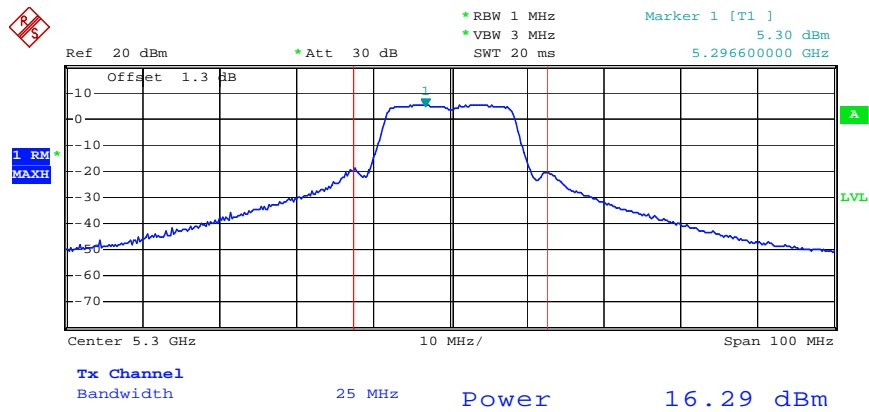

Date: 16.MAR.2010 11:53:34

Conducted Output Power Plot on Configuration IEEE 802.11a Ant. 1 / 5320 MHz

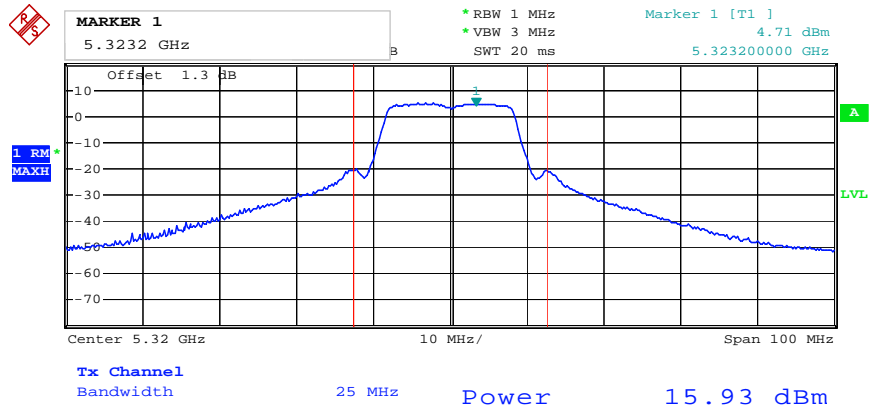

Date: 16.MAR.2010 11:56:50

4.4. Power Spectral Density Measurement

4.4.1. Limit

The power spectral density is defined as the highest level of power in dBm per MHz generated by the transmitter within the power envelope. The following table is power spectral density limits and decrease power density limit rule refer to section 4.3.1.

Frequency Range	Power Spectral Density limit (dBm/MHz)
5.15~5.25 GHz	4
5.25-5.35 GHz	11
5470-5725	11

4.4.2. Measuring Instruments and Setting

Please refer to section 5 of equipments list in this report. The following table is the setting of the spectrum analyzer.

Spectrum Parameter	Setting
Attenuation	Auto
Span Frequency	Encompass the entire emissions bandwidth (EBW) of the signal
RB	1000 kHz
VB	3000 kHz
Detector	Peak
Trace	Max Hold
Sweep Time	Auto

4.4.3. Test Procedures

1. The transmitter output (antenna port) was connected to the spectrum analyzer.
2. Set RBW of spectrum analyzer to 1000kHz and VBW to 3000kHz. Set Detector to Peak, Trace to Max Hold. Mark the frequency with maximum peak power as the center of the display of the spectrum.
3. Measuring multiple antennas, the connector is required to link with spectrum analyzer through a combiner.

4.4.4. Test Setup Layout

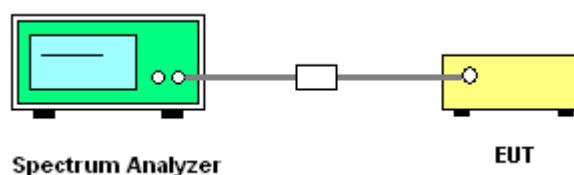

4.4.5. Test Deviation

There is no deviation with the original standard.

4.4.6. EUT Operation during Test

The EUT was programmed to be in continuously transmitting mode.

4.4.7. Test Result of Power Spectral Density

Temperature	18°C	Humidity	60%
Test Engineer	Johnson Chang	Configurations	IEEE 802.11n

Configuration IEEE 802.11n MCS0 20MHz Ant. 1 + Ant. 2

Channel	Frequency	Power Density (dBm)	Max. Limit (dBm)	Result
36	5180 MHz	-0.63	4.00	Complies
40	5200 MHz	-0.02	4.00	Complies
48	5240 MHz	-0.19	4.00	Complies
52	5260 MHz	-2.66	11.00	Complies
60	5300 MHz	-4.61	11.00	Complies
64	5320 MHz	-5.09	11.00	Complies
100	5500 MHz	-5.27	11.00	Complies
116	5580 MHz	-4.31	11.00	Complies
140	5700 MHz	-6.97	11.00	Complies

Configuration IEEE 802.11n MCS0 40MHz Ant. 1 + Ant. 2

Channel	Frequency	Power Density (dBm)	Max. Limit (dBm)	Result
38	5190 MHz	-11.64	4.00	Complies
46	5230 MHz	-11.36	4.00	Complies
54	5270 MHz	-16.85	11.00	Complies
62	5310 MHz	-17.77	11.00	Complies
102	5510MHz	-17.57	11.00	Complies
110	5550 MHz	-19.04	11.00	Complies
134	5670 MHz	-17.21	11.00	Complies

Temperature	18°C	Humidity	60%
Test Engineer	Johnson Chang	Configurations	IEEE 802.11a

Configuration IEEE 802.11a Ant. 1 + Ant. 2

Channel	Frequency	Power Density (dBm)	Max. Limit (dBm)	Result
36	5180 MHz	0.77	4.00	Complies
40	5200 MHz	0.76	4.00	Complies
48	5240 MHz	0.33	4.00	Complies
52	5260 MHz	1.68	11.00	Complies
60	5300 MHz	0.75	11.00	Complies
64	5320 MHz	0.71	11.00	Complies
100	5500 MHz	-0.49	11.00	Complies
116	5580 MHz	-0.61	11.00	Complies
140	5700 MHz	-2.75	11.00	Complies

Note: All the test values were listed in the report.

For plots, only the worse case of OFDM modulation was listed in the report.

Power Density Plot on Configuration IEEE 802.11a Ant. 1 + Ant. 2 / 5180 MHz

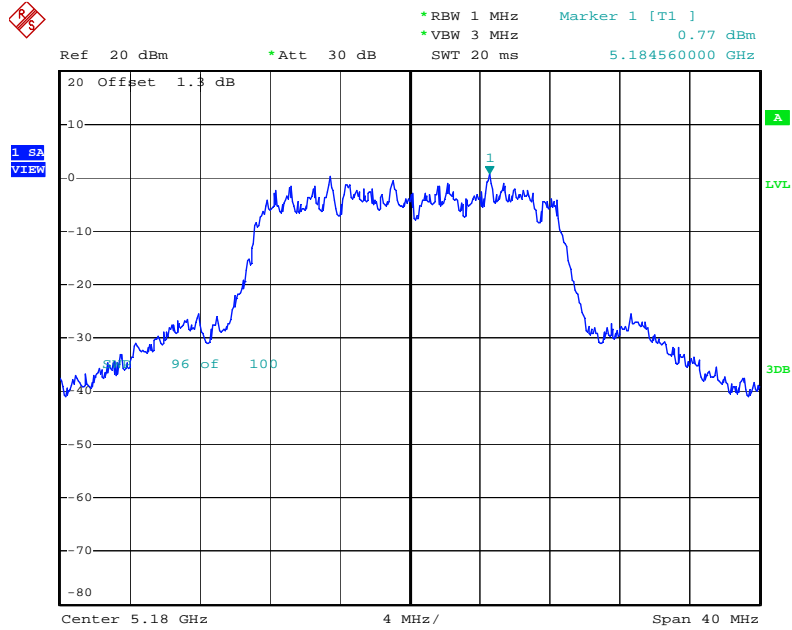

Date: 16.MAR.2010 15:06:13

Power Density Plot on Configuration IEEE 802.11a Ant. 1 + Ant. 2 / 5200 MHz

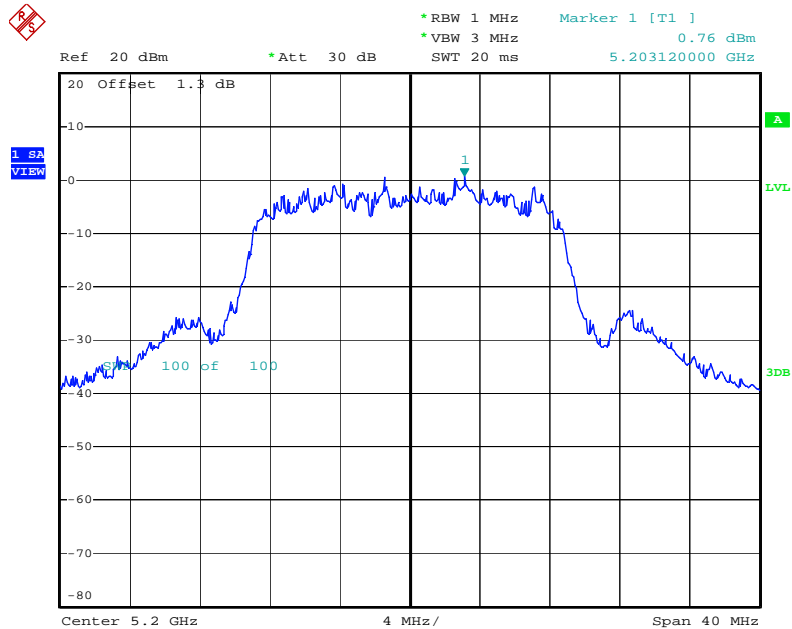

Date: 16.MAR.2010 15:10:17

Power Density Plot on Configuration IEEE 802.11a Ant. 1 + Ant. 2 / 5240 MHz

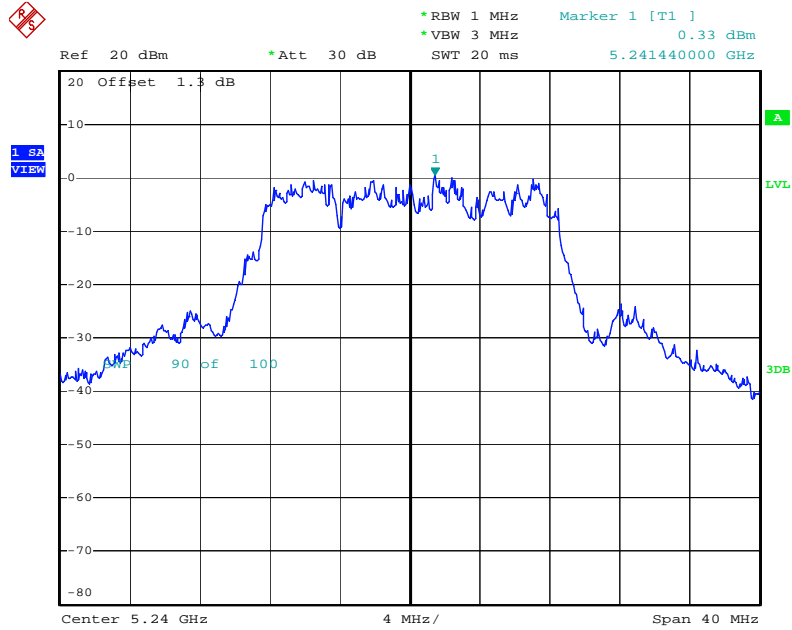

Date: 16.MAR.2010 15:01:02

Power Density Plot on Configuration IEEE 802.11a Ant. 1 + Ant. 2 / 5260 MHz

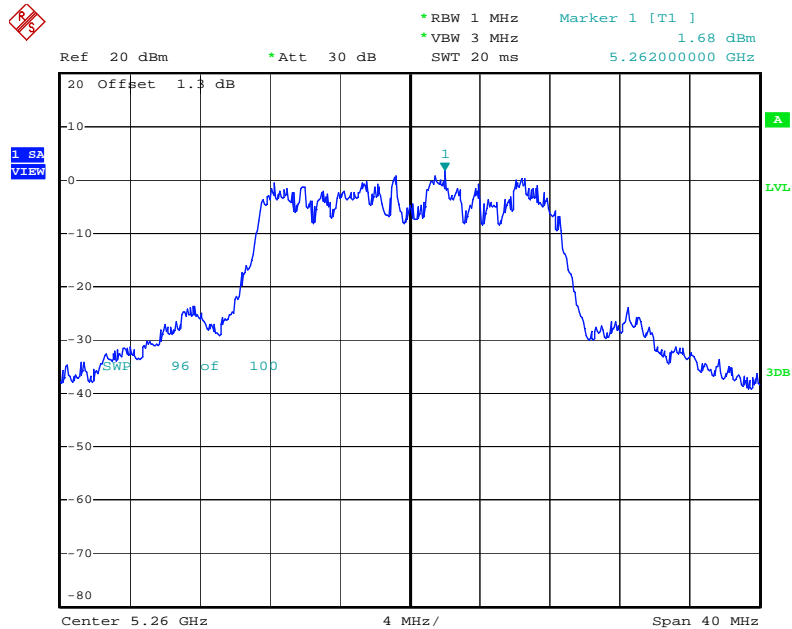

Date: 16.MAR.2010 14:59:34

Power Density Plot on Configuration IEEE 802.11a Ant. 1 + Ant. 2 / 5300 MHz

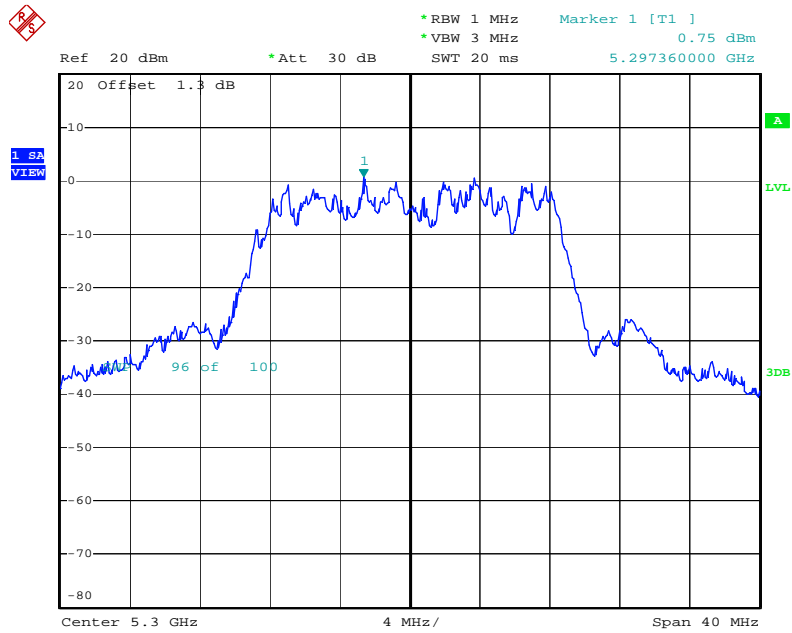

Date: 16.MAR.2010 14:58:11

Power Density Plot on Configuration IEEE 802.11a Ant. 1 + Ant. 2 / 5320 MHz

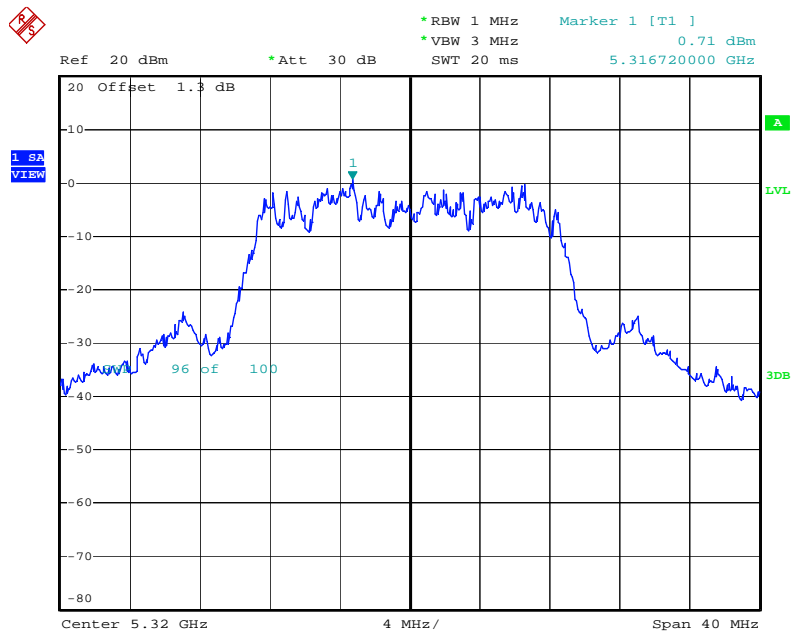

Date: 16.MAR.2010 14:52:13

4.5. Peak Excursion Measurement

4.5.1. Limit

The ratio of the peak excursion of the modulation envelope (measured using a peak hold function) to the maximum conducted output power (measured as specified above) shall not exceed 13 dB across any 1 MHz bandwidth or the emissions bandwidth whichever is less.

4.5.2. Measuring Instruments and Setting

Please refer to section 5 of equipments list in this report. The following table is the setting of the spectrum analyzer.

Spectrum Parameter	Setting
Attenuation	Auto
Span Frequency	Encompass the entire emissions bandwidth (EBW) of the signal
RB	1000 kHz (Peak Trace) / 1000 kHz (Average Trace)
VB	3000 kHz (Peak Trace) / 300 kHz (Average Trace)
Detector	Peak (Peak Trace) / Sample (Average Trace)
Trace	Max Hold
Sweep Time	60s

4.5.3. Test Procedures

1. The transmitter output (antenna port) was connected to the spectrum analyzer.
2. Set the spectrum analyzer span to view the entire emissions bandwidth. The largest difference between the following two traces (Peak Trace and Average Trace) must be ≤ 13 dB for all frequencies across the emissions bandwidth. Submit a plot.
3. Peak Trace: Set RBW = 1 MHz, VBW ≥ 3 MHz with peak detector and max-hold settings.
4. Average Trace: Method #3—video averaging with max hold--and sum power across the band. Set span to encompass the entire emissions bandwidth (EBW) of the signal. Set sweep trigger to "free run". Set RBW = 1 MHz. Set VBW $\geq 1/T$ (IEEE 802.11nVBW = 300kHz $\geq 1/4\mu$ s). Use sample detector mode if bin width (i.e., span/number of points in spectrum) < 0.5 RBW. Otherwise use peak detector mode. Set max hold. Allow max hold to run for 60 seconds.
5. Measuring multiple antennas, the connector is required to link with spectrum analyzer through a combiner.

4.5.4. Test Setup Layout

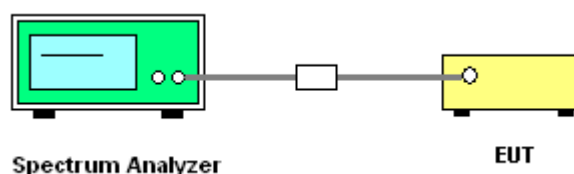

4.5.5. Test Deviation

There is no deviation with the original standard.

4.5.6. EUT Operation during Test

The EUT was programmed to be in continuously transmitting mode.

4.5.7. Test Result of Peak Excursion

Temperature	18°C	Humidity	60%
Test Engineer	Johnson Chang	Configurations	IEEE 802.11n

Configuration IEEE 802.11n MCS0 20MHz Ant. 1 + Ant. 2

Channel	Frequency	Peak Excursion (dB)	Max. Limit (dB)	Result
36	5180 MHz	5.13	13	Complies
40	5200 MHz	5.20	13	Complies
48	5240 MHz	4.02	13	Complies
52	5260 MHz	4.72	13	Complies
60	5300 MHz	5.19	13	Complies
64	5320 MHz	4.52	13	Complies
100	5500 MHz	5.29	13	Complies
116	5580 MHz	4.97	13	Complies
140	5700 MHz	4.13	13	Complies

Configuration IEEE 802.11n MCS0 40MHz Ant. 1 + Ant. 2

Channel	Frequency	Peak Excursion (dB)	Max. Limit (dB)	Result
38	5190 MHz	4.53	13	Complies
46	5230 MHz	4.64	13	Complies
54	5270 MHz	5.12	13	Complies
62	5310 MHz	5.07	13	Complies
102	5510MHz	5.20	13	Complies
110	5550 MHz	4.65	13	Complies
134	5670 MHz	4.67	13	Complies

Temperature	18°C	Humidity	60%
Test Engineer	Johnson Chang	Configurations	IEEE 802.11a

Configuration IEEE 802.11a Ant. 1 + Ant. 2

Channel	Frequency	Peak Excursion (dB)	Max. Limit (dB)	Result
36	5180 MHz	5.43	13	Complies
40	5200 MHz	5.20	13	Complies
48	5240 MHz	5.91	13	Complies
52	5260 MHz	6.41	13	Complies
60	5300 MHz	5.56	13	Complies
64	5320 MHz	6.47	13	Complies
100	5500 MHz	6.30	13	Complies
116	5580 MHz	6.48	13	Complies
140	5700 MHz	6.52	13	Complies

Note: All the test values were listed in the report.

For plots, only the worse case of OFDM modulation was listed in the report.

Peak Excursion Plot on Configuration IEEE 802.11a Ant. 1 + Ant. 2 / 5180 MHz

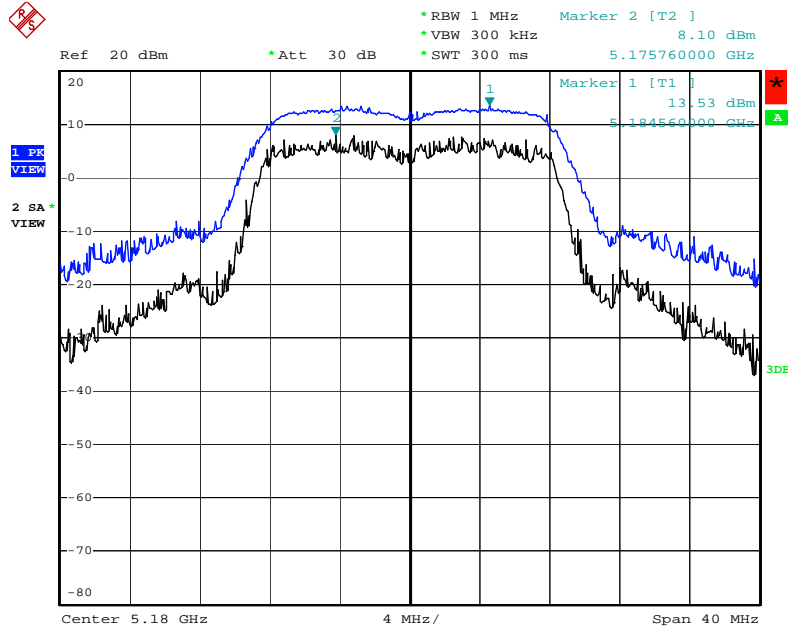

Date: 16.MAR.2010 15:06:25

Peak Excursion Plot on Configuration IEEE 802.11a Ant. 1 + Ant. 2 / 5200 MHz

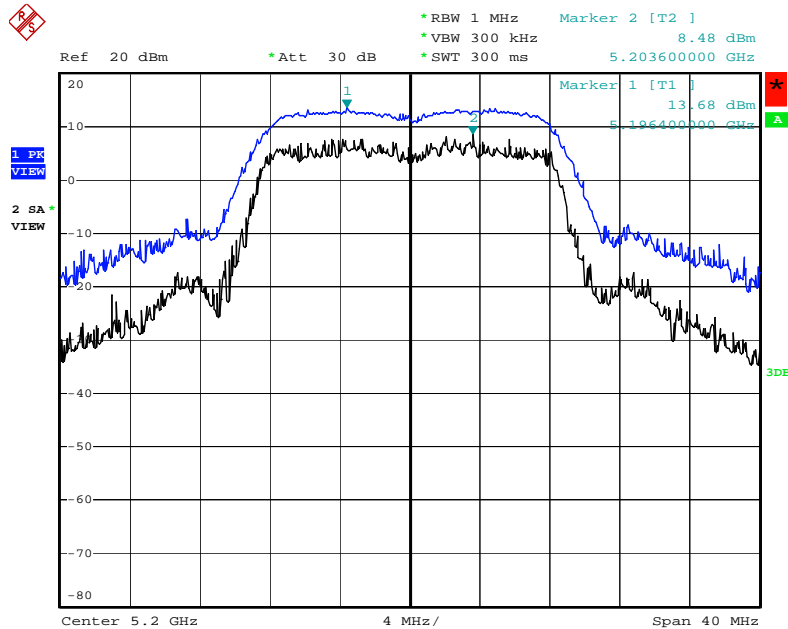

Date: 16.MAR.2010 15:10:29

Peak Excursion Plot on Configuration IEEE 802.11a Ant. 1 + Ant. 2 / 5240 MHz

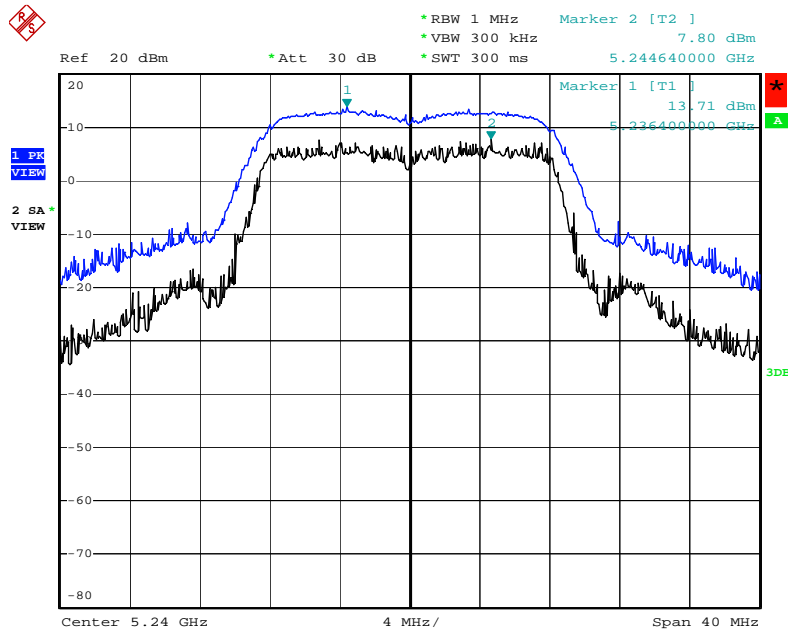

Date: 16.MAR.2010 15:01:14

Peak Excursion Plot on Configuration IEEE 802.11a Ant. 1 + Ant. 2 / 5500 MHz

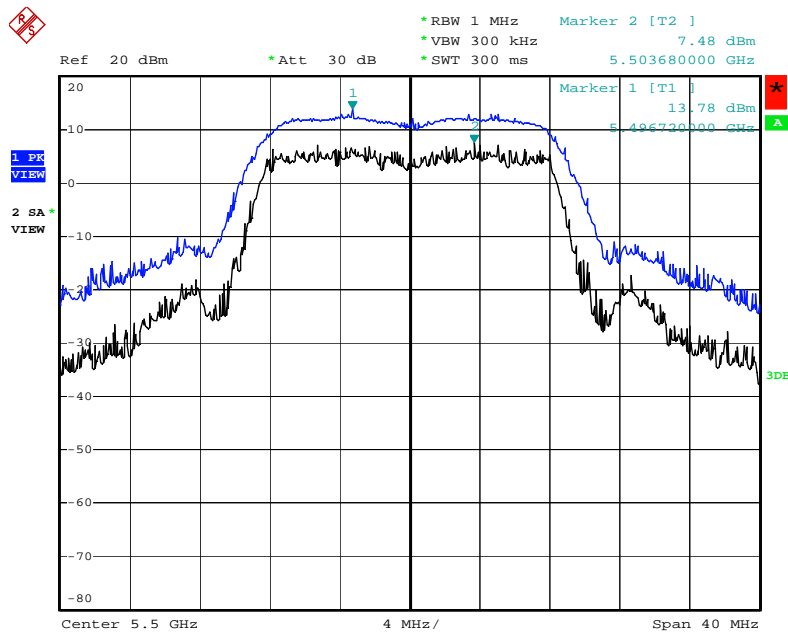

Date: 16.MAR.2010 14:50:34

Peak Excursion Plot on Configuration IEEE 802.11a Ant. 1 + Ant. 2 / 5580 MHz

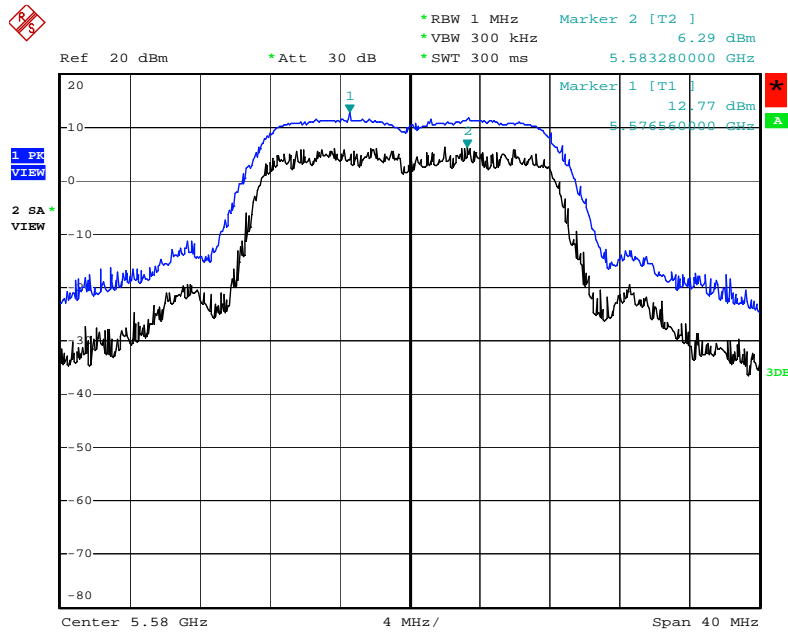

Date: 16.MAR.2010 14:48:12

Peak Excursion Plot on Configuration IEEE 802.11a Ant. 1 + Ant. 2 / 5700 MHz

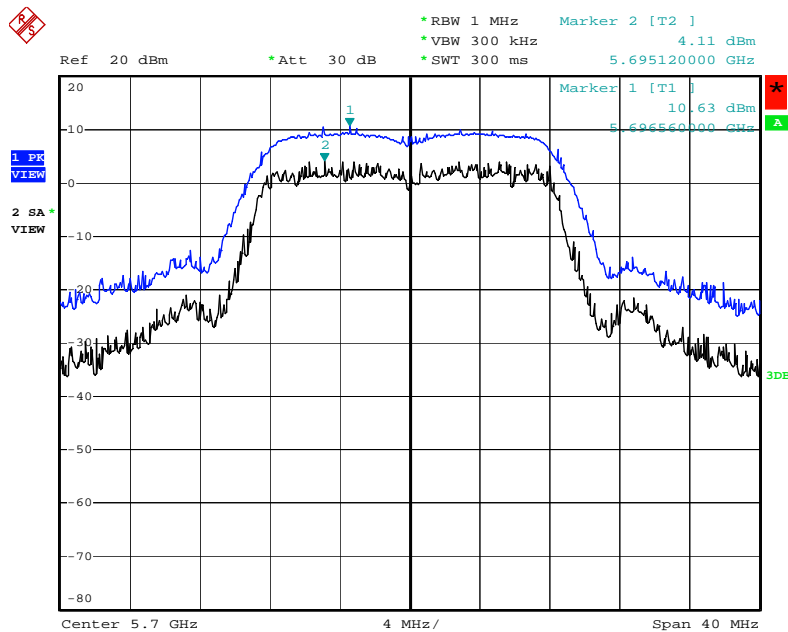

Date: 16.MAR.2010 14:45:57

4.6. Radiated Emissions Measurement

4.6.1. Limit

For transmitters operating in the 5.15-5.35 GHz band: all emissions outside of the 5.15-5.35 GHz band shall not exceed an EIRP of -27 dBm/MHz (68.3dBuV/m at 3m). For transmitters operating in the 5.470-5.725 GHz band: all emissions outside of the 5.470-5.725 GHz band shall not exceed an EIRP of -27 dBm/MHz (68.3dBuV/m at 3m). For transmitters operating in the 5.725-5.825 GHz band: all emissions within the frequency range from the band edge to 10 MHz above or below the band edge shall not exceed an EIRP of -17 dBm/MHz (78.3dBuV/m at 3m); for frequencies 10 MHz or greater above or below the band edge, emissions shall not exceed an EIRP of -27 dBm/MHz (68.3dBuV/m at 3m). In addition, in case the emission falls within the restricted band specified on 15.205(a), then the 15.209(a) limit in the table below has to be followed.

Frequencies (MHz)	Field Strength (microrvolts/meter)	Measurement Distance (meters)
0.009~0.490	2400/F(KHz)	300
0.490~1.705	24000/F(KHz)	30
1.705~30.0	30	30
30~88	100	3
88~216	150	3
216~960	200	3
Above 960	500	3

4.6.2. Measuring Instruments and Setting

Please refer to section 5 of equipments list in this report. The following table is the setting of spectrum analyzer and receiver.

Spectrum Parameter	Setting
Attenuation	Auto
Start Frequency	1000 MHz
Stop Frequency	40 GHz
RB / VB (Emission in restricted band)	1MHz / 1MHz for Peak, 1 MHz / 10Hz for Average
RB / VB (Emission in non-restricted band)	1000KHz / 1000KHz for peak

Receiver Parameter	Setting
Attenuation	Auto
Start ~ Stop Frequency	9kHz~150kHz / RB 200Hz for QP
Start ~ Stop Frequency	150kHz~30MHz / RB 9kHz for QP
Start ~ Stop Frequency	30MHz~1000MHz / RB 120kHz for QP

4.6.3. Test Procedures

1. Configure the EUT according to ANSI C63.4. The EUT was placed on the top of the turntable 0.8 meter above ground. The phase center of the receiving antenna mounted on the top of a height-variable antenna tower was placed 3 meters far away from the turntable.
2. Power on the EUT and all the supporting units. The turntable was rotated by 360 degrees to determine the position of the highest radiation.
3. The height of the broadband receiving antenna was varied between one meter and four meters above ground to find the maximum emissions field strength of both horizontal and vertical polarization.
4. For each suspected emissions, the antenna tower was scan (from 1 M to 4 M) and then the turntable was rotated (from 0 degree to 360 degrees) to find the maximum reading.
5. Set the test-receiver system to Peak or CISPR quasi-peak Detect Function with specified bandwidth under Maximum Hold Mode.
6. For emissions above 1GHz, use 1MHz VBW and RBW for peak reading. Then 1MHz RBW and 10Hz VBW for average reading in spectrum analyzer.
7. When the radiated emissions limits are expressed in terms of the average value of the emissions, and pulsed operation is employed, the measurement field strength shall be determined by averaging over one complete pulse train, including blanking intervals, as long as the pulse train does not exceed 0.1 seconds. As an alternative (provided the transmitter operates for longer than 0.1 seconds) or in cases where the pulse train exceeds 0.1 seconds, the measured field strength shall be determined from the average absolute voltage during a 0.1 second interval during which the field strength is at its maximum value.
8. If the emissions level of the EUT in peak mode was 3 dB lower than the average limit specified, then testing will be stopped and peak values of EUT will be reported, otherwise, the emissions which do not have 3 dB margin will be repeated one by one using the quasi-peak method for below 1GHz.
9. For testing above 1GHz, the emissions level of the EUT in peak mode was lower than average limit (that means the emissions level in peak mode also complies with the limit in average mode), then testing will be stopped and peak values of EUT will be reported, otherwise, the emissions will be measured in average mode again and reported.
10. In case the emission is lower than 30MHz, loop antenna has to be used for measurement and the recorded data should be QP measured by receiver. High – Low scan is not required in this case.

4.6.4. Test Setup Layout

For radiated emissions below 30MHz

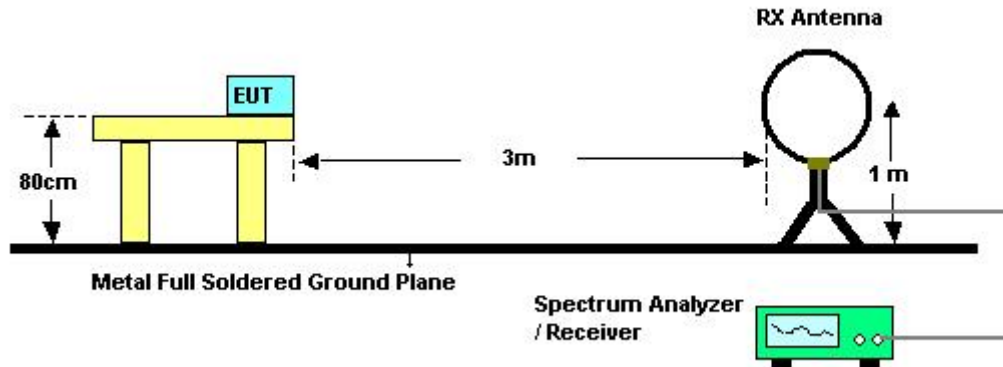

For radiated emissions above 30MHz

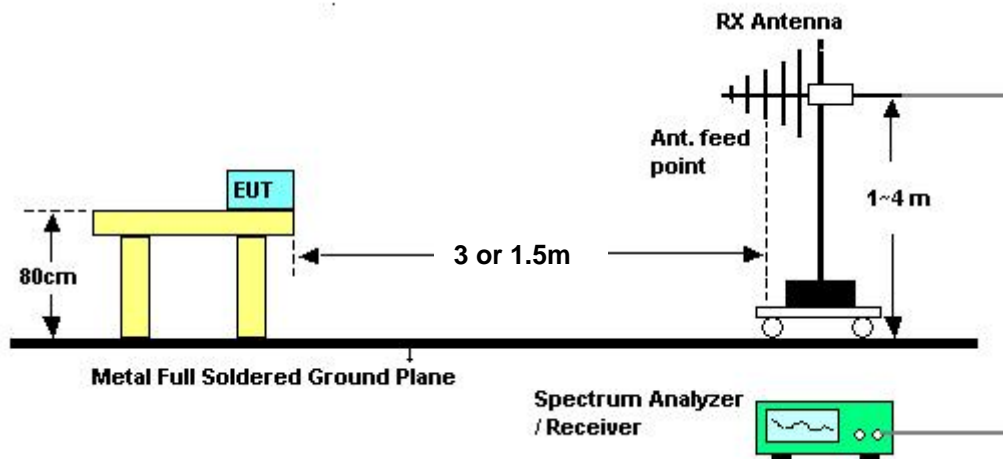

Above 5GHz shall be extrapolated to the specified distance using an extrapolation factor of 20 dB/decade from 3m to 1.5m.

Distance extrapolation factor = $20 \log (\text{specific distance [3m]} / \text{test distance [1.5m]})$ (dB);

Limit line = specific limits (dBuV) + distance extrapolation factor [6 dB].

4.6.5. Test Deviation

There is no deviation with the original standard.

4.6.6. EUT Operation during Test

The EUT was programmed to be in continuously transmitting mode.

4.6.7. Results of Radiated Emissions (9kHz~30MHz)

Temperature	24°C	Humidity	54%
Test Engineer	Alan Huang	Configurations	Normal Link

Freq. (MHz)	Level (dBuV)	Over Limit (dB)	Limit Line (dBuV)	Remark
-	-	-	-	See Note

Note:

The amplitude of spurious emissions that are attenuated by more than 20dB below the permissible value has no need to be reported.

Distance extrapolation factor = $40 \log(\text{specific distance} / \text{test distance})$ (dB);

Limit line = specific limits (dBuV) + distance extrapolation factor.

4.6.8. Results of Radiated Emissions (30MHz~1GHz)

Temperature	24°C	Humidity	54%
Test Engineer	Alan Huang	Configurations	Normal Link

Horizontal

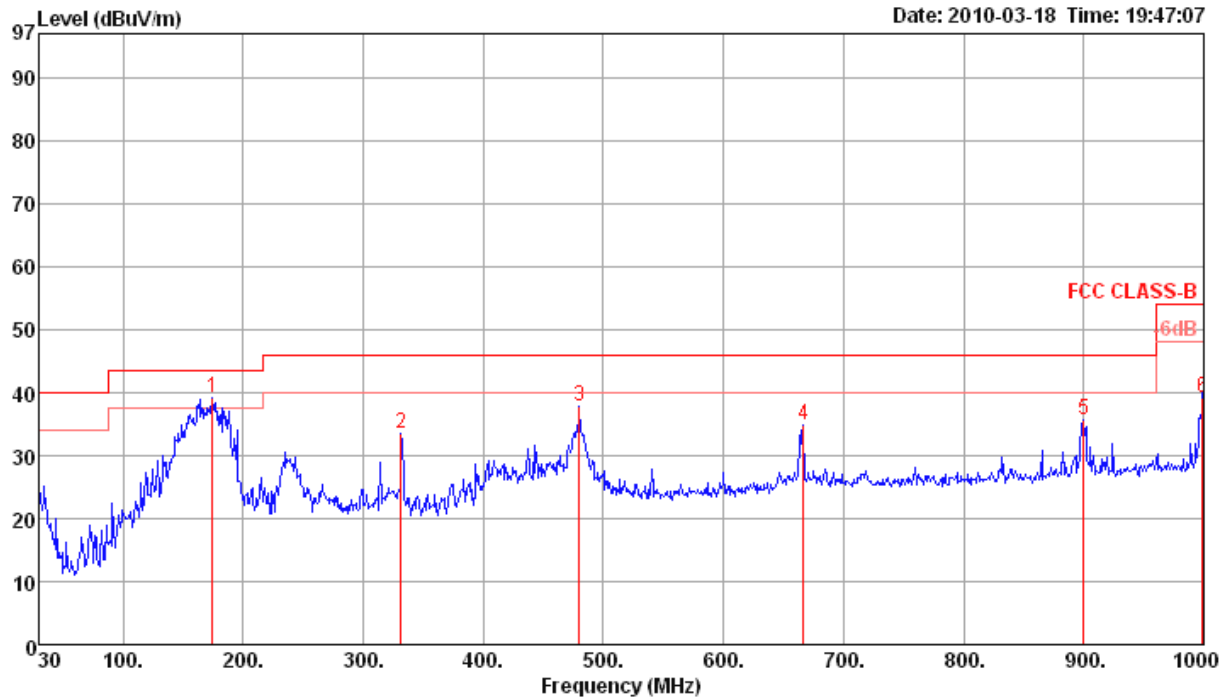

	Freq	Level	Limit	Over	Read	Cable	Preamp	Antenna	T/Pos	A/Pos	Remark	Pol/Phase
	MHz	dBuV/m	dBuV/m	dB	dBuV	dB	dB	dB/m	deg	cm		
1	174.53	39.19	43.50	-4.31	51.73	1.57	27.23	13.12	0	100	Peak	HORIZONTAL
2	331.67	33.51	46.00	-12.49	44.24	2.16	27.12	14.23	0	100	Peak	HORIZONTAL
3	480.08	37.85	46.00	-8.15	45.88	2.66	28.00	17.31	0	100	Peak	HORIZONTAL
4	666.32	34.97	46.00	-11.03	40.59	3.43	28.03	18.98	0	100	Peak	HORIZONTAL
5	900.09	35.65	46.00	-10.35	38.92	3.60	27.40	20.53	0	100	Peak	HORIZONTAL
6	999.03	39.05	54.00	-14.95	41.08	3.70	27.01	21.28	0	100	Peak	HORIZONTAL

Vertical

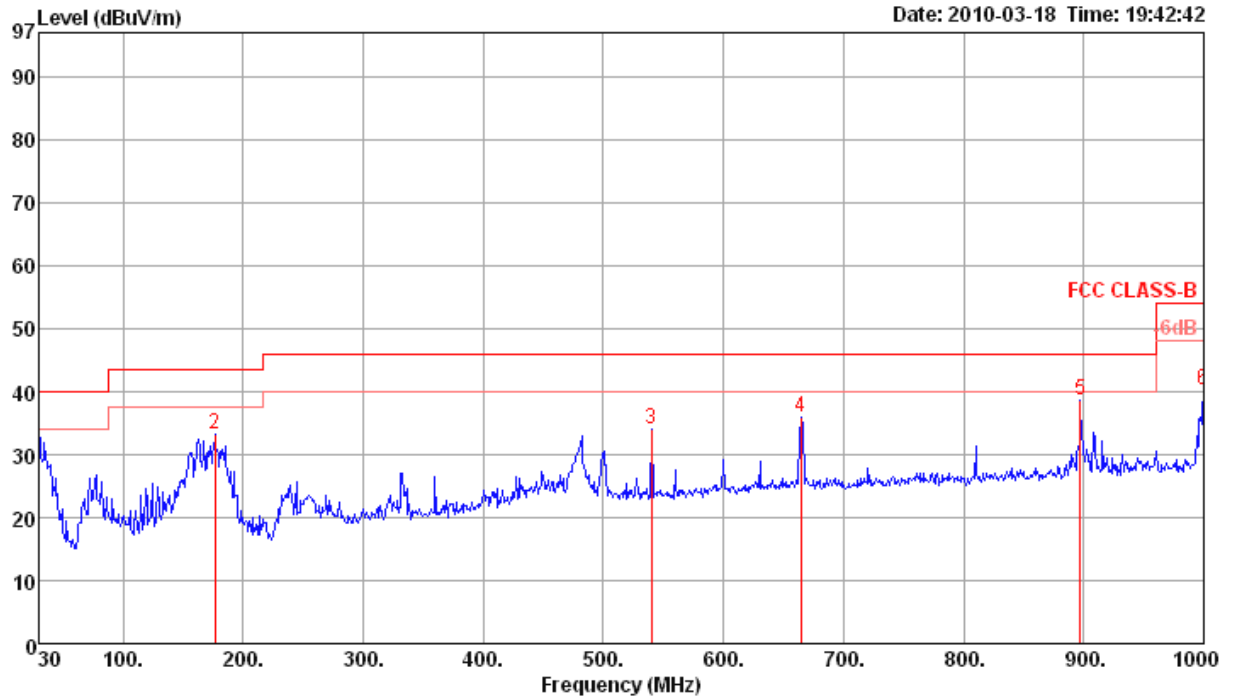

	Freq	Level	Limit	Over	Read	Cable	Preamp	Antenna	T/Pos	A/Pos	Remark	Pol/Phase
	MHz	dBuV/m	dBuV/m	dB	dBuV	dB	dB	dB/m	deg	cm		
1 p	30.00	35.25	40.00	-4.75	43.79	0.50	27.80	18.76	0	400	Peak	VERTICAL
2	176.47	33.13	43.50	-10.37	45.64	1.58	27.22	13.13	0	400	Peak	VERTICAL
3	540.22	34.04	46.00	-11.96	41.28	2.78	28.10	18.08	0	400	Peak	VERTICAL
4	664.38	35.89	46.00	-10.11	41.51	3.44	28.04	18.98	0	400	Peak	VERTICAL
5	897.18	38.56	46.00	-7.44	41.87	3.59	27.41	20.51	0	400	Peak	VERTICAL
6	1000.00	40.13	54.00	-13.87	42.14	3.70	27.00	21.29	0	400	Peak	VERTICAL

Note:

The amplitude of spurious emissions that are attenuated by more than 20dB below the permissible value has no need to be reported.

Emission level (dBuV/m) = 20 log Emission level (uV/m).

Corrected Reading: Antenna Factor + Cable Loss + Read Level - Preamp Factor = Level.

4.6.9. Results for Radiated Emissions (1GHz~40GHz)

Temperature	18°C	Humidity	55%
Test Engineer	Allen Liu	Configurations	IEEE 802.11n MCS0 20MHz Ch 36 / Ant. 1 + Ant. 2
Test Date	Mar. 05, 2010		

Horizontal

	Freq	Level	Limit Line	Over Limit	Read Level	Cable Loss	Antenna Factor	Preamp Factor	T/Pos	A/Pos	Remark	Pol/Phase
	MHz	dBuV/m	dBuV/m	dB	dBuV	dB	dB/m	dB	deg	cm		
1 p	10360.00	54.21	94.00	-39.79	44.97	6.49	38.37	35.62	172	100	Peak	HORIZONTAL
2 a	10360.01	41.64	74.00	-32.36	32.40	6.49	38.37	35.62	172	100	Average	HORIZONTAL

Vertical

	Freq	Level	Limit Line	Over Limit	Read Level	Cable Loss	Antenna Factor	Preamp Factor	T/Pos	A/Pos	Remark	Pol/Phase
	MHz	dBuV/m	dBuV/m	dB	dBuV	dB	dB/m	dB	deg	cm		
1 p	10360.00	55.35	94.00	-38.65	46.11	6.49	38.37	35.62	307	100	Peak	VERTICAL
2 a	10360.02	42.79	74.00	-31.21	33.55	6.49	38.37	35.62	307	100	Average	VERTICAL



Temperature	18°C	Humidity	55%
Test Engineer	Allen Liu	Configurations	IEEE 802.11n MCS0 20MHz Ch 40 / Ant. 1 + Ant. 2
Test Date	Mar. 05, 2010		

Horizontal

	Freq	Level	Limit	Over	Read	Cable	Antenna	Preamp	T/Pos	A/Pos	Remark	Pol/Phase
	MHz	dBuV/m	dBuV/m	dB	dBuV	Loss	Factor	Factor	deg	cm		
1 p	10399.98	55.96	94.00	-38.04	46.64	6.52	38.38	35.58	195	100	Peak	HORIZONTAL
2 a	10400.01	40.92	74.00	-33.08	31.60	6.52	38.38	35.58	195	100	Average	HORIZONTAL

Vertical

	Freq	Level	Limit	Over	Read	Cable	Antenna	Preamp	T/Pos	A/Pos	Remark	Pol/Phase
	MHz	dBuV/m	dBuV/m	dB	dBuV	Loss	Factor	Factor	deg	cm		
1 p	10399.99	57.01	94.00	-36.99	47.69	6.52	38.38	35.58	27	100	Peak	VERTICAL
2 a	10400.02	44.76	74.00	-29.24	35.44	6.52	38.38	35.58	27	100	Average	VERTICAL



Temperature	18°C	Humidity	55%
Test Engineer	Allen Liu	Configurations	IEEE 802.11n MCS0 20MHz Ch 48 / Ant. 1 + Ant. 2
Test Date	Mar. 05, 2010		

Horizontal

	Freq	Level	Limit	Over	Read	Cable	Antenna	Preamp	T/Pos	A/Pos	Remark	Pol/Phase
	MHz	dBuV/m	dBuV/m	dB	dBuV	Loss	Factor	Factor	deg	cm		
1 a	10480.00	42.64	74.00	-31.36	33.20	6.57	38.39	35.52	133	100	Average	HORIZONTAL
2 p	10480.00	55.70	94.00	-38.30	46.26	6.57	38.39	35.52	133	100	Peak	HORIZONTAL

Vertical

	Freq	Level	Limit	Over	Read	Cable	Antenna	Preamp	T/Pos	A/Pos	Remark	Pol/Phase
	MHz	dBuV/m	dBuV/m	dB	dBuV	Loss	Factor	Factor	deg	cm		
1 a	10480.00	46.84	74.00	-27.16	37.39	6.57	38.40	35.52	305	100	Average	VERTICAL
2 p	10480.00	56.49	94.00	-37.51	47.04	6.57	38.40	35.52	305	100	Peak	VERTICAL



Temperature	18°C	Humidity	55%
Test Engineer	Allen Liu	Configurations	IEEE 802.11n MCS0 20MHz Ch 52 / Ant. 1 + Ant. 2
Test Date	Mar. 05, 2010		

Horizontal

	Freq	Level	Limit Line	Over Limit	Read Level	Cable Loss	Antenna Factor	Preamp Factor	T/Pos	A/Pos	Remark	Pol/Phase
	MHz	dBuV/m	dBuV/m	dB	dBuV	dB	dB/m	dB	deg	cm		
1 a	10520.00	46.40	74.00	-27.60	36.92	6.58	38.40	35.50	245	100	Average	HORIZONTAL
2 p	10520.00	57.60	94.00	-36.40	48.12	6.58	38.40	35.50	245	100	Peak	HORIZONTAL

Vertical

	Freq	Level	Limit Line	Over Limit	Read Level	Cable Loss	Antenna Factor	Preamp Factor	T/Pos	A/Pos	Remark	Pol/Phase
	MHz	dBuV/m	dBuV/m	dB	dBuV	dB	dB/m	dB	deg	cm		
1 a	10520.00	41.61	74.00	-32.39	32.14	6.58	38.39	35.50	151	100	Average	VERTICAL
2 p	10520.00	53.92	94.00	-40.08	44.45	6.58	38.39	35.50	151	100	Peak	VERTICAL

Temperature	18°C	Humidity	55%
Test Engineer	Allen Liu	Configurations	IEEE 802.11n MCS0 20MHz Ch 60 / Ant. 1 + Ant. 2
Test Date	Mar. 05, 2010		

Horizontal

	Freq	Level	Limit	Over	Read	Cable	Antenna	Preamp	T/Pos	A/Pos	Remark	Pol/Phase
	MHz	dBuV/m	dBuV/m	dB	dBuV	dB	dB/m	dB	deg	cm		
1	10599.98	40.13	74.00	-33.87	30.56	6.61	38.38	35.42	147	100	Average	HORIZONTAL
2	10599.98	53.91	94.00	-40.09	44.34	6.61	38.38	35.42	147	100	Peak	HORIZONTAL
3 a	10600.01	40.11	60.00	-19.89	30.54	6.61	38.38	35.42	147	100	Average	HORIZONTAL
4 p	10600.01	53.30	80.00	-26.70	43.73	6.61	38.38	35.42	147	100	Peak	HORIZONTAL

Vertical

	Freq	Level	Limit	Over	Read	Cable	Antenna	Preamp	T/Pos	A/Pos	Remark	Pol/Phase
	MHz	dBuV/m	dBuV/m	dB	dBuV	dB	dB/m	dB	deg	cm		
1	10599.98	40.34	74.00	-33.66	30.77	6.61	38.38	35.42	279	100	Average	VERTICAL
2	10599.99	52.41	94.00	-41.59	42.84	6.61	38.38	35.42	279	100	Peak	VERTICAL
3 a	10600.00	40.36	60.00	-19.64	30.79	6.61	38.38	35.42	279	100	Average	VERTICAL
4 p	10600.01	53.13	80.00	-26.87	43.56	6.61	38.38	35.42	279	100	Peak	VERTICAL



Temperature	18°C	Humidity	55%
Test Engineer	Allen Liu	Configurations	IEEE 802.11n MCS0 20MHz Ch 64 / Ant. 1 + Ant. 2
Test Date	Mar. 05, 2010		

Horizontal

	Freq	Level	Limit Line	Over Limit	Read Level	Cable Loss	Antenna Factor	Preamp Factor	T/Pos	A/Pos	Remark	Pol/Phase
	MHz	dBuV/m	dBuV/m	dB	dBuV	dB	dB/m	dB	deg	cm		
1 a	10639.97	39.98	60.00	-20.02	30.38	6.62	38.37	35.39	142	100	Average	HORIZONTAL
2 p	10640.01	53.97	80.00	-26.03	44.37	6.62	38.37	35.39	142	100	Peak	HORIZONTAL

Vertical

	Freq	Level	Limit Line	Over Limit	Read Level	Cable Loss	Antenna Factor	Preamp Factor	T/Pos	A/Pos	Remark	Pol/Phase
	MHz	dBuV/m	dBuV/m	dB	dBuV	dB	dB/m	dB	deg	cm		
1 a	10640.01	40.33	60.00	-19.67	30.73	6.62	38.37	35.39	230	100	Average	VERTICAL
2 p	10640.02	53.80	80.00	-26.20	44.20	6.62	38.37	35.39	230	100	Peak	VERTICAL



Temperature	18°C	Humidity	55%
Test Engineer	Allen Liu	Configurations	IEEE 802.11n MCS0 20MHz Ch 100 / Ant. 1 + Ant. 2
Test Date	Mar. 05, 2010		

Horizontal

	Freq	Level	Limit	Over	Read	Cable	Antenna	Preamp	T/Pos	A/Pos	Remark	Pol/Phase
	MHz	dBuV/m	dBuV/m	dB	dBuV	Loss	Factor	Factor	deg	cm		
1 a	10999.97	40.64	60.00	-19.36	30.68	6.74	38.32	35.10	167	100	Average	HORIZONTAL
2 p	11000.02	54.77	80.00	-25.23	44.81	6.74	38.32	35.10	167	100	Peak	HORIZONTAL

Vertical

	Freq	Level	Limit	Over	Read	Cable	Antenna	Preamp	T/Pos	A/Pos	Remark	Pol/Phase
	MHz	dBuV/m	dBuV/m	dB	dBuV	Loss	Factor	Factor	deg	cm		
1 a	10999.97	42.24	60.00	-17.76	32.30	6.74	38.30	35.10	271	100	Average	VERTICAL
2 p	11000.00	56.27	80.00	-23.73	46.33	6.74	38.30	35.10	271	100	Peak	VERTICAL



Temperature	18°C	Humidity	55%
Test Engineer	Allen Liu	Configurations	IEEE 802.11n MCS0 20MHz Ch 116 / Ant. 1 + Ant. 2
Test Date	Mar. 05, 2010		

Horizontal

	Freq	Level	Limit	Over	Read	Cable	Antenna	Preamp	T/Pos	A/Pos	Remark	Pol/Phase
	MHz	dBuV/m	dBuV/m	dB	dBuV	Loss	Factor	Factor	deg	cm		
1 a	11159.99	41.73	60.00	-18.27	31.69	6.74	38.47	35.17	231	100	Average	HORIZONTAL
2 p	11159.99	54.30	80.00	-25.70	44.26	6.74	38.47	35.17	231	100	Peak	HORIZONTAL

Vertical

	Freq	Level	Limit	Over	Read	Cable	Antenna	Preamp	T/Pos	A/Pos	Remark	Pol/Phase
	MHz	dBuV/m	dBuV/m	dB	dBuV	Loss	Factor	Factor	deg	cm		
1 a	11159.97	44.40	60.00	-15.60	34.36	6.74	38.47	35.17	300	100	Average	VERTICAL
2 p	11159.98	57.17	80.00	-22.83	47.13	6.74	38.47	35.17	300	100	Peak	VERTICAL



Temperature	18°C	Humidity	55%
Test Engineer	Allen Liu	Configurations	IEEE 802.11n MCS0 20MHz Ch 140 / Ant. 1 + Ant. 2
Test Date	Mar. 05, 2010		

Horizontal

	Freq	Level	Limit	Over	Read	Cable	Antenna	Preamp	T/Pos	A/Pos	Remark	Pol/Phase
	MHz	dBuV/m	dBuV/m	dB	dBuV	Loss	Factor	Factor	deg	cm		
1 a	11399.99	40.89	60.00	-19.11	30.70	6.74	38.70	35.25	94	100	Average	HORIZONTAL
2 p	11400.01	53.80	80.00	-26.20	43.61	6.74	38.70	35.25	94	100	Peak	HORIZONTAL

Vertical

	Freq	Level	Limit	Over	Read	Cable	Antenna	Preamp	T/Pos	A/Pos	Remark	Pol/Phase
	MHz	dBuV/m	dBuV/m	dB	dBuV	Loss	Factor	Factor	deg	cm		
1 a	11399.99	41.98	60.00	-18.02	31.79	6.74	38.70	35.25	160	100	Average	VERTICAL
2 p	11400.01	53.81	80.00	-26.19	43.62	6.74	38.70	35.25	160	100	Peak	VERTICAL



Temperature	18°C	Humidity	55%
Test Engineer	Allen Liu	Configurations	IEEE 802.11n MCS0 40MHz Ch 38 / Ant. 1 + Ant. 2
Test Date	Mar. 05, 2010		

Horizontal

	Freq	Level	Limit	Over	Read	Cable	Antenna	Preamp	T/Pos	A/Pos	Remark	Pol/Phase
	MHz	dBuV/m	dBuV/m	dB	dBuV	Loss	Factor	Factor	deg	cm		
1 p	10380.00	52.47	94.00	-41.53	43.19	6.50	38.38	35.60	119	100	Peak	HORIZONTAL
2 a	10380.03	38.92	74.00	-35.08	29.64	6.50	38.38	35.60	119	100	Average	HORIZONTAL

Vertical

	Freq	Level	Limit	Over	Read	Cable	Antenna	Preamp	T/Pos	A/Pos	Remark	Pol/Phase
	MHz	dBuV/m	dBuV/m	dB	dBuV	Loss	Factor	Factor	deg	cm		
1 p	10380.02	52.58	94.00	-41.42	43.30	6.50	38.38	35.60	227	100	Peak	VERTICAL
2 a	10380.03	39.39	74.00	-34.61	30.11	6.50	38.38	35.60	227	100	Average	VERTICAL



Temperature	18°C	Humidity	55%
Test Engineer	Allen Liu	Configurations	IEEE 802.11n MCS0 40MHz Ch 46 / Ant. 1 + Ant. 2
Test Date	Mar. 05, 2010		

Horizontal

	Freq	Level	Limit	Over	Read	Cable	Antenna	Preamp	T/Pos	A/Pos	Remark	Pol/Phase
	MHz	dBuV/m	dBuV/m	dB	dBuV	Loss	Factor	Factor	deg	cm		
1 a	10459.99	39.23	74.00	-34.77	29.83	6.55	38.39	35.54	94	100	Average	HORIZONTAL
2 p	10460.02	52.71	94.00	-41.29	43.31	6.55	38.39	35.54	94	100	Peak	HORIZONTAL

Vertical

	Freq	Level	Limit	Over	Read	Cable	Antenna	Preamp	T/Pos	A/Pos	Remark	Pol/Phase
	MHz	dBuV/m	dBuV/m	dB	dBuV	Loss	Factor	Factor	deg	cm		
1 a	10460.01	40.22	74.00	-33.78	30.82	6.55	38.39	35.54	241	100	Average	VERTICAL
2 p	10460.01	53.93	94.00	-40.07	44.53	6.55	38.39	35.54	241	100	Peak	VERTICAL



Temperature	18°C	Humidity	55%
Test Engineer	Allen Liu	Configurations	IEEE 802.11n MCS0 40MHz Ch 54 / Ant. 1 + Ant. 2
Test Date	Mar. 05, 2010		

Horizontal

	Freq	Level	Limit	Over	Read	Cable	Antenna	Preamp	T/Pos	A/Pos	Remark	Pol/Phase
	MHz	dBuV/m	dBuV/m	dB	dBuV	Loss	Factor	Factor	deg	cm		
1 p	10539.98	54.44	94.00	-39.56	44.94	6.59	38.39	35.48	130	100	Peak	HORIZONTAL
2 a	10540.01	39.86	74.00	-34.14	30.36	6.59	38.39	35.48	130	100	Average	HORIZONTAL

Vertical

	Freq	Level	Limit	Over	Read	Cable	Antenna	Preamp	T/Pos	A/Pos	Remark	Pol/Phase
	MHz	dBuV/m	dBuV/m	dB	dBuV	Loss	Factor	Factor	deg	cm		
1 p	10539.99	55.08	94.00	-38.92	45.58	6.59	38.39	35.48	228	100	Peak	VERTICAL
2 a	10540.01	40.51	74.00	-33.49	31.01	6.59	38.39	35.48	228	100	Average	VERTICAL



Temperature	18°C	Humidity	55%
Test Engineer	Allen Liu	Configurations	IEEE 802.11n MCS0 40MHz Ch 62 / Ant. 1 + Ant. 2
Test Date	Mar. 05, 2010		

Horizontal

	Freq	Level	Limit Line	Over Limit	Read Level	Cable Loss	Antenna Factor	Preamp Factor	T/Pos	A/Pos	Remark	PoI/Phase
	MHz	dBuV/m	dBuV/m	dB	dBuV	dB	dB/m	dB	deg	cm		
1	10593.80	38.68	74.00	-35.32	29.13	6.61	38.38	35.44	72	100	Average	HORIZONTAL
2	10599.40	51.37	94.00	-42.63	41.80	6.61	38.38	35.42	72	100	Peak	HORIZONTAL
3 a	10619.97	38.41	60.00	-21.59	28.84	6.61	38.38	35.42	110	100	Average	HORIZONTAL
4 p	10620.01	52.40	80.00	-27.60	42.83	6.61	38.38	35.42	110	100	Peak	HORIZONTAL

Vertical

	Freq	Level	Limit Line	Over Limit	Read Level	Cable Loss	Antenna Factor	Preamp Factor	T/Pos	A/Pos	Remark	PoI/Phase
	MHz	dBuV/m	dBuV/m	dB	dBuV	dB	dB/m	dB	deg	cm		
1	10598.10	51.90	94.00	-42.10	42.33	6.61	38.38	35.42	109	100	Peak	VERTICAL
2	10598.20	38.54	74.00	-35.46	28.97	6.61	38.38	35.42	109	100	Average	VERTICAL
3 p	10620.00	53.68	80.00	-26.32	44.11	6.61	38.38	35.42	236	100	Peak	VERTICAL
4 a	10620.03	38.98	60.00	-21.02	29.41	6.61	38.38	35.42	236	100	Average	VERTICAL



Temperature	18°C	Humidity	55%
Test Engineer	Allen Liu	Configurations	IEEE 802.11n MCS0 40MHz Ch 102 / Ant. 1 + Ant. 2
Test Date	Mar. 05, 2010		

Horizontal

	Freq	Level	Limit	Over	Read	Cable	Antenna	Preamp	T/Pos	A/Pos	Remark	Pol/Phase
	MHz	dBuV/m	dBuV/m	dB	dBuV	Loss	Factor	Factor	deg	cm		
1 p	11020.00	53.78	80.00	-26.22	43.82	6.74	38.33	35.11	189	100	Peak	HORIZONTAL
2 a	11020.01	41.21	60.00	-18.79	31.25	6.74	38.33	35.11	189	100	Average	HORIZONTAL

Vertical

	Freq	Level	Limit	Over	Read	Cable	Antenna	Preamp	T/Pos	A/Pos	Remark	Pol/Phase
	MHz	dBuV/m	dBuV/m	dB	dBuV	Loss	Factor	Factor	deg	cm		
1 p	11019.99	55.22	80.00	-24.78	45.27	6.74	38.32	35.11	258	100	Peak	VERTICAL
2 a	11020.03	40.92	60.00	-19.08	30.97	6.74	38.32	35.11	258	100	Average	VERTICAL



Temperature	18°C	Humidity	55%
Test Engineer	Allen Liu	Configurations	IEEE 802.11n MCS0 40MHz Ch 110 / Ant. 1 + Ant. 2
Test Date	Mar. 05, 2010		

Horizontal

	Freq	Level	Limit	Over	Read	Cable	Antenna	Preamp	T/Pos	A/Pos	Remark	Pol/Phase
	MHz	dBuV/m	dBuV/m	dB	dBuV	Loss	Factor	Factor	deg	cm		
1 p	11100.02	56.69	80.00	-23.31	46.69	6.74	38.40	35.14	158	100	Peak	HORIZONTAL
2 a	11100.03	42.18	60.00	-17.82	32.18	6.74	38.40	35.14	158	100	Average	HORIZONTAL

Vertical

	Freq	Level	Limit	Over	Read	Cable	Antenna	Preamp	T/Pos	A/Pos	Remark	Pol/Phase
	MHz	dBuV/m	dBuV/m	dB	dBuV	Loss	Factor	Factor	deg	cm		
1 p	11100.00	62.54	80.00	-17.46	52.54	6.74	38.40	35.14	212	100	Peak	VERTICAL
2 a	11100.03	43.90	60.00	-16.10	33.90	6.74	38.40	35.14	212	100	Average	VERTICAL



Temperature	18°C	Humidity	55%
Test Engineer	Allen Liu	Configurations	IEEE 802.11n MCS0 40MHz Ch 134 / Ant. 1 + Ant. 2
Test Date	Mar. 05, 2010		

Horizontal

	Freq	Level	Limit Line	Over Limit	Read Level	Cable Loss	Antenna Factor	Preamp Factor	T/Pos	A/Pos	Remark	Pol/Phase
	MHz	dBuV/m	dBuV/m	dB	dBuV	dB	dB/m	dB	deg	cm		
1 p	11339.98	55.88	80.00	-24.12	45.75	6.74	38.63	35.24	43	100	Peak	HORIZONTAL
2 a	11340.01	40.56	60.00	-19.44	30.43	6.74	38.63	35.24	43	100	Average	HORIZONTAL

Vertical

	Freq	Level	Limit Line	Over Limit	Read Level	Cable Loss	Antenna Factor	Preamp Factor	T/Pos	A/Pos	Remark	Pol/Phase
	MHz	dBuV/m	dBuV/m	dB	dBuV	dB	dB/m	dB	deg	cm		
1 p	11340.01	56.85	80.00	-23.15	46.72	6.74	38.63	35.24	94	100	Peak	VERTICAL
2 a	11340.03	42.70	60.00	-17.30	32.57	6.74	38.63	35.24	94	100	Average	VERTICAL

Note:

The amplitude of spurious emissions that are attenuated by more than 20dB below the permissible value has no need to be reported.

Emission level (dBuV/m) = 20 log Emission level (uV/m).

Corrected Reading: Antenna Factor + Cable Loss + Read Level - Preamp Factor = Level.

The limits above 5GHz shall be extrapolated to the specified distance using an extrapolation factor of 20 dB/decade form 3m to 1.5m.

Distance extrapolation factor = 20 log (specific distance [3m] / test distance [1.5m]) (dB);

Limit line = specific limits (dBuV) + distance extrapolation factor [6 dB].



Temperature	18°C	Humidity	55%
Test Engineer	Allen Liu	Configurations	IEEE 802.11a Ch 36 / Ant. 1 + Ant. 2
Test Date	Mar. 05, 2010		

Horizontal

	Freq	Level	Limit Line	Over Limit	Read Level	CableAntenna Loss	Antenna Factor	Preamp Factor	T/Pos	A/Pos	Remark	Pol/Phase
	MHz	dBuV/m	dBuV/m	dB	dBuV	dB	dB/m	dB	deg	cm		
1 p	10360.00	52.07	94.00	-41.93	42.83	6.49	38.37	35.62	75	101	Peak	HORIZONTAL
2 a	10360.01	40.77	74.30	-33.53	31.53	6.49	38.37	35.62	75	101	Average	HORIZONTAL

Vertical

	Freq	Level	Limit Line	Over Limit	Read Level	CableAntenna Loss	Antenna Factor	Preamp Factor	T/Pos	A/Pos	Remark	Pol/Phase
	MHz	dBuV/m	dBuV/m	dB	dBuV	dB	dB/m	dB	deg	cm		
1 p	10359.98	54.20	94.00	-39.80	44.96	6.49	38.37	35.62	177	101	Peak	VERTICAL
2 a	10360.01	42.19	74.30	-32.11	32.95	6.49	38.37	35.62	177	101	Average	VERTICAL



Temperature	18°C	Humidity	55%
Test Engineer	Allen Liu	Configurations	IEEE 802.11a Ch 40 / Ant. 1 + Ant. 2
Test Date	Mar. 05, 2010		

Horizontal

	Freq	Level	Limit Line	Over Limit	Read Level	CableAntenna Loss	Antenna Factor	Preamp Factor	T/Pos	A/Pos	Remark	Pol/Phase
	MHz	dBuV/m	dBuV/m	dB	dBuV	dB	dB/m	dB	deg	cm		
1 p	10399.99	56.59	94.00	-37.41	47.27	6.52	38.38	35.58	14	100	Peak	HORIZONTAL
2 a	10400.01	47.00	74.30	-27.30	37.68	6.52	38.38	35.58	14	100	Average	HORIZONTAL

Vertical

	Freq	Level	Limit Line	Over Limit	Read Level	CableAntenna Loss	Antenna Factor	Preamp Factor	T/Pos	A/Pos	Remark	Pol/Phase
	MHz	dBuV/m	dBuV/m	dB	dBuV	dB	dB/m	dB	deg	cm		
1 a	10399.99	53.24	74.30	-21.06	43.92	6.52	38.38	35.58	114	100	Average	VERTICAL
2 p	10400.02	64.49	94.00	-29.51	55.17	6.52	38.38	35.58	114	100	Peak	VERTICAL



Temperature	18°C	Humidity	55%
Test Engineer	Allen Liu	Configurations	IEEE 802.11a Ch 48 / Ant. 1 + Ant. 2
Test Date	Mar. 05, 2010		

Horizontal

	Freq	Level	Limit Line	Over Limit	Read Level	Cable Loss	Antenna Factor	Preamp Factor	T/Pos	A/Pos	Remark	Pol/Phase
	MHz	dBuV/m	dBuV/m	dB	dBuV	dB	dB/m	dB	deg	cm		
1 a	10479.99	49.79	74.30	-24.51	40.35	6.57	38.39	35.52	142	122	Average	HORIZONTAL
2 p	10480.02	63.54	94.00	-30.46	54.10	6.57	38.39	35.52	142	122	Peak	HORIZONTAL

Vertical

	Freq	Level	Limit Line	Over Limit	Read Level	Cable Loss	Antenna Factor	Preamp Factor	T/Pos	A/Pos	Remark	Pol/Phase
	MHz	dBuV/m	dBuV/m	dB	dBuV	dB	dB/m	dB	deg	cm		
1 p	10479.98	64.85	94.00	-29.15	55.40	6.57	38.40	35.52	199	100	Peak	VERTICAL
2 a	10480.01	53.96	74.30	-20.34	44.51	6.57	38.40	35.52	199	100	Average	VERTICAL



Temperature	18°C	Humidity	55%
Test Engineer	Allen Liu	Configurations	IEEE 802.11a Ch 52 / Ant. 1 + Ant. 2
Test Date	Mar. 05, 2010		

Horizontal

	Freq	Level	Limit Line	Over Limit	Read Level	Cable Loss	Antenna Factor	Preamp Factor	T/Pos	A/Pos	Remark	Pol/Phase
	MHz	dBuV/m	dBuV/m	dB	dBuV	dB	dB/m	dB	deg	cm		
1 a	10520.00	47.01	74.30	-27.29	37.53	6.58	38.40	35.50	142	100	Average	HORIZONTAL
2 p	10520.01	59.94	94.00	-34.06	50.46	6.58	38.40	35.50	142	100	Peak	HORIZONTAL

Vertical

	Freq	Level	Limit Line	Over Limit	Read Level	Cable Loss	Antenna Factor	Preamp Factor	T/Pos	A/Pos	Remark	Pol/Phase
	MHz	dBuV/m	dBuV/m	dB	dBuV	dB	dB/m	dB	deg	cm		
1 a	10519.99	51.63	74.30	-22.67	42.16	6.58	38.39	35.50	213	100	Average	VERTICAL
2 p	10520.01	62.82	94.00	-31.18	53.35	6.58	38.39	35.50	213	100	Peak	VERTICAL



Temperature	18°C	Humidity	55%
Test Engineer	Allen Liu	Configurations	IEEE 802.11a Ch 60 / Ant. 1 + Ant. 2
Test Date	Mar. 05, 2010		

Horizontal

	Freq	Level	Limit Line	Over Limit	Read Level	Cable Loss	Antenna Factor	Preamp Factor	T/Pos	A/Pos	Remark	Pol/Phase
	MHz	dBuV/m	dBuV/m	dB	dBuV	dB	dB/m	dB	deg	cm		
1	10599.98	54.88	94.00	-39.12	45.31	6.61	38.38	35.42	53	100	Peak	HORIZONTAL
2	10599.99	40.00	74.00	-34.00	30.43	6.61	38.38	35.42	53	100	Average	HORIZONTAL
3 a	10600.00	44.45	60.00	-15.55	34.88	6.61	38.38	35.42	53	100	Average	HORIZONTAL
4 p	10600.00	52.51	80.00	-27.49	42.94	6.61	38.38	35.42	53	100	Peak	HORIZONTAL

Vertical

	Freq	Level	Limit Line	Over Limit	Read Level	Cable Loss	Antenna Factor	Preamp Factor	T/Pos	A/Pos	Remark	Pol/Phase
	MHz	dBuV/m	dBuV/m	dB	dBuV	dB	dB/m	dB	deg	cm		
1	10599.98	51.59	94.00	-42.41	42.02	6.61	38.38	35.42	134	100	Peak	VERTICAL
2	10599.99	41.28	74.00	-32.72	31.71	6.61	38.38	35.42	134	100	Average	VERTICAL
3 a	10600.00	47.87	60.00	-12.13	38.30	6.61	38.38	35.42	134	100	Average	VERTICAL
4 p	10600.01	56.43	80.00	-23.57	46.86	6.61	38.38	35.42	134	100	Peak	VERTICAL



Temperature	18°C	Humidity	55%
Test Engineer	Allen Liu	Configurations	IEEE 802.11a Ch 64 / Ant. 1 + Ant. 2
Test Date	Mar. 05, 2010		

Horizontal

	Freq	Level	Limit Line	Over Limit	Read Level	CableAntenna Loss	Antenna Factor	Preamp Factor	T/Pos	A/Pos	Remark	Pol/Phase
	MHz	dBuV/m	dBuV/m	dB	dBuV	dB	dB/m	dB	deg	cm		
1 a	10639.98	45.69	60.00	-14.31	36.09	6.62	38.37	35.39	166	100	Average	HORIZONTAL
2 p	10640.00	53.28	80.00	-26.72	43.68	6.62	38.37	35.39	166	100	Peak	HORIZONTAL

Vertical

	Freq	Level	Limit Line	Over Limit	Read Level	CableAntenna Loss	Antenna Factor	Preamp Factor	T/Pos	A/Pos	Remark	Pol/Phase
	MHz	dBuV/m	dBuV/m	dB	dBuV	dB	dB/m	dB	deg	cm		
1 a	10639.98	44.21	60.00	-15.79	34.61	6.62	38.37	35.39	72	100	Average	VERTICAL
2 p	10640.02	54.60	80.00	-25.40	45.00	6.62	38.37	35.39	72	100	Peak	VERTICAL



Temperature	18°C	Humidity	55%
Test Engineer	Allen Liu	Configurations	IEEE 802.11a Ch 100 / Ant. 1 + Ant. 2
Test Date	Mar. 05, 2010		

Horizontal

	Freq	Level	Limit Line	Over Limit	Read Level	CableAntenna Loss	Antenna Factor	Preamp Factor	T/Pos	A/Pos	Remark	Pol/Phase
	MHz	dBuV/m	dBuV/m	dB	dBuV	dB	dB/m	dB	deg	cm		
1 a	10999.60	49.61	60.00	-10.39	39.65	6.74	38.32	35.10	211	119	Average	HORIZONTAL
2 p	11001.72	62.75	80.00	-17.25	52.79	6.74	38.32	35.10	211	119	Peak	HORIZONTAL

Vertical

	Freq	Level	Limit Line	Over Limit	Read Level	CableAntenna Loss	Antenna Factor	Preamp Factor	T/Pos	A/Pos	Remark	Pol/Phase
	MHz	dBuV/m	dBuV/m	dB	dBuV	dB	dB/m	dB	deg	cm		
1 a	11000.32	50.29	60.00	-9.71	40.35	6.74	38.30	35.10	194	100	Average	VERTICAL
2 p	11009.64	64.77	80.00	-15.23	54.82	6.74	38.32	35.11	194	100	Peak	VERTICAL



Temperature	18°C	Humidity	55%
Test Engineer	Allen Liu	Configurations	IEEE 802.11a Ch 116 / Ant. 1 + Ant. 2
Test Date	Mar. 05, 2010		

Horizontal

	Freq	Level	Limit Line	Over Limit	Read Level	CableAntenna Loss	Antenna Factor	Preamp Factor	T/Pos	A/Pos	Remark	Pol/Phase
	MHz	dBuV/m	dBuV/m	dB	dBuV	dB	dB/m	dB	deg	cm		
1 p	11157.56	60.93	80.00	-19.07	50.90	6.74	38.45	35.16	237	118	Peak	HORIZONTAL
2 a	11158.92	47.50	60.00	-12.50	37.46	6.74	38.47	35.17	237	118	Average	HORIZONTAL

Vertical

	Freq	Level	Limit Line	Over Limit	Read Level	CableAntenna Loss	Antenna Factor	Preamp Factor	T/Pos	A/Pos	Remark	Pol/Phase
	MHz	dBuV/m	dBuV/m	dB	dBuV	dB	dB/m	dB	deg	cm		
1 p	11158.20	64.65	80.00	-15.35	54.63	6.74	38.45	35.17	271	121	Peak	VERTICAL
2 a	11159.92	51.66	60.00	-8.34	41.62	6.74	38.47	35.17	271	121	Average	VERTICAL



Temperature	18°C	Humidity	55%
Test Engineer	Allen Liu	Configurations	IEEE 802.11a Ch 140 / Ant. 1 + Ant. 2
Test Date	Mar. 05, 2010		

Horizontal

	Freq	Level	Limit Line	Over Limit	Read Level	Cable Loss	Antenna Factor	Preamp Factor	T/Pos	A/Pos	Remark	Pol/Phase
	MHz	dBuV/m	dBuV/m	dB	dBuV	dB	dB/m	dB	deg	cm		
1 a	11399.00	51.12	60.00	-8.88	40.93	6.74	38.70	35.25	176	115	Average	HORIZONTAL
2 p	11401.48	66.94	80.00	-13.06	56.75	6.74	38.70	35.25	176	115	Peak	HORIZONTAL

Vertical

	Freq	Level	Limit Line	Over Limit	Read Level	Cable Loss	Antenna Factor	Preamp Factor	T/Pos	A/Pos	Remark	Pol/Phase
	MHz	dBuV/m	dBuV/m	dB	dBuV	dB	dB/m	dB	deg	cm		
1 p	11399.20	66.78	80.00	-13.22	56.59	6.74	38.70	35.25	192	111	Peak	VERTICAL
2 a	11399.52	53.28	60.00	-6.72	43.09	6.74	38.70	35.25	192	111	Average	VERTICAL

Note:

The amplitude of spurious emissions that are attenuated by more than 20dB below the permissible value has no need to be reported.

Emission level (dBuV/m) = 20 log Emission level (uV/m).

Corrected Reading: Antenna Factor + Cable Loss + Read Level - Preamp Factor = Level.

The limits above 5GHz shall be extrapolated to the specified distance using an extrapolation factor of 20 dB/decade form 3m to 1.5m.

Distance extrapolation factor = 20 log (specific distance [3m] / test distance [1.5m]) (dB);

Limit line = specific limits (dBuV) + distance extrapolation factor [6 dB].

4.7. Band Edge Emissions Measurement

4.7.1. Limit

For transmitters operating in the 5.15-5.35 GHz band: all emissions outside of the 5.15-5.35 GHz band shall not exceed an EIRP of -27 dBm/MHz (68.3dBuV/m at 3m). For transmitters operating in the 5.470-5.725 GHz band: all emissions outside of the 5.470-5.725 GHz band shall not exceed an EIRP of -27 dBm/MHz (68.3dBuV/m at 3m). For transmitters operating in the 5.725-5.825 GHz band: all emissions within the frequency range from the band edge to 10 MHz above or below the band edge shall not exceed an EIRP of -17 dBm/MHz (78.3dBuV/m at 3m); for frequencies 10 MHz or greater above or below the band edge, emissions shall not exceed an EIRP of -27 dBm/MHz (68.3dBuV/m at 3m). In addition, in case the emission falls within the restricted band specified on 15.205(a), then the 15.209(a) limit in the table below has to be followed.

Frequencies (MHz)	Field Strength (micovolts/meter)	Measurement Distance (meters)
0.009~0.490	2400/F(KHz)	300
0.490~1.705	24000/F(KHz)	30
1.705~30.0	30	30
30~88	100	3
88~216	150	3
216~960	200	3
Above 960	500	3

4.7.2. Measuring Instruments and Setting

Please refer to section 5 of equipments list in this report. The following table is the setting of the spectrum analyzer.

Spectrum Parameter	Setting
Attenuation	Auto
Span Frequency	100 MHz
RB / VB (Emission in restricted band)	1MHz / 1MHz for Peak, 1 MHz / 10Hz for Average
RB / VB (Emission in non-restricted band)	1 MHz / 1 MHz for Peak

4.7.3. Test Procedures

1. The test procedure is the same as section 4.6.3, only the frequency range investigated is limited to 100MHz around bandedges.
2. In case the emission is fail due to the used RB/VB is too wide, marker-delta method of FCC Public Notice DA00-705 will be followed.

4.7.4. Test Setup Layout

This test setup layout is the same as that shown in section 4.6.4.

4.7.5. Test Deviation

There is no deviation with the original standard.

4.7.6. EUT Operation during Test

The EUT was programmed to be in continuously transmitting mode.

4.7.7. Test Result of Band Edge and Fundamental Emissions

Temperature	18°C	Humidity	55%
Test Engineer	Allen Liu	Configurations	IEEE 802.11n MCS0 20MHz Ch 36, 40 / Ant. 1 + Ant. 2
Test Date	Mar. 05, 2010		

Channel 36

	Freq	Level	Limit	Over	Read	CableAntenna	Preamp	T/Pos	A/Pos	Remark	Pol/Phase
	MHz	dBuV/m	dBuV/m	dB	dBuV	dB	dB/m	dB	deg	cm	
1 !	5150.00	58.91	60.00	-1.09	21.18	4.06	33.67	0.00	53	100 Average	VERTICAL
2 !	5150.00	74.85	80.00	-5.15	37.12	4.06	33.67	0.00	53	100 Peak	VERTICAL
3 a	5173.00	98.20	74.00			4.08	33.70	0.00	53	100 Average	VERTICAL
4 p	5185.60	115.80	94.00			4.08	33.73	0.00	53	100 Peak	VERTICAL

Item 3, 4 are the fundamental frequency at 5180 MHz.

Channel 40

	Freq	Level	Limit	Over	Read	CableAntenna	Preamp	T/Pos	A/Pos	Remark	Pol/Phase
	MHz	dBuV/m	dBuV/m	dB	dBuV	dB	dB/m	dB	deg	cm	
1	5148.80	67.97	80.00	-12.03	30.24	4.06	33.67	0.00	51	108 Peak	VERTICAL
2 !	5150.00	54.89	60.00	-5.11	17.16	4.06	33.67	0.00	51	108 Average	VERTICAL
3 a	5196.00	100.17	74.00			4.09	33.76	0.00	51	108 Average	VERTICAL
4 p	5196.00	115.81	94.00			4.09	33.76	0.00	51	108 Peak	VERTICAL

Item 3, 4 are the fundamental frequency at 5200 MHz.

Temperature	18°C	Humidity	55%
Test Engineer	Allen Liu	Configurations	IEEE 802.11n MCS0 20MHz Ch 60, 64 / Ant. 1 + Ant. 2
Test Date	Mar. 05, 2010		

Channel 60

	Freq	Level	Limit	Over	Read	CableAntenna	Preamp	T/Pos	A/Pos	Remark	Pol/Phase
	MHz	dBuV/m	dBuV/m	dB	dBuV	Loss	Factor	Factor	deg	cm	
1 p	5296.00	113.72	94.00			4.14	33.91	0.00	26	113 Peak	VERTICAL
2 a	5303.20	98.80	74.00			4.14	33.94	0.00	26	113 Average	VERTICAL
3 !	5350.00	55.29	60.00	-4.71	17.09	4.17	34.03	0.00	26	113 Average	VERTICAL
4	5351.20	67.13	80.00	-12.87	28.93	4.17	34.03	0.00	26	113 Peak	VERTICAL

Item 1, 2 are the fundamental frequency at 5300 MHz.

Channel 64

	Freq	Level	Limit	Over	Read	CableAntenna	Preamp	T/Pos	A/Pos	Remark	Pol/Phase
	MHz	dBuV/m	dBuV/m	dB	dBuV	Loss	Factor	Factor	deg	cm	
1 p	5313.60	117.83	94.00			4.14	33.94	0.00	46	113 Peak	VERTICAL
2 a	5316.00	102.75	74.00			4.16	33.97	0.00	46	113 Average	VERTICAL
3 !	5350.60	59.95	60.00	-0.05	21.75	4.17	34.03	0.00	46	113 Average	VERTICAL
4 !	5355.40	74.68	80.00	-5.32	36.48	4.17	34.03	0.00	46	113 Peak	VERTICAL

Item 1, 2 are the fundamental frequency at 5320 MHz.



Temperature	18°C	Humidity	55%
Test Engineer	Allen Liu	Configurations	IEEE 802.11n MCS0 20MHz Ch 100, 120, 140 / Ant. 1 + Ant. 2
Test Date	Mar. 05, 2010		

Channel 100

	Freq	Level	Limit Line	Over Limit	Read Level	Cable Loss	Antenna Factor	Preamp Factor	T/Pos	A/Pos	Remark	Pol/Phase
	MHz	dBuV/m	dBuV/m	dB	dBuV	dB	dB/m	dB	deg	cm		
1 !	5458.40	56.18	60.00	-3.82	17.74	4.23	34.21	0.00	47	107	Average	VERTICAL
2	5460.00	68.30	80.00	-11.70	29.86	4.23	34.21	0.00	47	107	Peak	VERTICAL
3	5469.20	72.22	94.00	-21.78	33.74	4.24	34.24	0.00	47	107	Peak	VERTICAL
4	5470.00	57.30	74.00	-16.70	18.82	4.24	34.24	0.00	47	107	Average	VERTICAL
5 a	5496.00	101.22	74.00			4.26	34.26	0.00	47	107	Average	VERTICAL
6 p	5498.60	117.52	94.00			4.26	34.26	0.00	47	107	Peak	VERTICAL

Item 5, 6 are the fundamental frequency at 5500 MHz.

Channel 140

	Freq	Level	Limit Line	Over Limit	Read Level	Cable Loss	Antenna Factor	Preamp Factor	T/Pos	A/Pos	Remark	Pol/Phase
	MHz	dBuV/m	dBuV/m	dB	dBuV	dB	dB/m	dB	deg	cm		
1 p	5695.80	118.88	94.00			4.36	34.34	0.00	41	102	Peak	VERTICAL
2 a	5703.40	103.60	74.00			4.38	34.34	0.00	41	102	Average	VERTICAL
3	5725.40	66.71	74.00	-7.29	27.98	4.39	34.34	0.00	41	102	Average	VERTICAL
4	5726.20	83.58	94.00	-10.42	44.85	4.39	34.34	0.00	41	102	Peak	VERTICAL

Item 1, 2 are the fundamental frequency at 5700 MHz.



Temperature	18°C	Humidity	55%
Test Engineer	Allen Liu	Configurations	IEEE 802.11n MCS0 40MHz Ch 38, 46 / Ant. 1 + Ant. 2
Test Date	Mar. 05, 2010		

Channel 38

	Freq	Level	Limit Line	Over Limit	Read Level	Cable Loss	Antenna Factor	Preamp Factor	T/Pos	A/Pos	Remark	Pol/Phase
	MHz	dBuV/m	dBuV/m	dB	dBuV	dB	dB/m	dB	deg	cm		
1 !	5150.00	59.58	60.00	-0.42	21.85	4.06	33.67	0.00	61	109	Average	VERTICAL
2 !	5150.00	77.55	80.00	-2.45	39.82	4.06	33.67	0.00	61	109	Peak	VERTICAL
3 p	5175.60	110.73	94.00			4.08	33.70	0.00	61	109	Peak	VERTICAL
4 a	5186.00	86.53	74.00			4.08	33.73	0.00	61	109	Average	VERTICAL

Item 3, 4 are the fundamental frequency at 5190 MHz.

Channel 46

	Freq	Level	Limit Line	Over Limit	Read Level	Cable Loss	Antenna Factor	Preamp Factor	T/Pos	A/Pos	Remark	Pol/Phase
	MHz	dBuV/m	dBuV/m	dB	dBuV	dB	dB/m	dB	deg	cm		
1	5147.60	72.87	80.00	-7.13	35.14	4.06	33.67	0.00	52	108	Peak	VERTICAL
2 !	5150.00	56.57	60.00	-3.43	18.84	4.06	33.67	0.00	52	108	Average	VERTICAL
3 a	5223.20	90.21	74.00			4.10	33.79	0.00	52	108	Average	VERTICAL
4 p	5236.00	115.75	94.00			4.10	33.82	0.00	52	108	Peak	VERTICAL

Item 3, 4 are the fundamental frequency at 5230 MHz.

Temperature	18°C	Humidity	55%
Test Engineer	Allen Liu	Configurations	IEEE 802.11n MCS0 40MHz Ch 54, 62 / Ant. 1 + Ant. 2
Test Date	Mar. 05, 2010		

Channel 54

	Freq	Level	Limit	Over	Read	CableAntenna	Preamp	T/Pos	A/Pos	Remark	Pol/Phase
	MHz	dBuV/m	dBuV/m	dB	dBuV	dB	dB/m	dB	deg	cm	
1 p	5265.60	114.08	94.00			4.13	33.88	0.00	48	110 Peak	VERTICAL
2 a	5272.80	89.76	74.00			4.13	33.88	0.00	48	110 Average	VERTICAL
3 !	5350.40	56.18	60.00	-3.82	17.98	4.17	34.03	0.00	48	110 Average	VERTICAL
4	5353.60	68.70	80.00	-11.30	30.50	4.17	34.03	0.00	48	110 Peak	VERTICAL

Item 1, 2 are the fundamental frequency at 5270 MHz.

Channel 62

	Freq	Level	Limit	Over	Read	CableAntenna	Preamp	T/Pos	A/Pos	Remark	Pol/Phase
	MHz	dBuV/m	dBuV/m	dB	dBuV	dB	dB/m	dB	deg	cm	
1 p	5318.40	113.31	94.00			4.16	33.97	0.00	45	112 Peak	VERTICAL
2 a	5323.20	87.70	74.00			4.16	33.97	0.00	45	112 Average	VERTICAL
3 !	5350.80	59.33	60.00	-0.67	21.13	4.17	34.03	0.00	45	112 Average	VERTICAL
4 !	5350.80	78.30	80.00	-1.70	40.10	4.17	34.03	0.00	45	112 Peak	VERTICAL

Item 1, 2 are the fundamental frequency at 5310 MHz.

Temperature	18°C	Humidity	55%
Test Engineer	Allen Liu	Configurations	IEEE 802.11n MCS0 40MHz Ch 102, 110, 134 / Ant. 1 + Ant. 2
Test Date	Mar. 05, 2010		

Channel 102

	Freq	Level	Limit	Over	Read	Cable	Antenna	Preamp	T/Pos	A/Pos	Remark	Pol/Phase
	MHz	dBuV/m	dBuV/m	dB	dBuV	dB	dB/m	dB	deg	cm		
1 !	5460.00	59.63	60.00	-0.37	21.19	4.23	34.21	0.00	24	108	Average	VERTICAL
2 !	5460.00	74.77	80.00	-5.23	36.33	4.23	34.21	0.00	24	108	Peak	VERTICAL
3	5468.40	81.02	94.00	-12.98	42.54	4.24	34.24	0.00	24	108	Peak	VERTICAL
4	5470.00	61.75	74.00	-12.25	23.27	4.24	34.24	0.00	24	108	Average	VERTICAL
5 a	5498.40	88.50	74.00			4.26	34.26	0.00	24	108	Average	VERTICAL
6 p	5518.80	112.78	94.00			4.26	34.30	0.00	24	108	Peak	VERTICAL

Item 5, 6 are the fundamental frequency at 5510MHz.

Channel 110

	Freq	Level	Limit	Over	Read	Cable	Antenna	Preamp	T/Pos	A/Pos	Remark	Pol/Phase
	MHz	dBuV/m	dBuV/m	dB	dBuV	dB	dB/m	dB	deg	cm		
1	5457.60	69.94	80.00	-10.06	31.50	4.23	34.21	0.00	73	100	Peak	VERTICAL
2 !	5460.00	56.70	60.00	-3.30	18.26	4.23	34.21	0.00	73	100	Average	VERTICAL
3	5465.20	71.93	94.00	-22.07	33.49	4.23	34.21	0.00	73	100	Peak	VERTICAL
4	5470.00	58.06	74.00	-15.94	19.58	4.24	34.24	0.00	73	100	Average	VERTICAL
5 a	5555.20	89.51	74.00			4.29	34.31	0.00	73	100	Average	VERTICAL
6 p	5555.60	114.69	94.00			4.29	34.31	0.00	73	100	Peak	VERTICAL

Item 5, 6 are the fundamental frequency at 5550 MHz.

Channel 134

	Freq	Level	Limit	Over	Read	Cable	Antenna	Preamp	T/Pos	A/Pos	Remark	Pol/Phase
	MHz	dBuV/m	dBuV/m	dB	dBuV	dB	dB/m	dB	deg	cm		
1 a	5665.20	91.16	74.00			4.34	34.33	0.00	44	108	Average	VERTICAL
2 p	5673.60	116.75	94.00			4.36	34.33	0.00	44	108	Peak	VERTICAL
3	5725.40	63.57	74.00	-10.43	24.84	4.39	34.34	0.00	44	108	Average	VERTICAL
4	5728.20	78.57	94.00	-15.43	39.84	4.39	34.34	0.00	44	108	Peak	VERTICAL

Item 1, 2 are the fundamental frequency at 5670 MHz.

Note:

Emission level (dBuV/m) = 20 log Emission level (uV/m)

Corrected Reading: Antenna Factor + Cable Loss + Read Level - Preamp Factor = Level

The limits above 5GHz shall be extrapolated to the specified distance using an extrapolation factor of 20 dB/decade from 3m to 1.5m.

Distance extrapolation factor = 20 log (specific distance [3m] / test distance [1.5m]) (dB);

Limit line = specific limits (dBuV) + distance extrapolation factor [6 dB].

Temperature	18°C	Humidity	55%
Test Engineer	Allen Liu	Configurations	IEEE 802.11a Ch 36, 40 / Ant. 1
Test Date	Mar. 05, 2010		

Channel 36

	Freq	Level	Limit Line	Over Limit	Read Level	Cable Loss	Antenna Factor	Preamp Factor	T/Pos	A/Pos	Remark	Pol/Phase
	MHz	dBuV/m	dBuV/m	dB	dBuV	dB	dB/m	dB	deg	cm		
1 !	5148.80	76.09	80.00	-3.91	38.36	4.06	33.67	0.00	53	117	Peak	VERTICAL
2 !	5150.00	59.84	60.00	-0.16	22.11	4.06	33.67	0.00	53	117	Average	VERTICAL
3 a	5174.40	102.83	74.30			4.08	33.70	0.00	53	117	Average	VERTICAL
4 p	5184.60	117.72	94.00			4.08	33.73	0.00	53	117	Peak	VERTICAL

Item 3, 4 are the fundamental frequency at 5180 MHz.

Channel 40

	Freq	Level	Limit Line	Over Limit	Read Level	Cable Loss	Antenna Factor	Preamp Factor	T/Pos	A/Pos	Remark	Pol/Phase
	MHz	dBuV/m	dBuV/m	dB	dBuV	dB	dB/m	dB	deg	cm		
1	5149.20	69.17	80.00	-10.83	31.44	4.06	33.67	0.00	351	100	Peak	VERTICAL
2 !	5150.00	56.48	60.00	-3.52	18.75	4.06	33.67	0.00	351	100	Average	VERTICAL
3 p	5203.20	115.32	94.00			4.09	33.76	0.00	351	100	Peak	VERTICAL
4 a	5203.60	101.29	74.30			4.09	33.76	0.00	351	100	Average	VERTICAL

Item 3, 4 are the fundamental frequency at 5200 MHz.



Temperature	18°C	Humidity	55%
Test Engineer	Allen Liu	Configurations	IEEE 802.11a Ch 60, 64 / Ant. 1
Test Date	Mar. 05, 2010		

Channel 60

	Freq	Level	Limit	Over	Read	CableAntenna	Preamp	T/Pos	A/Pos	Remark	Pol/Phase
	MHz	dBuV/m	dBuV/m	dB	dBuV	dB	dB/m	dB	deg	cm	
1 p	5296.80	119.05	94.00			4.14	33.94	0.00	53	115 Peak	VERTICAL
2 a	5303.60	104.45	74.30			4.14	33.94	0.00	53	115 Average	VERTICAL
3 !	5350.00	57.29	60.00	-2.71	19.09	4.17	34.03	0.00	53	115 Average	VERTICAL
4	5350.40	69.43	80.00	-10.57	31.23	4.17	34.03	0.00	53	115 Peak	VERTICAL

Item 1, 2 are the fundamental frequency at 5300 MHz.

Channel 64

	Freq	Level	Limit	Over	Read	CableAntenna	Preamp	T/Pos	A/Pos	Remark	Pol/Phase
	MHz	dBuV/m	dBuV/m	dB	dBuV	dB	dB/m	dB	deg	cm	
1 a	5323.20	102.05	74.30			4.16	33.97	0.00	57	123 Average	VERTICAL
2 p	5324.60	116.55	94.00			4.16	33.97	0.00	57	123 Peak	VERTICAL
3 !	5350.00	59.92	60.00	-0.08	21.72	4.17	34.03	0.00	57	123 Average	VERTICAL
4 !	5350.80	77.74	80.00	-2.26	39.54	4.17	34.03	0.00	57	123 Peak	VERTICAL

Item 1, 2 are the fundamental frequency at 5320 MHz.



Temperature	18°C	Humidity	55%
Test Engineer	Allen Liu	Configurations	IEEE 802.11a Ch 100, 140 / Ant. 1
Test Date	Mar. 05, 2010		

Channel 100

	Freq	Level	Limit Line	Over Limit	Read Level	Cable Loss	Antenna Factor	Preamp Factor	T/Pos	A/Pos	Remark	Pol/Phase
	MHz	dBuV/m	dBuV/m	dB	dBuV	dB	dB/m	dB	deg	cm		
1 !	5458.00	74.89	80.00	-5.11	36.45	4.23	34.21	0.00	72	117	Peak	VERTICAL
2 !	5460.00	59.90	60.00	-0.10	21.46	4.23	34.21	0.00	72	117	Average	VERTICAL
3	5469.00	83.77	94.00	-10.23	45.29	4.24	34.24	0.00	72	117	Peak	VERTICAL
4	5470.00	64.87	74.30	-9.43	26.39	4.24	34.24	0.00	72	117	Average	VERTICAL
5 a	5496.60	106.33	74.30			4.26	34.26	0.00	72	117	Average	VERTICAL
6 p	5500.40	118.32	94.00			4.26	34.26	0.00	72	117	Peak	VERTICAL

Item 5, 6 are the fundamental frequency at 5500 MHz.

Channel 140

	Freq	Level	Limit Line	Over Limit	Read Level	Cable Loss	Antenna Factor	Preamp Factor	T/Pos	A/Pos	Remark	Pol/Phase
	MHz	dBuV/m	dBuV/m	dB	dBuV	dB	dB/m	dB	deg	cm		
1 p	5697.20	117.47	94.00			4.36	34.34	0.00	77	100	Peak	VERTICAL
2 a	5705.80	102.87	74.00			4.38	34.34	0.00	77	100	Average	VERTICAL
3 !	5725.00	71.37	74.00	-2.63	32.64	4.39	34.34	0.00	77	100	Average	VERTICAL
4 !	5727.80	90.35	94.00	-3.65	51.62	4.39	34.34	0.00	77	100	Peak	VERTICAL

Item 1, 2 are the fundamental frequency at 5700 MHz.

Note:

Emission level (dBuV/m) = 20 log Emission level (uV/m)

Corrected Reading: Antenna Factor + Cable Loss + Read Level - Preamp Factor = Level

The limits above 5GHz shall be extrapolated to the specified distance using an extrapolation factor of 20 dB/decade form 3m to 1.5m.

Distance extrapolation factor = 20 log (specific distance [3m] / test distance [1.5m]) (dB);

Limit line = specific limits (dBuV) + distance extrapolation factor [6 dB].

4.8. Frequency Stability Measurement

4.8.1. Limit

Manufacturers of U-NII devices are responsible for ensuring frequency stability such that an emissions is maintained within the band of operation under all conditions of normal operation as specified in the user's manual or $\pm 20\text{ppm}$ (IEEE 802.11 specification).

4.8.2. Measuring Instruments and Setting

Please refer to section 5 of equipments list in this report. The following table is the setting of the spectrum analyzer.

Spectrum Parameter	Setting
Attenuation	Auto
Span Frequency	Entire absence of modulation emissions bandwidth
RB	10 kHz
VB	10 kHz
Sweep Time	Auto

4.8.3. Test Procedures

1. The transmitter output (antenna port) was connected to the spectrum analyzer.
2. EUT have transmitted absence of modulation signal and fixed channelize.
3. Set the spectrum analyzer span to view the entire absence of modulation emissions bandwidth.
4. Set RBW = 10 kHz, VBW = 10 kHz with peak detector and maxhold settings.
5. f_c is declaring of channel frequency. Then the frequency error formula is $(f_c - f) / f_c \times 10^6$ ppm and the limit is less than $\pm 20\text{ppm}$ (IEEE 802.11 specification).
6. The test extreme voltage is to change the primary supply voltage from 85 to 115 percent of the nominal value
7. Extreme temperature rule is $-30^\circ\text{C} \sim 50^\circ\text{C}$.
8. Measuring multiple antennas, the connector is required to link with spectrum analyzer through a combiner.

4.8.4. Test Setup Layout

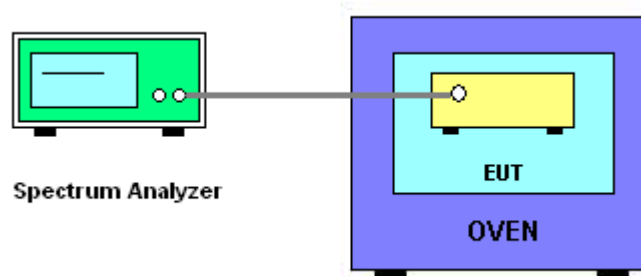

4.8.5. Test Deviation

There is no deviation with the original standard.

4.8.6. EUT Operation during Test

The EUT was programmed to be in continuously un-modulation transmitting mode.

4.8.7. Test Result of Frequency Stability

Voltage vs. Frequency Stability

Voltage	Measurement Frequency (MHz)	
	5200	5300
(V)		
126.50	5200.0190	5300.0139
110.00	5200.0288	5300.0238
93.50	5200.0268	5300.0264
Max. Deviation (MHz)	0.028826	0.026350
Max. Deviation (ppm)	5.54	4.97

Temperature vs. Frequency Stability

Temperature	Measurement Frequency (MHz)	
	5200	5300
(°C)		
-30	5199.9855	5299.9839
-20	5199.9661	5299.9662
-10	5199.9543	5299.9541
0	5199.9510	5299.9516
10	5199.9547	5299.9544
20	5199.9556	5299.9584
30	5199.9545	5299.9580
40	5199.9517	5299.9528
50	5199.9556	5299.9528
Max. Deviation (MHz)	0.049000	0.048400
Max. Deviation (ppm)	9.42	9.1321

4.9. Antenna Requirements

4.9.1. Limit

Except for special regulations, the Low-power Radio-frequency Devices must not be equipped with any jacket for installing an antenna with extension cable. An intentional radiator shall be designed to ensure that no antenna other than that furnished by the responsible party shall be used with the device. The use of a permanently attached antenna or of an antenna that uses a unique coupling to the intentional radiator shall be considered sufficient to comply with the provisions of this Section. The manufacturer may design the unit so that the user can replace a broken antenna, but the use of a standard antenna jack or electrical connector is prohibited. Further, this requirement does not apply to intentional radiators that must be professionally installed.

4.9.2. Antenna Connector Construction

Please refer to section 3.3 in this test report; antenna connector complied with the requirements.

5. LIST OF MEASURING EQUIPMENTS

Instrument	Manufacturer	Model No.	Serial No.	Characteristics	Calibration Date	Remark
EMC Receiver	R&S	ESCS 30	100174	9kHz – 2.75GHz	Apr. 15, 2009	Conduction (CO04-HY)
LISN	MessTec	NNB-2/16Z	99079	9kHz – 30MHz	Mar. 23, 2009	Conduction (CO04-HY)
LISN (Support Unit)	EMCO	3810/2NM	9703-1839	9kHz – 30MHz	Mar. 22, 2009	Conduction (CO04-HY)
LISN (Support Unit)	EMCO	3810/2NM	9703-1839	9kHz – 30MHz	Mar. 22, 2010	Conduction (CO04-HY)
RF Cable-CON	UTIFLEX	3102-26886-4	CB049	9kHz – 30MHz	Apr. 20, 2009	Conduction (CO04-HY)
ISN	SCHAFFNER	ISN T400	21653	9kHz – 30MHz	Jun. 11, 2009	Conduction (CO04-HY)
EMI Filter	LINDGREN	LRE-2030	2651	< 450 Hz	N/A	Conduction (CO04-HY)
3m Semi Anechoic Chamber	SIDT FRANKONIA	SAC-3M	03CH03-HY	30 MHz - 1 GHz 3m	Jun. 07, 2009	Radiation (03CH03-HY)
Amplifier	SCHAFFNER	COA9231A	18667	9 kHz - 2 GHz	Jan. 24, 2010	Radiation (03CH03-HY)
Amplifier	Agilent	8449B	3008A02120	1 GHz - 26.5 GHz	Jul. 21, 2009	Radiation (03CH03-HY)
Amplifier	MITEQ	AMF-6F-260400	9121372	26.5 GHz - 40 GHz	Apr. 06, 2009*	Radiation (03CH03-HY)
Spectrum Analyzer	R&S	FSP30	100305	9 kHz - 40 GHz	Feb. 03, 2010	Radiation (03CH03-HY)
Loop Antenna	R&S	HFH2-Z2	860004/001	9 kHz - 30 MHz	Jul. 28, 2008*	Radiation (03CH03-HY)
Bilog Antenna	SCHAFFNER	CBL 6112D	22237	30 MHz – 1 GHz	Sep. 26, 2009	Radiation (03CH03-HY)
Horn Antenna	EMCO	3115	6741	1GHz ~ 18GHz	Apr. 28, 2009	Radiation (03CH03-HY)
Horn Antenna	SCHWARZBECK	BBHA9170	BBHA9170154	15 GHz - 40 GHz	Jan. 11, 2010	Radiation (03CH03-HY)
RF Cable-R03m	Jye Bao	RG142	CB021	30 MHz - 1 GHz	Jan. 05, 2010	Radiation (03CH03-HY)
RF Cable-HIGH	SUHNER	SUCOFLEX 106	03CH03-HY	1 GHz - 40 GHz	Jan. 05, 2010	Radiation (03CH03-HY)
Turn Table	HD	DS 420	420/650/00	0 – 360 degree	N/A	Radiation (03CH03-HY)
Antenna Mast	HD	MA 240	240/560/00	1 m - 4 m	N/A	Radiation (03CH03-HY)
Spectrum Analyzer	R&S	FSU26.5	100015	20Hz ~ 26.5GHz	Oct. 29, 2009	Conducted (TH01-HY)
Power Meter	R&S	NRVS	100444	DC ~ 40GHz	Jul. 31, 2009	Conducted (TH01-HY)
Power Sensor	R&S	NRV-Z51	100666	DC ~ 30GHz	Aug. 05, 2009	Conducted (TH01-HY)
Power Sensor	R&S	NRV-Z32	100057	30MHz ~ 6GHz	Jul. 31, 2009	Conducted (TH01-HY)
AC Power Source	HPC	HPA-500W	HPA-9100024	AC 0 ~ 300V	Jul. 12, 2009*	Conducted (TH01-HY)
DC Power Source	G.W.	GPC-6030D	C671845	DC 1V ~ 60V	Mar. 13, 2010	Conducted (TH01-HY)
Temp. and Humidity Chamber	Giant Force	GTH-225-20-S	MAB0103-001	N/A	Aug. 06, 2009	Conducted (TH01-HY)
RF CABLE-1m	Jye Bao	RG142	CB034-1m	20MHz ~ 7GHz	Dec. 02, 2009	Conducted (TH01-HY)
RF CABLE-2m	Jye Bao	RG142	CB035-2m	20MHz ~ 1GHz	Dec. 02, 2009	Conducted (TH01-HY)
Vector Signal Generator	R&S	SMU200A	102098	100kHz ~ 6GHz	Feb. 13, 2010	Conducted (TH01-HY)
Signal Generator	R&S	SMR40	100116	10MHz ~ 40GHz	Mar. 25, 2009	Conducted (TH01-HY)

Note: Calibration Interval of instruments listed above is one year.

* Calibration Interval of instruments listed above is two year.

6. TEST LOCATION

SHIJR	ADD : 6Fl., No. 106, Sec. 1, Shintai 5th Rd., Shijr City, Taipei, Taiwan 221, R.O.C. TEL : 886-2-2696-2468 FAX : 886-2-2696-2255
HWA YA	ADD : No. 52, Hwa Ya 1st Rd., Kwei-Shan Hsiang, Tao Yuan Hsien, Taiwan, R.O.C. TEL : 886-3-327-3456 FAX : 886-3-318-0055
LINKOU	ADD : No. 30-2, Dingfu Tsuen, Linkou Shiang, Taipei, Taiwan 244, R.O.C TEL : 886-2-2601-1640 FAX : 886-2-2601-1695
DUNGHU	ADD : No. 3, Lane 238, Kangle St., Neihu Chiu, Taipei, Taiwan 114, R.O.C. TEL : 886-2-2631-4739 FAX : 886-2-2631-9740
JUNGHE	ADD : 7Fl., No. 758, Jungjeng Rd., Junghe City, Taipei, Taiwan 235, R.O.C. TEL : 886-2-8227-2020 FAX : 886-2-8227-2626
NEIHU	ADD : 4Fl., No. 339, Hsin Hu 2 nd Rd., Taipei 114, Taiwan, R.O.C. TEL : 886-2-2794-8886 FAX : 886-2-2794-9777
JHUBEI	ADD : No.8, Lane 724, Bo-ai St., Jhubei City, HsinChu County 302, Taiwan, R.O.C. TEL : 886-3-656-9065 FAX : 886-3-656-9085

7. TAF CERTIFICATE OF ACCREDITATION



Certificate No. : L1190-091230

財團法人全國認證基金會
Taiwan Accreditation Foundation

Certificate of Accreditation

This is to certify that

Sporton International Inc.
EMC & Wireless Communications Laboratory
No.52, Hwa Ya 1st Rd., Hwa Ya Technology Park, Kwei-Shan Hsiang, Tao Yuan Hsien,
Taiwan, R.O.C.

is accredited in respect of laboratory

Accreditation Criteria	: ISO/IEC 17025:2005
Accreditation Number	: 1190
Originally Accredited	: December 15, 2003
Effective Period	: January 10, 2010 to January 09, 2013
Accredited Scope	: Testing Field, see described in the Appendix
Specific Accreditation Program	: Accreditation Program for Designated Testing Laboratory for Commodities Inspection Accreditation Program for Telecommunication Equipment Testing Laboratory Accreditation Program for BSMI Mutual Recognition Arrangement with Foreign Authorities

Jay-san Chen

Jay-San Chen
President, Taiwan Accreditation Foundation
Date : December 30, 2009

Pl, total 22 pages

The Appendix forms an integral part of this Certificate, which shall be invalid when use without the Appendix