

# TEST REPORT

## CERTIFICATE OF CONFORMITY

**Standard:** 47 CFR FCC Part 15, Subpart E (Section 15.407)  
**Report No.:** RFBARR-WTW-P22060042A-8  
**FCC ID:** RAS-MT7927  
**Product:** 2TX 11be (WiFi7) BW320 + BT/BLE Combo Card  
**Brand:** MediaTek  
**Model No.:** MT7927  
**Received Date:** 2022/10/6  
**Test Date:** 2022/11/9 ~ 2023/1/31  
**Issued Date:** 2023/3/23

**Applicant:** MediaTek Inc.

**Address:** No. 1, Dusing 1st Rd., Hsinchu Science Park, Hsinchu City, 30078 Taiwan

**Issued By:** Bureau Veritas Consumer Products Services (H.K.) Ltd., Taoyuan Branch  
Hsin Chu Laboratory

**Lab Address:** E-2, No.1, Li Hsin 1st Road, Hsinchu Science Park, Hsinchu City 300, Taiwan

**Test Location (1):** E-2, No.1, Li Hsin 1st Road, Hsinchu Science Park, Hsinchu City 300, Taiwan

**FCC Registration /** 723255 / TW2022

**Designation Number:**

**Test Location (2):** No.19, Hwa Ya 2nd Rd., Wen Hwa Vil., Kwei Shan Dist., Taoyuan City 33383, TAIWAN

**FCC Registration /** 788550 / TW0003

**Designation Number:**

**Approved by:** \_\_\_\_\_



May Chen / Manager

**Date:** \_\_\_\_\_

2023/3/23

This test report consists of 969 pages in total. It may be duplicated completely for legal use with the approval of the applicant. It should not be reproduced except in full, without the written approval of our laboratory. The test results in the report only apply to the tested sample. The test results in this report are traceable to the national or international standards.



Prepared by : Vito Lung / Specialist

This report is governed by, and incorporates by reference, the Conditions of Testing as posted at the date of issuance of this report at <http://www.bureauveritas.com/home/about-us/our-business/cps/about-us/terms-conditions/> and is intended for your exclusive use. Any copying or replication of this report to or for any other person or entity, or use of our name or trademark, is permitted only with our prior written permission. This report sets forth our findings solely with respect to the test samples identified herein. The results set forth in this report are not indicative or representative of the quality or characteristics of the lot from which a test sample was taken or any similar or identical product unless specifically and expressly noted. Our report includes all of the tests requested by you and the results thereof based upon the information that you provided to us. Measurement uncertainty is only provided upon request for accredited tests. Statements of conformity are based on simple acceptance criteria without taking measurement uncertainty into account, unless otherwise requested in writing. You have 60 days from date of issuance of this report to notify us of any material error or omission caused by our negligence or if you require measurement uncertainty; provided, however, that such notice shall be in writing and shall specifically address the issue you wish to raise. A failure to raise such issue within the prescribed time shall constitute your unqualified acceptance of the completeness of this report, the tests conducted and the correctness of the report contents.

This report contains Contention-based Protocol test data that was produced under subcontract by Bureau Veritas Consumer Products Services (H.K.) Ltd., Taoyuan Branch Lin Kou Laboratories.

## Table of Contents

<b>Release Control Record</b> .....	<b>4</b>
<b>1 Certificate</b> .....	<b>5</b>
<b>2 Summary of Test Results</b> .....	<b>6</b>
2.1 Measurement Uncertainty .....	6
2.2 Supplementary Information .....	6
<b>3 General Information</b> .....	<b>7</b>
3.1 General Description of EUT .....	7
3.2 Antenna Description of EUT .....	9
3.3 Channel List .....	11
3.4 Test Mode Applicability and Tested Channel Detail .....	13
3.5 Duty Cycle of Test Signal .....	19
3.6 Test Program Used and Operation Descriptions .....	28
3.7 Connection Diagram of EUT and Peripheral Devices .....	28
3.8 Configuration of Peripheral Devices and Cable Connections .....	29
3.9 Test Program Used and Operation Descriptions .....	30
3.10 Connection Diagram of EUT and Peripheral Devices .....	30
3.11 Configuration of Peripheral Devices and Cable Connections .....	31
<b>4 Test Instruments</b> .....	<b>32</b>
4.1 RF Output Power .....	32
4.2 Power Spectral Density .....	32
4.3 Emission Bandwidth .....	32
4.4 In-Band Emission Mask .....	32
4.5 Occupied Bandwidth .....	32
4.6 AC Power Conducted Emissions .....	33
4.7 Unwanted Emissions below 1 GHz .....	33
4.8 Unwanted Emissions above 1 GHz .....	34
<b>5 Limits of Test Items</b> .....	<b>35</b>
5.1 RF Output Power .....	35
5.2 Power Spectral Density .....	35
5.3 Emission Bandwidth .....	35
5.4 In-Band Emission Mask .....	36
5.5 Occupied Bandwidth .....	36
5.6 AC Power Conducted Emissions .....	36
5.7 Unwanted Emissions below 1 GHz .....	37
5.8 Unwanted Emissions above 1 GHz .....	37
<b>6 Test Arrangements</b> .....	<b>38</b>
6.1 RF Output Power .....	38
6.1.1 Test Setup .....	38
6.1.2 Test Procedure .....	38
6.2 Power Spectral Density .....	38
6.2.1 Test Setup .....	38
6.2.2 Test Procedure .....	38
6.3 Emission Bandwidth .....	39
6.3.1 Test Setup .....	39
6.3.2 Test Procedure .....	39
6.4 In-Band Emission Mask .....	39
6.4.1 Test Setup .....	39
6.4.2 Test Procedure .....	39
6.5 Occupied Bandwidth .....	40
6.5.1 Test Setup .....	40
6.5.2 Test Procedure .....	40
6.6 AC Power Conducted Emissions .....	41
6.6.1 Test Setup .....	41
6.6.2 Test Procedure .....	41



6.7	Unwanted Emissions below 1 GHz .....	42
6.7.1	Test Setup .....	42
6.7.2	Test Procedure .....	43
6.8	Unwanted Emissions above 1 GHz .....	44
6.8.1	Test Setup .....	44
6.8.2	Test Procedure .....	45
<b>7</b>	<b>Test Results of Test Item .....</b>	<b>46</b>
7.1	RF Output Power .....	46
7.2	Power Spectral Density .....	60
7.3	Emission Bandwidth .....	82
7.4	In-Band Emission Mask .....	98
7.5	Occupied Bandwidth .....	143
7.6	AC Power Conducted Emissions .....	159
7.7	Unwanted Emissions below 1 GHz .....	163
7.8	Unwanted Emissions above 1 GHz .....	170
<b>8</b>	<b>Operational Restrictions for 6 GHz U-NII Devices .....</b>	<b>967</b>
<b>9</b>	<b>Pictures of Test Arrangements .....</b>	<b>968</b>
<b>10</b>	<b>Information of the Testing Laboratories .....</b>	<b>969</b>



## Release Control Record

Issue No.	Description	Date Issued
RFBARR-WTW-P22060042A-8	Original release.	2023/3/23

## 1 Certificate

**Product:** 2TX 11be (WiFi7) BW320 + BT/BLE Combo Card

**Brand:** MediaTek

**Test Model:** MT7927

**Sample Status:** Engineering sample

**Applicant:** MediaTek Inc.

**Test Date:** 2022/11/9 ~ 2023/1/31

**Standard:** 47 CFR FCC Part 15, Subpart E (Section 15.407)

**Measurement** ANSI C63.10-2013

**procedure:**

KDB 987594 D02 U-NII 6 GHz EMC Measurement v01v01

KDB 789033 D02 General UNII Test Procedure New Rules v02r01

KDB 662911 D01 Multiple Transmitter Output v02r01

The above equipment has been tested by **Bureau Veritas Consumer Products Services (H.K.) Ltd., Taoyuan Branch**, and found compliance with the requirement of the above standards. The test record, data evaluation & Equipment Under Test (EUT) configurations represented herein are true and accurate accounts of the measurements of the sample's RF characteristics under the conditions specified in this report.

## 2 Summary of Test Results

47 CFR FCC Part 15, Subpart E (Section 15.407)			
Clause	Test Item	Result	Remark
15.407(a)(7)(8)	RF Output Power	Pass	Meet the requirement of limit.
15.407(a)(7)(8)	Power Spectral Density	Pass	Meet the requirement of limit.
15.407(a)(10)	Occupied Bandwidth	Pass	Meet the requirement of limit.
15.407(b)(9)	AC Power Conducted Emissions	Pass	Minimum passing margin is -8.31 dB at 25.12500 MHz
15.407(b)(9)	Unwanted Emissions below 1 GHz	Pass	Minimum passing margin is -3.4 dB at 199.59, 199.80, 299.29, 896.45 MHz
15.407(b)(6) 15.407(b)(10)	Unwanted Emissions above 1 GHz	Pass	Minimum passing margin is -15.0 dB at 18315.00 MHz
15.407(b)(7)	In-Band Emission Mask	Pass	Meet the requirement of limit.
15.407(d)(6)	Contention-based Protocol	Pass	Refer to Note 2 below
15.407(g)	Frequency Stability	NA	Refer to Note 1 below
15.407(d)	Operational restrictions for 6 GHz U-NII devices	Pass	Declaration by applicant
15.203	Antenna Requirement	Pass	Antenna connector is ipex(MHF) not a standard connector.
---	Emission Bandwidth	Pass	Meet the requirement of limit.

### Notes:

- All test items (except Frequency Stability) were performed for this addendum. The others testing data refer to original test report.
- Contention-based Protocol test items refer to original test report (Report No.: RFBARR-WTW-P22060042A-2).
- Determining compliance based on the results of the compliance measurement, not taking into account measurement instrumentation uncertainty.

### 2.1 Measurement Uncertainty

Where relevant, the following measurement uncertainty levels have been estimated for tests performed on the EUT as specified in CISPR 16-4-2:

Measurement	Specification	Expanded Uncertainty (k=2) (±)
AC Power Conducted Emissions	150 kHz ~ 30 MHz	1.9 dB
Unwanted Emissions below 1 GHz	9 kHz ~ 30 MHz	3.1 dB
	30 MHz ~ 1 GHz	5.5 dB
Unwanted Emissions above 1 GHz	1 GHz ~ 18 GHz	5.1 dB
	18 GHz ~ 40 GHz	5.3 dB

The other instruments specified are routine verified to remain within the calibrated levels, no measurement uncertainty is required to be calculated.

### 2.2 Supplementary Information

There is not any deviation from the test standards for the test method, and no modifications required for compliance.

### 3 General Information

#### 3.1 General Description of EUT

Product	2TX 11be (WiFi7) BW320 + BT/BLE Combo Card
Brand	MediaTek
Test Model	MT7927
Status of EUT	Engineering sample
Power Supply Rating	3.3Vdc from host equipment
Modulation Type	64QAM, 16QAM, QPSK, BPSK for OFDM 1024QAM for OFDMA in 11ax mode 4096QAM for OFDMA in 11be mode
Modulation Technology	OFDM, OFDMA
Transfer Rate	802.11a: up to 54 Mbps 802.11ax: up to 1201.0 Mbps 802.11be: up to 5764.8 Mbps
Operating Frequency	5.955 ~ 6.425GHz, 6.525 ~ 6.875GHz
Number of Channel	802.11a/ax (HE20), 802.11be (EHT20): 41 802.11ax (HE40), 802.11be (EHT40): 20 802.11ax (HE80), 802.11be (EHT80): 9 802.11ax (HE160), 802.11be (EHT160): 4 802.11be (EHT320): 2
Resource Unit (RU)	Single RU: 26-tone, 52-tone, 106-tone, 242-tone, 484-tone, 996-tone Multi-RU(Small RU):52-tone + 26-tone, 106-tone + 26-tone Multi-RU (Large RU):484-tone + 242-tone, 996-tone + 484-tone, 2 * 996-tone
Output Power	5.955 GHz ~ 6.425 GHz : EIRP: 984.341 mW (29.93 dBm) 6.525 GHz ~ 6.875 GHz : EIRP: 945.29 mW (29.76 dBm)
EUT Category	Client Device (controlled of an standard power AP)

Note:

- This is a supplementary report of Report No: RFBARR-WTW-P22060042-2 R1. The differences between them are as below information:
  - ◆ Add dual client (6CD).
- According to above conditions, all test items (except Frequency Stability & Contention-based Protocol) need to be performed. And all data are verified to meet the requirement.
- Indoor client refer RFBARR-WTW-P22060042-2 R1 & RFBARR-WTW-P22060042A-2.
- There are Bluetooth and WLAN (2.4GHz & 5GHz & 6GHz) technology used for the EUT.
- Simultaneously transmission condition.

Condition	Technology	
1	WLAN (5GHz or 5.9GHz)	Bluetooth
2	WLAN (6GHz)	Bluetooth
3	WLAN (2.4GHz)	WLAN (5GHz or 5.9GHz)
4	WLAN (2.4GHz)	WLAN (6GHz)

Note: The emission of the simultaneous operation has been evaluated and no non-compliance was found.

6. The EUT support MRU mode is listed as below.

BW	Small size		Large size					
	26+52	26+106	484+242	996+484	996+484+242	996*2+484	996*3	996*3+484
20MHz	v	v	-	-	-	-	-	-
40MHz	v	v	-	-	-	-	-	-
80MHz	v	v	v	-	-	-	-	-
160MHz	v	v	v	v	v	-	-	-
320MHz	v	v	v	v	v	v	v	v

7. The above EUT information is declared by manufacturer and for more detailed features description, please refers to the manufacturer's specifications or user's manual.



### 3.2 Antenna Description of EUT

1. The antenna information is listed as below.

Antenna Set No	RF Chain No.	Brand	Model	Antenna Net Gain (dBi)	Frequency Range (GHz)	Antenna Type	Connector Type	Cable Length (mm)
1	Chain0	PSA	RFMTA340718EMLB302	3.18	2.4~2.4835	PIFA	ipex(MHF)	200
				4.92	5.15~5.895			
	Chain1	PSA	RFMTA340718EMLB302	3.18	2.4~2.4835	PIFA	ipex(MHF)	200
				4.92	5.15~5.895			
2	Chain0	PSA	RFMTA311020EMMB301	1.71	2.4~2.4835	PIFA	ipex(MHF)	200
				4.82	5.15~5.895			
				4.76	5.925~6.425			
				4.29	6.425~6.525			
				4.61	6.525~6.875			
	Chain1	PSA	RFMTA311020EMMB301	4.09	6.875~7.125	PIFA	ipex(MHF)	200
				1.71	2.4~2.4835			
				4.82	5.15~5.895			
				4.76	5.925~6.425			
				4.29	6.425~6.525			
3	Chain0	PSA	RFMTA421208IMMB701	-4.99	5.925~7.125	PIFA	i-pex(MHF)	300
	Chain1	PSA	RFMTA421208IMMB701	-4.99	5.925~7.125	PIFA	i-pex(MHF)	300

Note:

- From the above transmission chains, the worse case was found in transmission on Chain 0 for 1TX diversity sample. Therefore only the test data of the mode was recorded in this report.
- Max. gain was selected for the final test.

\* Detail antenna specification please refer to antenna datasheet and/or antenna measurement report.

2. The EUT incorporates a MIMO function:

6GHz Band				
MODULATION MODE	TX configuration		CDD mode	Beamforming mode
802.11a	SISO	1TX	Not Support	Not Support
802.11ax (HE20)		1TX	Not Support	Not Support
802.11ax (HE40)		1TX	Not Support	Not Support
802.11ax (HE80)		1TX	Not Support	Not Support
802.11ax (HE160)		1TX	Not Support	Not Support
802.11be (EHT20)		1TX	Not Support	Not Support
802.11be (EHT40)		1TX	Not Support	Not Support
802.11be (EHT80)		1TX	Not Support	Not Support
802.11be (EHT160)		1TX	Not Support	Not Support
802.11be (EHT320)		1TX	Not Support	Not Support
802.11a		MIMO	2TX	Support
802.11ax (HE20)	2TX		Support NSS2	Not Support
802.11ax (HE40)	2TX		Support NSS2	Not Support
802.11ax (HE80)	2TX		Support NSS2	Not Support
802.11ax (HE160)	2TX		Support NSS2	Not Support
802.11be (EHT20)	2TX		Support NSS2	Not Support
802.11be (EHT40)	2TX		Support NSS2	Not Support
802.11be (EHT80)	2TX		Support NSS2	Not Support
802.11be (EHT160)	2TX		Support NSS2	Not Support
802.11be (EHT320)	2TX		Support NSS2	Not Support

Note: The modulation and bandwidth are similar for 802.11ax mode for 20MHz (40MHz, 80MHz, 160MHz) and 802.11be mode for 20MHz (40MHz, 80MHz, 160MHz) therefore the manufacturer will control the power for 802.11ax/be mode and investigated worst case to representative mode in test report. (Final test mode refer to section 3.4)

### 3.3 Channel List

#### U-NII-5

24 channels are provided for 802.11a, 802.11ax (HE20), 802.11be (EHT20):

Channel	Frequency	Channel	Frequency	Channel	Frequency	Channel	Frequency
1	5955 MHz	5	5975 MHz	9	5955 MHz	13	6015 MHz
17	6035 MHz	21	6055 MHz	25	6075 MHz	29	6095 MHz
33	6115 MHz	37	6135 MHz	41	6155 MHz	45	6175 MHz
49	6195 MHz	53	6215 MHz	57	6235 MHz	61	6255 MHz
65	6275 MHz	69	6295 MHz	73	6315 MHz	77	6335 MHz
81	6355 MHz	85	6375 MHz	89	6395 MHz	93	6415MHz

12 channels are provided for 802.11ax (HE40), 802.11be (EHT40):

Channel	Frequency	Channel	Frequency	Channel	Frequency	Channel	Frequency
3	5965 MHz	11	6005 MHz	19	6045 MHz	27	6085 MHz
35	6125 MHz	43	6165 MHz	51	6205 MHz	59	6245 MHz
67	6285 MHz	75	6325 MHz	83	6365 MHz	91	6405 MHz

6 channels are provided for 802.11ax (HE80), 802.11be (EHT80):

Channel	Frequency	Channel	Frequency	Channel	Frequency	Channel	Frequency
7	5985 MHz	23	6065 MHz	39	6145 MHz	55	6225 MHz
71	6305 MHz	87	6385 MHz				

3 channels are provided for 802.11ax (HE160), 802.11be (EHT160):

Channel	Frequency	Channel	Frequency	Channel	Frequency
15	6025 MHz	47	6185 MHz	79	6345 MHz

2 channels are provided for 802.11be (EHT320):

Channel	Frequency	Channel	Frequency
31	6105 MHz	63	6265 MHz

## U-NII-7

17 channels are provided for 802.11a, 802.11ax (HE20), 802.11be (EHT20):

Channel	Frequency	Channel	Frequency	Channel	Frequency	Channel	Frequency
117	6535 MHz	121	6555 MHz	125	6575 MHz	129	6595 MHz
133	6615 MHz	137	6635 MHz	141	6655 MHz	145	6675 MHz
149	6695 MHz	153	6715 MHz	157	6735 MHz	161	6755 MHz
165	6775 MHz	169	6795 MHz	173	6815 MHz	177	6835 MHz
181	6855 MHz						

8 channels are provided for 802.11ax (HE40), 802.11be (EHT40):

Channel	Frequency	Channel	Frequency	Channel	Frequency	Channel	Frequency
123	6565 MHz	131	6605 MHz	139	6645 MHz	147	6685 MHz
155	6725 MHz	163	6765 MHz	171	6805 MHz	179	6845 MHz

3 channels are provided for 802.11ax (HE80), 802.11be (EHT80):

Channel	Frequency	Channel	Frequency	Channel	Frequency
135	6625 MHz	151	6705 MHz	167	6785 MHz

1 channels are provided for 802.11ax (HE160), 802.11be (EHT160):

Channel	Frequency
143	6665 MHz

Note: \* mean this's straddle channel.

### 3.4 Test Mode Applicability and Tested Channel Detail

Pre-Scan:	1. EUT can be used in the following ways: X-axis/ Y-axis/ Z-axis. Pre-scan these ways and find the worst case as a representative test condition.
Worst Case:	1. In the original report: X-axis/ Y-axis/ Z-axis Worst Condition: Z-axis

Following channel(s) was (were) selected for the final test as listed below:

Test Item	EUT Configure Mode	Mode	Signal Mode	Tested Channel	Modulation	Data Rate Parameter
RF Output Power / Power Spectral Density	A	802.11a	1TX / 2TX	1, 45, 93, 117, 149, 181	BPSK	6Mb/s
		802.11ax (HE20)	1T1S / 2T2S	1, 93, 117, 181	BPSK	MCS0
		802.11ax (HE40)	1T1S / 2T2S	3, 91, 123, 179	BPSK	MCS0
		802.11ax (HE80)	1T1S / 2T2S	7, 87, 135, 167	BPSK	MCS0
		802.11ax (HE160)	1T1S / 2T2S	15, 79, 143	BPSK	MCS0
		802.11be (EHT20)	1T1S / 2T2S	1, 45, 93, 117, 149, 181	BPSK	MCS0
		802.11be (EHT40)	1T1S / 2T2S	3, 43, 91, 123, 155, 179	BPSK	MCS0
		802.11be (EHT80)	1T1S / 2T2S	7, 39, 87, 135, 151, 167	BPSK	MCS0
		802.11be (EHT160)	1T1S / 2T2S	15, 47, 79, 143	BPSK	MCS0
		802.11be (EHT320)	1T1S / 2T2S	31, 63	BPSK	MCS0
		20 MHz Preamble 802.11ax (RU26)	1T1S / 2T2S	1(26/0), 93(26/8), 117(26/0), 181(26/8)	BPSK	MCS0
		20 MHz Preamble 802.11ax (RU52)	1T1S / 2T2S	1(52/37), 93(52/40), 117(52/37), 181(52/40)	BPSK	MCS0
		20 MHz Preamble 802.11ax (RU106)	1T1S / 2T2S	1(106/53), 93(106/54), 117(106/53), 181(106/54)	BPSK	MCS0
		20 MHz Preamble 802.11be (RU52+26)	1T1S / 2T2S	1(78/70), 93(78/72), 117(78/70), 181(78/72)	BPSK	MCS0
		20 MHz Preamble 802.11be (RU106+26)	1T1S / 2T2S	1(132/82), 93(132/83), 117(132/82), 181(132/83)	BPSK	MCS0
		80 MHz Preamble 802.11be (RU484+242)	1T1S / 2T2S	7(726/93), 87(726/90), 135(726/93)	BPSK	MCS0
		160 MHz Preamble 802.11be (RU996+484)	1T1S / 2T2S	15(1480/95-1), 79(1480/94-0*), 143(1480/95-1)	BPSK	MCS0
160 MHz Preamble 802.11be (RU996+484+242)	1T1S / 2T2S	15(1722/99-1), 79(1722/96-0), 143(1722/99-1)	BPSK	MCS0		

Test Item	EUT Configure Mode	Mode	Signal Mode	Tested Channel	Modulation	Data Rate Parameter
		320 MHz Preamble 802.11be (RU996*2+484)	1T1S / 2T2S	31(2476/101-1/0), 63(2476/102-0/1)	BPSK	MCS0
		320 MHz Preamble 802.11be (RU996*3)	1T1S / 2T2S	31(2988/104-1/1), 63(2988/104-0/0)	BPSK	MCS0
		320 MHz Preamble 802.11be (RU996*3+484)	1T1S / 2T2S	31(3472/106-1/1), 63(3472/105-0/0)	BPSK	MCS0
Emission Bandwidth	A	802.11a	1TX / 2TX	1, 45, 93, 117, 149, 181	BPSK	6Mb/s
		802.11ax (HE20)	1T1S / 2T2S	1, 93, 117, 181	BPSK	MCS0
		802.11ax (HE40)	1T1S / 2T2S	3, 91, 123, 179	BPSK	MCS0
		802.11ax (HE80)	1T1S / 2T2S	7, 87, 135, 167	BPSK	MCS0
		802.11ax (HE160)	1T1S / 2T2S	15, 79, 143	BPSK	MCS0
		802.11be (EHT20)	1T1S / 2T2S	1, 45, 93, 117, 149, 181	BPSK	MCS0
		802.11be (EHT40)	1T1S / 2T2S	3, 43, 91, 123, 155, 179	BPSK	MCS0
		802.11be (EHT80)	1T1S / 2T2S	7, 39, 87, 135, 151, 167	BPSK	MCS0
		802.11be (EHT160)	1T1S / 2T2S	15, 47, 79, 143	BPSK	MCS0
		802.11be (EHT320)	1T1S / 2T2S	31, 63	BPSK	MCS0
		20 MHz Preamble 802.11ax (RU26)	1T1S / 2T2S	1(26/0), 93(26/8), 117(26/0), 181(26/8)	BPSK	MCS0
		20 MHz Preamble 802.11ax (RU52)	1T1S / 2T2S	1(52/37), 93(52/40), 117(52/37), 181(52/40)	BPSK	MCS0
		20 MHz Preamble 802.11ax (RU106)	1T1S / 2T2S	1(106/53), 93(106/54), 117(106/53), 181(106/54)	BPSK	MCS0
		20 MHz Preamble 802.11be (RU52+26)	1T1S / 2T2S	1(78/70), 93(78/72), 117(78/70), 181(78/72)	BPSK	MCS0
		20 MHz Preamble 802.11be (RU106+26)	1T1S / 2T2S	1(132/82), 93(132/83), 117(132/82), 181(132/83)	BPSK	MCS0
		80 MHz Preamble 802.11be (RU484+242)	1T1S / 2T2S	7(726/93), 87(726/90), 135(726/93)	BPSK	MCS0
		160 MHz Preamble 802.11be (RU996+484)	1T1S / 2T2S	15(1480/95-1), 79(1480/94-0*), 143(1480/95-1)	BPSK	MCS0
		160 MHz Preamble 802.11be (RU996+484+242)	1T1S / 2T2S	15(1722/99-1), 79(1722/96-0), 143(1722/99-1)	BPSK	MCS0

Test Item	EUT Configure Mode	Mode	Signal Mode	Tested Channel	Modulation	Data Rate Parameter
		320 MHz Preamble 802.11be (RU996*2+484)	1T1S / 2T2S	31(2476/101-1/0), 63(2476/102-0/1)	BPSK	MCS0
		320 MHz Preamble 802.11be (RU996*3)	1T1S / 2T2S	31(2988/104-1/1), 63(2988/104-0/0)	BPSK	MCS0
		320 MHz Preamble 802.11be (RU996*3+484)	1T1S / 2T2S	31(3472/106-1/1), 63(3472/105-0/0)	BPSK	MCS0
In-Band Emission Mask	A	802.11a	1TX / 2TX	1, 45, 93, 117, 149, 181	BPSK	6Mb/s
		802.11ax (HE20)	1T1S / 2T2S	1, 93, 117, 181	BPSK	MCS0
		802.11ax (HE40)	1T1S / 2T2S	3, 91, 123, 179	BPSK	MCS0
		802.11ax (HE80)	1T1S / 2T2S	7, 87, 135, 167	BPSK	MCS0
		802.11ax (HE160)	1T1S / 2T2S	15, 79, 143	BPSK	MCS0
		802.11be (EHT20)	1T1S / 2T2S	1, 45, 93, 117, 149, 181	BPSK	MCS0
		802.11be (EHT40)	1T1S / 2T2S	3, 43, 91, 123, 155, 179	BPSK	MCS0
		802.11be (EHT80)	1T1S / 2T2S	7, 39, 87, 135, 151, 167	BPSK	MCS0
		802.11be (EHT160)	1T1S / 2T2S	15, 47, 79, 143	BPSK	MCS0
		802.11be (EHT320)	1T1S / 2T2S	31, 63	BPSK	MCS0
		20 MHz Preamble 802.11ax (RU26)	1T1S / 2T2S	1(26/0), 93(26/8), 117(26/0), 181(26/8)	BPSK	MCS0
		20 MHz Preamble 802.11ax (RU52)	1T1S / 2T2S	1(52/37), 93(52/40), 117(52/37), 181(52/40)	BPSK	MCS0
		20 MHz Preamble 802.11ax (RU106)	1T1S / 2T2S	1(106/53), 93(106/54), 117(106/53), 181(106/54)	BPSK	MCS0
		20 MHz Preamble 802.11be (RU52+26)	1T1S / 2T2S	1(78/70), 93(78/72), 117(78/70), 181(78/72)	BPSK	MCS0
		20 MHz Preamble 802.11be (RU106+26)	1T1S / 2T2S	1(132/82), 93(132/83), 117(132/82), 181(132/83)	BPSK	MCS0
		80 MHz Preamble 802.11be (RU484+242)	1T1S / 2T2S	7(726/93), 87(726/90), 135(726/93)	BPSK	MCS0
		160 MHz Preamble 802.11be (RU996+484)	1T1S / 2T2S	15(1480/95-1), 79(1480/94-0*), 143(1480/95-1)	BPSK	MCS0
160 MHz Preamble 802.11be (RU996+484+242)	1T1S / 2T2S	15(1722/99-1), 79(1722/96-0), 143(1722/99-1)	BPSK	MCS0		

Test Item	EUT Configure Mode	Mode	Signal Mode	Tested Channel	Modulation	Data Rate Parameter
		320 MHz Preamble 802.11be (RU996*2+484)	1T1S / 2T2S	31(2476/101-1/0), 63(2476/102-0/1)	BPSK	MCS0
		320 MHz Preamble 802.11be (RU996*3)	1T1S / 2T2S	31(2988/104-1/1), 63(2988/104-0/0)	BPSK	MCS0
		320 MHz Preamble 802.11be (RU996*3+484)	1T1S / 2T2S	31(3472/106-1/1), 63(3472/105-0/0)	BPSK	MCS0
Occupied Bandwidth	A	802.11a	1TX / 2TX	1, 45, 93, 117, 149, 181	BPSK	6Mb/s
		802.11ax (HE20)	1T1S / 2T2S	1, 93, 117, 181	BPSK	MCS0
		802.11ax (HE40)	1T1S / 2T2S	3, 91, 123, 179	BPSK	MCS0
		802.11ax (HE80)	1T1S / 2T2S	7, 87, 135, 167	BPSK	MCS0
		802.11ax (HE160)	1T1S / 2T2S	15, 79, 143	BPSK	MCS0
		802.11be (EHT20)	1T1S / 2T2S	1, 45, 93, 117, 149, 181	BPSK	MCS0
		802.11be (EHT40)	1T1S / 2T2S	3, 43, 91, 123, 155, 179	BPSK	MCS0
		802.11be (EHT80)	1T1S / 2T2S	7, 39, 87, 135, 151, 167	BPSK	MCS0
		802.11be (EHT160)	1T1S / 2T2S	15, 47, 79, 143		
		802.11be (EHT320)	1T1S / 2T2S	31, 63	BPSK	MCS0
		20 MHz Preamble 802.11ax (RU26)	1T1S / 2T2S	1(26/0), 93(26/8), 117(26/0), 181(26/8)	BPSK	MCS0
		20 MHz Preamble 802.11ax (RU52)	1T1S / 2T2S	1(52/37), 93(52/40), 117(52/37), 181(52/40)	BPSK	MCS0
		20 MHz Preamble 802.11ax (RU106)	1T1S / 2T2S	1(106/53), 93(106/54), 117(106/53), 181(106/54)	BPSK	MCS0
		20 MHz Preamble 802.11be (RU52+26)	1T1S / 2T2S	1(78/70), 93(78/72), 117(78/70), 181(78/72)	BPSK	MCS0
		20 MHz Preamble 802.11be (RU106+26)	1T1S / 2T2S	1(132/82), 93(132/83), 117(132/82), 181(132/83)	BPSK	MCS0
		80 MHz Preamble 802.11be (RU484+242)	1T1S / 2T2S	7(726/93), 87(726/90), 135(726/93)	BPSK	MCS0
		160 MHz Preamble 802.11be (RU996+484)	1T1S / 2T2S	15(1480/95-1), 79(1480/94-0*), 143(1480/95-1)	BPSK	MCS0
		160 MHz Preamble 802.11be (RU996+484+242)	1T1S / 2T2S	15(1722/99-1), 79(1722/96-0), 143(1722/99-1)	BPSK	MCS0



Test Item	EUT Configure Mode	Mode	Signal Mode	Tested Channel	Modulation	Data Rate Parameter
		320 MHz Preamble 802.11be (RU996*2+484)	1T1S / 2T2S	31(2476/101-1/0), 63(2476/102-0/1)	BPSK	MCS0
		320 MHz Preamble 802.11be (RU996*3)	1T1S / 2T2S	31(2988/104-1/1), 63(2988/104-0/0)	BPSK	MCS0
		320 MHz Preamble 802.11be (RU996*3+484)	1T1S / 2T2S	31(3472/106-1/1), 63(3472/105-0/0)	BPSK	MCS0
AC Power Conducted Emissions	B	802.11a	1TX	1	BPSK	6Mb/s
		802.11be (EHT40)	2T2S	43	BPSK	MCS0
Unwanted Emissions below 1 GHz	A, B	802.11a	1TX	1	BPSK	6Mb/s
		802.11be (EHT40)	2T2S	43	BPSK	MCS0
Unwanted Emissions above 1 GHz	A, B	802.11a	1TX / 2TX	1, 45, 93, 117, 149, 181	BPSK	6Mb/s
		802.11ax (HE20)	1T1S / 2T2S	1, 93, 117, 181	BPSK	MCS0
		802.11ax (HE40)	1T1S / 2T2S	3, 91, 123, 179	BPSK	MCS0
		802.11ax (HE80)	1T1S / 2T2S	7, 87, 135, 167	BPSK	MCS0
		802.11ax (HE160)	1T1S / 2T2S	15, 79, 143	BPSK	MCS0
		802.11be (EHT20)	1T1S / 2T2S	1, 45, 93, 117, 149, 181	BPSK	MCS0
		802.11be (EHT40)	1T1S / 2T2S	3, 43, 91, 123, 155, 179	BPSK	MCS0
		802.11be (EHT80)	1T1S / 2T2S	7, 39, 87, 135, 151, 167	BPSK	MCS0
		802.11be (EHT160)	1T1S / 2T2S	15, 47, 79, 143	BPSK	MCS0
		802.11be (EHT320)	1T1S / 2T2S	31, 63	BPSK	MCS0
		20 MHz Preamble 802.11ax (RU26)	1T1S / 2T2S	1(26/0), 93(26/8), 117(26/0), 181(26/8)	BPSK	MCS0
		20 MHz Preamble 802.11ax (RU52)	1T1S / 2T2S	1(52/37), 93(52/40), 117(52/37), 181(52/40)	BPSK	MCS0
		20 MHz Preamble 802.11ax (RU106)	1T1S / 2T2S	1(106/53), 93(106/54), 117(106/53), 181(106/54)	BPSK	MCS0
		20 MHz Preamble 802.11be (RU52+26)	1T1S / 2T2S	1(78/70), 93(78/72), 117(78/70), 181(78/72)	BPSK	MCS0
		20 MHz Preamble 802.11be (RU106+26)	1T1S / 2T2S	1(132/82), 93(132/83), 117(132/82), 181(132/83)	BPSK	MCS0
80 MHz Preamble 802.11be (RU484+242)	1T1S / 2T2S	7(726/93), 87(726/90), 135(726/93)	BPSK	MCS0		

Test Item	EUT Configure Mode	Mode	Signal Mode	Tested Channel	Modulation	Data Rate Parameter
		160 MHz Preamble 802.11be (RU996+484)	1T1S / 2T2S	15(1480/95-1), 79(1480/94-0*), 143(1480/95-1)	BPSK	MCS0
		160 MHz Preamble 802.11be (RU996+484+242)	1T1S / 2T2S	15(1722/99-1), 79(1722/96-0), 143(1722/99-1)	BPSK	MCS0
		320 MHz Preamble 802.11be (RU996*2+484)	1T1S / 2T2S	31(2476/101-1/0), 63(2476/102-0/1)	BPSK	MCS0
		320 MHz Preamble 802.11be (RU996*3)	1T1S / 2T2S	31(2988/104-1/1), 63(2988/104-0/0)	BPSK	MCS0
		320 MHz Preamble 802.11be (RU996*3+484)	1T1S / 2T2S	31(3472/106-1/1), 63(3472/105-0/0)	BPSK	MCS0
EUT Configure Mode:	A	EUT only (w/o antenna)				
	B	EUT with 50 ohm terminator				

### 3.5 Duty Cycle of Test Signal

**802.11a SP Client 1TX:** Duty cycle = 2.018 ms / 2.154 ms x 100% = 93.7%, duty factor =  $10 * \log (1/\text{Duty cycle}) = 0.28$  dB

**802.11ax (HE20) SP Client 1T1S:** Duty cycle = 3.938 ms / 4.079 ms x 100% = 96.5%, duty factor =  $10 * \log (1/\text{Duty cycle}) = 0.15$  dB

**802.11ax (HE40) SP Client 1T1S:** Duty cycle = 3.955 ms / 4.081 ms x 100% = 96.9%, duty factor =  $10 * \log (1/\text{Duty cycle}) = 0.14$  dB

**802.11ax (HE80) SP Client 1T1S:** Duty cycle = 1.928 ms / 2.048 ms x 100% = 94.1%, duty factor =  $10 * \log (1/\text{Duty cycle}) = 0.26$  dB

**802.11ax (HE160) SP Client 1T1S:** Duty cycle = 1.008 ms / 1.124 ms x 100% = 89.7%, duty factor =  $10 * \log (1/\text{Duty cycle}) = 0.47$  dB

**802.11be (EHT20) SP Client 1T1S:** Duty cycle = 4.642 ms / 4.767 ms x 100% = 97.4%, duty factor =  $10 * \log (1/\text{Duty cycle}) = 0.12$  dB

**802.11be (EHT40) SP Client 1T1S:** Duty cycle = 4.658 ms / 4.775 ms x 100% = 97.5%, duty factor =  $10 * \log (1/\text{Duty cycle}) = 0.11$  dB

**802.11be (EHT80) SP Client 1T1S:** Duty cycle = 2.268 ms / 2.39 ms x 100% = 94.9%, duty factor =  $10 * \log (1/\text{Duty cycle}) = 0.23$  dB

**802.11be (EHT160) SP Client 1T1S:** Duty cycle = 1.175 ms / 1.294 ms x 100% = 90.8%, duty factor =  $10 * \log (1/\text{Duty cycle}) = 0.42$  dB

**802.11be (EHT320) SP Client 1T1S:** Duty cycle = 0.627 ms / 0.745 ms x 100% = 84.2%, duty factor =  $10 * \log (1/\text{Duty cycle}) = 0.75$  dB

**802.11ax (HE) 26-tone RU SP Client\_1T1S:** Duty cycle = 0.583 ms / 0.7 ms x 100% = 83.3%, duty factor =  $10 * \log (1/\text{Duty cycle}) = 0.79$  dB

**802.11ax (HE) 52-tone RU SP Client\_1T1S:** Duty cycle = 0.499 ms / 0.617 ms x 100% = 80.9%, duty factor =  $10 * \log (1/\text{Duty cycle}) = 0.92$  dB

**802.11ax (HE) 106-tone RU SP Client\_1T1S:** Duty cycle = 0.436 ms / 0.553 ms x 100% = 78.8%, duty factor =  $10 * \log (1/\text{Duty cycle}) = 1.03$  dB

**802.11be (EHT20) 52+26-tone MRU SP Client\_1T1S:** Duty cycle = 0.468 ms / 0.585 ms x 100% = 80.0%, duty factor =  $10 * \log (1/\text{Duty cycle}) = 0.97$  dB

**802.11be (EHT20) 106+26-tone MRU SP Client\_1T1S:** Duty cycle = 0.468 ms / 0.585 ms x 100% = 80.0%, duty factor =  $10 * \log (1/\text{Duty cycle}) = 0.97$  dB

**802.11be (EHT80) 484+242-tone MRU SP Client\_1T1S:** Duty cycle = 0.358 ms / 0.476 ms x 100% = 75.2%, duty factor =  $10 * \log (1/\text{Duty cycle}) = 1.24$  dB

**802.11be (EHT160) 996+484-tone MRU SP Client\_1T1S:** Duty cycle = 0.346 ms / 0.463 ms x 100% = 74.7%, duty factor =  $10 * \log (1/\text{Duty cycle}) = 1.27$  dB

**802.11be (EHT160) 996+484+242-tone MRU SP Client\_1T1S:** Duty cycle = 0.346 ms / 0.463 ms x 100% = 74.7%, duty factor =  $10 * \log (1/\text{Duty cycle}) = 1.27$  dB

**802.11be (EHT320) 2x996+484-tone MRU SP Client 1T1S:** Duty cycle = 0.343 ms / 0.46 ms x 100% = 74.6%, duty factor =  $10 * \log (1/\text{Duty cycle}) = 1.27$  dB

**802.11be (EHT320) 3x996-tone MRU SP Client 1T1S:** Duty cycle = 0.343 ms / 0.46 ms x 100% = 74.6%, duty factor =  $10 * \log (1/\text{Duty cycle}) = 1.27$  dB

**802.11be (EHT320) 3x996+484-tone MRU SP Client 1T1S:** Duty cycle = 0.343 ms / 0.46 ms x 100% = 74.6%, duty factor =  $10 * \log (1/\text{Duty cycle}) = 1.27$  dB

**802.11a SP Client 2TX:** Duty cycle = 2.018 ms / 2.154 ms x 100% = 93.7%, duty factor =  $10 * \log (1/\text{Duty cycle}) = 0.28$  dB

**802.11ax (HE20) SP Client 2T2S:** Duty cycle = 3.938 ms / 4.079 ms x 100% = 96.5%, duty factor =  $10 * \log (1/\text{Duty cycle}) = 0.15$  dB

**802.11ax (HE40) SP Client 2T2S:** Duty cycle = 3.955 ms / 4.081 ms x 100% = 96.9%, duty factor =  $10 * \log (1/\text{Duty cycle}) = 0.14$  dB

**802.11ax (HE80) SP Client 2T2S:** Duty cycle = 1.928 ms / 2.048 ms x 100% = 94.1%, duty factor =  $10 * \log (1/\text{Duty cycle}) = 0.26$  dB

**802.11ax (HE160) SP Client 2T2S:** Duty cycle = 1.008 ms / 1.124 ms x 100% = 89.7%, duty factor =  $10 * \log (1/\text{Duty cycle}) = 0.47$  dB

**802.11be (EHT20) SP Client 2T2S:** Duty cycle = 4.642 ms / 4.767 ms x 100% = 97.4%, duty factor =  $10 * \log (1/\text{Duty cycle}) = 0.12$  dB

**802.11be (EHT40) SP Client 2T2S:** Duty cycle = 4.658 ms / 4.775 ms x 100% = 97.5%, duty factor =  $10 * \log (1/\text{Duty cycle}) = 0.11$  dB

**802.11be (EHT80) SP Client 2T2S:** Duty cycle = 2.268 ms / 2.39 ms x 100% = 94.9%, duty factor =  $10 * \log (1/\text{Duty cycle}) = 0.23$  dB

**802.11be (EHT160) SP Client 2T2S:** Duty cycle = 1.175 ms / 1.294 ms x 100% = 90.8%, duty factor =  $10 * \log (1/\text{Duty cycle}) = 0.42$  dB

**802.11be (EHT320) SP Client 2T2S:** Duty cycle = 0.627 ms / 0.745 ms x 100% = 84.2%, duty factor =  $10 * \log (1/\text{Duty cycle}) = 0.75$  dB

**802.11ax (HE) 26-tone RU SP Client\_2T2S:** Duty cycle = 0.343 ms / 0.461 ms x 100% = 74.4%, duty factor =  $10 * \log (1/\text{Duty cycle}) = 1.28$  dB

**802.11ax (HE) 52-tone RU SP Client\_2T2S:** Duty cycle = 0.304 ms / 0.424 ms x 100% = 71.7%, duty factor =  $10 * \log (1/\text{Duty cycle}) = 1.44$  dB

**802.11ax (HE) 106-tone RU SP Client\_2T2S:** Duty cycle = 0.272 ms / 0.389 ms x 100% = 69.9%, duty factor =  $10 * \log (1/\text{Duty cycle}) = 1.55$  dB

**802.11be (EHT20) 52+26-tone MRU SP Client\_2T2S:** Duty cycle = 0.288 ms / 0.404 ms x 100% = 71.3%, duty factor =  $10 * \log (1/\text{Duty cycle}) = 1.47$  dB

**802.11be (EHT20) 106+26-tone MRU SP Client\_2T2S:** Duty cycle = 0.288 ms / 0.404 ms x 100% = 71.3%, duty factor =  $10 * \log (1/\text{Duty cycle}) = 1.47$  dB

**802.11be (EHT80) 484+242-tone MRU SP Client\_2T2S:** Duty cycle = 0.231 ms / 0.348 ms x 100% = 66.4%, duty factor =  $10 * \log (1/\text{Duty cycle}) = 1.78$  dB

**802.11be (EHT160) 996+484-tone MRU SP Client\_2T2S:** Duty cycle = 0.228 ms / 0.344 ms x 100% = 66.3%, duty factor =  $10 * \log (1/\text{Duty cycle}) = 1.79$  dB

**802.11be (EHT160) 996+484+242-tone MRU SP Client\_2T2S:** Duty cycle = 0.228 ms / 0.344 ms x 100% = 66.3%, duty factor =  $10 * \log (1/\text{Duty cycle}) = 1.79$  dB

**802.11be (EHT320) 2x996+484-tone MRU SP Client 2T2S:** Duty cycle = 0.224 ms / 0.339 ms x 100% = 66.1%, duty factor =  $10 * \log (1/\text{Duty cycle}) = 1.80$  dB

**802.11be (EHT320) 3x996-tone MRU SP Client 2T2S:** Duty cycle = 0.224 ms / 0.339 ms x 100% = 66.1%, duty factor =  $10 * \log (1/\text{Duty cycle}) = 1.80$  dB

**802.11be (EHT320) 3x996+484-tone MRU SP Client 2T2S:** Duty cycle = 0.224 ms / 0.339 ms x 100% = 66.1%, duty factor =  $10 * \log (1/\text{Duty cycle}) = 1.80$  dB



BUREAU  
VERITAS

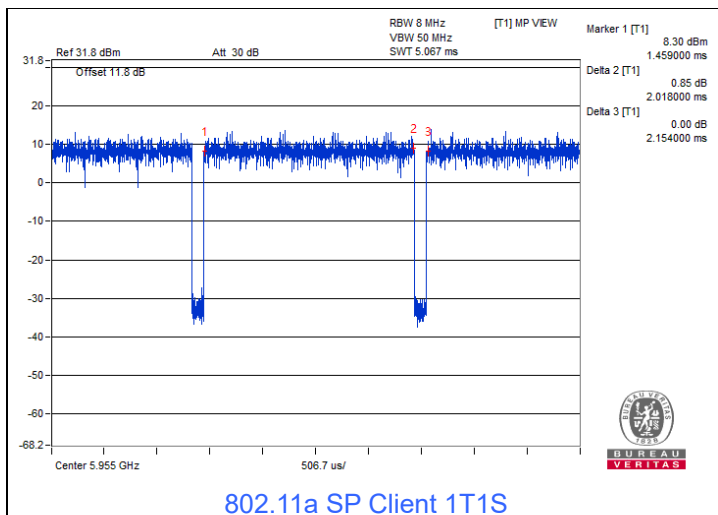

802.11a SP Client 1T1S

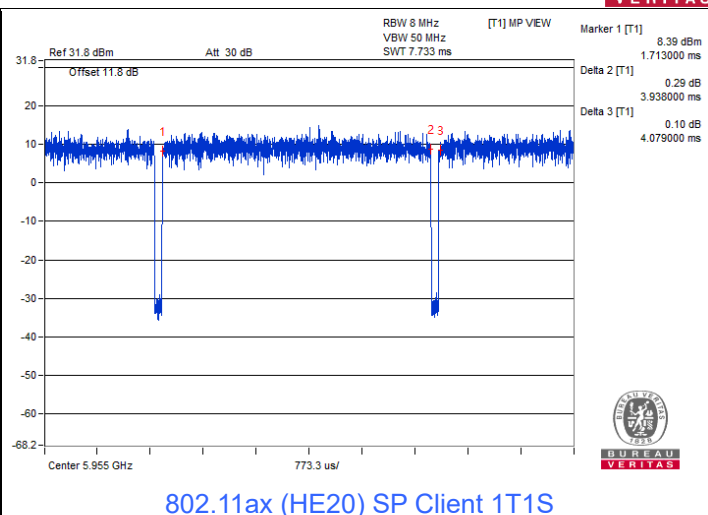

802.11ax (HE20) SP Client 1T1S

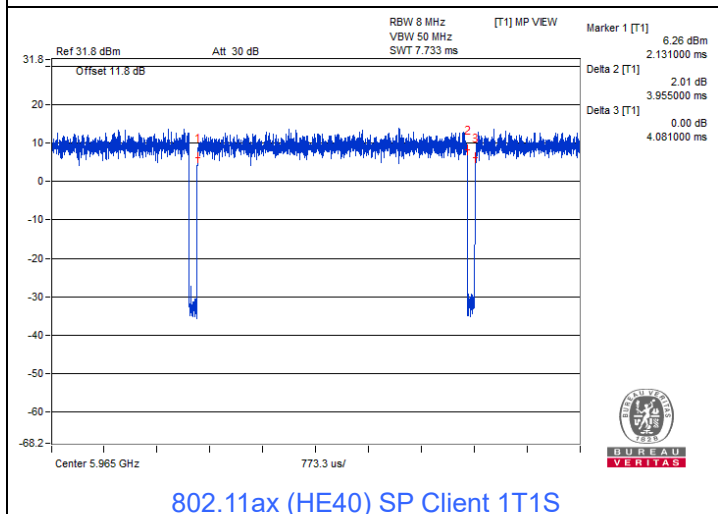

802.11ax (HE40) SP Client 1T1S

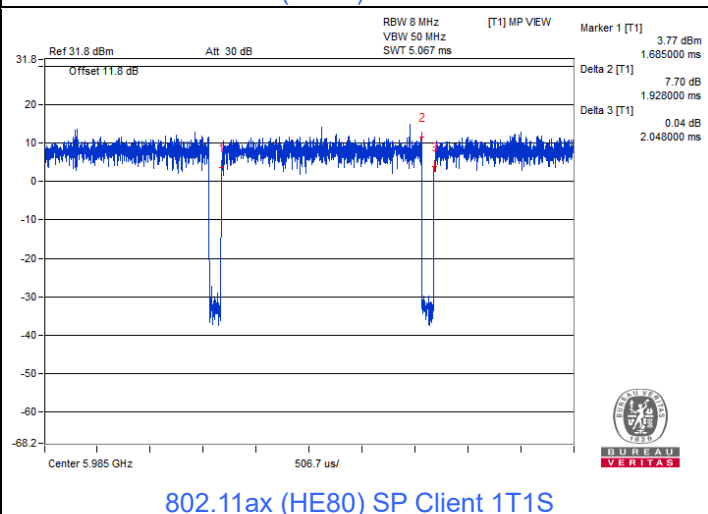

802.11ax (HE80) SP Client 1T1S

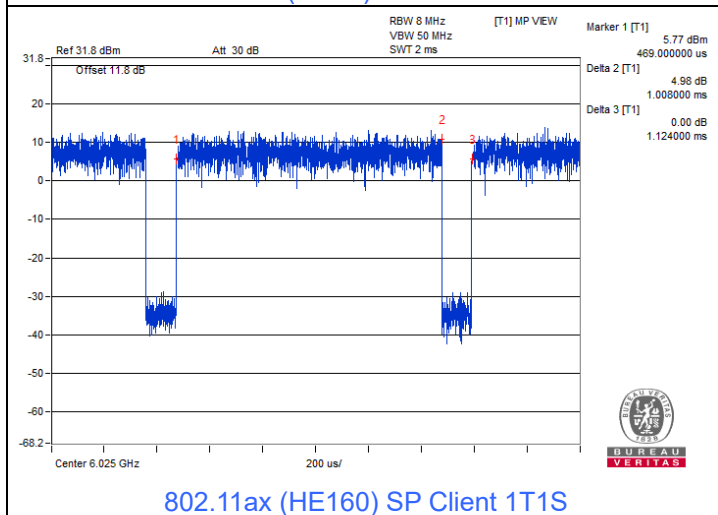

802.11ax (HE160) SP Client 1T1S

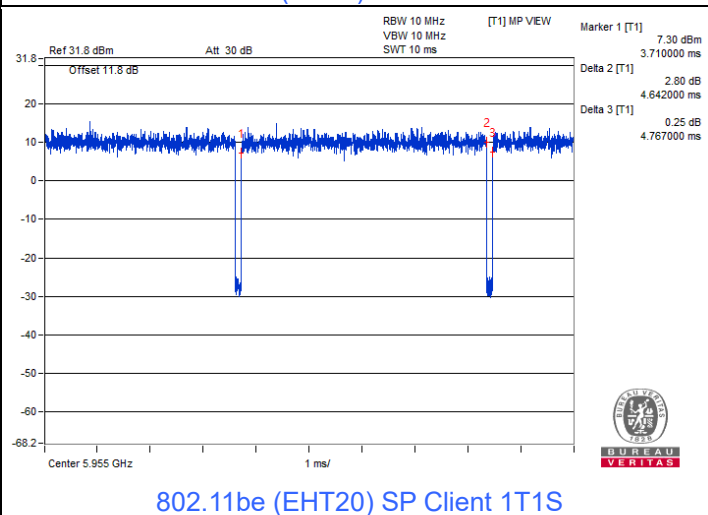

802.11be (EHT20) SP Client 1T1S

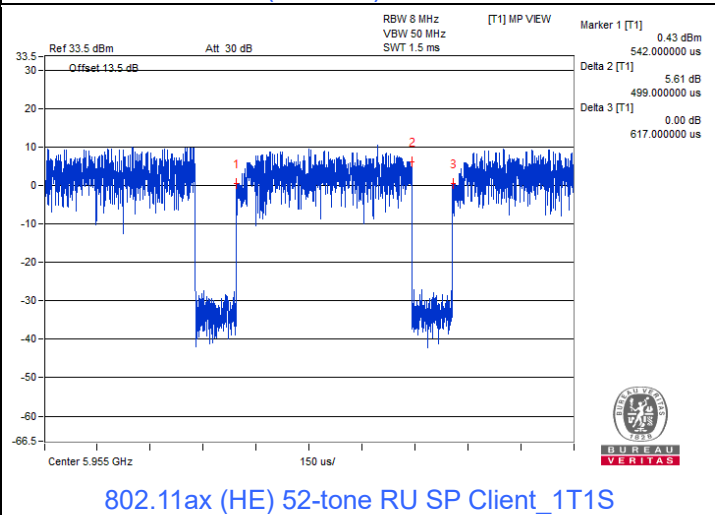
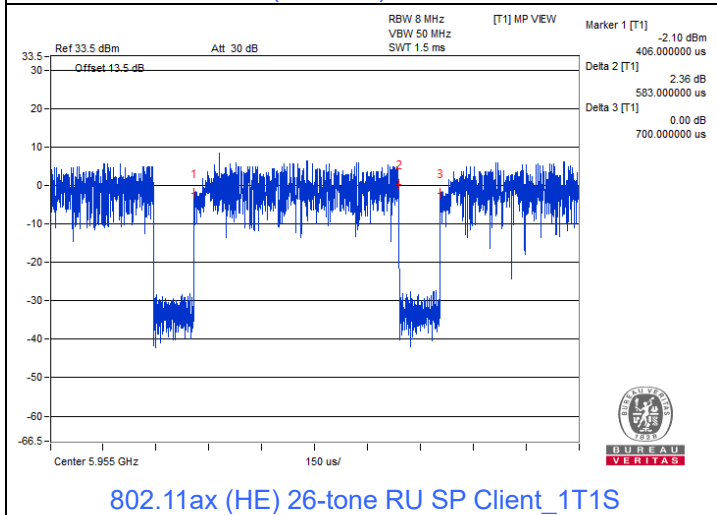
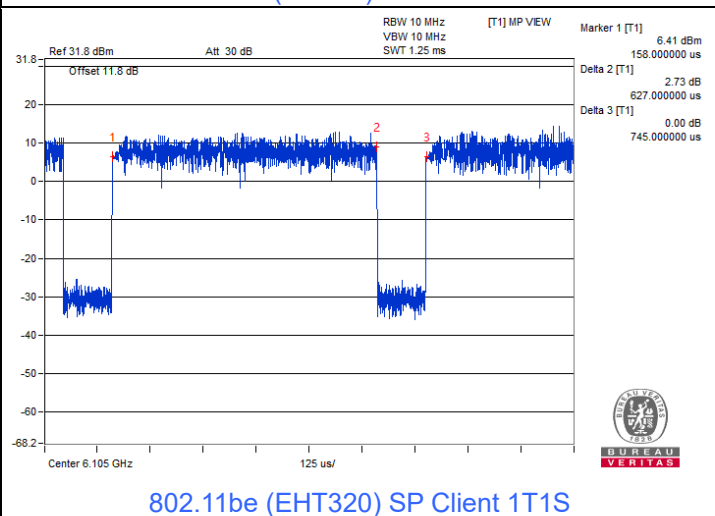
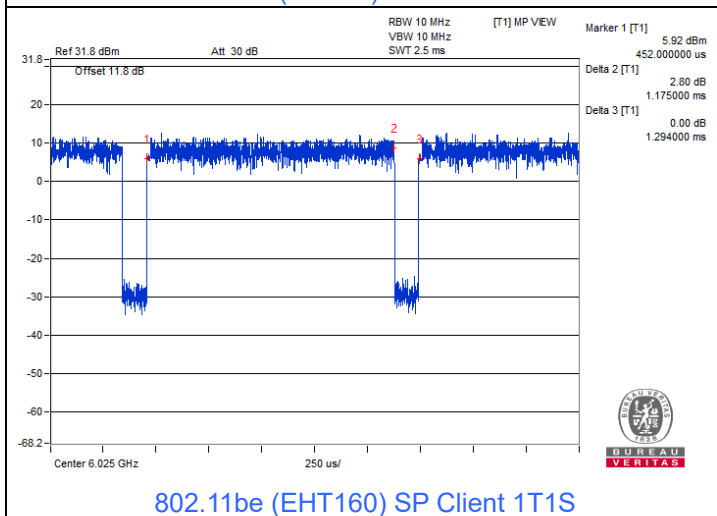
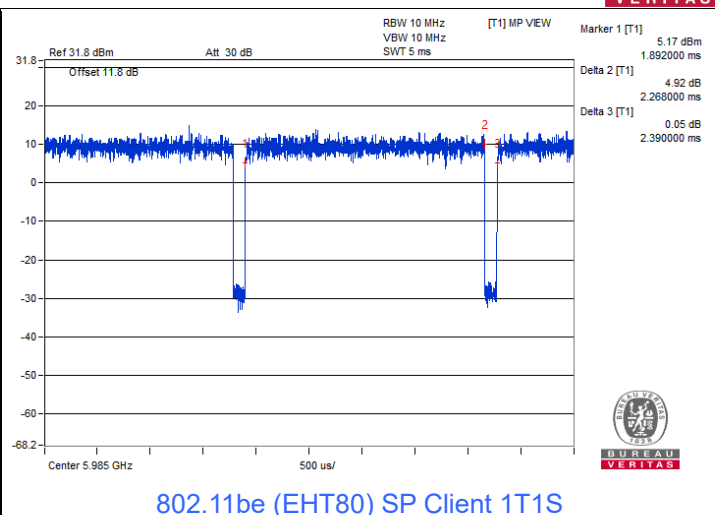
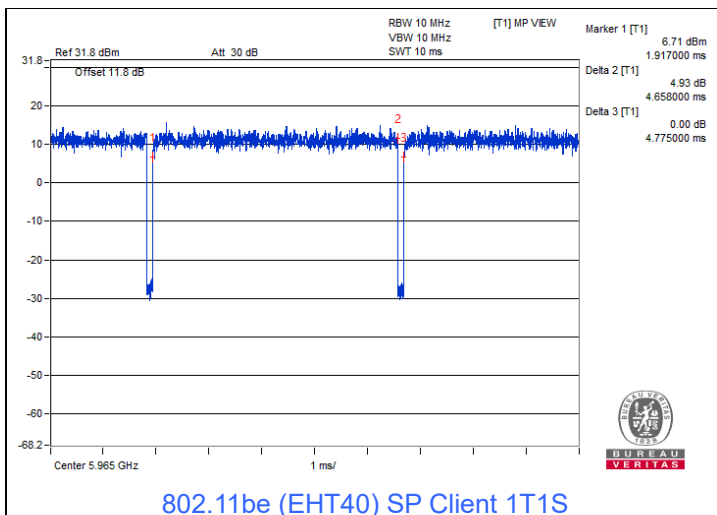

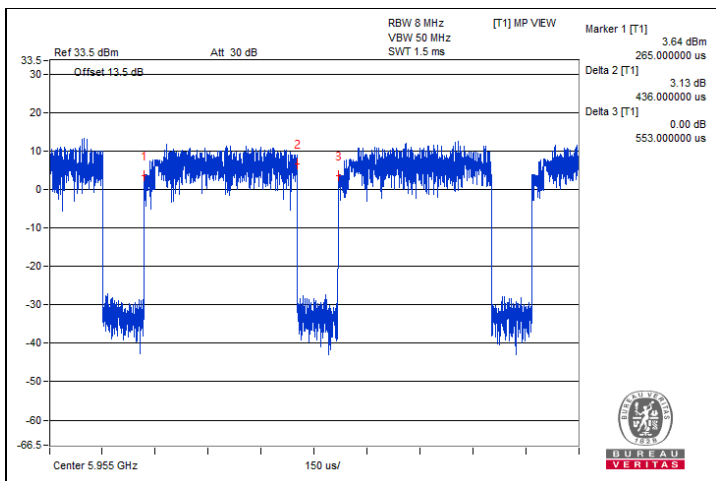

802.11ax (HE) 106-tone RU SP Client\_1T1S

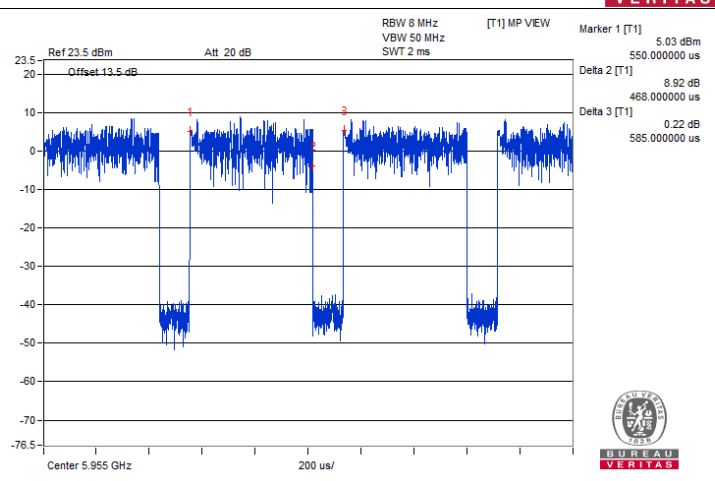

802.11be (EHT20) 52+26-tone MRU SP Client\_1T1S

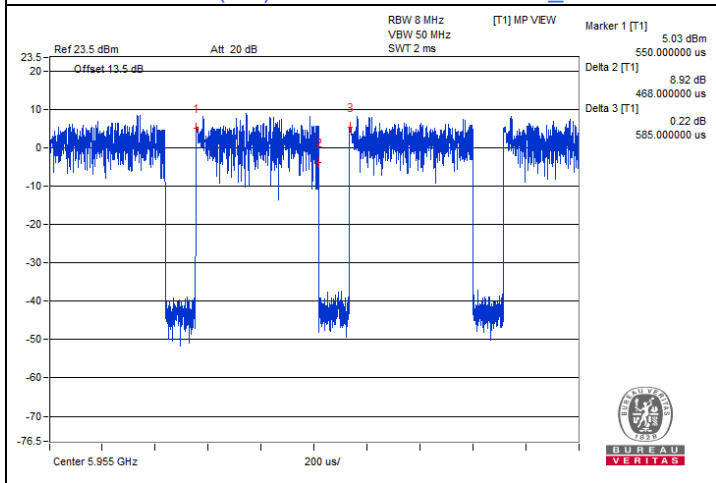

802.11be (EHT20) 106+26-tone MRU SP Client\_1T1S

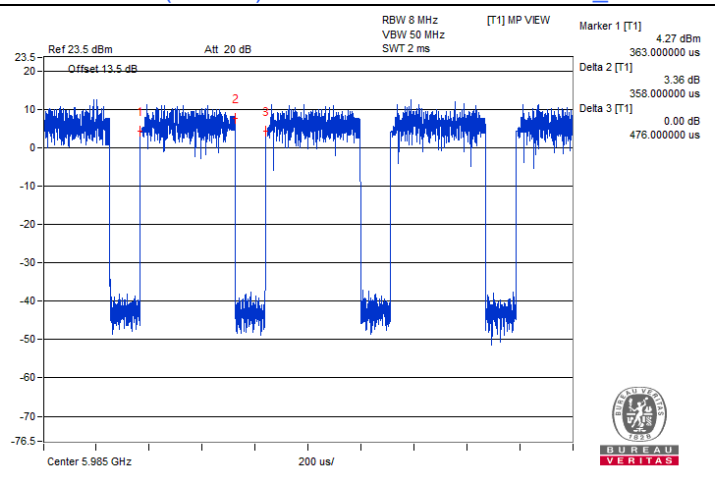

802.11be (EHT80) 484+242-tone MRU SP Client\_1T1S

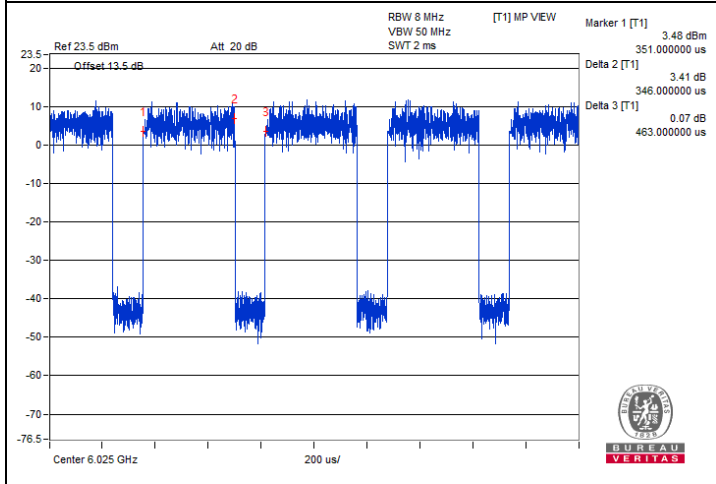

802.11be (EHT160) 996+484-tone MRU SP Client\_1T1S

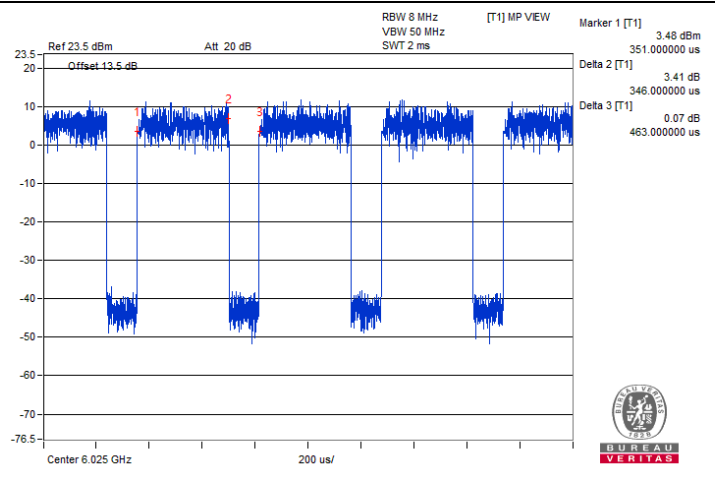

802.11be (EHT160) 996+484+242-tone MRU SP Client\_1T1S

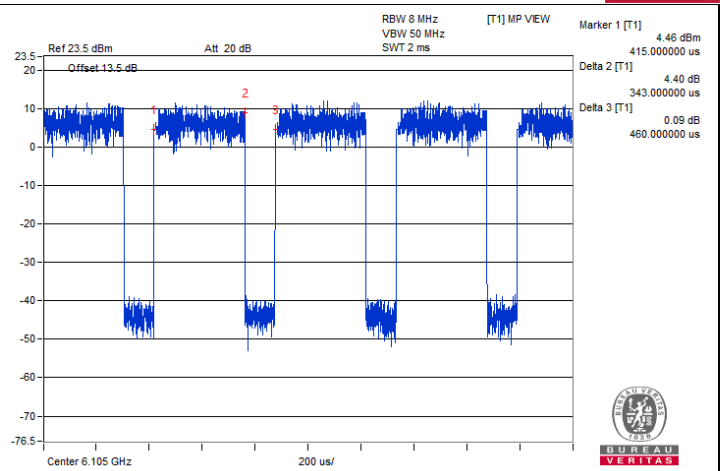
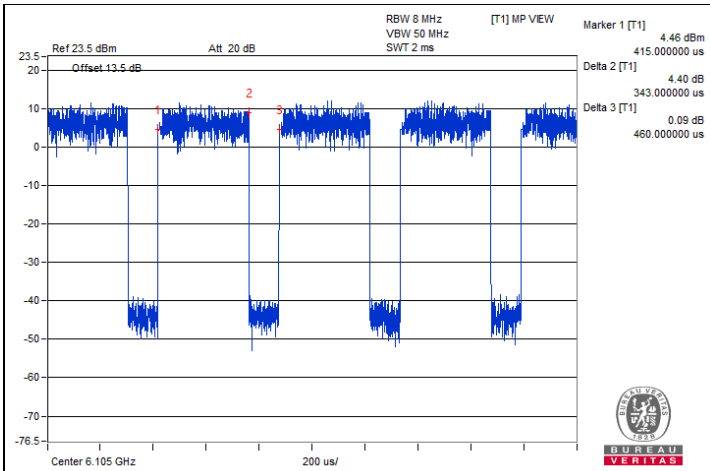

802.11be (EHT320) 2x996+484-tone MRU SP Client 1T1S

802.11be (EHT320) 3x996-tone MRU SP Client 1T1S

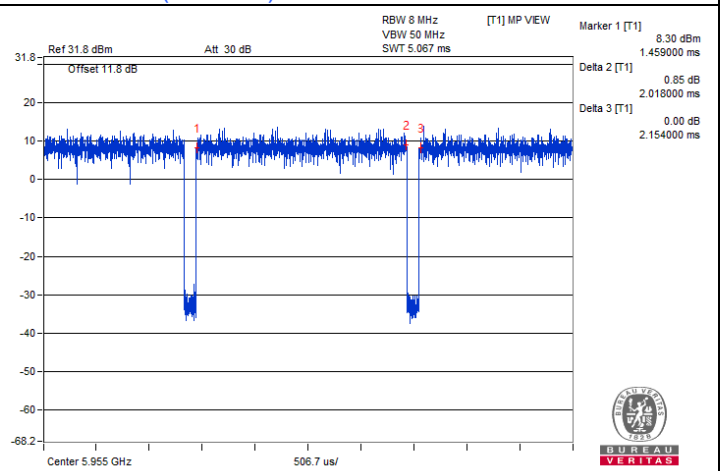
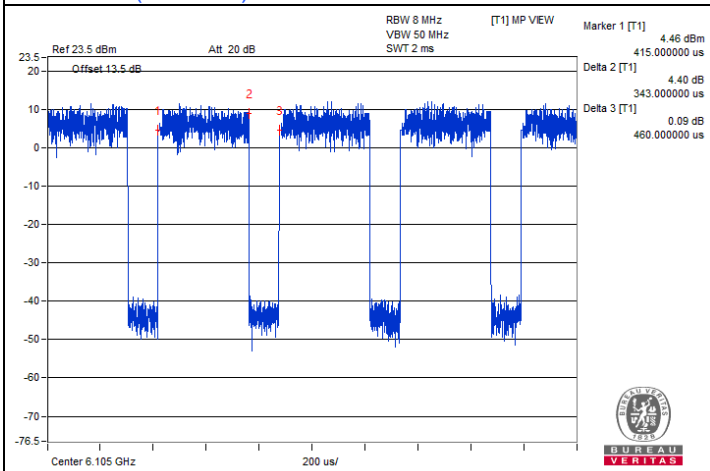

802.11be (EHT320) 3x996+484-tone MRU SP Client 1T1S

802.11a SP Client 2T2S

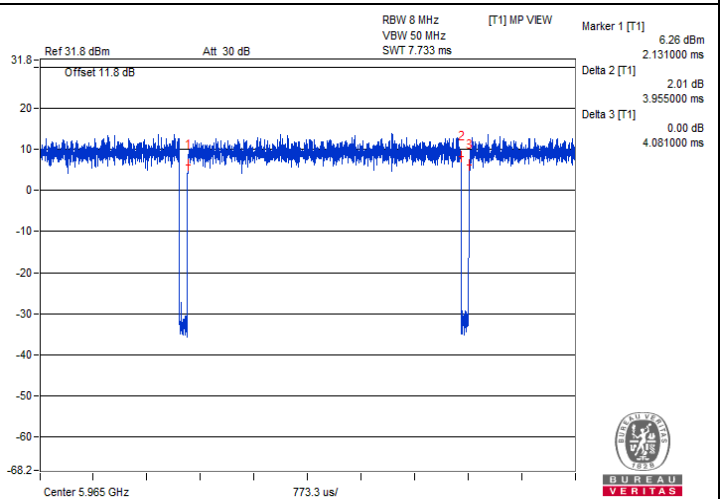
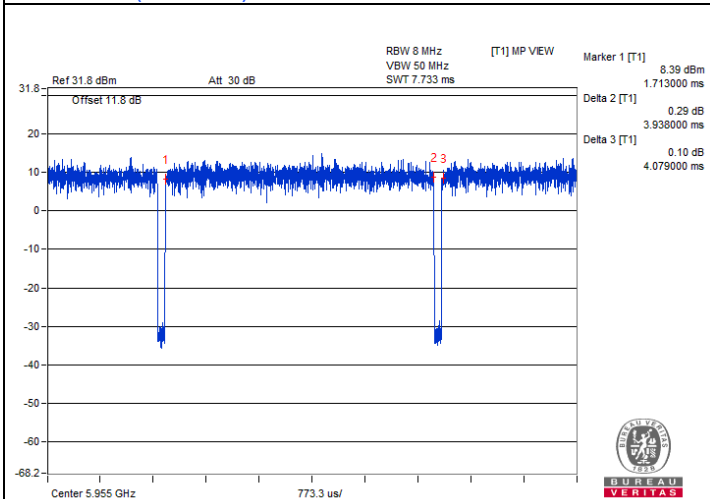

802.11ax (HE20) SP Client 2T2S

802.11ax (HE40) SP Client 2T2S



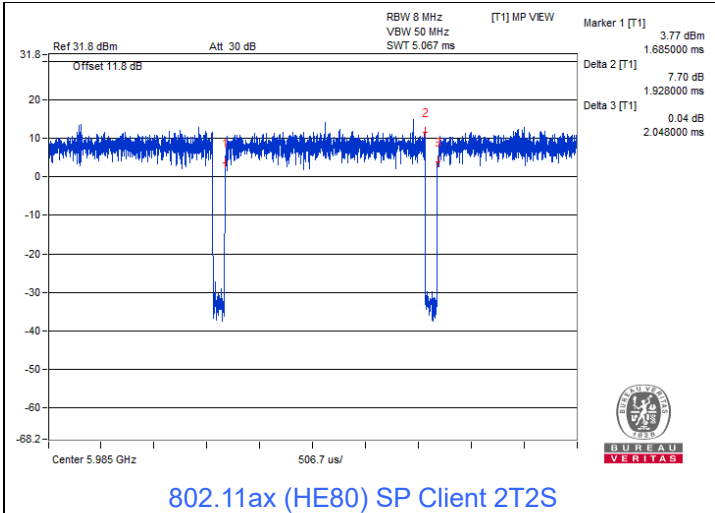

802.11ax (HE80) SP Client 2T2S

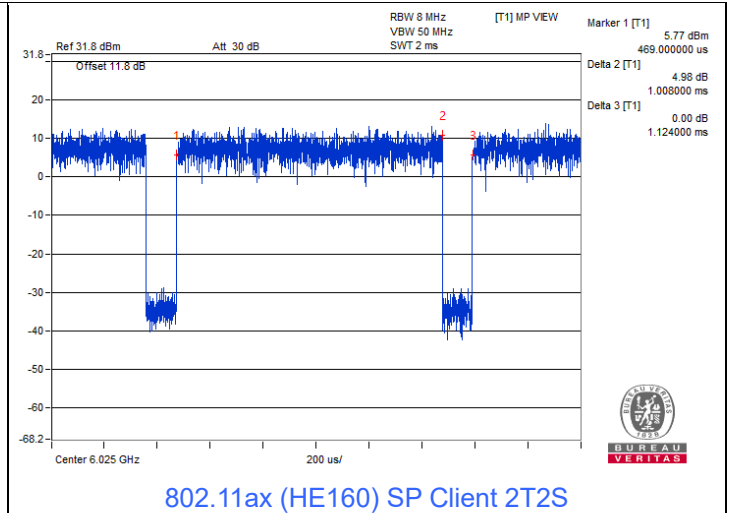

802.11ax (HE160) SP Client 2T2S

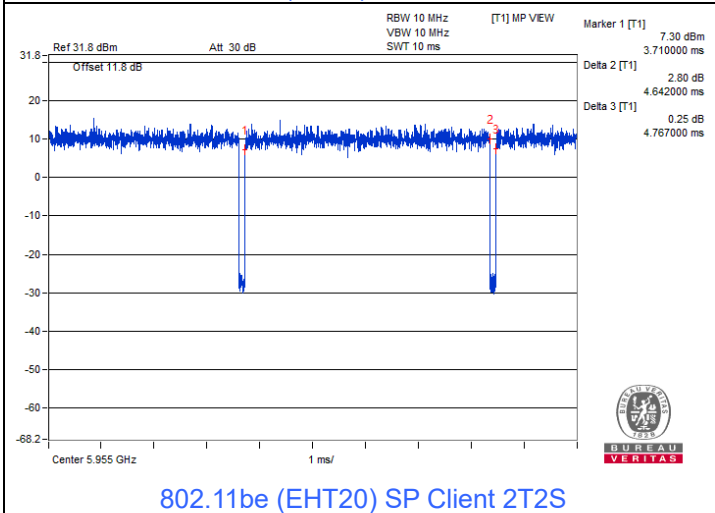

802.11be (EHT20) SP Client 2T2S

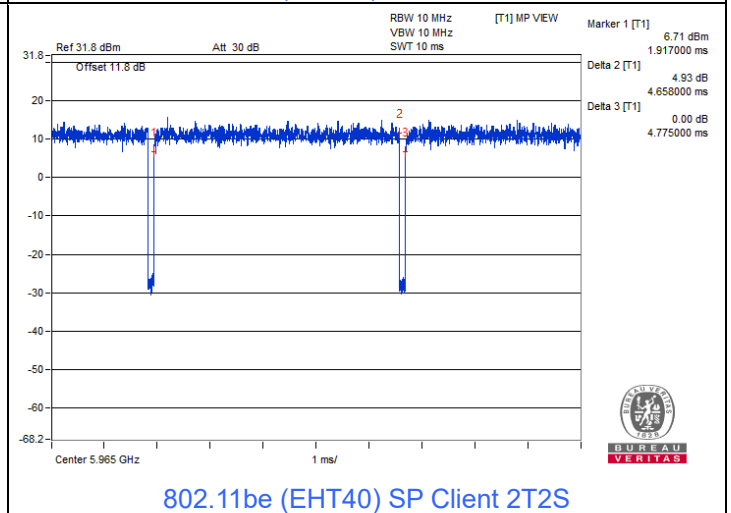

802.11be (EHT40) SP Client 2T2S

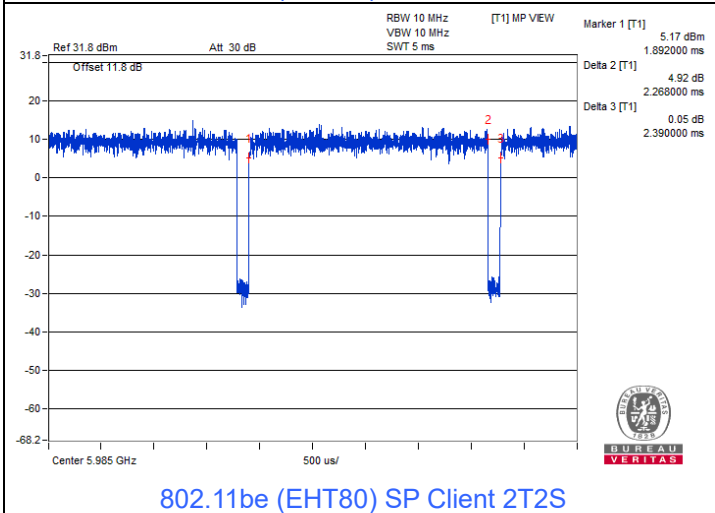

802.11be (EHT80) SP Client 2T2S

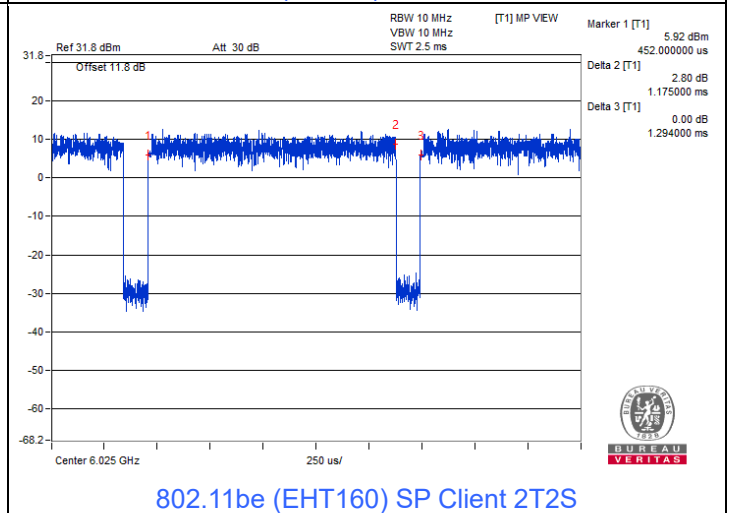

802.11be (EHT160) SP Client 2T2S

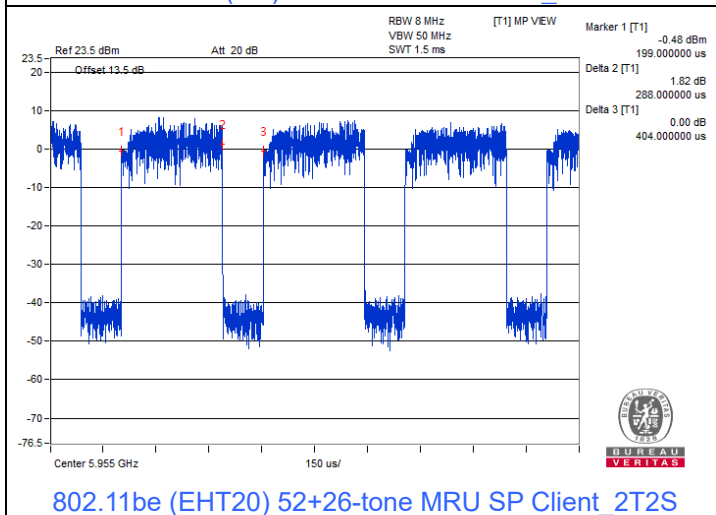
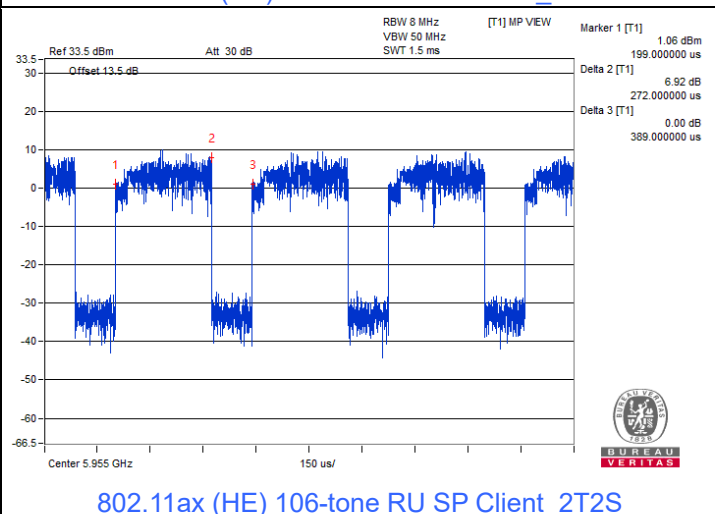
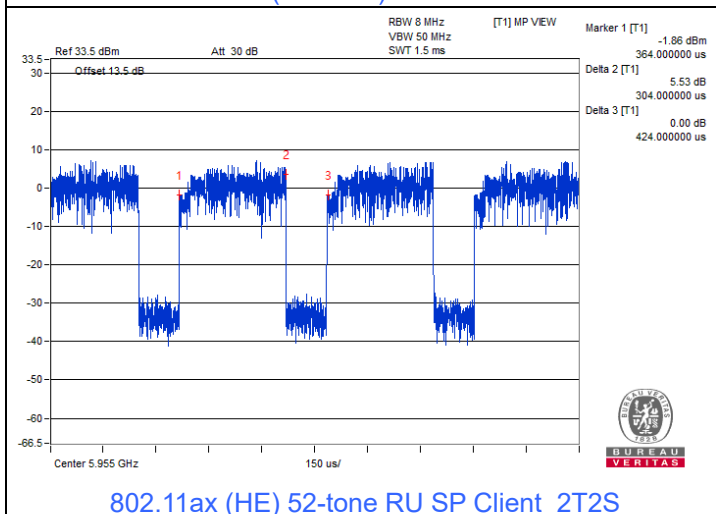
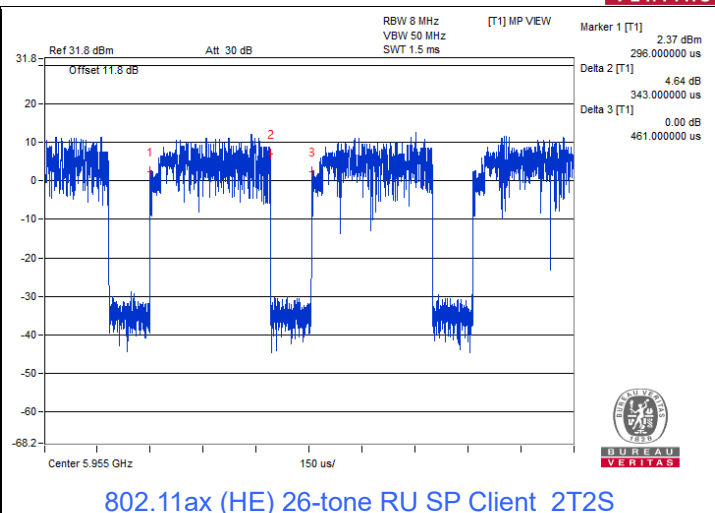
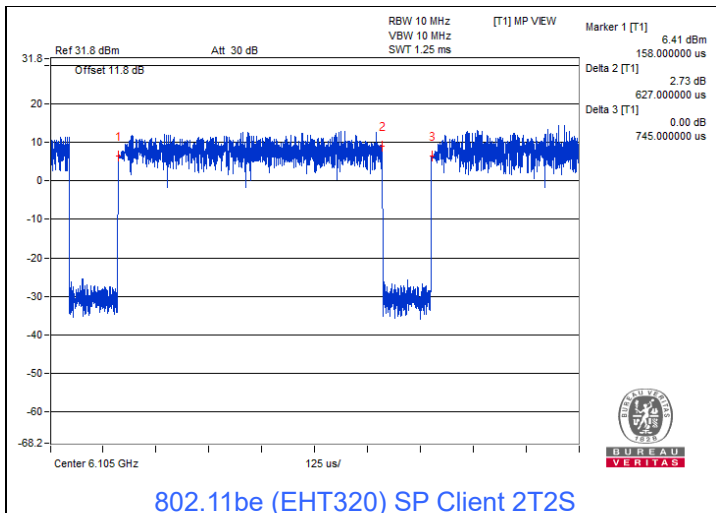

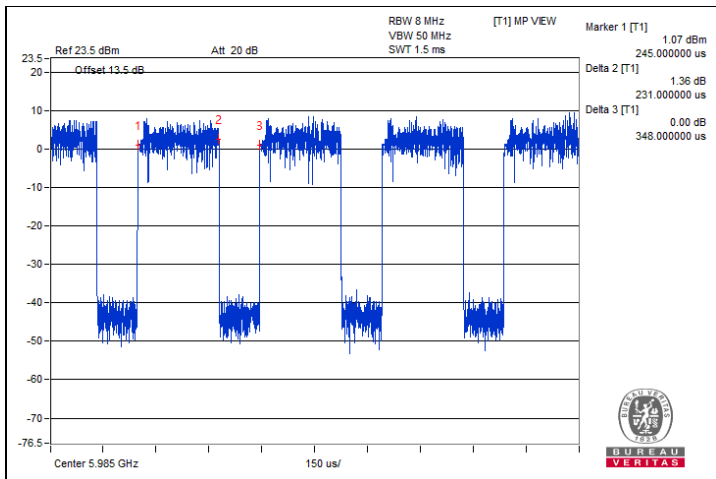

802.11be (EHT80) 484+242-tone MRU SP Client\_2T2S

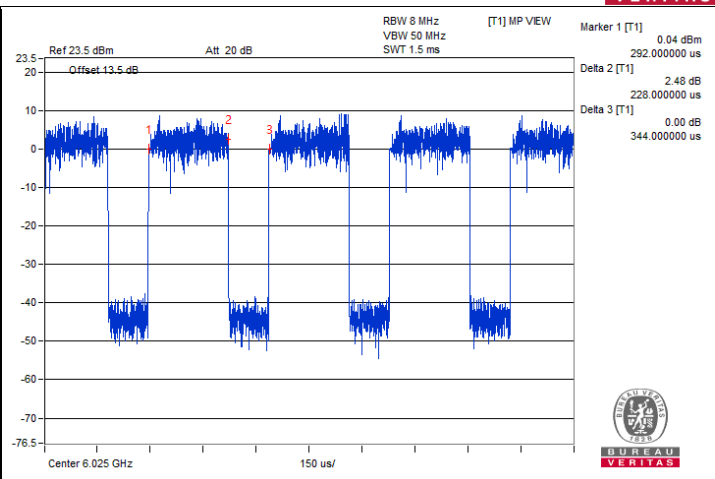

802.11be (EHT160) 996+484-tone MRU SP Client\_2T2S

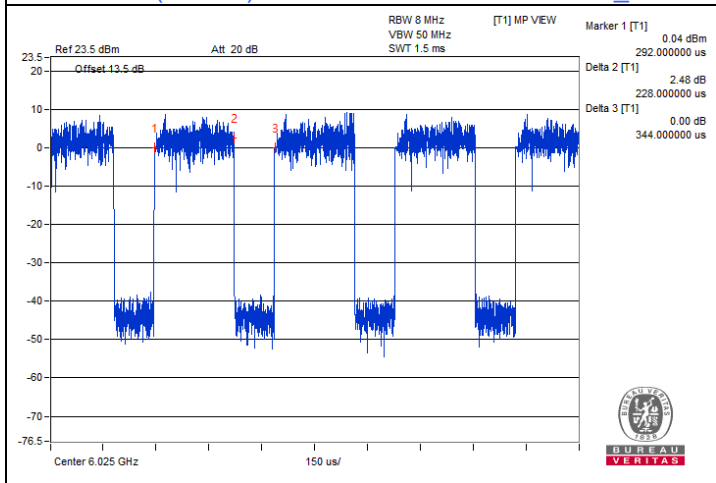

802.11be (EHT160) 996+484+242-tone MRU SP Client\_2T2S

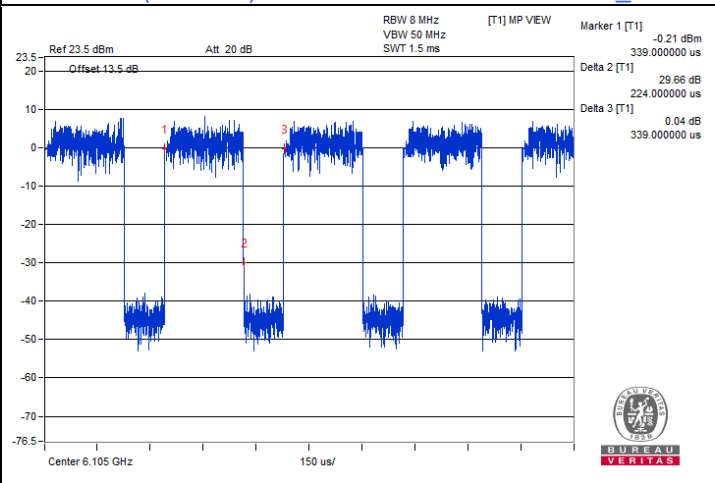

802.11be (EHT320) 2x996+484-tone MRU SP Client 2T2S

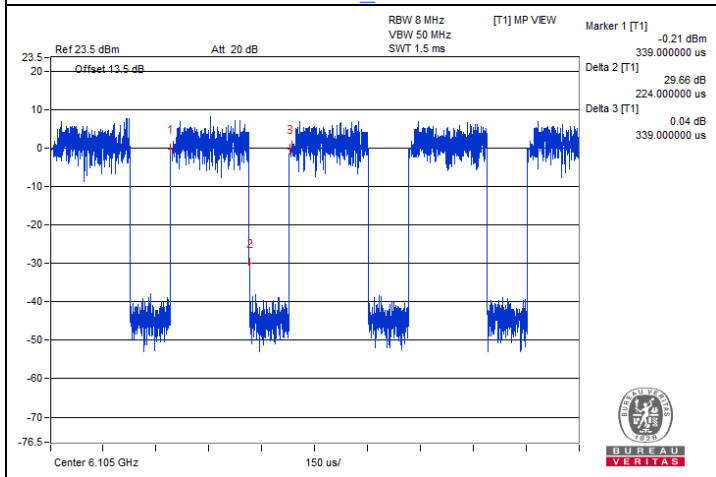

802.11be (EHT320) 3x996-tone MRU SP Client 2T2S

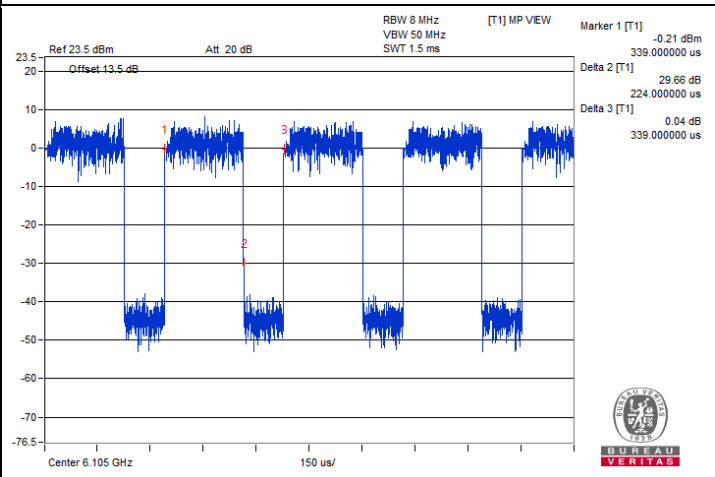

802.11be (EHT320) 3x996+484-tone MRU SP Client 2T2S

### 3.6 Test Program Used and Operation Descriptions

Controlling software (QAtool\_V26 (0.0.2.93)) has been activated to set the EUT under transmission condition continuously at specific channel frequency.

### 3.7 Connection Diagram of EUT and Peripheral Devices

#### For AC Power Conducted Emission test

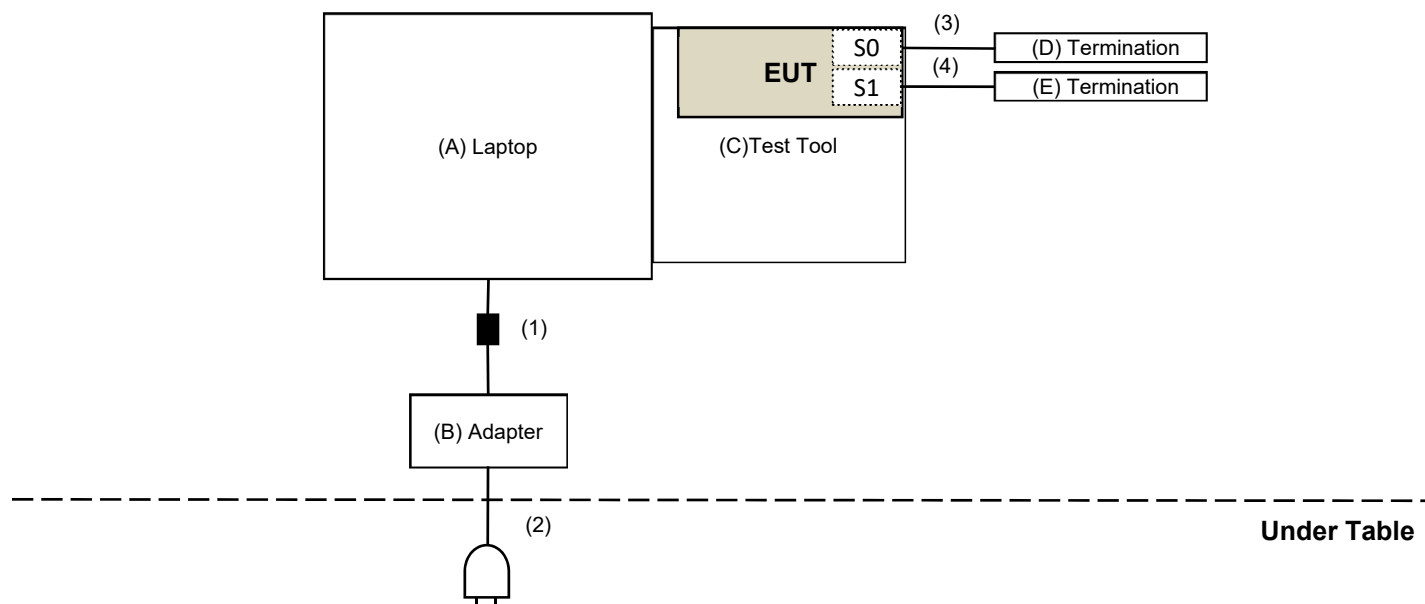

#### For Unwanted Emission test

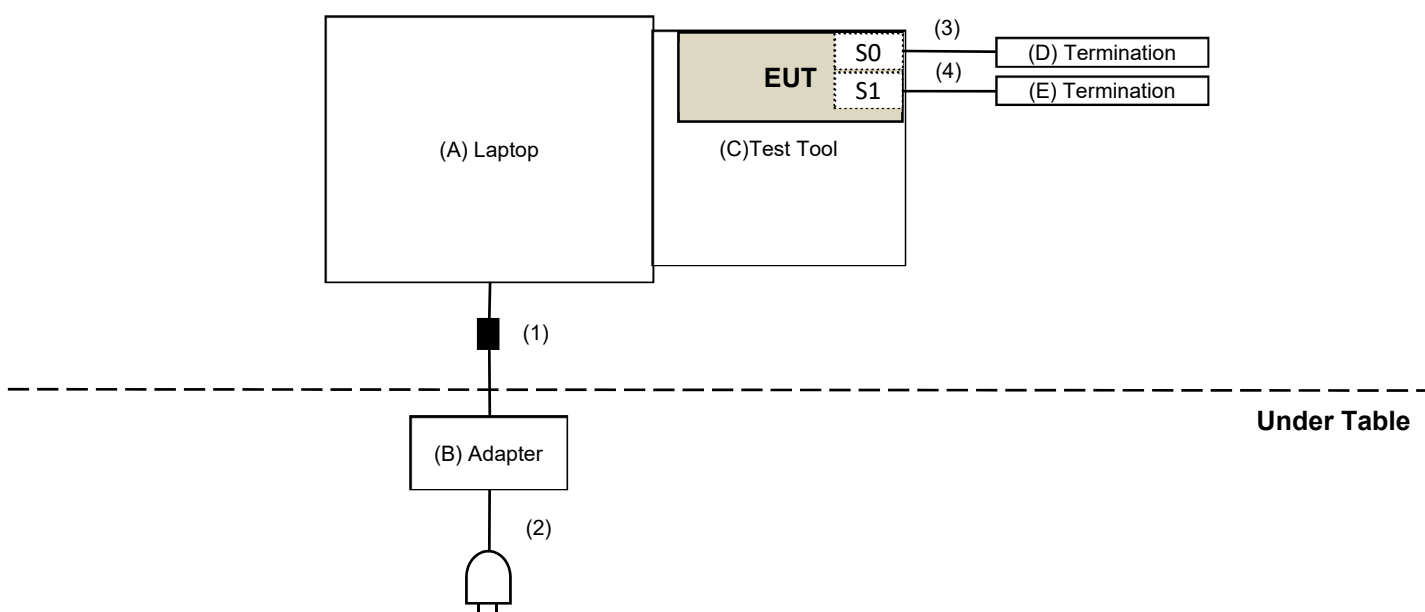

### 3.8 Configuration of Peripheral Devices and Cable Connections

ID	Product	Brand	Model No.	Serial No.	FCC ID	Remarks
A	Laptop	DELL	E5430	HYV4VY1	DoC	Provided by Lab
B	Adapter	DELL	LLA65NS2-01	N/A	N/A	Provided by Lab
C	Test Tool	Mediatek	MTK1849	N/A	N/A	Supplied by applicant
D	Termination	Marvelous	MVE5185	N/A	N/A	Provided by Lab
E	Termination	Marvelous	MVE5185	N/A	N/A	Provided by Lab

ID	Cable Descriptions	Qty.	Length (m)	Shielding (Yes/No)	Cores (Qty.)	Remarks
1	DC Cable	1	1.8	No	1	Provided by Lab
2	AC Cable	1	1	No	0	Provided by Lab
3	RF Cable	1	0.2	No	0	Provided by Lab
4	RF Cable	1	0.2	No	0	Provided by Lab

### 3.9 Test Program Used and Operation Descriptions

Controlling software (QAtool\_V26 (0.0.2.93)) has been activated to set the EUT under transmission condition continuously at specific channel frequency.

### 3.10 Connection Diagram of EUT and Peripheral Devices

#### For AC Power Conducted Emission test

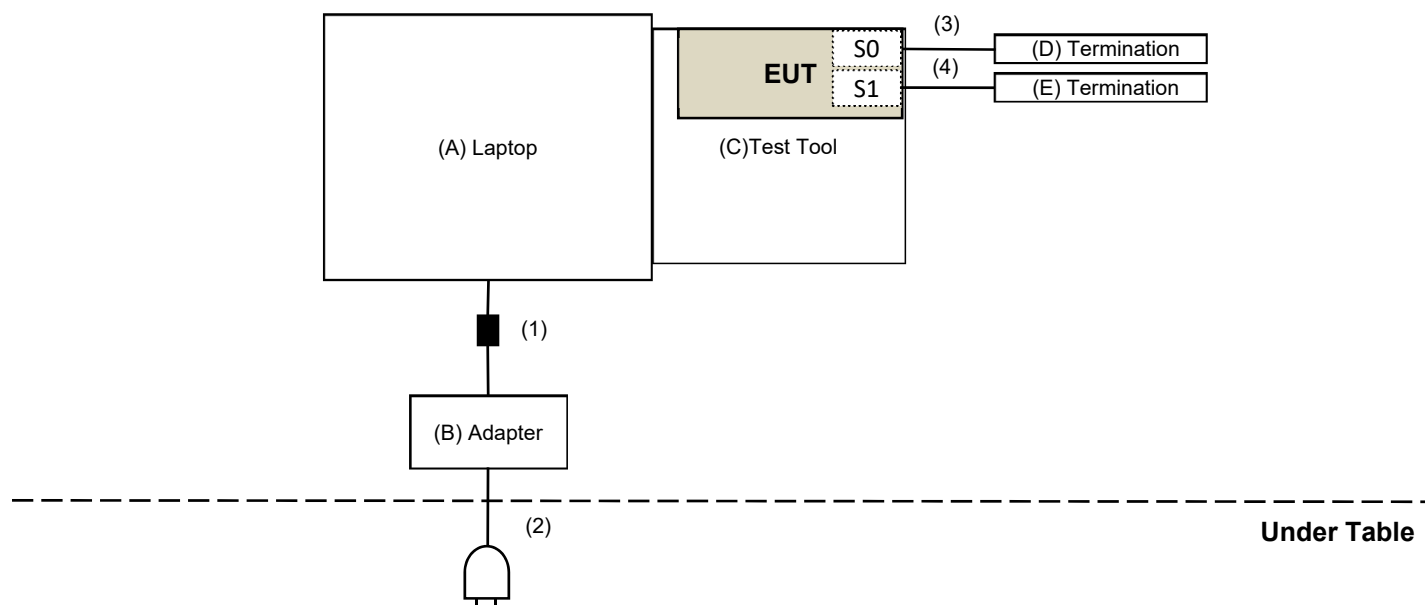

#### For Unwanted Emission test

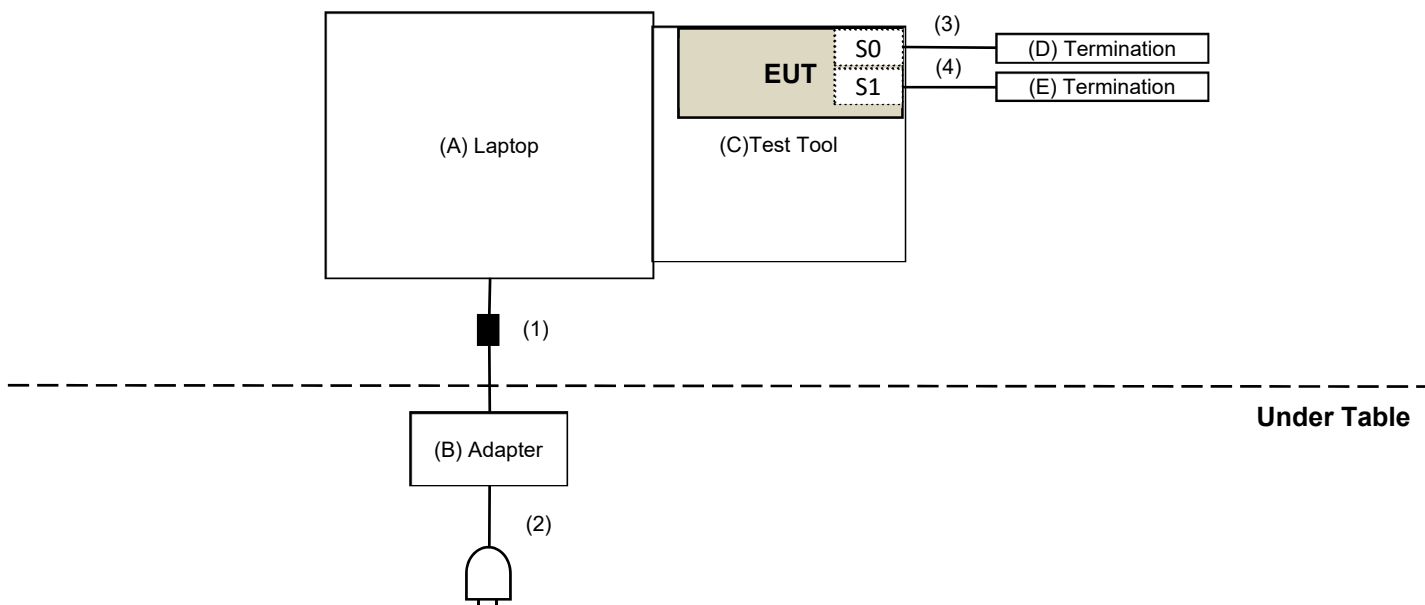

### 3.11 Configuration of Peripheral Devices and Cable Connections

ID	Product	Brand	Model No.	Serial No.	FCC ID	Remarks
A	Laptop	DELL	E5430	HYV4VY1	DoC	Provided by Lab
B	Adapter	DELL	LLA65NS2-01	N/A	N/A	Provided by Lab
C	Test Tool	Mediatek	MTK1849	N/A	N/A	Supplied by applicant
D	Termination	Marvelous	MVE5185	N/A	N/A	Provided by Lab
E	Termination	Marvelous	MVE5185	N/A	N/A	Provided by Lab

ID	Cable Descriptions	Qty.	Length (m)	Shielding (Yes/No)	Cores (Qty.)	Remarks
1	DC Cable	1	1.8	No	1	Provided by Lab
2	AC Cable	1	1	No	0	Provided by Lab
3	RF Cable	1	0.2	No	0	Provided by Lab
4	RF Cable	1	0.2	No	0	Provided by Lab

## 4 Test Instruments

The calibration interval of the all test instruments are 12 months and the calibrations are traceable to NML/ROC and NIST/USA.

### 4.1 RF Output Power

Description Manufacturer	Model No.	Serial No.	Calibrated Date	Calibrated Until
Power Meter Anritsu	ML2495A	1529002	2022/6/22	2023/6/21
Pulse Power Sensor Anritsu	MA2411B	1726434	2022/6/22	2023/6/21
Attenuator WOKEN	MDCS18N-10	MDCS18N-10-01	2022/4/5	2023/4/4
Software	ADT_RF Test Software V6.6.5.4	N/A	N/A	N/A

Notes:

1. The test was performed in Oven room 2.
2. Tested Date: 2022/11/9 ~ 2023/1/4

### 4.2 Power Spectral Density

Description Manufacturer	Model No.	Serial No.	Calibrated Date	Calibrated Until
Attenuator WOKEN	MDCS18N-10	MDCS18N-10-01	2022/4/5	2023/4/4
Software	ADT_RF Test Software V6.6.5.4	N/A	N/A	N/A
Spectrum Analyzer Keysight	N9020B	MY60112409	2022/3/11	2023/3/10

Notes:

1. The test was performed in Oven room 2.
2. Tested Date: 2022/11/9 ~ 2023/1/4

### 4.3 Emission Bandwidth

Refer to section 4.2 to get information of the instruments.

### 4.4 In-Band Emission Mask

Refer to section 4.2 to get information of the instruments.

### 4.5 Occupied Bandwidth

Refer to section 4.2 to get information of the instruments.



#### 4.6 AC Power Conducted Emissions

Description Manufacturer	Model No.	Serial No.	Calibrated Date	Calibrated Until
50 ohm terminal resistance	N/A	EMC-01	2022/9/27	2023/9/26
Fixed attenuator STI	STI02-2200-10	005	2022/8/24	2023/8/23
LISN R&S	ESH3-Z5	848773/004	2022/10/18	2023/10/17
RF Coaxial Cable JYEBO	5D-FB	COCCAB-001	2022/8/24	2023/8/23
Software BVADT	BVADT_Cond_V7.3.7.4	N/A	N/A	N/A
TEST RECEIVER R&S	ESCS 30	847124/029	2022/10/14	2023/10/13

Notes:

1. The test was performed in Conduction 1
2. Tested Date: 2022/12/25

#### 4.7 Unwanted Emissions below 1 GHz

Description Manufacturer	Model No.	Serial No.	Calibrated Date	Calibrated Until
Boresight Antenna Tower & Turn Table Max-Full	MF-7802BS	MF780208530	N/A	N/A
Fixed attenuator Mini-Circuits	UNAT-5+	PAD-ATT5-03	2022/1/10	2023/1/9
LOOP ANTENNA Electro-Metrics	EM-6879	264	2022/3/18	2023/3/17
Pre_Amplifier Agilent	8447D	2944A10636	2022/3/19	2023/3/18
Pre_Amplifier EMCI	EMC330N	980701	2022/3/8	2023/3/7
RF Coaxial Cable COMMATE/PEWC	8D	966-4-1	2022/3/8	2023/3/7
		966-4-2	2022/3/8	2023/3/7
		966-4-3	2022/3/8	2023/3/7
RF Coaxial Cable JYEBO	5D-FB	LOOPCAB-001	2022/1/6	2023/1/5
		LOOPCAB-002	2022/12/19	2023/12/18
Software	ADT_Radiated_V8.7.08	N/A	N/A	N/A
Spectrum Analyzer KEYSIGHT	N9030B	MY57142938	2022/4/26	2023/4/25
Trilog Broadband Antenna Schwarzbeck	VULB 9168	9168-406	2022/10/21	2023/10/20

Notes:

1. The test was performed in 966 Chamber No. 4.
2. Tested Date: 2022/12/21

#### 4.8 Unwanted Emissions above 1 GHz

Description Manufacturer	Model No.	Serial No.	Calibrated Date	Calibrated Until
Boresight Antenna Tower & Turn Table Max-Full	MF-7802BS	MF780208530	N/A	N/A
Horn Antenna Schwarzbeck	BBHA 9120D	9120D-783	2022/11/13	2023/11/12
	BBHA 9170	9170-739	2022/11/13	2023/11/12
Pre_Amplifier EMCI	EMC12630SE	980688	2022/10/4	2023/10/3
	EMC184045SE	980387	2022/1/10	2023/1/9
RF Cable-Frequency Range : 1- 26.5GHz EMCI	EMC104-SM-SM-1200	160922	2022/12/15	2023/12/14
RF Cable-Frequency range: 1- 40GHz EMCI	EMC102-KM-KM-1200	160924	2022/1/10	2023/1/9
RF Coaxial Cable EMCI	EMC-KM-KM-4000	200214	2022/3/8	2023/3/7
	EMC104-SM-SM-2000	180502	2022/4/25	2023/4/24
	EMC104-SM-SM-6000	210704	2022/11/4	2023/11/3
Software	ADT_Radiated_V8.7.08	N/A	N/A	N/A
Spectrum Analyzer Keysight	N9020B	MY60112410	2022/3/13	2023/3/12

Notes:

1. The test was performed in 966 Chamber No. 4.
2. Tested Date: 2022/12/22

## 5 Limits of Test Items

### 5.1 RF Output Power

Operation Band	EUT Category	Limit
		Max Average Power
U-NII-5 U-NII-7	Dual Client Devices ( controlled of an standard power AP )	EIRP 30 dBm

Per KDB 662911 Method of conducted output power measurement on IEEE 802.11 devices,

Array Gain = 0 dB (i.e., no array gain) for  $N_{ANT} \leq 4$ ;

Array Gain = 0 dB (i.e., no array gain) for channel widths  $\geq 40$  MHz for any  $N_{ANT}$ ;

Array Gain =  $5 \log(N_{ANT}/N_{SS})$  dB or 3 dB, whichever is less for 20-MHz channel widths with  $N_{ANT} \geq 5$ .

For power measurements on all other devices: Array Gain =  $10 \log(N_{ANT}/N_{SS})$  dB.

### 5.2 Power Spectral Density

Operation Band	EUT Category	Limit
		Peak Power Density
U-NII-5 U-NII-7	Dual Client Devices ( controlled of an standard power AP )	EIRP 17 dBm/MHz

### 5.3 Emission Bandwidth

The maximum transmitter channel bandwidth for U-NII devices in the 5.925-7.125 GHz band is 320 MHz.

## 5.4 In-Band Emission Mask

Test Item	Frequencies (MHz)	(X) dBc* <sup>1</sup>
Emission Mask	At 1 MHz outside of channel edge	20
	At one channel bandwidth from the channel center* <sup>2</sup>	28
	At one- and one-half times the channel bandwidth away from channel center* <sup>3</sup>	40
	More than one- and one-half times the channel bandwidth	40

\*<sup>1</sup> : The power spectral density must be suppressed by “x” dB

\*<sup>2</sup> : At frequencies between one megahertz outside an unlicensed device’s channel edge and one channel bandwidth from the center of the channel, the limits must be linearly interpolated between 20 dB and 28 dB suppression,

\*<sup>3</sup> : At frequencies between one and one- and one-half times an unlicensed device’s channel bandwidth, the limits must be linearly interpolated between 28 dB and 40 dB suppression.

## 5.5 Occupied Bandwidth

The maximum transmitter channel bandwidth for U-NII devices in the 5.925-7.125 GHz band is 320 MHz.

## 5.6 AC Power Conducted Emissions

Frequency (MHz)	Conducted Limit (dBuV)	
	Quasi-peak	Average
0.15 - 0.5	66 - 56	56 - 46
0.50 - 5.0	56	46
5.0 - 30.0	60	50

Notes:

1. The lower limit shall apply at the transition frequencies.
2. The limit decreases in line with the logarithm of the frequency in the range of 0.15 to 0.50 MHz.

## 5.7 Unwanted Emissions below 1 GHz

Radiated emissions which fall in the restricted bands must comply with the radiated emission limits specified as below table.

Frequencies (MHz)	Field Strength (microvolts/meter)	Measurement Distance (meters)
0.009 ~ 0.490	2400/F(kHz)	300
0.490 ~ 1.705	24000/F(kHz)	30
1.705 ~ 30.0	30	30
30 ~ 88	100	3
88 ~ 216	150	3
216 ~ 960	200	3
Above 960	500	3

Notes:

1. The lower limit shall apply at the transition frequencies.
2. Emission level (dBuV/m) = 20 log Emission level (uV/m).

## 5.8 Unwanted Emissions above 1 GHz

Radiated emissions which fall in the restricted bands must comply with the radiated emission limits specified as below table.

Frequencies (MHz)	Field Strength (microvolts/meter)	Measurement Distance (meters)
Above 960	500	3

Notes:

1. The lower limit shall apply at the transition frequencies.
2. Emission level (dBuV/m) = 20 log Emission level (uV/m).
3. For frequencies above 1000 MHz, the field strength limits are based on average detector, however, the peak field strength of any emission shall not exceed the maximum permitted average limits, specified above by more than 20 dB under any condition of modulation.

Limits of unwanted emission out of the restricted bands

Frequencies (MHz)	EIRP Limit	Equivalent Field Strength at 3 m
5925 MHz > F > 7125 MHz	Peak: -7 (dBm/MHz)	88.2 (dBuV/m)
	Average: -27 (dBm/MHz)	68.2 (dBuV/m)

Note: The following formula is used to convert the equipment isotropic radiated power (eirp) to field strength:

$$E = \frac{1000000\sqrt{30P}}{3} \text{ } \mu\text{V/m, where P is the eirp (Watts).}$$

## 6 Test Arrangements

### 6.1 RF Output Power

#### 6.1.1 Test Setup

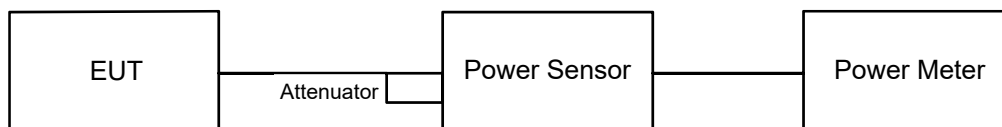

#### 6.1.2 Test Procedure

Method PM is used to perform output power measurement, trigger and gating function of wide band power meter is enabled to measure max output power of TX on burst and set the detector to average. Duty factor is not added to measured value.

### 6.2 Power Spectral Density

#### 6.2.1 Test Setup

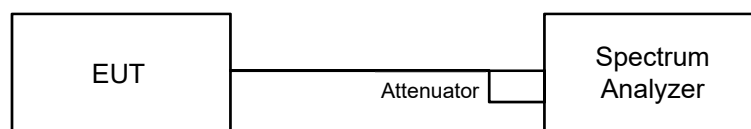

#### 6.2.2 Test Procedure

##### For specified measurement bandwidth 1 MHz:

Method SA-2

- a. Set span to encompass the entire emission bandwidth (EBW) of the signal.
- b. Set RBW = 1 MHz, Set VBW  $\geq$  3 MHz, Detector = RMS
- c. Sweep points  $\geq$   $[2 \times \text{span} / \text{RBW}]$ . (This gives bin-to-bin spacing  $\leq$  RBW / 2, so that narrowband signals are not lost between frequency bins.)
- d. Sweep time = auto, trigger set to "free run".
- e. Trace average at least 100 traces in power averaging mode.
- f. Use the peak search function on the instrument to find the peak of the spectrum and record its value.
- g. Record the max value and add  $10 \log (1/\text{duty cycle})$ .

## 6.3 Emission Bandwidth

### 6.3.1 Test Setup

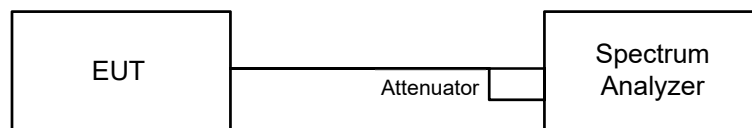

### 6.3.2 Test Procedure

- Set RBW = approximately 1% of the emission bandwidth.
- Set the VBW > RBW.
- Detector = Peak.
- Trace mode = max hold.
- Measure the maximum width of the emission that is 26 dB down from the peak of the emission. Compare this with the RBW setting of the analyzer. Readjust RBW and repeat measurement as needed until the RBW/EBW ratio is approximately 1%.

## 6.4 In-Band Emission Mask

### 6.4.1 Test Setup

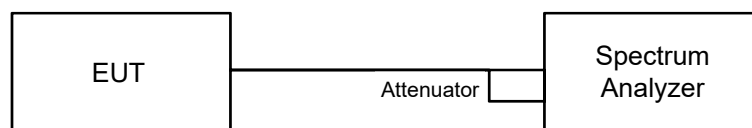

### 6.4.2 Test Procedure

- Connect output of the antenna port to a spectrum analyzer and adjust appropriate attenuation.
- Measure the 26 dB EBW using the test procedure 12.4.1 of ANSI C63.10-2013. (Determine the channel edge.)
- Measure the power spectral density (for emissions mask reference) using the following procedure:
  - Set the span to encompass the entire 26 dB EBW of the signal.
  - Set RBW = same RBW used for 26 dB EBW measurement.
  - Set VBW  $\geq [3 \times \text{RBW}]$ .
  - Number of points in sweep  $\geq [2 \times \text{span} / \text{RBW}]$ .
  - Sweep time = auto.
  - Detector = RMS (i.e., power averaging).
  - Trace average at least 100 traces in power averaging (rms) mode.
  - Use the peak search function on the instrument to find the peak of the spectrum.
- Using the measuring equipment limit line function, develop the emissions mask based on the following requirements. The emissions power spectral density must be reduced below the peak power spectral density (in dB) as follows:
  - Suppressed by 20 dB at 1 MHz outside of the channel edge. (The channel edge is defined as the 26-dB point on either side of the carrier center frequency.)
  - Suppressed by 28 dB at one channel bandwidth from the channel center.
  - Suppressed by 40 dB at one- and one-half times the channel bandwidth from the channel center.
- Adjust the span to encompass the entire mask as necessary and clear trace.
- Trace average at least 100 traces in power averaging (rms) mode.
- Adjust the reference level as necessary so that the crest of the channel touches the top of the emission mask

## 6.5 Occupied Bandwidth

### 6.5.1 Test Setup

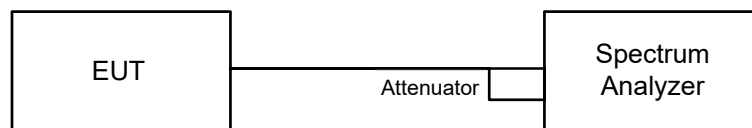

### 6.5.2 Test Procedure

The transmitter output was connected to the spectrum analyzer through an attenuator. The bandwidth of the fundamental frequency was measured by spectrum analyzer with resolution bandwidth in the range of 1% to 5% of the anticipated emission bandwidth, and a video bandwidth at least 3x the resolution bandwidth and set the detector to Sampling. The width of a frequency band such that, below the lower and above the upper frequency limits, the mean powers emitted are each equal to a specified percentage 0.5% of the total mean power of a given emission.



## 6.6 AC Power Conducted Emissions

### 6.6.1 Test Setup

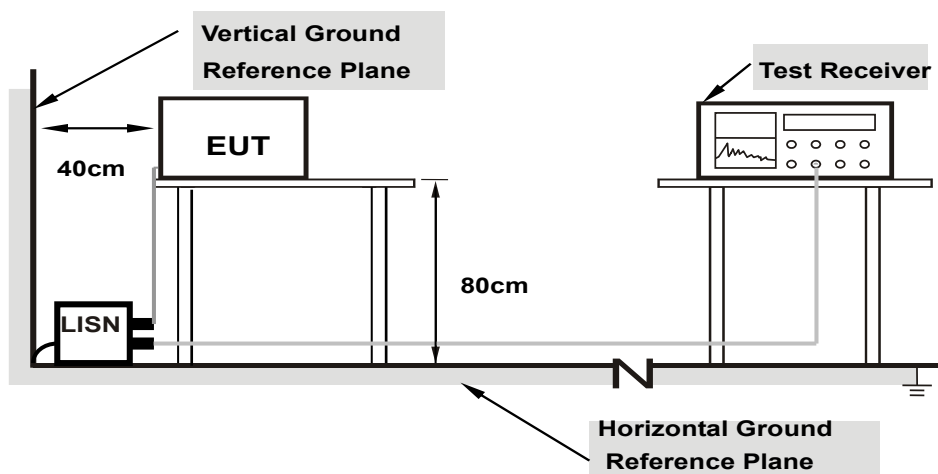

**Note: 1.Support units were connected to second LISN.**

For the actual test configuration, please refer to the attached file (Test Setup Photo).

### 6.6.2 Test Procedure

- The EUT was placed on a 0.8 meter to the top of table and placed 0.4 meters from the conducting wall of the shielded room with EUT being connected to the power mains through a line impedance stabilization network (LISN). Other support units were connected to the power mains through another LISN. The two LISNs provide 50 ohm/ 50 uH of coupling impedance for the measuring instrument.
- Both lines of the power mains connected to the EUT were checked for maximum conducted interference.
- The frequency range from 150 kHz to 30 MHz was searched. Emission levels under (Limit – 20 dB) was not recorded.

Note: The resolution bandwidth and video bandwidth of test receiver is 9 kHz for quasi-peak detection (QP) and average detection (AV) at frequency 0.15 MHz-30 MHz.

## 6.7 Unwanted Emissions below 1 GHz

### 6.7.1 Test Setup

#### For Conducted Configuration:

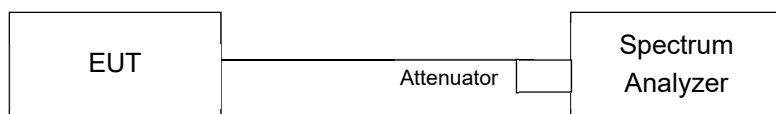

#### For Radiated Configuration:

#### For Radiated emission below 30 MHz

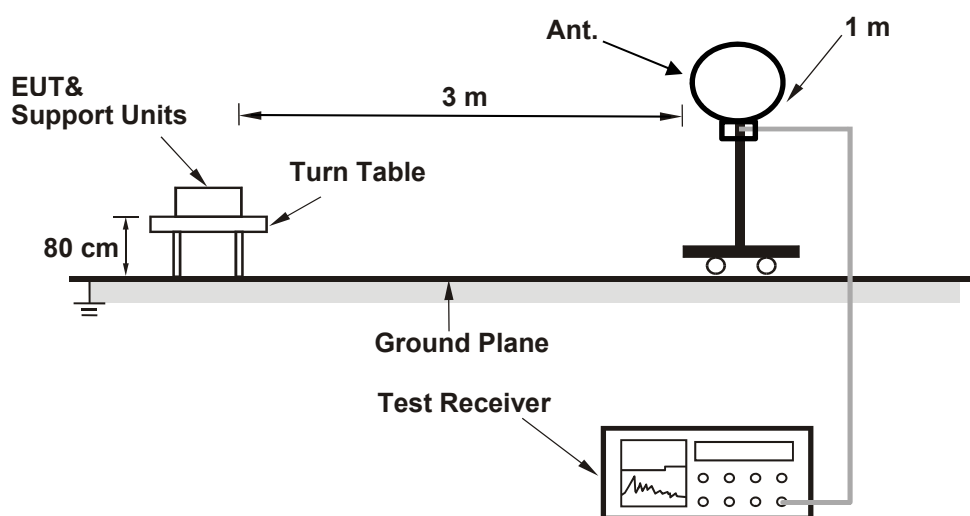

#### For Radiated emission above 30 MHz

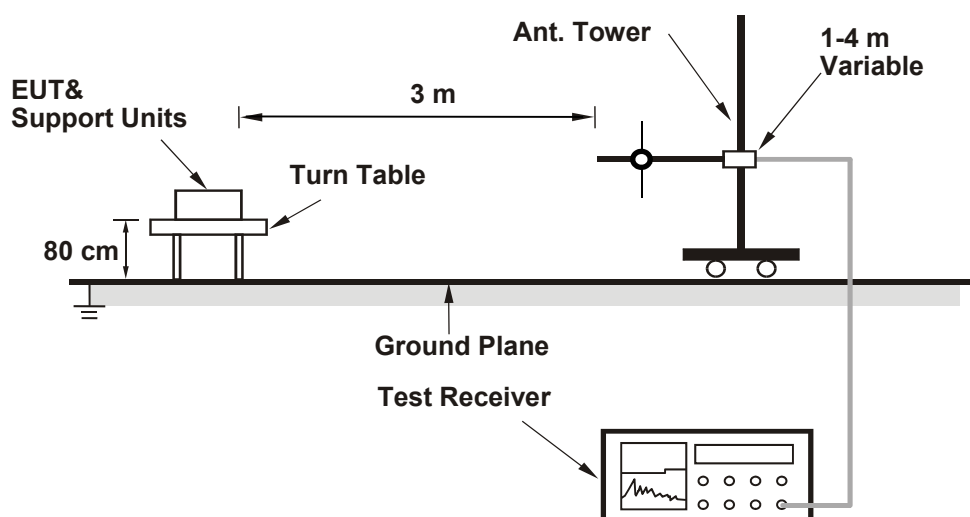

For the actual test configuration, please refer to the attached file (Test Setup Photo).

## 6.7.2 Test Procedure

Following FCC KDB 789033 D02 General UNII Test Procedures:

Radiated versus Conducted Measurements.

The unwanted emission limits in both the restricted and non-restricted bands are based on antenna-port conducted measurements in conjunction with cabinet emissions tests are permitted to demonstrate compliance.

The following steps was performed:

- a. Cabinet emissions measurements. Radiated measurement was performed to ensure that cabinet emissions are below the emission limits. For the cabinet-emission measurements the antenna was replaced by a termination matching the nominal impedance of the antenna.
- b. Conducted tests was performed using equipment that matches the nominal impedance of the antenna assembly used with the EUT.
- c. EIRP calculation. A value representative of an upper bound on out-of-band antenna gain (in dBi) shall be added to the measured antenna-port conducted emission power to compute EIRP within the specified measurement bandwidth. (For emissions in the restricted bands, additional calculations are required to convert EIRP to field strength at the specified distance.) The upper bound on antenna gain for a device with a single RF output shall be selected as the maximum in-band gain of the antenna across all operating bands or 2 dBi, whichever is greater.
- d. EIRP adjustments for multiple outputs. (Follow the procedures specified in FCC KDB Publication 662911)
- e. For all of Radiation emission test

### For Radiated emission below 30 MHz

- a. The EUT was placed on the top of a rotating table 0.8 meters above the ground at 3 meter chamber room for test. The table was rotated 360 degrees to determine the position of the highest radiation.
- b. The EUT was set 3 meters away from the interference-receiving antenna, which was mounted on the top of a variable-height antenna tower.
- c. Parallel, perpendicular, and ground-parallel orientations of the antenna are set to make the measurement.
- d. For each suspected emission, the EUT was arranged to its worst case and the rotatable table was turned from 0 degrees to 360 degrees to find the maximum reading.
- e. The test-receiver system was set to Quasi-Peak Detect Function and Specified Bandwidth with Maximum Hold Mode, except for the frequency band (9 kHz to 90 kHz and 110 kHz to 490 kHz) set to average detect function and peak detect function.

Notes:

1. The resolution bandwidth and video bandwidth of test receiver/spectrum analyzer is 200 Hz at frequency below 150 kHz.
2. The resolution bandwidth and video bandwidth of test receiver/spectrum analyzer is 9 kHz or 10 kHz at frequency (150 kHz to 30 MHz).
3. All modes of operation were investigated and the worst-case emissions are reported.

### For Radiated emission above 30 MHz

- a. The EUT was placed on the top of a rotating table 0.8 meters above the ground at 3 meter chamber room for test. The table was rotated 360 degrees to determine the position of the highest radiation.
- b. The EUT was set 3 meters away from the interference-receiving antenna, which was mounted on the top of a variable-height antenna tower.
- c. The height of antenna is varied from one meter to four meters above the ground to determine the maximum value of the field strength. Both horizontal and vertical polarizations of the antenna are set to make the measurement.
- d. For each suspected emission, the EUT was arranged to its worst case and then the antenna was tuned to heights from 1 meter to 4 meters and the rotatable table was turned from 0 degrees to 360 degrees to find the maximum reading.
- e. The test-receiver system was set to quasi-peak detect function and specified bandwidth with maximum hold mode when the test frequency is below 1 GHz.

Notes:

1. The resolution bandwidth and video bandwidth of test receiver/spectrum analyzer is 120 kHz for Quasi-peak detection (QP) at frequency below 1 GHz.
2. All modes of operation were investigated and the worst-case emissions are reported.

## 6.8 Unwanted Emissions above 1 GHz

### 6.8.1 Test Setup

#### For Conducted Configuration:

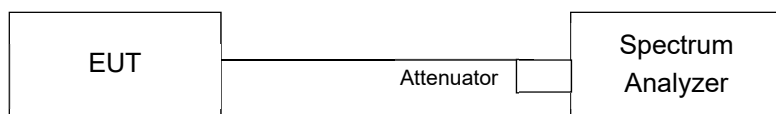

#### For Radiated Configuration:

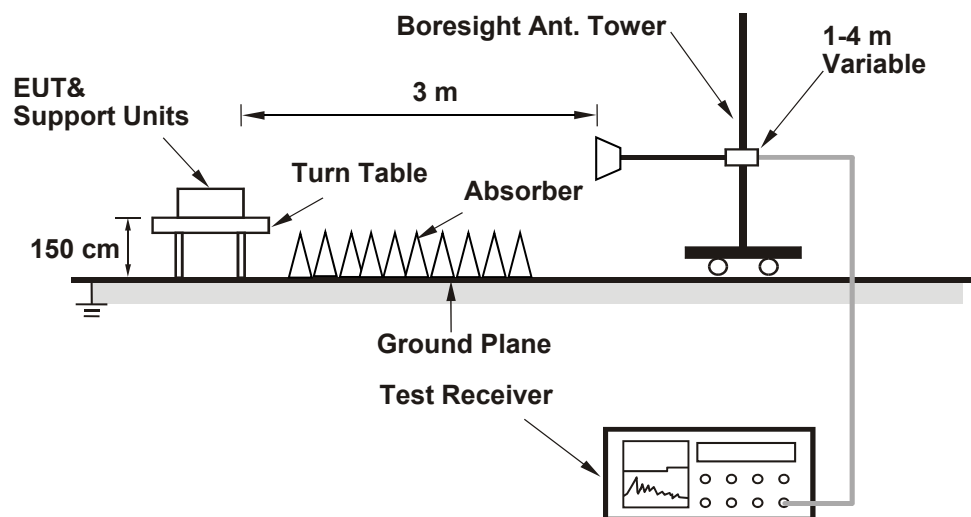

For the actual test configuration, please refer to the attached file (Test Setup Photo).

## 6.8.2 Test Procedure

Following FCC KDB 789033 D02 General UNII Test Procedures:

Radiated versus Conducted Measurements.

The unwanted emission limits in both the restricted and non-restricted bands are based on antenna-port conducted measurements in conjunction with cabinet emissions tests are permitted to demonstrate compliance.

The following steps was performed:

- a. Cabinet emissions measurements. Radiated measurement was performed to ensure that cabinet emissions are below the emission limits. For the cabinet-emission measurements the antenna was replaced by a termination matching the nominal impedance of the antenna.
- b. Conducted tests was performed using equipment that matches the nominal impedance of the antenna assembly used with the EUT.
- c. EIRP calculation. A value representative of an upper bound on out-of-band antenna gain (in dBi) shall be added to the measured antenna-port conducted emission power to compute EIRP within the specified measurement bandwidth. (For emissions in the restricted bands, additional calculations are required to convert EIRP to field strength at the specified distance.) The upper bound on antenna gain for a device with a single RF output shall be selected as the maximum in-band gain of the antenna across all operating bands or 2 dBi, whichever is greater.
- d. EIRP adjustments for multiple outputs. (Follow the procedures specified in FCC KDB Publication 662911)
- e. For all of Radiation emission test

### For Radiated emission above 1 GHz

- a. The EUT was placed on the top of a rotating table 1.5 meters above the ground at 3 meter chamber room for test. The table was rotated 360 degrees to determine the position of the highest radiation.
- b. The EUT was set 3 meters away from the interference-receiving antenna, which was mounted on the top of a variable-height antenna tower.
- c. The height of antenna is varied from one meter to four meters above the ground to determine the maximum value of the field strength. Both horizontal and vertical polarizations of the antenna are set to make the measurement.
- d. For each suspected emission, the EUT was arranged to its worst case and then the antenna was tuned to heights from 1 meter to 4 meters and the rotatable table was turned from 0 degrees to 360 degrees to find the maximum reading.
- e. The test-receiver system was set to peak and average detects function and specified bandwidth with maximum hold mode when the test frequency is above 1 GHz. If the peak reading value also meets average limit, measurement with the average detector is unnecessary.

Notes:

1. The resolution bandwidth of test receiver/spectrum analyzer is 1 MHz and the video bandwidth is 3 MHz for Peak detection (PK) and Average detection (AV) at frequency above 1 GHz.
2. For fundamental and harmonic signal measurement, the resolution bandwidth of test receiver/spectrum analyzer is 1 MHz and the video bandwidth is  $\geq 1/T$  (Duty cycle < 98%) or 10 Hz (Duty cycle  $\geq 98\%$ ) for Average detection (AV) at frequency above 1 GHz.
3. All modes of operation were investigated and the worst-case emissions are reported.

## 7 Test Results of Test Item

### 7.1 RF Output Power

Input Power:	120 Vac, 60 Hz	Environmental Conditions:	24°C, 66% RH	Tested By:	Eric Peng
--------------	----------------	---------------------------	--------------	------------	-----------

#### 802.11a SP Client 1TX

Chan.	Chan. Freq. (MHz)	Average Power (mW)	Average Power (dBm)	Antenna Gain (dBi)	EIRP (mW)	EIRP (dBm)	EIRP Limit (dBm)	Test Result
1	5955	211.349	23.25	4.76	632.412	28.01	30	Pass
45	6175	185.78	22.69	4.76	555.903	27.45	30	Pass
93	6415	186.638	22.71	4.76	558.47	27.47	30	Pass
117	6535	177.419	22.49	4.61	512.862	27.1	30	Pass
149	6695	177.828	22.50	4.61	514.044	27.11	30	Pass
181	6855	184.077	22.65	4.61	532.108	27.26	30	Pass

Notes:

1. For U-NII-5, The antenna gain is 4.76 dBi
2. For U-NII-7, The antenna gain is 4.61 dBi

#### 802.11ax (HE20) SP Client 1T1S

Chan.	Chan. Freq. (MHz)	Average Power (mW)	Average Power (dBm)	Antenna Gain (dBi)	EIRP (mW)	EIRP (dBm)	EIRP Limit (dBm)	Test Result
1	5955	194.984	22.90	4.76	583.444	27.66	30	Pass
93	6415	183.231	22.63	4.76	548.276	27.39	30	Pass
117	6535	172.187	22.36	4.61	497.737	26.97	30	Pass
181	6855	180.302	22.56	4.61	521.195	27.17	30	Pass

Notes:

1. For U-NII-5, The antenna gain is 4.76 dBi
2. For U-NII-7, The antenna gain is 4.61 dBi

#### 802.11ax (HE40) SP Client 1T1S

Chan.	Chan. Freq. (MHz)	Average Power (mW)	Average Power (dBm)	Antenna Gain (dBi)	EIRP (mW)	EIRP (dBm)	EIRP Limit (dBm)	Test Result
3	5965	103.753	20.16	4.76	310.456	24.92	30	Pass
91	6405	181.97	22.60	4.76	544.502	27.36	30	Pass
123	6565	180.302	22.56	4.61	521.195	27.17	30	Pass
179	6845	163.305	22.13	4.61	472.062	26.74	30	Pass

Notes:

1. For U-NII-5, The antenna gain is 4.76 dBi
2. For U-NII-7, The antenna gain is 4.61 dBi

### 802.11ax (HE80) SP Client 1T1S

Chan.	Chan. Freq. (MHz)	Average Power (mW)	Average Power (dBm)	Antenna Gain (dBi)	EIRP (mW)	EIRP (dBm)	EIRP Limit (dBm)	Test Result
7	5985	80.353	19.05	4.76	240.437	23.81	30	Pass
87	6385	158.855	22.01	4.76	475.336	26.77	30	Pass
135	6625	164.437	22.16	4.61	475.335	26.77	30	Pass
167	6785	166.725	22.22	4.61	481.949	26.83	30	Pass

Notes:

1. For U-NII-5, The antenna gain is 4.76 dBi
2. For U-NII-7, The antenna gain is 4.61 dBi

### 802.11ax (HE160) SP Client 1T1S

Chan.	Chan. Freq. (MHz)	Average Power (mW)	Average Power (dBm)	Antenna Gain (dBi)	EIRP (mW)	EIRP (dBm)	EIRP Limit (dBm)	Test Result
15	6025	89.743	19.53	4.76	268.535	24.29	30	Pass
79	6345	128.825	21.10	4.76	385.478	25.86	30	Pass
143	6665	168.655	22.27	4.61	487.528	26.88	30	Pass

Notes:

1. For U-NII-5, The antenna gain is 4.76 dBi
2. For U-NII-7, The antenna gain is 4.61 dBi

### 802.11be (EHT20) SP Client 1T1S

Chan.	Chan. Freq. (MHz)	Average Power (mW)	Average Power (dBm)	Antenna Gain (dBi)	EIRP (mW)	EIRP (dBm)	EIRP Limit (dBm)	Test Result
1	5955	197.697	22.96	4.76	591.562	27.72	30	Pass
45	6175	179.061	22.53	4.76	535.798	27.29	30	Pass
93	6415	185.353	22.68	4.76	554.625	27.44	30	Pass
117	6535	173.38	22.39	4.61	501.186	27	30	Pass
149	6695	165.959	22.20	4.61	479.734	26.81	30	Pass
181	6855	182.81	22.62	4.61	528.445	27.23	30	Pass

Notes:

1. For U-NII-5, The antenna gain is 4.76 dBi
2. For U-NII-7, The antenna gain is 4.61 dBi

### 802.11be (EHT40) SP Client 1T1S

Chan.	Chan. Freq. (MHz)	Average Power (mW)	Average Power (dBm)	Antenna Gain (dBi)	EIRP (mW)	EIRP (dBm)	EIRP Limit (dBm)	Test Result
3	5965	104.472	20.19	4.76	312.608	24.95	30	Pass
43	6165	185.78	22.69	4.76	555.903	27.45	30	Pass
91	6405	183.654	22.64	4.76	549.541	27.4	30	Pass
123	6565	180.717	22.57	4.61	522.395	27.18	30	Pass
155	6725	168.655	22.27	4.61	487.528	26.88	30	Pass
179	6845	165.196	22.18	4.61	477.529	26.79	30	Pass

Notes:

1. For U-NII-5, The antenna gain is 4.76 dBi
2. For U-NII-7, The antenna gain is 4.61 dBi

### 802.11be (EHT80) SP Client 1T1S

Chan.	Chan. Freq. (MHz)	Average Power (mW)	Average Power (dBm)	Antenna Gain (dBi)	EIRP (mW)	EIRP (dBm)	EIRP Limit (dBm)	Test Result
7	5985	87.498	19.42	4.76	261.817	24.18	30	Pass
39	6145	161.436	22.08	4.76	483.059	26.84	30	Pass
87	6385	164.816	22.17	4.76	493.173	26.93	30	Pass
135	6625	170.608	22.32	4.61	493.173	26.93	30	Pass
151	6705	164.059	22.15	4.61	474.242	26.76	30	Pass
167	6785	176.198	22.46	4.61	509.332	27.07	30	Pass

Notes:

1. For U-NII-5, The antenna gain is 4.76 dBi
2. For U-NII-7, The antenna gain is 4.61 dBi

### 802.11be (EHT160) SP Client 1T1S

Chan.	Chan. Freq. (MHz)	Average Power (mW)	Average Power (dBm)	Antenna Gain (dBi)	EIRP (mW)	EIRP (dBm)	EIRP Limit (dBm)	Test Result
15	6025	90.573	19.57	4.76	271.018	24.33	30	Pass
47	6185	105.439	20.23	4.76	315.501	24.99	30	Pass
79	6345	132.434	21.22	4.76	396.278	25.98	30	Pass
143	6665	151.356	21.80	4.61	437.522	26.41	30	Pass

Notes:

1. For U-NII-5, The antenna gain is 4.76 dBi
2. For U-NII-7, The antenna gain is 4.61 dBi



### 802.11be (EHT320) SP Client 1T1S

Chan.	Chan. Freq. (MHz)	Average Power (mW)	Average Power (dBm)	Antenna Gain (dBi)	EIRP (mW)	EIRP (dBm)	EIRP Limit (dBm)	Test Result
31	6105	96.383	19.84	4.76	288.403	24.6	30	Pass
63	6265	189.671	22.78	4.76	567.545	27.54	30	Pass

Notes:

1. For U-NII-5, The antenna gain is 4.76 dBi
2. For U-NII-7, The antenna gain is 4.61 dBi

### 802.11ax (HE) 26-tone RU SP Client\_1T1S

Chan.	Chan. Freq. (MHz)	Average Power (mW)	Average Power (dBm)	Antenna Gain (dBi)	EIRP (mW)	EIRP (dBm)	EIRP Limit (dBm)	Test Result
1	5955	41.4	16.17	4.76	123.88	20.93	30	Pass
93	6415	44.875	16.52	4.76	134.278	21.28	30	Pass
117	6535	43.551	16.39	4.61	125.892	21	30	Pass
181	6855	43.351	16.37	4.61	125.314	20.98	30	Pass

Notes:

1. For U-NII-5, The antenna gain is 4.76 dBi
2. For U-NII-7, The antenna gain is 4.61 dBi

### 802.11ax (HE) 52-tone RU SP Client\_1T1S

Chan.	Chan. Freq. (MHz)	Average Power (mW)	Average Power (dBm)	Antenna Gain (dBi)	EIRP (mW)	EIRP (dBm)	EIRP Limit (dBm)	Test Result
1	5955	80.353	19.05	4.76	240.437	23.81	30	Pass
93	6415	82.414	19.16	4.76	246.604	23.92	30	Pass
117	6535	88.512	19.47	4.61	255.86	24.08	30	Pass
181	6855	90.991	19.59	4.61	263.026	24.2	30	Pass

Notes:

1. For U-NII-5, The antenna gain is 4.76 dBi
2. For U-NII-7, The antenna gain is 4.61 dBi

### 802.11ax (HE) 106-tone RU SP Client\_1T1S

Chan.	Chan. Freq. (MHz)	Average Power (mW)	Average Power (dBm)	Antenna Gain (dBi)	EIRP (mW)	EIRP (dBm)	EIRP Limit (dBm)	Test Result
1	5955	162.93	22.12	4.76	487.53	26.88	30	Pass
93	6415	177.011	22.48	4.76	529.664	27.24	30	Pass
117	6535	172.584	22.37	4.61	498.885	26.98	30	Pass
181	6855	180.717	22.57	4.61	522.395	27.18	30	Pass

Notes:

1. For U-NII-5, The antenna gain is 4.76 dBi
2. For U-NII-7, The antenna gain is 4.61 dBi

### 802.11be (EHT20) 52+26-tone MRU SP Client\_1T1S

Chan.	Chan. Freq. (MHz)	Average Power (mW)	Average Power (dBm)	Antenna Gain (dBi)	EIRP (mW)	EIRP (dBm)	EIRP Limit (dBm)	Test Result
1	5955	128.233	21.08	4.76	383.707	25.84	30	Pass
93	6415	135.207	21.31	4.76	404.575	26.07	30	Pass
117	6535	131.22	21.18	4.61	379.315	25.79	30	Pass
181	6855	143.549	21.57	4.61	414.954	26.18	30	Pass

Notes:

1. For U-NII-5, The antenna gain is 4.76 dBi
2. For U-NII-7, The antenna gain is 4.61 dBi

### 802.11be (EHT20) 106+26-tone MRU SP Client\_1T1S

Chan.	Chan. Freq. (MHz)	Average Power (mW)	Average Power (dBm)	Antenna Gain (dBi)	EIRP (mW)	EIRP (dBm)	EIRP Limit (dBm)	Test Result
1	5955	196.789	22.94	4.76	588.845	27.7	30	Pass
93	6415	181.552	22.59	4.76	543.252	27.35	30	Pass
117	6535	171.396	22.34	4.61	495.451	26.95	30	Pass
181	6855	181.552	22.59	4.61	524.809	27.2	30	Pass

Notes:

1. For U-NII-5, The antenna gain is 4.76 dBi
2. For U-NII-7, The antenna gain is 4.61 dBi

### 802.11be (EHT80) 484+242-tone MRU SP Client\_1T1S

Chan.	Chan. Freq. (MHz)	Average Power (mW)	Average Power (dBm)	Antenna Gain (dBi)	EIRP (mW)	EIRP (dBm)	EIRP Limit (dBm)	Test Result
7	5985	84.723	19.28	4.76	253.514	24.04	30	Pass
87	6385	162.93	22.12	4.76	487.53	26.88	30	Pass
135	6625	167.494	22.24	4.61	484.172	26.85	30	Pass

Notes:

1. For U-NII-5, The antenna gain is 4.76 dBi
2. For U-NII-7, The antenna gain is 4.61 dBi

### 802.11be (EHT160) 996+484-tone MRU SP Client\_1T1S

Chan.	Chan. Freq. (MHz)	Average Power (mW)	Average Power (dBm)	Antenna Gain (dBi)	EIRP (mW)	EIRP (dBm)	EIRP Limit (dBm)	Test Result
15	6025	86.896	19.39	4.76	260.016	24.15	30	Pass
79	6345	141.579	21.51	4.76	423.642	26.27	30	Pass
143	6665	170.216	22.31	4.61	492.04	26.92	30	Pass

Notes:

1. For U-NII-5, The antenna gain is 4.76 dBi
2. For U-NII-7, The antenna gain is 4.61 dBi

### 802.11be (EHT160) 996+484+242-tone MRU SP Client\_1T1S

Chan.	Chan. Freq. (MHz)	Average Power (mW)	Average Power (dBm)	Antenna Gain (dBi)	EIRP (mW)	EIRP (dBm)	EIRP Limit (dBm)	Test Result
15	6025	85.704	19.33	4.76	256.449	24.09	30	Pass
79	6345	105.196	20.22	4.76	314.774	24.98	30	Pass
143	6665	125.603	20.99	4.61	363.078	25.6	30	Pass

Notes:

1. For U-NII-5, The antenna gain is 4.76 dBi
2. For U-NII-7, The antenna gain is 4.61 dBi

### 802.11be (EHT320) 2x996+484-tone MRU SP Client 1T1S

Chan.	Chan. Freq. (MHz)	Average Power (mW)	Average Power (dBm)	Antenna Gain (dBi)	EIRP (mW)	EIRP (dBm)	EIRP Limit (dBm)	Test Result
31	6105	95.719	19.81	4.76	286.417	24.57	30	Pass
63	6265	186.638	22.71	4.76	558.47	27.47	30	Pass

Notes:

1. For U-NII-5, The antenna gain is 4.76 dBi
2. For U-NII-7, The antenna gain is 4.61 dBi

### 802.11be (EHT320) 3x996-tone MRU SP Client 1T1S

Chan.	Chan. Freq. (MHz)	Average Power (mW)	Average Power (dBm)	Antenna Gain (dBi)	EIRP (mW)	EIRP (dBm)	EIRP Limit (dBm)	Test Result
31	6105	93.972	19.73	4.76	281.189	24.49	30	Pass
63	6265	188.365	22.75	4.76	563.638	27.51	30	Pass

Notes:

1. For U-NII-5, The antenna gain is 4.76 dBi
2. For U-NII-7, The antenna gain is 4.61 dBi

### 802.11be (EHT320) 3x996+484-tone MRU SP Client 1T1S

Chan.	Chan. Freq. (MHz)	Average Power (mW)	Average Power (dBm)	Antenna Gain (dBi)	EIRP (mW)	EIRP (dBm)	EIRP Limit (dBm)	Test Result
31	6105	93.325	19.70	4.76	279.253	24.46	30	Pass
63	6265	186.638	22.71	4.76	558.47	27.47	30	Pass

Notes:

1. For U-NII-5, The antenna gain is 4.76 dBi
2. For U-NII-7, The antenna gain is 4.61 dBi

### 802.11a SP Client 2TX

Chan.	Chan. Freq. (MHz)	Average Power (dBm)		Total Power (mW)	Total Power (dBm)	Maximum Gain (dBi)	EIRP (mW)	EIRP (dBm)	EIRP Limit (dBm)	Test Result
		Chain 0	Chain 1							
1	5955	17.94	17.83	122.904	20.90	4.76	367.761	25.66	30	Pass
45	6175	18.27	17.85	128.097	21.08	4.76	383.3	25.84	30	Pass
93	6415	18.13	18.18	130.779	21.17	4.76	391.325	25.93	30	Pass
117	6535	18.15	18.03	128.846	21.10	4.61	372.453	25.71	30	Pass
149	6695	18.13	18.09	129.43	21.12	4.61	374.141	25.73	30	Pass
181	6855	18.32	18.06	131.894	21.20	4.61	381.263	25.81	30	Pass

**Notes:**

1. Directional gain is the maximum gain of antennas.
2. For U-NII-5, The maximum gain is 4.76 dBi
3. For U-NII-7, The maximum gain is 4.61 dBi

### 802.11ax (HE20) SP Client 2T2S

Chan.	Chan. Freq. (MHz)	Average Power (dBm)		Total Power (mW)	Total Power (dBm)	Directional Gain (dBi)	EIRP (mW)	EIRP (dBm)	EIRP Limit (dBm)	Test Result
		Chain 0	Chain 1							
1	5955	20.93	21.14	253.897	24.05	4.76	759.727	28.81	30	Pass
93	6415	21.08	21.18	259.453	24.14	4.76	776.352	28.9	30	Pass
117	6535	21.07	21.20	259.764	24.15	4.61	750.895	28.76	30	Pass
181	6855	21.10	21.15	259.142	24.14	4.61	749.097	28.75	30	Pass

**Notes:**

1. For U-NII-5, The directional gain is 4.76 dBi
2. For U-NII-7, The directional gain is 4.61 dBi

### 802.11ax (HE40) SP Client 2T2S

Chan.	Chan. Freq. (MHz)	Average Power (dBm)		Total Power (mW)	Total Power (dBm)	Directional Gain (dBi)	EIRP (mW)	EIRP (dBm)	EIRP Limit (dBm)	Test Result
		Chain 0	Chain 1							
3	5965	19.92	19.70	191.5	22.82	4.76	573.019	27.58	30	Pass
91	6405	22.01	21.96	315.891	25.00	4.76	945.229	29.76	30	Pass
123	6565	22.05	21.73	309.261	24.90	4.61	893.975	29.51	30	Pass
179	6845	21.83	22.06	313.099	24.96	4.61	905.069	29.57	30	Pass

**Notes:**

1. For U-NII-5, The directional gain is 4.76 dBi
2. For U-NII-7, The directional gain is 4.61 dBi

**802.11ax (HE80) SP Client 2T2S**

Chan.	Chan. Freq. (MHz)	Average Power (dBm)		Total Power (mW)	Total Power (dBm)	Directional Gain (dBi)	EIRP (mW)	EIRP (dBm)	EIRP Limit (dBm)	Test Result
		Chain 0	Chain 1							
7	5985	18.84	19.12	158.218	21.99	4.76	473.43	26.75	30	Pass
87	6385	21.66	21.79	297.563	24.74	4.76	890.387	29.5	30	Pass
135	6625	21.93	22.18	321.151	25.07	4.61	928.345	29.68	30	Pass
167	6785	22.12	21.70	310.84	24.93	4.61	898.539	29.54	30	Pass

**Notes:**

1. For U-NII-5, The directional gain is 4.76 dBi
2. For U-NII-7, The directional gain is 4.61 dBi

**802.11ax (HE160) SP Client 2T2S**

Chan.	Chan. Freq. (MHz)	Average Power (dBm)		Total Power (mW)	Total Power (dBm)	Directional Gain (dBi)	EIRP (mW)	EIRP (dBm)	EIRP Limit (dBm)	Test Result
		Chain 0	Chain 1							
15	6025	18.94	19.10	159.626	22.03	4.76	477.643	26.79	30	Pass
79	6345	21.79	21.70	298.919	24.76	4.76	894.445	29.52	30	Pass
143	6665	21.98	21.79	308.769	24.90	4.61	892.552	29.51	30	Pass

**Notes:**

1. For U-NII-5, The directional gain is 4.76 dBi
2. For U-NII-7, The directional gain is 4.61 dBi

### 802.11be (EHT20) SP Client 2T2S

Chan.	Chan. Freq. (MHz)	Average Power (dBm)		Total Power (mW)	Total Power (dBm)	Directional Gain (dBi)	EIRP (mW)	EIRP (dBm)	EIRP Limit (dBm)	Test Result
		Chain 0	Chain 1							
1	5955	21.01	21.16	256.8	24.10	4.76	768.414	28.86	30	Pass
45	6175	21.32	21.37	272.607	24.36	4.76	815.712	29.12	30	Pass
93	6415	21.17	21.15	261.235	24.17	4.76	781.684	28.93	30	Pass
117	6535	21.16	21.18	261.837	24.18	4.61	756.887	28.79	30	Pass
149	6695	21.01	21.21	258.312	24.12	4.61	746.697	28.73	30	Pass
181	6855	21.15	21.20	262.142	24.19	4.61	757.769	28.8	30	Pass

Notes:

1. For U-NII-5, The directional gain is 4.76 dBi
2. For U-NII-7, The directional gain is 4.61 dBi

### 802.11be (EHT40) SP Client 2T2S

Chan.	Chan. Freq. (MHz)	Average Power (dBm)		Total Power (mW)	Total Power (dBm)	Directional Gain (dBi)	EIRP (mW)	EIRP (dBm)	EIRP Limit (dBm)	Test Result
		Chain 0	Chain 1							
3	5965	20.32	20.21	212.601	23.28	4.76	636.158	28.04	30	Pass
43	6165	22.26	22.06	328.962	25.17	4.76	984.341	29.93	30	Pass
91	6405	22.16	21.90	319.319	25.04	4.76	955.487	29.8	30	Pass
123	6565	22.14	21.81	315.387	24.99	4.61	911.683	29.6	30	Pass
155	6725	22.13	22.07	324.37	25.11	4.61	937.65	29.72	30	Pass
179	6845	22.05	22.13	323.63	25.10	4.61	935.511	29.71	30	Pass

Notes:

1. For U-NII-5, The directional gain is 4.76 dBi
2. For U-NII-7, The directional gain is 4.61 dBi

### 802.11be (EHT80) SP Client 2T2S

Chan.	Chan. Freq. (MHz)	Average Power (dBm)		Total Power (mW)	Total Power (dBm)	Directional Gain (dBi)	EIRP (mW)	EIRP (dBm)	EIRP Limit (dBm)	Test Result
		Chain 0	Chain 1							
7	5985	19.23	19.58	174.535	22.42	4.76	522.255	27.18	30	Pass
39	6145	21.94	21.79	307.323	24.88	4.76	919.592	29.64	30	Pass
87	6385	21.82	21.67	298.947	24.76	4.76	894.529	29.52	30	Pass
135	6625	22.29	21.90	324.315	25.11	4.61	937.491	29.72	30	Pass
151	6705	22.19	21.83	317.982	25.02	4.61	919.184	29.63	30	Pass
167	6785	22.12	21.80	314.286	24.97	4.61	908.5	29.58	30	Pass

Notes:

1. For U-NII-5, The directional gain is 4.76 dBi
2. For U-NII-7, The directional gain is 4.61 dBi

### 802.11be (EHT160) SP Client 2T2S

Chan.	Chan. Freq. (MHz)	Average Power (dBm)		Total Power (mW)	Total Power (dBm)	Directional Gain (dBi)	EIRP (mW)	EIRP (dBm)	EIRP Limit (dBm)	Test Result
		Chain 0	Chain 1							
15	6025	19.41	19.66	179.767	22.55	4.76	537.91	27.31	30	Pass
47	6185	21.33	21.95	292.506	24.66	4.76	875.255	29.42	30	Pass
79	6345	21.81	21.74	300.984	24.79	4.76	900.624	29.55	30	Pass
143	6665	22.08	22.19	327.013	25.15	4.61	945.29	29.76	30	Pass

Notes:

1. For U-NII-5, The directional gain is 4.76 dBi
2. For U-NII-7, The directional gain is 4.61 dBi

### 802.11be (EHT320) SP Client 2T2S

Chan.	Chan. Freq. (MHz)	Average Power (dBm)		Total Power (mW)	Total Power (dBm)	Directional Gain (dBi)	EIRP (mW)	EIRP (dBm)	EIRP Limit (dBm)	Test Result
		Chain 0	Chain 1							
31	6105	19.61	18.51	162.369	22.11	4.76	486.407	26.87	30	Pass
63	6265	22.21	21.95	323.016	25.09	4.76	966.051	29.85	30	Pass

Notes:

1. For U-NII-5, The directional gain is 4.76 dBi
2. For U-NII-7, The directional gain is 4.61 dBi

### 802.11ax (HE) 26-tone RU SP Client\_2T2S

Chan.	Chan. Freq. (MHz)	Average Power (dBm)		Total Power (mW)	Total Power (dBm)	Directional Gain (dBi)	EIRP (mW)	EIRP (dBm)	EIRP Limit (dBm)	Test Result
		Chain 0	Chain 1							
1	5955	12.88	12.79	38.42	15.85	4.76	114.963	20.61	30	Pass
93	6415	13.05	13.54	42.778	16.31	4.76	128.003	21.07	30	Pass
117	6535	12.94	13.17	40.428	16.07	4.61	116.864	20.68	30	Pass
181	6855	13.37	13.58	44.53	16.49	4.61	128.722	21.1	30	Pass

Notes:

1. For U-NII-5, The directional gain is 4.76 dBi
2. For U-NII-7, The directional gain is 4.61 dBi



**802.11ax (HE) 52-tone RU SP Client\_2T2S**

Chan.	Chan. Freq. (MHz)	Average Power (dBm)		Total Power (mW)	Total Power (dBm)	Directional Gain (dBi)	EIRP (mW)	EIRP (dBm)	EIRP Limit (dBm)	Test Result
		Chain 0	Chain 1							
1	5955	16.08	16.01	80.453	19.06	4.76	240.737	23.82	30	Pass
93	6415	16.50	16.67	91.12	19.60	4.76	272.655	24.36	30	Pass
117	6535	16.30	16.43	86.612	19.38	4.61	250.368	23.99	30	Pass
181	6855	16.36	16.79	91.004	19.59	4.61	263.063	24.2	30	Pass

**Notes:**

1. For U-NII-5, The directional gain is 4.76 dBi
2. For U-NII-7, The directional gain is 4.61 dBi

**802.11ax (HE) 106-tone RU SP Client\_2T2S**

Chan.	Chan. Freq. (MHz)	Average Power (dBm)		Total Power (mW)	Total Power (dBm)	Directional Gain (dBi)	EIRP (mW)	EIRP (dBm)	EIRP Limit (dBm)	Test Result
		Chain 0	Chain 1							
1	5955	18.80	18.54	147.307	21.68	4.76	440.782	26.44	30	Pass
93	6415	19.20	18.79	158.86	22.01	4.76	475.351	26.77	30	Pass
117	6535	19.16	18.97	161.3	22.08	4.61	466.267	26.69	30	Pass
181	6855	19.28	19.10	166.006	22.20	4.61	479.87	26.81	30	Pass

**Notes:**

1. For U-NII-5, The directional gain is 4.76 dBi
2. For U-NII-7, The directional gain is 4.61 dBi

**802.11be (EHT20) 52+26-tone MRU SP Client\_2T2S**

Chan.	Chan. Freq. (MHz)	Average Power (dBm)		Total Power (mW)	Total Power (dBm)	Directional Gain (dBi)	EIRP (mW)	EIRP (dBm)	EIRP Limit (dBm)	Test Result
		Chain 0	Chain 1							
1	5955	18.32	17.86	129.015	21.11	4.76	386.047	25.87	30	Pass
93	6415	18.18	18.05	129.592	21.13	4.76	387.774	25.89	30	Pass
117	6535	18.62	18.25	139.612	21.45	4.61	403.574	26.06	30	Pass
181	6855	18.58	18.49	142.743	21.55	4.61	412.624	26.16	30	Pass

**Notes:**

1. For U-NII-5, The directional gain is 4.76 dBi
2. For U-NII-7, The directional gain is 4.61 dBi

**802.11be (EHT20) 106+26-tone MRU SP Client\_2T2S**

Chan.	Chan. Freq. (MHz)	Average Power (dBm)		Total Power (mW)	Total Power (dBm)	Directional Gain (dBi)	EIRP (mW)	EIRP (dBm)	EIRP Limit (dBm)	Test Result
		Chain 0	Chain 1							
1	5955	20.15	20.09	205.608	23.13	4.76	615.234	27.89	30	Pass
93	6415	20.03	19.96	199.776	23.01	4.76	597.783	27.77	30	Pass
117	6535	20.26	20.18	210.401	23.23	4.61	608.202	27.84	30	Pass
181	6855	20.27	20.24	212.096	23.27	4.61	613.102	27.88	30	Pass

**Notes:**

1. For U-NII-5, The directional gain is 4.76 dBi
2. For U-NII-7, The directional gain is 4.61 dBi

**802.11be (EHT80) 484+242-tone MRU SP Client\_2T2S**

Chan.	Chan. Freq. (MHz)	Average Power (dBm)		Total Power (mW)	Total Power (dBm)	Directional Gain (dBi)	EIRP (mW)	EIRP (dBm)	EIRP Limit (dBm)	Test Result
		Chain 0	Chain 1							
7	5985	18.19	18.42	135.42	21.32	4.76	405.212	26.08	30	Pass
87	6385	21.61	21.52	286.783	24.58	4.76	858.131	29.34	30	Pass
135	6625	22.13	21.88	317.475	25.02	4.61	917.719	29.63	30	Pass

**Notes:**

1. For U-NII-5, The directional gain is 4.76 dBi
2. For U-NII-7, The directional gain is 4.61 dBi

**802.11be (EHT160) 996+484-tone MRU SP Client\_2T2S**

Chan.	Chan. Freq. (MHz)	Average Power (dBm)		Total Power (mW)	Total Power (dBm)	Directional Gain (dBi)	EIRP (mW)	EIRP (dBm)	EIRP Limit (dBm)	Test Result
		Chain 0	Chain 1							
15	6025	18.25	17.86	127.929	21.07	4.76	382.797	25.83	30	Pass
79	6345	21.65	21.83	298.623	24.75	4.76	893.559	29.51	30	Pass
143	6665	22.02	22.07	320.285	25.06	4.61	925.841	29.67	30	Pass

**Notes:**

1. For U-NII-5, The directional gain is 4.76 dBi
2. For U-NII-7, The directional gain is 4.61 dBi

**802.11be (EHT160) 996+484+242-tone MRU SP Client\_2T2S**

Chan.	Chan. Freq. (MHz)	Average Power (dBm)		Total Power (mW)	Total Power (dBm)	Directional Gain (dBi)	EIRP (mW)	EIRP (dBm)	EIRP Limit (dBm)	Test Result
		Chain 0	Chain 1							
15	6025	18.36	17.79	128.666	21.09	4.76	385.003	25.85	30	Pass
79	6345	20.71	20.79	237.711	23.76	4.76	711.294	28.52	30	Pass
143	6665	21.82	22.05	312.379	24.95	4.61	902.988	29.56	30	Pass

**Notes:**

1. For U-NII-5, The directional gain is 4.76 dBi
2. For U-NII-7, The directional gain is 4.61 dBi

**802.11be (EHT320) 2x996+484-tone MRU SP Client 2T2S**

Chan.	Chan. Freq. (MHz)	Average Power (dBm)		Total Power (mW)	Total Power (dBm)	Directional Gain (dBi)	EIRP (mW)	EIRP (dBm)	EIRP Limit (dBm)	Test Result
		Chain 0	Chain 1							
31	6105	19.43	18.14	152.863	21.84	4.76	457.407	26.6	30	Pass
63	6265	21.86	22.09	315.27	24.99	4.76	943.371	29.75	30	Pass

**Notes:**

1. For U-NII-5, The directional gain is 4.76 dBi
2. For U-NII-7, The directional gain is 4.61 dBi

**802.11be (EHT320) 3x996-tone MRU SP Client 2T2S**

Chan.	Chan. Freq. (MHz)	Average Power (dBm)		Total Power (mW)	Total Power (dBm)	Directional Gain (dBi)	EIRP (mW)	EIRP (dBm)	EIRP Limit (dBm)	Test Result
		Chain 0	Chain 1							
31	6105	19.51	18.23	155.858	21.93	4.76	466.368	26.69	30	Pass
63	6265	21.92	22.13	318.902	25.04	4.76	954.239	29.8	30	Pass

**Notes:**

1. For U-NII-5, The directional gain is 4.76 dBi
2. For U-NII-7, The directional gain is 4.61 dBi

**802.11be (EHT320) 3x996+484-tone MRU SP Client 2T2S**

Chan.	Chan. Freq. (MHz)	Average Power (dBm)		Total Power (mW)	Total Power (dBm)	Directional Gain (dBi)	EIRP (mW)	EIRP (dBm)	EIRP Limit (dBm)	Test Result
		Chain 0	Chain 1							
31	6105	19.48	18.17	154.33	21.88	4.76	461.796	26.64	30	Pass
63	6265	21.81	22.07	312.77	24.95	4.76	935.891	29.71	30	Pass

**Notes:**

1. For U-NII-5, The directional gain is 4.76 dBi
2. For U-NII-7, The directional gain is 4.61 dBi

## 7.2 Power Spectral Density

Input Power:	120 Vac, 60 Hz	Environmental Conditions:	24°C, 66% RH	Tested By:	Eric Peng
--------------	----------------	---------------------------	--------------	------------	-----------

### 802.11a SP Client 1TX

Chan.	Chan. Freq. (MHz)	PSD w/o Duty Factor (dBm/MHz)	Duty Factor (dB)	PSD (dBm/MHz)	Antenna Gain (dBi)	EIRP PSD (dBm/MHz)	EIRP PSD Limit (dBm/MHz)	Test Result
1	5955	10.79	0.28	11.07	4.76	15.83	17	Pass
45	6175	10.08	0.28	10.36	4.76	15.12	17	Pass
93	6415	10.25	0.28	10.53	4.76	15.29	17	Pass
117	6535	9.67	0.28	9.95	4.61	14.56	17	Pass
149	6695	9.84	0.28	10.12	4.61	14.73	17	Pass
181	6855	9.85	0.28	10.13	4.61	14.74	17	Pass

Notes:

1. For U-NII-5, The antenna gain is 4.76 dBi
2. For U-NII-7, The antenna gain is 4.61 dBi

### 802.11ax (HE20) SP Client 1T1S

Chan.	Chan. Freq. (MHz)	PSD w/o Duty Factor (dBm/MHz)	Duty Factor (dB)	PSD (dBm/MHz)	Antenna Gain (dBi)	EIRP PSD (dBm/MHz)	EIRP PSD Limit (dBm/MHz)	Test Result
1	5955	10.53	0.15	10.68	4.76	15.44	17	Pass
93	6415	9.98	0.15	10.13	4.76	14.89	17	Pass
117	6535	9.82	0.15	9.97	4.61	14.58	17	Pass
181	6855	9.82	0.15	9.97	4.61	14.58	17	Pass

Notes:

1. For U-NII-5, The antenna gain is 4.76 dBi
2. For U-NII-7, The antenna gain is 4.61 dBi

### 802.11ax (HE40) SP Client 1T1S

Chan.	Chan. Freq. (MHz)	PSD w/o Duty Factor (dBm/MHz)	Duty Factor (dB)	PSD (dBm/MHz)	Antenna Gain (dBi)	EIRP PSD (dBm/MHz)	EIRP PSD Limit (dBm/MHz)	Test Result
3	5965	6.81	0.14	6.95	4.76	11.71	17	Pass
91	6405	7.23	0.14	7.37	4.76	12.13	17	Pass
123	6565	7.12	0.14	7.26	4.61	11.87	17	Pass
179	6845	6.98	0.14	7.12	4.61	11.73	17	Pass

Notes:

1. For U-NII-5, The antenna gain is 4.76 dBi
2. For U-NII-7, The antenna gain is 4.61 dBi

**802.11ax (HE80) SP Client 1T1S**

Chan.	Chan. Freq. (MHz)	PSD w/o Duty Factor (dBm/MHz)	Duty Factor (dB)	PSD (dBm/MHz)	Antenna Gain (dBi)	EIRP PSD (dBm/MHz)	EIRP PSD Limit (dBm/MHz)	Test Result
7	5985	3.27	0.26	3.53	4.76	8.29	17	Pass
87	6385	4.41	0.26	4.67	4.76	9.43	17	Pass
135	6625	4.51	0.26	4.77	4.61	9.38	17	Pass
167	6785	4.07	0.26	4.33	4.61	8.94	17	Pass

**Notes:**

1. For U-NII-5, The antenna gain is 4.76 dBi
2. For U-NII-7, The antenna gain is 4.61 dBi

**802.11ax (HE160) SP Client 1T1S**

Chan.	Chan. Freq. (MHz)	PSD w/o Duty Factor (dBm/MHz)	Duty Factor (dB)	PSD (dBm/MHz)	Antenna Gain (dBi)	EIRP PSD (dBm/MHz)	EIRP PSD Limit (dBm/MHz)	Test Result
15	6025	-0.06	0.47	0.41	4.76	5.17	17	Pass
79	6345	1.79	0.47	2.26	4.76	7.02	17	Pass
143	6665	1.18	0.47	1.65	4.61	6.26	17	Pass

**Notes:**

1. For U-NII-5, The antenna gain is 4.76 dBi
2. For U-NII-7, The antenna gain is 4.61 dBi

**802.11be (EHT20) SP Client 1T1S**

Chan.	Chan. Freq. (MHz)	PSD w/o Duty Factor (dBm/MHz)	Duty Factor (dB)	PSD (dBm/MHz)	Antenna Gain (dBi)	EIRP PSD (dBm/MHz)	EIRP PSD Limit (dBm/MHz)	Test Result
1	5955	10.65	0.12	10.77	4.76	15.53	17	Pass
45	6175	10.47	0.12	10.59	4.76	15.35	17	Pass
93	6415	10.15	0.12	10.27	4.76	15.03	17	Pass
117	6535	9.74	0.12	9.86	4.61	14.47	17	Pass
149	6695	9.87	0.12	9.99	4.61	14.6	17	Pass
181	6855	9.83	0.12	9.95	4.61	14.56	17	Pass

**Notes:**

1. For U-NII-5, The antenna gain is 4.76 dBi
2. For U-NII-7, The antenna gain is 4.61 dBi

### 802.11be (EHT40) SP Client 1T1S

Chan.	Chan. Freq. (MHz)	PSD w/o Duty Factor (dBm/MHz)	Duty Factor (dB)	PSD (dBm/MHz)	Antenna Gain (dBi)	EIRP PSD (dBm/MHz)	EIRP PSD Limit (dBm/MHz)	Test Result
3	5965	7.21	0.11	7.32	4.76	12.08	17	Pass
43	6165	7.41	0.11	7.52	4.76	12.28	17	Pass
91	6405	7.16	0.11	7.27	4.76	12.03	17	Pass
123	6565	7.17	0.11	7.28	4.61	11.89	17	Pass
155	6725	6.91	0.11	7.02	4.61	11.63	17	Pass
179	6845	6.88	0.11	6.99	4.61	11.6	17	Pass

Notes:

1. For U-NII-5, The antenna gain is 4.76 dBi
2. For U-NII-7, The antenna gain is 4.61 dBi

### 802.11be (EHT80) SP Client 1T1S

Chan.	Chan. Freq. (MHz)	PSD w/o Duty Factor (dBm/MHz)	Duty Factor (dB)	PSD (dBm/MHz)	Antenna Gain (dBi)	EIRP PSD (dBm/MHz)	EIRP PSD Limit (dBm/MHz)	Test Result
7	5985	3.68	0.23	3.91	4.76	8.67	17	Pass
39	6145	4.12	0.23	4.35	4.76	9.11	17	Pass
87	6385	4.12	0.23	4.35	4.76	9.11	17	Pass
135	6625	4.62	0.23	4.85	4.61	9.46	17	Pass
151	6705	3.79	0.23	4.02	4.61	8.63	17	Pass
167	6785	4.13	0.23	4.36	4.61	8.97	17	Pass

Notes:

1. For U-NII-5, The antenna gain is 4.76 dBi
2. For U-NII-7, The antenna gain is 4.61 dBi

### 802.11be (EHT160) SP Client 1T1S

Chan.	Chan. Freq. (MHz)	PSD w/o Duty Factor (dBm/MHz)	Duty Factor (dB)	PSD (dBm/MHz)	Antenna Gain (dBi)	EIRP PSD (dBm/MHz)	EIRP PSD Limit (dBm/MHz)	Test Result
15	6025	-0.04	0.42	0.38	4.76	5.14	17	Pass
47	6185	0.71	0.42	1.13	4.76	5.89	17	Pass
79	6345	2.02	0.42	2.44	4.76	7.2	17	Pass
143	6665	1.72	0.42	2.14	4.61	6.75	17	Pass

Notes:

1. For U-NII-5, The antenna gain is 4.76 dBi
2. For U-NII-7, The antenna gain is 4.61 dBi

### 802.11be (EHT320) SP Client 1T1S

Chan.	Chan. Freq. (MHz)	PSD w/o Duty Factor (dBm/MHz)	Duty Factor (dB)	PSD (dBm/MHz)	Antenna Gain (dBi)	EIRP PSD (dBm/MHz)	EIRP PSD Limit (dBm/MHz)	Test Result
31	6105	-2.18	0.75	-1.43	4.76	3.33	17	Pass
63	6265	-1.22	0.75	-0.47	4.76	4.29	17	Pass

Notes:

1. For U-NII-5, The antenna gain is 4.76 dBi
2. For U-NII-7, The antenna gain is 4.61 dBi

### 802.11ax (HE) 26-tone RU SP Client\_1T1S

Chan.	Chan. Freq. (MHz)	PSD w/o Duty Factor (dBm/MHz)	Duty Factor (dB)	PSD (dBm/MHz)	Antenna Gain (dBi)	EIRP PSD (dBm/MHz)	EIRP PSD Limit (dBm/MHz)	Test Result
1	5955	11.12	0.79	11.91	4.76	16.67	17	Pass
93	6415	11.34	0.79	12.13	4.76	16.89	17	Pass
117	6535	11.44	0.79	12.23	4.61	16.84	17	Pass
181	6855	11.16	0.79	11.95	4.61	16.56	17	Pass

Notes:

1. For U-NII-5, The antenna gain is 4.76 dBi
2. For U-NII-7, The antenna gain is 4.61 dBi

### 802.11ax (HE) 52-tone RU SP Client\_1T1S

Chan.	Chan. Freq. (MHz)	PSD w/o Duty Factor (dBm/MHz)	Duty Factor (dB)	PSD (dBm/MHz)	Antenna Gain (dBi)	EIRP PSD (dBm/MHz)	EIRP PSD Limit (dBm/MHz)	Test Result
1	5955	11.11	0.92	12.03	4.76	16.79	17	Pass
93	6415	10.87	0.92	11.79	4.76	16.55	17	Pass
117	6535	11.01	0.92	11.93	4.61	16.54	17	Pass
181	6855	11.12	0.92	12.04	4.61	16.65	17	Pass

Notes:

1. For U-NII-5, The antenna gain is 4.76 dBi
2. For U-NII-7, The antenna gain is 4.61 dBi

**802.11ax (HE) 106-tone RU SP Client\_1T1S**

Chan.	Chan. Freq. (MHz)	PSD w/o Duty Factor (dBm/MHz)	Duty Factor (dB)	PSD (dBm/MHz)	Antenna Gain (dBi)	EIRP PSD (dBm/MHz)	EIRP PSD Limit (dBm/MHz)	Test Result
1	5955	10.86	1.03	11.89	4.76	16.65	17	Pass
93	6415	10.9	1.03	11.93	4.76	16.69	17	Pass
117	6535	10.98	1.03	12.01	4.61	16.62	17	Pass
181	6855	10.87	1.03	11.90	4.61	16.51	17	Pass

**Notes:**

1. For U-NII-5, The antenna gain is 4.76 dBi
2. For U-NII-7, The antenna gain is 4.61 dBi

**802.11be (EHT20) 52+26-tone MRU SP Client\_1T1S**

Chan.	Chan. Freq. (MHz)	PSD w/o Duty Factor (dBm/MHz)	Duty Factor (dB)	PSD (dBm/MHz)	Antenna Gain (dBi)	EIRP PSD (dBm/MHz)	EIRP PSD Limit (dBm/MHz)	Test Result
1	5955	10.85	0.97	11.82	4.76	16.58	17	Pass
93	6415	10.87	0.97	11.84	4.76	16.6	17	Pass
117	6535	11.25	0.97	12.22	4.61	16.83	17	Pass
181	6855	10.89	0.97	11.86	4.61	16.47	17	Pass

**Notes:**

1. For U-NII-5, The antenna gain is 4.76 dBi
2. For U-NII-7, The antenna gain is 4.61 dBi

**802.11be (EHT20) 106+26-tone MRU SP Client\_1T1S**

Chan.	Chan. Freq. (MHz)	PSD w/o Duty Factor (dBm/MHz)	Duty Factor (dB)	PSD (dBm/MHz)	Antenna Gain (dBi)	EIRP PSD (dBm/MHz)	EIRP PSD Limit (dBm/MHz)	Test Result
1	5955	11.04	0.97	12.01	4.76	16.77	17	Pass
93	6415	10.38	0.97	11.35	4.76	16.11	17	Pass
117	6535	10.15	0.97	11.12	4.61	15.73	17	Pass
181	6855	10.52	0.97	11.49	4.61	16.1	17	Pass

**Notes:**

1. For U-NII-5, The antenna gain is 4.76 dBi
2. For U-NII-7, The antenna gain is 4.61 dBi



### 802.11be (EHT80) 484+242-tone MRU SP Client\_1T1S

Chan.	Chan. Freq. (MHz)	PSD w/o Duty Factor (dBm/MHz)	Duty Factor (dB)	PSD (dBm/MHz)	Antenna Gain (dBi)	EIRP PSD (dBm/MHz)	EIRP PSD Limit (dBm/MHz)	Test Result
7	5985	1.32	1.24	2.56	4.76	7.32	17	Pass
87	6385	3.39	1.24	4.63	4.76	9.39	17	Pass
135	6625	3.34	1.24	4.58	4.61	9.19	17	Pass

Notes:

1. For U-NII-5, The antenna gain is 4.76 dBi
2. For U-NII-7, The antenna gain is 4.61 dBi

### 802.11be (EHT160) 996+484-tone MRU SP Client\_1T1S

Chan.	Chan. Freq. (MHz)	PSD w/o Duty Factor (dBm/MHz)	Duty Factor (dB)	PSD (dBm/MHz)	Antenna Gain (dBi)	EIRP PSD (dBm/MHz)	EIRP PSD Limit (dBm/MHz)	Test Result
15	6025	-1.67	1.27	-0.40	4.76	4.36	17	Pass
79	6345	-0.48	1.27	0.79	4.76	5.55	17	Pass
143	6665	0.68	1.27	1.95	4.61	6.56	17	Pass

Notes:

1. For U-NII-5, The antenna gain is 4.76 dBi
2. For U-NII-7, The antenna gain is 4.61 dBi

### 802.11be (EHT160) 996+484+242-tone MRU SP Client\_1T1S

Chan.	Chan. Freq. (MHz)	PSD w/o Duty Factor (dBm/MHz)	Duty Factor (dB)	PSD (dBm/MHz)	Antenna Gain (dBi)	EIRP PSD (dBm/MHz)	EIRP PSD Limit (dBm/MHz)	Test Result
15	6025	-2.26	1.27	-0.99	4.76	3.77	17	Pass
79	6345	-2.11	1.27	-0.84	4.76	3.92	17	Pass
143	6665	-1.34	1.27	-0.07	4.61	4.54	17	Pass

Notes:

1. For U-NII-5, The antenna gain is 4.76 dBi
2. For U-NII-7, The antenna gain is 4.61 dBi

### 802.11be (EHT320) 2x996+484-tone MRU SP Client 1T1S

Chan.	Chan. Freq. (MHz)	PSD w/o Duty Factor (dBm/MHz)	Duty Factor (dB)	PSD (dBm/MHz)	Antenna Gain (dBi)	EIRP PSD (dBm/MHz)	EIRP PSD Limit (dBm/MHz)	Test Result
31	6105	-3.03	1.27	-1.76	4.76	3	17	Pass
63	6265	-1.66	1.27	-0.39	4.76	4.37	17	Pass

Notes:

1. For U-NII-5, The antenna gain is 4.76 dBi
2. For U-NII-7, The antenna gain is 4.61 dBi

**802.11be (EHT320) 3x996-tone MRU SP Client 1T1S**

Chan.	Chan. Freq. (MHz)	PSD w/o Duty Factor (dBm/MHz)	Duty Factor (dB)	PSD (dBm/MHz)	Antenna Gain (dBi)	EIRP PSD (dBm/MHz)	EIRP PSD Limit (dBm/MHz)	Test Result
31	6105	-3.81	1.27	-2.54	4.76	2.22	17	Pass
63	6265	-2.53	1.27	-1.26	4.76	3.5	17	Pass

**Notes:**

1. For U-NII-5, The antenna gain is 4.76 dBi
2. For U-NII-7, The antenna gain is 4.61 dBi

**802.11be (EHT320) 3x996+484-tone MRU SP Client 1T1S**

Chan.	Chan. Freq. (MHz)	PSD w/o Duty Factor (dBm/MHz)	Duty Factor (dB)	PSD (dBm/MHz)	Antenna Gain (dBi)	EIRP PSD (dBm/MHz)	EIRP PSD Limit (dBm/MHz)	Test Result
31	6105	-4.5	1.27	-3.23	4.76	1.53	17	Pass
63	6265	-3.02	1.27	-1.75	4.76	3.01	17	Pass

**Notes:**

1. For U-NII-5, The antenna gain is 4.76 dBi
2. For U-NII-7, The antenna gain is 4.61 dBi

**802.11a SP Client 2TX**

Chan.	Chan. Freq. (MHz)	PSD w/o Duty Factor (dBm/MHz)		Duty Factor (dB)	Total PSD (dBm/MHz)	Directional Gain (dBi)	EIRP PSD (dBm/MHz)	EIRP PSD Limit (dBm/MHz)	Test Result
		Chain 0	Chain 1						
1	5955	5.58	5.71	0.28	8.94	7.77	16.71	17	Pass
45	6175	5.97	5.88	0.28	9.22	7.77	16.99	17	Pass
93	6415	5.69	6.04	0.28	9.16	7.77	16.93	17	Pass
117	6535	5.46	5.80	0.28	8.92	7.62	16.54	17	Pass
149	6695	5.30	6.01	0.28	8.96	7.62	16.58	17	Pass
181	6855	5.66	5.97	0.28	9.11	7.62	16.73	17	Pass

**Notes:**

1. Method E) 2) a) of power density measurement of KDB 662911 is using for calculating total power density. Total power density is summing entire spectra across corresponding frequency bins on the various outputs by computer.
2. Directional gain = gain of antenna element + 10 log (2 of TX antenna elements)
3. For U-NII-5, The directional gain is 7.77 dBi
4. For U-NII-7, The directional gain is 7.62 dBi

**802.11ax (HE20) SP Client 2T2S**

Chan.	Chan. Freq. (MHz)	PSD w/o Duty Factor (dBm/MHz)		Duty Factor (dB)	Total PSD (dBm/MHz)	Directional Gain (dBi)	EIRP PSD (dBm/MHz)	EIRP PSD Limit (dBm/MHz)	Test Result
		Chain 0	Chain 1						
1	5955	8.85	8.76	0.15	11.97	4.76	16.73	17	Pass
93	6415	8.71	9.02	0.15	12.03	4.76	16.79	17	Pass
117	6535	8.97	9.19	0.15	12.24	4.61	16.85	17	Pass
181	6855	8.93	9.19	0.15	12.22	4.61	16.83	17	Pass

**Notes:**

1. Method E) 2) a) of power density measurement of KDB 662911 is using for calculating total power density. Total power density is summing entire spectra across corresponding frequency bins on the various outputs by computer.
2. For U-NII-5, The directional gain is 4.76 dBi
3. For U-NII-7, The directional gain is 4.61 dBi

**802.11ax (HE40) SP Client 2T2S**

Chan.	Chan. Freq. (MHz)	PSD w/o Duty Factor (dBm/MHz)		Duty Factor (dB)	Total PSD (dBm/MHz)	Directional Gain (dBi)	EIRP PSD (dBm/MHz)	EIRP PSD Limit (dBm/MHz)	Test Result
		Chain 0	Chain 1						
3	5965	6.86	7.11	0.14	10.14	4.76	14.9	17	Pass
91	6405	6.94	6.80	0.14	10.02	4.76	14.78	17	Pass
123	6565	6.56	7.31	0.14	10.10	4.61	14.71	17	Pass
179	6845	6.30	7.75	0.14	10.24	4.61	14.85	17	Pass

**Notes:**

1. Method E) 2) a) of power density measurement of KDB 662911 is using for calculating total power density. Total power density is summing entire spectra across corresponding frequency bins on the various outputs by computer.
2. For U-NII-5, The directional gain is 4.76 dBi
3. For U-NII-7, The directional gain is 4.61 dBi

**802.11ax (HE80) SP Client 2T2S**

Chan.	Chan. Freq. (MHz)	PSD w/o Duty Factor (dBm/MHz)		Duty Factor (dB)	Total PSD (dBm/MHz)	Directional Gain (dBi)	EIRP PSD (dBm/MHz)	EIRP PSD Limit (dBm/MHz)	Test Result
		Chain 0	Chain 1						
7	5985	3.98	4.38	0.26	7.45	4.76	12.21	17	Pass
87	6385	3.77	3.87	0.26	7.09	4.76	11.85	17	Pass
135	6625	3.68	3.71	0.26	6.97	4.61	11.58	17	Pass
167	6785	3.42	3.81	0.26	6.89	4.61	11.5	17	Pass

**Notes:**

1. Method E) 2) a) of power density measurement of KDB 662911 is using for calculating total power density. Total power density is summing entire spectra across corresponding frequency bins on the various outputs by computer.
2. For U-NII-5, The directional gain is 4.76 dBi
3. For U-NII-7, The directional gain is 4.61 dBi

**802.11ax (HE160) SP Client 2T2S**

Chan.	Chan. Freq. (MHz)	PSD w/o Duty Factor (dBm/MHz)		Duty Factor (dB)	Total PSD (dBm/MHz)	Directional Gain (dBi)	EIRP PSD (dBm/MHz)	EIRP PSD Limit (dBm/MHz)	Test Result
		Chain 0	Chain 1						
15	6025	0.21	1.23	0.47	4.23	4.76	8.99	17	Pass
79	6345	0.74	0.77	0.47	4.24	4.76	9	17	Pass
143	6665	0.39	0.37	0.47	3.86	4.61	8.47	17	Pass

**Notes:**

1. Method E) 2) a) of power density measurement of KDB 662911 is using for calculating total power density. Total power density is summing entire spectra across corresponding frequency bins on the various outputs by computer.
2. For U-NII-5, The directional gain is 4.76 dBi
3. For U-NII-7, The directional gain is 4.61 dBi

**802.11be (EHT20) SP Client 2T2S**

Chan.	Chan. Freq. (MHz)	PSD w/o Duty Factor (dBm/MHz)		Duty Factor (dB)	Total PSD (dBm/MHz)	Directional Gain (dBi)	EIRP PSD (dBm/MHz)	EIRP PSD Limit (dBm/MHz)	Test Result
		Chain 0	Chain 1						
1	5955	8.69	8.90	0.12	11.93	4.76	16.69	17	Pass
45	6175	8.87	9.24	0.12	12.19	4.76	16.95	17	Pass
93	6415	8.80	9.18	0.12	12.12	4.76	16.88	17	Pass
117	6535	8.40	9.01	0.12	11.85	4.61	16.46	17	Pass
149	6695	8.91	9.34	0.12	12.26	4.61	16.87	17	Pass
181	6855	9.07	9.10	0.12	12.22	4.61	16.83	17	Pass

**Notes:**

1. Method E) 2) a) of power density measurement of KDB 662911 is using for calculating total power density. Total power density is summing entire spectra across corresponding frequency bins on the various outputs by computer.
2. For U-NII-5, The directional gain is 4.76 dBi
3. For U-NII-7, The directional gain is 4.61 dBi

**802.11be (EHT40) SP Client 2T2S**

Chan.	Chan. Freq. (MHz)	PSD w/o Duty Factor (dBm/MHz)		Duty Factor (dB)	Total PSD (dBm/MHz)	Directional Gain (dBi)	EIRP PSD (dBm/MHz)	EIRP PSD Limit (dBm/MHz)	Test Result
		Chain 0	Chain 1						
3	5965	6.91	7.26	0.11	10.21	4.76	14.97	17	Pass
43	6165	6.86	7.89	0.11	10.53	4.76	15.29	17	Pass
91	6405	7.12	7.53	0.11	10.45	4.76	15.21	17	Pass
123	6565	6.37	7.29	0.11	9.97	4.61	14.58	17	Pass
155	6725	6.83	7.47	0.11	10.28	4.61	14.89	17	Pass
179	6845	6.67	7.66	0.11	10.31	4.61	14.92	17	Pass

**Notes:**

1. Method E) 2) a) of power density measurement of KDB 662911 is using for calculating total power density. Total power density is summing entire spectra across corresponding frequency bins on the various outputs by computer.
2. For U-NII-5, The directional gain is 4.76 dBi
3. For U-NII-7, The directional gain is 4.61 dBi

**802.11be (EHT80) SP Client 2T2S**

Chan.	Chan. Freq. (MHz)	PSD w/o Duty Factor (dBm/MHz)		Duty Factor (dB)	Total PSD (dBm/MHz)	Directional Gain (dBi)	EIRP PSD (dBm/MHz)	EIRP PSD Limit (dBm/MHz)	Test Result
		Chain 0	Chain 1						
7	5985	3.64	4.10	0.23	7.12	4.76	11.88	17	Pass
39	6145	3.12	4.01	0.23	6.83	4.76	11.59	17	Pass
87	6385	3.83	3.99	0.23	7.15	4.76	11.91	17	Pass
135	6625	3.45	3.74	0.23	6.84	4.61	11.45	17	Pass
151	6705	3.22	3.80	0.23	6.76	4.61	11.37	17	Pass
167	6785	3.51	3.37	0.23	6.68	4.61	11.29	17	Pass

**Notes:**

1. Method E) 2) a) of power density measurement of KDB 662911 is using for calculating total power density. Total power density is summing entire spectra across corresponding frequency bins on the various outputs by computer.
2. For U-NII-5, The directional gain is 4.76 dBi
3. For U-NII-7, The directional gain is 4.61 dBi

### 802.11be (EHT160) SP Client 2T2S

Chan.	Chan. Freq. (MHz)	PSD w/o Duty Factor (dBm/MHz)		Duty Factor (dB)	Total PSD (dBm/MHz)	Directional Gain (dBi)	EIRP PSD (dBm/MHz)	EIRP PSD Limit (dBm/MHz)	Test Result
		Chain 0	Chain 1						
15	6025	0.30	0.90	0.42	4.04	4.76	8.8	17	Pass
47	6185	0.68	0.83	0.42	4.19	4.76	8.95	17	Pass
79	6345	1.73	1.21	0.42	4.91	4.76	9.67	17	Pass
143	6665	0.94	1.60	0.42	4.71	4.61	9.32	17	Pass

Notes:

1. Method E) 2) a) of power density measurement of KDB 662911 is using for calculating total power density. Total power density is summing entire spectra across corresponding frequency bins on the various outputs by computer.
2. For U-NII-5, The directional gain is 4.76 dBi
3. For U-NII-7, The directional gain is 4.61 dBi

### 802.11be (EHT320) SP Client 2T2S

Chan.	Chan. Freq. (MHz)	PSD w/o Duty Factor (dBm/MHz)		Duty Factor (dB)	Total PSD (dBm/MHz)	Directional Gain (dBi)	EIRP PSD (dBm/MHz)	EIRP PSD Limit (dBm/MHz)	Test Result
		Chain 0	Chain 1						
31	6105	-6.92	-8.13	0.75	-3.72	4.76	1.04	17	Pass
63	6265	-8.22	-7.64	0.75	-4.16	4.76	0.6	17	Pass

Notes:

1. Method E) 2) a) of power density measurement of KDB 662911 is using for calculating total power density. Total power density is summing entire spectra across corresponding frequency bins on the various outputs by computer.
2. For U-NII-5, The directional gain is 4.76 dBi
3. For U-NII-7, The directional gain is 4.61 dBi

### 802.11ax (HE) 26-tone RU SP Client\_2T2S

Chan.	Chan. Freq. (MHz)	PSD w/o Duty Factor (dBm/MHz)		Duty Factor (dB)	Total PSD (dBm/MHz)	Directional Gain (dBi)	EIRP PSD (dBm/MHz)	EIRP PSD Limit (dBm/MHz)	Test Result
		Chain 0	Chain 1						
1	5955	7.96	7.72	1.28	12.13	4.76	16.89	17	Pass
93	6415	7.53	7.68	1.28	11.90	4.76	16.66	17	Pass
117	6535	7.94	7.90	1.28	12.21	4.61	16.82	17	Pass
181	6855	7.58	8.12	1.28	12.15	4.61	16.76	17	Pass

Notes:

1. Method E) 2) a) of power density measurement of KDB 662911 is using for calculating total power density. Total power density is summing entire spectra across corresponding frequency bins on the various outputs by computer.
2. For U-NII-5, The directional gain is 4.76 dBi
3. For U-NII-7, The directional gain is 4.61 dBi

### 802.11ax (HE) 52-tone RU SP Client\_2T2S

Chan.	Chan. Freq. (MHz)	PSD w/o Duty Factor (dBm/MHz)		Duty Factor (dB)	Total PSD (dBm/MHz)	Directional Gain (dBi)	EIRP PSD (dBm/MHz)	EIRP PSD Limit (dBm/MHz)	Test Result
		Chain 0	Chain 1						
1	5955	7.30	8.18	1.44	12.21	4.76	16.97	17	Pass
93	6415	7.47	7.43	1.44	11.90	4.76	16.66	17	Pass
117	6535	7.35	7.42	1.44	11.84	4.61	16.45	17	Pass
181	6855	7.33	7.61	1.44	11.92	4.61	16.53	17	Pass

Notes:

1. Method E) 2) a) of power density measurement of KDB 662911 is using for calculating total power density. Total power density is summing entire spectra across corresponding frequency bins on the various outputs by computer.
2. For U-NII-5, The directional gain is 4.76 dBi
3. For U-NII-7, The directional gain is 4.61 dBi

### 802.11ax (HE) 106-tone RU SP Client\_2T2S

Chan.	Chan. Freq. (MHz)	PSD w/o Duty Factor (dBm/MHz)		Duty Factor (dB)	Total PSD (dBm/MHz)	Directional Gain (dBi)	EIRP PSD (dBm/MHz)	EIRP PSD Limit (dBm/MHz)	Test Result
		Chain 0	Chain 1						
1	5955	7.19	7.35	1.55	11.83	4.76	16.59	17	Pass
93	6415	7.22	7.87	1.55	12.12	4.76	16.88	17	Pass
117	6535	7.18	7.76	1.55	12.04	4.61	16.65	17	Pass
181	6855	7.34	7.47	1.55	11.97	4.61	16.58	17	Pass

Notes:

1. Method E) 2) a) of power density measurement of KDB 662911 is using for calculating total power density. Total power density is summing entire spectra across corresponding frequency bins on the various outputs by computer.
2. For U-NII-5, The directional gain is 4.76 dBi
3. For U-NII-7, The directional gain is 4.61 dBi

### 802.11be (EHT20) 52+26-tone MRU SP Client\_2T2S

Chan.	Chan. Freq. (MHz)	PSD w/o Duty Factor (dBm/MHz)		Duty Factor (dB)	Total PSD (dBm/MHz)	Directional Gain (dBi)	EIRP PSD (dBm/MHz)	EIRP PSD Limit (dBm/MHz)	Test Result
		Chain 0	Chain 1						
1	5955	7.41	7.16	1.47	11.77	4.76	16.53	17	Pass
93	6415	7.25	7.30	1.47	11.76	4.76	16.52	17	Pass
117	6535	7.78	7.83	1.47	12.29	4.61	16.9	17	Pass
181	6855	7.33	7.20	1.47	11.75	4.61	16.36	17	Pass

Notes:

1. Method E) 2) a) of power density measurement of KDB 662911 is using for calculating total power density. Total power density is summing entire spectra across corresponding frequency bins on the various outputs by computer.
2. For U-NII-5, The directional gain is 4.76 dBi
3. For U-NII-7, The directional gain is 4.61 dBi

### 802.11be (EHT20) 106+26-tone MRU SP Client\_2T2S

Chan.	Chan. Freq. (MHz)	PSD w/o Duty Factor (dBm/MHz)		Duty Factor (dB)	Total PSD (dBm/MHz)	Directional Gain (dBi)	EIRP PSD (dBm/MHz)	EIRP PSD Limit (dBm/MHz)	Test Result
		Chain 0	Chain 1						
1	5955	7.54	7.13	1.47	11.82	4.76	16.58	17	Pass
93	6415	7.31	8.00	1.47	12.15	4.76	16.91	17	Pass
117	6535	7.17	7.50	1.47	11.82	4.61	16.43	17	Pass
181	6855	7.12	7.64	1.47	11.87	4.61	16.48	17	Pass

Notes:

1. Method E) 2) a) of power density measurement of KDB 662911 is using for calculating total power density. Total power density is summing entire spectra across corresponding frequency bins on the various outputs by computer.
2. For U-NII-5, The directional gain is 4.76 dBi
3. For U-NII-7, The directional gain is 4.61 dBi



**802.11be (EHT80) 484+242-tone MRU SP Client\_2T2S**

Chan.	Chan. Freq. (MHz)	PSD w/o Duty Factor (dBm/MHz)		Duty Factor (dB)	Total PSD (dBm/MHz)	Directional Gain (dBi)	EIRP PSD (dBm/MHz)	EIRP PSD Limit (dBm/MHz)	Test Result
		Chain 0	Chain 1						
7	5985	3.76	3.94	1.78	8.64	4.76	13.4	17	Pass
87	6385	3.26	4.37	1.78	8.64	4.76	13.4	17	Pass
135	6625	3.31	3.77	1.78	8.34	4.61	12.95	17	Pass

**Notes:**

1. Method E) 2) a) of power density measurement of KDB 662911 is using for calculating total power density. Total power density is summing entire spectra across corresponding frequency bins on the various outputs by computer.
2. For U-NII-5, The directional gain is 4.76 dBi
3. For U-NII-7, The directional gain is 4.61 dBi

**802.11be (EHT160) 996+484-tone MRU SP Client\_2T2S**

Chan.	Chan. Freq. (MHz)	PSD w/o Duty Factor (dBm/MHz)		Duty Factor (dB)	Total PSD (dBm/MHz)	Directional Gain (dBi)	EIRP PSD (dBm/MHz)	EIRP PSD Limit (dBm/MHz)	Test Result
		Chain 0	Chain 1						
15	6025	0.36	0.86	1.79	5.42	4.76	10.18	17	Pass
79	6345	0.31	0.72	1.79	5.32	4.76	10.08	17	Pass
143	6665	0.44	0.56	1.79	5.30	4.61	9.91	17	Pass

**Notes:**

1. Method E) 2) a) of power density measurement of KDB 662911 is using for calculating total power density. Total power density is summing entire spectra across corresponding frequency bins on the various outputs by computer.
2. For U-NII-5, The directional gain is 4.76 dBi
3. For U-NII-7, The directional gain is 4.61 dBi

**802.11be (EHT160) 996+484+242-tone MRU SP Client\_2T2S**

Chan.	Chan. Freq. (MHz)	PSD w/o Duty Factor (dBm/MHz)		Duty Factor (dB)	Total PSD (dBm/MHz)	Directional Gain (dBi)	EIRP PSD (dBm/MHz)	EIRP PSD Limit (dBm/MHz)	Test Result
		Chain 0	Chain 1						
15	6025	-0.26	0.35	1.79	4.86	4.76	9.62	17	Pass
79	6345	-1.50	-1.22	1.79	3.44	4.76	8.2	17	Pass
143	6665	-1.60	-1.71	1.79	3.15	4.61	7.76	17	Pass

**Notes:**

1. Method E) 2) a) of power density measurement of KDB 662911 is using for calculating total power density. Total power density is summing entire spectra across corresponding frequency bins on the various outputs by computer.
2. For U-NII-5, The directional gain is 4.76 dBi
3. For U-NII-7, The directional gain is 4.61 dBi

### 802.11be (EHT320) 2x996+484-tone MRU SP Client 2T2S

Chan.	Chan. Freq. (MHz)	PSD w/o Duty Factor (dBm/MHz)		Duty Factor (dB)	Total PSD (dBm/MHz)	Directional Gain (dBi)	EIRP PSD (dBm/MHz)	EIRP PSD Limit (dBm/MHz)	Test Result
		Chain 0	Chain 1						
31	6105	-1.61	-2.91	1.8	2.60	4.76	7.36	17	Pass
63	6265	-2.08	-1.55	1.8	3.00	4.76	7.76	17	Pass

Notes:

- Method E) 2) a) of power density measurement of KDB 662911 is using for calculating total power density. Total power density is summing entire spectra across corresponding frequency bins on the various outputs by computer.
- For U-NII-5, The directional gain is 4.76 dBi
- For U-NII-7, The directional gain is 4.61 dBi

### 802.11be (EHT320) 3x996-tone MRU SP Client 2T2S

Chan.	Chan. Freq. (MHz)	PSD w/o Duty Factor (dBm/MHz)		Duty Factor (dB)	Total PSD (dBm/MHz)	Directional Gain (dBi)	EIRP PSD (dBm/MHz)	EIRP PSD Limit (dBm/MHz)	Test Result
		Chain 0	Chain 1						
31	6105	-2.37	-3.18	1.8	2.05	4.76	6.81	17	Pass
63	6265	-3.04	-2.52	1.8	2.04	4.76	6.8	17	Pass

Notes:

- Method E) 2) a) of power density measurement of KDB 662911 is using for calculating total power density. Total power density is summing entire spectra across corresponding frequency bins on the various outputs by computer.
- For U-NII-5, The directional gain is 4.76 dBi
- For U-NII-7, The directional gain is 4.61 dBi

### 802.11be (EHT320) 3x996+484-tone MRU SP Client 2T2S

Chan.	Chan. Freq. (MHz)	PSD w/o Duty Factor (dBm/MHz)		Duty Factor (dB)	Total PSD (dBm/MHz)	Directional Gain (dBi)	EIRP PSD (dBm/MHz)	EIRP PSD Limit (dBm/MHz)	Test Result
		Chain 0	Chain 1						
31	6105	-3.13	-3.71	1.8	1.40	4.76	6.16	17	Pass
63	6265	-3.40	-3.06	1.8	1.58	4.76	6.34	17	Pass

Notes:

- Method E) 2) a) of power density measurement of KDB 662911 is using for calculating total power density. Total power density is summing entire spectra across corresponding frequency bins on the various outputs by computer.
- For U-NII-5, The directional gain is 4.76 dBi
- For U-NII-7, The directional gain is 4.61 dBi



### Spectrum Plot of Maximum Value

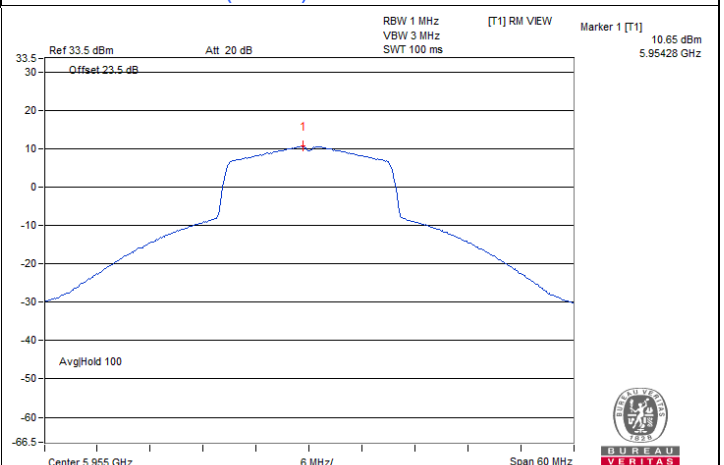
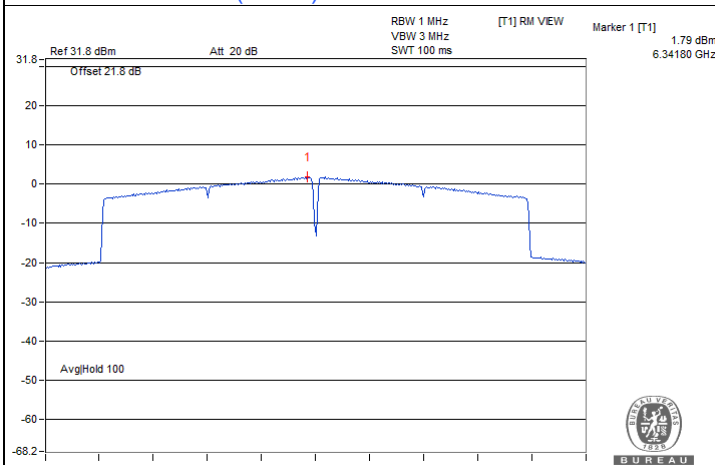
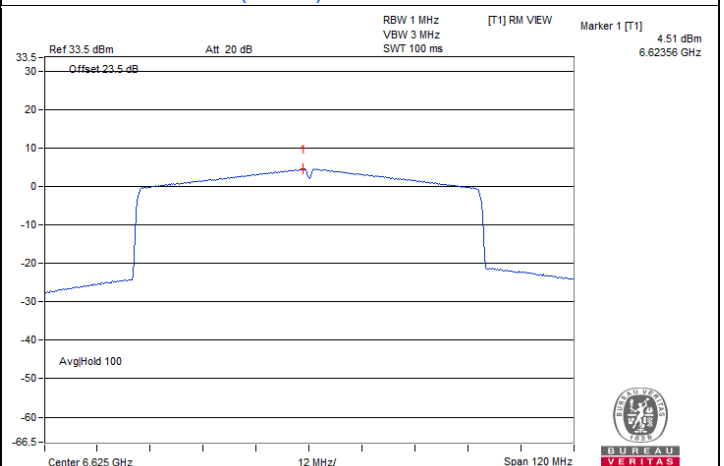
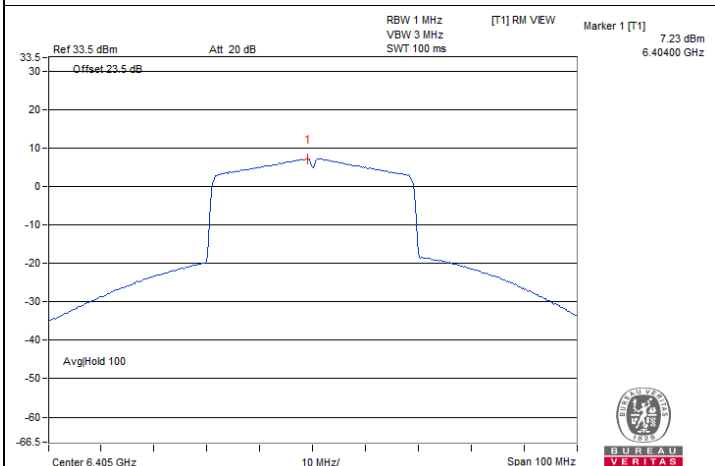
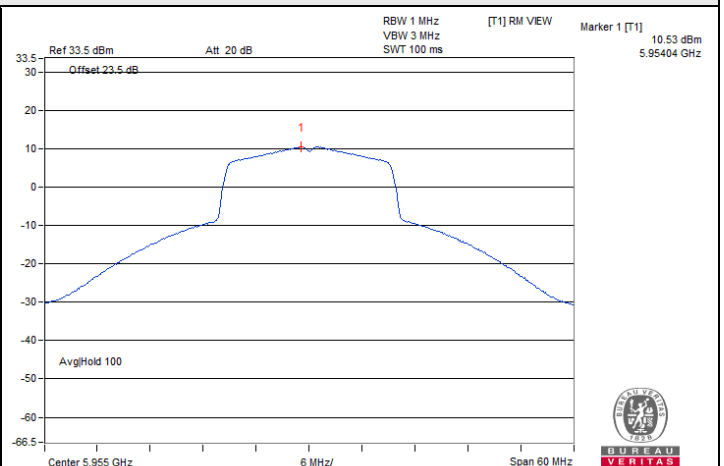
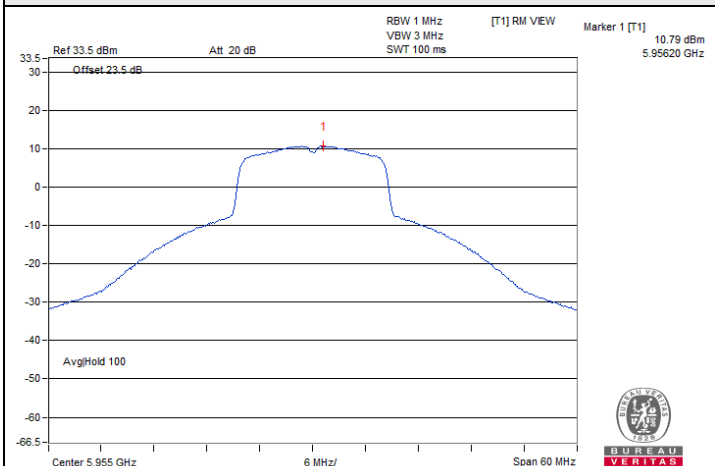



### Spectrum Plot of Maximum Value

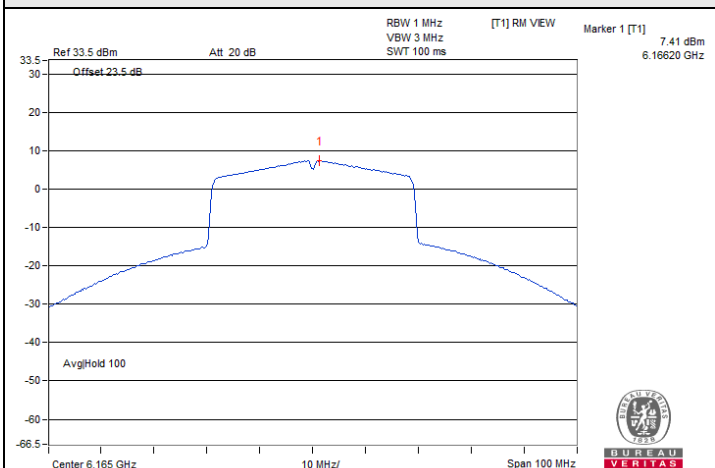

802.11be (EHT40) SP Client 1T1S : CH 43

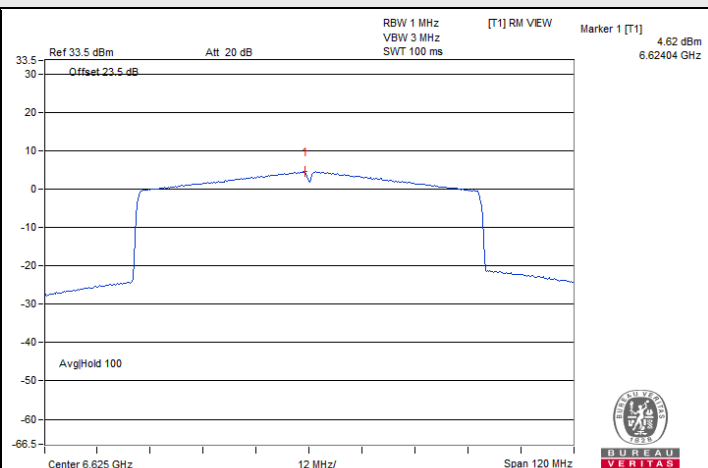

802.11be (EHT80) SP Client 1T1S : CH 135

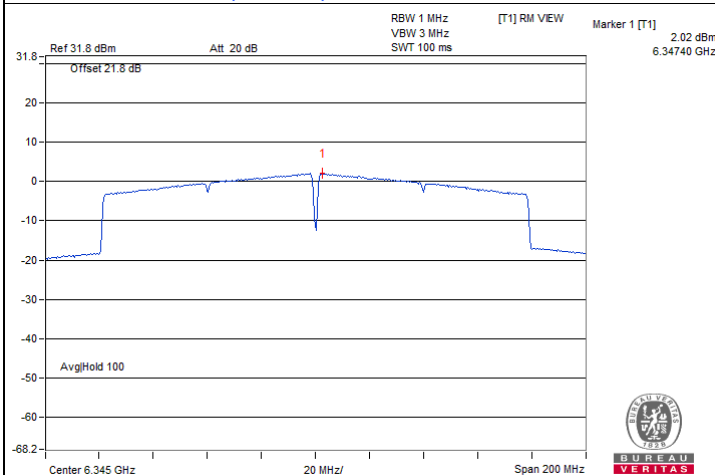

802.11be (EHT160) SP Client 1T1S : CH 79

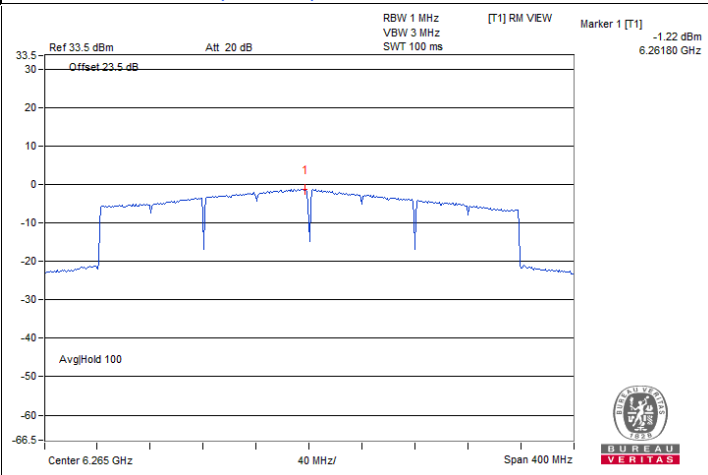

802.11be (EHT320) SP Client 1T1S : CH 63

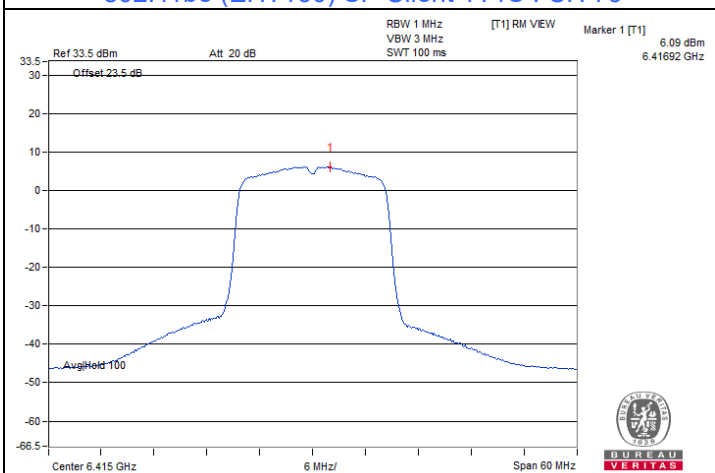

802.11a SP Client 2T2S / Chain 1 : CH 93

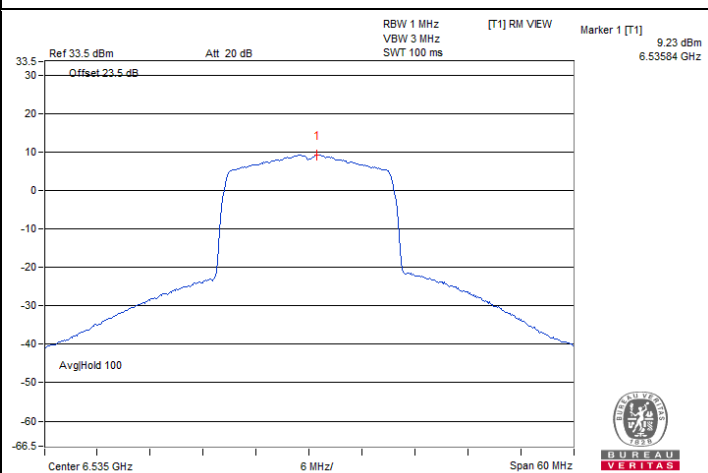

802.11ax (HE20) SP Client 2T2S / Chain 1 : CH 117

### Spectrum Plot of Maximum Value

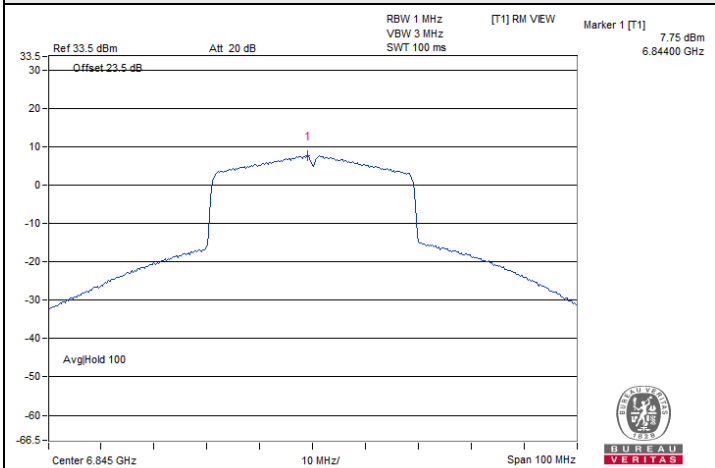

802.11ax (HE40) SP Client 2T2S / Chain 1 : CH 179

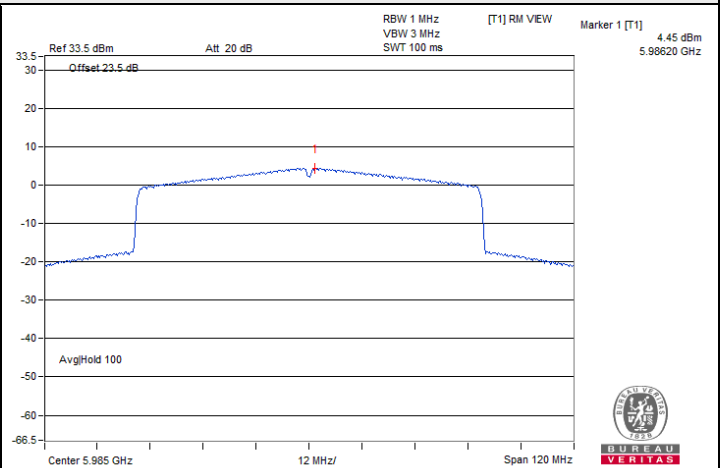

802.11ax (HE80) SP Client 2T2S / Chain 1 : CH 7

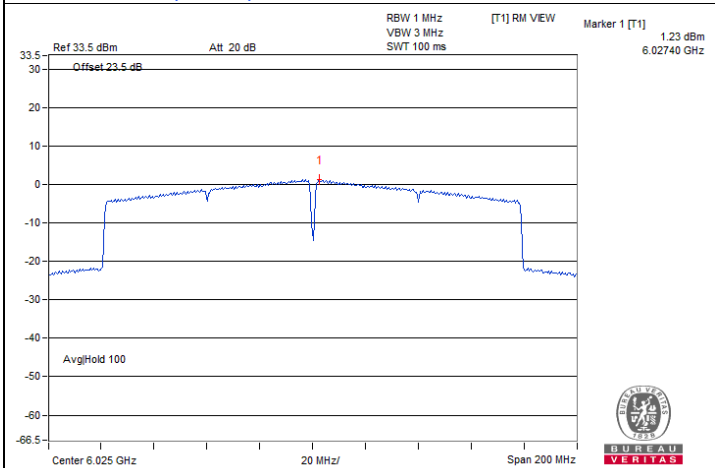

802.11ax (HE160) SP Client 2T2S / Chain 1 : CH 15

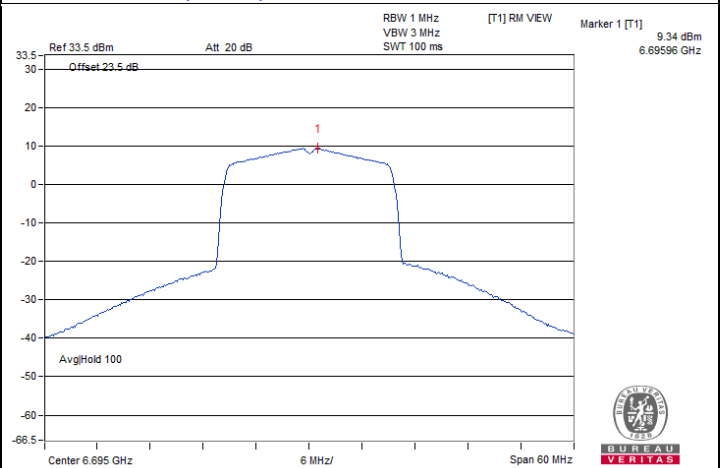

802.11be (EHT20) SP Client 2T2S / Chain 1 : CH 149

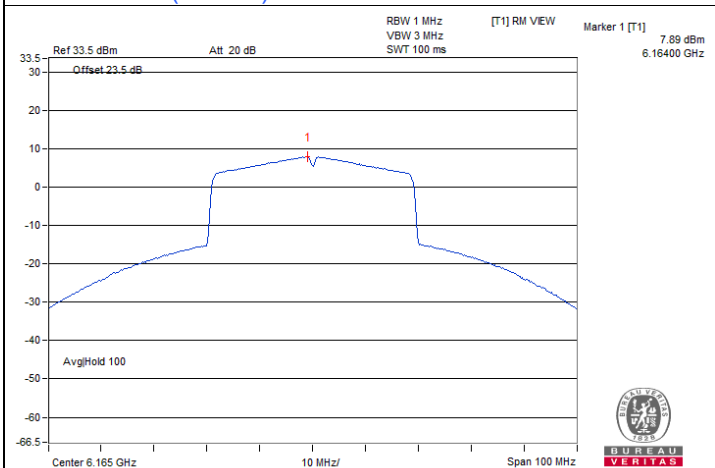

802.11be (EHT40) SP Client 2T2S / Chain 1 : CH 43

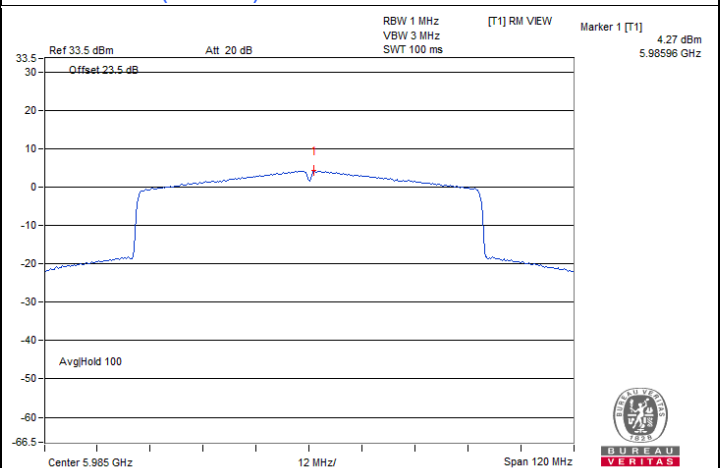

802.11be (EHT80) SP Client 2T2S / Chain 1 : CH 7

### Spectrum Plot of Maximum Value

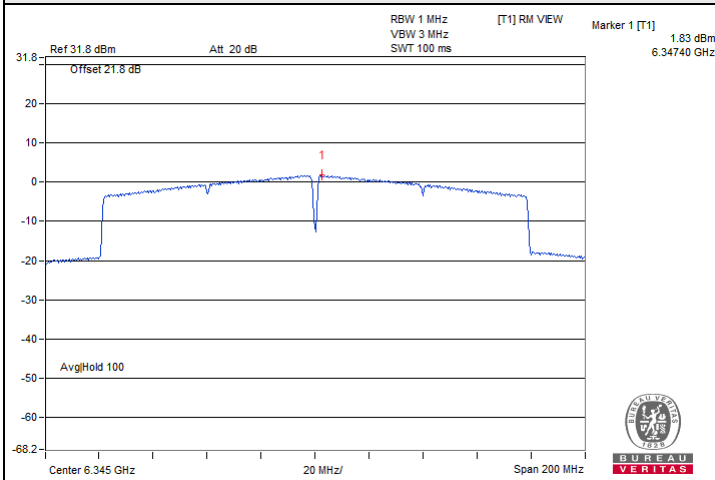

802.11be (EHT160) SP Client 2T2S / Chain 0 : CH 79

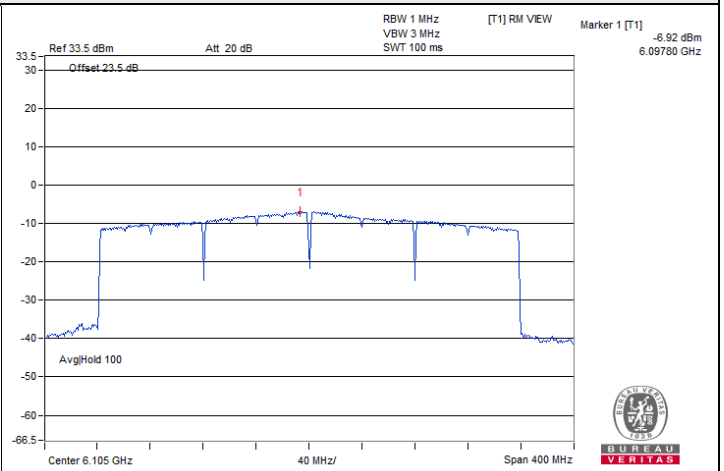

802.11be (EHT320) SP Client 2T2S / Chain 0 : CH 31

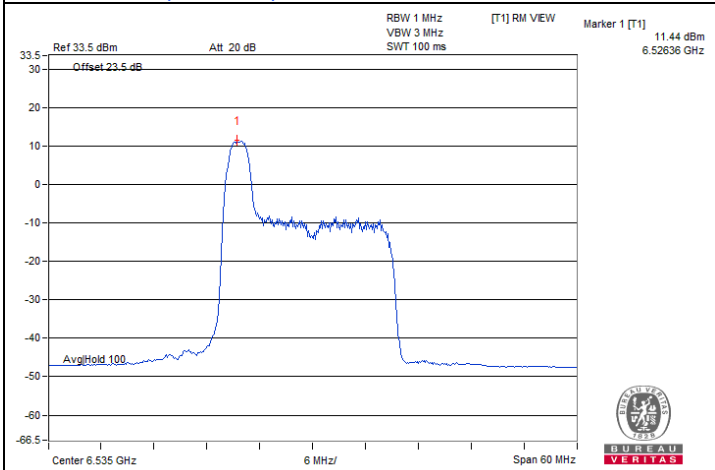

802.11ax (HE) 26-tone RU SP Client\_1T1S : CH 117@0

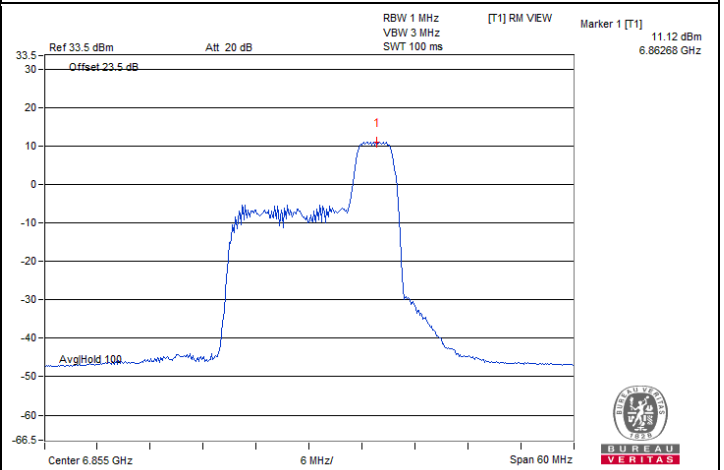

802.11ax (HE) 52-tone RU SP Client\_1T1S : CH 181@40

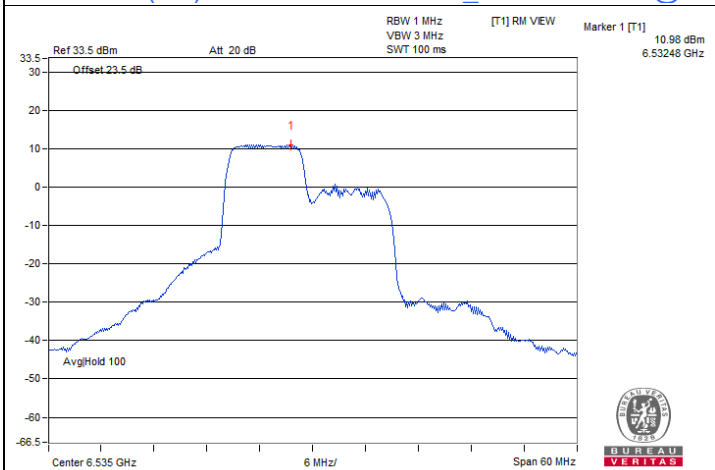

802.11ax (HE) 106-tone RU SP Client\_1T1S : CH 117@53

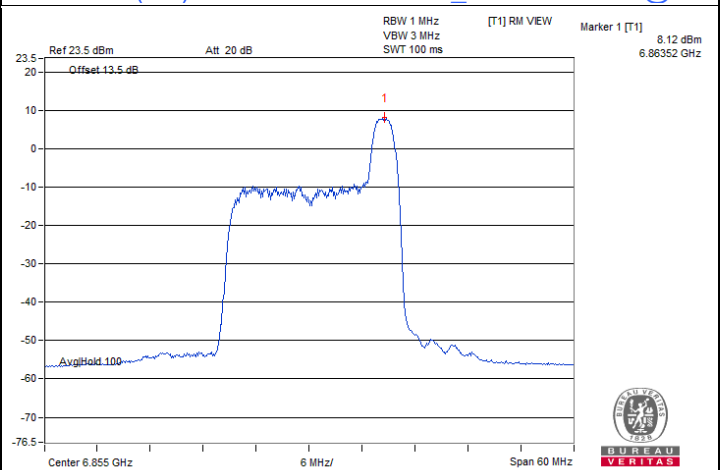

802.11ax (HE) 26-tone RU SP Client\_2T2S / Chain 1 : CH 181@8



### Spectrum Plot of Maximum Value

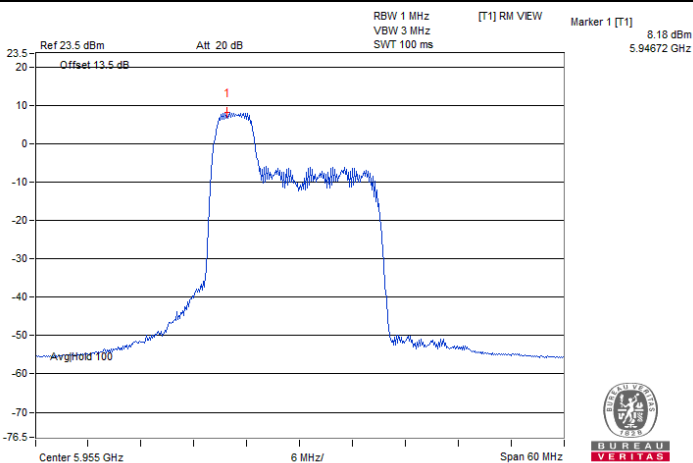

802.11ax (HE) 52-tone RU SP Client\_2T2S / Chain 1 : CH 1@37

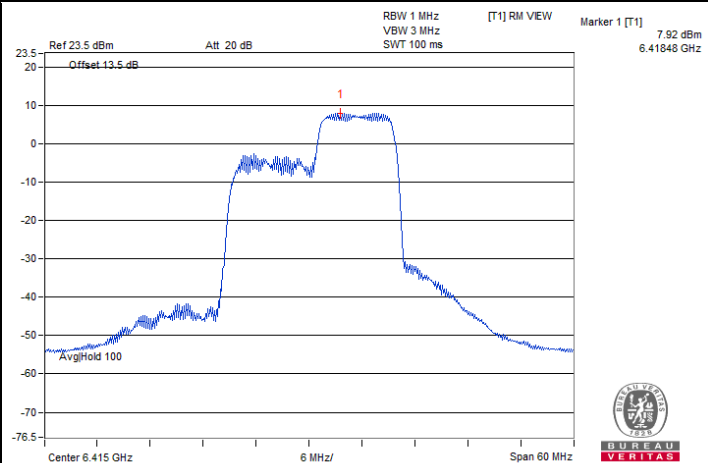

802.11ax (HE) 106-tone RU SP Client\_2T2S / Chain 1 : CH 93@54

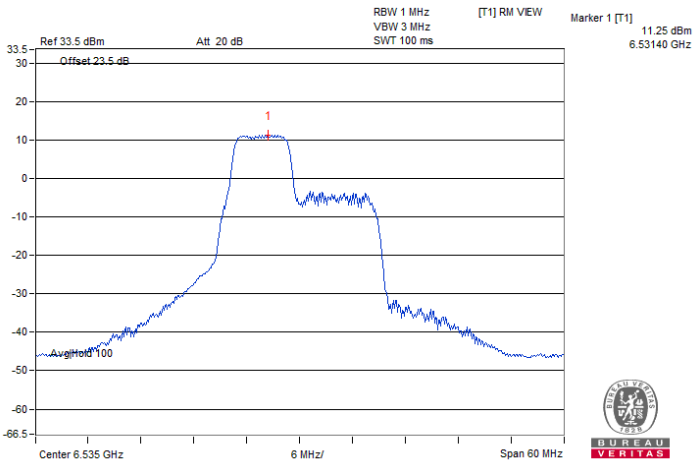

802.11be (EHT20) 52+26-tone MRU SP Client\_1T1S : CH 117@70

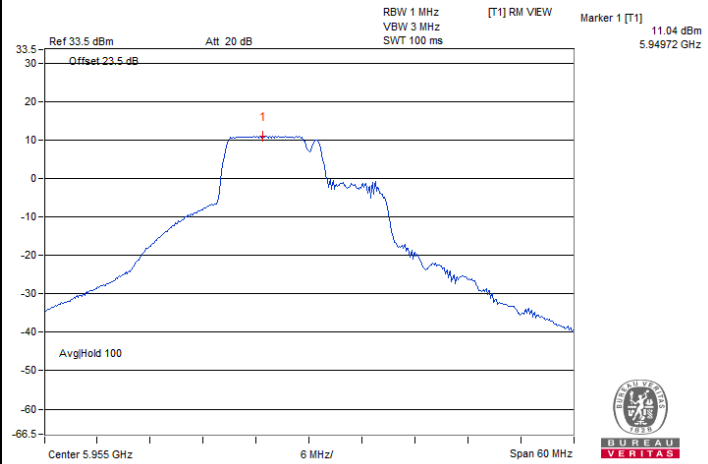

802.11be (EHT20) 106+26-tone MRU SP Client\_1T1S : CH 1@82

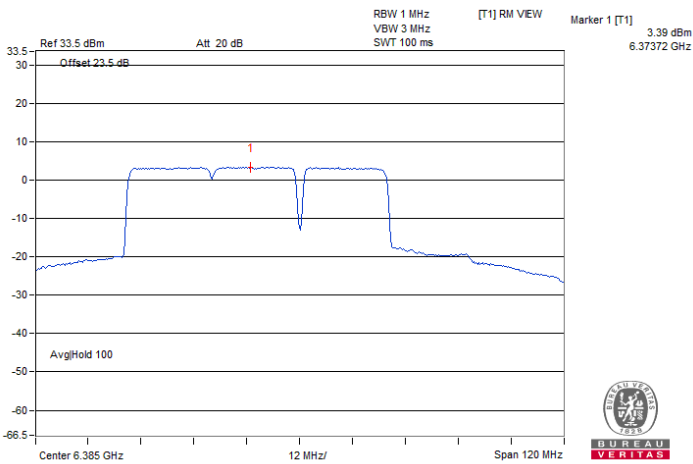

802.11be (EHT80) 484+242-tone MRU SP Client\_1T1S : CH 87@90

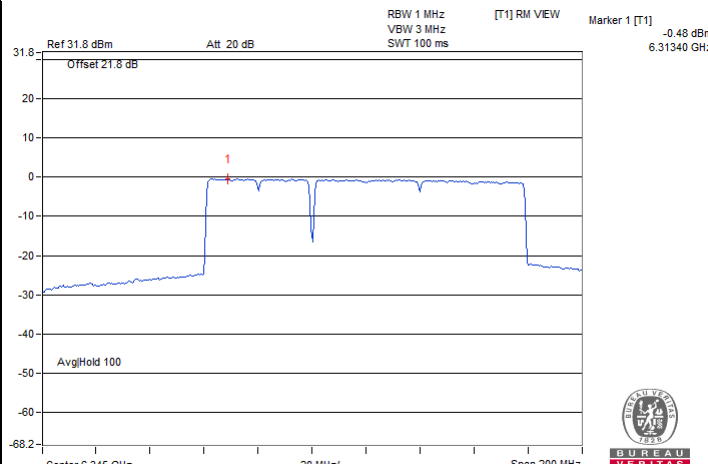

802.11be (EHT160) 996+484-tone MRU SP Client\_1T1S : CH 79@94\_0



### Spectrum Plot of Maximum Value

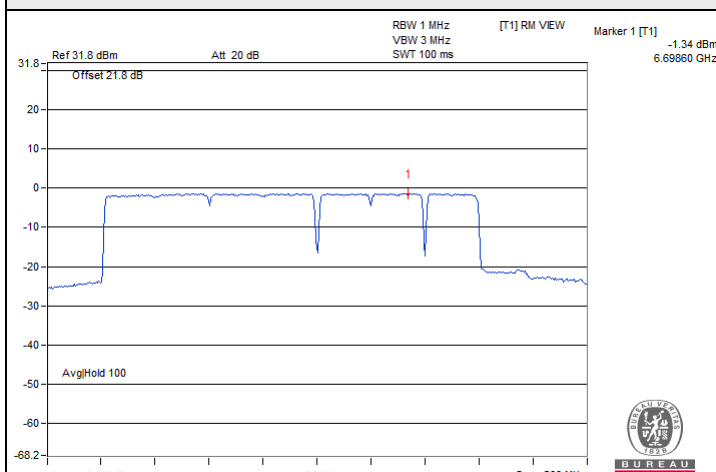

802.11be (EHT160) 996+484+242-tone MRU SP Client\_1T1S : CH 143@99\_1

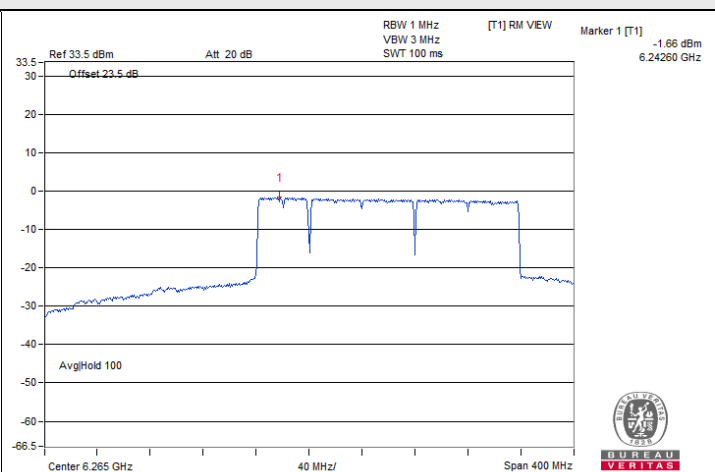

802.11be (EHT320) 2x996+484-tone MRU SP Client 1T1S : CH 63@102\_0/1

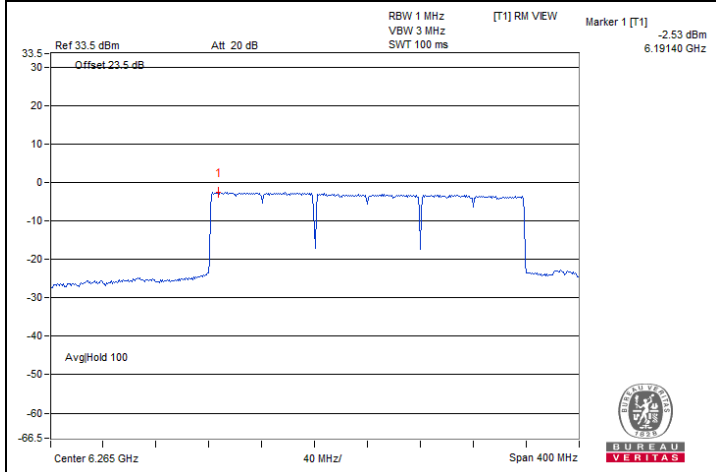

802.11be (EHT320) 3x996-tone MRU SP Client 1T1S : CH 63@104\_0/0

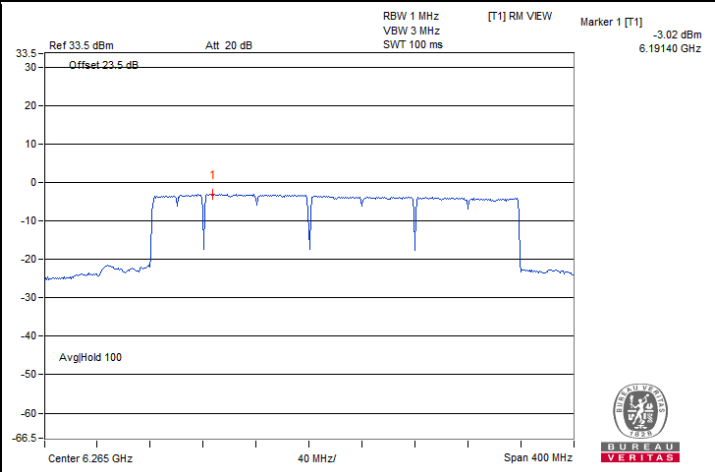

802.11be (EHT320) 3x996+484-tone MRU SP Client 1T1S : CH 63@105\_0/0

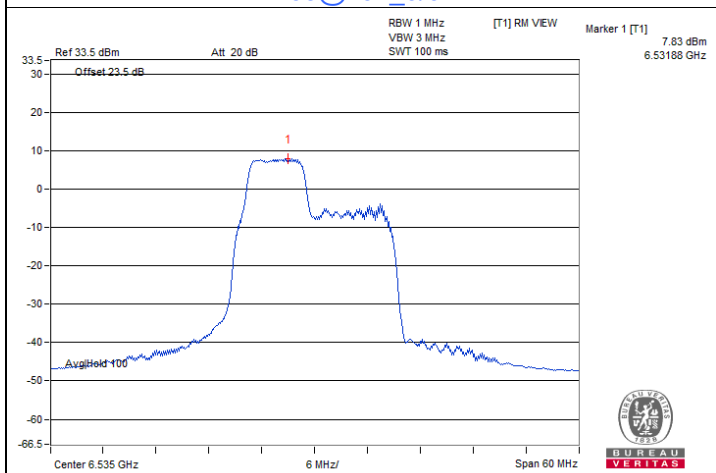

802.11be (EHT20) 52+26-tone MRU SP Client\_2T2S / Chain 1 : CH 117@70

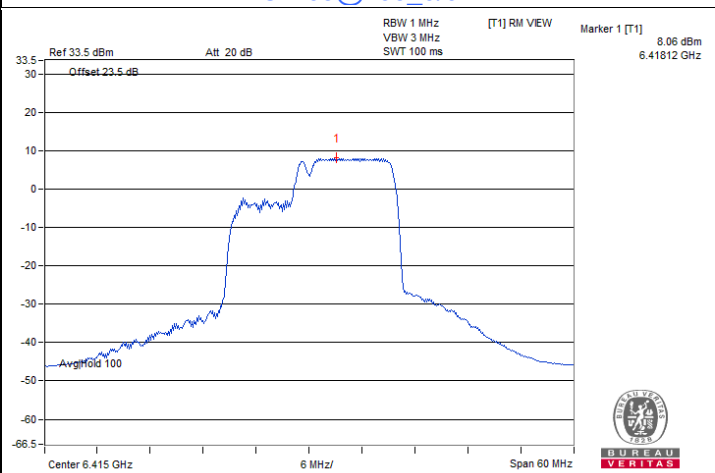

802.11be (EHT20) 106+26-tone MRU SP Client\_2T2S / Chain 1 : CH 93@83



### Spectrum Plot of Maximum Value

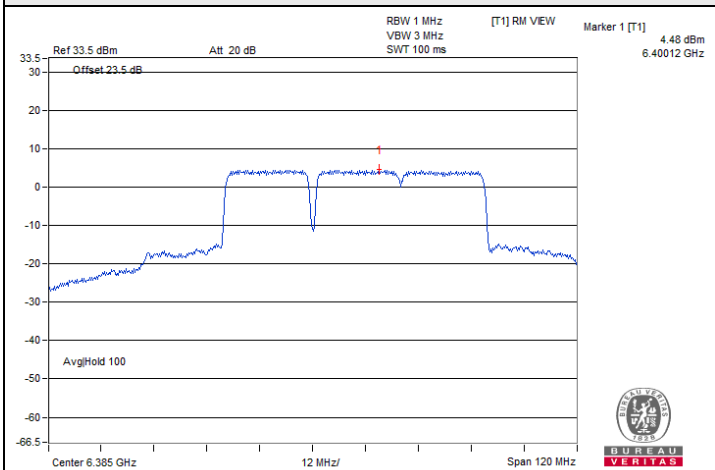

802.11be (EHT80) 484+242-tone MRU SP Client\_2T2S / Chain 1 : CH 87@90

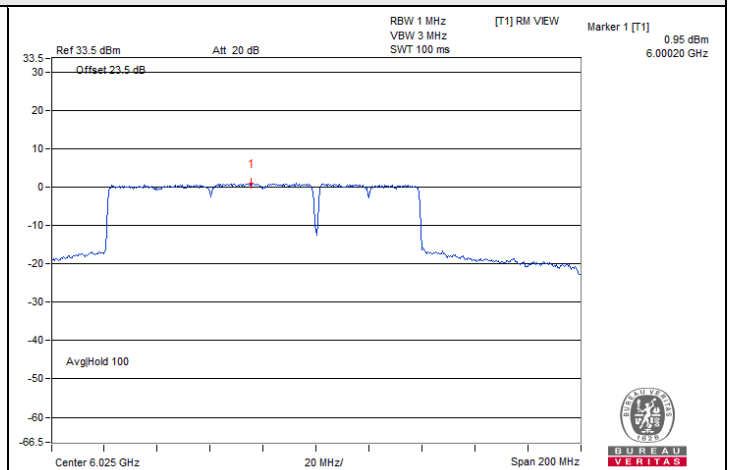

802.11be (EHT160) 996+484-tone MRU SP Client\_2T2S / Chain 1 : CH 15@95\_1

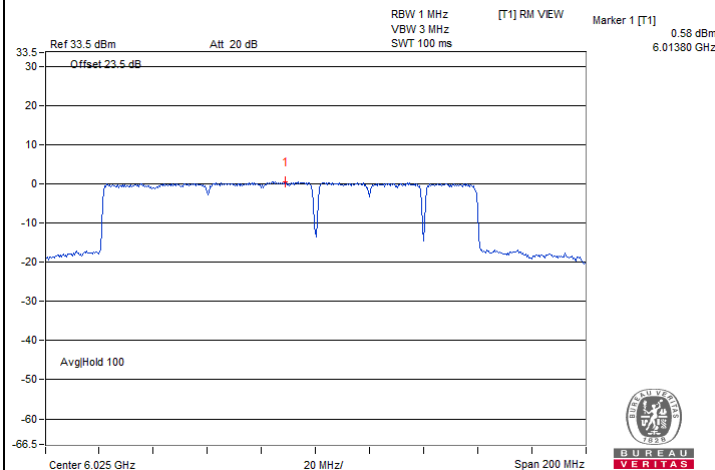

802.11be (EHT160) 996+484+242-tone MRU SP Client\_2T2S / Chain 1 : CH 15@99\_1

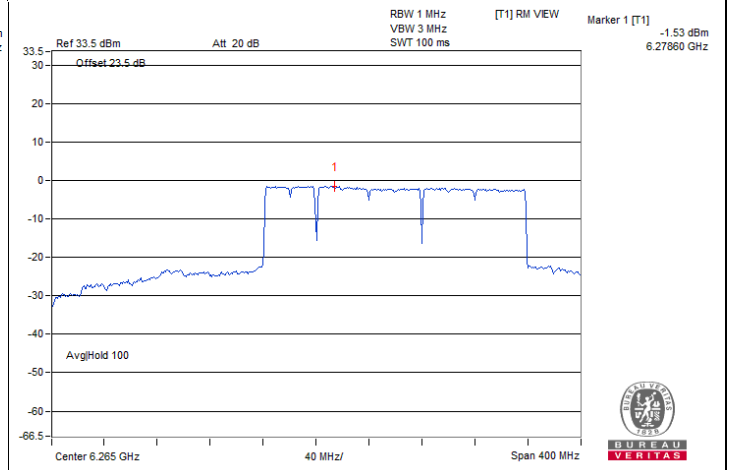

802.11be (EHT320) 2x996+484-tone MRU SP Client 2T2S / Chain 1 : CH 63@102\_0\_1

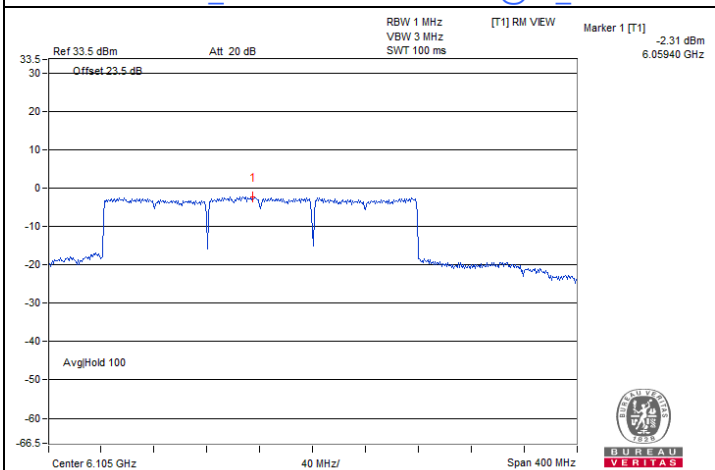

802.11be (EHT320) 3x996-tone MRU SP Client 2T2S / Chain 0 : CH 31@104\_1\_1

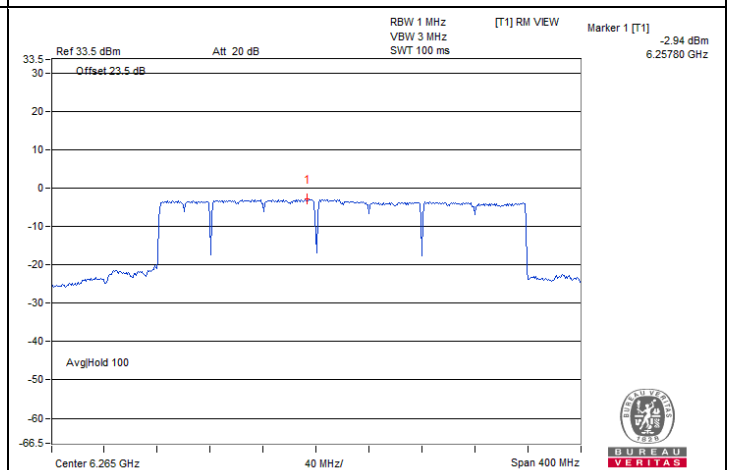

802.11be (EHT320) 3x996+484-tone MRU SP Client 2T2S / Chain 1 : CH 63@105\_0\_0

### 7.3 Emission Bandwidth

Input Power:	120 Vac, 60 Hz	Environmental Conditions:	24°C, 66% RH	Tested By:	Eric Peng
--------------	----------------	---------------------------	--------------	------------	-----------

#### 802.11a SP Client 1S1T

Channel	Frequency (MHz)	26dB Bandwidth (MHz)	Maximum Limit (MHz)	Test Result
1	5955	42.19	320	Pass
45	6175	36.9	320	Pass
93	6415	40.49	320	Pass
117	6535	42.08	320	Pass
149	6695	42.77	320	Pass
181	6855	42.26	320	Pass

#### 802.11ax (HE20) SP Client 1S1T

Channel	Frequency (MHz)	26dB Bandwidth (MHz)	Maximum Limit (MHz)	Test Result
1	5955	38.75	320	Pass
93	6415	41.88	320	Pass
117	6535	41.83	320	Pass
181	6855	43.75	320	Pass

#### 802.11ax (HE40) SP Client 1S1T

Channel	Frequency (MHz)	26dB Bandwidth (MHz)	Maximum Limit (MHz)	Test Result
3	5965	56.6	320	Pass
91	6405	81.68	320	Pass
123	6565	85.66	320	Pass
179	6845	85.45	320	Pass

#### 802.11ax (HE80) SP Client 1S1T

Channel	Frequency (MHz)	26dB Bandwidth (MHz)	Maximum Limit (MHz)	Test Result
7	5985	87.59	320	Pass
87	6385	176.62	320	Pass
135	6625	172.69	320	Pass
167	6785	175.49	320	Pass

**802.11ax (HE160) SP Client 1S1T**

Channel	Frequency (MHz)	26dB Bandwidth (MHz)	Maximum Limit (MHz)	Test Result
15	6025	273.11	320	Pass
79	6345	285.18	320	Pass
143	6665	287.9	320	Pass

**802.11be (EHT20) SP Client 1S1T**

Channel	Frequency (MHz)	26dB Bandwidth (MHz)	Maximum Limit (MHz)	Test Result
1	5955	40.07	320	Pass
45	6175	38.35	320	Pass
93	6415	41.64	320	Pass
117	6535	36.98	320	Pass
149	6695	42.55	320	Pass
181	6855	44.33	320	Pass

**802.11be (EHT40) SP Client 1S1T**

Channel	Frequency (MHz)	26dB Bandwidth (MHz)	Maximum Limit (MHz)	Test Result
3	5965	59.45	320	Pass
43	6165	76.08	320	Pass
91	6405	83.33	320	Pass
123	6565	86.39	320	Pass
155	6725	83.85	320	Pass
179	6845	88.09	320	Pass

**802.11be (EHT80) SP Client 1S1T**

Channel	Frequency (MHz)	26dB Bandwidth (MHz)	Maximum Limit (MHz)	Test Result
7	5985	80.08	320	Pass
39	6145	154.99	320	Pass
87	6385	170.44	320	Pass
135	6625	170.83	320	Pass
151	6705	173.29	320	Pass
167	6785	169.05	320	Pass

### 802.11be (EHT160) SP Client 1S1T

Channel	Frequency (MHz)	26dB Bandwidth (MHz)	Maximum Limit (MHz)	Test Result
15	6025	271.97	320	Pass
47	6185	263.46	320	Pass
79	6345	311.49	320	Pass
143	6665	318.43	320	Pass

### 802.11be (EHT320) SP Client 1S1T

Channel	Frequency (MHz)	26dB Bandwidth (MHz)	Maximum Limit (MHz)	Test Result
31	6105	605.49	320	Note
63	6265	682.02	320	Note

Note: Please refer to 99% OBW measurement test results for Wi-Fi 320 MHz BW mode.

### 802.11ax (HE) 26-tone RU SP Client\_1T1S

Channel	Frequency (MHz)	26dB Bandwidth (MHz)	Maximum Limit (MHz)	Test Result
1	5955	19.33	320	Pass
93	6415	19.33	320	Pass
117	6535	19.23	320	Pass
181	6855	19.37	320	Pass

### 802.11ax (HE) 52-tone RU SP Client\_1T1S

Channel	Frequency (MHz)	26dB Bandwidth (MHz)	Maximum Limit (MHz)	Test Result
1	5955	21.27	320	Pass
93	6415	20.6	320	Pass
117	6535	19.38	320	Pass
181	6855	20.31	320	Pass

### 802.11ax (HE) 106-tone RU SP Client\_1T1S

Channel	Frequency (MHz)	26dB Bandwidth (MHz)	Maximum Limit (MHz)	Test Result
1	5955	29.83	320	Pass
93	6415	24.29	320	Pass
117	6535	24.62	320	Pass
181	6855	23.78	320	Pass

**802.11be (EHT20) 52+26-tone MRU SP Client\_1T1S**

Channel	Frequency (MHz)	26dB Bandwidth (MHz)	Maximum Limit (MHz)	Test Result
1	5955	22.51	320	Pass
93	6415	21.14	320	Pass
117	6535	19.95	320	Pass
181	6855	21.07	320	Pass

**802.11be (EHT20) 106+26-tone MRU SP Client\_1T1S**

Channel	Frequency (MHz)	26dB Bandwidth (MHz)	Maximum Limit (MHz)	Test Result
1	5955	35.88	320	Pass
93	6415	29.65	320	Pass
117	6535	28.05	320	Pass
181	6855	30.68	320	Pass

**802.11be (EHT80) 484+242-tone MRU SP Client\_1T1S**

Channel	Frequency (MHz)	26dB Bandwidth (MHz)	Maximum Limit (MHz)	Test Result
7	5985	94.34	320	Pass
87	6385	151.88	320	Pass
135	6625	137.14	320	Pass

**802.11be (EHT160) 996+484-tone MRU SP Client\_1T1S**

Channel	Frequency (MHz)	26dB Bandwidth (MHz)	Maximum Limit (MHz)	Test Result
15	6025	267.98	320	Pass
79	6345	296.96	320	Pass
143	6665	253.18	320	Pass

**802.11be (EHT160) 996+484+242-tone MRU SP Client\_1T1S**

Channel	Frequency (MHz)	26dB Bandwidth (MHz)	Maximum Limit (MHz)	Test Result
15	6025	313.09	320	Pass
79	6345	293.41	320	Pass
143	6665	297.76	320	Pass

### 802.11be (EHT320) 2x996+484-tone MRU SP Client 1T1S

Channel	Frequency (MHz)	26dB Bandwidth (MHz)	Maximum Limit (MHz)	Test Result
31	6105	459.67	320	Note
63	6265	482.11	320	Note

Note: Please refer to 99% OBW measurement test results for Wi-Fi 320 MHz BW mode.

### 802.11be (EHT320) 3x996-tone MRU SP Client 1T1S

Channel	Frequency (MHz)	26dB Bandwidth (MHz)	Maximum Limit (MHz)	Test Result
31	6105	477.18	320	Note
63	6265	608.48	320	Note

Note: Please refer to 99% OBW measurement test results for Wi-Fi 320 MHz BW mode.

### 802.11be (EHT320) 3x996+484-tone MRU SP Client 1T1S

Channel	Frequency (MHz)	26dB Bandwidth (MHz)	Maximum Limit (MHz)	Test Result
31	6105	610.12	320	Note
63	6265	757.61	320	Note

Note: Please refer to 99% OBW measurement test results for Wi-Fi 320 MHz BW mode.

### 802.11a SP Client 2S2T

Channel	Frequency (MHz)	26dB Bandwidth (MHz)		Maximum Limit (MHz)	Test Result
		Chain 0	Chain 1		
1	5955	18.16	21.36	320	Pass
45	6175	18.41	18.45	320	Pass
93	6415	20.80	19.28	320	Pass
117	6535	19.86	18.19	320	Pass
149	6695	29.03	19.59	320	Pass
181	6855	23.18	18.21	320	Pass

### 802.11ax (HE20) SP Client 2S2T

Channel	Frequency (MHz)	26dB Bandwidth (MHz)		Maximum Limit (MHz)	Test Result
		Chain 0	Chain 1		
1	5955	28.83	38.82	320	Pass
93	6415	27.50	30.43	320	Pass
117	6535	28.03	26.25	320	Pass
181	6855	29.68	25.37	320	Pass

**802.11ax (HE40) SP Client 2S2T**

Channel	Frequency (MHz)	26dB Bandwidth (MHz)		Maximum Limit (MHz)	Test Result
		Chain 0	Chain 1		
3	5965	43.42	63.30	320	Pass
91	6405	65.19	66.12	320	Pass
123	6565	72.54	70.73	320	Pass
179	6845	77.52	67.57	320	Pass

**802.11ax (HE80) SP Client 2S2T**

Channel	Frequency (MHz)	26dB Bandwidth (MHz)		Maximum Limit (MHz)	Test Result
		Chain 0	Chain 1		
7	5985	79.93	104.63	320	Pass
87	6385	110.61	139.55	320	Pass
135	6625	138.72	110.07	320	Pass
167	6785	156.90	115.38	320	Pass

**802.11ax (HE160) SP Client 2S2T**

Channel	Frequency (MHz)	26dB Bandwidth (MHz)		Maximum Limit (MHz)	Test Result
		Chain 0	Chain 1		
15	6025	250.35	262.58	320	Pass
79	6345	286.28	315.13	320	Pass
143	6665	282.23	280.55	320	Pass

**802.11be (EHT20) SP Client 2S2T**

Channel	Frequency (MHz)	26dB Bandwidth (MHz)		Maximum Limit (MHz)	Test Result
		Chain 0	Chain 1		
1	5955	34.85	32.37	320	Pass
45	6175	26.52	33.10	320	Pass
93	6415	34.50	32.71	320	Pass
117	6535	36.22	29.29	320	Pass
149	6695	40.21	32.66	320	Pass
181	6855	35.49	35.37	320	Pass

**802.11be (EHT40) SP Client 2S2T**

Channel	Frequency (MHz)	26dB Bandwidth (MHz)		Maximum Limit (MHz)	Test Result
		Chain 0	Chain 1		
3	5965	47.28	67.60	320	Pass
43	6165	71.53	83.22	320	Pass
91	6405	73.42	77.04	320	Pass
123	6565	80.21	75.38	320	Pass
155	6725	81.05	77.30	320	Pass
179	6845	79.04	72.26	320	Pass

**802.11be (EHT80) SP Client 2S2T**

Channel	Frequency (MHz)	26dB Bandwidth (MHz)		Maximum Limit (MHz)	Test Result
		Chain 0	Chain 1		
7	5985	80.13	110.35	320	Pass
39	6145	130.87	143.80	320	Pass
87	6385	144.77	143.37	320	Pass
135	6625	152.92	141.97	320	Pass
151	6705	158.57	130.94	320	Pass
167	6785	152.50	141.23	320	Pass

**802.11be (EHT160) SP Client 2S2T**

Channel	Frequency (MHz)	26dB Bandwidth (MHz)		Maximum Limit (MHz)	Test Result
		Chain 0	Chain 1		
15	6025	162.37	268.68	320	Pass
47	6185	255.34	286.72	320	Pass
79	6345	254.36	304.89	320	Pass
143	6665	282.42	249.04	320	Pass

**802.11be (EHT320) SP Client 2S2T**

Channel	Frequency (MHz)	26dB Bandwidth (MHz)		Maximum Limit (MHz)	Test Result
		Chain 0	Chain 1		
31	6105	564.16	632.16	320	Note
63	6265	606.93	647.04	320	Note

Note: Please refer to 99% OBW measurement test results for Wi-Fi 320 MHz BW mode.



**802.11ax (HE) 26-tone RU SP Client\_2T2S**

Channel	Frequency (MHz)	26dB Bandwidth (MHz)		Maximum Limit (MHz)	Test Result
		Chain 0	Chain 1		
1	5955	19.16	19.08	320	Pass
93	6415	19.29	19.19	320	Pass
117	6535	19.18	19.18	320	Pass
181	6855	19.32	19.28	320	Pass

**802.11ax (HE) 52-tone RU SP Client\_2T2S**

Channel	Frequency (MHz)	26dB Bandwidth (MHz)		Maximum Limit (MHz)	Test Result
		Chain 0	Chain 1		
1	5955	19.24	19.14	320	Pass
93	6415	19.43	19.28	320	Pass
117	6535	19.31	19.21	320	Pass
181	6855	19.41	19.38	320	Pass

**802.11ax (HE) 106-tone RU SP Client\_2T2S**

Channel	Frequency (MHz)	26dB Bandwidth (MHz)		Maximum Limit (MHz)	Test Result
		Chain 0	Chain 1		
1	5955	23.73	21.07	320	Pass
93	6415	20.23	19.95	320	Pass
117	6535	19.33	19.33	320	Pass
181	6855	19.57	19.83	320	Pass

**802.11be (EHT20) 52+26-tone MRU SP Client\_2T2S**

Channel	Frequency (MHz)	26dB Bandwidth (MHz)		Maximum Limit (MHz)	Test Result
		Chain 0	Chain 1		
1	5955	20.85	18.67	320	Pass
93	6415	18.94	18.69	320	Pass
117	6535	18.99	18.71	320	Pass
181	6855	18.97	18.61	320	Pass

**802.11be (EHT20) 106+26-tone MRU SP Client\_2T2S**

Channel	Frequency (MHz)	26dB Bandwidth (MHz)		Maximum Limit (MHz)	Test Result
		Chain 0	Chain 1		
1	5955	27.77	23.83	320	Pass
93	6415	19.62	19.51	320	Pass
117	6535	21.28	20.03	320	Pass
181	6855	21.78	20.43	320	Pass

**802.11be (EHT80) 484+242-tone MRU SP Client\_2T2S**

Channel	Frequency (MHz)	26dB Bandwidth (MHz)		Maximum Limit (MHz)	Test Result
		Chain 0	Chain 1		
7	5985	92.35	84.27	320	Pass
87	6385	133.19	129.54	320	Pass
135	6625	96.27	87.32	320	Pass

**802.11be (EHT160) 996+484-tone MRU SP Client\_2T2S**

Channel	Frequency (MHz)	26dB Bandwidth (MHz)		Maximum Limit (MHz)	Test Result
		Chain 0	Chain 1		
15	6025	261.57	206.19	320	Pass
79	6345	253.86	246.03	320	Pass
143	6665	222.89	214.50	320	Pass

**802.11be (EHT160) 996+484+242-tone MRU SP Client\_2T2S**

Channel	Frequency (MHz)	26dB Bandwidth (MHz)		Maximum Limit (MHz)	Test Result
		Chain 0	Chain 1		
15	6025	299.33	302.41	320	Pass
79	6345	314.25	313.79	320	Pass
143	6665	301.39	310.48	320	Pass

**802.11be (EHT320) 2x996+484-tone MRU SP Client 2T2S**

Channel	Frequency (MHz)	26dB Bandwidth (MHz)		Maximum Limit (MHz)	Test Result
		Chain 0	Chain 1		
31	6105	461.65	461.88	320	Note
63	6265	488.96	498.98	320	Note

Note: Please refer to 99% OBW measurement test results for Wi-Fi 320 MHz BW mode.

**802.11be (EHT320) 3x996-tone MRU SP Client 2T2S**

Channel	Frequency (MHz)	26dB Bandwidth (MHz)		Maximum Limit (MHz)	Test Result
		Chain 0	Chain 1		
31	6105	483.57	472.95	320	Note
63	6265	638.05	556.23	320	Note

Note: Please refer to 99% OBW measurement test results for Wi-Fi 320 MHz BW mode.



### 802.11be (EHT320) 3x996+484-tone MRU SP Client 2T2S

Channel	Frequency (MHz)	26dB Bandwidth (MHz)		Maximum Limit (MHz)	Test Result
		Chain 0	Chain 1		
31	6105	616.58	613.88	320	Note
63	6265	675.73	675.44	320	Note

Note: Please refer to 99% OBW measurement test results for Wi-Fi 320 MHz BW mode.

#### Spectrum Plot of Maximum Value

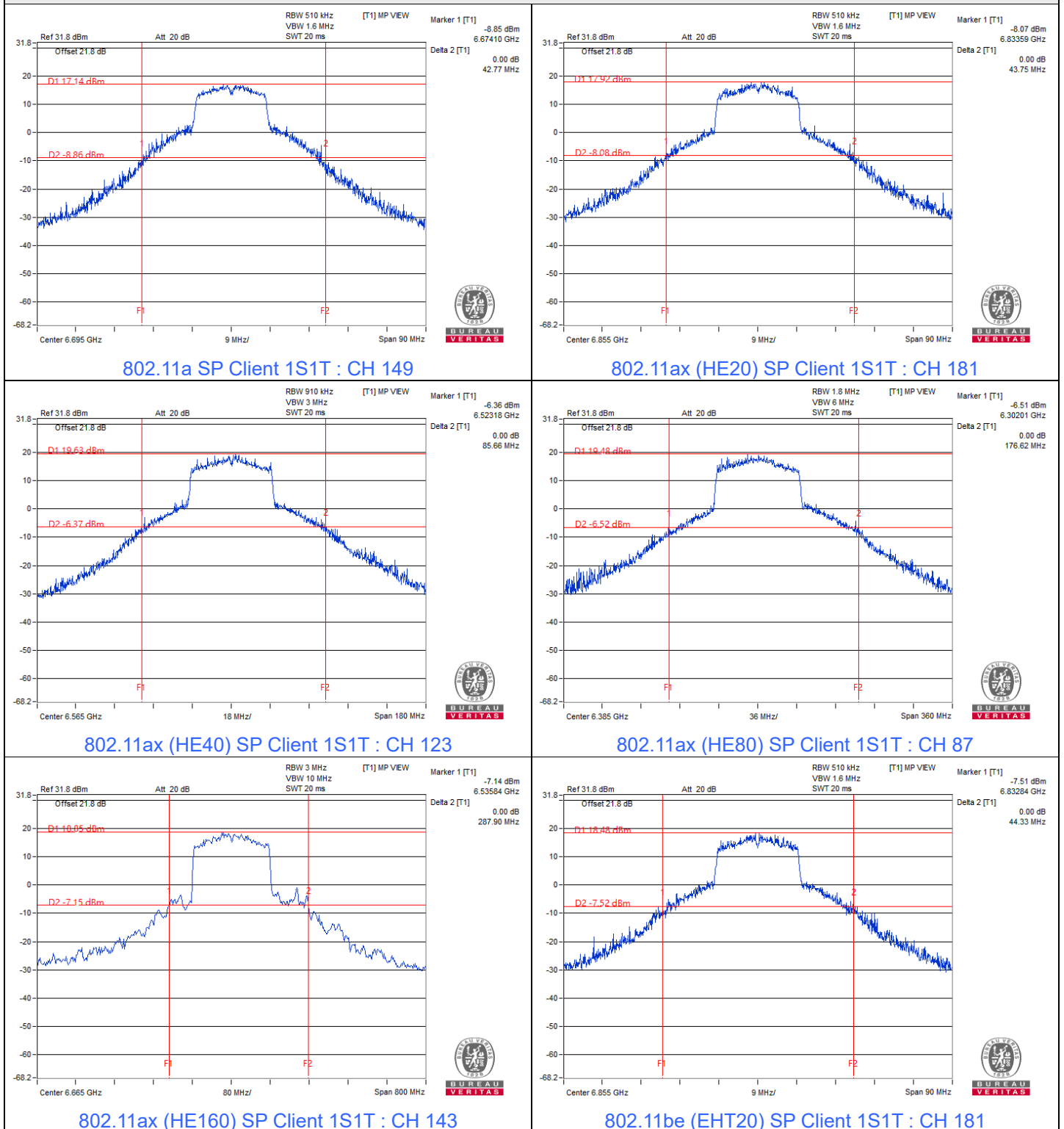

### Spectrum Plot of Maximum Value

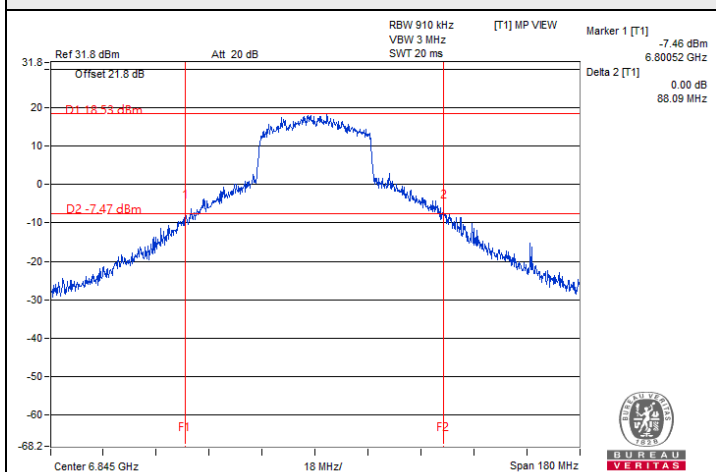

802.11be (EHT40) SP Client 1S1T : CH 179

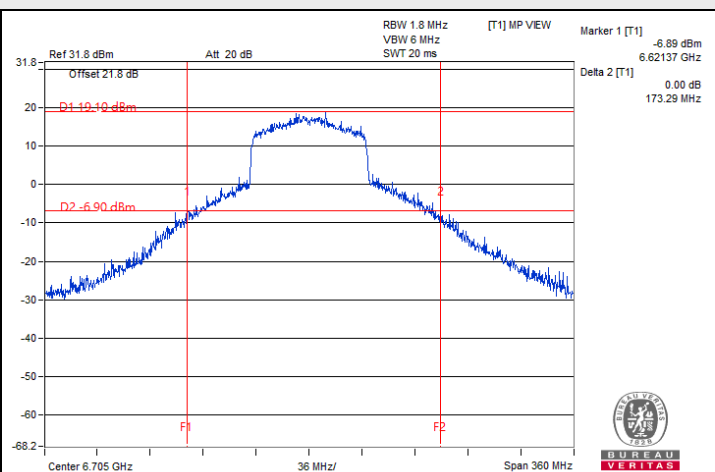

802.11be (EHT80) SP Client 1S1T : CH 151

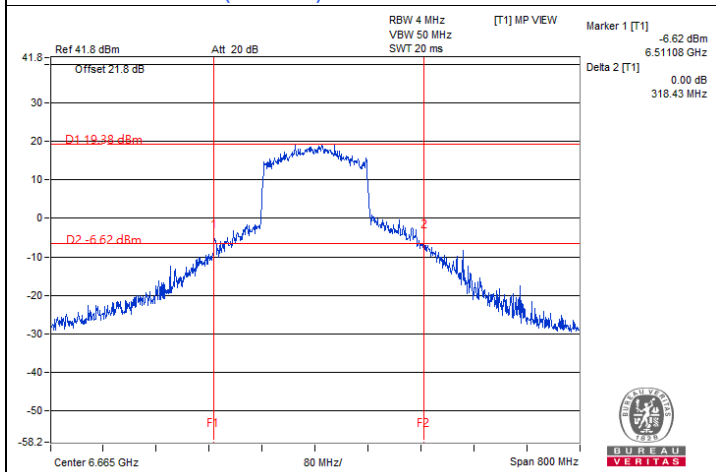

802.11be (EHT160) SP Client 1S1T : CH 143

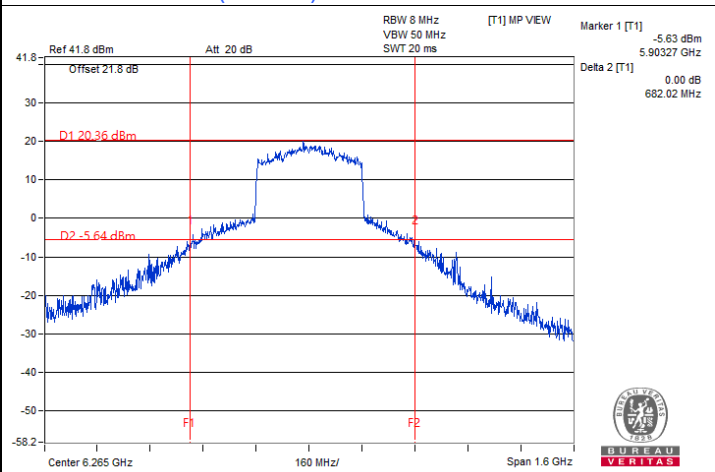

802.11be (EHT320) SP Client 1S1T : CH 63

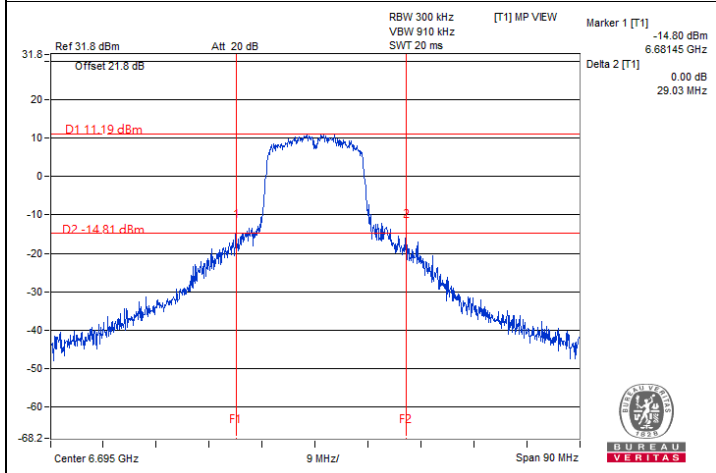

802.11a SP Client 2S2T / Chain 0 : CH 149

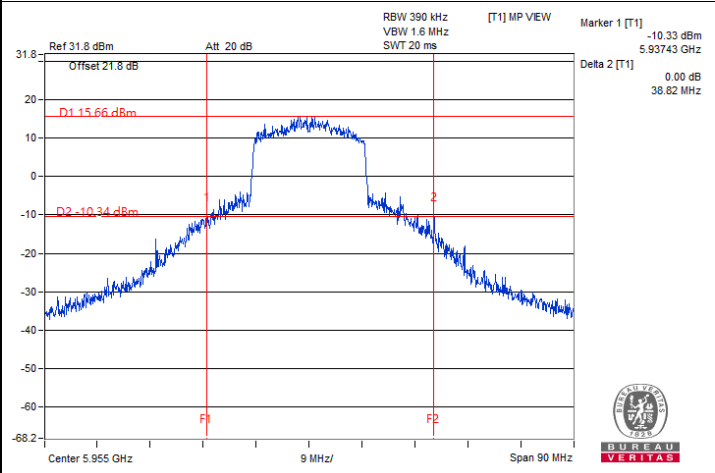

802.11ax (HE20) SP Client 2S2T / Chain 1 : CH 1



### Spectrum Plot of Maximum Value

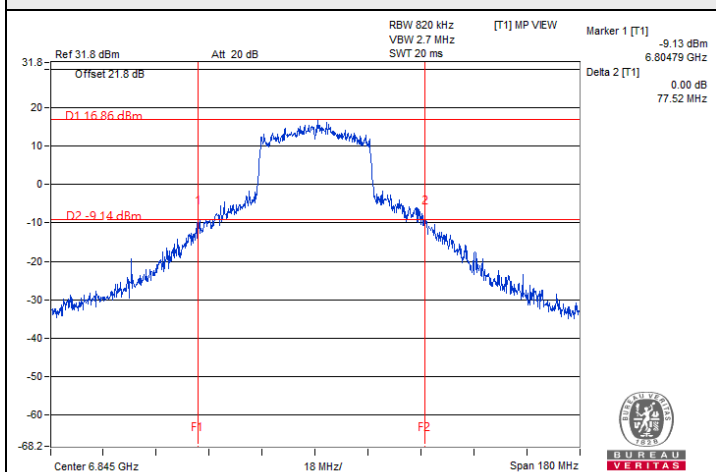

802.11ax (HE40) SP Client 2S2T / Chain 0 : CH 179

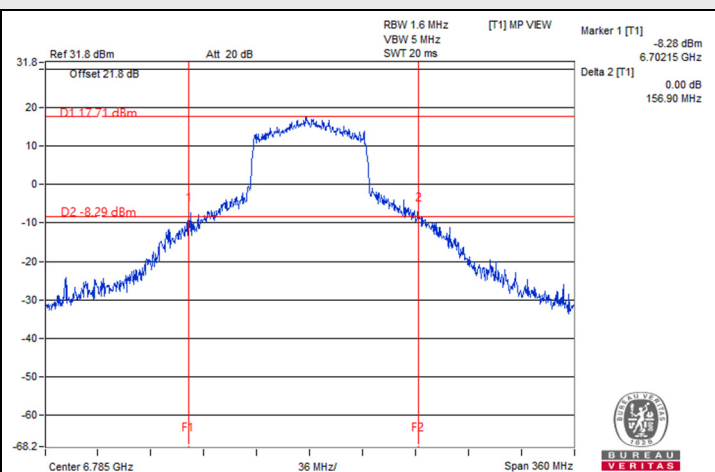

802.11ax (HE80) SP Client 2S2T / Chain 0 : CH 167

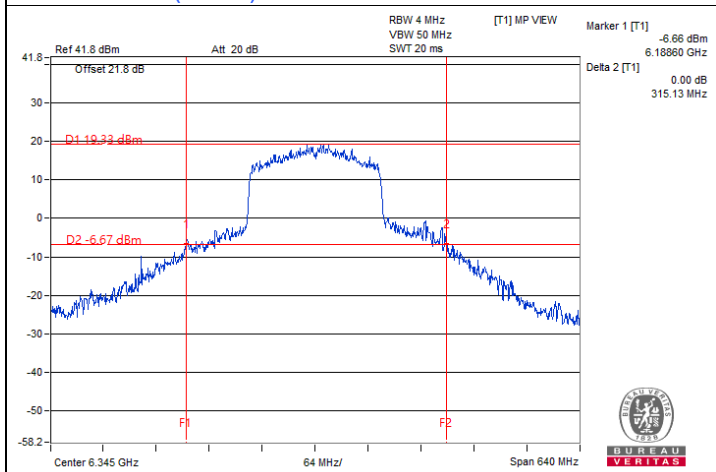

802.11ax (HE160) SP Client 2S2T / Chain 1 : CH 79

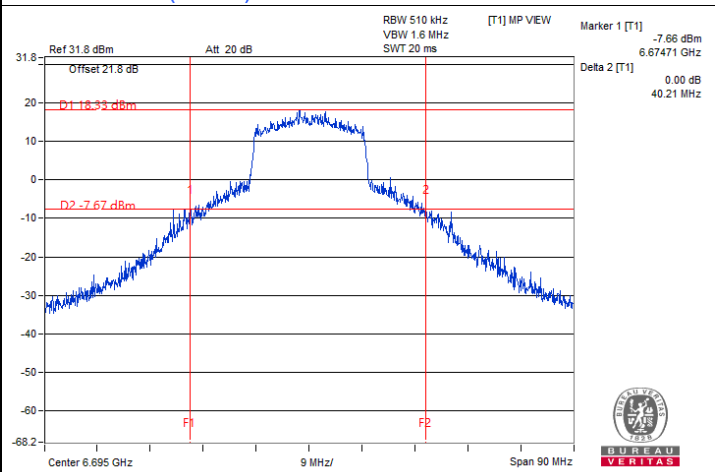

802.11be (EHT20) SP Client 2S2T / Chain 0 : CH 149

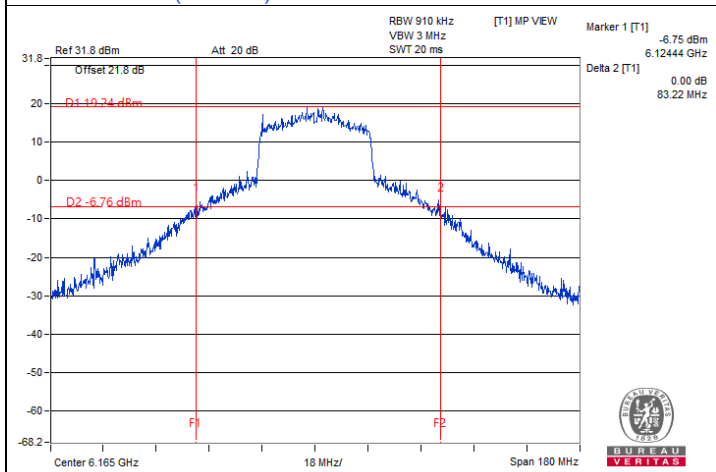

802.11be (EHT40) SP Client 2S2T / Chain 1 : CH 43

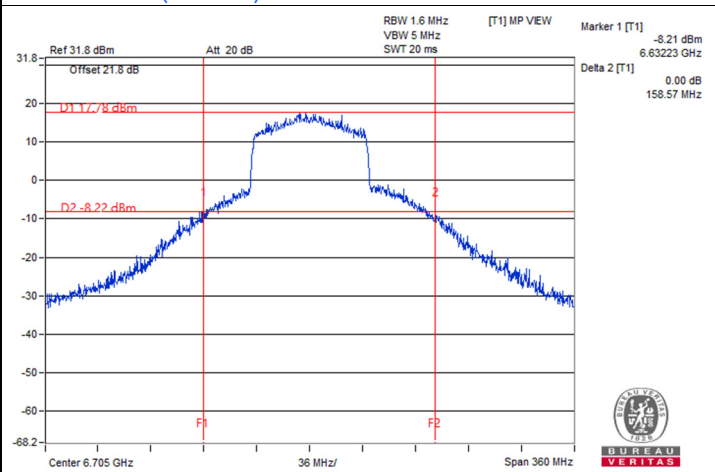

802.11be (EHT80) SP Client 2S2T / Chain 0 : CH 151



### Spectrum Plot of Maximum Value

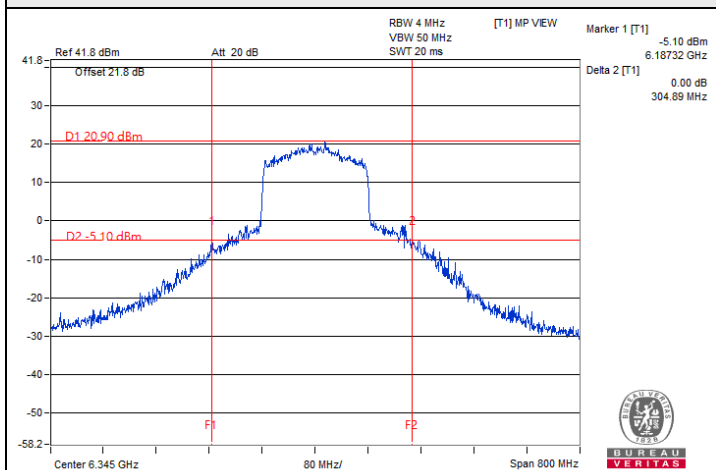

802.11be (EHT160) SP Client 2S2T / Chain 1 : CH 79

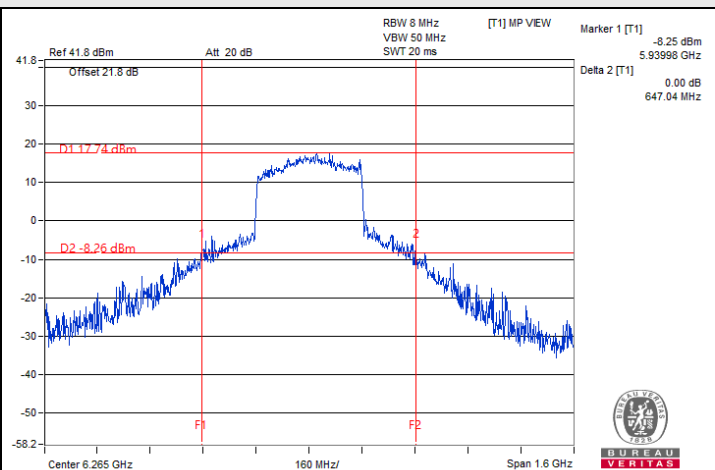

802.11be (EHT320) SP Client 2S2T / Chain 1 : CH 63

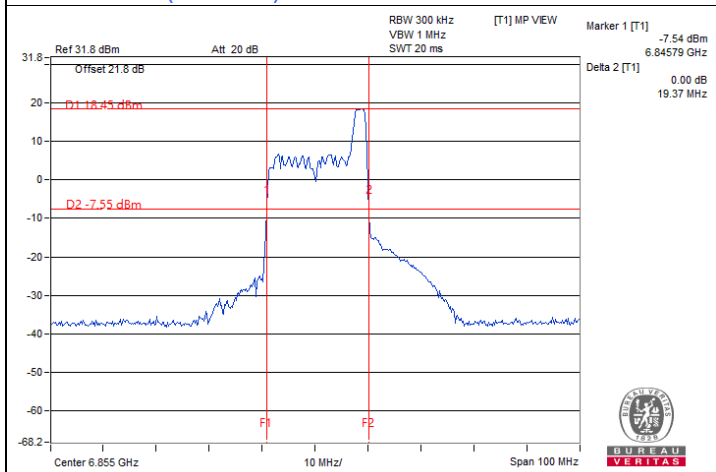

802.11ax (HE) 26-tone RU SP Client\_1T1S : CH 181@8

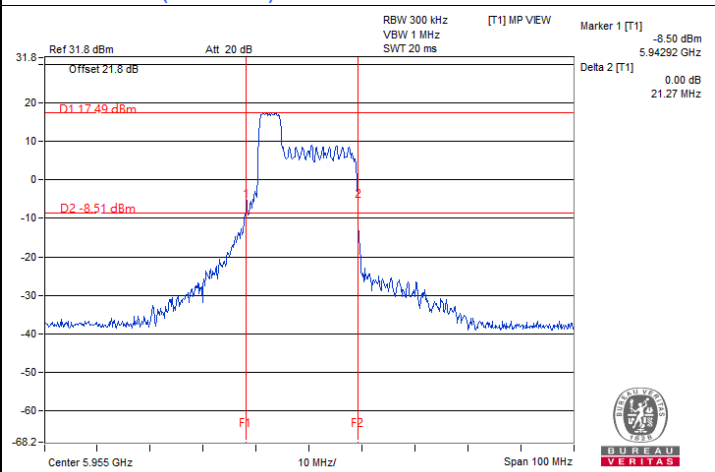

802.11ax (HE) 52-tone RU SP Client\_1T1S : CH 1@37

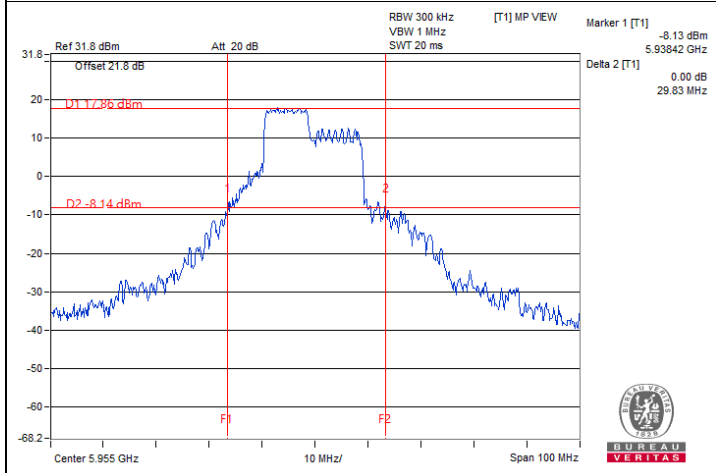

802.11ax (HE) 106-tone RU SP Client\_1T1S : CH 1@53

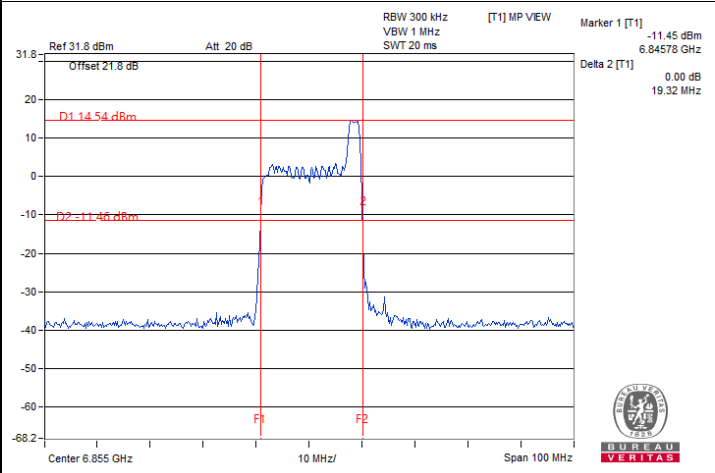

802.11ax (HE) 26-tone RU SP Client\_2T2S / Chain 0 : CH 181@8



### Spectrum Plot of Maximum Value

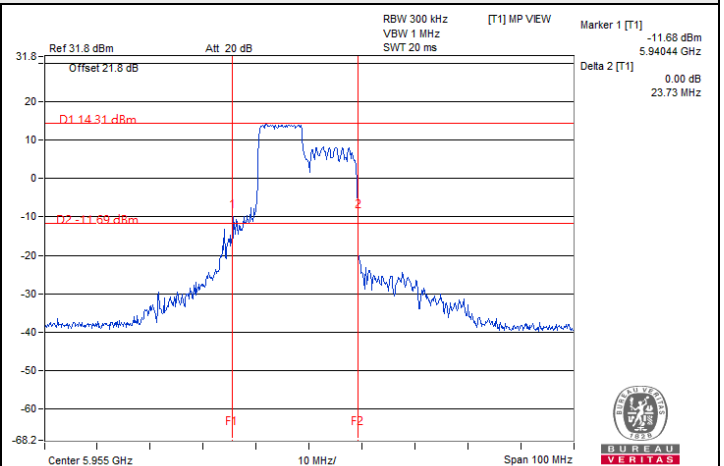
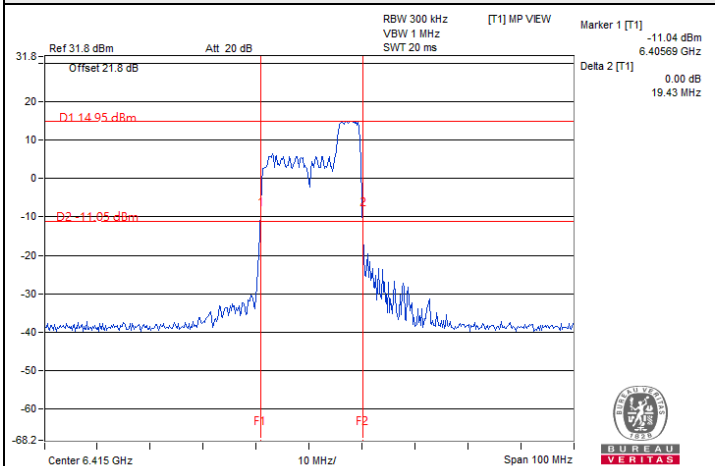

802.11ax (HE) 52-tone RU SP Client\_2T2S / Chain 0 : CH 93@40

802.11ax (HE) 106-tone RU SP Client\_2T2S / Chain 0 : CH 1@53

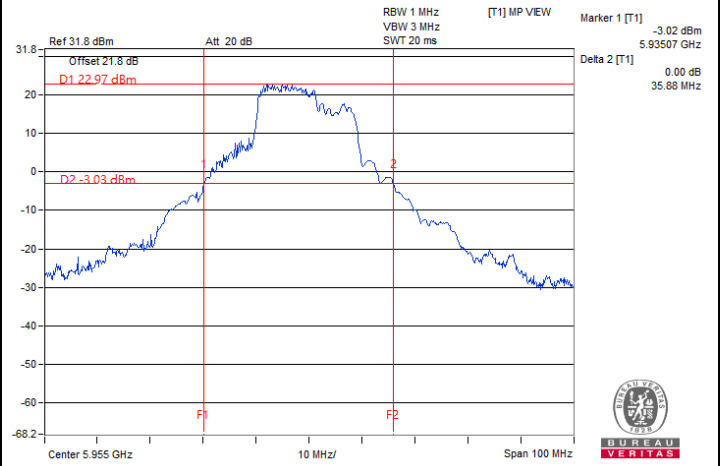
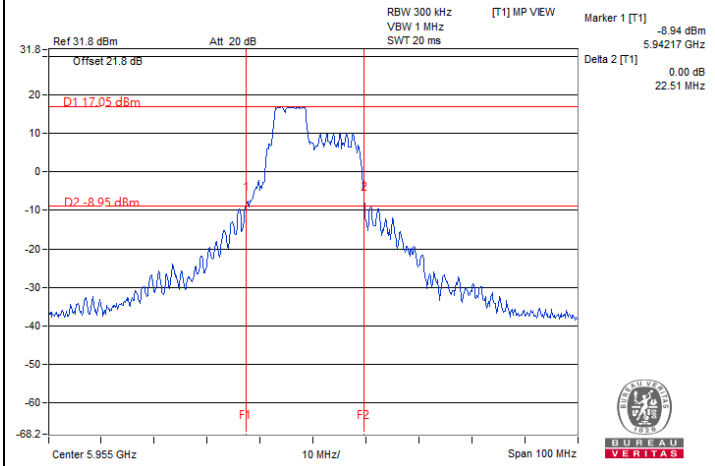

802.11be (EHT20) 52+26-tone MRU SP Client\_1T1S : CH 1@70

802.11be (EHT20) 106+26-tone MRU SP Client\_1T1S : CH 1@82

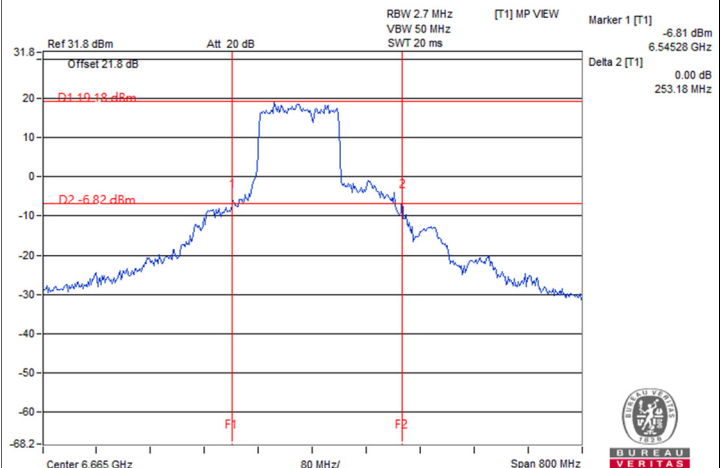
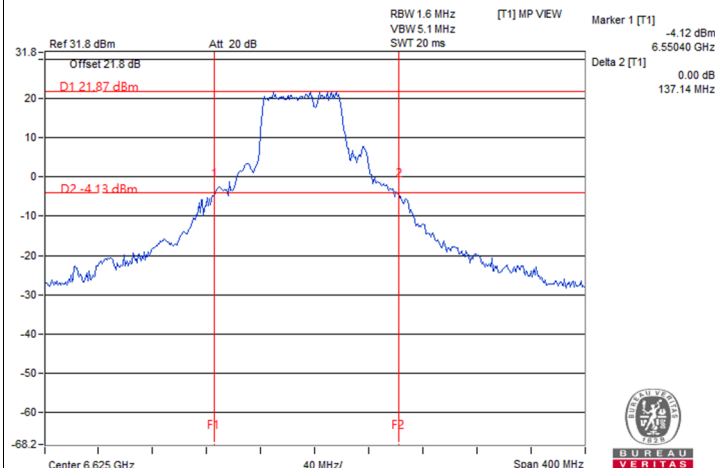

802.11be (EHT80) 484+242-tone MRU SP Client\_1T1S : CH 135@90

802.11be (EHT160) 996+484-tone MRU SP Client\_1T1S : CH 143@94\_0



### Spectrum Plot of Maximum Value

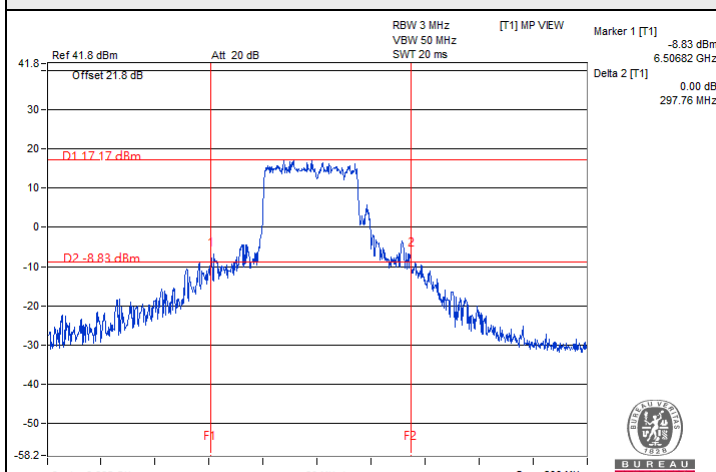

802.11be (EHT160) 996+484+242-tone MRU SP Client\_1T1S : CH 143@96\_0

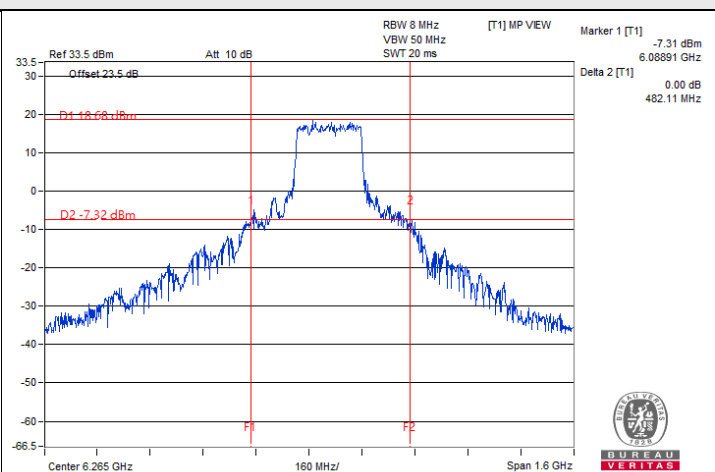

802.11be (EHT320) 2x996+484-tone MRU SP Client 1T1S : CH 63@102\_0/1

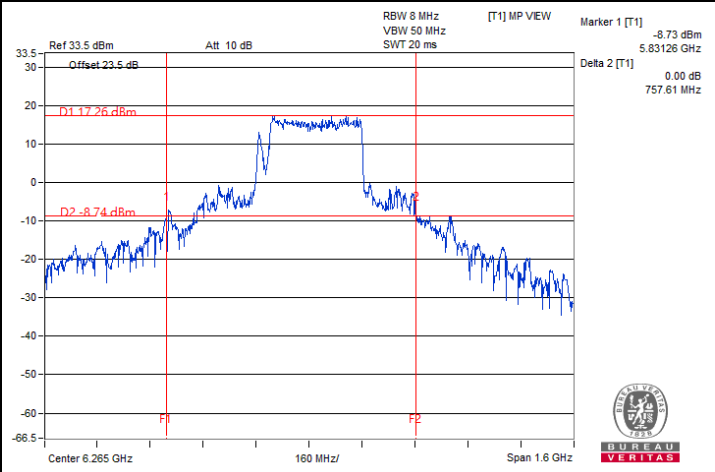
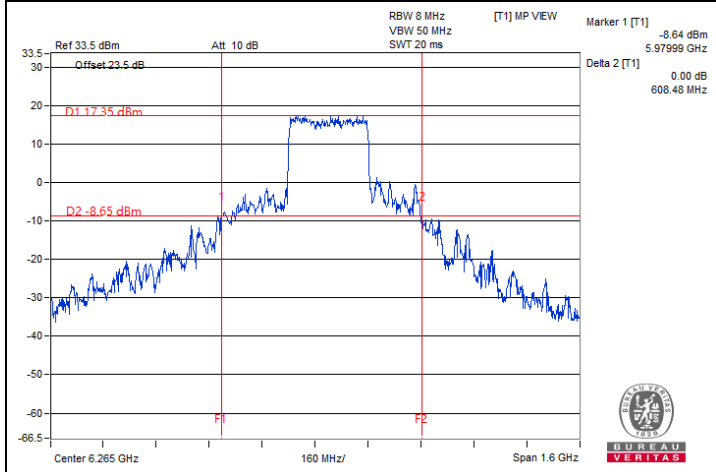

802.11be (EHT320) 3x996-tone MRU SP Client 1T1S : CH 63@104\_0/0

802.11be (EHT320) 3x996+484-tone MRU SP Client 1T1S : CH 63@105\_0/0

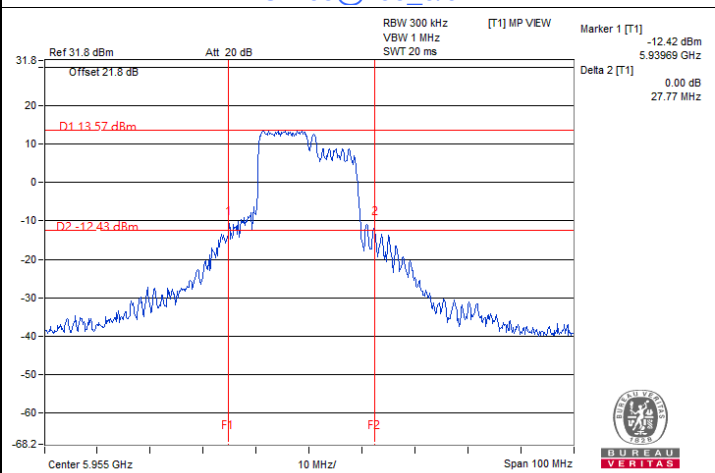
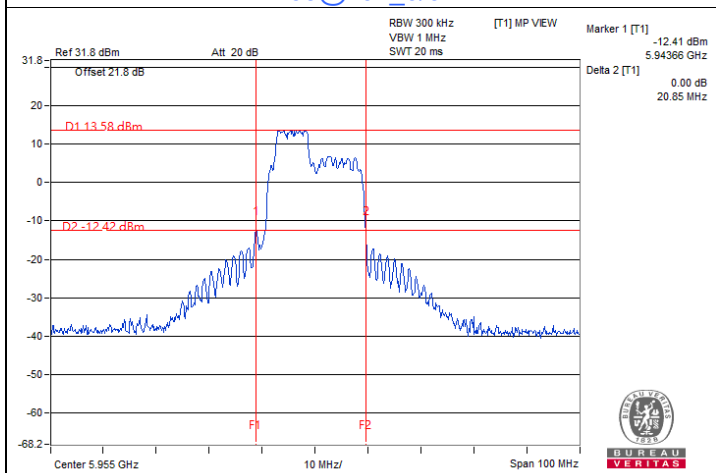

802.11be (EHT20) 52+26-tone MRU SP Client\_2T2S / Chain 0 : CH 1@70

802.11be (EHT20) 106+26-tone MRU SP Client\_2T2S / Chain 0 : CH 1@82





### Spectrum Plot of Maximum Value

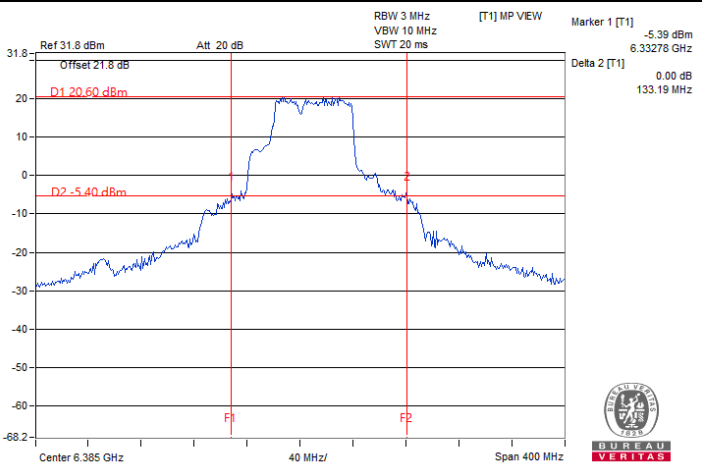

802.11be (EHT80) 484+242-tone MRU SP Client\_2T2S / Chain 0 : CH 87@90

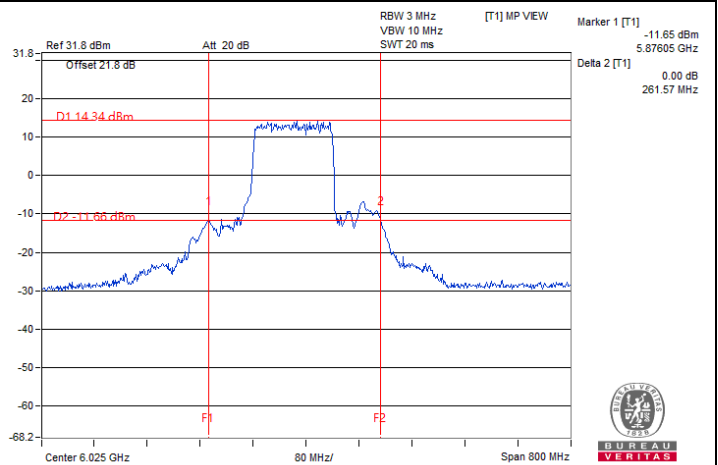

802.11be (EHT160) 996+484-tone MRU SP Client\_2T2S / Chain 0 : CH 15@95\_1

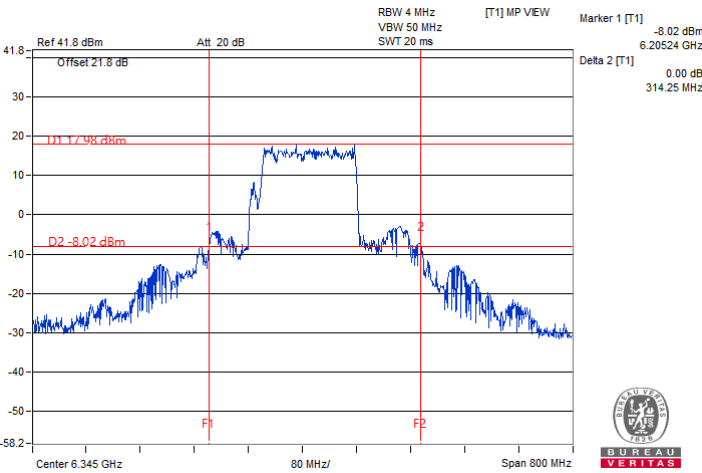

802.11be (EHT160) 996+484+242-tone MRU SP Client\_2T2S / Chain 0 : CH 79@96\_0

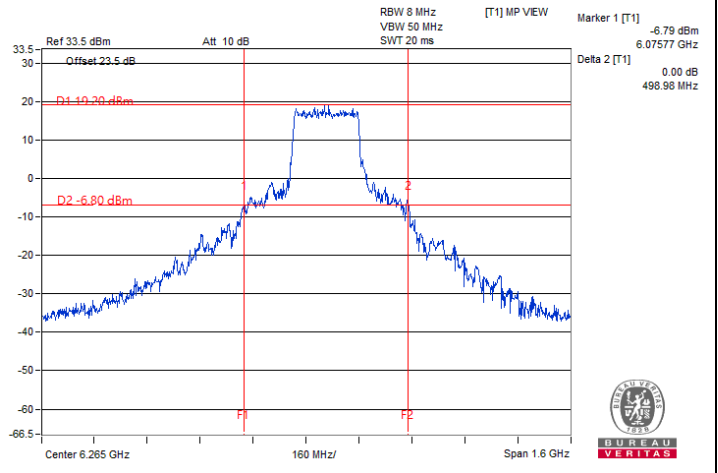

802.11be (EHT320) 2x996+484-tone MRU SP Client 2T2S / Chain 1 : CH 63@102\_0\_1

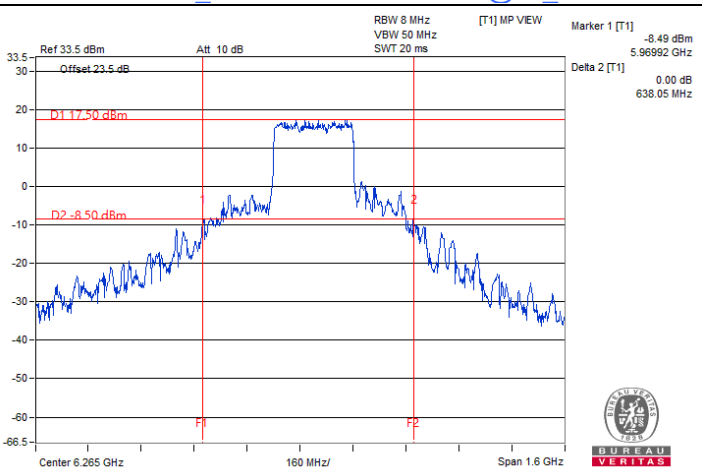

802.11be (EHT320) 3x996-tone MRU SP Client 2T2S / Chain 0 : CH 63@104\_0\_0

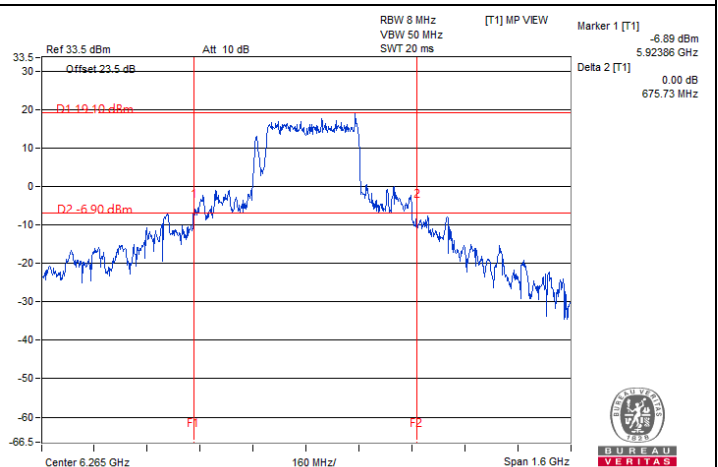

802.11be (EHT320) 3x996+484-tone MRU SP Client 2T2S / Chain 0 : CH 63@105\_0\_0

### 7.4 In-Band Emission Mask

Input Power:	120 Vac, 60 Hz	Environmental Conditions:	24°C, 66% RH	Tested By:	Eric Peng
--------------	----------------	---------------------------	--------------	------------	-----------

#### 802.11a SP Client 1S1T

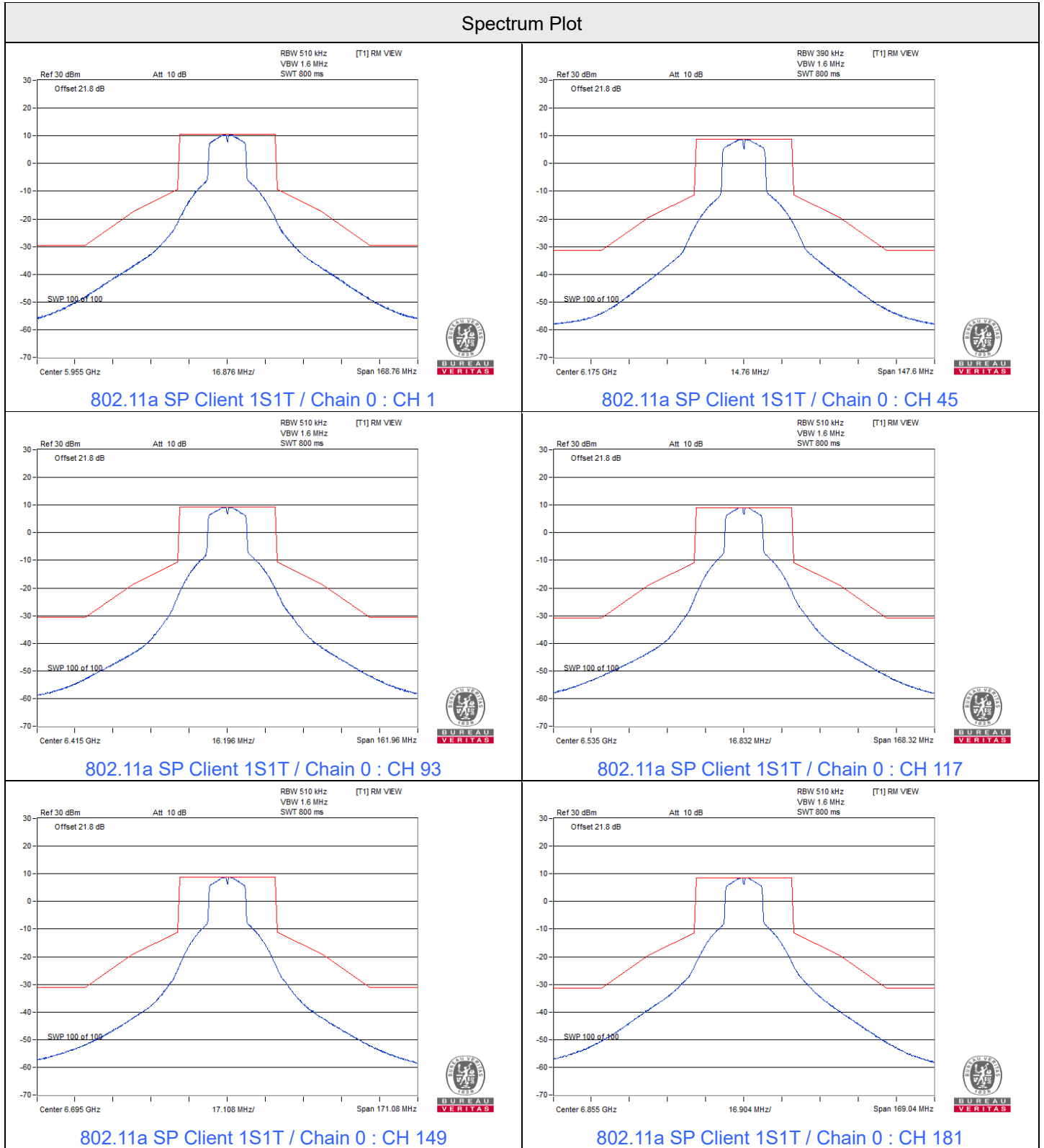



### 802.11ax (HE20) SP Client 1S1T

#### Spectrum Plot

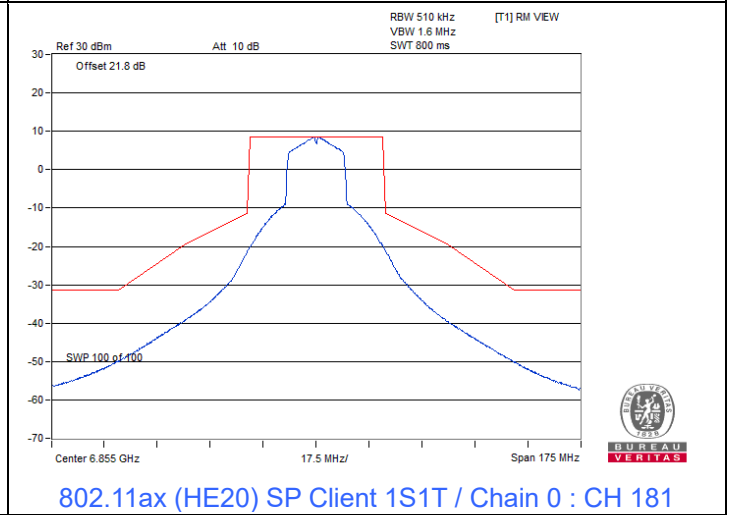
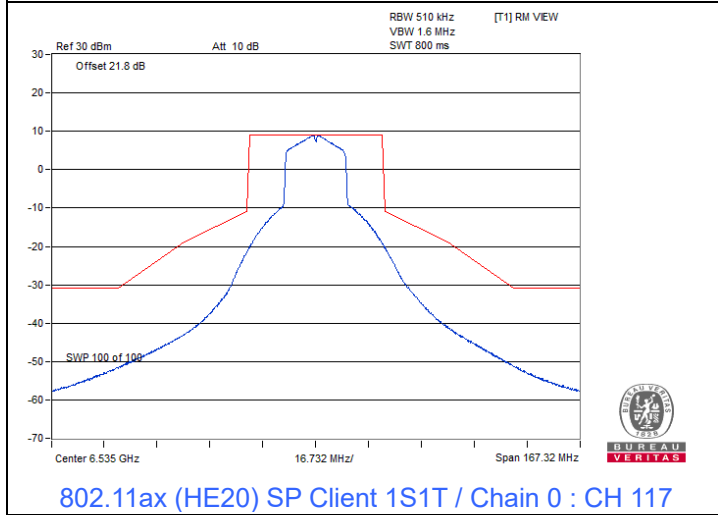
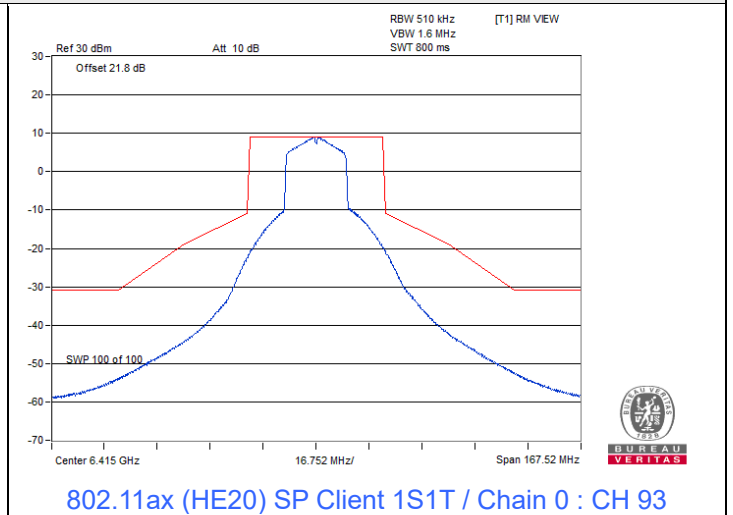
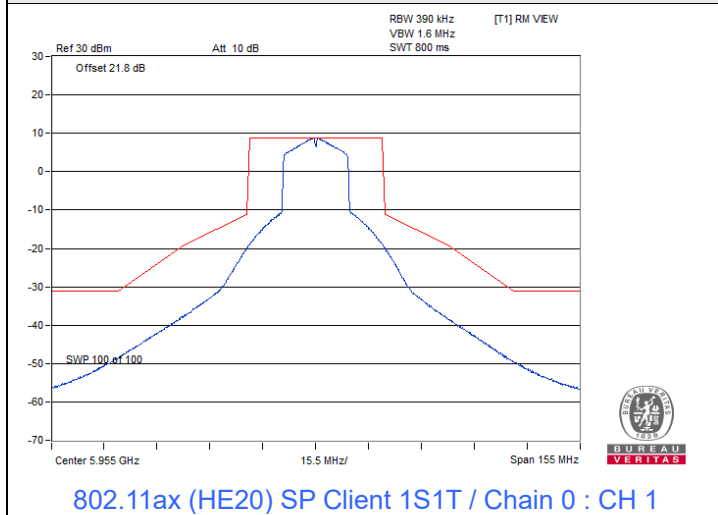

802.11ax (HE40) SP Client 1S1T

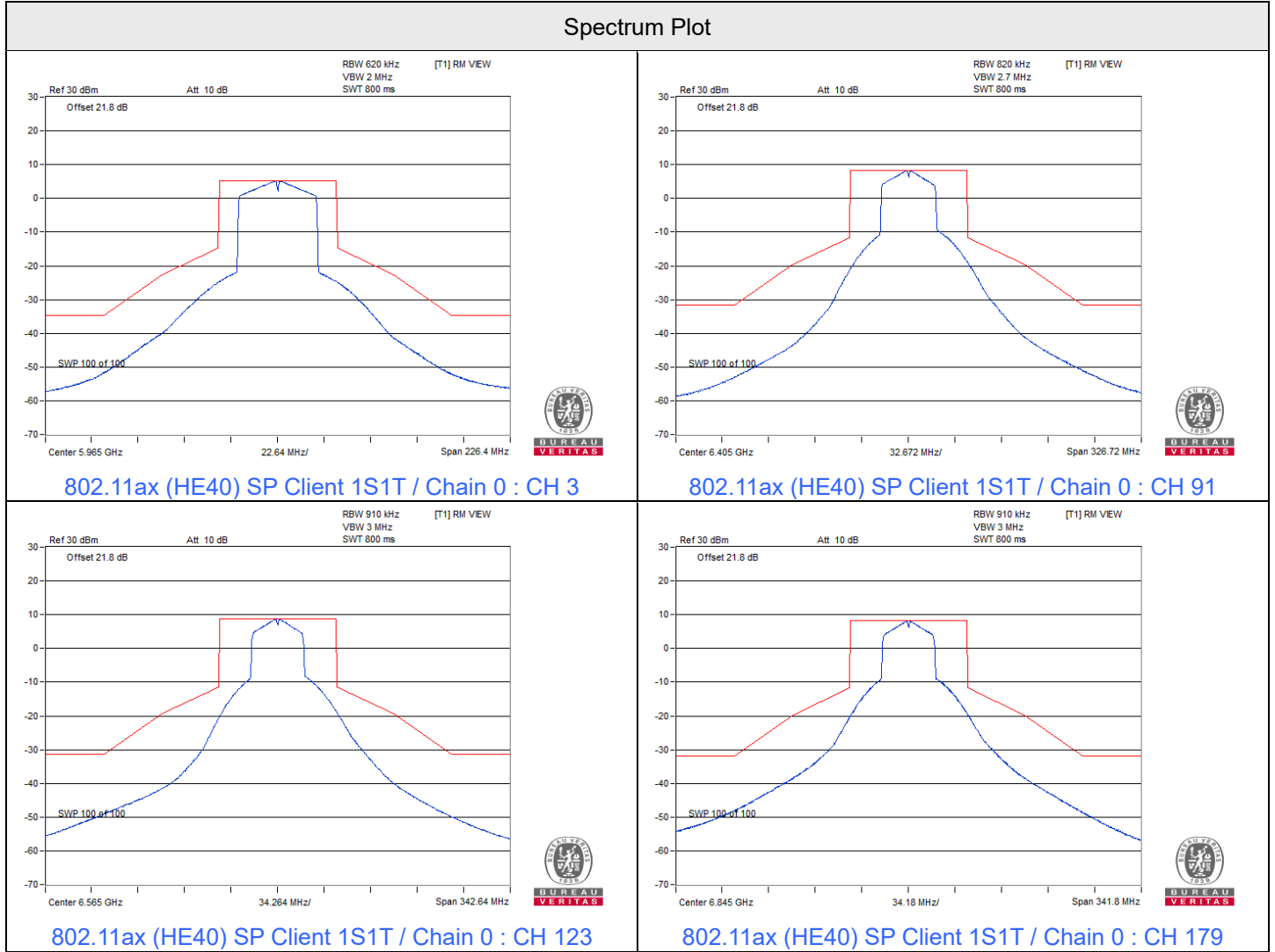



### 802.11ax (HE80) SP Client 1S1T

#### Spectrum Plot

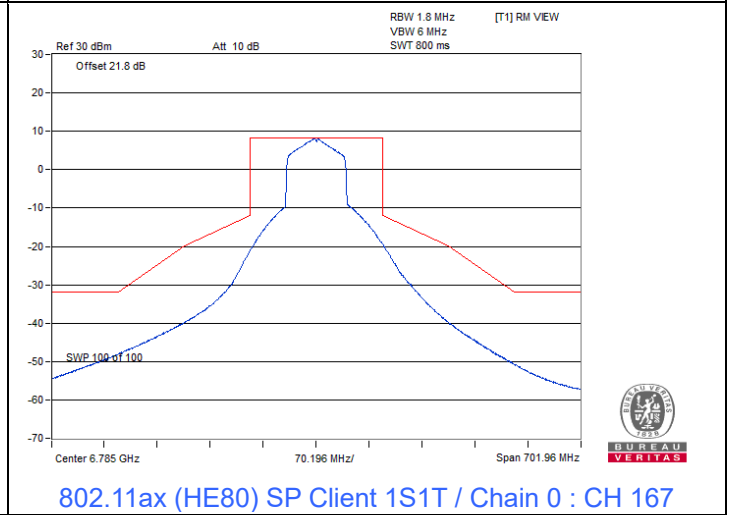
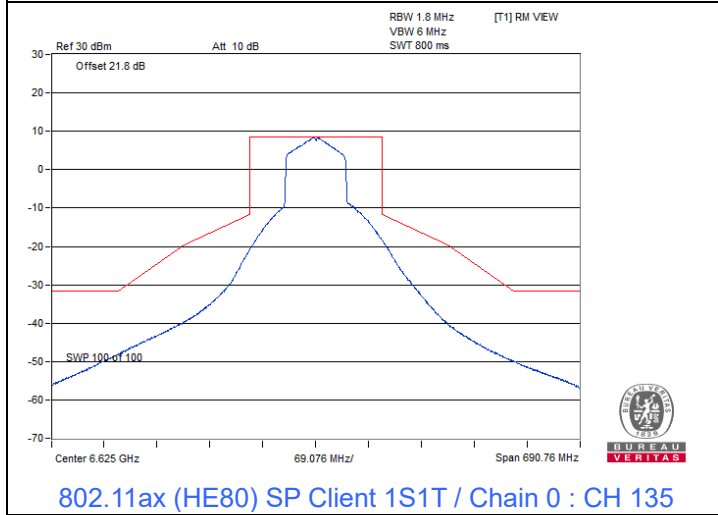
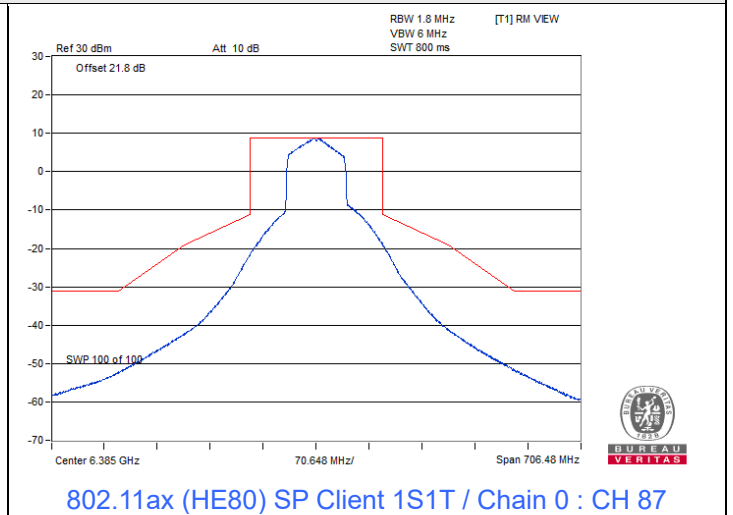
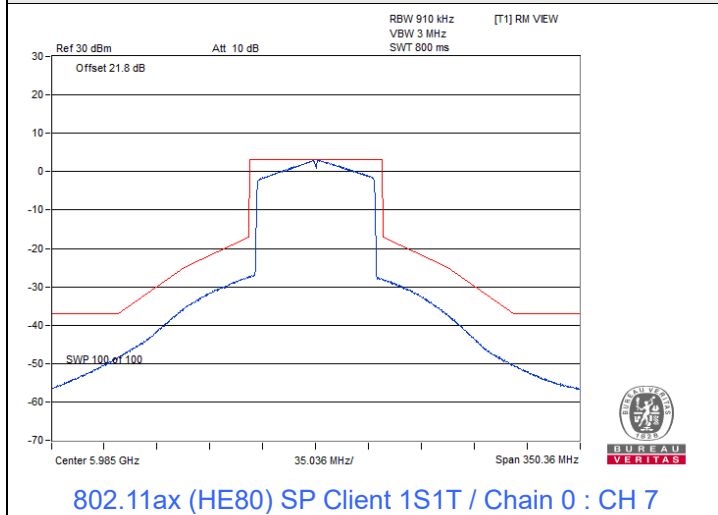

802.11ax (HE160) SP Client 1S1T

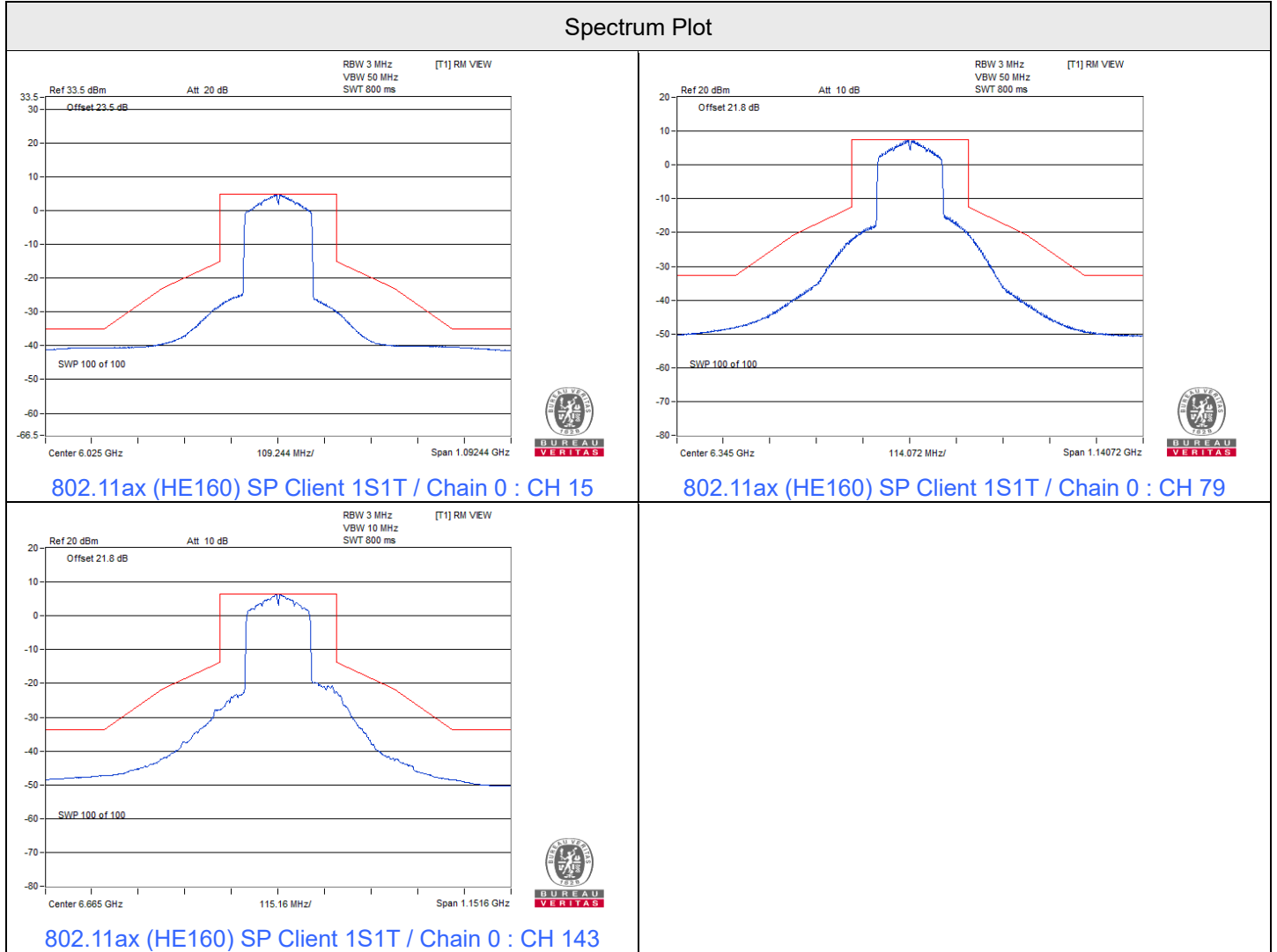

802.11be (EHT20) SP Client 1S1T

Spectrum Plot

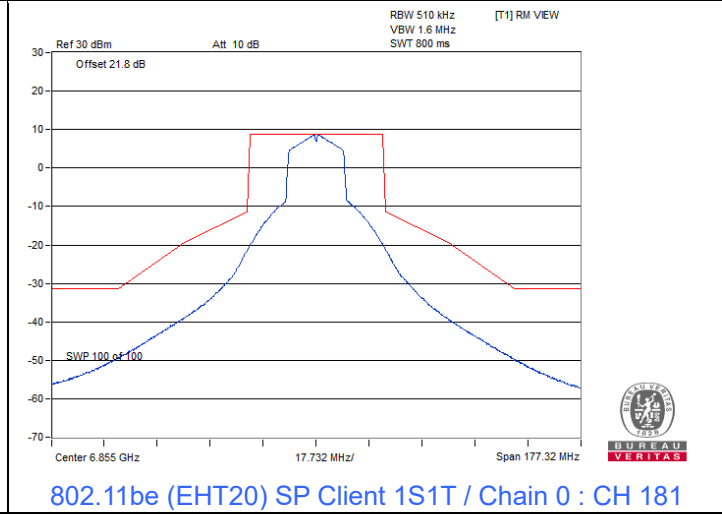
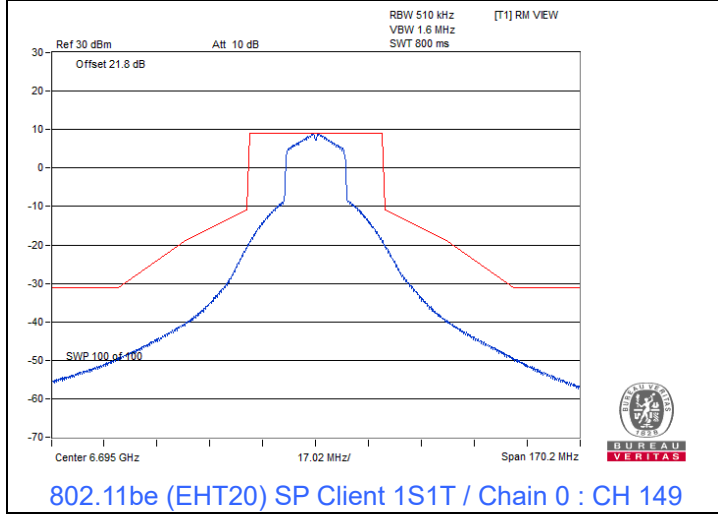
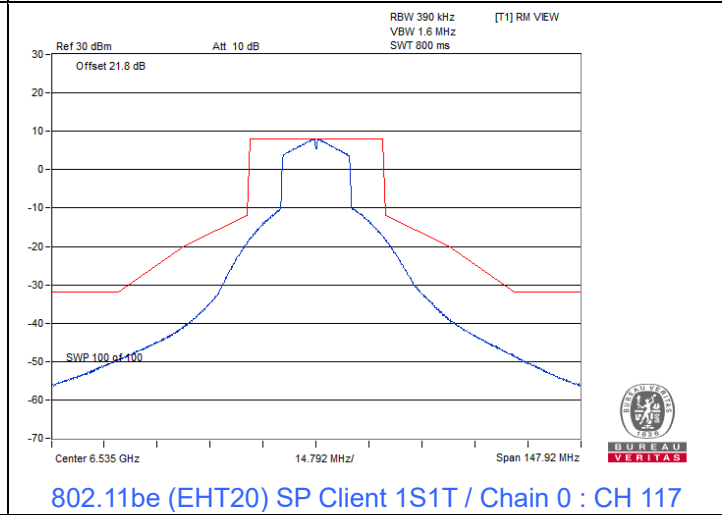
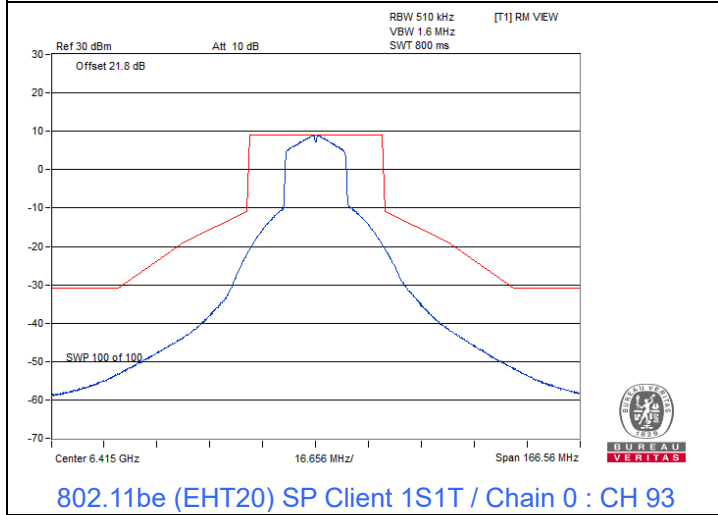
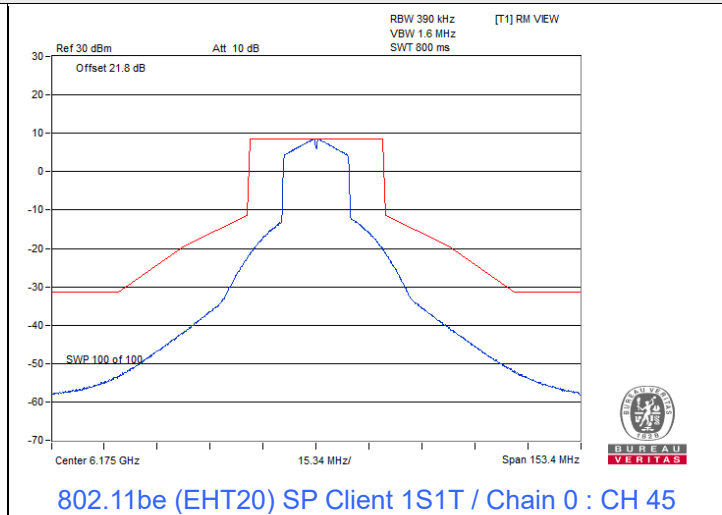
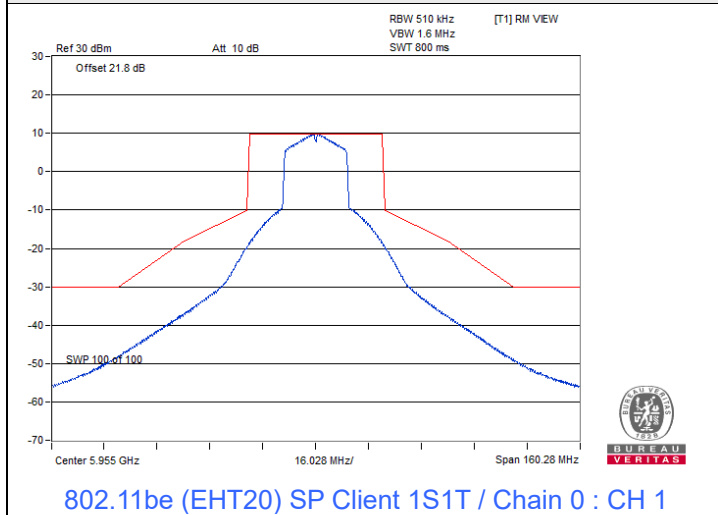

802.11be (EHT40) SP Client 1S1T

Spectrum Plot

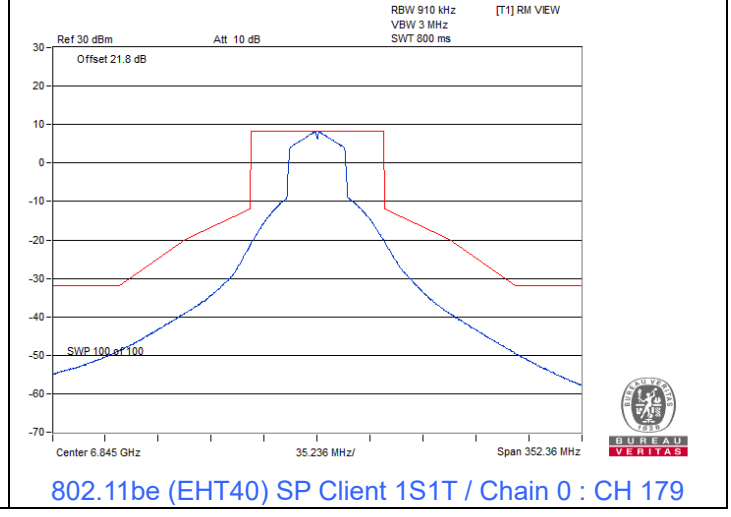
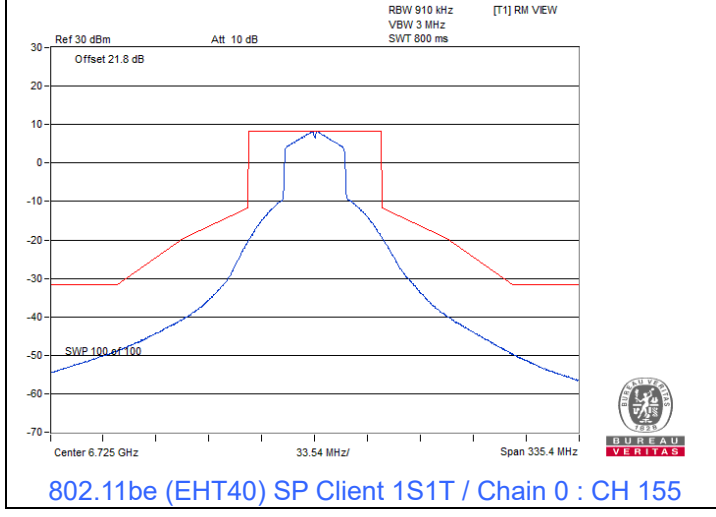
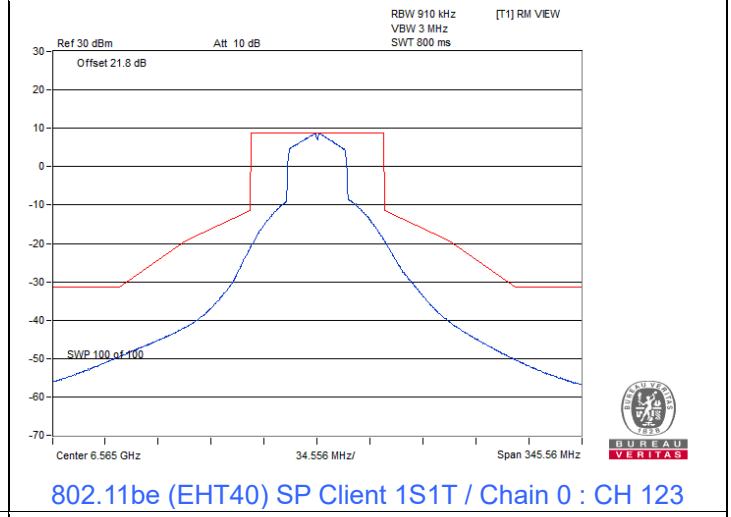
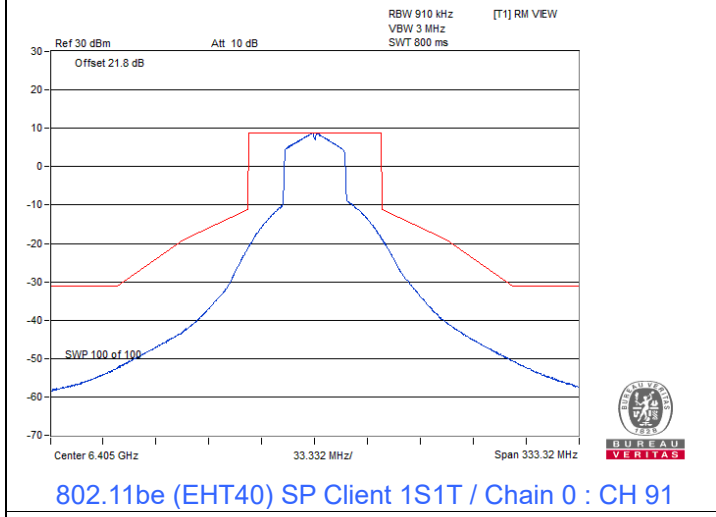
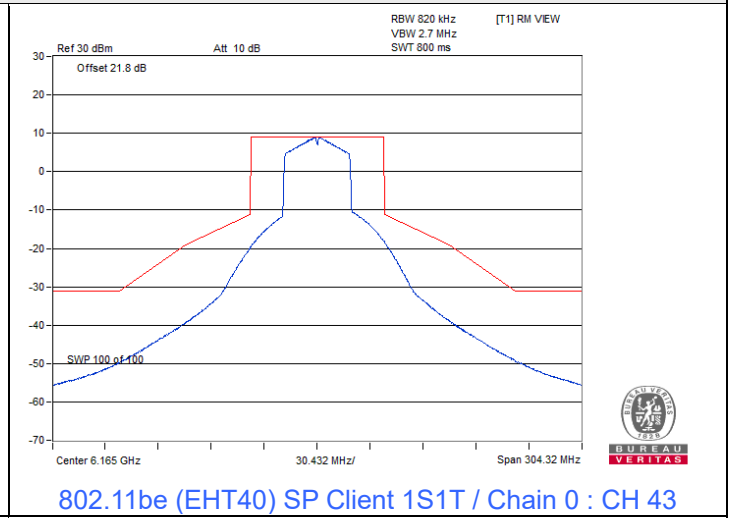
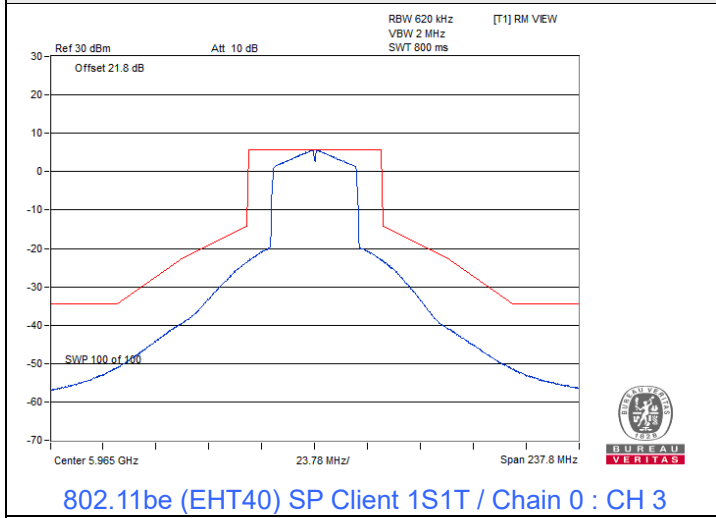



802.11be (EHT80) SP Client 1S1T

Spectrum Plot

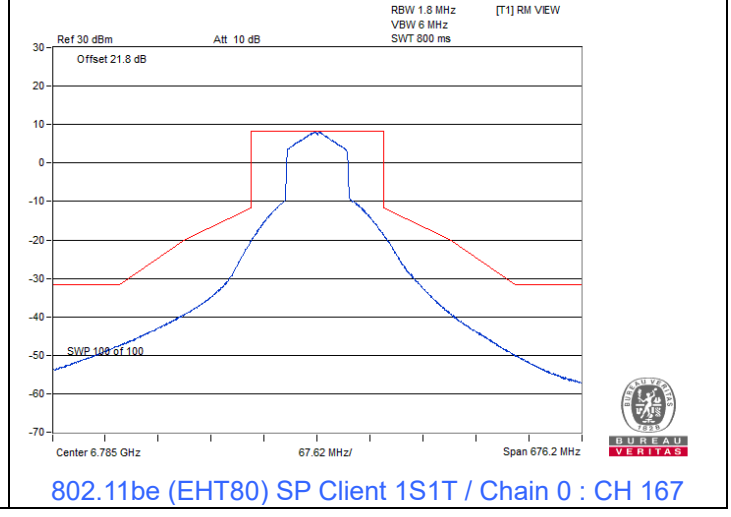
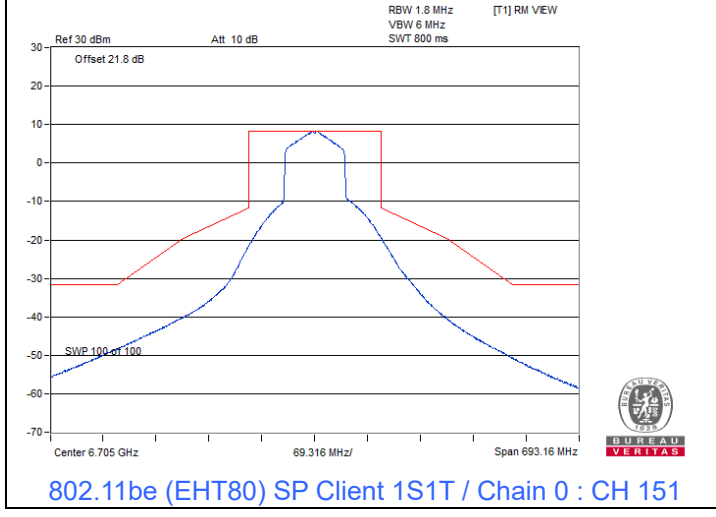
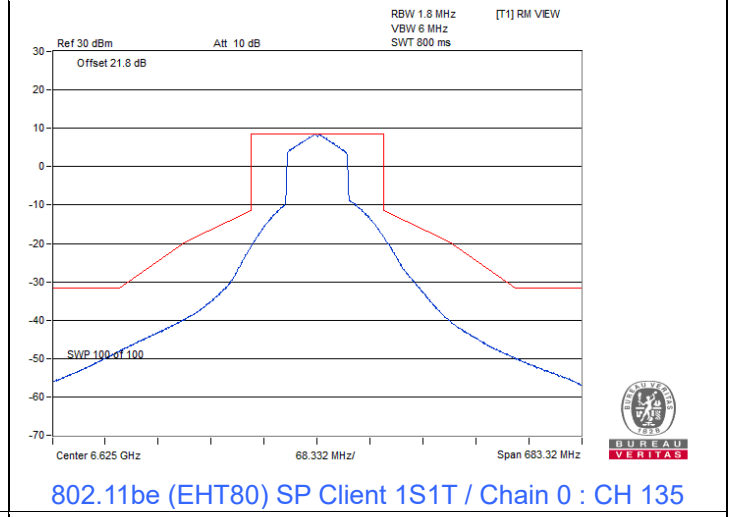
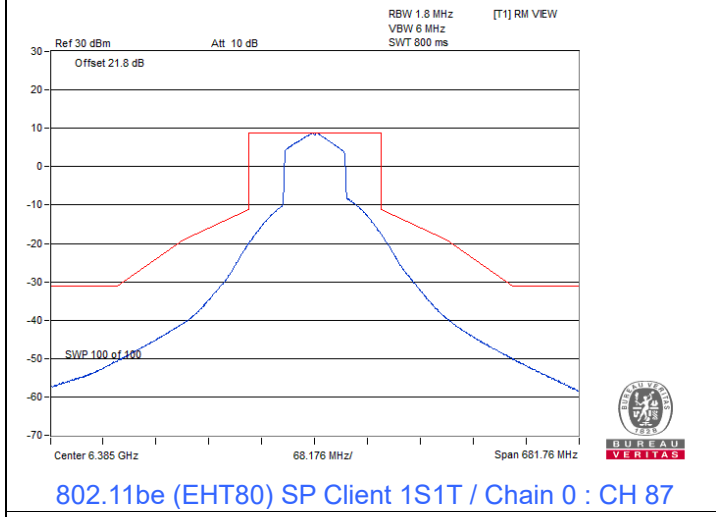
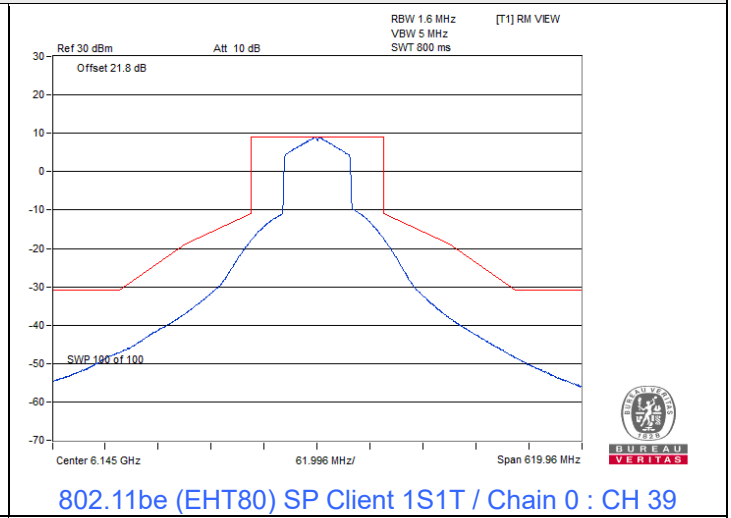
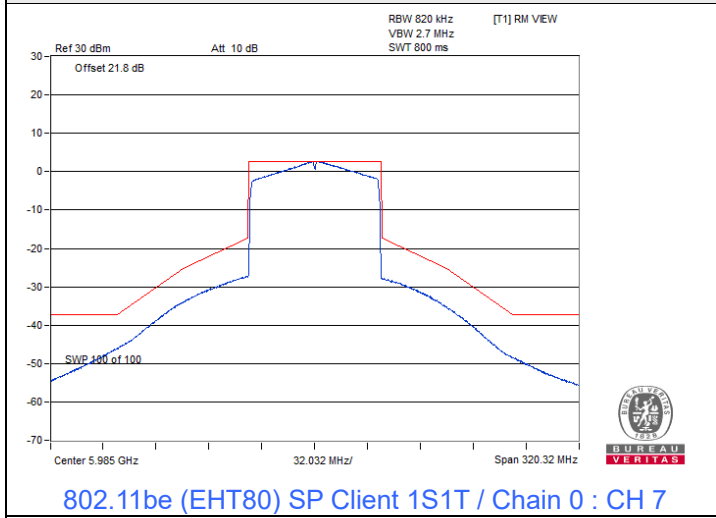

802.11be (EHT160) SP Client 1S1T

Spectrum Plot

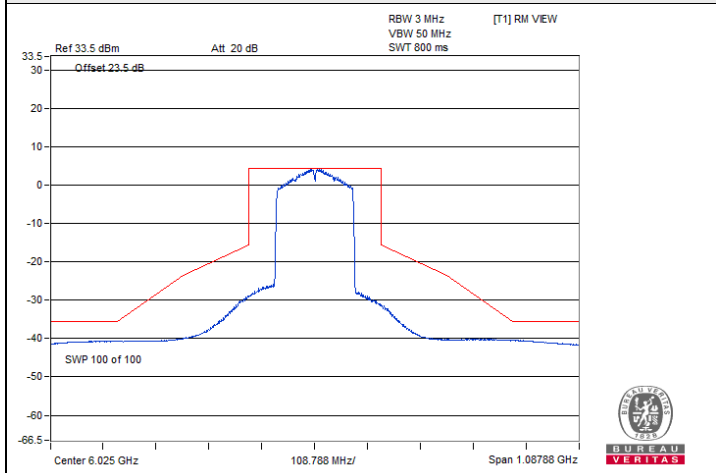

802.11be (EHT160) SP Client 1S1T / Chain 0 : CH 15

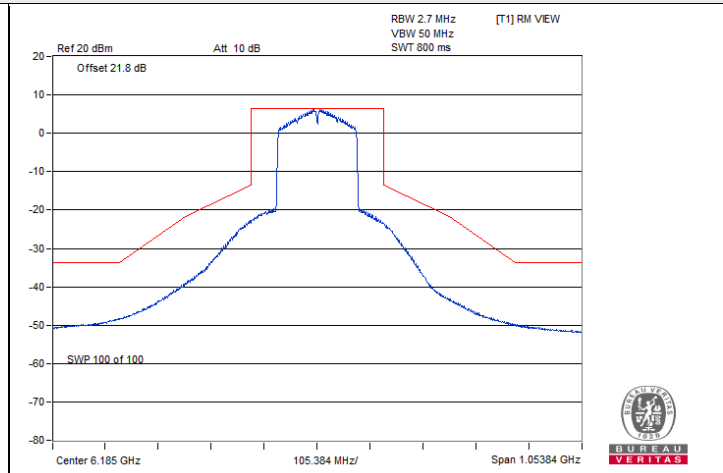

802.11be (EHT160) SP Client 1S1T / Chain 0 : CH 47

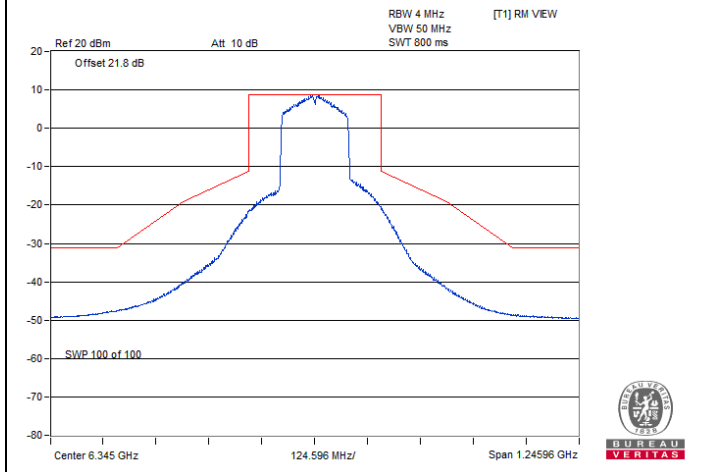

802.11be (EHT160) SP Client 1S1T / Chain 0 : CH 79

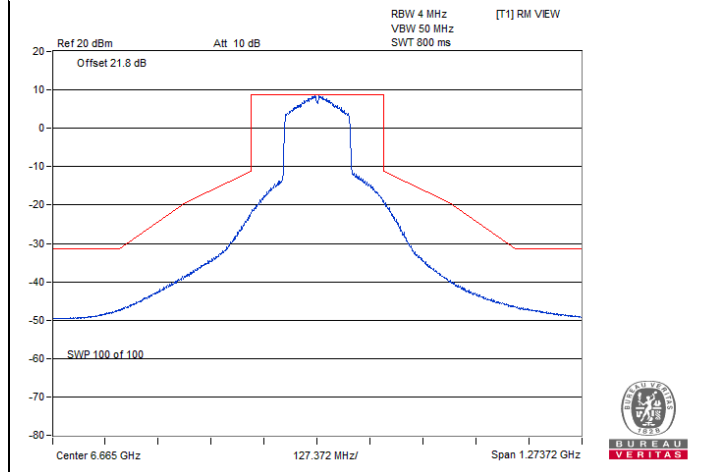

802.11be (EHT160) SP Client 1S1T / Chain 0 : CH 143

802.11be (EHT320) SP Client 1S1T

Spectrum Plot

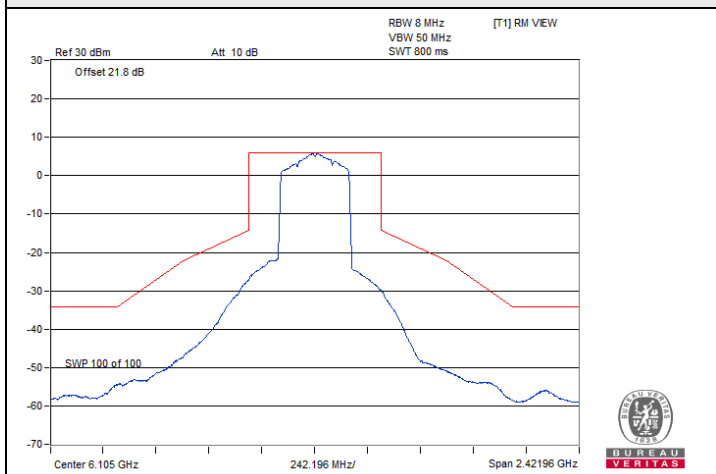

802.11be (EHT320) SP Client 1S1T / Chain 0 : CH 31

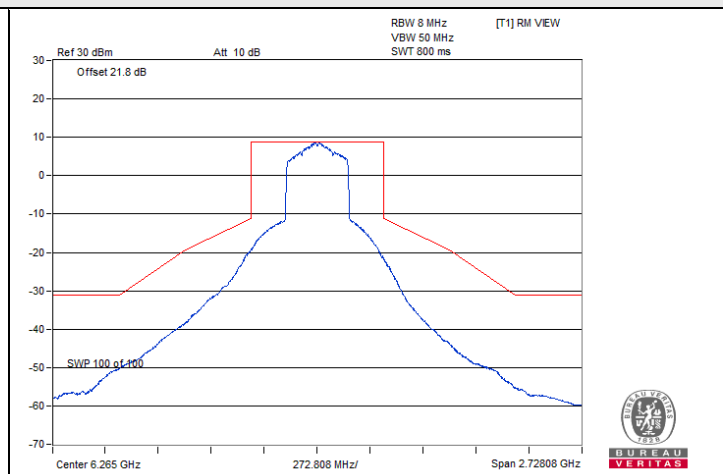

802.11be (EHT320) SP Client 1S1T / Chain 0 : CH 63



### 802.11ax (HE) 26-tone RU SP Client\_1T1S

#### Spectrum Plot

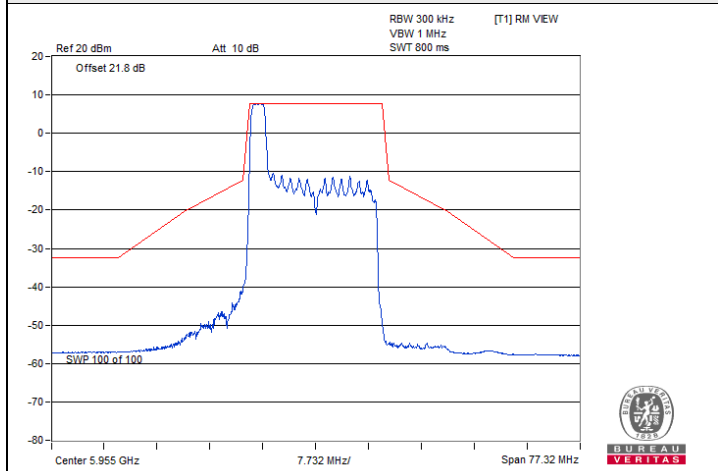

802.11ax (HE) 26-tone RU SP Client\_1T1S : CH 1@0

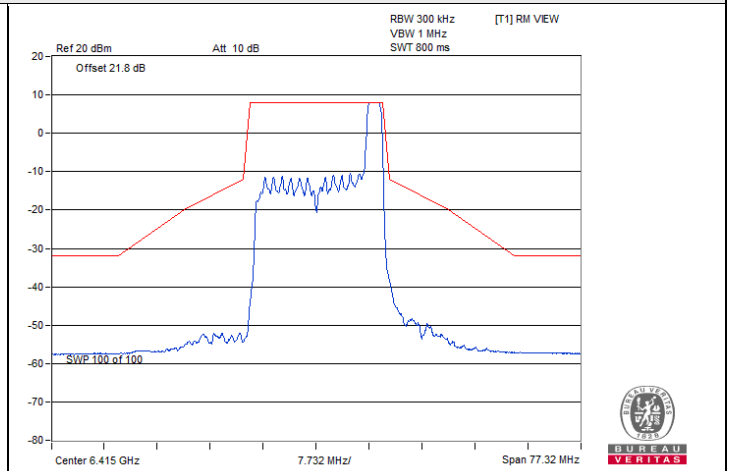

802.11ax (HE) 26-tone RU SP Client\_1T1S : CH 93@8

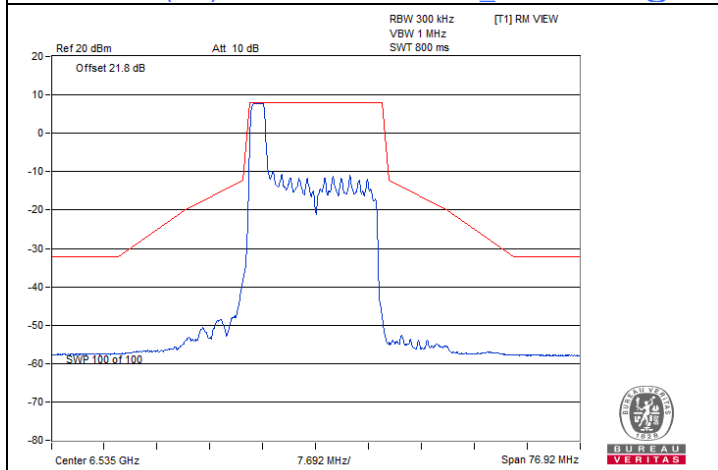

802.11ax (HE) 26-tone RU SP Client\_1T1S : CH 117@0

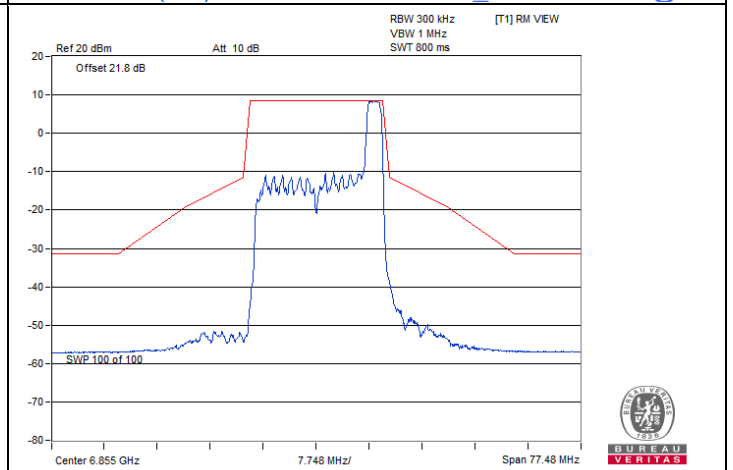

802.11ax (HE) 26-tone RU SP Client\_1T1S : CH 181@8

### 802.11ax (HE) 52-tone RU SP Client\_1T1S

#### Spectrum Plot

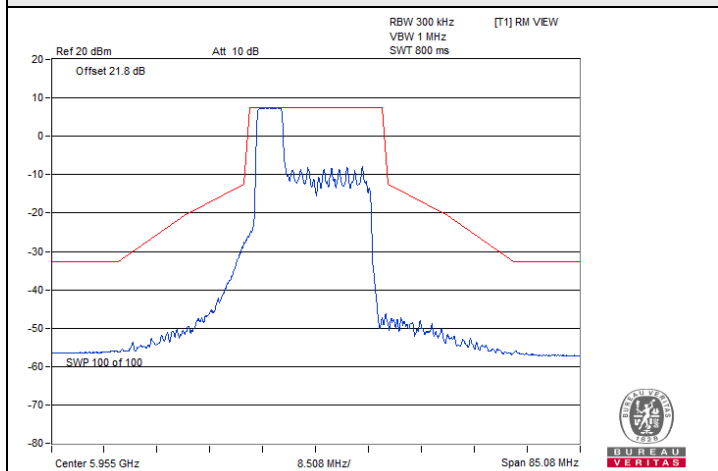

802.11ax (HE) 52-tone RU SP Client\_1T1S : CH 1@37

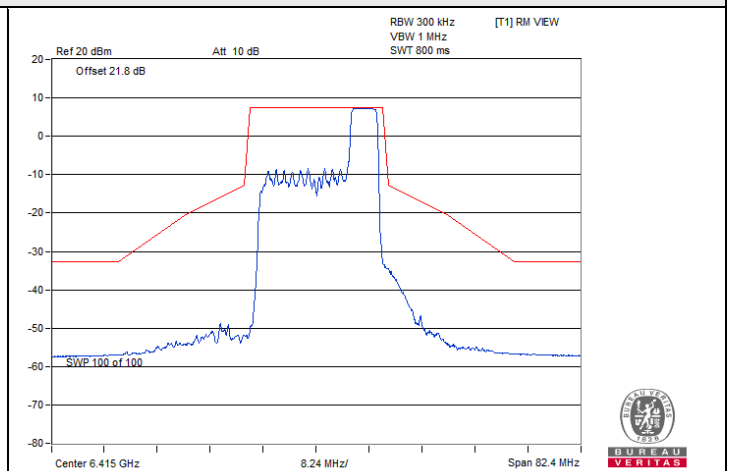

802.11ax (HE) 52-tone RU SP Client\_1T1S : CH 93@40

### Spectrum Plot

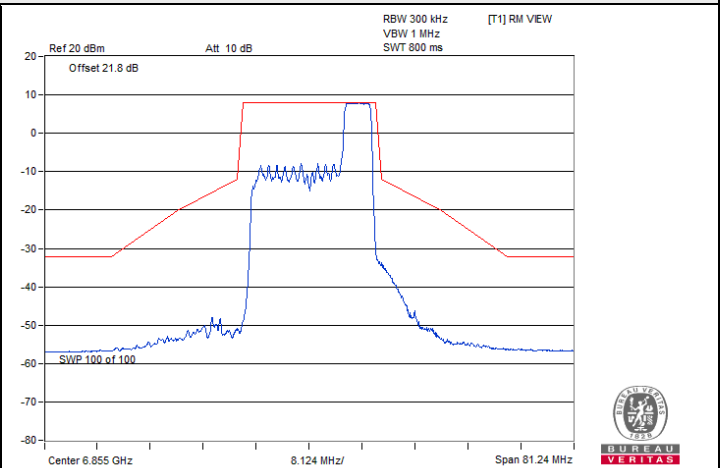
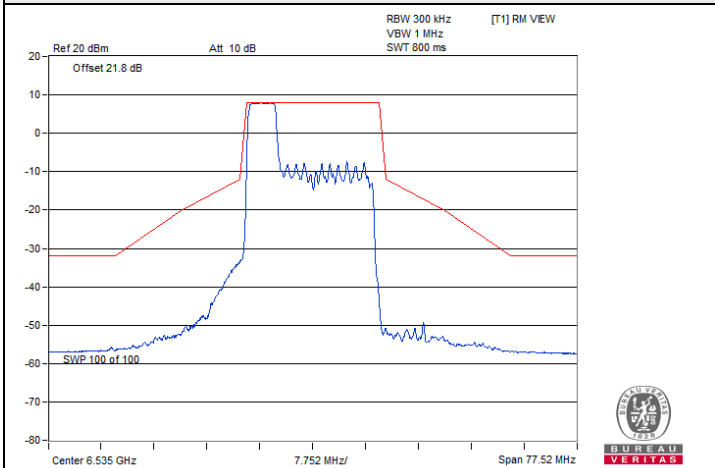

802.11ax (HE) 52-tone RU SP Client\_1T1S : CH 117@37

802.11ax (HE) 52-tone RU SP Client\_1T1S : CH 181@40

### 802.11ax (HE) 106-tone RU SP Client\_1T1S

### Spectrum Plot

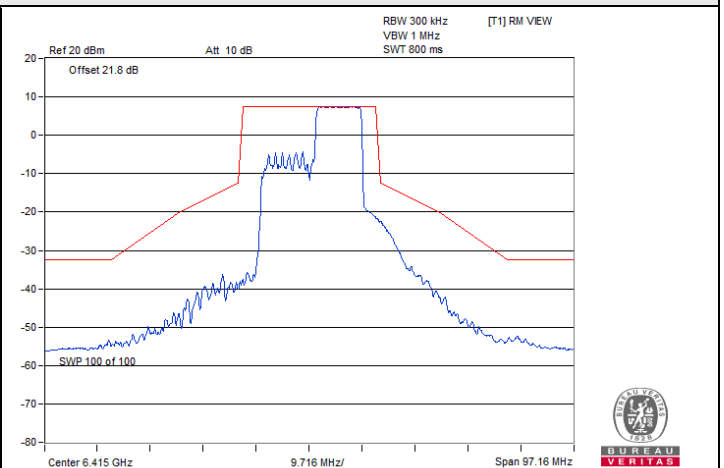
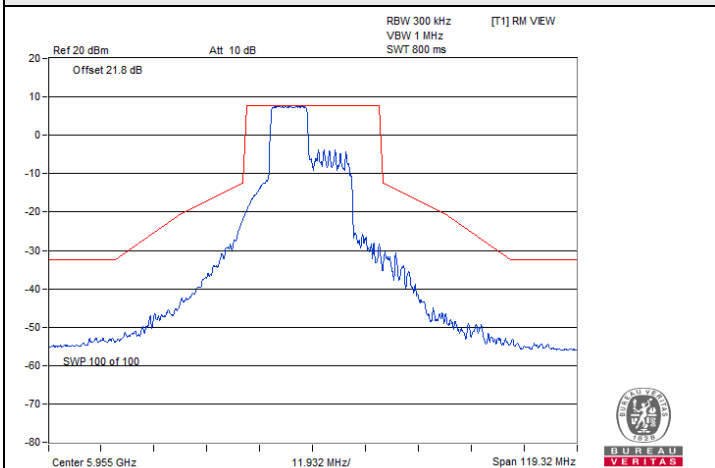

802.11ax (HE) 106-tone RU SP Client\_1T1S : CH 1@53

802.11ax (HE) 106-tone RU SP Client\_1T1S : CH 93@54

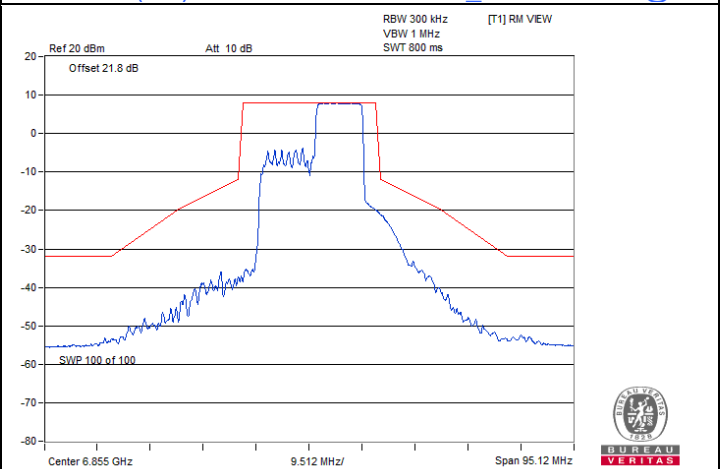
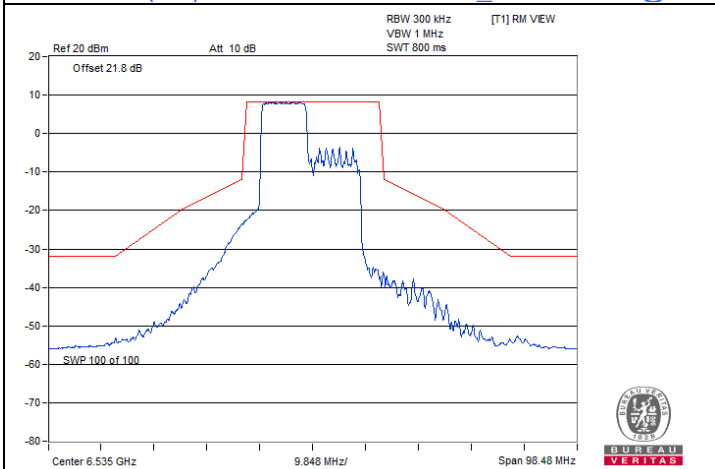

802.11ax (HE) 106-tone RU SP Client\_1T1S : CH 117@53

802.11ax (HE) 106-tone RU SP Client\_1T1S : CH 181@54



### 802.11ax (HE) 26-tone RU SP Client\_2T2S

#### Spectrum Plot

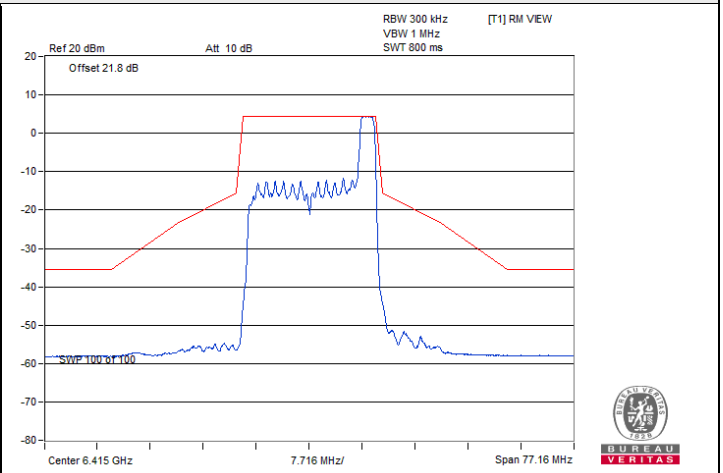
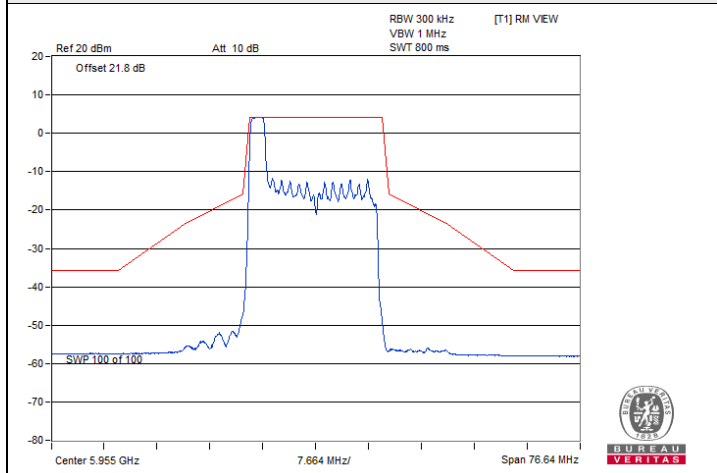

802.11ax (HE) 26-tone RU SP Client\_2T2S / Chain 0 : CH 1@0

802.11ax (HE) 26-tone RU SP Client\_2T2S / Chain 0 : CH 93@8

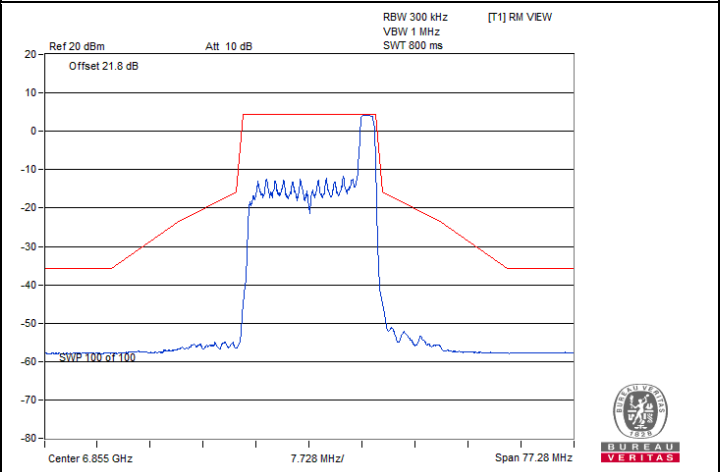
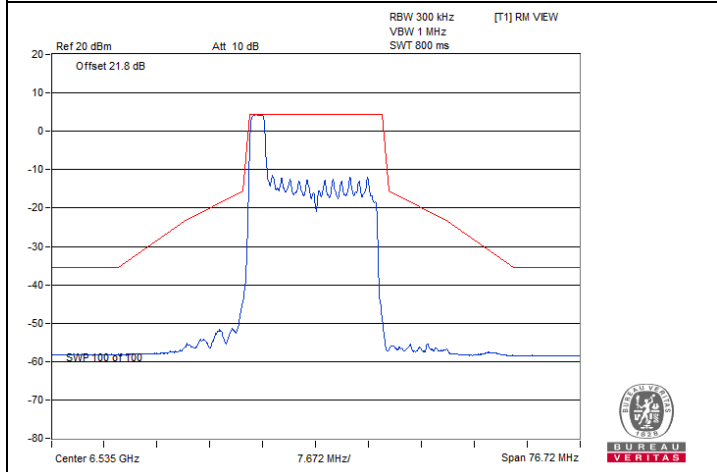

802.11ax (HE) 26-tone RU SP Client\_2T2S / Chain 0 : CH 117@0

802.11ax (HE) 26-tone RU SP Client\_2T2S / Chain 0 : CH 181@8

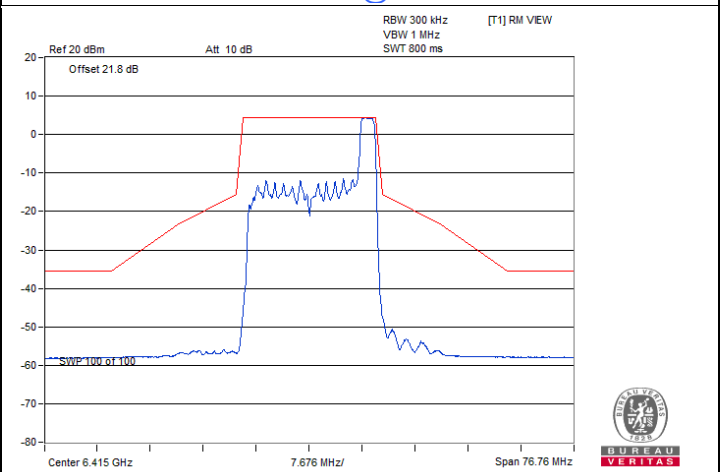
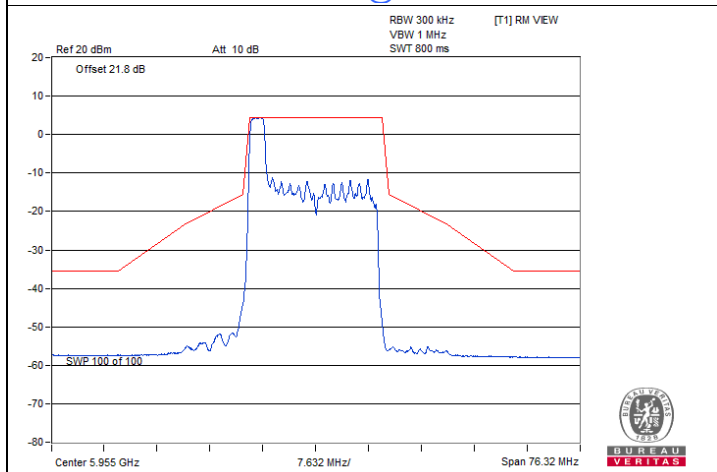

802.11ax (HE) 26-tone RU SP Client\_2T2S / Chain 1 : CH 1@0

802.11ax (HE) 26-tone RU SP Client\_2T2S / Chain 1 : CH 93@8

### Spectrum Plot

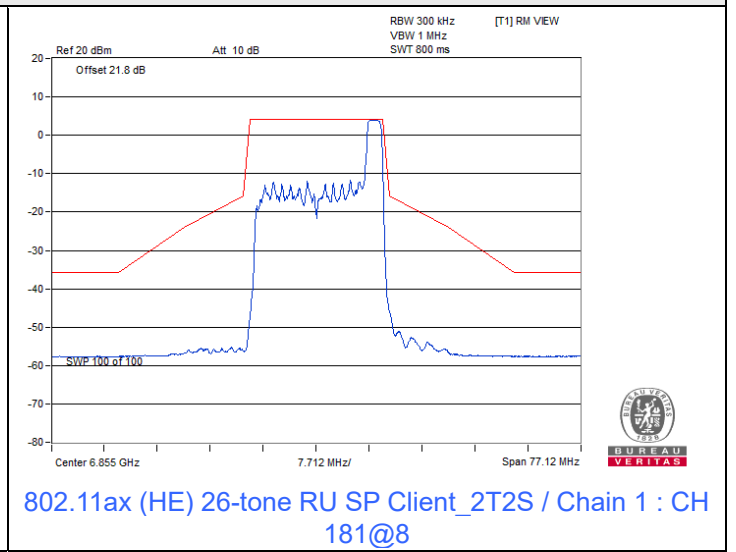
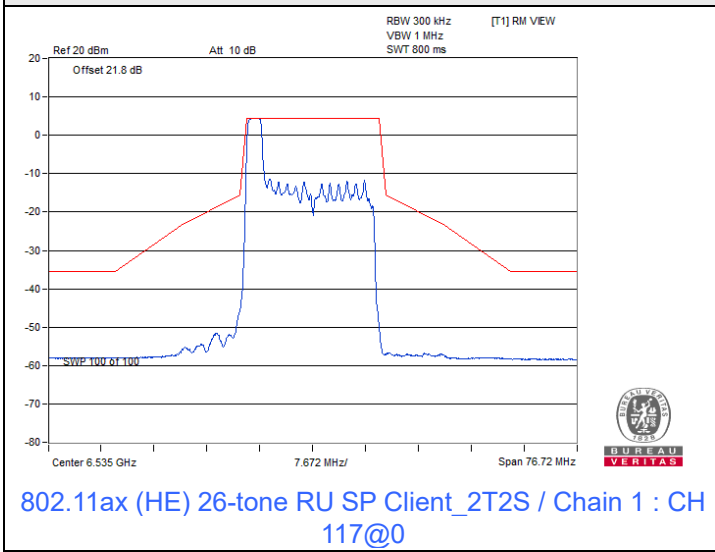

### 802.11ax (HE) 52-tone RU SP Client\_2T2S

### Spectrum Plot

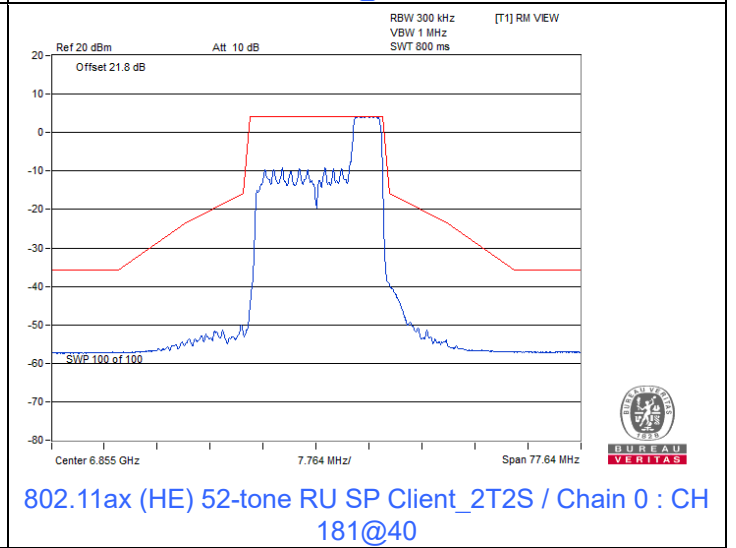
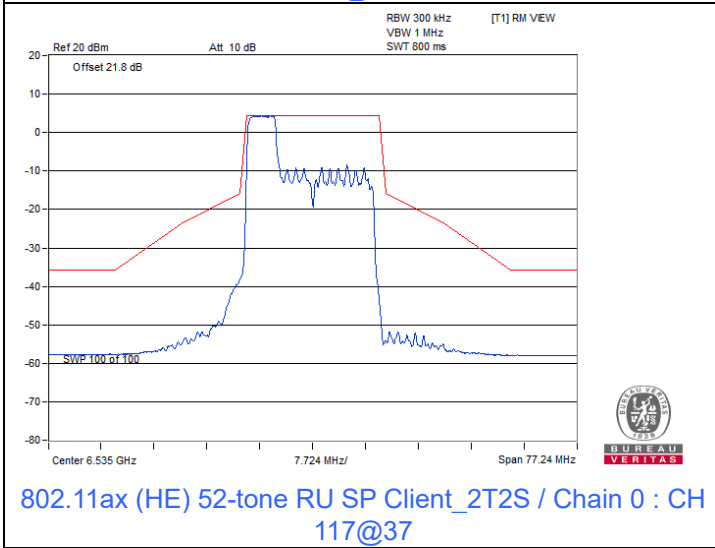
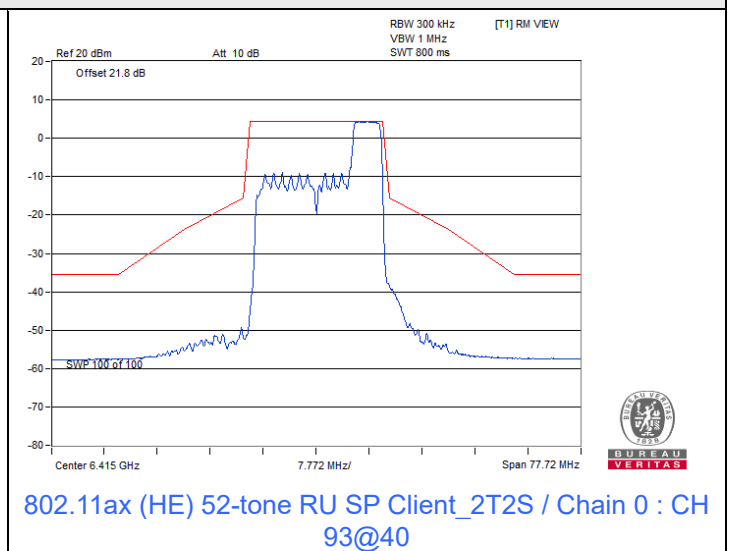
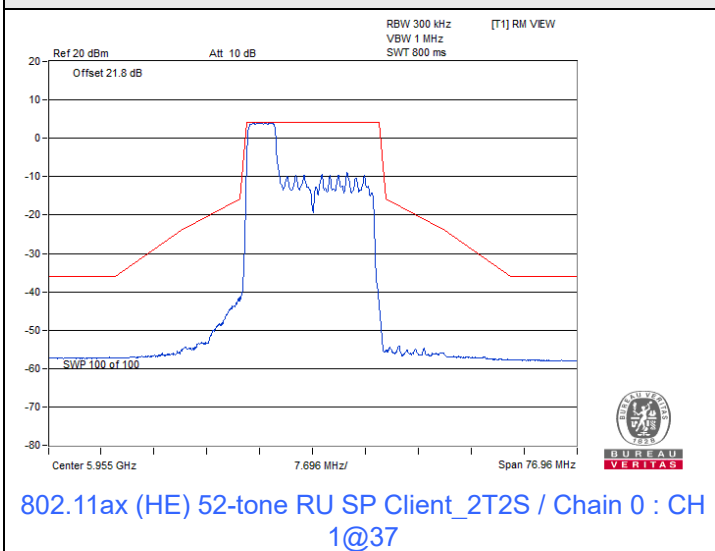

### Spectrum Plot

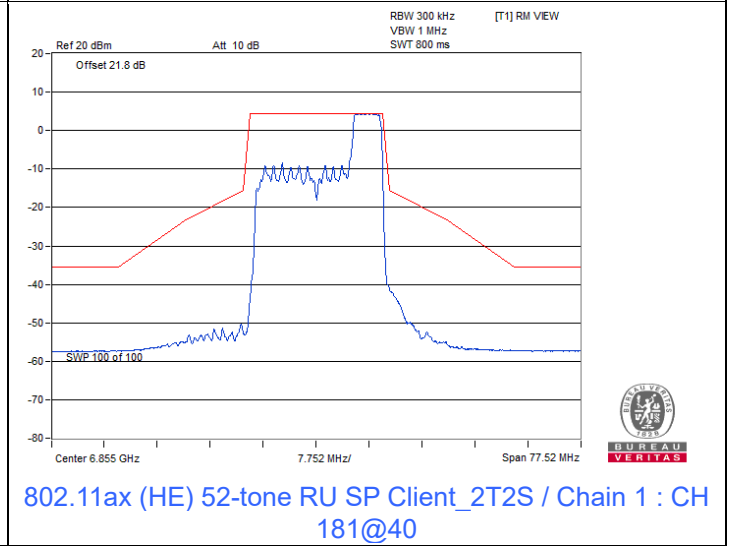
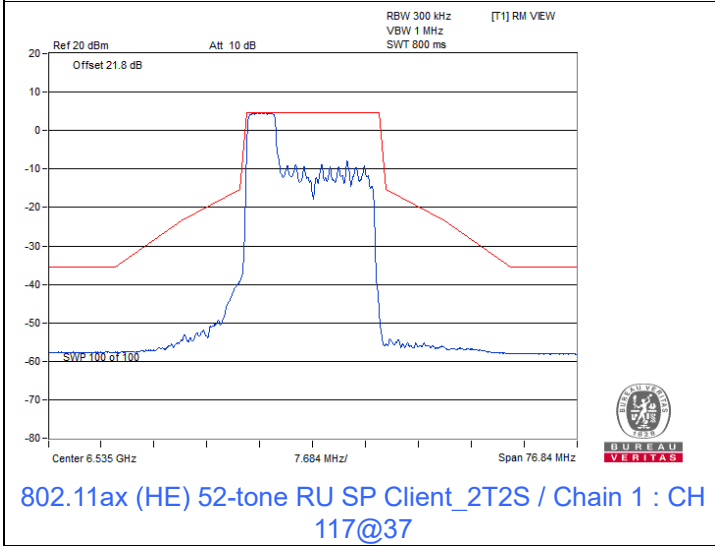
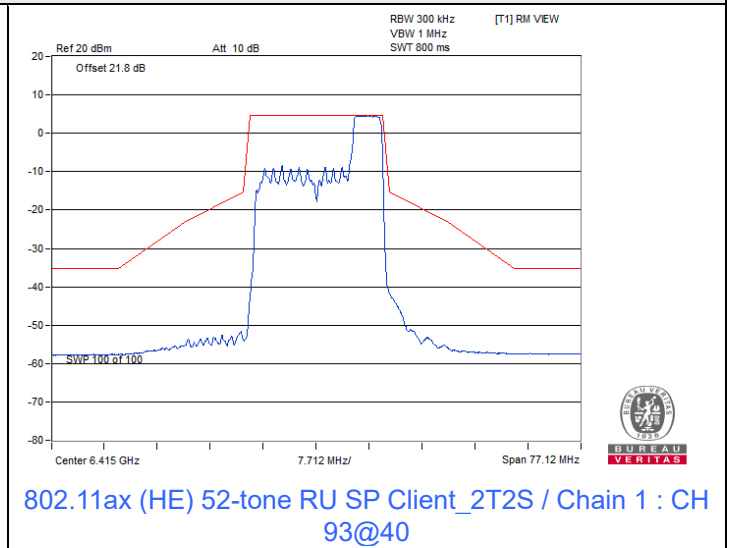
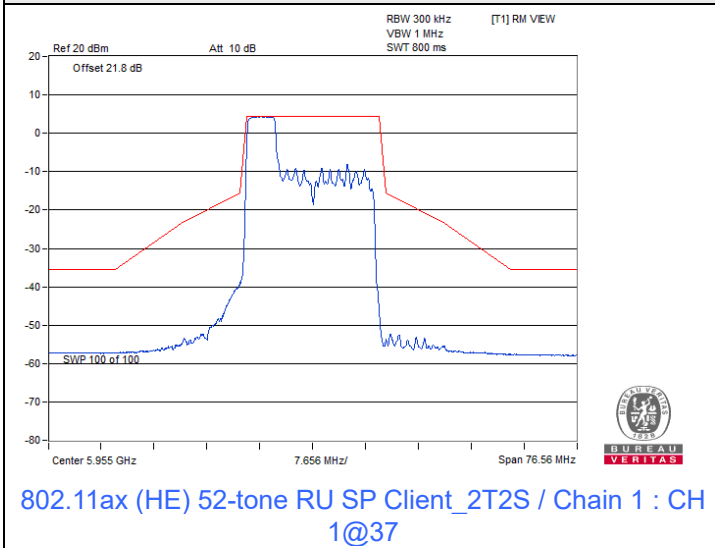

### 802.11ax (HE) 106-tone RU SP Client\_2T2S

### Spectrum Plot

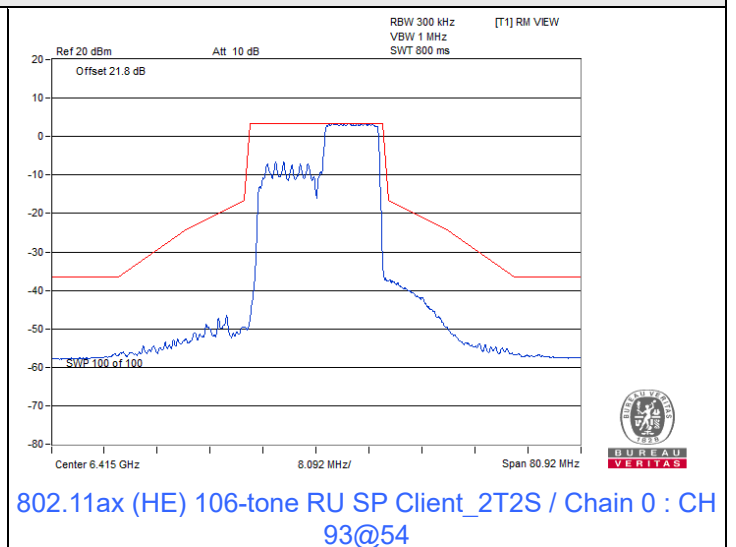
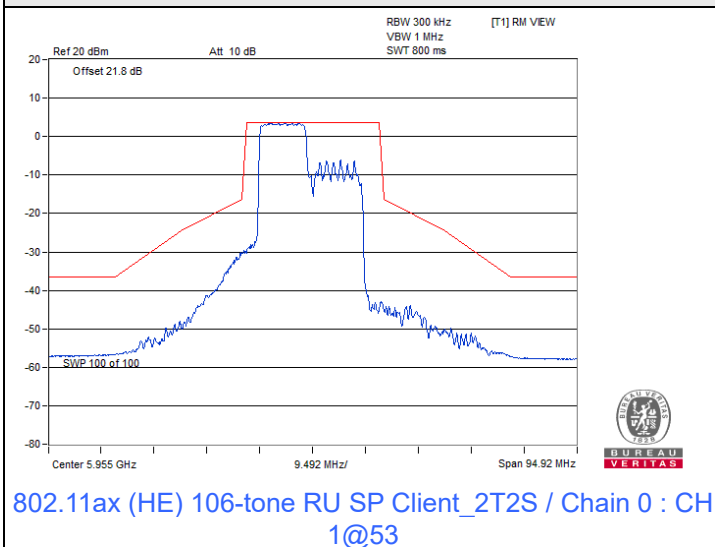



### Spectrum Plot

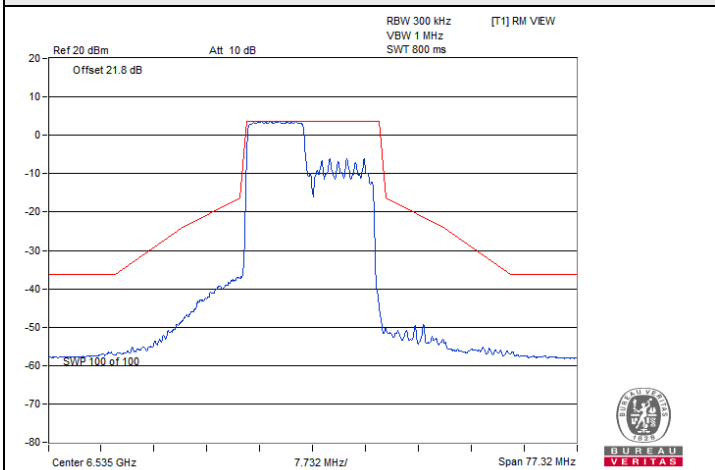

802.11ax (HE) 106-tone RU SP Client\_2T2S / Chain 0 : CH 117@53

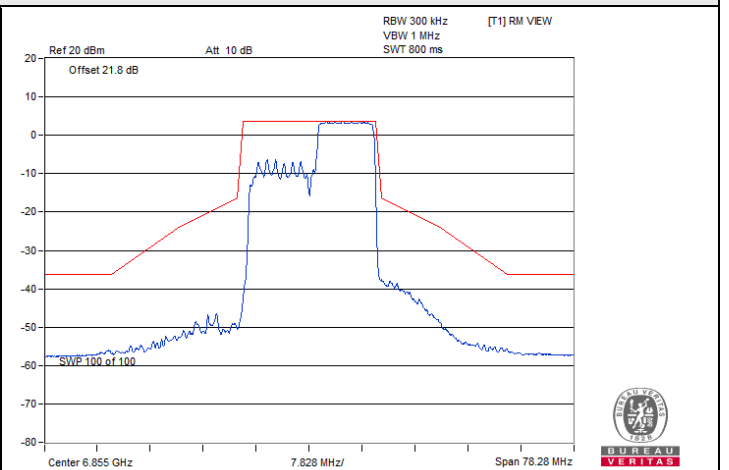

802.11ax (HE) 106-tone RU SP Client\_2T2S / Chain 0 : CH 181@54

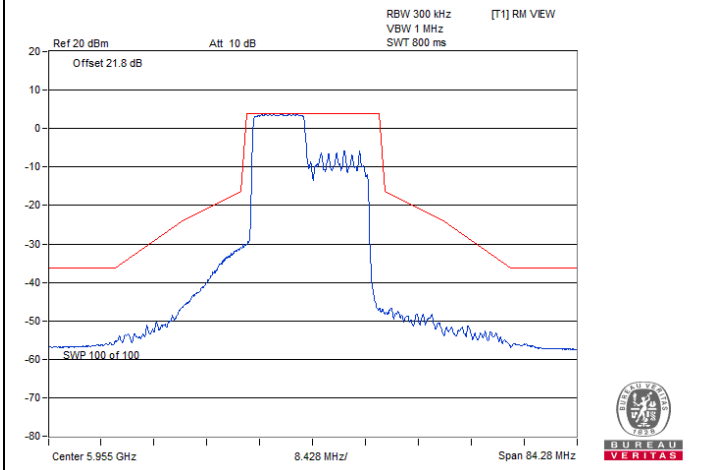

802.11ax (HE) 106-tone RU SP Client\_2T2S / Chain 1 : CH 1@53

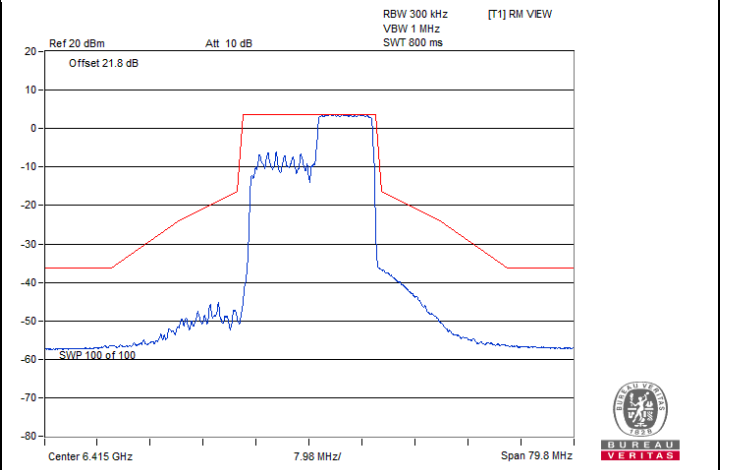

802.11ax (HE) 106-tone RU SP Client\_2T2S / Chain 1 : CH 93@54

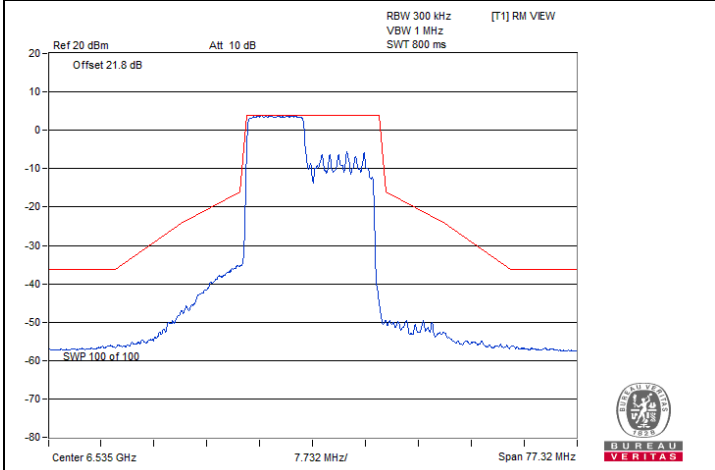

802.11ax (HE) 106-tone RU SP Client\_2T2S / Chain 1 : CH 117@53

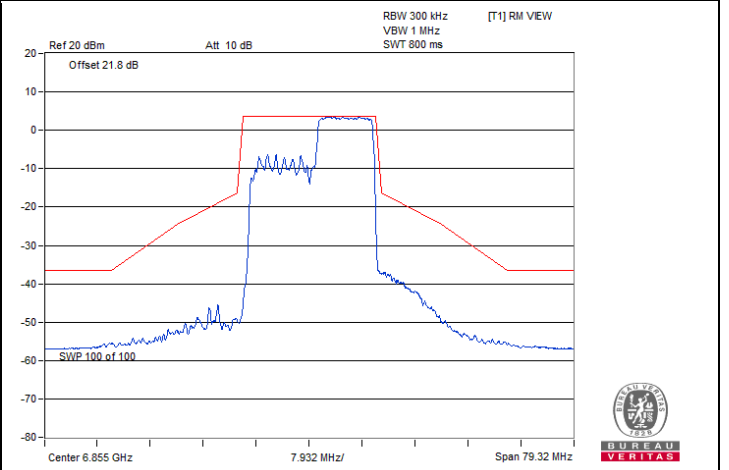

802.11ax (HE) 106-tone RU SP Client\_2T2S / Chain 1 : CH 181@54



### 802.11be (EHT20) 52+26-tone MRU SP Client\_1T1S

#### Spectrum Plot

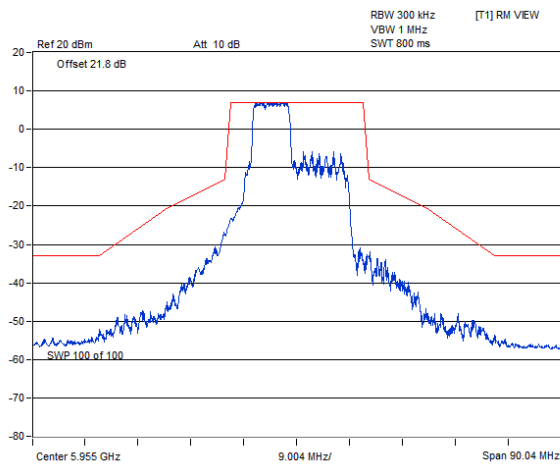

802.11be (EHT20) 52+26-tone MRU SP Client\_1T1S : CH 1@70

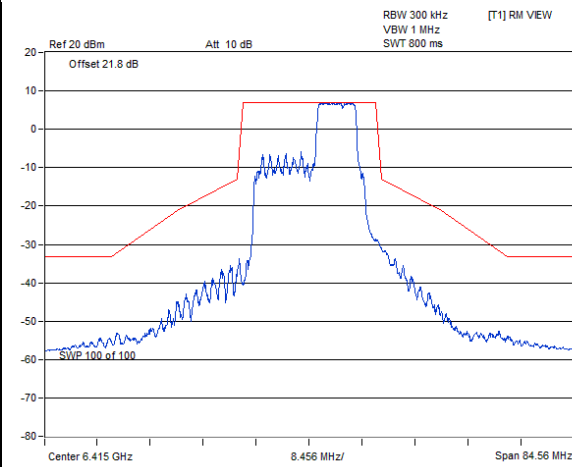

802.11be (EHT20) 52+26-tone MRU SP Client\_1T1S : CH 93@72

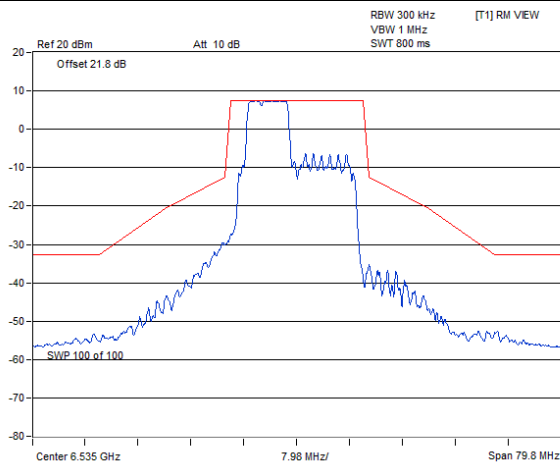

802.11be (EHT20) 52+26-tone MRU SP Client\_1T1S : CH 117@70

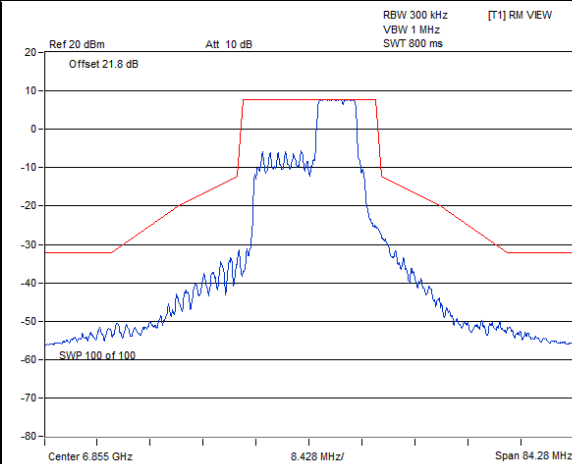

802.11be (EHT20) 52+26-tone MRU SP Client\_1T1S : CH 181@72

### 802.11be (EHT20) 106+26-tone MRU SP Client\_1T1S

#### Spectrum Plot

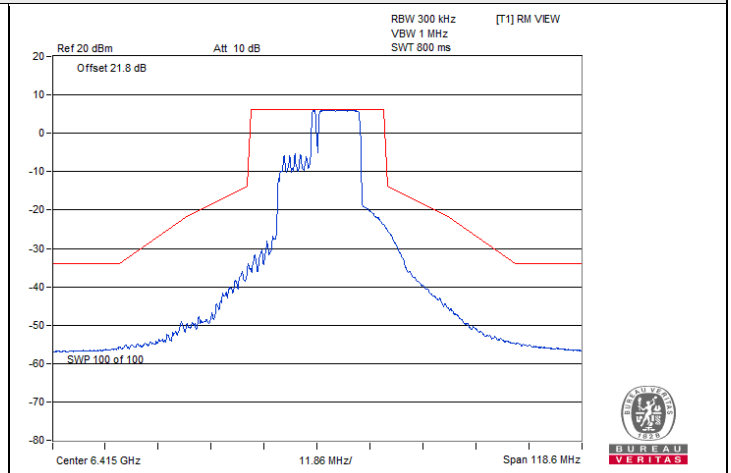
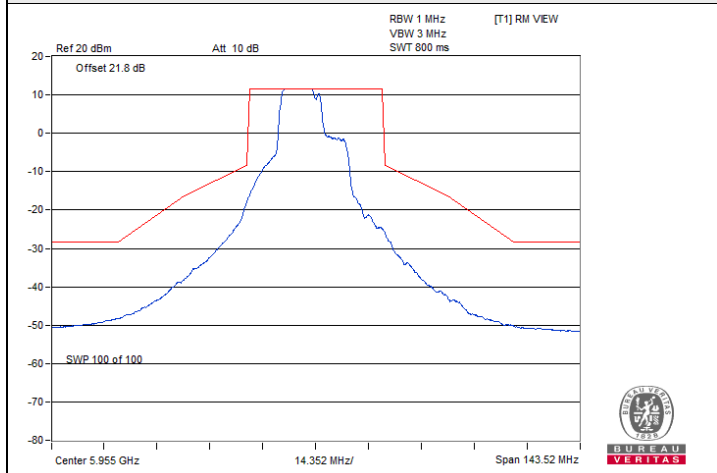

802.11be (EHT20) 106+26-tone MRU SP Client\_1T1S : CH 1@82

802.11be (EHT20) 106+26-tone MRU SP Client\_1T1S : CH 93@83

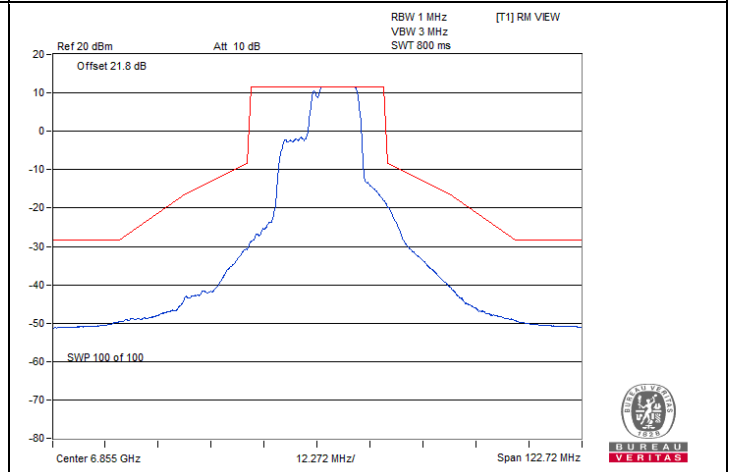
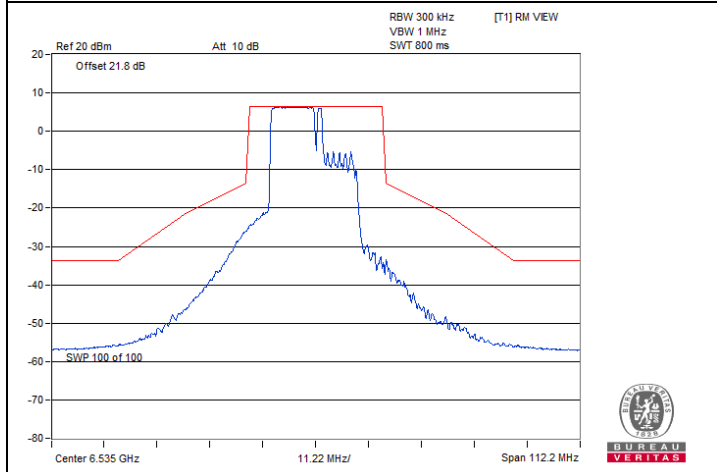

802.11be (EHT20) 106+26-tone MRU SP Client\_1T1S : CH 117@82

802.11be (EHT20) 106+26-tone MRU SP Client\_1T1S : CH 181@83

802.11be (EHT80) 484+242-tone MRU SP Client\_1T1S

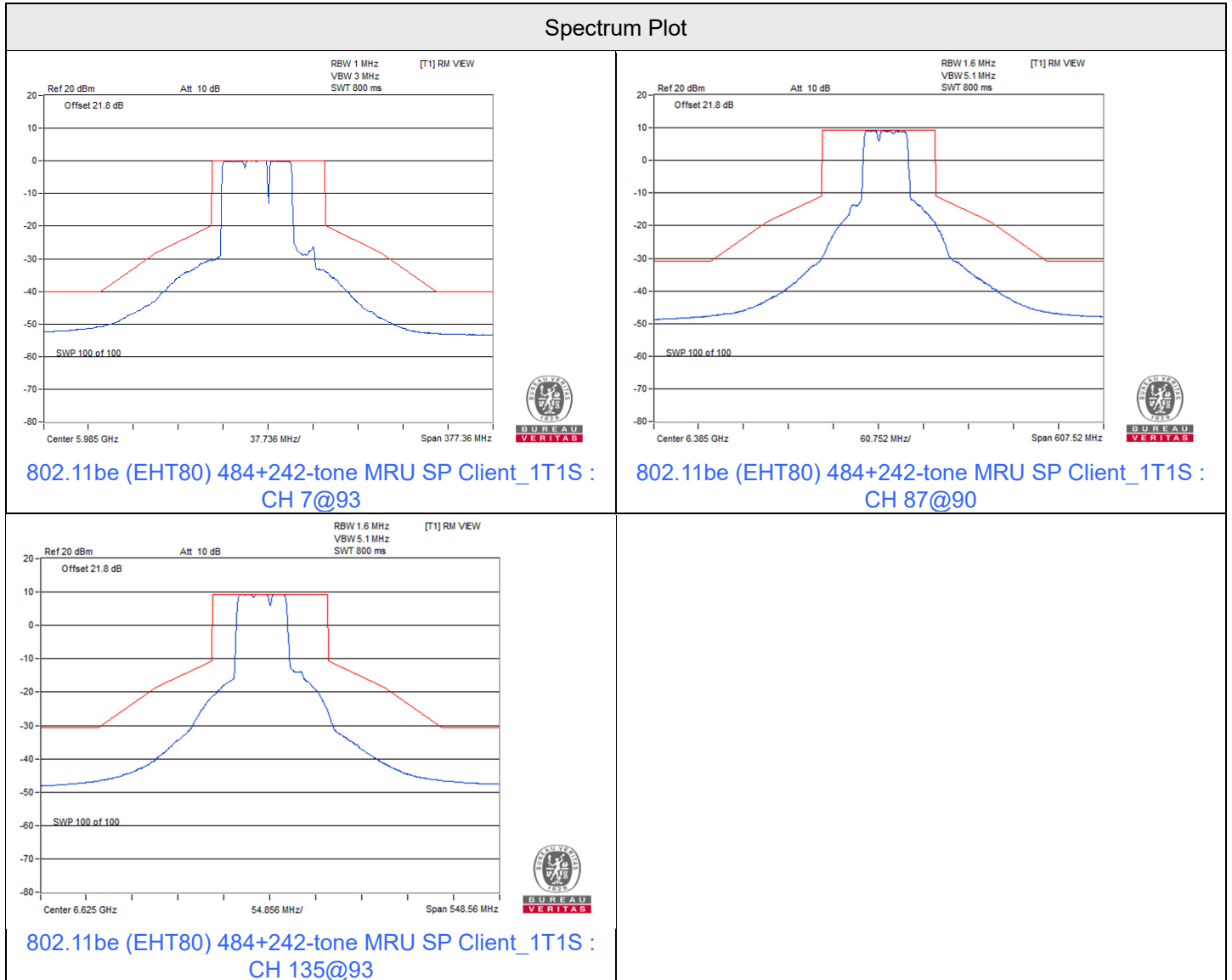



### 802.11be (EHT160) 996+484-tone MRU SP Client\_1T1S

## Spectrum Plot

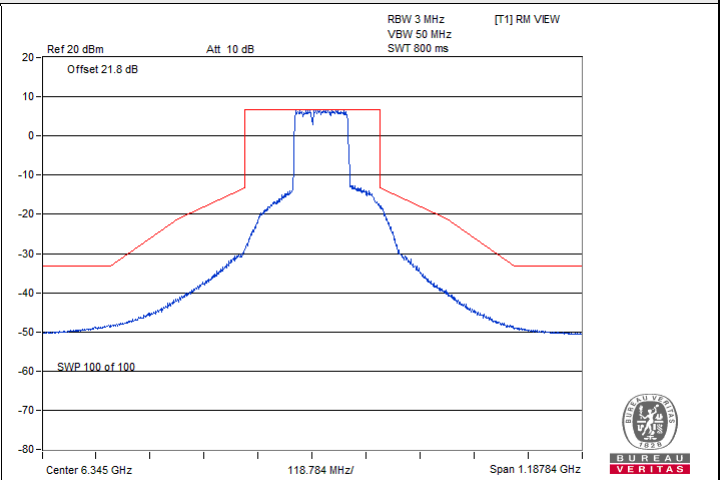
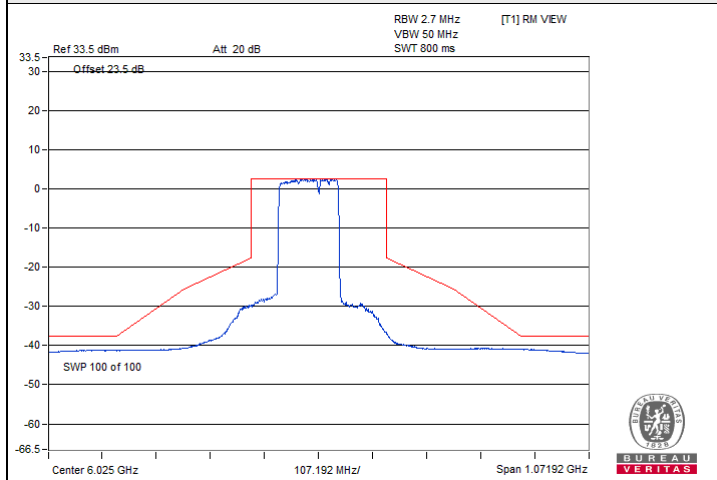

802.11be (EHT160) 996+484-tone MRU SP Client\_1T1S :  
CH 15@95\_1

802.11be (EHT160) 996+484-tone MRU SP Client\_1T1S :  
CH 79@94\_0

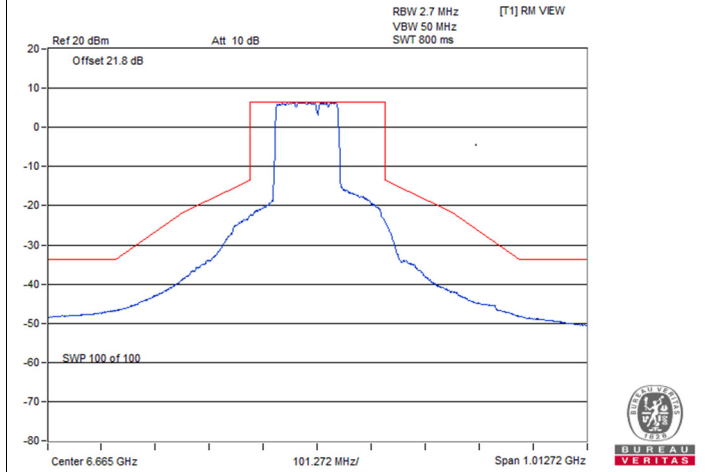

802.11be (EHT160) 996+484-tone MRU SP Client\_1T1S :  
CH 143@95\_1

802.11be (EHT160) 996+484+242-tone MRU SP Client\_1T1S

Spectrum Plot

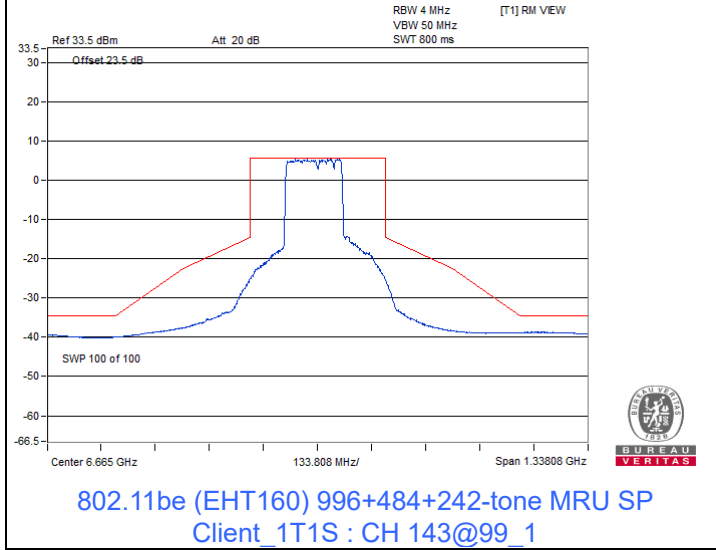
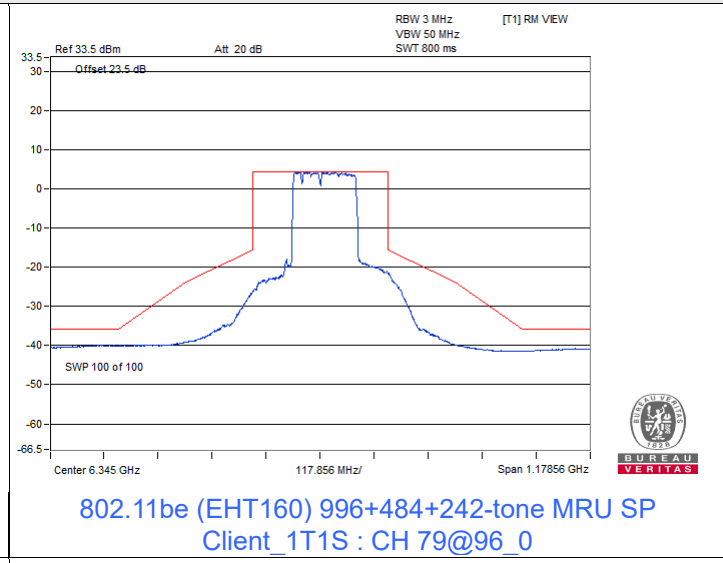
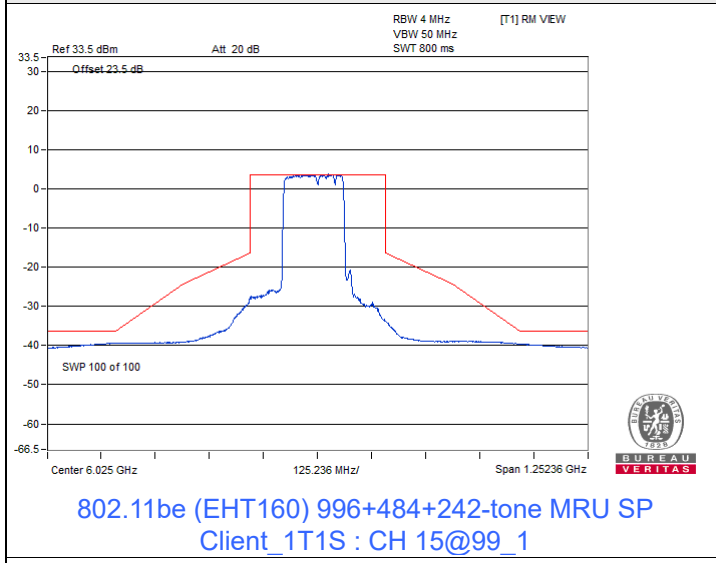

802.11be (EHT320) 2x996+484-tone MRU SP Client 1T1S

Spectrum Plot

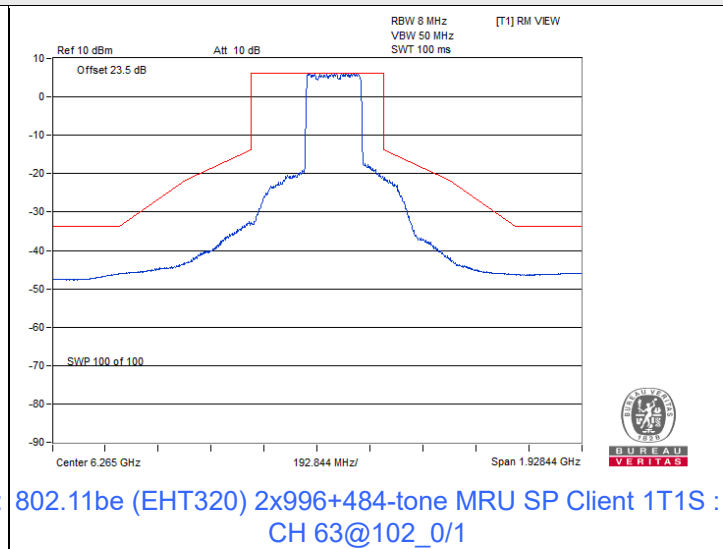
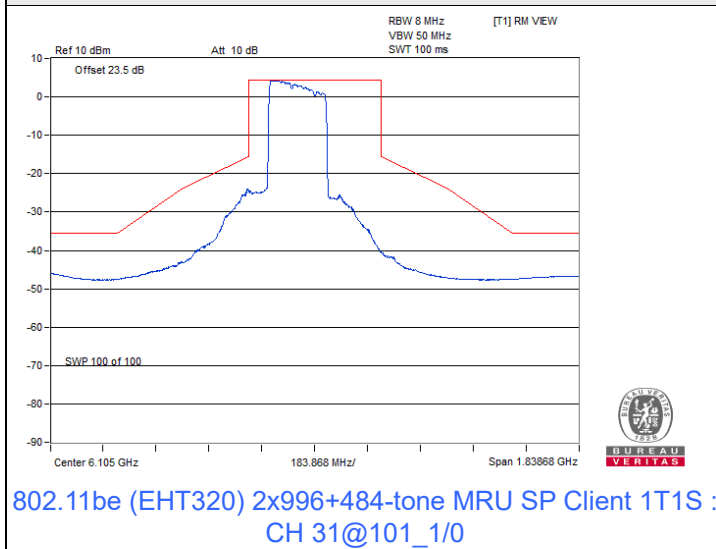

802.11be (EHT320) 3x996-tone MRU SP Client 1T1S

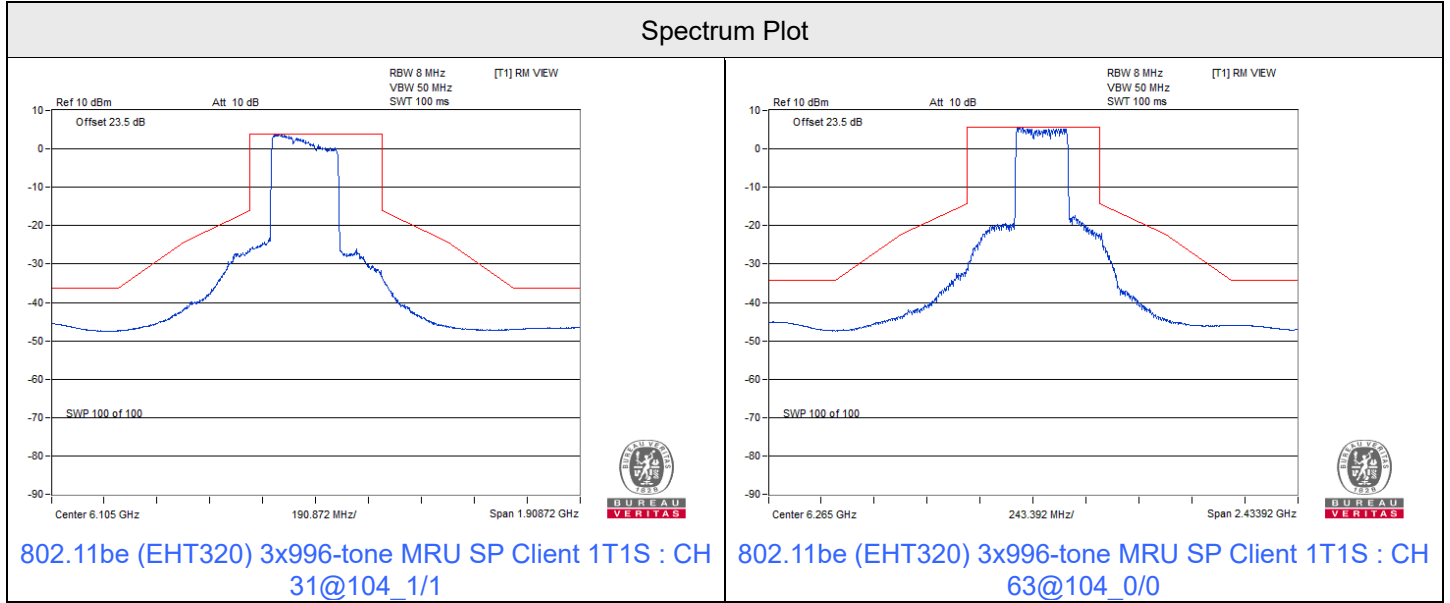

802.11be (EHT320) 3x996+484-tone MRU SP Client 1T1S

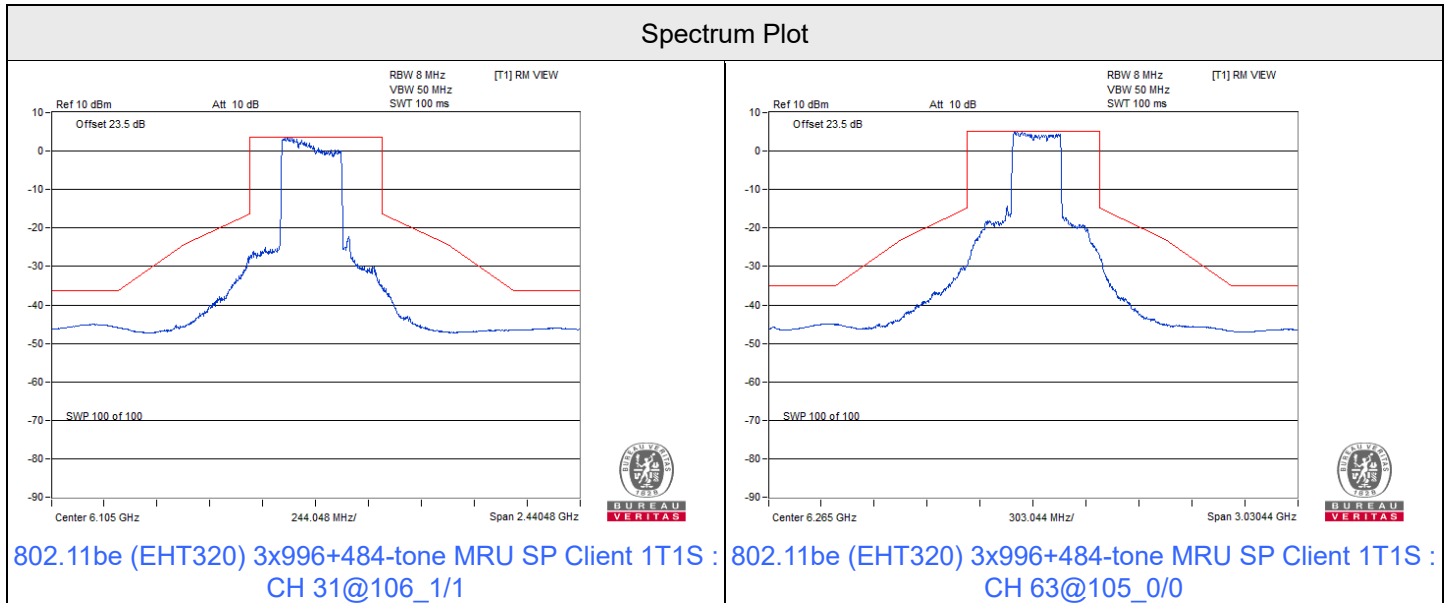

802.11a SP Client 2S2T

Spectrum Plot

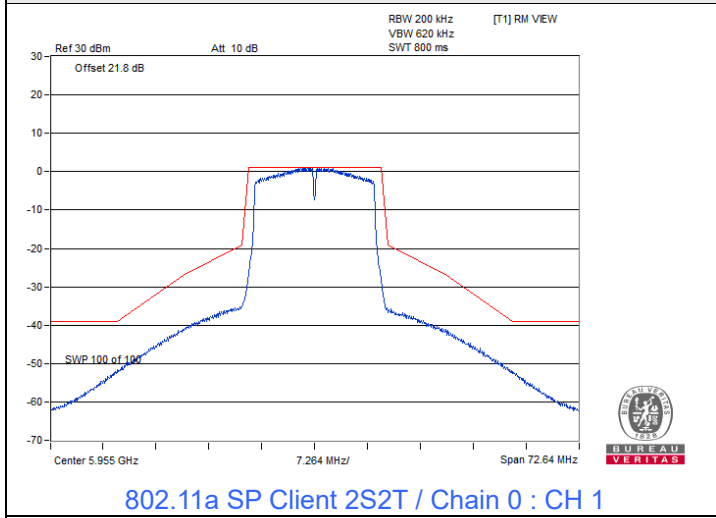

802.11a SP Client 2S2T / Chain 0 : CH 1

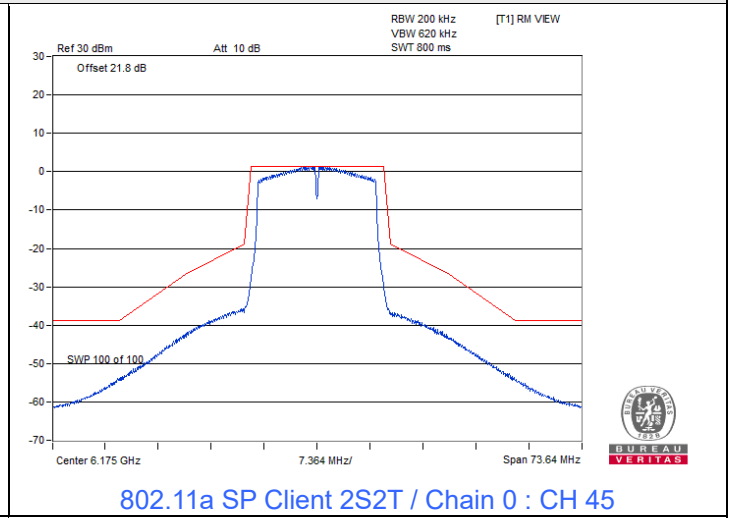

802.11a SP Client 2S2T / Chain 0 : CH 45

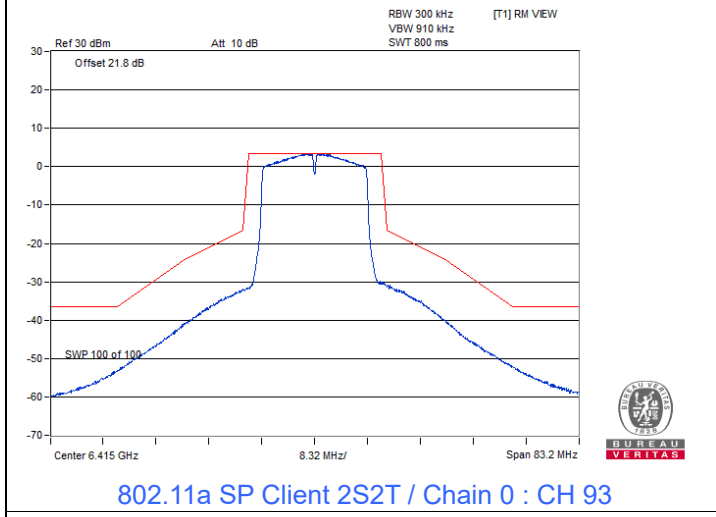

802.11a SP Client 2S2T / Chain 0 : CH 93

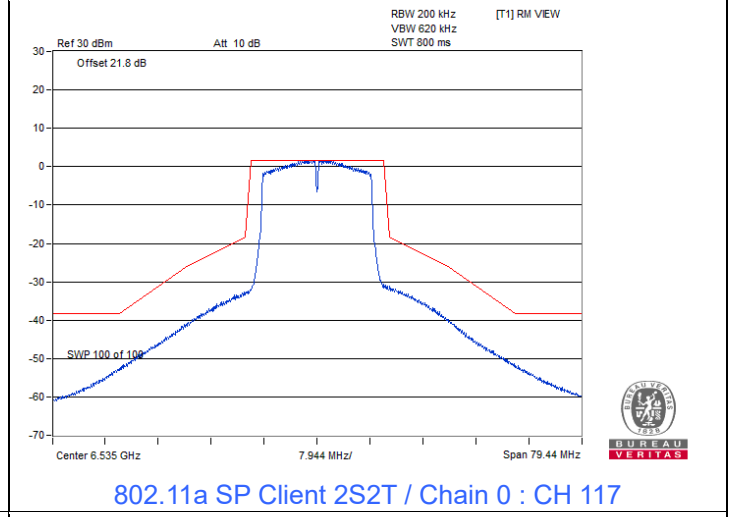

802.11a SP Client 2S2T / Chain 0 : CH 117

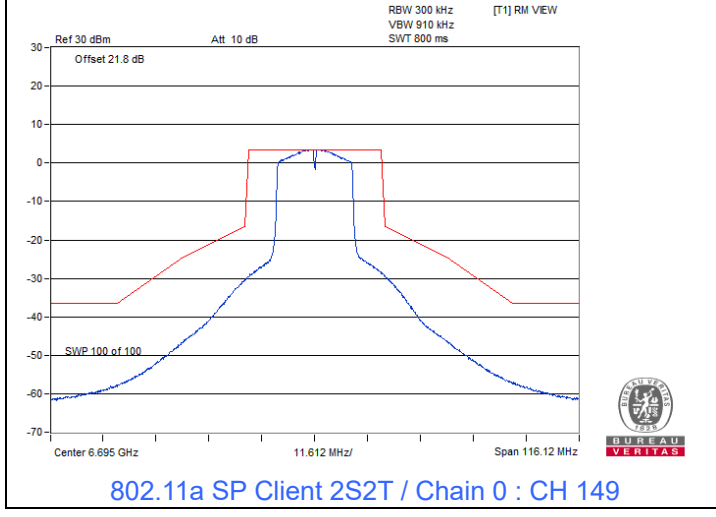

802.11a SP Client 2S2T / Chain 0 : CH 149

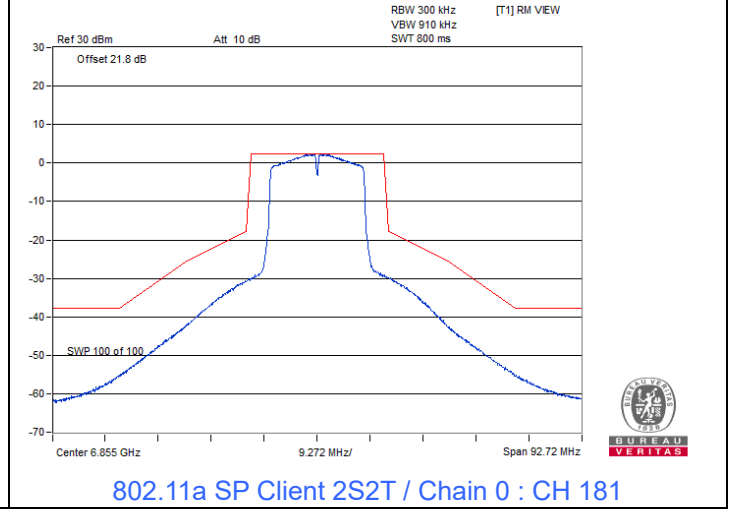

802.11a SP Client 2S2T / Chain 0 : CH 181

### Spectrum Plot

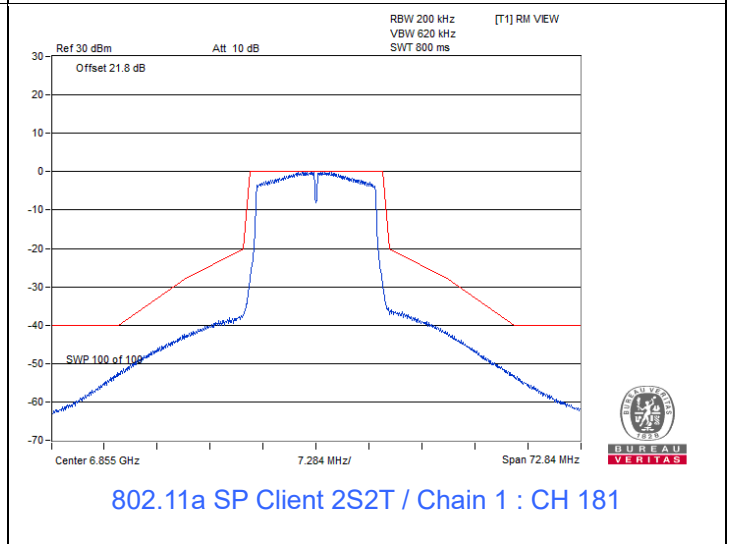
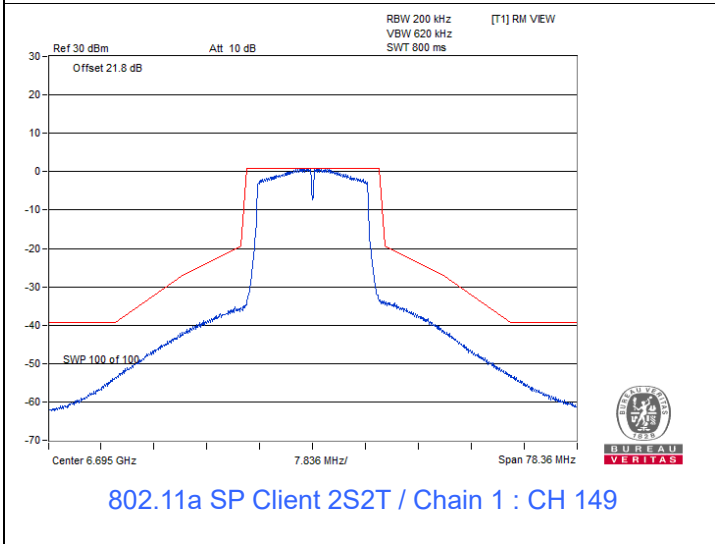
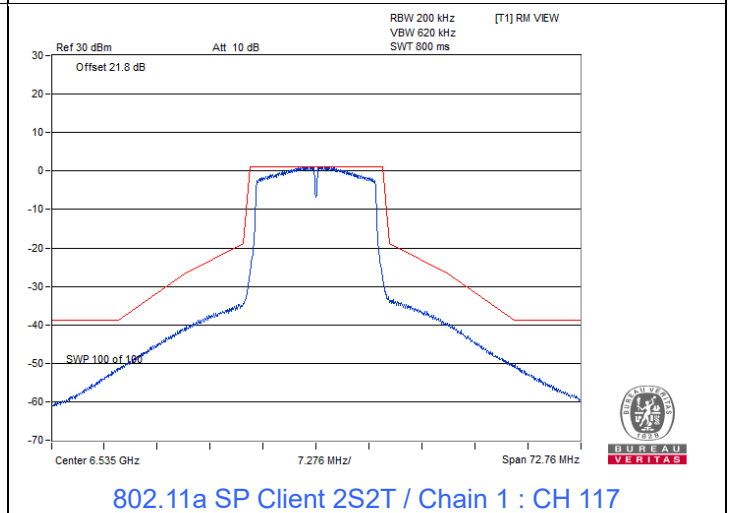
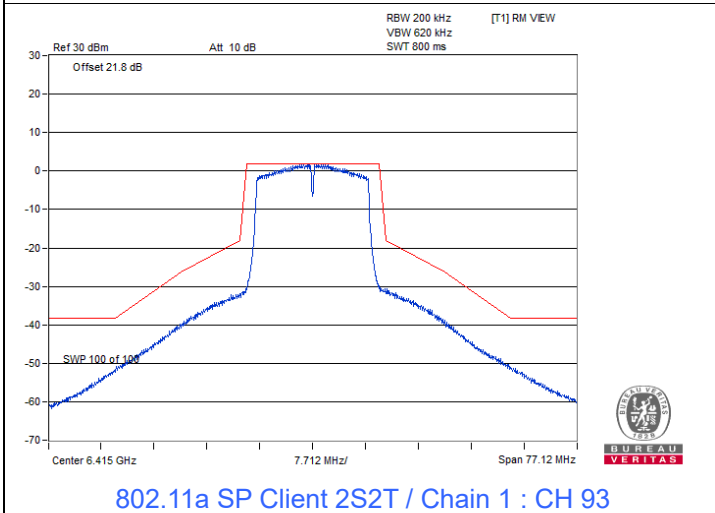
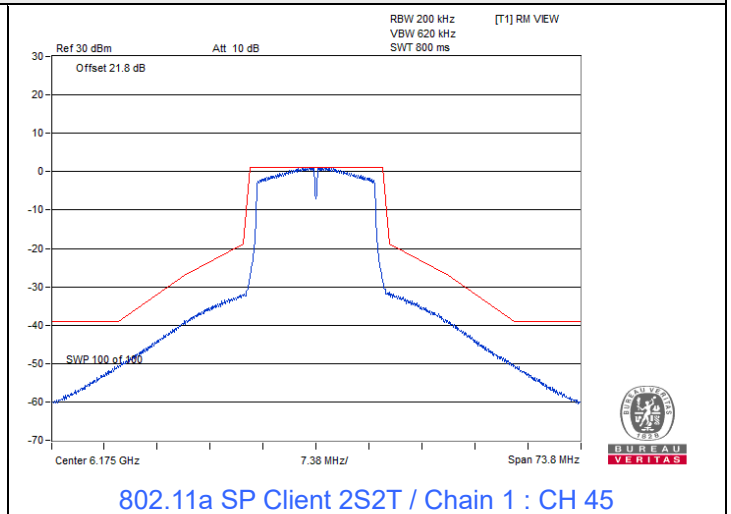
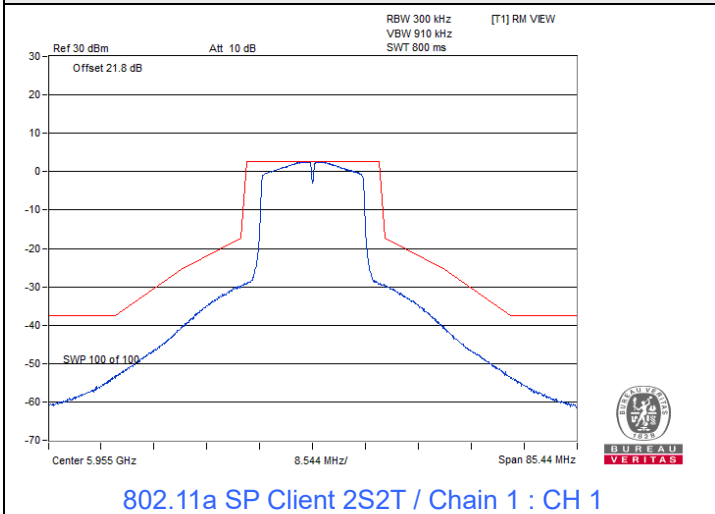





802.11ax (HE20) SP Client 2S2T

Spectrum Plot

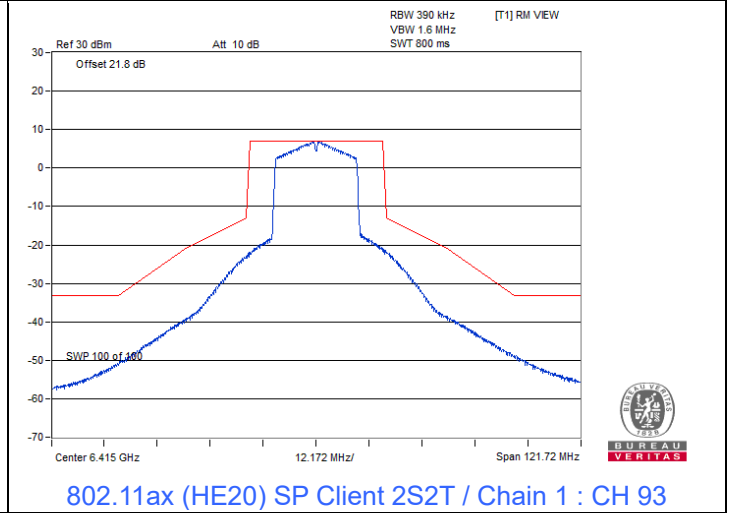
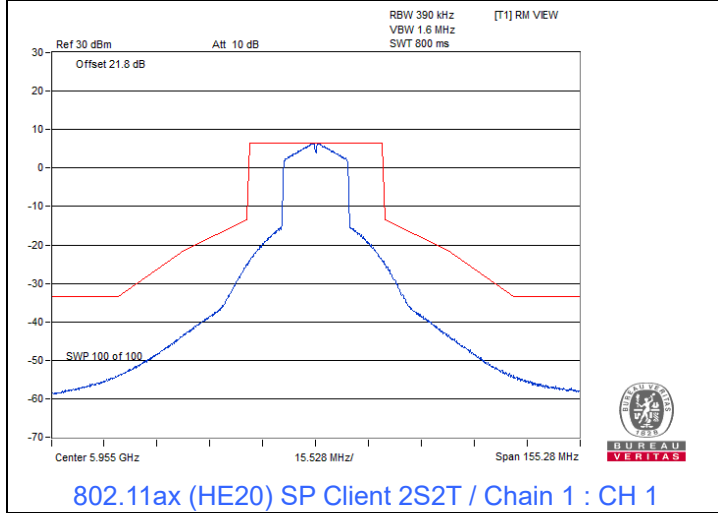
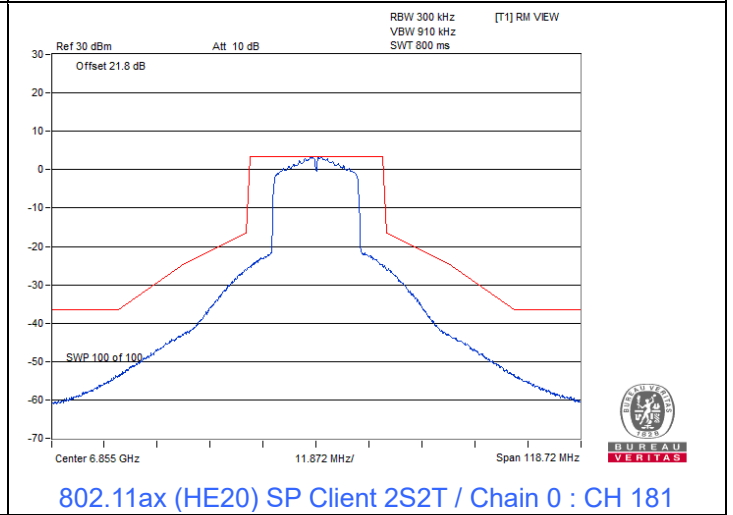
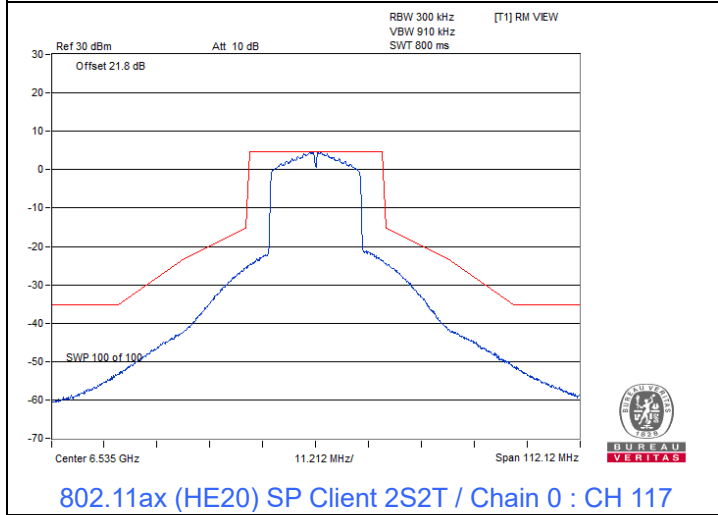
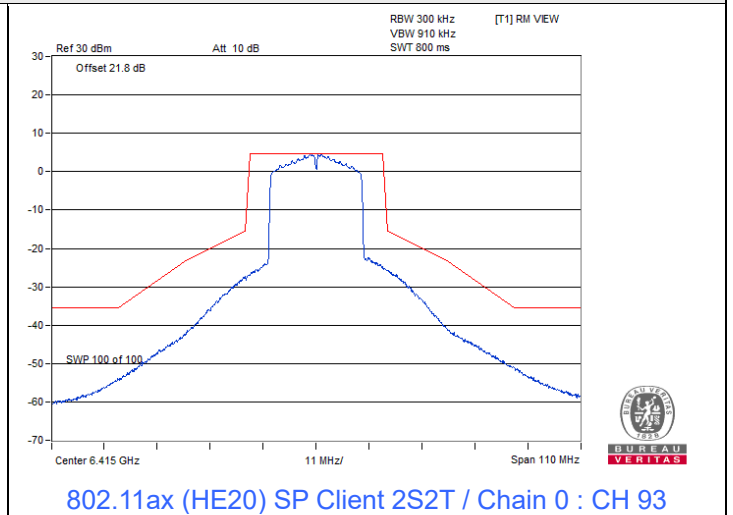
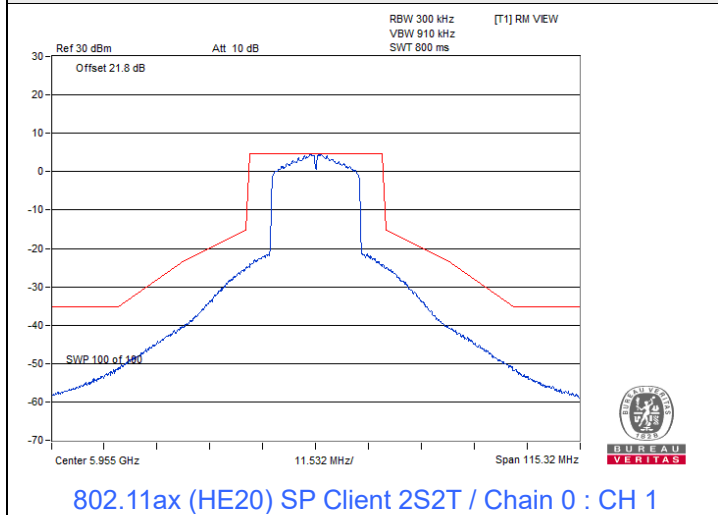

### Spectrum Plot

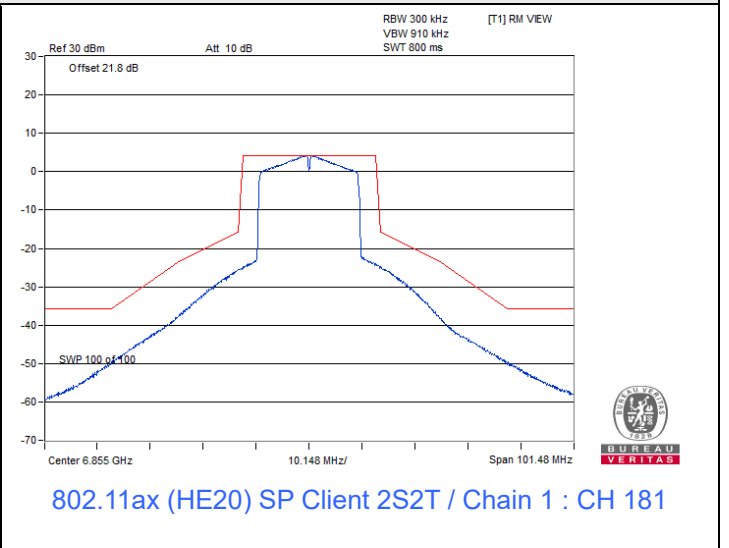
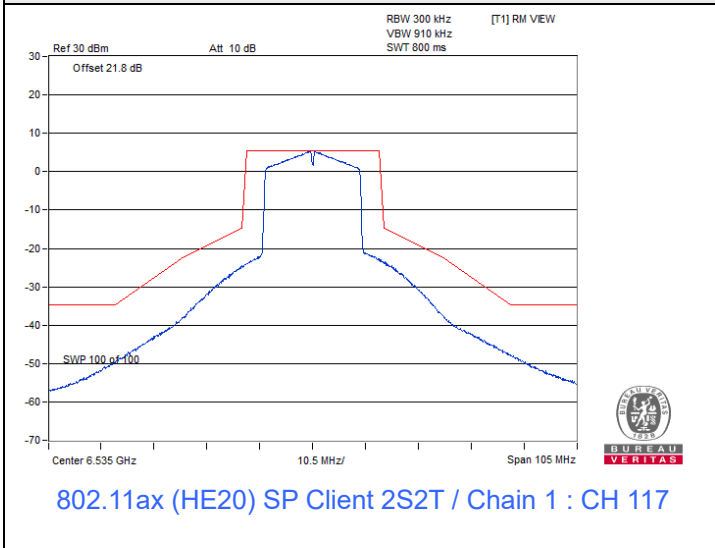

### 802.11ax (HE40) SP Client 2S2T

### Spectrum Plot

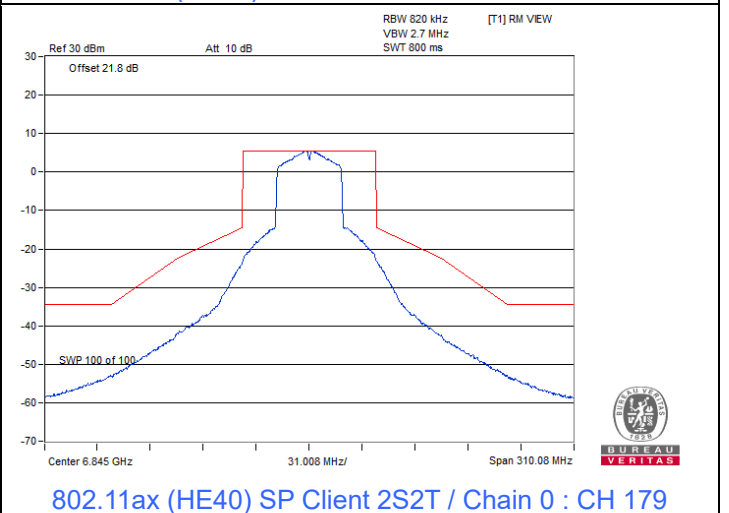
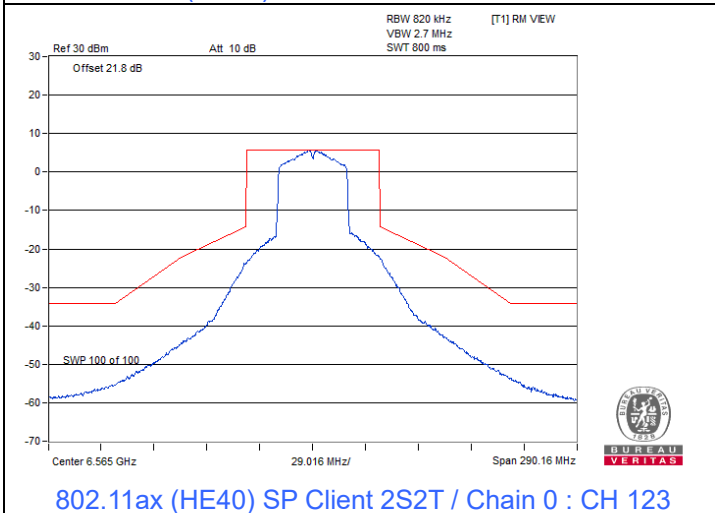
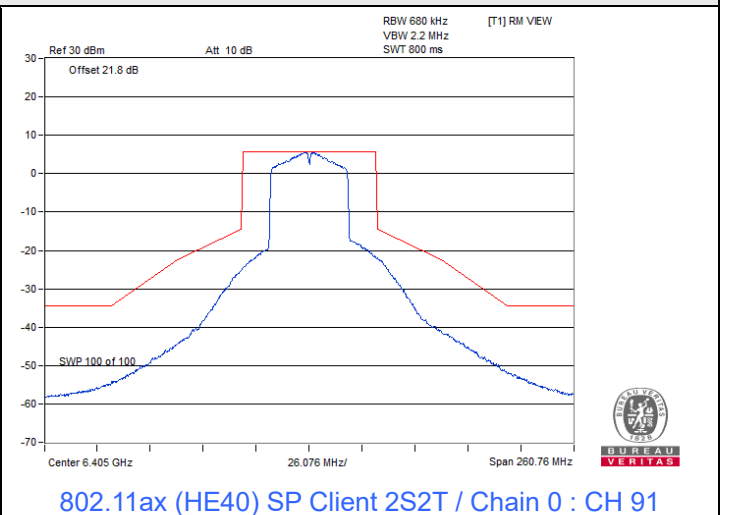
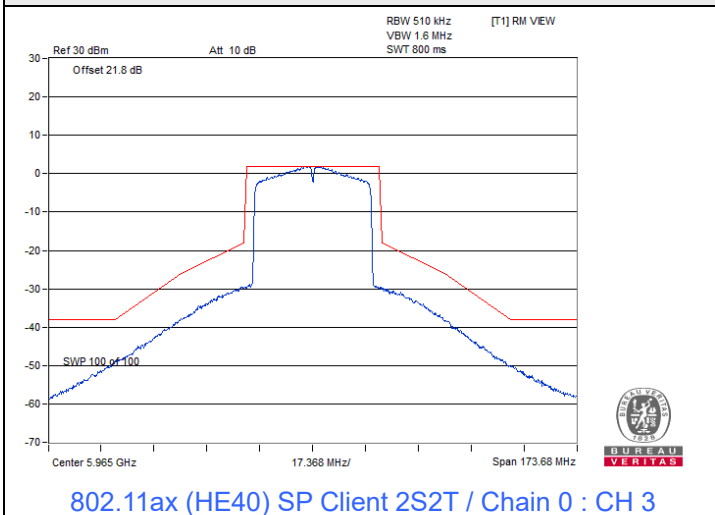

### Spectrum Plot

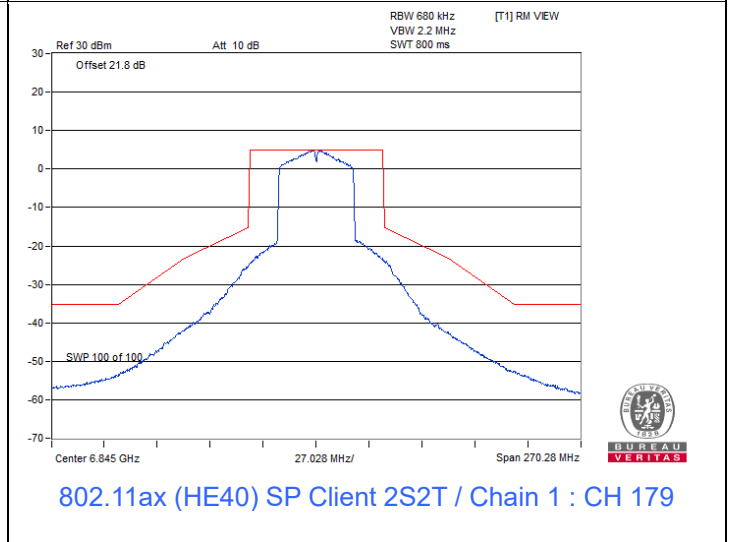
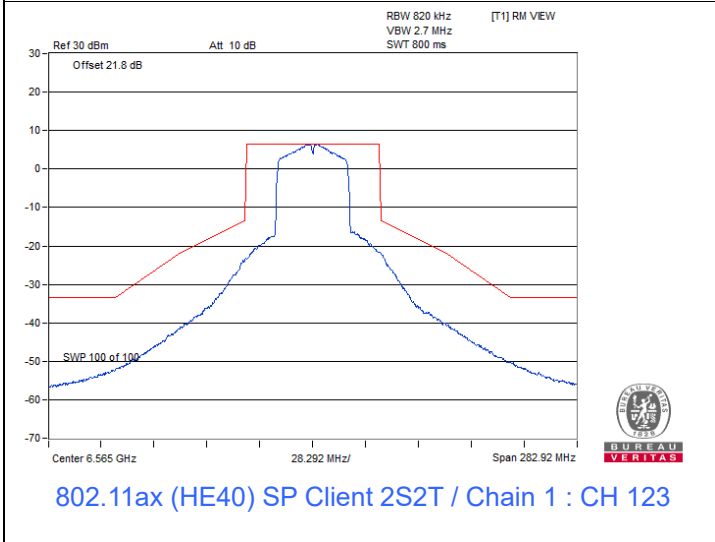
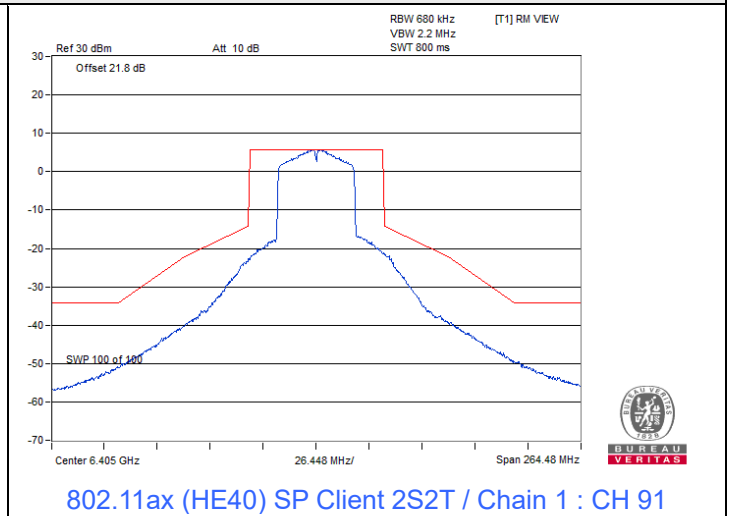
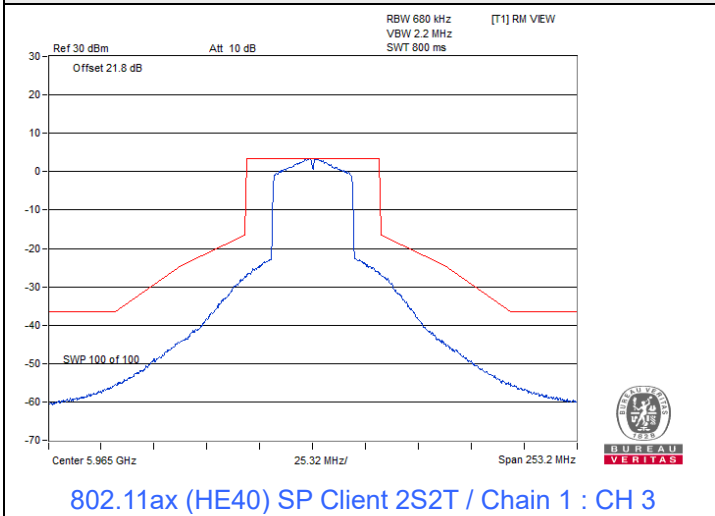

### 802.11ax (HE80) SP Client 2S2T

### Spectrum Plot

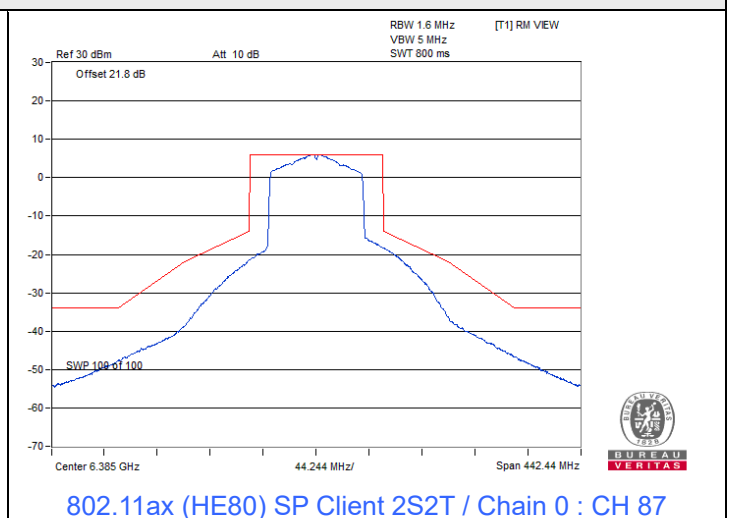
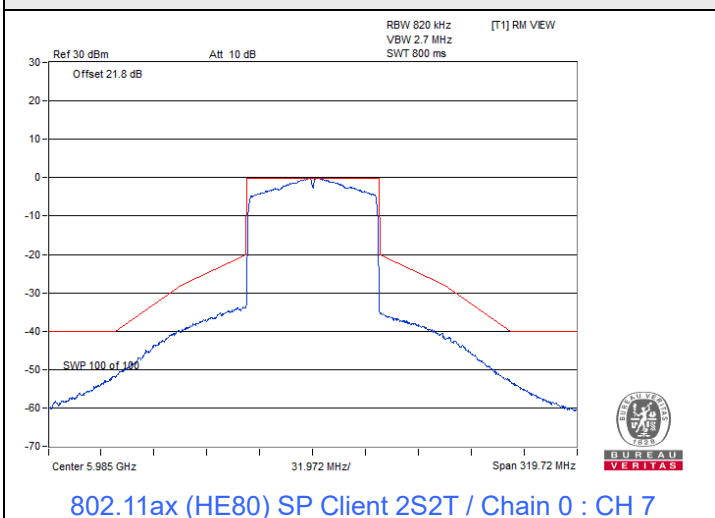

### Spectrum Plot

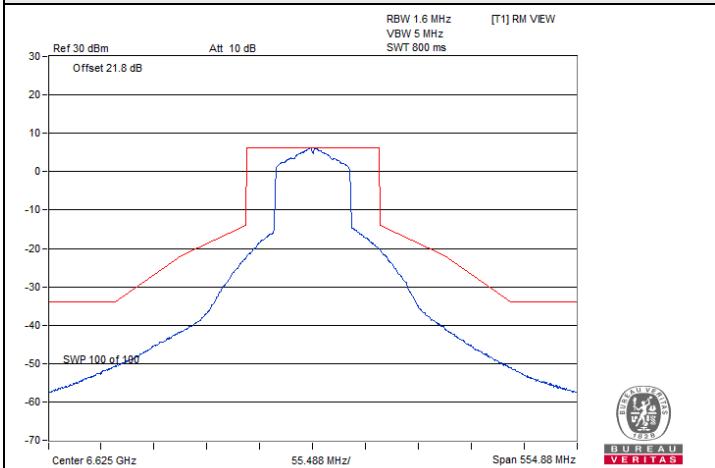

802.11ax (HE80) SP Client 2S2T / Chain 0 : CH 135

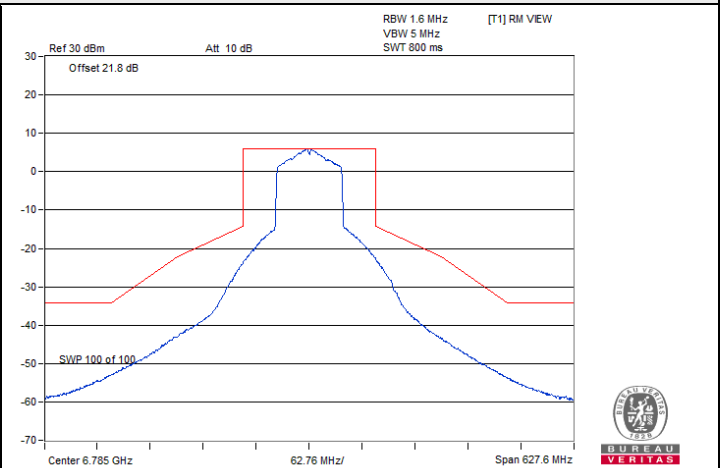

802.11ax (HE80) SP Client 2S2T / Chain 0 : CH 167

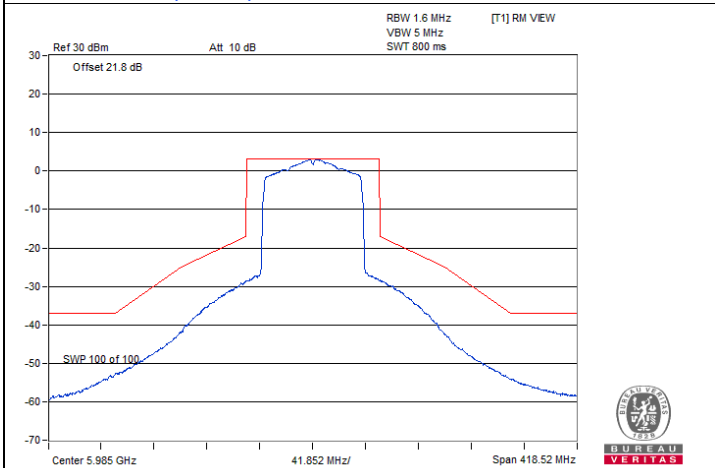

802.11ax (HE80) SP Client 2S2T / Chain 1 : CH 7

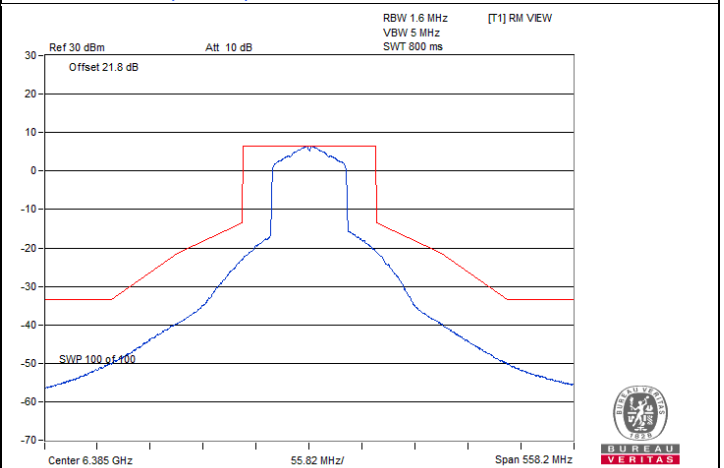

802.11ax (HE80) SP Client 2S2T / Chain 1 : CH 87

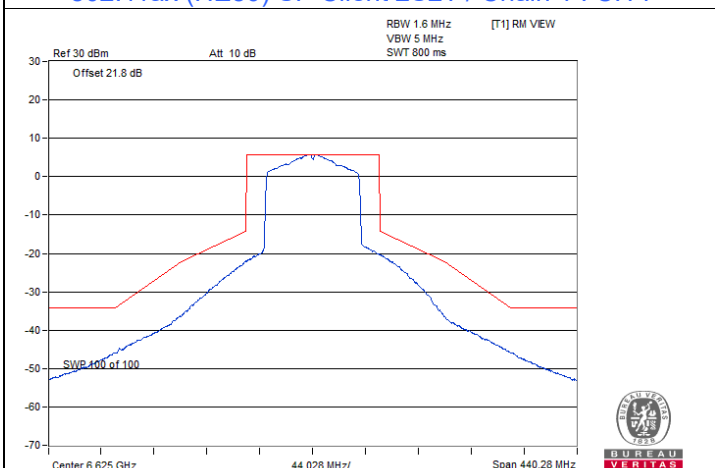

802.11ax (HE80) SP Client 2S2T / Chain 1 : CH 135

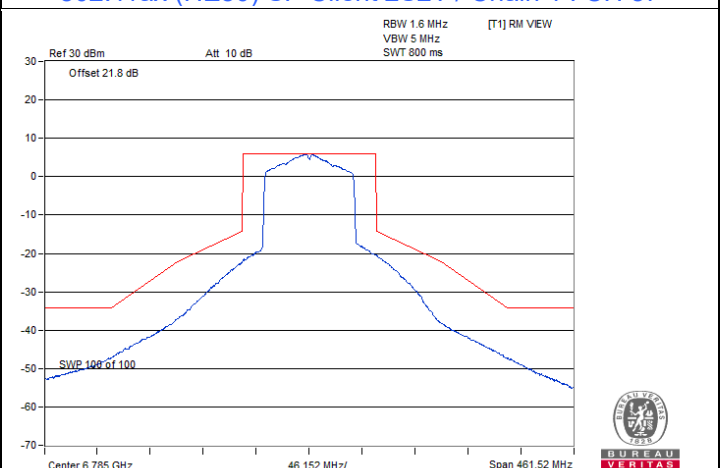

802.11ax (HE80) SP Client 2S2T / Chain 1 : CH 167

802.11ax (HE160) SP Client 2S2T

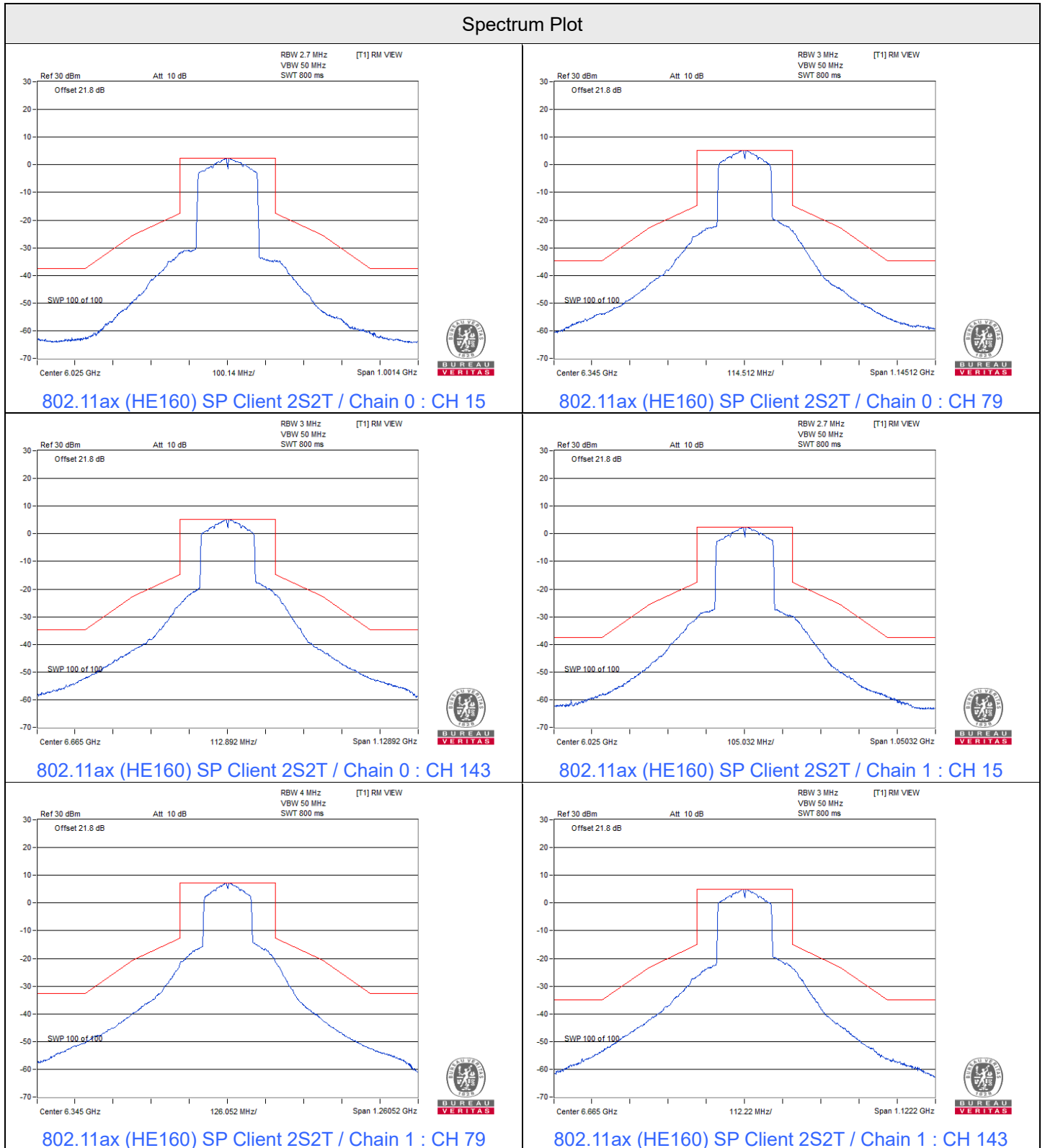

802.11be (EHT20) SP Client 2S2T

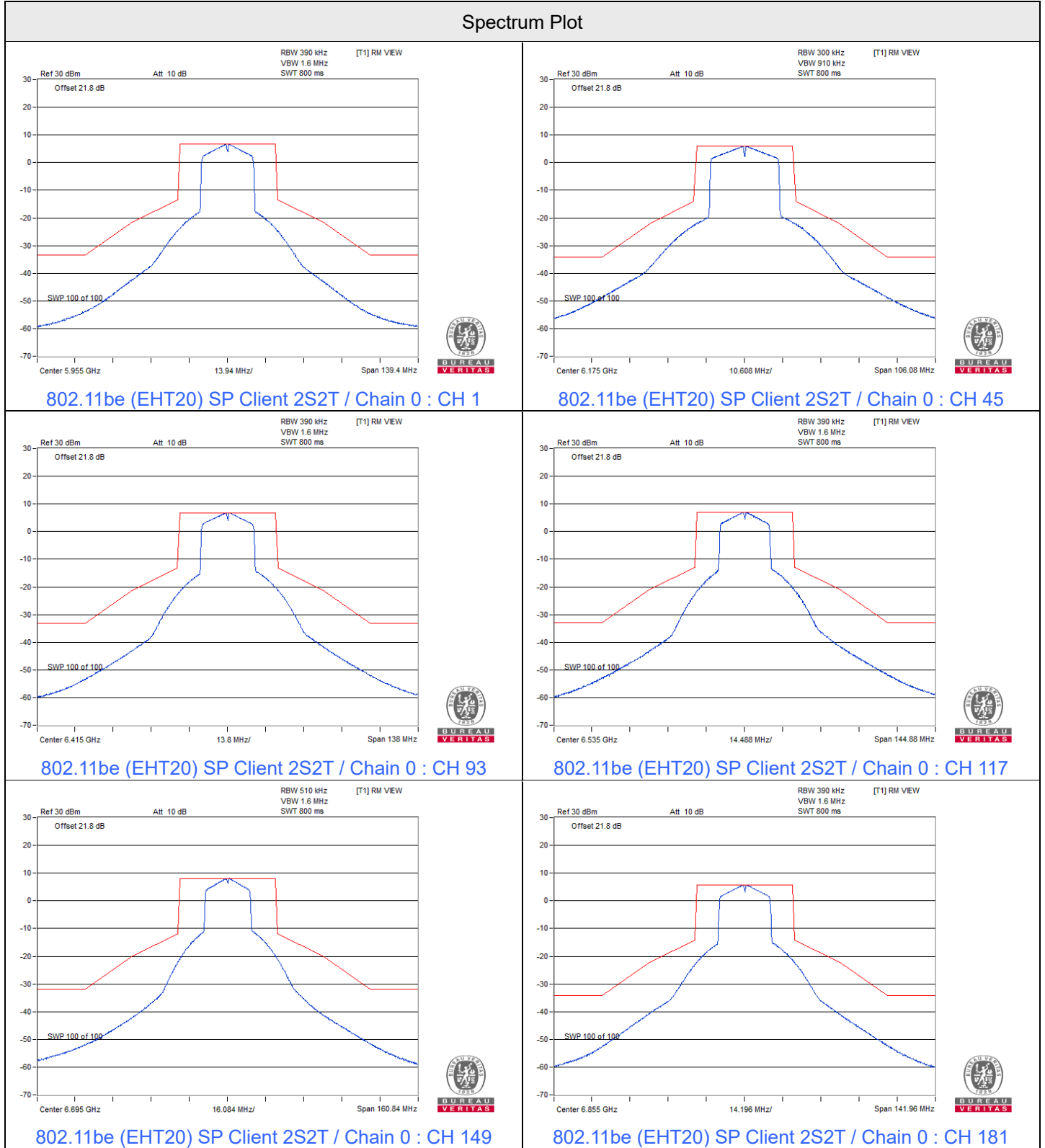

### Spectrum Plot

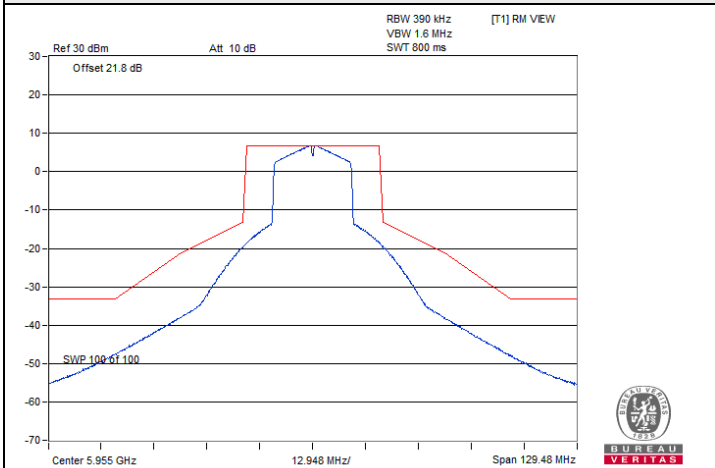

802.11be (EHT20) SP Client 2S2T / Chain 1 : CH 1

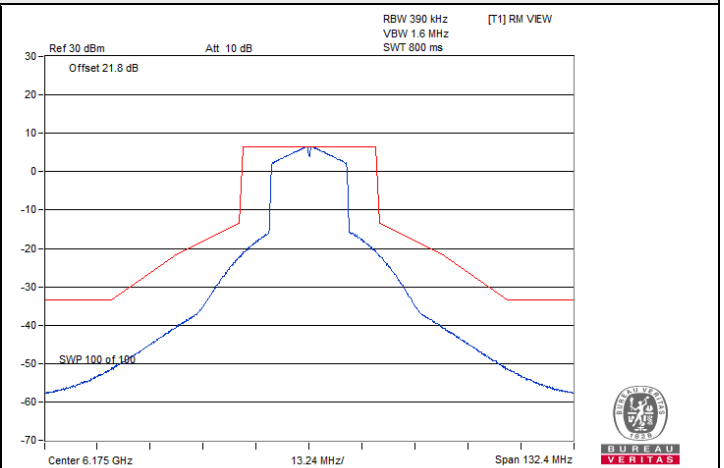

802.11be (EHT20) SP Client 2S2T / Chain 1 : CH 45

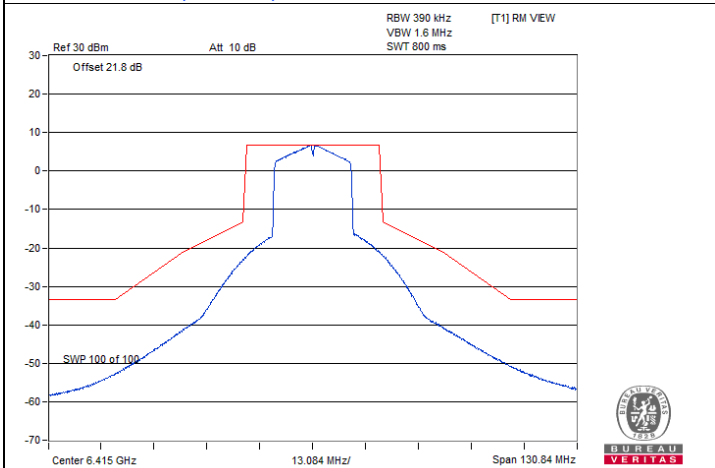

802.11be (EHT20) SP Client 2S2T / Chain 1 : CH 93

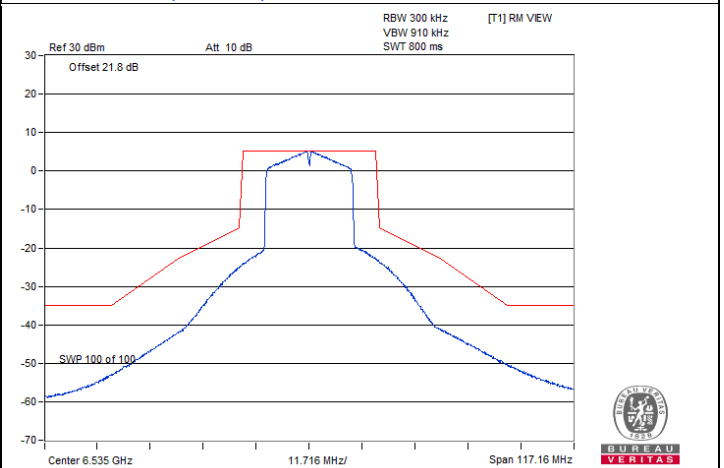

802.11be (EHT20) SP Client 2S2T / Chain 1 : CH 117

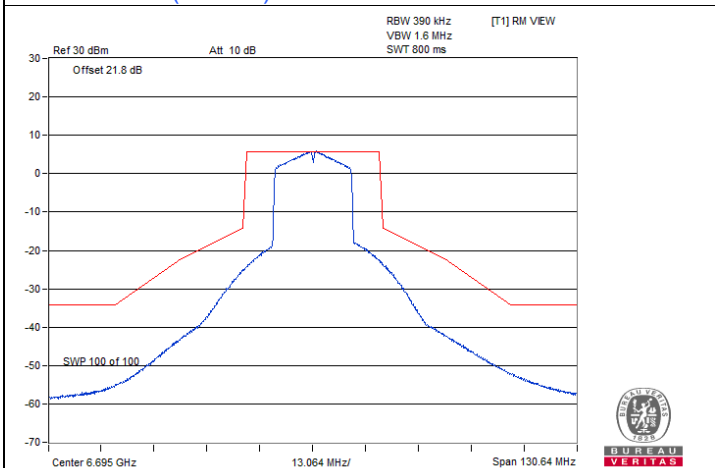

802.11be (EHT20) SP Client 2S2T / Chain 1 : CH 149

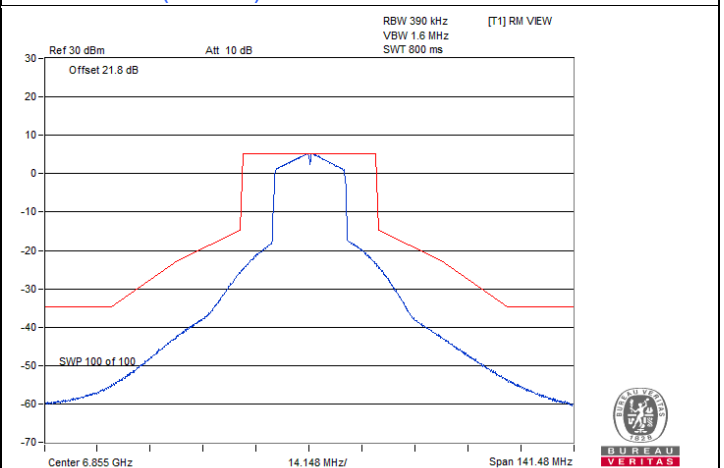

802.11be (EHT20) SP Client 2S2T / Chain 1 : CH 181

802.11be (EHT40) SP Client 2S2T

Spectrum Plot

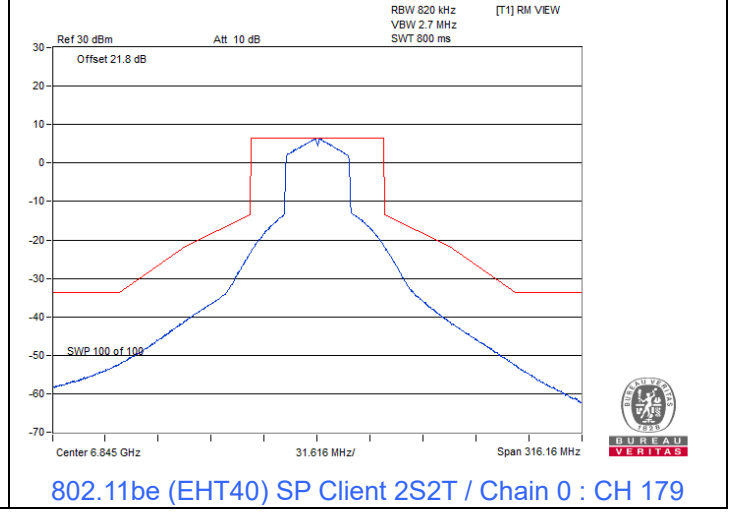
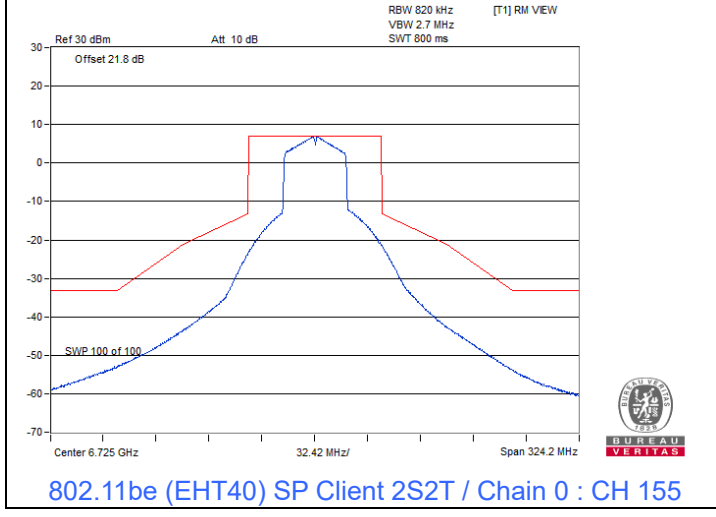
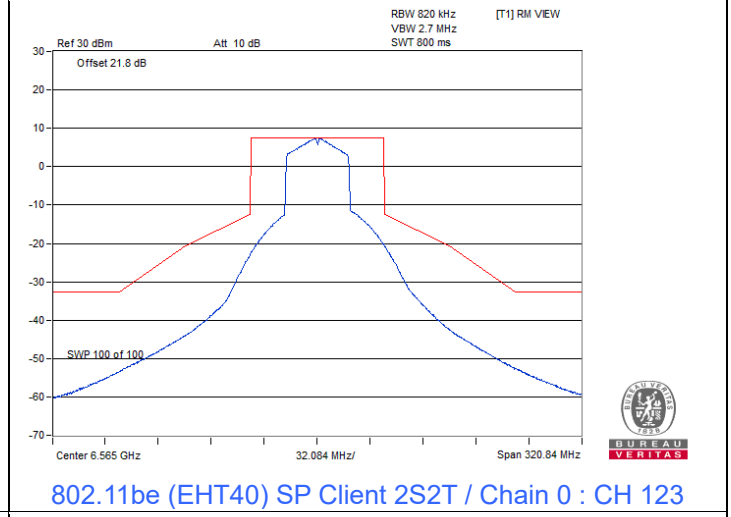
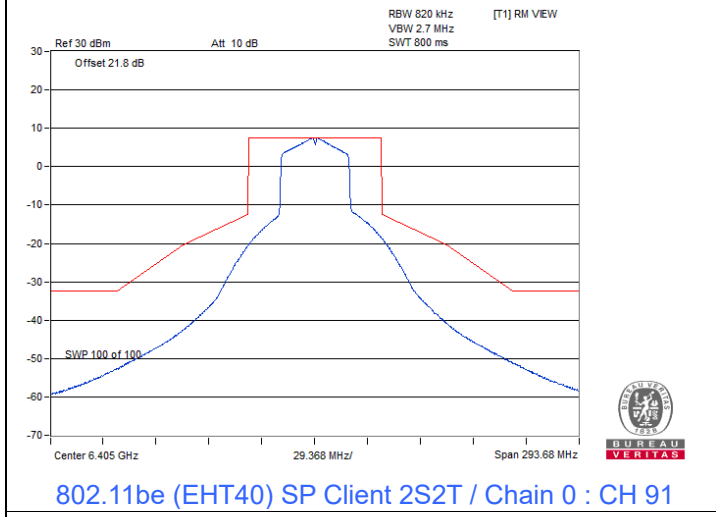
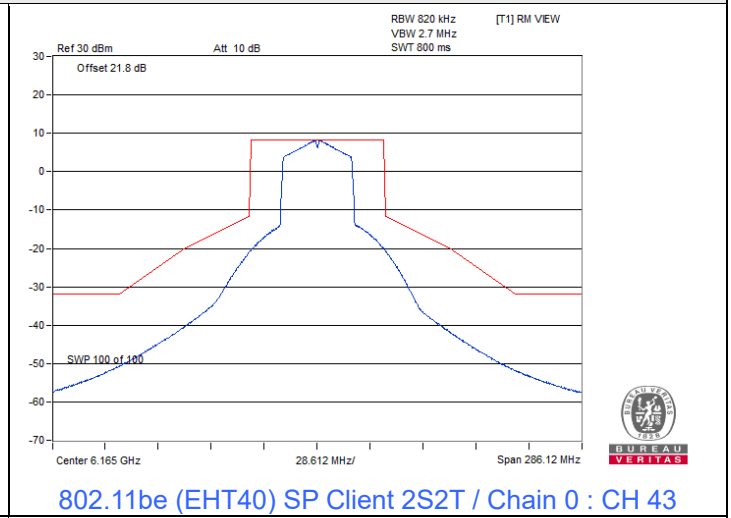
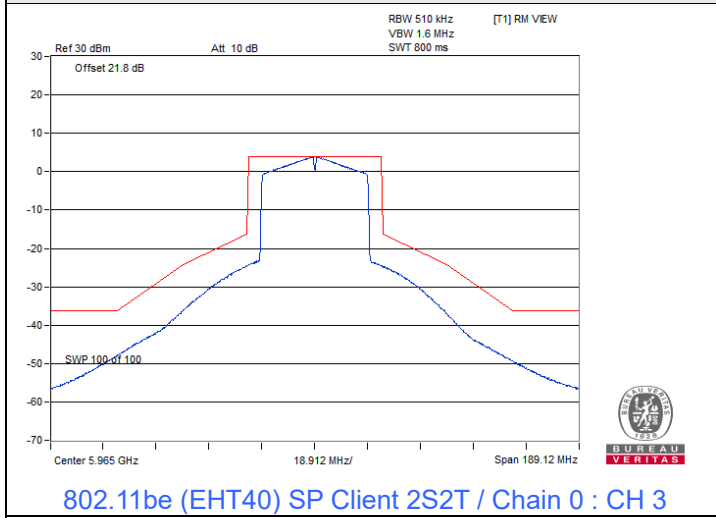



### Spectrum Plot

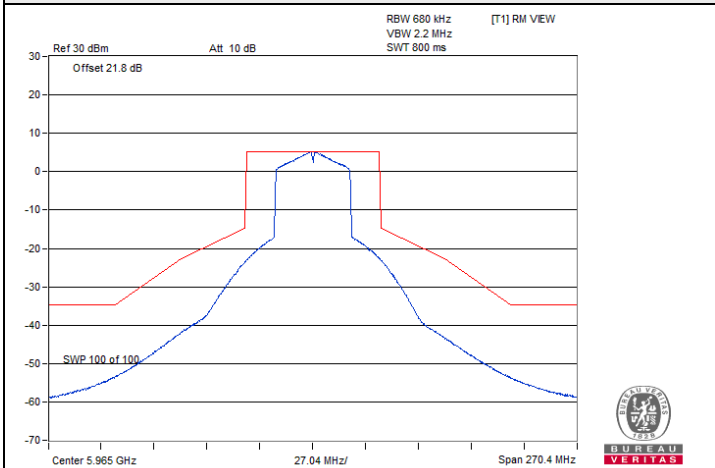

802.11be (EHT40) SP Client 2S2T / Chain 1 : CH 3

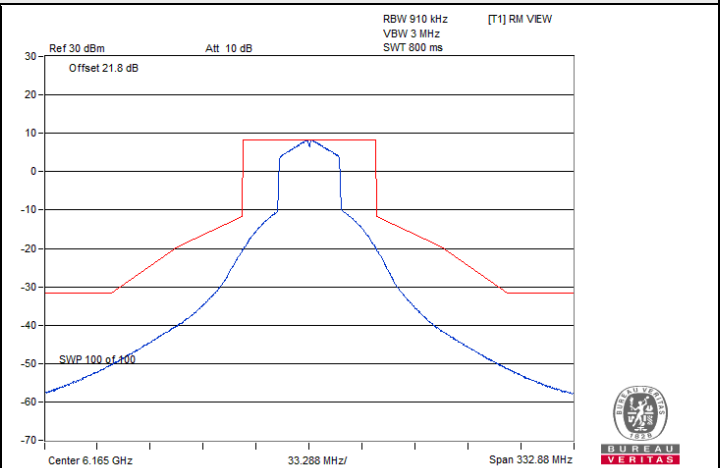

802.11be (EHT40) SP Client 2S2T / Chain 1 : CH 43

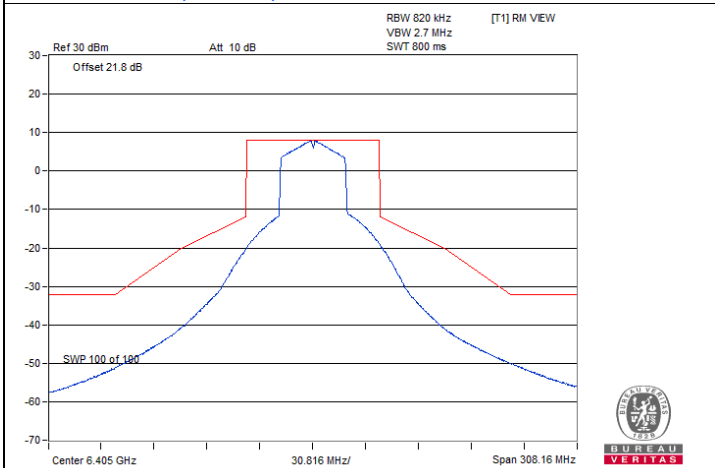

802.11be (EHT40) SP Client 2S2T / Chain 1 : CH 91

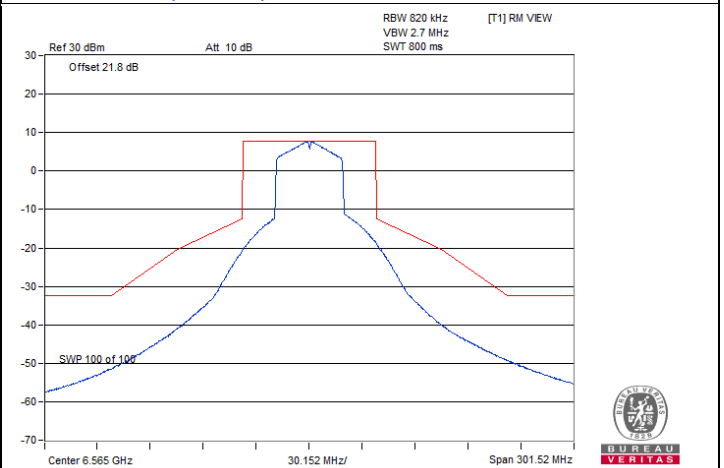

802.11be (EHT40) SP Client 2S2T / Chain 1 : CH 123

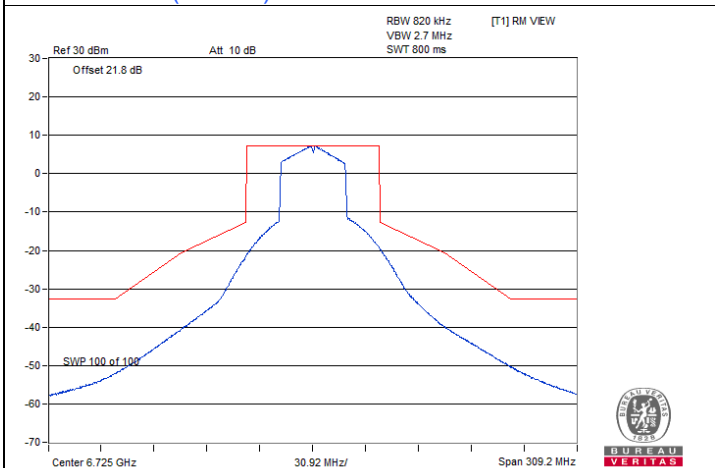

802.11be (EHT40) SP Client 2S2T / Chain 1 : CH 155

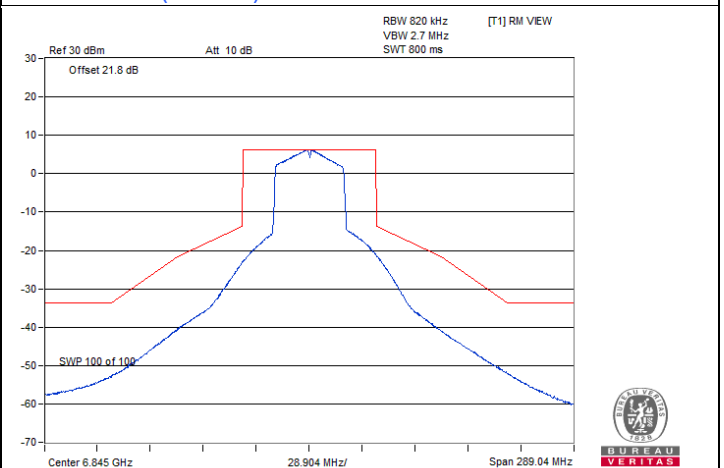

802.11be (EHT40) SP Client 2S2T / Chain 1 : CH 179

802.11be (EHT80) SP Client 2S2T

Spectrum Plot

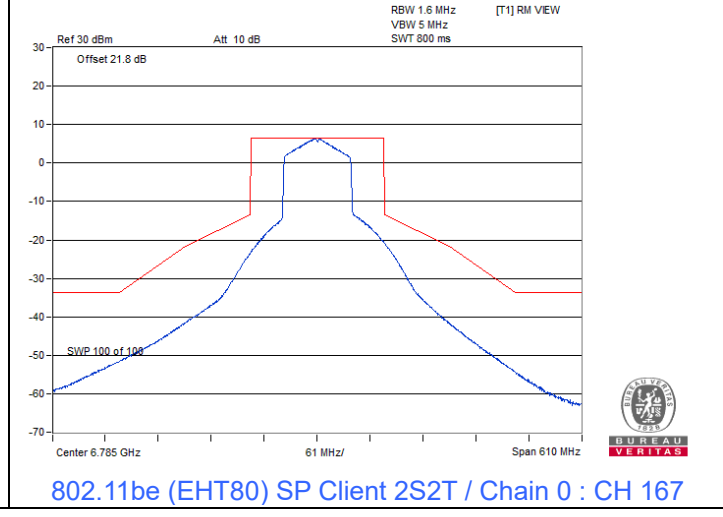
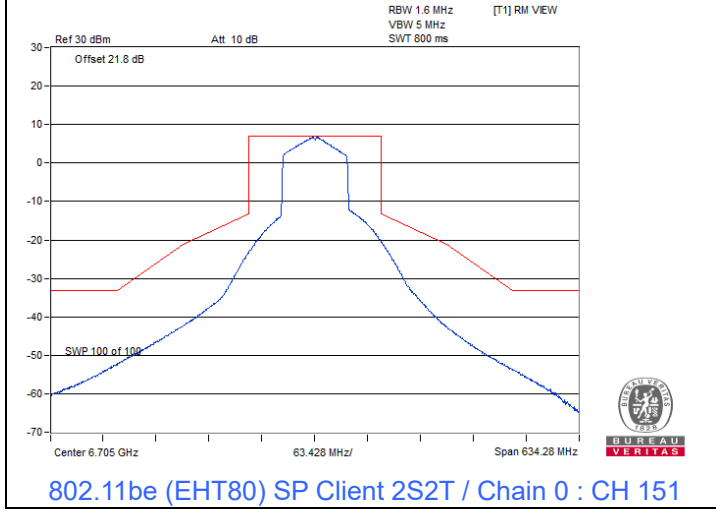
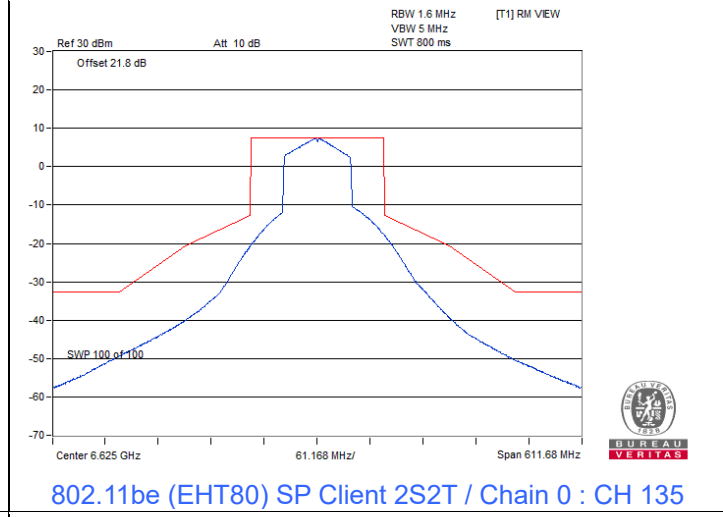
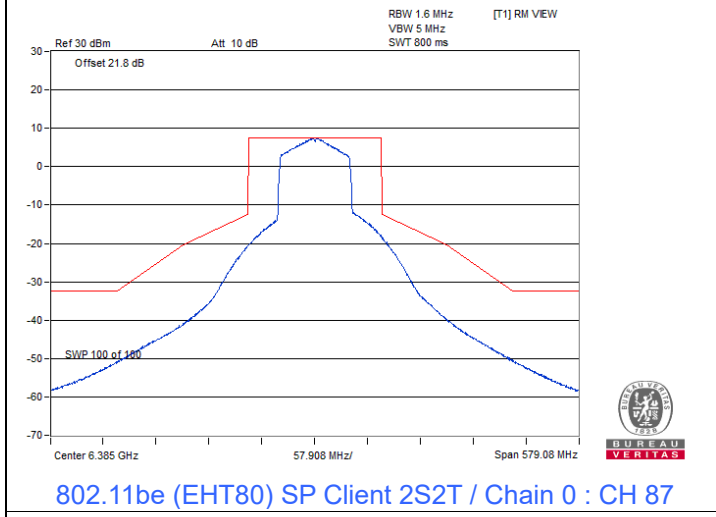
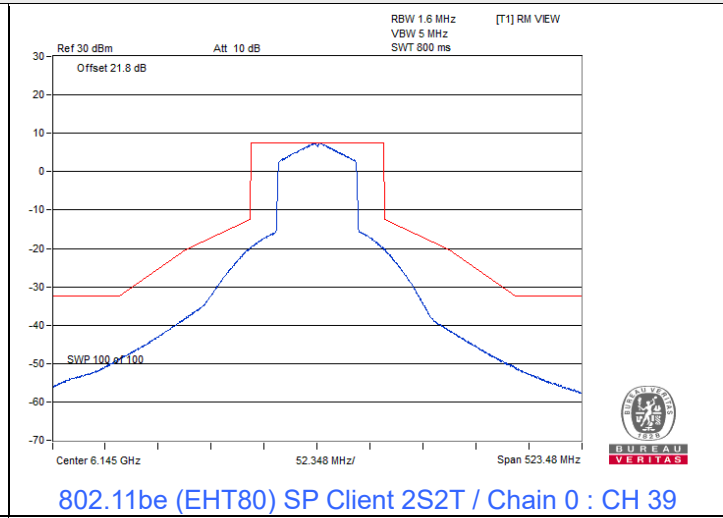
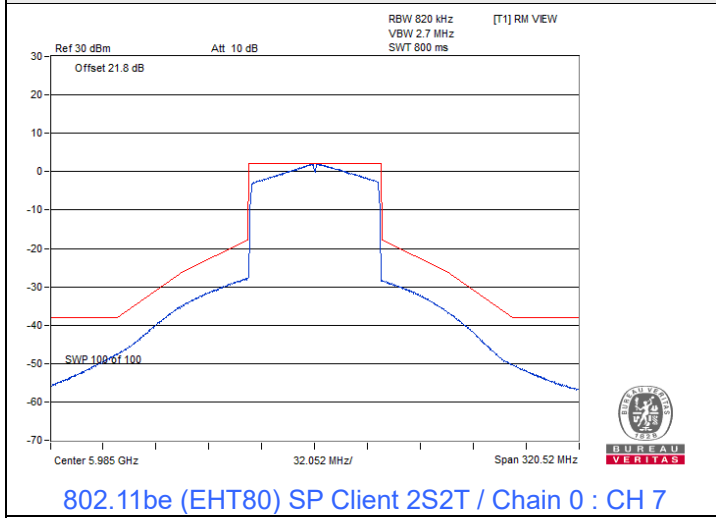

### Spectrum Plot

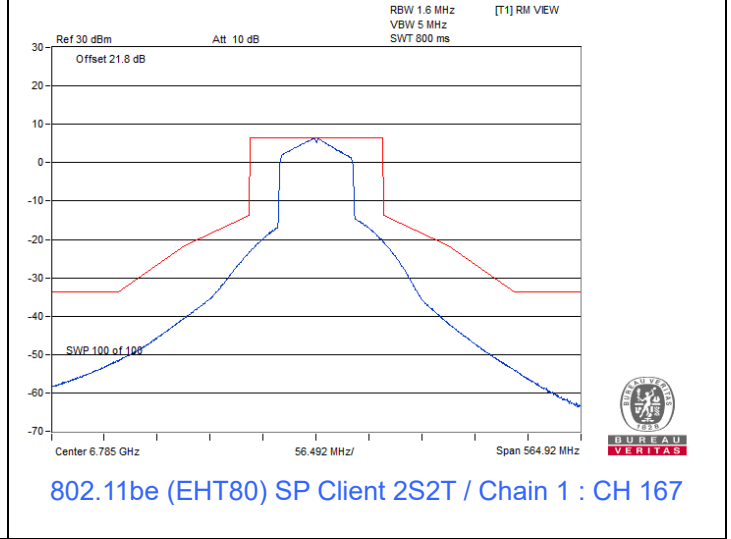
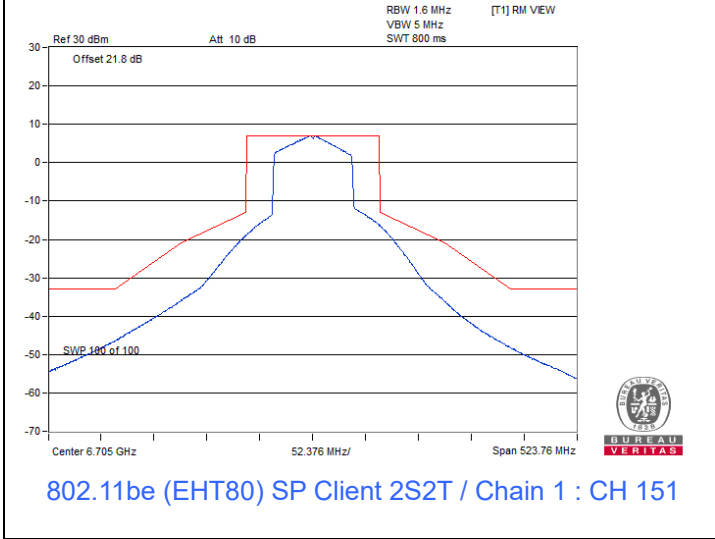
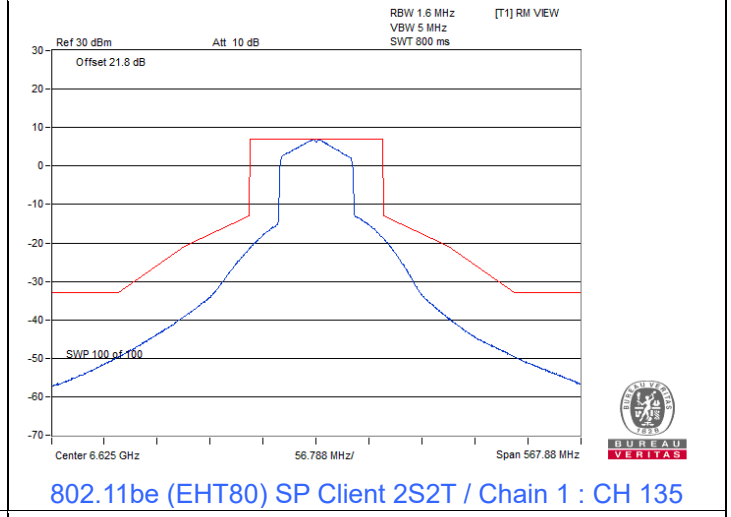
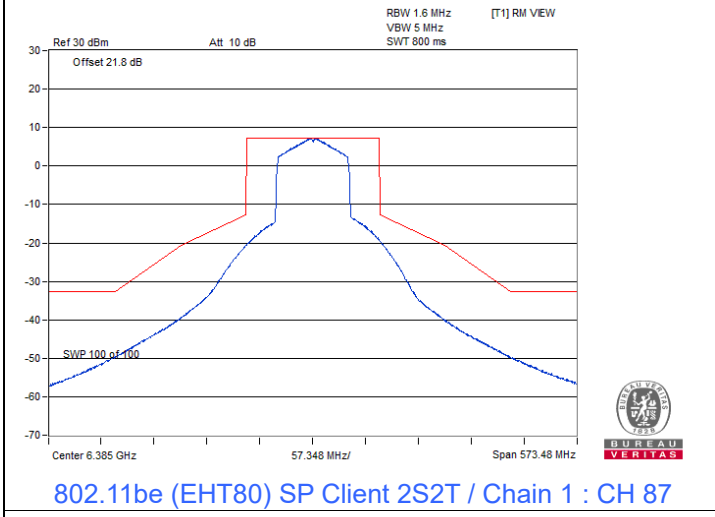
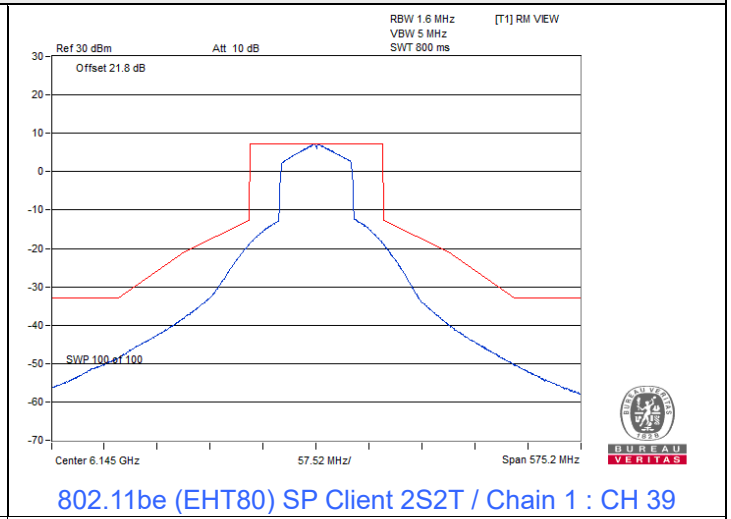
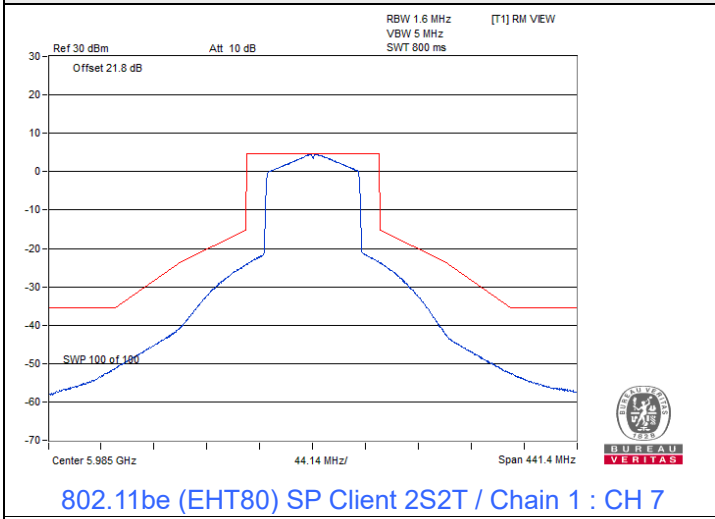

802.11be (EHT160) SP Client 2S2T

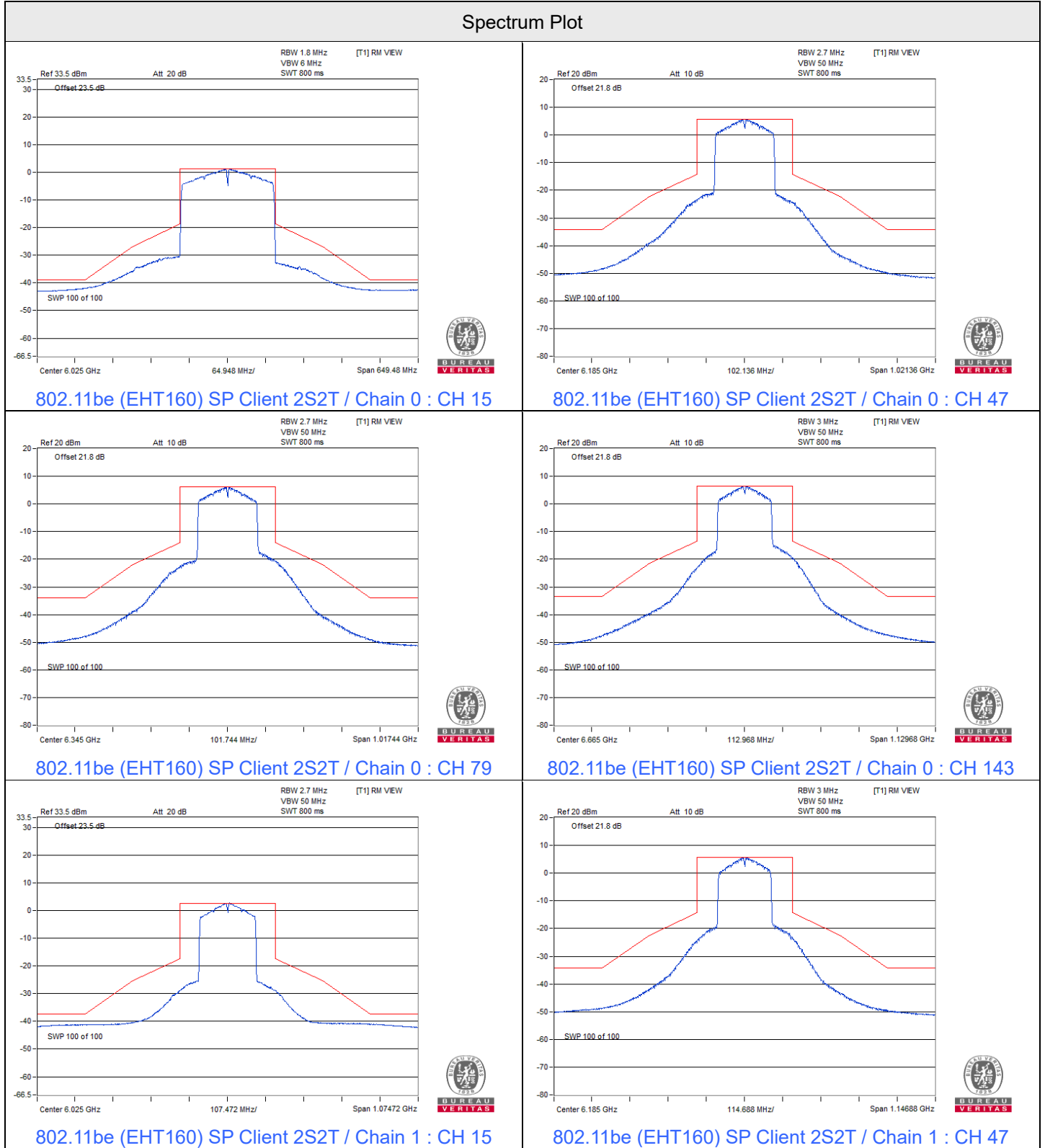

### Spectrum Plot

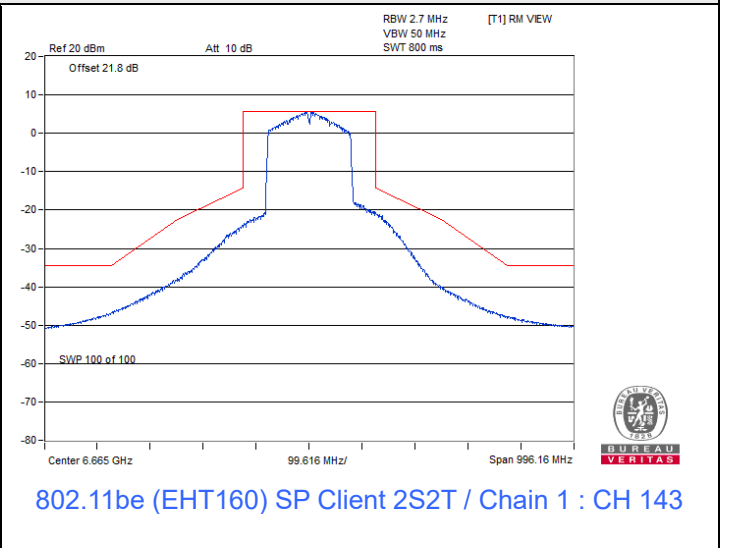
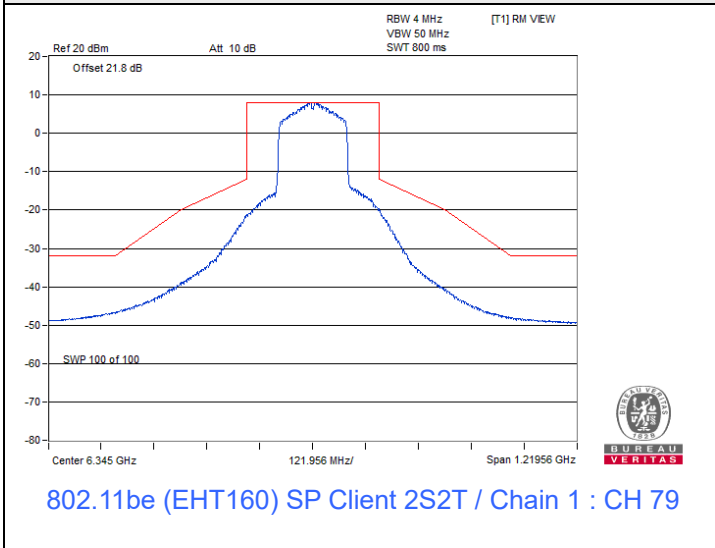

### 802.11be (EHT320) SP Client 2S2T

### Spectrum Plot

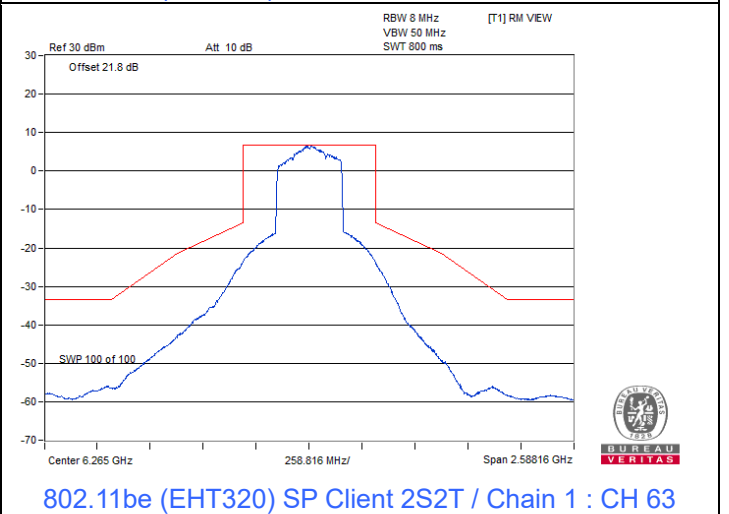
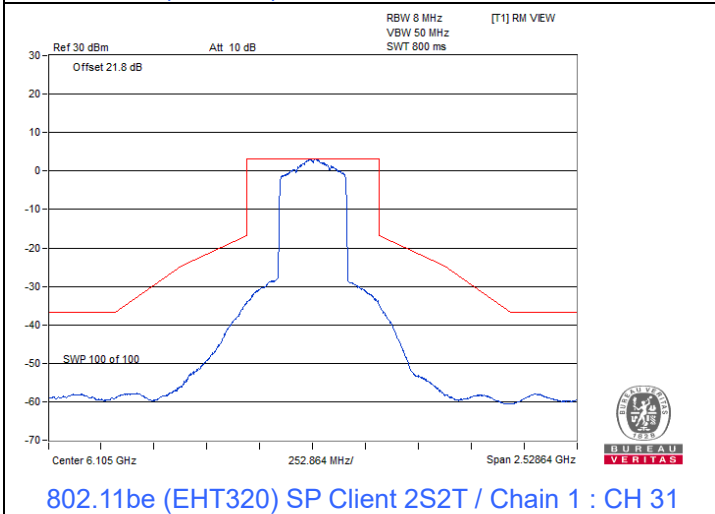
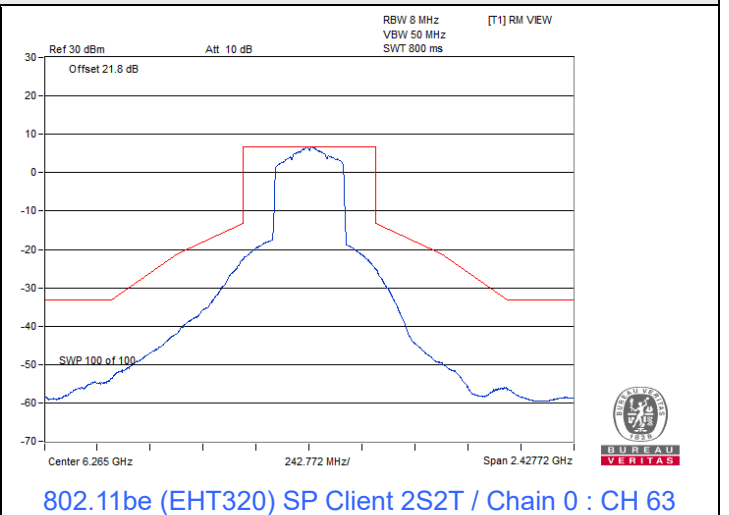
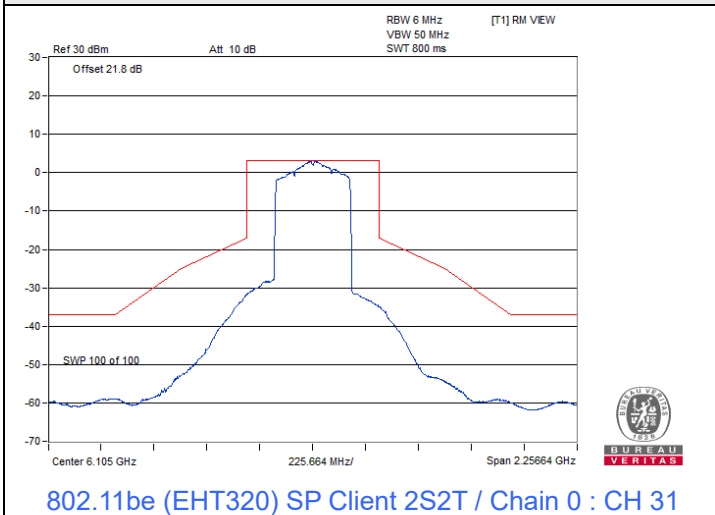



### 802.11be (EHT20) 52+26-tone MRU SP Client\_2T2S

#### Spectrum Plot

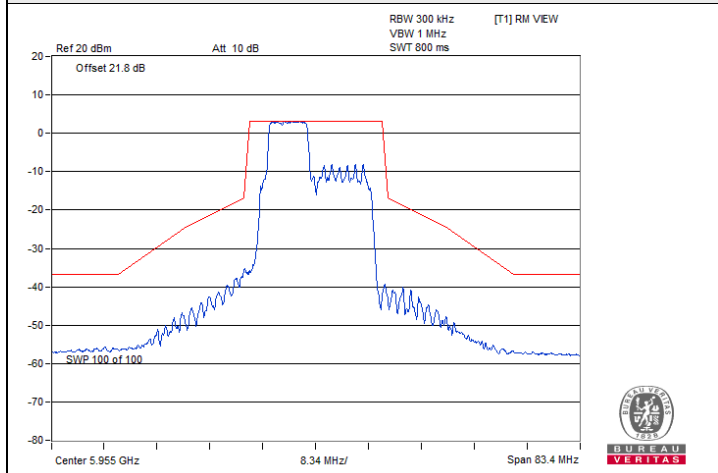

802.11be (EHT20) 52+26-tone MRU SP Client\_2T2S / Chain 0 : CH 1@70

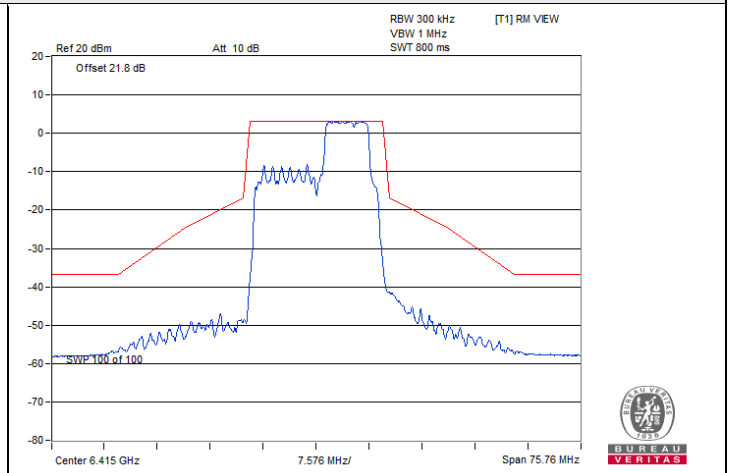

802.11be (EHT20) 52+26-tone MRU SP Client\_2T2S / Chain 0 : CH 93@72

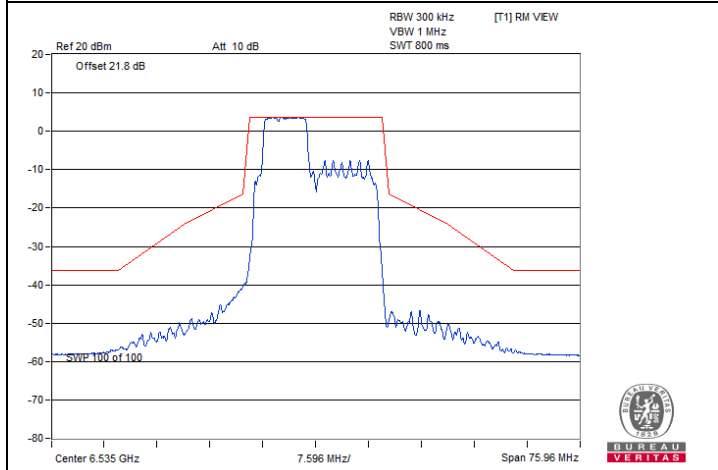

802.11be (EHT20) 52+26-tone MRU SP Client\_2T2S / Chain 0 : CH 117@70

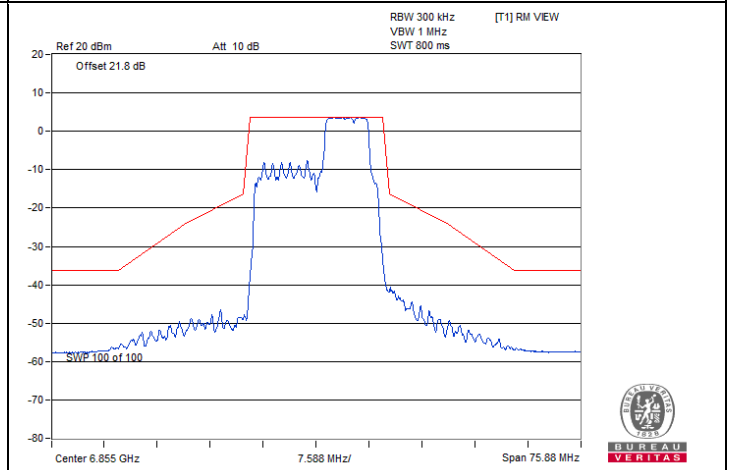

802.11be (EHT20) 52+26-tone MRU SP Client\_2T2S / Chain 0 : CH 181@72

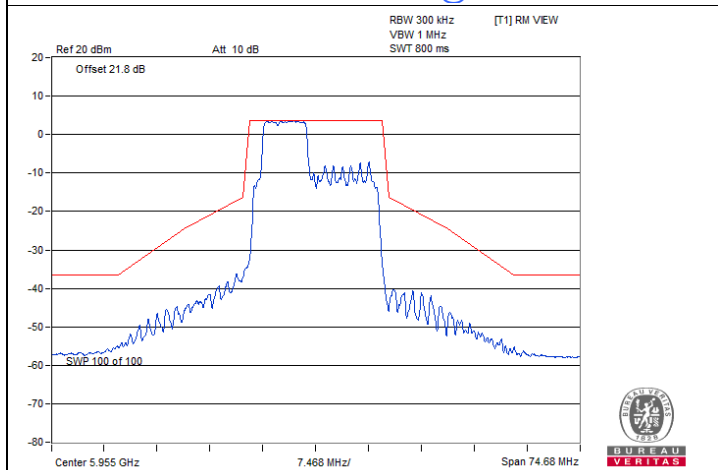

802.11be (EHT20) 52+26-tone MRU SP Client\_2T2S / Chain 1 : CH 1@70

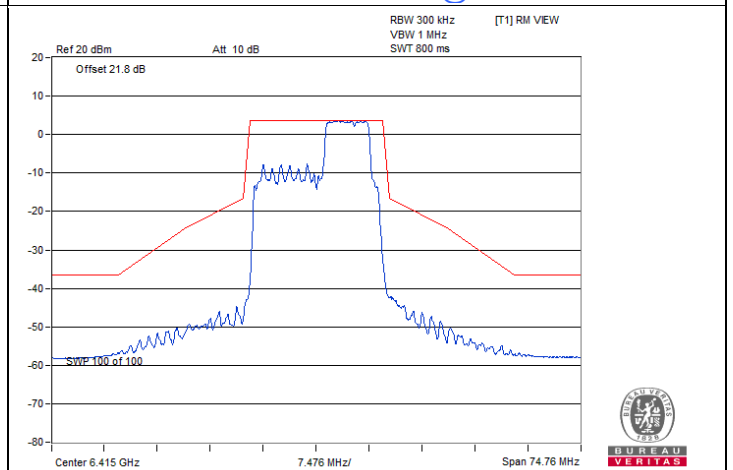

802.11be (EHT20) 52+26-tone MRU SP Client\_2T2S / Chain 1 : CH 93@72

### Spectrum Plot

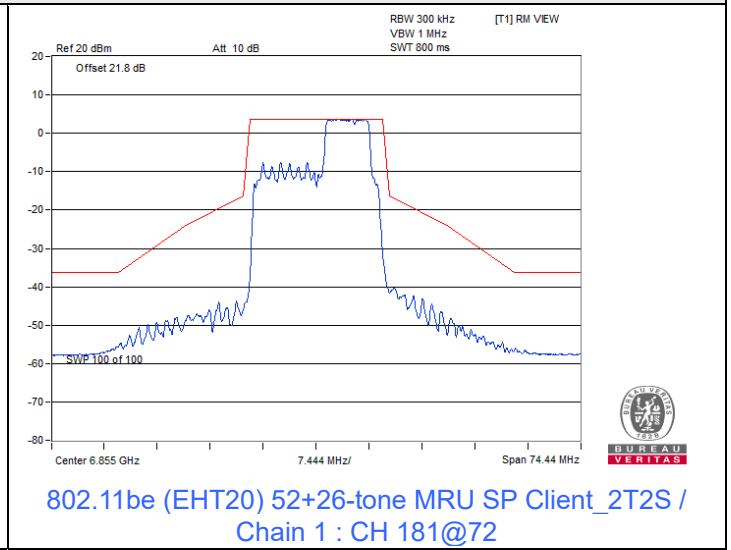
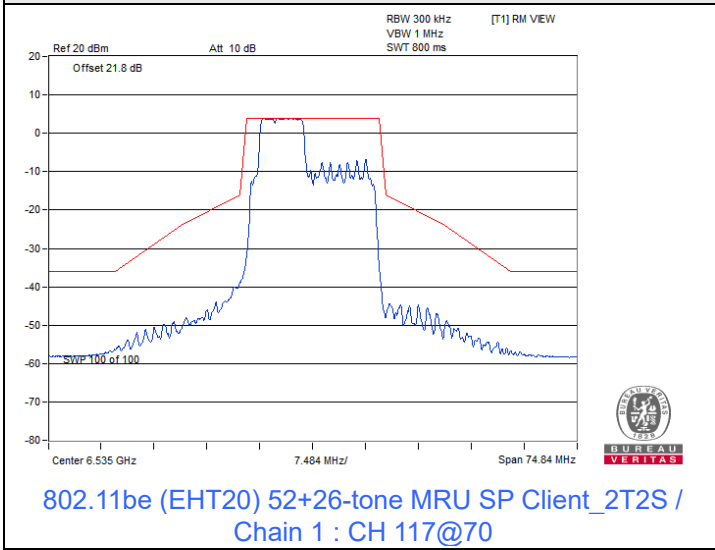

### 802.11be (EHT20) 106+26-tone MRU SP Client\_2T2S

### Spectrum Plot

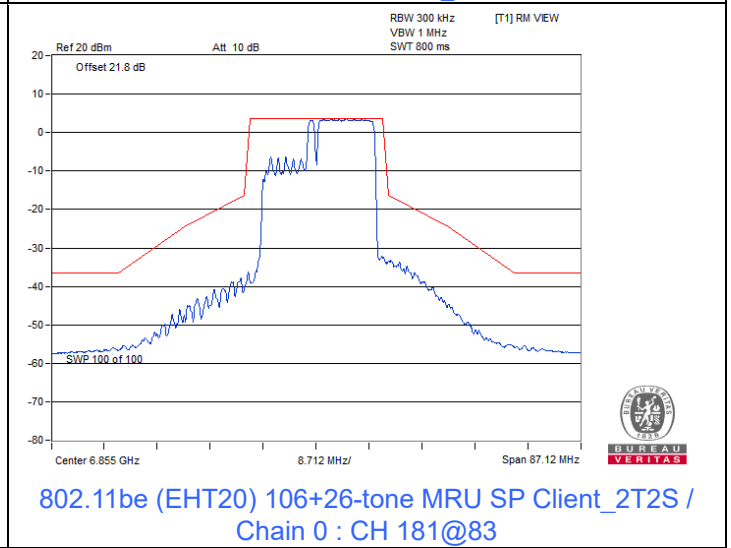
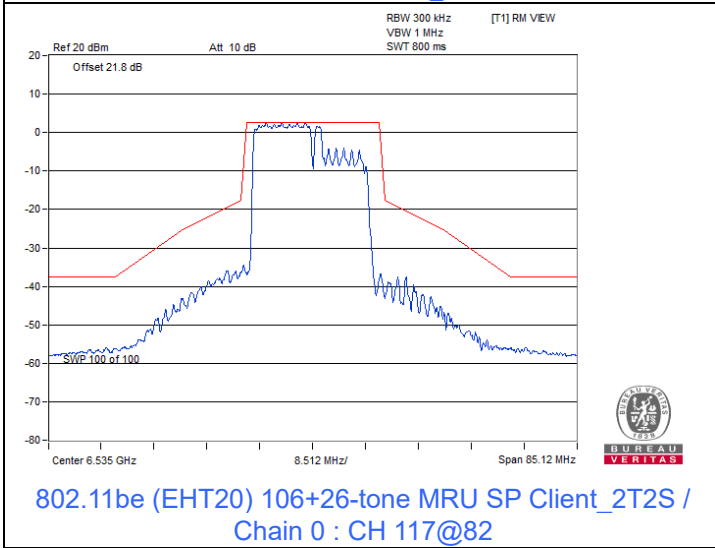
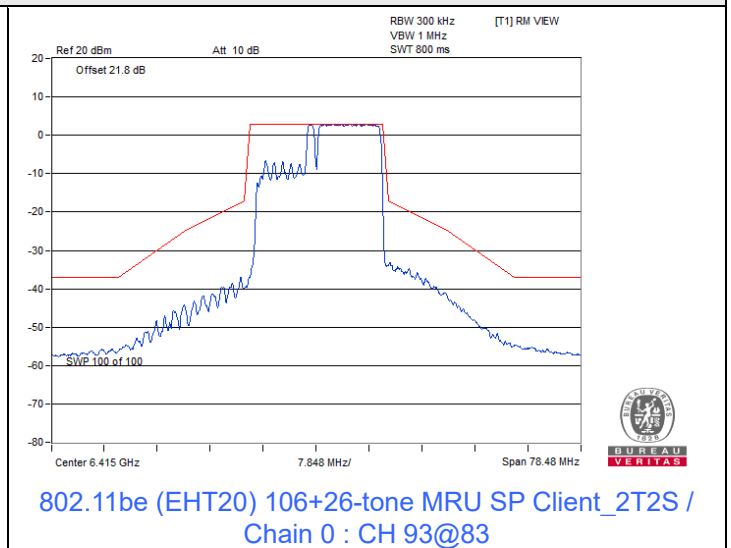
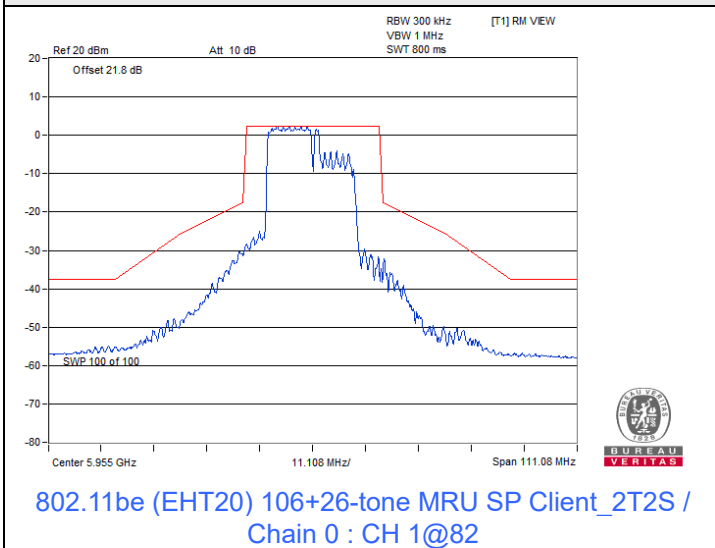

### Spectrum Plot

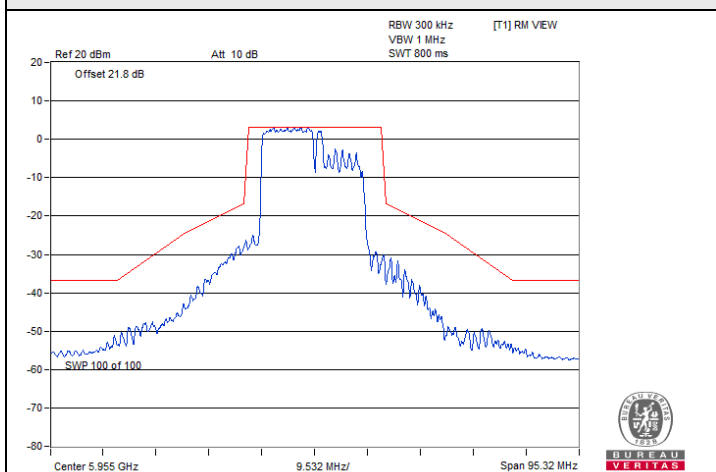

802.11be (EHT20) 106+26-tone MRU SP Client\_2T2S /  
Chain 1 : CH 1@82

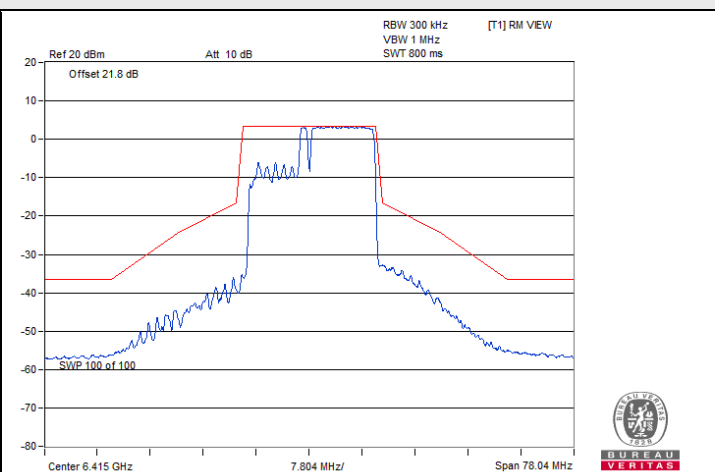

802.11be (EHT20) 106+26-tone MRU SP Client\_2T2S /  
Chain 1 : CH 93@83

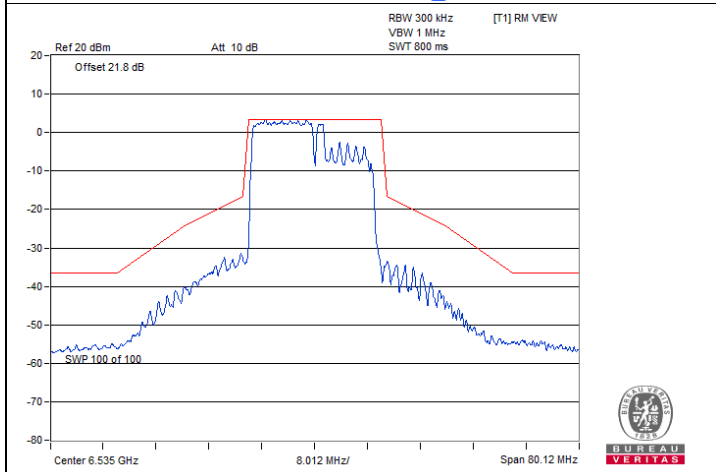

802.11be (EHT20) 106+26-tone MRU SP Client\_2T2S /  
Chain 1 : CH 117@82

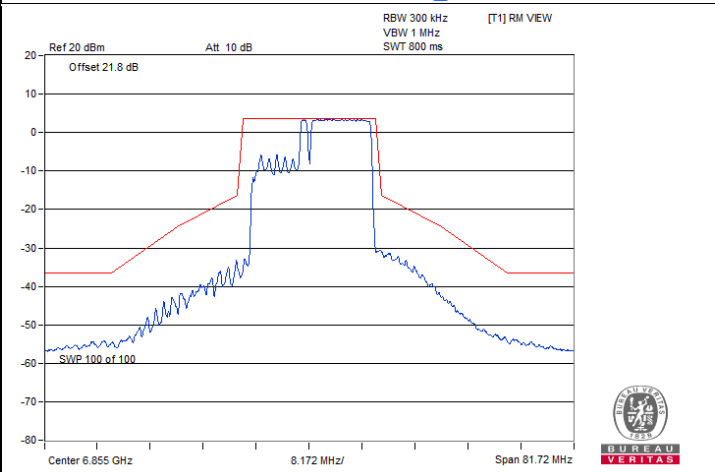

802.11be (EHT20) 106+26-tone MRU SP Client\_2T2S /  
Chain 1 : CH 181@83





### 802.11be (EHT80) 484+242-tone MRU SP Client\_2T2S

#### Spectrum Plot

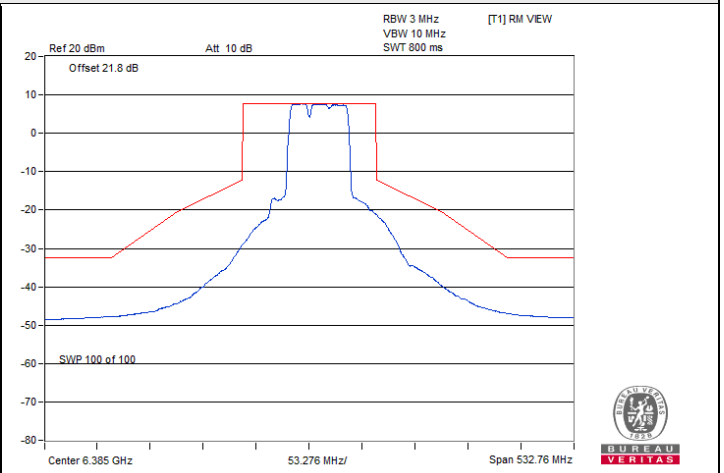
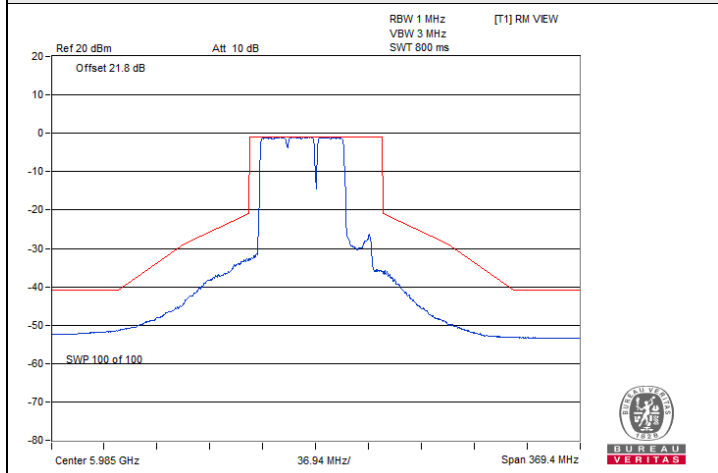

802.11be (EHT80) 484+242-tone MRU SP Client\_2T2S / Chain 0 : CH 7@93

802.11be (EHT80) 484+242-tone MRU SP Client\_2T2S / Chain 0 : CH 87@90

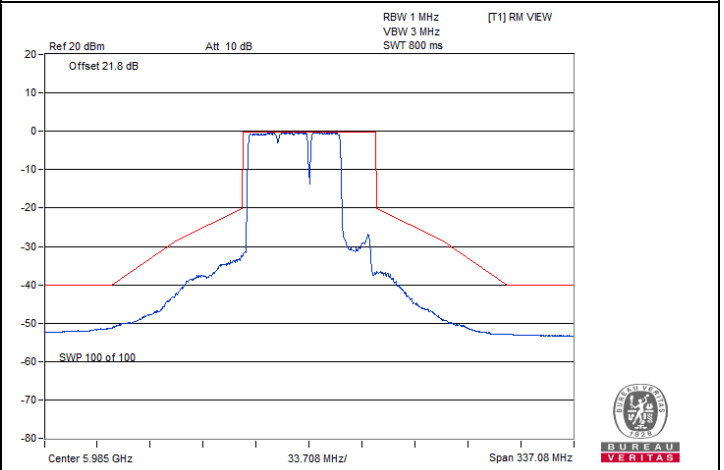
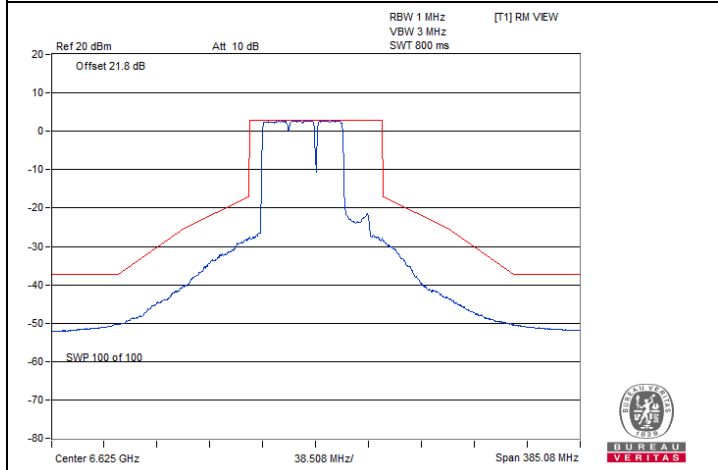

802.11be (EHT80) 484+242-tone MRU SP Client\_2T2S / Chain 0 : CH 135@93

802.11be (EHT80) 484+242-tone MRU SP Client\_2T2S / Chain 1 : CH 7@93

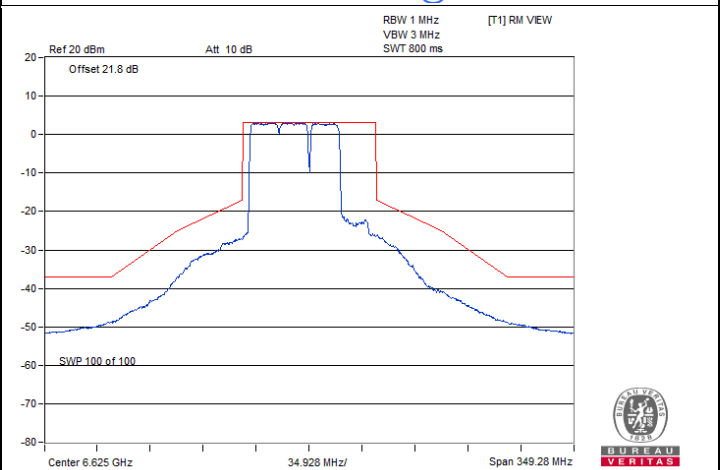
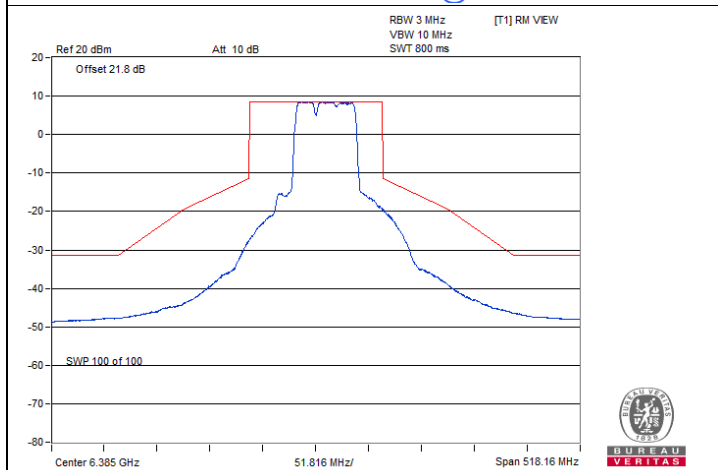

802.11be (EHT80) 484+242-tone MRU SP Client\_2T2S / Chain 1 : CH 87@90

802.11be (EHT80) 484+242-tone MRU SP Client\_2T2S / Chain 1 : CH 135@93

802.11be (EHT160) 996+484-tone MRU SP Client\_2T2S

Spectrum Plot

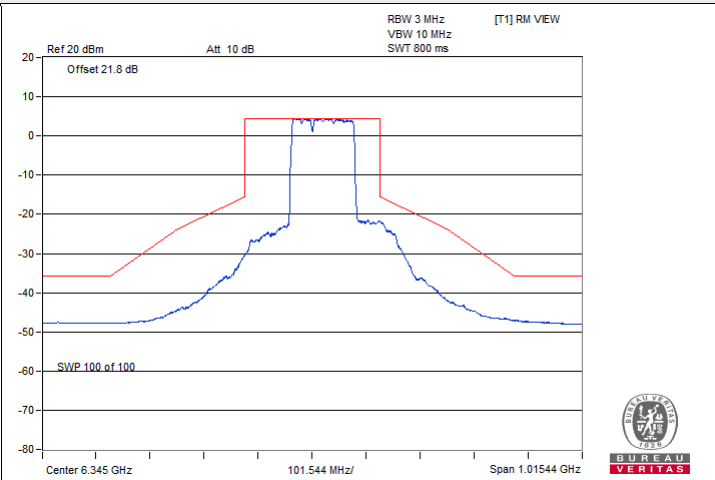
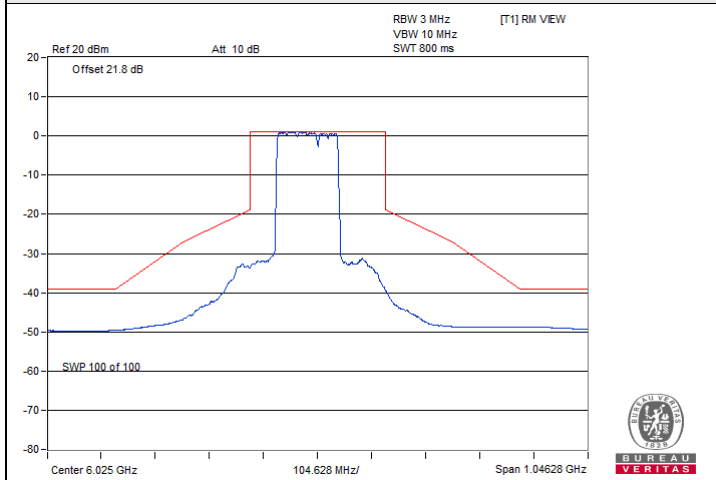

802.11be (EHT160) 996+484-tone MRU SP Client\_2T2S / Chain 0 : CH 15@95\_1

802.11be (EHT160) 996+484-tone MRU SP Client\_2T2S / Chain 0 : CH 79@94\_0

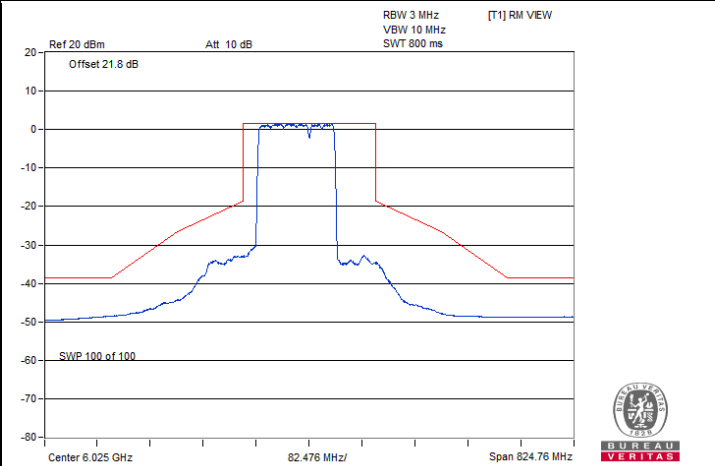
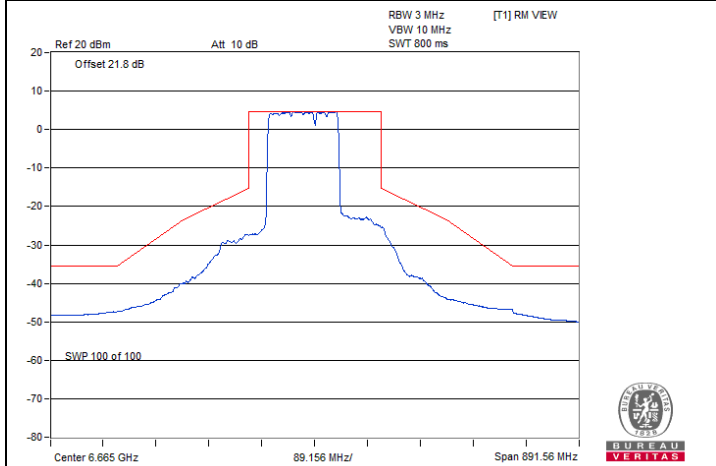

802.11be (EHT160) 996+484-tone MRU SP Client\_2T2S / Chain 0 : CH 143@95\_1

802.11be (EHT160) 996+484-tone MRU SP Client\_2T2S / Chain 1 : CH 15@95\_1

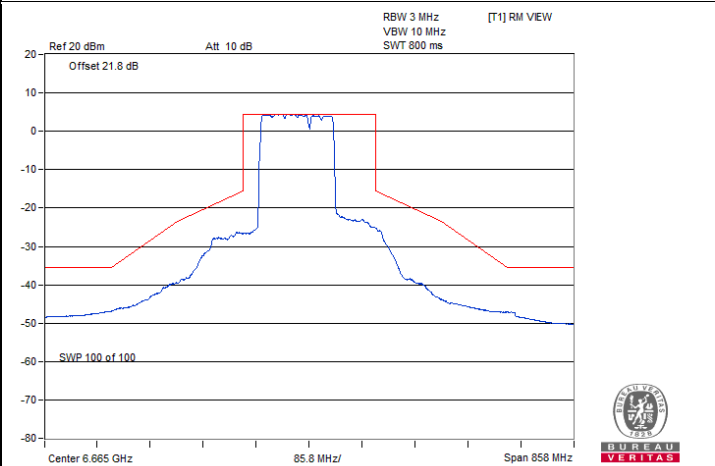
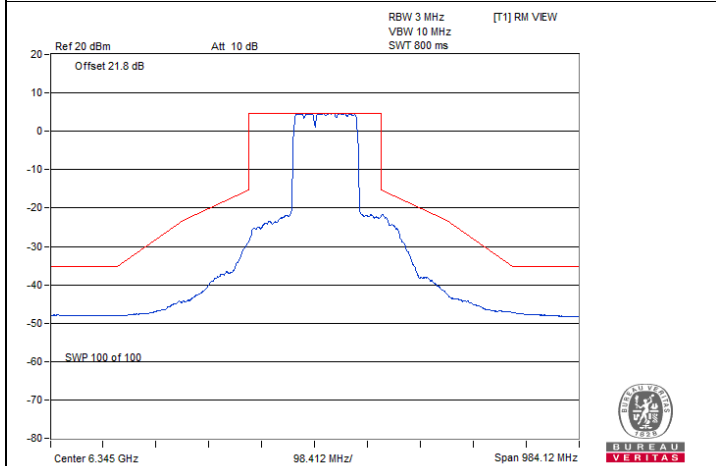

802.11be (EHT160) 996+484-tone MRU SP Client\_2T2S / Chain 1 : CH 79@94\_0

802.11be (EHT160) 996+484-tone MRU SP Client\_2T2S / Chain 1 : CH 143@95\_1

802.11be (EHT160) 996+484+242-tone MRU SP Client\_2T2S

Spectrum Plot

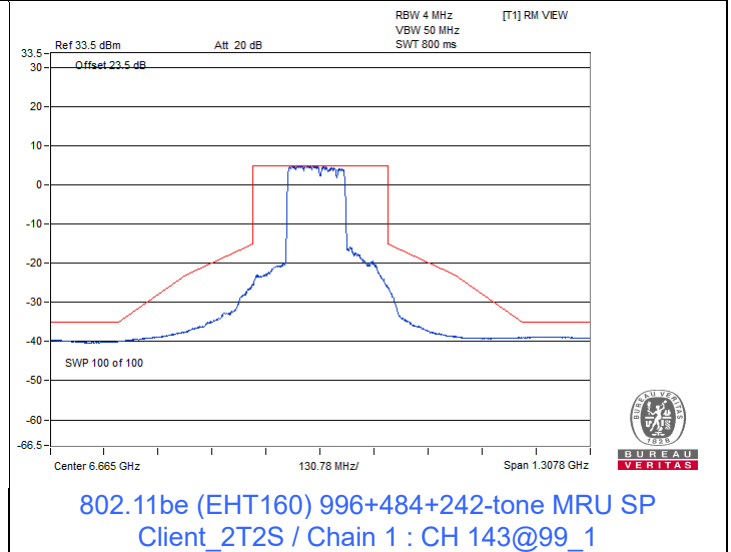
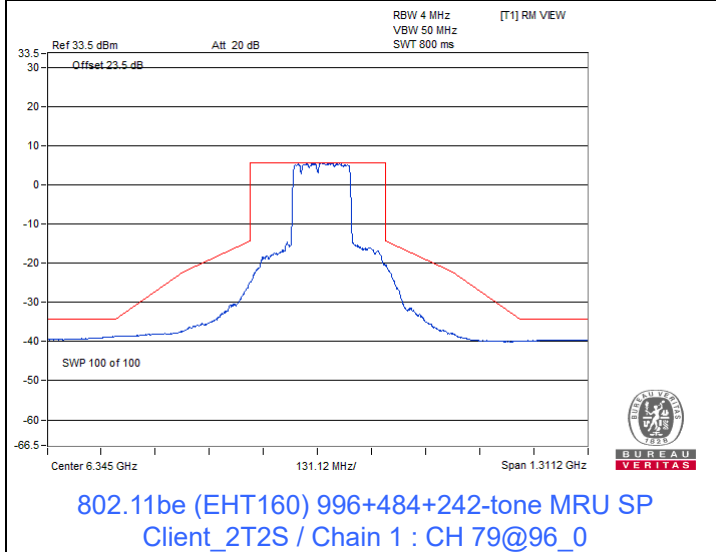
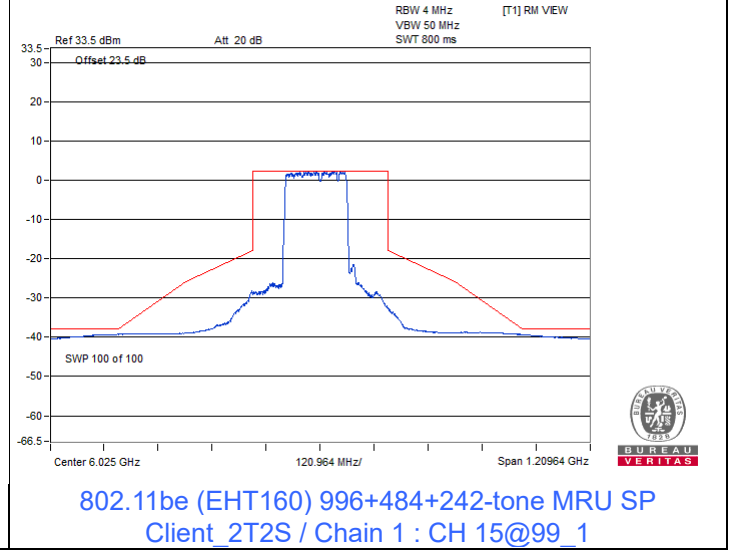
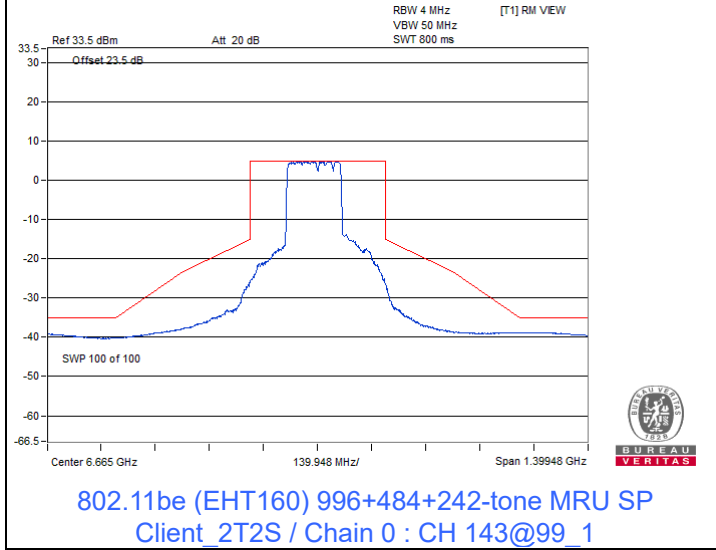
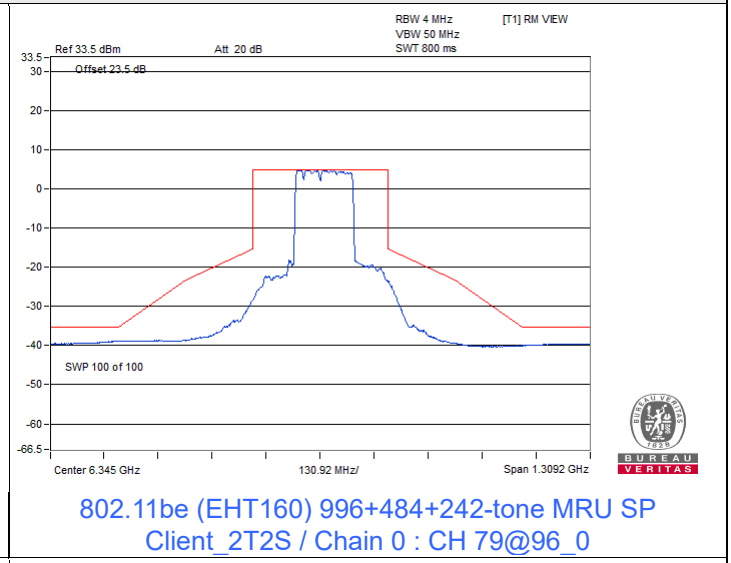
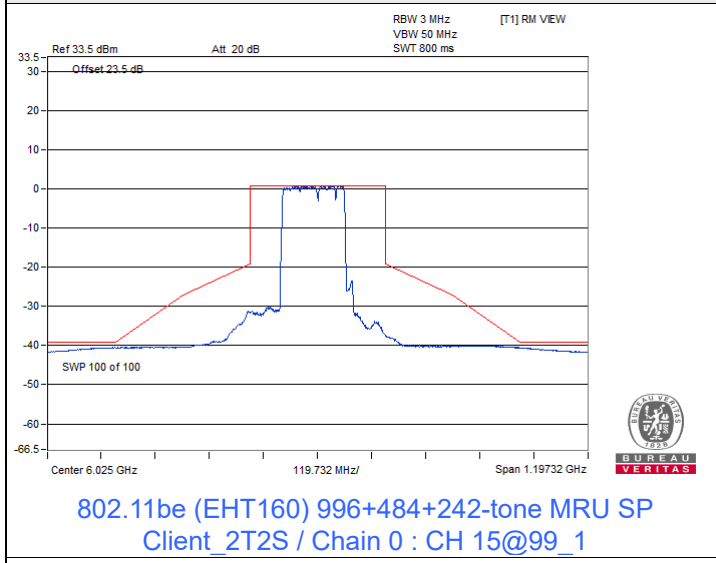



802.11be (EHT320) 2x996+484-tone MRU SP Client 2T2S

Spectrum Plot

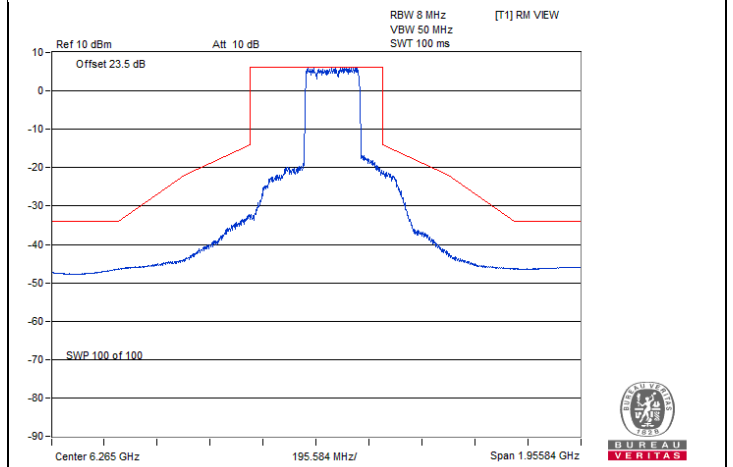
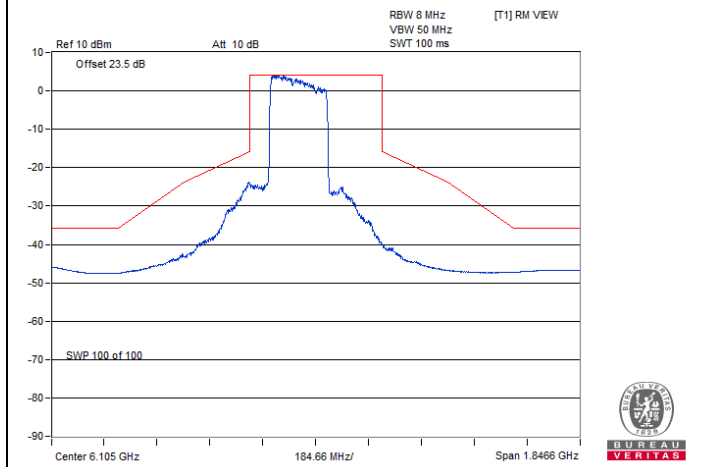

802.11be (EHT320) 2x996+484-tone MRU SP Client 2T2S / Chain 0 : CH 31@101\_1\_0

802.11be (EHT320) 2x996+484-tone MRU SP Client 2T2S / Chain 0 : CH 63@102\_0\_1

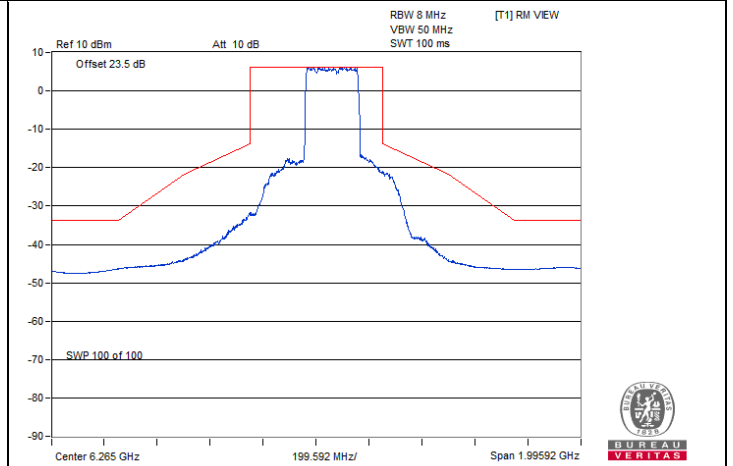
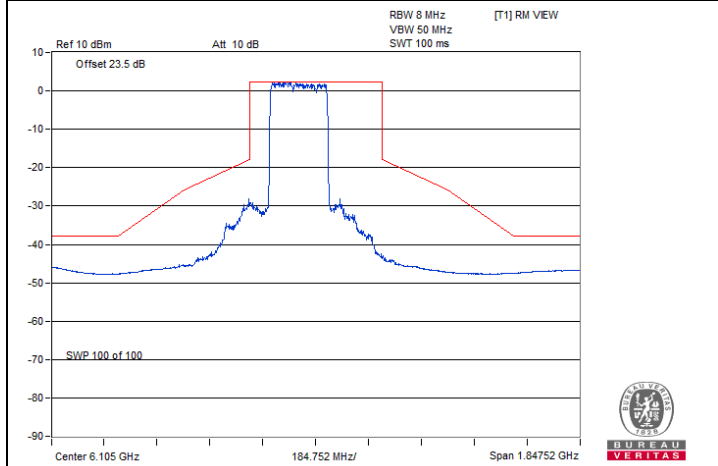

802.11be (EHT320) 2x996+484-tone MRU SP Client 2T2S / Chain 1 : CH 31@101\_1\_0

802.11be (EHT320) 2x996+484-tone MRU SP Client 2T2S / Chain 1 : CH 63@102\_0\_1



### 802.11be (EHT320) 3x996-tone MRU SP Client 2T2S

#### Spectrum Plot

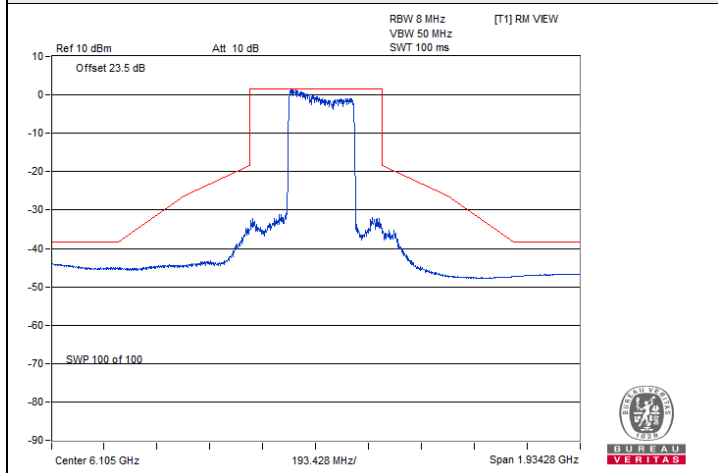

802.11be (EHT320) 3x996-tone MRU SP Client 2T2S /  
Chain 0 : CH 31@104\_1\_1

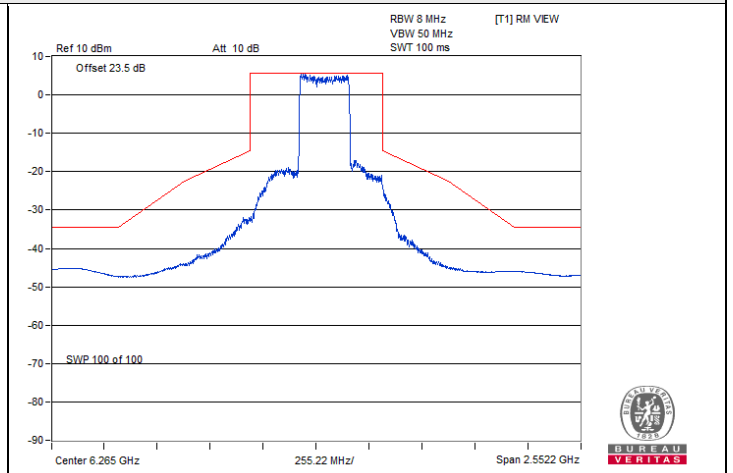

802.11be (EHT320) 3x996-tone MRU SP Client 2T2S /  
Chain 0 : CH 63@104\_0\_0

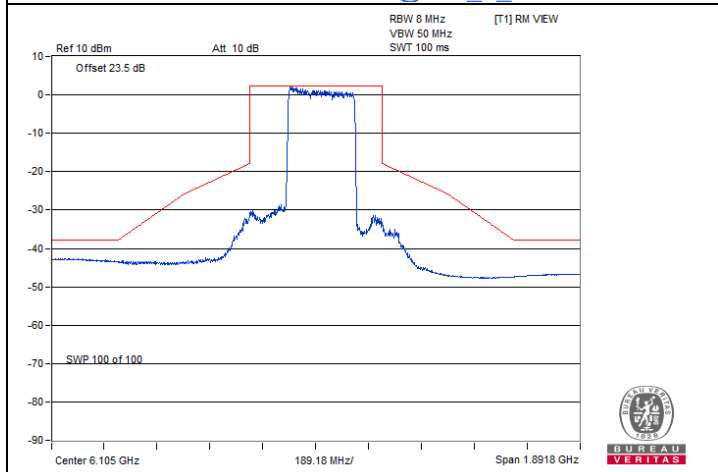

802.11be (EHT320) 3x996-tone MRU SP Client 2T2S /  
Chain 1 : CH 31@104\_1\_1

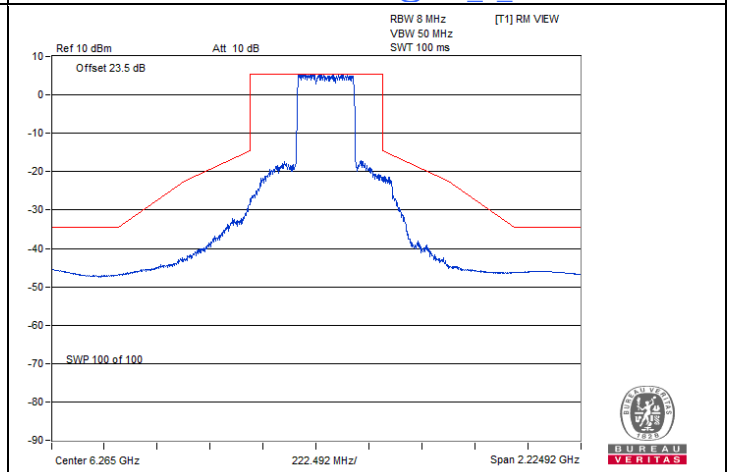

802.11be (EHT320) 3x996-tone MRU SP Client 2T2S /  
Chain 1 : CH 63@104\_0\_0

### 802.11be (EHT320) 3x996+484-tone MRU SP Client 2T2S

#### Spectrum Plot

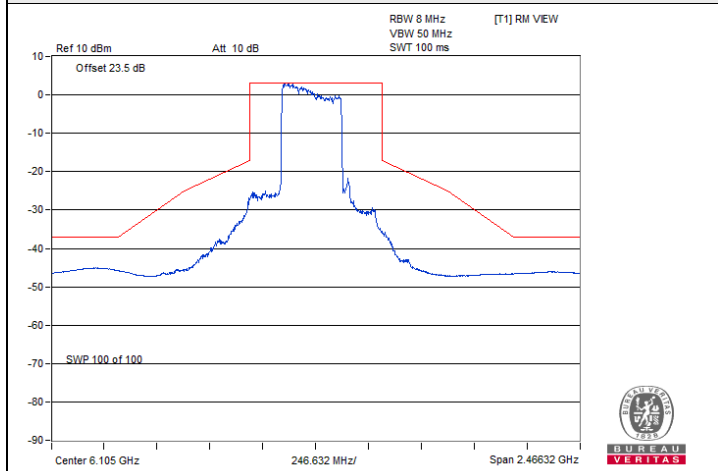

802.11be (EHT320) 3x996+484-tone MRU SP Client 2T2S / Chain 0 : CH 31@106\_1\_1

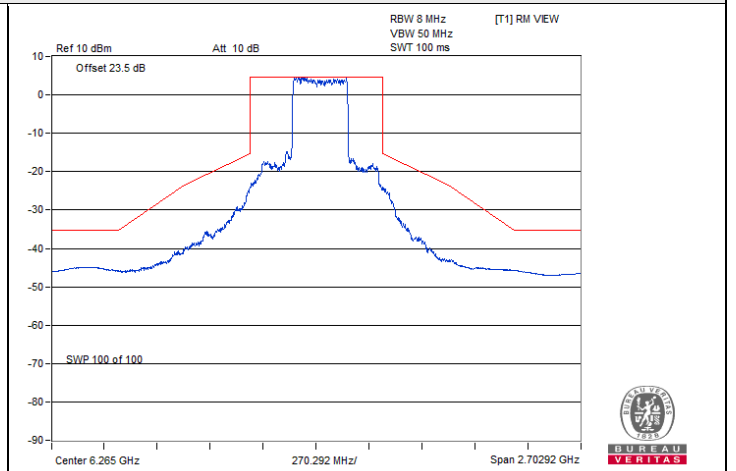

802.11be (EHT320) 3x996+484-tone MRU SP Client 2T2S / Chain 0 : CH 63@105\_0\_0

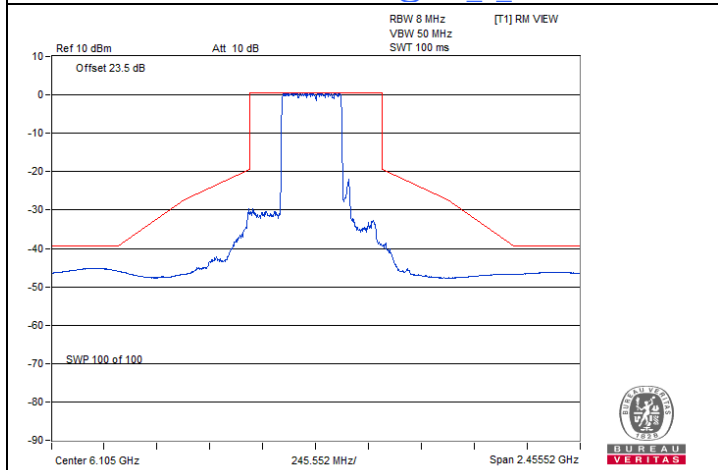

802.11be (EHT320) 3x996+484-tone MRU SP Client 2T2S / Chain 1 : CH 31@106\_1\_1

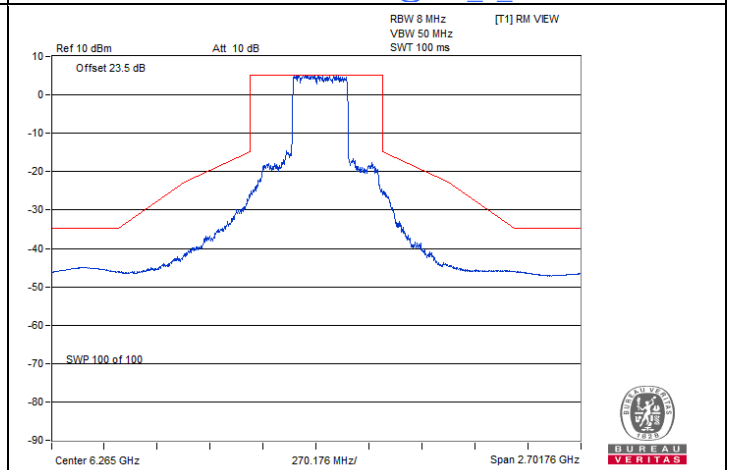

802.11be (EHT320) 3x996+484-tone MRU SP Client 2T2S / Chain 1 : CH 63@105\_0\_0

## 7.5 Occupied Bandwidth

Input Power:	120 Vac, 60 Hz	Environmental Conditions:	24°C, 66% RH	Tested By:	Eric Peng
--------------	----------------	---------------------------	--------------	------------	-----------

### 802.11a SP Client 1TX

Channel	Frequency (MHz)	Occupied Bandwidth (MHz)	Maximum Limit (MHz)	Test Result
1	5955	26.18	320	Pass
45	6175	17.16	320	Pass
93	6415	16.8	320	Pass
117	6535	16.56	320	Pass
149	6695	16.56	320	Pass
181	6855	16.56	320	Pass

### 802.11ax (HE20) SP Client 1T1S

Channel	Frequency (MHz)	Occupied Bandwidth (MHz)	Maximum Limit (MHz)	Test Result
1	5955	23.4	320	Pass
93	6415	18.96	320	Pass
117	6535	18.96	320	Pass
181	6855	18.96	320	Pass

### 802.11ax (HE40) SP Client 1T1S

Channel	Frequency (MHz)	Occupied Bandwidth (MHz)	Maximum Limit (MHz)	Test Result
3	5965	38.4	320	Pass
91	6405	38.4	320	Pass
123	6565	38.16	320	Pass
179	6845	38.4	320	Pass

### 802.11ax (HE80) SP Client 1T1S

Channel	Frequency (MHz)	Occupied Bandwidth (MHz)	Maximum Limit (MHz)	Test Result
7	5985	77.28	320	Pass
87	6385	77.76	320	Pass
135	6625	77.28	320	Pass
167	6785	77.28	320	Pass

**802.11ax (HE160) SP Client 1T1S**

Channel	Frequency (MHz)	Occupied Bandwidth (MHz)	Maximum Limit (MHz)	Test Result
15	6025	158.4	320	Pass
79	6345	164.16	320	Pass
143	6665	159.36	320	Pass

**802.11be (EHT20) SP Client 1T1S**

Channel	Frequency (MHz)	Occupied Bandwidth (MHz)	Maximum Limit (MHz)	Test Result
1	5955	24.26	320	Pass
45	6175	19.2	320	Pass
93	6415	18.96	320	Pass
117	6535	18.96	320	Pass
149	6695	18.96	320	Pass
181	6855	18.96	320	Pass

**802.11be (EHT40) SP Client 1T1S**

Channel	Frequency (MHz)	Occupied Bandwidth (MHz)	Maximum Limit (MHz)	Test Result
3	5965	38.16	320	Pass
43	6165	38.88	320	Pass
91	6405	38.16	320	Pass
123	6565	38.16	320	Pass
155	6725	38.16	320	Pass
179	6845	38.16	320	Pass

**802.11be (EHT80) SP Client 1T1S**

Channel	Frequency (MHz)	Occupied Bandwidth (MHz)	Maximum Limit (MHz)	Test Result
7	5985	77.28	320	Pass
39	6145	78.72	320	Pass
87	6385	77.76	320	Pass
135	6625	76.8	320	Pass
151	6705	77.28	320	Pass
167	6785	77.28	320	Pass



**802.11be (EHT160) SP Client 1T1S**

Channel	Frequency (MHz)	Occupied Bandwidth (MHz)	Maximum Limit (MHz)	Test Result
15	6025	158.4	320	Pass
47	6185	162.24	320	Pass
79	6345	160.32	320	Pass
143	6665	158.4	320	Pass

**802.11be (EHT320) SP Client 1T1S**

Channel	Frequency (MHz)	Occupied Bandwidth (MHz)	Maximum Limit (MHz)	Test Result
31	6105	315.84	320	Pass
63	6265	318.72	320	Pass

**802.11ax (HE) 26-tone RU SP Client\_1T1S**

Channel	Frequency (MHz)	Occupied Bandwidth (MHz)	Maximum Limit (MHz)	Test Result
1	5955	18.08	320	Pass
93	6415	18.08	320	Pass
117	6535	18	320	Pass
181	6855	18.12	320	Pass

**802.11ax (HE) 52-tone RU SP Client\_1T1S**

Channel	Frequency (MHz)	Occupied Bandwidth (MHz)	Maximum Limit (MHz)	Test Result
1	5955	18.17	320	Pass
93	6415	18.12	320	Pass
117	6535	18.12	320	Pass
181	6855	18.12	320	Pass

**802.11ax (HE) 106-tone RU SP Client\_1T1S**

Channel	Frequency (MHz)	Occupied Bandwidth (MHz)	Maximum Limit (MHz)	Test Result
1	5955	20.52	320	Pass
93	6415	18.24	320	Pass
117	6535	18.12	320	Pass
181	6855	18.24	320	Pass

**802.11ax (HE) 26-tone RU SP Client\_2T2S**

Channel	Frequency (MHz)	Occupied Bandwidth (MHz)		Maximum Limit (MHz)	Test Result
		Chain 0	Chain 1		
1	5955	18.08	18.00	320	Pass
93	6415	18.12	18.12	320	Pass
117	6535	18.00	18.00	320	Pass
181	6855	18.24	18.12	320	Pass

**802.11ax (HE) 52-tone RU SP Client\_2T2S**

Channel	Frequency (MHz)	Occupied Bandwidth (MHz)		Maximum Limit (MHz)	Test Result
		Chain 0	Chain 1		
1	5955	18.09	17.92	320	Pass
93	6415	18.12	18.12	320	Pass
117	6535	18.12	18.00	320	Pass
181	6855	18.00	18.00	320	Pass

**802.11ax (HE) 106-tone RU SP Client\_2T2S**

Channel	Frequency (MHz)	Occupied Bandwidth (MHz)		Maximum Limit (MHz)	Test Result
		Chain 0	Chain 1		
1	5955	18.09	18.00	320	Pass
93	6415	18.12	18.00	320	Pass
117	6535	18.00	18.00	320	Pass
181	6855	18.00	18.12	320	Pass

**802.11be (EHT20) 52+26-tone MRU SP Client\_1T1S**

Channel	Frequency (MHz)	Occupied Bandwidth (MHz)	Maximum Limit (MHz)	Test Result
1	5955	17.48	320	Pass
93	6415	17.13	320	Pass
117	6535	17.16	320	Pass
181	6855	17.28	320	Pass

**802.11be (EHT20) 106+26-tone MRU SP Client\_1T1S**

Channel	Frequency (MHz)	Occupied Bandwidth (MHz)	Maximum Limit (MHz)	Test Result
1	5955	21.82	320	Pass
93	6415	18.36	320	Pass
117	6535	18.24	320	Pass
181	6855	18.36	320	Pass

**802.11be (EHT80) 484+242-tone MRU SP Client\_1T1S**

Channel	Frequency (MHz)	Occupied Bandwidth (MHz)	Maximum Limit (MHz)	Test Result
7	5985	76.18	320	Pass
87	6385	72.48	320	Pass
135	6625	65.76	320	Pass

**802.11be (EHT160) 996+484-tone MRU SP Client\_1T1S**

Channel	Frequency (MHz)	Occupied Bandwidth (MHz)	Maximum Limit (MHz)	Test Result
15	6025	121.05	320	Pass
79	6345	162.24	320	Pass
143	6665	143.04	320	Pass

**802.11be (EHT160) 996+484+242-tone MRU SP Client\_1T1S**

Channel	Frequency (MHz)	Occupied Bandwidth (MHz)	Maximum Limit (MHz)	Test Result
15	6025	158.61	320	Pass
79	6345	188.16	320	Pass
143	6665	165.12	320	Pass

**802.11be (EHT320) 2x996+484-tone MRU SP Client 1T1S**

Channel	Frequency (MHz)	Occupied Bandwidth (MHz)	Maximum Limit (MHz)	Test Result
31	6105	197.76	320	Pass
63	6265	199.68	320	Pass

**802.11be (EHT320) 3x996-tone MRU SP Client 1T1S**

Channel	Frequency (MHz)	Occupied Bandwidth (MHz)	Maximum Limit (MHz)	Test Result
31	6105	237.12	320	Pass
63	6265	239.04	320	Pass

**802.11be (EHT320) 3x996+484-tone MRU SP Client 1T1S**

Channel	Frequency (MHz)	Occupied Bandwidth (MHz)	Maximum Limit (MHz)	Test Result
31	6105	277.44	320	Pass
63	6265	284.16	320	Pass

**802.11a SP Client 2Tx**

Channel	Frequency (MHz)	Occupied Bandwidth (MHz)		Maximum Limit (MHz)	Test Result
		Chain 0	Chain 1		
1	5955	16.34	16.34	320	Pass
45	6175	16.32	16.32	320	Pass
93	6415	16.32	16.32	320	Pass
117	6535	16.34	16.32	320	Pass
149	6695	16.32	16.32	320	Pass
181	6855	16.32	16.32	320	Pass

**802.11ax (HE20) SP Client 2T2S**

Channel	Frequency (MHz)	Occupied Bandwidth (MHz)		Maximum Limit (MHz)	Test Result
		Chain 0	Chain 1		
1	5955	18.96	18.96	320	Pass
93	6415	18.84	18.84	320	Pass
117	6535	18.72	18.72	320	Pass
181	6855	18.84	18.84	320	Pass

**802.11ax (HE40) SP Client 2T2S**

Channel	Frequency (MHz)	Occupied Bandwidth (MHz)		Maximum Limit (MHz)	Test Result
		Chain 0	Chain 1		
3	5965	37.92	37.92	320	Pass
91	6405	37.92	37.92	320	Pass
123	6565	37.92	37.92	320	Pass
179	6845	38.16	38.40	320	Pass

**802.11ax (HE80) SP Client 2T2S**

Channel	Frequency (MHz)	Occupied Bandwidth (MHz)		Maximum Limit (MHz)	Test Result
		Chain 0	Chain 1		
7	5985	77.28	76.80	320	Pass
87	6385	77.28	76.80	320	Pass
135	6625	76.80	77.28	320	Pass
167	6785	77.28	76.80	320	Pass

**802.11ax (HE160) SP Client 2T2S**

Channel	Frequency (MHz)	Occupied Bandwidth (MHz)		Maximum Limit (MHz)	Test Result
		Chain 0	Chain 1		
15	6025	156.48	156.48	320	Pass
79	6345	156.48	157.91	320	Pass
143	6665	156.48	156.48	320	Pass

**802.11be (EHT20) SP Client 2T2S**

Channel	Frequency (MHz)	Occupied Bandwidth (MHz)		Maximum Limit (MHz)	Test Result
		Chain 0	Chain 1		
1	5955	18.96	18.96	320	Pass
45	6175	18.96	18.84	320	Pass
93	6415	18.72	18.84	320	Pass
117	6535	18.72	18.84	320	Pass
149	6695	18.84	18.84	320	Pass
181	6855	18.84	18.84	320	Pass

**802.11be (EHT40) SP Client 2T2S**

Channel	Frequency (MHz)	Occupied Bandwidth (MHz)		Maximum Limit (MHz)	Test Result
		Chain 0	Chain 1		
3	5965	38.16	37.92	320	Pass
43	6165	38.64	38.16	320	Pass
91	6405	38.16	38.16	320	Pass
123	6565	37.92	37.92	320	Pass
155	6725	37.92	38.40	320	Pass
179	6845	37.92	37.92	320	Pass

**802.11be (EHT80) SP Client 2T2S**

Channel	Frequency (MHz)	Occupied Bandwidth (MHz)		Maximum Limit (MHz)	Test Result
		Chain 0	Chain 1		
7	5985	77.28	76.80	320	Pass
39	6145	77.28	77.28	320	Pass
87	6385	76.80	76.80	320	Pass
135	6625	76.80	77.28	320	Pass
151	6705	76.80	76.80	320	Pass
167	6785	76.80	76.80	320	Pass

**802.11be (EHT160) SP Client 2T2S**

Channel	Frequency (MHz)	Occupied Bandwidth (MHz)		Maximum Limit (MHz)	Test Result
		Chain 0	Chain 1		
15	6025	158.40	156.48	320	Pass
47	6185	171.84	166.08	320	Pass
79	6345	160.70	158.40	320	Pass
143	6665	159.36	159.36	320	Pass

**802.11be (EHT320) SP Client 2T2S**

Channel	Frequency (MHz)	Occupied Bandwidth (MHz)		Maximum Limit (MHz)	Test Result
		Chain 0	Chain 1		
31	6105	316.80	315.84	320	Pass
63	6265	319.68	318.72	320	Pass

**802.11be (EHT20) 52+26-tone MRU SP Client\_2T2S**

Channel	Frequency (MHz)	Occupied Bandwidth (MHz)		Maximum Limit (MHz)	Test Result
		Chain 0	Chain 1		
1	5955	17.22	17.13	320	Pass
93	6415	17.16	17.16	320	Pass
117	6535	17.16	17.04	320	Pass
181	6855	17.04	17.04	320	Pass

**802.11be (EHT20) 106+26-tone MRU SP Client\_2T2S**

Channel	Frequency (MHz)	Occupied Bandwidth (MHz)		Maximum Limit (MHz)	Test Result
		Chain 0	Chain 1		
1	5955	18.27	18.18	320	Pass
93	6415	18.12	18.12	320	Pass
117	6535	18.24	18.18	320	Pass
181	6855	18.12	18.12	320	Pass

**802.11be (EHT80) 484+242-tone MRU SP Client\_2T2S**

Channel	Frequency (MHz)	Occupied Bandwidth (MHz)		Maximum Limit (MHz)	Test Result
		Chain 0	Chain 1		
7	5985	74.08	74.44	320	Pass
87	6385	67.20	67.20	320	Pass
135	6625	62.88	73.74	320	Pass

**802.11be (EHT160) 996+484-tone MRU SP Client\_2T2S**

Channel	Frequency (MHz)	Occupied Bandwidth (MHz)		Maximum Limit (MHz)	Test Result
		Chain 0	Chain 1		
15	6025	121.05	119.65	320	Pass
79	6345	121.92	121.92	320	Pass
143	6665	120.96	121.92	320	Pass

**802.11be (EHT160) 996+484+242-tone MRU SP Client\_2T2S**

Channel	Frequency (MHz)	Occupied Bandwidth (MHz)		Maximum Limit (MHz)	Test Result
		Chain 0	Chain 1		
15	6025	156.52	155.13	320	Pass
79	6345	157.44	156.48	320	Pass
143	6665	156.48	157.44	320	Pass

**802.11be (EHT320) 2x996+484-tone MRU SP Client 2T2S**

Channel	Frequency (MHz)	Occupied Bandwidth (MHz)		Maximum Limit (MHz)	Test Result
		Chain 0	Chain 1		
31	6105	197.76	196.80	320	Pass
63	6265	197.76	198.72	320	Pass

**802.11be (EHT320) 3x996-tone MRU SP Client 2T2S**

Channel	Frequency (MHz)	Occupied Bandwidth (MHz)		Maximum Limit (MHz)	Test Result
		Chain 0	Chain 1		
31	6105	237.12	236.16	320	Pass
63	6265	239.04	239.04	320	Pass

**802.11be (EHT320) 3x996+484-tone MRU SP Client 2T2S**

Channel	Frequency (MHz)	Occupied Bandwidth (MHz)		Maximum Limit (MHz)	Test Result
		Chain 0	Chain 1		
31	6105	277.44	277.44	320	Pass
63	6265	317.92	291.84	320	Pass



### Spectrum Plot of Maximum Value

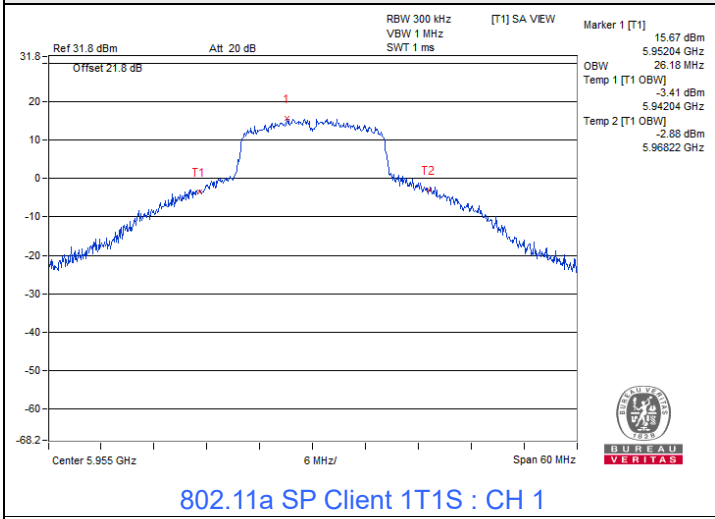

802.11a SP Client 1T1S : CH 1

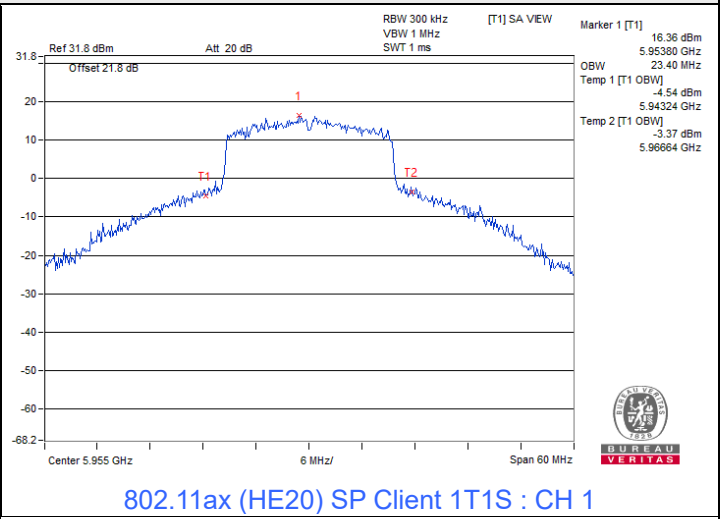

802.11ax (HE20) SP Client 1T1S : CH 1

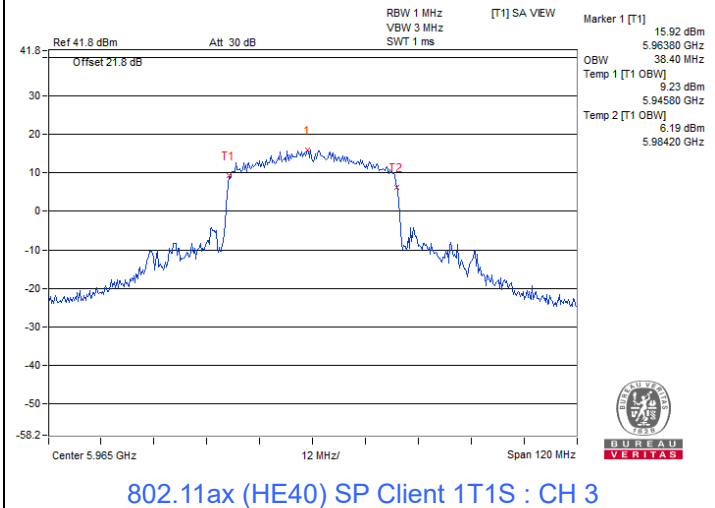

802.11ax (HE40) SP Client 1T1S : CH 3

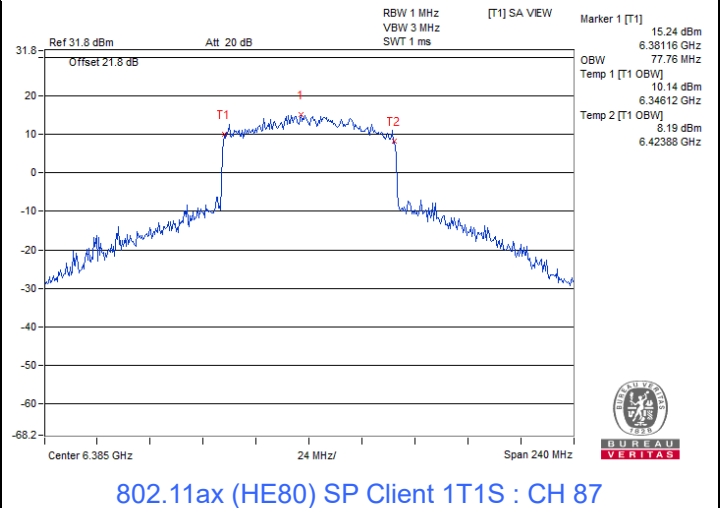

802.11ax (HE80) SP Client 1T1S : CH 87

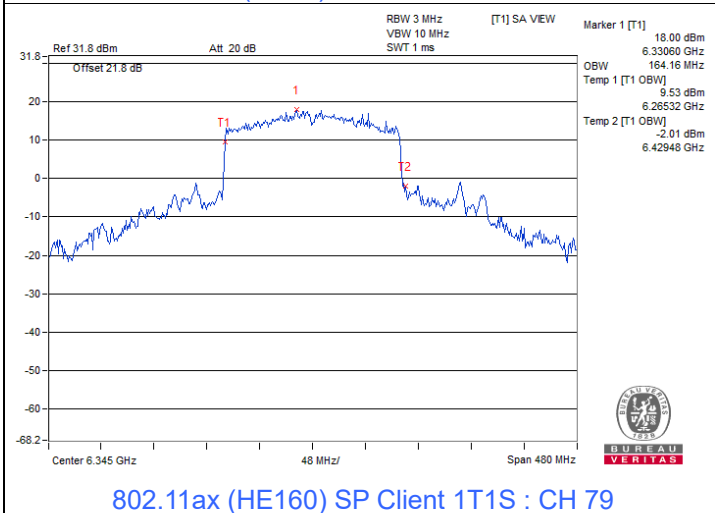

802.11ax (HE160) SP Client 1T1S : CH 79

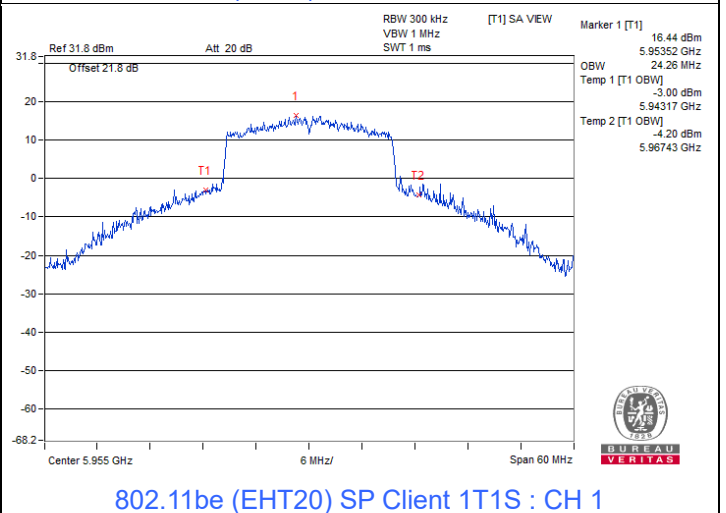

802.11be (EHT20) SP Client 1T1S : CH 1





### Spectrum Plot of Maximum Value

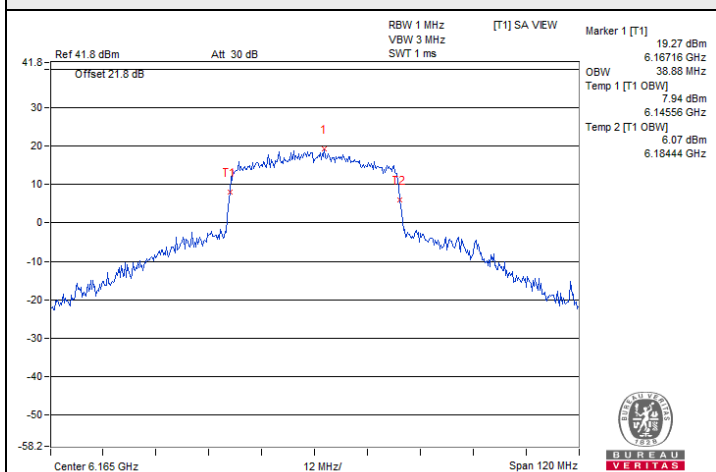

802.11be (EHT40) SP Client 1T1S : CH 43

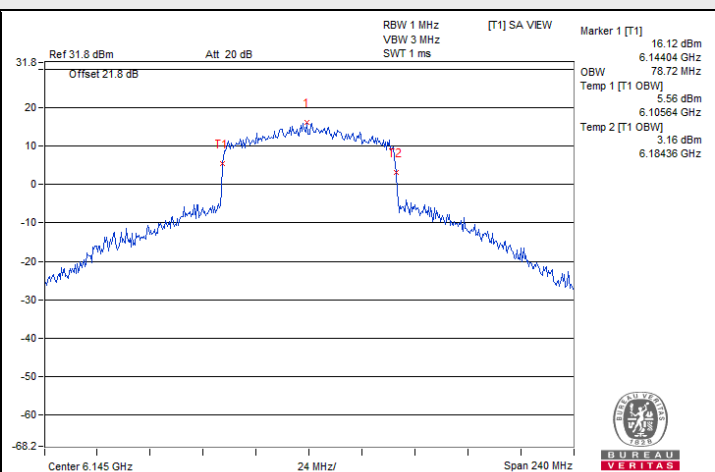

802.11be (EHT80) SP Client 1T1S : CH 39

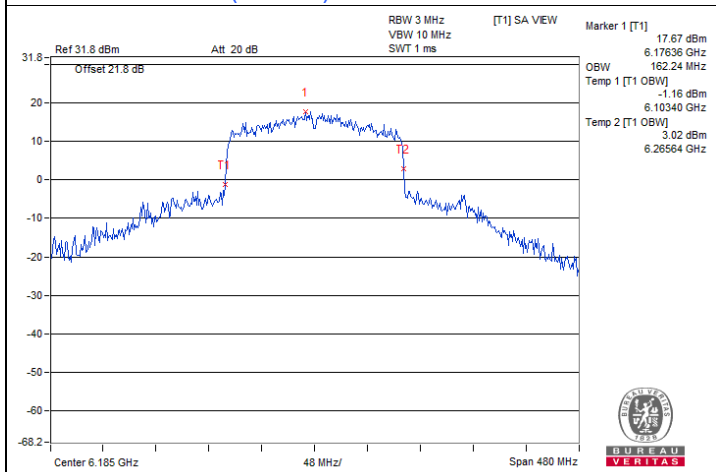

802.11be (EHT160) SP Client 1T1S : CH 47

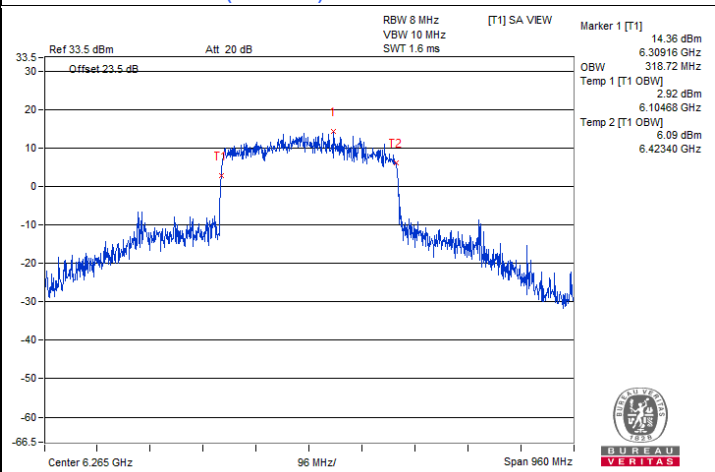

802.11be (EHT320) SP Client 1T1S : CH 63

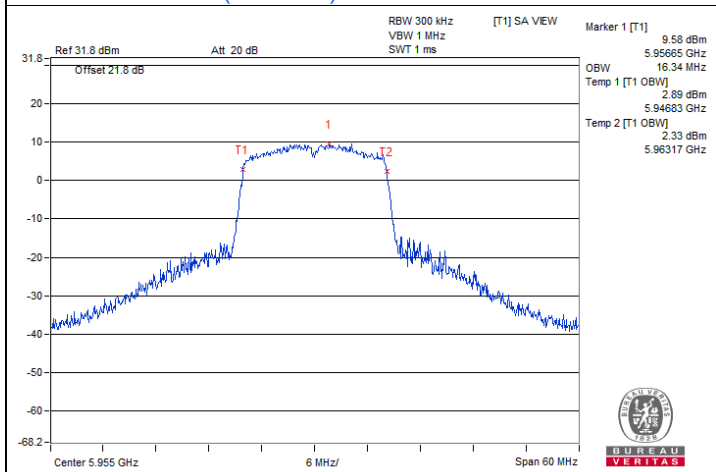

802.11a SP Client 2T2S / Chain 0 : CH 1

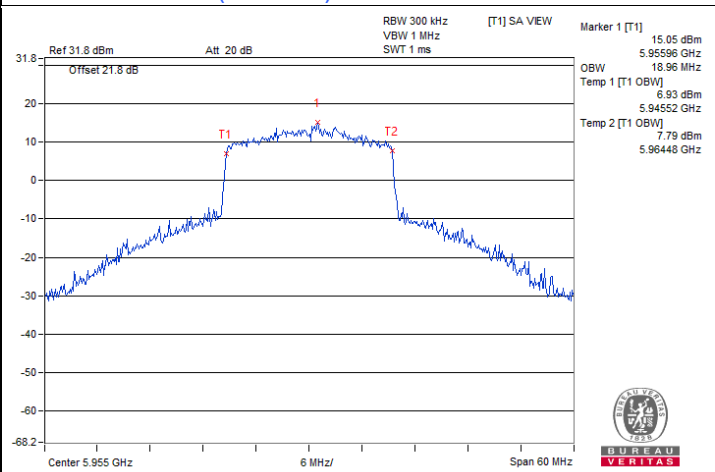

802.11ax (HE20) SP Client 2T2S / Chain 0 : CH 1



### Spectrum Plot of Maximum Value

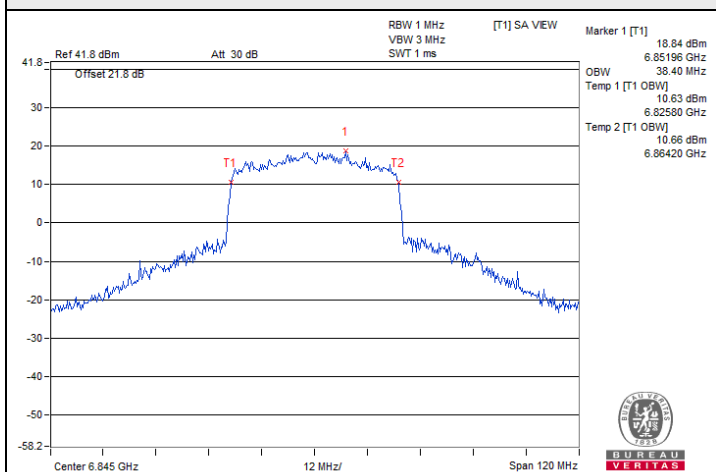

802.11ax (HE40) SP Client 2T2S / Chain 1 : CH 179

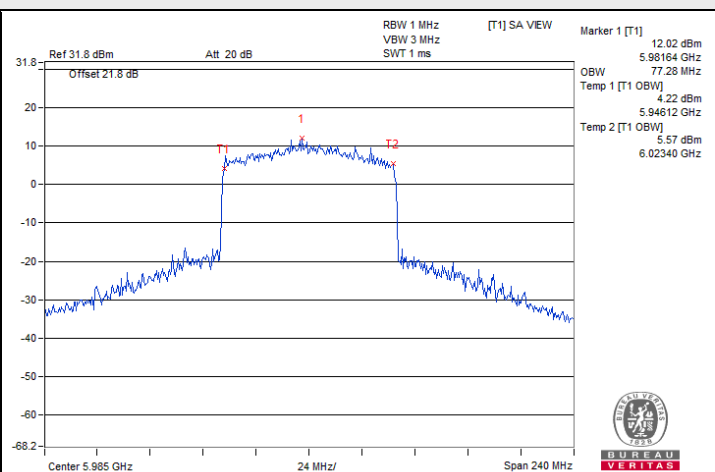

802.11ax (HE80) SP Client 2T2S / Chain 0 : CH 7

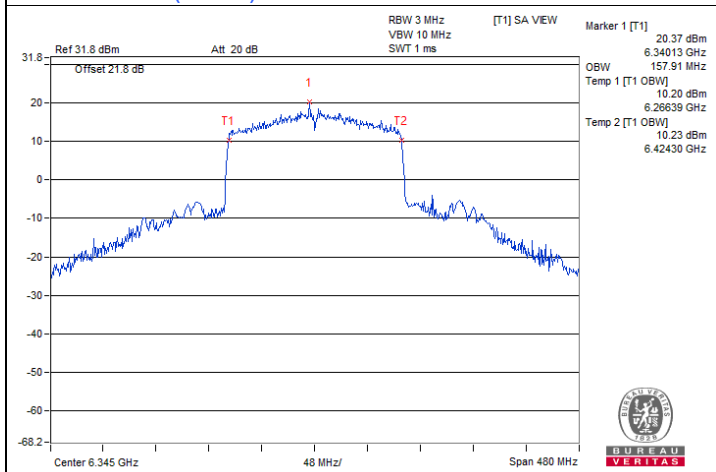

802.11ax (HE160) SP Client 2T2S / Chain 1 : CH 79

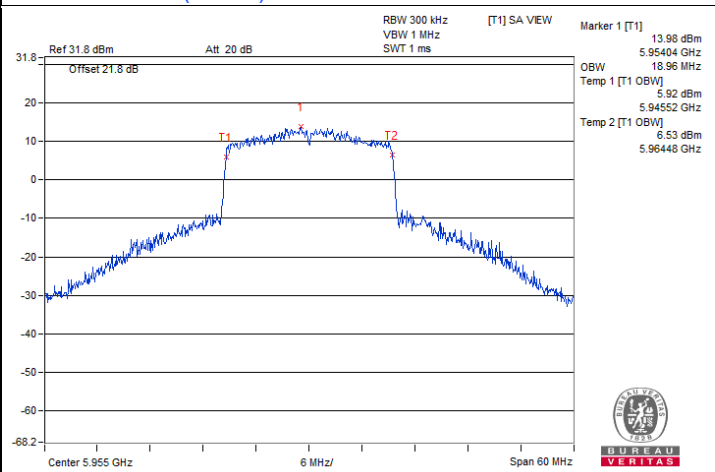

802.11be (EHT20) SP Client 2T2S / Chain 0 : CH 1

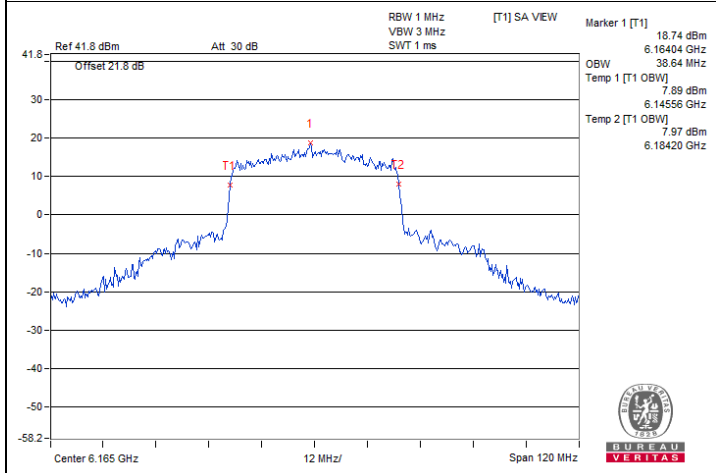

802.11be (EHT40) SP Client 2T2S / Chain 0 : CH 43

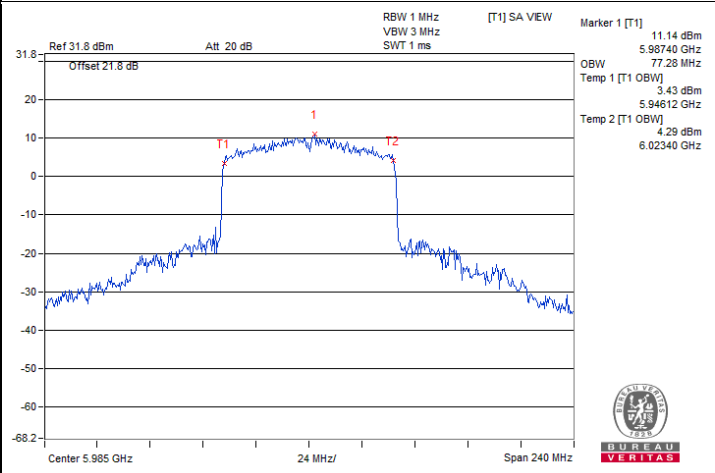

802.11be (EHT80) SP Client 2T2S / Chain 0 : CH 7



### Spectrum Plot of Maximum Value

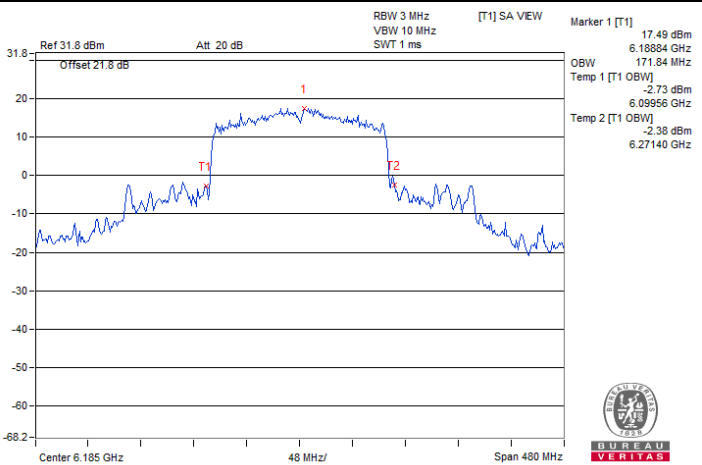

802.11be (EHT160) SP Client 2T2S / Chain 0 : CH 47

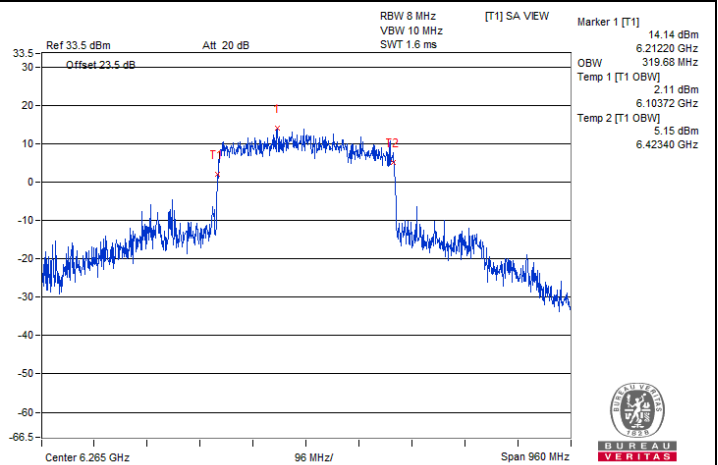

802.11be (EHT320) SP Client 2T2S / Chain 0 : CH 63

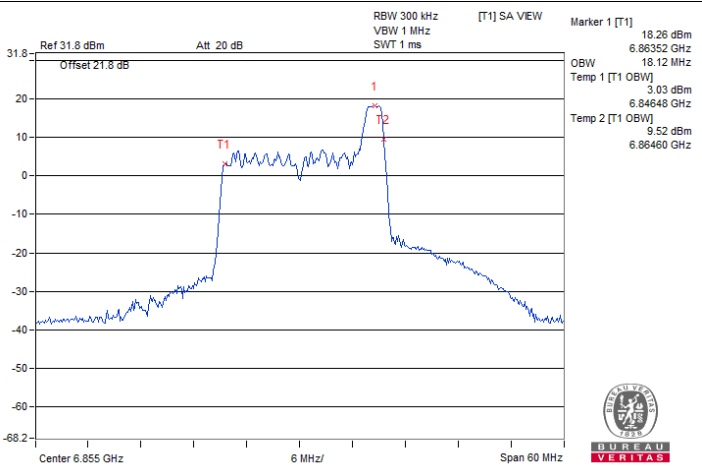

802.11ax (HE) 26-tone RU SP Client\_1T1S : CH 181@8

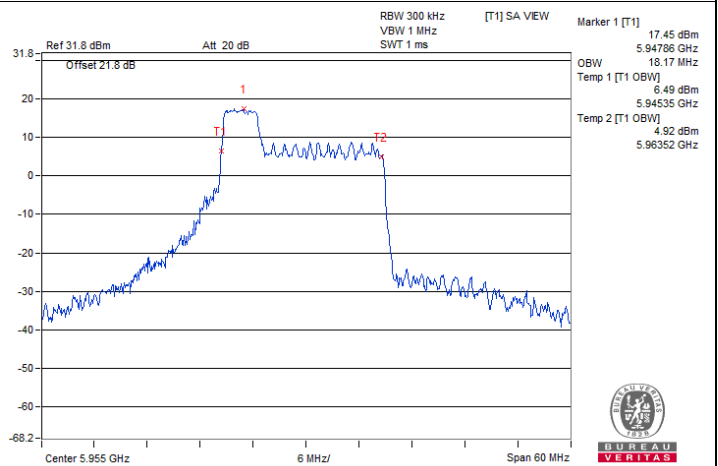

802.11ax (HE) 52-tone RU SP Client\_1T1S : CH 1@37

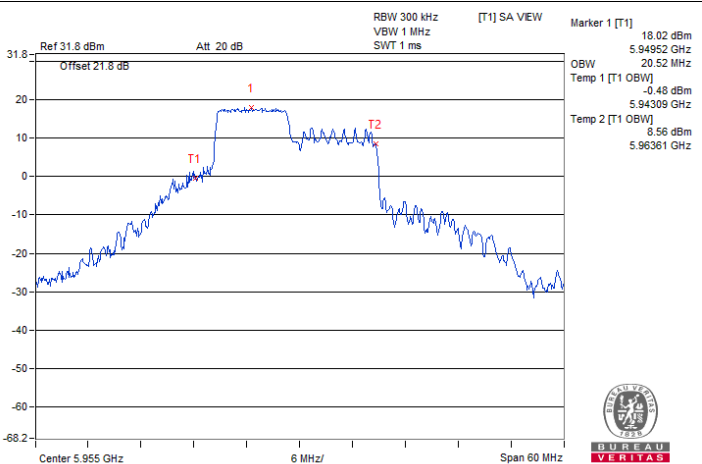

802.11ax (HE) 106-tone RU SP Client\_1T1S : CH 1@53

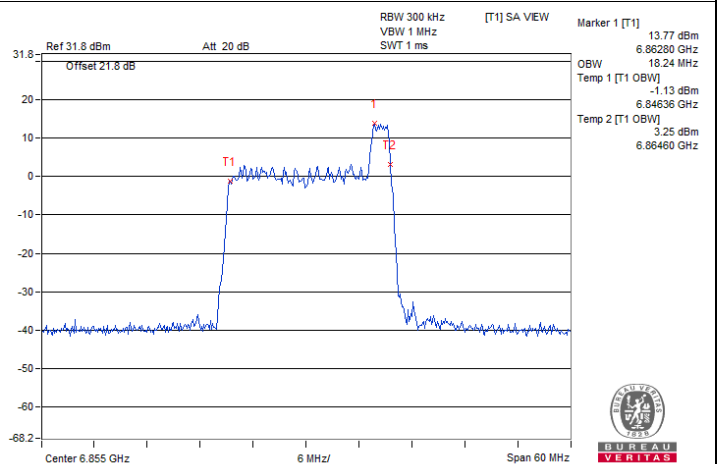

802.11ax (HE) 26-tone RU SP Client\_2T2S / Chain 0 : CH 181@8

### Spectrum Plot of Maximum Value

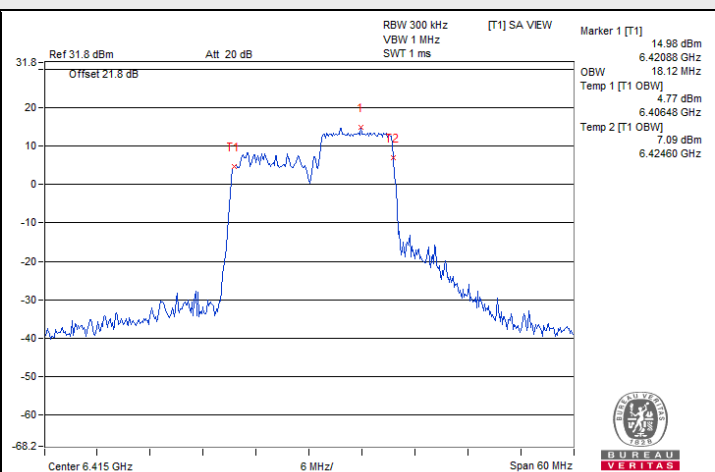
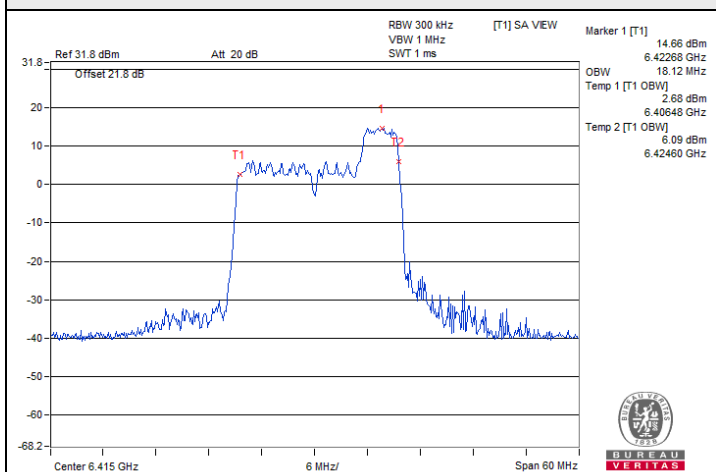

802.11ax (HE) 52-tone RU SP Client\_2T2S / Chain 0 : CH 93@40

802.11ax (HE) 106-tone RU SP Client\_2T2S / Chain 0 : CH 93@54

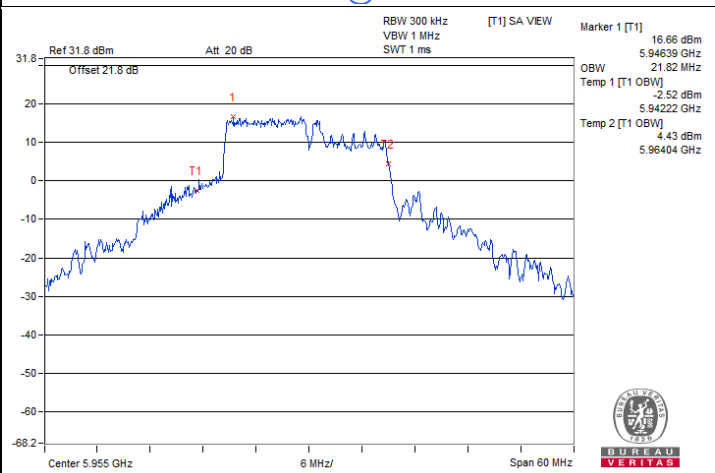
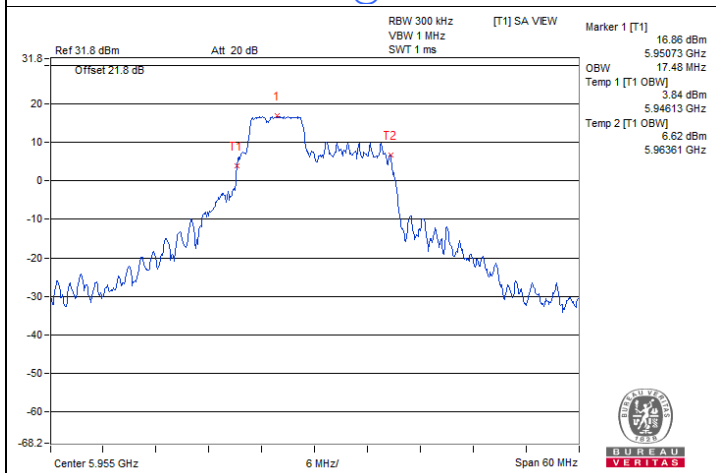

802.11be (EHT20) 52+26-tone MRU SP Client\_1T1S : CH 1@70

802.11be (EHT20) 106+26-tone MRU SP Client\_1T1S : CH 1@82

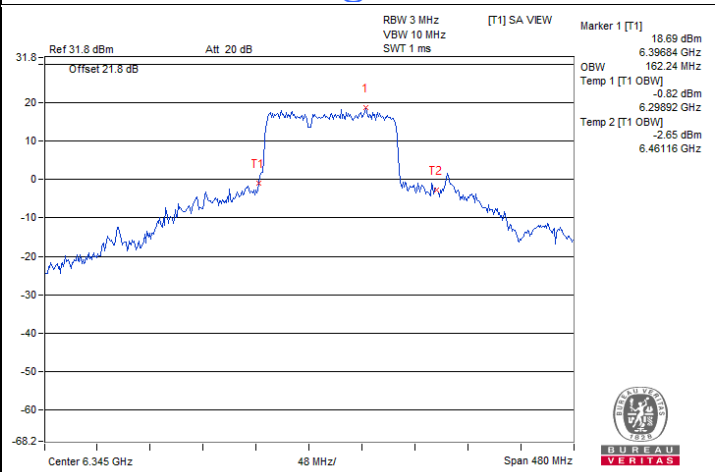
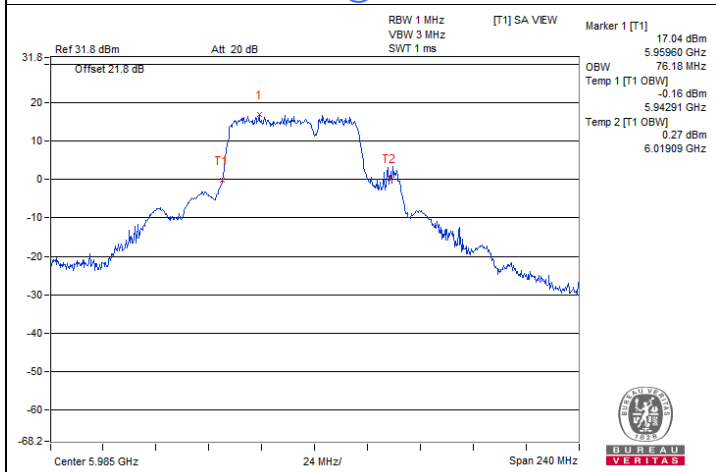

802.11be (EHT80) 484+242-tone MRU SP Client\_1T1S : CH 7@93

802.11be (EHT160) 996+484-tone MRU SP Client\_1T1S : CH 79@94\_0

### Spectrum Plot of Maximum Value

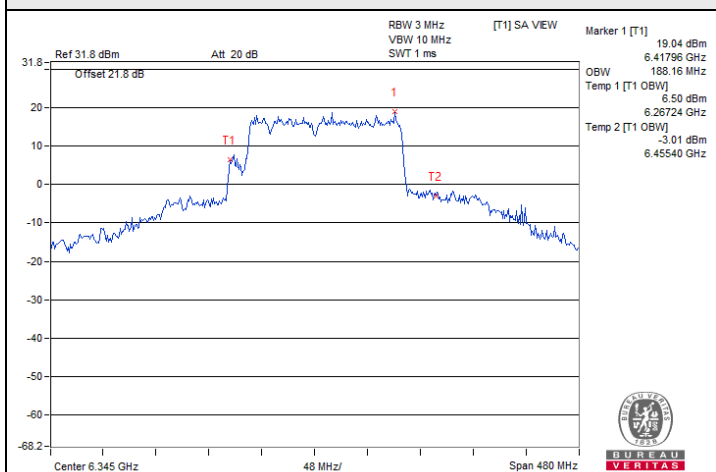

802.11be (EHT160) 996+484+242-tone MRU SP Client\_1T1S : CH 79@96\_0

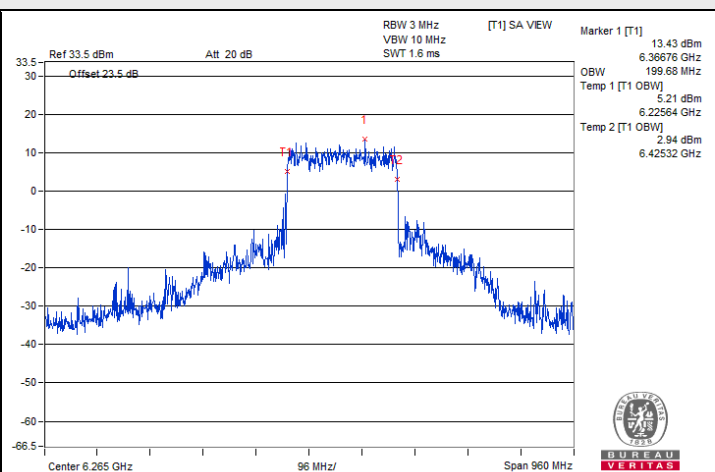

802.11be (EHT320) 2x996+484-tone MRU SP Client 1T1S : CH 63@102\_0/1

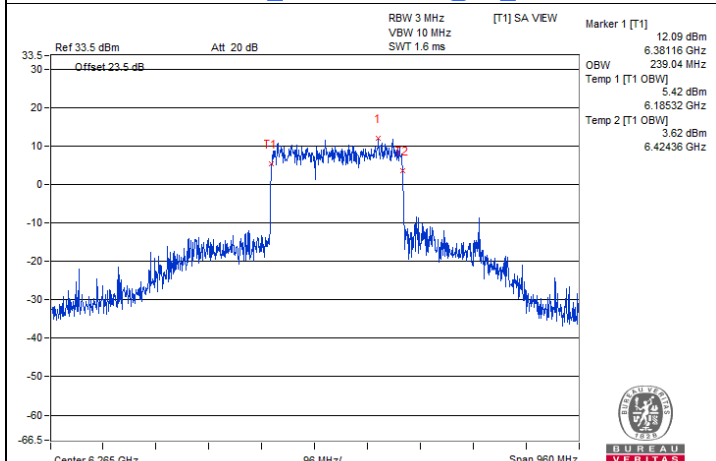

802.11be (EHT320) 3x996-tone MRU SP Client 1T1S : CH 63@104\_0/0

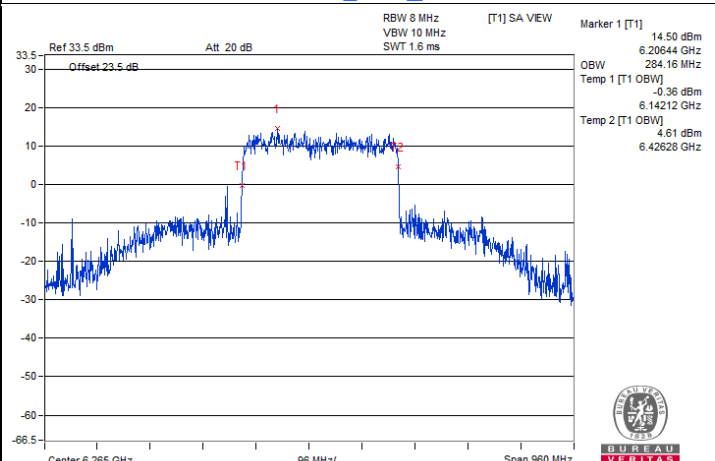

802.11be (EHT320) 3x996+484-tone MRU SP Client 1T1S : CH 63@105\_0/0

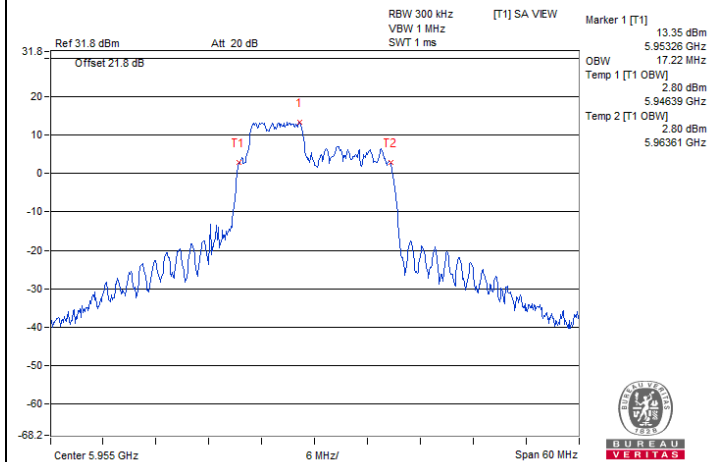

802.11be (EHT20) 52+26-tone MRU SP Client\_2T2S / Chain 0 : CH 1@70

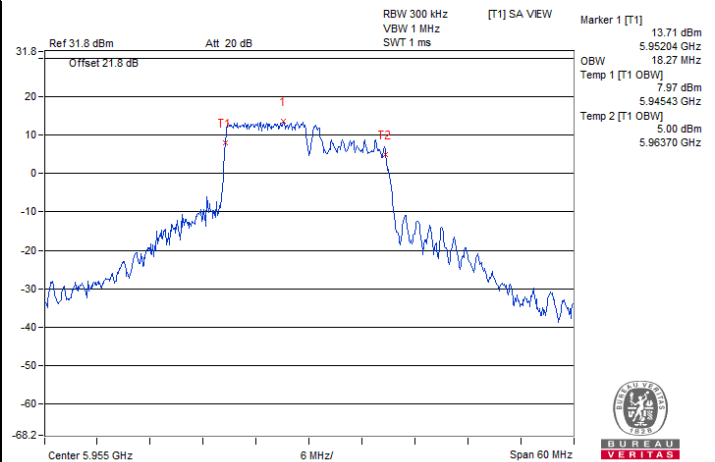

802.11be (EHT20) 106+26-tone MRU SP Client\_2T2S / Chain 0 : CH 1@82



### Spectrum Plot of Maximum Value

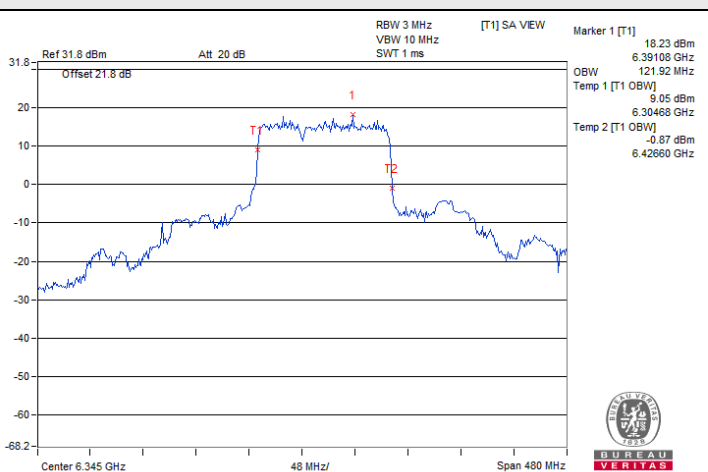
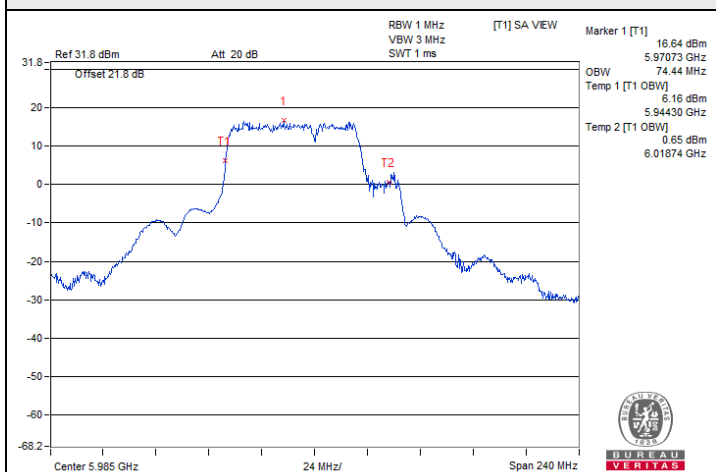

802.11be (EHT80) 484+242-tone MRU SP Client\_2T2S / Chain 1 : CH 7@93

802.11be (EHT160) 996+484-tone MRU SP Client\_2T2S / Chain 0 : CH 79@94\_0

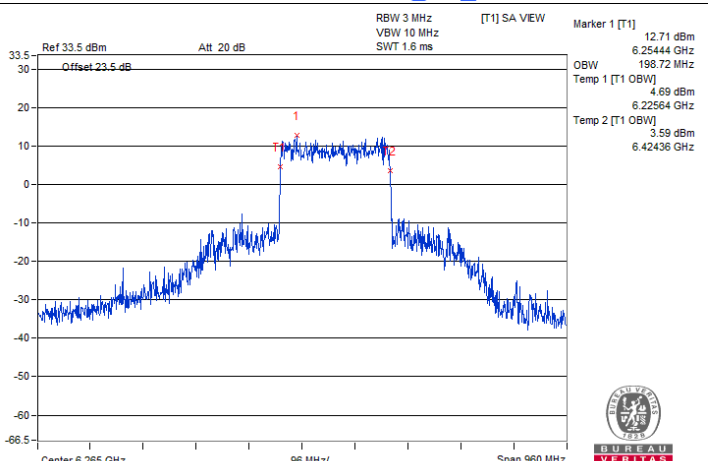
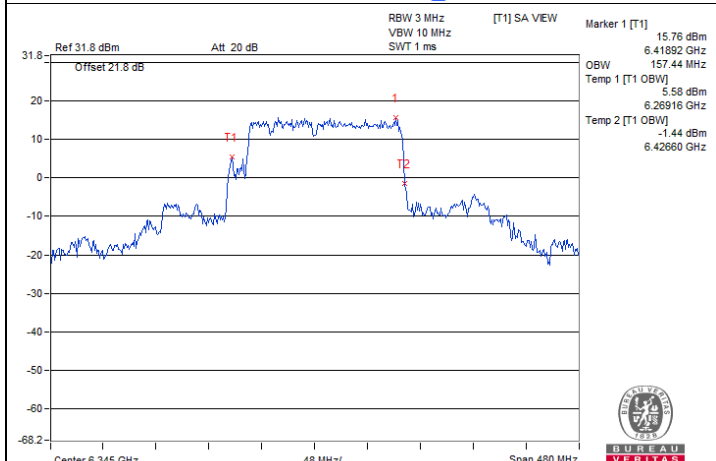

802.11be (EHT160) 996+484+242-tone MRU SP Client\_2T2S / Chain 0 : CH 79@96\_0

802.11be (EHT320) 2x996+484-tone MRU SP Client 2T2S / Chain 1 : CH 63@102\_0\_1

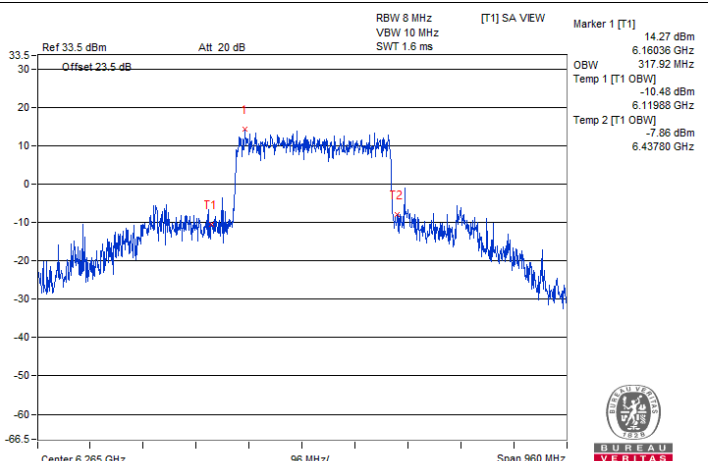
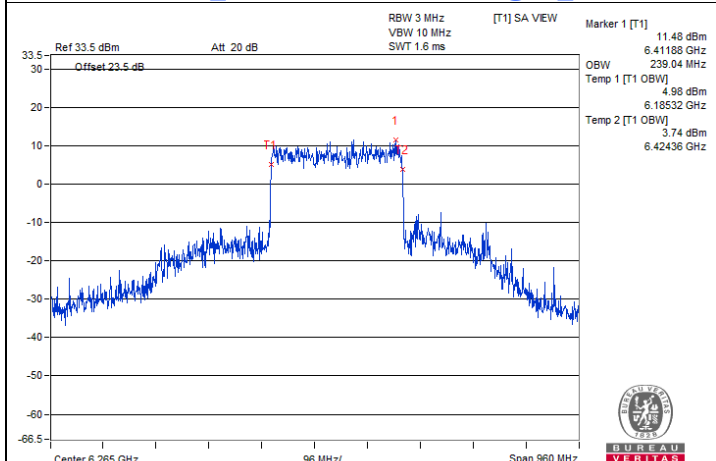

802.11be (EHT320) 3x996-tone MRU SP Client 2T2S / Chain 0 : CH 63@104\_0\_0

802.11be (EHT320) 3x996+484-tone MRU SP Client 2T2S / Chain 0 : CH 63@105\_0\_0

## 7.6 AC Power Conducted Emissions

1TX

<b>RF Mode</b>	802.11a	<b>Channel</b>	CH 1 : 5955 MHz
<b>Frequency Range</b>	150kHz ~ 30MHz	<b>Detector Function &amp; Resolution Bandwidth</b>	Quasi-Peak (QP) / Average (AV), 9 kHz
<b>Input Power</b>	120 Vac, 60 Hz	<b>Environmental Conditions</b>	23°C, 68% RH
<b>Tested By</b>	Tom Yang		

Phase Of Power : Line (L)										
No	Frequency (MHz)	Correction Factor (dB)	Reading Value (dBuV)		Emission Level (dBuV)		Limit (dBuV)		Margin (dB)	
			Q.P.	AV.	Q.P.	AV.	Q.P.	AV.	Q.P.	AV.
1	0.15391	9.96	42.69	24.76	52.65	34.72	65.79	55.79	-13.14	-21.07
2	0.25938	9.96	32.16	11.83	42.12	21.79	61.45	51.45	-19.33	-29.66
3	0.52500	9.98	16.85	2.95	26.83	12.93	56.00	46.00	-29.17	-33.07
4	3.53906	10.13	21.93	15.16	32.06	25.29	56.00	46.00	-23.94	-20.71
5	14.89453	10.79	16.68	4.68	27.47	15.47	60.00	50.00	-32.53	-34.53
6	25.11062	11.18	28.33	20.86	39.51	32.04	60.00	50.00	-20.49	-17.96

### Remarks:

1. Q.P. and AV. are abbreviations of quasi-peak and average individually.
2. The emission levels of other frequencies were very low against the limit.
3. Margin value = Emission level – Limit value
4. Correction factor = Insertion loss + Cable loss
5. Emission Level = Correction Factor + Reading Value



<b>RF Mode</b>	802.11a	<b>Channel</b>	CH 1 : 5955 MHz
<b>Frequency Range</b>	150kHz ~ 30MHz	<b>Detector Function &amp; Resolution Bandwidth</b>	Quasi-Peak (QP) / Average (AV), 9 kHz
<b>Input Power</b>	120 Vac, 60 Hz	<b>Environmental Conditions</b>	23°C, 68% RH
<b>Tested By</b>	Tom Yang		

Phase Of Power : Neutral (N)										
No	Frequency (MHz)	Correction Factor (dB)	Reading Value (dBuV)		Emission Level (dBuV)		Limit (dBuV)		Margin (dB)	
			Q.P.	AV.	Q.P.	AV.	Q.P.	AV.	Q.P.	AV.
1	0.15000	9.93	40.78	20.93	50.71	30.86	66.00	56.00	-15.29	-25.14
2	0.24375	9.94	34.25	14.93	44.19	24.87	61.97	51.97	-17.78	-27.10
3	0.52891	9.95	17.17	3.56	27.12	13.51	56.00	46.00	-28.88	-32.49
4	3.48438	10.08	21.96	15.47	32.04	25.55	56.00	46.00	-23.96	-20.45
5	14.61719	10.59	17.57	7.77	28.16	18.36	60.00	50.00	-31.84	-31.64
6	23.59375	10.85	28.01	24.23	38.86	35.08	60.00	50.00	-21.14	-14.92

**Remarks:**

1. Q.P. and AV. are abbreviations of quasi-peak and average individually.
2. The emission levels of other frequencies were very low against the limit.
3. Margin value = Emission level – Limit value
4. Correction factor = Insertion loss + Cable loss
5. Emission Level = Correction Factor + Reading Value

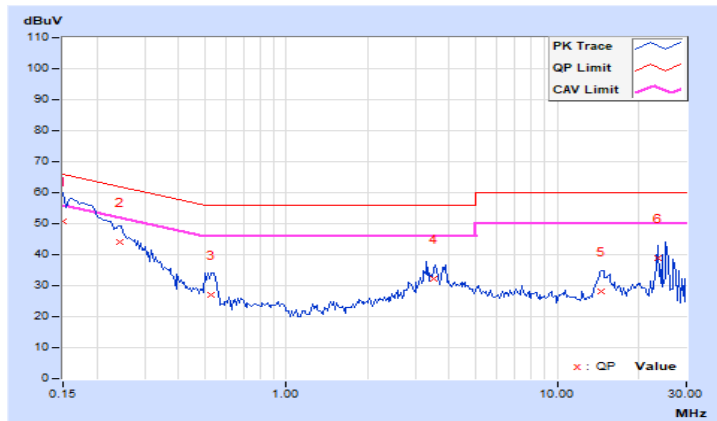



<b>RF Mode</b>	802.11be (EHT40)	<b>Channel</b>	CH 43 : 6165 MHz
<b>Frequency Range</b>	150 kHz ~ 30 MHz	<b>Detector Function &amp; Resolution Bandwidth</b>	Quasi-Peak (QP) / Average (AV), 9 kHz
<b>Input Power (System)</b>	120 Vac, 60 Hz	<b>Environmental Conditions</b>	23°C, 68% RH
<b>Tested By</b>	Tom Yang		

Phase Of Power : Line (L)										
No	Frequency (MHz)	Correction Factor (dB)	Reading Value (dBuV)		Emission Level (dBuV)		Limit (dBuV)		Margin (dB)	
			Q.P.	AV.	Q.P.	AV.	Q.P.	AV.	Q.P.	AV.
1	0.16172	9.96	44.88	27.63	54.84	37.59	65.38	55.38	-10.54	-17.79
2	0.28281	9.96	29.03	10.69	38.99	20.65	60.73	50.73	-21.74	-30.08
3	0.53672	9.98	17.85	4.99	27.83	14.97	56.00	46.00	-28.17	-31.03
4	3.54688	10.13	21.77	15.04	31.90	25.17	56.00	46.00	-24.10	-20.83
5	14.78125	10.79	16.72	4.74	27.51	15.53	60.00	50.00	-32.49	-34.47
6	23.60156	11.16	30.17	26.63	41.33	37.79	60.00	50.00	-18.67	-12.21

**Remarks:**

1. Q.P. and AV. are abbreviations of quasi-peak and average individually.
2. The emission levels of other frequencies were very low against the limit.
3. Margin value = Emission level – Limit value
4. Correction factor = Insertion loss + Cable loss
5. Emission Level = Correction Factor + Reading Value

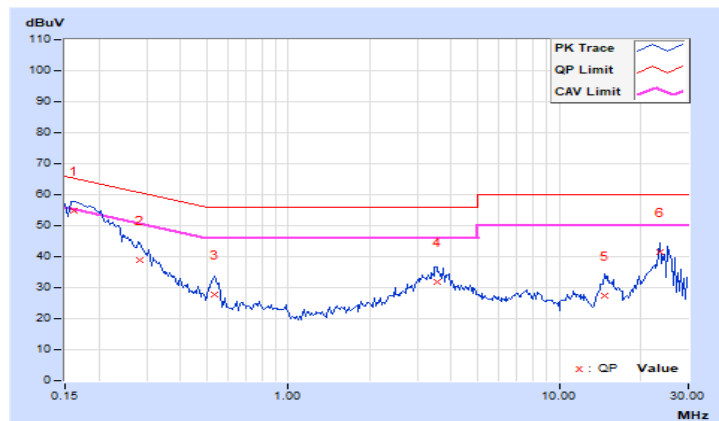

RF Mode	802.11be (EHT40)	Channel	CH 43 : 6165 MHz
Frequency Range	150 kHz ~ 30 MHz	Detector Function & Resolution Bandwidth	Quasi-Peak (QP) / Average (AV), 9 kHz
Input Power (System)	120 Vac, 60 Hz	Environmental Conditions	23°C, 68% RH
Tested By	Tom Yang		

Phase Of Power : Neutral (N)										
No	Frequency (MHz)	Correction Factor (dB)	Reading Value (dBuV)		Emission Level (dBuV)		Limit (dBuV)		Margin (dB)	
			Q.P.	AV.	Q.P.	AV.	Q.P.	AV.	Q.P.	AV.
1	0.16172	9.93	45.26	29.52	55.19	39.45	65.38	55.38	-10.19	-15.93
2	0.27109	9.94	30.21	8.10	40.15	18.04	61.08	51.08	-20.93	-33.04
3	0.54453	9.95	18.78	6.16	28.73	16.11	56.00	46.00	-27.27	-29.89
4	3.50391	10.08	23.09	16.30	33.17	26.38	56.00	46.00	-22.83	-19.62
5	14.69531	10.59	17.71	7.97	28.30	18.56	60.00	50.00	-31.70	-31.44
<b>6</b>	<b>25.12500</b>	<b>10.86</b>	<b>32.01</b>	<b>30.83</b>	<b>42.87</b>	<b>41.69</b>	<b>60.00</b>	<b>50.00</b>	<b>-17.13</b>	<b>-8.31</b>

**Remarks:**

1. Q.P. and AV. are abbreviations of quasi-peak and average individually.
2. The emission levels of other frequencies were very low against the limit.
3. Margin value = Emission level – Limit value
4. Correction factor = Insertion loss + Cable loss
5. Emission Level = Correction Factor + Reading Value

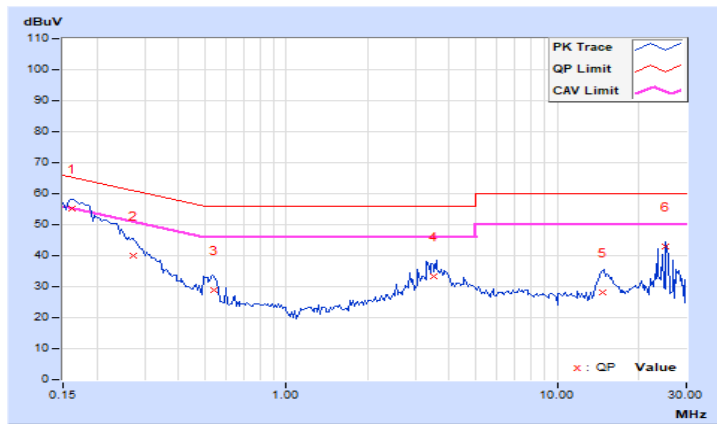

## 7.7 Unwanted Emissions below 1 GHz

### Radiated versus Conducted Measurement

#### For Radiated measurement:

The level of unwanted emissions was measured when radiated by the cabinet or structure of the equipment with the antenna connector(s) terminated by a specified load (cabinet radiation)

#### For Conducted measurement:

The level of unwanted emissions was measured as their power in a specified load (conducted spurious emissions).

### Conducted Emission Convert Formula

- a. Emission Level (dBuV/m) = EIRP Level (dBm) – 20log(d) + 104.8  
d = measurement distance in 3 meters.
- b. EIRP Level (dBm) = Raw Value(dBm) + Correction Factor(dB)
- c. Correction Factor is directional gain, and the composite gain will be used when signal support the correlated signal  
For the out of band spurious the gain for the specific band may have been used rather than the highest gain across all bands.  
For the band edge the gain for the specific band may have been used.

#### Notes:

1. In restricted bands below 1000 MHz, add upper bound on ground plane reflection:  
For f = 30 – 1000 MHz, add 4.7 dB.
2. The conducted emission test was considered some factor to compute test result.

1T1S

Mode A  
802.11a - Channel 1

No.	Frequency (MHz)	Emission Level (dBuV/m)	Limit (dBuV/m)	Margin (dB)	Raw Value (dBm)	Correction Factor (dB)	EIRP Level (dBm)
1	32.06	24.34	40	-15.66	-75.68	4.76	-70.92
2	178.53	22.86	43.5	-20.64	-77.16	4.76	-72.40
3	311.66	23.06	46	-22.94	-76.96	4.76	-72.20
4	484.2	23.69	46	-22.31	-76.33	4.76	-71.57
5	654.8	24.21	46	-21.79	-75.81	4.76	-71.05
6	933.19	24.99	46	-21.01	-75.03	4.76	-70.27

Remarks:

1. Margin value = Emission Level – Limit value
2. The other emission levels were very low against the limit.

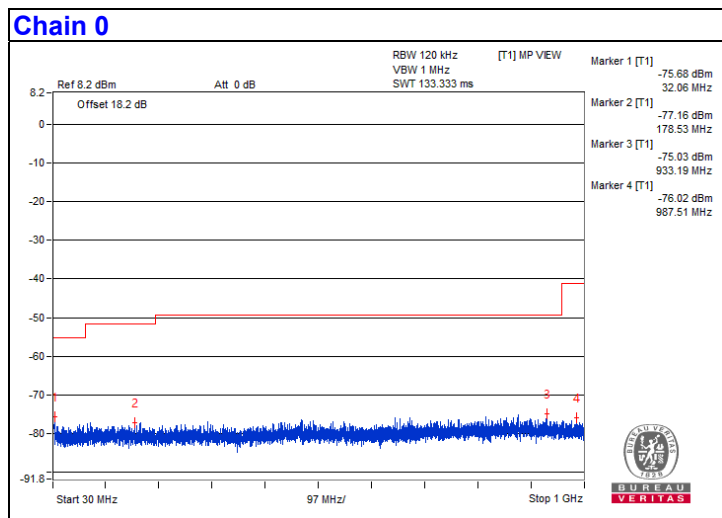

## Mode B

<b>RF Mode</b>	802.11a	<b>Channel</b>	CH 1 : 5955 MHz
<b>Frequency Range</b>	30 MHz ~ 1 GHz	<b>Detector Function &amp; Bandwidth</b>	(QP) RB = 120kHz
<b>Input Power</b>	120 Vac, 60 Hz	<b>Environmental Conditions</b>	25°C, 67% RH
<b>Tested By</b>	Tom Yang		

Antenna Polarity & Test Distance : Horizontal at 3 m								
No	Frequency (MHz)	Emission Level (dBuV/m)	Limit (dBuV/m)	Margin (dB)	Antenna Height (m)	Table Angle (Degree)	Raw Value (dBuV)	Correction Factor (dB/m)
1	174.01	38.3 QP	43.5	-5.2	1.50 H	178	51.1	-12.8
2	<b>199.59</b>	<b>40.1 QP</b>	<b>43.5</b>	<b>-3.4</b>	<b>1.50 H</b>	<b>174</b>	<b>55.1</b>	<b>-15.0</b>
3	<b>299.29</b>	<b>42.6 QP</b>	<b>46.0</b>	<b>-3.4</b>	<b>1.00 H</b>	<b>355</b>	<b>53.4</b>	<b>-10.8</b>
4	398.09	32.9 QP	46.0	-13.1	1.50 H	160	40.8	-7.9
5	697.46	39.7 QP	46.0	-6.3	1.00 H	123	40.4	-0.7
6	898.02	41.8 QP	46.0	-4.2	1.50 H	82	38.6	3.2

### Remarks:

1. Emission Level(dBuV/m) = Raw Value(dBuV) + Correction Factor(dB/m)
2. Correction Factor(dB/m) = Antenna Factor(dB/m) + Cable Factor(dB) – Pre-Amplifier Factor(dB)
3. Margin value = Emission Level – Limit value
4. The other emission levels were very low against the limit of frequency range 30 MHz ~ 1 GHz.
5. The emission levels were very low against the limit of frequency range 9 kHz ~ 30 MHz: the amplitude of spurious emissions attenuated more than 20 dB below the permissible value to be report.

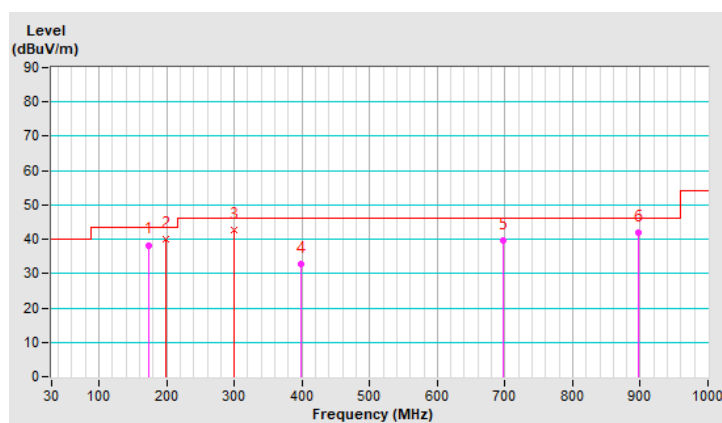

<b>RF Mode</b>	802.11a	<b>Channel</b>	CH 1 : 5955 MHz
<b>Frequency Range</b>	30 MHz ~ 1 GHz	<b>Detector Function &amp; Bandwidth</b>	(QP) RB = 120kHz
<b>Input Power</b>	120 Vac, 60 Hz	<b>Environmental Conditions</b>	25°C, 67% RH
<b>Tested By</b>	Tom Yang		

Antenna Polarity & Test Distance : Vertical at 3 m								
No	Frequency (MHz)	Emission Level (dBUV/m)	Limit (dBUV/m)	Margin (dB)	Antenna Height (m)	Table Angle (Degree)	Raw Value (dBUV)	Correction Factor (dB/m)
1	38.66	22.2 QP	40.0	-17.8	1.50 V	7	35.2	-13.0
2	178.15	32.0 QP	43.5	-11.5	2.00 V	47	45.3	-13.3
3	199.39	34.6 QP	43.5	-8.9	1.00 V	134	49.6	-15.0
4	299.10	39.4 QP	46.0	-6.6	1.00 V	106	50.2	-10.8
5	398.64	30.3 QP	46.0	-15.7	2.00 V	92	38.2	-7.9
6	698.11	34.4 QP	46.0	-11.6	1.50 V	49	35.1	-0.7

**Remarks:**

1. Emission Level(dBUV/m) = Raw Value(dBUV) + Correction Factor(dB/m)
2. Correction Factor(dB/m) = Antenna Factor(dB/m) + Cable Factor(dB) – Pre-Amplifier Factor(dB)
3. Margin value = Emission Level – Limit value
4. The other emission levels were very low against the limit of frequency range 30 MHz ~ 1 GHz.
5. The emission levels were very low against the limit of frequency range 9 kHz ~ 30 MHz: the amplitude of spurious emissions attenuated more than 20 dB below the permissible value to be report.

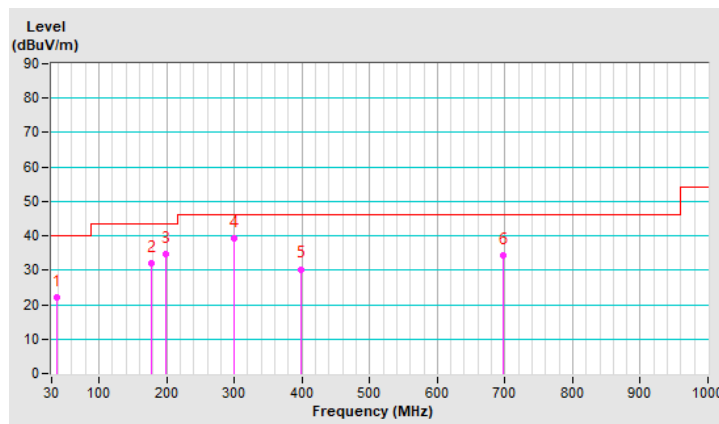

2T2S

Mode A

802.11be (EHT40) - Channel 43

No.	Frequency (MHz)	Emission Level (dBuV/m)	Limit (dBuV/m)	Margin (dB)	Raw Value (dBm)		Correction Factor (dB)	EIRP Level (dBm)
					Chain0	Chain1		
1	30.36	26.06	40	-13.94	-77.68	-76.36	4.76	-69.20
2	123.24	24.46	43.5	-19.04	-78.15	-79.04	4.76	-70.80
3	339.18	25.1	46	-20.9	-80.04	-76.51	4.76	-70.16
4	559.74	25.6	46	-20.4	-75.63	-80.58	4.76	-69.66
5	746.7	26.79	46	-19.21	-74.63	-78.83	4.76	-68.47
6	905.91	26.49	46	-19.51	-76	-77.15	4.76	-68.77

Remarks:

1. Margin value = Emission Level – Limit value
2. The other emission levels were very low against the limit.

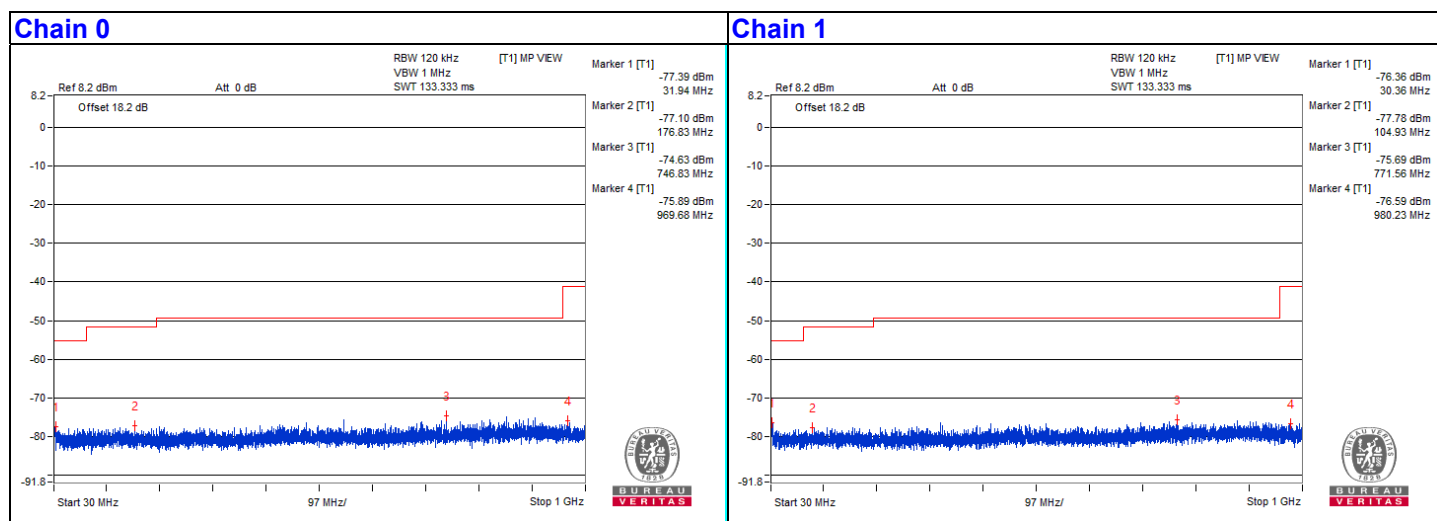

## Mode B

<b>RF Mode</b>	802.11be (EHT40)	<b>Channel</b>	CH 43 : 6165 MHz
<b>Frequency Range</b>	30 MHz ~ 1 GHz	<b>Detector Function &amp; Bandwidth</b>	(QP) RB = 120kHz
<b>Input Power</b>	120 Vac, 60 Hz	<b>Environmental Conditions</b>	25°C, 67% RH
<b>Tested By</b>	Tom Yang		

Antenna Polarity & Test Distance : Horizontal at 3 m								
No	Frequency (MHz)	Emission Level (dBuV/m)	Limit (dBuV/m)	Margin (dB)	Antenna Height (m)	Table Angle (Degree)	Raw Value (dBuV)	Correction Factor (dB/m)
1	177.19	38.2 QP	43.5	-5.3	1.50 H	12	51.4	-13.2
2	<b>199.80</b>	<b>40.1 QP</b>	<b>43.5</b>	<b>-3.4</b>	<b>2.00 H</b>	<b>0</b>	<b>55.1</b>	<b>-15.0</b>
3	299.15	41.9 QP	46.0	-4.1	1.50 H	345	52.7	-10.8
4	398.10	33.4 QP	46.0	-12.6	1.00 H	169	41.3	-7.9
5	698.14	40.2 QP	46.0	-5.8	1.50 H	314	40.9	-0.7
6	<b>896.45</b>	<b>42.6 QP</b>	<b>46.0</b>	<b>-3.4</b>	<b>1.50 H</b>	<b>145</b>	<b>39.4</b>	<b>3.2</b>

### Remarks:

1. Emission Level(dBuV/m) = Raw Value(dBuV) + Correction Factor(dB/m)
2. Correction Factor(dB/m) = Antenna Factor(dB/m) + Cable Factor(dB) – Pre-Amplifier Factor(dB)
3. Margin value = Emission Level – Limit value
4. The other emission levels were very low against the limit of frequency range 30 MHz ~ 1 GHz.
5. The emission levels were very low against the limit of frequency range 9 kHz ~ 30 MHz: the amplitude of spurious emissions attenuated more than 20 dB below the permissible value to be report.

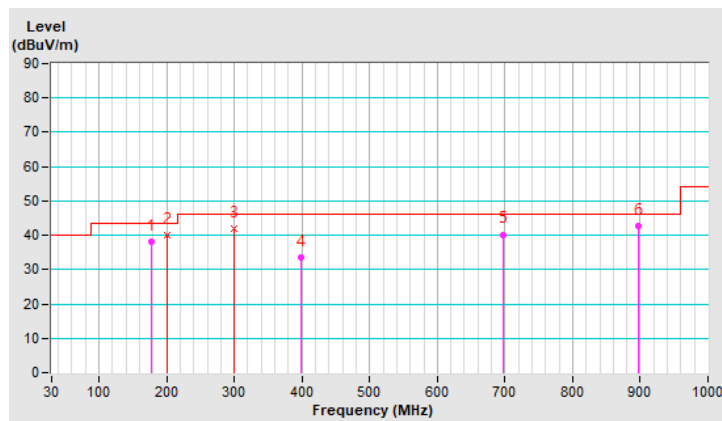



<b>RF Mode</b>	802.11be (EHT40)	<b>Channel</b>	CH 43 : 6165 MHz
<b>Frequency Range</b>	30 MHz ~ 1 GHz	<b>Detector Function &amp; Bandwidth</b>	(QP) RB = 120kHz
<b>Input Power</b>	120 Vac, 60 Hz	<b>Environmental Conditions</b>	25°C, 67% RH
<b>Tested By</b>	Tom Yang		

Antenna Polarity & Test Distance : Vertical at 3 m								
No	Frequency (MHz)	Emission Level (dBUV/m)	Limit (dBUV/m)	Margin (dB)	Antenna Height (m)	Table Angle (Degree)	Raw Value (dBUV)	Correction Factor (dB/m)
1	38.54	22.3 QP	40.0	-17.7	1.50 V	355	35.4	-13.1
2	199.78	35.2 QP	43.5	-8.3	1.00 V	54	50.2	-15.0
3	299.07	40.2 QP	46.0	-5.8	1.00 V	111	51.0	-10.8
4	397.79	30.7 QP	46.0	-15.3	2.00 V	128	38.7	-8.0
5	554.26	28.5 QP	46.0	-17.5	1.00 V	181	32.5	-4.0
6	895.93	39.4 QP	46.0	-6.6	1.00 V	59	36.2	3.2

**Remarks:**

1. Emission Level(dBUV/m) = Raw Value(dBUV) + Correction Factor(dB/m)
2. Correction Factor(dB/m) = Antenna Factor(dB/m) + Cable Factor(dB) – Pre-Amplifier Factor(dB)
3. Margin value = Emission Level – Limit value
4. The other emission levels were very low against the limit of frequency range 30 MHz ~ 1 GHz.
5. The emission levels were very low against the limit of frequency range 9 kHz ~ 30 MHz: the amplitude of spurious emissions attenuated more than 20 dB below the permissible value to be report.

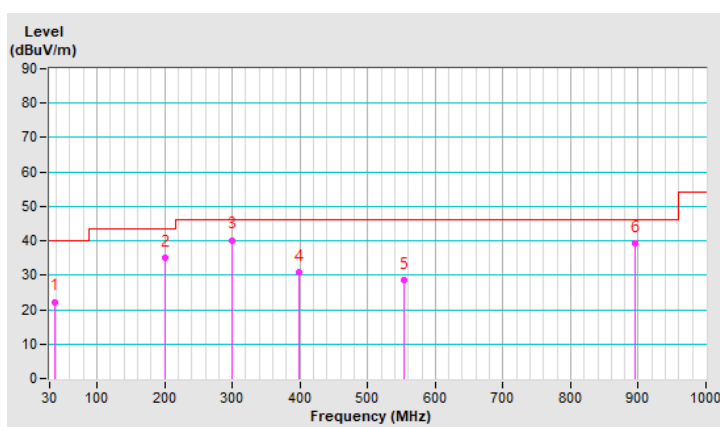

## 7.8 Unwanted Emissions above 1 GHz

### Radiated versus Conducted Measurement

#### For Radiated measurement:

The level of unwanted emissions was measured when radiated by the cabinet or structure of the equipment with the antenna connector(s) terminated by a specified load (cabinet radiation)

#### For Conducted measurement:

The level of unwanted emissions was measured as their power in a specified load (conducted spurious emissions).

### Conducted Emission Convert Formula

- a. Emission Level (dBuV/m) = EIRP Level (dBm) – 20log(d) + 104.8  
d = measurement distance in 3 meters.
- b. EIRP Level (dBm) = Raw Value(dBm) + Correction Factor(dB)
- c. Correction Factor is directional gain, and the composite gain will be used when signal support the correlated signal  
For the out of band spurious the gain for the specific band may have been used rather than the highest gain across all bands.  
For the band edge the gain for the specific band may have been used.

#### Notes:

1. In restricted bands below 1000 MHz, add upper bound on ground plane reflection:  
For f = 30 – 1000 MHz, add 4.7 dB.
2. The conducted emission test was considered some factor to compute test result.

Mode A

1T1S

802.11a - Channel 1

Conducted spurious emission table

No.	Frequency (MHz)	Emission Level (dBuV/m)	Limit (dBuV/m)	Margin (dB)	Raw Value (dBm)	Correction Factor (dB)	EIRP Level (dBm)
1	11906.25	63.36 PK	74	-10.64	-36.66	4.76	-31.90
2	11903.12	42.59 AV	54	-11.41	-57.43	4.76	-52.67
3	17870	54.36 PK	74	-19.64	-45.66	4.76	-40.90
4	17855.62	43.29 AV	54	-10.71	-56.73	4.76	-51.97

Remarks:

1. Margin value = Emission Level – Limit value
2. The other emission levels were very low against the limit.

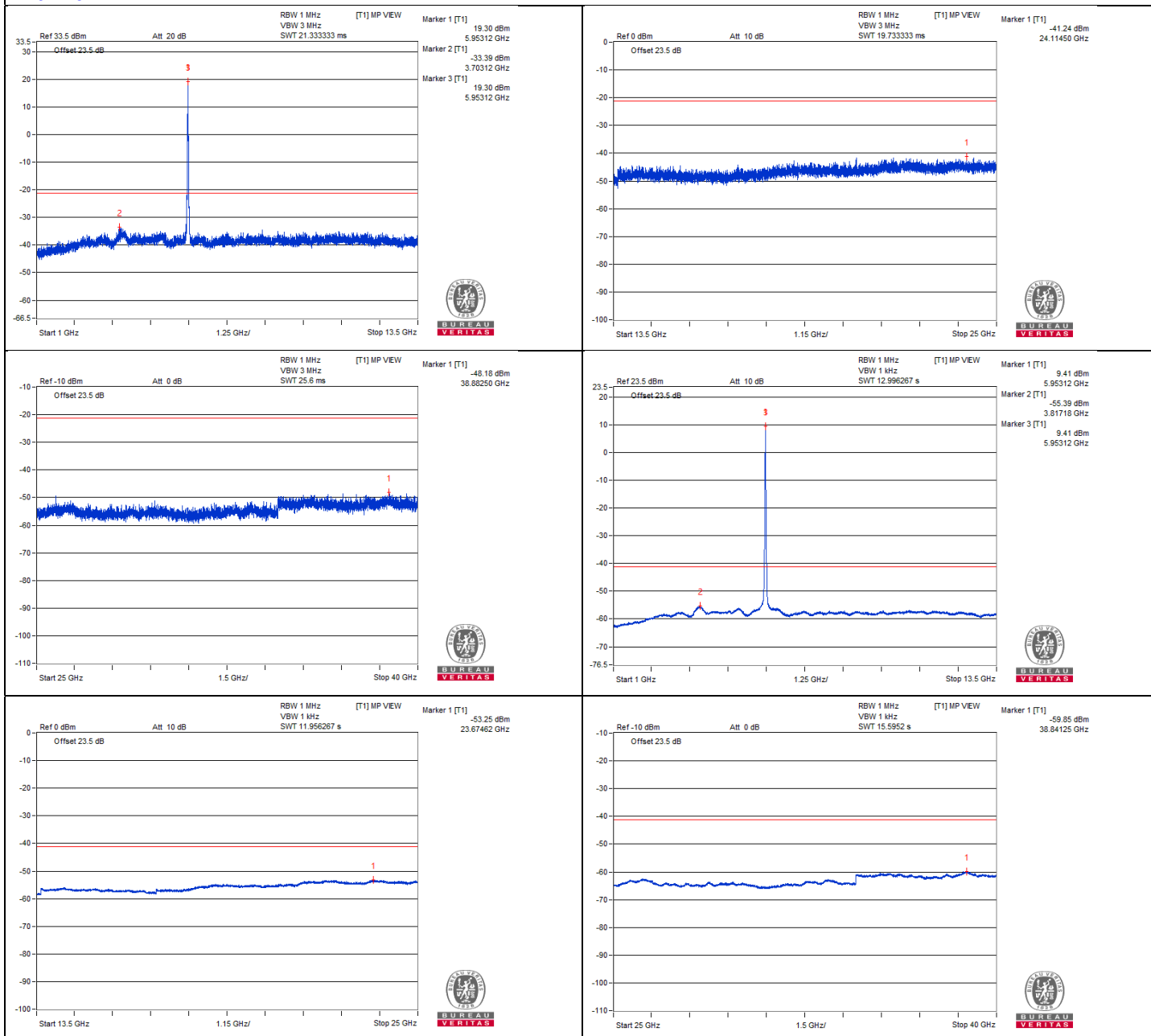
**Chain 0**

**Bandedge table**

No.	Frequency (MHz)	Emission Level (dBuV/m)	Limit (dBuV/m)	Margin (dB)	Raw Value (dBm)	Correction Factor (dB)	EIRP Level (dBm)
1	#5924.6	80.04 PK	88.2	-8.16	-19.98	4.76	-15.22
2	#5924.87	66.45 AV	68.2	-1.75	-33.57	4.76	-28.81

Remarks:

1. Margin value = Emission Level – Limit value
2. The other emission levels were very low against the limit.
3. " # " : The frequency is out of the restricted band.

**Chain 0**

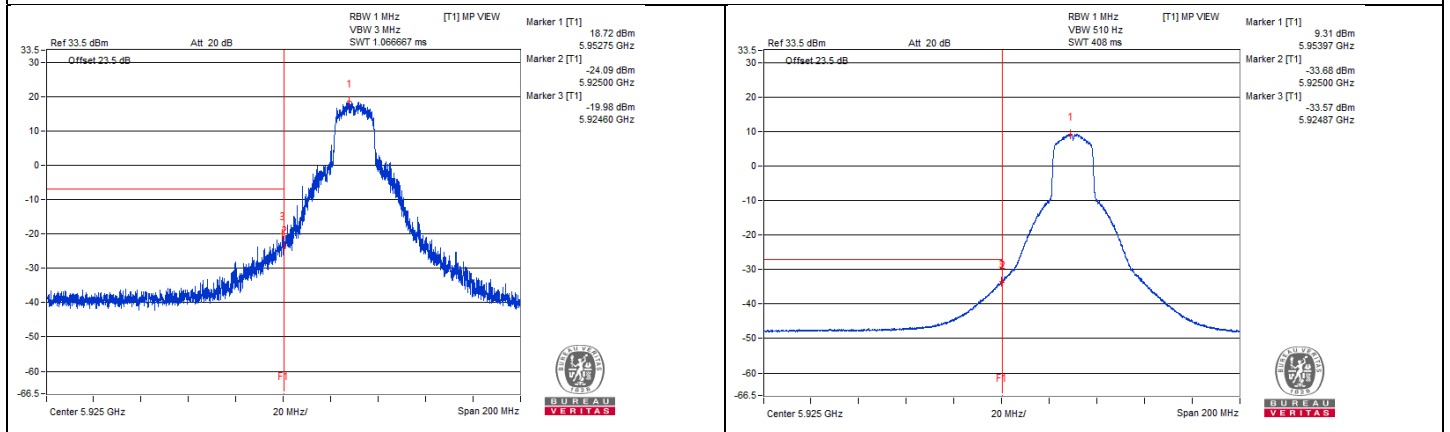

**802.11a - Channel 45**
**Conducted spurious emission table**

No.	Frequency (MHz)	Emission Level (dBuV/m)	Limit (dBuV/m)	Margin (dB)	Raw Value (dBm)	Correction Factor (dB)	EIRP Level (dBm)
1	12357.81	62.87 PK	74	-11.13	-37.15	4.76	-32.39
2	12356.25	42.68 AV	54	-11.32	-57.34	4.76	-52.58
3	18526.93	54.67 PK	74	-19.33	-45.35	4.76	-40.59
4	18516.87	44.38 AV	54	-9.62	-55.64	4.76	-50.88

**Remarks:**

1. Margin value = Emission Level – Limit value
2. The other emission levels were very low against the limit.

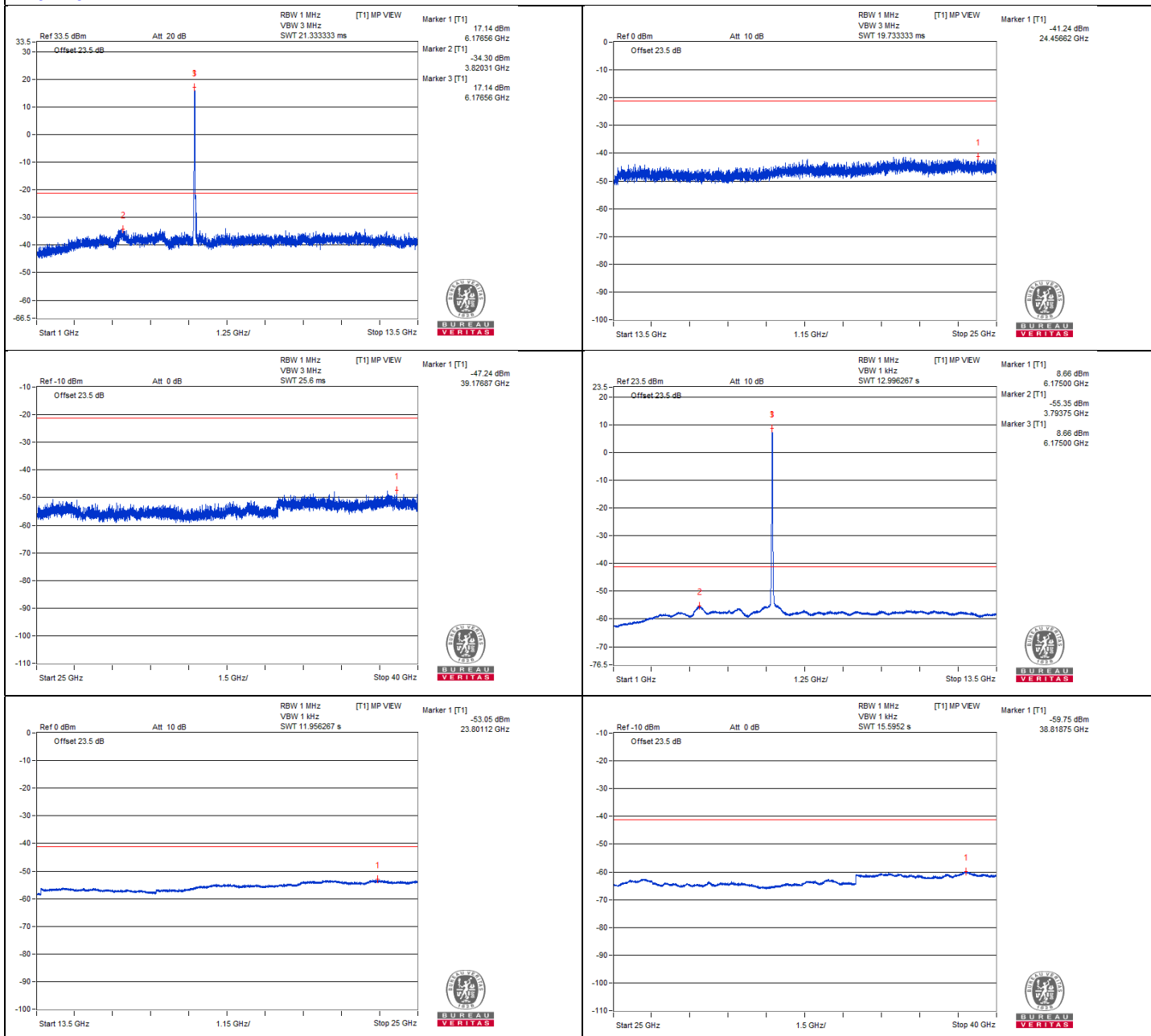
**Chain 0**

**802.11a - Channel 93**

**Conducted spurious emission table**

No.	Frequency (MHz)	Emission Level (dBuV/m)	Limit (dBuV/m)	Margin (dB)	Raw Value (dBm)	Correction Factor (dB)	EIRP Level (dBm)
1	#12821.87	62 PK	88.2	-26.2	-38.02	4.76	-33.26
2	#12837.5	41.73 AV	68.2	-26.47	-58.29	4.76	-53.53
3	19237.06	55.62 PK	74	-18.38	-44.4	4.76	-39.64
4	19250	45.18 AV	54	-8.82	-54.84	4.76	-50.08

Remarks:

1. Margin value = Emission Level – Limit value
2. The other emission levels were very low against the limit.
3. " # " : The frequency is out of the restricted band.



### Chain 0

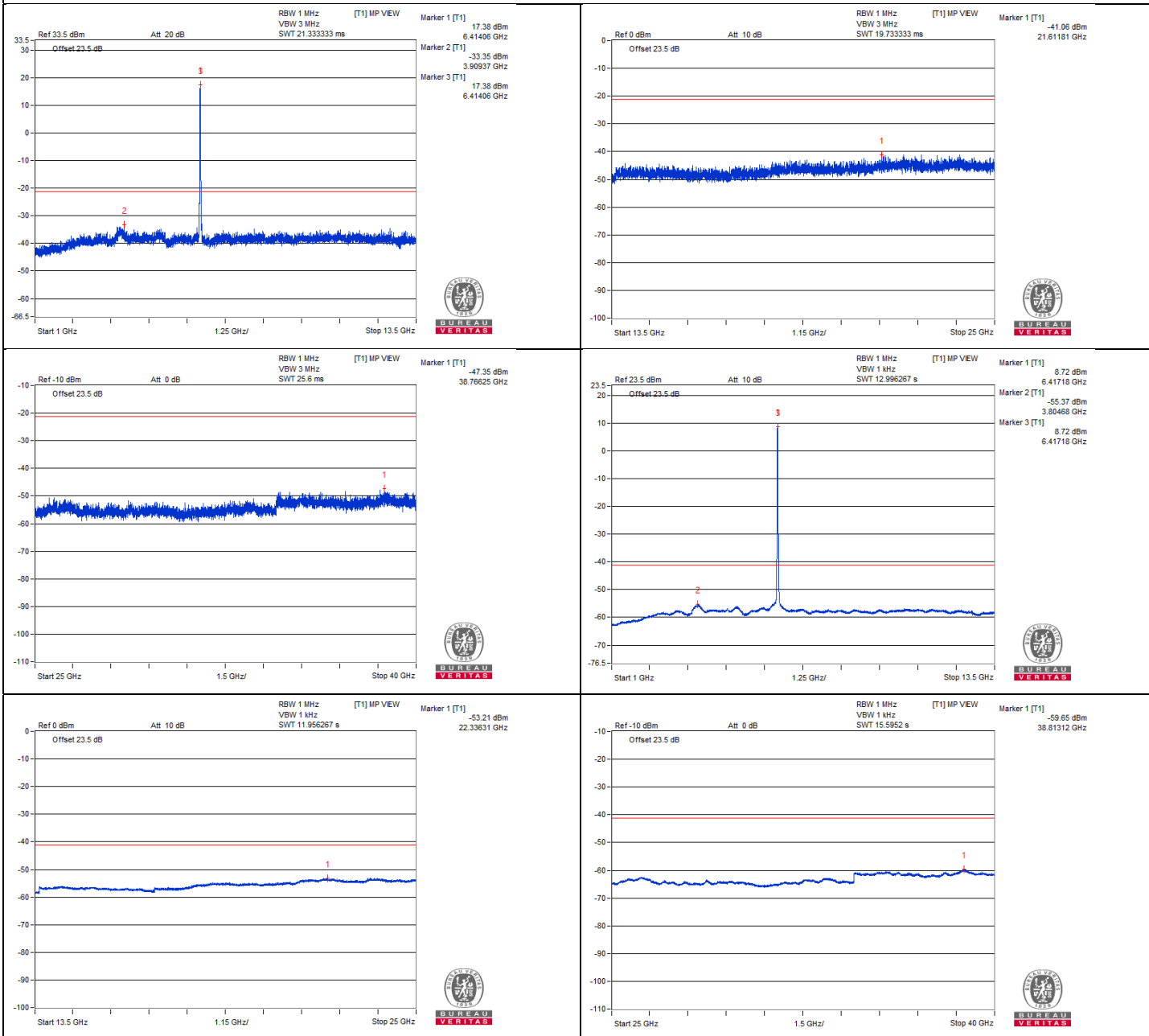

802.11a - Channel 117

Conducted spurious emission table

No.	Frequency (MHz)	Emission Level (dBuV/m)	Limit (dBuV/m)	Margin (dB)	Raw Value (dBm)	Correction Factor (dB)	EIRP Level (dBm)
1	#13075	61.63 PK	88.2	-26.57	-38.39	4.76	-33.63
2	#13071.87	41.39 AV	68.2	-26.81	-58.63	4.76	-53.87
3	19612.25	55.05 PK	74	-18.95	-44.97	4.76	-40.21
4	19606.5	44.48 AV	54	-9.52	-55.54	4.76	-50.78

Remarks:

1. Margin value = Emission Level – Limit value
2. The other emission levels were very low against the limit.
3. " # " : The frequency is out of the restricted band.

### Chain 0

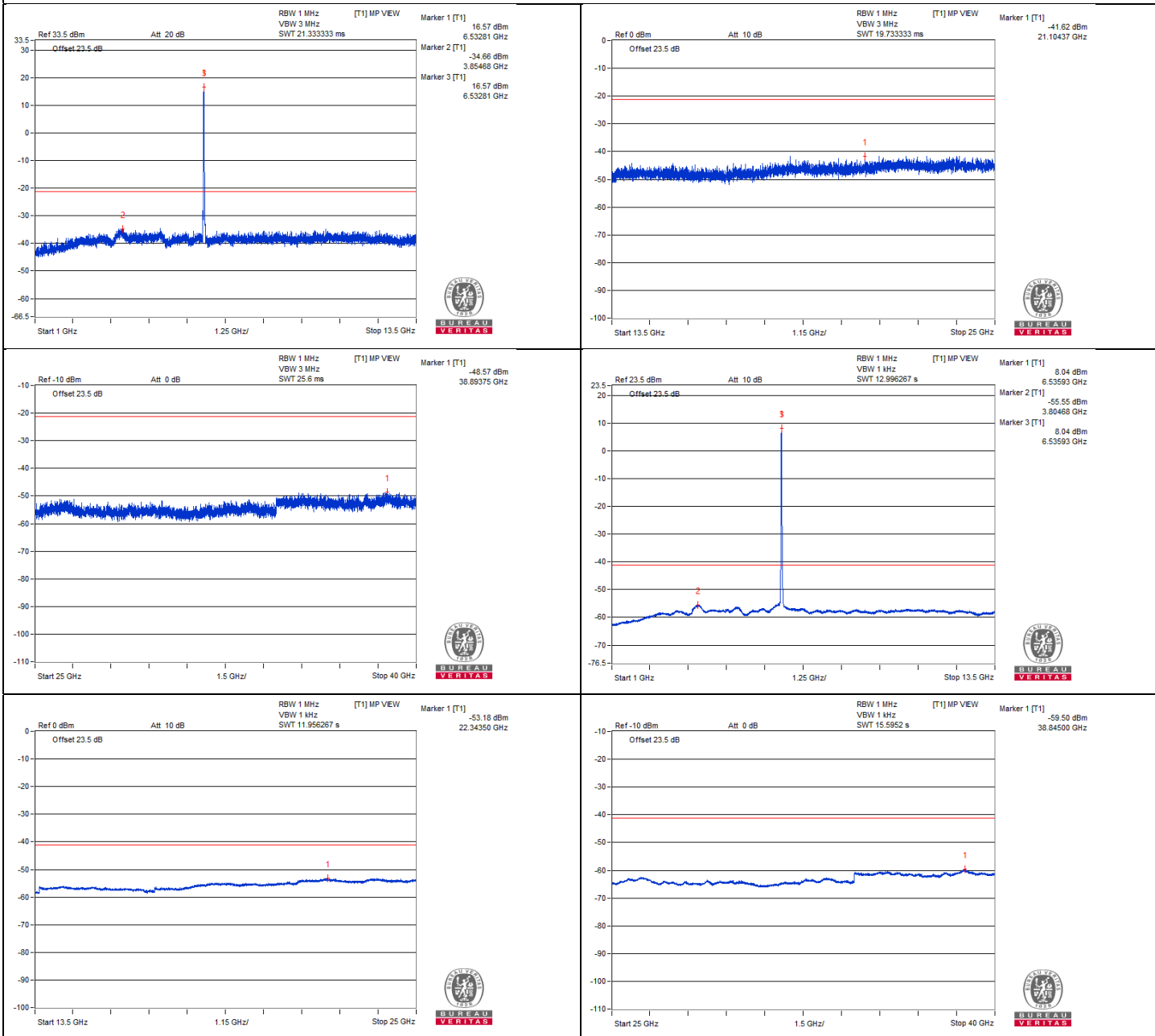

**802.11a - Channel 149**
**Conducted spurious emission table**

No.	Frequency (MHz)	Emission Level (dBuV/m)	Limit (dBuV/m)	Margin (dB)	Raw Value (dBm)	Correction Factor (dB)	EIRP Level (dBm)
1	13392.18	62.92 PK	74	-11.08	-37.1	4.76	-32.34
2	13395.31	41.63 AV	54	-12.37	-58.39	4.76	-53.63
3	20076.56	55.11 PK	74	-18.89	-44.91	4.76	-40.15
4	20079.43	44.8 AV	54	-9.2	-55.22	4.76	-50.46

**Remarks:**

1. Margin value = Emission Level – Limit value
2. The other emission levels were very low against the limit.



### Chain 0

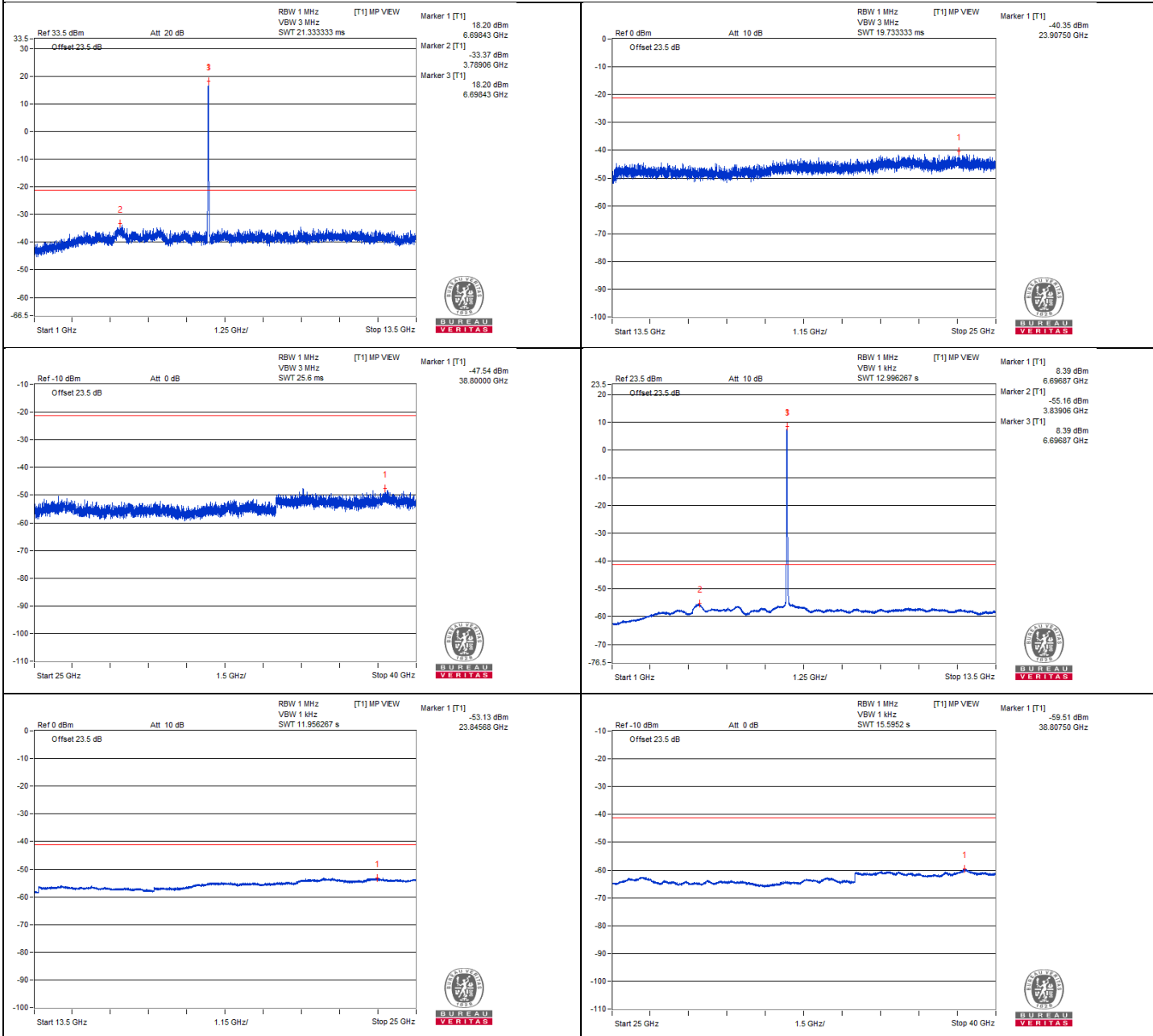

**802.11a - Channel 181**
**Conducted spurious emission table**

No.	Frequency (MHz)	Emission Level (dBuV/m)	Limit (dBuV/m)	Margin (dB)	Raw Value (dBm)	Correction Factor (dB)	EIRP Level (dBm)
1	#13712.75	54.7 PK	88.2	-33.5	-45.32	4.76	-40.56
2	#13709.87	43.29 AV	68.2	-24.91	-56.73	4.76	-51.97
3	20571.06	55.58 PK	74	-18.42	-44.44	4.76	-39.68
4	20556.68	44.83 AV	54	-9.17	-55.19	4.76	-50.43

**Remarks:**

1. Margin value = Emission Level – Limit value
2. The other emission levels were very low against the limit.
3. " # " : The frequency is out of the restricted band.

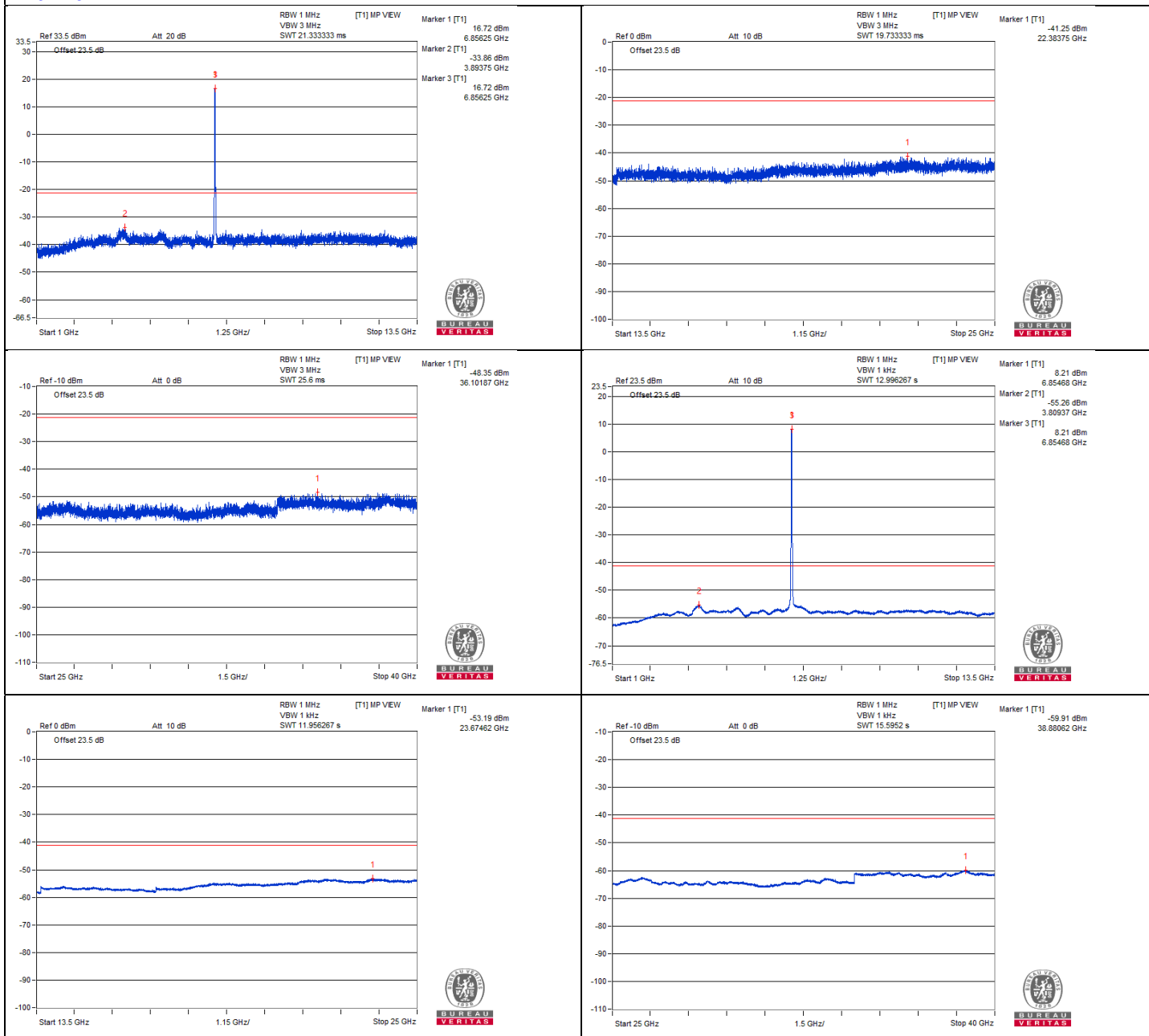
**Chain 0**

**Bandedge table**

No.	Frequency (MHz)	Emission Level (dBuV/m)	Limit (dBuV/m)	Margin (dB)	Raw Value (dBm)	Correction Factor (dB)	EIRP Level (dBm)
1	#7209.15	65.16 PK	88.2	-23.04	-34.71	4.61	-30.10
2	#7205.1	52.42 AV	68.2	-15.78	-47.45	4.61	-42.84

Remarks:

1. Margin value = Emission Level – Limit value
2. The other emission levels were very low against the limit.
3. " # " : The frequency is out of the restricted band.

**Chain 0**

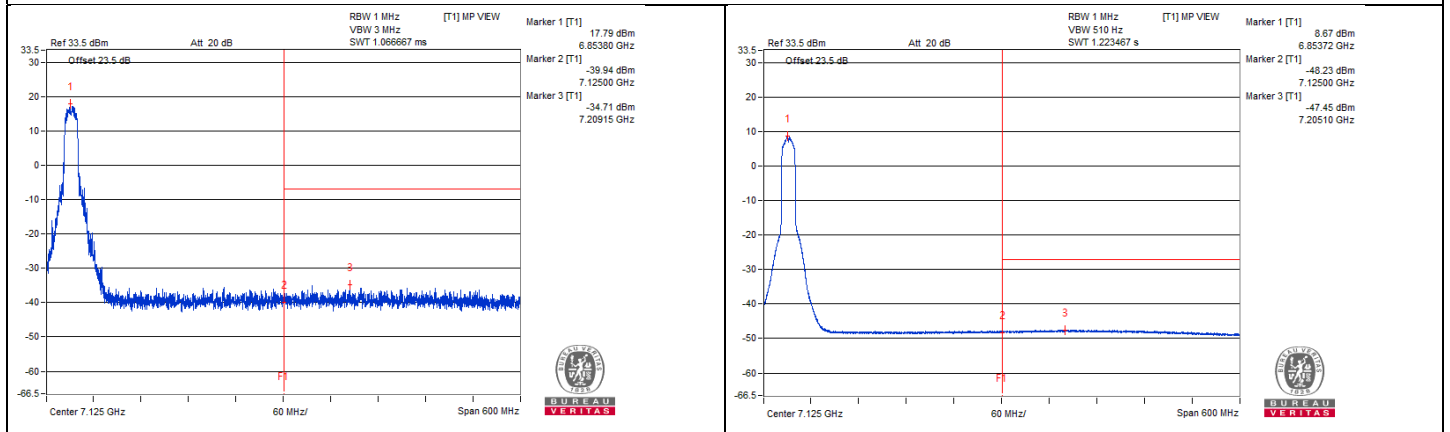



### 802.11ax (HE20) - Channel 1

#### Conducted spurious emission table

No.	Frequency (MHz)	Emission Level (dBuV/m)	Limit (dBuV/m)	Margin (dB)	Raw Value (dBm)	Correction Factor (dB)	EIRP Level (dBm)
1	11912.5	62.81 PK	74	-11.19	-37.21	4.76	-32.45
2	11909.37	42.61 AV	54	-11.39	-57.41	4.76	-52.65
3	17858.5	53.03 PK	74	-20.97	-46.99	4.76	-42.23
4	17870	43.01 AV	54	-10.99	-57.01	4.76	-52.25

#### Remarks:

1. Margin value = Emission Level – Limit value
2. The other emission levels were very low against the limit.

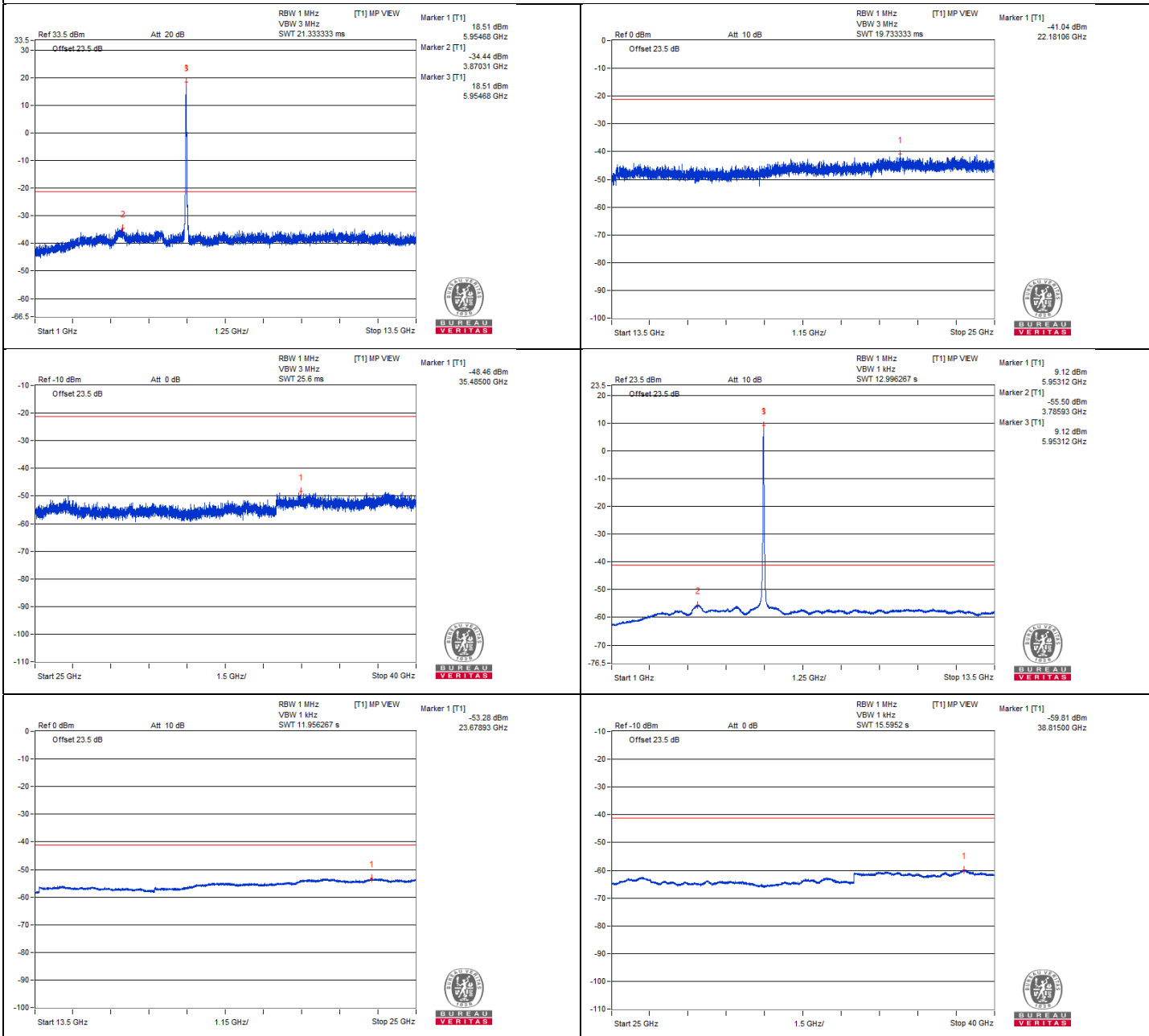
**Chain 0**

**Bandedge table**

No.	Frequency (MHz)	Emission Level (dBuV/m)	Limit (dBuV/m)	Margin (dB)	Raw Value (dBm)	Correction Factor (dB)	EIRP Level (dBm)
1	#5924.45	79.71 PK	88.2	-8.49	-20.31	4.76	-15.55
2	#5925	66.52 AV	68.2	-1.68	-33.5	4.76	-28.74

Remarks:

1. Margin value = Emission Level – Limit value
2. The other emission levels were very low against the limit.
3. " # " : The frequency is out of the restricted band.

**Chain 0**

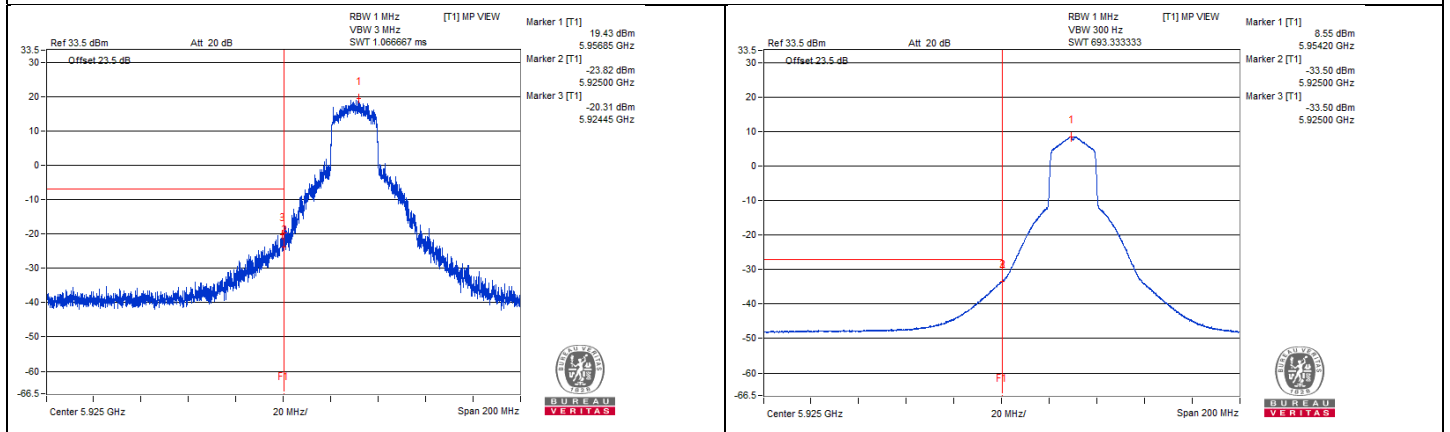

**802.11ax (HE20) - Channel 93**
**Conducted spurious emission table**

No.	Frequency (MHz)	Emission Level (dBuV/m)	Limit (dBuV/m)	Margin (dB)	Raw Value (dBm)	Correction Factor (dB)	EIRP Level (dBm)
1	#12820.31	61.98 PK	88.2	-26.22	-38.04	4.76	-33.28
2	#12821.87	41.9 AV	68.2	-26.3	-58.12	4.76	-53.36
3	19242.81	54.66 PK	74	-19.34	-45.36	4.76	-40.60
4	19244.25	45 AV	54	-9	-55.02	4.76	-50.26

**Remarks:**

1. Margin value = Emission Level – Limit value
2. The other emission levels were very low against the limit.
3. " # " : The frequency is out of the restricted band.

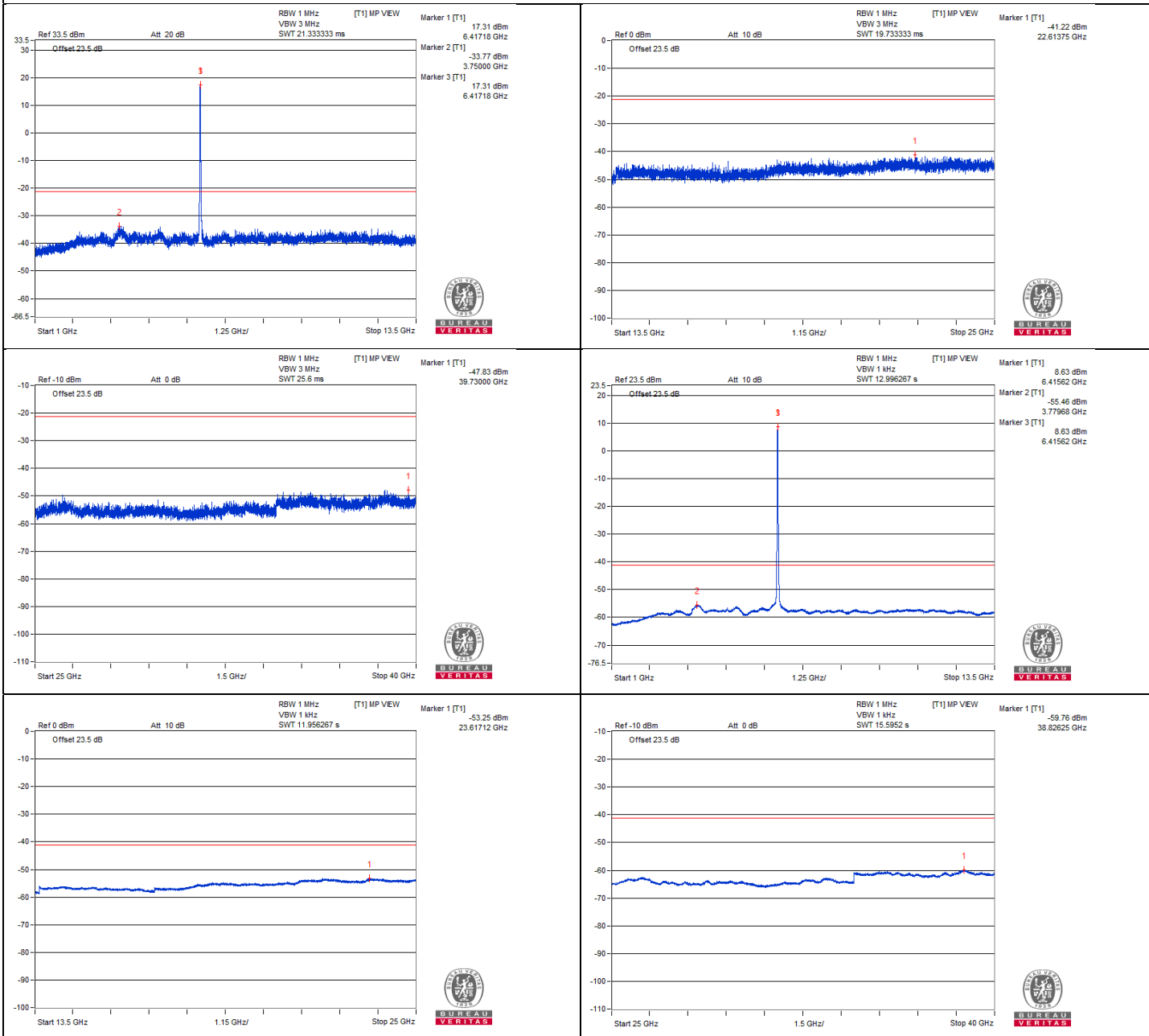
**Chain 0**

**802.11ax (HE20) - Channel 117**
**Conducted spurious emission table**

No.	Frequency (MHz)	Emission Level (dBuV/m)	Limit (dBuV/m)	Margin (dB)	Raw Value (dBm)	Correction Factor (dB)	EIRP Level (dBm)
1	#13067.18	62.55 PK	88.2	-25.65	-37.47	4.76	-32.71
2	#13062.5	41.43 AV	68.2	-26.77	-58.59	4.76	-53.83
3	19600.75	56.03 PK	74	-17.97	-43.99	4.76	-39.23
4	19597.87	44.56 AV	54	-9.44	-55.46	4.76	-50.70

**Remarks:**

1. Margin value = Emission Level – Limit value
2. The other emission levels were very low against the limit.
3. " # " : The frequency is out of the restricted band.

### Chain 0

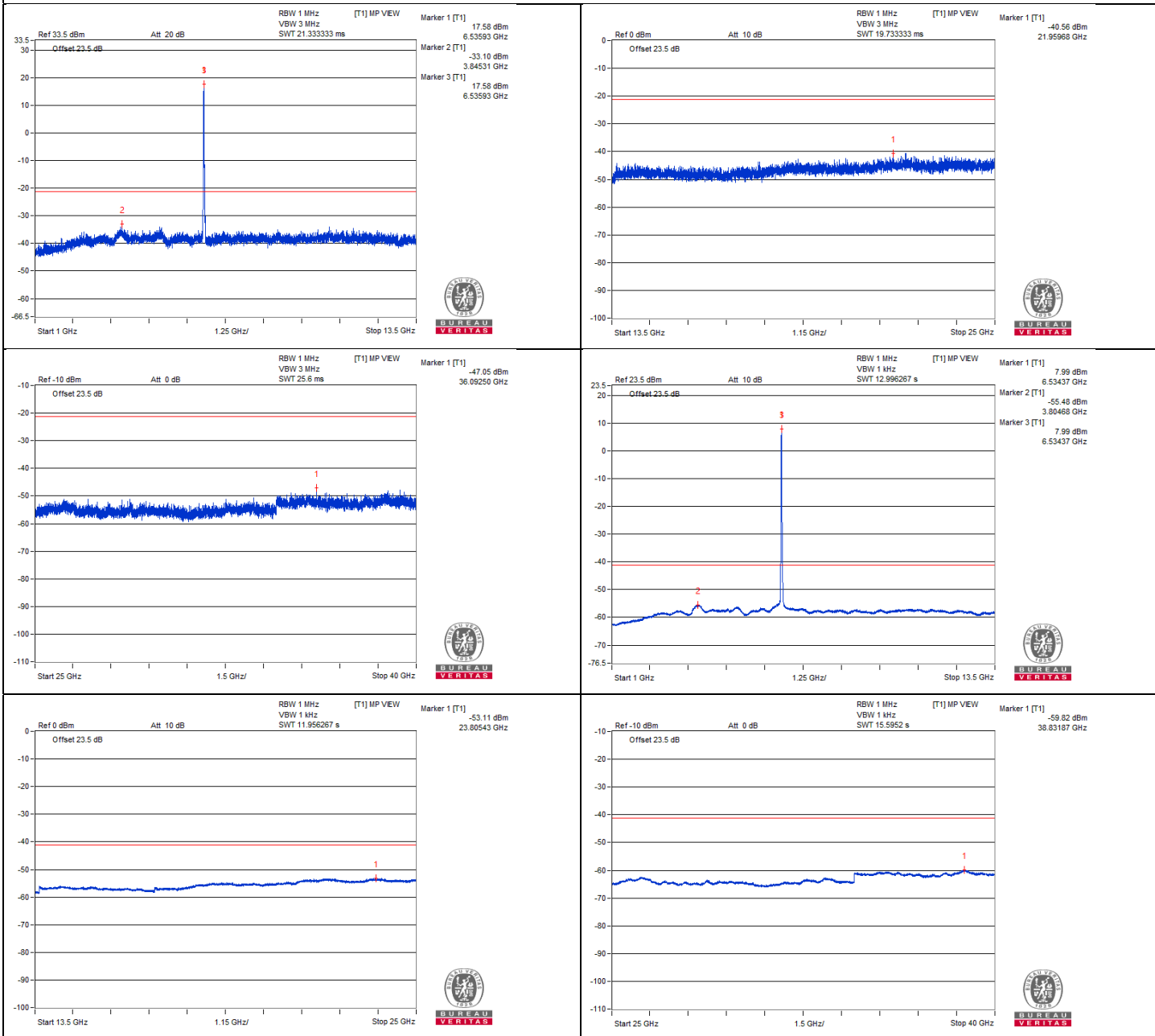

**802.11ax (HE20) - Channel 181**
**Conducted spurious emission table**

No.	Frequency (MHz)	Emission Level (dBuV/m)	Limit (dBuV/m)	Margin (dB)	Raw Value (dBm)	Correction Factor (dB)	EIRP Level (dBm)
1	#13701.25	54.29 PK	88.2	-33.91	-45.73	4.76	-40.97
2	#13692.62	43.65 AV	68.2	-24.55	-56.37	4.76	-51.61
3	20575.37	54.84 PK	74	-19.16	-45.18	4.76	-40.42
4	20559.56	44.92 AV	54	-9.08	-55.1	4.76	-50.34

**Remarks:**

1. Margin value = Emission Level – Limit value
2. The other emission levels were very low against the limit.
3. " # " : The frequency is out of the restricted band.

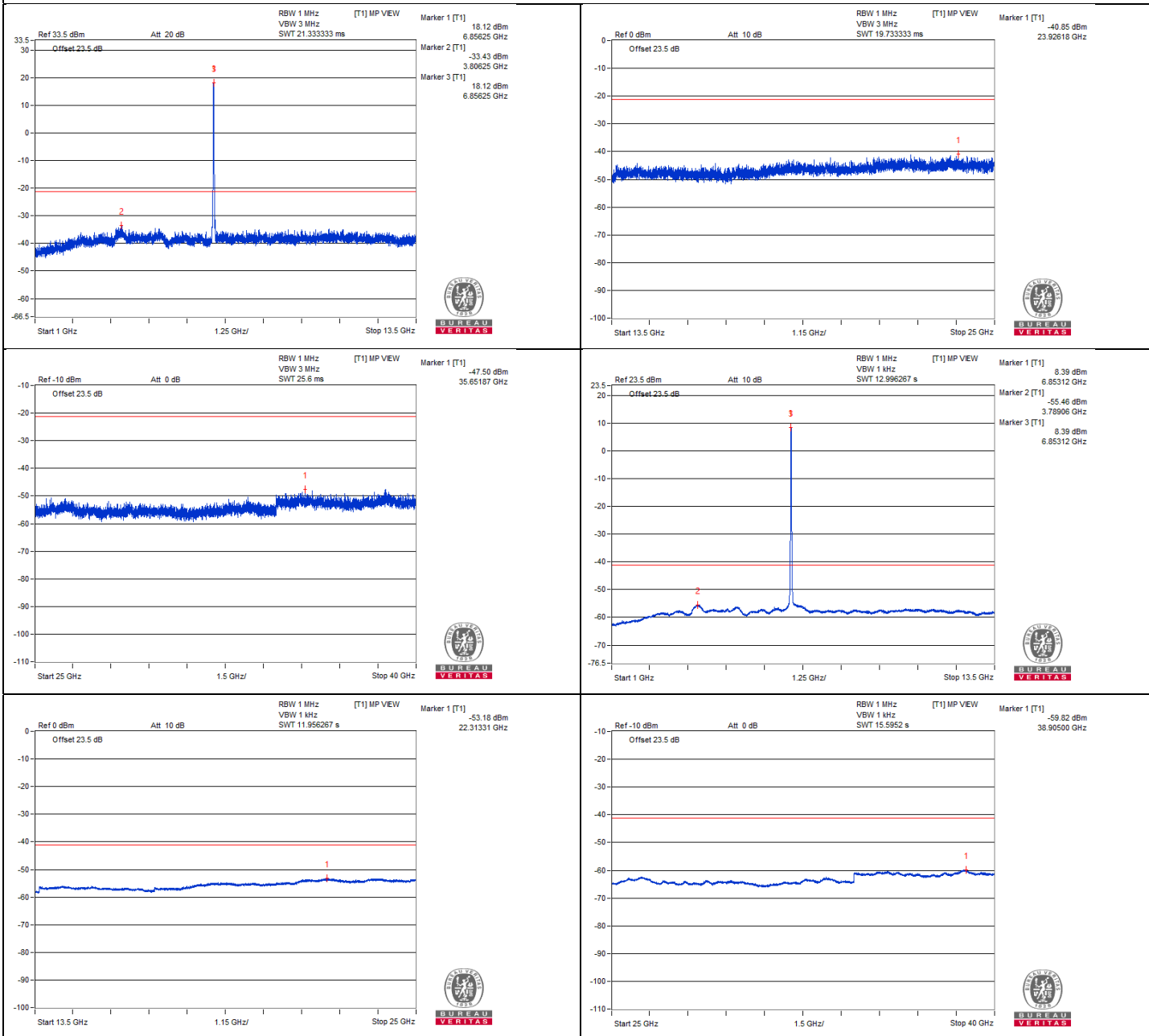

**Chain 0**

**Bandedge table**

No.	Frequency (MHz)	Emission Level (dBuV/m)	Limit (dBuV/m)	Margin (dB)	Raw Value (dBm)	Correction Factor (dB)	EIRP Level (dBm)
1	#7139.85	63.95 PK	88.2	-24.25	-35.92	4.61	-31.31
2	#7213.35	52.24 AV	68.2	-15.96	-47.63	4.61	-43.02

Remarks:

1. Margin value = Emission Level – Limit value
2. The other emission levels were very low against the limit.
3. " # " : The frequency is out of the restricted band.

**Chain 0**

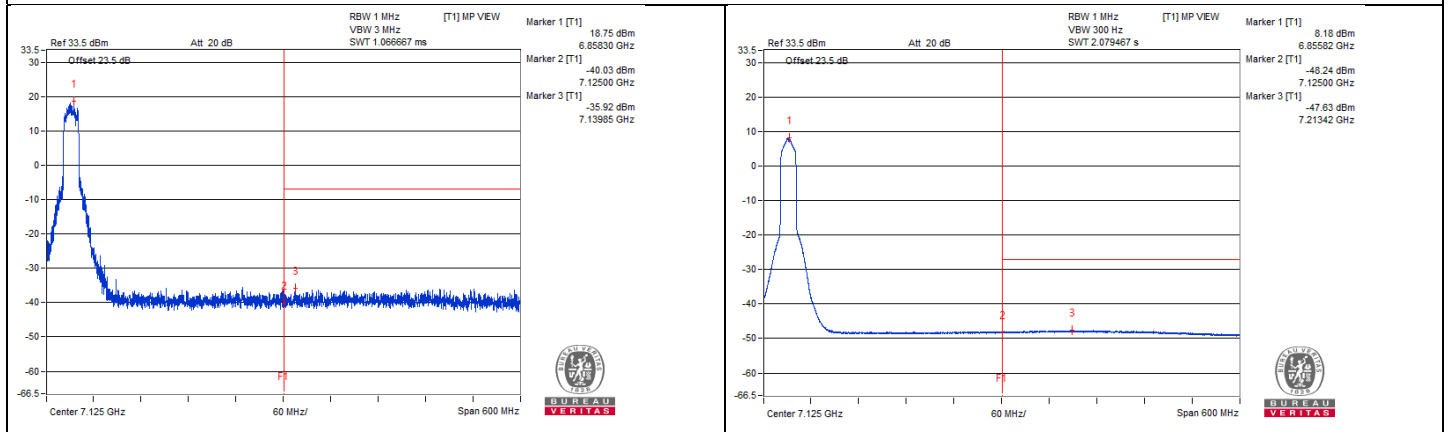

### 802.11ax (HE40) - Channel 3

#### Conducted spurious emission table

No.	Frequency (MHz)	Emission Level (dBuV/m)	Limit (dBuV/m)	Margin (dB)	Raw Value (dBm)	Correction Factor (dB)	EIRP Level (dBm)
1	11935.93	63.8 PK	74	-10.2	-36.22	4.76	-31.46
2	11920.31	42.38 AV	54	-11.62	-57.64	4.76	-52.88
3	17898.75	55.16 PK	74	-18.84	-44.86	4.76	-40.10
4	17904.5	43.11 AV	54	-10.89	-56.91	4.76	-52.15

Remarks:

1. Margin value = Emission Level – Limit value
2. The other emission levels were very low against the limit.

### Chain 0

