

TEST REPORT

CERTIFICATE OF CONFORMITY

Standard: 47 CFR FCC Part 15, Subpart E (Section 15.407)
Report No.: RFBARR-WTW-P22060042A-1
FCC ID: RAS-MT7927
Product: 2TX 11be (WiFi7) BW320 + BT/BLE Combo Card
Brand: MediaTek
Model No.: MT7927
Received Date: 2022/10/6
Test Date: 2022/11/12 ~ 2022/12/25
Issued Date: 2023/3/23

Applicant: MediaTek Inc.

Address: No. 1, Dusing 1st Rd., Hsinchu Science Park, Hsinchu City, 30078 Taiwan

Issued By: Bureau Veritas Consumer Products Services (H.K.) Ltd., Taoyuan Branch
Hsin Chu Laboratory

Lab Address: E-2, No.1, Li Hsin 1st Road, Hsinchu Science Park, Hsinchu City 300, Taiwan

Test Location: E-2, No.1, Li Hsin 1st Road, Hsinchu Science Park, Hsinchu City 300, Taiwan

FCC Registration / 723255 / TW2022

Designation Number:

Approved by: _____

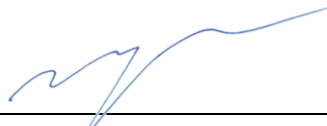

May Chen / Manager

Date: _____

2023/3/23

This test report consists of 119 pages in total. It may be duplicated completely for legal use with the approval of the applicant. It should not be reproduced except in full, without the written approval of our laboratory. The test results in the report only apply to the tested sample. The test results in this report are traceable to the national or international standards.



Prepared by : Vivian Huang / Specialist

This report is governed by, and incorporates by reference, the Conditions of Testing as posted at the date of issuance of this report at <http://www.bureauveritas.com/home/about-us/our-business/cps/about-us/terms-conditions/> and is intended for your exclusive use. Any copying or replication of this report to or for any other person or entity, or use of our name or trademark, is permitted only with our prior written permission. This report sets forth our findings solely with respect to the test samples identified herein. The results set forth in this report are not indicative or representative of the quality or characteristics of the lot from which a test sample was taken or any similar or identical product unless specifically and expressly noted. Our report includes all of the tests requested by you and the results thereof based upon the information that you provided to us. Measurement uncertainty is only provided upon request for accredited tests. Statements of conformity are based on simple acceptance criteria without taking measurement uncertainty into account, unless otherwise requested in writing. You have 60 days from date of issuance of this report to notify us of any material error or omission caused by our negligence or if you require measurement uncertainty; provided, however, that such notice shall be in writing and shall specifically address the issue you wish to raise. A failure to raise such issue within the prescribed time shall constitute your unqualified acceptance of the completeness of this report, the tests conducted and the correctness of the report contents.

Table of Contents

Release Control Record	4
1 Certificate	5
2 Summary of Test Results	6
2.1 Measurement Uncertainty	6
2.2 Supplementary Information	6
3 General Information	7
3.1 General Description of EUT	7
3.2 Antenna Description of EUT	9
3.3 Channel List	10
3.4 Test Mode Applicability and Tested Channel Detail	12
3.5 Duty Cycle of Test Signal	14
3.6 Test Program Used and Operation Descriptions	18
3.7 Connection Diagram of EUT and Peripheral Devices	18
3.8 Configuration of Peripheral Devices and Cable Connections	19
4 Test Instruments	20
4.1 26 dB Bandwidth	20
4.2 RF Output Power	20
4.3 Power Spectral Density	20
4.4 6 dB Bandwidth	20
4.5 Occupied Bandwidth	20
4.6 AC Power Conducted Emissions	21
4.7 Unwanted Emissions below 1 GHz	21
4.8 Unwanted Emissions above 1 GHz	22
5 Limits of Test Items	23
5.1 26 dB Bandwidth	23
5.2 RF Output Power	23
5.3 Power Spectral Density	23
5.4 6 dB Bandwidth	23
5.5 Occupied Bandwidth	23
5.6 AC Power Conducted Emissions	24
5.7 Unwanted Emissions below 1 GHz	24
5.8 Unwanted Emissions above 1 GHz	25
6 Test Arrangements	26
6.1 26 dB Bandwidth	26
6.1.1 Test Setup	26
6.1.2 Test Procedure	26
6.2 RF Output Power	26
6.2.1 Test Setup	26
6.2.2 Test Procedure	26
6.3 Power Spectral Density	27
6.3.1 Test Setup	27
6.3.2 Test Procedure	27
6.4 6 dB Bandwidth	27
6.4.1 Test Setup	27
6.4.2 Test Procedure	27
6.5 Occupied Bandwidth	28
6.5.1 Test Setup	28
6.5.2 Test Procedure	28
6.6 AC Power Conducted Emissions	28
6.6.1 Test Setup	28
6.6.2 Test Procedure	28
6.7 Unwanted Emissions below 1 GHz	29
6.7.1 Test Setup	29
6.7.2 Test Procedure	30



6.8	Unwanted Emissions above 1 GHz.....	31
6.8.1	Test Setup	31
6.8.2	Test Procedure.....	31
7	Test Results of Test Item	32
7.1	26 dB Bandwidth	32
7.2	RF Output Power.....	34
7.3	Power Spectral Density	37
7.4	6 dB Bandwidth	45
7.5	Occupied Bandwidth.....	47
7.6	AC Power Conducted Emissions	53
7.7	Unwanted Emissions below 1 GHz	55
7.8	Unwanted Emissions above 1 GHz.....	57
8	Pictures of Test Arrangements	118
9	Information of the Testing Laboratories	119



Release Control Record

Issue No.	Description	Date Issued
RFBARR-WTW-P22060042A-1	Original release.	2023/3/23

1 Certificate

Product: 2TX 11be (WiFi7) BW320 + BT/BLE Combo Card

Brand: MediaTek

Test Model: MT7927

Sample Status: Engineering sample

Applicant: MediaTek Inc.

Test Date: 2022/11/12 ~ 2022/12/25

Standard: 47 CFR FCC Part 15, Subpart E (Section 15.407)

Measurement ANSI C63.10-2013

procedure: KDB 789033 D02 General UNII Test Procedure New Rules v02r01

KDB 662911 D01 Multiple Transmitter Output v02r01

The above equipment has been tested by **Bureau Veritas Consumer Products Services (H.K.) Ltd., Taoyuan Branch**, and found compliance with the requirement of the above standards. The test record, data evaluation & Equipment Under Test (EUT) configurations represented herein are true and accurate accounts of the measurements of the sample's RF characteristics under the conditions specified in this report.

2 Summary of Test Results

47 CFR FCC Part 15, Subpart E (Section 15.407)			
Clause	Test Item	Result	Remark
15.407(a)(2)	26 dB Bandwidth	Pass	For U-NII-2A U-NII-2C Band output power limitation is determined based on 26dBc bandwidth.
15.407(a)(1) 15.407(a)(2) 15.407(a)(3)	RF Output Power	Pass	Meet the requirement of limit.
15.407(a)(1) 15.407(a)(2) 15.407(a)(3)	Power Spectral Density	Pass	Meet the requirement of limit.
15.407(e)	6 dB Bandwidth	Pass	Meet the requirement of limit. (U-NII-3 Band only)
---	Occupied Bandwidth	-	Reference only.
15.407(g)	Frequency Stability	NA	Refer to Note 1 below
15.407(b)(9)	AC Power Conducted Emissions	Pass	Minimum passing margin is -7.36 dB at 0.15000 MHz
15.407(b)(9)	Unwanted Emissions below 1 GHz	Pass	Minimum passing margin is -3.2 dB at 199.36 MHz
15.407(b) (1/10) 15.407(b) (2/10) 15.407(b) (3/10) 15.407(b) (4(i)/10)	Unwanted Emissions above 1 GHz	Pass	Minimum passing margin is -0.1 dB at 11490.00, 5150.00 MHz
15.203	Antenna Requirement	Pass	Antenna connector is ipex(MHF) not a standard connector.

Notes:

1. All test items (except Frequency Stability) were performed for this addendum. The others testing data refer to original test report.
2. Determining compliance based on the results of the compliance measurement, not taking into account measurement instrumentation uncertainty.

2.1 Measurement Uncertainty

Where relevant, the following measurement uncertainty levels have been estimated for tests performed on the EUT as specified in CISPR 16-4-2:

Measurement	Specification	Expanded Uncertainty (k=2) (±)
AC Power Conducted Emissions	150 kHz ~ 30 MHz	1.9 dB
Unwanted Emissions below 1 GHz	9 kHz ~ 30 MHz	3.1 dB
	30 MHz ~ 1 GHz	5.5 dB
Unwanted Emissions above 1 GHz	1 GHz ~ 18 GHz	5.1 dB
	18 GHz ~ 40 GHz	5.3 dB

The other instruments specified are routine verified to remain within the calibrated levels, no measurement uncertainty is required to be calculated.

2.2 Supplementary Information

There is not any deviation from the test standards for the test method, and no modifications required for compliance.

3 General Information

3.1 General Description of EUT

Product	2TX 11be (WiFi7) BW320 + BT/BLE Combo Card
Brand	MediaTek
Test Model	MT7927
Status of EUT	Engineering sample
Power Supply Rating	3.3Vdc from host equipment
Modulation Type	64QAM, 16QAM, QPSK, BPSK for OFDM 256QAM for OFDM in 11ac mode 1024QAM for OFDMA in 11ax mode 4096QAM for OFDMA in 11be mode
Modulation Technology	OFDM, OFDMA
Transfer Rate	802.11a: up to 54Mbps 802.11n: up to 300Mbps 802.11ac: up to 1733.3 Mbps 802.11ax: up to 2401.9 Mbps 802.11be: up to 2882.4 Mbps
Operating Frequency	5.18 GHz ~ 5.25 GHz 5.25 GHz ~ 5.32 GHz 5.5 GHz ~ 5.72 GHz 5.745 GHz ~ 5.825 GHz
Number of Channel	U-NII-1: 802.11a, 802.11n (HT20), 802.11ac (VHT20), 802.11ax (HE20), 802.11be (EHT20): 4 802.11n (HT40), 802.11ac (VHT40), 802.11ax (HE40), 802.11be (EHT40): 2 802.11ac (VHT80), 802.11ax (HE80), 802.11be (EHT80): 1 U-NII-2A: 802.11a, 802.11n (HT20), 802.11ac (VHT20), 802.11ax (HE20): 4 802.11n (HT40), 802.11ac (VHT40), 802.11ax (HE40): 2 802.11ac (VHT80), 802.11ax (HE80): 1 802.11ac (VHT160), 802.11ax (HE160): 1 U-NII-2C: 802.11a, 802.11n (HT20), 802.11ac (VHT20), 802.11ax (HE20): 12 802.11n (HT40), 802.11ac (VHT40), 802.11ax (HE40): 6 802.11ac (VHT80), 802.11ax (HE80): 3 802.11ac (VHT160), 802.11ax (HE160): 1 U-NII-3: 802.11a, 802.11n (HT20), 802.11ac (VHT20), 802.11ax (HE20), 802.11be (EHT20): 5 802.11n (HT40), 802.11ac (VHT40), 802.11ax (HE40), 802.11be (EHT40): 2 802.11ac (VHT80), 802.11ax (HE80), 802.11be (EHT80): 1
Resource Unit (RU)	Single RU: 26-tone, 52-tone, 106-tone, 242-tone, 484-tone, 996-tone Multi-RU(Small RU):52-tone + 26-tone, 106-tone + 26-tone Multi-RU (Large RU):484-tone + 242-tone, 996-tone +484-tone, 2 * 996-tone
Channel Puncturing (Large RU)	80 MHz punctured by 20 MHz ; 160 MHz punctured by 20 MHz 160 MHz punctured by 40 MHz
Output Power	5.18 GHz ~ 5.25 GHz : 115.488 mW (20.63 dBm) 5.25 GHz ~ 5.32 GHz : 101.165 mW (20.05 dBm) 5.5 GHz ~ 5.72 GHz : 109.486 mW (20.39 dBm) 5.745 GHz ~ 5.825 GHz : 410.234 mW (26.13 dBm)
EUT Category	Client device

Note:

1. This is a supplementary report of Report No: RFBARR-WTW-P22060042-1. The differences between them are as below information:
 - ◆ Add Tone RU / MRU (2T)
2. According to above conditions, all test items (except Frequency Stability) need to be performed. And all data are verified to meet the requirement.
3. There are Bluetooth and WLAN (2.4GHz & 5GHz & 6GHz) technology used for the EUT.
4. Simultaneously transmission condition.

Condition	Technology	
1	WLAN (5GHz or 5.9GHz)	Bluetooth
2	WLAN (6GHz)	Bluetooth
3	WLAN (2.4GHz)	WLAN (5GHz or 5.9GHz)
4	WLAN (2.4GHz)	WLAN (6GHz)

Note: The emission of the simultaneous operation has been evaluated and no non-compliance was found.

5. The EUT support MRU mode is listed as below.

BW	Small size		Large size
	26+52	26+106	484+242
20MHz	v	v	-
40MHz	v	v	-
80MHz	v	v	v

6. The above EUT information is declared by manufacturer and for more detailed features description, please refers to the manufacturer's specifications or user's manual.

3.2 Antenna Description of EUT

1. The antenna information is listed as below.

Antenna Set No	RF Chain No.	Brand	Model	Antenna Net Gain (dBi)	Frequency Range (GHz)	Antenna Type	Connector Type	Cable Length (mm)
1	Chain0	PSA	RFMTA340718EMLB302	3.18	2.4~2.4835	PIFA	ipex(MHF)	200
				4.92	5.15~5.895			
	Chain1	PSA	RFMTA340718EMLB302	3.18	2.4~2.4835	PIFA	ipex(MHF)	200
				4.92	5.15~5.895			
2	Chain0	PSA	RFMTA311020EMMB301	1.71	2.4~2.4835	PIFA	ipex(MHF)	200
				4.82	5.15~5.895			
				4.76	5.925~6.425			
				4.29	6.425~6.525			
	Chain1	PSA	RFMTA311020EMMB301	4.61	6.525~6.875	PIFA	ipex(MHF)	200
				4.09	6.875~7.125			
				1.71	2.4~2.4835			
				4.82	5.15~5.895			
3	Chain0	PSA	RFMTA421208IMMB701	-4.99	5.925~7.125	PIFA	i-pex(MHF)	300
	Chain1	PSA	RFMTA421208IMMB701	-4.99	5.925~7.125	PIFA	i-pex(MHF)	300

Note:

1. Max. gain was selected for the final test.

* Detail antenna specification please refer to antenna datasheet and/or antenna measurement report.

2. The EUT incorporates a MIMO function:

5 GHz Band		
Modulation Mode	TX & RX Configuration	
802.11a	2TX	2RX
802.11n (HT20)	2TX	2RX
802.11n (HT40)	2TX	2RX
802.11ac (VHT20)	2TX	2RX
802.11ac (VHT40)	2TX	2RX
802.11ac (VHT80)	2TX	2RX
802.11ac (VHT160)	2TX	2RX
802.11ax (HE20)	2TX	2RX
802.11ax (HE40)	2TX	2RX
802.11ax (HE80)	2TX	2RX
802.11ax (HE160)	2TX	2RX
802.11be (EHT20)	2TX	2RX
802.11be (EHT40)	2TX	2RX
802.11be (EHT80)	2TX	2RX
802.11be (EHT160)	2TX	2RX

Note:

The modulation and bandwidth are similar for 802.11n mode for 20MHz (40MHz), 802.11ac mode for 20MHz (40MHz, 80MHz, 160MHz), 802.11ax mode for 20MHz (40MHz, 80MHz, 160MHz) and 802.11be mode for 20MHz (40MHz, 80MHz, 160MHz) therefore the manufacturer will control the power for 802.11n/ac/ax mode is same as the 802.11be mode & 802.11n/ac mode is same as the 802.11ax mode or more lower than it and investigated worst case to representative mode in test report.

3.3 Channel List

FOR 5180 ~ 5320 MHz

8 channels are provided for 802.11a, 802.11n (HT20), 802.11ac (VHT20), 802.11ax (HE20), 802.11be (EHT20):

Channel	Frequency	Channel	Frequency
36	5180 MHz	52	5260 MHz
40	5200 MHz	56	5280 MHz
44	5220 MHz	60	5300 MHz
48	5240 MHz	64	5320 MHz

4 channels are provided for 802.11n (HT40), 802.11ac (VHT40), 802.11ax (HE40), 802.11be (EHT40):

Channel	Frequency	Channel	Frequency
38	5190 MHz	54	5270 MHz
46	5230 MHz	62	5310 MHz

2 channels are provided for 802.11ac (VHT80), 802.11ax (HE80), 802.11be (EHT80):

Channel	Frequency	Channel	Frequency
42	5210 MHz	58	5290 MHz

1 straddle channel is provided for 802.11ac (VHT160) and 802.11ax (HE160):

Channel	Frequency
50	5250 MHz

FOR 5500 ~ 5720 MHz

12 channels are provided for 802.11a, 802.11n (HT20), 802.11ac (VHT20), 802.11ax (HE20):

Channel	Frequency	Channel	Frequency
100	5500 MHz	124	5620 MHz
104	5520 MHz	128	5640 MHz
108	5540 MHz	132	5660 MHz
112	5560 MHz	136	5680 MHz
116	5580 MHz	140	5700 MHz
120	5600 MHz	144	5720 MHz

6 channels are provided for 802.11n (HT40), 802.11ac (VHT40), 802.11ax (HE40):

Channel	Frequency	Channel	Frequency
102	5510 MHz	126	5630 MHz
110	5550 MHz	134	5670 MHz
118	5590 MHz	142	5710 MHz

3 channels are provided for 802.11ac (VHT80), 802.11ax (HE80):

Channel	Frequency	Channel	Frequency
106	5530 MHz	138	5690 MHz
122	5610 MHz		

1 straddle channel is provided for 802.11ac (VHT160), 802.11ax (HE160):

Channel	Frequency
114	5570 MHz

FOR 5745 ~ 5825 MHz:

5 channels are provided for 802.11a, 802.11n (HT20), 802.11ac (VHT20), 802.11ax (HE20), 802.11be (EHT20):

Channel	Frequency	Channel	Frequency
149	5745 MHz	161	5805 MHz
153	5765 MHz	165	5825 MHz
157	5785 MHz		

2 channels are provided for 802.11n (HT40), 802.11ac (VHT40), 802.11ax (HE40), 802.11be (EHT40):

Channel	Frequency	Channel	Frequency
151	5755 MHz	159	5795 MHz

1 channel is provided for 802.11ac (VHT80), 802.11ax (HE80), 802.11be (EHT80):

Channel	Frequency
155	5775 MHz

3.4 Test Mode Applicability and Tested Channel Detail

Pre-Scan:	1. EUT can be used in the following ways: X-axis/ Y-axis/ Z-axis. Pre-scan these ways and find the worst case as a representative test condition.
Worst Case:	1. In the original report: X-axis/ Y-axis/ Z-axis Worst Condition: Z-axis

Following channel(s) was (were) selected for the final test as listed below:

Test Item	Mode	Tested Channel	Modulation	Data Rate Parameter	RU/MRU Index
26 dB Bandwidth	802.11ax (HE) 26-tone RU	64	BPSK	MCS0	8
		100, 140			0, 8
	802.11ax (HE) 52-tone RU	64	BPSK	MCS0	40
		100, 140			37, 40
	802.11ax (HE) 106-tone RU	64	BPSK	MCS0	54
		100, 140			53, 54
RF Output Power / Power Spectral Density	802.11ax (HE) 26-tone RU	64	BPSK	MCS0	8
		100, 140			0, 8
	802.11ax (HE) 52-tone RU	64	BPSK	MCS0	40
		100, 140			37, 40
	802.11ax (HE) 106-tone RU	64	BPSK	MCS0	54
		100, 140			53, 54
	802.11be (EHT) 26-tone RU	36	BPSK	MCS0	0
		149, 165			0, 8
	802.11be (EHT) 52-tone RU	36	BPSK	MCS0	37
		149, 165			37, 40
	802.11be (EHT) 106-tone RU	36	BPSK	MCS0	53
		149, 165			53, 54
	802.11be (EHT) 106+26-tone MRU	36	BPSK	MCS0	82
		149, 165			82, 83
802.11be (EHT) 52+26-tone MRU	36	BPSK	MCS0	70	
	149, 165			70, 72	
802.11be (EHT) 484+242-tone MRU	42	BPSK	MCS0	92	
	155			92	
6 dB Bandwidth	802.11be (EHT) 26-tone RU	149, 165	BPSK	MCS0	0, 8
	802.11be (EHT) 52-tone RU	149, 165	BPSK	MCS0	37, 40
	802.11be (EHT) 106-tone RU	149, 165	BPSK	MCS0	53, 54
	802.11be (EHT) 106+26-tone MRU	149, 165	BPSK	MCS0	82, 83
	802.11be (EHT) 52+26-tone MRU	149, 165	BPSK	MCS0	70, 72
	802.11be (EHT) 484+242-tone MRU	155	BPSK	MCS0	92



Occupied Bandwidth	802.11ax (HE) 26-tone RU	64	BPSK	MCS0	8
		100, 140			0, 8
	802.11ax (HE) 52-tone RU	64	BPSK	MCS0	40
		100, 140			37, 40
	802.11ax (HE) 106-tone RU	64	BPSK	MCS0	54
		100, 140			53, 54
	802.11be (EHT) 26-tone RU	36	BPSK	MCS0	0
		149, 165			0, 8
	802.11be (EHT) 52-tone RU	36	BPSK	MCS0	37
		149, 165			37, 40
802.11be (EHT) 106-tone RU	36	BPSK	MCS0	53	
	149, 165			53, 54	
802.11be (EHT) 106+26-tone MRU	36	BPSK	MCS0	82	
	149, 165			82, 83	
802.11be (EHT) 52+26-tone MRU	36	BPSK	MCS0	70	
	149, 165			70, 72	
802.11be (EHT) 484+242-tone MRU	42	BPSK	MCS0	92	
	155			92	
AC Power Conducted Emissions	802.11be (EHT) 52+26-tone MRU	149	BPSK	MCS0	70
Unwanted Emissions below 1 GHz	802.11be (EHT) 52+26-tone MRU	149	BPSK	MCS0	70
Unwanted Emissions above 1 GHz	802.11ax (HE) 26-tone RU	64	BPSK	MCS0	8
		100, 140			0, 8
	802.11ax (HE) 52-tone RU	64	BPSK	MCS0	40
		100, 140			37, 40
	802.11ax (HE) 106-tone RU	64	BPSK	MCS0	54
		100, 140			53, 54
	802.11be (EHT) 26-tone RU	36	BPSK	MCS0	0
		149, 165			0, 8
	802.11be (EHT) 52-tone RU	36	BPSK	MCS0	37
		149, 165			37, 40
802.11be (EHT) 106-tone RU	36	BPSK	MCS0	53	
	149, 165			53, 54	
802.11be (EHT) 106+26-tone MRU	36	BPSK	MCS0	82	
	149, 165			82, 83	
802.11be (EHT) 52+26-tone MRU	36	BPSK	MCS0	70	
	149, 165			70, 72	
802.11be (EHT) 484+242-tone MRU	42	BPSK	MCS0	92	
	155			92	

3.5 Duty Cycle of Test Signal

802.11ax (HE) 26-tone RU: Duty cycle = $0.58 \text{ ms} / 0.696 \text{ ms} \times 100\% = 83.3\%$, duty factor = $10 * \log (1/\text{Duty cycle}) = 0.79 \text{ dB}$

802.11ax (HE) 52-tone RU: Duty cycle = $0.496 \text{ ms} / 0.611 \text{ ms} \times 100\% = 81.2\%$, duty factor = $10 * \log (1/\text{Duty cycle}) = 0.91 \text{ dB}$

802.11ax (HE) 106-tone RU: Duty cycle = $0.437 \text{ ms} / 0.552 \text{ ms} \times 100\% = 79.2\%$, duty factor = $10 * \log (1/\text{Duty cycle}) = 1.01 \text{ dB}$

802.11be (EHT) 26-tone RU: Duty cycle = $0.58 \text{ ms} / 0.696 \text{ ms} \times 100\% = 83.3\%$, duty factor = $10 * \log (1/\text{Duty cycle}) = 0.79 \text{ dB}$

802.11be (EHT) 52-tone RU: Duty cycle = $0.496 \text{ ms} / 0.611 \text{ ms} \times 100\% = 81.2\%$, duty factor = $10 * \log (1/\text{Duty cycle}) = 0.91 \text{ dB}$

802.11be (EHT) 106-tone RU: Duty cycle = $0.437 \text{ ms} / 0.552 \text{ ms} \times 100\% = 79.2\%$, duty factor = $10 * \log (1/\text{Duty cycle}) = 1.01 \text{ dB}$

802.11be (EHT20) 52+26-tone MRU: Duty cycle = $0.468 \text{ ms} / 0.584 \text{ ms} \times 100\% = 80.1\%$, duty factor = $10 * \log (1/\text{Duty cycle}) = 0.96 \text{ dB}$

802.11be (EHT20) 106+26-tone MRU: Duty cycle = $0.501 \text{ ms} / 0.616 \text{ ms} \times 100\% = 81.3\%$, duty factor = $10 * \log (1/\text{Duty cycle}) = 0.90 \text{ dB}$

802.11be (EHT80) 484+242-tone MRU: Duty cycle = $0.36 \text{ ms} / 0.475 \text{ ms} \times 100\% = 75.8\%$, duty factor = $10 * \log (1/\text{Duty cycle}) = 1.20 \text{ dB}$

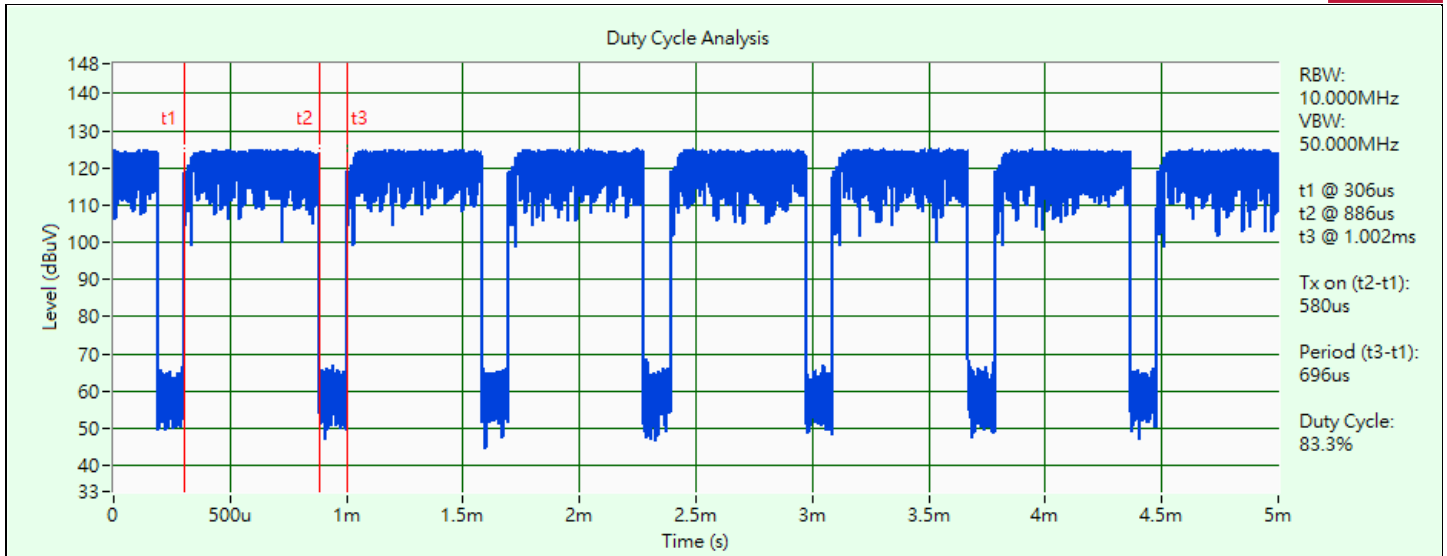

802.11ax (HE) 26-tone RU

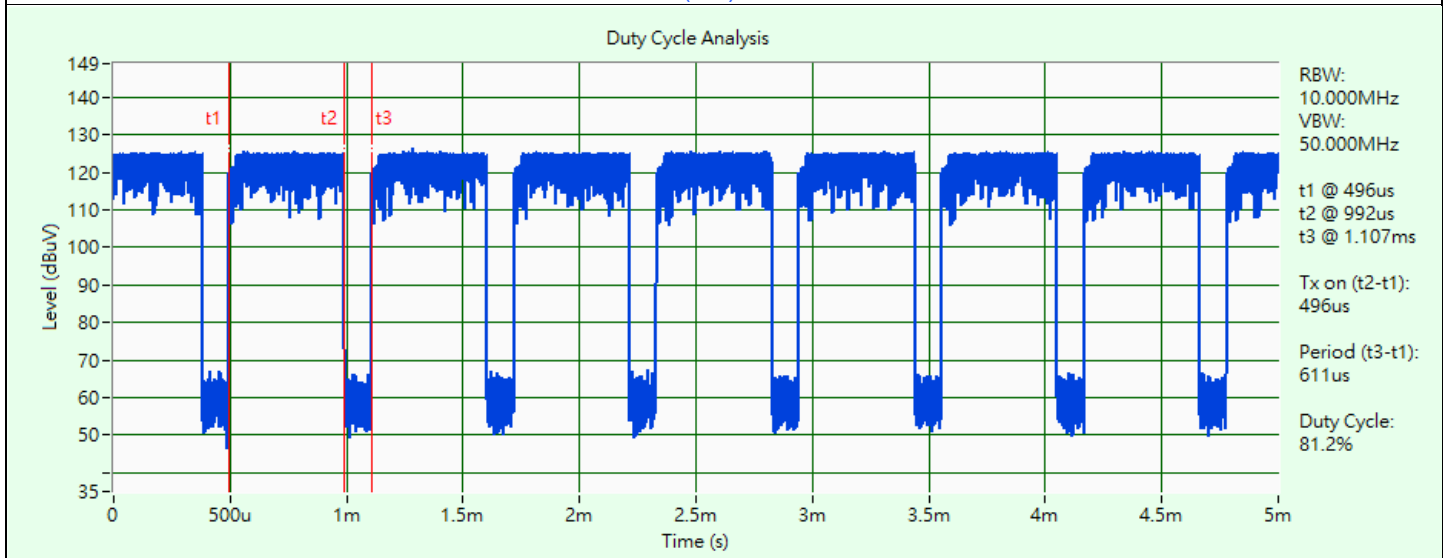

802.11ax (HE) 52-tone RU

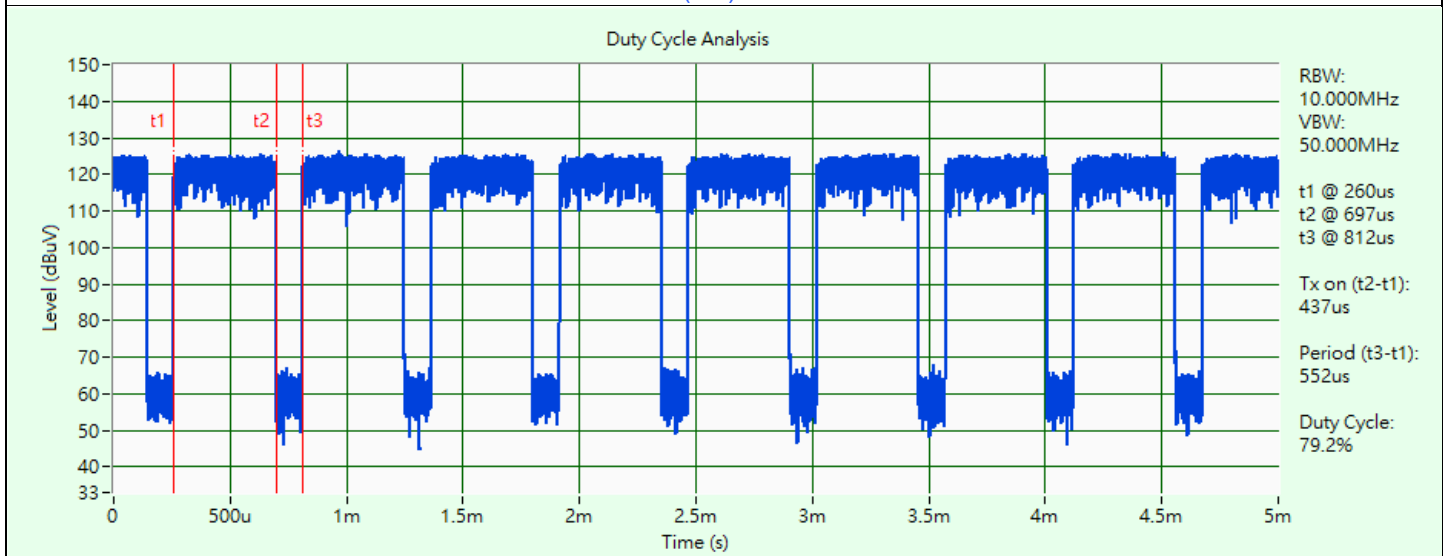

802.11ax (HE) 106-tone RU

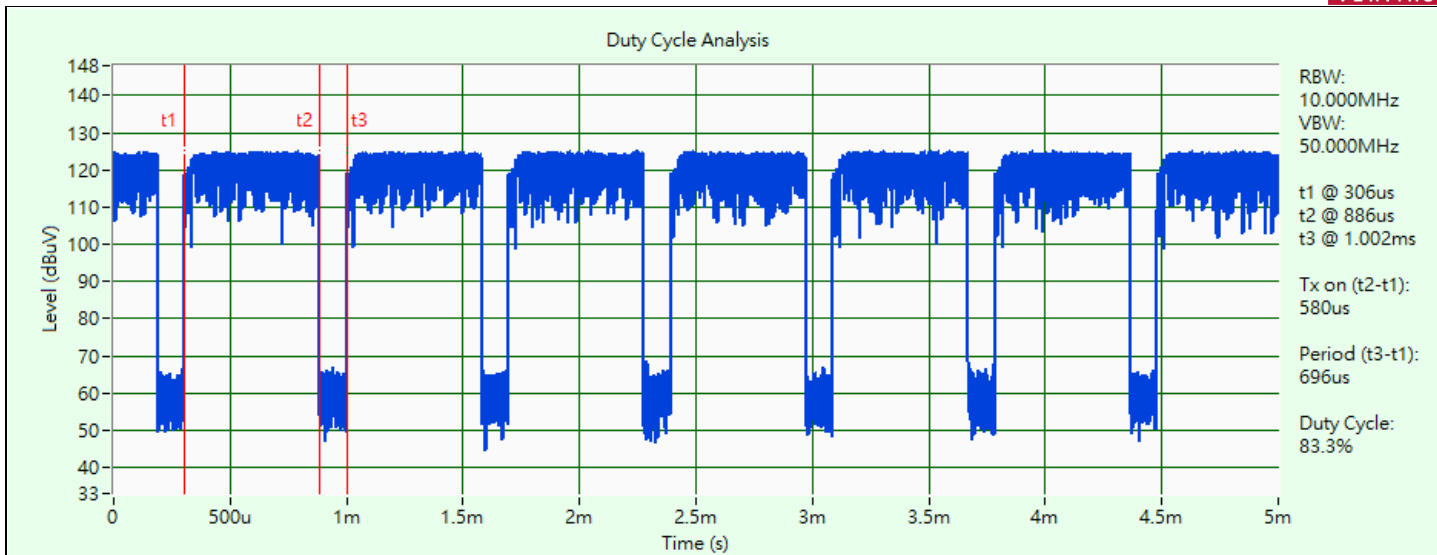

802.11be (EHT) 26-tone RU

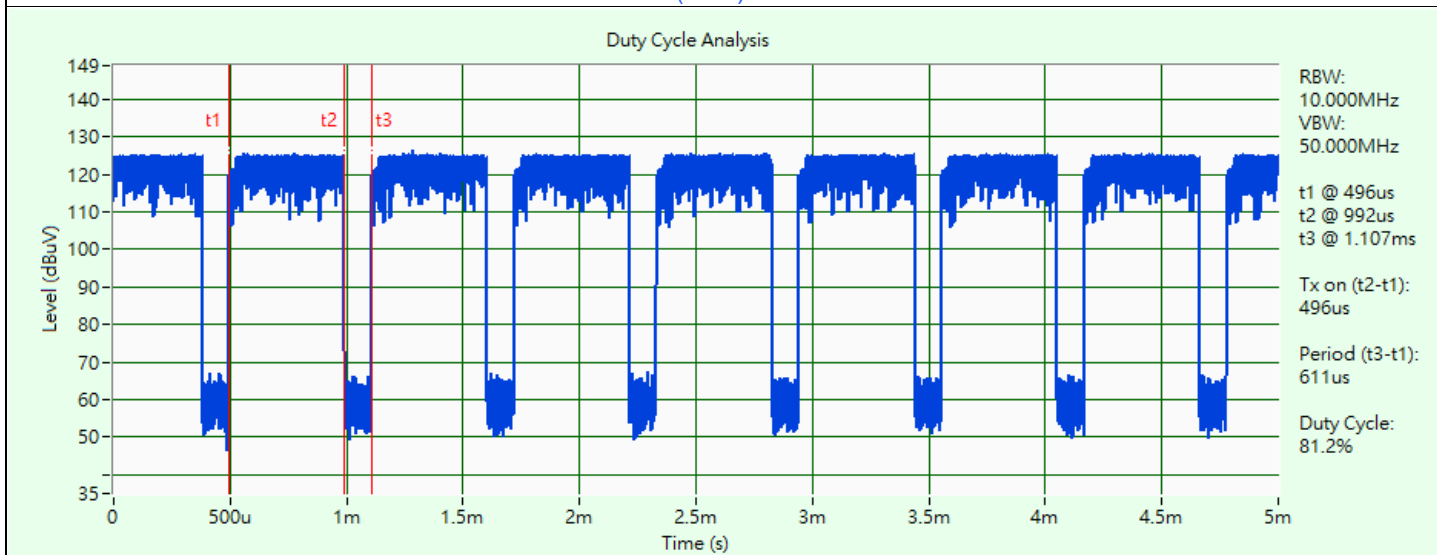

802.11be (EHT) 52-tone RU

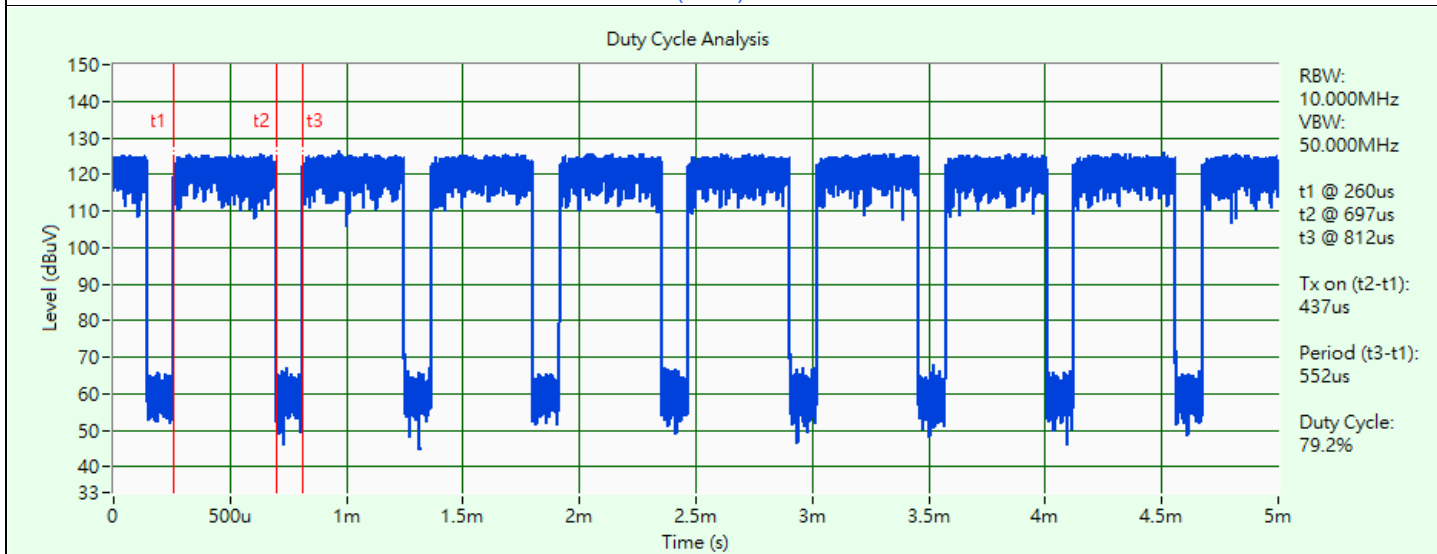

802.11be (EHT) 106-tone RU

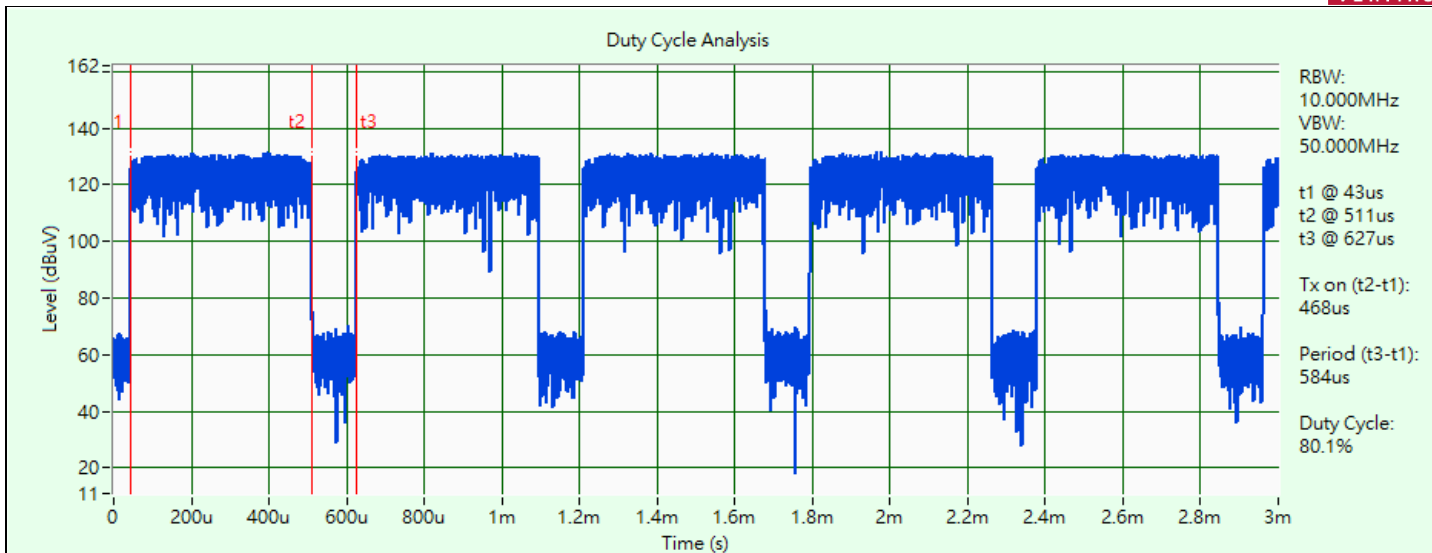

802.11be (EHT20) 52+26-tone MRU

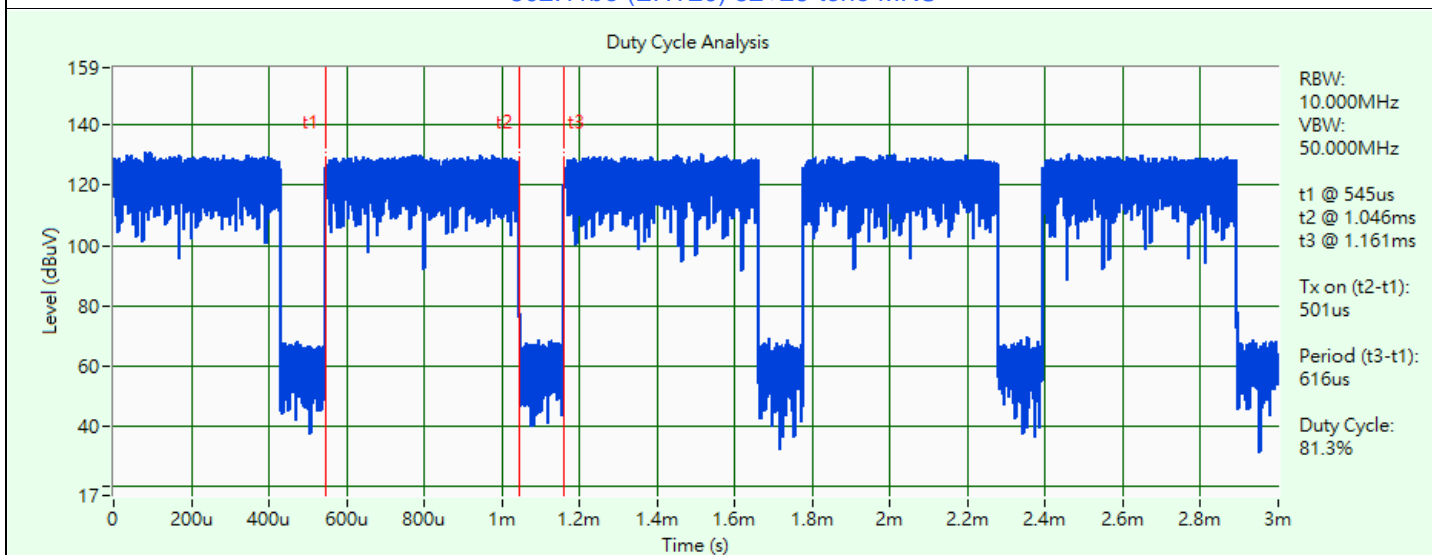

802.11be (EHT20) 106+26-tone MRU

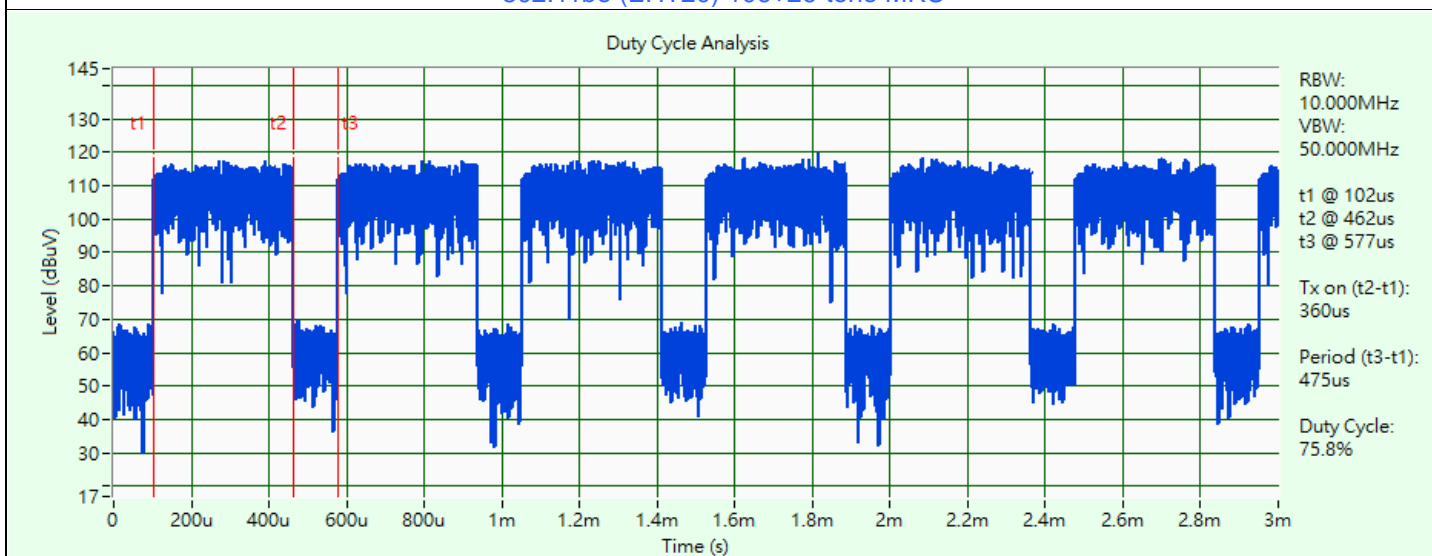

802.11be (EHT80) 484+242-tone MRU

3.6 Test Program Used and Operation Descriptions

Controlling software (QAtool_V26 (0.0.2.93)) has been activated to set the EUT under transmission condition continuously at specific channel frequency.

3.7 Connection Diagram of EUT and Peripheral Devices

For AC Power Conducted Emission test

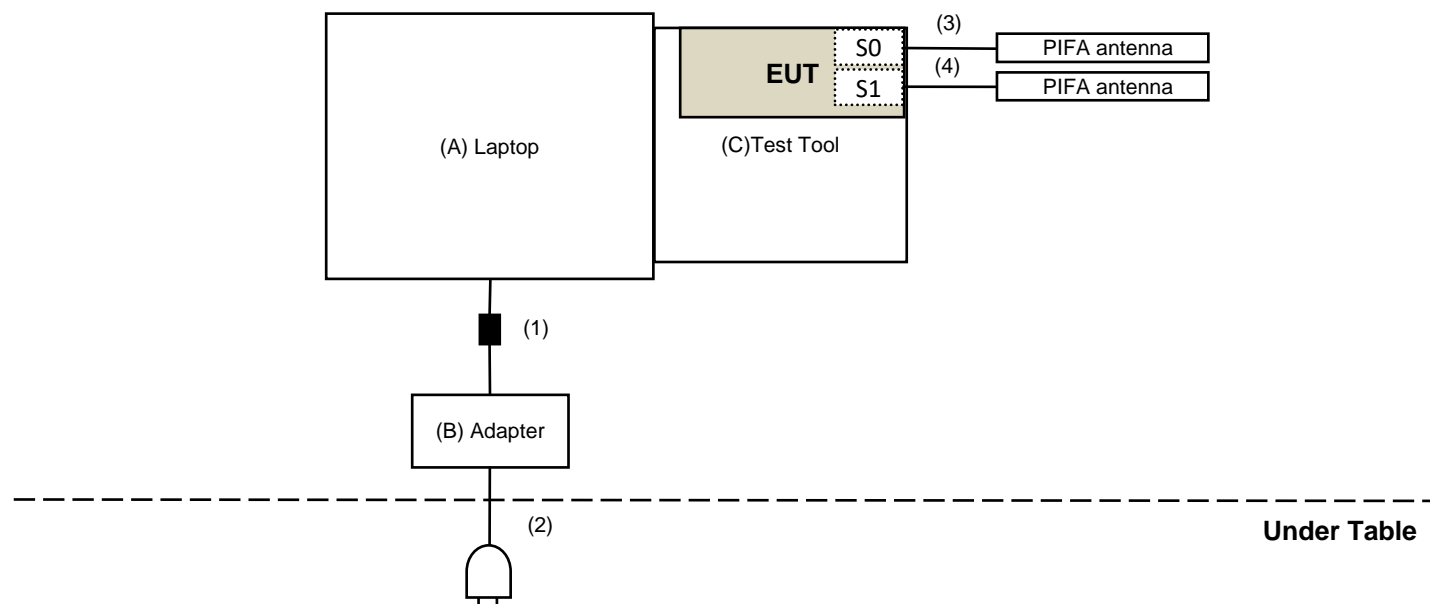

For Unwanted Emission test

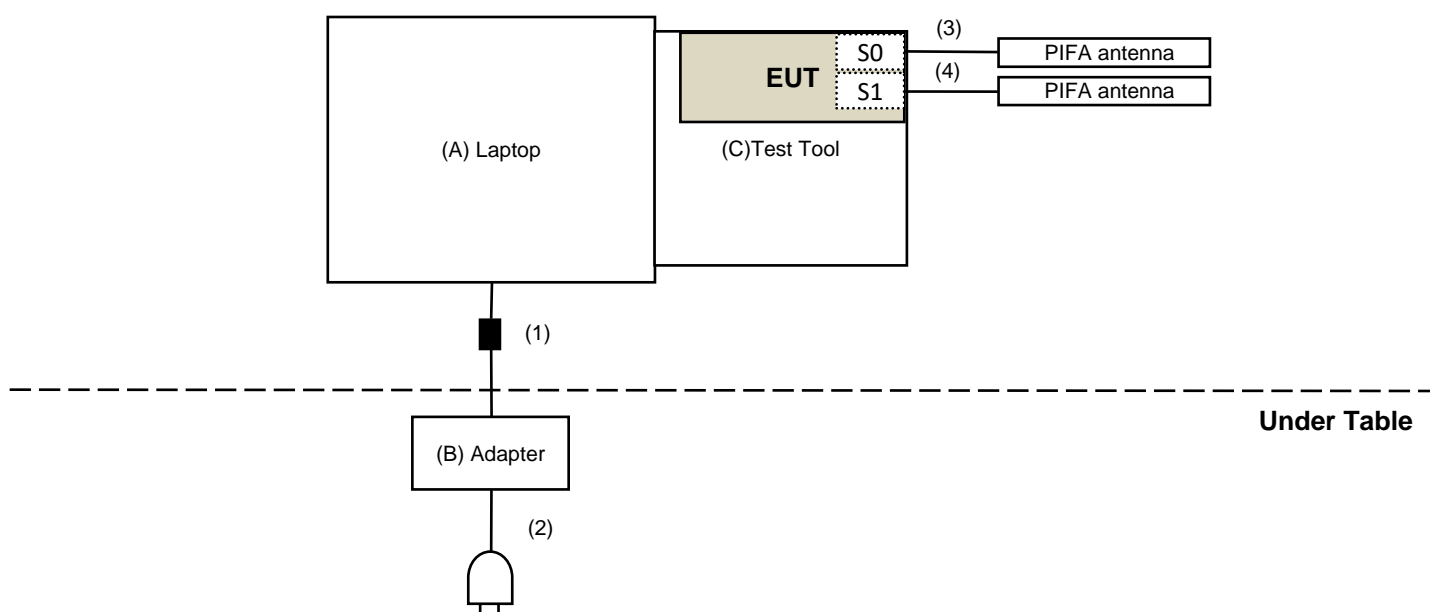

3.8 Configuration of Peripheral Devices and Cable Connections

ID	Product	Brand	Model No.	Serial No.	FCC ID	Remarks
A	Laptop	DELL	E5430	HYV4VY1	DoC	Provided by Lab
B	Adapter	DELL	LLA65NS2-01	N/A	N/A	Provided by Lab
C	Test Tool	Mediatek	MTK1849	N/A	N/A	Supplied by applicant

ID	Cable Descriptions	Qty.	Length (m)	Shielding (Yes/No)	Cores (Qty.)	Remarks
1	DC Cable	1	1.8	No	1	Provided by Lab
2	AC Cable	1	1	No	0	Provided by Lab
3	RF Cable	1	0.2	No	0	Supplied by applicant
4	RF Cable	1	0.2	No	0	Supplied by applicant

4 Test Instruments

The calibration interval of the all test instruments are 12 months and the calibrations are traceable to NML/ROC and NIST/USA.

4.1 26 dB Bandwidth

Description Manufacturer	Model No.	Serial No.	Calibrated Date	Calibrated Until
Attenuator WOKEN	MDCS18N-10	MDCS18N-10-01	2022/4/5	2023/4/4
Software	ADT_RF Test Software V6.6.5.4	N/A	N/A	N/A
Spectrum Analyzer Keysight	N9020B	MY60112409	2022/3/11	2023/3/10

Notes:

1. The test was performed in Oven room 2.
2. Tested Date: 2022/12/13

4.2 RF Output Power

Description Manufacturer	Model No.	Serial No.	Calibrated Date	Calibrated Until
Power Meter Anritsu	ML2495A	1529002	2022/6/22	2023/6/21
Pulse Power Sensor Anritsu	MA2411B	1726434	2022/6/22	2023/6/21
Attenuator WOKEN	MDCS18N-10	MDCS18N-10-01	2022/4/5	2023/4/4
Software	ADT_RF Test Software V6.6.5.4	N/A	N/A	N/A

Notes:

1. The test was performed in Oven room 2.
2. Tested Date: 2022/12/13

4.3 Power Spectral Density

Refer to section 4.1 to get information of the instruments.

4.4 6 dB Bandwidth

Refer to section 4.1 to get information of the instruments.

4.5 Occupied Bandwidth

Refer to section 4.1 to get information of the instruments.

4.6 AC Power Conducted Emissions

Description Manufacturer	Model No.	Serial No.	Calibrated Date	Calibrated Until
50 ohm terminal resistance	N/A	EMC-01	2022/9/27	2023/9/26
Fixed attenuator STI	STI02-2200-10	005	2022/8/24	2023/8/23
LISN R&S	ESH3-Z5	848773/004	2022/10/18	2023/10/17
RF Coaxial Cable JYEBO	5D-FB	COCCAB-001	2022/8/24	2023/8/23
Software BVADT	BVADT_Cond_V7.3.7.4	N/A	N/A	N/A
TEST RECEIVER R&S	ESCS 30	847124/029	2022/10/14	2023/10/13

Notes:

1. The test was performed in Conduction 1
2. Tested Date: 2022/12/25

4.7 Unwanted Emissions below 1 GHz

Description Manufacturer	Model No.	Serial No.	Calibrated Date	Calibrated Until
Boresight Antenna Tower & Turn Table Max-Full	MF-7802BS	MF780208530	N/A	N/A
Fixed attenuator Mini-Circuits	UNAT-5+	PAD-ATT5-03	2022/1/10	2023/1/9
LOOP ANTENNA Electro-Metrics	EM-6879	264	2022/3/18	2023/3/17
Pre_Amplifier Agilent	8447D	2944A10636	2022/3/19	2023/3/18
Pre_Amplifier EMCI	EMC330N	980701	2022/3/8	2023/3/7
RF Coaxial Cable COMMATE/PEWC	8D	966-4-1	2022/3/8	2023/3/7
		966-4-2	2022/3/8	2023/3/7
		966-4-3	2022/3/8	2023/3/7
RF Coaxial Cable JYEBO	5D-FB	LOOPCAB-001	2022/1/6	2023/1/5
		LOOPCAB-002	2022/12/19	2023/12/18
Software	ADT_Radiated_V8.7.08	N/A	N/A	N/A
Spectrum Analyzer KEYSIGHT	N9030B	MY57142938	2022/4/26	2023/4/25
Trilog Broadband Antenna Schwarzbeck	VULB 9168	9168-406	2022/10/21	2023/10/20

Notes:

1. The test was performed in 966 Chamber No. 4.
2. Tested Date: 2022/12/21

4.8 Unwanted Emissions above 1 GHz

Description Manufacturer	Model No.	Serial No.	Calibrated Date	Calibrated Until
Boresight Antenna Tower & Turn Table Max-Full	MF-7802BS	MF780208530	N/A	N/A
Horn Antenna Schwarzbeck	BBHA 9120D	9120D-783	2021/11/14	2022/11/13
			2022/11/13	2023/11/12
	BBHA 9170	9170-739	2021/11/14	2022/11/13
			2022/11/13	2023/11/12
Pre_Amplifier EMCI	EMC12630SE	980688	2022/10/4	2023/10/3
	EMC184045SE	980387	2022/1/10	2023/1/9
RF Cable-Frequency Range : 1- 26.5GHz EMCI	EMC104-SM-SM-1200	160922	2021/12/24	2022/12/23
			2022/12/15	2023/12/14
RF Cable-Frequency range: 1- 40GHz EMCI	EMC102-KM-KM-1200	160924	2022/1/10	2023/1/9
RF Coaxial Cable EMCI	EMC-KM-KM-4000	200214	2022/3/8	2023/3/7
	EMC104-SM-SM-2000	180502	2022/4/25	2023/4/24
	EMC104-SM-SM-6000	210704	2022/11/4	2023/11/3
Software	ADT_Radiated_V8.7.08	N/A	N/A	N/A
Spectrum Analyzer Keysight	N9020B	MY60112410	2022/3/13	2023/3/12

Notes:

1. The test was performed in 966 Chamber No. 4.
2. Tested Date: 2022/11/12 ~ 2022/12/25

5 Limits of Test Items

5.1 26 dB Bandwidth

The results are for reference only.

5.2 RF Output Power

Operation Band	EUT Category	Limit
U-NII-1	Outdoor Access Point	1 Watt (30 dBm) (Max. e.i.r.p \leq 125mW(21 dBm) at any elevation angle above 30 degrees as measured from the horizon)
	Fixed point-to-point Access Point	1 Watt (30 dBm)
	Indoor Access Point	1 Watt (30 dBm)
	Mobile and Portable client device	250mW (24 dBm)

Operation Band	Limit
U-NII-2A	250 mW (24 dBm) or 11 dBm+10 log B*
U-NII-2C	250 mW (24 dBm) or 11 dBm+10 log B*
U-NII-3	1 Watt (30 dBm)

*B is the 26 dB emission bandwidth in megahertz

Per KDB 662911 D01 Multiple Transmitter Output Method of conducted output power measurement on IEEE 802.11 devices,

Array Gain = 0 dB (i.e., no array gain) for $N_{ANT} \leq 4$;

Array Gain = 0 dB (i.e., no array gain) for channel widths ≥ 40 MHz for any N_{ANT} ;

Array Gain = 5 log(N_{ANT}/N_{SS}) dB or 3 dB, whichever is less, for 20-MHz channel widths with $N_{ANT} \geq 5$.

For power measurements on all other devices: Array Gain = 10 log(N_{ANT}/N_{SS}) dB.

5.3 Power Spectral Density

Operation Band	EUT Category	Limit
U-NII-1	Outdoor Access Point	17 dBm/MHz
	Fixed point-to-point Access Point	
	Indoor Access Point	
	Mobile and Portable client device	11 dBm/MHz

Operation Band	Limit
U-NII-2A	11 dBm/MHz
U-NII-2C	11 dBm/MHz
U-NII-3	30 dBm/500 kHz

5.4 6 dB Bandwidth

Within the 5.725-5.850 GHz band, the minimum 6 dB bandwidth of U-NII devices shall be at least 500 kHz.

5.5 Occupied Bandwidth

The results are for reference only.

5.6 AC Power Conducted Emissions

Frequency (MHz)	Conducted Limit (dBuV)	
	Quasi-peak	Average
0.15 - 0.5	66 - 56	56 - 46
0.50 - 5.0	56	46
5.0 - 30.0	60	50

Notes:

1. The lower limit shall apply at the transition frequencies.
2. The limit decreases in line with the logarithm of the frequency in the range of 0.15 to 0.50 MHz.

5.7 Unwanted Emissions below 1 GHz

Radiated emissions which fall in the restricted bands must comply with the radiated emission limits specified as below table.

Frequencies (MHz)	Field Strength (microvolts/meter)	Measurement Distance (meters)
0.009 ~ 0.490	2400/F(kHz)	300
0.490 ~ 1.705	24000/F(kHz)	30
1.705 ~ 30.0	30	30
30 ~ 88	100	3
88 ~ 216	150	3
216 ~ 960	200	3
Above 960	500	3

Notes:

1. The lower limit shall apply at the transition frequencies.
2. Emission level (dBuV/m) = 20 log Emission level (uV/m).

5.8 Unwanted Emissions above 1 GHz

Radiated emissions which fall in the restricted bands must comply with the radiated emission limits specified as below table.

Frequencies (MHz)	Field Strength (microvolts/meter)	Measurement Distance (meters)
Above 960	500	3

Notes:

1. The lower limit shall apply at the transition frequencies.
2. Emission level (dBuV/m) = 20 log Emission level (uV/m).
3. For frequencies above 1000 MHz, the field strength limits are based on average detector, however, the peak field strength of any emission shall not exceed the maximum permitted average limits, specified above by more than 20 dB under any condition of modulation.

Limits of unwanted emission out of the restricted bands

Applicable To	Limit	
789033 D02 General UNII Test Procedure New Rules v02r01	Field Strength at 3 m	
	PK: 74 (dBμV/m)	AV: 54 (dBμV/m)

For transmitters operating in the 5.15-5.25 GHz band:

Applicable To	EIRP Limit	Equivalent Field Strength at 3 m
15.407(b)(1)	PK: -27 (dBm/MHz)	PK: 68.2 (dBμV/m)

For transmitters operating in the 5.25-5.35 GHz band:

Applicable To	EIRP Limit	Equivalent Field Strength at 3 m
15.407(b)(2)	PK: -27 (dBm/MHz)	PK: 68.2 (dBμV/m)

For transmitters operating in the 5.47-5.725 GHz band:

Applicable To	EIRP Limit	Equivalent Field Strength at 3 m
15.407(b)(3)	PK: -27 (dBm/MHz)	PK: 68.2 (dBμV/m)

For transmitters operating in the 5.725-5.850 GHz band:

Applicable To	EIRP Limit	Equivalent Field Strength at 3 m
15.407(b)(4)(i)	PK: -27 (dBm/MHz) ^{*1}	PK: 68.2 (dBμV/m) ^{*1}
	PK: 10 (dBm/MHz) ^{*2}	PK: 105.2 (dBμV/m) ^{*2}
	PK: 15.6 (dBm/MHz) ^{*3}	PK: 110.8 (dBμV/m) ^{*3}
	PK: 27 (dBm/MHz) ^{*4}	PK: 122.2 (dBμV/m) ^{*4}

^{*1} beyond 75 MHz or more above of the band edge.

^{*2} below the band edge increasing linearly to 10 dBm/MHz at 25 MHz above.

^{*3} below the band edge increasing linearly to a level of 15.6 dBm/MHz at 5 MHz above.

^{*4} from 5 MHz above or below the band edge increasing linearly to a level of 27 dBm/MHz at the band edge.

Note: The following formula is used to convert the equipment isotropic radiated power (eirp) to field strength:

$$E = \frac{1000000\sqrt{30P}}{3} \mu\text{V/m, where P is the eirp (Watts).}$$

6 Test Arrangements

6.1 26 dB Bandwidth

6.1.1 Test Setup

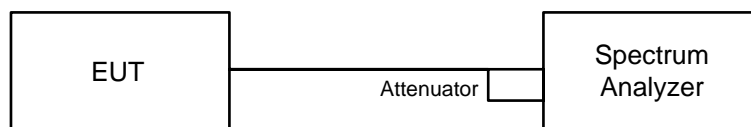

6.1.2 Test Procedure

- Set RBW = approximately 1% of the emission bandwidth.
- Set the VBW > RBW.
- Detector = Peak.
- Trace mode = max hold.
- Measure the maximum width of the emission that is 26 dB down from the peak of the emission. Compare this with the RBW setting of the analyzer. Readjust RBW and repeat measurement as needed until the RBW/EBW ratio is approximately 1%.

6.2 RF Output Power

6.2.1 Test Setup

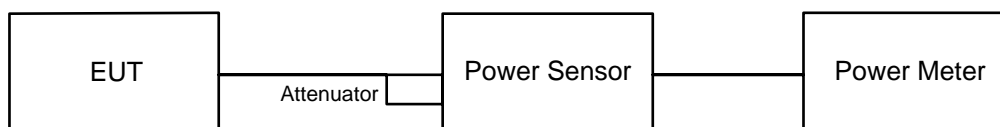

6.2.2 Test Procedure

Method PM is used to perform output power measurement, trigger and gating function of wide band power meter is enabled to measure max output power of TX on burst and set the detector to average. Duty factor is not added to measured value.

6.3 Power Spectral Density

6.3.1 Test Setup

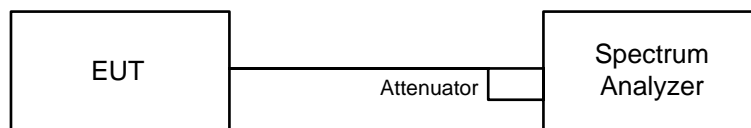

6.3.2 Test Procedure

For specified measurement bandwidth 1 MHz:

Method SA-2

- Set span to encompass the entire emission bandwidth (EBW) of the signal.
- Set RBW = 1 MHz, Set VBW \geq 3 MHz, Detector = RMS
- Sweep points \geq $[2 \times \text{span} / \text{RBW}]$. (This gives bin-to-bin spacing \leq RBW / 2, so that narrowband signals are not lost between frequency bins.)
- Sweep time = auto, trigger set to "free run".
- Trace average at least 100 traces in power averaging mode.
- Use the peak search function on the instrument to find the peak of the spectrum and record its value.
- Record the max value and add 10 log (1/duty cycle).

For specified measurement bandwidth 500 kHz:

Method SA-2

- Set span to encompass the entire emission bandwidth (EBW) of the signal.
- Set RBW = 300 kHz, Set VBW \geq 1 MHz, Detector = RMS
- Scale the observed power level to an equivalent value in 500 kHz by adjusting (increasing) the measured power by a bandwidth correction factor (BWCF) where $\text{BWCF} = 10\log(500 \text{ kHz}/300 \text{ kHz})$
- Sweep points \geq $[2 \times \text{span} / \text{RBW}]$. (This gives bin-to-bin spacing \leq RBW / 2, so that narrowband signals are not lost between frequency bins.)
- Sweep time = auto, trigger set to "free run".
- Trace average at least 100 traces in power averaging mode.
- Use the peak search function on the instrument to find the peak of the spectrum and record its value.
- Record the max value and add 10 log (1/duty cycle).

6.4 6 dB Bandwidth

6.4.1 Test Setup

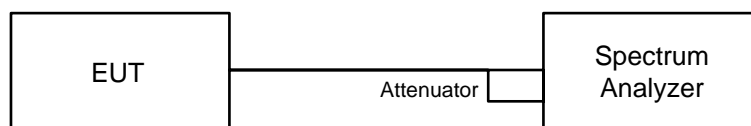

6.4.2 Test Procedure

- Set resolution bandwidth (RBW) = 100 kHz.
- Set the video bandwidth (VBW) \geq 3 x RBW, Detector = Peak.
- Trace mode = max hold.
- Sweep = auto couple.
- Measure the maximum width of the emission that is constrained by the frequencies associated with the two amplitude points (upper and lower) that are attenuated by 6 dB relative to the maximum level measured in the fundamental emission.

6.5 Occupied Bandwidth

6.5.1 Test Setup

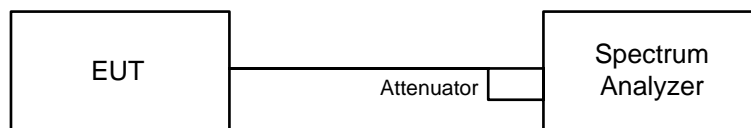

6.5.2 Test Procedure

The transmitter output was connected to the spectrum analyzer through an attenuator. The bandwidth of the fundamental frequency was measured by spectrum analyzer with resolution bandwidth in the range of 1% to 5% of the anticipated emission bandwidth, and a video bandwidth at least 3x the resolution bandwidth and set the detector to Sampling. The width of a frequency band such that, below the lower and above the upper frequency limits, the mean powers emitted are each equal to a specified percentage 0.5% of the total mean power of a given emission.

6.6 AC Power Conducted Emissions

6.6.1 Test Setup

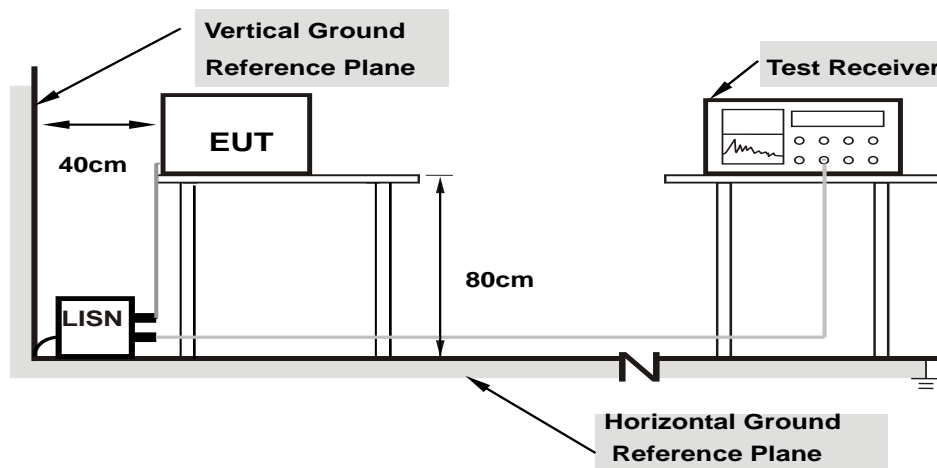

Note: 1.Support units were connected to second LISN.

For the actual test configuration, please refer to the attached file (Test Setup Photo).

6.6.2 Test Procedure

- The EUT was placed on a 0.8 meter to the top of table and placed 0.4 meters from the conducting wall of the shielded room with EUT being connected to the power mains through a line impedance stabilization network (LISN). Other support units were connected to the power mains through another LISN. The two LISNs provide 50 ohm/ 50 uH of coupling impedance for the measuring instrument.
- Both lines of the power mains connected to the EUT were checked for maximum conducted interference.
- The frequency range from 150 kHz to 30 MHz was searched. Emission levels under (Limit – 20 dB) was not recorded.

Note: The resolution bandwidth and video bandwidth of test receiver is 9 kHz for quasi-peak detection (QP) and average detection (AV) at frequency 0.15 MHz-30 MHz.

6.7 Unwanted Emissions below 1 GHz

6.7.1 Test Setup

For Radiated emission below 30 MHz

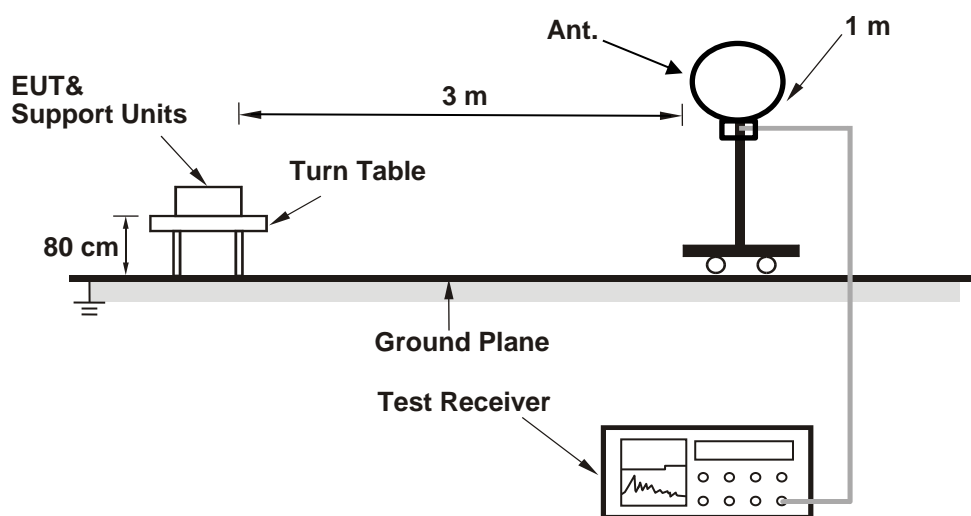

For Radiated emission above 30 MHz

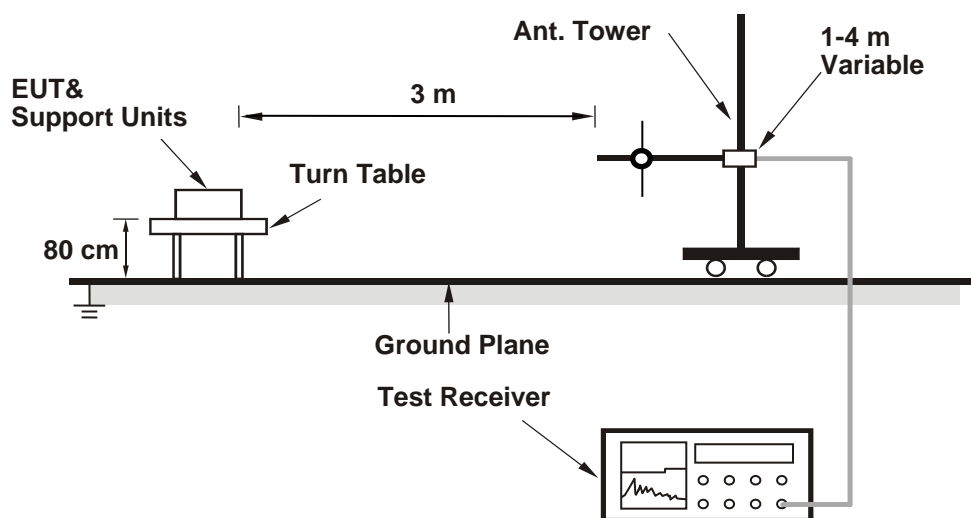

For the actual test configuration, please refer to the attached file (Test Setup Photo).

6.7.2 Test Procedure

For Radiated emission below 30 MHz

- a. The EUT was placed on the top of a rotating table 0.8 meters above the ground at 3 meter chamber room for test. The table was rotated 360 degrees to determine the position of the highest radiation.
- b. The EUT was set 3 meters away from the interference-receiving antenna, which was mounted on the top of a variable-height antenna tower.
- c. Parallel, perpendicular, and ground-parallel orientations of the antenna are set to make the measurement.
- d. For each suspected emission, the EUT was arranged to its worst case and the rotatable table was turned from 0 degrees to 360 degrees to find the maximum reading.
- e. The test-receiver system was set to Quasi-Peak Detect Function and Specified Bandwidth with Maximum Hold Mode, except for the frequency band (9 kHz to 90 kHz and 110 kHz to 490 kHz) set to average detect function and peak detect function.

Notes:

1. The resolution bandwidth and video bandwidth of test receiver/spectrum analyzer is 200 Hz at frequency below 150 kHz.
2. The resolution bandwidth and video bandwidth of test receiver/spectrum analyzer is 9 kHz or 10 kHz at frequency (150 kHz to 30 MHz).
3. All modes of operation were investigated and the worst-case emissions are reported.

For Radiated emission above 30 MHz

- a. The EUT was placed on the top of a rotating table 0.8 meters above the ground at 3 meter chamber room for test. The table was rotated 360 degrees to determine the position of the highest radiation.
- b. The EUT was set 3 meters away from the interference-receiving antenna, which was mounted on the top of a variable-height antenna tower.
- c. The height of antenna is varied from one meter to four meters above the ground to determine the maximum value of the field strength. Both horizontal and vertical polarizations of the antenna are set to make the measurement.
- d. For each suspected emission, the EUT was arranged to its worst case and then the antenna was tuned to heights from 1 meter to 4 meters and the rotatable table was turned from 0 degrees to 360 degrees to find the maximum reading.
- e. The test-receiver system was set to quasi-peak detect function and specified bandwidth with maximum hold mode when the test frequency is below 1 GHz.

Notes:

1. The resolution bandwidth and video bandwidth of test receiver/spectrum analyzer is 120 kHz for Quasi-peak detection (QP) at frequency below 1 GHz.
2. All modes of operation were investigated and the worst-case emissions are reported.

6.8 Unwanted Emissions above 1 GHz

6.8.1 Test Setup

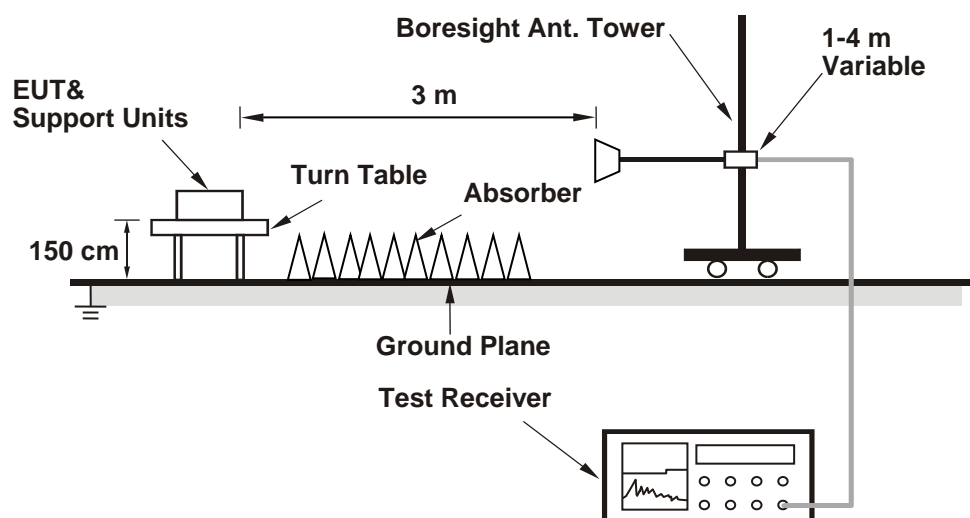

For the actual test configuration, please refer to the attached file (Test Setup Photo).

6.8.2 Test Procedure

- The EUT was placed on the top of a rotating table 1.5 meters above the ground at 3 meter chamber room for test. The table was rotated 360 degrees to determine the position of the highest radiation.
- The EUT was set 3 meters away from the interference-receiving antenna, which was mounted on the top of a variable-height antenna tower.
- The height of antenna is varied from one meter to four meters above the ground to determine the maximum value of the field strength. Both horizontal and vertical polarizations of the antenna are set to make the measurement.
- For each suspected emission, the EUT was arranged to its worst case and then the antenna was tuned to heights from 1 meter to 4 meters and the rotatable table was turned from 0 degrees to 360 degrees to find the maximum reading.
- The test-receiver system was set to peak and average detects function and specified bandwidth with maximum hold mode when the test frequency is above 1 GHz. If the peak reading value also meets average limit, measurement with the average detector is unnecessary.

Notes:

- The resolution bandwidth of test receiver/spectrum analyzer is 1 MHz and the video bandwidth is 3 MHz for Peak detection (PK) and Average detection (AV) at frequency above 1 GHz.
- For fundamental and harmonic signal measurement, the resolution bandwidth of test receiver/spectrum analyzer is 1 MHz and the video bandwidth is $\geq 1/T$ (Duty cycle $< 98\%$) or 10 Hz (Duty cycle $\geq 98\%$) for Average detection (AV) at frequency above 1 GHz.
- All modes of operation were investigated and the worst-case emissions are reported.

7 Test Results of Test Item

7.1 26 dB Bandwidth

Input Power:	3.3 Vdc	Environmental Conditions:	25°C, 60% RH	Tested By:	Katina Lu
--------------	---------	---------------------------	--------------	------------	-----------

802.11ax (HE) 26-tone RU

Channel	Frequency (MHz)	26 dB Bandwidth (MHz)	
		Chain 0	Chain 1
64	5320	19.25	19.12
100	5500	19.19	19.18
140	5700	19.29	19.31

Determined Output Power Limit			
Channel Number	Freq.(MHz)	Min. B(MHz)	Determined Conducted Power Limit (dBm)
64	5320	19.12	23.81 < 24
100	5500	19.18	23.82 < 24
140	5700	19.29	23.85 < 24

Note: For U-NII-2A, U-NII-2C Band output power limitation is determined based on 26dBc bandwidth.

802.11ax (HE) 52-tone RU

Channel	Frequency (MHz)	26 dB Bandwidth (MHz)	
		Chain 0	Chain 1
64	5320	19.36	19.29
100	5500	19.22	19.19
140	5700	19.36	19.29

Determined Output Power Limit			
Channel Number	Freq.(MHz)	Min. B(MHz)	Determined Conducted Power Limit (dBm)
64	5320	19.29	23.85 < 24
100	5500	19.19	23.83 < 24
140	5700	19.29	23.85 < 24

Note: For U-NII-2A, U-NII-2C Band output power limitation is determined based on 26dBc bandwidth.



802.11ax (HE) 106-tone RU

Channel	Frequency (MHz)	26 dB Bandwidth (MHz)	
		Chain 0	Chain 1
64	5320	22.46	19.44
100	5500	19.33	19.39
140	5700	21.25	19.49

Determined Output Power Limit			
Channel Number	Freq.(MHz)	Min. B(MHz)	Determined Conducted Power Limit (dBm)
64	5320	19.44	23.88 < 24
100	5500	19.33	23.86 < 24
140	5700	19.49	23.89 < 24

Note: For U-NII-2A, U-NII-2C Band output power limitation is determined based on 26dBc bandwidth.

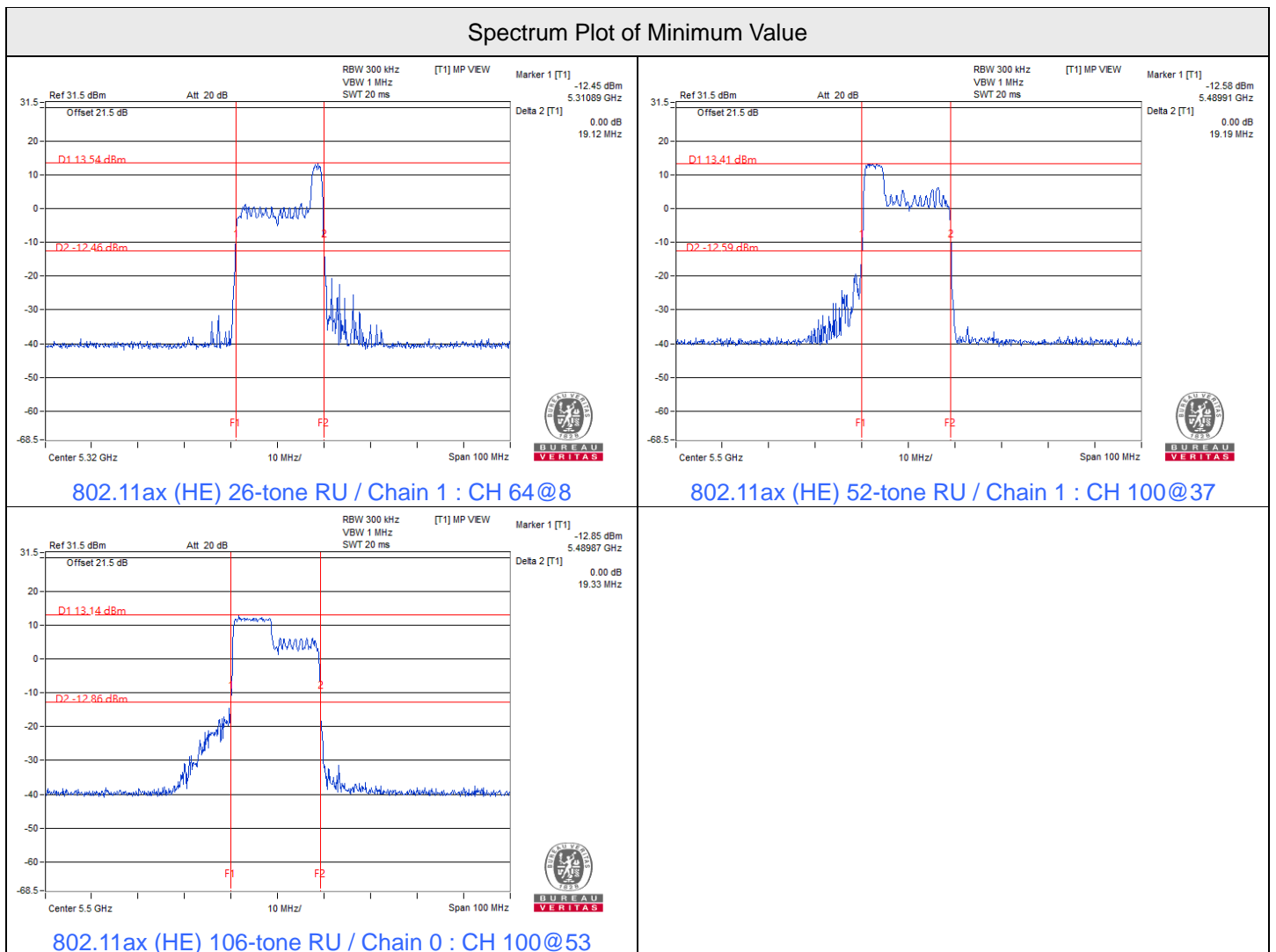

7.2 RF Output Power

Input Power:	3.3 Vdc	Environmental Conditions:	25°C, 60% RH	Tested By:	Katina Lu
--------------	---------	---------------------------	--------------	------------	-----------

802.11ax (HE) 26-tone RU

Chan.	Chan. Freq. (MHz)	Average Power (dBm)		Total Power (mW)	Total Power (dBm)	Power Limit (dBm)	Test Result
		Chain 0	Chain 1				
64	5320	11.69	11.76	29.754	14.74	24	Pass
100	5500	11.57	11.51	28.513	14.55	24	Pass
140	5700	11.67	11.24	27.994	14.47	24	Pass

Notes:

1. Directional gain is the maximum gain of antennas.
2. For U-NII-2A, the maximum gain is 4.92 dBi < 6 dBi, so the output power limit shall not be reduced.
3. For U-NII-2C, the maximum gain is 4.92 dBi < 6 dBi, so the output power limit shall not be reduced.

802.11ax (HE) 52-tone RU

Chan.	Chan. Freq. (MHz)	Average Power (dBm)		Total Power (mW)	Total Power (dBm)	Power Limit (dBm)	Test Result
		Chain 0	Chain 1				
64	5320	14.46	14.53	56.305	17.51	24	Pass
100	5500	14.25	15.04	58.523	17.67	24	Pass
140	5700	14.69	14.19	55.686	17.46	24	Pass

Notes:

1. Directional gain is the maximum gain of antennas.
2. For U-NII-2A, the maximum gain is 4.92 dBi < 6 dBi, so the output power limit shall not be reduced.
3. For U-NII-2C, the maximum gain is 4.92 dBi < 6 dBi, so the output power limit shall not be reduced.

802.11ax (HE) 106-tone RU

Chan.	Chan. Freq. (MHz)	Average Power (dBm)		Total Power (mW)	Total Power (dBm)	Power Limit (dBm)	Test Result
		Chain 0	Chain 1				
64	5320	17.03	17.05	101.165	20.05	24	Pass
100	5500	16.91	17.81	109.486	20.39	24	Pass
140	5700	16.57	15.75	82.978	19.19	24	Pass

Notes:

1. Directional gain is the maximum gain of antennas.
2. For U-NII-2A, the maximum gain is 4.92 dBi < 6 dBi, so the output power limit shall not be reduced.
3. For U-NII-2C, the maximum gain is 4.92 dBi < 6 dBi, so the output power limit shall not be reduced.

802.11be (EHT) 26-tone RU

Chan.	Chan. Freq. (MHz)	Average Power (dBm)		Total Power (mW)	Total Power (dBm)	Power Limit (dBm)	Test Result
		Chain 0	Chain 1				
36	5180	11.22	11.40	27.047	14.32	24	Pass
149	5745	22.59	22.63	364.783	25.62	30	Pass
165	5825	22.69	23.06	388.082	25.89	30	Pass

Notes:

1. Directional gain is the maximum gain of antennas.
2. For U-NII-1, the maximum gain is 4.92 dBi < 6 dBi, so the output power limit shall not be reduced.
3. For U-NII-3, the maximum gain is 4.92 dBi < 6 dBi, so the output power limit shall not be reduced.

802.11be (EHT) 52-tone RU

Chan.	Chan. Freq. (MHz)	Average Power (dBm)		Total Power (mW)	Total Power (dBm)	Power Limit (dBm)	Test Result
		Chain 0	Chain 1				
36	5180	14.29	14.49	54.972	17.40	24	Pass
149	5745	22.56	22.73	367.801	25.66	30	Pass
165	5825	22.85	23.20	401.682	26.04	30	Pass

Notes:

1. Directional gain is the maximum gain of antennas.
2. For U-NII-1, the maximum gain is 4.92 dBi < 6 dBi, so the output power limit shall not be reduced.
3. For U-NII-3, the maximum gain is 4.92 dBi < 6 dBi, so the output power limit shall not be reduced.

802.11be (EHT) 106-tone RU

Chan.	Chan. Freq. (MHz)	Average Power (dBm)		Total Power (mW)	Total Power (dBm)	Power Limit (dBm)	Test Result
		Chain 0	Chain 1				
36	5180	17.49	17.52	112.598	20.52	24	Pass
149	5745	22.89	22.92	390.42	25.92	30	Pass
165	5825	22.83	23.06	394.169	25.96	30	Pass

Notes:

1. Directional gain is the maximum gain of antennas.
2. For U-NII-1, the maximum gain is 4.92 dBi < 6 dBi, so the output power limit shall not be reduced.
3. For U-NII-3, the maximum gain is 4.92 dBi < 6 dBi, so the output power limit shall not be reduced.

802.11be (EHT20) 52+26-tone MRU

Chan.	Chan. Freq. (MHz)	Average Power (dBm)		Total Power (mW)	Total Power (dBm)	Power Limit (dBm)	Test Result
		Chain 0	Chain 1				
36	5180	15.92	16.11	79.916	19.03	24	Pass
149	5745	23.11	23.13	410.234	26.13	30	Pass
165	5825	22.79	23.03	391.017	25.92	30	Pass

Notes:

1. Directional gain is the maximum gain of antennas.
2. For U-NII-1, the maximum gain is 4.92 dBi < 6 dBi, so the output power limit shall not be reduced.
3. For U-NII-3, the maximum gain is 4.92 dBi < 6 dBi, so the output power limit shall not be reduced.

802.11be (EHT20) 106+26-tone MRU

Chan.	Chan. Freq. (MHz)	Average Power (dBm)		Total Power (mW)	Total Power (dBm)	Power Limit (dBm)	Test Result
		Chain 0	Chain 1				
36	5180	17.59	17.64	115.488	20.63	24	Pass
149	5745	23.08	23.13	408.825	26.12	30	Pass
165	5825	22.74	23.05	389.768	25.91	30	Pass

Notes:

1. Directional gain is the maximum gain of antennas.
2. For U-NII-1, the maximum gain is 4.92 dBi < 6 dBi, so the output power limit shall not be reduced.
3. For U-NII-3, the maximum gain is 4.92 dBi < 6 dBi, so the output power limit shall not be reduced.

802.11be (EHT80) 484+242-tone MRU

Chan.	Chan. Freq. (MHz)	Average Power (dBm)		Total Power (mW)	Total Power (dBm)	Power Limit (dBm)	Test Result
		Chain 0	Chain 1				
42	5210	12.87	12.66	37.814	15.78	24	Pass
155	5775	17.04	16.72	97.572	19.89	30	Pass

Notes:

1. Directional gain is the maximum gain of antennas.
2. For U-NII-1, the maximum gain is 4.92 dBi < 6 dBi, so the output power limit shall not be reduced.
3. For U-NII-3, the maximum gain is 4.92 dBi < 6 dBi, so the output power limit shall not be reduced.

7.3 Power Spectral Density

Input Power:	3.3 Vdc	Environmental Conditions:	25°C, 60% RH	Tested By:	Katina Lu
--------------	---------	---------------------------	--------------	------------	-----------

802.11ax (HE) 26-tone RU

Chan.	Chan. Freq. (MHz)	PSD w/o Duty Factor (dBm/MHz)		Duty Factor (dB)	Total PSD (dBm/MHz)	Max. PSD Limit (dBm/MHz)	Test Result
		Chain 0	Chain 1				
64	5320	5.17	4.86	0.79	8.82	9.07	Pass
100	5500	5.06	5.27	0.79	8.97	9.07	Pass
140	5700	5.13	4.89	0.79	8.81	9.07	Pass

Notes:

1. Method E) 2) a) of power density measurement of KDB 662911 is using for calculating total power density. Total power density is summing entire spectra across corresponding frequency bins on the various outputs by computer.
2. Directional gain = gain of antenna element + 10 log (2 of TX antenna elements)
3. For U-NII-2A, the directional gain is 7.93 dBi > 6 dBi, so the power density limit shall be reduced to 11-(7.93-6) = 9.07 dBm/MHz.
4. For U-NII-2C, the directional gain is 7.93 dBi > 6 dBi, so the power density limit shall be reduced to 11-(7.93-6) = 9.07 dBm/MHz.

802.11ax (HE) 52-tone RU

Chan.	Chan. Freq. (MHz)	PSD w/o Duty Factor (dBm/MHz)		Duty Factor (dB)	Total PSD (dBm/MHz)	Max. PSD Limit (dBm/MHz)	Test Result
		Chain 0	Chain 1				
64	5320	5.08	4.72	0.91	8.82	9.07	Pass
100	5500	4.64	5.49	0.91	9.01	9.07	Pass
140	5700	4.94	4.77	0.91	8.78	9.07	Pass

Notes:

1. Method E) 2) a) of power density measurement of KDB 662911 is using for calculating total power density. Total power density is summing entire spectra across corresponding frequency bins on the various outputs by computer.
2. Directional gain = gain of antenna element + 10 log (2 of TX antenna elements)
3. For U-NII-2A, the directional gain is 7.93 dBi > 6 dBi, so the power density limit shall be reduced to 11-(7.93-6) = 9.07 dBm/MHz.
4. For U-NII-2C, the directional gain is 7.93 dBi > 6 dBi, so the power density limit shall be reduced to 11-(7.93-6) = 9.07 dBm/MHz.

802.11ax (HE) 106-tone RU

Chan.	Chan. Freq. (MHz)	PSD w/o Duty Factor (dBm/MHz)		Duty Factor (dB)	Total PSD (dBm/MHz)	Max. PSD Limit (dBm/MHz)	Test Result
		Chain 0	Chain 1				
64	5320	5.04	4.47	1.01	8.78	9.07	Pass
100	5500	4.33	5.28	1.01	8.85	9.07	Pass
140	5700	4.61	4.43	1.01	8.54	9.07	Pass

Notes:

- Method E) 2) a) of power density measurement of KDB 662911 is using for calculating total power density. Total power density is summing entire spectra across corresponding frequency bins on the various outputs by computer.
- Directional gain = gain of antenna element + 10 log (2 of TX antenna elements)
- For U-NII-2A, the directional gain is 7.93 dBi > 6 dBi, so the power density limit shall be reduced to 11-(7.93-6) = 9.07 dBm/MHz.
- For U-NII-2C, the directional gain is 7.93 dBi > 6 dBi, so the power density limit shall be reduced to 11-(7.93-6) = 9.07 dBm/MHz.

802.11be (EHT) 26-tone RU

Chan.	Chan. Freq. (MHz)	PSD w/o Duty Factor (dBm/MHz)		Duty Factor (dB)	Total PSD (dBm/MHz)	Max. PSD Limit (dBm/MHz)	Test Result
		Chain 0	Chain 1				
36	5180	5.05	5.26	0.79	8.96	9.07	Pass

Notes:

- Method E) 2) a) of power density measurement of KDB 662911 is using for calculating total power density. Total power density is summing entire spectra across corresponding frequency bins on the various outputs by computer.
- Directional gain = gain of antenna element + 10 log (2 of TX antenna elements)
- For U-NII-1, the directional gain is 7.93 dBi > 6dBi, so the power density limit shall be reduced to 11-(7.93-6) = 9.07 dBm/MHz.

802.11be (EHT) 52-tone RU

Chan.	Chan. Freq. (MHz)	PSD w/o Duty Factor (dBm/MHz)		Duty Factor (dB)	Total PSD (dBm/MHz)	Max. PSD Limit (dBm/MHz)	Test Result
		Chain 0	Chain 1				
36	5180	4.79	5.46	0.91	9.06	9.07	Pass

Notes:

- Method E) 2) a) of power density measurement of KDB 662911 is using for calculating total power density. Total power density is summing entire spectra across corresponding frequency bins on the various outputs by computer.
- Directional gain = gain of antenna element + 10 log (2 of TX antenna elements)
- For U-NII-1, the directional gain is 7.93 dBi > 6dBi, so the power density limit shall be reduced to 11-(7.93-6) = 9.07 dBm/MHz.

802.11be (EHT) 106-tone RU

Chan.	Chan. Freq. (MHz)	PSD w/o Duty Factor (dBm/MHz)		Duty Factor (dB)	Total PSD (dBm/MHz)	Max. PSD Limit (dBm/MHz)	Test Result
		Chain 0	Chain 1				
36	5180	4.51	5.05	1.01	8.81	9.07	Pass

Notes:

1. Method E) 2) a) of power density measurement of KDB 662911 is using for calculating total power density. Total power density is summing entire spectra across corresponding frequency bins on the various outputs by computer.
2. Directional gain = gain of antenna element + 10 log (2 of TX antenna elements)
3. For U-NII-1, the directional gain is 7.93 dBi > 6dBi, so the power density limit shall be reduced to $11-(7.93-6) = 9.07$ dBm/MHz.

802.11be (EHT20) 52+26-tone MRU

Chan.	Chan. Freq. (MHz)	PSD w/o Duty Factor (dBm/MHz)		Duty Factor (dB)	Total PSD (dBm/MHz)	Max. PSD Limit (dBm/MHz)	Test Result
		Chain 0	Chain 1				
36	5180	4.63	5.08	0.96	8.83	9.07	Pass

Notes:

1. Method E) 2) a) of power density measurement of KDB 662911 is using for calculating total power density. Total power density is summing entire spectra across corresponding frequency bins on the various outputs by computer.
2. Directional gain = gain of antenna element + 10 log (2 of TX antenna elements)
3. For U-NII-1, the directional gain is 7.93 dBi > 6dBi, so the power density limit shall be reduced to $11-(7.93-6) = 9.07$ dBm/MHz.

802.11be (EHT20) 106+26-tone MRU

Chan.	Chan. Freq. (MHz)	PSD w/o Duty Factor (dBm/MHz)		Duty Factor (dB)	Total PSD (dBm/MHz)	Max. PSD Limit (dBm/MHz)	Test Result
		Chain 0	Chain 1				
36	5180	4.83	4.72	0.90	8.69	9.07	Pass

Notes:

1. Method E) 2) a) of power density measurement of KDB 662911 is using for calculating total power density. Total power density is summing entire spectra across corresponding frequency bins on the various outputs by computer.
2. Directional gain = gain of antenna element + 10 log (2 of TX antenna elements)
3. For U-NII-1, the directional gain is 7.93 dBi > 6dBi, so the power density limit shall be reduced to $11-(7.93-6) = 9.07$ dBm/MHz.

802.11be (EHT80) 484+242-tone MRU

Chan.	Chan. Freq. (MHz)	PSD w/o Duty Factor (dBm/MHz)		Duty Factor (dB)	Total PSD (dBm/MHz)	Max. PSD Limit (dBm/MHz)	Test Result
		Chain 0	Chain 1				
42	5210	-6.44	-5.78	1.20	-1.89	9.07	Pass

Notes:

1. Method E) 2) a) of power density measurement of KDB 662911 is using for calculating total power density. Total power density is summing entire spectra across corresponding frequency bins on the various outputs by computer.
2. Directional gain = gain of antenna element + 10 log (2 of TX antenna elements)
3. For U-NII-1, the directional gain is 7.93 dBi > 6dBi, so the power density limit shall be reduced to $11-(7.93-6) = 9.07$ dBm/MHz.

802.11be (EHT) 26-tone RU

Chan.	Chan. Freq. (MHz)	PSD w/o Duty Factor (dBm/300kHz)		Total PSD w/o Duty Factor (dBm/300kHz)	Duty Factor (dB)	Total PSD (dBm/500kHz)	PSD Limit (dBm/500kHz)	Test Result
		Chain 0	Chain 1					
149	5745	8.51	8.39	11.46	0.79	14.47	28.07	Pass
165	5825	9.09	9.03	12.07	0.79	15.08	28.07	Pass

Notes:

1. Method E) 2) b) Measure and sum spectral maxima across the outputs of KDB 662911 is using for calculating total power density.
2. Directional gain = gain of antenna element + 10 log (2 of TX antenna elements)
3. For U-NII-3, the directional gain is 7.93 dBi > 6 dBi, so the power density limit shall be reduced to $30-(7.93-6) = 28.07$ dBm/500kHz.

802.11be (EHT) 52-tone RU

Chan.	Chan. Freq. (MHz)	PSD w/o Duty Factor (dBm/300kHz)		Total PSD w/o Duty Factor (dBm/300kHz)	Duty Factor (dB)	Total PSD (dBm/500kHz)	PSD Limit (dBm/500kHz)	Test Result
		Chain 0	Chain 1					
149	5745	6.14	5.92	9.04	0.91	12.17	28.07	Pass
165	5825	6.35	6.43	9.4	0.91	12.53	28.07	Pass

Notes:

1. Method E) 2) b) Measure and sum spectral maxima across the outputs of KDB 662911 is using for calculating total power density.
2. Directional gain = gain of antenna element + 10 log (2 of TX antenna elements)
3. For U-NII-3, the directional gain is 7.93 dBi > 6 dBi, so the power density limit shall be reduced to $30-(7.93-6) = 28.07$ dBm/500kHz.

802.11be (EHT) 106-tone RU

Chan.	Chan. Freq. (MHz)	PSD w/o Duty Factor (dBm/300kHz)		Total PSD w/o Duty Factor (dBm/300kHz)	Duty Factor (dB)	Total PSD (dBm/500kHz)	PSD Limit (dBm/500kHz)	Test Result
		Chain 0	Chain 1					
149	5745	3.55	3.56	6.57	1.01	9.80	28.07	Pass
165	5825	3.44	3.39	6.43	1.01	9.66	28.07	Pass

Notes:

1. Method E) 2) b) Measure and sum spectral maxima across the outputs of KDB 662911 is using for calculating total power density.
2. Directional gain = gain of antenna element + 10 log (2 of TX antenna elements)
3. For U-NII-3, the directional gain is 7.93 dBi > 6 dBi, so the power density limit shall be reduced to $30 - (7.93 - 6) = 28.07$ dBm/500kHz.

802.11be (EHT20) 52+26-tone MRU

Chan.	Chan. Freq. (MHz)	PSD w/o Duty Factor (dBm/300kHz)		Total PSD w/o Duty Factor (dBm/300kHz)	Duty Factor (dB)	Total PSD (dBm/500kHz)	PSD Limit (dBm/500kHz)	Test Result
		Chain 0	Chain 1					
149	5745	4.61	4.66	7.65	0.96	10.83	28.07	Pass
165	5825	4.59	4.59	7.6	0.96	10.78	28.07	Pass

Notes:

1. Method E) 2) b) Measure and sum spectral maxima across the outputs of KDB 662911 is using for calculating total power density.
2. Directional gain = gain of antenna element + 10 log (2 of TX antenna elements)
3. For U-NII-3, the directional gain is 7.93 dBi > 6 dBi, so the power density limit shall be reduced to $30 - (7.93 - 6) = 28.07$ dBm/500kHz.

802.11be (EHT20) 106+26-tone MRU

Chan.	Chan. Freq. (MHz)	PSD w/o Duty Factor (dBm/300kHz)		Total PSD w/o Duty Factor (dBm/300kHz)	Duty Factor (dB)	Total PSD (dBm/500kHz)	PSD Limit (dBm/500kHz)	Test Result
		Chain 0	Chain 1					
149	5745	2.86	3.03	5.96	0.9	9.08	28.07	Pass
165	5825	2.75	2.69	5.73	0.9	8.85	28.07	Pass

Notes:

1. Method E) 2) b) Measure and sum spectral maxima across the outputs of KDB 662911 is using for calculating total power density.
2. Directional gain = gain of antenna element + 10 log (2 of TX antenna elements)
3. For U-NII-3, the directional gain is 7.93 dBi > 6 dBi, so the power density limit shall be reduced to $30 - (7.93 - 6) = 28.07$ dBm/500kHz.



802.11be (EHT80) 484+242-tone MRU

Chan.	Chan. Freq. (MHz)	PSD w/o Duty Factor (dBm/300kHz)		Total PSD w/o Duty Factor (dBm/300kHz)	Duty Factor (dB)	Total PSD (dBm/500kHz)	PSD Limit (dBm/500kHz)	Test Result
		Chain 0	Chain 1					
155	5775	-10.76	-10.01	-7.36	1.2	-3.94	28.07	Pass

Notes:

1. Method E) 2) b) Measure and sum spectral maxima across the outputs of KDB 662911 is using for calculating total power density.
2. Directional gain = gain of antenna element + 10 log (2 of TX antenna elements)
3. For U-NII-3, the directional gain is 7.93 dBi > 6 dBi, so the power density limit shall be reduced to 30-(7.93-6) = 28.07 dBm/500kHz.

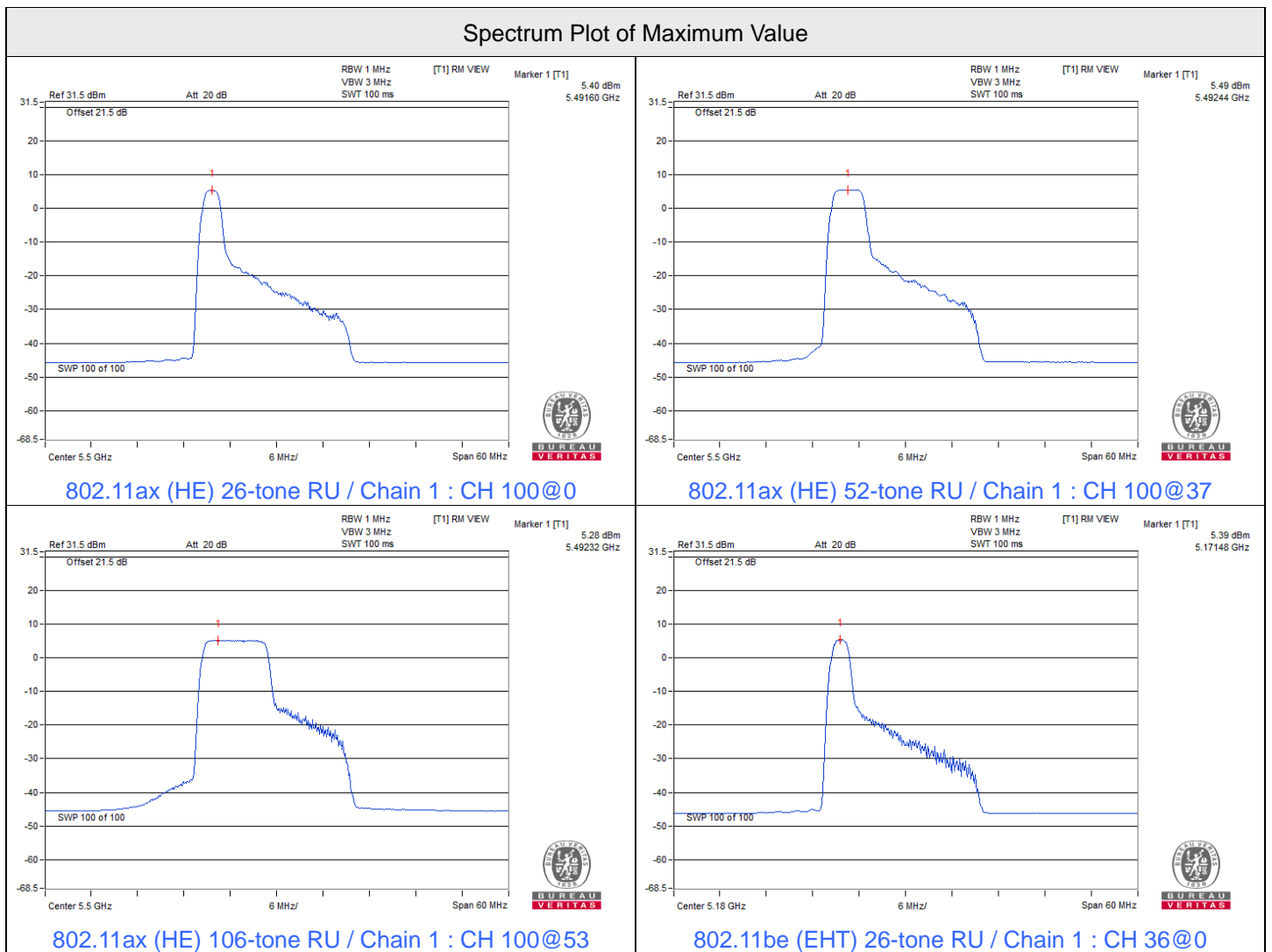

Spectrum Plot of Maximum Value

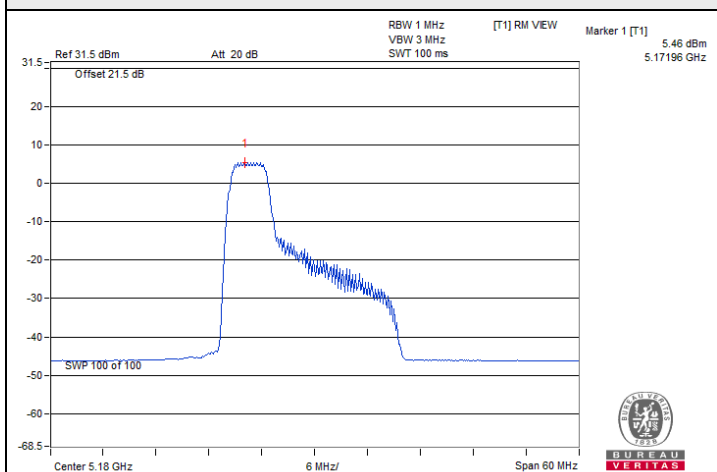

802.11be (EHT) 52-tone RU / Chain 1 : CH 36@37

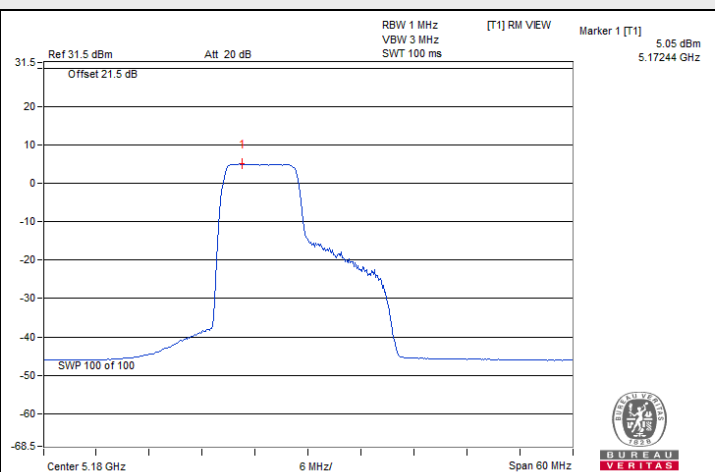

802.11be (EHT) 106-tone RU / Chain 1 : CH 36@53

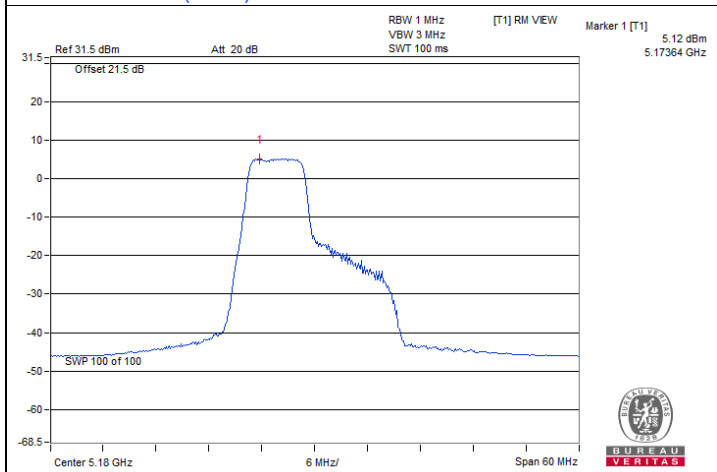

802.11be (EHT20) 52+26-tone MRU / Chain 1 : CH 36@70

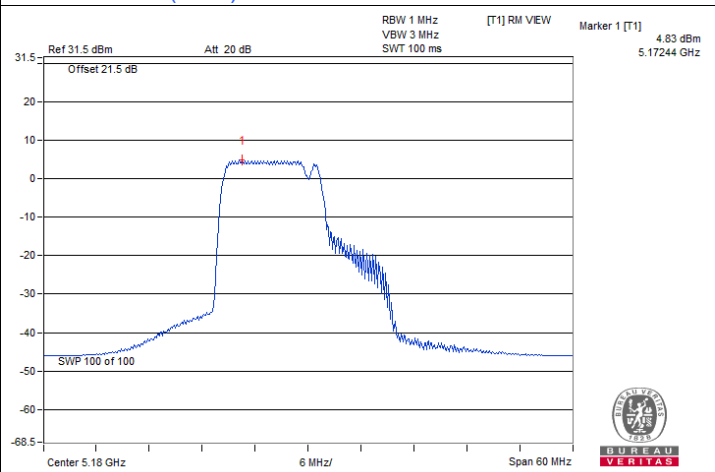

802.11be (EHT20) 106+26-tone MRU / Chain 0 : CH 36@82

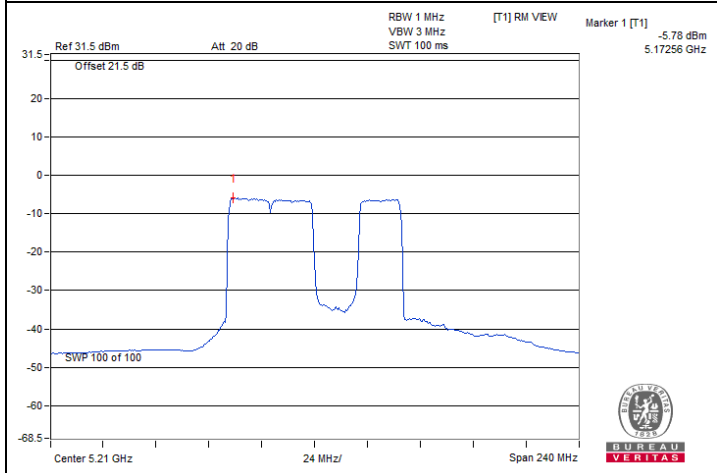

802.11be (EHT80) 484+242-tone MRU / Chain 1 : CH 42@92

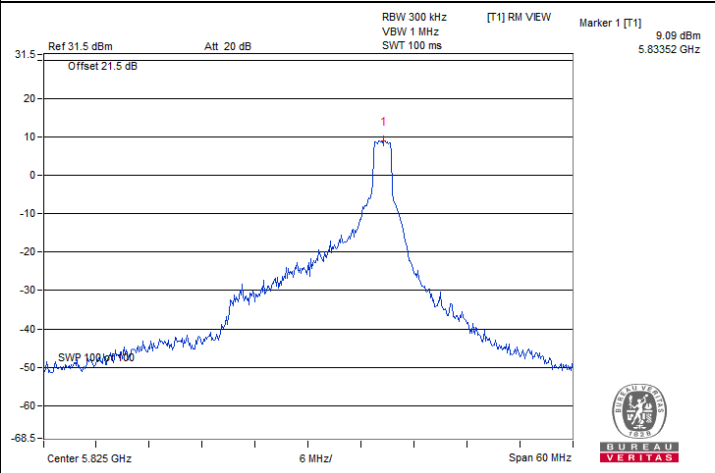

802.11be (EHT) 26-tone RU / Chain 0 : CH 165@8

Spectrum Plot of Maximum Value

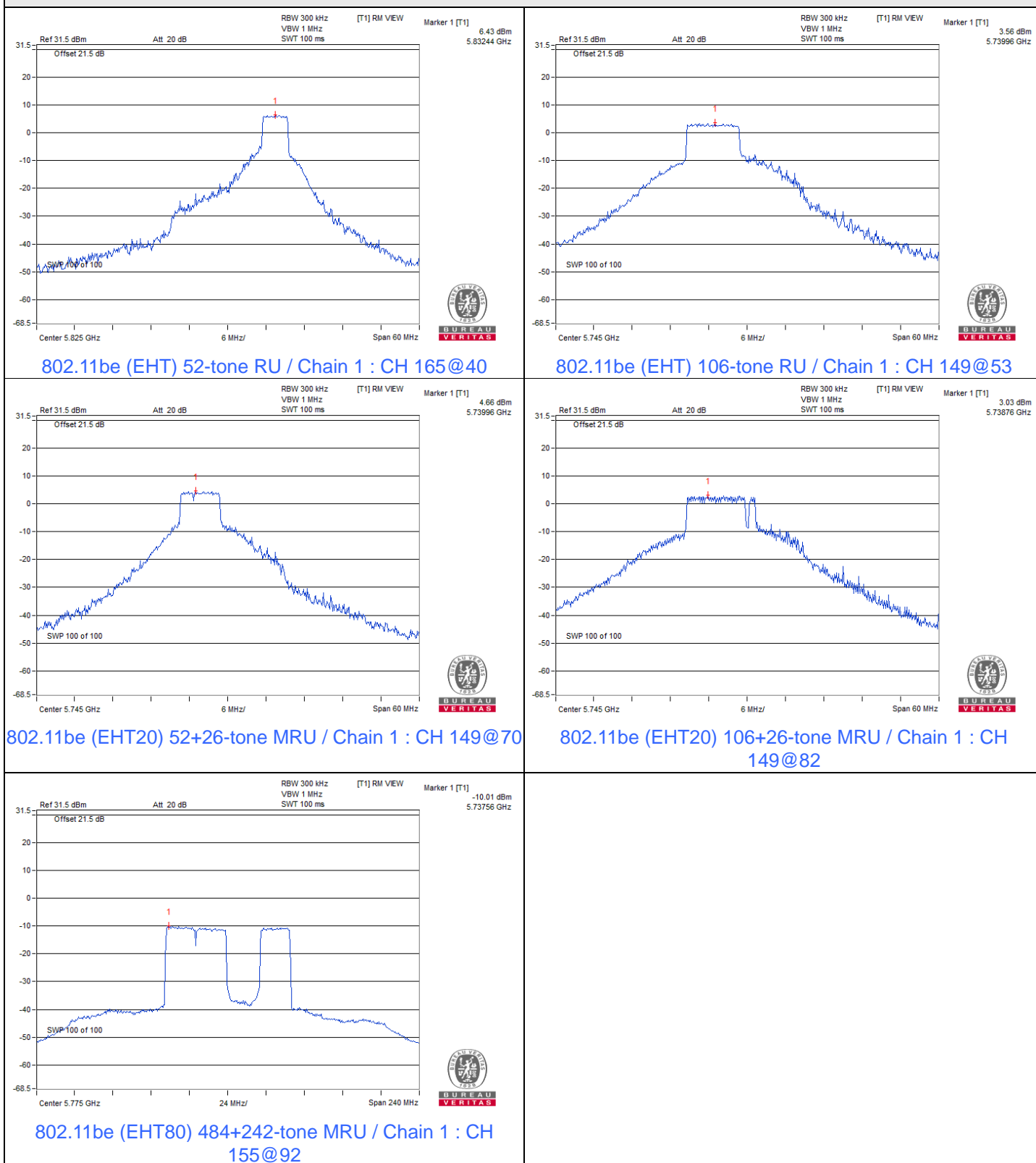

7.4 6 dB Bandwidth

Input Power:	3.3 Vdc	Environmental Conditions:	25°C, 60% RH	Tested By:	Katina Lu
--------------	---------	---------------------------	--------------	------------	-----------

802.11be (EHT) 26-tone RU

Channel	Frequency (MHz)	6 dB Bandwidth (MHz)		Minimum Limit (MHz)	Test Result
		Chain 0	Chain 1		
149	5745	2.11	2.13	0.5	Pass
165	5825	2.15	2.11	0.5	Pass

802.11be (EHT) 52-tone RU

Channel	Frequency (MHz)	6 dB Bandwidth (MHz)		Minimum Limit (MHz)	Test Result
		Chain 0	Chain 1		
149	5745	17.10	17.04	0.5	Pass
165	5825	15.81	17.10	0.5	Pass

802.11be (EHT) 106-tone RU

Channel	Frequency (MHz)	6 dB Bandwidth (MHz)		Minimum Limit (MHz)	Test Result
		Chain 0	Chain 1		
149	5745	17.19	17.18	0.5	Pass
165	5825	17.14	17.15	0.5	Pass

802.11be (EHT20) 52+26-tone MRU

Channel	Frequency (MHz)	6 dB Bandwidth (MHz)		Minimum Limit (MHz)	Test Result
		Chain 0	Chain 1		
149	5745	15.18	15.17	0.5	Pass
165	5825	15.17	15.17	0.5	Pass

802.11be (EHT20) 106+26-tone MRU

Channel	Frequency (MHz)	6 dB Bandwidth (MHz)		Minimum Limit (MHz)	Test Result
		Chain 0	Chain 1		
149	5745	18.19	18.16	0.5	Pass
165	5825	17.40	17.18	0.5	Pass

802.11be (EHT80) 484+242-tone MRU

Channel	Frequency (MHz)	6 dB Bandwidth (MHz)		Minimum Limit (MHz)	Test Result
		Chain 0	Chain 1		
155	5775	78.38	78.43	0.5	Pass

Spectrum Plot of Minimum Value

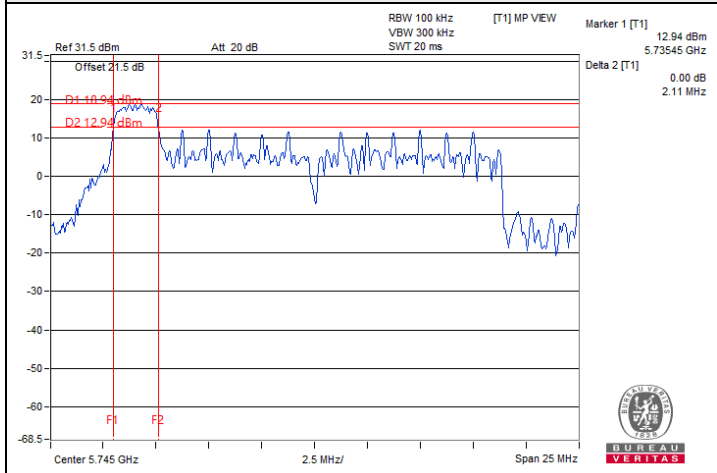

802.11be (EHT) 26-tone RU / Chain 0 : CH 149@0

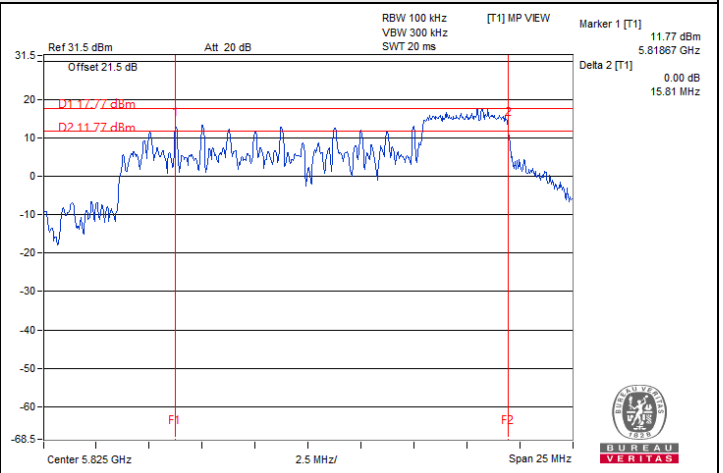

802.11be (EHT) 52-tone RU / Chain 0 : CH 165@40

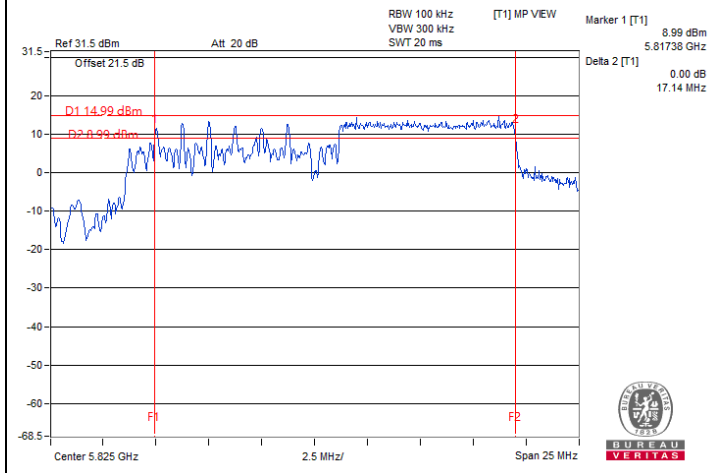

802.11be (EHT) 106-tone RU / Chain 0 : CH 165@54

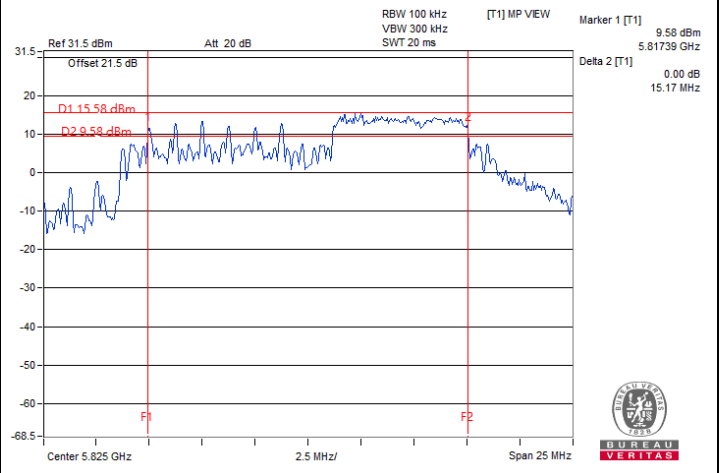

802.11be (EHT20) 52+26-tone MRU / Chain 0 : CH 165@72

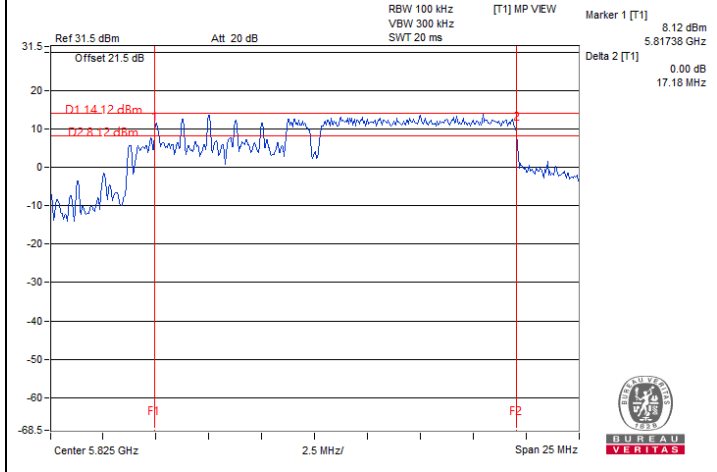

802.11be (EHT20) 106+26-tone MRU / Chain 1 : CH 165@83

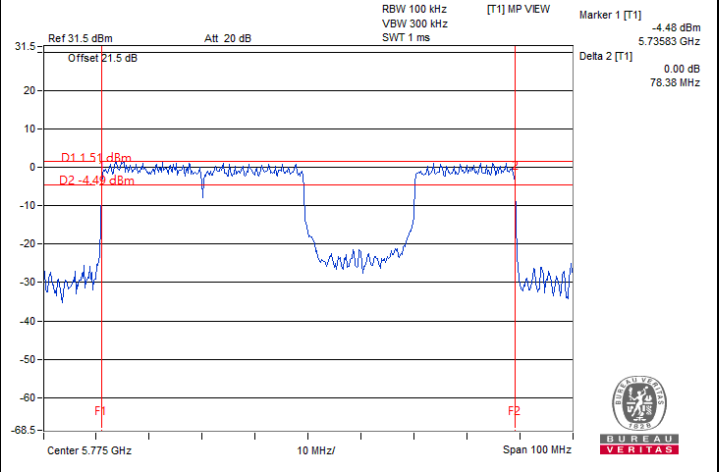

802.11be (EHT80) 484+242-tone MRU / Chain 0 : CH 155@92

7.5 Occupied Bandwidth

Input Power:	3.3 Vdc	Environmental Conditions:	25°C, 60% RH	Tested By:	Katina Lu
--------------	---------	---------------------------	--------------	------------	-----------

802.11ax (HE) 26-tone RU

Channel	Frequency (MHz)	Occupied Bandwidth (MHz)	
		Chain 0	Chain 1
64	5320	18.17	18.17
100	5500	18.12	18.12
140	5700	18.12	18.12

802.11ax (HE) 52-tone RU

Channel	Frequency (MHz)	Occupied Bandwidth (MHz)	
		Chain 0	Chain 1
64	5320	18.18	18.09
100	5500	18.09	18.00
140	5700	18.18	18.09

802.11ax (HE) 106-tone RU

Channel	Frequency (MHz)	Occupied Bandwidth (MHz)	
		Chain 0	Chain 1
64	5320	18.18	18.09
100	5500	18.09	18.00
140	5700	18.12	18.12

802.11be (EHT) 26-tone RU

Channel	Frequency (MHz)	Occupied Bandwidth (MHz)	
		Chain 0	Chain 1
36	5180	18.17	18.08
149	5745	19.08	19.44
165	5825	19.80	21.36

802.11be (EHT) 52-tone RU

Channel	Frequency (MHz)	Occupied Bandwidth (MHz)	
		Chain 0	Chain 1
36	5180	18.09	18.00
149	5745	21.04	26.08
165	5825	20.70	22.69

802.11be (EHT) 106-tone RU

Channel	Frequency (MHz)	Occupied Bandwidth (MHz)	
		Chain 0	Chain 1
36	5180	18.09	18.09
149	5745	23.04	27.13
165	5825	22.00	23.40

802.11be (EHT20) 52+26-tone MRU

Channel	Frequency (MHz)	Occupied Bandwidth (MHz)	
		Chain 0	Chain 1
36	5180	17.22	17.13
149	5745	20.40	23.88
165	5825	20.64	22.08

802.11be (EHT20) 106+26-tone MRU

Channel	Frequency (MHz)	Occupied Bandwidth (MHz)	
		Chain 0	Chain 1
36	5180	18.18	18.18
149	5745	24.60	27.60
165	5825	23.64	25.32

802.11be (EHT80) 484+242-tone MRU

Channel	Frequency (MHz)	Occupied Bandwidth (MHz)	
		Chain 0	Chain 1
42	5210	0.00	0.00
155	5775	78.24	78.24



Spectrum Plot of Maximum Value

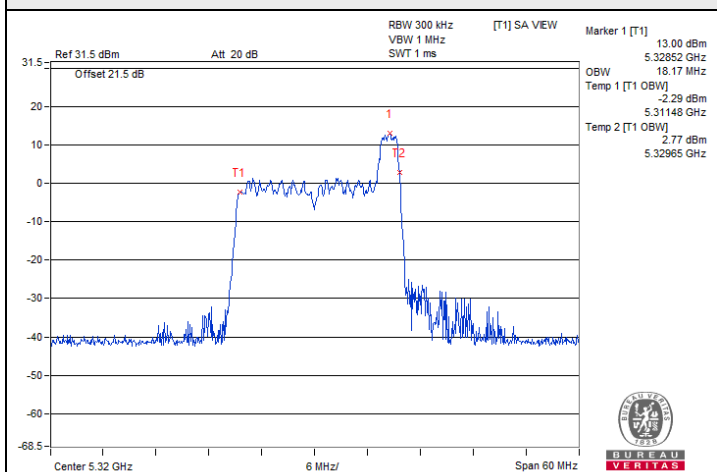

802.11ax (HE) 26-tone RU / Chain 0 : CH 64@8

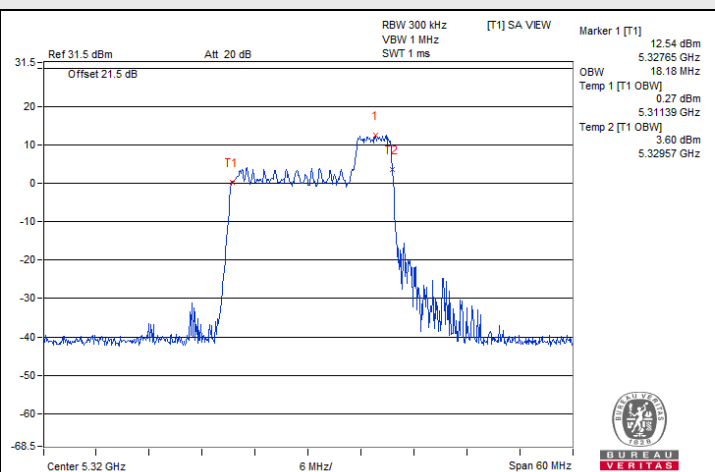

802.11ax (HE) 52-tone RU / Chain 0 : CH 64@40

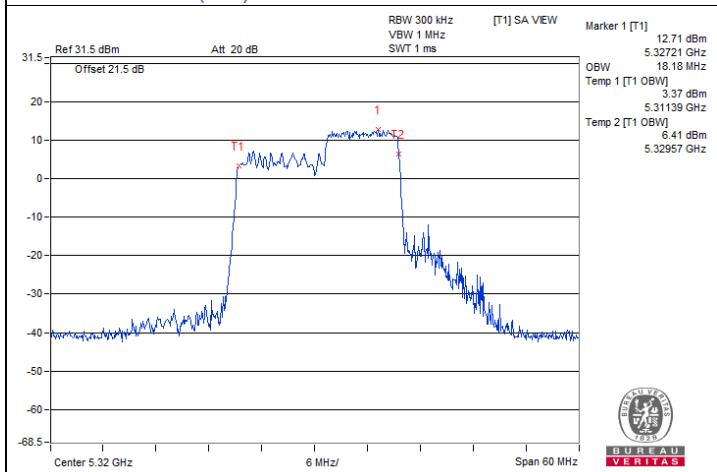

802.11ax (HE) 106-tone RU / Chain 0 : CH 64@54

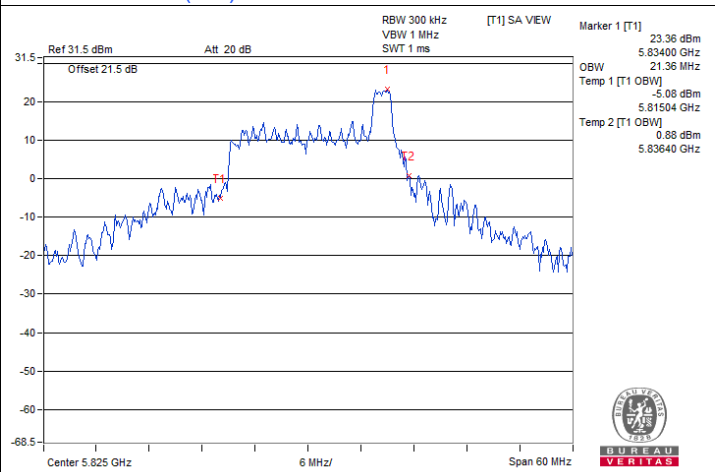

802.11be (EHT) 26-tone RU / Chain 1 : CH 165@8

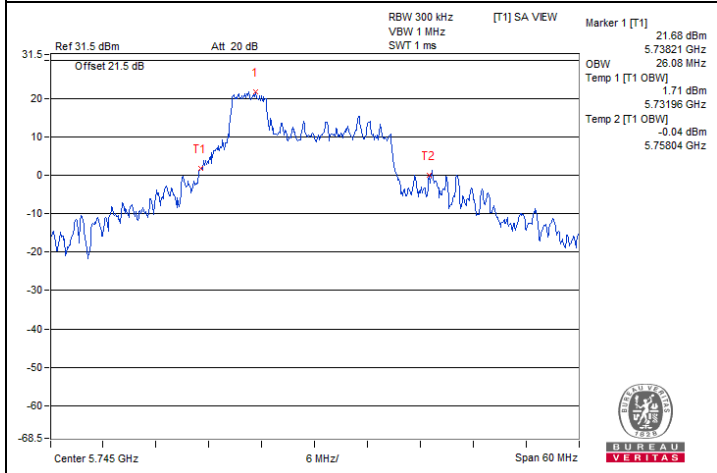

802.11be (EHT) 52-tone RU / Chain 1 : CH 149@37

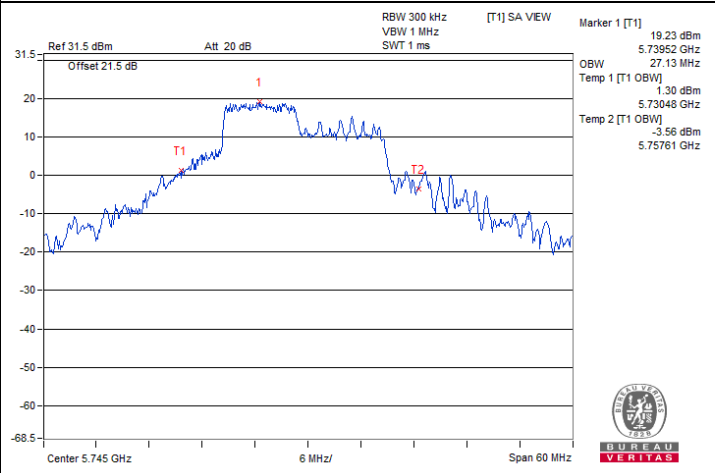

802.11be (EHT) 106-tone RU / Chain 1 : CH 149@53



Spectrum Plot of Maximum Value

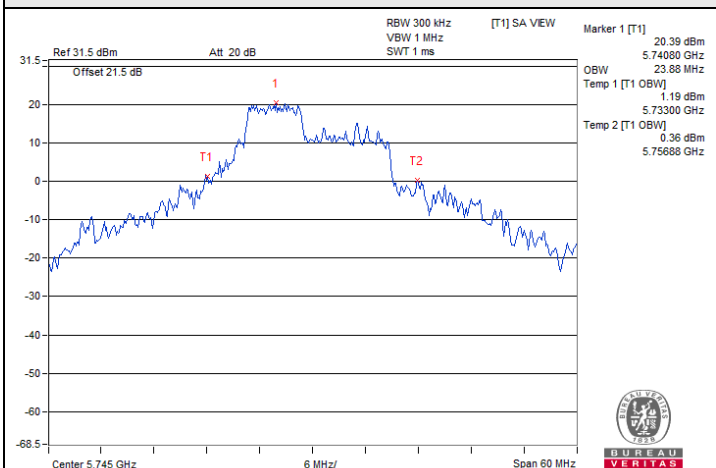

802.11be (EHT20) 52+26-tone MRU / Chain 1 : CH 149@70

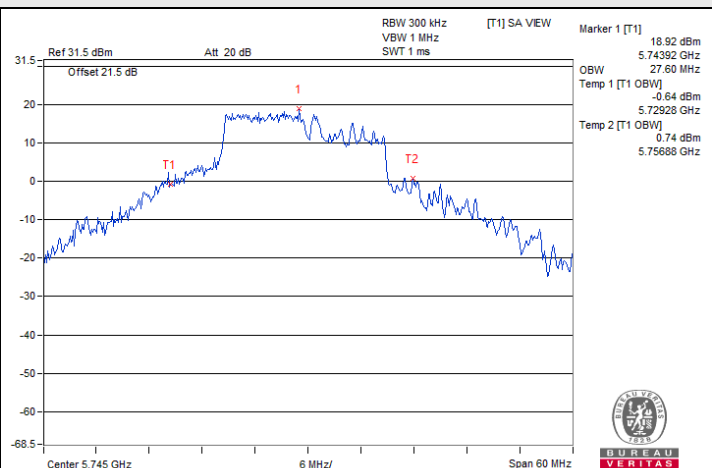

802.11be (EHT20) 106+26-tone MRU / Chain 1 : CH 149@82

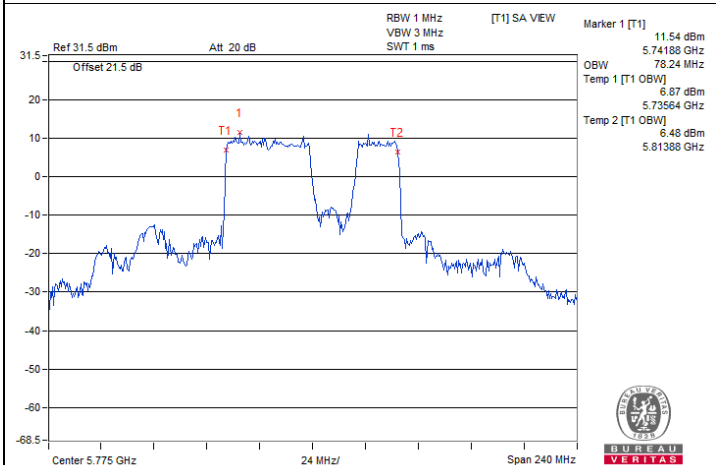

802.11be (EHT80) 484+242-tone MRU / Chain 0 : CH 155@92

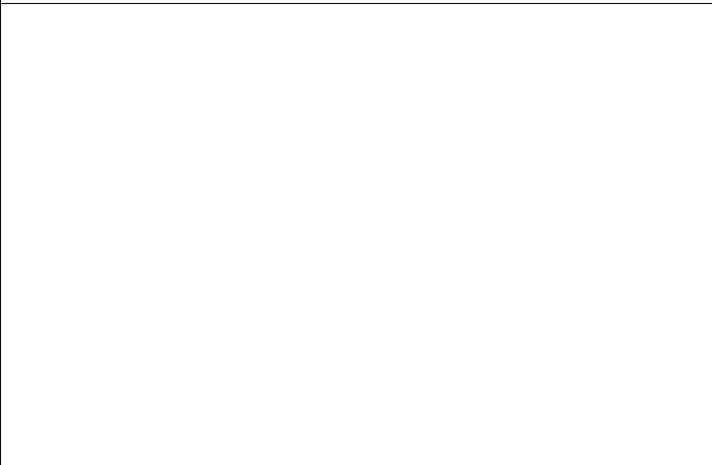

802.11be (EHT80) 484+242-tone MRU / Chain 1 : CH 42@92

Spectrum Plot for nearby DFS band (DFS is required, if 99% OCP straddle into U-NII-2A)

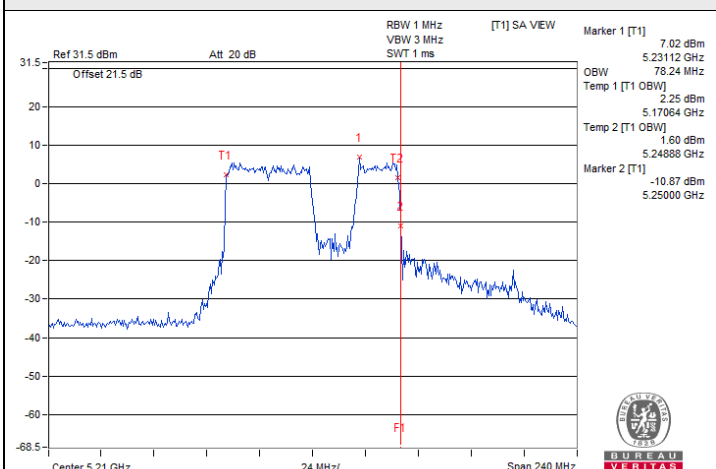

802.11be (EHT80) 484+242-tone MRU / Chain 0 : CH 42@92

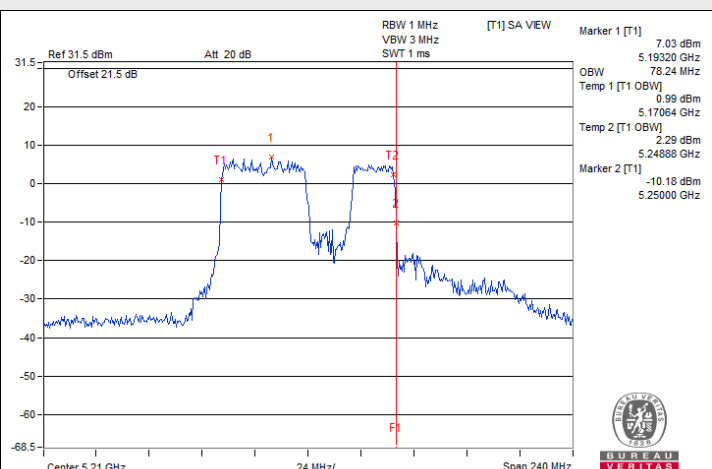

802.11be (EHT80) 484+242-tone MRU / Chain 1 : CH 42@92



Spectrum Plot for nearby DFS band (DFS is required, if 99% OCP straddle into U-NII-2C)

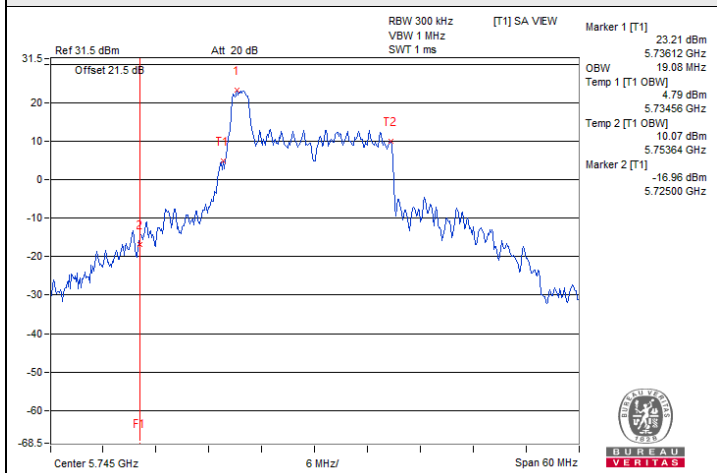

802.11be (EHT) 26-tone RU / Chain 0 : CH 149@0

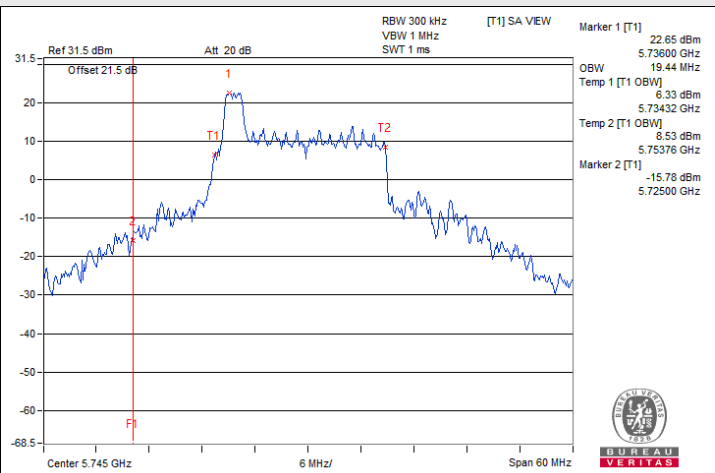

802.11be (EHT) 26-tone RU / Chain 1 : CH 149@0

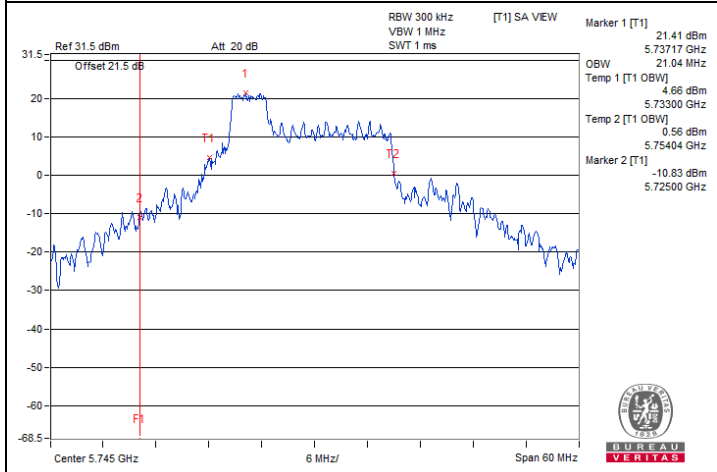

802.11be (EHT) 52-tone RU / Chain 0 : CH 149@37

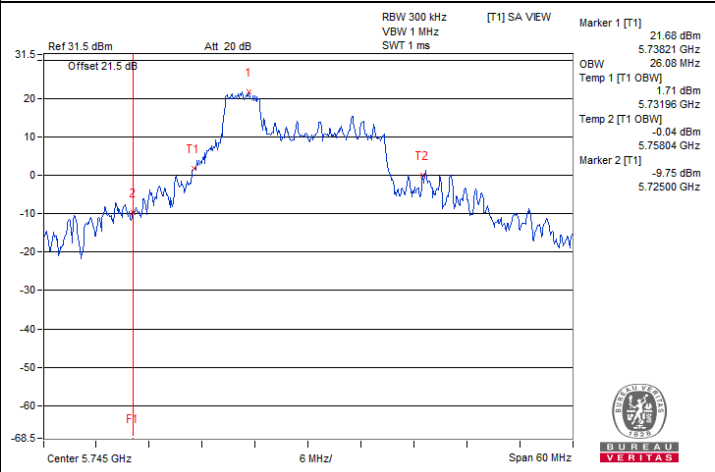

802.11be (EHT) 52-tone RU / Chain 1 : CH 149@37

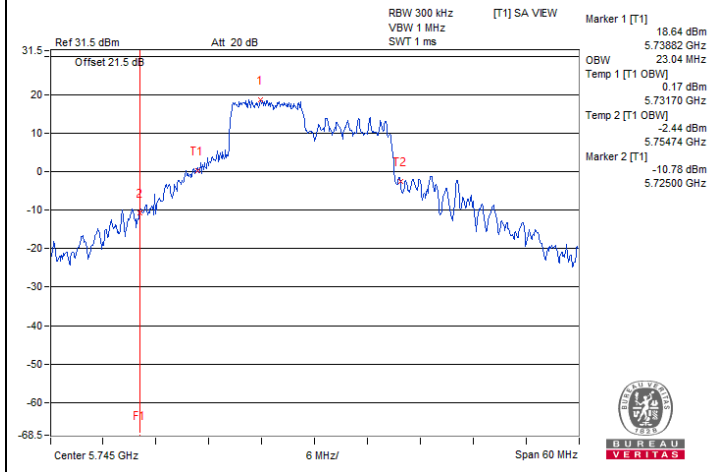

802.11be (EHT) 106-tone RU / Chain 0 : CH 149@53

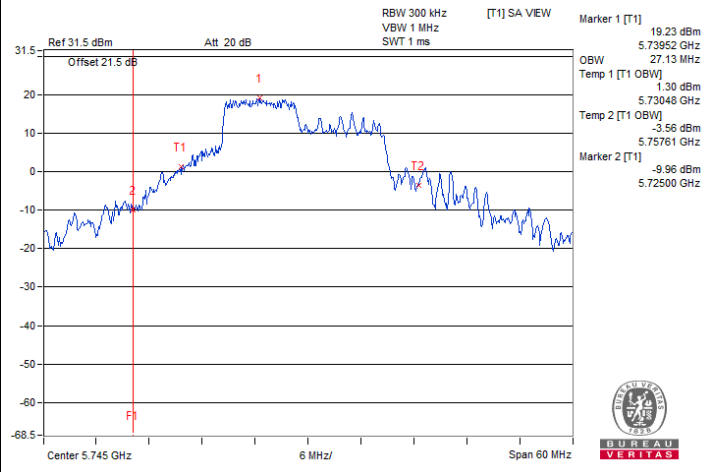

802.11be (EHT) 106-tone RU / Chain 1 : CH 149@53

Spectrum Plot for nearby DFS band (DFS is required, if 99% OCP straddle into U-NII-2C)

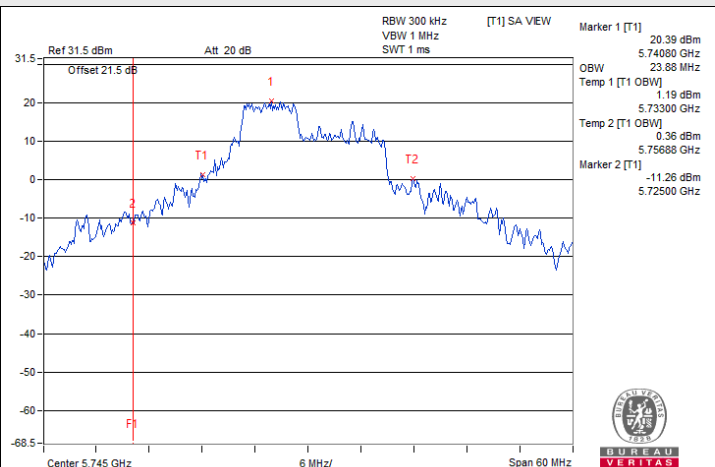
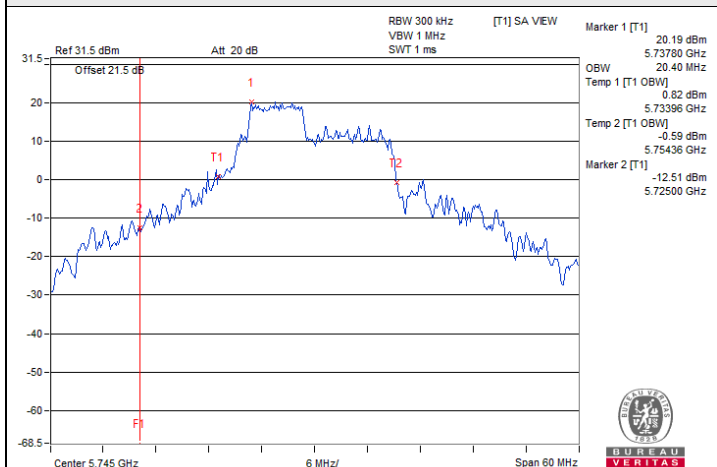

802.11be (EHT20) 52+26-tone MRU / Chain 0 : CH 149@70 802.11be (EHT20) 52+26-tone MRU / Chain 1 : CH 149@70

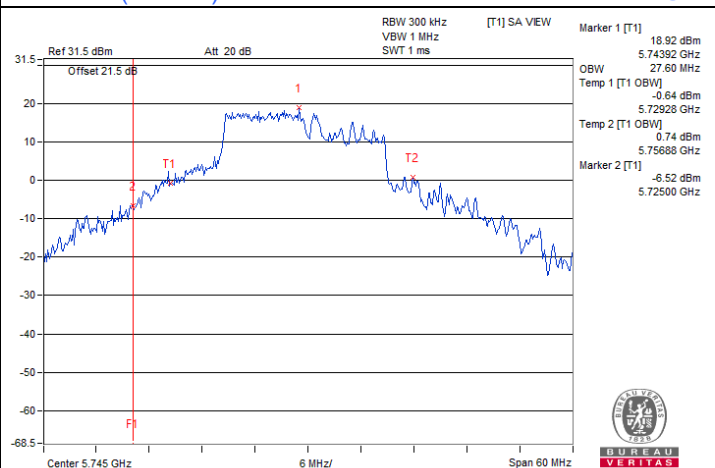
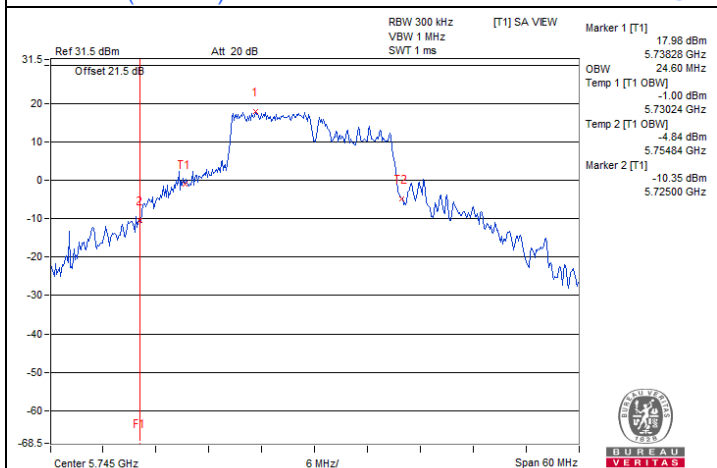

802.11be (EHT20) 106+26-tone MRU / Chain 0 : CH 149@82

802.11be (EHT20) 106+26-tone MRU / Chain 1 : CH 149@82

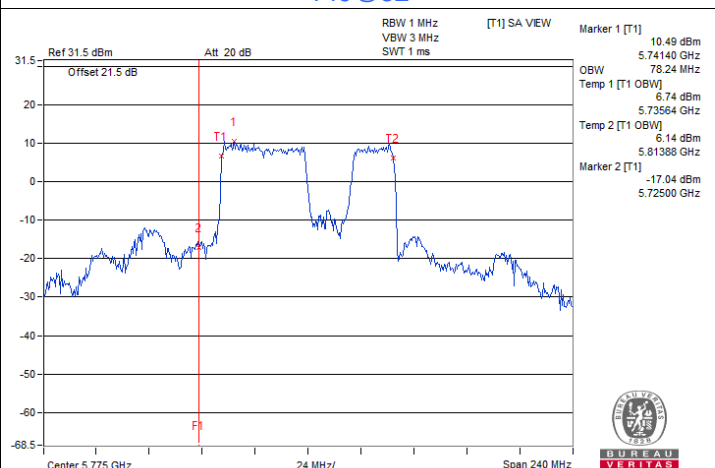
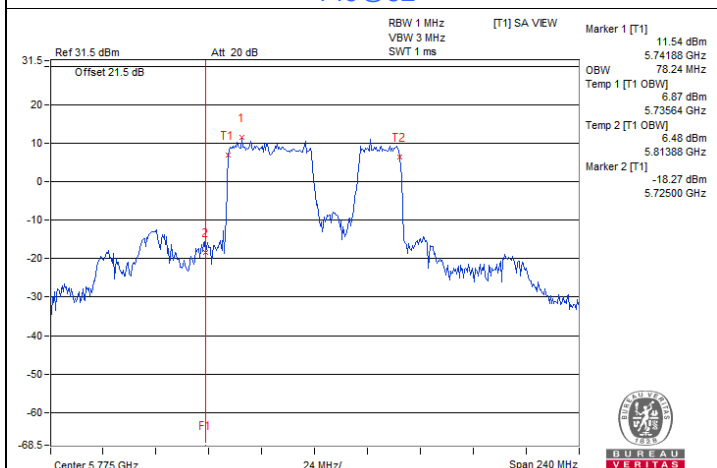

802.11be (EHT80) 484+242-tone MRU / Chain 0 : CH 155@92

802.11be (EHT80) 484+242-tone MRU / Chain 1 : CH 155@92

7.6 AC Power Conducted Emissions

RF Mode	802.11be (EHT) 52+26-tone MRU	Channel	CH 149 : 5745 MHz
Frequency Range	150 kHz ~ 30 MHz	Detector Function & Resolution Bandwidth	Quasi-Peak (QP) / Average (AV), 9 kHz
Input Power (System)	120 Vac, 60 Hz	Environmental Conditions	23°C, 68% RH
Tested By	Tom Yang		

Phase Of Power : Line (L)										
No	Frequency (MHz)	Correction Factor (dB)	Reading Value (dBuV)		Emission Level (dBuV)		Limit (dBuV)		Margin (dB)	
			Q.P.	AV.	Q.P.	AV.	Q.P.	AV.	Q.P.	AV.
1	0.15000	9.96	48.68	28.77	58.64	38.73	66.00	56.00	-7.36	-17.27
2	0.23594	9.96	35.31	13.28	45.27	23.24	62.24	52.24	-16.97	-29.00
3	0.52500	9.98	18.88	3.42	28.86	13.40	56.00	46.00	-27.14	-32.60
4	3.63672	10.13	22.83	14.92	32.96	25.05	56.00	46.00	-23.04	-20.95
5	15.44141	10.83	16.44	5.41	27.27	16.24	60.00	50.00	-32.73	-33.76
6	24.98047	11.18	23.39	14.44	34.57	25.62	60.00	50.00	-25.43	-24.38

Remarks:

1. Q.P. and AV. are abbreviations of quasi-peak and average individually.
2. The emission levels of other frequencies were very low against the limit.
3. Margin value = Emission level – Limit value
4. Correction factor = Insertion loss + Cable loss
5. Emission Level = Correction Factor + Reading Value

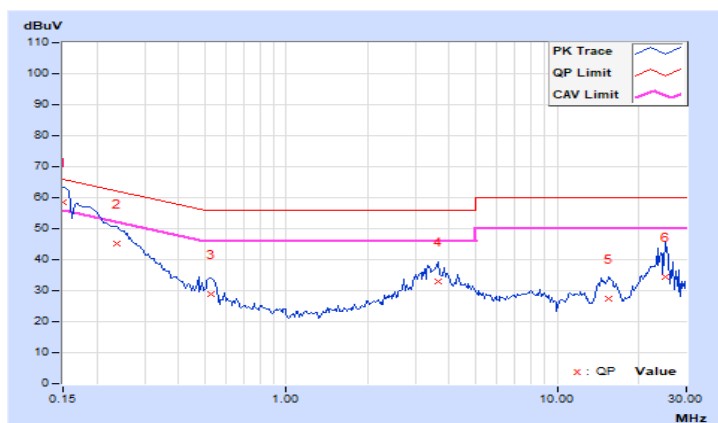

RF Mode	802.11be (EHT) 52+26-tone MRU	Channel	CH 149 : 5745 MHz
Frequency Range	150 kHz ~ 30 MHz	Detector Function & Resolution Bandwidth	Quasi-Peak (QP) / Average (AV), 9 kHz
Input Power (System)	120 Vac, 60 Hz	Environmental Conditions	23°C, 68% RH
Tested By	Tom Yang		

Phase Of Power : Neutral (N)										
No	Frequency (MHz)	Correction Factor (dB)	Reading Value (dBuV)		Emission Level (dBuV)		Limit (dBuV)		Margin (dB)	
			Q.P.	AV.	Q.P.	AV.	Q.P.	AV.	Q.P.	AV.
1	0.15000	9.93	46.46	22.68	56.39	32.61	66.00	56.00	-9.61	-23.39
2	0.22422	9.94	38.07	18.59	48.01	28.53	62.66	52.66	-14.65	-24.13
3	0.53281	9.95	19.92	5.85	29.87	15.80	56.00	46.00	-26.13	-30.20
4	3.46094	10.08	22.43	15.93	32.51	26.01	56.00	46.00	-23.49	-19.99
5	15.04688	10.61	17.63	8.05	28.24	18.66	60.00	50.00	-31.76	-31.34
6	25.84375	10.86	19.91	6.29	30.77	17.15	60.00	50.00	-29.23	-32.85

Remarks:

1. Q.P. and AV. are abbreviations of quasi-peak and average individually.
2. The emission levels of other frequencies were very low against the limit.
3. Margin value = Emission level – Limit value
4. Correction factor = Insertion loss + Cable loss
5. Emission Level = Correction Factor + Reading Value

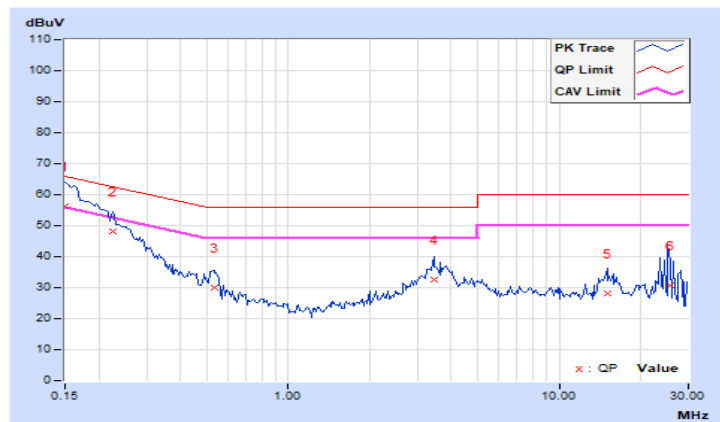

7.7 Unwanted Emissions below 1 GHz

RF Mode	802.11be (EHT) 52+26-tone MRU	Channel	CH 149 : 5745 MHz
Frequency Range	30 MHz ~ 1 GHz	Detector Function & Bandwidth	(QP) RB = 120kHz
Input Power (System)	120 Vac, 60 Hz	Environmental Conditions	25°C, 67% RH
Tested By	Tom Yang		

Antenna Polarity & Test Distance : Horizontal at 3 m

No	Frequency (MHz)	Emission Level (dBuV/m)	Limit (dBuV/m)	Margin (dB)	Antenna Height (m)	Table Angle (Degree)	Raw Value (dBuV)	Correction Factor (dB/m)
1	182.19	38.5 QP	43.5	-5.0	1.50 H	169	52.3	-13.8
2	199.36	40.3 QP	43.5	-3.2	1.50 H	152	55.3	-15.0
3	299.01	42.2 QP	46.0	-3.8	1.00 H	360	53.0	-10.8
4	398.31	32.5 QP	46.0	-13.5	1.00 H	137	40.4	-7.9
5	697.04	39.3 QP	46.0	-6.7	1.00 H	96	40.0	-0.7
6	897.98	42.1 QP	46.0	-3.9	1.50 H	107	38.9	3.2

Remarks:

1. Emission Level(dBuV/m) = Raw Value(dBuV) + Correction Factor(dB/m)
2. Correction Factor(dB/m) = Antenna Factor(dB/m) + Cable Factor(dB) – Pre-Amplifier Factor(dB)
3. Margin value = Emission Level – Limit value
4. The other emission levels were very low against the limit of frequency range 30 MHz ~ 1 GHz.
5. The emission levels were very low against the limit of frequency range 9 kHz ~ 30 MHz: the amplitude of spurious emissions attenuated more than 20 dB below the permissible value to be report.

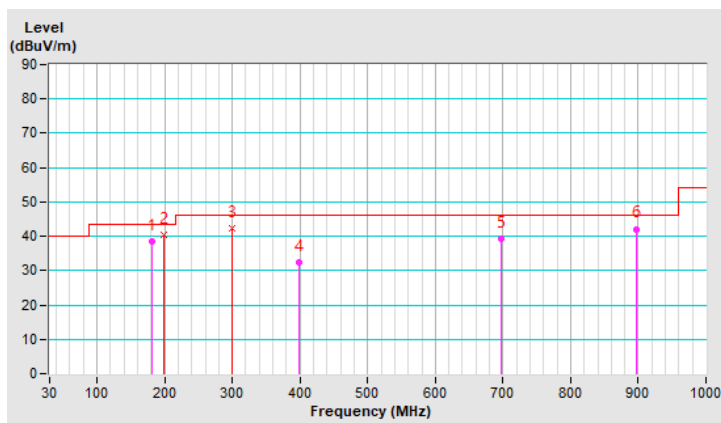

RF Mode	802.11be (EHT) 52+26-tone MRU	Channel	CH 149 : 5745 MHz
Frequency Range	30 MHz ~ 1 GHz	Detector Function & Bandwidth	(QP) RB = 120kHz
Input Power (System)	120 Vac, 60 Hz	Environmental Conditions	25°C, 67% RH
Tested By	Tom Yang		

Antenna Polarity & Test Distance : Vertical at 3 m								
No	Frequency (MHz)	Emission Level (dBuV/m)	Limit (dBuV/m)	Margin (dB)	Antenna Height (m)	Table Angle (Degree)	Raw Value (dBuV)	Correction Factor (dB/m)
1	38.71	21.7 QP	40.0	-18.3	1.50 V	2	34.7	-13.0
2	199.17	34.1 QP	43.5	-9.4	1.50 V	101	49.1	-15.0
3	299.32	39.7 QP	46.0	-6.3	1.00 V	83	50.5	-10.8
4	398.31	29.9 QP	46.0	-16.1	2.00 V	85	37.8	-7.9
5	698.43	34.8 QP	46.0	-11.2	2.00 V	71	35.5	-0.7
6	898.00	39.4 QP	46.0	-6.6	1.00 V	67	36.2	3.2

Remarks:

1. Emission Level(dBuV/m) = Raw Value(dBuV) + Correction Factor(dB/m)
2. Correction Factor(dB/m) = Antenna Factor(dB/m) + Cable Factor(dB) – Pre-Amplifier Factor(dB)
3. Margin value = Emission Level – Limit value
4. The other emission levels were very low against the limit of frequency range 30 MHz ~ 1 GHz.
5. The emission levels were very low against the limit of frequency range 9 kHz ~ 30 MHz: the amplitude of spurious emissions attenuated more than 20 dB below the permissible value to be report.

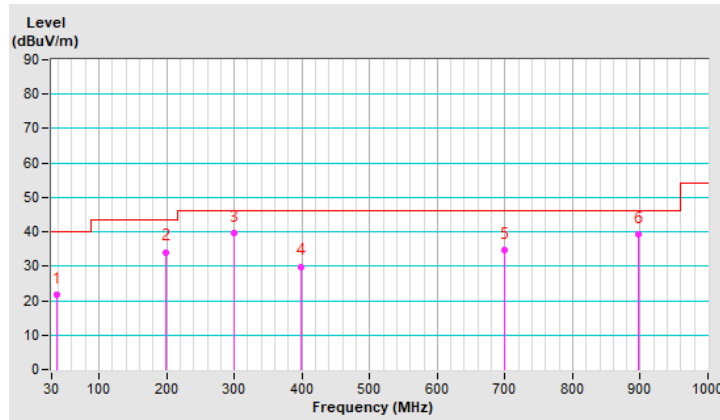

7.8 Unwanted Emissions above 1 GHz

RF Mode	802.11ax (HE) 26-tone RU	Channel	CH 64 : 5320 MHz
Frequency Range	1 GHz ~ 40 GHz	Detector Function & Bandwidth	(PK) RB = 1 MHz, VB = 3 MHz (AV) RB = 1 MHz, VB = 2 kHz
Input Power (System)	120 Vac, 60 Hz	Environmental Conditions	24°C, 69% RH
Tested By	Tom Yang		

Antenna Polarity & Test Distance : Horizontal at 3 m								
No	Frequency (MHz)	Emission Level (dBuV/m)	Limit (dBuV/m)	Margin (dB)	Antenna Height (m)	Table Angle (Degree)	Raw Value (dBuV)	Correction Factor (dB/m)
1	*5320.00	124.2 PK			2.05 H	90	120.0	4.2
2	*5320.00	117.4 AV			2.05 H	90	113.2	4.2
3	5350.00	72.2 PK	74.0	-1.8	2.05 H	90	67.9	4.3
4	5350.00	53.6 AV	54.0	-0.4	2.05 H	90	49.3	4.3
5	10640.00	49.3 PK	74.0	-24.7	1.82 H	40	35.3	14.0
6	10640.00	40.8 AV	54.0	-13.2	1.82 H	40	26.8	14.0
7	15960.00	48.6 PK	74.0	-25.4	1.77 H	344	33.6	15.0
8	15960.00	38.5 AV	54.0	-15.5	1.77 H	344	23.5	15.0

Remarks:

1. Emission Level(dBuV/m) = Raw Value(dBuV) + Correction Factor(dB/m)
2. Correction Factor(dB/m) = Antenna Factor(dB/m) + Cable Factor(dB) – Pre-Amplifier Factor(dB)
3. Margin value = Emission Level – Limit value
4. The other emission levels were very low against the limit.
5. " * " : Fundamental frequency, the limit was restricted at the RF Output Power.

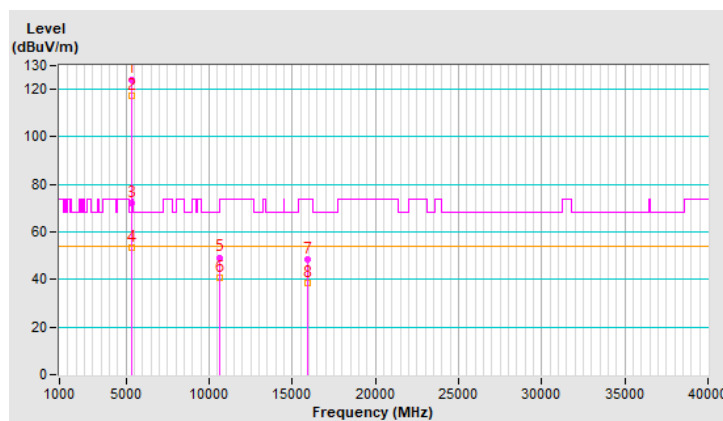

RF Mode	802.11ax (HE) 26-tone RU	Channel	CH 64 : 5320 MHz
Frequency Range	1 GHz ~ 40 GHz	Detector Function & Bandwidth	(PK) RB = 1 MHz, VB = 3 MHz (AV) RB = 1 MHz, VB = 2 kHz
Input Power (System)	120 Vac, 60 Hz	Environmental Conditions	24°C, 69% RH
Tested By	Tom Yang		

Antenna Polarity & Test Distance : Vertical at 3 m								
No	Frequency (MHz)	Emission Level (dBuV/m)	Limit (dBuV/m)	Margin (dB)	Antenna Height (m)	Table Angle (Degree)	Raw Value (dBuV)	Correction Factor (dB/m)
1	*5320.00	121.2 PK			1.99 V	33	117.0	4.2
2	*5320.00	113.0 AV			1.99 V	33	108.8	4.2
3	5350.00	61.3 PK	74.0	-12.7	1.99 V	33	57.0	4.3
4	5350.00	44.8 AV	54.0	-9.2	1.99 V	33	40.5	4.3
5	10640.00	47.4 PK	74.0	-26.6	2.68 V	198	33.4	14.0
6	10640.00	38.5 AV	54.0	-15.5	2.68 V	198	24.5	14.0
7	15960.00	47.5 PK	74.0	-26.5	1.95 V	331	32.5	15.0
8	15960.00	38.6 AV	54.0	-15.4	1.95 V	331	23.6	15.0

Remarks:

1. Emission Level(dBuV/m) = Raw Value(dBuV) + Correction Factor(dB/m)
2. Correction Factor(dB/m) = Antenna Factor(dB/m) + Cable Factor(dB) – Pre-Amplifier Factor(dB)
3. Margin value = Emission Level – Limit value
4. The other emission levels were very low against the limit.
5. " * " : Fundamental frequency, the limit was restricted at the RF Output Power.

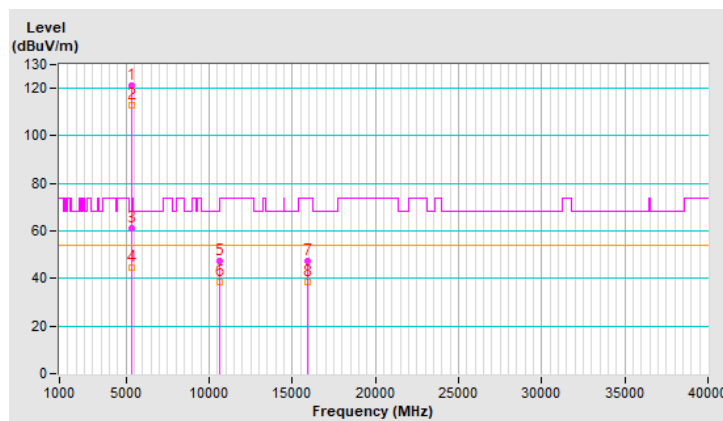

RF Mode	802.11ax (HE) 26-tone RU	Channel	CH 100 : 5500 MHz
Frequency Range	1 GHz ~ 40 GHz	Detector Function & Bandwidth	(PK) RB = 1 MHz, VB = 3 MHz (AV) RB = 1 MHz, VB = 2 kHz
Input Power (System)	120 Vac, 60 Hz	Environmental Conditions	24°C, 69% RH
Tested By	Tom Yang		

Antenna Polarity & Test Distance : Horizontal at 3 m								
No	Frequency (MHz)	Emission Level (dBuV/m)	Limit (dBuV/m)	Margin (dB)	Antenna Height (m)	Table Angle (Degree)	Raw Value (dBuV)	Correction Factor (dB/m)
1	5460.00	56.7 PK	74.0	-17.3	2.07 H	90	52.2	4.5
2	5460.00	43.3 AV	54.0	-10.7	2.07 H	90	38.8	4.5
3	#5470.00	67.7 PK	68.2	-0.5	2.07 H	90	63.2	4.5
4	*5500.00	123.4 PK			2.07 H	90	118.8	4.6
5	*5500.00	116.6 AV			2.07 H	90	112.0	4.6
6	11000.00	49.1 PK	74.0	-24.9	1.79 H	31	34.1	15.0
7	11000.00	40.1 AV	54.0	-13.9	1.79 H	31	25.1	15.0
8	#16500.00	48.9 PK	68.2	-19.3	1.76 H	344	31.7	17.2

Remarks:

1. Emission Level(dBuV/m) = Raw Value(dBuV) + Correction Factor(dB/m)
2. Correction Factor(dB/m) = Antenna Factor(dB/m) + Cable Factor(dB) – Pre-Amplifier Factor(dB)
3. Margin value = Emission Level – Limit value
4. The other emission levels were very low against the limit.
5. " * " : Fundamental frequency, the limit was restricted at the RF Output Power.
6. " # " : The radiated frequency is out of the restricted band.

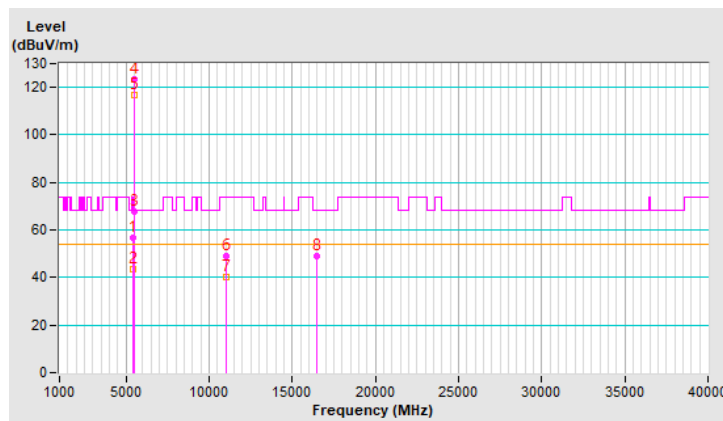

RF Mode	802.11ax (HE) 26-tone RU	Channel	CH 100 : 5500 MHz
Frequency Range	1 GHz ~ 40 GHz	Detector Function & Bandwidth	(PK) RB = 1 MHz, VB = 3 MHz (AV) RB = 1 MHz, VB = 2 kHz
Input Power (System)	120 Vac, 60 Hz	Environmental Conditions	24°C, 69% RH
Tested By	Tom Yang		

Antenna Polarity & Test Distance : Vertical at 3 m								
No	Frequency (MHz)	Emission Level (dBuV/m)	Limit (dBuV/m)	Margin (dB)	Antenna Height (m)	Table Angle (Degree)	Raw Value (dBuV)	Correction Factor (dB/m)
1	5460.00	54.1 PK	74.0	-19.9	1.97 V	36	49.6	4.5
2	5460.00	41.3 AV	54.0	-12.7	1.97 V	36	36.8	4.5
3	#5470.00	57.9 PK	68.2	-10.3	1.97 V	36	53.4	4.5
4	*5500.00	118.9 PK			1.97 V	36	114.3	4.6
5	*5500.00	111.1 AV			1.97 V	36	106.5	4.6
6	11000.00	47.7 PK	74.0	-26.3	2.64 V	195	32.7	15.0
7	11000.00	38.9 AV	54.0	-15.1	2.64 V	195	23.9	15.0
8	#16500.00	47.7 PK	68.2	-20.5	1.90 V	333	30.5	17.2

Remarks:

1. Emission Level(dBuV/m) = Raw Value(dBuV) + Correction Factor(dB/m)
2. Correction Factor(dB/m) = Antenna Factor(dB/m) + Cable Factor(dB) – Pre-Amplifier Factor(dB)
3. Margin value = Emission Level – Limit value
4. The other emission levels were very low against the limit.
5. " * " : Fundamental frequency, the limit was restricted at the RF Output Power.
6. " # " : The radiated frequency is out of the restricted band.

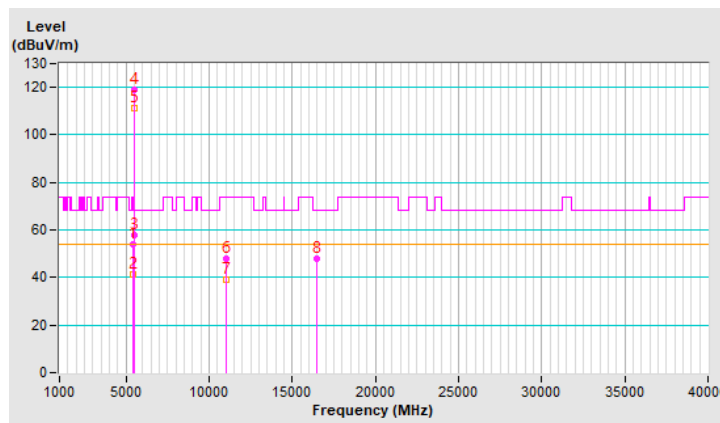

RF Mode	802.11ax (HE) 26-tone RU	Channel	CH 140 : 5700 MHz
Frequency Range	1 GHz ~ 40 GHz	Detector Function & Bandwidth	(PK) RB = 1 MHz, VB = 3 MHz (AV) RB = 1 MHz, VB = 2 kHz
Input Power (System)	120 Vac, 60 Hz	Environmental Conditions	24°C, 69% RH
Tested By	Tom Yang		

Antenna Polarity & Test Distance : Horizontal at 3 m								
No	Frequency (MHz)	Emission Level (dBuV/m)	Limit (dBuV/m)	Margin (dB)	Antenna Height (m)	Table Angle (Degree)	Raw Value (dBuV)	Correction Factor (dB/m)
1	*5700.00	122.9 PK			2.08 H	86	118.3	4.6
2	*5700.00	116.1 AV			2.08 H	86	111.5	4.6
3	#5725.00	67.8 PK	68.2	-0.4	2.08 H	86	63.1	4.7
4	11400.00	49.3 PK	74.0	-24.7	1.81 H	34	34.3	15.0
5	11400.00	39.4 AV	54.0	-14.6	1.81 H	34	24.4	15.0
6	#17100.00	48.6 PK	68.2	-19.6	1.74 H	357	29.6	19.0

Remarks:

1. Emission Level(dBuV/m) = Raw Value(dBuV) + Correction Factor(dB/m)
2. Correction Factor(dB/m) = Antenna Factor(dB/m) + Cable Factor(dB) – Pre-Amplifier Factor(dB)
3. Margin value = Emission Level – Limit value
4. The other emission levels were very low against the limit.
5. " * " : Fundamental frequency, the limit was restricted at the RF Output Power.
6. " # " : The radiated frequency is out of the restricted band.

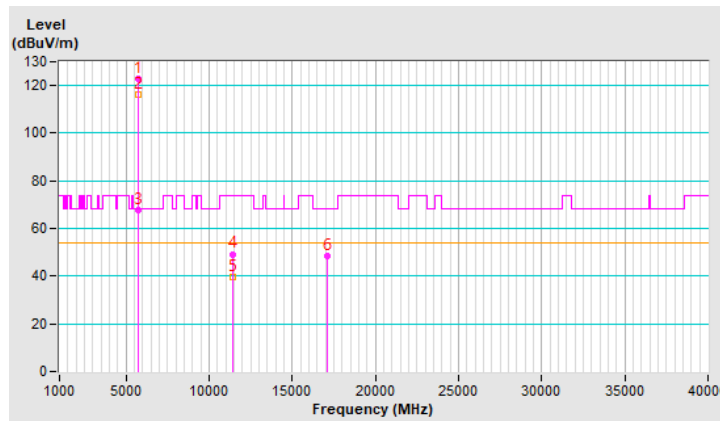

RF Mode	802.11ax (HE) 26-tone RU	Channel	CH 140 : 5700 MHz
Frequency Range	1 GHz ~ 40 GHz	Detector Function & Bandwidth	(PK) RB = 1 MHz, VB = 3 MHz (AV) RB = 1 MHz, VB = 2 kHz
Input Power (System)	120 Vac, 60 Hz	Environmental Conditions	24°C, 69% RH
Tested By	Tom Yang		

Antenna Polarity & Test Distance : Vertical at 3 m								
No	Frequency (MHz)	Emission Level (dBuV/m)	Limit (dBuV/m)	Margin (dB)	Antenna Height (m)	Table Angle (Degree)	Raw Value (dBuV)	Correction Factor (dB/m)
1	*5700.00	117.8 PK			1.95 V	24	113.2	4.6
2	*5700.00	110.2 AV			1.95 V	24	105.6	4.6
3	#5725.00	57.9 PK	68.2	-10.3	1.95 V	24	53.2	4.7
4	11400.00	46.8 PK	74.0	-27.2	2.74 V	209	31.8	15.0
5	11400.00	38.1 AV	54.0	-15.9	2.74 V	209	23.1	15.0
6	#17100.00	47.1 PK	68.2	-21.1	1.93 V	341	28.1	19.0

Remarks:

1. Emission Level(dBuV/m) = Raw Value(dBuV) + Correction Factor(dB/m)
2. Correction Factor(dB/m) = Antenna Factor(dB/m) + Cable Factor(dB) – Pre-Amplifier Factor(dB)
3. Margin value = Emission Level – Limit value
4. The other emission levels were very low against the limit.
5. " * " : Fundamental frequency, the limit was restricted at the RF Output Power.
6. " # " : The radiated frequency is out of the restricted band.

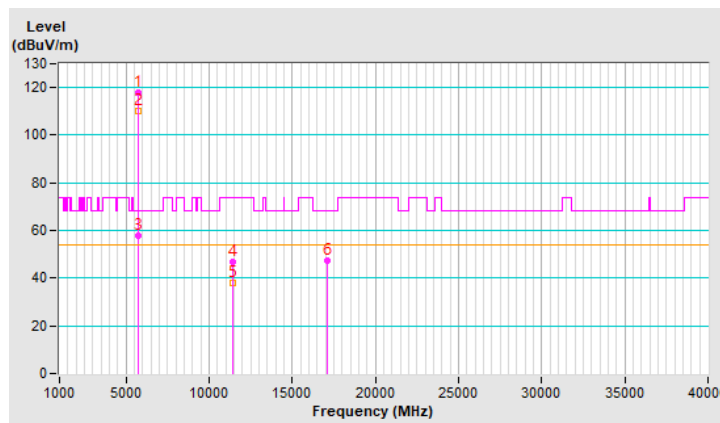

RF Mode	802.11ax (HE) 52-tone RU	Channel	CH 64 : 5320 MHz
Frequency Range	1 GHz ~ 40 GHz	Detector Function & Bandwidth	(PK) RB = 1 MHz, VB = 3 MHz (AV) RB = 1 MHz, VB = 3 kHz
Input Power (System)	120 Vac, 60 Hz	Environmental Conditions	24°C, 69% RH
Tested By	Tom Yang		

Antenna Polarity & Test Distance : Horizontal at 3 m								
No	Frequency (MHz)	Emission Level (dBuV/m)	Limit (dBuV/m)	Margin (dB)	Antenna Height (m)	Table Angle (Degree)	Raw Value (dBuV)	Correction Factor (dB/m)
1	*5320.00	122.6 PK			2.07 H	88	118.4	4.2
2	*5320.00	115.5 AV			2.07 H	88	111.3	4.2
3	5352.20	72.5 PK	74.0	-1.5	2.07 H	88	68.2	4.3
4	5352.20	53.7 AV	54.0	-0.3	2.07 H	88	49.4	4.3
5	10640.00	47.6 PK	74.0	-26.4	1.82 H	32	33.6	14.0
6	10640.00	38.7 AV	54.0	-15.3	1.82 H	32	24.7	14.0
7	15960.00	47.4 PK	74.0	-26.6	1.80 H	337	32.4	15.0
8	15960.00	36.4 AV	54.0	-17.6	1.80 H	337	21.4	15.0

Remarks:

1. Emission Level(dBuV/m) = Raw Value(dBuV) + Correction Factor(dB/m)
2. Correction Factor(dB/m) = Antenna Factor(dB/m) + Cable Factor(dB) – Pre-Amplifier Factor(dB)
3. Margin value = Emission Level – Limit value
4. The other emission levels were very low against the limit.
5. " * " : Fundamental frequency, the limit was restricted at the RF Output Power.

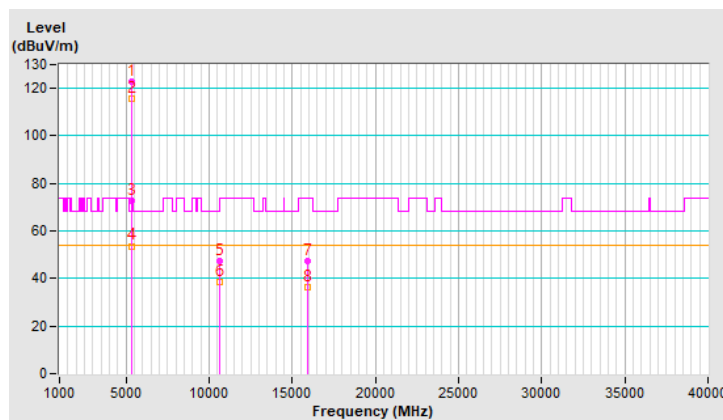

RF Mode	802.11ax (HE) 52-tone RU	Channel	CH 64 : 5320 MHz
Frequency Range	1 GHz ~ 40 GHz	Detector Function & Bandwidth	(PK) RB = 1 MHz, VB = 3 MHz (AV) RB = 1 MHz, VB = 3 kHz
Input Power (System)	120 Vac, 60 Hz	Environmental Conditions	24°C, 69% RH
Tested By	Tom Yang		

Antenna Polarity & Test Distance : Vertical at 3 m								
No	Frequency (MHz)	Emission Level (dBuV/m)	Limit (dBuV/m)	Margin (dB)	Antenna Height (m)	Table Angle (Degree)	Raw Value (dBuV)	Correction Factor (dB/m)
1	*5320.00	119.5 PK			2.00 V	32	115.3	4.2
2	*5320.00	110.6 AV			2.00 V	32	106.4	4.2
3	5352.20	65.5 PK	74.0	-8.5	2.00 V	32	61.2	4.3
4	5352.20	46.4 AV	54.0	-7.6	2.00 V	32	42.1	4.3
5	10640.00	46.7 PK	74.0	-27.3	2.73 V	203	32.7	14.0
6	10640.00	36.6 AV	54.0	-17.4	2.73 V	203	22.6	14.0
7	15960.00	47.5 PK	74.0	-26.5	1.90 V	318	32.5	15.0
8	15960.00	36.5 AV	54.0	-17.5	1.90 V	318	21.5	15.0

Remarks:

1. Emission Level(dBuV/m) = Raw Value(dBuV) + Correction Factor(dB/m)
2. Correction Factor(dB/m) = Antenna Factor(dB/m) + Cable Factor(dB) – Pre-Amplifier Factor(dB)
3. Margin value = Emission Level – Limit value
4. The other emission levels were very low against the limit.
5. " * " : Fundamental frequency, the limit was restricted at the RF Output Power.

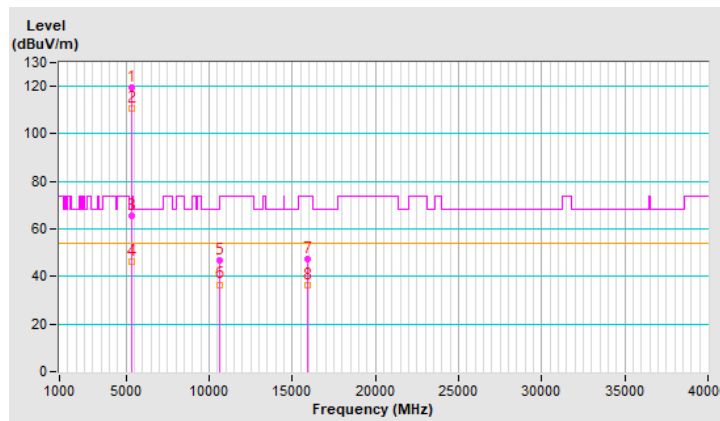

RF Mode	802.11ax (HE) 52-tone RU	Channel	CH 100 : 5500 MHz
Frequency Range	1 GHz ~ 40 GHz	Detector Function & Bandwidth	(PK) RB = 1 MHz, VB = 3 MHz (AV) RB = 1 MHz, VB = 3 kHz
Input Power (System)	120 Vac, 60 Hz	Environmental Conditions	24°C, 69% RH
Tested By	Tom Yang		

Antenna Polarity & Test Distance : Horizontal at 3 m								
No	Frequency (MHz)	Emission Level (dBuV/m)	Limit (dBuV/m)	Margin (dB)	Antenna Height (m)	Table Angle (Degree)	Raw Value (dBuV)	Correction Factor (dB/m)
1	5460.00	56.5 PK	74.0	-17.5	2.08 H	88	52.0	4.5
2	5460.00	44.1 AV	54.0	-9.9	2.08 H	88	39.6	4.5
3	#5469.60	68.0 PK	68.2	-0.2	2.08 H	88	63.5	4.5
4	*5500.00	121.6 PK			2.08 H	88	117.0	4.6
5	*5500.00	113.1 AV			2.08 H	88	108.5	4.6
6	11000.00	47.5 PK	74.0	-26.5	1.81 H	33	32.5	15.0
7	11000.00	38.4 AV	54.0	-15.6	1.81 H	33	23.4	15.0
8	#16500.00	47.5 PK	68.2	-20.7	1.83 H	323	30.3	17.2

Remarks:

1. Emission Level(dBuV/m) = Raw Value(dBuV) + Correction Factor(dB/m)
2. Correction Factor(dB/m) = Antenna Factor(dB/m) + Cable Factor(dB) – Pre-Amplifier Factor(dB)
3. Margin value = Emission Level – Limit value
4. The other emission levels were very low against the limit.
5. " * " : Fundamental frequency, the limit was restricted at the RF Output Power.
6. " # " : The radiated frequency is out of the restricted band.

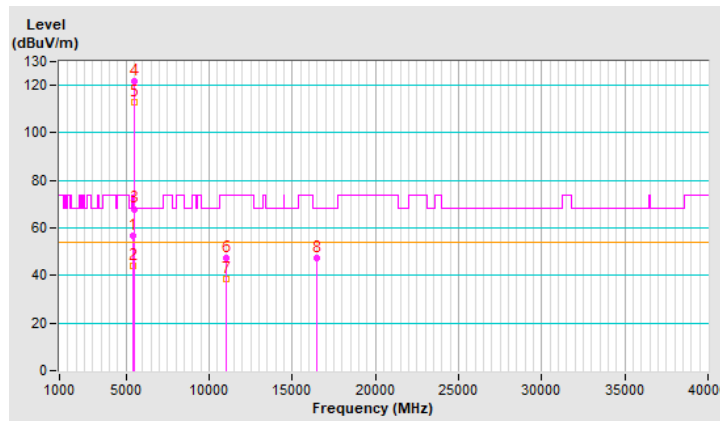

RF Mode	802.11ax (HE) 52-tone RU	Channel	CH 100 : 5500 MHz
Frequency Range	1 GHz ~ 40 GHz	Detector Function & Bandwidth	(PK) RB = 1 MHz, VB = 3 MHz (AV) RB = 1 MHz, VB = 3 kHz
Input Power (System)	120 Vac, 60 Hz	Environmental Conditions	24°C, 69% RH
Tested By	Tom Yang		

Antenna Polarity & Test Distance : Vertical at 3 m								
No	Frequency (MHz)	Emission Level (dBuV/m)	Limit (dBuV/m)	Margin (dB)	Antenna Height (m)	Table Angle (Degree)	Raw Value (dBuV)	Correction Factor (dB/m)
1	5449.75	53.1 PK	74.0	-20.9	2.07 V	33	48.6	4.5
2	5449.75	41.5 AV	54.0	-12.5	2.07 V	33	37.0	4.5
3	#5470.00	57.2 PK	68.2	-11.0	2.07 V	33	52.7	4.5
4	*5500.00	116.4 PK			2.07 V	33	111.8	4.6
5	*5500.00	108.5 AV			2.07 V	33	103.9	4.6
6	11000.00	47.1 PK	74.0	-26.9	2.77 V	217	32.1	15.0
7	11000.00	36.7 AV	54.0	-17.3	2.77 V	217	21.7	15.0
8	#16500.00	48.0 PK	68.2	-20.2	1.95 V	325	30.8	17.2

Remarks:

1. Emission Level(dBuV/m) = Raw Value(dBuV) + Correction Factor(dB/m)
2. Correction Factor(dB/m) = Antenna Factor(dB/m) + Cable Factor(dB) – Pre-Amplifier Factor(dB)
3. Margin value = Emission Level – Limit value
4. The other emission levels were very low against the limit.
5. " * " : Fundamental frequency, the limit was restricted at the RF Output Power.
6. " # " : The radiated frequency is out of the restricted band.

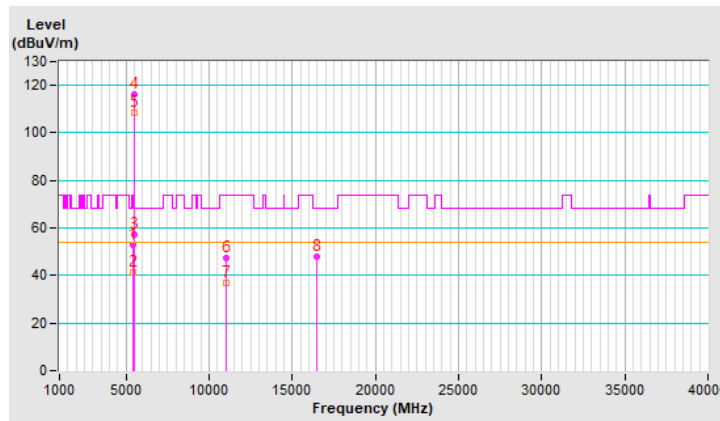

RF Mode	802.11ax (HE) 52-tone RU	Channel	CH 140 : 5700 MHz
Frequency Range	1 GHz ~ 40 GHz	Detector Function & Bandwidth	(PK) RB = 1 MHz, VB = 3 MHz (AV) RB = 1 MHz, VB = 3 kHz
Input Power (System)	120 Vac, 60 Hz	Environmental Conditions	24°C, 69% RH
Tested By	Tom Yang		

Antenna Polarity & Test Distance : Horizontal at 3 m								
No	Frequency (MHz)	Emission Level (dBuV/m)	Limit (dBuV/m)	Margin (dB)	Antenna Height (m)	Table Angle (Degree)	Raw Value (dBuV)	Correction Factor (dB/m)
1	*5700.00	121.1 PK			2.20 H	96	116.5	4.6
2	*5700.00	113.1 AV			2.20 H	96	108.5	4.6
3	#5725.00	67.6 PK	68.2	-0.6	2.20 H	96	62.9	4.7
4	11400.00	47.5 PK	74.0	-26.5	1.77 H	30	32.5	15.0
5	11400.00	38.5 AV	54.0	-15.5	1.77 H	30	23.5	15.0
6	#17100.00	46.8 PK	68.2	-21.4	1.78 H	326	27.8	19.0

Remarks:

1. Emission Level(dBuV/m) = Raw Value(dBuV) + Correction Factor(dB/m)
2. Correction Factor(dB/m) = Antenna Factor(dB/m) + Cable Factor(dB) – Pre-Amplifier Factor(dB)
3. Margin value = Emission Level – Limit value
4. The other emission levels were very low against the limit.
5. " * " : Fundamental frequency, the limit was restricted at the RF Output Power.
6. " # " : The radiated frequency is out of the restricted band.

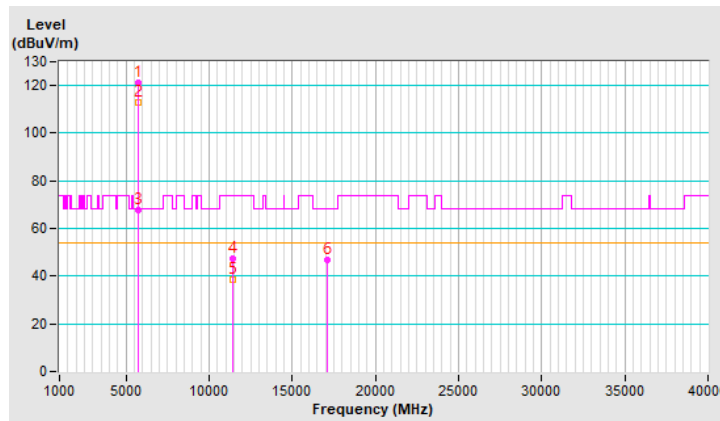

RF Mode	802.11ax (HE) 52-tone RU	Channel	CH 140 : 5700 MHz
Frequency Range	1 GHz ~ 40 GHz	Detector Function & Bandwidth	(PK) RB = 1 MHz, VB = 3 MHz (AV) RB = 1 MHz, VB = 3 kHz
Input Power (System)	120 Vac, 60 Hz	Environmental Conditions	24°C, 69% RH
Tested By	Tom Yang		

Antenna Polarity & Test Distance : Vertical at 3 m								
No	Frequency (MHz)	Emission Level (dBuV/m)	Limit (dBuV/m)	Margin (dB)	Antenna Height (m)	Table Angle (Degree)	Raw Value (dBuV)	Correction Factor (dB/m)
1	*5700.00	115.9 PK			2.07 V	46	111.3	4.6
2	*5700.00	106.8 AV			2.07 V	46	102.2	4.6
3	#5725.00	58.2 PK	68.2	-10.0	2.07 V	46	53.5	4.7
4	11400.00	47.0 PK	74.0	-27.0	2.78 V	215	32.0	15.0
5	11400.00	36.7 AV	54.0	-17.3	2.78 V	215	21.7	15.0
6	#17100.00	47.9 PK	68.2	-20.3	1.86 V	305	28.9	19.0

Remarks:

1. Emission Level(dBuV/m) = Raw Value(dBuV) + Correction Factor(dB/m)
2. Correction Factor(dB/m) = Antenna Factor(dB/m) + Cable Factor(dB) – Pre-Amplifier Factor(dB)
3. Margin value = Emission Level – Limit value
4. The other emission levels were very low against the limit.
5. " * " : Fundamental frequency, the limit was restricted at the RF Output Power.
6. " # " : The radiated frequency is out of the restricted band.

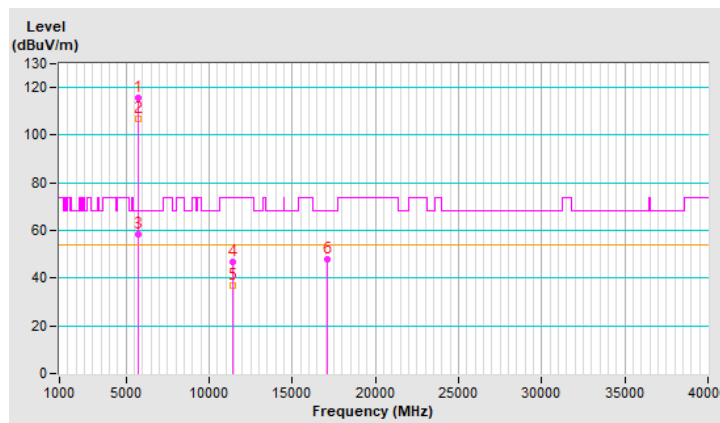

RF Mode	802.11ax (HE) 106-tone RU	Channel	CH 64 : 5320 MHz
Frequency Range	1 GHz ~ 40 GHz	Detector Function & Bandwidth	(PK) RB = 1 MHz, VB = 3 MHz (AV) RB = 1 MHz, VB = 3 kHz
Input Power (System)	120 Vac, 60 Hz	Environmental Conditions	24°C, 69% RH
Tested By	Tom Yang		

Antenna Polarity & Test Distance : Horizontal at 3 m								
No	Frequency (MHz)	Emission Level (dBuV/m)	Limit (dBuV/m)	Margin (dB)	Antenna Height (m)	Table Angle (Degree)	Raw Value (dBuV)	Correction Factor (dB/m)
1	*5320.00	121.1 PK			2.07 H	87	116.9	4.2
2	*5320.00	112.1 AV			2.07 H	87	107.9	4.2
3	5350.00	70.5 PK	74.0	-3.5	2.07 H	87	66.2	4.3
4	5350.00	53.8 AV	54.0	-0.2	2.07 H	87	49.5	4.3
5	10640.00	46.7 PK	74.0	-27.3	1.76 H	23	32.7	14.0
6	10640.00	35.6 AV	54.0	-18.4	1.76 H	23	21.6	14.0
7	15960.00	46.5 PK	74.0	-27.5	1.77 H	348	31.5	15.0
8	15960.00	35.3 AV	54.0	-18.7	1.77 H	348	20.3	15.0

Remarks:

1. Emission Level(dBuV/m) = Raw Value(dBuV) + Correction Factor(dB/m)
2. Correction Factor(dB/m) = Antenna Factor(dB/m) + Cable Factor(dB) – Pre-Amplifier Factor(dB)
3. Margin value = Emission Level – Limit value
4. The other emission levels were very low against the limit.
5. " * " : Fundamental frequency, the limit was restricted at the RF Output Power.

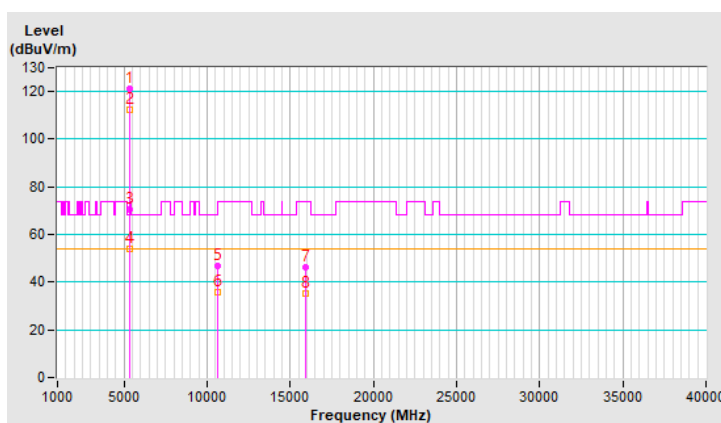

RF Mode	802.11ax (HE) 106-tone RU	Channel	CH 64 : 5320 MHz
Frequency Range	1 GHz ~ 40 GHz	Detector Function & Bandwidth	(PK) RB = 1 MHz, VB = 3 MHz (AV) RB = 1 MHz, VB = 3 kHz
Input Power (System)	120 Vac, 60 Hz	Environmental Conditions	24°C, 69% RH
Tested By	Tom Yang		

Antenna Polarity & Test Distance : Vertical at 3 m								
No	Frequency (MHz)	Emission Level (dBuV/m)	Limit (dBuV/m)	Margin (dB)	Antenna Height (m)	Table Angle (Degree)	Raw Value (dBuV)	Correction Factor (dB/m)
1	*5320.00	115.5 PK			2.05 V	37	111.3	4.2
2	*5320.00	106.8 AV			2.05 V	37	102.6	4.2
3	5350.00	57.8 PK	74.0	-16.2	2.05 V	37	53.5	4.3
4	5350.00	44.7 AV	54.0	-9.3	2.05 V	37	40.4	4.3
5	10640.00	44.6 PK	74.0	-29.4	2.69 V	188	30.6	14.0
6	10640.00	33.4 AV	54.0	-20.6	2.69 V	188	19.4	14.0
7	15960.00	46.9 PK	74.0	-27.1	1.87 V	303	31.9	15.0
8	15960.00	35.8 AV	54.0	-18.2	1.87 V	303	20.8	15.0

Remarks:

1. Emission Level(dBuV/m) = Raw Value(dBuV) + Correction Factor(dB/m)
2. Correction Factor(dB/m) = Antenna Factor(dB/m) + Cable Factor(dB) – Pre-Amplifier Factor(dB)
3. Margin value = Emission Level – Limit value
4. The other emission levels were very low against the limit.
5. " * " : Fundamental frequency, the limit was restricted at the RF Output Power.

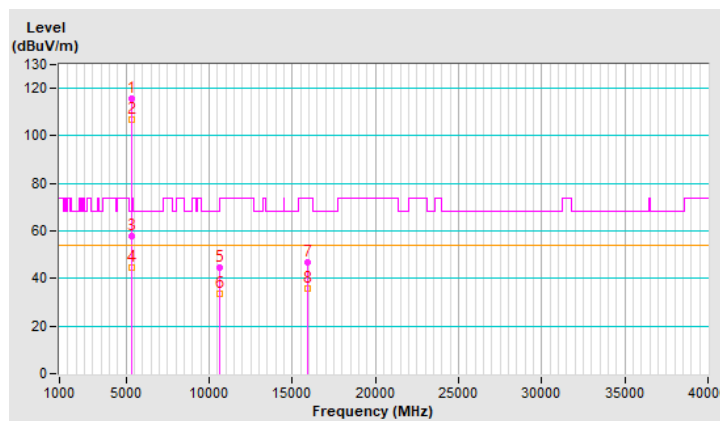

RF Mode	802.11ax (HE) 106-tone RU	Channel	CH 100 : 5500 MHz
Frequency Range	1 GHz ~ 40 GHz	Detector Function & Bandwidth	(PK) RB = 1 MHz, VB = 3 MHz (AV) RB = 1 MHz, VB = 3 kHz
Input Power (System)	120 Vac, 60 Hz	Environmental Conditions	24°C, 69% RH
Tested By	Tom Yang		

Antenna Polarity & Test Distance : Horizontal at 3 m								
No	Frequency (MHz)	Emission Level (dBuV/m)	Limit (dBuV/m)	Margin (dB)	Antenna Height (m)	Table Angle (Degree)	Raw Value (dBuV)	Correction Factor (dB/m)
1	5460.00	56.2 PK	74.0	-17.8	1.91 H	87	51.7	4.5
2	5460.00	43.1 AV	54.0	-10.9	1.91 H	87	38.6	4.5
3	#5468.20	67.7 PK	68.2	-0.5	1.91 H	87	63.2	4.5
4	*5500.00	118.0 PK			1.91 H	87	113.4	4.6
5	*5500.00	109.3 AV			1.91 H	87	104.7	4.6
6	11000.00	46.3 PK	74.0	-27.7	1.77 H	22	31.3	15.0
7	11000.00	35.3 AV	54.0	-18.7	1.77 H	22	20.3	15.0
8	#16500.00	46.4 PK	68.2	-21.8	1.75 H	360	29.2	17.2

Remarks:

1. Emission Level(dBuV/m) = Raw Value(dBuV) + Correction Factor(dB/m)
2. Correction Factor(dB/m) = Antenna Factor(dB/m) + Cable Factor(dB) – Pre-Amplifier Factor(dB)
3. Margin value = Emission Level – Limit value
4. The other emission levels were very low against the limit.
5. " * " : Fundamental frequency, the limit was restricted at the RF Output Power.
6. " # " : The radiated frequency is out of the restricted band.

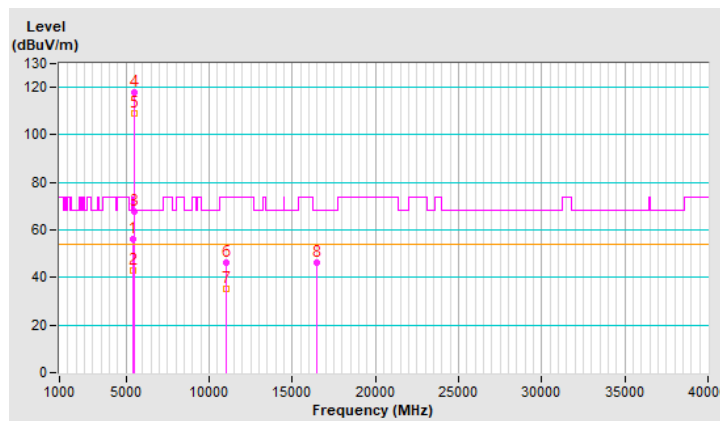

RF Mode	802.11ax (HE) 106-tone RU	Channel	CH 100 : 5500 MHz
Frequency Range	1 GHz ~ 40 GHz	Detector Function & Bandwidth	(PK) RB = 1 MHz, VB = 3 MHz (AV) RB = 1 MHz, VB = 3 kHz
Input Power (System)	120 Vac, 60 Hz	Environmental Conditions	24°C, 69% RH
Tested By	Tom Yang		

Antenna Polarity & Test Distance : Vertical at 3 m								
No	Frequency (MHz)	Emission Level (dBuV/m)	Limit (dBuV/m)	Margin (dB)	Antenna Height (m)	Table Angle (Degree)	Raw Value (dBuV)	Correction Factor (dB/m)
1	5460.00	52.3 PK	74.0	-21.7	2.11 V	33	47.8	4.5
2	5460.00	42.2 AV	54.0	-11.8	2.11 V	33	37.7	4.5
3	#5466.40	60.1 PK	68.2	-8.1	2.11 V	33	55.6	4.5
4	*5500.00	116.3 PK			2.11 V	33	111.7	4.6
5	*5500.00	106.2 AV			2.11 V	33	101.6	4.6
6	11000.00	44.3 PK	74.0	-29.7	2.69 V	204	29.3	15.0
7	11000.00	33.0 AV	54.0	-21.0	2.69 V	204	18.0	15.0
8	#16500.00	47.2 PK	68.2	-21.0	1.86 V	297	30.0	17.2

Remarks:

1. Emission Level(dBuV/m) = Raw Value(dBuV) + Correction Factor(dB/m)
2. Correction Factor(dB/m) = Antenna Factor(dB/m) + Cable Factor(dB) – Pre-Amplifier Factor(dB)
3. Margin value = Emission Level – Limit value
4. The other emission levels were very low against the limit.
5. " * " : Fundamental frequency, the limit was restricted at the RF Output Power.
6. " # " : The radiated frequency is out of the restricted band.

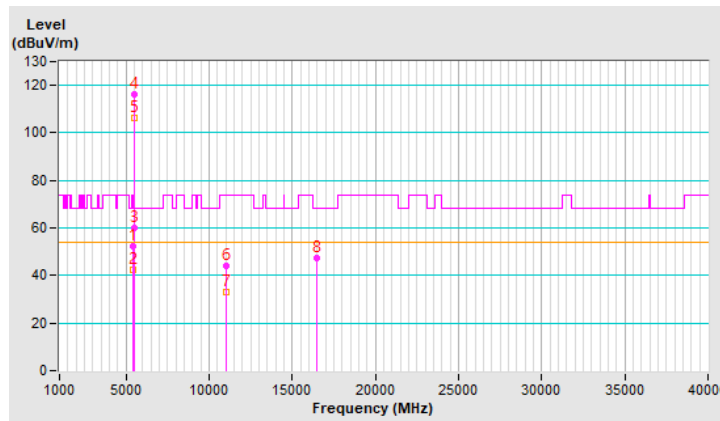

RF Mode	802.11ax (HE) 106-tone RU	Channel	CH 140 : 5700 MHz
Frequency Range	1 GHz ~ 40 GHz	Detector Function & Bandwidth	(PK) RB = 1 MHz, VB = 3 MHz (AV) RB = 1 MHz, VB = 3 kHz
Input Power (System)	120 Vac, 60 Hz	Environmental Conditions	24°C, 69% RH
Tested By	Tom Yang		

Antenna Polarity & Test Distance : Horizontal at 3 m								
No	Frequency (MHz)	Emission Level (dBuV/m)	Limit (dBuV/m)	Margin (dB)	Antenna Height (m)	Table Angle (Degree)	Raw Value (dBuV)	Correction Factor (dB/m)
1	*5700.00	120.0 PK			2.10 H	85	115.4	4.6
2	*5700.00	109.3 AV			2.10 H	85	104.7	4.6
3	#5725.00	67.9 PK	68.2	-0.3	2.10 H	85	63.2	4.7
4	11400.00	46.7 PK	74.0	-27.3	1.79 H	28	31.7	15.0
5	11400.00	35.7 AV	54.0	-18.3	1.79 H	28	20.7	15.0
6	#17100.00	46.2 PK	68.2	-22.0	1.77 H	342	27.2	19.0

Remarks:

1. Emission Level(dBuV/m) = Raw Value(dBuV) + Correction Factor(dB/m)
2. Correction Factor(dB/m) = Antenna Factor(dB/m) + Cable Factor(dB) – Pre-Amplifier Factor(dB)
3. Margin value = Emission Level – Limit value
4. The other emission levels were very low against the limit.
5. " * " : Fundamental frequency, the limit was restricted at the RF Output Power.
6. " # " : The radiated frequency is out of the restricted band.

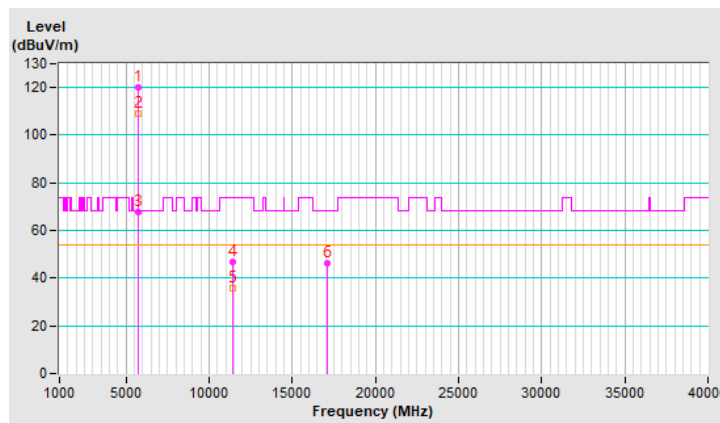

RF Mode	802.11ax (HE) 106-tone RU	Channel	CH 140 : 5700 MHz
Frequency Range	1 GHz ~ 40 GHz	Detector Function & Bandwidth	(PK) RB = 1 MHz, VB = 3 MHz (AV) RB = 1 MHz, VB = 3 kHz
Input Power (System)	120 Vac, 60 Hz	Environmental Conditions	24°C, 69% RH
Tested By	Tom Yang		

Antenna Polarity & Test Distance : Vertical at 3 m								
No	Frequency (MHz)	Emission Level (dBUV/m)	Limit (dBUV/m)	Margin (dB)	Antenna Height (m)	Table Angle (Degree)	Raw Value (dBUV)	Correction Factor (dB/m)
1	*5700.00	114.9 PK			2.06 V	43	110.3	4.6
2	*5700.00	104.9 AV			2.06 V	43	100.3	4.6
3	#5725.00	59.7 PK	68.2	-8.5	2.06 V	43	55.0	4.7
4	11400.00	44.6 PK	74.0	-29.4	2.74 V	192	29.6	15.0
5	11400.00	33.3 AV	54.0	-20.7	2.74 V	192	18.3	15.0
6	#17100.00	47.1 PK	68.2	-21.1	1.87 V	309	28.1	19.0

Remarks:

1. Emission Level(dBUV/m) = Raw Value(dBUV) + Correction Factor(dB/m)
2. Correction Factor(dB/m) = Antenna Factor(dB/m) + Cable Factor(dB) – Pre-Amplifier Factor(dB)
3. Margin value = Emission Level – Limit value
4. The other emission levels were very low against the limit.
5. " * " : Fundamental frequency, the limit was restricted at the RF Output Power.
6. " # " : The radiated frequency is out of the restricted band.

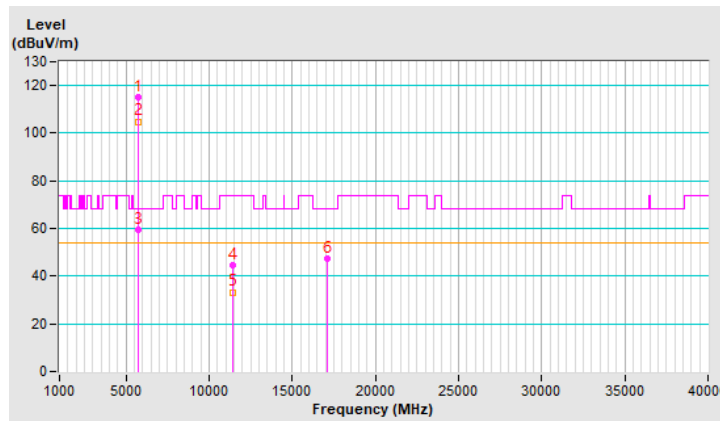

RF Mode	802.11be (EHT) 26-tone RU	Channel	CH 36 : 5180 MHz
Frequency Range	1 GHz ~ 40 GHz	Detector Function & Bandwidth	(PK) RB = 1 MHz, VB = 3 MHz (AV) RB = 1 MHz, VB = 2 kHz
Input Power (System)	120 Vac, 60 Hz	Environmental Conditions	24°C, 69% RH
Tested By	Tom Yang		

Antenna Polarity & Test Distance : Horizontal at 3 m								
No	Frequency (MHz)	Emission Level (dBuV/m)	Limit (dBuV/m)	Margin (dB)	Antenna Height (m)	Table Angle (Degree)	Raw Value (dBuV)	Correction Factor (dB/m)
1	5150.00	71.8 PK	74.0	-2.2	2.04 H	99	67.3	4.5
2	5150.00	53.5 AV	54.0	-0.5	2.04 H	99	49.0	4.5
3	*5180.00	124.4 PK			2.04 H	99	120.0	4.4
4	*5180.00	117.3 AV			2.04 H	99	112.9	4.4
5	#10360.00	49.1 PK	68.2	-19.1	1.79 H	54	35.0	14.1
6	15540.00	49.2 PK	74.0	-24.8	1.76 H	329	34.5	14.7
7	15540.00	39.3 AV	54.0	-14.7	1.76 H	329	24.6	14.7

Remarks:

1. Emission Level(dBuV/m) = Raw Value(dBuV) + Correction Factor(dB/m)
2. Correction Factor(dB/m) = Antenna Factor(dB/m) + Cable Factor(dB) – Pre-Amplifier Factor(dB)
3. Margin value = Emission Level – Limit value
4. The other emission levels were very low against the limit.
5. " * " : Fundamental frequency, the limit was restricted at the RF Output Power.
6. " # " : The radiated frequency is out of the restricted band.

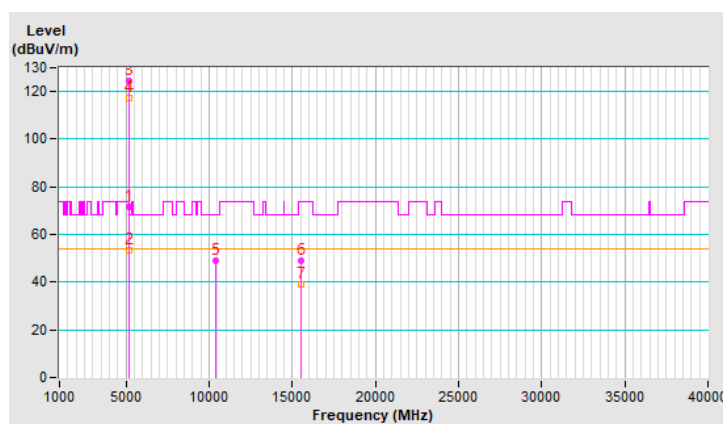

RF Mode	802.11be (EHT) 26-tone RU	Channel	CH 36 : 5180 MHz
Frequency Range	1 GHz ~ 40 GHz	Detector Function & Bandwidth	(PK) RB = 1 MHz, VB = 3 MHz (AV) RB = 1 MHz, VB = 2 kHz
Input Power (System)	120 Vac, 60 Hz	Environmental Conditions	24°C, 69% RH
Tested By	Tom Yang		

Antenna Polarity & Test Distance : Vertical at 3 m								
No	Frequency (MHz)	Emission Level (dBuV/m)	Limit (dBuV/m)	Margin (dB)	Antenna Height (m)	Table Angle (Degree)	Raw Value (dBuV)	Correction Factor (dB/m)
1	5150.00	64.1 PK	74.0	-9.9	2.01 V	147	59.6	4.5
2	5150.00	48.1 AV	54.0	-5.9	2.01 V	147	43.6	4.5
3	*5180.00	121.9 PK			2.01 V	147	117.5	4.4
4	*5180.00	113.1 AV			2.01 V	147	108.7	4.4
5	#10360.00	47.6 PK	68.2	-20.6	2.67 V	190	33.5	14.1
6	15540.00	47.5 PK	74.0	-26.5	1.89 V	331	32.8	14.7
7	15540.00	38.3 AV	54.0	-15.7	1.89 V	331	23.6	14.7

Remarks:

1. Emission Level(dBuV/m) = Raw Value(dBuV) + Correction Factor(dB/m)
2. Correction Factor(dB/m) = Antenna Factor(dB/m) + Cable Factor(dB) – Pre-Amplifier Factor(dB)
3. Margin value = Emission Level – Limit value
4. The other emission levels were very low against the limit.
5. " * " : Fundamental frequency, the limit was restricted at the RF Output Power.
6. " # " : The radiated frequency is out of the restricted band.

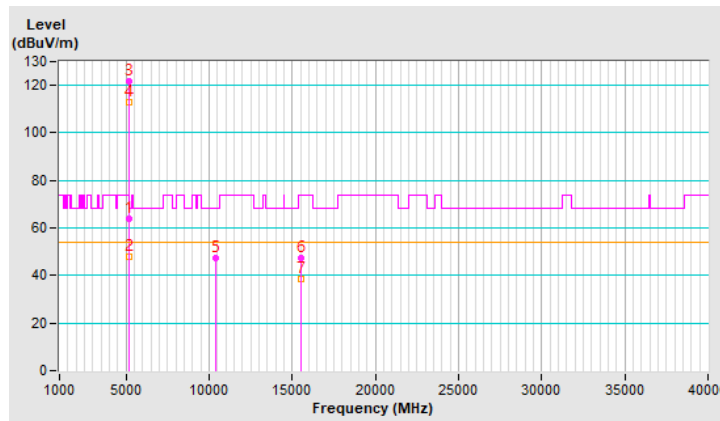

RF Mode	802.11be (EHT) 26-tone RU	Channel	CH 149 : 5745 MHz
Frequency Range	1 GHz ~ 40 GHz	Detector Function & Bandwidth	(PK) RB = 1 MHz, VB = 3 MHz (AV) RB = 1 MHz, VB = 2 kHz
Input Power (System)	120 Vac, 60 Hz	Environmental Conditions	24°C, 69% RH
Tested By	Tom Yang		

Antenna Polarity & Test Distance : Horizontal at 3 m								
No	Frequency (MHz)	Emission Level (dBuV/m)	Limit (dBuV/m)	Margin (dB)	Antenna Height (m)	Table Angle (Degree)	Raw Value (dBuV)	Correction Factor (dB/m)
1	#5646.90	58.8 PK	68.2	-9.4	2.01 H	77	54.0	4.8
2	*5745.00	125.2 PK			2.01 H	77	120.5	4.7
3	*5745.00	120.2 AV			2.01 H	77	115.5	4.7
4	#6012.20	54.1 PK	68.2	-14.1	2.01 H	77	48.9	5.2
5	11490.00	63.2 PK	74.0	-10.8	1.84 H	91	48.2	15.0
6	11490.00	52.2 AV	54.0	-1.8	1.84 H	91	37.2	15.0
7	#17235.00	53.6 PK	68.2	-14.6	1.43 H	183	34.7	18.9

Remarks:

1. Emission Level(dBuV/m) = Raw Value(dBuV) + Correction Factor(dB/m)
2. Correction Factor(dB/m) = Antenna Factor(dB/m) + Cable Factor(dB) – Pre-Amplifier Factor(dB)
3. Margin value = Emission Level – Limit value
4. The other emission levels were very low against the limit.
5. " * " : Fundamental frequency, the limit was restricted at the RF Output Power.
6. " # " : The radiated frequency is out of the restricted band.

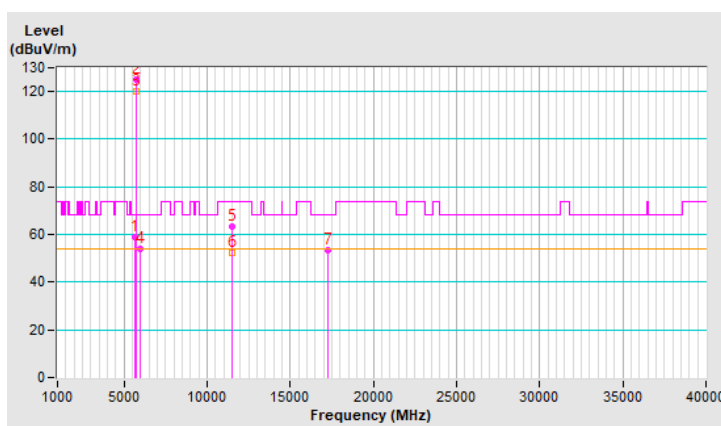

RF Mode	802.11be (EHT) 26-tone RU	Channel	CH 149 : 5745 MHz
Frequency Range	1 GHz ~ 40 GHz	Detector Function & Bandwidth	(PK) RB = 1 MHz, VB = 3 MHz (AV) RB = 1 MHz, VB = 2 kHz
Input Power (System)	120 Vac, 60 Hz	Environmental Conditions	24°C, 69% RH
Tested By	Tom Yang		

Antenna Polarity & Test Distance : Vertical at 3 m								
No	Frequency (MHz)	Emission Level (dBuV/m)	Limit (dBuV/m)	Margin (dB)	Antenna Height (m)	Table Angle (Degree)	Raw Value (dBuV)	Correction Factor (dB/m)
1	#5593.70	54.7 PK	68.2	-13.5	1.87 V	159	50.3	4.4
2	*5745.00	122.2 PK			1.87 V	159	117.5	4.7
3	*5745.00	116.0 AV			1.87 V	159	111.3	4.7
4	#5949.50	51.6 PK	68.2	-16.6	1.87 V	159	46.4	5.2
5	11490.00	64.9 PK	74.0	-9.1	2.68 V	109	49.9	15.0
6	11490.00	53.9 AV	54.0	-0.1	2.68 V	109	38.9	15.0
7	#17235.00	53.6 PK	68.2	-14.6	1.53 V	208	34.7	18.9

Remarks:

1. Emission Level(dBuV/m) = Raw Value(dBuV) + Correction Factor(dB/m)
2. Correction Factor(dB/m) = Antenna Factor(dB/m) + Cable Factor(dB) – Pre-Amplifier Factor(dB)
3. Margin value = Emission Level – Limit value
4. The other emission levels were very low against the limit.
5. " * " : Fundamental frequency, the limit was restricted at the RF Output Power.
6. " # " : The radiated frequency is out of the restricted band.

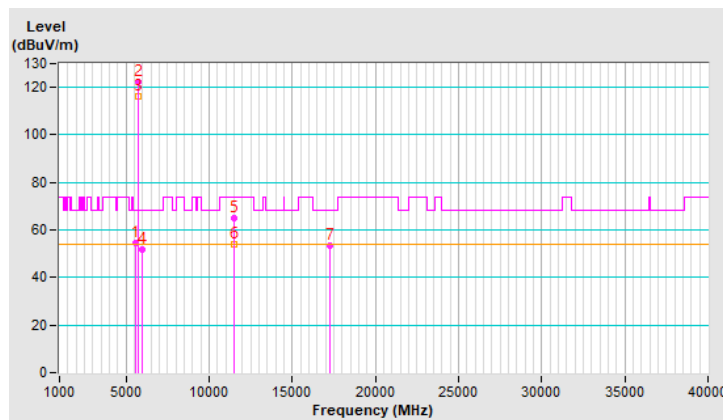

RF Mode	802.11be (EHT) 26-tone RU	Channel	CH 165 : 5825 MHz
Frequency Range	1 GHz ~ 40 GHz	Detector Function & Bandwidth	(PK) RB = 1 MHz, VB = 3 MHz (AV) RB = 1 MHz, VB = 2 kHz
Input Power (System)	120 Vac, 60 Hz	Environmental Conditions	24°C, 69% RH
Tested By	Tom Yang		

Antenna Polarity & Test Distance : Horizontal at 3 m								
No	Frequency (MHz)	Emission Level (dBuV/m)	Limit (dBuV/m)	Margin (dB)	Antenna Height (m)	Table Angle (Degree)	Raw Value (dBuV)	Correction Factor (dB/m)
1	#5641.50	54.6 PK	68.2	-13.6	2.07 H	81	49.9	4.7
2	*5825.00	125.9 PK			2.07 H	81	120.8	5.1
3	*5825.00	121.2 AV			2.07 H	81	116.1	5.1
4	#5947.31	56.8 PK	68.2	-11.4	2.07 H	81	51.6	5.2
5	11650.00	61.6 PK	74.0	-12.4	1.72 H	95	46.7	14.9
6	11650.00	52.0 AV	54.0	-2.0	1.72 H	95	37.1	14.9
7	#17475.00	53.0 PK	68.2	-15.2	1.51 H	177	33.0	20.0

Remarks:

1. Emission Level(dBuV/m) = Raw Value(dBuV) + Correction Factor(dB/m)
2. Correction Factor(dB/m) = Antenna Factor(dB/m) + Cable Factor(dB) – Pre-Amplifier Factor(dB)
3. Margin value = Emission Level – Limit value
4. The other emission levels were very low against the limit.
5. " * " : Fundamental frequency, the limit was restricted at the RF Output Power.
6. " # " : The radiated frequency is out of the restricted band.

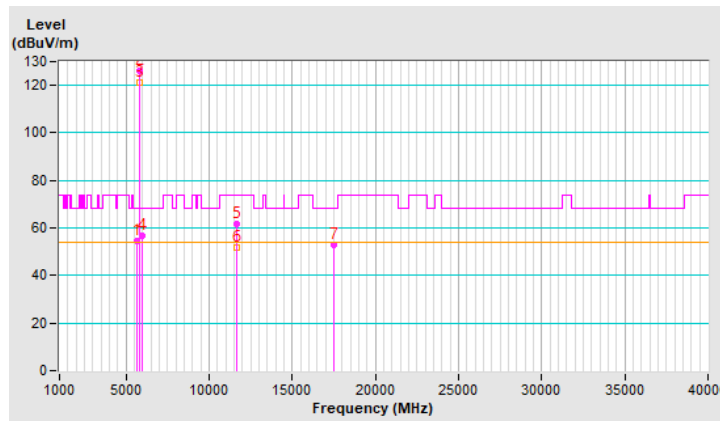

RF Mode	802.11be (EHT) 26-tone RU	Channel	CH 165 : 5825 MHz
Frequency Range	1 GHz ~ 40 GHz	Detector Function & Bandwidth	(PK) RB = 1 MHz, VB = 3 MHz (AV) RB = 1 MHz, VB = 2 kHz
Input Power (System)	120 Vac, 60 Hz	Environmental Conditions	24°C, 69% RH
Tested By	Tom Yang		

Antenna Polarity & Test Distance : Vertical at 3 m								
No	Frequency (MHz)	Emission Level (dBuV/m)	Limit (dBuV/m)	Margin (dB)	Antenna Height (m)	Table Angle (Degree)	Raw Value (dBuV)	Correction Factor (dB/m)
1	#5648.10	52.4 PK	68.2	-15.8	1.96 V	39	47.6	4.8
2	*5825.00	121.0 PK			1.96 V	39	115.9	5.1
3	*5825.00	115.7 AV			1.96 V	39	110.6	5.1
4	#5990.34	52.5 PK	68.2	-15.7	1.96 V	39	47.3	5.2
5	11650.00	62.7 PK	74.0	-11.3	2.58 V	98	47.8	14.9
6	11650.00	52.8 AV	54.0	-1.2	2.58 V	98	37.9	14.9
7	#17475.00	52.9 PK	68.2	-15.3	1.66 V	204	32.9	20.0

Remarks:

1. Emission Level(dBuV/m) = Raw Value(dBuV) + Correction Factor(dB/m)
2. Correction Factor(dB/m) = Antenna Factor(dB/m) + Cable Factor(dB) – Pre-Amplifier Factor(dB)
3. Margin value = Emission Level – Limit value
4. The other emission levels were very low against the limit.
5. " * " : Fundamental frequency, the limit was restricted at the RF Output Power.
6. " # " : The radiated frequency is out of the restricted band.

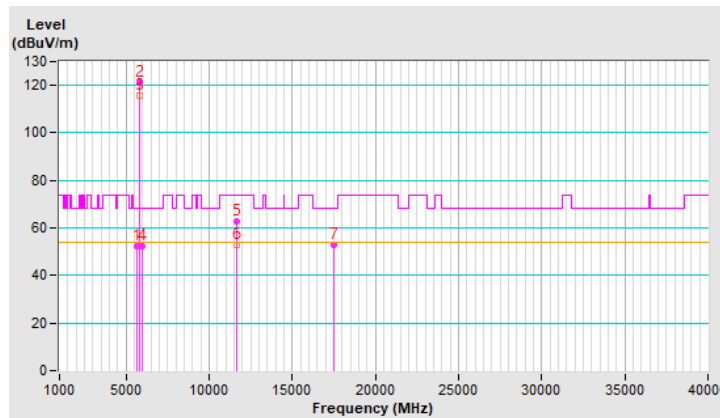

RF Mode	802.11be (EHT) 52-tone RU	Channel	CH 36 : 5180 MHz
Frequency Range	1 GHz ~ 40 GHz	Detector Function & Bandwidth	(PK) RB = 1 MHz, VB = 3 MHz (AV) RB = 1 MHz, VB = 3 kHz
Input Power (System)	120 Vac, 60 Hz	Environmental Conditions	24°C, 69% RH
Tested By	Tom Yang		

Antenna Polarity & Test Distance : Horizontal at 3 m								
No	Frequency (MHz)	Emission Level (dBUV/m)	Limit (dBUV/m)	Margin (dB)	Antenna Height (m)	Table Angle (Degree)	Raw Value (dBUV)	Correction Factor (dB/m)
1	5150.00	73.0 PK	74.0	-1.0	2.11 H	91	68.5	4.5
2	5150.00	53.9 AV	54.0	-0.1	2.11 H	91	49.4	4.5
3	*5180.00	123.1 PK			2.11 H	91	118.7	4.4
4	*5180.00	115.1 AV			2.11 H	91	110.7	4.4
5	#10360.00	47.3 PK	68.2	-20.9	1.84 H	42	33.2	14.1
6	15540.00	47.4 PK	74.0	-26.6	1.77 H	317	32.7	14.7
7	15540.00	36.6 AV	54.0	-17.4	1.77 H	317	21.9	14.7

Remarks:

1. Emission Level(dBUV/m) = Raw Value(dBUV) + Correction Factor(dB/m)
2. Correction Factor(dB/m) = Antenna Factor(dB/m) + Cable Factor(dB) – Pre-Amplifier Factor(dB)
3. Margin value = Emission Level – Limit value
4. The other emission levels were very low against the limit.
5. " * " : Fundamental frequency, the limit was restricted at the RF Output Power.
6. " # " : The radiated frequency is out of the restricted band.

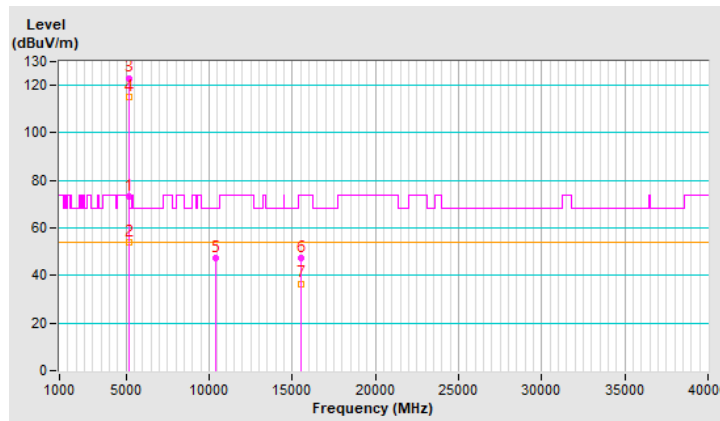

RF Mode	802.11be (EHT) 52-tone RU	Channel	CH 36 : 5180 MHz
Frequency Range	1 GHz ~ 40 GHz	Detector Function & Bandwidth	(PK) RB = 1 MHz, VB = 3 MHz (AV) RB = 1 MHz, VB = 3 kHz
Input Power (System)	120 Vac, 60 Hz	Environmental Conditions	24°C, 69% RH
Tested By	Tom Yang		

Antenna Polarity & Test Distance : Vertical at 3 m								
No	Frequency (MHz)	Emission Level (dBuV/m)	Limit (dBuV/m)	Margin (dB)	Antenna Height (m)	Table Angle (Degree)	Raw Value (dBuV)	Correction Factor (dB/m)
1	5148.20	66.9 PK	74.0	-7.1	1.92 V	155	62.4	4.5
2	5148.20	47.0 AV	54.0	-7.0	1.92 V	155	42.5	4.5
3	*5180.00	119.4 PK			1.92 V	155	115.0	4.4
4	*5180.00	110.8 AV			1.92 V	155	106.4	4.4
5	#10360.00	46.5 PK	68.2	-21.7	2.75 V	194	32.4	14.1
6	15540.00	46.8 PK	74.0	-27.2	1.97 V	301	32.1	14.7
7	15540.00	35.5 AV	54.0	-18.5	1.97 V	301	20.8	14.7

Remarks:

1. Emission Level(dBuV/m) = Raw Value(dBuV) + Correction Factor(dB/m)
2. Correction Factor(dB/m) = Antenna Factor(dB/m) + Cable Factor(dB) – Pre-Amplifier Factor(dB)
3. Margin value = Emission Level – Limit value
4. The other emission levels were very low against the limit.
5. " * " : Fundamental frequency, the limit was restricted at the RF Output Power.
6. " # " : The radiated frequency is out of the restricted band.

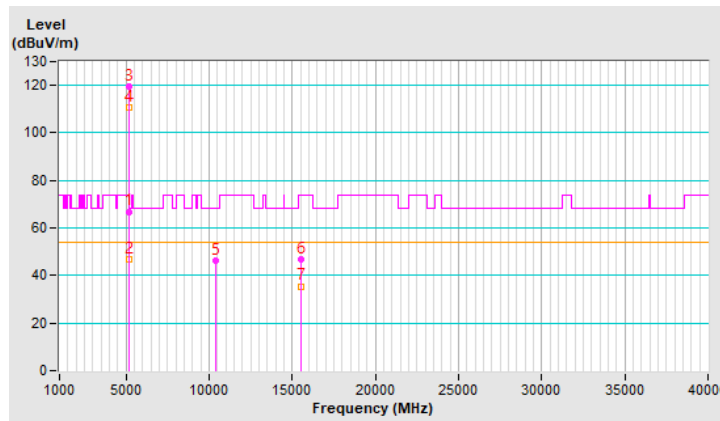

RF Mode	802.11be (EHT) 52-tone RU	Channel	CH 149 : 5745 MHz
Frequency Range	1 GHz ~ 40 GHz	Detector Function & Bandwidth	(PK) RB = 1 MHz, VB = 3 MHz (AV) RB = 1 MHz, VB = 3 kHz
Input Power (System)	120 Vac, 60 Hz	Environmental Conditions	24°C, 69% RH
Tested By	Tom Yang		

Antenna Polarity & Test Distance : Horizontal at 3 m								
No	Frequency (MHz)	Emission Level (dBuV/m)	Limit (dBuV/m)	Margin (dB)	Antenna Height (m)	Table Angle (Degree)	Raw Value (dBuV)	Correction Factor (dB/m)
1	#5640.24	57.7 PK	68.2	-10.5	2.14 H	97	53.0	4.7
2	*5745.00	125.1 PK			2.14 H	97	120.4	4.7
3	*5745.00	118.9 AV			2.14 H	97	114.2	4.7
4	#5993.70	53.5 PK	68.2	-14.7	2.14 H	97	48.3	5.2
5	11490.00	63.5 PK	74.0	-10.5	1.80 H	88	48.5	15.0
6	11490.00	52.4 AV	54.0	-1.6	1.80 H	88	37.4	15.0
7	#17235.00	52.3 PK	68.2	-15.9	1.48 H	167	33.4	18.9

Remarks:

1. Emission Level(dBuV/m) = Raw Value(dBuV) + Correction Factor(dB/m)
2. Correction Factor(dB/m) = Antenna Factor(dB/m) + Cable Factor(dB) – Pre-Amplifier Factor(dB)
3. Margin value = Emission Level – Limit value
4. The other emission levels were very low against the limit.
5. " * " : Fundamental frequency, the limit was restricted at the RF Output Power.
6. " # " : The radiated frequency is out of the restricted band.

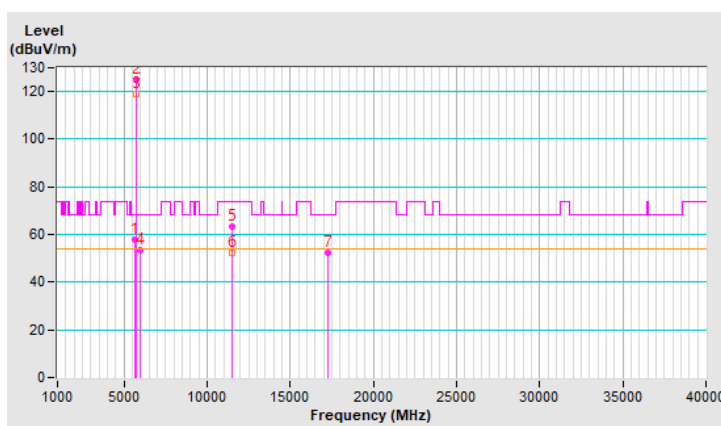

RF Mode	802.11be (EHT) 52-tone RU	Channel	CH 149 : 5745 MHz
Frequency Range	1 GHz ~ 40 GHz	Detector Function & Bandwidth	(PK) RB = 1 MHz, VB = 3 MHz (AV) RB = 1 MHz, VB = 3 kHz
Input Power (System)	120 Vac, 60 Hz	Environmental Conditions	24°C, 69% RH
Tested By	Tom Yang		

Antenna Polarity & Test Distance : Vertical at 3 m								
No	Frequency (MHz)	Emission Level (dBuV/m)	Limit (dBuV/m)	Margin (dB)	Antenna Height (m)	Table Angle (Degree)	Raw Value (dBuV)	Correction Factor (dB/m)
1	#5645.20	55.0 PK	68.2	-13.2	1.88 V	155	50.2	4.8
2	*5745.00	120.9 PK			1.88 V	155	116.2	4.7
3	*5745.00	113.0 AV			1.88 V	155	108.3	4.7
4	#5994.00	51.5 PK	68.2	-16.7	1.88 V	155	46.3	5.2
5	11490.00	63.3 PK	74.0	-10.7	2.55 V	101	48.3	15.0
6	11490.00	53.8 AV	54.0	-0.2	2.55 V	101	38.8	15.0
7	#17235.00	52.6 PK	68.2	-15.6	1.61 V	198	33.7	18.9

Remarks:

1. Emission Level(dBuV/m) = Raw Value(dBuV) + Correction Factor(dB/m)
2. Correction Factor(dB/m) = Antenna Factor(dB/m) + Cable Factor(dB) – Pre-Amplifier Factor(dB)
3. Margin value = Emission Level – Limit value
4. The other emission levels were very low against the limit.
5. " * " : Fundamental frequency, the limit was restricted at the RF Output Power.
6. " # " : The radiated frequency is out of the restricted band.

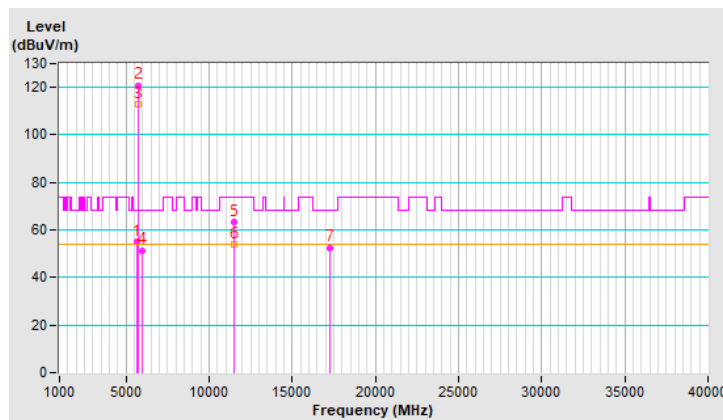

RF Mode	802.11be (EHT) 52-tone RU	Channel	CH 165 : 5825 MHz
Frequency Range	1 GHz ~ 40 GHz	Detector Function & Bandwidth	(PK) RB = 1 MHz, VB = 3 MHz (AV) RB = 1 MHz, VB = 3 kHz
Input Power (System)	120 Vac, 60 Hz	Environmental Conditions	24°C, 69% RH
Tested By	Tom Yang		

Antenna Polarity & Test Distance : Horizontal at 3 m								
No	Frequency (MHz)	Emission Level (dBuV/m)	Limit (dBuV/m)	Margin (dB)	Antenna Height (m)	Table Angle (Degree)	Raw Value (dBuV)	Correction Factor (dB/m)
1	#5611.90	54.7 PK	68.2	-13.5	2.02 H	77	50.1	4.6
2	*5825.00	125.2 PK			2.02 H	77	120.1	5.1
3	*5825.00	118.4 AV			2.02 H	77	113.3	5.1
4	#5939.10	57.0 PK	68.2	-11.2	2.02 H	77	51.9	5.1
5	11650.00	61.5 PK	74.0	-12.5	1.72 H	79	46.6	14.9
6	11650.00	51.9 AV	54.0	-2.1	1.72 H	79	37.0	14.9
7	#17475.00	51.7 PK	68.2	-16.5	1.51 H	176	31.7	20.0

Remarks:

1. Emission Level(dBuV/m) = Raw Value(dBuV) + Correction Factor(dB/m)
2. Correction Factor(dB/m) = Antenna Factor(dB/m) + Cable Factor(dB) – Pre-Amplifier Factor(dB)
3. Margin value = Emission Level – Limit value
4. The other emission levels were very low against the limit.
5. " * " : Fundamental frequency, the limit was restricted at the RF Output Power.
6. " # " : The radiated frequency is out of the restricted band.

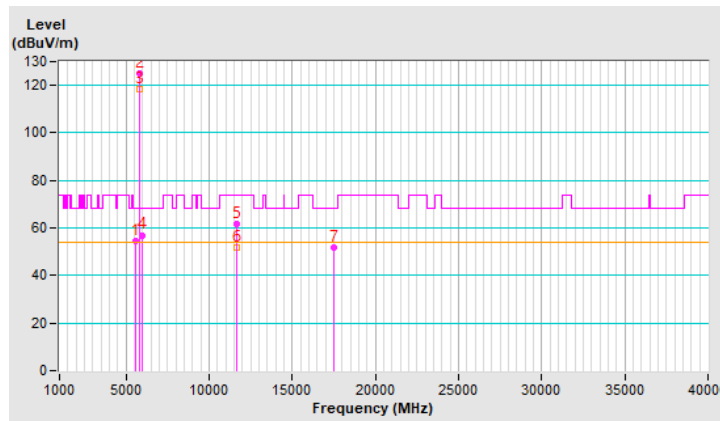

RF Mode	802.11be (EHT) 52-tone RU	Channel	CH 165 : 5825 MHz
Frequency Range	1 GHz ~ 40 GHz	Detector Function & Bandwidth	(PK) RB = 1 MHz, VB = 3 MHz (AV) RB = 1 MHz, VB = 3 kHz
Input Power (System)	120 Vac, 60 Hz	Environmental Conditions	24°C, 69% RH
Tested By	Tom Yang		

Antenna Polarity & Test Distance : Vertical at 3 m								
No	Frequency (MHz)	Emission Level (dBuV/m)	Limit (dBuV/m)	Margin (dB)	Antenna Height (m)	Table Angle (Degree)	Raw Value (dBuV)	Correction Factor (dB/m)
1	#5645.50	53.0 PK	68.2	-15.2	1.91 V	47	48.2	4.8
2	*5825.00	121.2 PK			1.91 V	47	116.1	5.1
3	*5825.00	113.4 AV			1.91 V	47	108.3	5.1
4	#5964.30	52.8 PK	68.2	-15.4	1.91 V	47	47.6	5.2
5	11650.00	60.4 PK	74.0	-13.6	2.46 V	97	45.5	14.9
6	11650.00	52.3 AV	54.0	-1.7	2.46 V	97	37.4	14.9
7	#17475.00	52.5 PK	68.2	-15.7	1.71 V	240	32.5	20.0

Remarks:

1. Emission Level(dBuV/m) = Raw Value(dBuV) + Correction Factor(dB/m)
2. Correction Factor(dB/m) = Antenna Factor(dB/m) + Cable Factor(dB) – Pre-Amplifier Factor(dB)
3. Margin value = Emission Level – Limit value
4. The other emission levels were very low against the limit.
5. " * " : Fundamental frequency, the limit was restricted at the RF Output Power.
6. " # " : The radiated frequency is out of the restricted band.

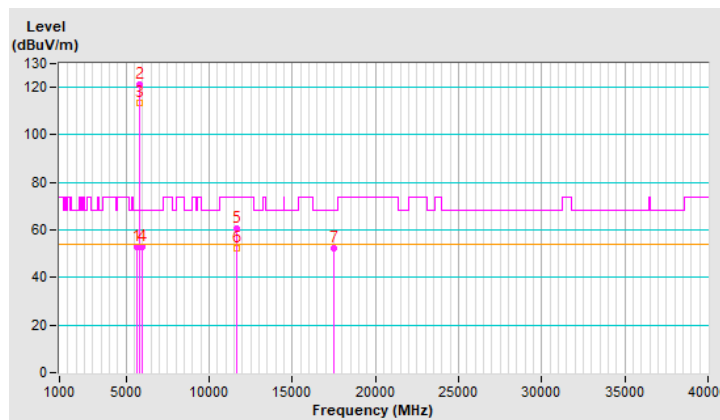

RF Mode	802.11be (EHT) 106-tone RU	Channel	CH 36 : 5180 MHz
Frequency Range	1 GHz ~ 40 GHz	Detector Function & Bandwidth	(PK) RB = 1 MHz, VB = 3 MHz (AV) RB = 1 MHz, VB = 3 kHz
Input Power (System)	120 Vac, 60 Hz	Environmental Conditions	24°C, 69% RH
Tested By	Tom Yang		

Antenna Polarity & Test Distance : Horizontal at 3 m								
No	Frequency (MHz)	Emission Level (dBuV/m)	Limit (dBuV/m)	Margin (dB)	Antenna Height (m)	Table Angle (Degree)	Raw Value (dBuV)	Correction Factor (dB/m)
1	5150.00	72.0 PK	74.0	-2.0	2.00 H	90	67.5	4.5
2	5150.00	53.9 AV	54.0	-0.1	2.00 H	90	49.4	4.5
3	*5180.00	120.8 PK			2.00 H	90	116.4	4.4
4	*5180.00	112.4 AV			2.00 H	90	108.0	4.4
5	#10360.00	45.2 PK	68.2	-23.0	1.83 H	34	31.1	14.1
6	15540.00	47.1 PK	74.0	-26.9	1.82 H	340	32.4	14.7
7	15540.00	36.1 AV	54.0	-17.9	1.82 H	340	21.4	14.7

Remarks:

1. Emission Level(dBuV/m) = Raw Value(dBuV) + Correction Factor(dB/m)
2. Correction Factor(dB/m) = Antenna Factor(dB/m) + Cable Factor(dB) – Pre-Amplifier Factor(dB)
3. Margin value = Emission Level – Limit value
4. The other emission levels were very low against the limit.
5. " * " : Fundamental frequency, the limit was restricted at the RF Output Power.
6. " # " : The radiated frequency is out of the restricted band.

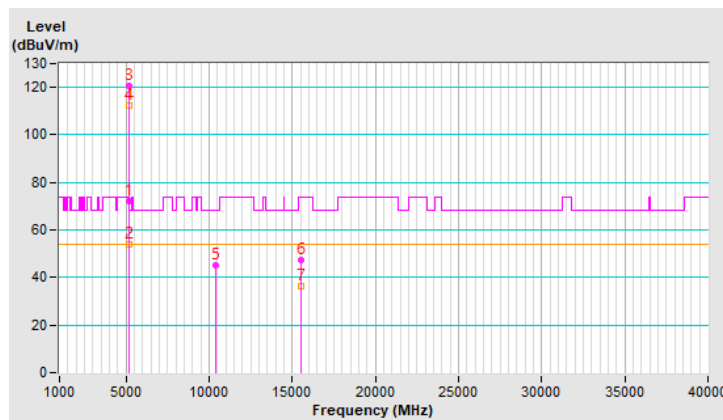

RF Mode	802.11be (EHT) 106-tone RU	Channel	CH 36 : 5180 MHz
Frequency Range	1 GHz ~ 40 GHz	Detector Function & Bandwidth	(PK) RB = 1 MHz, VB = 3 MHz (AV) RB = 1 MHz, VB = 3 kHz
Input Power (System)	120 Vac, 60 Hz	Environmental Conditions	24°C, 69% RH
Tested By	Tom Yang		

Antenna Polarity & Test Distance : Vertical at 3 m								
No	Frequency (MHz)	Emission Level (dBuV/m)	Limit (dBuV/m)	Margin (dB)	Antenna Height (m)	Table Angle (Degree)	Raw Value (dBuV)	Correction Factor (dB/m)
1	5150.00	62.1 PK	74.0	-11.9	1.77 V	149	57.6	4.5
2	5150.00	44.9 AV	54.0	-9.1	1.77 V	149	40.4	4.5
3	*5180.00	115.0 PK			1.77 V	149	110.6	4.4
4	*5180.00	106.5 AV			1.77 V	149	102.1	4.4
5	#10360.00	43.8 PK	68.2	-24.4	2.62 V	191	29.7	14.1
6	15540.00	46.8 PK	74.0	-27.2	1.79 V	310	32.1	14.7
7	15540.00	35.8 AV	54.0	-18.2	1.79 V	310	21.1	14.7

Remarks:

1. Emission Level(dBuV/m) = Raw Value(dBuV) + Correction Factor(dB/m)
2. Correction Factor(dB/m) = Antenna Factor(dB/m) + Cable Factor(dB) – Pre-Amplifier Factor(dB)
3. Margin value = Emission Level – Limit value
4. The other emission levels were very low against the limit.
5. " * " : Fundamental frequency, the limit was restricted at the RF Output Power.
6. " # " : The radiated frequency is out of the restricted band.

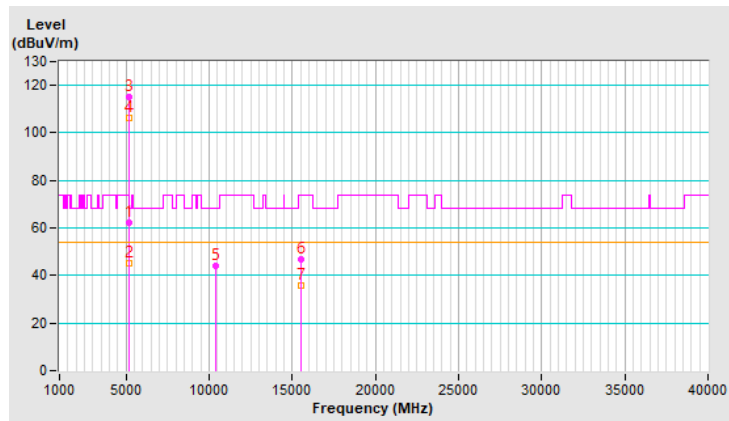

RF Mode	802.11be (EHT) 106-tone RU	Channel	CH 149 : 5745 MHz
Frequency Range	1 GHz ~ 40 GHz	Detector Function & Bandwidth	(PK) RB = 1 MHz, VB = 3 MHz (AV) RB = 1 MHz, VB = 3 kHz
Input Power (System)	120 Vac, 60 Hz	Environmental Conditions	24°C, 69% RH
Tested By	Tom Yang		

Antenna Polarity & Test Distance : Horizontal at 3 m								
No	Frequency (MHz)	Emission Level (dBuV/m)	Limit (dBuV/m)	Margin (dB)	Antenna Height (m)	Table Angle (Degree)	Raw Value (dBuV)	Correction Factor (dB/m)
1	#5648.30	61.2 PK	68.2	-7.0	1.96 H	81	56.4	4.8
2	*5745.00	122.8 PK			1.96 H	81	118.1	4.7
3	*5745.00	115.3 AV			1.96 H	81	110.6	4.7
4	#5961.84	53.3 PK	68.2	-14.9	1.96 H	81	48.1	5.2
5	11490.00	61.8 PK	74.0	-12.2	1.71 H	90	46.8	15.0
6	11490.00	51.2 AV	54.0	-2.8	1.71 H	90	36.2	15.0
7	#17235.00	52.9 PK	68.2	-15.3	1.58 H	150	34.0	18.9

Remarks:

1. Emission Level(dBuV/m) = Raw Value(dBuV) + Correction Factor(dB/m)
2. Correction Factor(dB/m) = Antenna Factor(dB/m) + Cable Factor(dB) – Pre-Amplifier Factor(dB)
3. Margin value = Emission Level – Limit value
4. The other emission levels were very low against the limit.
5. " * " : Fundamental frequency, the limit was restricted at the RF Output Power.
6. " # " : The radiated frequency is out of the restricted band.

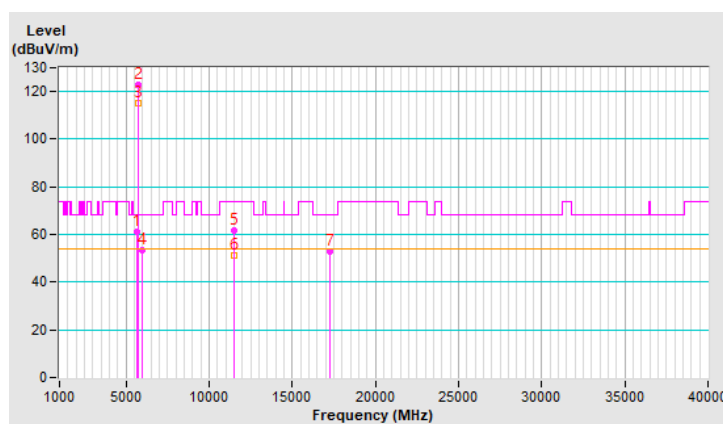

RF Mode	802.11be (EHT) 106-tone RU	Channel	CH 149 : 5745 MHz
Frequency Range	1 GHz ~ 40 GHz	Detector Function & Bandwidth	(PK) RB = 1 MHz, VB = 3 MHz (AV) RB = 1 MHz, VB = 3 kHz
Input Power (System)	120 Vac, 60 Hz	Environmental Conditions	24°C, 69% RH
Tested By	Tom Yang		

Antenna Polarity & Test Distance : Vertical at 3 m								
No	Frequency (MHz)	Emission Level (dBuV/m)	Limit (dBuV/m)	Margin (dB)	Antenna Height (m)	Table Angle (Degree)	Raw Value (dBuV)	Correction Factor (dB/m)
1	#5643.30	58.4 PK	68.2	-9.8	1.87 V	153	53.6	4.8
2	*5745.00	118.2 PK			1.87 V	153	113.5	4.7
3	*5745.00	110.6 AV			1.87 V	153	105.9	4.7
4	#5990.70	51.9 PK	68.2	-16.3	1.87 V	153	46.7	5.2
5	11490.00	61.4 PK	74.0	-12.6	2.44 V	78	46.4	15.0
6	11490.00	51.8 AV	54.0	-2.2	2.44 V	78	36.8	15.0
7	#17235.00	52.4 PK	68.2	-15.8	1.62 V	208	33.5	18.9

Remarks:

1. Emission Level(dBuV/m) = Raw Value(dBuV) + Correction Factor(dB/m)
2. Correction Factor(dB/m) = Antenna Factor(dB/m) + Cable Factor(dB) – Pre-Amplifier Factor(dB)
3. Margin value = Emission Level – Limit value
4. The other emission levels were very low against the limit.
5. " * " : Fundamental frequency, the limit was restricted at the RF Output Power.
6. " # " : The radiated frequency is out of the restricted band.

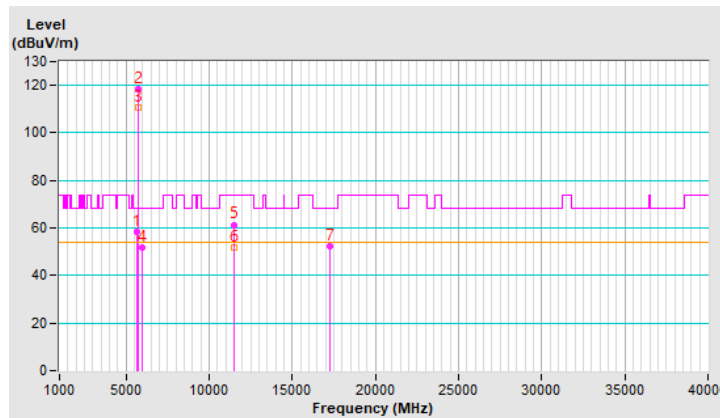

RF Mode	802.11be (EHT) 106-tone RU	Channel	CH 165 : 5825 MHz
Frequency Range	1 GHz ~ 40 GHz	Detector Function & Bandwidth	(PK) RB = 1 MHz, VB = 3 MHz (AV) RB = 1 MHz, VB = 3 kHz
Input Power (System)	120 Vac, 60 Hz	Environmental Conditions	24°C, 69% RH
Tested By	Tom Yang		

Antenna Polarity & Test Distance : Horizontal at 3 m								
No	Frequency (MHz)	Emission Level (dBuV/m)	Limit (dBuV/m)	Margin (dB)	Antenna Height (m)	Table Angle (Degree)	Raw Value (dBuV)	Correction Factor (dB/m)
1	#5634.94	53.4 PK	68.2	-14.8	2.07 H	96	48.7	4.7
2	*5825.00	123.3 PK			2.07 H	96	118.2	5.1
3	*5825.00	115.0 AV			2.07 H	96	109.9	5.1
4	#5924.70	57.3 PK	68.2	-10.9	2.07 H	96	52.2	5.1
5	11650.00	60.1 PK	74.0	-13.9	1.65 H	91	45.2	14.9
6	11650.00	48.7 AV	54.0	-5.3	1.65 H	91	33.8	14.9
7	#17475.00	53.5 PK	68.2	-14.7	1.48 H	190	33.5	20.0

Remarks:

1. Emission Level(dBuV/m) = Raw Value(dBuV) + Correction Factor(dB/m)
2. Correction Factor(dB/m) = Antenna Factor(dB/m) + Cable Factor(dB) – Pre-Amplifier Factor(dB)
3. Margin value = Emission Level – Limit value
4. The other emission levels were very low against the limit.
5. " * " : Fundamental frequency, the limit was restricted at the RF Output Power.
6. " # " : The radiated frequency is out of the restricted band.

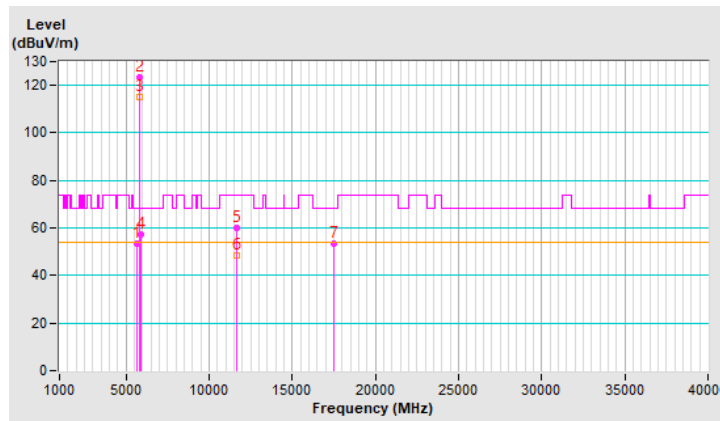

RF Mode	802.11be (EHT) 106-tone RU	Channel	CH 165 : 5825 MHz
Frequency Range	1 GHz ~ 40 GHz	Detector Function & Bandwidth	(PK) RB = 1 MHz, VB = 3 MHz (AV) RB = 1 MHz, VB = 3 kHz
Input Power (System)	120 Vac, 60 Hz	Environmental Conditions	24°C, 69% RH
Tested By	Tom Yang		

Antenna Polarity & Test Distance : Vertical at 3 m								
No	Frequency (MHz)	Emission Level (dBuV/m)	Limit (dBuV/m)	Margin (dB)	Antenna Height (m)	Table Angle (Degree)	Raw Value (dBuV)	Correction Factor (dB/m)
1	#5589.17	52.1 PK	68.2	-16.1	1.97 V	35	47.7	4.4
2	*5825.00	119.1 PK			1.97 V	35	114.0	5.1
3	*5825.00	110.4 AV			1.97 V	35	105.3	5.1
4	#5933.62	53.0 PK	68.2	-15.2	1.97 V	35	47.9	5.1
5	11650.00	60.0 PK	74.0	-14.0	2.49 V	101	45.1	14.9
6	11650.00	49.3 AV	54.0	-4.7	2.49 V	101	34.4	14.9
7	#17475.00	53.7 PK	68.2	-14.5	1.61 V	235	33.7	20.0

Remarks:

1. Emission Level(dBuV/m) = Raw Value(dBuV) + Correction Factor(dB/m)
2. Correction Factor(dB/m) = Antenna Factor(dB/m) + Cable Factor(dB) – Pre-Amplifier Factor(dB)
3. Margin value = Emission Level – Limit value
4. The other emission levels were very low against the limit.
5. " * " : Fundamental frequency, the limit was restricted at the RF Output Power.
6. " # " : The radiated frequency is out of the restricted band.

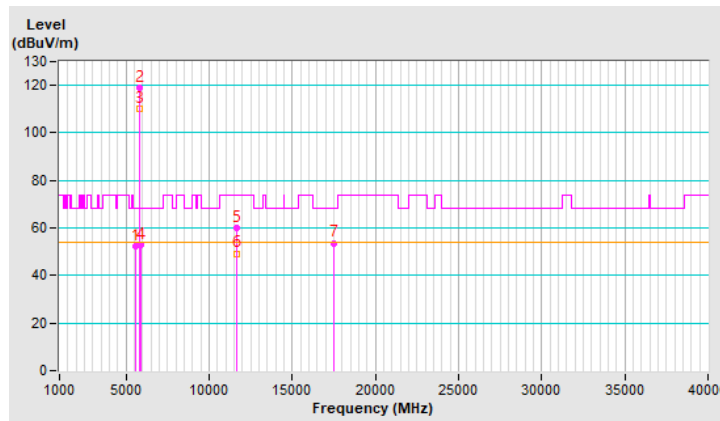

RF Mode	802.11be (EHT) 106+26-tone MRU	Channel	CH 36 : 5180 MHz
Frequency Range	1 GHz ~ 40 GHz	Detector Function & Bandwidth	(PK) RB = 1 MHz, VB = 3 MHz (AV) RB = 1 MHz, VB = 2 kHz
Input Power (System)	120 Vac, 60 Hz	Environmental Conditions	24°C, 69% RH
Tested By	Tom Yang		

Antenna Polarity & Test Distance : Horizontal at 3 m								
No	Frequency (MHz)	Emission Level (dBuV/m)	Limit (dBuV/m)	Margin (dB)	Antenna Height (m)	Table Angle (Degree)	Raw Value (dBuV)	Correction Factor (dB/m)
1	5150.00	73.7 PK	74.0	-0.3	2.16 H	83	69.2	4.5
2	5150.00	51.6 AV	54.0	-2.4	2.16 H	83	47.1	4.5
3	*5180.00	121.3 PK			2.16 H	83	116.9	4.4
4	*5180.00	113.3 AV			2.16 H	83	108.9	4.4
5	#10360.00	45.4 PK	68.2	-22.8	2.05 H	95	31.3	14.1
6	15540.00	47.2 PK	74.0	-26.8	1.80 H	360	32.5	14.7
7	15540.00	35.5 AV	54.0	-18.5	1.80 H	360	20.8	14.7

Remarks:

1. Emission Level(dBuV/m) = Raw Value(dBuV) + Correction Factor(dB/m)
2. Correction Factor(dB/m) = Antenna Factor(dB/m) + Cable Factor(dB) – Pre-Amplifier Factor(dB)
3. Margin value = Emission Level – Limit value
4. The other emission levels were very low against the limit.
5. " * " : Fundamental frequency, the limit was restricted at the RF Output Power.
6. " # " : The radiated frequency is out of the restricted band.

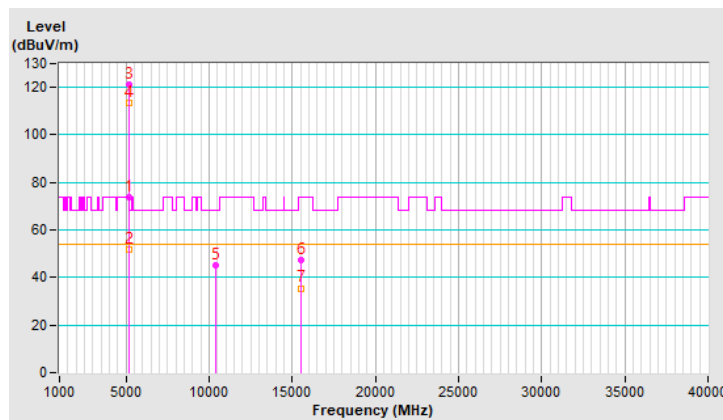

RF Mode	802.11be (EHT) 106+26-tone MRU	Channel	CH 36 : 5180 MHz
Frequency Range	1 GHz ~ 40 GHz	Detector Function & Bandwidth	(PK) RB = 1 MHz, VB = 3 MHz (AV) RB = 1 MHz, VB = 2 kHz
Input Power (System)	120 Vac, 60 Hz	Environmental Conditions	24°C, 69% RH
Tested By	Tom Yang		

Antenna Polarity & Test Distance : Vertical at 3 m								
No	Frequency (MHz)	Emission Level (dBuV/m)	Limit (dBuV/m)	Margin (dB)	Antenna Height (m)	Table Angle (Degree)	Raw Value (dBuV)	Correction Factor (dB/m)
1	5150.00	67.5 PK	74.0	-6.5	2.06 V	150	63.0	4.5
2	5150.00	45.9 AV	54.0	-8.1	2.06 V	150	41.4	4.5
3	*5180.00	114.9 PK			2.06 V	150	110.5	4.4
4	*5180.00	105.9 AV			2.06 V	150	101.5	4.4
5	#10360.00	44.3 PK	68.2	-23.9	2.86 V	195	30.2	14.1
6	15540.00	47.2 PK	74.0	-26.8	1.87 V	338	32.5	14.7
7	15540.00	35.3 AV	54.0	-18.7	1.87 V	338	20.6	14.7

Remarks:

1. Emission Level(dBuV/m) = Raw Value(dBuV) + Correction Factor(dB/m)
2. Correction Factor(dB/m) = Antenna Factor(dB/m) + Cable Factor(dB) – Pre-Amplifier Factor(dB)
3. Margin value = Emission Level – Limit value
4. The other emission levels were very low against the limit.
5. " * " : Fundamental frequency, the limit was restricted at the RF Output Power.
6. " # " : The radiated frequency is out of the restricted band.

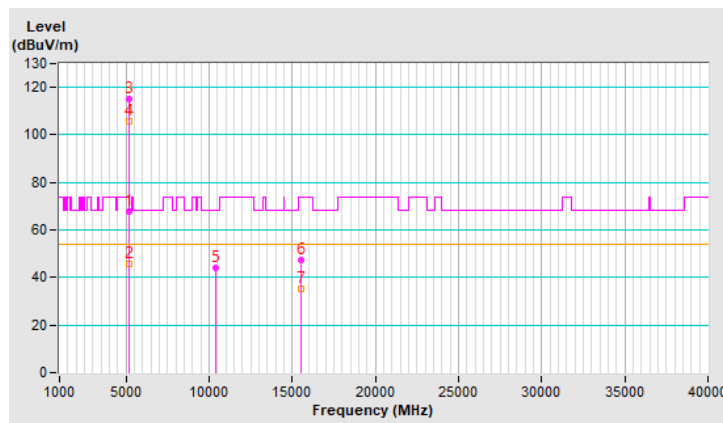

RF Mode	802.11be (EHT) 106+26-tone MRU	Channel	CH 149 : 5745 MHz
Frequency Range	1 GHz ~ 40 GHz	Detector Function & Bandwidth	(PK) RB = 1 MHz, VB = 3 MHz (AV) RB = 1 MHz, VB = 2 kHz
Input Power (System)	120 Vac, 60 Hz	Environmental Conditions	24°C, 69% RH
Tested By	Tom Yang		

Antenna Polarity & Test Distance : Horizontal at 3 m								
No	Frequency (MHz)	Emission Level (dBuV/m)	Limit (dBuV/m)	Margin (dB)	Antenna Height (m)	Table Angle (Degree)	Raw Value (dBuV)	Correction Factor (dB/m)
1	#5639.42	58.4 PK	68.2	-9.8	1.93 H	84	53.7	4.7
2	*5745.00	122.7 PK			1.93 H	84	118.0	4.7
3	*5745.00	114.8 AV			1.93 H	84	110.1	4.7
4	#5954.13	53.3 PK	68.2	-14.9	1.93 H	84	48.1	5.2
5	11490.00	57.9 PK	74.0	-16.1	1.65 H	117	42.9	15.0
6	11490.00	48.3 AV	54.0	-5.7	1.65 H	117	33.3	15.0
7	#17235.00	51.2 PK	68.2	-17.0	1.50 H	173	32.3	18.9

Remarks:

1. Emission Level(dBuV/m) = Raw Value(dBuV) + Correction Factor(dB/m)
2. Correction Factor(dB/m) = Antenna Factor(dB/m) + Cable Factor(dB) – Pre-Amplifier Factor(dB)
3. Margin value = Emission Level – Limit value
4. The other emission levels were very low against the limit.
5. " * " : Fundamental frequency, the limit was restricted at the RF Output Power.
6. " # " : The radiated frequency is out of the restricted band.

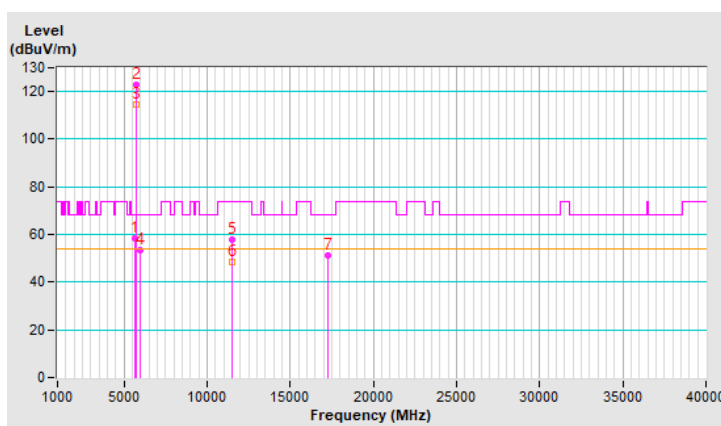

RF Mode	802.11be (EHT) 106+26-tone MRU	Channel	CH 149 : 5745 MHz
Frequency Range	1 GHz ~ 40 GHz	Detector Function & Bandwidth	(PK) RB = 1 MHz, VB = 3 MHz (AV) RB = 1 MHz, VB = 2 kHz
Input Power (System)	120 Vac, 60 Hz	Environmental Conditions	24°C, 69% RH
Tested By	Tom Yang		

Antenna Polarity & Test Distance : Vertical at 3 m								
No	Frequency (MHz)	Emission Level (dBuV/m)	Limit (dBuV/m)	Margin (dB)	Antenna Height (m)	Table Angle (Degree)	Raw Value (dBuV)	Correction Factor (dB/m)
1	#5648.06	55.4 PK	68.2	-12.8	1.90 V	145	50.6	4.8
2	*5745.00	117.5 PK			1.90 V	145	112.8	4.7
3	*5745.00	109.7 AV			1.90 V	145	105.0	4.7
4	#6022.70	51.6 PK	68.2	-16.6	1.90 V	145	46.3	5.3
5	11490.00	59.8 PK	74.0	-14.2	2.62 V	94	44.8	15.0
6	11490.00	49.9 AV	54.0	-4.1	2.62 V	94	34.9	15.0
7	#17235.00	51.0 PK	68.2	-17.2	1.69 V	244	32.1	18.9

Remarks:

1. Emission Level(dBuV/m) = Raw Value(dBuV) + Correction Factor(dB/m)
2. Correction Factor(dB/m) = Antenna Factor(dB/m) + Cable Factor(dB) – Pre-Amplifier Factor(dB)
3. Margin value = Emission Level – Limit value
4. The other emission levels were very low against the limit.
5. " * " : Fundamental frequency, the limit was restricted at the RF Output Power.
6. " # " : The radiated frequency is out of the restricted band.

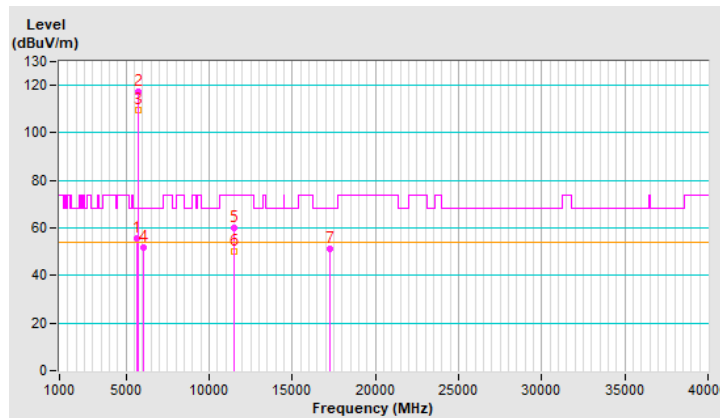

RF Mode	802.11be (EHT) 106+26-tone MRU	Channel	CH 165 : 5825 MHz
Frequency Range	1 GHz ~ 40 GHz	Detector Function & Bandwidth	(PK) RB = 1 MHz, VB = 3 MHz (AV) RB = 1 MHz, VB = 2 kHz
Input Power (System)	120 Vac, 60 Hz	Environmental Conditions	24°C, 69% RH
Tested By	Tom Yang		

Antenna Polarity & Test Distance : Horizontal at 3 m								
No	Frequency (MHz)	Emission Level (dBuV/m)	Limit (dBuV/m)	Margin (dB)	Antenna Height (m)	Table Angle (Degree)	Raw Value (dBuV)	Correction Factor (dB/m)
1	#5632.67	54.3 PK	68.2	-13.9	2.12 H	85	49.6	4.7
2	*5825.00	123.5 PK			2.12 H	85	118.4	5.1
3	*5825.00	115.6 AV			2.12 H	85	110.5	5.1
4	#5964.08	56.1 PK	68.2	-12.1	2.12 H	85	50.9	5.2
5	11650.00	57.2 PK	74.0	-16.8	1.62 H	111	42.3	14.9
6	11650.00	47.3 AV	54.0	-6.7	1.62 H	111	32.4	14.9
7	#17475.00	50.4 PK	68.2	-17.8	1.44 H	176	30.4	20.0

Remarks:

1. Emission Level(dBuV/m) = Raw Value(dBuV) + Correction Factor(dB/m)
2. Correction Factor(dB/m) = Antenna Factor(dB/m) + Cable Factor(dB) – Pre-Amplifier Factor(dB)
3. Margin value = Emission Level – Limit value
4. The other emission levels were very low against the limit.
5. " * " : Fundamental frequency, the limit was restricted at the RF Output Power.
6. " # " : The radiated frequency is out of the restricted band.

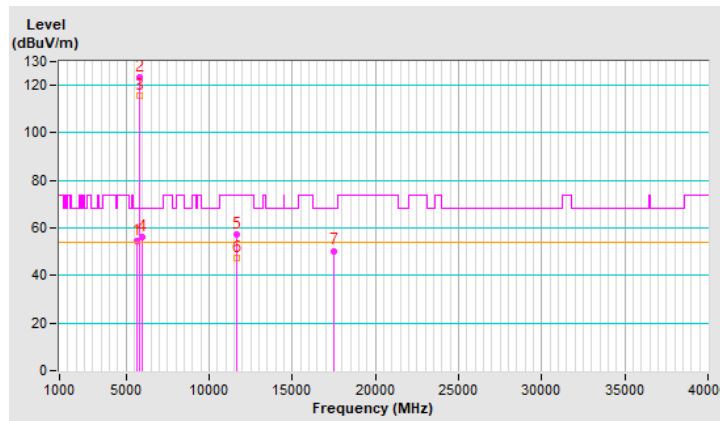

RF Mode	802.11be (EHT) 106+26-tone MRU	Channel	CH 165 : 5825 MHz
Frequency Range	1 GHz ~ 40 GHz	Detector Function & Bandwidth	(PK) RB = 1 MHz, VB = 3 MHz (AV) RB = 1 MHz, VB = 2 kHz
Input Power (System)	120 Vac, 60 Hz	Environmental Conditions	24°C, 69% RH
Tested By	Tom Yang		

Antenna Polarity & Test Distance : Vertical at 3 m								
No	Frequency (MHz)	Emission Level (dBuV/m)	Limit (dBuV/m)	Margin (dB)	Antenna Height (m)	Table Angle (Degree)	Raw Value (dBuV)	Correction Factor (dB/m)
1	#5635.98	51.8 PK	68.2	-16.4	1.98 V	36	47.1	4.7
2	*5825.00	118.4 PK			1.98 V	36	113.3	5.1
3	*5825.00	109.6 AV			1.98 V	36	104.5	5.1
4	#5957.93	52.4 PK	68.2	-15.8	1.98 V	36	47.2	5.2
5	11650.00	58.9 PK	74.0	-15.1	2.62 V	80	44.0	14.9
6	11650.00	48.1 AV	54.0	-5.9	2.62 V	80	33.2	14.9
7	#17475.00	49.9 PK	68.2	-18.3	1.75 V	230	29.9	20.0

Remarks:

1. Emission Level(dBuV/m) = Raw Value(dBuV) + Correction Factor(dB/m)
2. Correction Factor(dB/m) = Antenna Factor(dB/m) + Cable Factor(dB) – Pre-Amplifier Factor(dB)
3. Margin value = Emission Level – Limit value
4. The other emission levels were very low against the limit.
5. " * " : Fundamental frequency, the limit was restricted at the RF Output Power.
6. " # " : The radiated frequency is out of the restricted band.

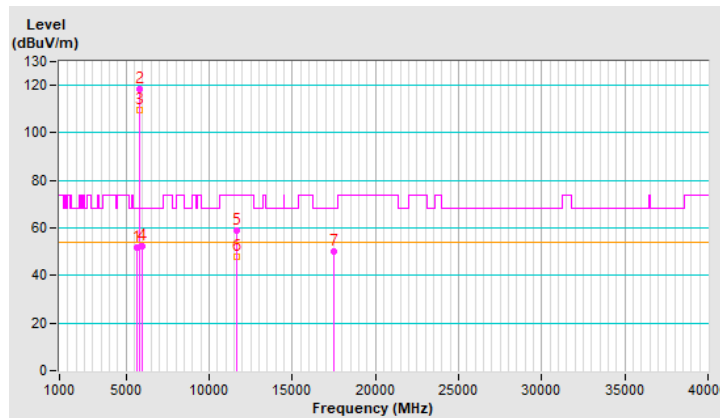

RF Mode	802.11be (EHT) 52+26-tone MRU	Channel	CH 36 : 5180 MHz
Frequency Range	1 GHz ~ 40 GHz	Detector Function & Bandwidth	(PK) RB = 1 MHz, VB = 3 MHz (AV) RB = 1 MHz, VB = 3 kHz
Input Power (System)	120 Vac, 60 Hz	Environmental Conditions	24°C, 69% RH
Tested By	Tom Yang		

Antenna Polarity & Test Distance : Horizontal at 3 m								
No	Frequency (MHz)	Emission Level (dBuV/m)	Limit (dBuV/m)	Margin (dB)	Antenna Height (m)	Table Angle (Degree)	Raw Value (dBuV)	Correction Factor (dB/m)
1	5150.00	73.4 PK	74.0	-0.6	2.17 H	83	68.9	4.5
2	5150.00	53.5 AV	54.0	-0.5	2.17 H	83	49.0	4.5
3	*5180.00	125.1 PK			2.17 H	83	120.7	4.4
4	*5180.00	115.5 AV			2.17 H	83	111.1	4.4
5	#10360.00	48.2 PK	68.2	-20.0	1.92 H	78	34.1	14.1
6	15540.00	47.5 PK	74.0	-26.5	1.74 H	348	32.8	14.7
7	15540.00	36.2 AV	54.0	-17.8	1.74 H	348	21.5	14.7

Remarks:

1. Emission Level(dBuV/m) = Raw Value(dBuV) + Correction Factor(dB/m)
2. Correction Factor(dB/m) = Antenna Factor(dB/m) + Cable Factor(dB) – Pre-Amplifier Factor(dB)
3. Margin value = Emission Level – Limit value
4. The other emission levels were very low against the limit.
5. " * " : Fundamental frequency, the limit was restricted at the RF Output Power.
6. " # " : The radiated frequency is out of the restricted band.

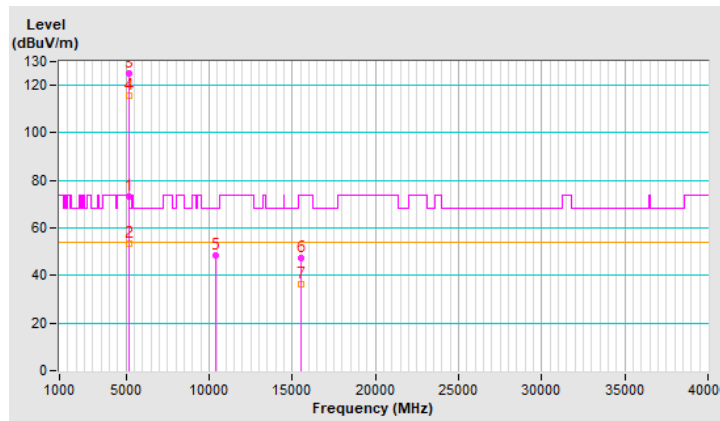

RF Mode	802.11be (EHT) 52+26-tone MRU	Channel	CH 36 : 5180 MHz
Frequency Range	1 GHz ~ 40 GHz	Detector Function & Bandwidth	(PK) RB = 1 MHz, VB = 3 MHz (AV) RB = 1 MHz, VB = 3 kHz
Input Power (System)	120 Vac, 60 Hz	Environmental Conditions	24°C, 69% RH
Tested By	Tom Yang		

Antenna Polarity & Test Distance : Vertical at 3 m								
No	Frequency (MHz)	Emission Level (dBuV/m)	Limit (dBuV/m)	Margin (dB)	Antenna Height (m)	Table Angle (Degree)	Raw Value (dBuV)	Correction Factor (dB/m)
1	5147.90	65.4 PK	74.0	-8.6	2.03 V	140	60.9	4.5
2	5147.90	46.9 AV	54.0	-7.1	2.03 V	140	42.4	4.5
3	*5180.00	115.9 PK			2.03 V	140	111.5	4.4
4	*5180.00	108.5 AV			2.03 V	140	104.1	4.4
5	#10360.00	48.7 PK	68.2	-19.5	2.86 V	173	34.6	14.1
6	15540.00	47.3 PK	74.0	-26.7	1.91 V	333	32.6	14.7
7	15540.00	35.6 AV	54.0	-18.4	1.91 V	333	20.9	14.7

Remarks:

1. Emission Level(dBuV/m) = Raw Value(dBuV) + Correction Factor(dB/m)
2. Correction Factor(dB/m) = Antenna Factor(dB/m) + Cable Factor(dB) – Pre-Amplifier Factor(dB)
3. Margin value = Emission Level – Limit value
4. The other emission levels were very low against the limit.
5. " * " : Fundamental frequency, the limit was restricted at the RF Output Power.
6. " # " : The radiated frequency is out of the restricted band.

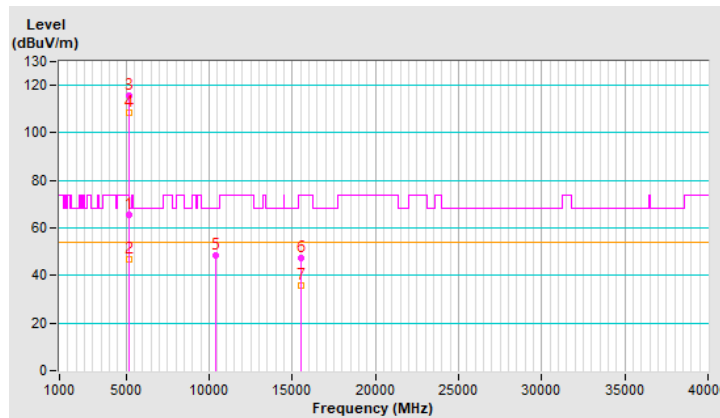

RF Mode	802.11be (EHT) 52+26-tone MRU	Channel	CH 149 : 5745 MHz
Frequency Range	1 GHz ~ 40 GHz	Detector Function & Bandwidth	(PK) RB = 1 MHz, VB = 3 MHz (AV) RB = 1 MHz, VB = 3 kHz
Input Power (System)	120 Vac, 60 Hz	Environmental Conditions	24°C, 69% RH
Tested By	Tom Yang		

Antenna Polarity & Test Distance : Horizontal at 3 m								
No	Frequency (MHz)	Emission Level (dBuV/m)	Limit (dBuV/m)	Margin (dB)	Antenna Height (m)	Table Angle (Degree)	Raw Value (dBuV)	Correction Factor (dB/m)
1	#5638.47	59.3 PK	68.2	-8.9	2.05 H	83	54.6	4.7
2	*5745.00	126.1 PK			2.05 H	83	121.4	4.7
3	*5745.00	117.8 AV			2.05 H	83	113.1	4.7
4	#5932.52	55.5 PK	68.2	-12.7	2.05 H	83	50.4	5.1
5	11490.00	58.7 PK	74.0	-15.3	1.71 H	99	43.7	15.0
6	11490.00	50.3 AV	54.0	-3.7	1.71 H	99	35.3	15.0
7	#17235.00	50.7 PK	68.2	-17.5	1.47 H	171	31.8	18.9

Remarks:

1. Emission Level(dBuV/m) = Raw Value(dBuV) + Correction Factor(dB/m)
2. Correction Factor(dB/m) = Antenna Factor(dB/m) + Cable Factor(dB) – Pre-Amplifier Factor(dB)
3. Margin value = Emission Level – Limit value
4. The other emission levels were very low against the limit.
5. " * " : Fundamental frequency, the limit was restricted at the RF Output Power.
6. " # " : The radiated frequency is out of the restricted band.

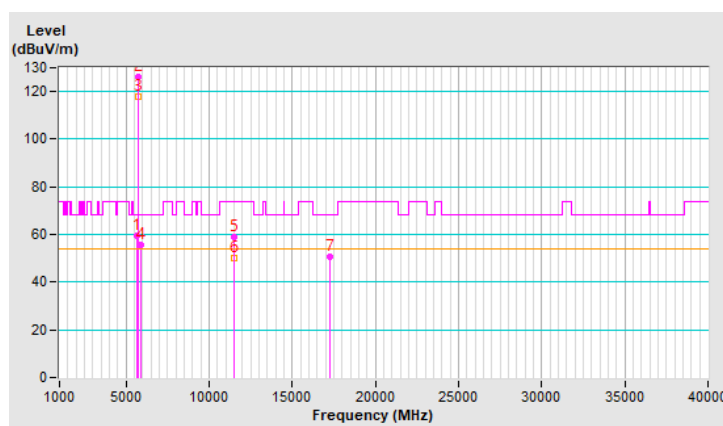

RF Mode	802.11be (EHT) 52+26-tone MRU	Channel	CH 149 : 5745 MHz
Frequency Range	1 GHz ~ 40 GHz	Detector Function & Bandwidth	(PK) RB = 1 MHz, VB = 3 MHz (AV) RB = 1 MHz, VB = 3 kHz
Input Power (System)	120 Vac, 60 Hz	Environmental Conditions	24°C, 69% RH
Tested By	Tom Yang		

Antenna Polarity & Test Distance : Vertical at 3 m								
No	Frequency (MHz)	Emission Level (dBuV/m)	Limit (dBuV/m)	Margin (dB)	Antenna Height (m)	Table Angle (Degree)	Raw Value (dBuV)	Correction Factor (dB/m)
1	#5648.00	55.3 PK	68.2	-12.9	1.86 V	145	50.5	4.8
2	*5745.00	119.0 PK			1.86 V	145	114.3	4.7
3	*5745.00	111.8 AV			1.86 V	145	107.1	4.7
4	#5950.71	52.3 PK	68.2	-15.9	1.86 V	145	47.1	5.2
5	11490.00	60.2 PK	74.0	-13.8	2.61 V	94	45.2	15.0
6	11490.00	51.7 AV	54.0	-2.3	2.61 V	94	36.7	15.0
7	#17235.00	50.5 PK	68.2	-17.7	1.59 V	220	31.6	18.9

Remarks:

1. Emission Level(dBuV/m) = Raw Value(dBuV) + Correction Factor(dB/m)
2. Correction Factor(dB/m) = Antenna Factor(dB/m) + Cable Factor(dB) – Pre-Amplifier Factor(dB)
3. Margin value = Emission Level – Limit value
4. The other emission levels were very low against the limit.
5. " * " : Fundamental frequency, the limit was restricted at the RF Output Power.
6. " # " : The radiated frequency is out of the restricted band.

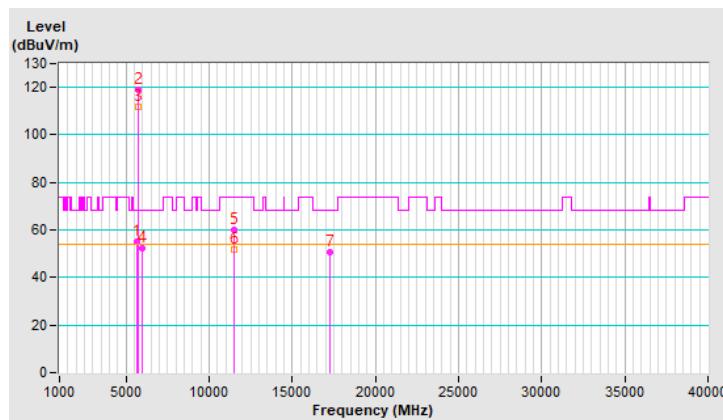

RF Mode	802.11be (EHT) 52+26-tone MRU	Channel	CH 165 : 5825 MHz
Frequency Range	1 GHz ~ 40 GHz	Detector Function & Bandwidth	(PK) RB = 1 MHz, VB = 3 MHz (AV) RB = 1 MHz, VB = 3 kHz
Input Power (System)	120 Vac, 60 Hz	Environmental Conditions	24°C, 69% RH
Tested By	Tom Yang		

Antenna Polarity & Test Distance : Horizontal at 3 m								
No	Frequency (MHz)	Emission Level (dBuV/m)	Limit (dBuV/m)	Margin (dB)	Antenna Height (m)	Table Angle (Degree)	Raw Value (dBuV)	Correction Factor (dB/m)
1	#5620.18	56.3 PK	68.2	-11.9	2.10 H	84	51.7	4.6
2	*5825.00	127.1 PK			2.10 H	84	122.0	5.1
3	*5825.00	118.0 AV			2.10 H	84	112.9	5.1
4	#5932.23	56.5 PK	68.2	-11.7	2.10 H	84	51.4	5.1
5	11650.00	58.2 PK	74.0	-15.8	1.68 H	110	43.3	14.9
6	11650.00	48.4 AV	54.0	-5.6	1.68 H	110	33.5	14.9
7	#17475.00	50.9 PK	68.2	-17.3	1.46 H	173	30.9	20.0

Remarks:

1. Emission Level(dBuV/m) = Raw Value(dBuV) + Correction Factor(dB/m)
2. Correction Factor(dB/m) = Antenna Factor(dB/m) + Cable Factor(dB) – Pre-Amplifier Factor(dB)
3. Margin value = Emission Level – Limit value
4. The other emission levels were very low against the limit.
5. " * " : Fundamental frequency, the limit was restricted at the RF Output Power.
6. " # " : The radiated frequency is out of the restricted band.

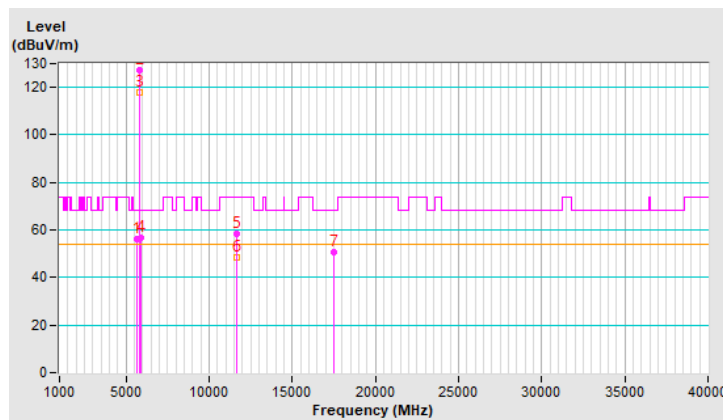

RF Mode	802.11be (EHT) 52+26-tone MRU	Channel	CH 165 : 5825 MHz
Frequency Range	1 GHz ~ 40 GHz	Detector Function & Bandwidth	(PK) RB = 1 MHz, VB = 3 MHz (AV) RB = 1 MHz, VB = 3 kHz
Input Power (System)	120 Vac, 60 Hz	Environmental Conditions	24°C, 69% RH
Tested By	Tom Yang		

Antenna Polarity & Test Distance : Vertical at 3 m								
No	Frequency (MHz)	Emission Level (dBuV/m)	Limit (dBuV/m)	Margin (dB)	Antenna Height (m)	Table Angle (Degree)	Raw Value (dBuV)	Correction Factor (dB/m)
1	#5620.56	51.2 PK	68.2	-17.0	2.01 V	35	46.6	4.6
2	*5825.00	120.7 PK			2.01 V	35	115.6	5.1
3	*5825.00	111.8 AV			2.01 V	35	106.7	5.1
4	#6019.11	52.2 PK	68.2	-16.0	2.01 V	35	47.0	5.2
5	11650.00	57.8 PK	74.0	-16.2	1.95 V	95	42.9	14.9
6	11650.00	49.0 AV	54.0	-5.0	1.95 V	95	34.1	14.9
7	#17475.00	50.9 PK	68.2	-17.3	1.65 V	233	30.9	20.0

Remarks:

1. Emission Level(dBuV/m) = Raw Value(dBuV) + Correction Factor(dB/m)
2. Correction Factor(dB/m) = Antenna Factor(dB/m) + Cable Factor(dB) – Pre-Amplifier Factor(dB)
3. Margin value = Emission Level – Limit value
4. The other emission levels were very low against the limit.
5. " * " : Fundamental frequency, the limit was restricted at the RF Output Power.
6. " # " : The radiated frequency is out of the restricted band.

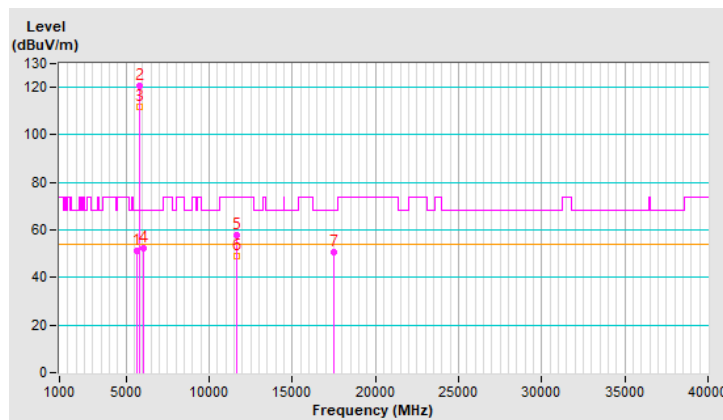

RF Mode	802.11be (EHT) 484+242-tone MRU	Channel	CH 42 : 5210 MHz
Frequency Range	1 GHz ~ 40 GHz	Detector Function & Bandwidth	(PK) RB = 1 MHz, VB = 3 MHz (AV) RB = 1 MHz, VB = 3 kHz
Input Power (System)	120 Vac, 60 Hz	Environmental Conditions	24°C, 69% RH
Tested By	Tom Yang		

Antenna Polarity & Test Distance : Horizontal at 3 m								
No	Frequency (MHz)	Emission Level (dBuV/m)	Limit (dBuV/m)	Margin (dB)	Antenna Height (m)	Table Angle (Degree)	Raw Value (dBuV)	Correction Factor (dB/m)
1	5150.00	62.8 PK	74.0	-11.2	2.05 H	84	58.3	4.5
2	5150.00	53.8 AV	54.0	-0.2	2.05 H	84	49.3	4.5
3	*5210.00	110.3 PK			2.05 H	84	106.1	4.2
4	*5210.00	100.6 AV			2.05 H	84	96.4	4.2
5	5350.00	51.4 PK	74.0	-22.6	2.05 H	84	47.1	4.3
6	5350.00	41.5 AV	54.0	-12.5	2.05 H	84	37.2	4.3
7	#10420.00	45.2 PK	68.2	-23.0	2.01 H	81	31.2	14.0
8	15630.00	47.7 PK	74.0	-26.3	1.83 H	355	33.2	14.5
9	15630.00	35.8 AV	54.0	-18.2	1.83 H	355	21.3	14.5

Remarks:

1. Emission Level(dBuV/m) = Raw Value(dBuV) + Correction Factor(dB/m)
2. Correction Factor(dB/m) = Antenna Factor(dB/m) + Cable Factor(dB) – Pre-Amplifier Factor(dB)
3. Margin value = Emission Level – Limit value
4. The other emission levels were very low against the limit.
5. " * " : Fundamental frequency, the limit was restricted at the RF Output Power.
6. " # " : The radiated frequency is out of the restricted band.

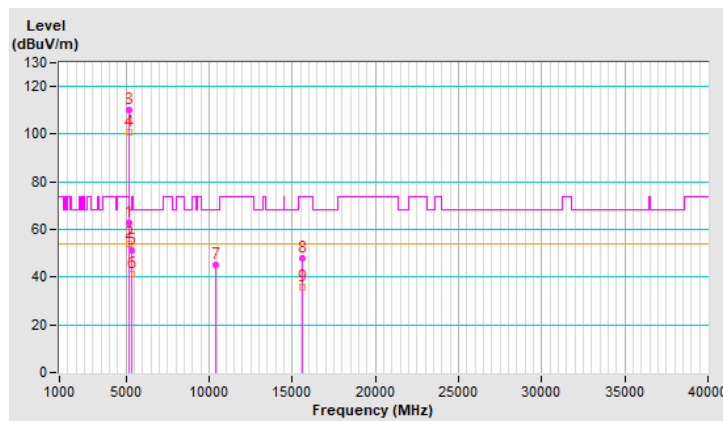

RF Mode	802.11be (EHT) 484+242-tone MRU	Channel	CH 42 : 5210 MHz
Frequency Range	1 GHz ~ 40 GHz	Detector Function & Bandwidth	(PK) RB = 1 MHz, VB = 3 MHz (AV) RB = 1 MHz, VB = 3 kHz
Input Power (System)	120 Vac, 60 Hz	Environmental Conditions	24°C, 69% RH
Tested By	Tom Yang		

Antenna Polarity & Test Distance : Vertical at 3 m								
No	Frequency (MHz)	Emission Level (dBuV/m)	Limit (dBuV/m)	Margin (dB)	Antenna Height (m)	Table Angle (Degree)	Raw Value (dBuV)	Correction Factor (dB/m)
1	5137.70	58.3 PK	74.0	-15.7	1.00 V	139	53.8	4.5
2	5137.70	48.6 AV	54.0	-5.4	1.00 V	139	44.1	4.5
3	*5210.00	105.9 PK			1.00 V	139	101.7	4.2
4	*5210.00	95.6 AV			1.00 V	139	91.4	4.2
5	5376.41	51.7 PK	74.0	-22.3	1.00 V	139	47.4	4.3
6	5376.41	41.0 AV	54.0	-13.0	1.00 V	139	36.7	4.3
7	#10420.00	44.0 PK	68.2	-24.2	2.89 V	191	30.0	14.0
8	15630.00	47.3 PK	74.0	-26.7	1.89 V	347	32.8	14.5
9	15630.00	35.2 AV	54.0	-18.8	1.89 V	347	20.7	14.5

Remarks:

1. Emission Level(dBuV/m) = Raw Value(dBuV) + Correction Factor(dB/m)
2. Correction Factor(dB/m) = Antenna Factor(dB/m) + Cable Factor(dB) – Pre-Amplifier Factor(dB)
3. Margin value = Emission Level – Limit value
4. The other emission levels were very low against the limit.
5. " * " : Fundamental frequency, the limit was restricted at the RF Output Power.
6. " # " : The radiated frequency is out of the restricted band.

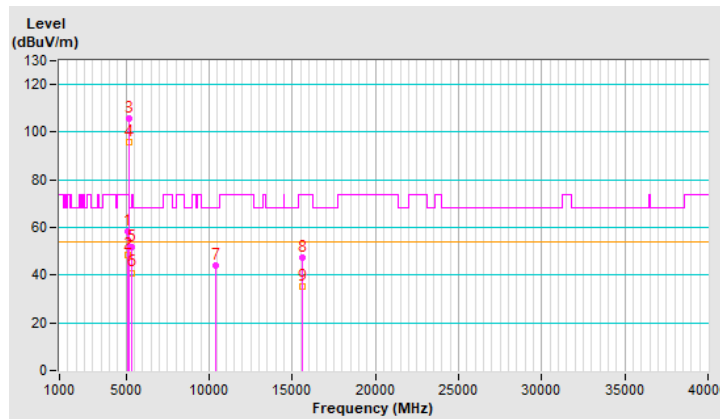

RF Mode	802.11be (EHT) 484+242-tone MRU	Channel	CH 155 : 5775 MHz
Frequency Range	1 GHz ~ 40 GHz	Detector Function & Bandwidth	(PK) RB = 1 MHz, VB = 3 MHz (AV) RB = 1 MHz, VB = 3 kHz
Input Power (System)	120 Vac, 60 Hz	Environmental Conditions	24°C, 69% RH
Tested By	Tom Yang		

Antenna Polarity & Test Distance : Horizontal at 3 m								
No	Frequency (MHz)	Emission Level (dBuV/m)	Limit (dBuV/m)	Margin (dB)	Antenna Height (m)	Table Angle (Degree)	Raw Value (dBuV)	Correction Factor (dB/m)
1	#5636.97	67.6 PK	68.2	-0.6	2.06 H	79	62.9	4.7
2	*5775.00	111.1 PK			2.06 H	79	106.3	4.8
3	*5775.00	102.8 AV			2.06 H	79	98.0	4.8
4	#5925.84	62.6 PK	68.2	-5.6	2.06 H	79	57.5	5.1
5	11550.00	50.4 PK	74.0	-23.6	1.62 H	98	35.6	14.8
6	11550.00	39.7 AV	54.0	-14.3	1.62 H	98	24.9	14.8
7	#17325.00	46.9 PK	68.2	-21.3	1.38 H	177	27.9	19.0

Remarks:

1. Emission Level(dBuV/m) = Raw Value(dBuV) + Correction Factor(dB/m)
2. Correction Factor(dB/m) = Antenna Factor(dB/m) + Cable Factor(dB) – Pre-Amplifier Factor(dB)
3. Margin value = Emission Level – Limit value
4. The other emission levels were very low against the limit.
5. " * " : Fundamental frequency, the limit was restricted at the RF Output Power.
6. " # " : The radiated frequency is out of the restricted band.

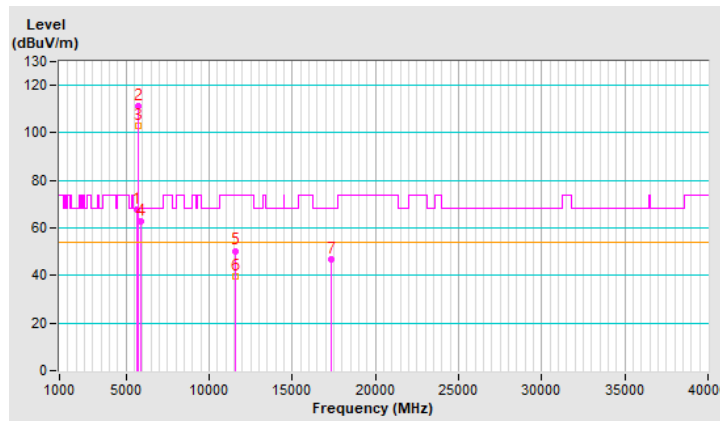

RF Mode	802.11be (EHT) 484+242-tone MRU	Channel	CH 155 : 5775 MHz
Frequency Range	1 GHz ~ 40 GHz	Detector Function & Bandwidth	(PK) RB = 1 MHz, VB = 3 MHz (AV) RB = 1 MHz, VB = 3 kHz
Input Power (System)	120 Vac, 60 Hz	Environmental Conditions	24°C, 69% RH
Tested By	Tom Yang		

Antenna Polarity & Test Distance : Vertical at 3 m								
No	Frequency (MHz)	Emission Level (dBuV/m)	Limit (dBuV/m)	Margin (dB)	Antenna Height (m)	Table Angle (Degree)	Raw Value (dBuV)	Correction Factor (dB/m)
1	#5643.85	67.5 PK	68.2	-0.7	2.11 V	147	62.7	4.8
2	*5775.00	105.3 PK			2.11 V	147	100.5	4.8
3	*5775.00	97.1 AV			2.11 V	147	92.3	4.8
4	#5927.33	57.2 PK	68.2	-11.0	2.11 V	147	52.1	5.1
5	11550.00	51.3 PK	74.0	-22.7	2.63 V	88	36.5	14.8
6	11550.00	40.7 AV	54.0	-13.3	2.63 V	88	25.9	14.8
7	#17325.00	46.8 PK	68.2	-21.4	1.71 V	215	27.8	19.0

Remarks:

1. Emission Level(dBuV/m) = Raw Value(dBuV) + Correction Factor(dB/m)
2. Correction Factor(dB/m) = Antenna Factor(dB/m) + Cable Factor(dB) – Pre-Amplifier Factor(dB)
3. Margin value = Emission Level – Limit value
4. The other emission levels were very low against the limit.
5. " * " : Fundamental frequency, the limit was restricted at the RF Output Power.
6. " # " : The radiated frequency is out of the restricted band.

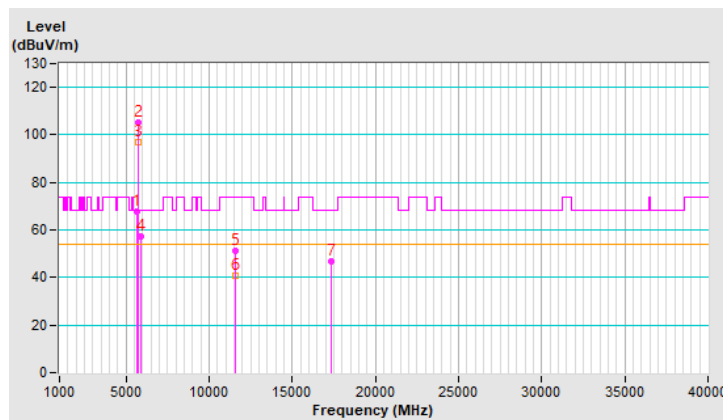

Plot of Band Edge

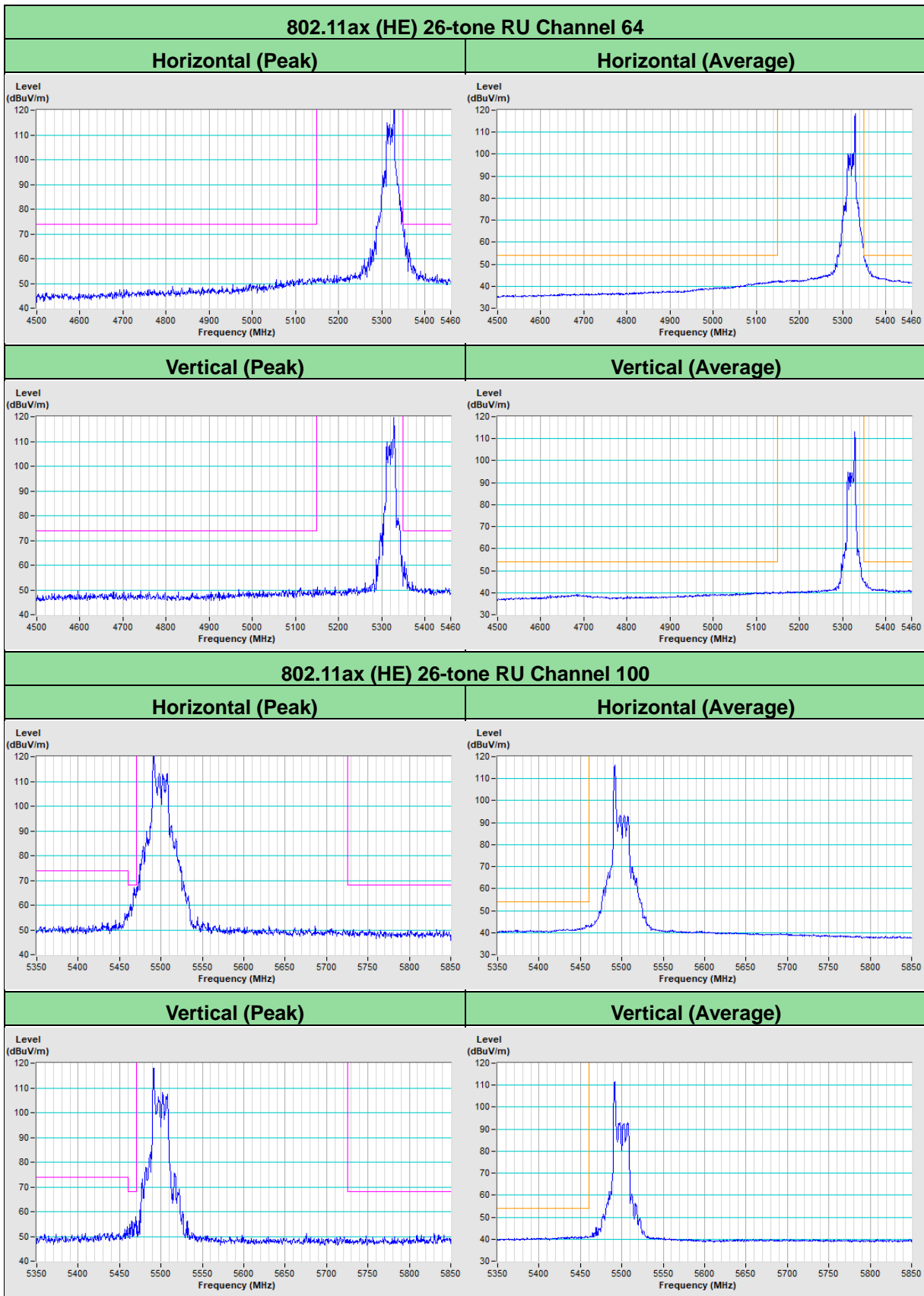

802.11be (EHT) 106+26-tone MRU Channel 36

Horizontal (Peak) Horizontal (Average)

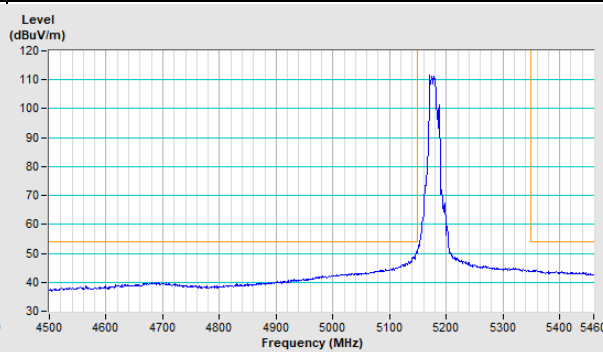
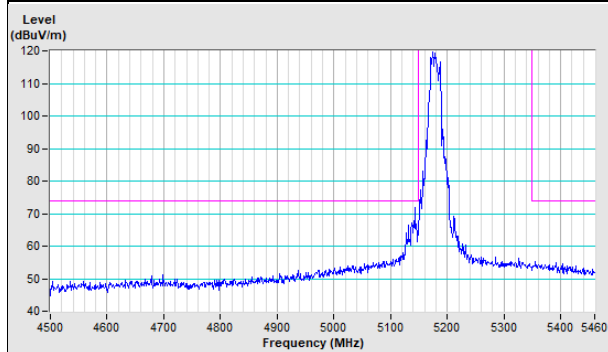

Vertical (Peak) Vertical (Average)

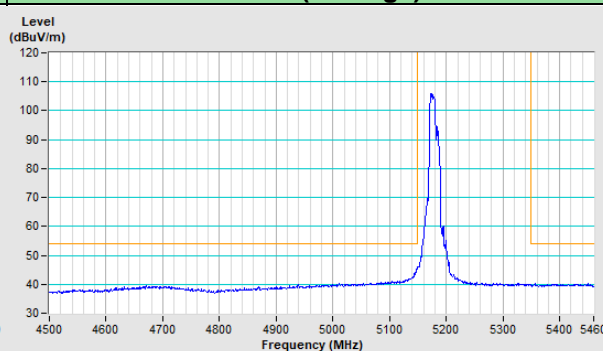
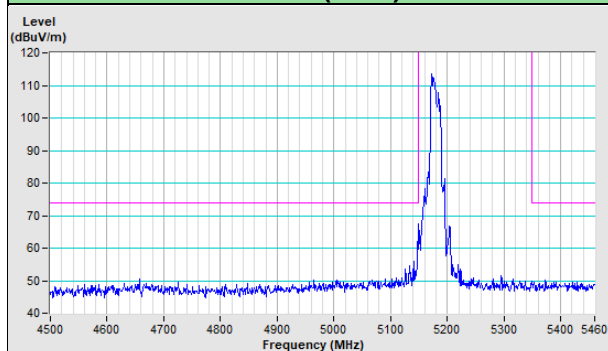

802.11be (EHT) 106+26-tone MRU Channel 149

Horizontal (Peak) Vertical (Peak)

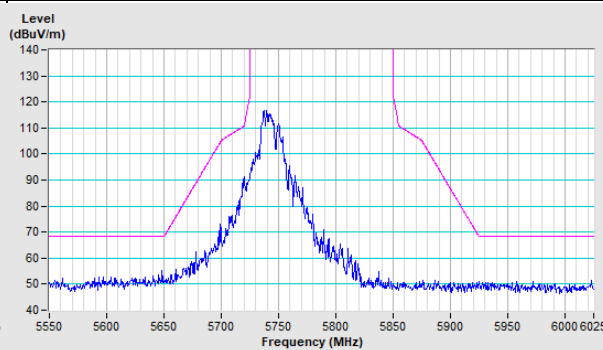
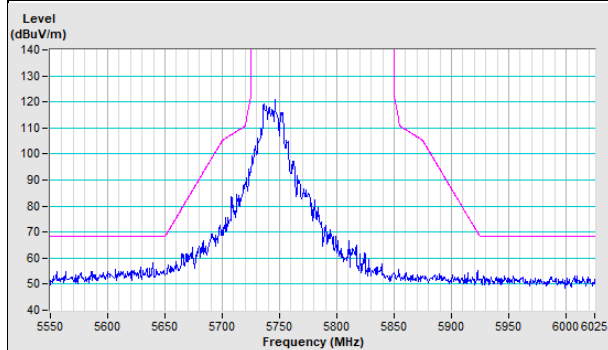

802.11be (EHT) 106+26-tone MRU Channel 165

Horizontal (Peak) Vertical (Peak)

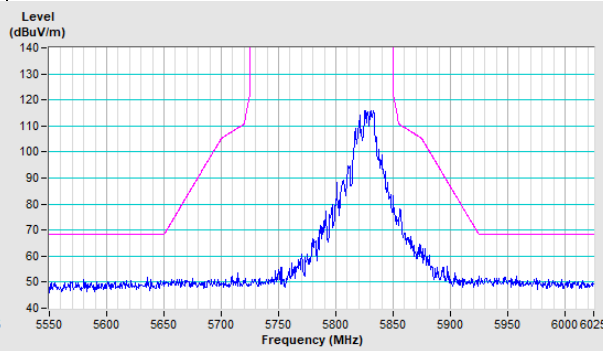
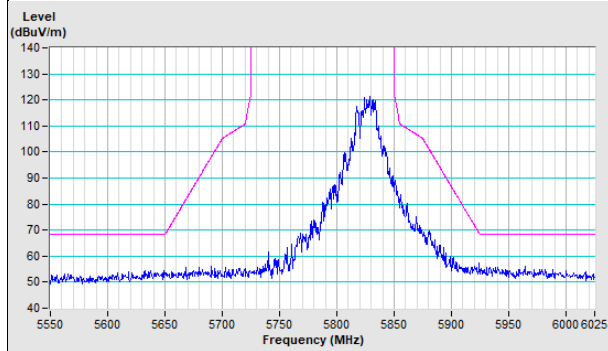

802.11be (EHT) 52+26-tone MRU Channel 36

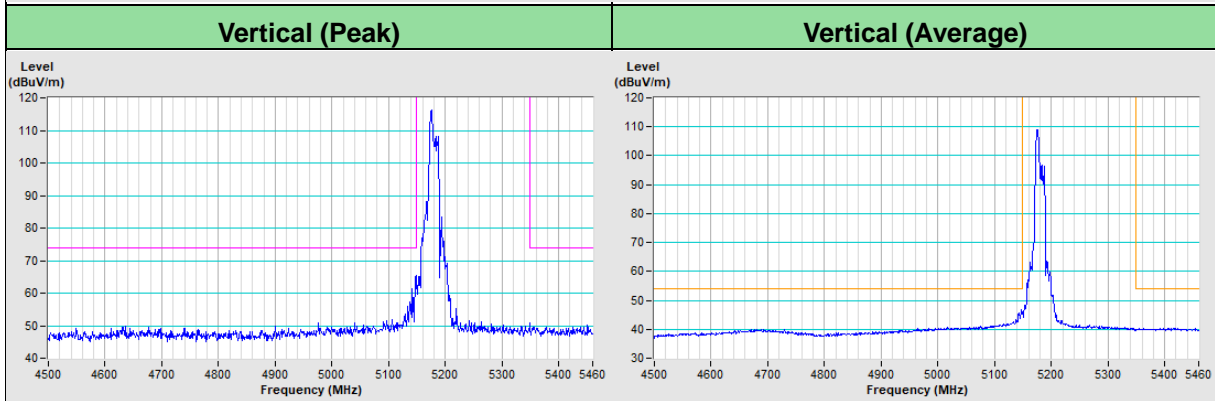
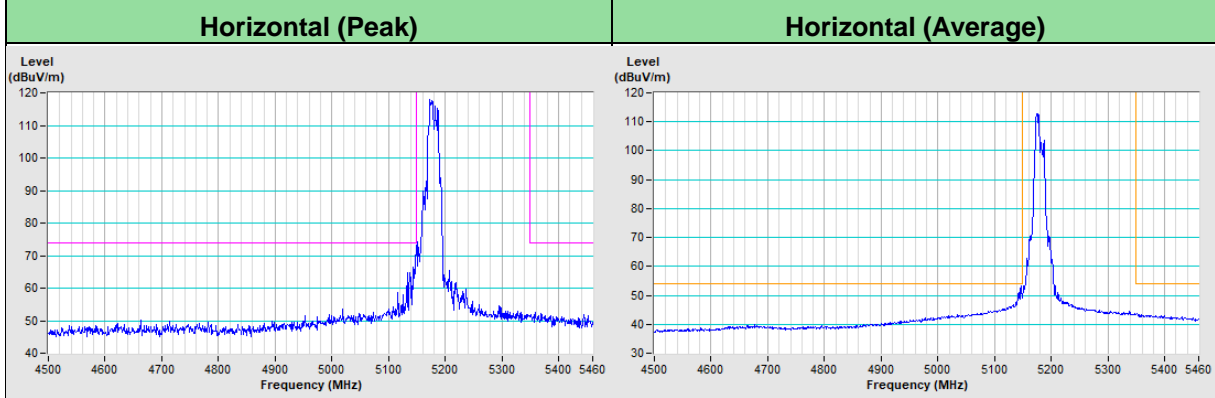

802.11be (EHT) 52+26-tone MRU Channel 149

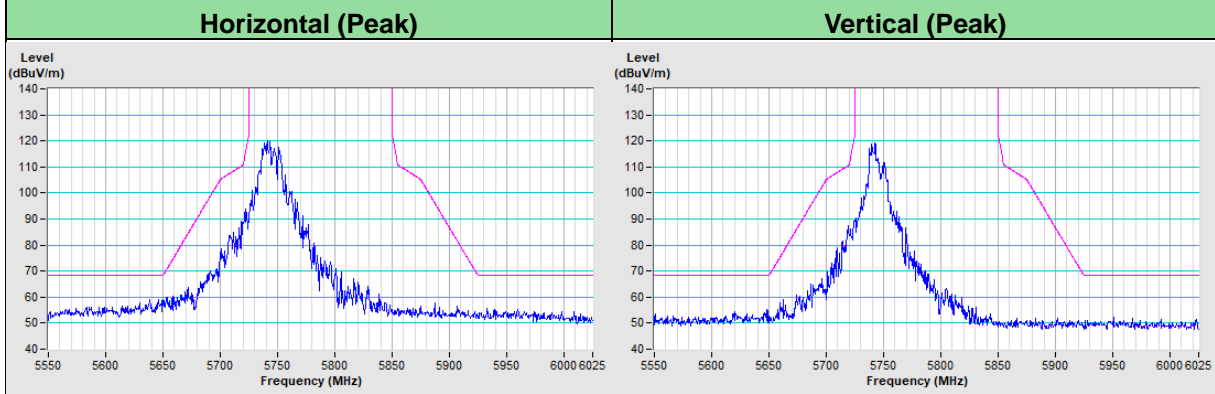

802.11be (EHT) 52+26-tone MRU Channel 165

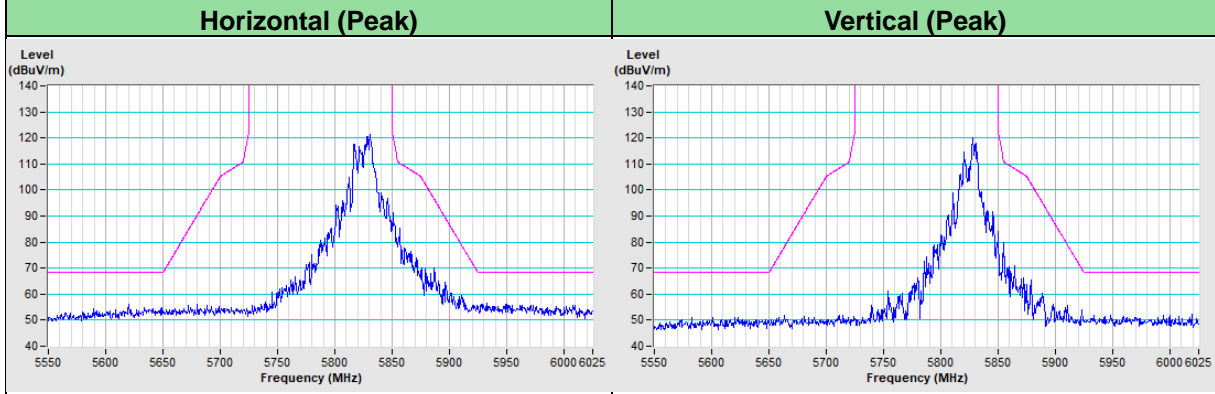

802.11be (EHT) 484+242-tone MRU Channel 42

Horizontal (Peak)	Horizontal (Average)
--------------------------	-----------------------------

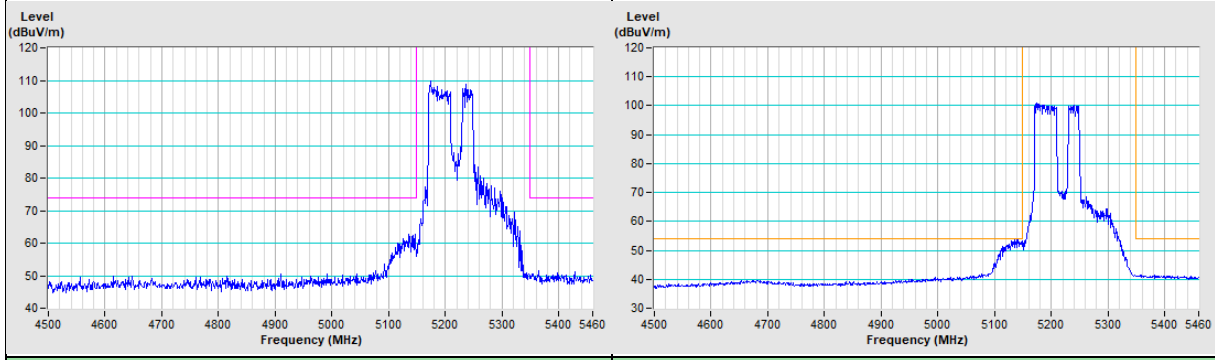

Vertical (Peak)	Vertical (Average)
------------------------	---------------------------

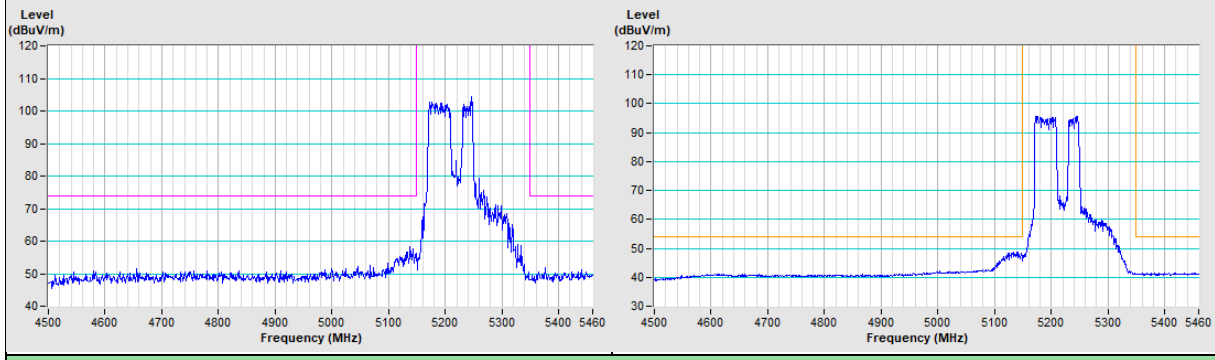

802.11be (EHT) 484+242-tone MRU Channel 155

Horizontal (Peak)	Vertical (Peak)
--------------------------	------------------------

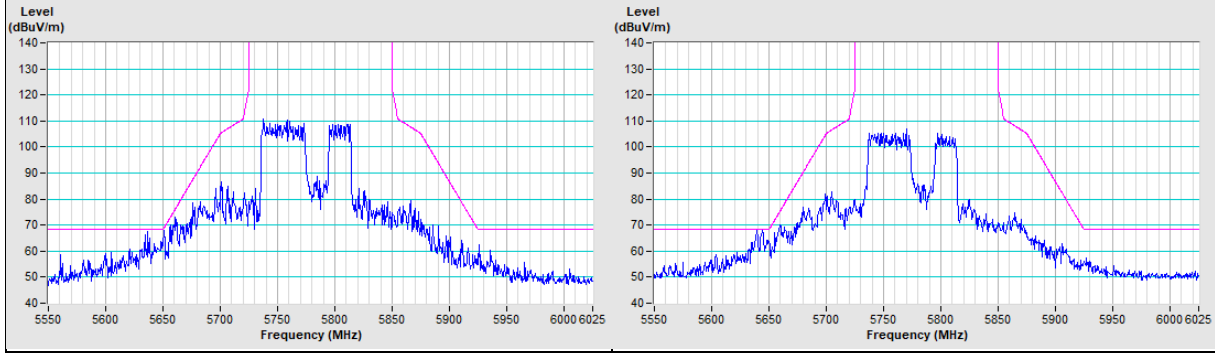

8 Pictures of Test Arrangements

Please refer to the attached file (Test Setup Photo)

9 Information of the Testing Laboratories

We, Bureau Veritas Consumer Products Services (H.K.) Ltd., Taoyuan Branch, were founded in 1988 to provide our best service in EMC, Radio, Telecom and Safety consultation. Our laboratories are FCC recognized accredited test firms and accredited according to ISO/IEC 17025.

If you have any comments, please feel free to contact us at the following:

Lin Kou EMC/RF Lab

Tel: 886-2-26052180

Fax: 886-2-26051924

Hsin Chu EMC/RF/Telecom Lab

Tel: 886-3-6668565

Fax: 886-3-6668323

Hwa Ya EMC/RF/Safety Lab

Tel: 886-3-3183232

Fax: 886-3-3270892

Email: service.adt@bureauveritas.com

Web Site: <http://ee.bureauveritas.com.tw>

The address and road map of all our labs can be found in our web site also.

--- END ---