

TEST REPORT

CERTIFICATE OF CONFORMITY

Standard: 47 CFR FCC Part 15, Subpart E (Section 15.407)
Report No.: RFBARR-WTW-P22060042A-2
FCC ID: RAS-MT7927
Product: 2TX 11be (WiFi7) BW320 + BT/BLE Combo Card
Brand: MediaTek
Model No.: MT7927
Received Date: 2022/10/6
Test Date: 2022/12/21 ~ 2023/2/9
Issued Date: 2023/3/23

Applicant: MediaTek Inc.

Address: No. 1, Dusing 1st Rd., Hsinchu Science Park, Hsinchu City, 30078 Taiwan

Issued By: Bureau Veritas Consumer Products Services (H.K.) Ltd., Taoyuan Branch
Hsin Chu Laboratory

Lab Address: E-2, No.1, Li Hsin 1st Road, Hsinchu Science Park, Hsinchu City 300, Taiwan

Test Location (1): E-2, No.1, Li Hsin 1st Road, Hsinchu Science Park, Hsinchu City 300, Taiwan

FCC Registration / 723255 / TW2022

Designation Number:

Test Location (2): No.19, Hwa Ya 2nd Rd., Wen Hwa Vil., Kwei Shan Dist., Taoyuan City 33383, TAIWAN

FCC Registration / 788550 / TW0003

Designation Number:

Approved by: _____

May Chen / Manager

Date: _____

2023/3/23

This test report consists of 781 pages in total. It may be duplicated completely for legal use with the approval of the applicant. It should not be reproduced except in full, without the written approval of our laboratory. The test results in the report only apply to the tested sample. The test results in this report are traceable to the national or international standards.



Prepared by : Vivian Huang / Specialist

This report is governed by, and incorporates by reference, the Conditions of Testing as posted at the date of issuance of this report at <http://www.bureauveritas.com/home/about-us/our-business/cps/about-us/terms-conditions/>, and is intended for your exclusive use. Any copying or replication of this report to or for any other person or entity, or use of our name or trademark, is permitted only with our prior written permission. This report sets forth our findings solely with respect to the test samples identified herein. The results set forth in this report are not indicative or representative of the quality or characteristics of the lot from which a test sample was taken or any similar or identical product unless specifically and expressly noted. Our report includes all of the tests requested by you and the results thereof based upon the information that you provided to us. Measurement uncertainty is only provided upon request for accredited tests. Statements of conformity are based on simple acceptance criteria without taking measurement uncertainty into account, unless otherwise requested in writing. You have 60 days from date of issuance of this report to notify us of any material error or omission caused by our negligence or if you require measurement uncertainty; provided, however, that such notice shall be in writing and shall specifically address the issue you wish to raise. A failure to raise such issue within the prescribed time shall constitute your unqualified acceptance of the completeness of this report, the tests conducted and the correctness of the report contents.

This report contains Content-based Protocol test data that was produced under subcontract by Bureau Veritas Consumer Products Services (H.K.) Ltd., Taoyuan Branch Lin Kou Laboratories.

Table of Contents

Release Control Record	4
1 Certificate	5
2 Summary of Test Results	6
2.1 Measurement Uncertainty	6
2.2 Supplementary Information	6
3 General Information	7
3.1 General Description of EUT	7
3.2 Antenna Description of EUT	9
3.3 Channel List	11
3.4 Test Mode Applicability and Tested Channel Detail	15
3.5 Duty Cycle of Test Signal	21
3.6 Test Program Used and Operation Descriptions	26
3.7 Connection Diagram of EUT and Peripheral Devices	26
3.8 Configuration of Peripheral Devices and Cable Connections	27
4 Test Instruments	28
4.1 RF Output Power	28
4.2 Power Spectral Density	28
4.3 Emission Bandwidth	28
4.4 In-Band Emission Mask	28
4.5 Occupied Bandwidth	28
4.6 Contention-based Protocol	29
4.7 AC Power Conducted Emissions	30
4.8 Unwanted Emissions below 1 GHz	30
4.9 Unwanted Emissions above 1 GHz	31
5 Limits of Test Items	32
5.1 RF Output Power	32
5.2 Power Spectral Density	32
5.3 Emission Bandwidth	32
5.4 In-Band Emission Mask	32
5.5 Occupied Bandwidth	32
5.6 Contention-based Protocol	33
5.7 AC Power Conducted Emissions	33
5.8 Unwanted Emissions below 1 GHz	33
5.9 Unwanted Emissions above 1 GHz	34
6 Test Arrangements	35
6.1 RF Output Power	35
6.1.1 Test Setup	35
6.1.2 Test Procedure	35
6.2 Power Spectral Density	35
6.2.1 Test Setup	35
6.2.2 Test Procedure	35
6.3 Emission Bandwidth	36
6.3.1 Test Setup	36
6.3.2 Test Procedure	36
6.4 In-Band Emission Mask	36
6.4.1 Test Setup	36
6.4.2 Test Procedure	36
6.5 Occupied Bandwidth	37
6.5.1 Test Setup	37
6.5.2 Test Procedure	37
6.6 Contention-based Protocol	38
6.6.1 Test Setup	38
6.6.2 Test Procedure	38
6.7 AC Power Conducted Emissions	39



6.7.1	Test Setup	39
6.7.2	Test Procedure	39
6.8	Unwanted Emissions below 1 GHz	40
6.8.1	Test Setup	40
6.8.2	Test Procedure	41
6.9	Unwanted Emissions above 1 GHz	42
6.9.1	Test Setup	42
6.9.2	Test Procedure	43
7	Test Results of Test Item	44
7.1	RF Output Power	44
7.2	Power Spectral Density	53
7.3	Emission Bandwidth	67
7.4	In-Band Emission Mask	77
7.5	Occupied Bandwidth	107
7.6	Contention-based Protocol (Subcontract Item)	117
7.7	AC Power Conducted Emissions	141
7.8	Unwanted Emissions below 1 GHz	145
7.9	Unwanted Emissions above 1 GHz	152
8	Operational Restrictions for 6 GHz U-NII Devices	779
9	Pictures of Test Arrangements	780
10	Information of the Testing Laboratories	781



Release Control Record

Issue No.	Description	Date Issued
RFBARR-WTW-P22060042A-2	Original release.	2023/3/23

1 Certificate

Product: 2TX 11be (WiFi7) BW320 + BT/BLE Combo Card

Brand: MediaTek

Test Model: MT7927

Sample Status: Engineering sample

Applicant: MediaTek Inc.

Test Date: 2022/12/21 ~ 2023/2/9

Standard: 47 CFR FCC Part 15, Subpart E (Section 15.407)

Measurement ANSI C63.10-2013

procedure:

KDB 987594 D02 U-NII 6 GHz EMC Measurement v01v01

KDB 789033 D02 General UNII Test Procedure New Rules v02r01

KDB 662911 D01 Multiple Transmitter Output v02r01

The above equipment has been tested by **Bureau Veritas Consumer Products Services (H.K.) Ltd., Taoyuan Branch**, and found compliance with the requirement of the above standards. The test record, data evaluation & Equipment Under Test (EUT) configurations represented herein are true and accurate accounts of the measurements of the sample's RF characteristics under the conditions specified in this report.

2 Summary of Test Results

47 CFR FCC Part 15, Subpart E (Section 15.407)			
Clause	Test Item	Result	Remark
15.407(a)(8)	RF Output Power	Pass	Meet the requirement of limit.
15.407(a)(8)	Power Spectral Density	Pass	Meet the requirement of limit.
15.407(a)(10)	Occupied Bandwidth	Pass	Meet the requirement of limit.
15.407(b)(9)	AC Power Conducted Emissions	Pass	Minimum passing margin is -6.35 dB at 0.15199 MHz
15.407(b)(9)	Unwanted Emissions below 1 GHz	Pass	Minimum passing margin is -3.0 dB at 897.89 MHz
15.407(b)(6) 15.407(b)(10)	Unwanted Emissions above 1 GHz	Pass	Minimum passing margin is -14.9 dB at 19755.00 MHz
15.407(b)(7)	In-Band Emission Mask	Pass	Meet the requirement of limit.
15.407(d)(6)	Contention-based Protocol	Pass	Meet the requirement of limit.
15.407(g)	Frequency Stability	NA	Refer to Note 1 below
15.407(d)	Operational restrictions for 6 GHz U-NII devices	Pass	Declaration by applicant
15.203	Antenna Requirement	Pass	Antenna connector is ipex(MHF) not a standard connector.
---	Emission Bandwidth	-	Reference only.

Notes:

1. All test items (except Frequency Stability) were performed for this addendum. The others testing data refer to original test report.
2. Determining compliance based on the results of the compliance measurement, not taking into account measurement instrumentation uncertainty.

2.1 Measurement Uncertainty

Where relevant, the following measurement uncertainty levels have been estimated for tests performed on the EUT as specified in CISPR 16-4-2:

Measurement	Specification	Expanded Uncertainty (k=2) (±)
AC Power Conducted Emissions	150 kHz ~ 30 MHz	1.9 dB
Unwanted Emissions below 1 GHz	9 kHz ~ 30 MHz	3.1 dB
	30 MHz ~ 1 GHz	5.5 dB
Unwanted Emissions above 1 GHz	1 GHz ~ 18 GHz	5.1 dB
	18 GHz ~ 40 GHz	5.3 dB

The other instruments specified are routine verified to remain within the calibrated levels, no measurement uncertainty is required to be calculated.

2.2 Supplementary Information

There is not any deviation from the test standards for the test method, and no modifications required for compliance.

3 General Information

3.1 General Description of EUT

Product	2TX 11be (WiFi7) BW320 + BT/BLE Combo Card
Brand	MediaTek
Test Model	MT7927
Status of EUT	Engineering sample
Power Supply Rating	3.3Vdc from host equipment
Modulation Type	64QAM, 16QAM, QPSK, BPSK for OFDM 1024QAM for OFDMA in 11ax mode 4096QAM for OFDMA in 11be mode
Modulation Technology	OFDM, OFDMA
Transfer Rate	802.11a: up to 54 Mbps 802.11ax: up to 1201.0 Mbps 802.11be: up to 5764.8 Mbps
Operating Frequency	5.955 ~ 6.425GHz, 6.425 ~ 6.525GHz, 6.525 ~ 6.875GHz, 6.875 ~ 7.115GHz
Number of Channel	802.11a/ax (HE20), 802.11be (EHT20): 59 802.11ax (HE40), 802.11be (EHT40): 29 802.11ax (HE80), 802.11be (EHT80): 14 802.11ax (HE160), 802.11be (EHT160): 7 802.11be (EHT320): 6
Resource Unit (RU)	Single RU: 26-tone, 52-tone, 106-tone, 242-tone, 484-tone, 996-tone Multi-RU(Small RU):52-tone + 26-tone, 106-tone + 26-tone Multi-RU (Large RU):484-tone + 242-tone, 996-tone + 484-tone, 2 * 996-tone
Channel Puncturing (Large RU)	80 MHz punctured by 20 MHz ; 160 MHz punctured by 20 MHz 160 MHz punctured by 40 MHz
Output Power	5.955 GHz ~ 6.425 GHz : EIRP: 193.983 mW (22.88 dBm) 6.425 GHz ~ 6.525 GHz : EIRP: 54.534 mW (17.37 dBm) 6.525 GHz ~ 6.875 GHz : EIRP: 189.672 mW (22.78 dBm) 6.875 GHz ~ 7.115 GHz : EIRP: 177.665 mW (22.5 dBm)
EUT Category	Client Device (controlled of an indoor AP)

Note:

- This is a supplementary report of Report No: RFBARR-WTW-P22060042-2 R1. The differences between them are as below information:
 - ◆ Enabling Tone RU / MRU (2T).
- According to above conditions, all test items (except Frequency Stability) need to be performed. And all data are verified to meet the requirement.
- There are Bluetooth and WLAN (2.4GHz & 5GHz & 6GHz) technology used for the EUT.
- Simultaneously transmission condition.

Condition	Technology	
1	WLAN (5GHz or 5.9GHz)	Bluetooth
2	WLAN (6GHz)	Bluetooth
3	WLAN (2.4GHz)	WLAN (5GHz or 5.9GHz)
4	WLAN (2.4GHz)	WLAN (6GHz)

Note: The emission of the simultaneous operation has been evaluated and no non-compliance was found.

5. The EUT support MRU mode is listed as below.

BW	Small size		Large size					
	26+52	26+106	484+242	996+484	996+484+242	996*2+484	996*3	996*3+484
20MHz	v	v	-	-	-	-	-	-
40MHz	v	v	-	-	-	-	-	-
80MHz	v	v	v	-	-	-	-	-
160MHz	v	v	v	v	v	-	-	-
320MHz	v	v	v	v	v	v	v	v

6. The above EUT information is declared by manufacturer and for more detailed features description, please refers to the manufacturer's specifications or user's manual.

3.2 Antenna Description of EUT

1. The antenna information is listed as below.

Antenna Set No	RF Chain No.	Brand	Model	Antenna Net Gain (dBi)	Frequency Range (GHz)	Antenna Type	Connector Type	Cable Length (mm)
1	Chain0	PSA	RFMTA340718EMLB302	3.18	2.4~2.4835	PIFA	ipex(MHF)	200
				4.92	5.15~5.895			
	Chain1	PSA	RFMTA340718EMLB302	3.18	2.4~2.4835	PIFA	ipex(MHF)	
				4.92	5.15~5.895			
2	Chain0	PSA	RFMTA311020EMMB301	1.71	2.4~2.4835	PIFA	ipex(MHF)	
				4.82	5.15~5.895			
				4.76	5.925~6.425			
				4.29	6.425~6.525			
				4.61	6.525~6.875			
	Chain1	PSA	RFMTA311020EMMB301	4.09	6.875~7.125	PIFA	ipex(MHF)	
				1.71	2.4~2.4835			
				4.82	5.15~5.895			
				4.76	5.925~6.425			
				4.29	6.425~6.525			
3	Chain0	PSA	RFMTA421208IMMB701	-4.99	5.925~7.125	PIFA	i-pex(MHF)	300
	Chain1	PSA	RFMTA421208IMMB701	-4.99	5.925~7.125	PIFA	i-pex(MHF)	300

Note:

- From the above transmission chains, the worse case was found in transmission on Chain 0 for 1TX diversity sample. Therefore only the test data of the mode was recorded in this report.
- Max. gain was selected for the final test.

* Detail antenna specification please refer to antenna datasheet and/or antenna measurement report.

2. The EUT incorporates a MIMO function:

6GHz Band				
MODULATION MODE	TX configuration		CDD mode	Beamforming mode
802.11a	SISO	1TX	Not Support	Not Support
802.11ax (HE20)		1TX	Not Support	Not Support
802.11ax (HE40)		1TX	Not Support	Not Support
802.11ax (HE80)		1TX	Not Support	Not Support
802.11ax (HE160)		1TX	Not Support	Not Support
802.11be (EHT20)		1TX	Not Support	Not Support
802.11be (EHT40)		1TX	Not Support	Not Support
802.11be (EHT80)		1TX	Not Support	Not Support
802.11be (EHT160)		1TX	Not Support	Not Support
802.11be (EHT320)		1TX	Not Support	Not Support
802.11a		MIMO	2TX	Support
802.11ax (HE20)	2TX		Support NSS2	Not Support
802.11ax (HE40)	2TX		Support NSS2	Not Support
802.11ax (HE80)	2TX		Support NSS2	Not Support
802.11ax (HE160)	2TX		Support NSS2	Not Support
802.11be (EHT20)	2TX		Support NSS2	Not Support
802.11be (EHT40)	2TX		Support NSS2	Not Support
802.11be (EHT80)	2TX		Support NSS2	Not Support
802.11be (EHT160)	2TX		Support NSS2	Not Support
802.11be (EHT320)	2TX		Support NSS2	Not Support

Note: The modulation and bandwidth are similar for 802.11ax mode for 20MHz (40MHz, 80MHz, 160MHz) and 802.11be mode for 20MHz (40MHz, 80MHz, 160MHz) therefore the manufacturer will control the power for 802.11ax/be mode and investigated worst case to representative mode in test report. (Final test mode refer to section 3.4)

3.3 Channel List

U-NII-5

24 channels are provided for 802.11a, 802.11ax (HE20), 802.11be (EHT20):

Channel	Frequency	Channel	Frequency	Channel	Frequency	Channel	Frequency
1	5955 MHz	5	5975 MHz	9	5955 MHz	13	6015 MHz
17	6035 MHz	21	6055 MHz	25	6075 MHz	29	6095 MHz
33	6115 MHz	37	6135 MHz	41	6155 MHz	45	6175 MHz
49	6195 MHz	53	6215 MHz	57	6235 MHz	61	6255 MHz
65	6275 MHz	69	6295 MHz	73	6315 MHz	77	6335 MHz
81	6355 MHz	85	6375 MHz	89	6395 MHz	93	6415MHz

12 channels are provided for 802.11ax (HE40), 802.11be (EHT40):

Channel	Frequency	Channel	Frequency	Channel	Frequency	Channel	Frequency
3	5965 MHz	11	6005 MHz	19	6045 MHz	27	6085 MHz
35	6125 MHz	43	6165 MHz	51	6205 MHz	59	6245 MHz
67	6285 MHz	75	6325 MHz	83	6365 MHz	91	6405 MHz

6 channels are provided for 802.11ax (HE80), 802.11be (EHT80):

Channel	Frequency	Channel	Frequency	Channel	Frequency	Channel	Frequency
7	5985 MHz	23	6065 MHz	39	6145 MHz	55	6225 MHz
71	6305 MHz	87	6385 MHz				

3 channels are provided for 802.11ax (HE160), 802.11be (EHT160):

Channel	Frequency	Channel	Frequency	Channel	Frequency
15	6025 MHz	47	6185 MHz	79	6345 MHz

2 channels are provided for 802.11be (EHT320):

Channel	Frequency	Channel	Frequency
31	6105 MHz	63	6265 MHz

U-NII-6

5 channels are provided for 802.11a, 802.11ax (HE20), 802.11be (EHT20):

Channel	Frequency	Channel	Frequency	Channel	Frequency	Channel	Frequency
97	6435 MHz	101	6455 MHz	105	6475 MHz	109	6495 MHz
113	6515 MHz						

3 channels are provided for 802.11ax (HE40), 802.11be (EHT40):

Channel	Frequency	Channel	Frequency	Channel	Frequency
99	6445 MHz	107	6485 MHz	*115	6525 MHz

1 channel is provided for 802.11ax (HE80), 802.11be (EHT80):

Channel	Frequency
103	6465 MHz

1 channel is provided for 802.11ax (HE160), 802.11be (EHT160):

Channel	Frequency
*111	6505 MHz

1 channel is provided for 802.11be (EHT320):

Channel	Frequency
*95	6425 MHz

U-NII-7

18 channels are provided for 802.11a, 802.11ax (HE20), 802.11be (EHT20):

Channel	Frequency	Channel	Frequency	Channel	Frequency	Channel	Frequency
117	6535 MHz	121	6555 MHz	125	6575 MHz	129	6595 MHz
133	6615 MHz	137	6635 MHz	141	6655 MHz	145	6675 MHz
149	6695 MHz	153	6715 MHz	157	6735 MHz	161	6755 MHz
165	6775 MHz	169	6795 MHz	173	6815 MHz	177	6835 MHz
181	6855 MHz	*185	6875 MHz				

8 channels are provided for 802.11ax (HE40), 802.11be (EHT40):

Channel	Frequency	Channel	Frequency	Channel	Frequency	Channel	Frequency
123	6565 MHz	131	6605 MHz	139	6645 MHz	147	6685 MHz
155	6725 MHz	163	6765 MHz	171	6805 MHz	179	6845 MHz

5 channels are provided for 802.11ax (HE80), 802.11be (EHT80):

Channel	Frequency	Channel	Frequency	Channel	Frequency	Channel	Frequency
*119	6545 MHz	135	6625 MHz	151	6705 MHz	167	6785 MHz
*183	6865 MHz						

2 channels are provided for 802.11ax (HE160), 802.11be (EHT160):

Channel	Frequency	Channel	Frequency
143	6665 MHz	*175	6825 MHz

2 channels are provided for 802.11be (EHT320):

Channel	Frequency	Channel	Frequency
*127	6585 MHz	*159	6745 MHz

U-NII-8

12 channels are provided for 802.11a, 802.11ax (HE20), 802.11be (EHT20):

Channel	Frequency	Channel	Frequency	Channel	Frequency	Channel	Frequency
189	6895 MHz	193	6915 MHz	197	6935 MHz	201	6955 MHz
205	6975 MHz	209	6995 MHz	213	7015 MHz	217	7035 MHz
221	7055 MHz	225	7075 MHz	229	7095 MHz	233	7115 MHz

6 channels are provided for 802.11ax (HE40), 802.11be (EHT40):

Channel	Frequency	Channel	Frequency	Channel	Frequency
*187	6885 MHz	195	6925 MHz	203	6965 MHz
211	7005 MHz	219	7045 MHz	227	7085 MHz

2 channels are provided for 802.11ax (HE80), 802.11be (EHT80):

Channel	Frequency	Channel	Frequency
199	6945 MHz	215	7025 MHz

1 channel is provided for 802.11ax (HE160), 802.11be (EHT160):

Channel	Frequency
207	6985 MHz

1 channel is provided for 802.11be (EHT320):

Channel	Frequency
*191	6905 MHz

Note: * mean this's straddle channel.

3.4 Test Mode Applicability and Tested Channel Detail

Pre-Scan:	1. EUT can be used in the following ways: X-axis/ Y-axis/ Z-axis. Pre-scan these ways and find the worst case as a representative test condition.
Worst Case:	1. In the original report: X-axis/ Y-axis/ Z-axis Worst Condition: Z-axis

Following channel(s) was (were) selected for the final test as listed below:

Test Item	EUT Configure Mode	Mode	Signal Mode	Tested Channel	Modulation	Data Rate Parameter
RF Output Power / Power Spectral Density	A	20 MHz Preamble 802.11ax (RU26)	1T1S / 2T2S	1(26/0), 93(26/8), 97(26/0), 117(26/0), 181(26/8), 233(26/8)	BPSK	MCS0
		20 MHz Preamble 802.11ax (RU52)	1T1S / 2T2S	1(52/37), 93(52/40), 97(52/37), 17(52/37), 181(52/40), 33(52/40)	BPSK	MCS0
		20 MHz Preamble 802.11ax (RU106)	1T1S / 2T2S	1(106/53), 93(106/54), 97(106/53), 117(106/53), 181(106/40), 233(106/40)	BPSK	MCS0
		20 MHz Preamble 802.11be (RU52+26)	1T1S / 2T2S	1(78/70), 93(78/72), 97(78/70), 117(78/70), 181(78/72), 233(78/72)	BPSK	MCS0
		20 MHz Preamble 802.11be (RU26+106)	1T1S / 2T2S	1(132/82), 93(132/83), 97(132/82), 117(132/82), 181(132/83), 233(132/83)	BPSK	MCS0
		80 MHz Preamble 802.11be (RU484+242)	1T1S / 2T2S	7(726/93), 87(726/90), 103(726/93), 135(726/93), 215 (726/90)	BPSK	MCS0
		160 MHz Preamble 802.11be (RU996+484)	1T1S / 2T2S	15(1480/95-1), 79(1480/94-0*), 143(1480/95-1), 207(1480/94-0*)	BPSK	MCS0
		160 MHz Preamble 802.11be (RU996+484+242)	1T1S / 2T2S	15(1722/99-1), 79(1722/96-0), 143(1722/99-1), 207(1722/96-0)	BPSK	MCS0
		320 MHz Preamble 802.11be (RU996*2+484)	1T1S / 2T2S	31(2476/101-1/0), 63(2476/102-0/1) , 127(2476/101-1/0), 191(2476/102-0/1)	BPSK	MCS0
		320 MHz Preamble 802.11be (RU996*3)	1T1S / 2T2S	31(2988/104-1/1), 63(2988/104-0/0) , 127(2988/104-1/1), 191(2988/104-0/0)	BPSK	MCS0
		320 MHz Preamble 802.11be (RU996*3+484)	1T1S / 2T2S	31(3472/106-1/1), 63(3472/105-0/0) , 127(3472/106-1/1), 191(3472/105-0/0)	BPSK	MCS0

Test Item	EUT Configure Mode	Mode	Signal Mode	Tested Channel	Modulation	Data Rate Parameter
Emission Bandwidth	A	20 MHz Preamble 802.11ax (RU26)	1T1S / 2T2S	1(26/0), 93(26/8), 97(26/0), 117(26/0), 181(26/8), 233(26/8)	BPSK	MCS0
		20 MHz Preamble 802.11ax (RU52)	1T1S / 2T2S	1(52/37), 93(52/40), 97(52/37), 117(52/37), 181(52/40), 233(52/40)	BPSK	MCS0
		20 MHz Preamble 802.11ax (RU106)	1T1S / 2T2S	1(106/53), 93(106/54), 97(106/53), 117(106/53), 181(106/40), 233(106/40)	BPSK	MCS0
		20 MHz Preamble 802.11be (RU52+26)	1T1S / 2T2S	1(78/70), 93(78/72), 97(78/70), 117(78/70), 181(78/72), 233(78/72)	BPSK	MCS0
		20 MHz Preamble 802.11be (RU26+106)	1T1S / 2T2S	1(132/82), 93(132/83), 97(132/82), 117(132/82), 181(132/83), 233(132/83)	BPSK	MCS0
		80 MHz Preamble 802.11be (RU484+242)	1T1S / 2T2S	7(726/93), 87(726/90), 103(726/93), 135(726/93), 215 (726/90)	BPSK	MCS0
		160 MHz Preamble 802.11be (RU996+484)	1T1S / 2T2S	15(1480/95-1), 79(1480/94-0*), 143(1480/95-1), 207(1480/94-0*)	BPSK	MCS0
		160 MHz Preamble 802.11be (RU996+484+242)	1T1S / 2T2S	15(1722/99-1), 79(1722/96-0), 143(1722/99-1), 207(1722/96-0)	BPSK	MCS0
		320 MHz Preamble 802.11be (RU996*2+484)	1T1S / 2T2S	31(2476/101-1/0), 63(2476/102-0/1) , 127(2476/101-1/0), 191(2476/102-0/1)	BPSK	MCS0
		320 MHz Preamble 802.11be (RU996*3)	1T1S / 2T2S	31(2988/104-1/1), 63(2988/104-0/0) , 127(2988/104-1/1), 191(2988/104-0/0)	BPSK	MCS0
		320 MHz Preamble 802.11be (RU996*3+484)	1T1S / 2T2S	31(3472/106-1/1), 63(3472/105-0/0) , 127(3472/106-1/1), 191(3472/105-0/0)	BPSK	MCS0

Test Item	EUT Configure Mode	Mode	Signal Mode	Tested Channel	Modulation	Data Rate Parameter
In-Band Emission Mask	A	20 MHz Preamble 802.11ax (RU26)	1T1S / 2T2S	1(26/0), 93(26/8), 97(26/0), 117(26/0), 181(26/8), 233(26/8)	BPSK	MCS0
		20 MHz Preamble 802.11ax (RU52)	1T1S / 2T2S	1(52/37), 93(52/40), 97(52/37), 117(52/37), 181(52/40), 233(52/40)	BPSK	MCS0
		20 MHz Preamble 802.11ax (RU106)	1T1S / 2T2S	1(106/53), 93(106/54), 97(106/53), 117(106/53), 181(106/40), 233(106/40)	BPSK	MCS0
		20 MHz Preamble 802.11be (RU52+26)	1T1S / 2T2S	1(78/70), 93(78/72), 97(78/70), 117(78/70), 181(78/72), 233(78/72)	BPSK	MCS0
		20 MHz Preamble 802.11be (RU26+106)	1T1S / 2T2S	1(132/82), 93(132/83), 97(132/82), 117(132/82), 181(132/83), 233(132/83)	BPSK	MCS0
		80 MHz Preamble 802.11be (RU484+242)	1T1S / 2T2S	7(726/93), 87(726/90), 103(726/93), 135(726/93), 215 (726/90)	BPSK	MCS0
		160 MHz Preamble 802.11be (RU996+484)	1T1S / 2T2S	15(1480/95-1), 79(1480/94-0*), 143(1480/95-1), 207(1480/94-0*)	BPSK	MCS0
		160 MHz Preamble 802.11be (RU996+484+242)	1T1S / 2T2S	15(1722/99-1), 79(1722/96-0), 143(1722/99-1), 207(1722/96-0)	BPSK	MCS0
		320 MHz Preamble 802.11be (RU996*2+484)	1T1S / 2T2S	31(2476/101-1/0), 63(2476/102-0/1) , 127(2476/101-1/0), 191(2476/102-0/1)	BPSK	MCS0
		320 MHz Preamble 802.11be (RU996*3)	1T1S / 2T2S	31(2988/104-1/1), 63(2988/104-0/0) , 127(2988/104-1/1), 191(2988/104-0/0)	BPSK	MCS0
		320 MHz Preamble 802.11be (RU996*3+484)	1T1S / 2T2S	31(3472/106-1/1), 63(3472/105-0/0) , 127(3472/106-1/1), 191(3472/105-0/0)	BPSK	MCS0

Test Item	EUT Configure Mode	Mode	Signal Mode	Tested Channel	Modulation	Data Rate Parameter
Occupied Bandwidth	A	20 MHz Preamble 802.11ax (RU26)	1T1S / 2T2S	1(26/0), 93(26/8), 97(26/0), 117(26/0), 181(26/8), 233(26/8)	BPSK	MCS0
		20 MHz Preamble 802.11ax (RU52)	1T1S / 2T2S	1(52/37), 93(52/40), 97(52/37), 117(52/37), 181(52/40), 233(52/40)	BPSK	MCS0
		20 MHz Preamble 802.11ax (RU106)	1T1S / 2T2S	1(106/53), 93(106/54), 97(106/53), 117(106/53), 181(106/40), 233(106/40)	BPSK	MCS0
		20 MHz Preamble 802.11be (RU52+26)	1T1S / 2T2S	1(78/70), 93(78/72), 97(78/70), 117(78/70), 181(78/72), 233(78/72)	BPSK	MCS0
		20 MHz Preamble 802.11be (RU26+106)	1T1S / 2T2S	1(132/82), 93(132/83), 97(132/82), 117(132/82), 181(132/83), 233(132/83)	BPSK	MCS0
		80 MHz Preamble 802.11be (RU484+242)	1T1S / 2T2S	7(726/93), 87(726/90), 103(726/93), 135(726/93), 215 (726/90)	BPSK	MCS0
		160 MHz Preamble 802.11be (RU996+484)	1T1S / 2T2S	15(1480/95-1), 79(1480/94-0*), 143(1480/95-1), 207(1480/94-0*)	BPSK	MCS0
		160 MHz Preamble 802.11be (RU996+484+242)	1T1S / 2T2S	15(1722/99-1), 79(1722/96-0), 143(1722/99-1), 207(1722/96-0)	BPSK	MCS0
		320 MHz Preamble 802.11be (RU996*2+484)	1T1S / 2T2S	31(2476/101-1/0), 63(2476/102-0/1) , 127(2476/101-1/0), 191(2476/102-0/1)	BPSK	MCS0
		320 MHz Preamble 802.11be (RU996*3)	1T1S / 2T2S	31(2988/104-1/1), 63(2988/104-0/0) , 127(2988/104-1/1), 191(2988/104-0/0)	BPSK	MCS0
		320 MHz Preamble 802.11be (RU996*3+484)	1T1S / 2T2S	31(3472/106-1/1), 63(3472/105-0/0) , 127(3472/106-1/1), 191(3472/105-0/0)	BPSK	MCS0

Test Item	EUT Configure Mode	Mode	Signal Mode	Tested Channel	Modulation	Data Rate Parameter
Contention-based Protocol	A	802.11be (EHT20)	1T1S / 2T2S	45, 105, 149, 209	BPSK	MCS0
		802.11be (EHT320)	1T1S / 2T2S	31, 95, 159, 191	BPSK	MCS0
AC Power Conducted Emissions	B	320 MHz Preamble 802.11be (RU996*2+484)	1T1S	63	BPSK	MCS0
		320 MHz Preamble 802.11be (RU996*3+484)	2T2S	31	BPSK	MCS0
Unwanted Emissions below 1 GHz	A, B	320 MHz Preamble 802.11be (RU996*2+484)	1T1S	63	BPSK	MCS0
		320 MHz Preamble 802.11be (RU996*3+484)	2T2S	31	BPSK	MCS0
Unwanted Emissions above 1 GHz	A, B	20 MHz Preamble 802.11ax (RU26)	1T1S / 2T2S	1(26/0), 93(26/8), 97(26/0), 117(26/0), 181(26/8), 233(26/8)	BPSK	MCS0
		20 MHz Preamble 802.11ax (RU52)	1T1S / 2T2S	1(52/37), 93(52/40), 97(52/37), 117(52/37), 181(52/40), 233(52/40)	BPSK	MCS0
		20 MHz Preamble 802.11ax (RU106)	1T1S / 2T2S	1(106/53), 93(106/54), 97(106/53), 117(106/53), 181(106/40), 233(106/40)	BPSK	MCS0
		20 MHz Preamble 802.11be (RU52+26)	1T1S / 2T2S	1(78/70), 93(78/72), 97(78/70), 117(78/70), 181(78/72), 233(78/72)	BPSK	MCS0
		20 MHz Preamble 802.11be (RU26+106)	1T1S / 2T2S	1(132/82), 93(132/83), 97(132/82), 117(132/82), 181(132/83), 233(132/83)	BPSK	MCS0
		80 MHz Preamble 802.11be (RU484+242)	1T1S / 2T2S	7(726/93), 87(726/90), 103(726/93), 135(726/93), 215 (726/90)	BPSK	MCS0
		160 MHz Preamble 802.11be (RU996+484)	1T1S / 2T2S	15(1480/95-1), 79(1480/94-0*), 143(1480/95-1), 207(1480/94-0*)	BPSK	MCS0
		160 MHz Preamble 802.11be (RU996+484+242)	1T1S / 2T2S	15(1722/99-1), 79(1722/96-0), 143(1722/99-1), 207(1722/96-0)	BPSK	MCS0

Test Item	EUT Configure Mode	Mode	Signal Mode	Tested Channel	Modulation	Data Rate Parameter
		320 MHz Preamble 802.11be (RU996*2+484)	1T1S / 2T2S	31(2476/101-1/0), 63(2476/102-0/1) , 127(2476/101-1/0), 191(2476/102-0/1)	BPSK	MCS0
		320 MHz Preamble 802.11be (RU996*3)	1T1S / 2T2S	31(2988/104-1/1), 63(2988/104-0/0) , 127(2988/104-1/1), 191(2988/104-0/0)	BPSK	MCS0
		320 MHz Preamble 802.11be (RU996*3+484)	1T1S / 2T2S	31(3472/106-1/1), 63(3472/105-0/0) , 127(3472/106-1/1), 191(3472/105-0/0)	BPSK	MCS0
EUT Configure Mode:	A	EUT only (w/o antenna)				
	B	EUT with 50 ohm terminator				

3.5 Duty Cycle of Test Signal

802.11ax (HE) 26-tone RU Indoor_1T1S: Duty cycle = $0.583 \text{ ms} / 0.7 \text{ ms} \times 100\% = 83.3\%$, duty factor = $10 * \log (1/\text{Duty cycle}) = 0.79 \text{ dB}$

802.11ax (HE) 52-tone RU Indoor_1T1S: Duty cycle = $0.499 \text{ ms} / 0.617 \text{ ms} \times 100\% = 80.9\%$, duty factor = $10 * \log (1/\text{Duty cycle}) = 0.92 \text{ dB}$

802.11ax (HE) 106-tone RU Indoor_1T1S: Duty cycle = $0.436 \text{ ms} / 0.553 \text{ ms} \times 100\% = 78.8\%$, duty factor = $10 * \log (1/\text{Duty cycle}) = 1.03 \text{ dB}$

802.11be (EHT20) 52+26-tone MRU Indoor_1T1S: Duty cycle = $0.468 \text{ ms} / 0.585 \text{ ms} \times 100\% = 80.0\%$, duty factor = $10 * \log (1/\text{Duty cycle}) = 0.97 \text{ dB}$

802.11be (EHT20) 106+26-tone MRU Indoor_1T1S: Duty cycle = $0.468 \text{ ms} / 0.585 \text{ ms} \times 100\% = 80.0\%$, duty factor = $10 * \log (1/\text{Duty cycle}) = 0.97 \text{ dB}$

802.11be (EHT80) 484+242-tone MRU Indoor_1T1S: Duty cycle = $0.358 \text{ ms} / 0.476 \text{ ms} \times 100\% = 75.2\%$, duty factor = $10 * \log (1/\text{Duty cycle}) = 1.24 \text{ dB}$

802.11be (EHT160) 996+484-tone MRU Indoor_1T1S: Duty cycle = $0.346 \text{ ms} / 0.463 \text{ ms} \times 100\% = 74.7\%$, duty factor = $10 * \log (1/\text{Duty cycle}) = 1.27 \text{ dB}$

802.11be (EHT160) 996+484+242-tone MRU Indoor_1T1S: Duty cycle = $0.346 \text{ ms} / 0.463 \text{ ms} \times 100\% = 74.7\%$, duty factor = $10 * \log (1/\text{Duty cycle}) = 1.27 \text{ dB}$

802.11be (EHT320) 2x996+484-tone MRU Indoor_1T1S: Duty cycle = $0.343 \text{ ms} / 0.46 \text{ ms} \times 100\% = 74.6\%$, duty factor = $10 * \log (1/\text{Duty cycle}) = 1.27 \text{ dB}$

802.11be (EHT320) 3x996-tone MRU Indoor_1T1S: Duty cycle = $0.343 \text{ ms} / 0.46 \text{ ms} \times 100\% = 74.6\%$, duty factor = $10 * \log (1/\text{Duty cycle}) = 1.27 \text{ dB}$

802.11be (EHT320) 3x996+484-tone MRU Indoor_1T1S: Duty cycle = $0.343 \text{ ms} / 0.46 \text{ ms} \times 100\% = 74.6\%$, duty factor = $10 * \log (1/\text{Duty cycle}) = 1.27 \text{ dB}$

802.11ax (HE) 26-tone RU Indoor_2T2S: Duty cycle = $0.343 \text{ ms} / 0.461 \text{ ms} \times 100\% = 74.4\%$, duty factor = $10 * \log (1/\text{Duty cycle}) = 1.28 \text{ dB}$

802.11ax (HE) 52-tone RU Indoor_2T2S: Duty cycle = $0.304 \text{ ms} / 0.424 \text{ ms} \times 100\% = 71.7\%$, duty factor = $10 * \log (1/\text{Duty cycle}) = 1.44 \text{ dB}$

802.11ax (HE) 106-tone RU Indoor_2T2S: Duty cycle = $0.272 \text{ ms} / 0.389 \text{ ms} \times 100\% = 69.9\%$, duty factor = $10 * \log (1/\text{Duty cycle}) = 1.55 \text{ dB}$

802.11be (EHT20) 52+26-tone MRU Indoor_2T2S: Duty cycle = $0.288 \text{ ms} / 0.404 \text{ ms} \times 100\% = 71.3\%$, duty factor = $10 * \log (1/\text{Duty cycle}) = 1.47 \text{ dB}$

802.11be (EHT20) 106+26-tone MRU Indoor_2T2S: Duty cycle = $0.288 \text{ ms} / 0.404 \text{ ms} \times 100\% = 71.3\%$, duty factor = $10 * \log (1/\text{Duty cycle}) = 1.47 \text{ dB}$

802.11be (EHT80) 484+242-tone MRU Indoor_2T2S: Duty cycle = $0.231 \text{ ms} / 0.348 \text{ ms} \times 100\% = 66.4\%$, duty factor = $10 * \log (1/\text{Duty cycle}) = 1.78 \text{ dB}$

802.11be (EHT160) 996+484-tone MRU Indoor_2T2S: Duty cycle = $0.228 \text{ ms} / 0.344 \text{ ms} \times 100\% = 66.3\%$, duty factor = $10 * \log (1/\text{Duty cycle}) = 1.79 \text{ dB}$

802.11be (EHT160) 996+484+242-tone MRU Indoor_2T2S: Duty cycle = $0.228 \text{ ms} / 0.344 \text{ ms} \times 100\% = 66.3\%$, duty factor = $10 * \log (1/\text{Duty cycle}) = 1.79 \text{ dB}$

802.11be (EHT320) 2x996+484-tone MRU Indoor_2T2S: Duty cycle = $0.224 \text{ ms} / 0.339 \text{ ms} \times 100\% = 66.1\%$, duty factor = $10 * \log (1/\text{Duty cycle}) = 1.80 \text{ dB}$

802.11be (EHT320) 3x996-tone MRU Indoor_2T2S: Duty cycle = $0.224 \text{ ms} / 0.339 \text{ ms} \times 100\% = 66.1\%$, duty factor = $10 * \log (1/\text{Duty cycle}) = 1.80 \text{ dB}$

802.11be (EHT320) 3x996+484-tone MRU Indoor_2T2S: Duty cycle = $0.224 \text{ ms} / 0.339 \text{ ms} \times 100\% = 66.1\%$, duty factor = $10 * \log (1/\text{Duty cycle}) = 1.80 \text{ dB}$



BUREAU VERITAS

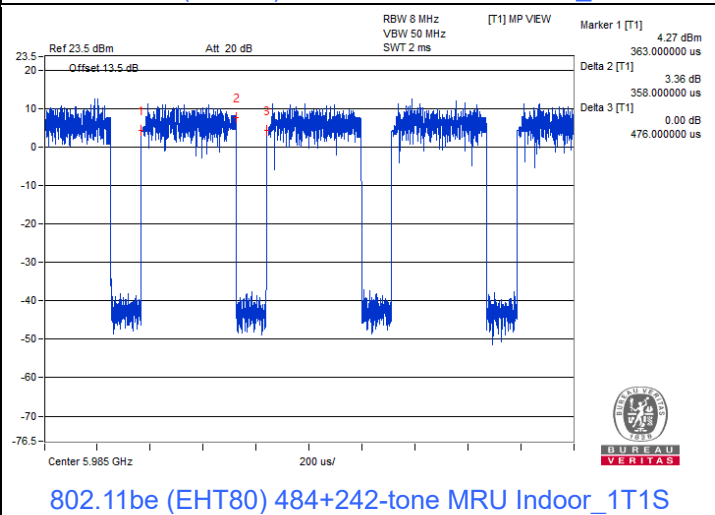
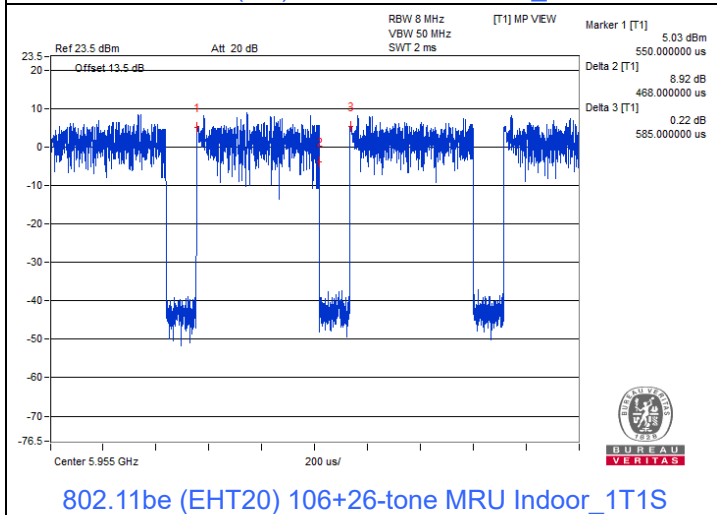
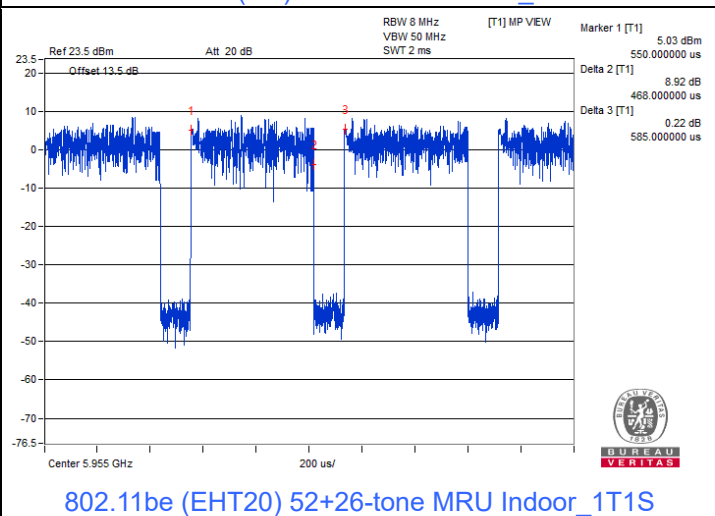
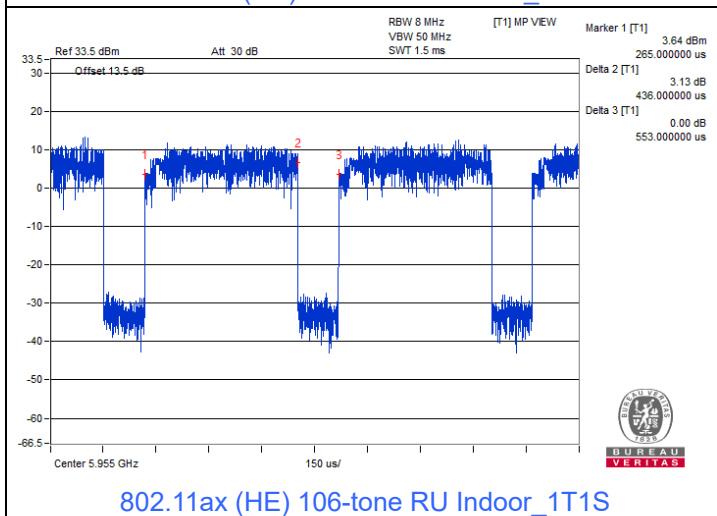
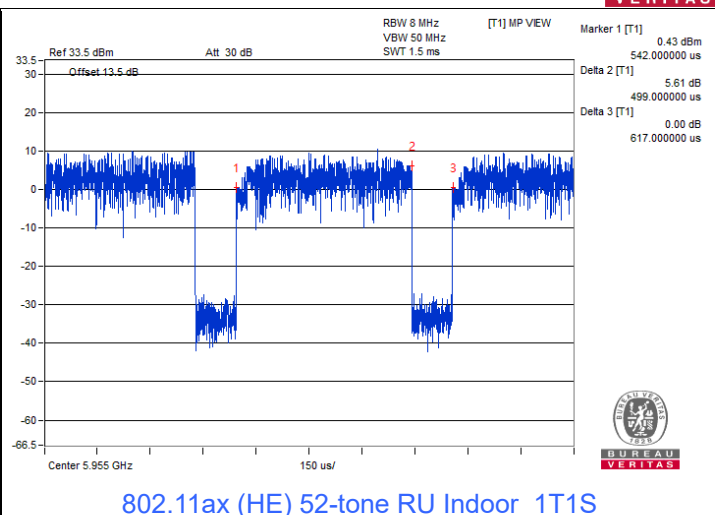
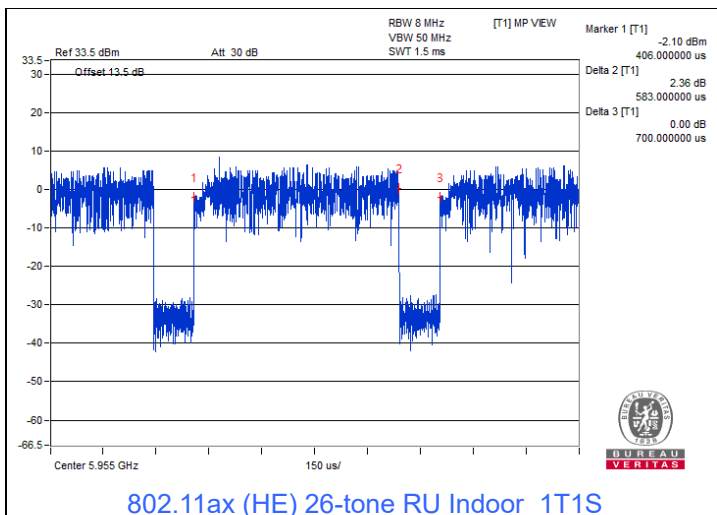

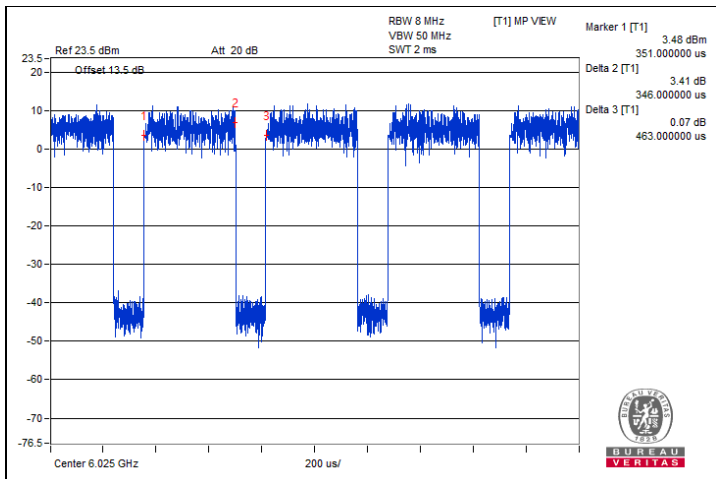

802.11be (EHT160) 996+484-tone MRU Indoor_1T1S

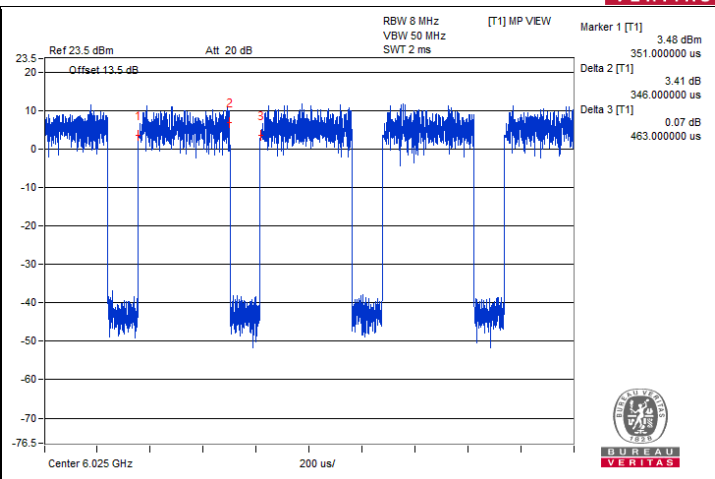

802.11be (EHT160) 996+484+242-tone MRU Indoor_1T1S

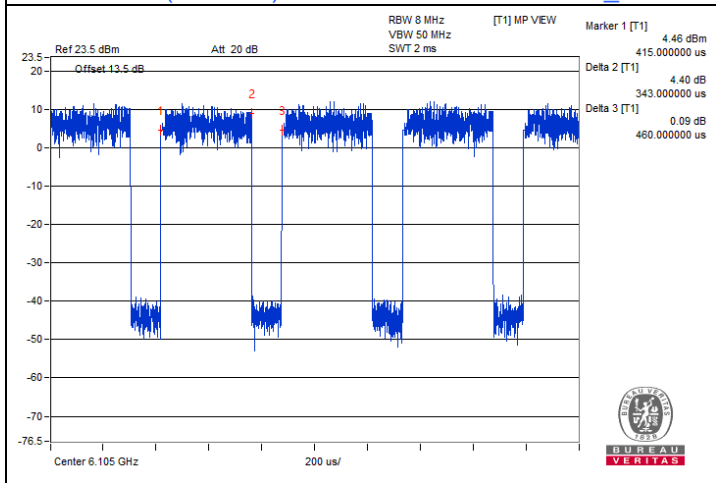

802.11be (EHT320) 2x996+484-tone MRU Indoor_1T1S

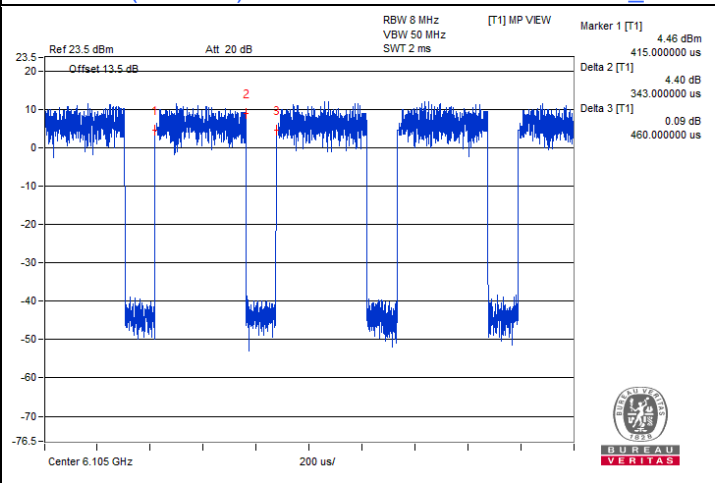

802.11be (EHT320) 3x996-tone MRU Indoor_1T1S

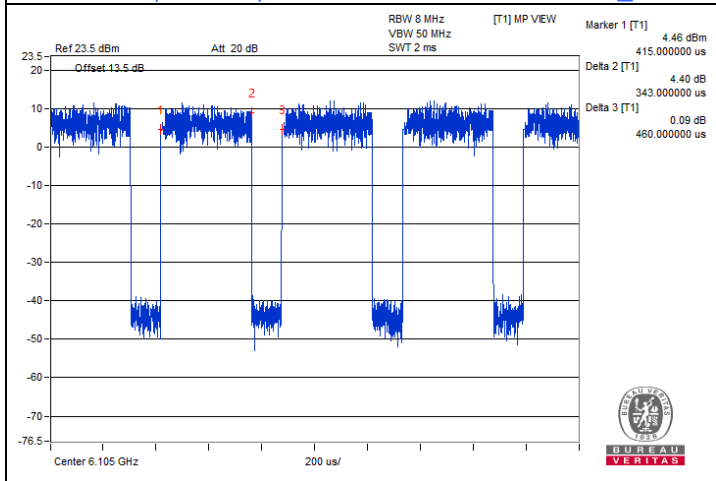

802.11be (EHT320) 3x996+484-tone MRU Indoor_1T1S

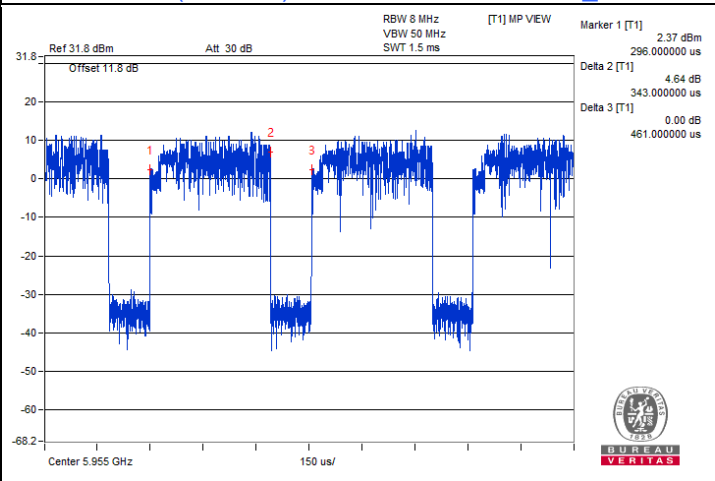

802.11ax (HE) 26-tone RU Indoor_2T2S



BUREAU VERITAS

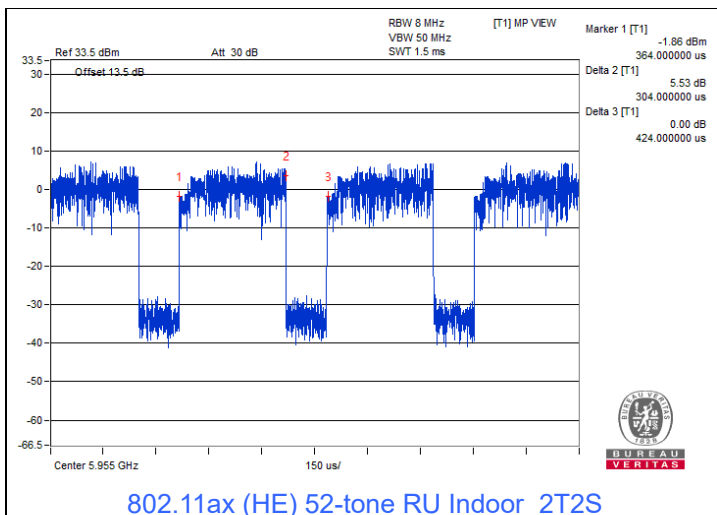

802.11ax (HE) 52-tone RU Indoor_2T2S

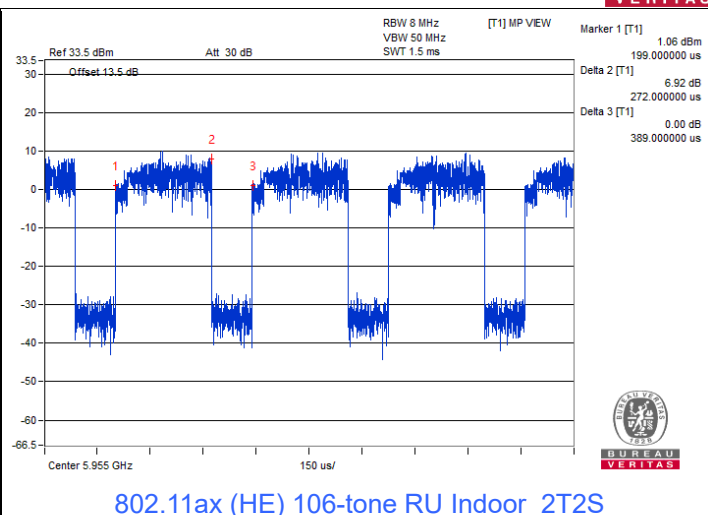

802.11ax (HE) 106-tone RU Indoor_2T2S

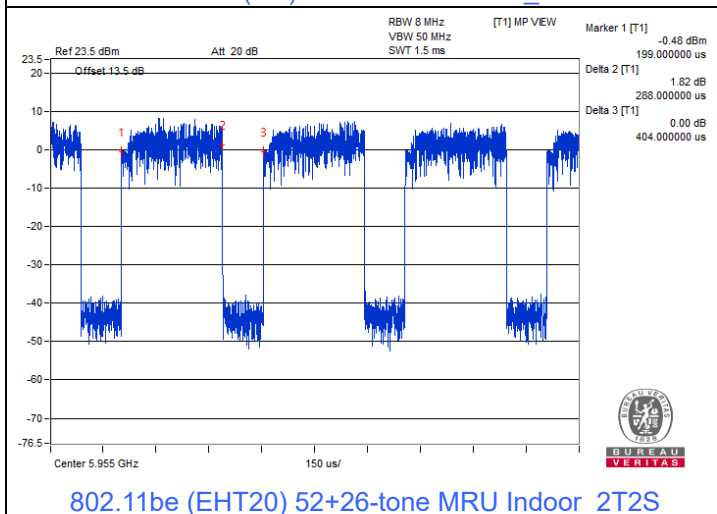

802.11be (EHT20) 52+26-tone MRU Indoor_2T2S

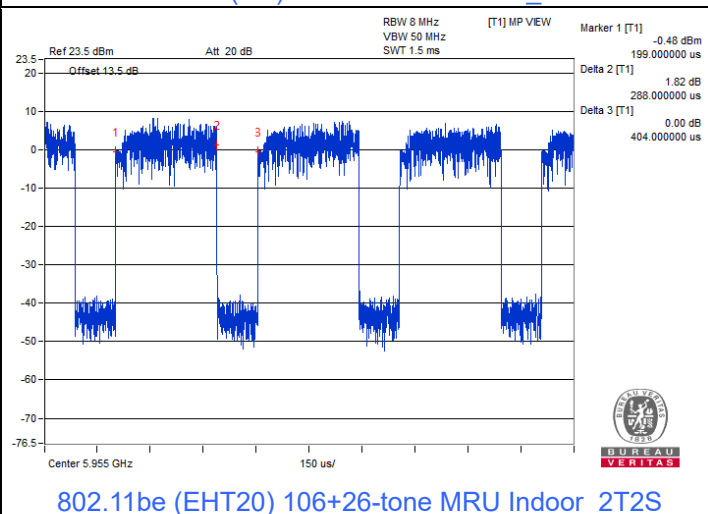

802.11be (EHT20) 106+26-tone MRU Indoor_2T2S

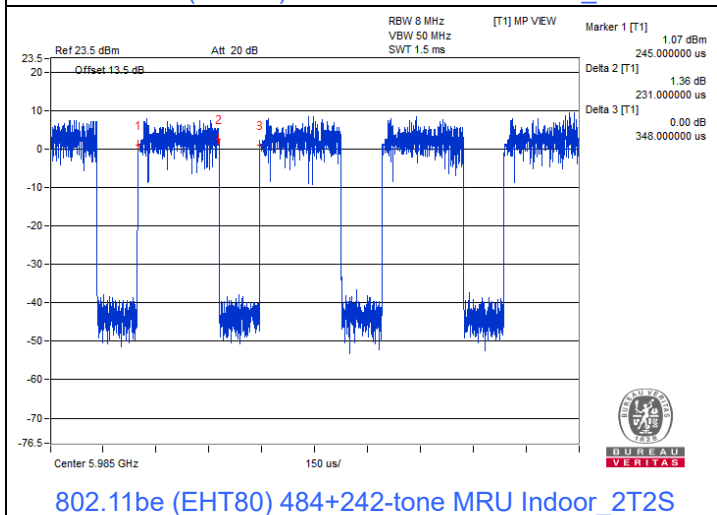

802.11be (EHT80) 484+242-tone MRU Indoor_2T2S

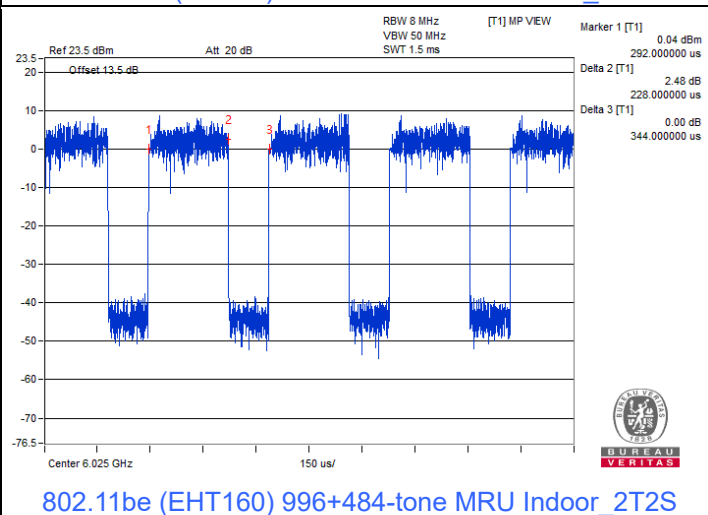

802.11be (EHT160) 996+484-tone MRU Indoor_2T2S



BUREAU VERITAS

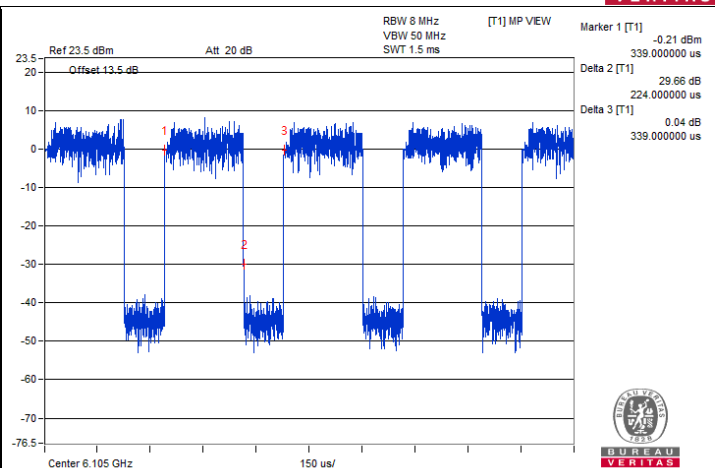
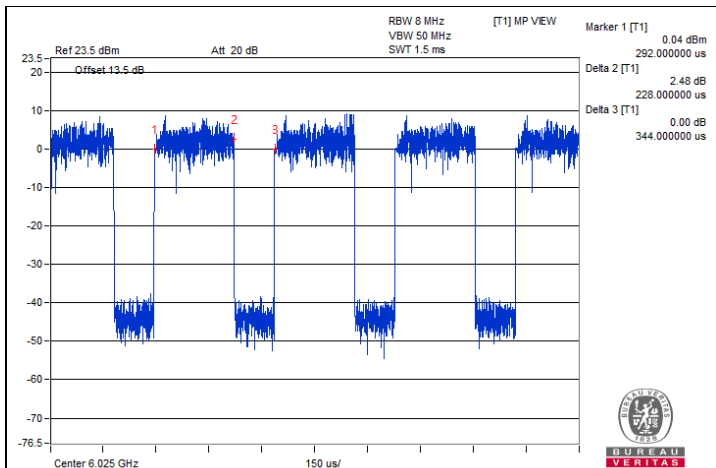

802.11be (EHT160) 996+484+242-tone MRU Indoor_2T2S

802.11be (EHT320) 2x996+484-tone MRU Indoor_2T2S

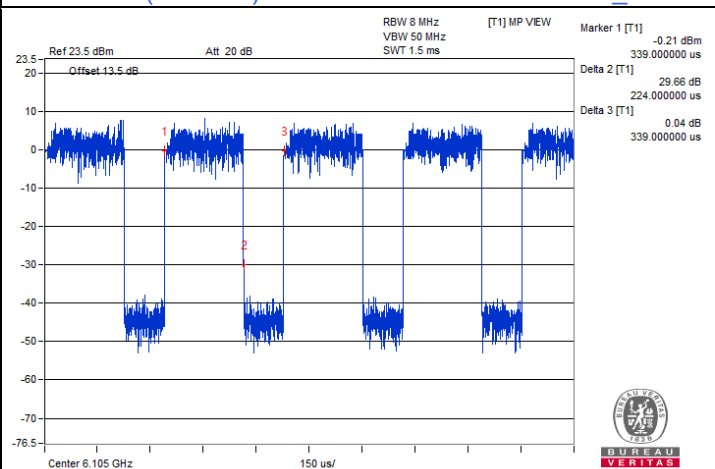
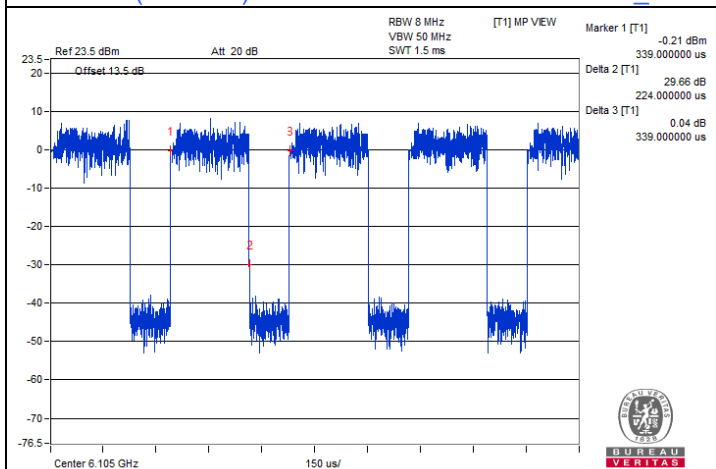

802.11be (EHT320) 3x996-tone MRU Indoor_2T2S

802.11be (EHT320) 3x996+484-tone MRU Indoor_2T2S

3.6 Test Program Used and Operation Descriptions

Controlling software (QAtool_V26 (0.0.2.93)) has been activated to set the EUT under transmission condition continuously at specific channel frequency.

3.7 Connection Diagram of EUT and Peripheral Devices

For AC Power Conducted Emission test

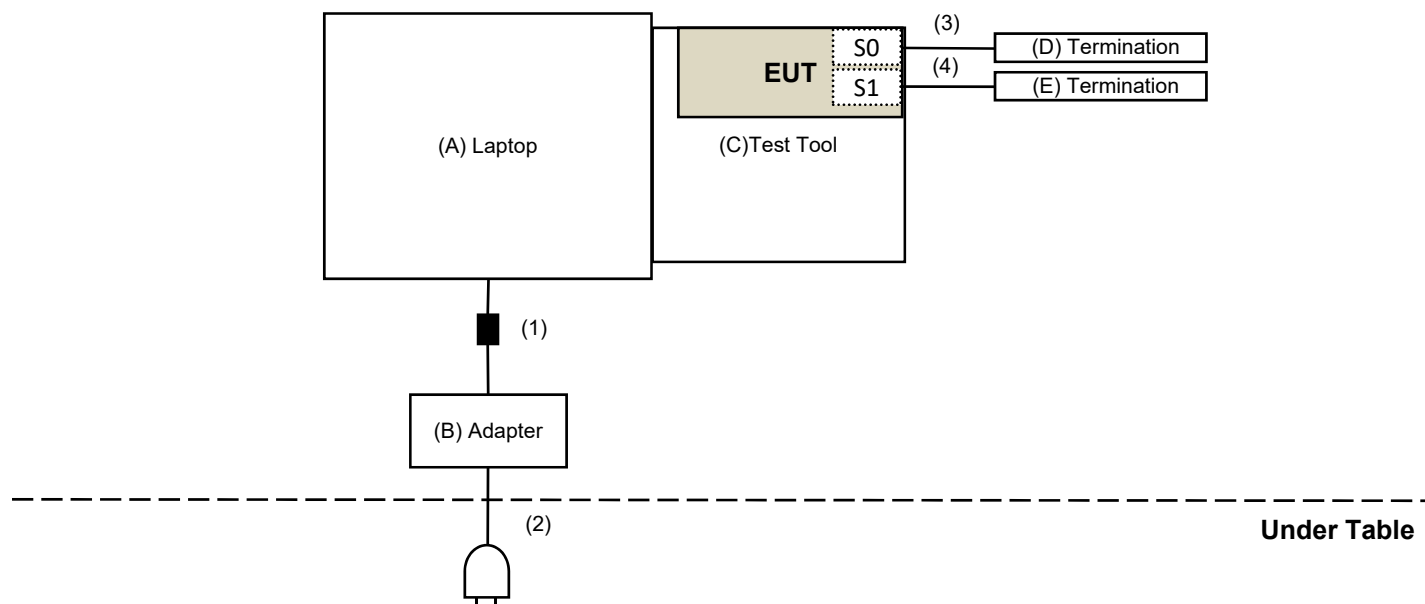

For Unwanted Emission test

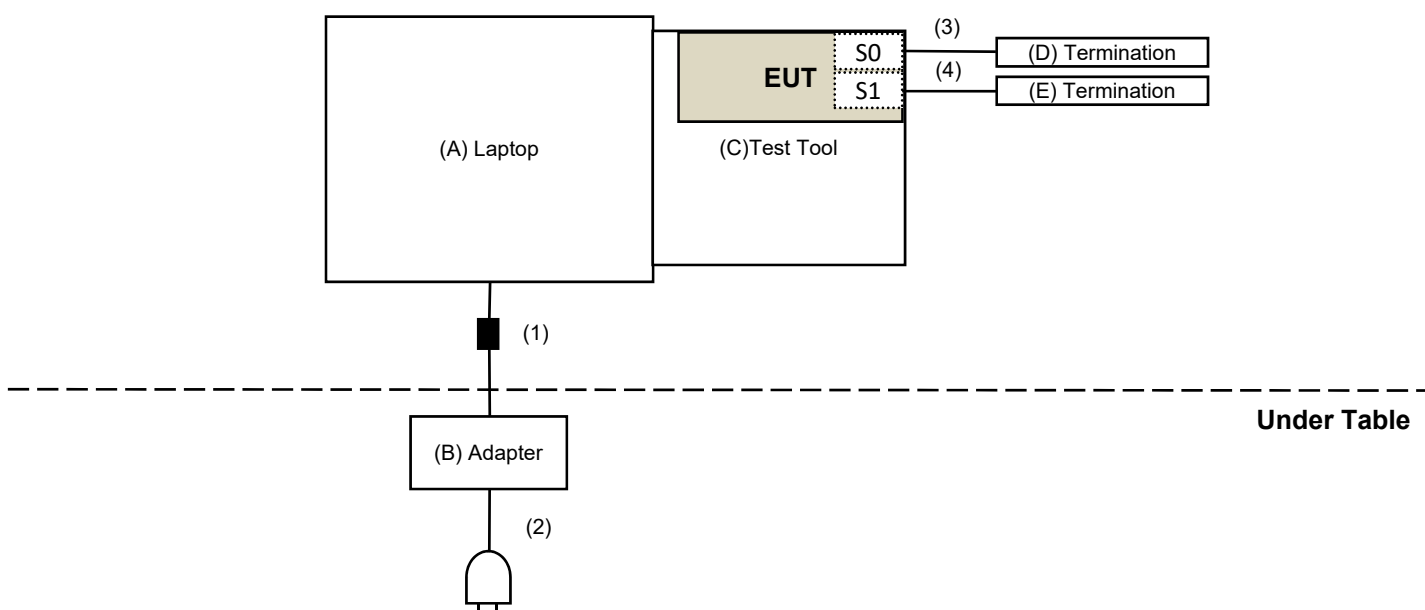

3.8 Configuration of Peripheral Devices and Cable Connections

ID	Product	Brand	Model No.	Serial No.	FCC ID	Remarks
A	Laptop	DELL	E5430	HYV4VY1	DoC	Provided by Lab
B	Adapter	DELL	LLA65NS2-01	N/A	N/A	Provided by Lab
C	Test Tool	Mediatek	MTK1849	N/A	N/A	Supplied by applicant
D	Termination	Marvelous	MVE5185	N/A	N/A	Provided by Lab
E	Termination	Marvelous	MVE5185	N/A	N/A	Provided by Lab

ID	Cable Descriptions	Qty.	Length (m)	Shielding (Yes/No)	Cores (Qty.)	Remarks
1	DC Cable	1	1.8	No	1	Provided by Lab
2	AC Cable	1	1	No	0	Provided by Lab
3	RF Cable	1	0.2	No	0	Provided by Lab
4	RF Cable	1	0.2	No	0	Provided by Lab

4 Test Instruments

The calibration interval of the all test instruments are 12 months and the calibrations are traceable to NML/ROC and NIST/USA.

4.1 RF Output Power

Description Manufacturer	Model No.	Serial No.	Calibrated Date	Calibrated Until
Power Meter Anritsu	ML2495A	1529002	2022/6/22	2023/6/21
Pulse Power Sensor Anritsu	MA2411B	1726434	2022/6/22	2023/6/21
Attenuator WOKEN	MDCS18N-10	MDCS18N-10-01	2022/4/5	2023/4/4
Software	ADT_RF Test Software V6.6.5.4	N/A	N/A	N/A

Notes:

1. The test was performed in Oven room 2.
2. Tested Date: 2023/1/4 ~ 2023/2/9

4.2 Power Spectral Density

Description Manufacturer	Model No.	Serial No.	Calibrated Date	Calibrated Until
Attenuator WOKEN	MDCS18N-10	MDCS18N-10-01	2022/4/5	2023/4/4
Software	ADT_RF Test Software V6.6.5.4	N/A	N/A	N/A
Spectrum Analyzer Keysight	N9020B	MY60112409	2022/3/11	2023/3/10

Notes:

1. The test was performed in Oven room 2.
2. Tested Date: 2023/1/4 ~ 2023/2/9

4.3 Emission Bandwidth

Refer to section 4.2 to get information of the instruments.

4.4 In-Band Emission Mask

Refer to section 4.2 to get information of the instruments.

4.5 Occupied Bandwidth

Refer to section 4.2 to get information of the instruments.

4.6 Contention-based Protocol

Description Manufacturer	Model No.	Serial No.	Calibrated Date	Calibrated Until
N9030B - PXA Signal Analyzer KEYSIGHT	N9030B	MY57140938	2022/3/15	2023/3/14
MXA Signal Analyzer KEYSIGHT	N9020B	MY60110513	2022/12/26	2023/12/25
MXG Vector signal generator Agilent	N5182B	MY53050430	2022/11/29	2023/11/28
Combiner / Splitter (Model:ZN2PD- 9G) Mini-Circuits	ZN2PD-9G	ZN2PD-9G	2022/6/9	2023/6/8
N5182BU KEYSIGHT	N5182BU	MY59360189	2022/11/29	2023/11/28

Notes:

1. The test was performed in Adaptivity room.
2. Tested Date: 2023/1/31

4.7 AC Power Conducted Emissions

Description Manufacturer	Model No.	Serial No.	Calibrated Date	Calibrated Until
50 ohm terminal resistance	N/A	EMC-01	2022/9/27	2023/9/26
Fixed attenuator STI	STI02-2200-10	005	2022/8/24	2023/8/23
LISN R&S	ESH3-Z5	848773/004	2022/10/18	2023/10/17
RF Coaxial Cable JYEBO	5D-FB	COCCAB-001	2022/8/24	2023/8/23
Software BVADT	BVADT_Cond_V7.3.7.4	N/A	N/A	N/A
TEST RECEIVER R&S	ESCS 30	847124/029	2022/10/14	2023/10/13

Notes:

1. The test was performed in Conduction 1
2. Tested Date: 2022/12/25

4.8 Unwanted Emissions below 1 GHz

Description Manufacturer	Model No.	Serial No.	Calibrated Date	Calibrated Until
Boresight Antenna Tower & Turn Table Max-Full	MF-7802BS	MF780208530	N/A	N/A
Fixed attenuator Mini-Circuits	UNAT-5+	PAD-ATT5-03	2022/1/10	2023/1/9
LOOP ANTENNA Electro-Metrics	EM-6879	264	2022/3/18	2023/3/17
Pre_Amplifier Agilent	8447D	2944A10636	2022/3/19	2023/3/18
Pre_Amplifier EMCI	EMC330N	980701	2022/3/8	2023/3/7
RF Coaxial Cable COMMATE/PEWC	8D	966-4-1	2022/3/8	2023/3/7
		966-4-2	2022/3/8	2023/3/7
		966-4-3	2022/3/8	2023/3/7
RF Coaxial Cable JYEBO	5D-FB	LOOPCAB-001	2022/1/6	2023/1/5
		LOOPCAB-002	2022/12/19	2023/12/18
Software	ADT_Radiated_V8.7.08	N/A	N/A	N/A
Spectrum Analyzer KEYSIGHT	N9030B	MY57142938	2022/4/26	2023/4/25
Trilog Broadband Antenna Schwarzbeck	VULB 9168	9168-406	2022/10/21	2023/10/20

Notes:

1. The test was performed in 966 Chamber No. 4.
2. Tested Date: 2022/12/21

4.9 Unwanted Emissions above 1 GHz

Description Manufacturer	Model No.	Serial No.	Calibrated Date	Calibrated Until
Boresight Antenna Tower & Turn Table Max-Full	MF-7802BS	MF780208530	N/A	N/A
Horn Antenna Schwarzbeck	BBHA 9120D	9120D-783	2022/11/13	2023/11/12
	BBHA 9170	9170-739	2022/11/13	2023/11/12
Pre_Amplifier EMCI	EMC12630SE	980688	2022/10/4	2023/10/3
	EMC184045SE	980387	2022/1/10	2023/1/9
RF Cable-Frequency Range : 1- 26.5GHz EMCI	EMC104-SM-SM-1200	160922	2022/12/15	2023/12/14
RF Cable-Frequency range: 1- 40GHz EMCI	EMC102-KM-KM-1200	160924	2022/1/10	2023/1/9
RF Coaxial Cable EMCI	EMC-KM-KM-4000	200214	2022/3/8	2023/3/7
	EMC104-SM-SM-2000	180502	2022/4/25	2023/4/24
	EMC104-SM-SM-6000	210704	2022/11/4	2023/11/3
Software	ADT_Radiated_V8.7.08	N/A	N/A	N/A
Spectrum Analyzer Keysight	N9020B	MY60112410	2022/3/13	2023/3/12

Notes:

1. The test was performed in 966 Chamber No. 4.
2. Tested Date: 2022/12/22

5 Limits of Test Items

5.1 RF Output Power

Operation Band	EUT Category	Limit
		Max Average Power
U-NII-5 U-NII-6 U-NII-7 U-NII-8	Client Devices (controlled of an indoor AP)	EIRP 24 dBm

Per KDB 662911 Method of conducted output power measurement on IEEE 802.11 devices,

Array Gain = 0 dB (i.e., no array gain) for $N_{ANT} \leq 4$;

Array Gain = 0 dB (i.e., no array gain) for channel widths ≥ 40 MHz for any N_{ANT} ;

Array Gain = $5 \log(N_{ANT}/N_{SS})$ dB or 3 dB, whichever is less for 20-MHz channel widths with $N_{ANT} \geq 5$.

For power measurements on all other devices: Array Gain = $10 \log(N_{ANT}/N_{SS})$ dB.

5.2 Power Spectral Density

Operation Band	EUT Category	Limit
		Peak Power Density
U-NII-5 U-NII-6 U-NII-7 U-NII-8	Client Devices (controlled of an indoor AP)	EIRP -1 dBm/MHz

5.3 Emission Bandwidth

The results are for reference only.

5.4 In-Band Emission Mask

Test Item	Frequencies (MHz)	(X) dBc*1
Emission Mask	At 1 MHz outside of channel edge	20
	At one channel bandwidth from the channel center*2	28
	At one- and one-half times the channel bandwidth away from channel center*3	40
	More than one- and one-half times the channel bandwidth	40

*1 : The power spectral density must be suppressed by "x" dB

*2 : At frequencies between one megahertz outside an unlicensed device's channel edge and one channel bandwidth from the center of the channel, the limits must be linearly interpolated between 20 dB and 28 dB suppression,

*3 : At frequencies between one and one- and one-half times an unlicensed device's channel bandwidth, the limits must be linearly interpolated between 28 dB and 40 dB suppression.

5.5 Occupied Bandwidth

The maximum transmitter channel bandwidth for U-NII devices in the 5.925-7.125 GHz band is 320 MHz.

5.6 Contention-based Protocol

Unlicensed indoor low-power devices must detect co-channel radio frequency power that is at least -62 dBm (The threshold is referenced to a 0 dBi antenna gain.) or lower. Additionally, indoor low-power devices must detect co-channel energy with 90% or greater certainty.

5.7 AC Power Conducted Emissions

Frequency (MHz)	Conducted Limit (dBuV)	
	Quasi-peak	Average
0.15 - 0.5	66 - 56	56 - 46
0.50 - 5.0	56	46
5.0 - 30.0	60	50

Notes:

1. The lower limit shall apply at the transition frequencies.
2. The limit decreases in line with the logarithm of the frequency in the range of 0.15 to 0.50 MHz.

5.8 Unwanted Emissions below 1 GHz

Radiated emissions which fall in the restricted bands must comply with the radiated emission limits specified as below table.

Frequencies (MHz)	Field Strength (microvolts/meter)	Measurement Distance (meters)
0.009 ~ 0.490	2400/F(kHz)	300
0.490 ~ 1.705	24000/F(kHz)	30
1.705 ~ 30.0	30	30
30 ~ 88	100	3
88 ~ 216	150	3
216 ~ 960	200	3
Above 960	500	3

Notes:

1. The lower limit shall apply at the transition frequencies.
2. Emission level (dBuV/m) = 20 log Emission level (uV/m).

5.9 Unwanted Emissions above 1 GHz

Radiated emissions which fall in the restricted bands must comply with the radiated emission limits specified as below table.

Frequencies (MHz)	Field Strength (microvolts/meter)	Measurement Distance (meters)
Above 960	500	3

Notes:

1. The lower limit shall apply at the transition frequencies.
2. Emission level (dBuV/m) = 20 log Emission level (uV/m).
3. For frequencies above 1000 MHz, the field strength limits are based on average detector, however, the peak field strength of any emission shall not exceed the maximum permitted average limits, specified above by more than 20 dB under any condition of modulation.

Limits of unwanted emission out of the restricted bands

Frequencies (MHz)	EIRP Limit	Equivalent Field Strength at 3 m
5925 MHz > F > 7125 MHz	Peak: -7 (dBm/MHz)	88.2 (dBuV/m)
	Average: -27 (dBm/MHz)	68.2 (dBuV/m)

Note: The following formula is used to convert the equipment isotropic radiated power (eirp) to field strength:

$$E = \frac{1000000 \sqrt{30P}}{3} \mu\text{V/m, where P is the eirp (Watts).}$$

6 Test Arrangements

6.1 RF Output Power

6.1.1 Test Setup

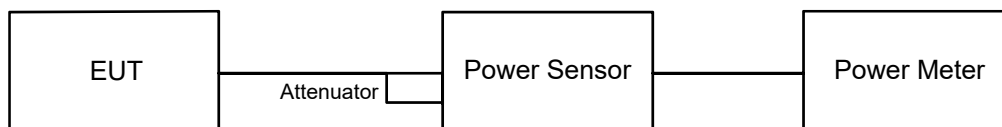

6.1.2 Test Procedure

Method PM is used to perform output power measurement, trigger and gating function of wide band power meter is enabled to measure max output power of TX on burst and set the detector to average. Duty factor is not added to measured value.

6.2 Power Spectral Density

6.2.1 Test Setup

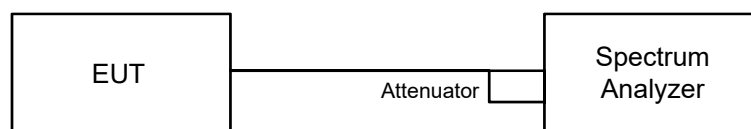

6.2.2 Test Procedure

For specified measurement bandwidth 1 MHz:

Method SA-2

- a. Set span to encompass the entire emission bandwidth (EBW) of the signal.
- b. Set RBW = 1 MHz, Set VBW \geq 3 MHz, Detector = RMS
- c. Sweep points \geq $[2 \times \text{span} / \text{RBW}]$. (This gives bin-to-bin spacing \leq RBW / 2, so that narrowband signals are not lost between frequency bins.)
- d. Sweep time = auto, trigger set to "free run".
- e. Trace average at least 100 traces in power averaging mode.
- f. Use the peak search function on the instrument to find the peak of the spectrum and record its value.
- g. Record the max value and add $10 \log (1/\text{duty cycle})$.

6.3 Emission Bandwidth

6.3.1 Test Setup

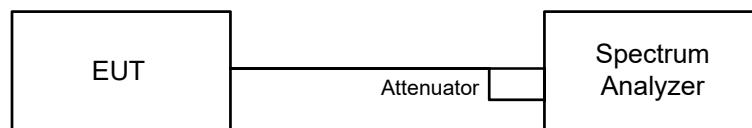

6.3.2 Test Procedure

- a. Set RBW = approximately 1% of the emission bandwidth.
- b. Set the VBW > RBW.
- c. Detector = Peak.
- d. Trace mode = max hold.
- e. Measure the maximum width of the emission that is 26 dB down from the peak of the emission. Compare this with the RBW setting of the analyzer. Readjust RBW and repeat measurement as needed until the RBW/EBW ratio is approximately 1%.

6.4 In-Band Emission Mask

6.4.1 Test Setup

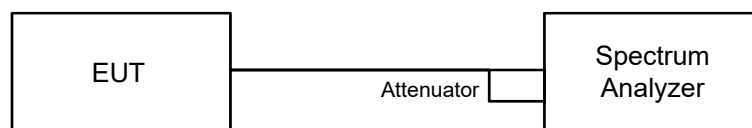

6.4.2 Test Procedure

- a. Connect output of the antenna port to a spectrum analyzer and adjust appropriate attenuation.
- b. Measure the 26 dB EBW using the test procedure 12.4.1 of ANSI C63.10-2013. (Determine the channel edge.)
- c. Measure the power spectral density (for emissions mask reference) using the following procedure:
 - a) Set the span to encompass the entire 26 dB EBW of the signal.
 - b) Set RBW = same RBW used for 26 dB EBW measurement.
 - c) Set VBW ≥ [3 X RBW].
 - d) Number of points in sweep ≥ [2 X span / RBW].
 - e) Sweep time = auto.
 - f) Detector = RMS (i.e., power averaging).
 - g) Trace average at least 100 traces in power averaging (rms) mode.
 - h) Use the peak search function on the instrument to find the peak of the spectrum.
- a. Using the measuring equipment limit line function, develop the emissions mask based on the following requirements. The emissions power spectral density must be reduced below the peak power spectral density (in dB) as follows:
 - a) Suppressed by 20 dB at 1 MHz outside of the channel edge. (The channel edge is defined as the 26-dB point on either side of the carrier center frequency.)
 - b) Suppressed by 28 dB at one channel bandwidth from the channel center.
 - c) Suppressed by 40 dB at one- and one-half times the channel bandwidth from the channel center.
- a. Adjust the span to encompass the entire mask as necessary and clear trace.
- b. Trace average at least 100 traces in power averaging (rms) mode.
- c. Adjust the reference level as necessary so that the crest of the channel touches the top of the emission mask

6.5 Occupied Bandwidth

6.5.1 Test Setup

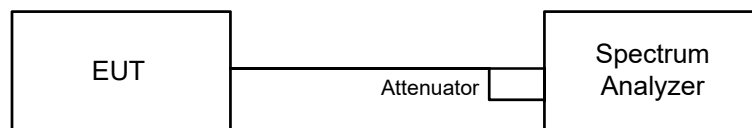

6.5.2 Test Procedure

The transmitter output was connected to the spectrum analyzer through an attenuator. The bandwidth of the fundamental frequency was measured by spectrum analyzer with resolution bandwidth in the range of 1% to 5% of the anticipated emission bandwidth, and a video bandwidth at least 3x the resolution bandwidth and set the detector to Sampling. The width of a frequency band such that, below the lower and above the upper frequency limits, the mean powers emitted are each equal to a specified percentage 0.5% of the total mean power of a given emission.

6.6 Contention-based Protocol

6.6.1 Test Setup

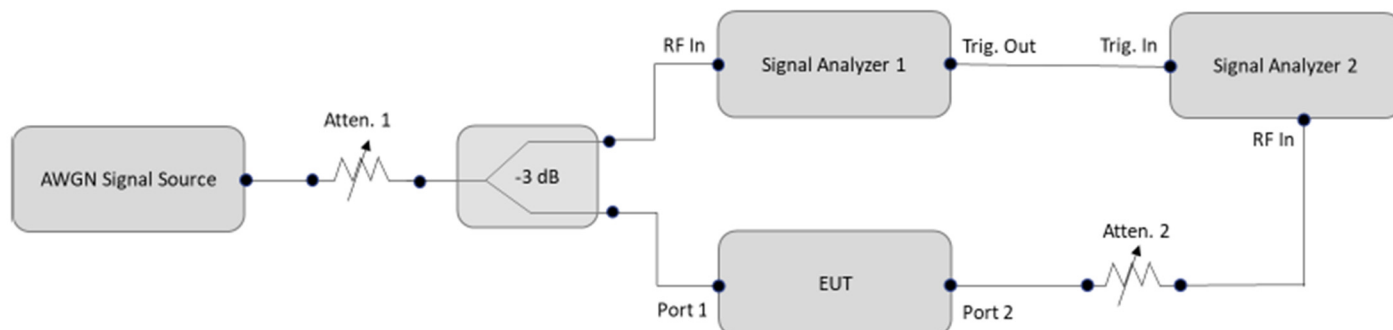

6.6.2 Test Procedure

- Set the signal analyzer center frequency to the nominal EUT channel center frequency. The span range of the signal analyzer shall be between two times and five times the OBW of the EUT. Connect the output port of the EUT to the signal analyzer 2. Ensure that the attenuator 2 provides enough attenuation to not overload the signal analyzer 2 receiver.
- Monitoring the signal analyzer 2, verify the EUT is operating and transmitting with the parameters (set as following section 4.7.5 EUT operating condition).
- Determine number of times detection threshold test as following table,

If	Number of Tests	Placement of Incumbent Transmission
$BW_{EUT} \leq BW_{Inc}$	Once	Same as EUT transmission
$BW_{Inc} < BW_{EUT} \leq 2x BW_{Inc}$	Once	Contained within BW_{EUT}
$2x BW_{Inc} < BW_{EUT} \leq 4x BW_{Inc}$	Twice. (Incumbent transmission is contained within BW_{EUT})	Closely to the lower edge and upper edge of the EUT Channel
$BW_{EUT} > 4x BW_{Inc}$	Three times	Closely to the lower edge, in the middle and upper edge of the EUT Channel

- Using an AWGN signal source, generate (but do not transmit, i.e., RF OFF) a 10 MHz-wide AWGN signal. Use step c table to determine the center frequency of the 10 MHz AWGN signal relative to the EUT's channel bandwidth and center frequency.
- Set the AWGN signal power to an extremely low level (more than 20 dB below the -62 dBm threshold). Connect the AWGN signal source, via a 3-dB splitter, to the signal analyzer 1 and the EUT.
- Transmit the AWGN signal (RF ON) and verify its characteristics on the signal analyzer 1.
- Monitor the signal analyzer 2 to verify if the AWGN signal has been detected and the EUT has ceased transmission. If the EUT continues to transmit, then incrementally increase the AWGN signal power level until the EUT stops transmitting.
- (Including all losses in the RF paths) Determine and record the AWGN signal power level (at the EUT's antenna port) at which the EUT ceased transmission. Repeat the procedure at least 10 times to verify the EUT can detect an AWGN signal with 90% (or better) level of certainty.
- Refer to step c table to determine number of times the detection threshold testing needs to be repeated. If testing is required more than once, then go back to step d, choose a different center frequency for the AWGN signal and repeat the process.

6.7 AC Power Conducted Emissions

6.7.1 Test Setup

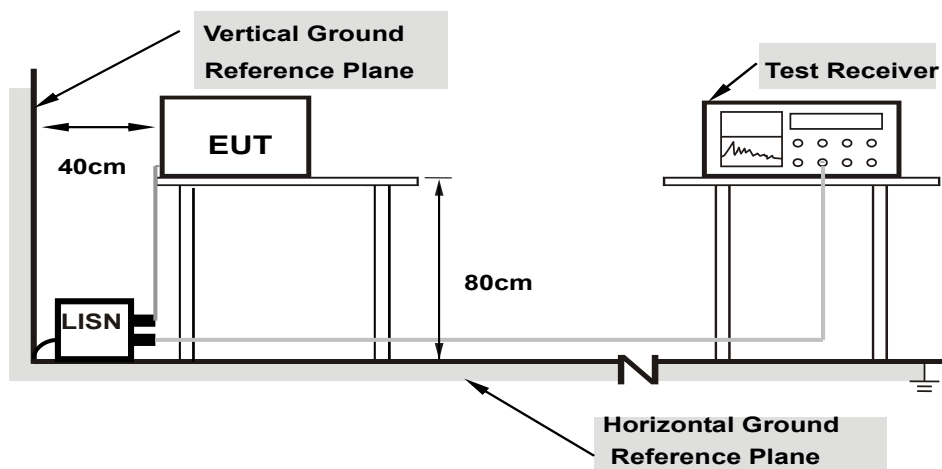

Note: 1.Support units were connected to second LISN.

For the actual test configuration, please refer to the attached file (Test Setup Photo).

6.7.2 Test Procedure

- The EUT was placed on a 0.8 meter to the top of table and placed 0.4 meters from the conducting wall of the shielded room with EUT being connected to the power mains through a line impedance stabilization network (LISN). Other support units were connected to the power mains through another LISN. The two LISNs provide 50 ohm/ 50 uH of coupling impedance for the measuring instrument.
- Both lines of the power mains connected to the EUT were checked for maximum conducted interference.
- The frequency range from 150 kHz to 30 MHz was searched. Emission levels under (Limit – 20 dB) was not recorded.

Note: The resolution bandwidth and video bandwidth of test receiver is 9 kHz for quasi-peak detection (QP) and average detection (AV) at frequency 0.15 MHz-30 MHz.

6.8 Unwanted Emissions below 1 GHz

6.8.1 Test Setup

For Conducted Configuration:

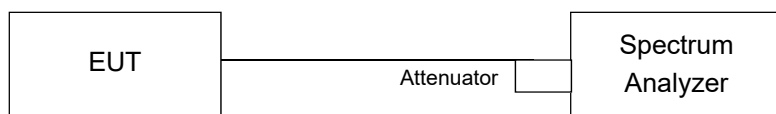

For Radiated Configuration:

For Radiated emission below 30 MHz

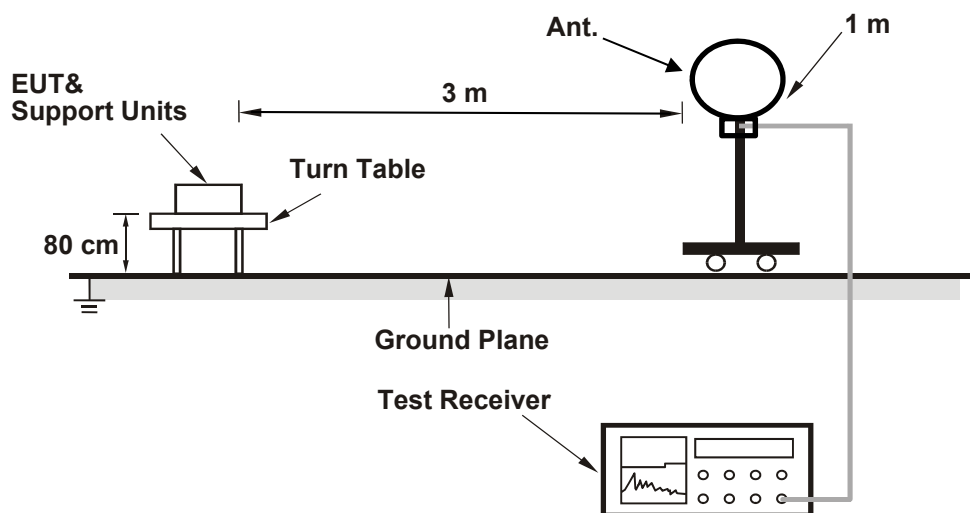

For Radiated emission above 30 MHz

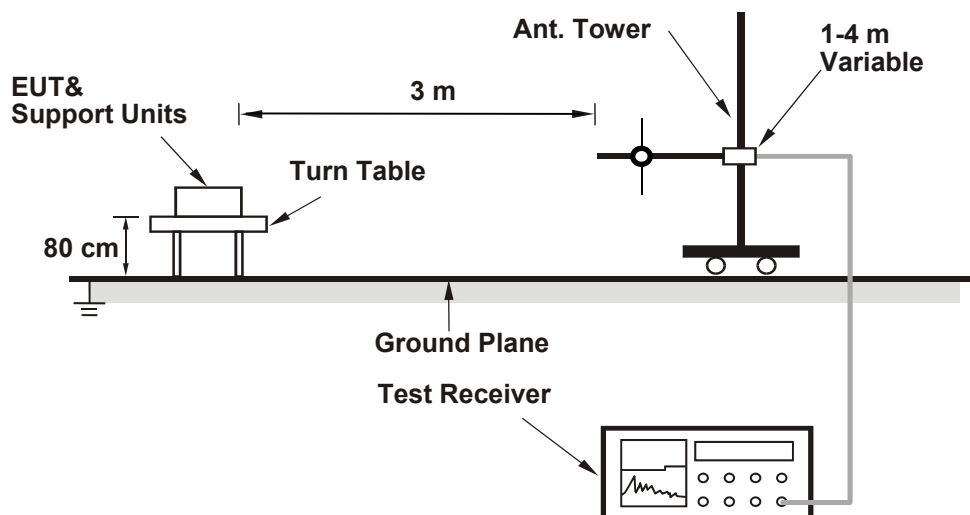

For the actual test configuration, please refer to the attached file (Test Setup Photo).

6.8.2 Test Procedure

Following FCC KDB 789033 D02 General UNII Test Procedures:

Radiated versus Conducted Measurements.

The unwanted emission limits in both the restricted and non-restricted bands are based on antenna-port conducted measurements in conjunction with cabinet emissions tests are permitted to demonstrate compliance.

The following steps was performed:

- a. Cabinet emissions measurements. Radiated measurement was performed to ensure that cabinet emissions are below the emission limits. For the cabinet-emission measurements the antenna was replaced by a termination matching the nominal impedance of the antenna.
- b. Conducted tests was performed using equipment that matches the nominal impedance of the antenna assembly used with the EUT.
- c. EIRP calculation. A value representative of an upper bound on out-of-band antenna gain (in dBi) shall be added to the measured antenna-port conducted emission power to compute EIRP within the specified measurement bandwidth. (For emissions in the restricted bands, additional calculations are required to convert EIRP to field strength at the specified distance.) The upper bound on antenna gain for a device with a single RF output shall be selected as the maximum in-band gain of the antenna across all operating bands or 2 dBi, whichever is greater.
- d. EIRP adjustments for multiple outputs. (Follow the procedures specified in FCC KDB Publication 662911)
- e. For all of Radiation emission test

For Radiated emission below 30 MHz

- a. The EUT was placed on the top of a rotating table 0.8 meters above the ground at 3 meter chamber room for test. The table was rotated 360 degrees to determine the position of the highest radiation.
- b. The EUT was set 3 meters away from the interference-receiving antenna, which was mounted on the top of a variable-height antenna tower.
- c. Parallel, perpendicular, and ground-parallel orientations of the antenna are set to make the measurement.
- d. For each suspected emission, the EUT was arranged to its worst case and the rotatable table was turned from 0 degrees to 360 degrees to find the maximum reading.
- e. The test-receiver system was set to Quasi-Peak Detect Function and Specified Bandwidth with Maximum Hold Mode, except for the frequency band (9 kHz to 90 kHz and 110 kHz to 490 kHz) set to average detect function and peak detect function.

Notes:

1. The resolution bandwidth and video bandwidth of test receiver/spectrum analyzer is 200 Hz at frequency below 150 kHz.
2. The resolution bandwidth and video bandwidth of test receiver/spectrum analyzer is 9 kHz or 10 kHz at frequency (150 kHz to 30 MHz).
3. All modes of operation were investigated and the worst-case emissions are reported.

For Radiated emission above 30 MHz

- a. The EUT was placed on the top of a rotating table 0.8 meters above the ground at 3 meter chamber room for test. The table was rotated 360 degrees to determine the position of the highest radiation.
- b. The EUT was set 3 meters away from the interference-receiving antenna, which was mounted on the top of a variable-height antenna tower.
- c. The height of antenna is varied from one meter to four meters above the ground to determine the maximum value of the field strength. Both horizontal and vertical polarizations of the antenna are set to make the measurement.
- d. For each suspected emission, the EUT was arranged to its worst case and then the antenna was tuned to heights from 1 meter to 4 meters and the rotatable table was turned from 0 degrees to 360 degrees to find the maximum reading.
- e. The test-receiver system was set to quasi-peak detect function and specified bandwidth with maximum hold mode when the test frequency is below 1 GHz.

Notes:

1. The resolution bandwidth and video bandwidth of test receiver/spectrum analyzer is 120 kHz for Quasi-peak detection (QP) at frequency below 1 GHz.
2. All modes of operation were investigated and the worst-case emissions are reported.

6.9 Unwanted Emissions above 1 GHz

6.9.1 Test Setup

For Conducted Configuration:

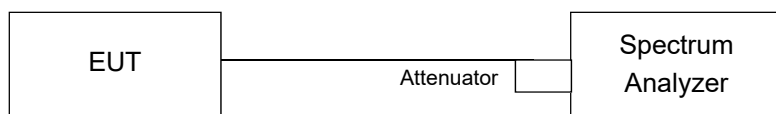

For Radiated Configuration:

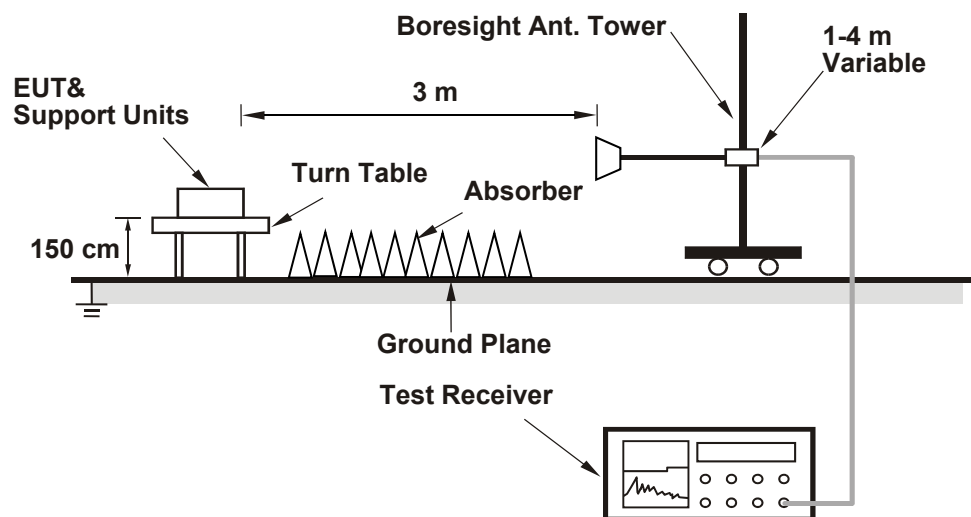

For the actual test configuration, please refer to the attached file (Test Setup Photo).

6.9.2 Test Procedure

Following FCC KDB 789033 D02 General UNII Test Procedures:

Radiated versus Conducted Measurements.

The unwanted emission limits in both the restricted and non-restricted bands are based on antenna-port conducted measurements in conjunction with cabinet emissions tests are permitted to demonstrate compliance.

The following steps was performed:

- a. Cabinet emissions measurements. Radiated measurement was performed to ensure that cabinet emissions are below the emission limits. For the cabinet-emission measurements the antenna was replaced by a termination matching the nominal impedance of the antenna.
- b. Conducted tests was performed using equipment that matches the nominal impedance of the antenna assembly used with the EUT.
- c. EIRP calculation. A value representative of an upper bound on out-of-band antenna gain (in dBi) shall be added to the measured antenna-port conducted emission power to compute EIRP within the specified measurement bandwidth. (For emissions in the restricted bands, additional calculations are required to convert EIRP to field strength at the specified distance.) The upper bound on antenna gain for a device with a single RF output shall be selected as the maximum in-band gain of the antenna across all operating bands or 2 dBi, whichever is greater.
- d. EIRP adjustments for multiple outputs. (Follow the procedures specified in FCC KDB Publication 662911)
- e. For all of Radiation emission test

For Radiated emission above 1 GHz

- a. The EUT was placed on the top of a rotating table 1.5 meters above the ground at 3 meter chamber room for test. The table was rotated 360 degrees to determine the position of the highest radiation.
- b. The EUT was set 3 meters away from the interference-receiving antenna, which was mounted on the top of a variable-height antenna tower.
- c. The height of antenna is varied from one meter to four meters above the ground to determine the maximum value of the field strength. Both horizontal and vertical polarizations of the antenna are set to make the measurement.
- d. For each suspected emission, the EUT was arranged to its worst case and then the antenna was tuned to heights from 1 meter to 4 meters and the rotatable table was turned from 0 degrees to 360 degrees to find the maximum reading.
- e. The test-receiver system was set to peak and average detects function and specified bandwidth with maximum hold mode when the test frequency is above 1 GHz. If the peak reading value also meets average limit, measurement with the average detector is unnecessary.

Notes:

1. The resolution bandwidth of test receiver/spectrum analyzer is 1 MHz and the video bandwidth is 3 MHz for Peak detection (PK) and Average detection (AV) at frequency above 1 GHz.
2. For fundamental and harmonic signal measurement, the resolution bandwidth of test receiver/spectrum analyzer is 1 MHz and the video bandwidth is $\geq 1/T$ (Duty cycle < 98%) or 10 Hz (Duty cycle $\geq 98\%$) for Average detection (AV) at frequency above 1 GHz.
3. All modes of operation were investigated and the worst-case emissions are reported.

7 Test Results of Test Item

7.1 RF Output Power

Input Power:	3.3 Vdc	Environmental Conditions:	23°C, 62% RH	Tested By:	Eric Peng
--------------	---------	---------------------------	--------------	------------	-----------

802.11ax (HE) 26-tone RU Indoor_1T1S

Chan.	Chan. Freq. (MHz)	Average Power (mW)	Average Power (dBm)	Antenna Gain (dBi)	EIRP (mW)	EIRP (dBm)	EIRP Limit (dBm)	Test Result
1	5955	0.8166	-0.88	4.76	2.443	3.88	24	Pass
93	6415	0.9078	-0.42	4.76	2.716	4.34	24	Pass
97	6435	0.869	-0.61	4.29	2.334	3.68	24	Pass
117	6535	0.8017	-0.96	4.61	2.317	3.65	24	Pass
181	6855	0.778	-1.09	4.61	2.249	3.52	24	Pass
233	7115	0.9376	-0.28	4.09	2.404	3.81	24	Pass

Notes:

1. For U-NII-5, The antenna gain is 4.76 dBi
2. For U-NII-6, The antenna gain is 4.29 dBi
3. For U-NII-7, The antenna gain is 4.61 dBi
4. For U-NII-8, The antenna gain is 4.09 dBi

802.11ax (HE) 52-tone RU Indoor_1T1S

Chan.	Chan. Freq. (MHz)	Average Power (mW)	Average Power (dBm)	Antenna Gain (dBi)	EIRP (mW)	EIRP (dBm)	EIRP Limit (dBm)	Test Result
1	5955	1.521	1.82	4.76	4.551	6.58	24	Pass
93	6415	1.51	1.79	4.76	4.518	6.55	24	Pass
97	6435	1.722	2.36	4.29	4.624	6.65	24	Pass
117	6535	1.611	2.07	4.61	4.657	6.68	24	Pass
233	7115	1.923	2.84	4.09	4.932	6.93	24	Pass

Notes:

1. For U-NII-5, The antenna gain is 4.76 dBi
2. For U-NII-6, The antenna gain is 4.29 dBi
3. For U-NII-7, The antenna gain is 4.61 dBi
4. For U-NII-8, The antenna gain is 4.09 dBi

802.11ax (HE) 106-tone RU Indoor_1T1S

Chan.	Chan. Freq. (MHz)	Average Power (mW)	Average Power (dBm)	Antenna Gain (dBi)	EIRP (mW)	EIRP (dBm)	EIRP Limit (dBm)	Test Result
1	5955	2.917	4.65	4.76	8.728	9.41	24	Pass
93	6415	2.958	4.71	4.76	8.851	9.47	24	Pass
97	6435	3.228	5.09	4.29	8.668	9.38	24	Pass
117	6535	3.251	5.12	4.61	9.398	9.73	24	Pass
181	6855	3.119	4.94	4.61	9.016	9.55	24	Pass
233	7115	3.499	5.44	4.09	8.973	9.53	24	Pass

Notes:

1. For U-NII-5, The antenna gain is 4.76 dBi
2. For U-NII-6, The antenna gain is 4.29 dBi
3. For U-NII-7, The antenna gain is 4.61 dBi
4. For U-NII-8, The antenna gain is 4.09 dBi

802.11be (EHT20) 52+26-tone MRU Indoor_1T1S

Chan.	Chan. Freq. (MHz)	Average Power (mW)	Average Power (dBm)	Antenna Gain (dBi)	EIRP (mW)	EIRP (dBm)	EIRP Limit (dBm)	Test Result
1	5955	2.382	3.77	4.76	7.128	8.53	24	Pass
93	6415	2.41	3.82	4.76	7.211	8.58	24	Pass
97	6435	2.466	3.92	4.29	6.622	8.21	24	Pass
117	6535	2.328	3.67	4.61	6.73	8.28	24	Pass
181	6855	2.472	3.93	4.61	7.146	8.54	24	Pass
233	7115	2.742	4.38	4.09	7.032	8.47	24	Pass

Notes:

1. For U-NII-5, The antenna gain is 4.76 dBi
2. For U-NII-6, The antenna gain is 4.29 dBi
3. For U-NII-7, The antenna gain is 4.61 dBi
4. For U-NII-8, The antenna gain is 4.09 dBi

802.11be (EHT20) 106+26-tone MRU Indoor_1T1S

Chan.	Chan. Freq. (MHz)	Average Power (mW)	Average Power (dBm)	Antenna Gain (dBi)	EIRP (mW)	EIRP (dBm)	EIRP Limit (dBm)	Test Result
1	5955	3.673	5.65	4.76	10.991	10.41	24	Pass
93	6415	3.698	5.68	4.76	11.065	10.44	24	Pass
97	6435	3.846	5.85	4.29	10.328	10.14	24	Pass
117	6535	3.69	5.67	4.61	10.667	10.28	24	Pass
181	6855	3.936	5.95	4.61	11.378	10.56	24	Pass
233	7115	4.426	6.46	4.09	11.35	10.55	24	Pass

Notes:

1. For U-NII-5, The antenna gain is 4.76 dBi
2. For U-NII-6, The antenna gain is 4.29 dBi
3. For U-NII-7, The antenna gain is 4.61 dBi
4. For U-NII-8, The antenna gain is 4.09 dBi

802.11be (EHT80) 484+242-tone MRU Indoor_1T1S

Chan.	Chan. Freq. (MHz)	Average Power (mW)	Average Power (dBm)	Antenna Gain (dBi)	EIRP (mW)	EIRP (dBm)	EIRP Limit (dBm)	Test Result
7	5985	18.239	12.61	4.76	54.576	17.37	24	Pass
87	6385	19.055	12.80	4.76	57.018	17.56	24	Pass
103	6465	20.137	13.04	4.29	54.075	17.33	24	Pass
135	6625	19.364	12.87	4.61	55.975	17.48	24	Pass
215	7025	22.491	13.52	4.09	57.678	17.61	24	Pass

Notes:

1. For U-NII-5, The antenna gain is 4.76 dBi
2. For U-NII-6, The antenna gain is 4.29 dBi
3. For U-NII-7, The antenna gain is 4.61 dBi
4. For U-NII-8, The antenna gain is 4.09 dBi

802.11be (EHT160) 996+484-tone MRU Indoor_1T1S

Chan.	Chan. Freq. (MHz)	Average Power (mW)	Average Power (dBm)	Antenna Gain (dBi)	EIRP (mW)	EIRP (dBm)	EIRP Limit (dBm)	Test Result
15	6025	33.497	15.25	4.76	100.232	20.01	24	Pass
79	6345	33.42	15.24	4.76	100.001	20	24	Pass
143	6665	33.266	15.22	4.61	96.161	19.83	24	Pass
207	6985	35.237	15.47	4.09	90.365	19.56	24	Pass

Notes:

1. For U-NII-5, The antenna gain is 4.76 dBi
2. For U-NII-6, The antenna gain is 4.29 dBi
3. For U-NII-7, The antenna gain is 4.61 dBi
4. For U-NII-8, The antenna gain is 4.09 dBi

802.11be (EHT160) 996+484+242-tone MRU Indoor_1T1S

Chan.	Chan. Freq. (MHz)	Average Power (mW)	Average Power (dBm)	Antenna Gain (dBi)	EIRP (mW)	EIRP (dBm)	EIRP Limit (dBm)	Test Result
15	6025	34.119	15.33	4.76	102.093	20.09	24	Pass
79	6345	32.509	15.12	4.76	97.276	19.88	24	Pass
143	6665	34.594	15.39	4.61	100	20	24	Pass
207	6985	34.754	15.41	4.09	89.126	19.5	24	Pass

Notes:

1. For U-NII-5, The antenna gain is 4.76 dBi
2. For U-NII-6, The antenna gain is 4.29 dBi
3. For U-NII-7, The antenna gain is 4.61 dBi
4. For U-NII-8, The antenna gain is 4.09 dBi

802.11be (EHT320) 2x996+484-tone MRU Indoor_1T1S

Chan.	Chan. Freq. (MHz)	Average Power (mW)	Average Power (dBm)	Antenna Gain (dBi)	EIRP (mW)	EIRP (dBm)	EIRP Limit (dBm)	Test Result
31	6105	60.395	17.81	4.76	180.718	22.57	24	Pass
63	6265	55.463	17.44	4.76	165.96	22.2	24	Pass
127	6585	62.23	17.94	4.61	179.887	22.55	24	Pass
191	6905	68.549	18.36	4.09	175.793	22.45	24	Pass

Notes:

1. For U-NII-5, The antenna gain is 4.76 dBi
2. For U-NII-6, The antenna gain is 4.29 dBi
3. For U-NII-7, The antenna gain is 4.61 dBi
4. For U-NII-8, The antenna gain is 4.09 dBi

802.11be (EHT320) 3x996-tone MRU Indoor_1T1S

Chan.	Chan. Freq. (MHz)	Average Power (mW)	Average Power (dBm)	Antenna Gain (dBi)	EIRP (mW)	EIRP (dBm)	EIRP Limit (dBm)	Test Result
31	6105	63.973	18.06	4.76	191.424	22.82	24	Pass
63	6265	64.714	18.11	4.76	193.641	22.87	24	Pass
127	6585	65.313	18.15	4.61	188.799	22.76	24	Pass
191	6905	68.077	18.33	4.09	174.582	22.42	24	Pass

Notes:

1. For U-NII-5, The antenna gain is 4.76 dBi
2. For U-NII-6, The antenna gain is 4.29 dBi
3. For U-NII-7, The antenna gain is 4.61 dBi
4. For U-NII-8, The antenna gain is 4.09 dBi

802.11be (EHT320) 3x996+484-tone MRU Indoor_1T1S

Chan.	Chan. Freq. (MHz)	Average Power (mW)	Average Power (dBm)	Antenna Gain (dBi)	EIRP (mW)	EIRP (dBm)	EIRP Limit (dBm)	Test Result
31	6105	63.533	18.03	4.76	190.108	22.79	24	Pass
63	6265	64.417	18.09	4.76	192.753	22.85	24	Pass
127	6585	65.615	18.17	4.61	189.672	22.78	24	Pass
191	6905	67.453	18.29	4.09	172.982	22.38	24	Pass

Notes:

1. For U-NII-5, The antenna gain is 4.76 dBi
2. For U-NII-6, The antenna gain is 4.29 dBi
3. For U-NII-7, The antenna gain is 4.61 dBi
4. For U-NII-8, The antenna gain is 4.09 dBi

802.11ax (HE) 26-tone RU Indoor_2T2S

Chan.	Chan. Freq. (MHz)	Average Power (dBm)		Total Power (mW)	Total Power (dBm)	Directional Gain (dBi)	EIRP (mW)	EIRP (dBm)	EIRP Limit (dBm)	Test Result
		Chain 0	Chain 1							
1	5955	-3.62	-3.42	0.8895	-0.51	4.76	2.662	4.25	24	Pass
93	6415	-3.63	-3.70	0.8601	-0.65	4.76	2.574	4.11	24	Pass
97	6435	-3.53	-3.99	0.8426	-0.74	4.29	2.263	3.55	24	Pass
117	6535	-3.72	-4.04	0.8191	-0.87	4.61	2.368	3.74	24	Pass
181	6855	-3.80	-4.02	0.8131	-0.90	4.61	2.35	3.71	24	Pass
233	7115	-3.45	-3.68	0.8804	-0.55	4.09	2.258	3.54	24	Pass

Notes:

1. For U-NII-5, The directional gain is 4.76 dBi
2. For U-NII-6, The directional gain is 4.29 dBi
3. For U-NII-7, The directional gain is 4.61 dBi
4. For U-NII-8, The directional gain is 4.09 dBi

802.11ax (HE) 52-tone RU Indoor_2T2S

Chan.	Chan. Freq. (MHz)	Average Power (dBm)		Total Power (mW)	Total Power (dBm)	Directional Gain (dBi)	EIRP (mW)	EIRP (dBm)	EIRP Limit (dBm)	Test Result
		Chain 0	Chain 1							
1	5955	-0.73	-0.77	1.6828	2.26	4.76	5.035	7.02	24	Pass
93	6415	-0.25	-0.93	1.7513	2.43	4.76	5.24	7.19	24	Pass
97	6435	-0.37	-0.96	1.72	2.36	4.29	4.619	6.65	24	Pass
117	6535	-0.36	-0.64	1.7834	2.51	4.61	5.155	7.12	24	Pass
181	6855	-0.46	-0.31	1.8306	2.63	4.61	5.292	7.24	24	Pass
233	7115	-0.16	-0.22	1.9144	2.82	4.09	4.909	6.91	24	Pass

Notes:

1. For U-NII-5, The directional gain is 4.76 dBi
2. For U-NII-6, The directional gain is 4.29 dBi
3. For U-NII-7, The directional gain is 4.61 dBi
4. For U-NII-8, The directional gain is 4.09 dBi

802.11ax (HE) 106-tone RU Indoor_2T2S

Chan.	Chan. Freq. (MHz)	Average Power (dBm)		Total Power (mW)	Total Power (dBm)	Directional Gain (dBi)	EIRP (mW)	EIRP (dBm)	EIRP Limit (dBm)	Test Result
		Chain 0	Chain 1							
1	5955	1.91	2.08	3.167	5.01	4.76	9.477	9.77	24	Pass
93	6415	2.17	1.96	3.219	5.08	4.76	9.632	9.84	24	Pass
97	6435	2.54	2.23	3.466	5.40	4.29	9.307	9.69	24	Pass
117	6535	2.35	2.14	3.355	5.26	4.61	9.698	9.87	24	Pass
181	6855	2.19	2.46	3.418	5.34	4.61	9.88	9.95	24	Pass
233	7115	2.57	2.48	3.577	5.54	4.09	9.173	9.63	24	Pass

Notes:

1. For U-NII-5, The directional gain is 4.76 dBi
2. For U-NII-6, The directional gain is 4.29 dBi
3. For U-NII-7, The directional gain is 4.61 dBi
4. For U-NII-8, The directional gain is 4.09 dBi

802.11be (EHT20) 52+26-tone MRU Indoor_2T2S

Chan.	Chan. Freq. (MHz)	Average Power (dBm)		Total Power (mW)	Total Power (dBm)	Directional Gain (dBi)	EIRP (mW)	EIRP (dBm)	EIRP Limit (dBm)	Test Result
		Chain 0	Chain 1							
1	5955	0.78	0.98	2.45	3.89	4.76	7.331	8.65	24	Pass
93	6415	0.84	0.70	2.388	3.78	4.76	7.146	8.54	24	Pass
97	6435	1.08	0.62	2.436	3.87	4.29	6.541	8.16	24	Pass
117	6535	0.59	0.68	2.315	3.65	4.61	6.692	8.26	24	Pass
181	6855	1.03	1.12	2.562	4.09	4.61	7.406	8.7	24	Pass
233	7115	1.59	1.46	2.842	4.54	4.09	7.288	8.63	24	Pass

Notes:

1. For U-NII-5, The directional gain is 4.76 dBi
2. For U-NII-6, The directional gain is 4.29 dBi
3. For U-NII-7, The directional gain is 4.61 dBi
4. For U-NII-8, The directional gain is 4.09 dBi

802.11be (EHT20) 106+26-tone MRU Indoor_2T2S

Chan.	Chan. Freq. (MHz)	Average Power (dBm)		Total Power (mW)	Total Power (dBm)	Directional Gain (dBi)	EIRP (mW)	EIRP (dBm)	EIRP Limit (dBm)	Test Result
		Chain 0	Chain 1							
1	5955	2.92	2.83	3.878	5.89	4.76	11.604	10.65	24	Pass
93	6415	2.89	2.75	3.829	5.83	4.76	11.457	10.59	24	Pass
97	6435	3.07	2.67	3.877	5.88	4.29	10.411	10.17	24	Pass
117	6535	2.76	2.70	3.75	5.74	4.61	10.84	10.35	24	Pass
181	6855	3.07	3.21	4.122	6.15	4.61	11.915	10.76	24	Pass
233	7115	3.69	3.45	4.552	6.58	4.09	11.674	10.67	24	Pass

Notes:

1. For U-NII-5, The directional gain is 4.76 dBi
2. For U-NII-6, The directional gain is 4.29 dBi
3. For U-NII-7, The directional gain is 4.61 dBi
4. For U-NII-8, The directional gain is 4.09 dBi

802.11be (EHT80) 484+242-tone MRU Indoor_2T2S

Chan.	Chan. Freq. (MHz)	Average Power (dBm)		Total Power (mW)	Total Power (dBm)	Directional Gain (dBi)	EIRP (mW)	EIRP (dBm)	EIRP Limit (dBm)	Test Result
		Chain 0	Chain 1							
7	5985	9.51	9.83	18.549	12.68	4.76	55.504	17.44	24	Pass
87	6385	9.65	9.78	18.732	12.73	4.76	56.051	17.49	24	Pass
103	6465	10.01	9.81	19.595	12.92	4.29	52.619	17.21	24	Pass
135	6625	9.95	9.93	19.726	12.95	4.61	57.022	17.56	24	Pass
215	7025	9.99	10.33	20.766	13.17	4.09	53.254	17.26	24	Pass

Notes:

1. For U-NII-5, The directional gain is 4.76 dBi
2. For U-NII-6, The directional gain is 4.29 dBi
3. For U-NII-7, The directional gain is 4.61 dBi
4. For U-NII-8, The directional gain is 4.09 dBi

802.11be (EHT160) 996+484-tone MRU Indoor_2T2S

Chan.	Chan. Freq. (MHz)	Average Power (dBm)		Total Power (mW)	Total Power (dBm)	Directional Gain (dBi)	EIRP (mW)	EIRP (dBm)	EIRP Limit (dBm)	Test Result
		Chain 0	Chain 1							
15	6025	12.27	12.33	33.966	15.31	4.76	101.635	20.07	24	Pass
79	6345	12.41	12.35	34.597	15.39	4.76	103.523	20.15	24	Pass
143	6665	12.43	12.30	34.481	15.38	4.61	99.674	19.99	24	Pass
207	6985	12.34	13.01	37.138	15.70	4.09	95.24	19.79	24	Pass

Notes:

1. For U-NII-5, The directional gain is 4.76 dBi
2. For U-NII-6, The directional gain is 4.29 dBi
3. For U-NII-7, The directional gain is 4.61 dBi
4. For U-NII-8, The directional gain is 4.09 dBi

802.11be (EHT160) 996+484+242-tone MRU Indoor_2T2S

Chan.	Chan. Freq. (MHz)	Average Power (dBm)		Total Power (mW)	Total Power (dBm)	Directional Gain (dBi)	EIRP (mW)	EIRP (dBm)	EIRP Limit (dBm)	Test Result
		Chain 0	Chain 1							
15	6025	12.18	12.43	34.018	15.32	4.76	101.791	20.08	24	Pass
79	6345	12.28	12.34	34.044	15.32	4.76	101.869	20.08	24	Pass
143	6665	12.39	12.41	34.756	15.41	4.61	100.468	20.02	24	Pass
207	6985	12.60	13.05	38.381	15.84	4.09	98.427	19.93	24	Pass

Notes:

1. For U-NII-5, The directional gain is 4.76 dBi
2. For U-NII-6, The directional gain is 4.29 dBi
3. For U-NII-7, The directional gain is 4.61 dBi
4. For U-NII-8, The directional gain is 4.09 dBi

802.11be (EHT320) 2x996+484-tone MRU Indoor_2T2S

Chan.	Chan. Freq. (MHz)	Average Power (dBm)		Total Power (mW)	Total Power (dBm)	Directional Gain (dBi)	EIRP (mW)	EIRP (dBm)	EIRP Limit (dBm)	Test Result
		Chain 0	Chain 1							
31	6105	15.12	13.74	56.168	17.49	4.76	168.07	22.25	24	Pass
63	6265	14.42	14.76	57.592	17.60	4.76	172.331	22.36	24	Pass
127	6585	14.69	14.53	57.823	17.62	4.61	167.148	22.23	24	Pass
191	6905	14.46	15.65	64.654	18.11	4.09	165.804	22.2	24	Pass

Notes:

1. For U-NII-5, The directional gain is 4.76 dBi
2. For U-NII-6, The directional gain is 4.29 dBi
3. For U-NII-7, The directional gain is 4.61 dBi
4. For U-NII-8, The directional gain is 4.09 dBi

802.11be (EHT320) 3x996-tone MRU Indoor_2T2S

Chan.	Chan. Freq. (MHz)	Average Power (dBm)		Total Power (mW)	Total Power (dBm)	Directional Gain (dBi)	EIRP (mW)	EIRP (dBm)	EIRP Limit (dBm)	Test Result
		Chain 0	Chain 1							
31	6105	15.46	14.21	61.519	17.89	4.76	184.081	22.65	24	Pass
63	6265	14.80	15.13	62.783	17.98	4.76	187.863	22.74	24	Pass
127	6585	15.13	14.97	63.989	18.06	4.61	184.972	22.67	24	Pass
191	6905	14.68	16.01	69.279	18.41	4.09	177.665	22.5	24	Pass

Notes:

1. For U-NII-5, The directional gain is 4.76 dBi
2. For U-NII-6, The directional gain is 4.29 dBi
3. For U-NII-7, The directional gain is 4.61 dBi
4. For U-NII-8, The directional gain is 4.09 dBi

802.11be (EHT320) 3x996+484-tone MRU Indoor_2T2S

Chan.	Chan. Freq. (MHz)	Average Power (dBm)		Total Power (mW)	Total Power (dBm)	Directional Gain (dBi)	EIRP (mW)	EIRP (dBm)	EIRP Limit (dBm)	Test Result
		Chain 0	Chain 1							
31	6105	15.64	14.50	64.828	18.12	4.76	193.983	22.88	24	Pass
63	6265	14.82	15.12	62.848	17.98	4.76	188.058	22.74	24	Pass
127	6585	15.15	14.92	63.78	18.05	4.61	184.368	22.66	24	Pass
191	6905	14.62	15.91	67.968	18.32	4.09	174.303	22.41	24	Pass

Notes:

1. For U-NII-5, The directional gain is 4.76 dBi
2. For U-NII-6, The directional gain is 4.29 dBi
3. For U-NII-7, The directional gain is 4.61 dBi
4. For U-NII-8, The directional gain is 4.09 dBi

7.2 Power Spectral Density

Input Power:	3.3 Vdc	Environmental Conditions:	23°C, 62% RH	Tested By:	Eric Peng
--------------	---------	---------------------------	--------------	------------	-----------

802.11ax (HE) 26-tone RU Indoor_1T1S

Chan.	Chan. Freq. (MHz)	PSD w/o Duty Factor (dBm/MHz)	Duty Factor (dB)	PSD (dBm/MHz)	Antenna Gain (dBi)	EIRP PSD (dBm/MHz)	EIRP PSD Limit (dBm/MHz)	Test Result
1	5955	-6.79	0.79	-6.00	4.76	-1.24	-1	Pass
93	6415	-6.68	0.79	-5.89	4.76	-1.13	-1	Pass
97	6435	-6.32	0.79	-5.53	4.29	-1.24	-1	Pass
117	6535	-6.62	0.79	-5.83	4.61	-1.22	-1	Pass
181	6855	-6.63	0.79	-5.84	4.61	-1.23	-1	Pass
233	7115	-5.99	0.79	-5.20	4.09	-1.11	-1	Pass

Notes:

1. For U-NII-5, The antenna gain is 4.76 dBi
2. For U-NII-6, The antenna gain is 4.29 dBi
3. For U-NII-7, The antenna gain is 4.61 dBi
4. For U-NII-8, The antenna gain is 4.09 dBi

802.11ax (HE) 52-tone RU Indoor_1T1S

Chan.	Chan. Freq. (MHz)	PSD w/o Duty Factor (dBm/MHz)	Duty Factor (dB)	PSD (dBm/MHz)	Antenna Gain (dBi)	EIRP PSD (dBm/MHz)	EIRP PSD Limit (dBm/MHz)	Test Result
1	5955	-7.01	0.92	-6.09	4.76	-1.33	-1	Pass
93	6415	-6.92	0.92	-6.00	4.76	-1.24	-1	Pass
97	6435	-6.28	0.92	-5.36	4.29	-1.07	-1	Pass
117	6535	-6.73	0.92	-5.81	4.61	-1.2	-1	Pass
233	7115	-6.26	0.92	-5.34	4.09	-1.25	-1	Pass

Notes:

1. For U-NII-5, The antenna gain is 4.76 dBi
2. For U-NII-6, The antenna gain is 4.29 dBi
3. For U-NII-7, The antenna gain is 4.61 dBi
4. For U-NII-8, The antenna gain is 4.09 dBi

802.11ax (HE) 106-tone RU Indoor_1T1S

Chan.	Chan. Freq. (MHz)	PSD w/o Duty Factor (dBm/MHz)	Duty Factor (dB)	PSD (dBm/MHz)	Antenna Gain (dBi)	EIRP PSD (dBm/MHz)	EIRP PSD Limit (dBm/MHz)	Test Result
1	5955	-6.95	1.03	-5.92	4.76	-1.16	-1	Pass
93	6415	-7.06	1.03	-6.03	4.76	-1.27	-1	Pass
97	6435	-6.57	1.03	-5.54	4.29	-1.25	-1	Pass
117	6535	-6.87	1.03	-5.84	4.61	-1.23	-1	Pass
181	6855	-6.92	1.03	-5.89	4.61	-1.28	-1	Pass
233	7115	-6.54	1.03	-5.51	4.09	-1.42	-1	Pass

Notes:

1. For U-NII-5, The antenna gain is 4.76 dBi
2. For U-NII-6, The antenna gain is 4.29 dBi
3. For U-NII-7, The antenna gain is 4.61 dBi
4. For U-NII-8, The antenna gain is 4.09 dBi

802.11be (EHT20) 52+26-tone MRU Indoor_1T1S

Chan.	Chan. Freq. (MHz)	PSD w/o Duty Factor (dBm/MHz)	Duty Factor (dB)	PSD (dBm/MHz)	Antenna Gain (dBi)	EIRP PSD (dBm/MHz)	EIRP PSD Limit (dBm/MHz)	Test Result
1	5955	-6.78	0.97	-5.81	4.76	-1.05	-1	Pass
93	6415	-6.74	0.97	-5.77	4.76	-1.01	-1	Pass
97	6435	-6.53	0.97	-5.56	4.29	-1.27	-1	Pass
117	6535	-7.02	0.97	-6.05	4.61	-1.44	-1	Pass
181	6855	-6.77	0.97	-5.80	4.61	-1.19	-1	Pass
233	7115	-6.36	0.97	-5.39	4.09	-1.3	-1	Pass

Notes:

1. For U-NII-5, The antenna gain is 4.76 dBi
2. For U-NII-6, The antenna gain is 4.29 dBi
3. For U-NII-7, The antenna gain is 4.61 dBi
4. For U-NII-8, The antenna gain is 4.09 dBi

802.11be (EHT20) 106+26-tone MRU Indoor_1T1S

Chan.	Chan. Freq. (MHz)	PSD w/o Duty Factor (dBm/MHz)	Duty Factor (dB)	PSD (dBm/MHz)	Antenna Gain (dBi)	EIRP PSD (dBm/MHz)	EIRP PSD Limit (dBm/MHz)	Test Result
1	5955	-7.03	0.97	-6.06	4.76	-1.3	-1	Pass
93	6415	-6.83	0.97	-5.86	4.76	-1.1	-1	Pass
97	6435	-6.55	0.97	-5.58	4.29	-1.29	-1	Pass
117	6535	-6.97	0.97	-6.00	4.61	-1.39	-1	Pass
181	6855	-7	0.97	-6.03	4.61	-1.42	-1	Pass
233	7115	-6.29	0.97	-5.32	4.09	-1.23	-1	Pass

Notes:

1. For U-NII-5, The antenna gain is 4.76 dBi
2. For U-NII-6, The antenna gain is 4.29 dBi
3. For U-NII-7, The antenna gain is 4.61 dBi
4. For U-NII-8, The antenna gain is 4.09 dBi

802.11be (EHT80) 484+242-tone MRU Indoor_1T1S

Chan.	Chan. Freq. (MHz)	PSD w/o Duty Factor (dBm/MHz)	Duty Factor (dB)	PSD (dBm/MHz)	Antenna Gain (dBi)	EIRP PSD (dBm/MHz)	EIRP PSD Limit (dBm/MHz)	Test Result
7	5985	-7.33	1.24	-6.09	4.76	-1.33	-1	Pass
87	6385	-7.58	1.24	-6.34	4.76	-1.58	-1	Pass
103	6465	-6.89	1.24	-5.65	4.29	-1.36	-1	Pass
135	6625	-7.36	1.24	-6.12	4.61	-1.51	-1	Pass
215	7025	-6.8	1.24	-5.56	4.09	-1.47	-1	Pass

Notes:

1. For U-NII-5, The antenna gain is 4.76 dBi
2. For U-NII-6, The antenna gain is 4.29 dBi
3. For U-NII-7, The antenna gain is 4.61 dBi
4. For U-NII-8, The antenna gain is 4.09 dBi

802.11be (EHT160) 996+484-tone MRU Indoor_1T1S

Chan.	Chan. Freq. (MHz)	PSD w/o Duty Factor (dBm/MHz)	Duty Factor (dB)	PSD (dBm/MHz)	Antenna Gain (dBi)	EIRP PSD (dBm/MHz)	EIRP PSD Limit (dBm/MHz)	Test Result
15	6025	-7.4	1.27	-6.13	4.76	-1.37	-1	Pass
79	6345	-7.12	1.27	-5.85	4.76	-1.09	-1	Pass
143	6665	-7.22	1.27	-5.95	4.61	-1.34	-1	Pass
207	6985	-6.81	1.27	-5.54	4.09	-1.45	-1	Pass

Notes:

1. For U-NII-5, The antenna gain is 4.76 dBi
2. For U-NII-6, The antenna gain is 4.29 dBi
3. For U-NII-7, The antenna gain is 4.61 dBi
4. For U-NII-8, The antenna gain is 4.09 dBi

802.11be (EHT160) 996+484+242-tone MRU Indoor_1T1S

Chan.	Chan. Freq. (MHz)	PSD w/o Duty Factor (dBm/MHz)	Duty Factor (dB)	PSD (dBm/MHz)	Antenna Gain (dBi)	EIRP PSD (dBm/MHz)	EIRP PSD Limit (dBm/MHz)	Test Result
15	6025	-7.22	1.27	-5.95	4.76	-1.19	-1	Pass
79	6345	-7.45	1.27	-6.18	4.76	-1.42	-1	Pass
143	6665	-7.32	1.27	-6.05	4.61	-1.44	-1	Pass
207	6985	-6.73	1.27	-5.46	4.09	-1.37	-1	Pass

Notes:

1. For U-NII-5, The antenna gain is 4.76 dBi
2. For U-NII-6, The antenna gain is 4.29 dBi
3. For U-NII-7, The antenna gain is 4.61 dBi
4. For U-NII-8, The antenna gain is 4.09 dBi

802.11be (EHT320) 2x996+484-tone MRU Indoor_1T1S

Chan.	Chan. Freq. (MHz)	PSD w/o Duty Factor (dBm/MHz)	Duty Factor (dB)	PSD (dBm/MHz)	Antenna Gain (dBi)	EIRP PSD (dBm/MHz)	EIRP PSD Limit (dBm/MHz)	Test Result
31	6105	-7.25	1.27	-5.98	4.76	-1.22	-1	Pass
63	6265	-7.32	1.27	-6.05	4.76	-1.29	-1	Pass
127	6585	-6.94	1.27	-5.67	4.61	-1.06	-1	Pass
191	6905	-6.43	1.27	-5.16	4.09	-1.07	-1	Pass

Notes:

1. For U-NII-5, The antenna gain is 4.76 dBi
2. For U-NII-6, The antenna gain is 4.29 dBi
3. For U-NII-7, The antenna gain is 4.61 dBi
4. For U-NII-8, The antenna gain is 4.09 dBi

802.11be (EHT320) 3x996-tone MRU Indoor_1T1S

Chan.	Chan. Freq. (MHz)	PSD w/o Duty Factor (dBm/MHz)	Duty Factor (dB)	PSD (dBm/MHz)	Antenna Gain (dBi)	EIRP PSD (dBm/MHz)	EIRP PSD Limit (dBm/MHz)	Test Result
31	6105	-7.44	1.27	-6.17	4.76	-1.41	-1	Pass
63	6265	-7.48	1.27	-6.21	4.76	-1.45	-1	Pass
127	6585	-7.38	1.27	-6.11	4.61	-1.5	-1	Pass
191	6905	-6.53	1.27	-5.26	4.09	-1.17	-1	Pass

Notes:

1. For U-NII-5, The antenna gain is 4.76 dBi
2. For U-NII-6, The antenna gain is 4.29 dBi
3. For U-NII-7, The antenna gain is 4.61 dBi
4. For U-NII-8, The antenna gain is 4.09 dBi

802.11be (EHT320) 3x996+484-tone MRU Indoor_1T1S

Chan.	Chan. Freq. (MHz)	PSD w/o Duty Factor (dBm/MHz)	Duty Factor (dB)	PSD (dBm/MHz)	Antenna Gain (dBi)	EIRP PSD (dBm/MHz)	EIRP PSD Limit (dBm/MHz)	Test Result
31	6105	-7.5	1.27	-6.23	4.76	-1.47	-1	Pass
63	6265	-7.19	1.27	-5.92	4.76	-1.16	-1	Pass
127	6585	-6.95	1.27	-5.68	4.61	-1.07	-1	Pass
191	6905	-6.6	1.27	-5.33	4.09	-1.24	-1	Pass

Notes:

1. For U-NII-5, The antenna gain is 4.76 dBi
2. For U-NII-6, The antenna gain is 4.29 dBi
3. For U-NII-7, The antenna gain is 4.61 dBi
4. For U-NII-8, The antenna gain is 4.09 dBi

802.11ax (HE) 26-tone RU Indoor_2T2S

Chan.	Chan. Freq. (MHz)	PSD w/o Duty Factor (dBm/MHz)		Duty Factor (dB)	Total PSD (dBm/MHz)	Directional Gain (dBi)	EIRP PSD (dBm/MHz)	EIRP PSD Limit (dBm/MHz)	Test Result
		Chain 0	Chain 1						
1	5955	-10.39	-9.91	1.28	-5.85	4.76	-1.09	-1	Pass
93	6415	-9.85	-10.31	1.28	-5.78	4.76	-1.02	-1	Pass
97	6435	-9.35	-10.30	1.28	-5.51	4.29	-1.22	-1	Pass
117	6535	-10.36	-10.05	1.28	-5.91	4.61	-1.3	-1	Pass
181	6855	-9.75	-10.79	1.28	-5.95	4.61	-1.34	-1	Pass
233	7115	-9.45	-9.53	1.28	-5.20	4.09	-1.11	-1	Pass

Notes:

1. Method E) 2) a) of power density measurement of KDB 662911 is using for calculating total power density. Total power density is summing entire spectra across corresponding frequency bins on the various outputs by computer.
2. For U-NII-5, The directional gain is 4.76 dBi
3. For U-NII-6, The directional gain is 4.29 dBi
4. For U-NII-7, The directional gain is 4.61 dBi
5. For U-NII-8, The directional gain is 4.09 dBi

802.11ax (HE) 52-tone RU Indoor_2T2S

Chan.	Chan. Freq. (MHz)	PSD w/o Duty Factor (dBm/MHz)		Duty Factor (dB)	Total PSD (dBm/MHz)	Directional Gain (dBi)	EIRP PSD (dBm/MHz)	EIRP PSD Limit (dBm/MHz)	Test Result
		Chain 0	Chain 1						
1	5955	-10.01	-10.71	1.44	-5.90	4.76	-1.14	-1	Pass
93	6415	-10.36	-10.62	1.44	-6.04	4.76	-1.28	-1	Pass
97	6435	-9.98	-10.18	1.44	-5.63	4.29	-1.34	-1	Pass
117	6535	-10.10	-10.16	1.44	-5.68	4.61	-1.07	-1	Pass
181	6855	-10.12	-10.38	1.44	-5.80	4.61	-1.19	-1	Pass
233	7115	-9.58	-9.57	1.44	-5.12	4.09	-1.03	-1	Pass

Notes:

1. Method E) 2) a) of power density measurement of KDB 662911 is using for calculating total power density. Total power density is summing entire spectra across corresponding frequency bins on the various outputs by computer.
2. For U-NII-5, The directional gain is 4.76 dBi
3. For U-NII-6, The directional gain is 4.29 dBi
4. For U-NII-7, The directional gain is 4.61 dBi
5. For U-NII-8, The directional gain is 4.09 dBi

802.11ax (HE) 106-tone RU Indoor_2T2S

Chan.	Chan. Freq. (MHz)	PSD w/o Duty Factor (dBm/MHz)		Duty Factor (dB)	Total PSD (dBm/MHz)	Directional Gain (dBi)	EIRP PSD (dBm/MHz)	EIRP PSD Limit (dBm/MHz)	Test Result
		Chain 0	Chain 1						
1	5955	-10.10	-10.69	1.55	-5.82	4.76	-1.06	-1	Pass
93	6415	-10.34	-10.79	1.55	-6.00	4.76	-1.24	-1	Pass
97	6435	-9.85	-10.17	1.55	-5.45	4.29	-1.16	-1	Pass
117	6535	-10.08	-10.85	1.55	-5.89	4.61	-1.28	-1	Pass
181	6855	-10.02	-10.42	1.55	-5.66	4.61	-1.05	-1	Pass
233	7115	-10.39	-9.96	1.55	-5.61	4.09	-1.52	-1	Pass

Notes:

1. Method E) 2) a) of power density measurement of KDB 662911 is using for calculating total power density. Total power density is summing entire spectra across corresponding frequency bins on the various outputs by computer.
2. For U-NII-5, The directional gain is 4.76 dBi
3. For U-NII-6, The directional gain is 4.29 dBi
4. For U-NII-7, The directional gain is 4.61 dBi
5. For U-NII-8, The directional gain is 4.09 dBi

802.11be (EHT20) 52+26-tone MRU Indoor_2T2S

Chan.	Chan. Freq. (MHz)	PSD w/o Duty Factor (dBm/MHz)		Duty Factor (dB)	Total PSD (dBm/MHz)	Directional Gain (dBi)	EIRP PSD (dBm/MHz)	EIRP PSD Limit (dBm/MHz)	Test Result
		Chain 0	Chain 1						
1	5955	-10.23	-10.36	1.47	-5.81	4.76	-1.05	-1	Pass
93	6415	-10.98	-10.08	1.47	-6.03	4.76	-1.27	-1	Pass
97	6435	-10.04	-10.33	1.47	-5.70	4.29	-1.41	-1	Pass
117	6535	-10.19	-10.97	1.47	-6.08	4.61	-1.47	-1	Pass
181	6855	-9.87	-10.63	1.47	-5.75	4.61	-1.14	-1	Pass
233	7115	-9.60	-9.82	1.47	-5.23	4.09	-1.14	-1	Pass

Notes:

1. Method E) 2) a) of power density measurement of KDB 662911 is using for calculating total power density. Total power density is summing entire spectra across corresponding frequency bins on the various outputs by computer.
2. For U-NII-5, The directional gain is 4.76 dBi
3. For U-NII-6, The directional gain is 4.29 dBi
4. For U-NII-7, The directional gain is 4.61 dBi
5. For U-NII-8, The directional gain is 4.09 dBi

802.11be (EHT20) 106+26-tone MRU Indoor_2T2S

Chan.	Chan. Freq. (MHz)	PSD w/o Duty Factor (dBm/MHz)		Duty Factor (dB)	Total PSD (dBm/MHz)	Directional Gain (dBi)	EIRP PSD (dBm/MHz)	EIRP PSD Limit (dBm/MHz)	Test Result
		Chain 0	Chain 1						
1	5955	-10.21	-10.30	1.47	-5.77	4.76	-1.01	-1	Pass
93	6415	-10.17	-10.35	1.47	-5.78	4.76	-1.02	-1	Pass
97	6435	-9.77	-10.38	1.47	-5.58	4.29	-1.29	-1	Pass
117	6535	-10.64	-10.48	1.47	-6.08	4.61	-1.47	-1	Pass
181	6855	-10.58	-9.83	1.47	-5.71	4.61	-1.1	-1	Pass
233	7115	-9.49	-10.01	1.47	-5.26	4.09	-1.17	-1	Pass

Notes:

1. Method E) 2) a) of power density measurement of KDB 662911 is using for calculating total power density. Total power density is summing entire spectra across corresponding frequency bins on the various outputs by computer.
2. For U-NII-5, The directional gain is 4.76 dBi
3. For U-NII-6, The directional gain is 4.29 dBi
4. For U-NII-7, The directional gain is 4.61 dBi
5. For U-NII-8, The directional gain is 4.09 dBi

802.11be (EHT80) 484+242-tone MRU Indoor_2T2S

Chan.	Chan. Freq. (MHz)	PSD w/o Duty Factor (dBm/MHz)		Duty Factor (dB)	Total PSD (dBm/MHz)	Directional Gain (dBi)	EIRP PSD (dBm/MHz)	EIRP PSD Limit (dBm/MHz)	Test Result
		Chain 0	Chain 1						
7	5985	-10.95	-10.51	1.78	-5.93	4.76	-1.17	-1	Pass
87	6385	-10.90	-10.50	1.78	-5.91	4.76	-1.15	-1	Pass
103	6465	-10.47	-10.16	1.78	-5.52	4.29	-1.23	-1	Pass
135	6625	-10.61	-10.79	1.78	-5.91	4.61	-1.3	-1	Pass
215	7025	-9.85	-10.38	1.78	-5.32	4.09	-1.23	-1	Pass

Notes:

1. Method E) 2) a) of power density measurement of KDB 662911 is using for calculating total power density. Total power density is summing entire spectra across corresponding frequency bins on the various outputs by computer.
2. For U-NII-5, The directional gain is 4.76 dBi
3. For U-NII-6, The directional gain is 4.29 dBi
4. For U-NII-7, The directional gain is 4.61 dBi
5. For U-NII-8, The directional gain is 4.09 dBi

802.11be (EHT160) 996+484-tone MRU Indoor_2T2S

Chan.	Chan. Freq. (MHz)	PSD w/o Duty Factor (dBm/MHz)		Duty Factor (dB)	Total PSD (dBm/MHz)	Directional Gain (dBi)	EIRP PSD (dBm/MHz)	EIRP PSD Limit (dBm/MHz)	Test Result
		Chain 0	Chain 1						
15	6025	-11.00	-10.70	1.79	-6.05	4.76	-1.29	-1	Pass
79	6345	-10.69	-10.55	1.79	-5.82	4.76	-1.06	-1	Pass
143	6665	-10.49	-10.51	1.79	-5.70	4.61	-1.09	-1	Pass
207	6985	-10.78	-9.51	1.79	-5.30	4.09	-1.21	-1	Pass

Notes:

1. Method E) 2) a) of power density measurement of KDB 662911 is using for calculating total power density. Total power density is summing entire spectra across corresponding frequency bins on the various outputs by computer.
2. For U-NII-5, The directional gain is 4.76 dBi
3. For U-NII-6, The directional gain is 4.29 dBi
4. For U-NII-7, The directional gain is 4.61 dBi
5. For U-NII-8, The directional gain is 4.09 dBi

802.11be (EHT160) 996+484+242-tone MRU Indoor_2T2S

Chan.	Chan. Freq. (MHz)	PSD w/o Duty Factor (dBm/MHz)		Duty Factor (dB)	Total PSD (dBm/MHz)	Directional Gain (dBi)	EIRP PSD (dBm/MHz)	EIRP PSD Limit (dBm/MHz)	Test Result
		Chain 0	Chain 1						
15	6025	-10.98	-10.85	1.79	-6.11	4.76	-1.35	-1	Pass
79	6345	-10.98	-10.52	1.79	-5.94	4.76	-1.18	-1	Pass
143	6665	-10.48	-10.87	1.79	-5.87	4.61	-1.26	-1	Pass
207	6985	-10.80	-9.99	1.79	-5.58	4.09	-1.49	-1	Pass

Notes:

1. Method E) 2) a) of power density measurement of KDB 662911 is using for calculating total power density. Total power density is summing entire spectra across corresponding frequency bins on the various outputs by computer.
2. For U-NII-5, The directional gain is 4.76 dBi
3. For U-NII-6, The directional gain is 4.29 dBi
4. For U-NII-7, The directional gain is 4.61 dBi
5. For U-NII-8, The directional gain is 4.09 dBi

802.11be (EHT320) 2x996+484-tone MRU Indoor_2T2S

Chan.	Chan. Freq. (MHz)	PSD w/o Duty Factor (dBm/MHz)		Duty Factor (dB)	Total PSD (dBm/MHz)	Directional Gain (dBi)	EIRP PSD (dBm/MHz)	EIRP PSD Limit (dBm/MHz)	Test Result
		Chain 0	Chain 1						
31	6105	-9.88	-12.63	1.8	-6.23	4.76	-1.47	-1	Pass
63	6265	-10.56	-11.90	1.8	-6.37	4.76	-1.61	-1	Pass
127	6585	-11.25	-10.65	1.8	-6.13	4.61	-1.52	-1	Pass
191	6905	-11.79	-9.04	1.8	-5.39	4.09	-1.3	-1	Pass

Notes:

1. Method E) 2) a) of power density measurement of KDB 662911 is using for calculating total power density. Total power density is summing entire spectra across corresponding frequency bins on the various outputs by computer.
2. For U-NII-5, The directional gain is 4.76 dBi
3. For U-NII-6, The directional gain is 4.29 dBi
4. For U-NII-7, The directional gain is 4.61 dBi
5. For U-NII-8, The directional gain is 4.09 dBi

802.11be (EHT320) 3x996-tone MRU Indoor_2T2S

Chan.	Chan. Freq. (MHz)	PSD w/o Duty Factor (dBm/MHz)		Duty Factor (dB)	Total PSD (dBm/MHz)	Directional Gain (dBi)	EIRP PSD (dBm/MHz)	EIRP PSD Limit (dBm/MHz)	Test Result
		Chain 0	Chain 1						
31	6105	-10.25	-12.30	1.8	-6.34	4.76	-1.58	-1	Pass
63	6265	-11.06	-11.09	1.8	-6.26	4.76	-1.5	-1	Pass
127	6585	-10.34	-11.33	1.8	-6.00	4.61	-1.39	-1	Pass
191	6905	-11.74	-9.44	1.8	-5.63	4.09	-1.54	-1	Pass

Notes:

1. Method E) 2) a) of power density measurement of KDB 662911 is using for calculating total power density. Total power density is summing entire spectra across corresponding frequency bins on the various outputs by computer.
2. For U-NII-5, The directional gain is 4.76 dBi
3. For U-NII-6, The directional gain is 4.29 dBi
4. For U-NII-7, The directional gain is 4.61 dBi
5. For U-NII-8, The directional gain is 4.09 dBi

802.11be (EHT320) 3x996+484-tone MRU Indoor_2T2S

Chan.	Chan. Freq. (MHz)	PSD w/o Duty Factor (dBm/MHz)		Duty Factor (dB)	Total PSD (dBm/MHz)	Directional Gain (dBi)	EIRP PSD (dBm/MHz)	EIRP PSD Limit (dBm/MHz)	Test Result
		Chain 0	Chain 1						
31	6105	-10.28	-11.03	1.8	-5.83	4.76	-1.07	-1	Pass
63	6265	-10.95	-10.35	1.8	-5.83	4.76	-1.07	-1	Pass
127	6585	-10.68	-11.21	1.8	-6.13	4.61	-1.52	-1	Pass
191	6905	-11.83	-9.33	1.8	-5.59	4.09	-1.5	-1	Pass

Notes:

1. Method E) 2) a) of power density measurement of KDB 662911 is using for calculating total power density. Total power density is summing entire spectra across corresponding frequency bins on the various outputs by computer.
2. For U-NII-5, The directional gain is 4.76 dBi
3. For U-NII-6, The directional gain is 4.29 dBi
4. For U-NII-7, The directional gain is 4.61 dBi
5. For U-NII-8, The directional gain is 4.09 dBi

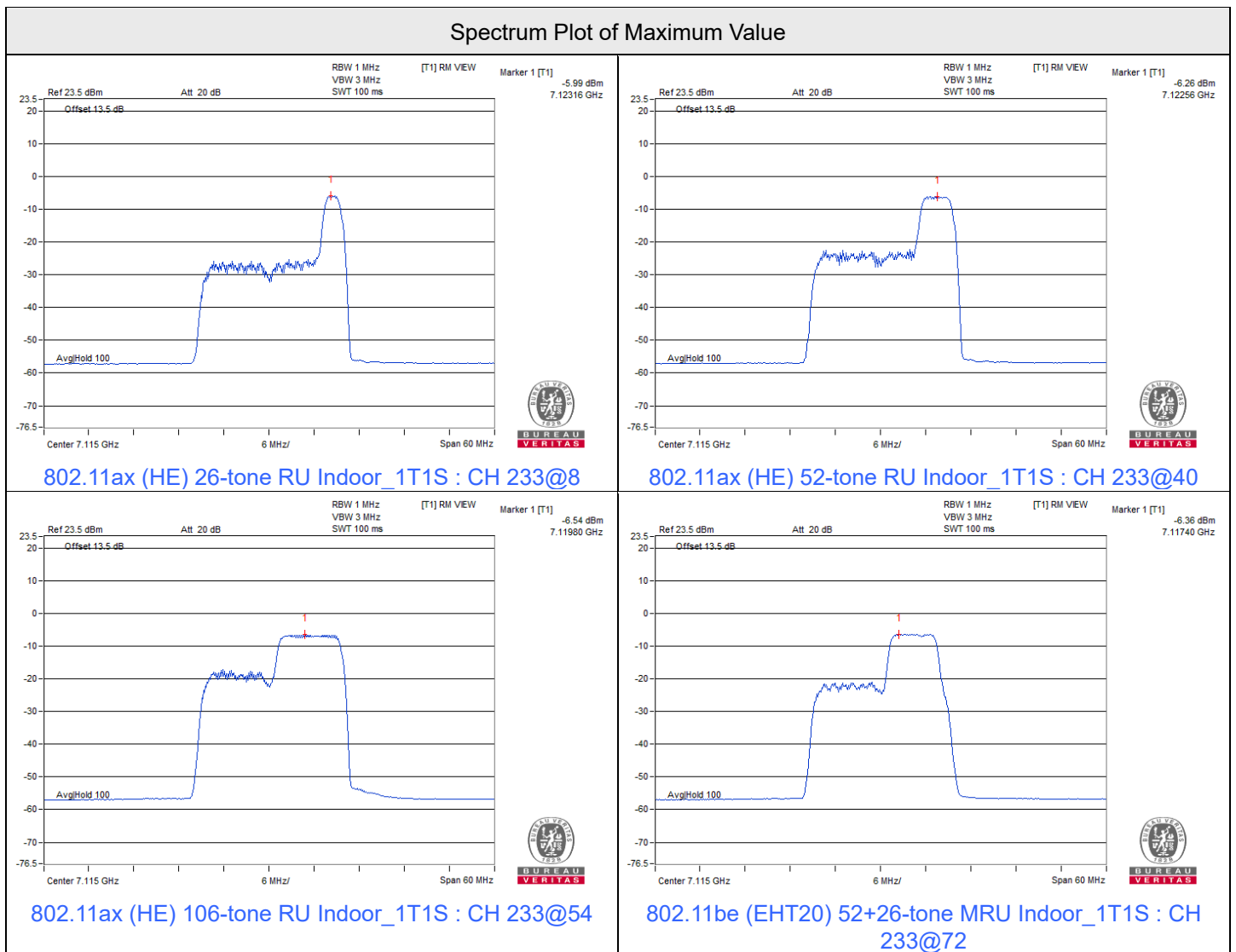



Spectrum Plot of Maximum Value

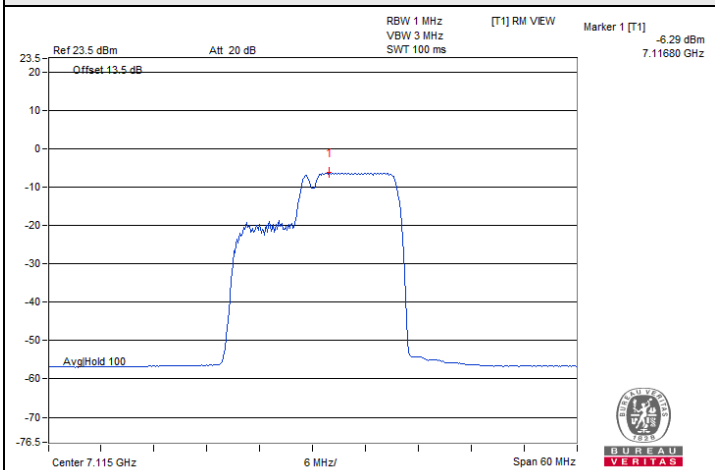

802.11be (EHT20) 106+26-tone MRU Indoor_1T1S : CH 233@83

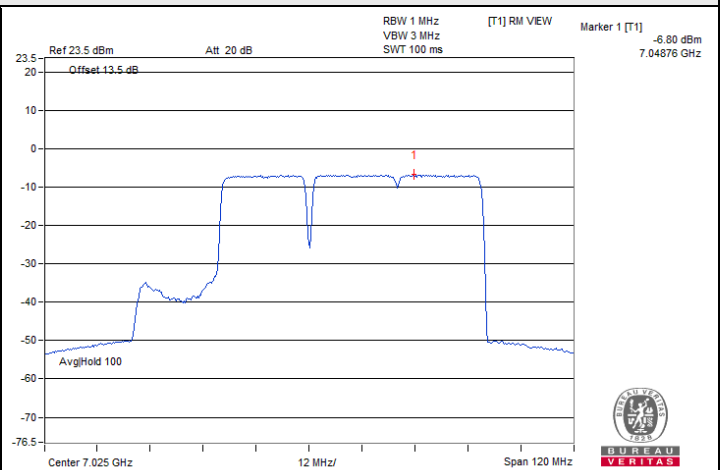

802.11be (EHT80) 484+242-tone MRU Indoor_1T1S : CH 215@90

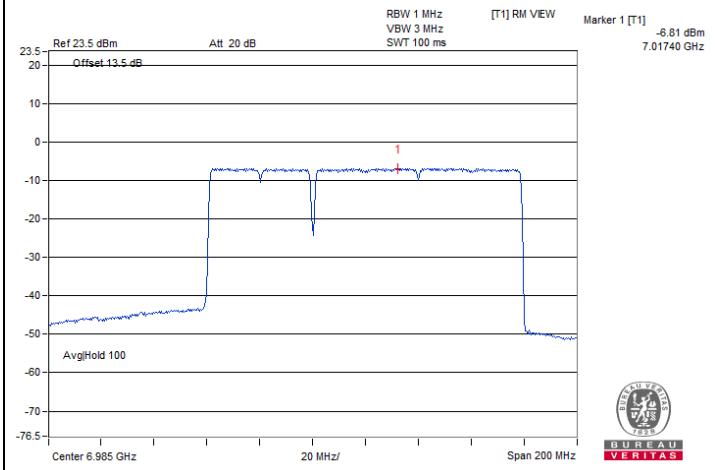

802.11be (EHT160) 996+484-tone MRU Indoor_1T1S : CH 207@95_1

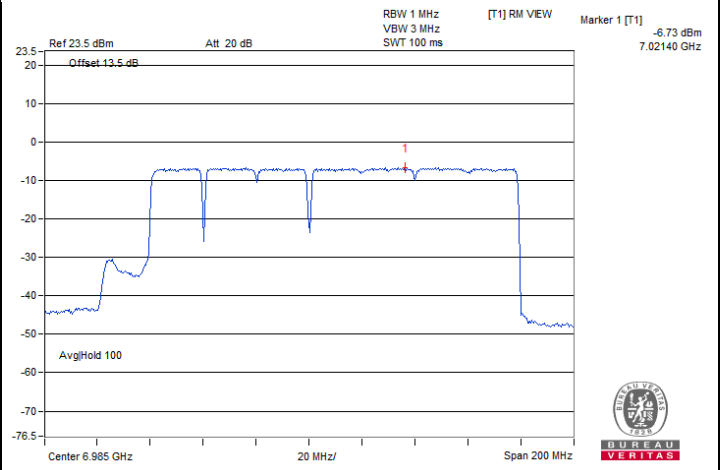

802.11be (EHT160) 996+484+242-tone MRU Indoor_1T1S : CH 207@99_1

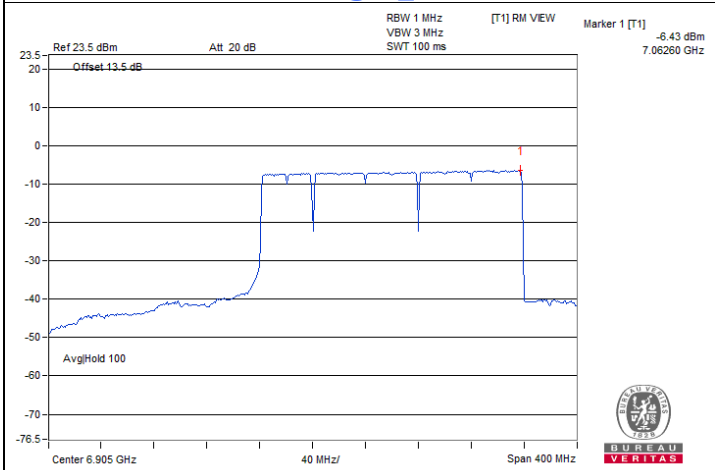

802.11be (EHT320) 2x996+484-tone MRU Indoor_1T1S : CH 191@102

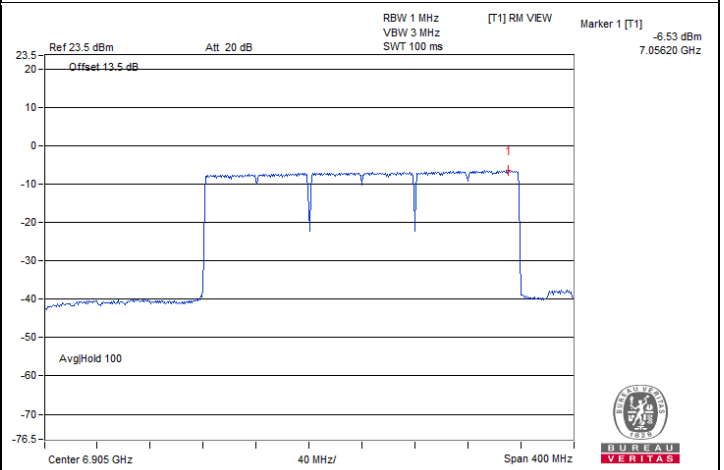

802.11be (EHT320) 3x996-tone MRU Indoor_1T1S : CH 191@104



Spectrum Plot of Maximum Value

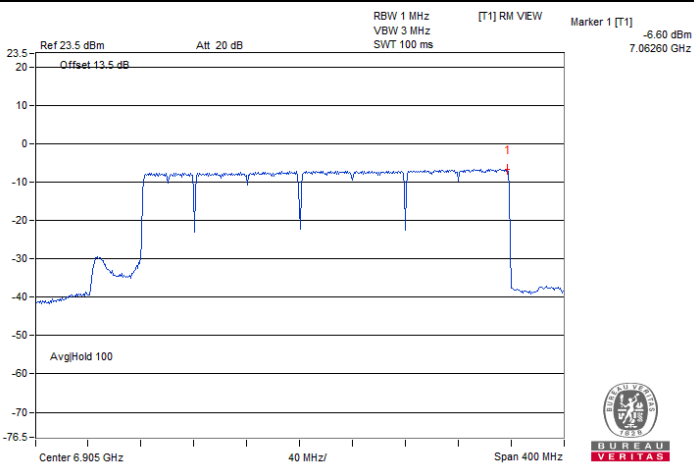

802.11be (EHT320) 3x996+484-tone MRU Indoor_1T1S : CH 191@105

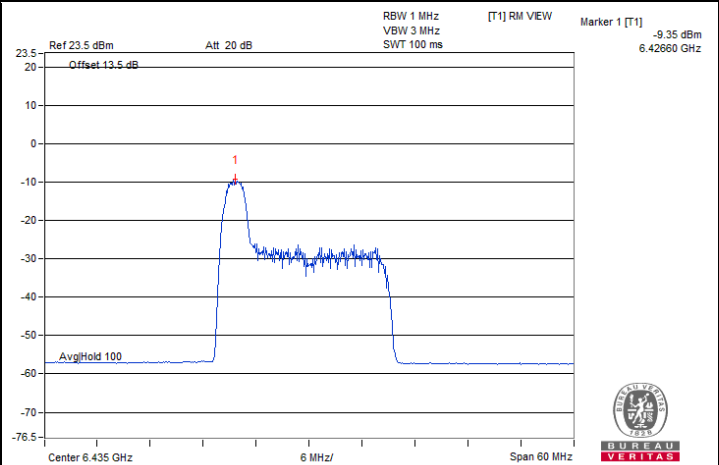

802.11ax (HE) 26-tone RU Indoor_2T2S / Chain 0 : CH 97@0

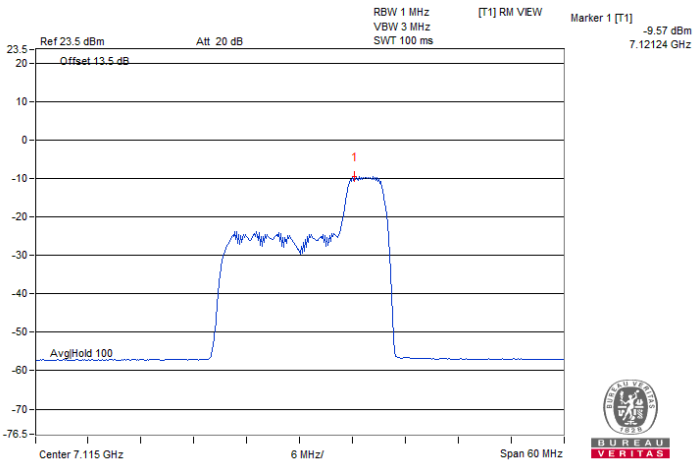

802.11ax (HE) 52-tone RU Indoor_2T2S / Chain 1 : CH 233@40

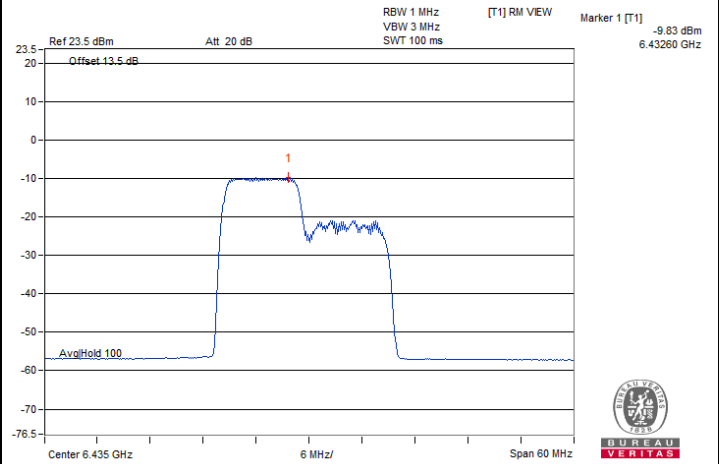

802.11ax (HE) 106-tone RU Indoor_2T2S / Chain 0 : CH 97@53

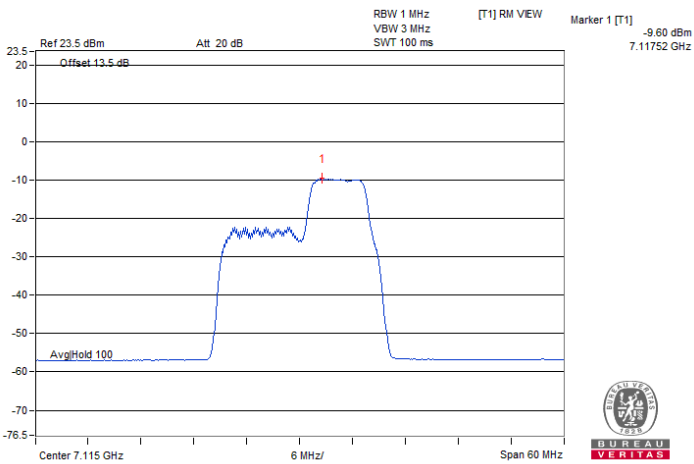

802.11be (EHT20) 52+26-tone MRU Indoor_2T2S / Chain 0 : CH 233@72

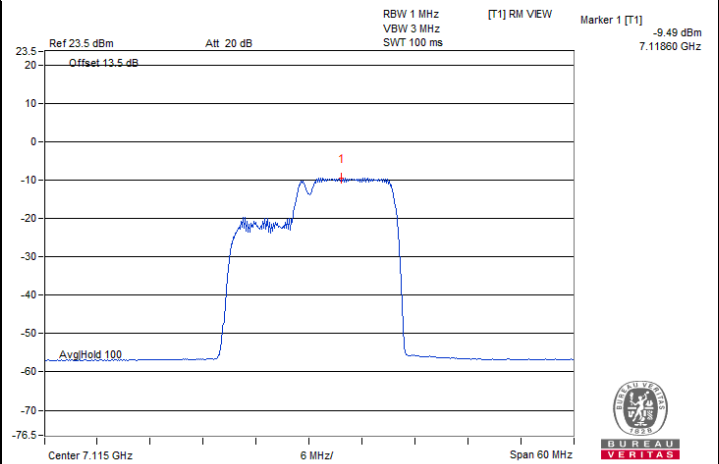

802.11be (EHT20) 106+26-tone MRU Indoor_2T2S / Chain 0 : CH 233@93



Spectrum Plot of Maximum Value

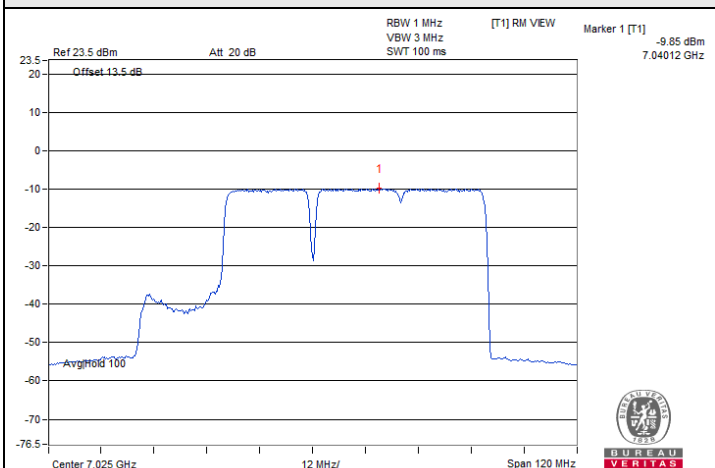

802.11be (EHT80) 484+242-tone MRU Indoor_2T2S / Chain 0 : CH 215@90

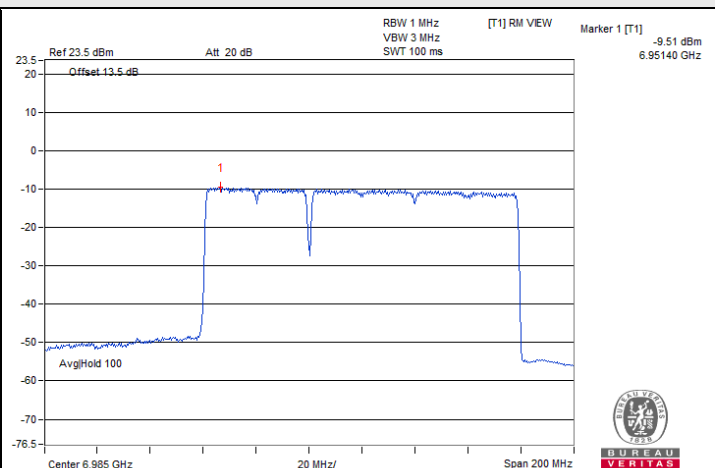

802.11be (EHT160) 996+484-tone MRU Indoor_2T2S / Chain 1 : CH 207@95_1

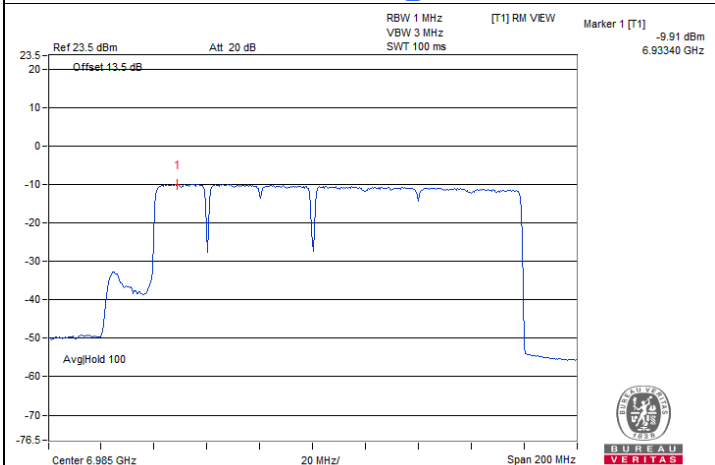

802.11be (EHT160) 996+484+242-tone MRU Indoor_2T2S / Chain 1 : CH 207@99_1

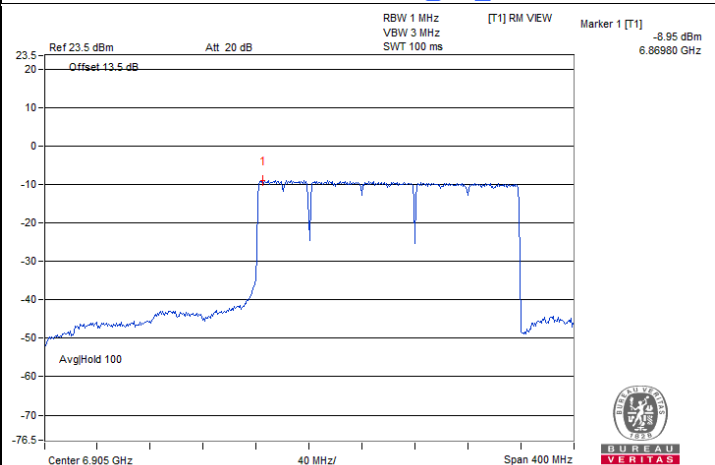

802.11be (EHT320) 2x996+484-tone MRU Indoor_2T2S / Chain 1 : CH 191@102

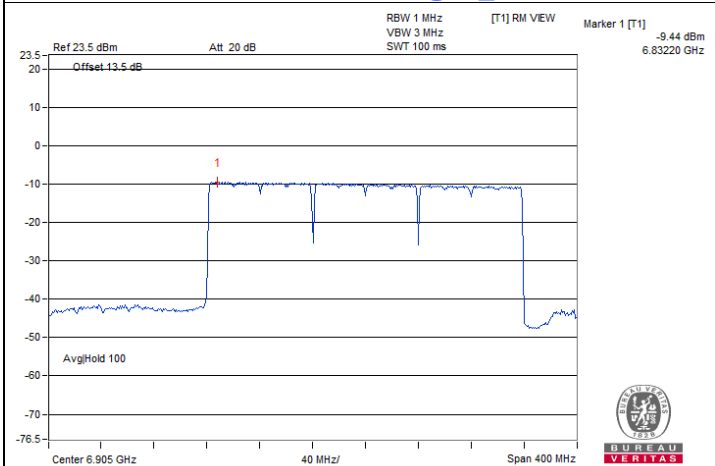

802.11be (EHT320) 3x996-tone MRU Indoor_2T2S / Chain 1 : CH 191@104

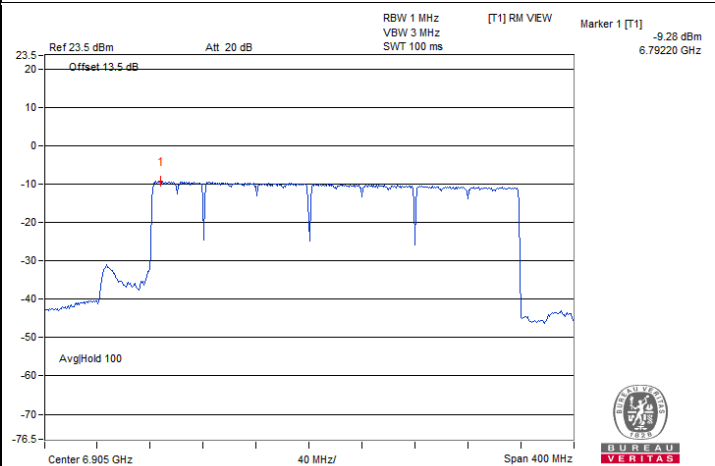

802.11be (EHT320) 3x996+484-tone MRU Indoor_2T2S / Chain 1 : CH 191@105

7.3 Emission Bandwidth

Input Power:	3.3 Vdc	Environmental Conditions:	23°C, 62% RH	Tested By:	Eric Peng
--------------	---------	---------------------------	--------------	------------	-----------

802.11ax (HE) 26-tone RU Indoor_1T1S

Channel	Frequency (MHz)	26dB Bandwidth (MHz)
1	5955	19.14
93	6415	19.29
97	6435	19.18
117	6535	19.17
181	6855	19.32
233	7115	19.37

802.11ax (HE) 52-tone RU Indoor_1T1S

Channel	Frequency (MHz)	26dB Bandwidth (MHz)
1	5955	19.28
93	6415	19.43
97	6435	19.33
117	6535	19.36
233	7115	19.42

802.11ax (HE) 106-tone RU Indoor_1T1S

Channel	Frequency (MHz)	26dB Bandwidth (MHz)
1	5955	19.38
93	6415	19.59
97	6435	19.46
117	6535	19.34
181	6855	19.62
233	7115	19.59

802.11be (EHT20) 52+26-tone MRU Indoor_1T1S

Channel	Frequency (MHz)	26dB Bandwidth (MHz)
1	5955	18.93
93	6415	18.9
97	6435	18.9
117	6535	18.99
181	6855	18.88
233	7115	18.9

802.11be (EHT20) 106+26-tone MRU Indoor_1T1S

Channel	Frequency (MHz)	26dB Bandwidth (MHz)
1	5955	19.66
93	6415	19.62
97	6435	19.71
117	6535	19.74
181	6855	19.58
233	7115	19.64

802.11be (EHT80) 484+242-tone MRU Indoor_1T1S

Channel	Frequency (MHz)	26dB Bandwidth (MHz)
7	5985	80.14
87	6385	80.37
103	6465	80.38
135	6625	80.03
215	7025	80.42

802.11be (EHT160) 996+484-tone MRU Indoor_1T1S

Channel	Frequency (MHz)	26dB Bandwidth (MHz)
15	6025	271.67
79	6345	186.96
143	6665	188.27
207	6985	189.64

802.11be (EHT160) 996+484+242-tone MRU Indoor_1T1S

Channel	Frequency (MHz)	26dB Bandwidth (MHz)
15	6025	203.21
79	6345	225.08
143	6665	164.43
207	6985	231

802.11be (EHT320) 2x996+484-tone MRU Indoor_1T1S

Channel	Frequency (MHz)	26dB Bandwidth (MHz)
31	6105	486.04
63	6265	473.86
127	6585	398.16
191	6905	455.13

802.11be (EHT320) 3x996-tone MRU Indoor_1T1S

Channel	Frequency (MHz)	26dB Bandwidth (MHz)
31	6105	535
63	6265	525.47
127	6585	451.29
191	6905	493.88

802.11be (EHT320) 3x996+484-tone MRU Indoor_1T1S

Channel	Frequency (MHz)	26dB Bandwidth (MHz)
31	6105	616.13
63	6265	653.43
127	6585	606.01
191	6905	595.53

802.11ax (HE) 26-tone RU Indoor_2T2S

Channel	Frequency (MHz)	26dB Bandwidth (MHz)	
		Chain 0	Chain 1
1	5955	19.15	19.15
93	6415	19.31	19.22
97	6435	19.25	19.16
117	6535	19.25	19.16
181	6855	19.38	19.27
233	7115	19.38	19.19

802.11ax (HE) 52-tone RU Indoor_2T2S

Channel	Frequency (MHz)	26dB Bandwidth (MHz)	
		Chain 0	Chain 1
1	5955	19.26	19.18
93	6415	19.47	19.38
97	6435	19.40	19.27
117	6535	19.34	19.22
181	6855	19.41	19.34
233	7115	19.40	19.34

802.11ax (HE) 106-tone RU Indoor_2T2S

Channel	Frequency (MHz)	26dB Bandwidth (MHz)	
		Chain 0	Chain 1
1	5955	19.32	19.25
93	6415	19.51	19.53
97	6435	19.36	19.33
117	6535	19.39	19.30
181	6855	19.56	19.33
233	7115	19.52	19.54

802.11be (EHT20) 52+26-tone MRU Indoor_2T2S

Channel	Frequency (MHz)	26dB Bandwidth (MHz)	
		Chain 0	Chain 1
1	5955	18.91	18.72
93	6415	18.97	18.69
97	6435	18.99	18.81
117	6535	18.98	18.83
181	6855	18.94	18.72
233	7115	18.94	18.69

802.11be (EHT20) 106+26-tone MRU Indoor_2T2S

Channel	Frequency (MHz)	26dB Bandwidth (MHz)	
		Chain 0	Chain 1
1	5955	19.67	19.46
93	6415	19.64	19.51
97	6435	19.73	19.65
117	6535	19.72	19.65
181	6855	19.71	19.48
233	7115	19.73	19.43

802.11be (EHT80) 484+242-tone MRU Indoor_2T2S

Channel	Frequency (MHz)	26dB Bandwidth (MHz)	
		Chain 0	Chain 1
7	5985	79.97	80.15
87	6385	80.34	80.35
103	6465	80.31	80.23
135	6625	80.36	80.06
215	7025	80.10	80.39

802.11be (EHT160) 996+484-tone MRU Indoor_2T2S

Channel	Frequency (MHz)	26dB Bandwidth (MHz)	
		Chain 0	Chain 1
15	6025	125.29	124.75
79	6345	124.87	125.26
143	6665	124.68	125.07
207	6985	125.03	125.27

802.11be (EHT160) 996+484+242-tone MRU Indoor_2T2S

Channel	Frequency (MHz)	26dB Bandwidth (MHz)	
		Chain 0	Chain 1
15	6025	162.94	162.97
79	6345	163.45	163.18
143	6665	163.26	162.76
207	6985	163.00	163.04

802.11be (EHT320) 2x996+484-tone MRU Indoor_2T2S

Channel	Frequency (MHz)	26dB Bandwidth (MHz)	
		Chain 0	Chain 1
31	6105	372.83	425.57
63	6265	468.18	471.77
127	6585	308.47	266.54
191	6905	452.40	451.79

802.11be (EHT320) 3x996-tone MRU Indoor_2T2S

Channel	Frequency (MHz)	26dB Bandwidth (MHz)	
		Chain 0	Chain 1
31	6105	397.14	389.44
63	6265	428.43	424.35
127	6585	372.98	375.37
191	6905	502.13	493.82

802.11be (EHT320) 3x996+484-tone MRU Indoor_2T2S

Channel	Frequency (MHz)	26dB Bandwidth (MHz)	
		Chain 0	Chain 1
31	6105	592.53	605.19
63	6265	590.53	582.35
127	6585	586.03	464.08
191	6905	636.60	481.97



Spectrum Plot of Maximum Value

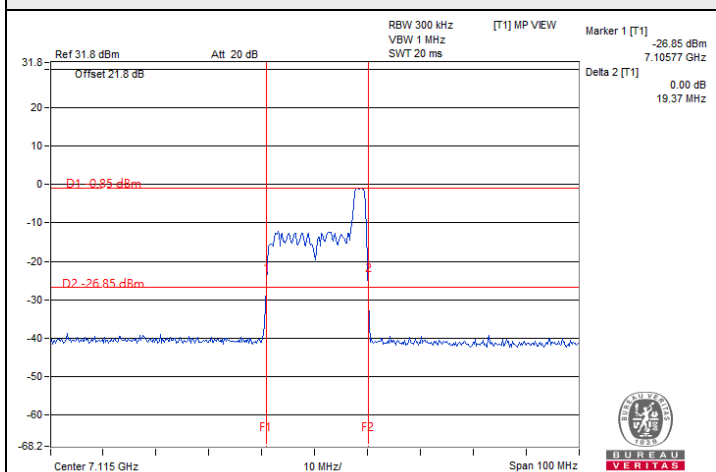

802.11ax (HE) 26-tone RU Indoor_1T1S : CH 233@8

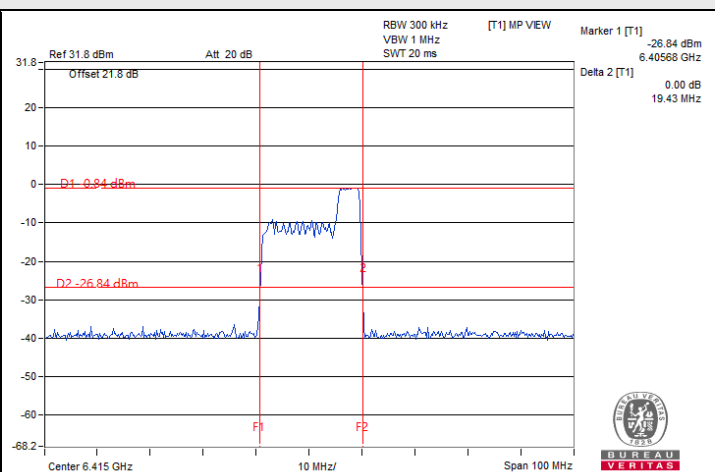

802.11ax (HE) 52-tone RU Indoor_1T1S : CH 93@40

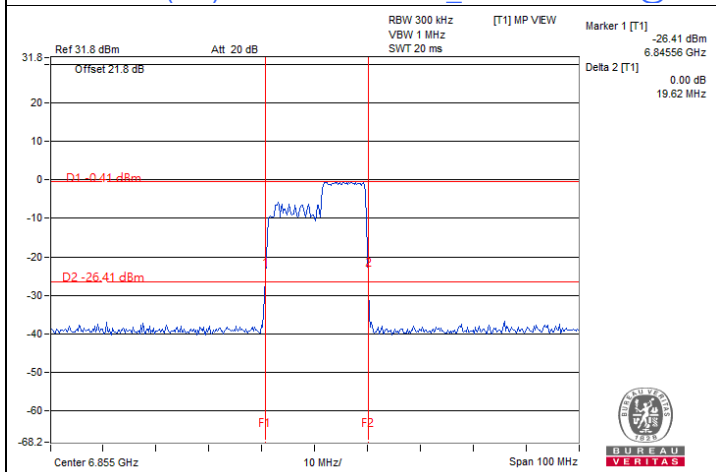

802.11ax (HE) 106-tone RU Indoor_1T1S : CH 181@54

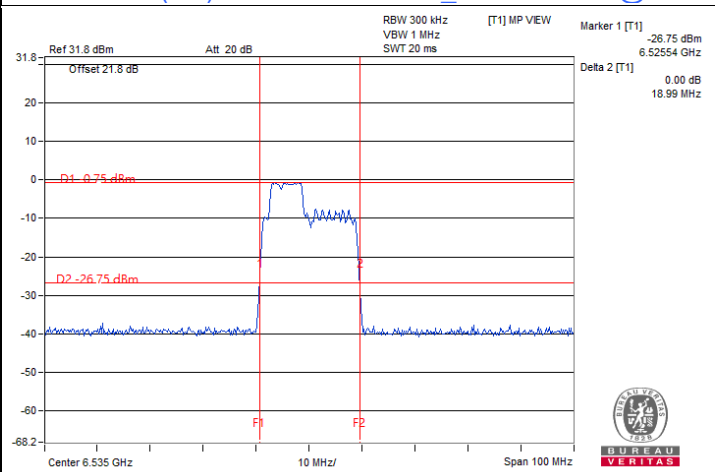

802.11be (EHT20) 52+26-tone MRU Indoor_1T1S : CH 117@70

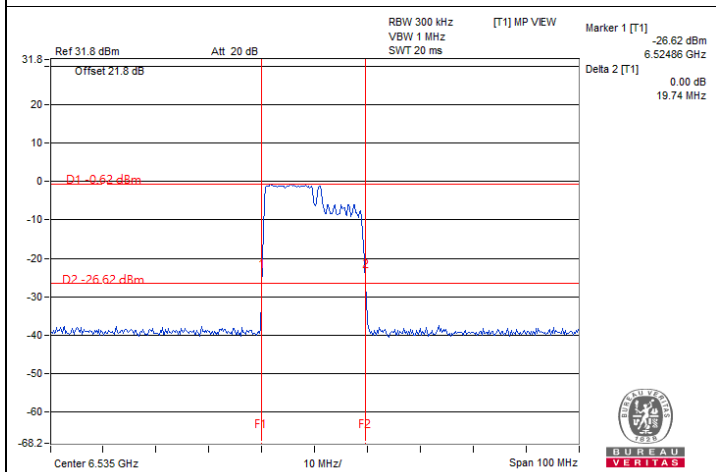

802.11be (EHT20) 106+26-tone MRU Indoor_1T1S : CH 117@82

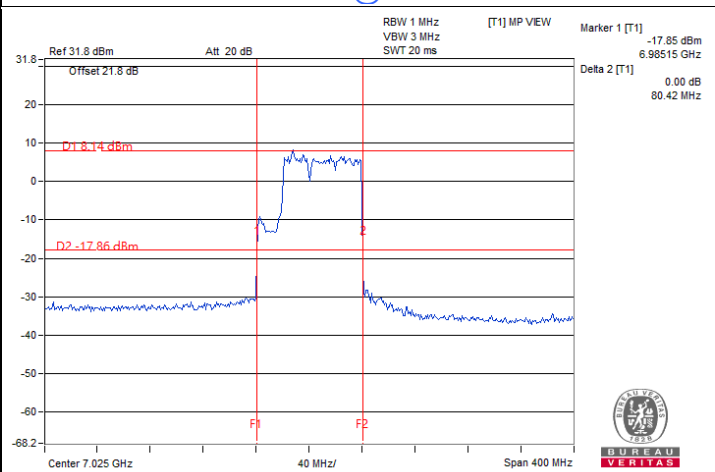

802.11be (EHT80) 484+242-tone MRU Indoor_1T1S : CH 215@90



Spectrum Plot of Maximum Value

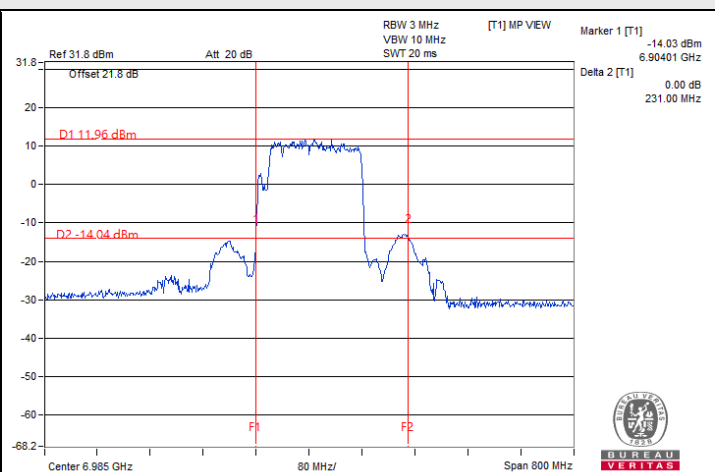
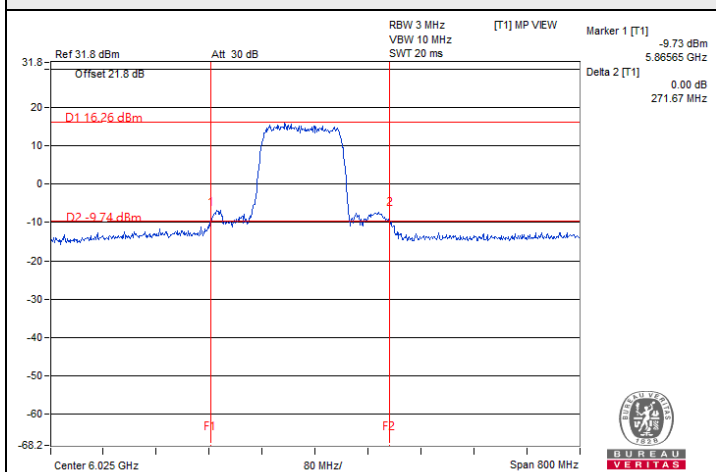

802.11be (EHT160) 996+484-tone MRU Indoor_1T1S : CH 15@95_1

802.11be (EHT160) 996+484+242-tone MRU Indoor_1T1S : CH 207@99_1

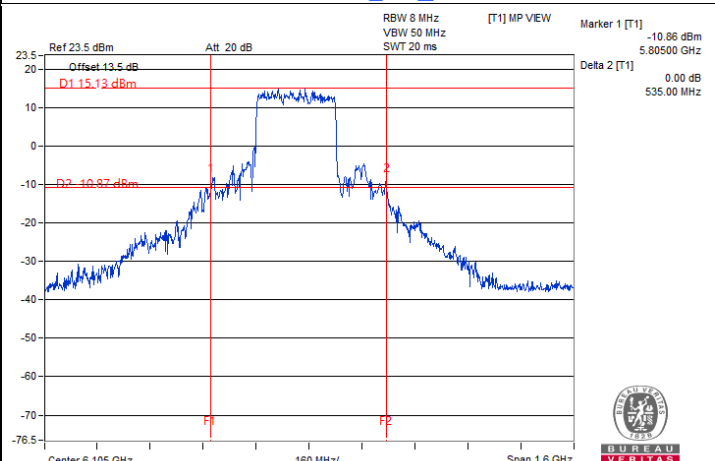
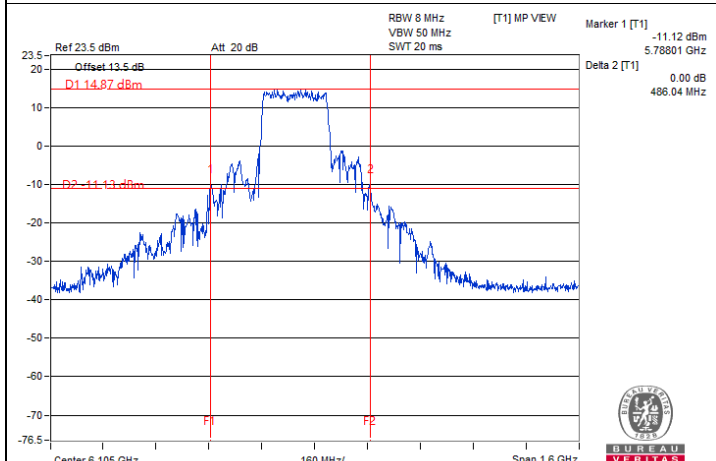

802.11be (EHT320) 2x996+484-tone MRU Indoor_1T1S : CH 31@101

802.11be (EHT320) 3x996-tone MRU Indoor_1T1S : CH 31@104

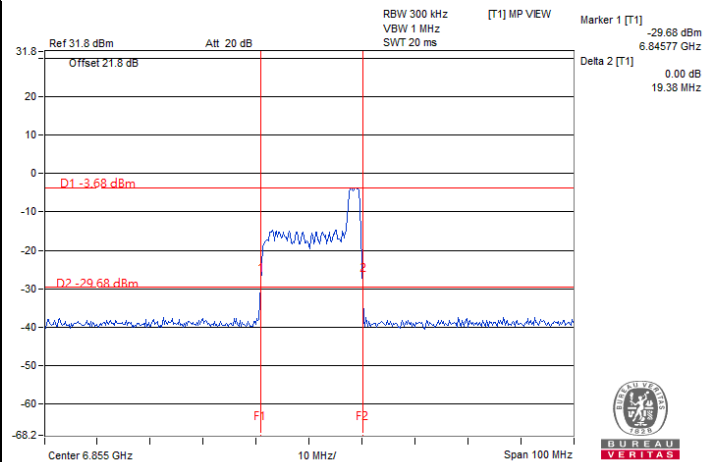
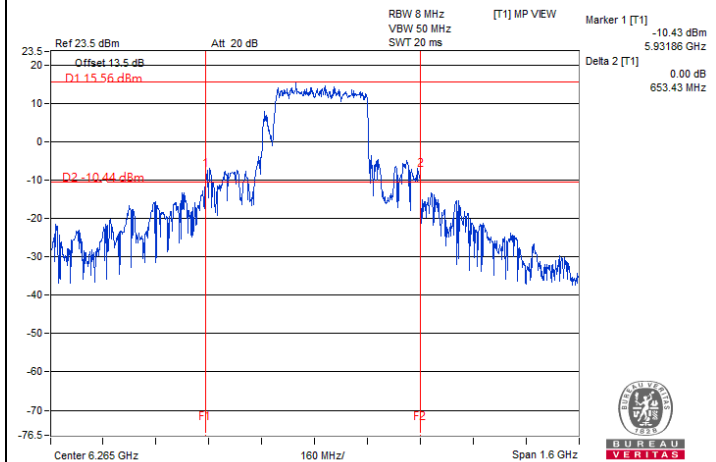

802.11be (EHT320) 3x996+484-tone MRU Indoor_1T1S : CH 63@105

802.11ax (HE) 26-tone RU Indoor_2T2S / Chain 0 : CH 181@8



Spectrum Plot of Maximum Value

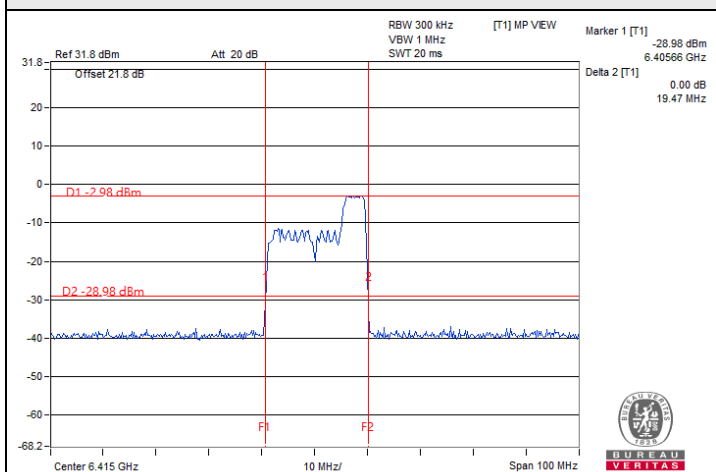

802.11ax (HE) 52-tone RU Indoor_2T2S / Chain 0 : CH 93@40

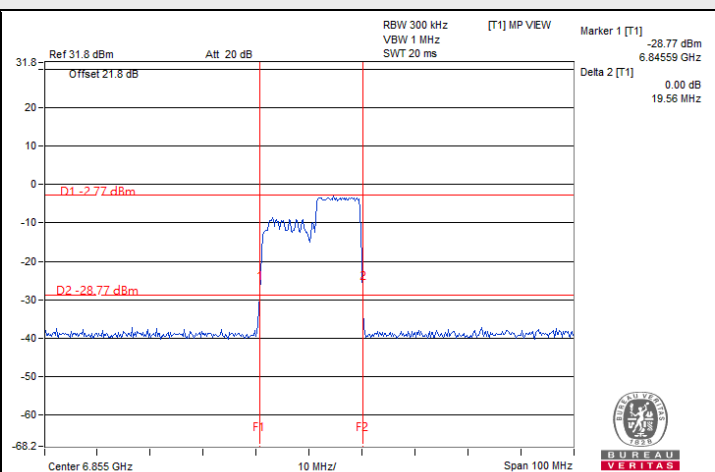

802.11ax (HE) 106-tone RU Indoor_2T2S / Chain 0 : CH 181@54

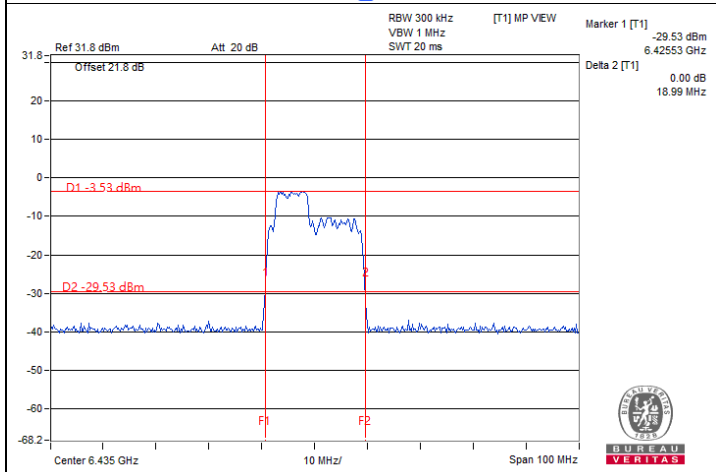

802.11be (EHT20) 52+26-tone MRU Indoor_2T2S / Chain 0 : CH 97@70

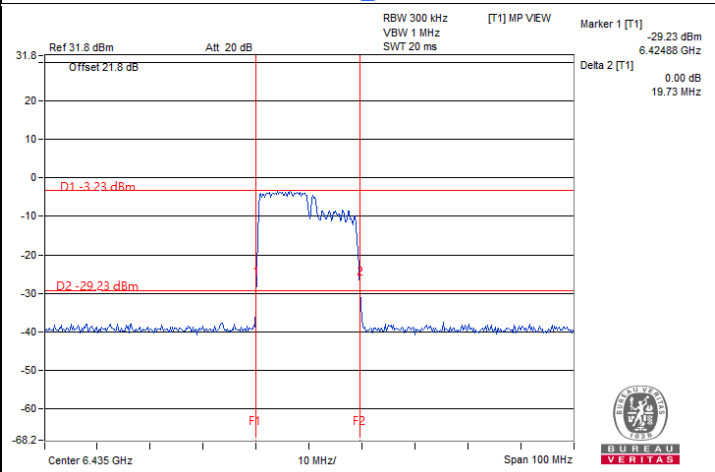

802.11be (EHT20) 106+26-tone MRU Indoor_2T2S / Chain 0 : CH 97@82

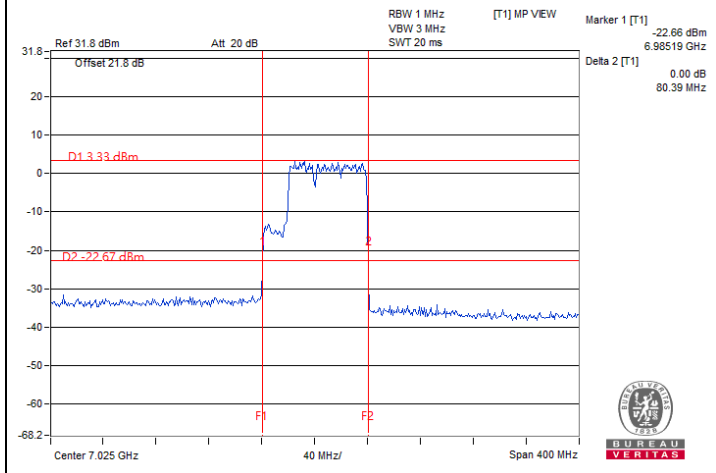

802.11be (EHT80) 484+242-tone MRU Indoor_2T2S / Chain 1 : CH 215@90

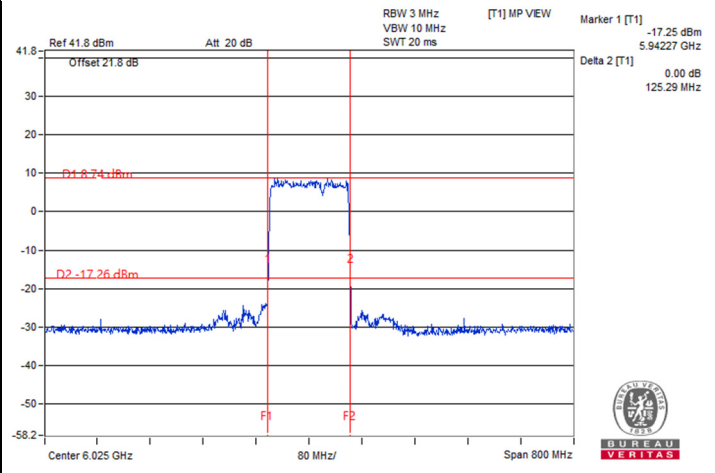

802.11be (EHT160) 996+484-tone MRU Indoor_2T2S / Chain 0 : CH 15@95_1

Spectrum Plot of Maximum Value

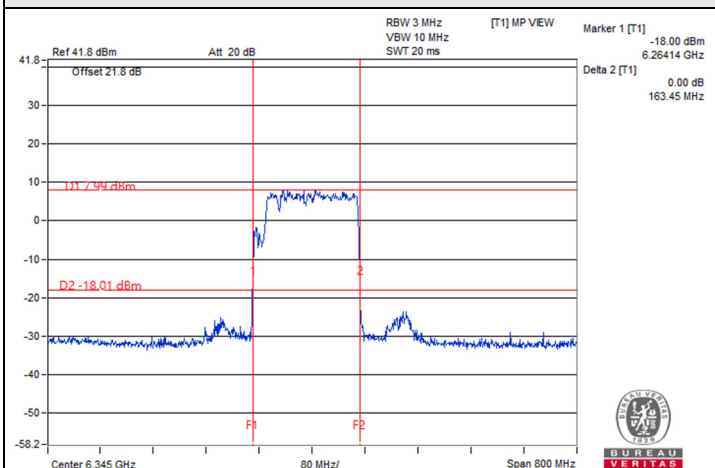

802.11be (EHT160) 996+484+242-tone MRU Indoor_2T2S / Chain 0 : CH 79@96_0

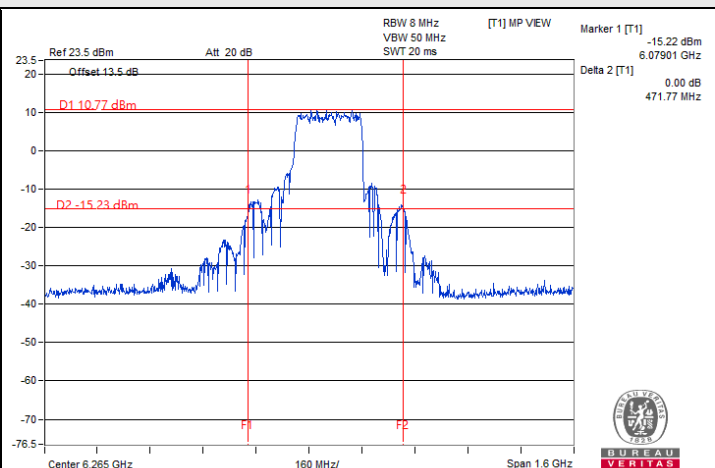

802.11be (EHT320) 2x996+484-tone MRU Indoor_2T2S / Chain 1 : CH 63@102

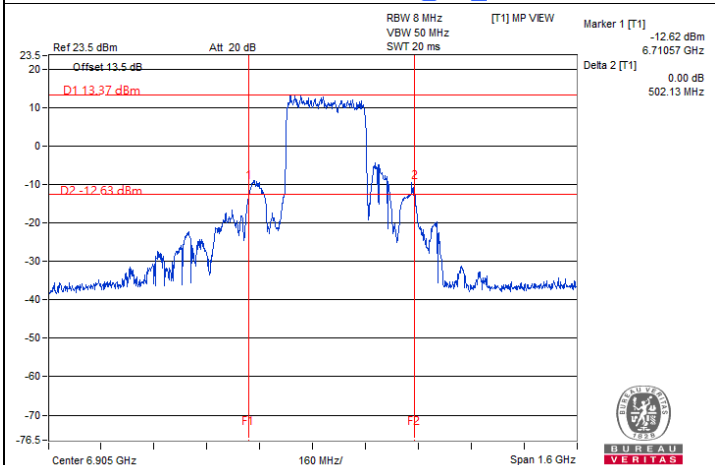

802.11be (EHT320) 3x996-tone MRU Indoor_2T2S / Chain 0 : CH 191@104

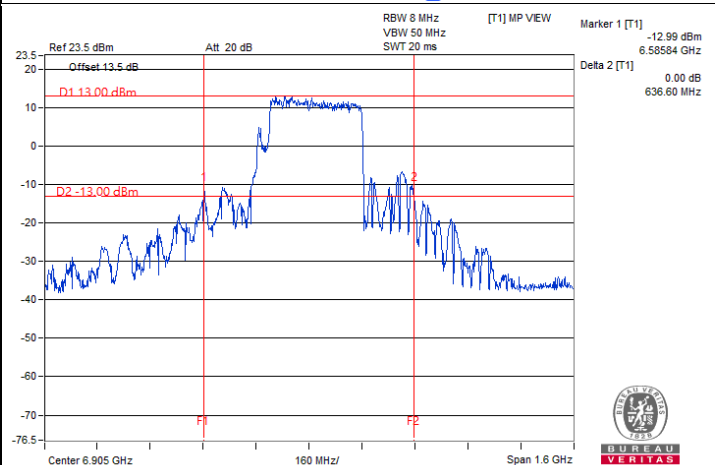

802.11be (EHT320) 3x996+484-tone MRU Indoor_2T2S / Chain 0 : CH 191@105

7.4 In-Band Emission Mask

Input Power:	3.3 Vdc	Environmental Conditions:	23°C, 62% RH	Tested By:	Eric Peng
--------------	---------	---------------------------	--------------	------------	-----------

802.11ax (HE) 26-tone RU Indoor_1T1S

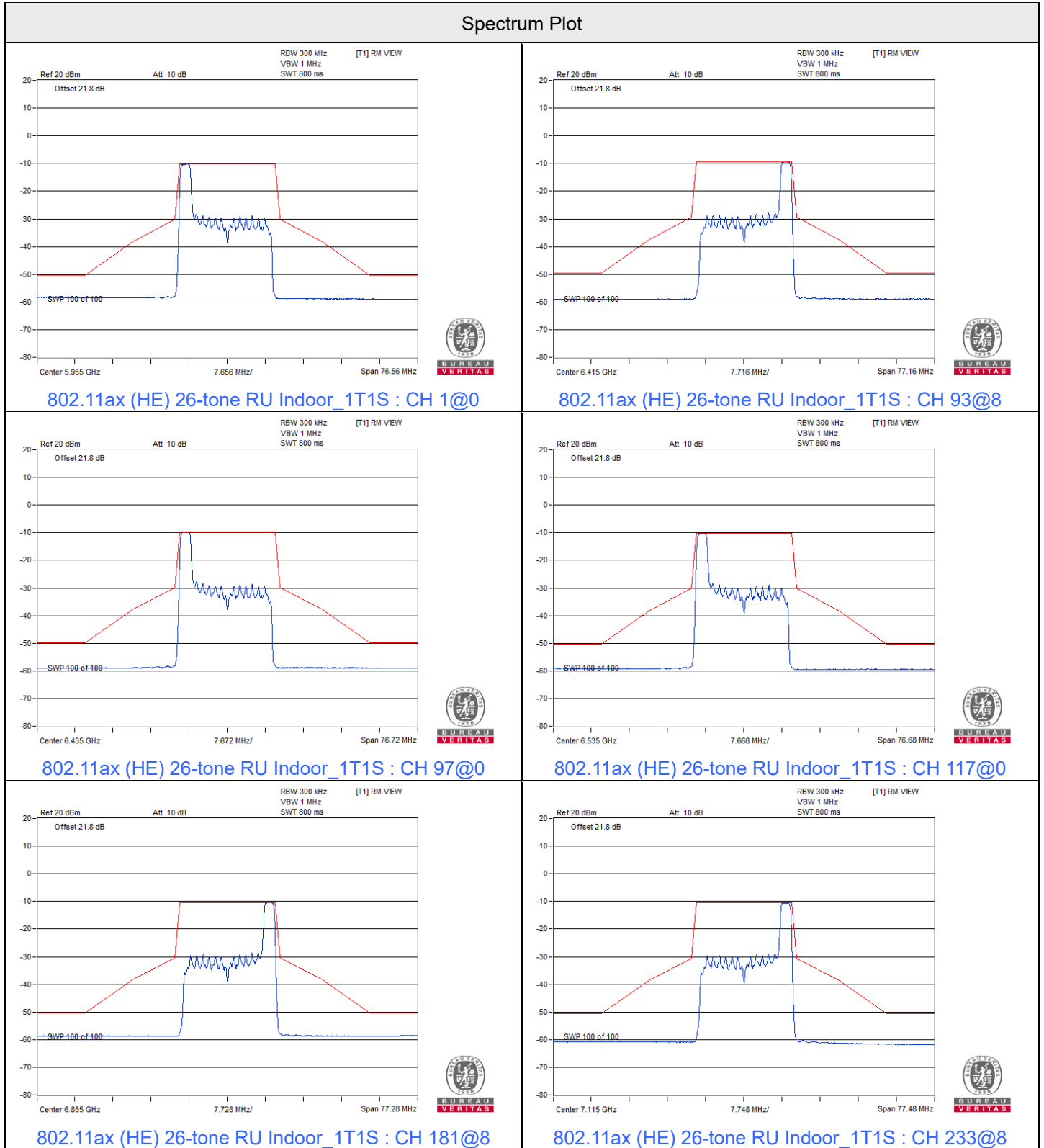



802.11ax (HE) 52-tone RU Indoor_1T1S

Spectrum Plot

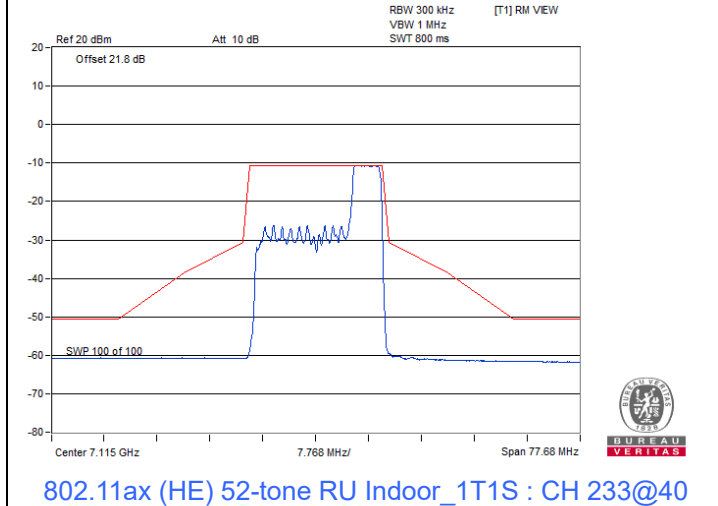
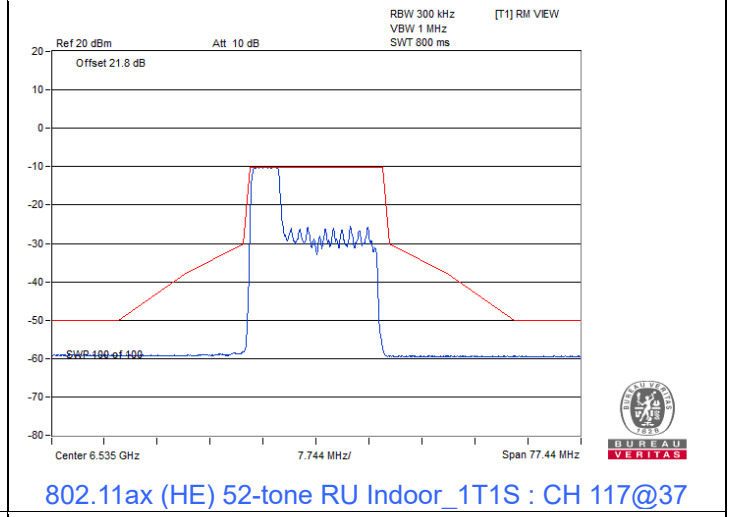
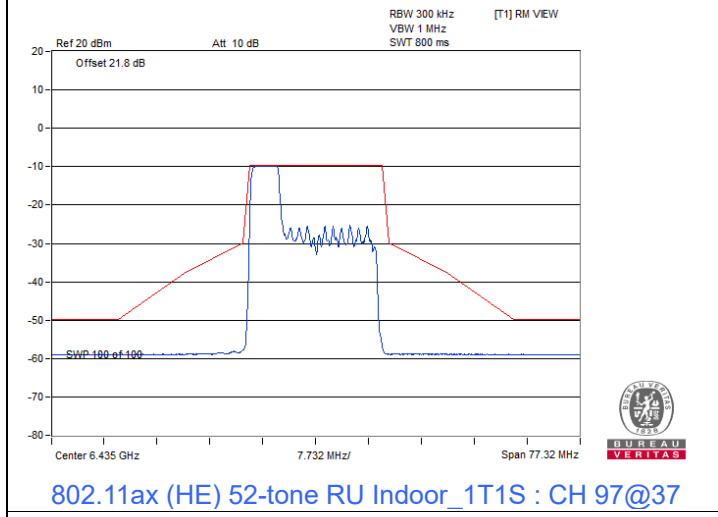
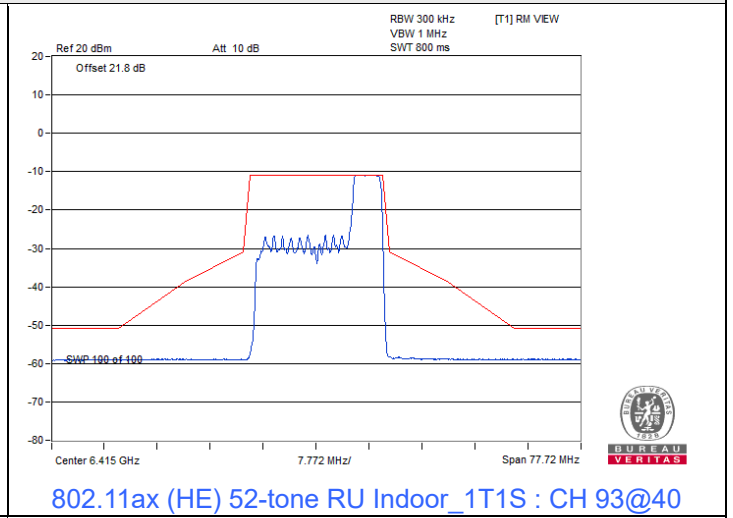
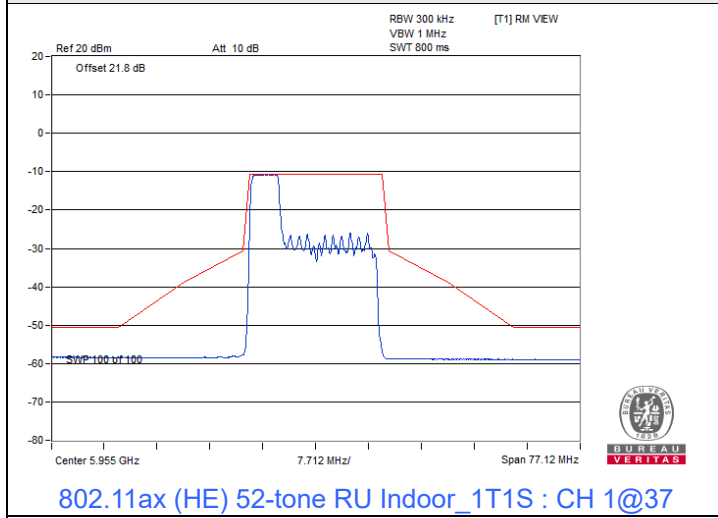

802.11ax (HE) 106-tone RU Indoor_1T1S

Spectrum Plot

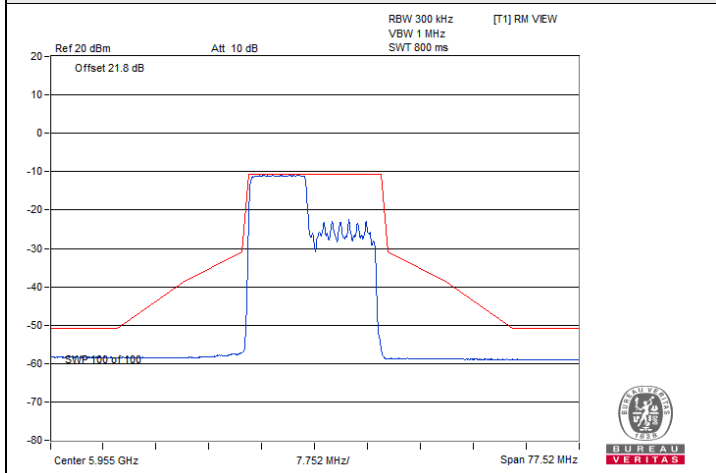

802.11ax (HE) 106-tone RU Indoor_1T1S : CH 1@53

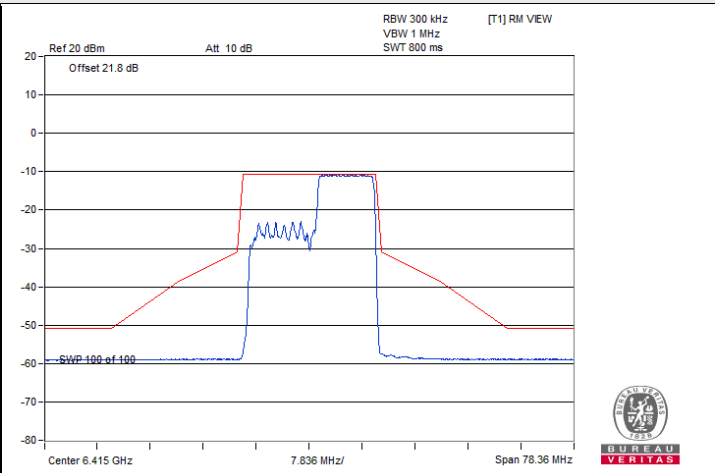

802.11ax (HE) 106-tone RU Indoor_1T1S : CH 93@54

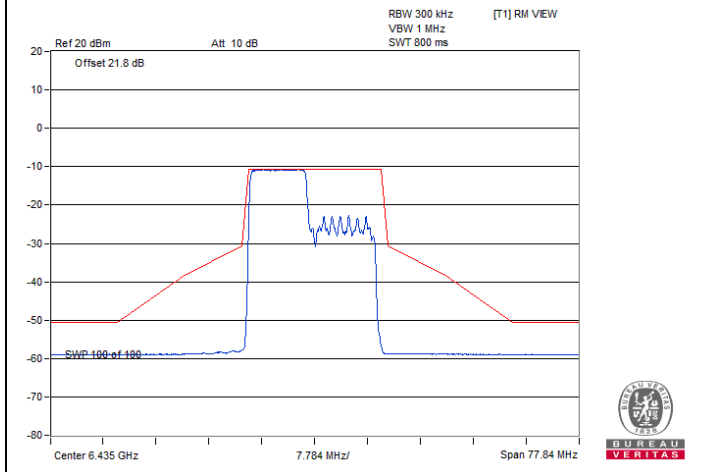

802.11ax (HE) 106-tone RU Indoor_1T1S : CH 97@53

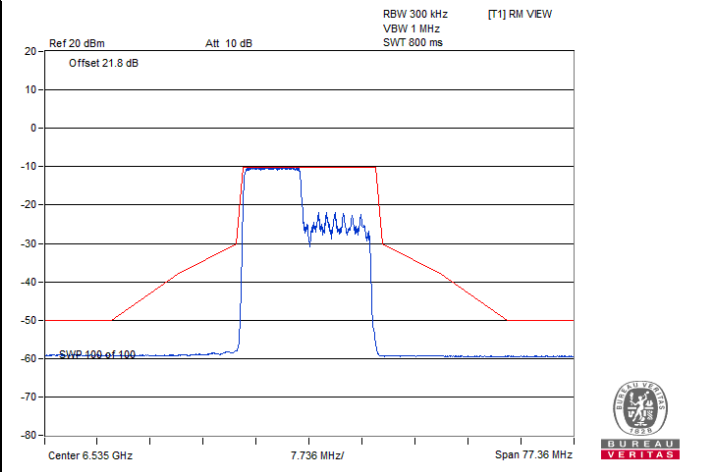

802.11ax (HE) 106-tone RU Indoor_1T1S : CH 117@54

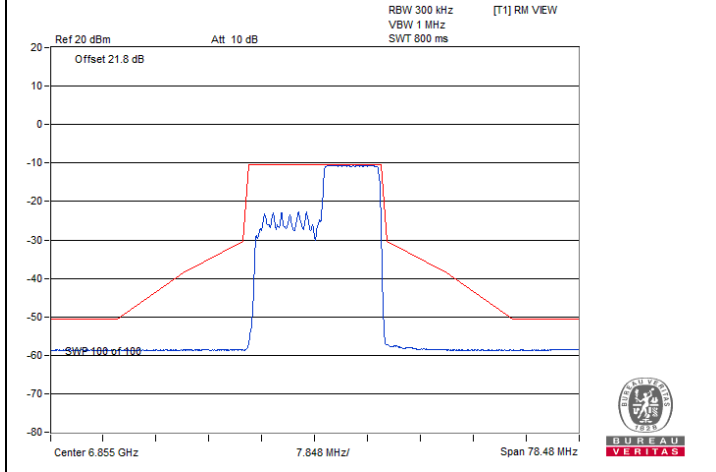

802.11ax (HE) 106-tone RU Indoor_1T1S : CH 181@54

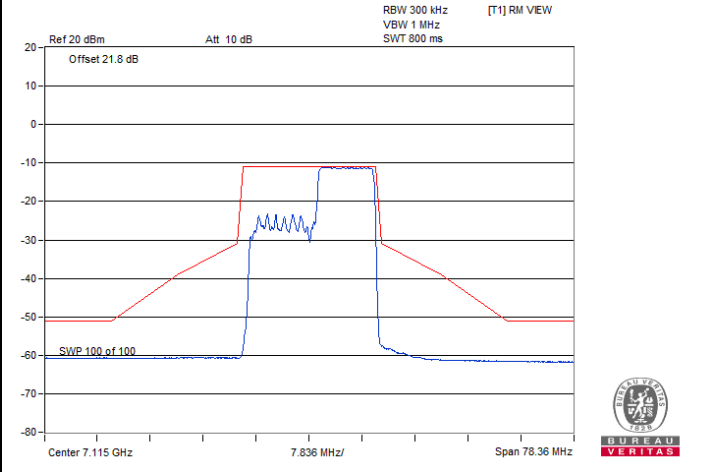

802.11ax (HE) 106-tone RU Indoor_1T1S : CH 233@54



802.11be (EHT20) 52+26-tone MRU Indoor_1T1S

Spectrum Plot

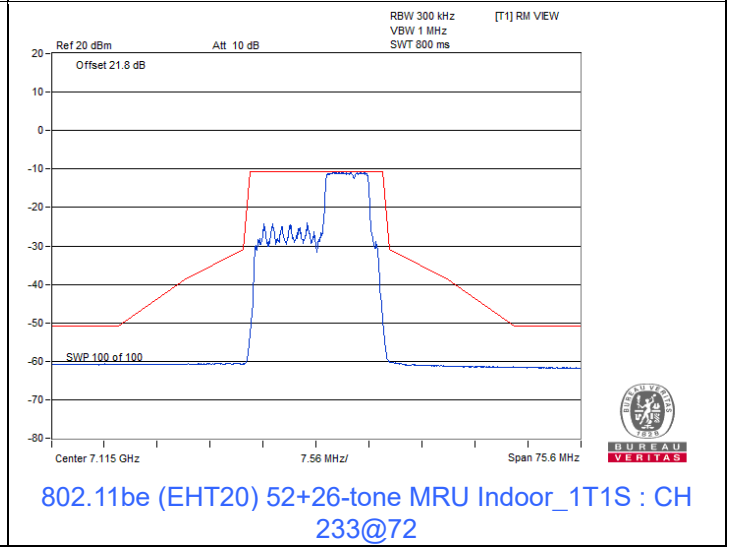
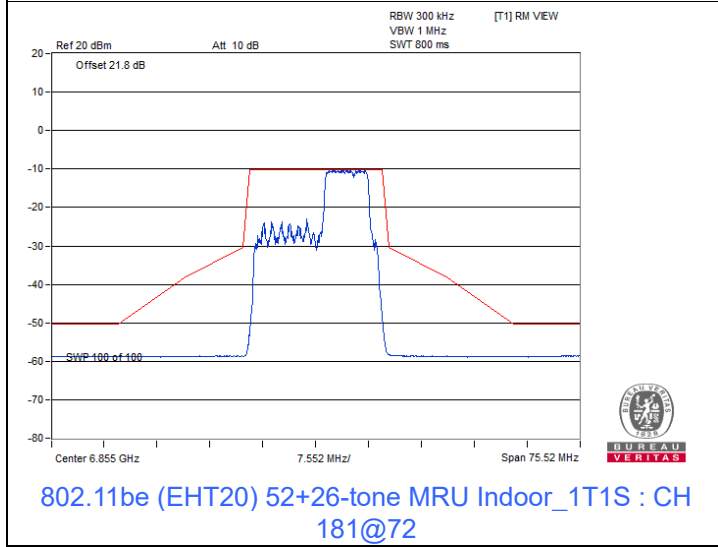
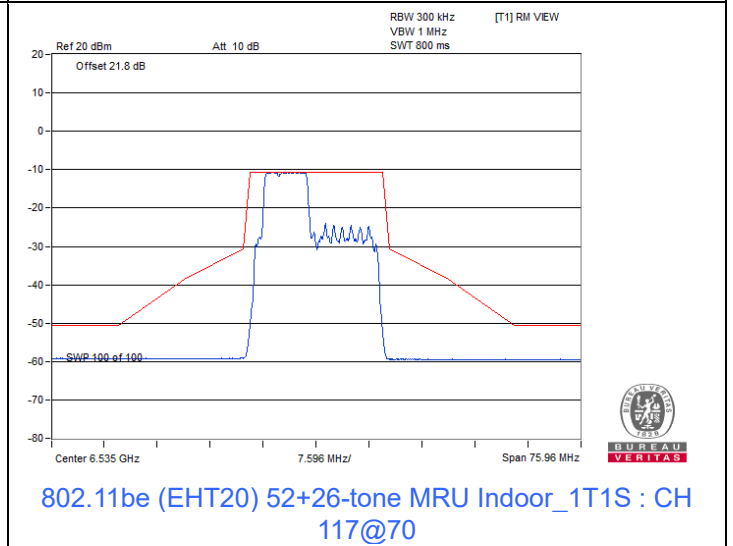
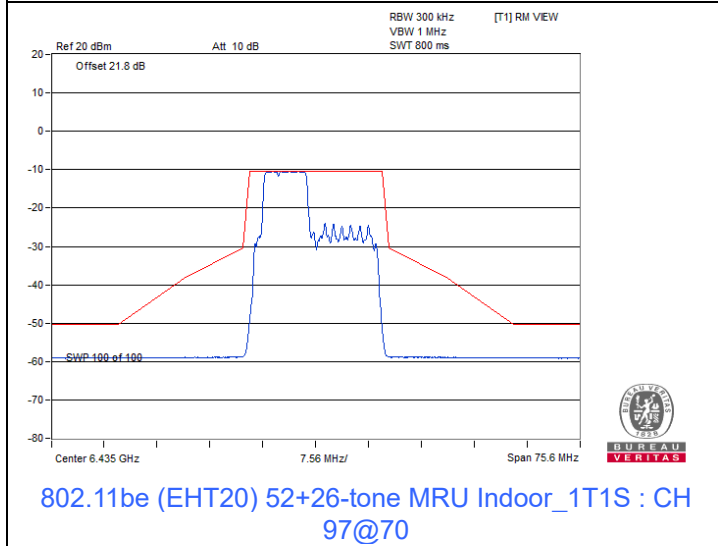
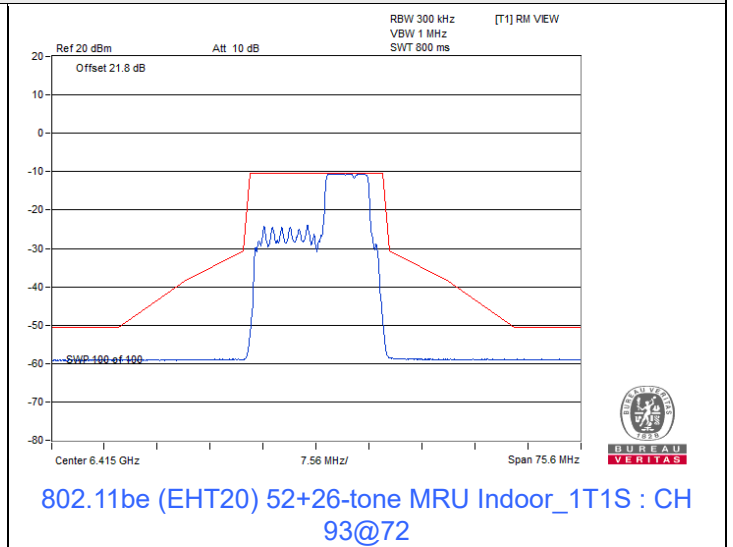
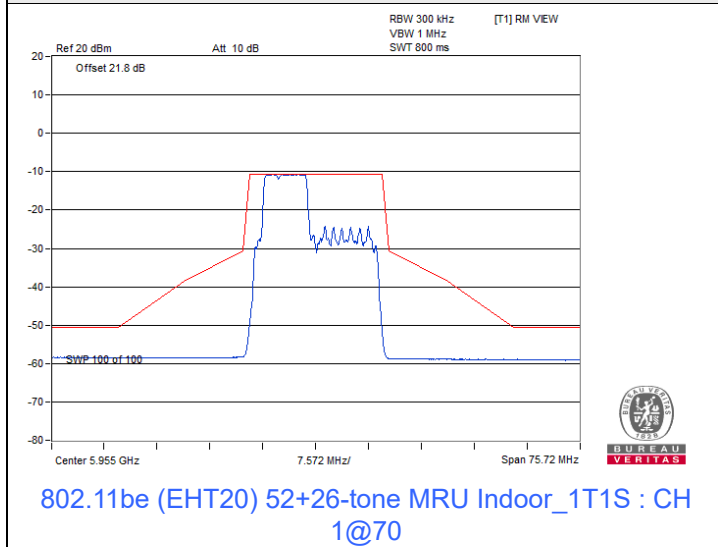



802.11be (EHT20) 106+26-tone MRU Indoor_1T1S

Spectrum Plot

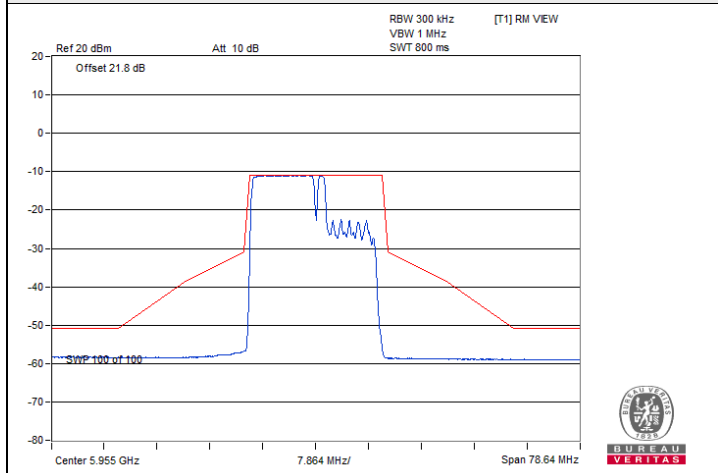

802.11be (EHT20) 106+26-tone MRU Indoor_1T1S : CH 1@82

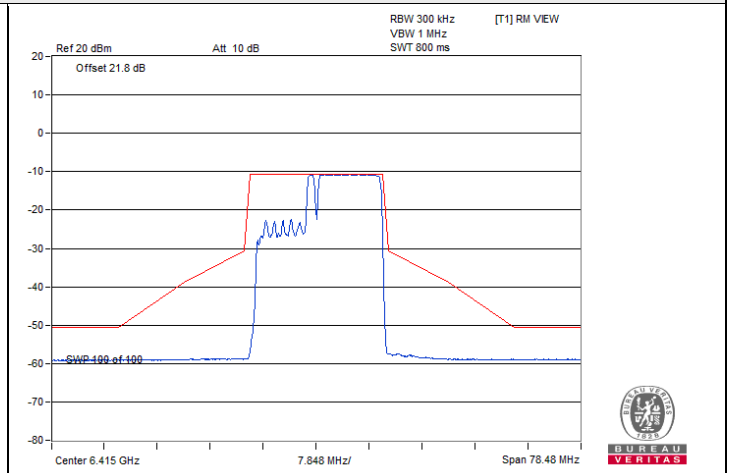

802.11be (EHT20) 106+26-tone MRU Indoor_1T1S : CH 93@83

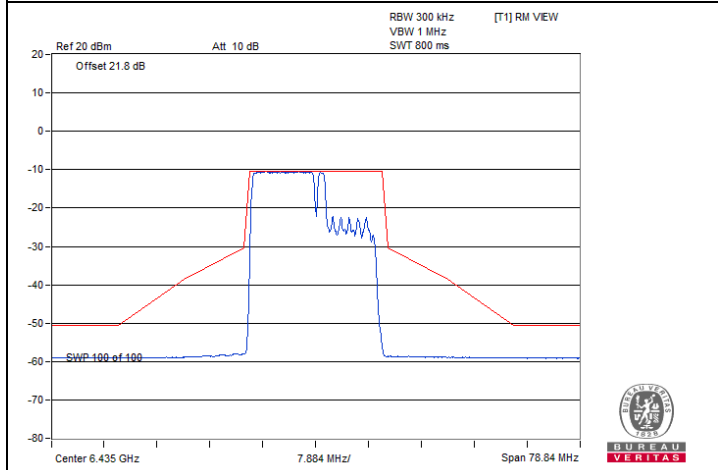

802.11be (EHT20) 106+26-tone MRU Indoor_1T1S : CH 97@82

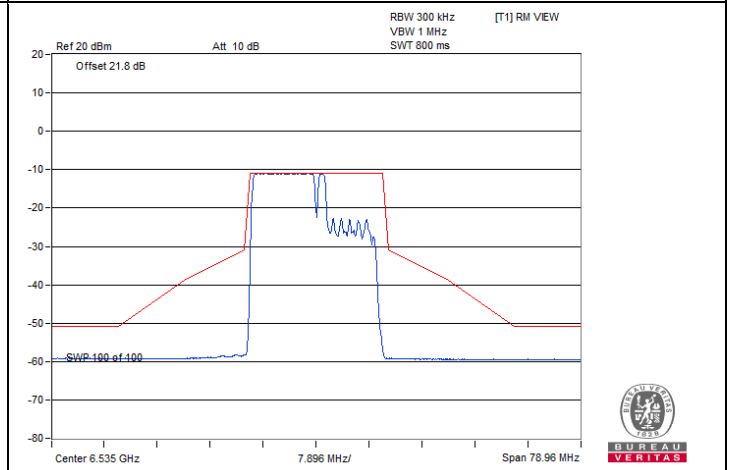

802.11be (EHT20) 106+26-tone MRU Indoor_1T1S : CH 117@82

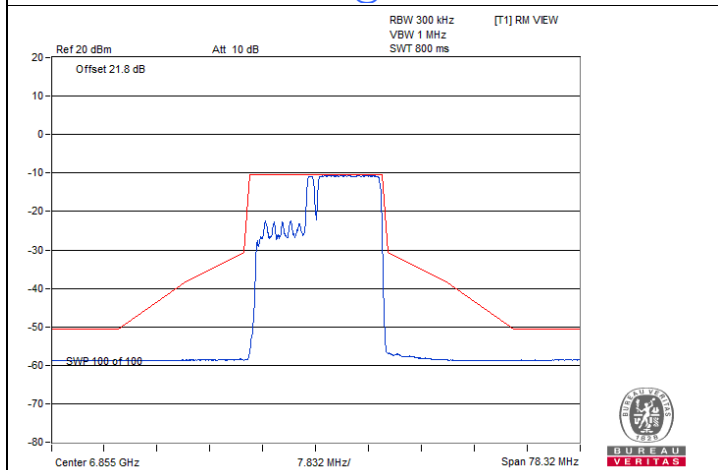

802.11be (EHT20) 106+26-tone MRU Indoor_1T1S : CH 181@83

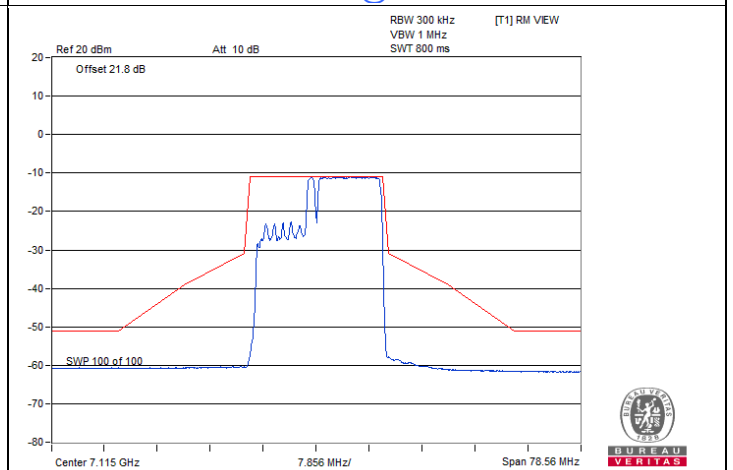

802.11be (EHT20) 106+26-tone MRU Indoor_1T1S : CH 233@83



802.11be (EHT80) 484+242-tone MRU Indoor_1T1S

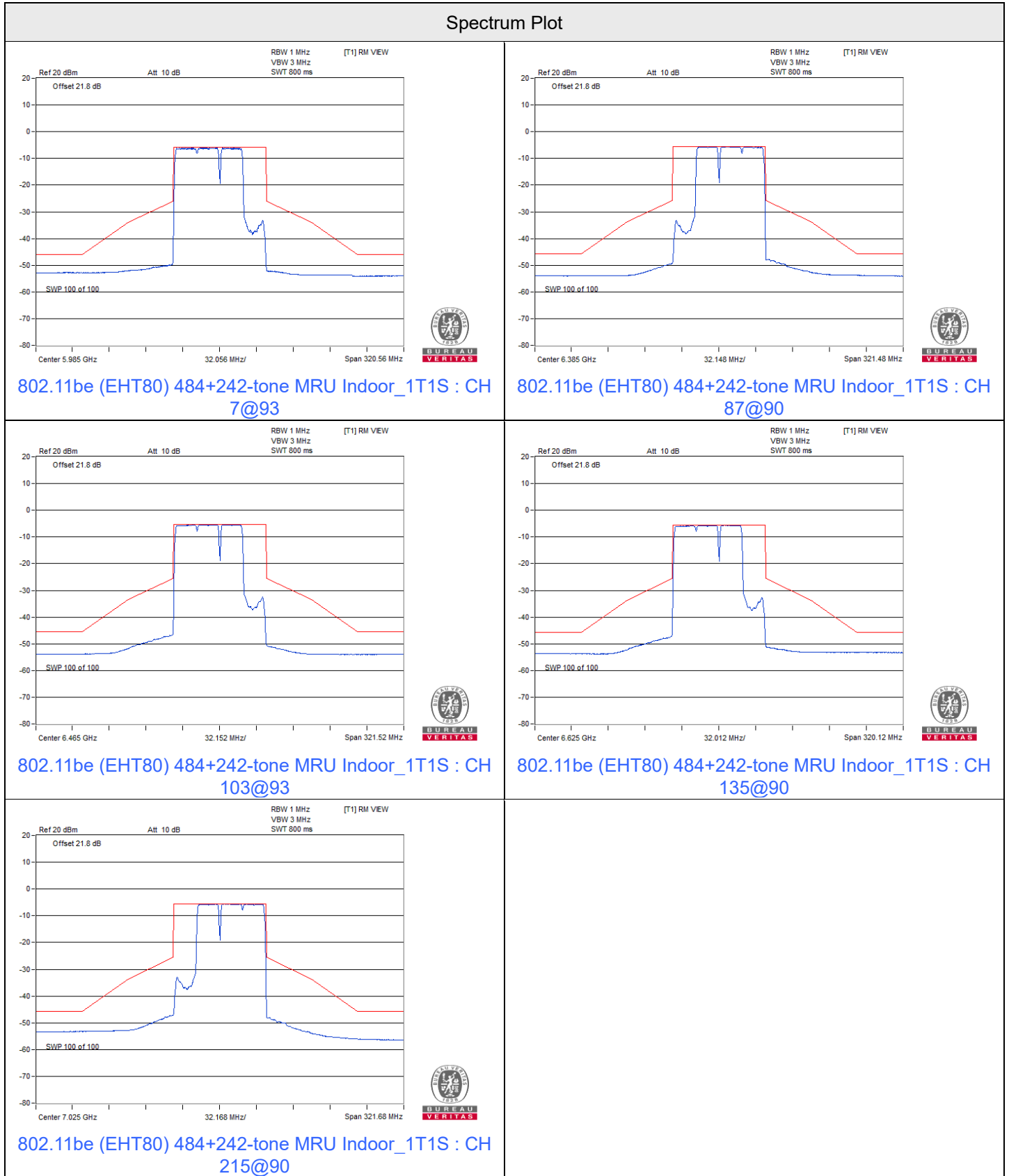



802.11be (EHT160) 996+484-tone MRU Indoor_1T1S

Spectrum Plot

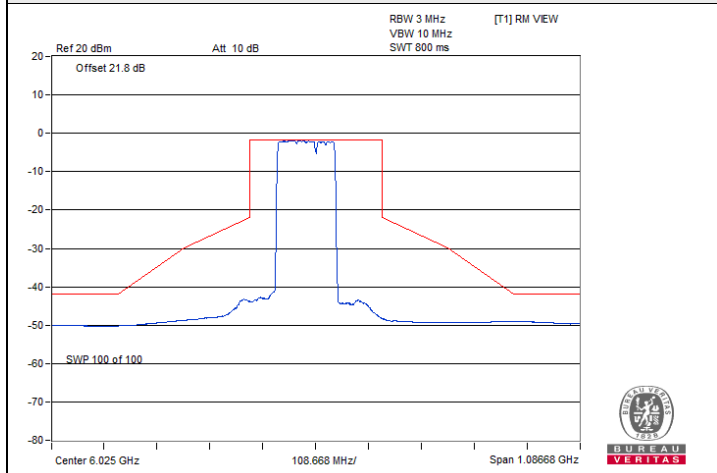

802.11be (EHT160) 996+484-tone MRU Indoor_1T1S : CH 15@95_1

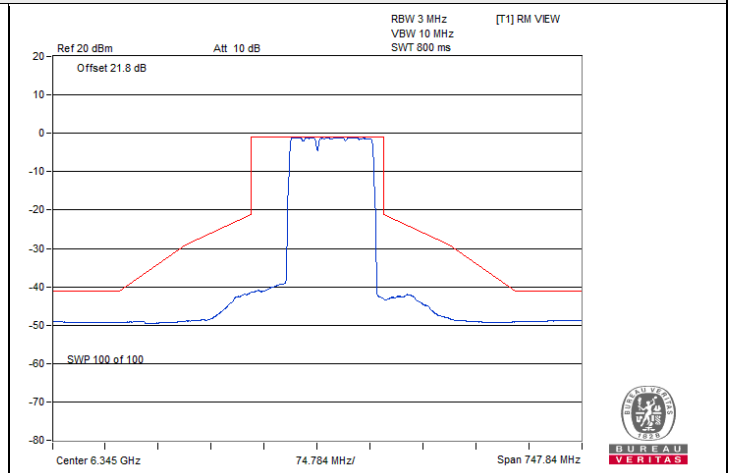

802.11be (EHT160) 996+484-tone MRU Indoor_1T1S : CH 79@94_0

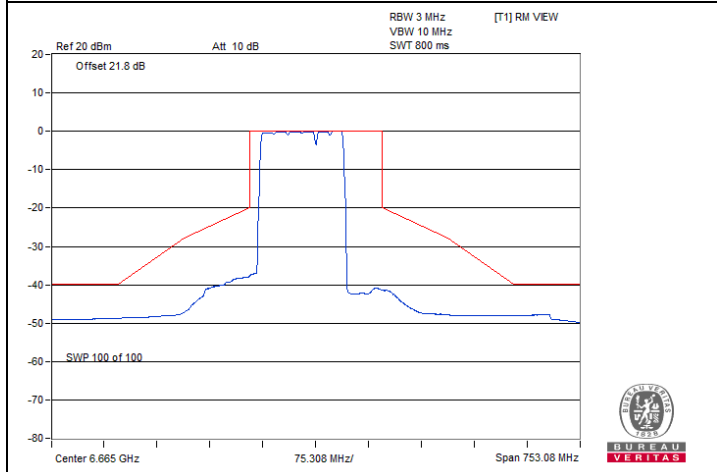

802.11be (EHT160) 996+484-tone MRU Indoor_1T1S : CH 143@95_1

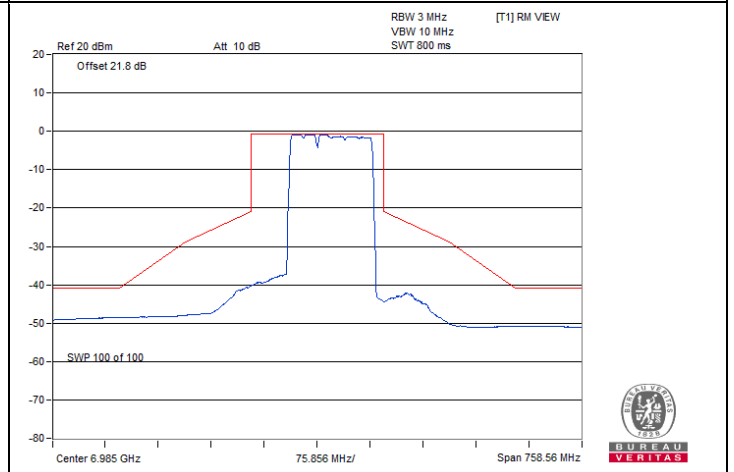

802.11be (EHT160) 996+484-tone MRU Indoor_1T1S : CH 207@95_1



802.11be (EHT160) 996+484+242-tone MRU Indoor_1T1S

Spectrum Plot

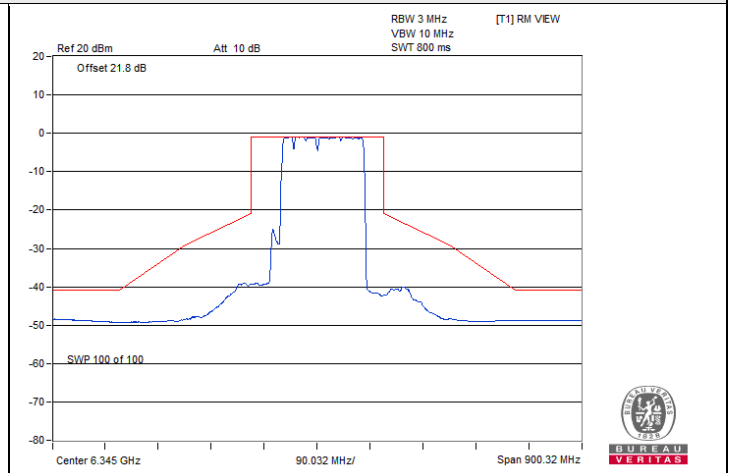
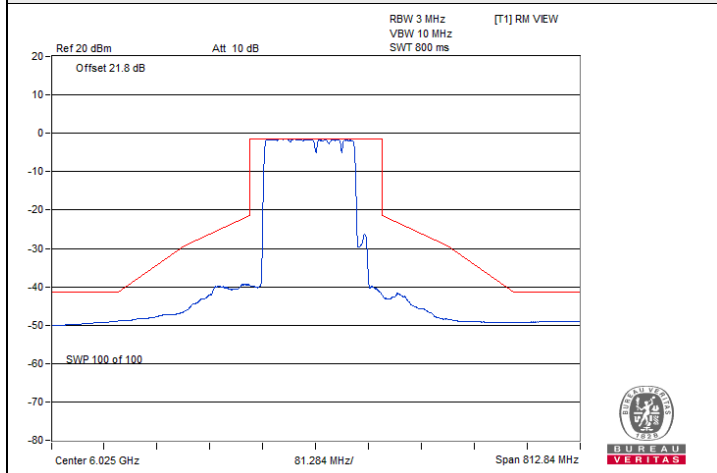

802.11be (EHT160) 996+484+242-tone MRU Indoor_1T1S : 802.11be (EHT160) 996+484+242-tone MRU Indoor_1T1S :
CH 15@99_1 CH 79@96_0

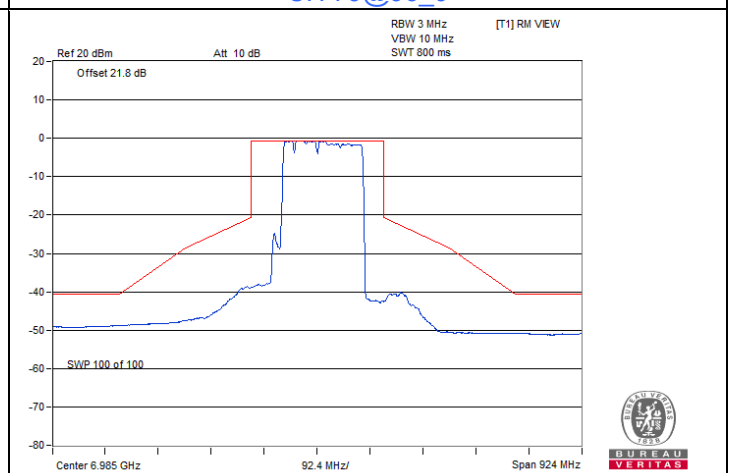
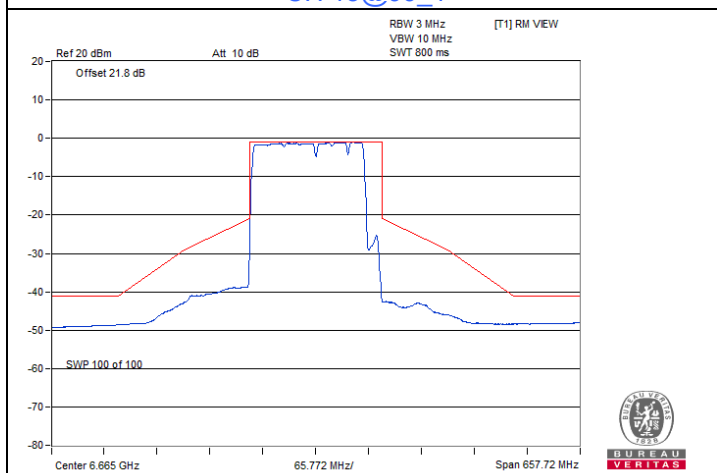

802.11be (EHT160) 996+484+242-tone MRU Indoor_1T1S : 802.11be (EHT160) 996+484+242-tone MRU Indoor_1T1S :
CH 143@99_1 CH 207@99_1

802.11be (EHT320) 2x996+484-tone MRU Indoor_1T1S

Spectrum Plot

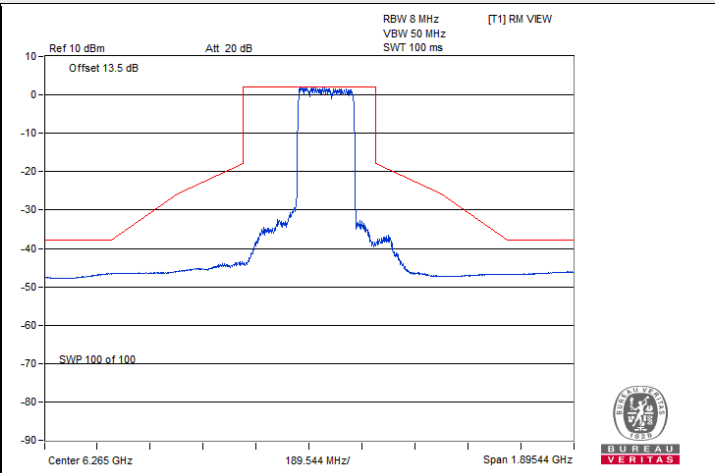
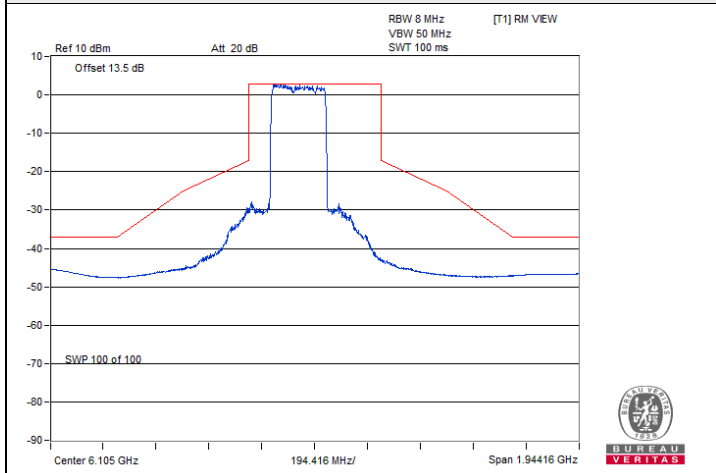

802.11be (EHT320) 2x996+484-tone MRU Indoor_1T1S :
CH 31@101

802.11be (EHT320) 2x996+484-tone MRU Indoor_1T1S :
CH 63@102

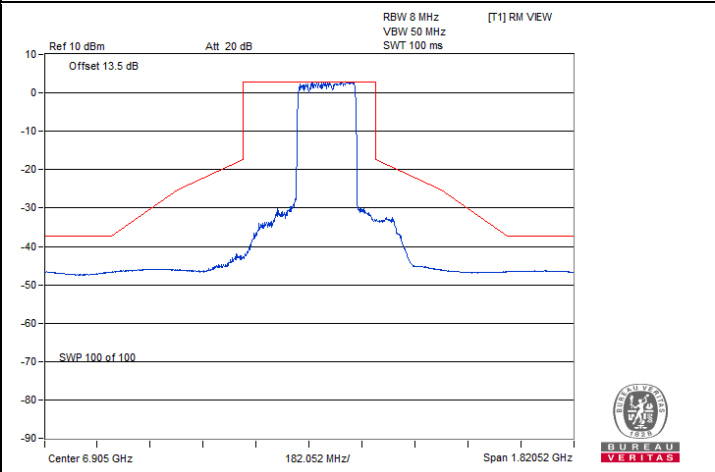
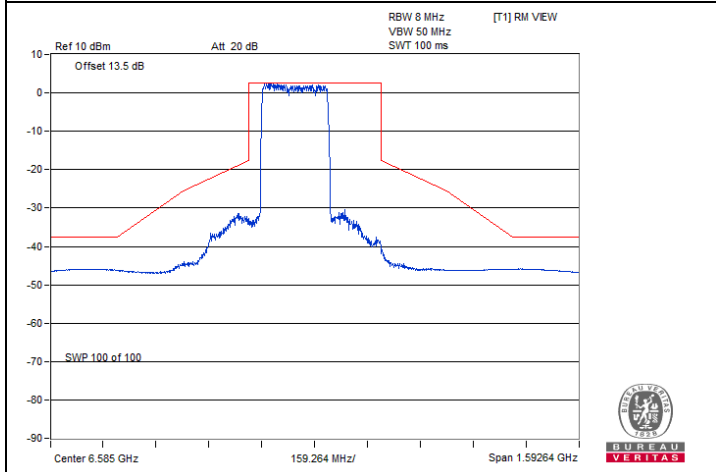

802.11be (EHT320) 2x996+484-tone MRU Indoor_1T1S :
CH 127@101

802.11be (EHT320) 2x996+484-tone MRU Indoor_1T1S :
CH 191@102



802.11be (EHT320) 3x996-tone MRU Indoor_1T1S

Spectrum Plot

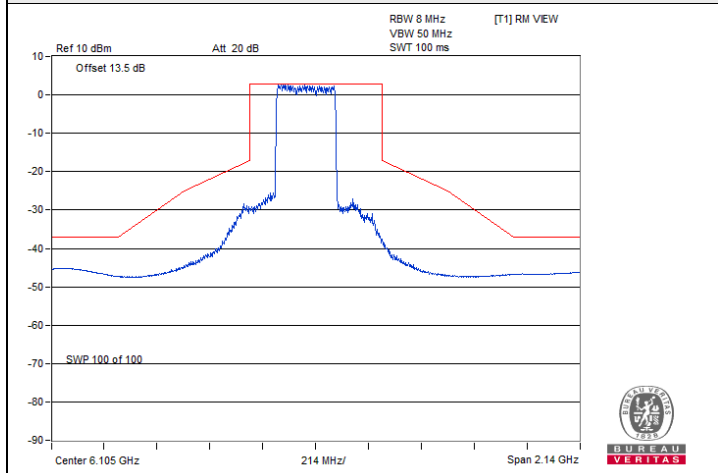

802.11be (EHT320) 3x996-tone MRU Indoor_1T1S : CH 31@104

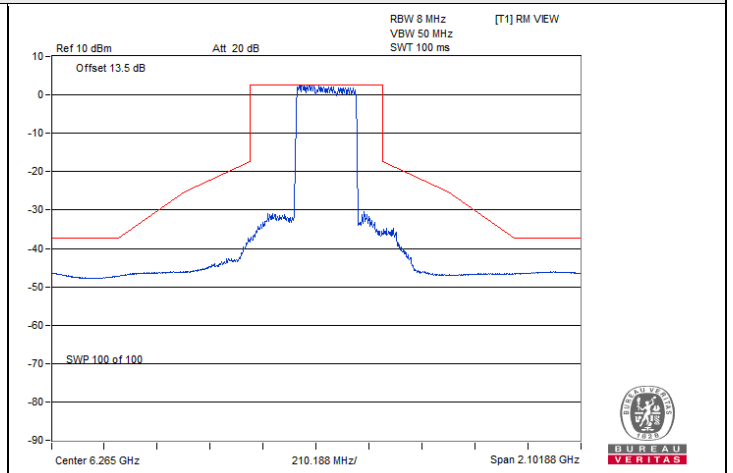

802.11be (EHT320) 3x996-tone MRU Indoor_1T1S : CH 63@104

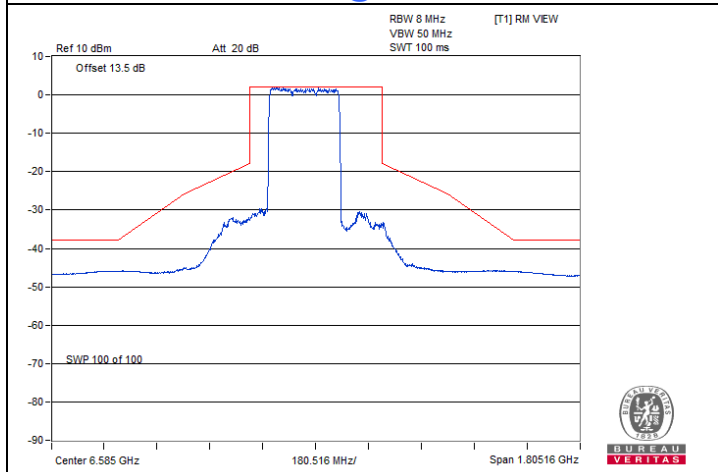

802.11be (EHT320) 3x996-tone MRU Indoor_1T1S : CH 127@104

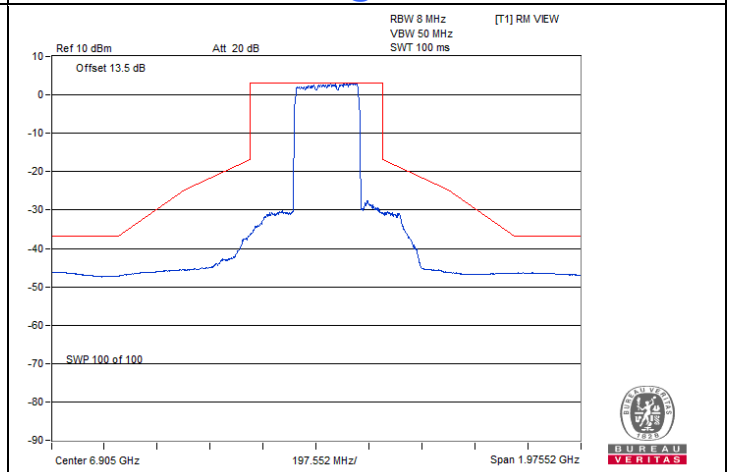

802.11be (EHT320) 3x996-tone MRU Indoor_1T1S : CH 191@104



802.11be (EHT320) 3x996+484-tone MRU Indoor_1T1S

Spectrum Plot

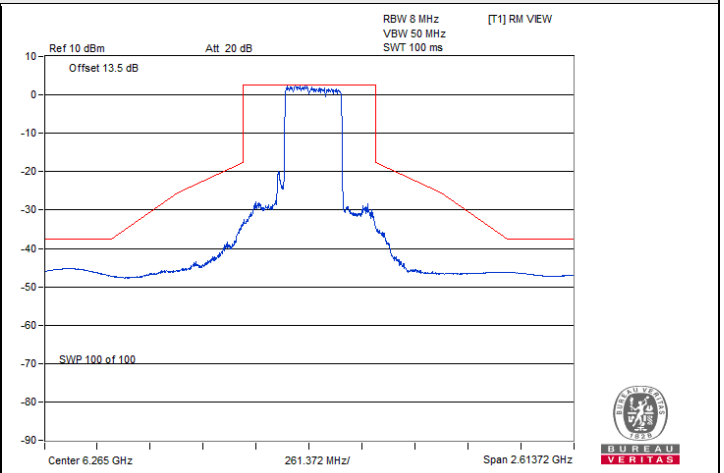
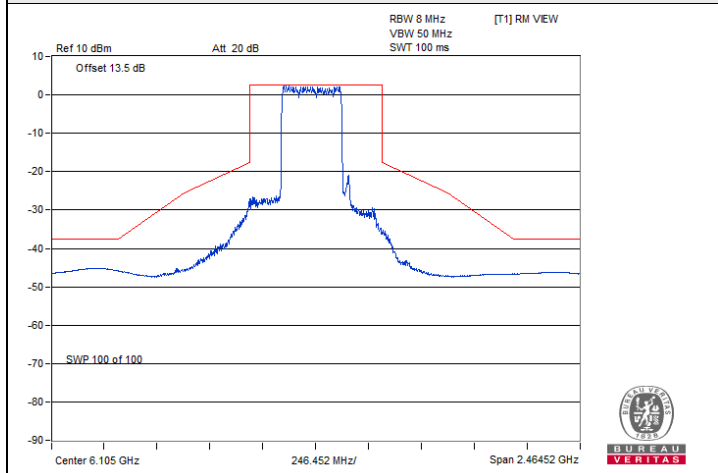

802.11be (EHT320) 3x996+484-tone MRU Indoor_1T1S :
CH 31@106

802.11be (EHT320) 3x996+484-tone MRU Indoor_1T1S :
CH 63@105

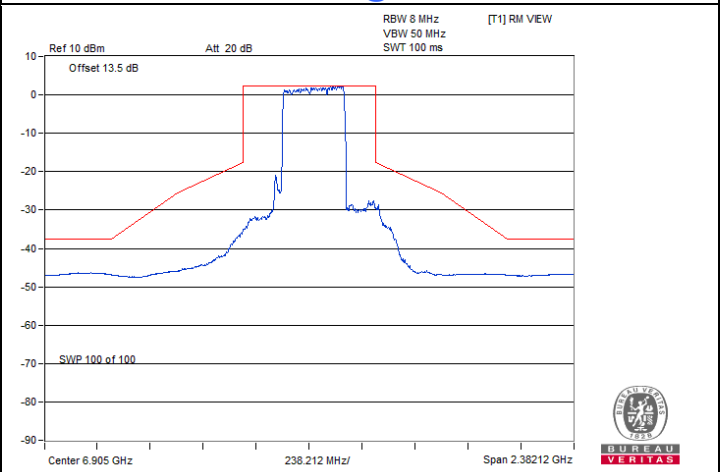
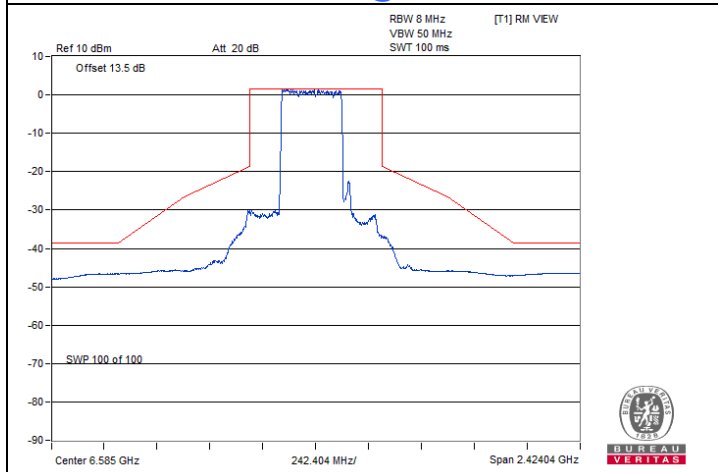

802.11be (EHT320) 3x996+484-tone MRU Indoor_1T1S :
CH 127@106

802.11be (EHT320) 3x996+484-tone MRU Indoor_1T1S :
CH 191@105

802.11ax (HE) 26-tone RU Indoor_2T2S

Spectrum Plot

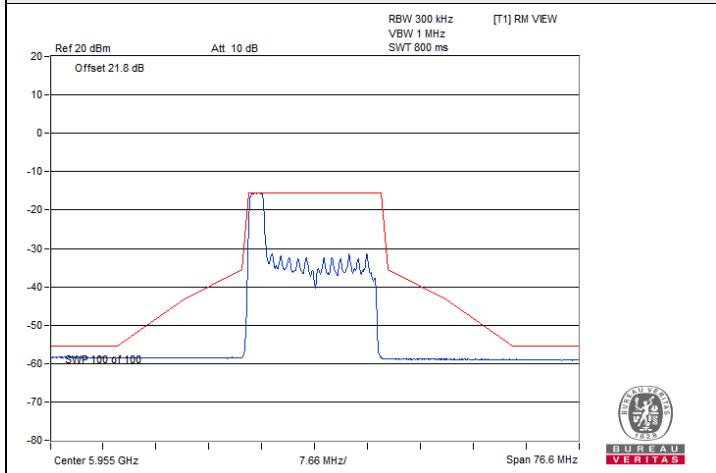

802.11ax (HE) 26-tone RU Indoor_2T2S / Chain 0 : CH 1@0

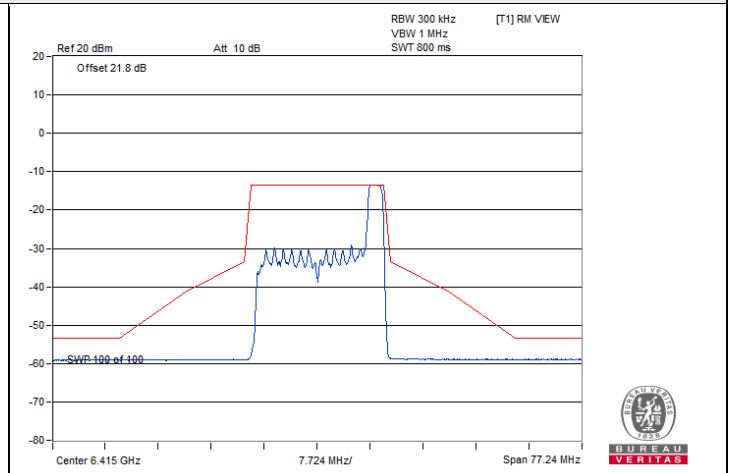

802.11ax (HE) 26-tone RU Indoor_2T2S / Chain 0 : CH 93@8

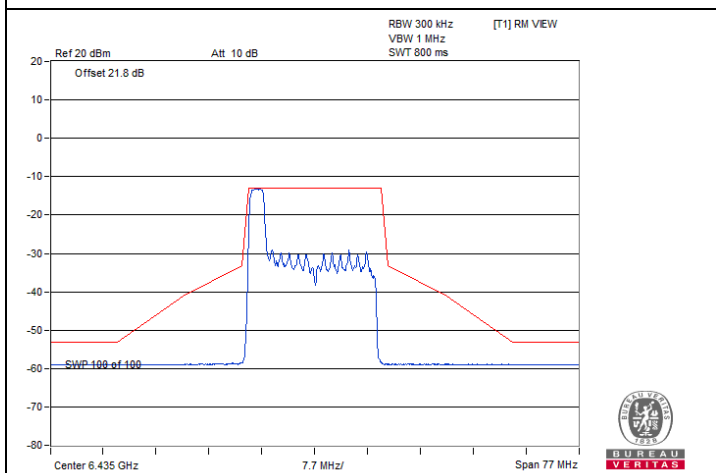

802.11ax (HE) 26-tone RU Indoor_2T2S / Chain 0 : CH 97@0

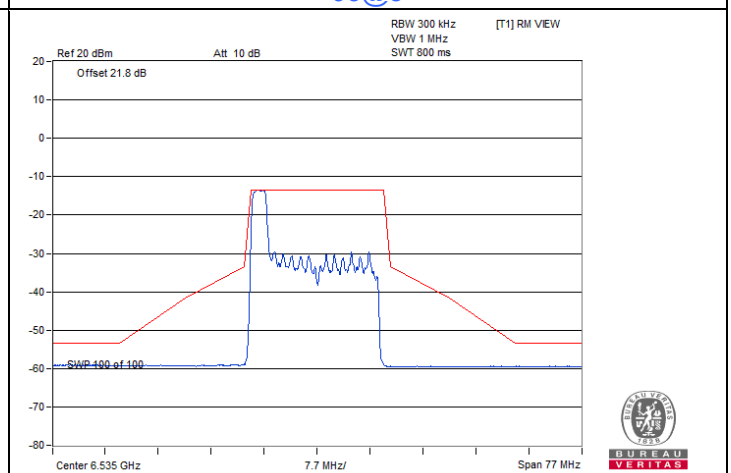

802.11ax (HE) 26-tone RU Indoor_2T2S / Chain 0 : CH 117@0

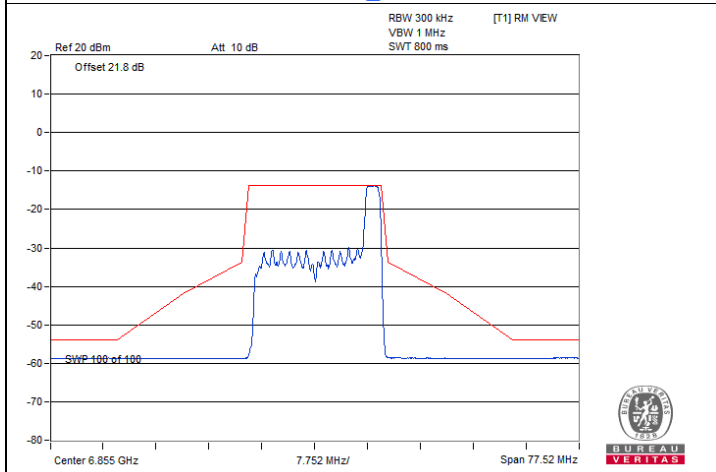

802.11ax (HE) 26-tone RU Indoor_2T2S / Chain 0 : CH 181@8

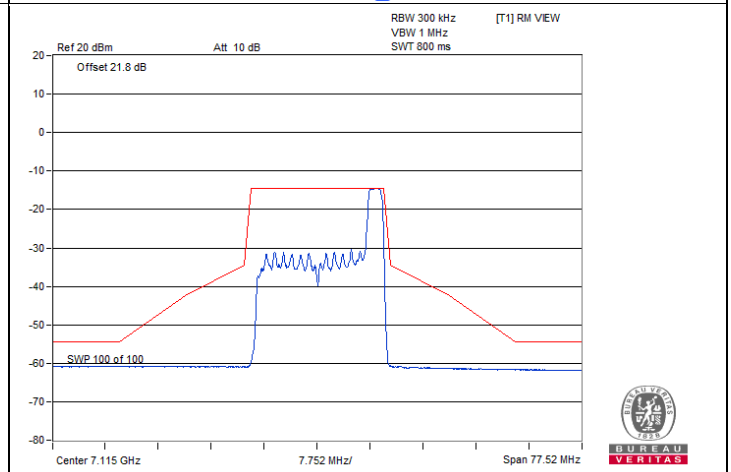

802.11ax (HE) 26-tone RU Indoor_2T2S / Chain 0 : CH 233@8

Spectrum Plot

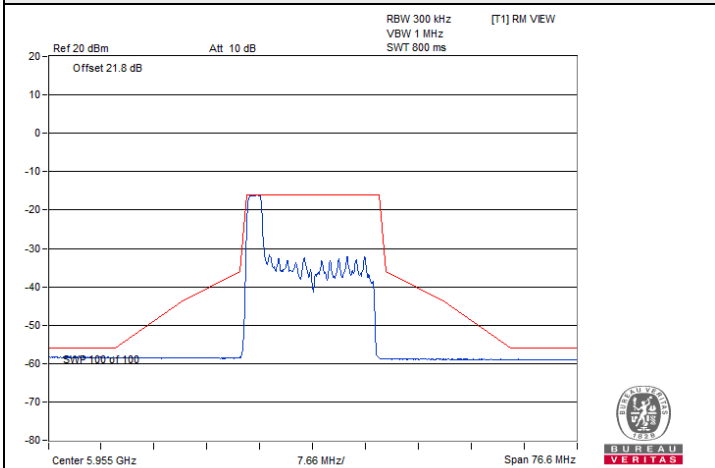

802.11ax (HE) 26-tone RU Indoor_2T2S / Chain 1 : CH 1@0

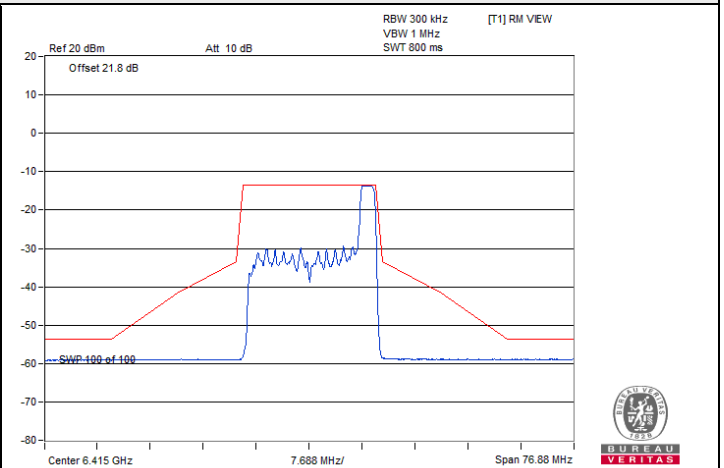

802.11ax (HE) 26-tone RU Indoor_2T2S / Chain 1 : CH 93@8

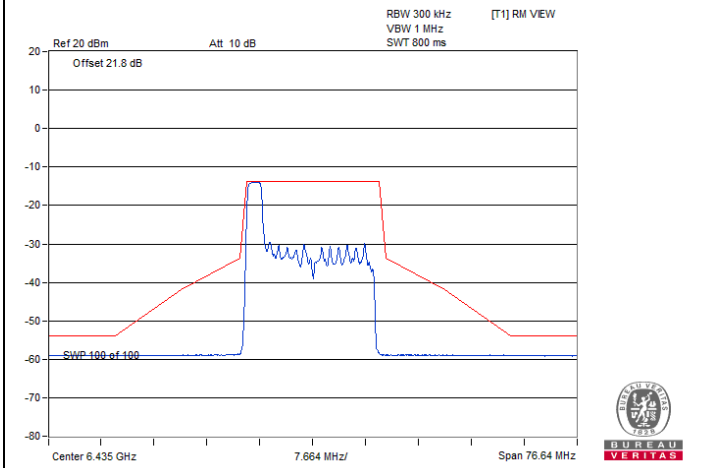

802.11ax (HE) 26-tone RU Indoor_2T2S / Chain 1 : CH 97@0

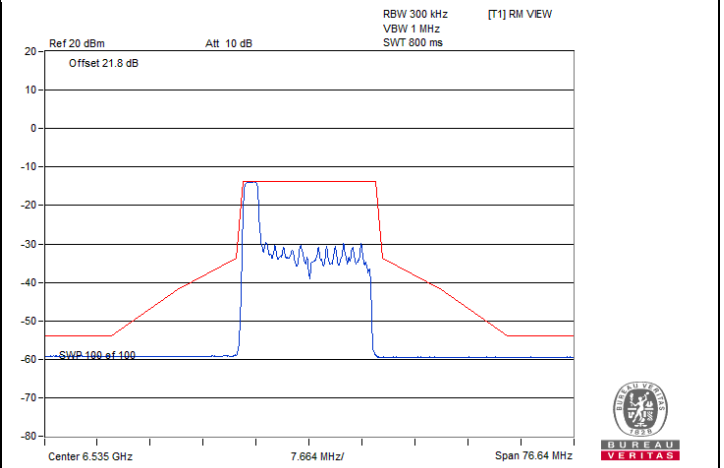

802.11ax (HE) 26-tone RU Indoor_2T2S / Chain 1 : CH 117@0

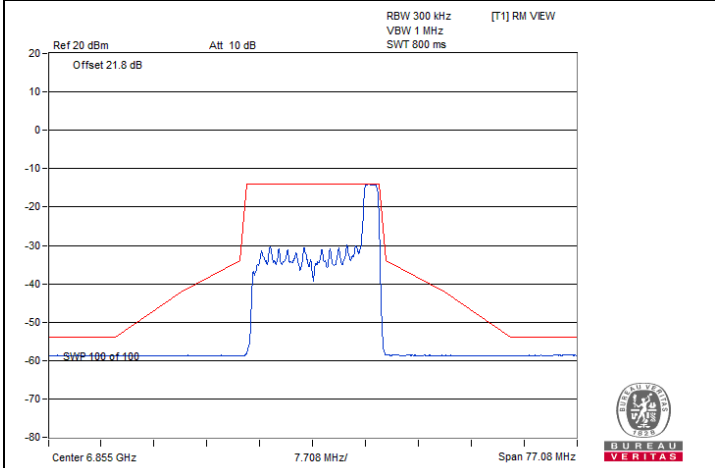

802.11ax (HE) 26-tone RU Indoor_2T2S / Chain 1 : CH 181@8

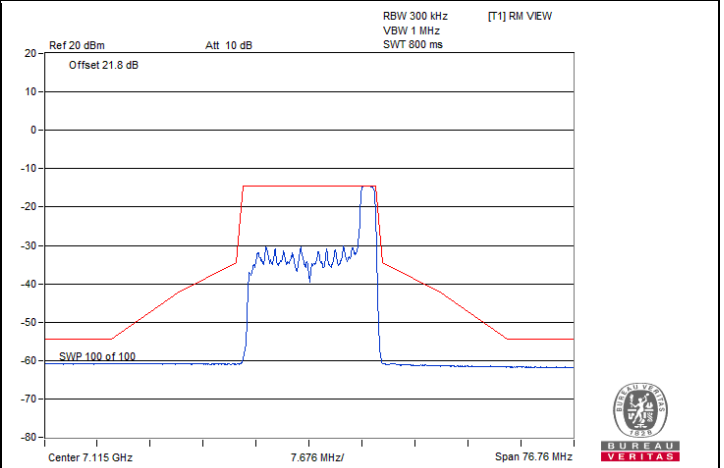

802.11ax (HE) 26-tone RU Indoor_2T2S / Chain 1 : CH 233@8



802.11ax (HE) 52-tone RU Indoor_2T2S

Spectrum Plot

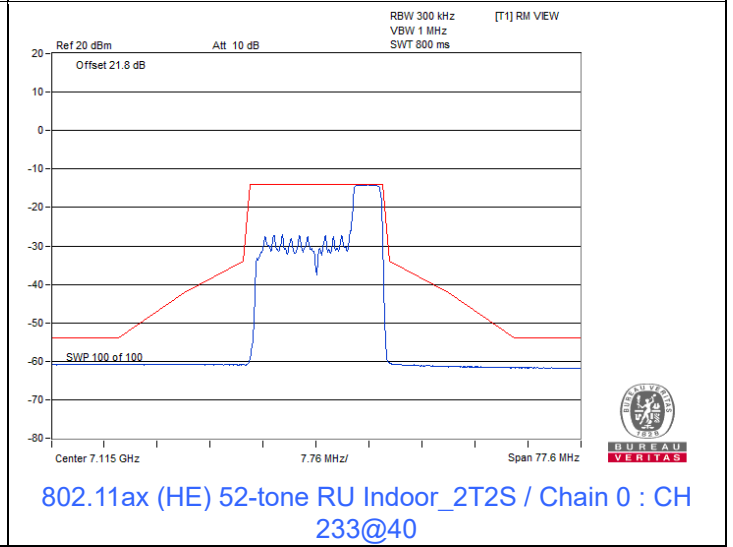
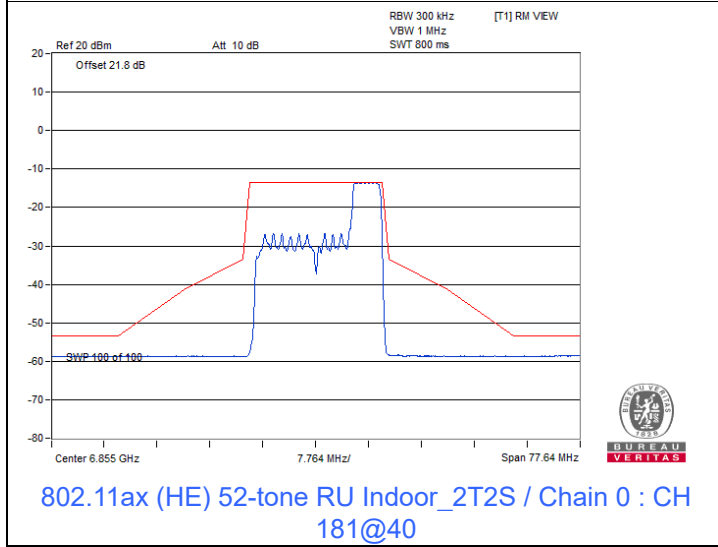
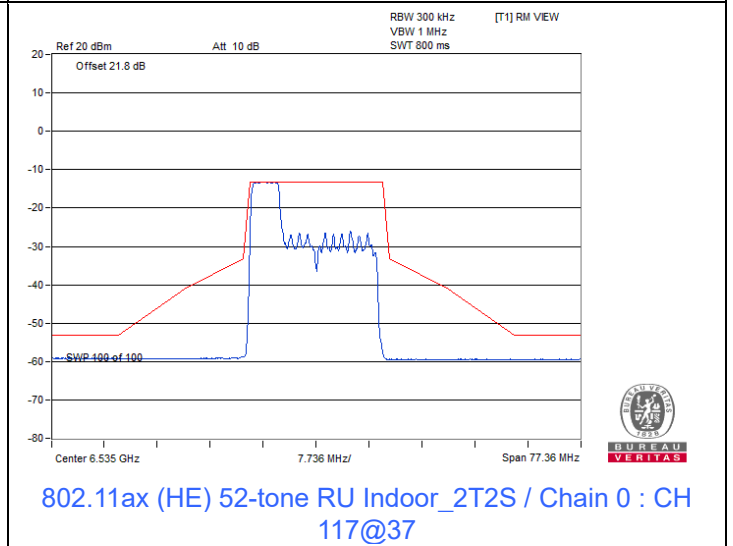
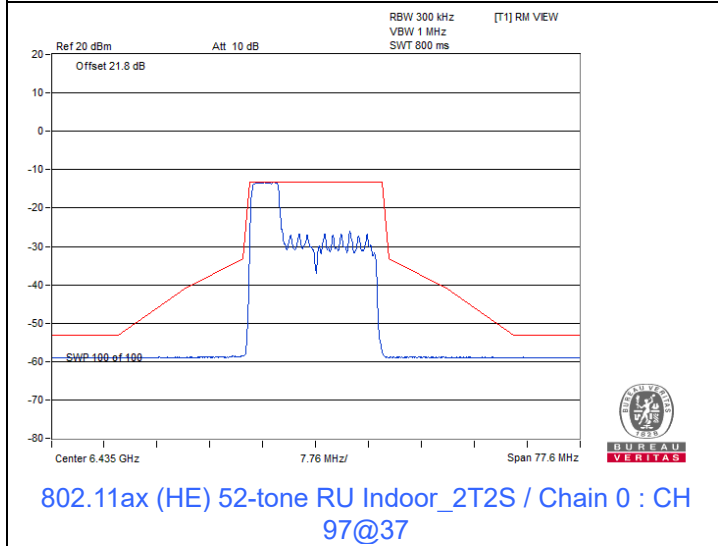
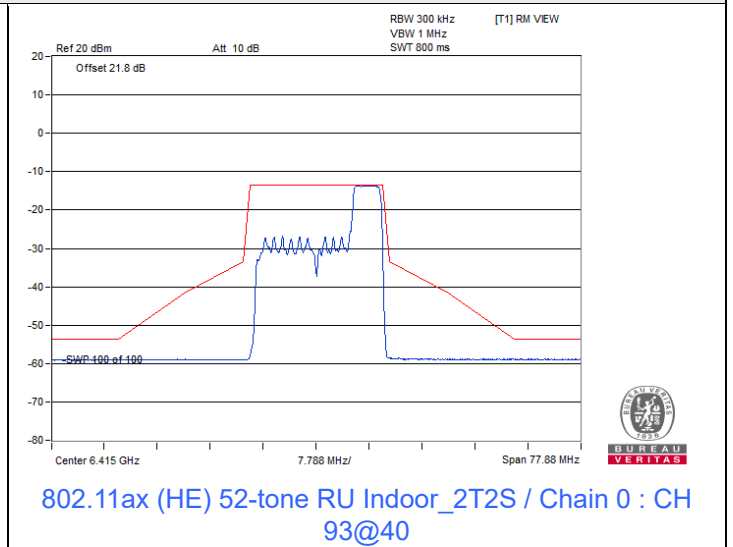
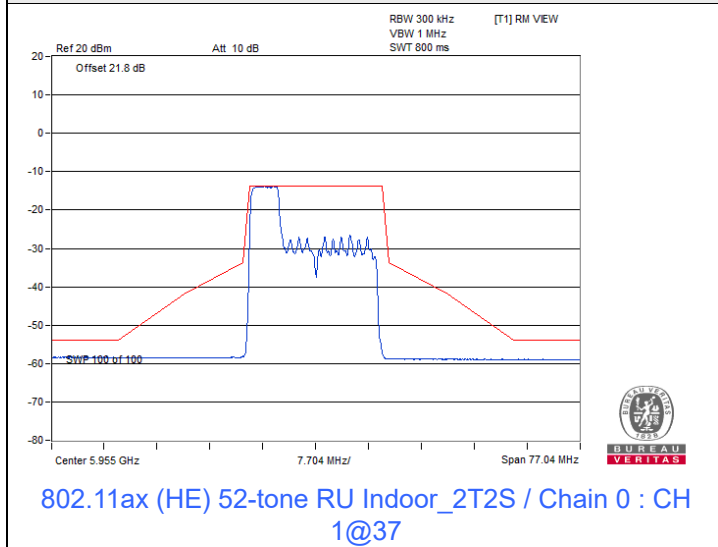

Spectrum Plot

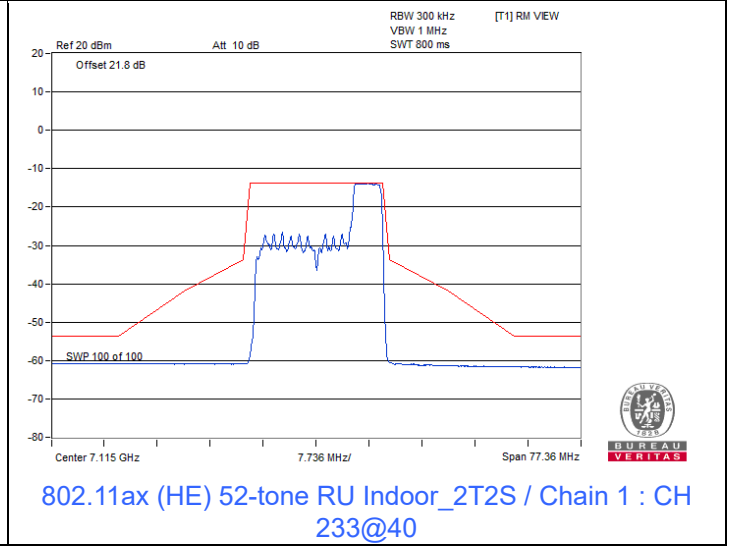
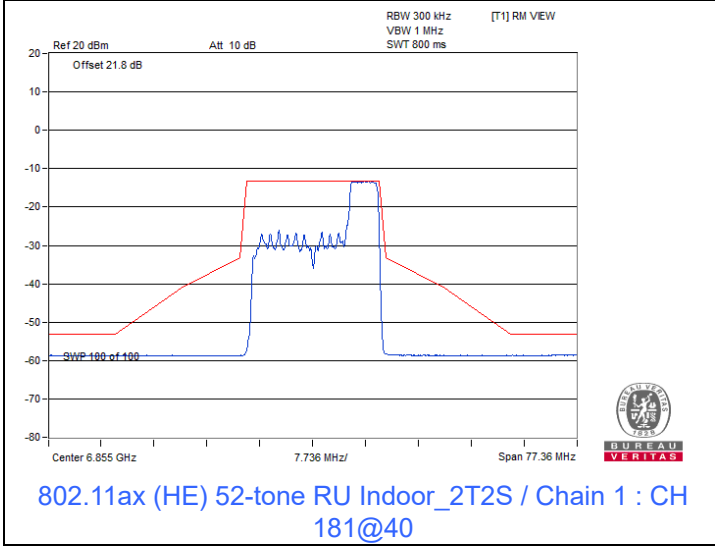
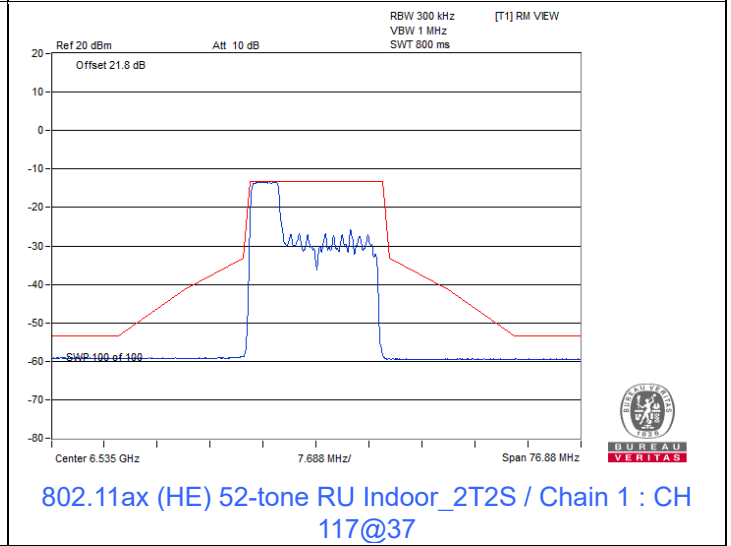
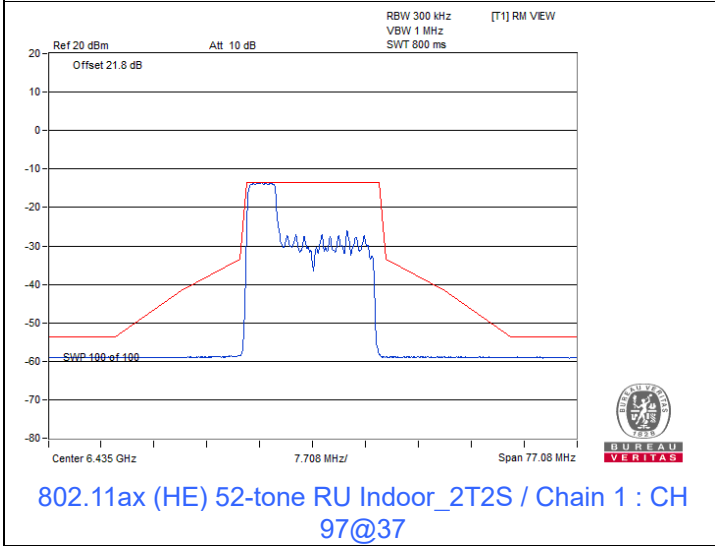
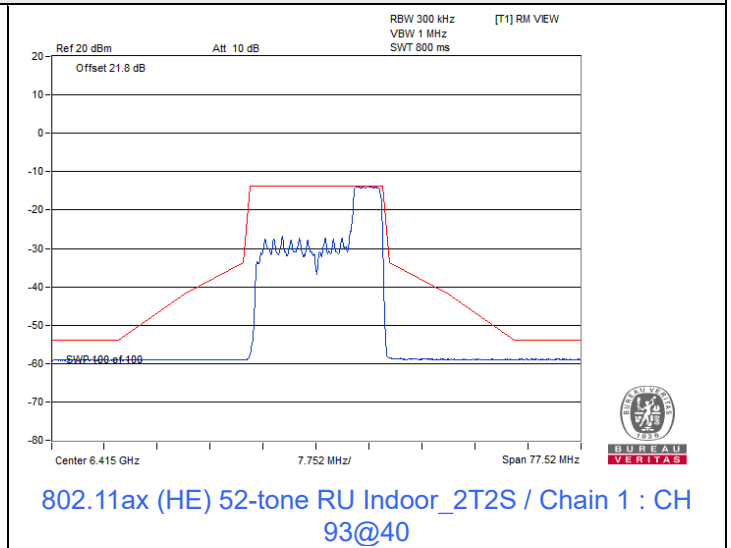
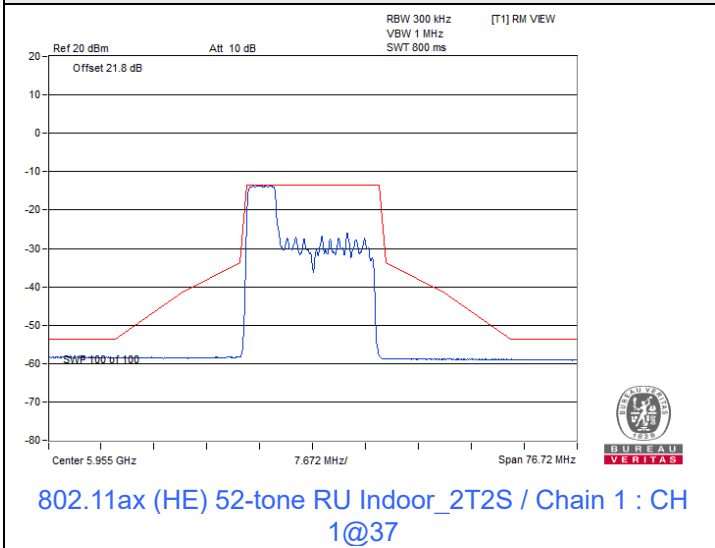



802.11ax (HE) 106-tone RU Indoor_2T2S

Spectrum Plot

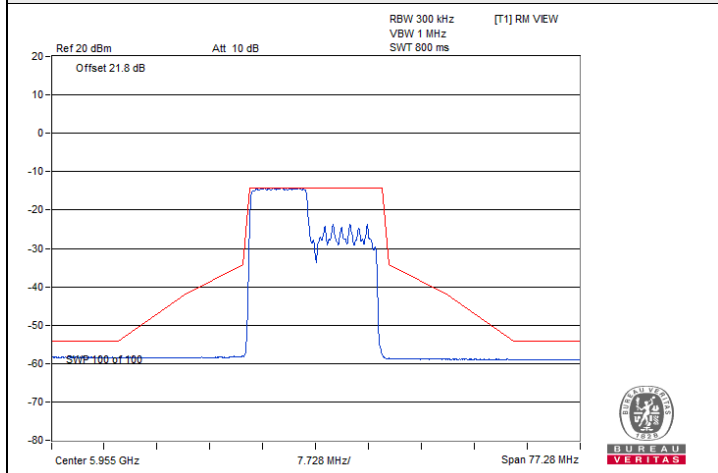

802.11ax (HE) 106-tone RU Indoor_2T2S / Chain 0 : CH 1@53

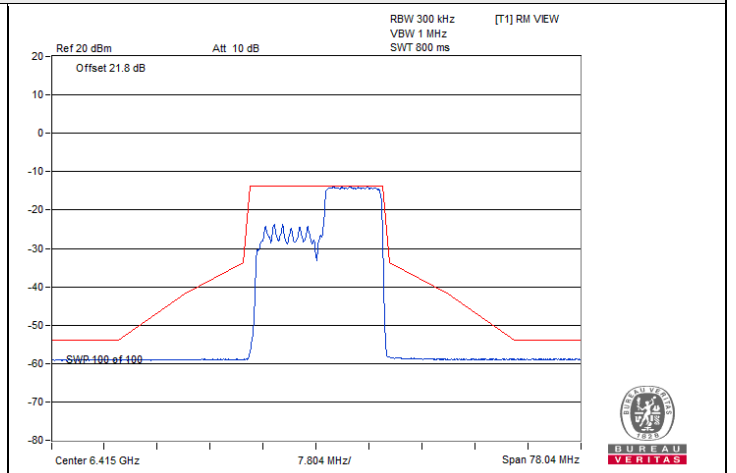

802.11ax (HE) 106-tone RU Indoor_2T2S / Chain 0 : CH 93@54

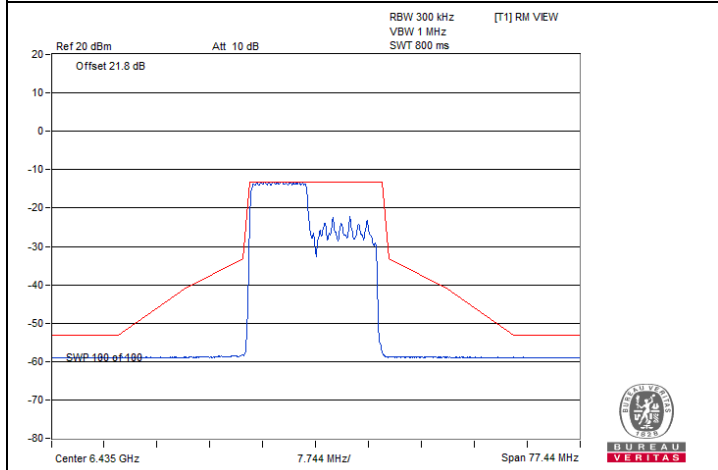

802.11ax (HE) 106-tone RU Indoor_2T2S / Chain 0 : CH 97@53

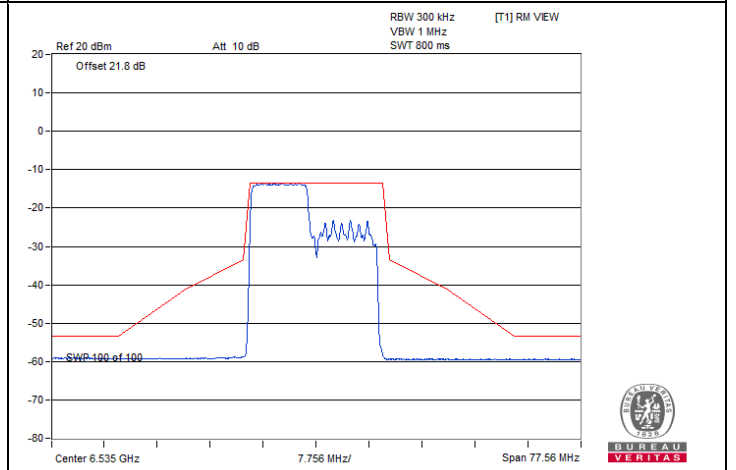

802.11ax (HE) 106-tone RU Indoor_2T2S / Chain 0 : CH 117@53

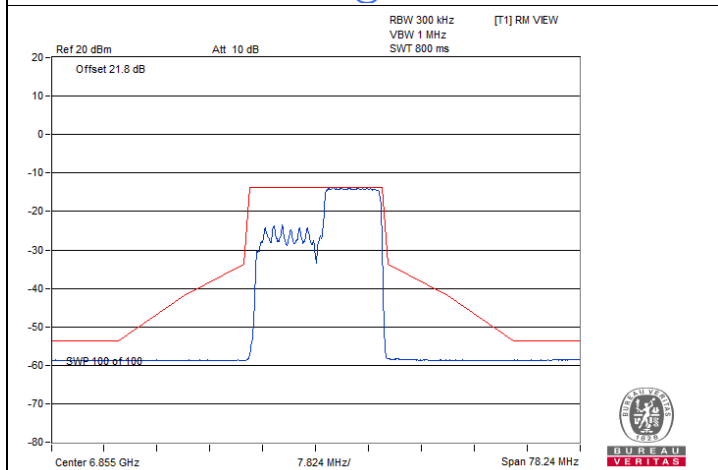

802.11ax (HE) 106-tone RU Indoor_2T2S / Chain 0 : CH 181@54

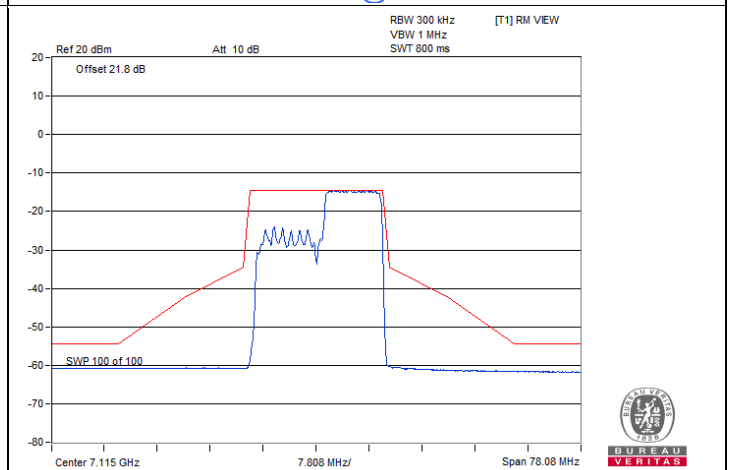

802.11ax (HE) 106-tone RU Indoor_2T2S / Chain 0 : CH 233@54

Spectrum Plot

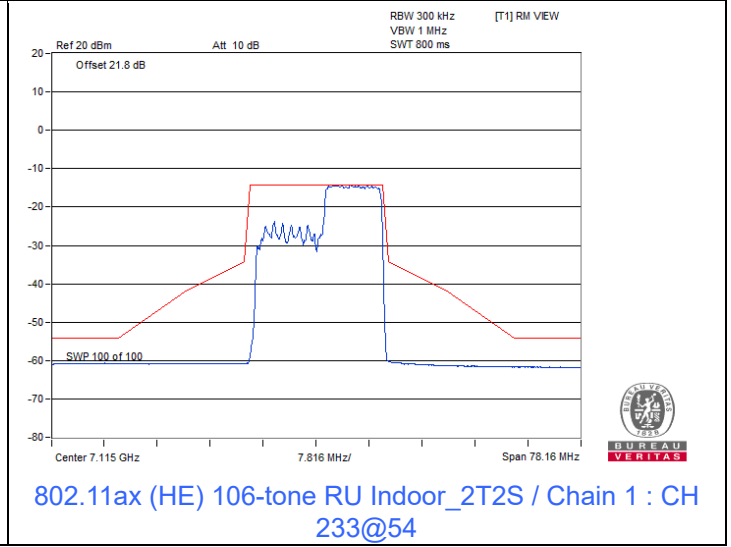
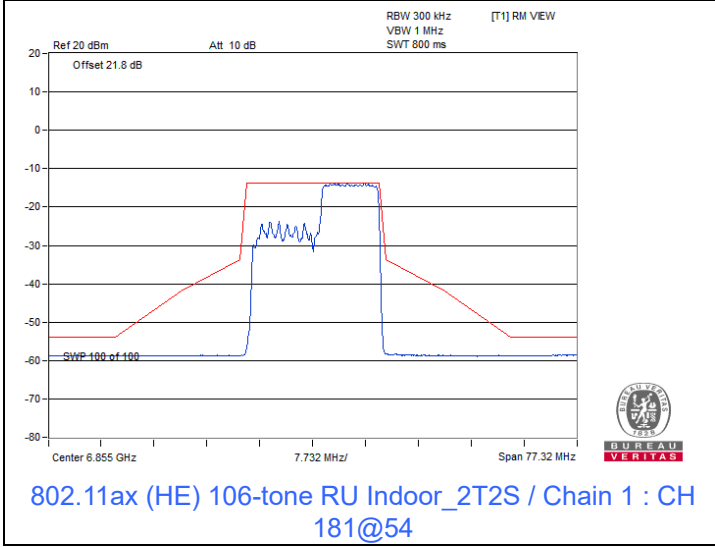
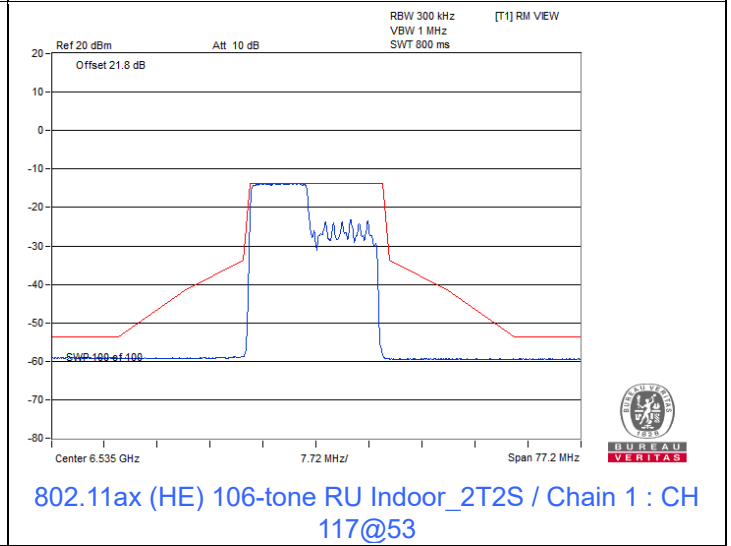
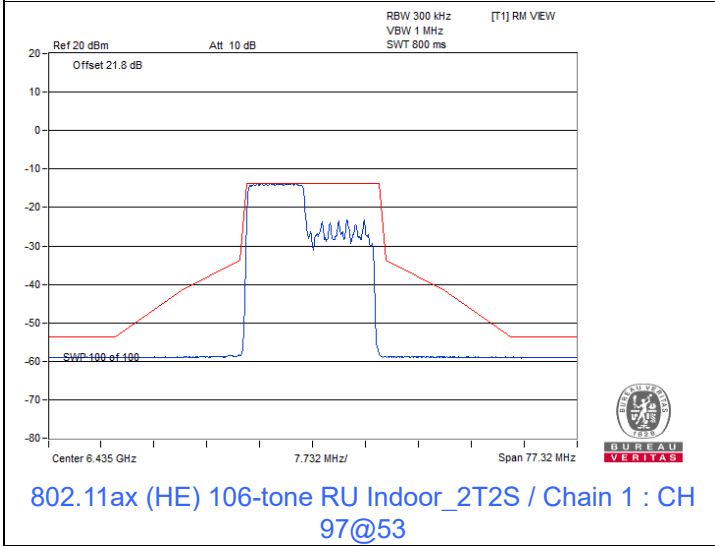
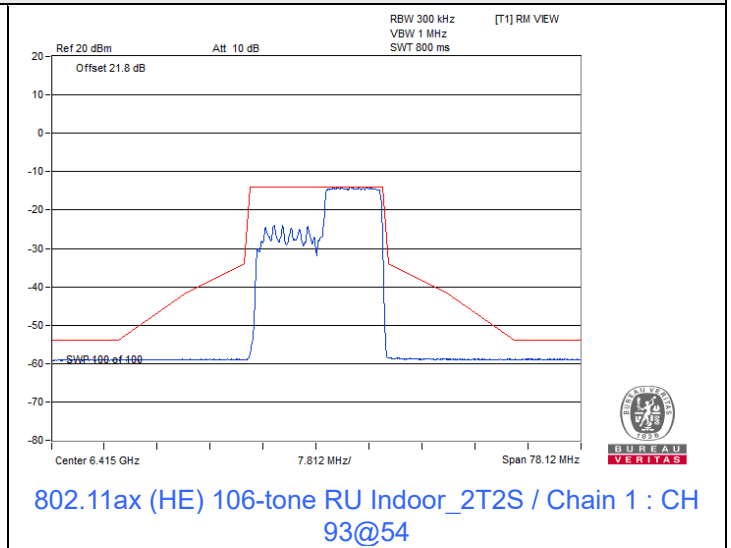
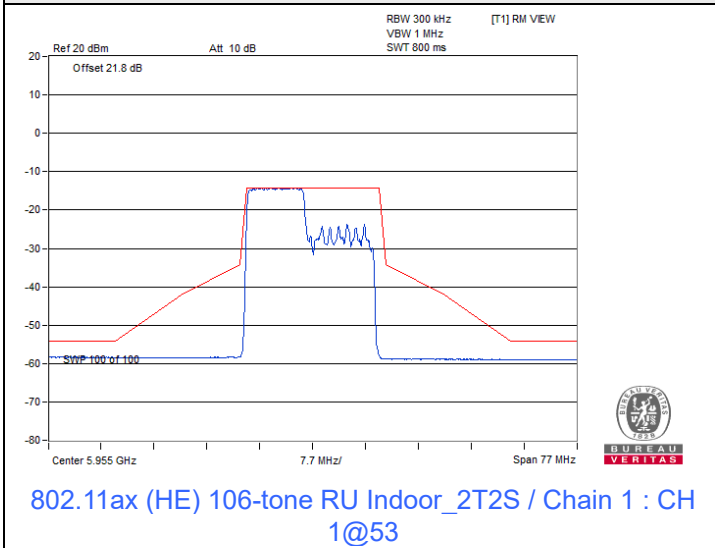



802.11be (EHT20) 52+26-tone MRU Indoor_2T2S

Spectrum Plot

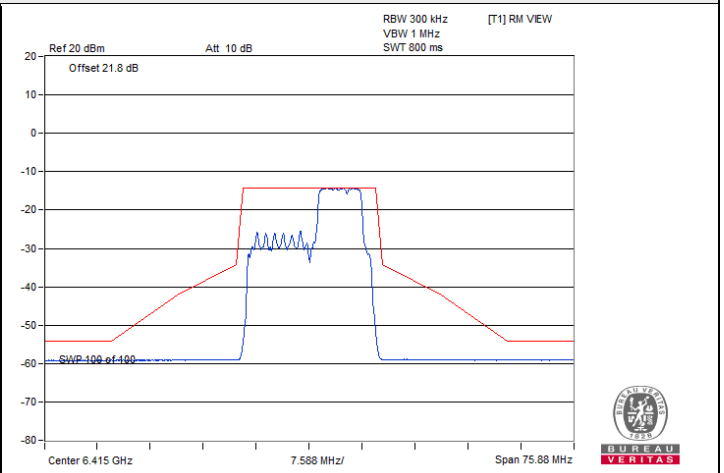
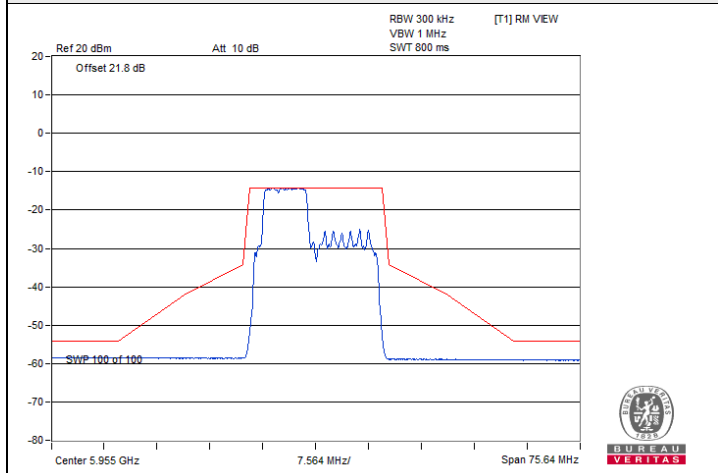

802.11be (EHT20) 52+26-tone MRU Indoor_2T2S / Chain 0 : CH 1@70

802.11be (EHT20) 52+26-tone MRU Indoor_2T2S / Chain 0 : CH 93@72

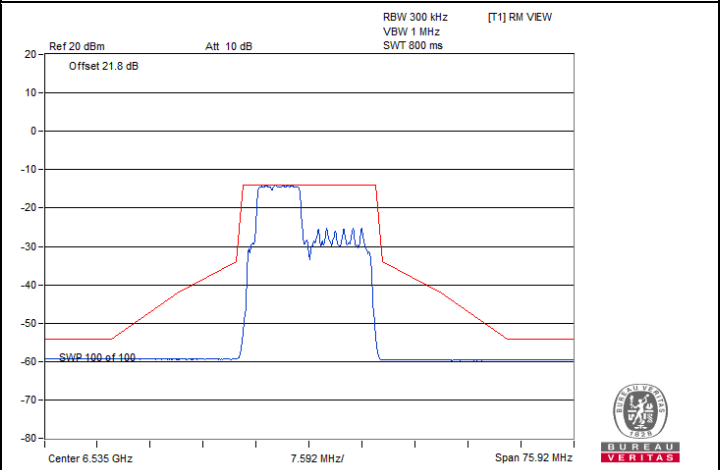
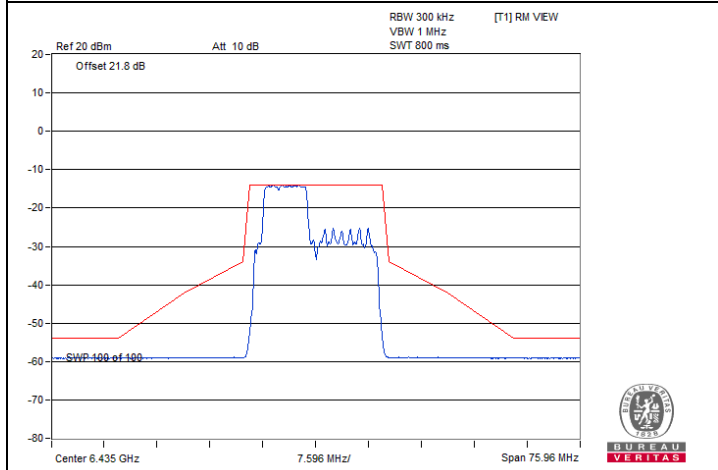

802.11be (EHT20) 52+26-tone MRU Indoor_2T2S / Chain 0 : CH 97@70

802.11be (EHT20) 52+26-tone MRU Indoor_2T2S / Chain 0 : CH 117@70

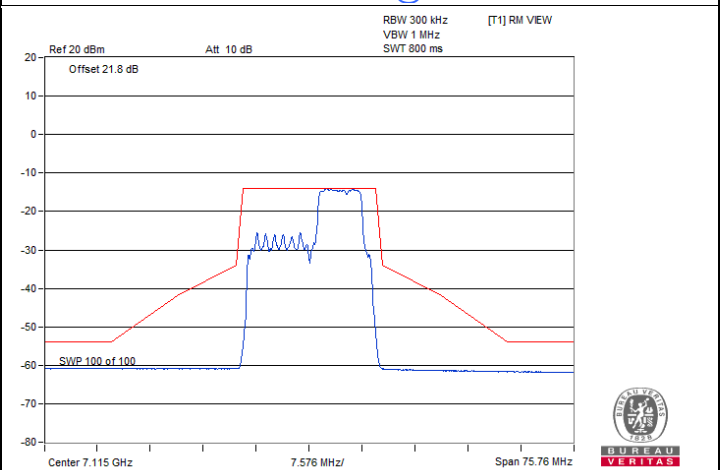
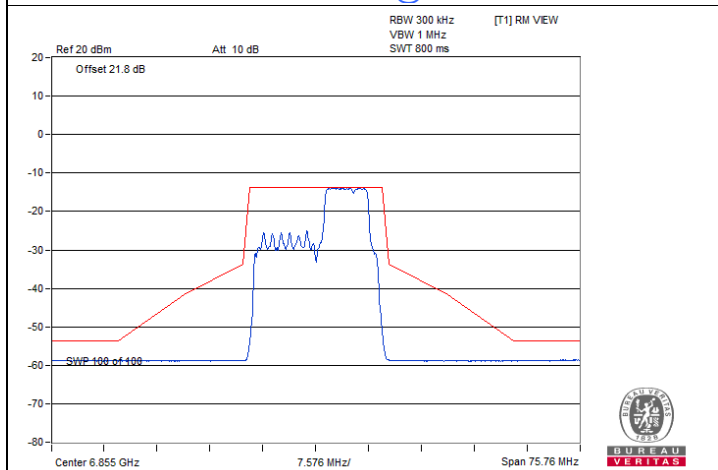

802.11be (EHT20) 52+26-tone MRU Indoor_2T2S / Chain 0 : CH 181@72

802.11be (EHT20) 52+26-tone MRU Indoor_2T2S / Chain 0 : CH 233@72

Spectrum Plot

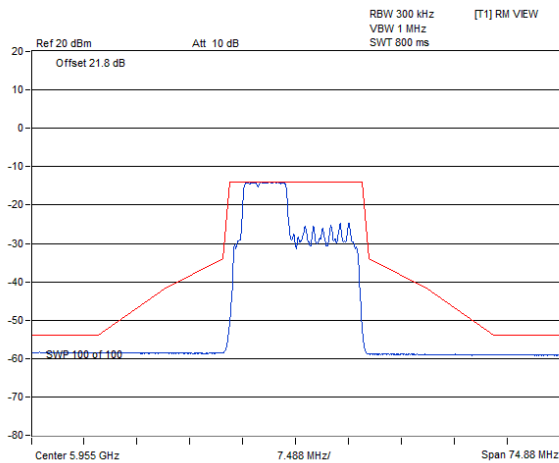

802.11be (EHT20) 52+26-tone MRU Indoor_2T2S / Chain 1 : CH 1@70

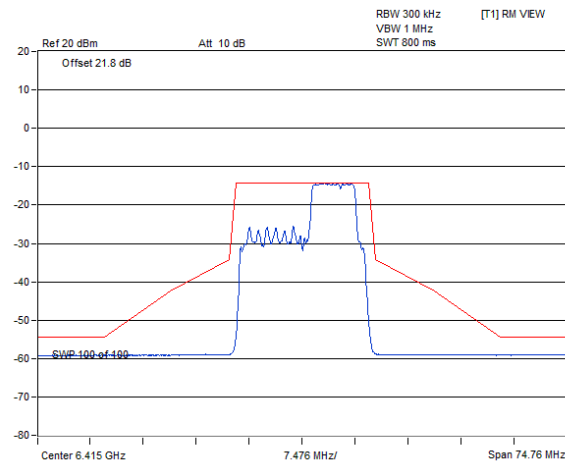

802.11be (EHT20) 52+26-tone MRU Indoor_2T2S / Chain 1 : CH 93@72

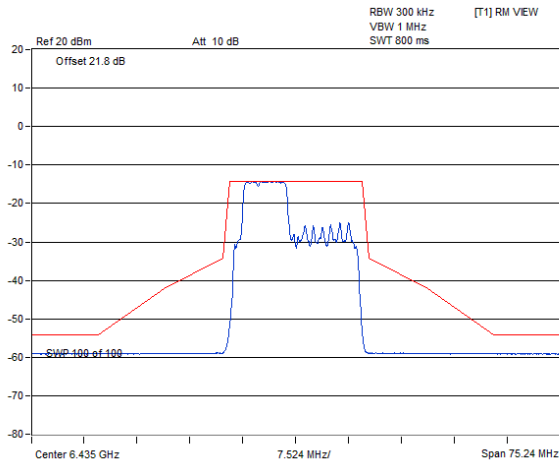

802.11be (EHT20) 52+26-tone MRU Indoor_2T2S / Chain 1 : CH 97@70

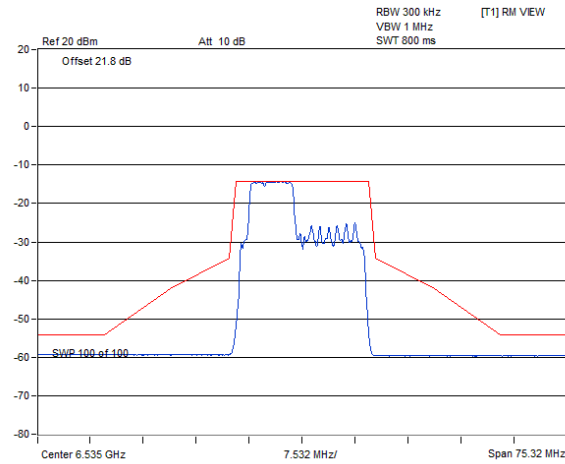

802.11be (EHT20) 52+26-tone MRU Indoor_2T2S / Chain 1 : CH 117@70

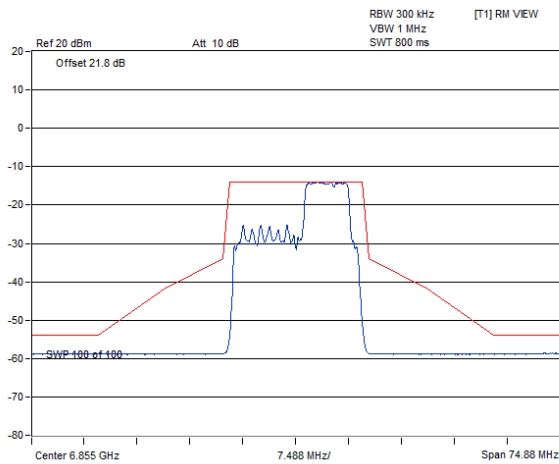

802.11be (EHT20) 52+26-tone MRU Indoor_2T2S / Chain 1 : CH 181@72

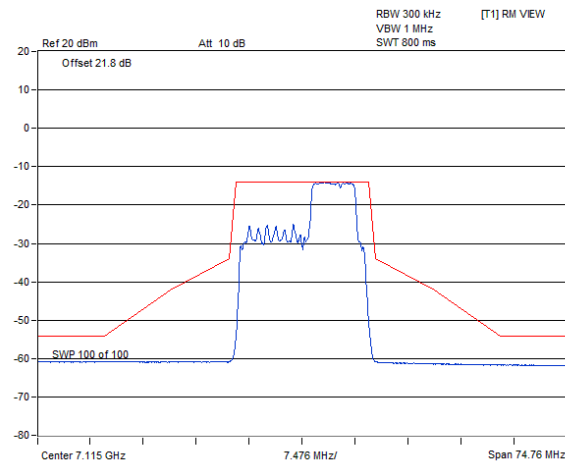

802.11be (EHT20) 52+26-tone MRU Indoor_2T2S / Chain 1 : CH 233@72



802.11be (EHT20) 106+26-tone MRU Indoor_2T2S

Spectrum Plot

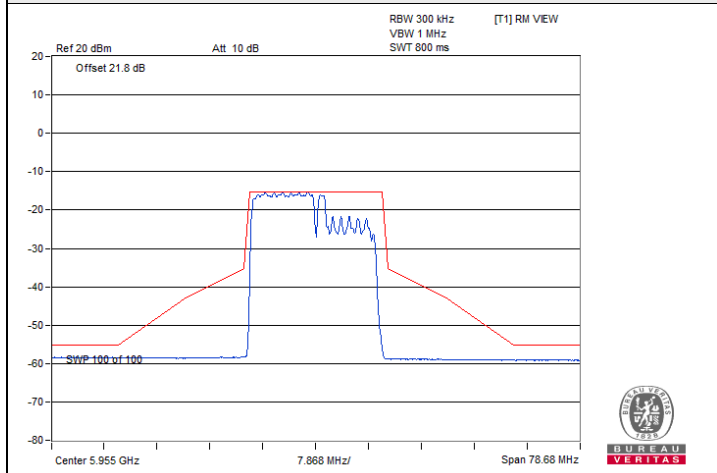

802.11be (EHT20) 106+26-tone MRU Indoor_2T2S / Chain 0 : CH 1@82

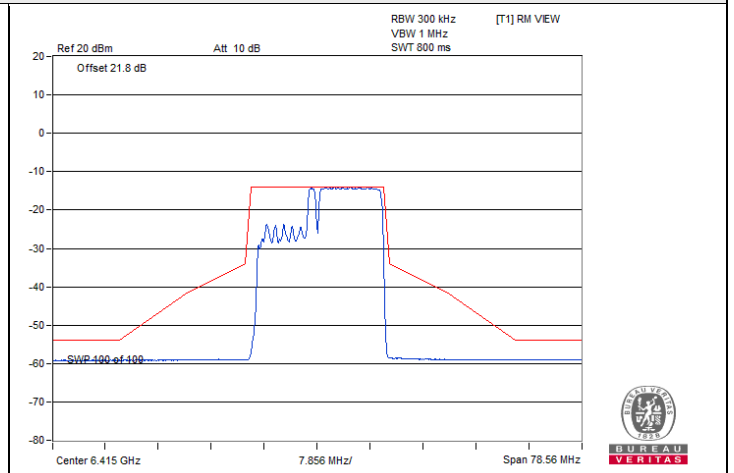

802.11be (EHT20) 106+26-tone MRU Indoor_2T2S / Chain 0 : CH 93@93

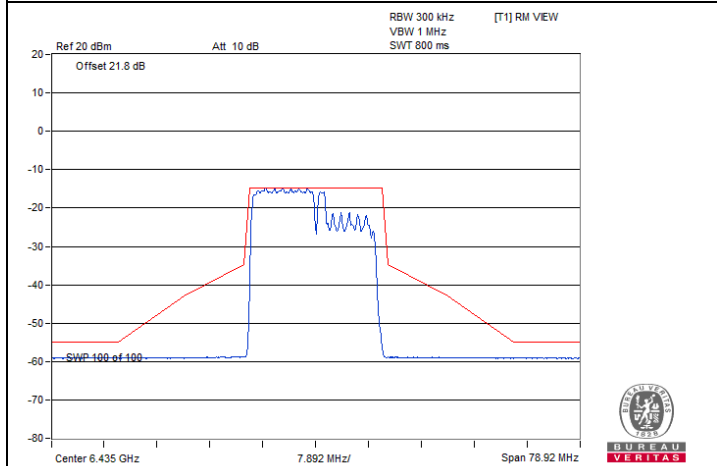

802.11be (EHT20) 106+26-tone MRU Indoor_2T2S / Chain 0 : CH 97@82

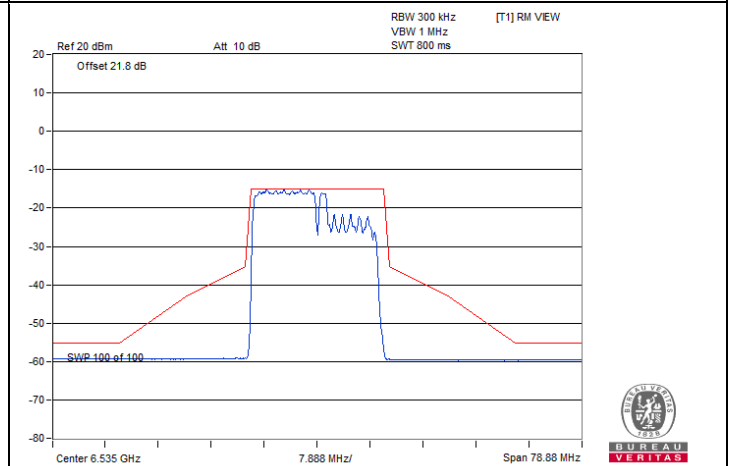

802.11be (EHT20) 106+26-tone MRU Indoor_2T2S / Chain 0 : CH 117@82

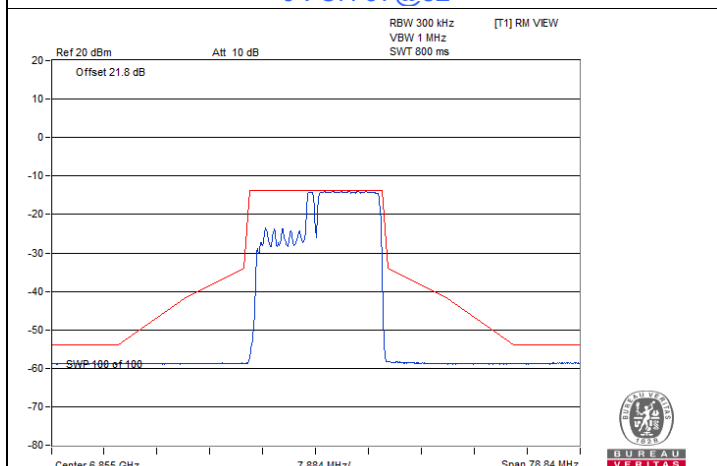

802.11be (EHT20) 106+26-tone MRU Indoor_2T2S / Chain 0 : CH 181@93

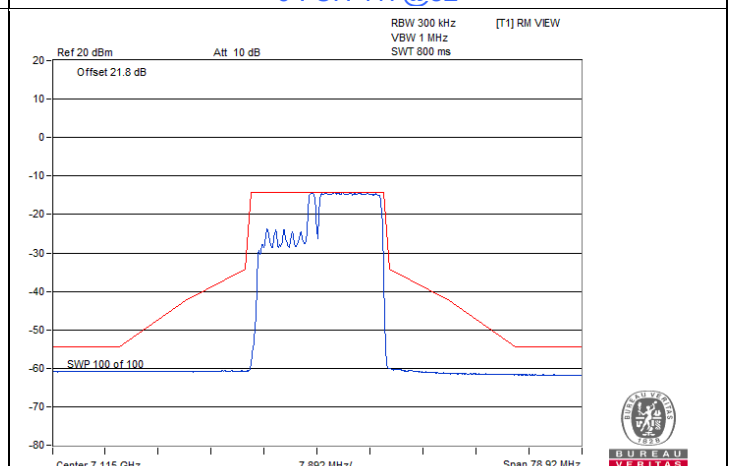

802.11be (EHT20) 106+26-tone MRU Indoor_2T2S / Chain 0 : CH 233@93

Spectrum Plot

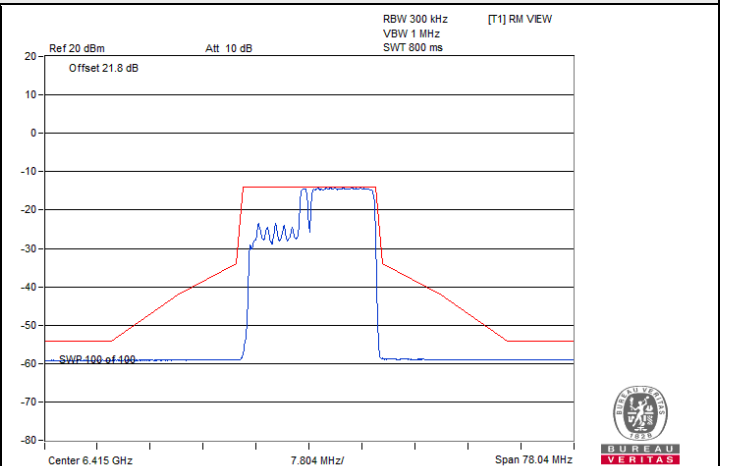
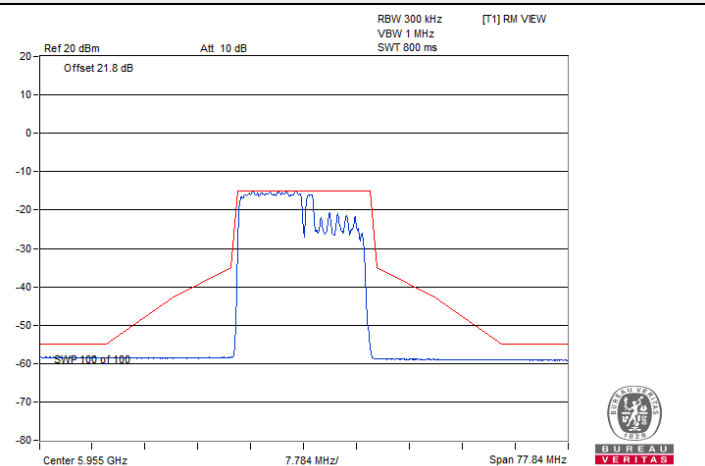

802.11be (EHT20) 106+26-tone MRU Indoor_2T2S / Chain 1 : CH 1@82

802.11be (EHT20) 106+26-tone MRU Indoor_2T2S / Chain 1 : CH 93@93

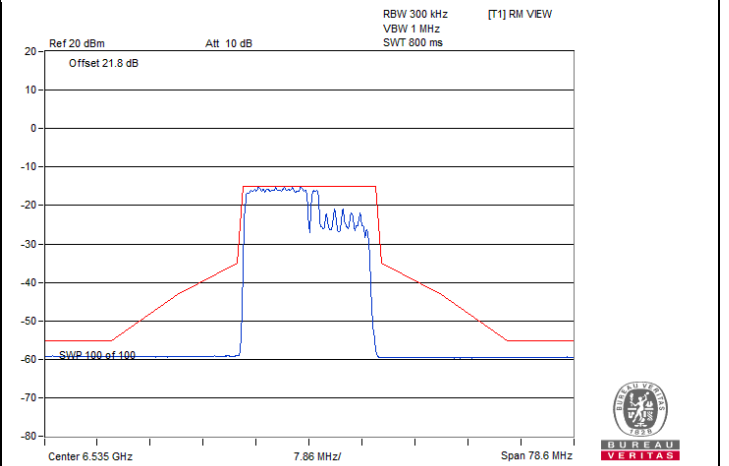
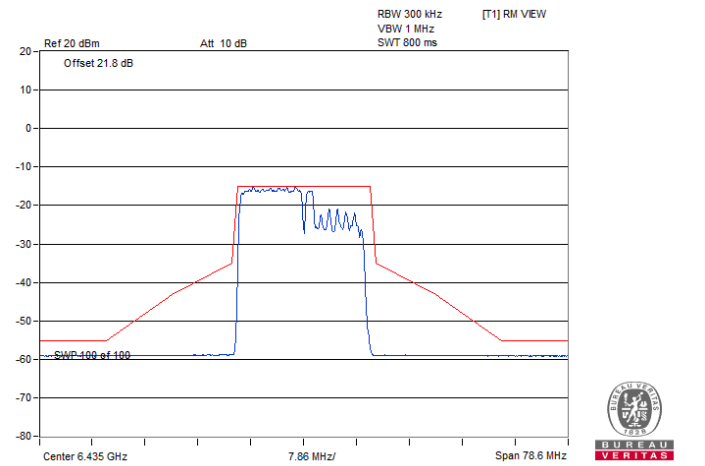

802.11be (EHT20) 106+26-tone MRU Indoor_2T2S / Chain 1 : CH 97@82

802.11be (EHT20) 106+26-tone MRU Indoor_2T2S / Chain 1 : CH 117@82

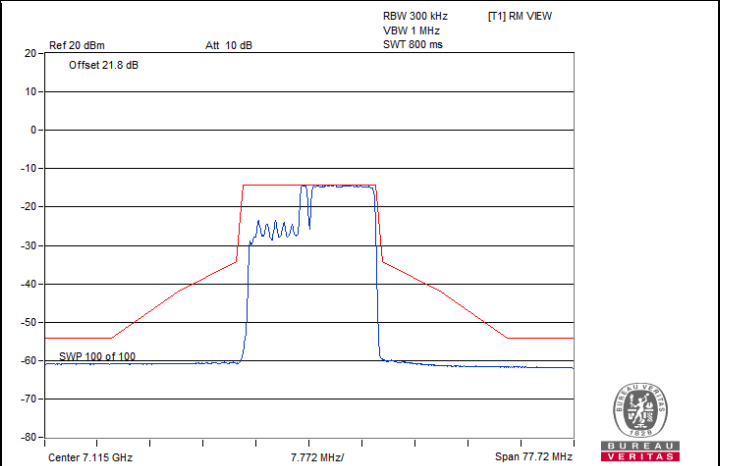
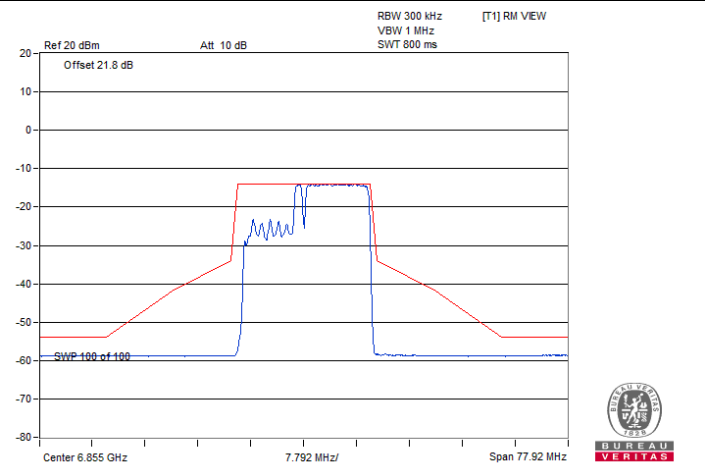

802.11be (EHT20) 106+26-tone MRU Indoor_2T2S / Chain 1 : CH 181@93

802.11be (EHT20) 106+26-tone MRU Indoor_2T2S / Chain 1 : CH 233@93



802.11be (EHT80) 484+242-tone MRU Indoor_2T2S

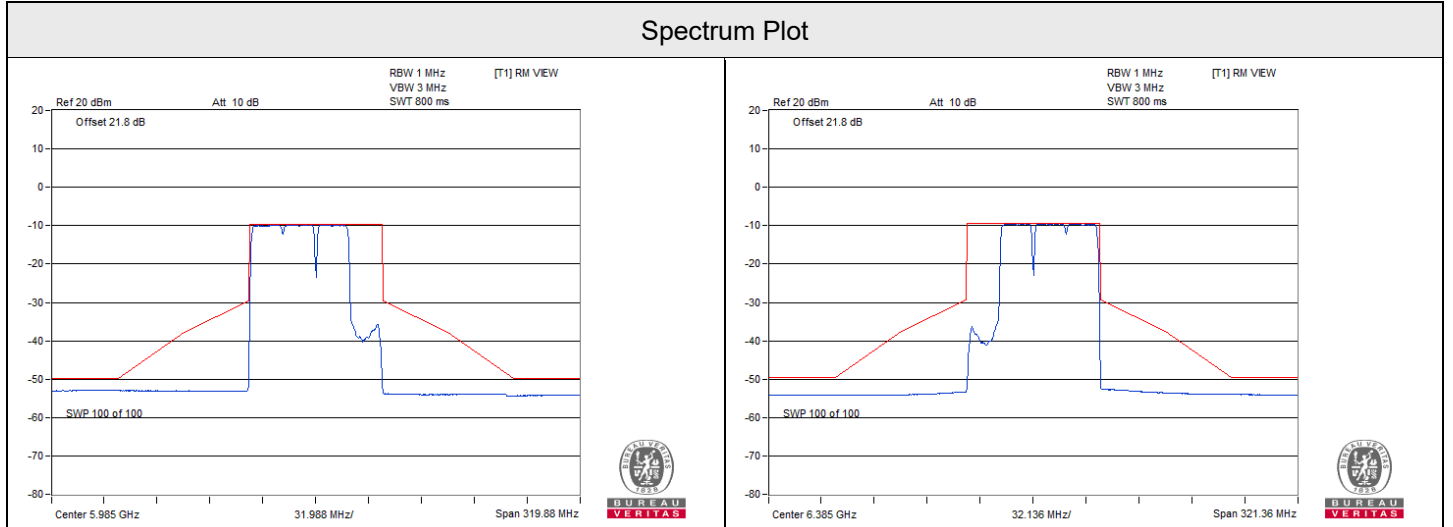

802.11be (EHT80) 484+242-tone MRU Indoor_2T2S / Chain 0 : CH 7@93 802.11be (EHT80) 484+242-tone MRU Indoor_2T2S / Chain 0 : CH 87@90

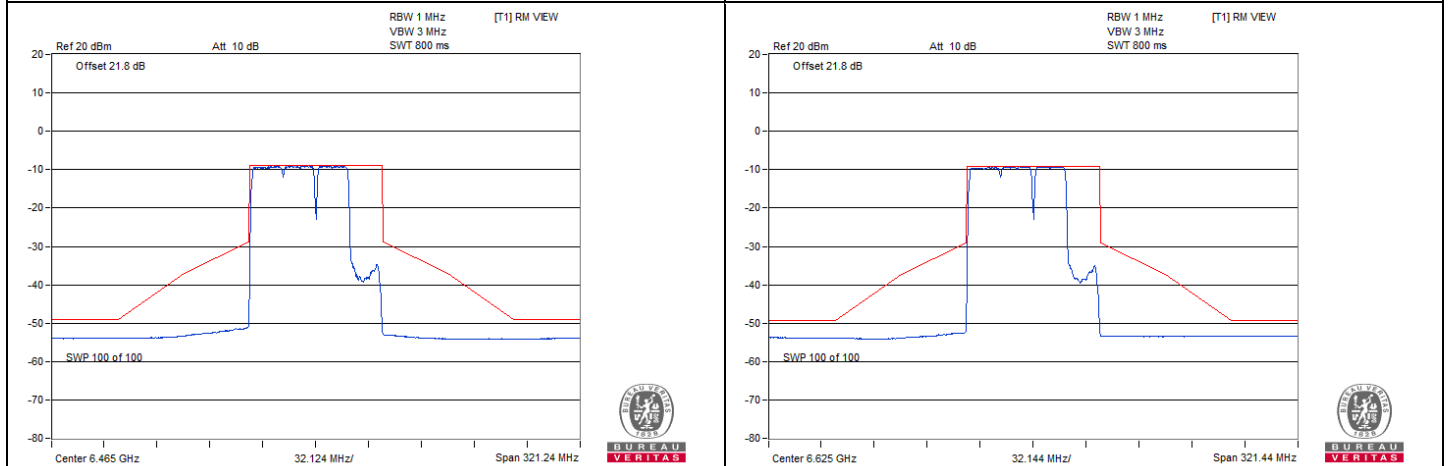

802.11be (EHT80) 484+242-tone MRU Indoor_2T2S / Chain 0 : CH 103@93 802.11be (EHT80) 484+242-tone MRU Indoor_2T2S / Chain 0 : CH 135@90

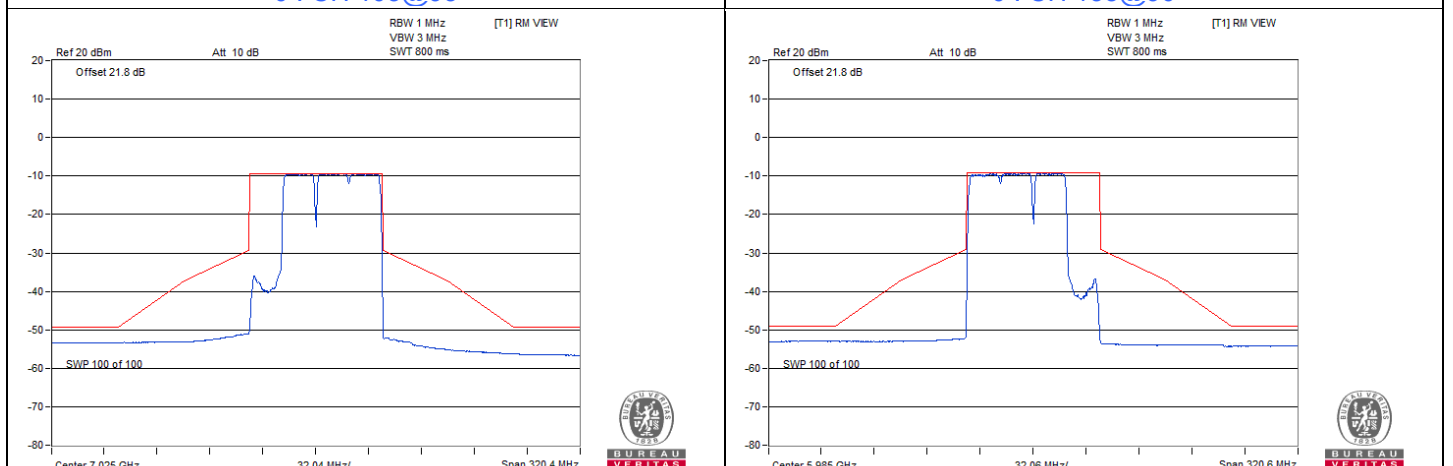

802.11be (EHT80) 484+242-tone MRU Indoor_2T2S / Chain 0 : CH 215@90 802.11be (EHT80) 484+242-tone MRU Indoor_2T2S / Chain 1 : CH 7@93

Spectrum Plot

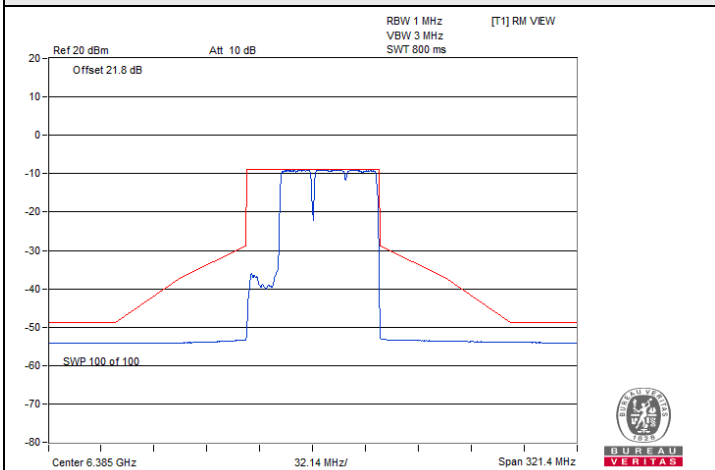

802.11be (EHT80) 484+242-tone MRU Indoor_2T2S / Chain 1 : CH 87@90

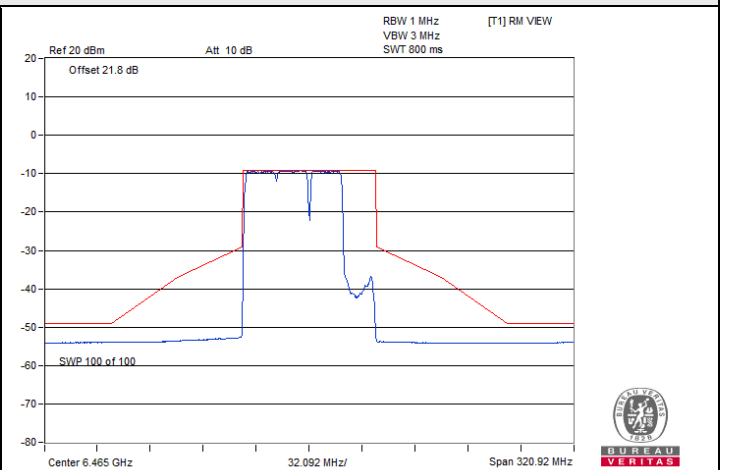

802.11be (EHT80) 484+242-tone MRU Indoor_2T2S / Chain 1 : CH 103@93

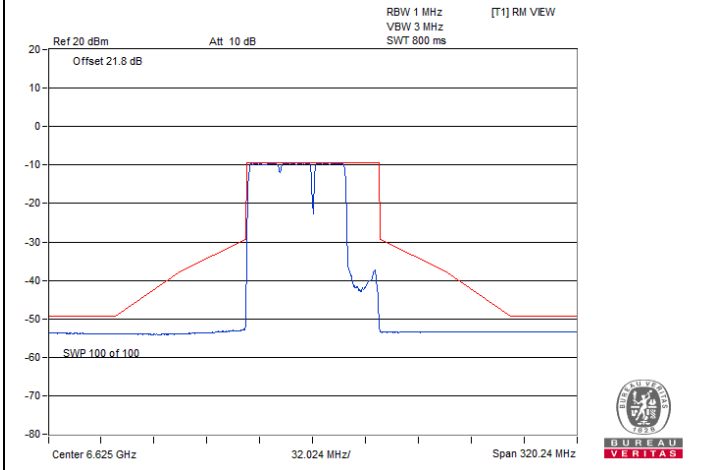

802.11be (EHT80) 484+242-tone MRU Indoor_2T2S / Chain 1 : CH 135@90

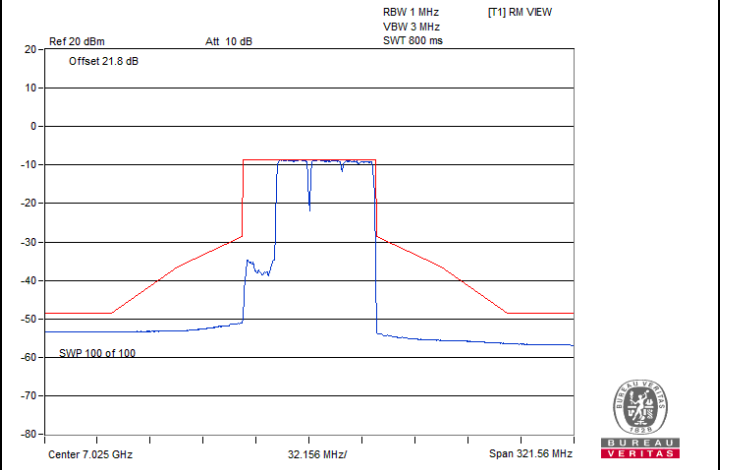

802.11be (EHT80) 484+242-tone MRU Indoor_2T2S / Chain 1 : CH 215@90

802.11be (EHT160) 996+484-tone MRU Indoor_2T2S

Spectrum Plot

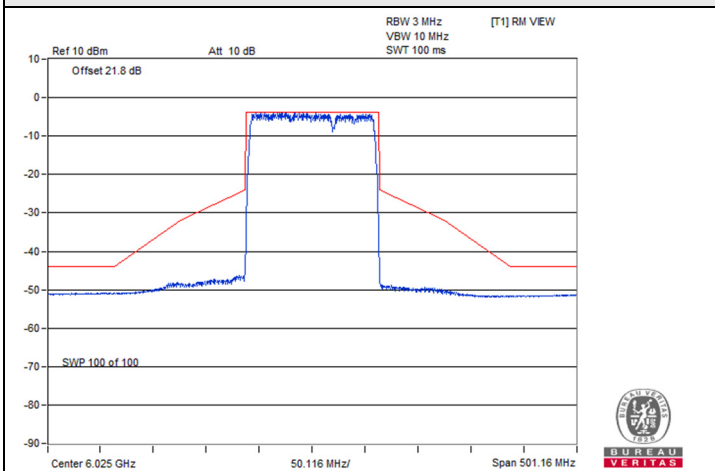

802.11be (EHT160) 996+484-tone MRU Indoor_2T2S / Chain 0 : CH 15@95_1

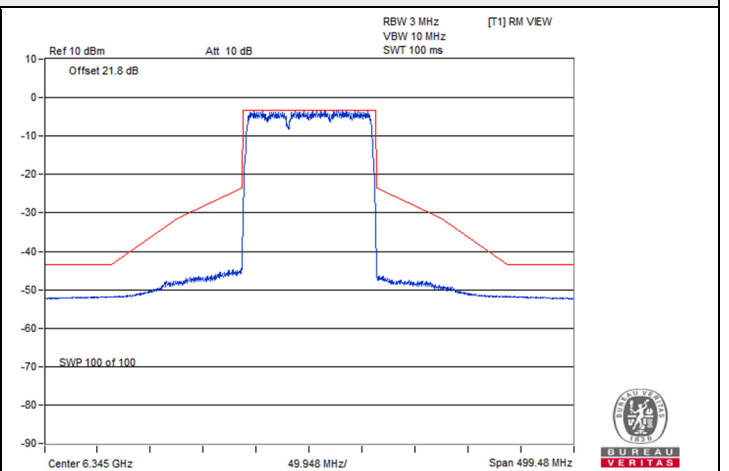

802.11be (EHT160) 996+484-tone MRU Indoor_2T2S / Chain 0 : CH 79@94_0

Spectrum Plot

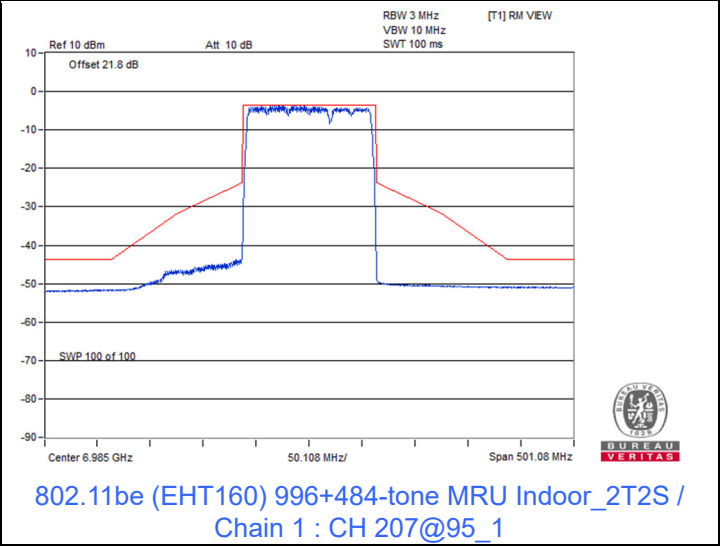
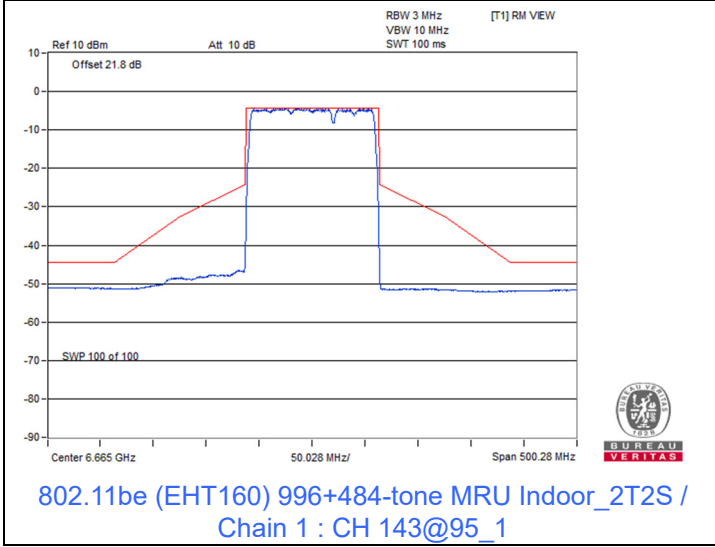
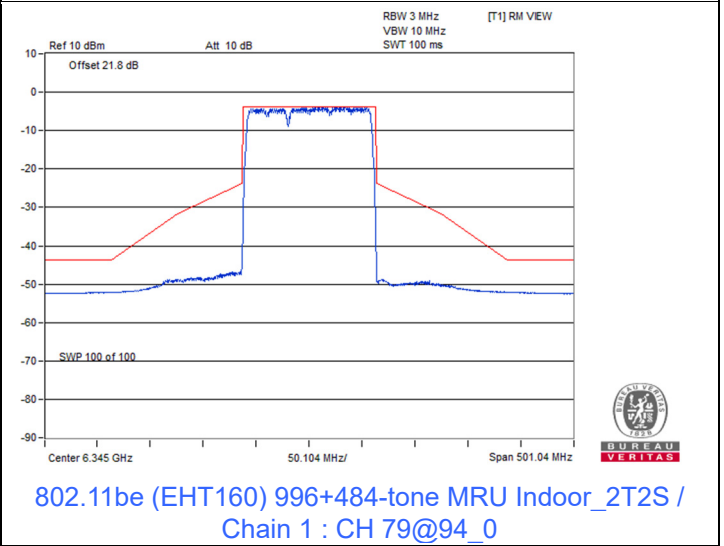
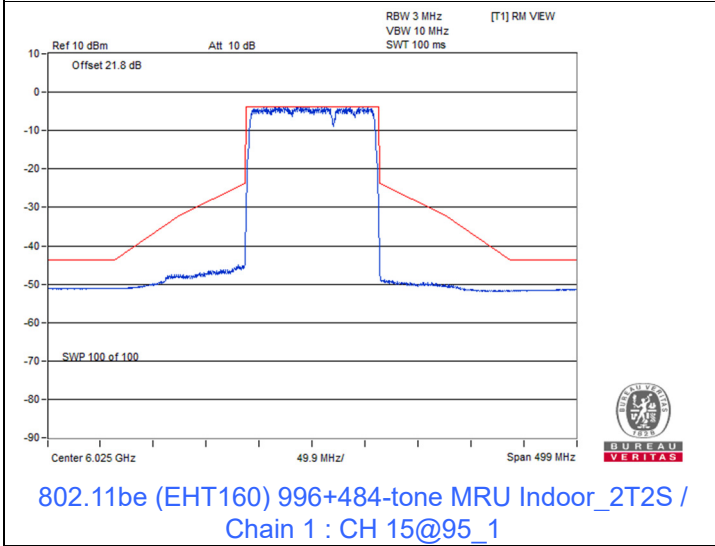
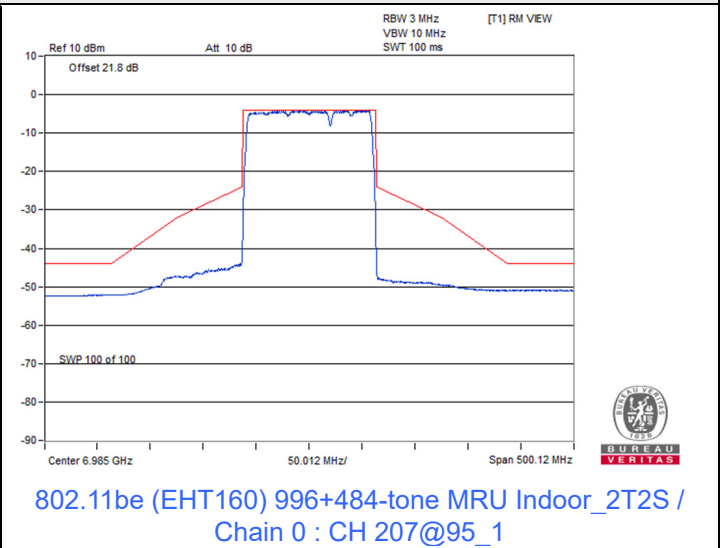
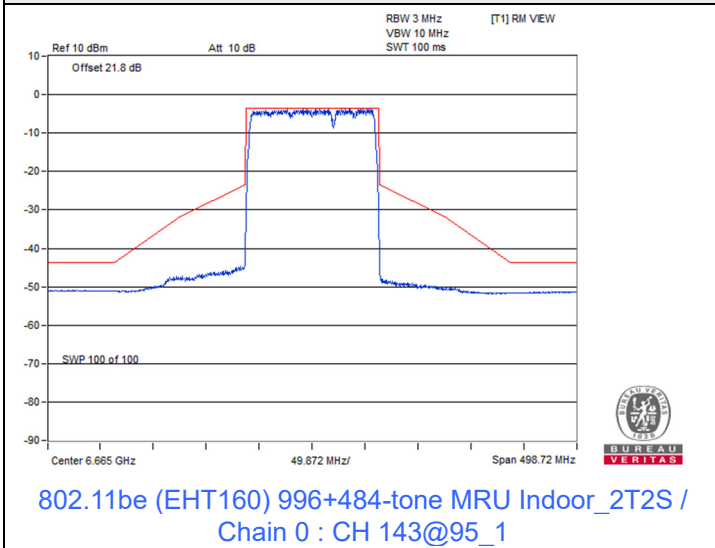



802.11be (EHT160) 996+484+242-tone MRU Indoor_2T2S

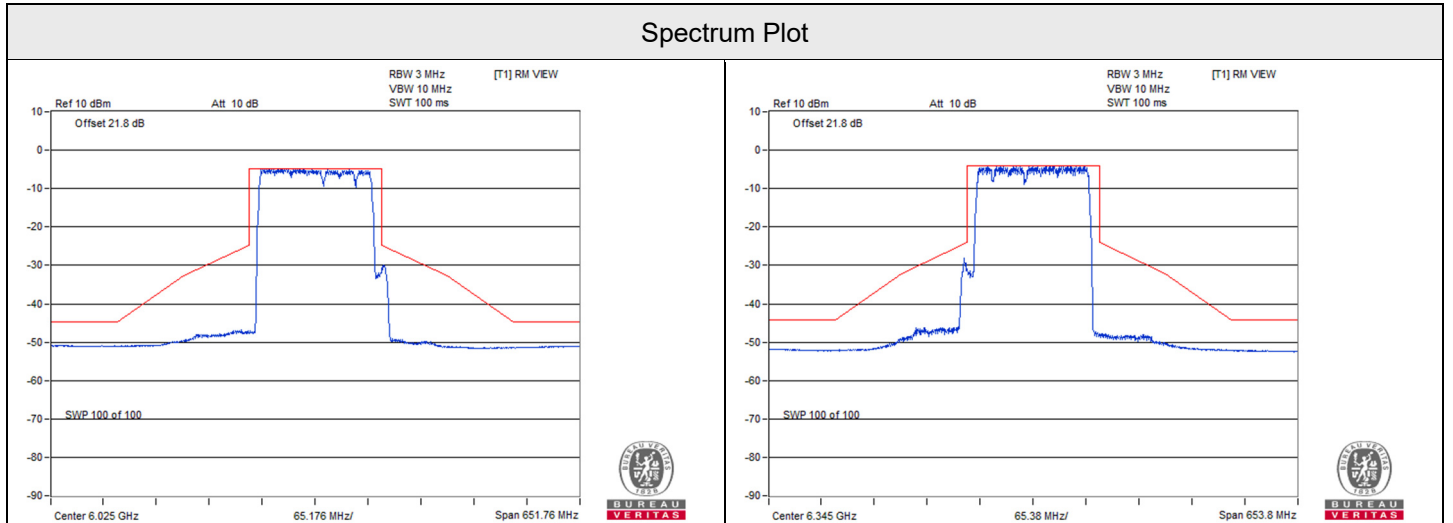

802.11be (EHT160) 996+484+242-tone MRU Indoor_2T2S / Chain 0 : CH 15@99_1 / 802.11be (EHT160) 996+484+242-tone MRU Indoor_2T2S / Chain 0 : CH 79@96_0

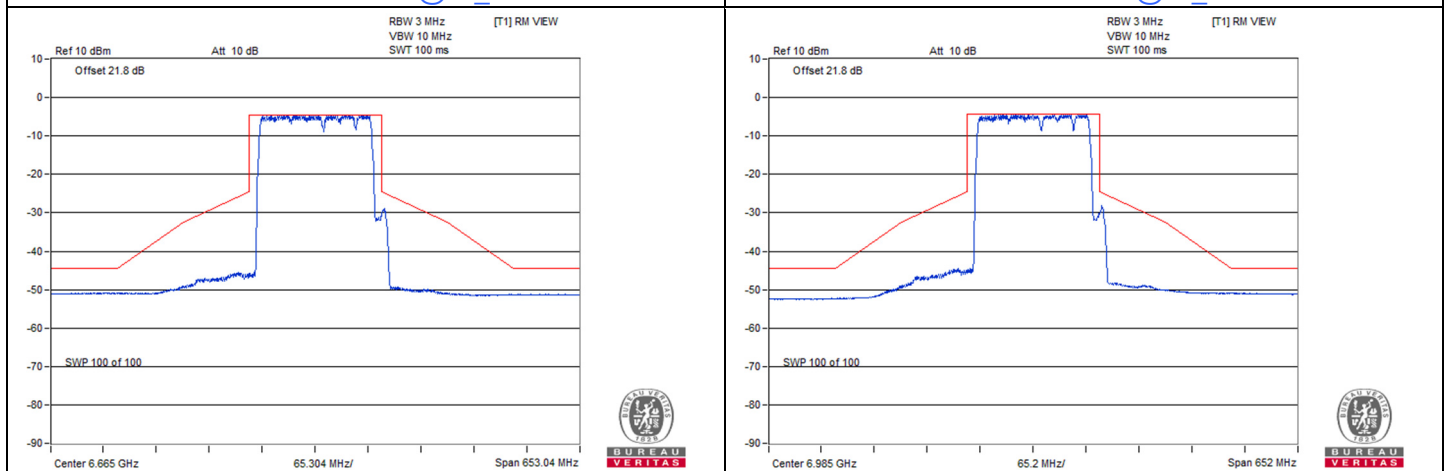

802.11be (EHT160) 996+484+242-tone MRU Indoor_2T2S / Chain 0 : CH 143@99_1 / 802.11be (EHT160) 996+484+242-tone MRU Indoor_2T2S / Chain 0 : CH 207@99_1

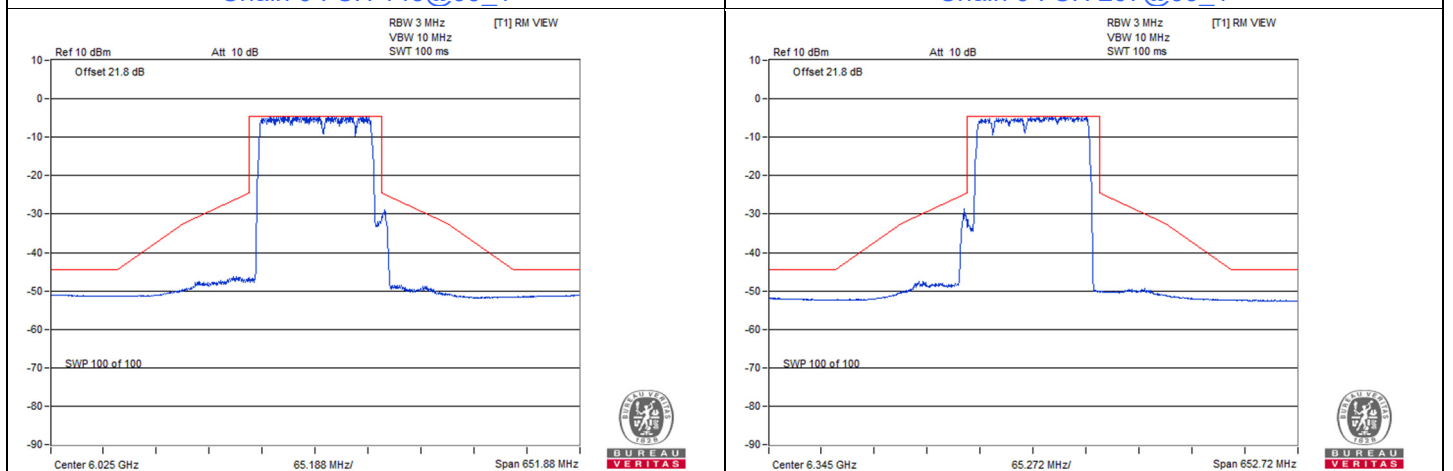

802.11be (EHT160) 996+484+242-tone MRU Indoor_2T2S / Chain 1 : CH 15@99_1 / 802.11be (EHT160) 996+484+242-tone MRU Indoor_2T2S / Chain 1 : CH 79@96_0

Spectrum Plot

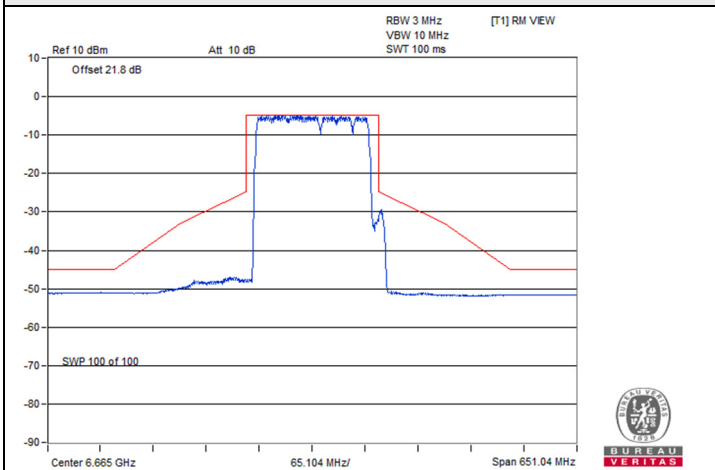

802.11be (EHT160) 996+484+242-tone MRU Indoor_2T2S / Chain 1 : CH 143@99_1

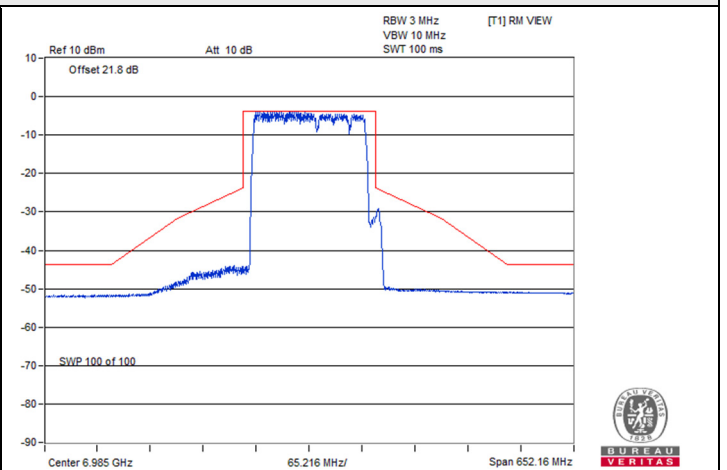

802.11be (EHT160) 996+484+242-tone MRU Indoor_2T2S / Chain 1 : CH 207@99_1

802.11be (EHT320) 2x996+484-tone MRU Indoor_2T2S

Spectrum Plot

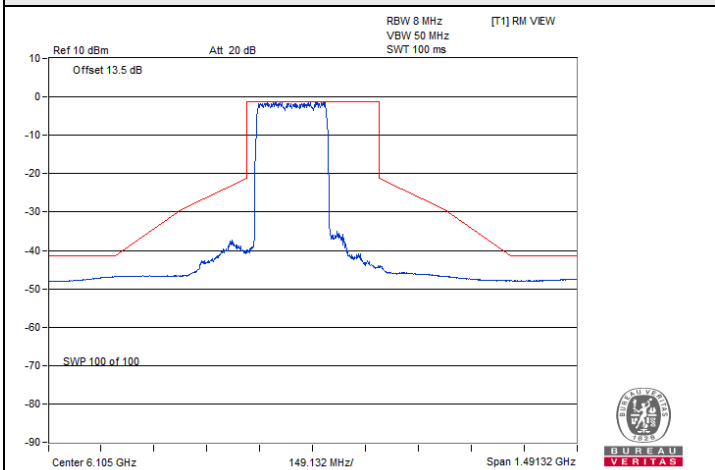

802.11be (EHT320) 2x996+484-tone MRU Indoor_2T2S / Chain 0 : CH 31@101

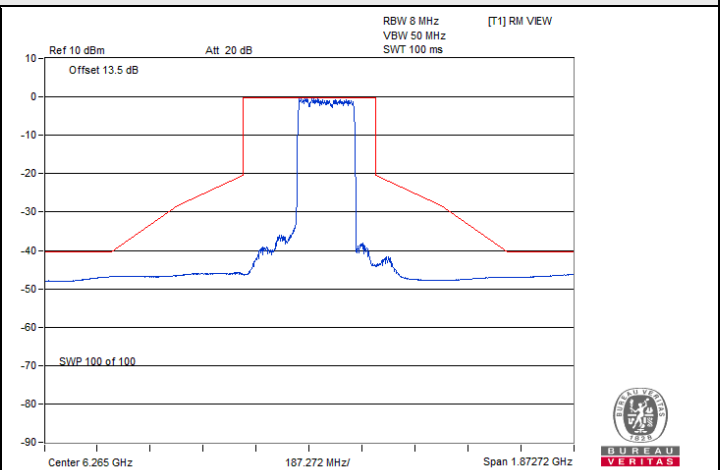

802.11be (EHT320) 2x996+484-tone MRU Indoor_2T2S / Chain 0 : CH 63@102

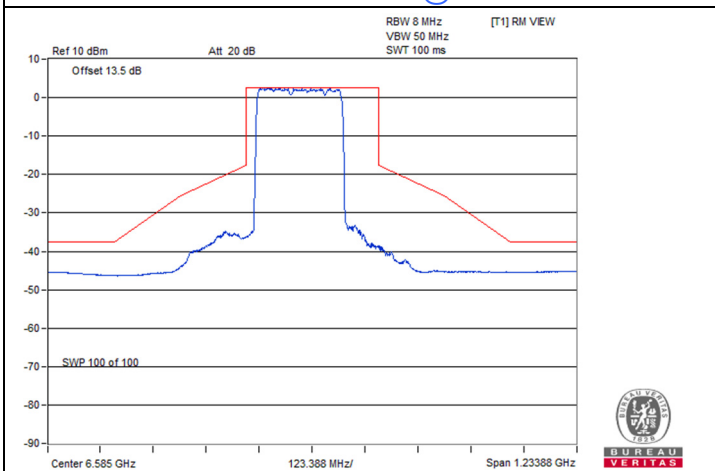

802.11be (EHT320) 2x996+484-tone MRU Indoor_2T2S / Chain 0 : CH 127@101

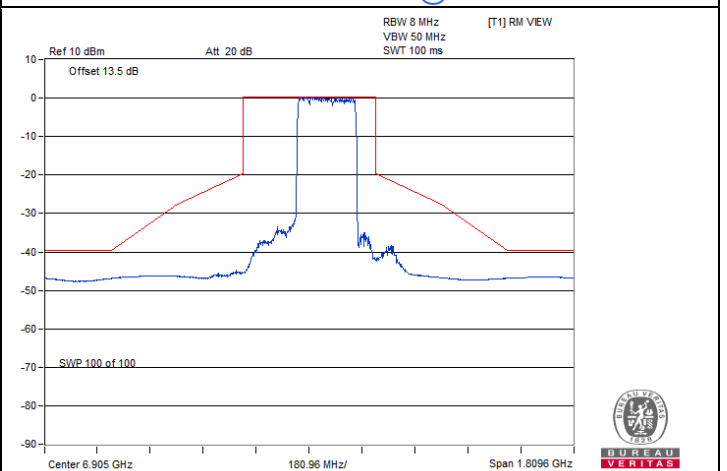

802.11be (EHT320) 2x996+484-tone MRU Indoor_2T2S / Chain 0 : CH 191@102

Spectrum Plot

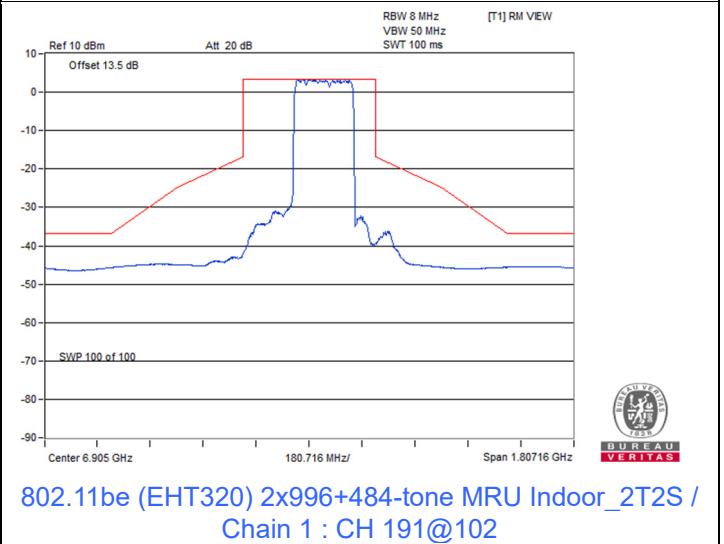
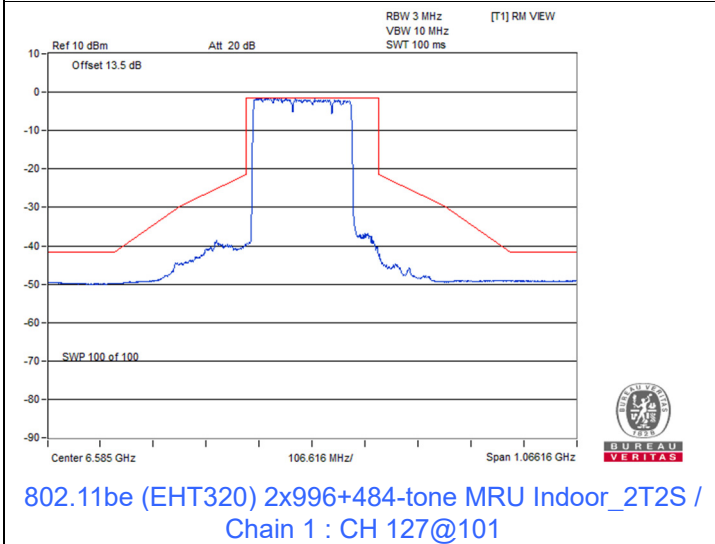
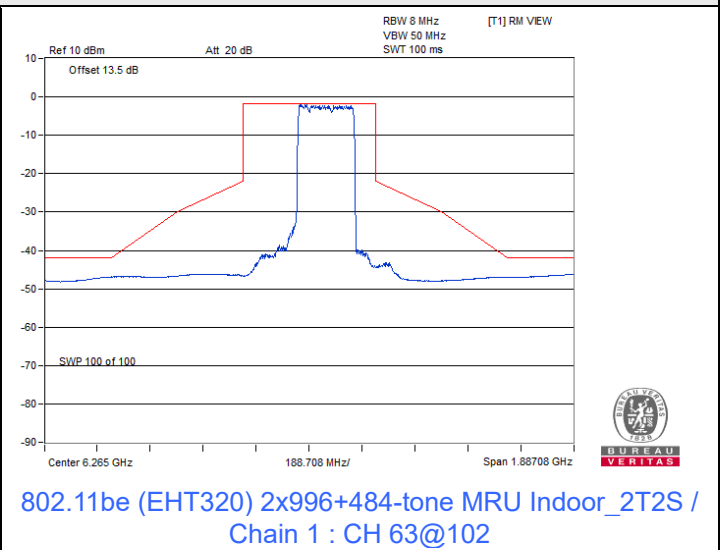
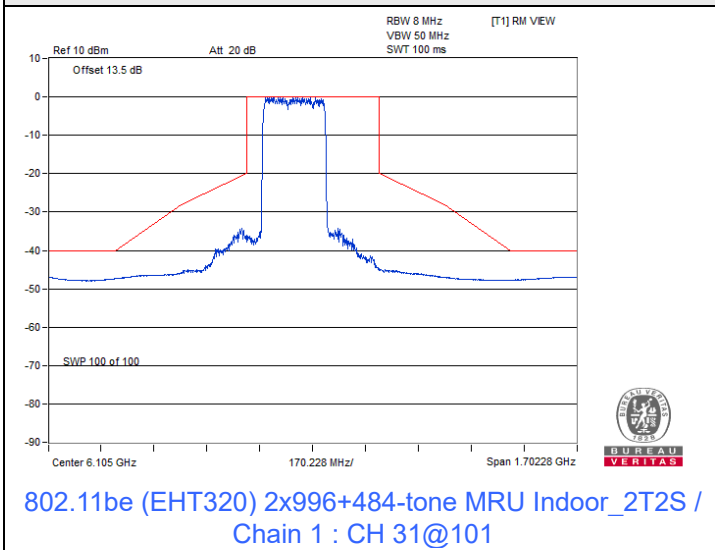

802.11be (EHT320) 3x996-tone MRU Indoor_2T2S

Spectrum Plot

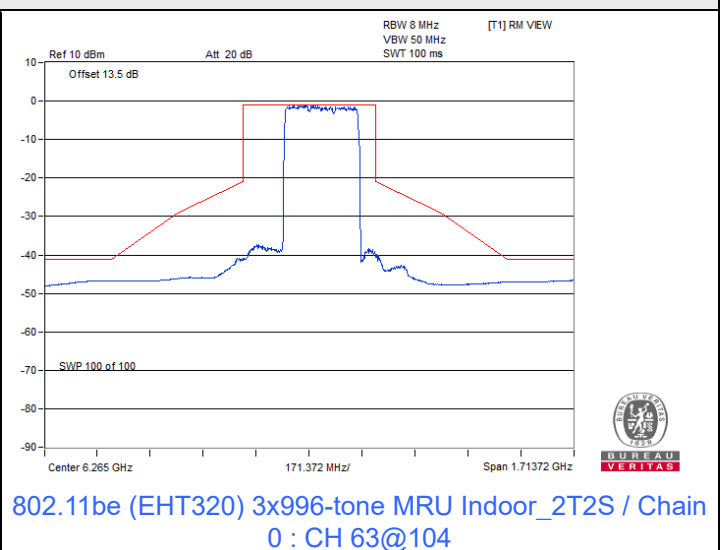
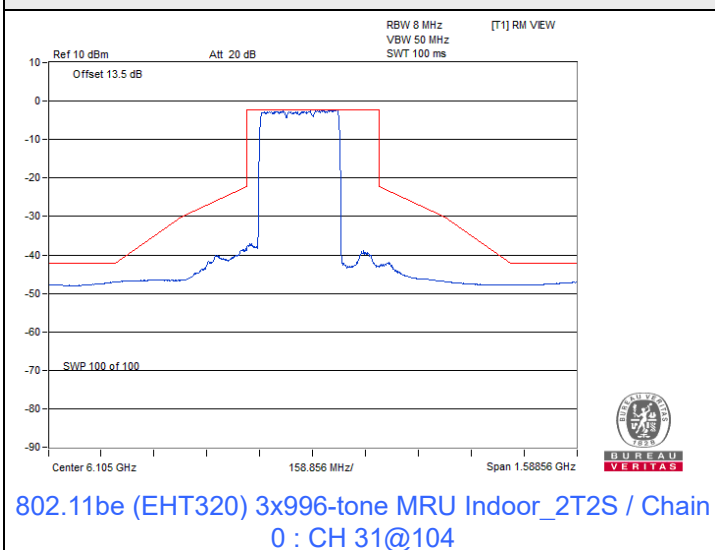



Spectrum Plot

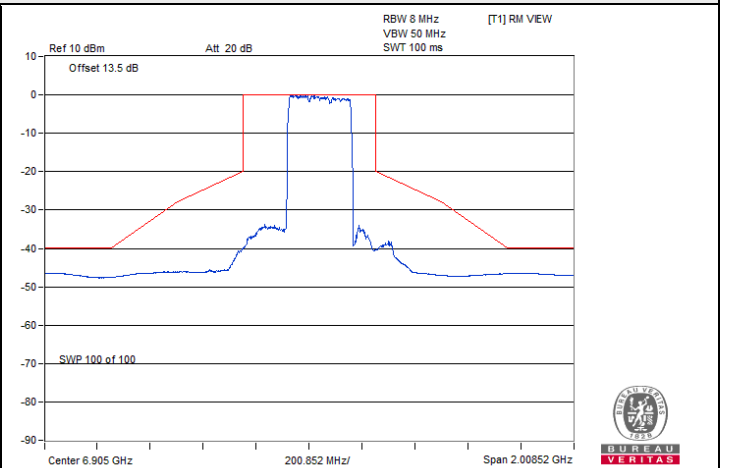
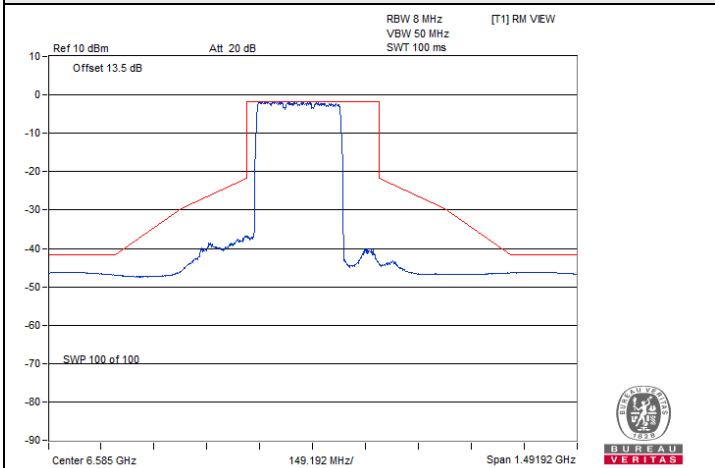

802.11be (EHT320) 3x996-tone MRU Indoor_2T2S / Chain 0 : CH 127@104

802.11be (EHT320) 3x996-tone MRU Indoor_2T2S / Chain 0 : CH 191@104

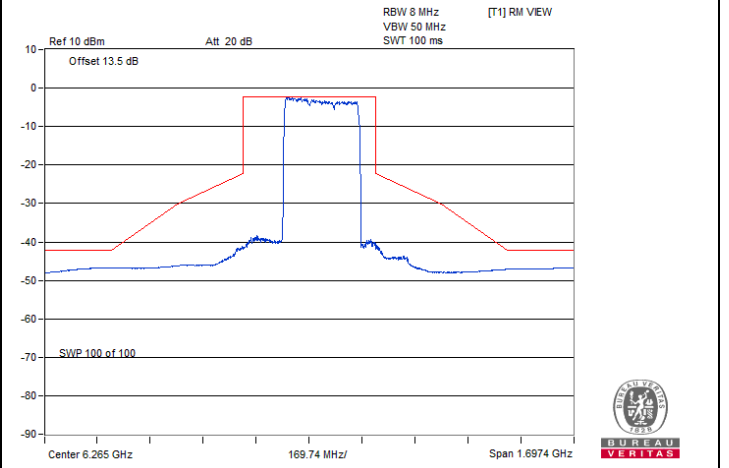
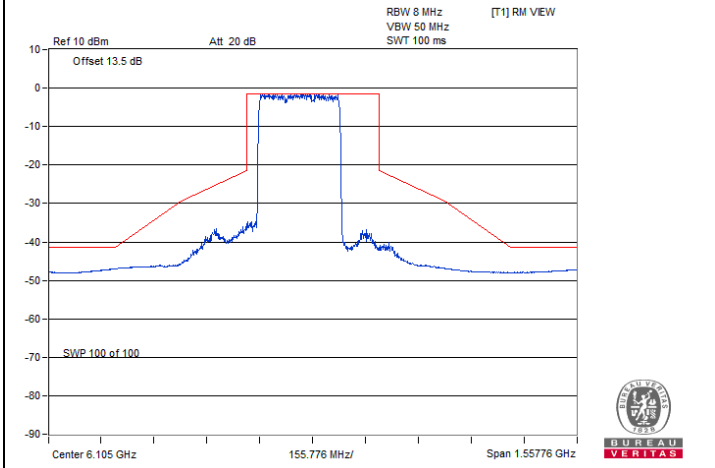

802.11be (EHT320) 3x996-tone MRU Indoor_2T2S / Chain 1 : CH 31@104

802.11be (EHT320) 3x996-tone MRU Indoor_2T2S / Chain 1 : CH 63@104

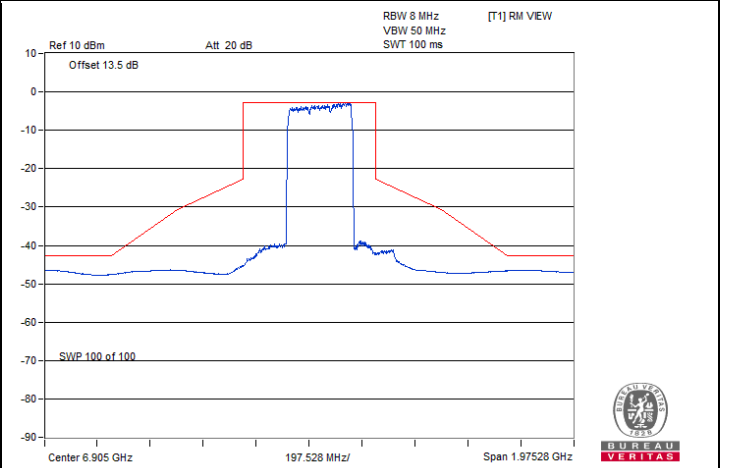
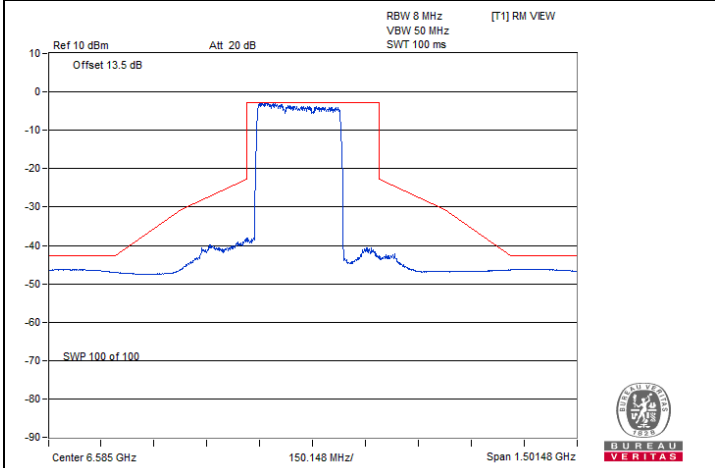

802.11be (EHT320) 3x996-tone MRU Indoor_2T2S / Chain 1 : CH 127@104

802.11be (EHT320) 3x996-tone MRU Indoor_2T2S / Chain 1 : CH 191@104



802.11be (EHT320) 3x996+484-tone MRU Indoor_2T2S

Spectrum Plot

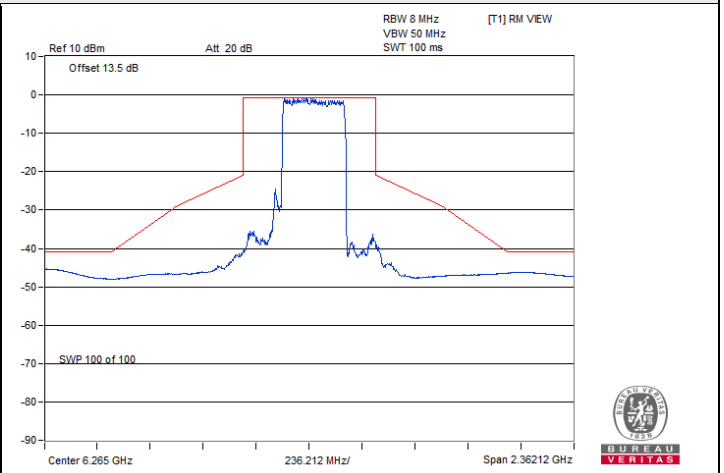
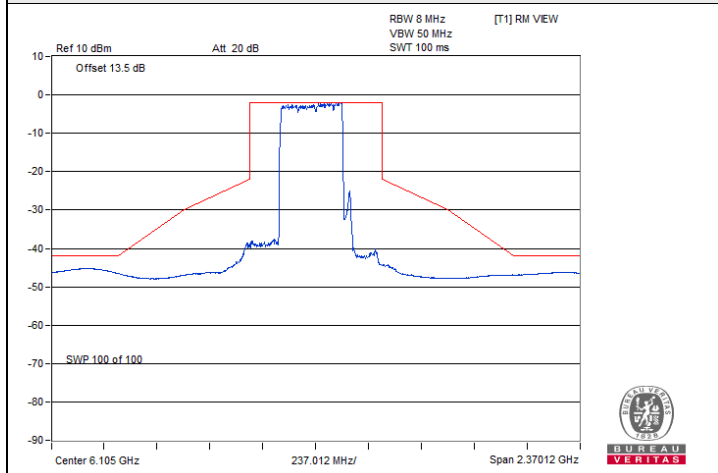

802.11be (EHT320) 3x996+484-tone MRU Indoor_2T2S / Chain 0 : CH 31@106

802.11be (EHT320) 3x996+484-tone MRU Indoor_2T2S / Chain 0 : CH 63@105

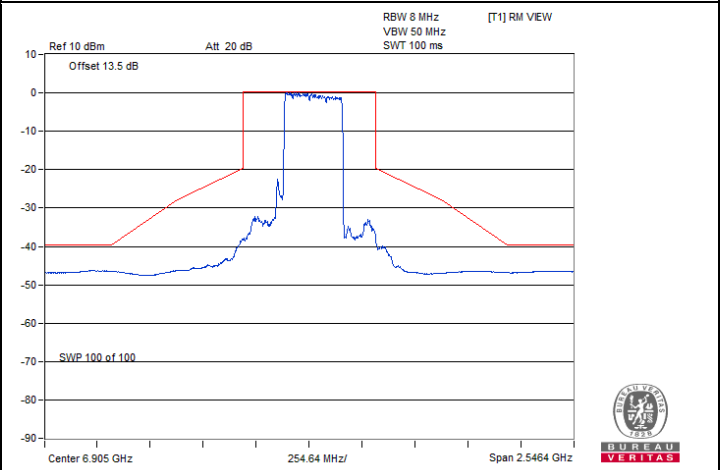
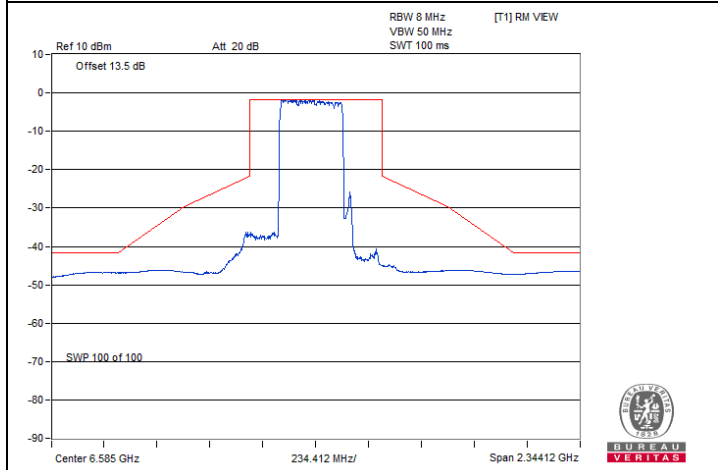

802.11be (EHT320) 3x996+484-tone MRU Indoor_2T2S / Chain 0 : CH 127@105

802.11be (EHT320) 3x996+484-tone MRU Indoor_2T2S / Chain 0 : CH 191@105

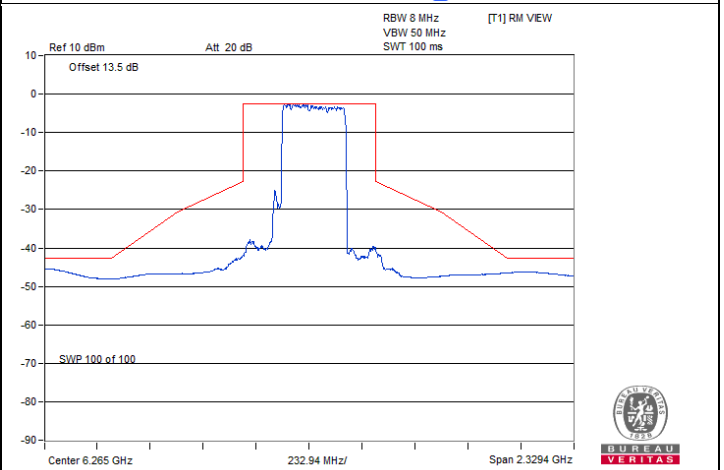
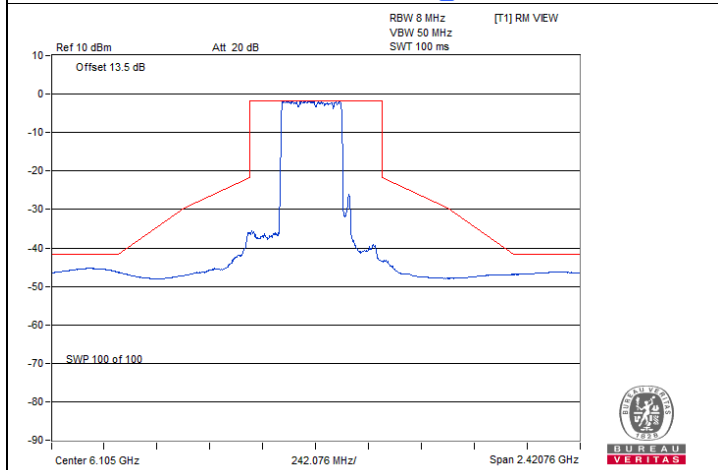

802.11be (EHT320) 3x996+484-tone MRU Indoor_2T2S / Chain 1 : CH 31@106

802.11be (EHT320) 3x996+484-tone MRU Indoor_2T2S / Chain 1 : CH 63@105

Spectrum Plot

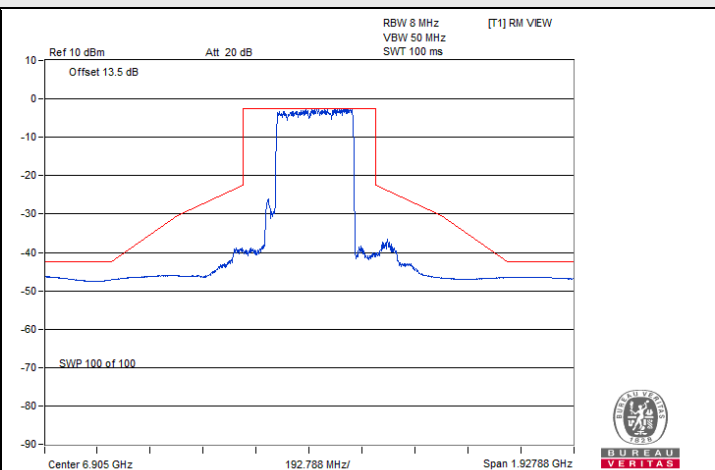
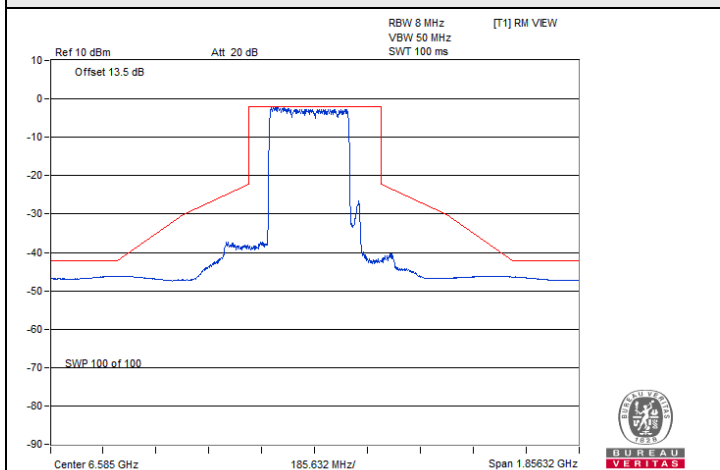

802.11be (EHT320) 3x996+484-tone MRU Indoor_2T2S /
Chain 1 : CH 127@105

802.11be (EHT320) 3x996+484-tone MRU Indoor_2T2S /
Chain 1 : CH 191@105

7.5 Occupied Bandwidth

Input Power:	3.3 Vdc	Environmental Conditions:	23°C, 62% RH	Tested By:	Eric Peng
--------------	---------	---------------------------	--------------	------------	-----------

802.11ax (HE) 26-tone RU Indoor_1T1S

Channel	Frequency (MHz)	Occupied Bandwidth (MHz)	Maximum Limit (MHz)	Test Result
1	5955	18.26	320	Pass
93	6415	18.24	320	Pass
97	6435	18.12	320	Pass
117	6535	18.12	320	Pass
181	6855	18.24	320	Pass
233	7115	18.24	320	Pass

802.11ax (HE) 52-tone RU Indoor_1T1S

Channel	Frequency (MHz)	Occupied Bandwidth (MHz)	Maximum Limit (MHz)	Test Result
1	5955	18.18	320	Pass
93	6415	18.24	320	Pass
97	6435	18.12	320	Pass
117	6535	18.12	320	Pass
233	7115	18.12	320	Pass

802.11ax (HE) 106-tone RU Indoor_1T1S

Channel	Frequency (MHz)	Occupied Bandwidth (MHz)	Maximum Limit (MHz)	Test Result
1	5955	18.18	320	Pass
93	6415	18.24	320	Pass
97	6435	18.12	320	Pass
117	6535	18.18	320	Pass
181	6855	18.24	320	Pass
233	7115	18.12	320	Pass

802.11be (EHT20) 52+26-tone MRU Indoor_1T1S

Channel	Frequency (MHz)	Occupied Bandwidth (MHz)	Maximum Limit (MHz)	Test Result
1	5955	17.22	320	Pass
93	6415	17.16	320	Pass
97	6435	17.22	320	Pass
117	6535	17.16	320	Pass
181	6855	17.28	320	Pass
233	7115	17.16	320	Pass

802.11be (EHT20) 106+26-tone MRU Indoor_1T1S

Channel	Frequency (MHz)	Occupied Bandwidth (MHz)	Maximum Limit (MHz)	Test Result
1	5955	18.09	320	Pass
93	6415	18.12	320	Pass
97	6435	18.12	320	Pass
117	6535	18.12	320	Pass
181	6855	18.12	320	Pass
233	7115	18.12	320	Pass

802.11be (EHT80) 484+242-tone MRU Indoor_1T1S

Channel	Frequency (MHz)	Occupied Bandwidth (MHz)	Maximum Limit (MHz)	Test Result
7	5985	70.95	320	Pass
87	6385	61.44	320	Pass
103	6465	60.48	320	Pass
135	6625	72	320	Pass
215	7025	64.8	320	Pass

802.11be (EHT160) 996+484-tone MRU Indoor_1T1S

Channel	Frequency (MHz)	Occupied Bandwidth (MHz)	Maximum Limit (MHz)	Test Result
15	6025	118.26	320	Pass
79	6345	119.04	320	Pass
143	6665	118.26	320	Pass
207	6985	117.12	320	Pass

802.11be (EHT160) 996+484+242-tone MRU Indoor_1T1S

Channel	Frequency (MHz)	Occupied Bandwidth (MHz)	Maximum Limit (MHz)	Test Result
15	6025	155.13	320	Pass
79	6345	154.43	320	Pass
143	6665	152.64	320	Pass
207	6985	152.35	320	Pass

802.11be (EHT320) 2x996+484-tone MRU Indoor_1T1S

Channel	Frequency (MHz)	Occupied Bandwidth (MHz)	Maximum Limit (MHz)	Test Result
31	6105	196.8	320	Pass
63	6265	196.8	320	Pass
127	6585	196.8	320	Pass
191	6905	197.76	320	Pass

802.11be (EHT320) 3x996-tone MRU Indoor_1T1S

Channel	Frequency (MHz)	Occupied Bandwidth (MHz)	Maximum Limit (MHz)	Test Result
31	6105	237.12	320	Pass
63	6265	235.2	320	Pass
127	6585	236.16	320	Pass
191	6905	236.16	320	Pass

802.11be (EHT320) 3x996+484-tone MRU Indoor_1T1S

Channel	Frequency (MHz)	Occupied Bandwidth (MHz)	Maximum Limit (MHz)	Test Result
31	6105	276.48	320	Pass
63	6265	279.36	320	Pass
127	6585	276.48	320	Pass
191	6905	277.44	320	Pass

802.11ax (HE) 26-tone RU Indoor_2T2S

Channel	Frequency (MHz)	Occupied Bandwidth (MHz)		Maximum Limit (MHz)	Test Result
		Chain 0	Chain 1		
1	5955	18.44	18.52	320	Pass
93	6415	18.36	18.36	320	Pass
97	6435	18.36	18.26	320	Pass
117	6535	18.36	18.36	320	Pass
181	6855	18.24	18.36	320	Pass
233	7115	18.36	18.24	320	Pass

802.11ax (HE) 52-tone RU Indoor_2T2S

Channel	Frequency (MHz)	Occupied Bandwidth (MHz)		Maximum Limit (MHz)	Test Result
		Chain 0	Chain 1		
1	5955	18.18	18.18	320	Pass
93	6415	18.24	18.24	320	Pass
97	6435	18.24	18.12	320	Pass
117	6535	18.24	18.12	320	Pass
181	6855	18.24	18.24	320	Pass
233	7115	18.24	18.24	320	Pass

802.11ax (HE) 106-tone RU Indoor_2T2S

Channel	Frequency (MHz)	Occupied Bandwidth (MHz)		Maximum Limit (MHz)	Test Result
		Chain 0	Chain 1		
1	5955	18.18	18.18	320	Pass
93	6415	18.24	18.12	320	Pass
97	6435	18.12	18.12	320	Pass
117	6535	18.12	18.12	320	Pass
181	6855	18.24	18.18	320	Pass
233	7115	18.18	18.12	320	Pass

802.11be (EHT20) 52+26-tone MRU Indoor_2T2S

Channel	Frequency (MHz)	Occupied Bandwidth (MHz)		Maximum Limit (MHz)	Test Result
		Chain 0	Chain 1		
1	5955	17.31	17.22	320	Pass
93	6415	17.28	17.28	320	Pass
97	6435	17.28	17.28	320	Pass
117	6535	17.28	17.16	320	Pass
181	6855	17.28	17.28	320	Pass
233	7115	17.16	17.16	320	Pass

802.11be (EHT20) 106+26-tone MRU Indoor_2T2S

Channel	Frequency (MHz)	Occupied Bandwidth (MHz)		Maximum Limit (MHz)	Test Result
		Chain 0	Chain 1		
1	5955	18.27	18.09	320	Pass
93	6415	18.12	18.12	320	Pass
97	6435	18.12	18.24	320	Pass
117	6535	18.24	18.24	320	Pass
181	6855	18.12	18.24	320	Pass
233	7115	18.24	18.12	320	Pass

802.11be (EHT80) 484+242-tone MRU Indoor_2T2S

Channel	Frequency (MHz)	Occupied Bandwidth (MHz)		Maximum Limit (MHz)	Test Result
		Chain 0	Chain 1		
7	5985	71.65	74.08	320	Pass
87	6385	63.36	61.44	320	Pass
103	6465	62.88	59.52	320	Pass
135	6625	62.40	59.52	320	Pass
215	7025	65.28	68.64	320	Pass

802.11be (EHT160) 996+484-tone MRU Indoor_2T2S

Channel	Frequency (MHz)	Occupied Bandwidth (MHz)		Maximum Limit (MHz)	Test Result
		Chain 0	Chain 1		
15	6025	118.26	118.95	320	Pass
79	6345	118.08	118.08	320	Pass
143	6665	118.08	119.04	320	Pass
207	6985	117.12	118.26	320	Pass

802.11be (EHT160) 996+484+242-tone MRU Indoor_2T2S

Channel	Frequency (MHz)	Occupied Bandwidth (MHz)		Maximum Limit (MHz)	Test Result
		Chain 0	Chain 1		
15	6025	152.34	150.95	320	Pass
79	6345	153.60	151.68	320	Pass
143	6665	151.68	150.72	320	Pass
207	6985	151.68	151.68	320	Pass

802.11be (EHT320) 2x996+484-tone MRU Indoor_2T2S

Channel	Frequency (MHz)	Occupied Bandwidth (MHz)		Maximum Limit (MHz)	Test Result
		Chain 0	Chain 1		
31	6105	195.84	194.88	320	Pass
63	6265	196.80	196.80	320	Pass
127	6585	195.84	197.76	320	Pass
191	6905	196.80	197.76	320	Pass

802.11be (EHT320) 3x996-tone MRU Indoor_2T2S

Channel	Frequency (MHz)	Occupied Bandwidth (MHz)		Maximum Limit (MHz)	Test Result
		Chain 0	Chain 1		
31	6105	236.16	236.16	320	Pass
63	6265	235.20	236.16	320	Pass
127	6585	236.16	236.16	320	Pass
191	6905	235.20	236.16	320	Pass

802.11be (EHT320) 3x996+484-tone MRU Indoor_2T2S

Channel	Frequency (MHz)	Occupied Bandwidth (MHz)		Maximum Limit (MHz)	Test Result
		Chain 0	Chain 1		
31	6105	275.52	277.44	320	Pass
63	6265	275.52	277.44	320	Pass
127	6585	276.48	275.52	320	Pass
191	6905	276.48	275.52	320	Pass

Spectrum Plot of Maximum Value

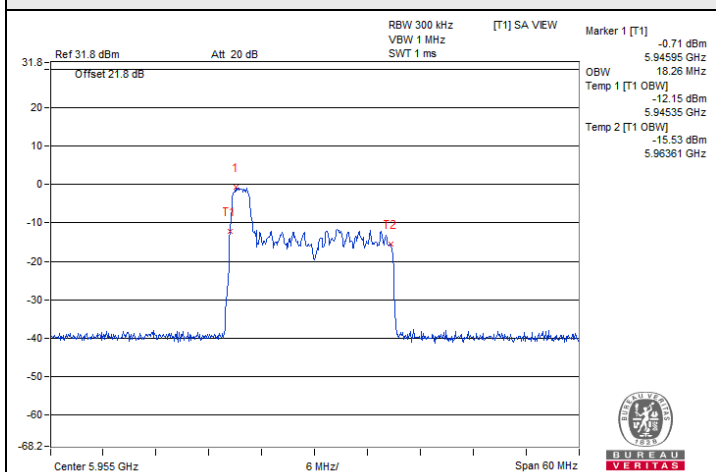

802.11ax (HE) 26-tone RU Indoor_1T1S : CH 1@0

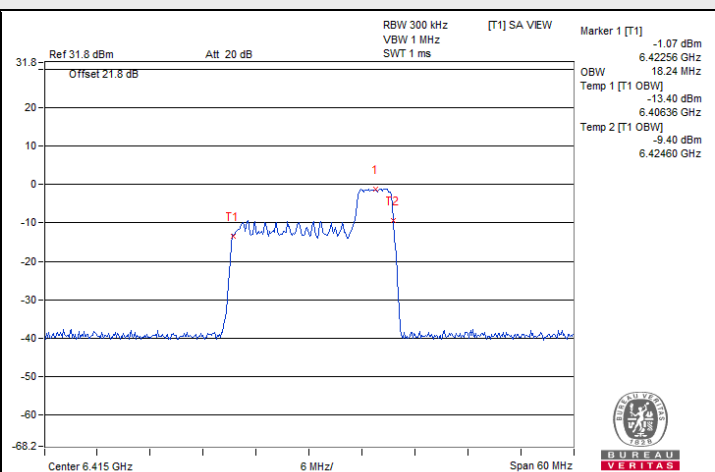

802.11ax (HE) 52-tone RU Indoor_1T1S : CH 93@40

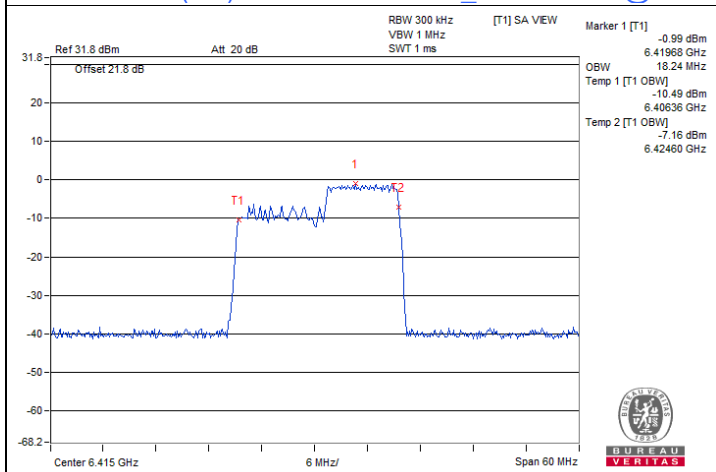

802.11ax (HE) 106-tone RU Indoor_1T1S : CH 93@54

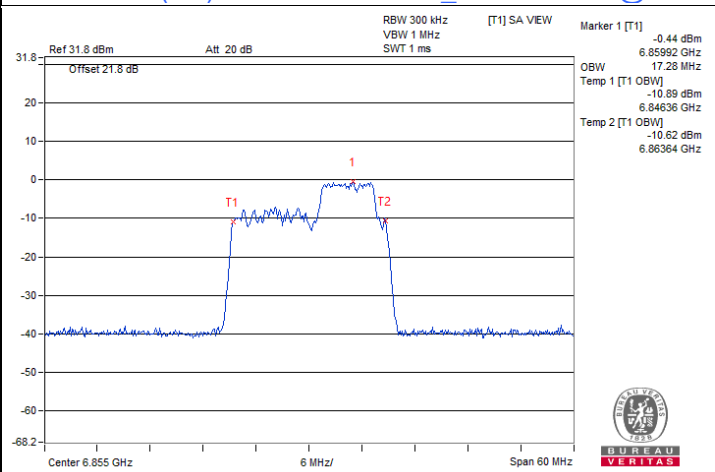

802.11be (EHT20) 52+26-tone MRU Indoor_1T1S : CH 181@72

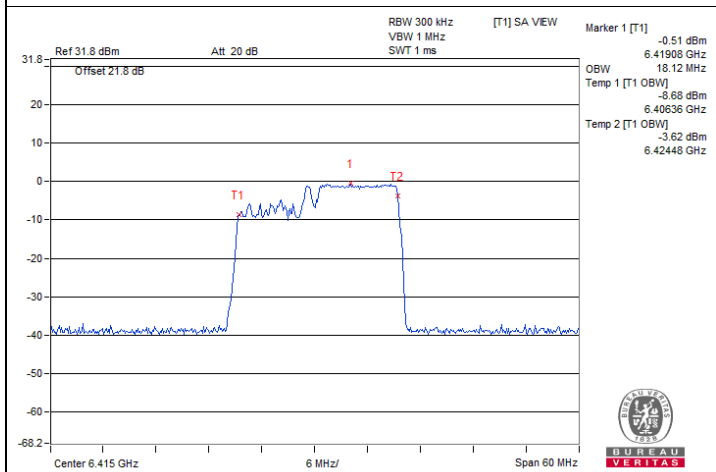

802.11be (EHT20) 106+26-tone MRU Indoor_1T1S : CH 93@83

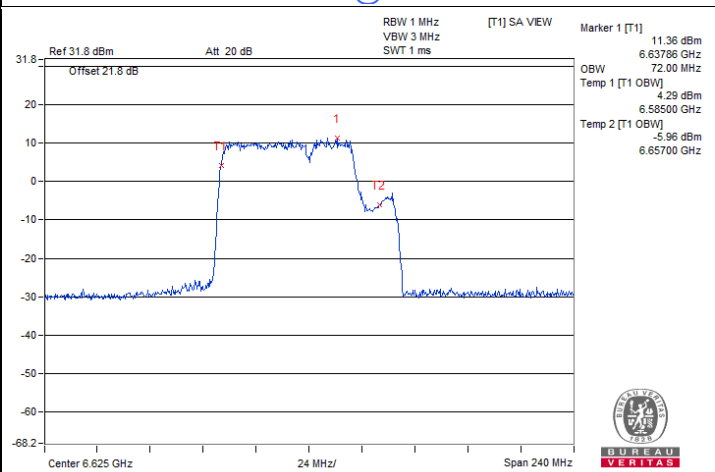

802.11be (EHT80) 484+242-tone MRU Indoor_1T1S : CH 135@90



Spectrum Plot of Maximum Value

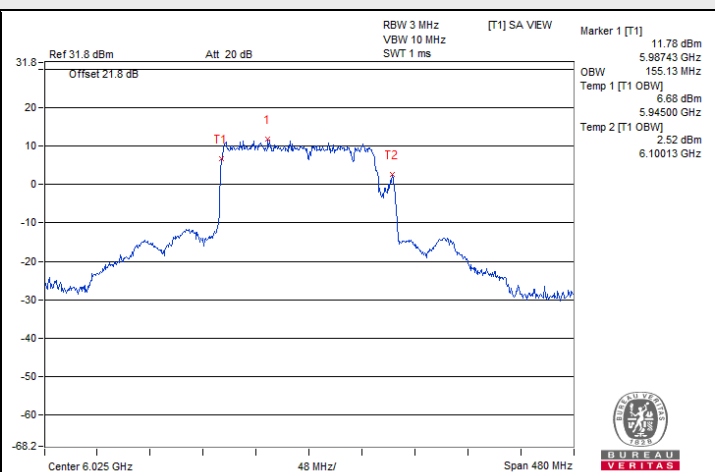
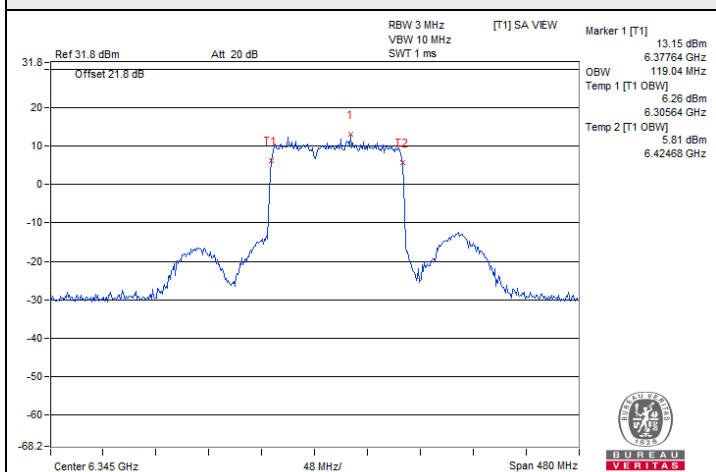

802.11be (EHT160) 996+484-tone MRU Indoor_1T1S : CH 79@94_0

802.11be (EHT160) 996+484+242-tone MRU Indoor_1T1S : CH 15@99_1

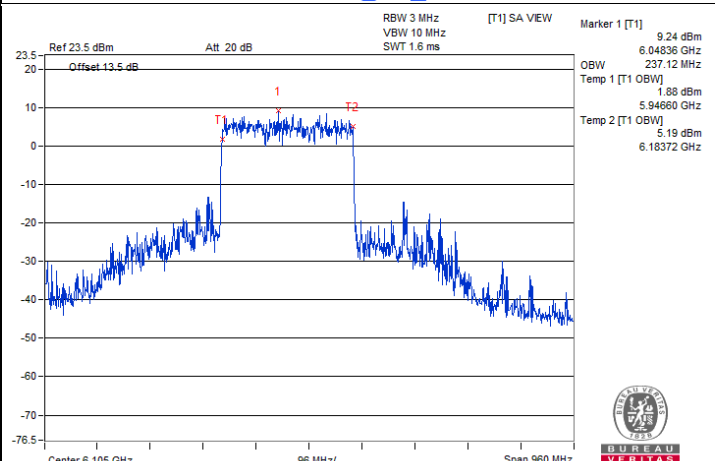
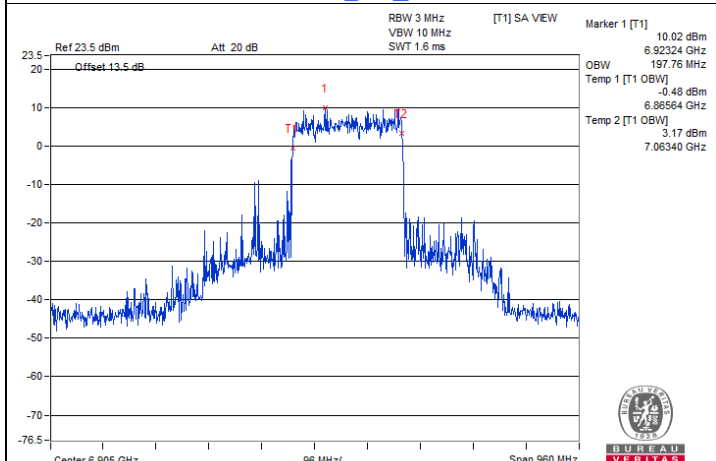

802.11be (EHT320) 2x996+484-tone MRU Indoor_1T1S : CH 191@102

802.11be (EHT320) 3x996-tone MRU Indoor_1T1S : CH 31@104

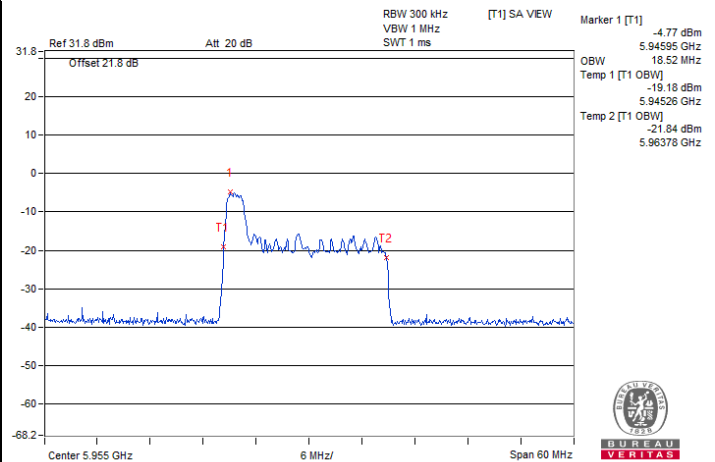
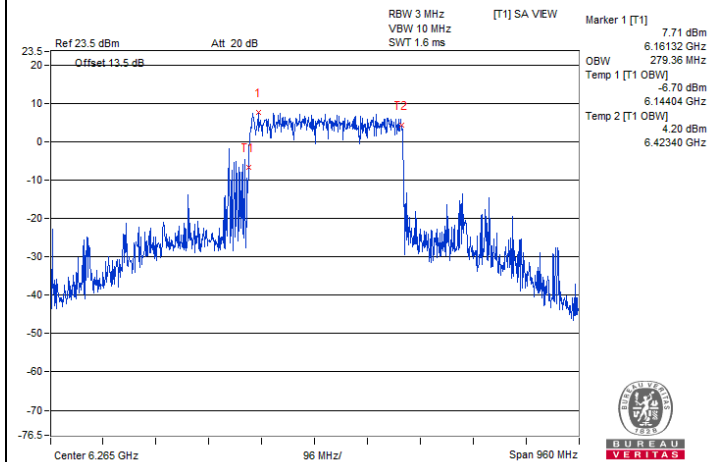

802.11be (EHT320) 3x996+484-tone MRU Indoor_1T1S : CH 63@105

802.11ax (HE) 26-tone RU Indoor_2T2S / Chain 1 : CH 1@0

Spectrum Plot of Maximum Value

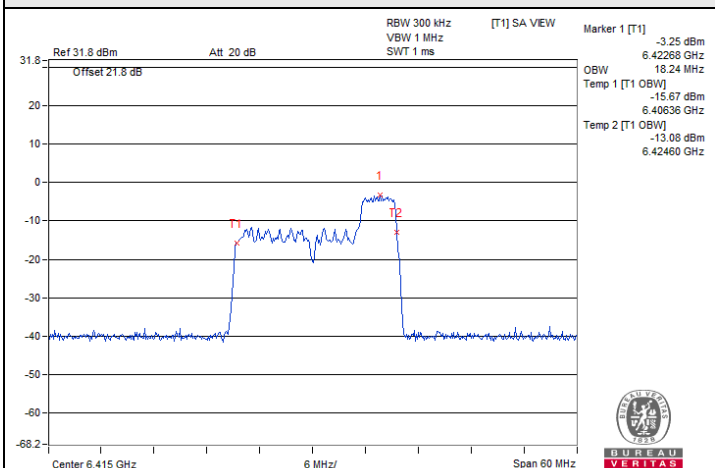

802.11ax (HE) 52-tone RU Indoor_2T2S / Chain 0 : CH 93@40

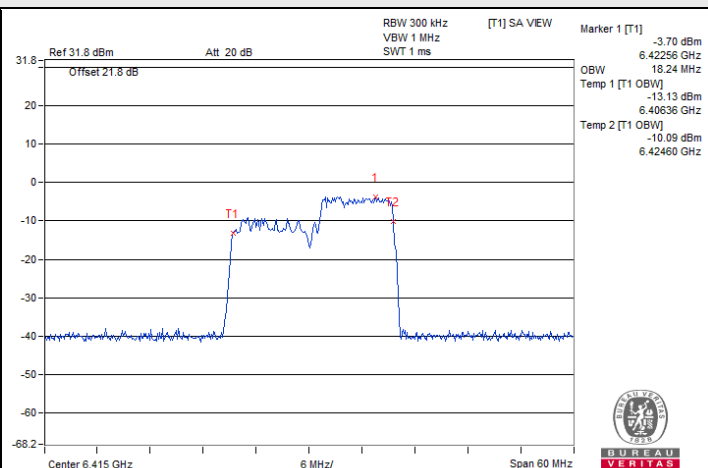

802.11ax (HE) 106-tone RU Indoor_2T2S / Chain 0 : CH 93@54

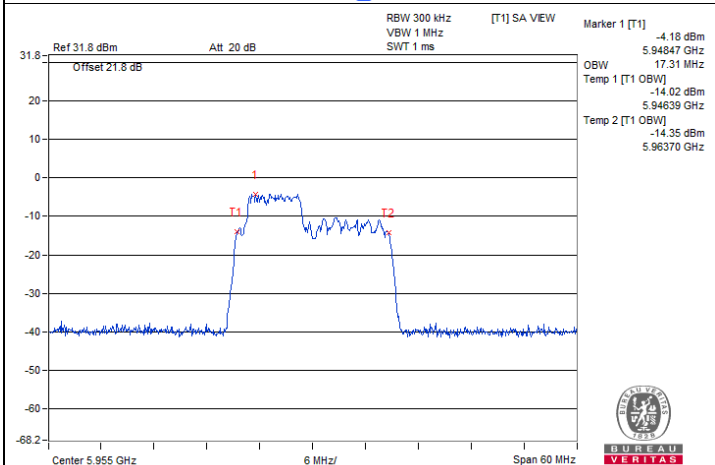

802.11be (EHT20) 52+26-tone MRU Indoor_2T2S / Chain 0 : CH 1@70

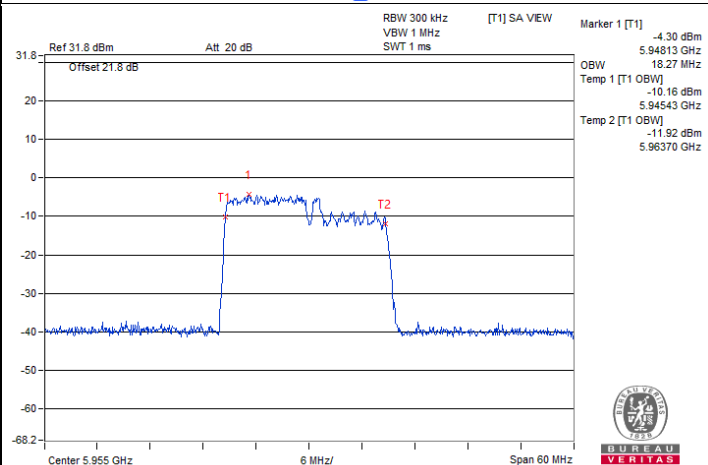

802.11be (EHT20) 106+26-tone MRU Indoor_2T2S / Chain 0 : CH 1@82

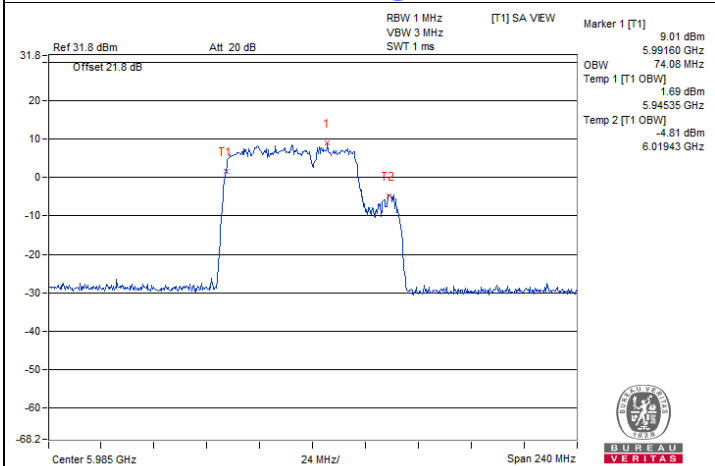

802.11be (EHT80) 484+242-tone MRU Indoor_2T2S / Chain 1 : CH 7@93

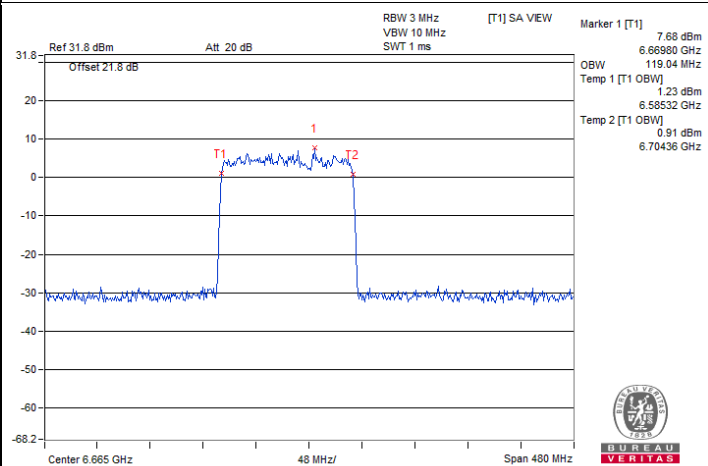

802.11be (EHT160) 996+484-tone MRU Indoor_2T2S / Chain 1 : CH 143@95_1



Spectrum Plot of Maximum Value

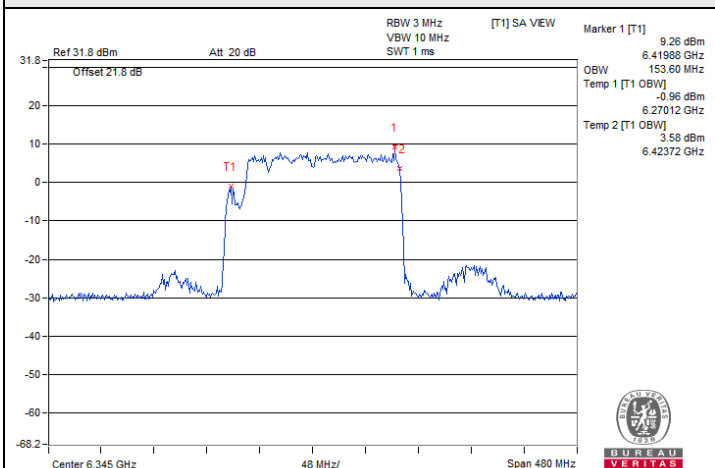

802.11be (EHT160) 996+484+242-tone MRU Indoor_2T2S / Chain 0 : CH 79@96_0

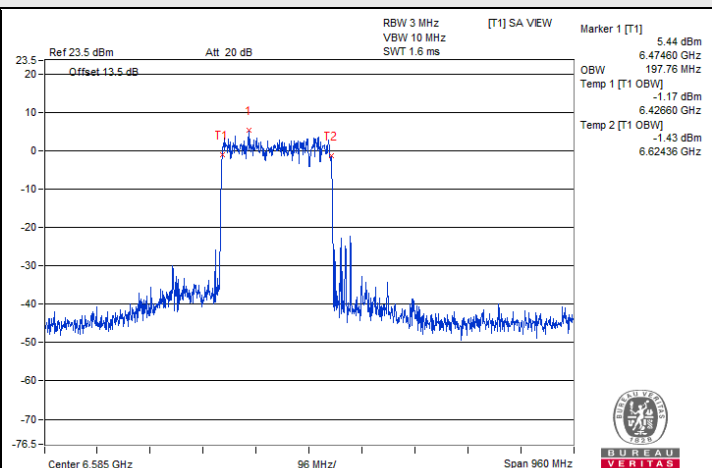

802.11be (EHT320) 2x996+484-tone MRU Indoor_2T2S / Chain 1 : CH 127@101

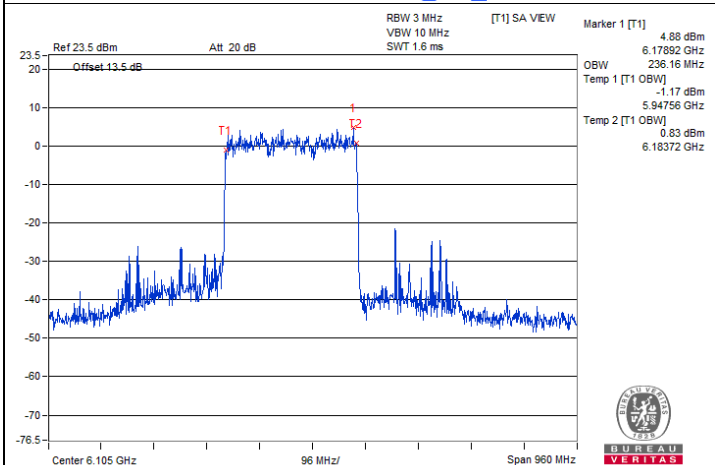

802.11be (EHT320) 3x996-tone MRU Indoor_2T2S / Chain 0 : CH 31@104

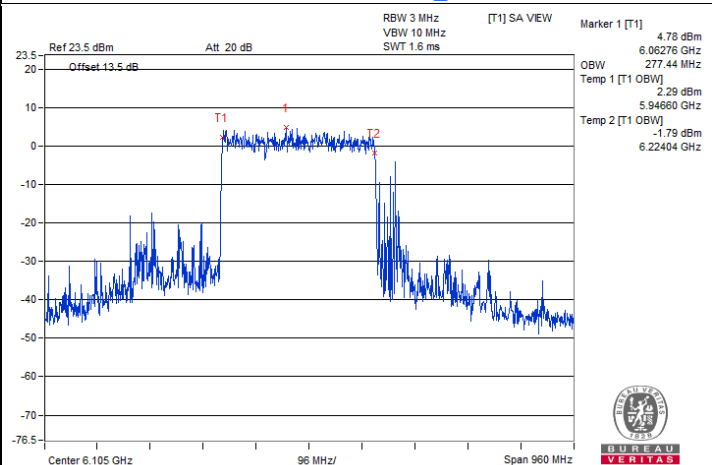

802.11be (EHT320) 3x996+484-tone MRU Indoor_2T2S / Chain 1 : CH 31@106

7.6 Contention-based Protocol (Subcontract Item)

Environmental Conditions:	25°C, 60% RH	Tested By:	Stan Shih
---------------------------	--------------	------------	-----------

1T1S

For U-NII-5

Contention Based Protocol Measurement										
Operation Mode	Channel Bandwidth (MHz)	Channel Number	Channel Freq. (MHz)	Injected Signal (AWGN)		Antenna Gain (dBi)	Path Loss (dB) (Note 2)	Adjusted Power (dBm)	Detection Limit	EUT TX Status
				Freq. (MHz)	Power (dBm)					
802.11be	20	45	6175	6175	-82	-4.99	0	-77.01	-62	OFF
					-82.5	-4.99	0	-77.51	-62	Minimal
					-86.99	-4.99	0	-82	-62	ON
	320	31	6105	5950	-82	-4.99	0	-77.01	-62	OFF
					-82.5	-4.99	0	-77.51	-62	Minimal
					-86.99	-4.99	0	-82	-62	ON
				6105	-82	-4.99	0	-77.01	-62	OFF
					-82.5	-4.99	0	-77.51	-62	Minimal
					-86.99	-4.99	0	-82	-62	ON
				6260	-82	-4.99	0	-77.01	-62	OFF
					-82.5	-4.99	0	-77.51	-62	Minimal
					-86.99	-4.99	0	-82	-62	ON

Notes:

- Adjusted Power (dBm) = Injected Signal (AWGN) Power (dBm) - Antenna Gain (dBi) + Path Loss (dB)
- Antenna gain values include all the applicable path losses.
- After evaluation, only the Chain 0 was chosen for test and presented in the test report.

Contention Based Protocol Detection Probability															
Operation Mode	Channel Bandwidth (MHz)	AWGN Signal Freq. (MHz)	#01	#02	#03	#04	#05	#06	#07	#08	#09	#10	Detection Probability	Detection Limit	Test Result
802.11be	20	6175	v	v	v	v	v	v	v	v	v	v	100%	90%	Pass
	320	5950	v	v	v	v	v	v	v	v	v	v	100%	90%	Pass
		6105	v	v	v	v	v	v	v	v	v	v	100%	90%	Pass
		6260	v	v	v	v	v	v	v	v	v	v	100%	90%	Pass

Plots of EUT Tx waveform

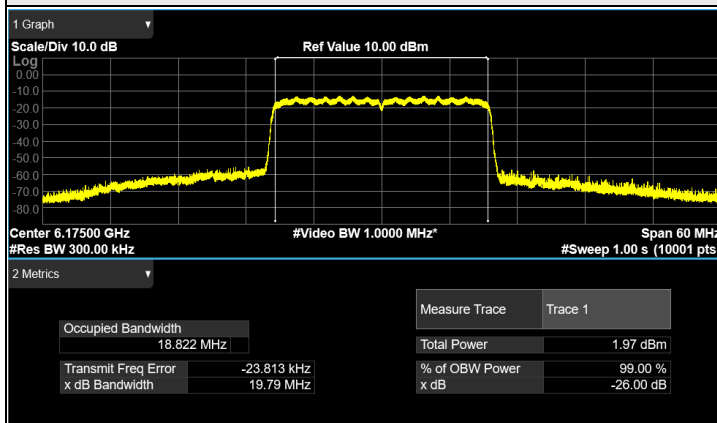

802.11be (EHT20) / CH45

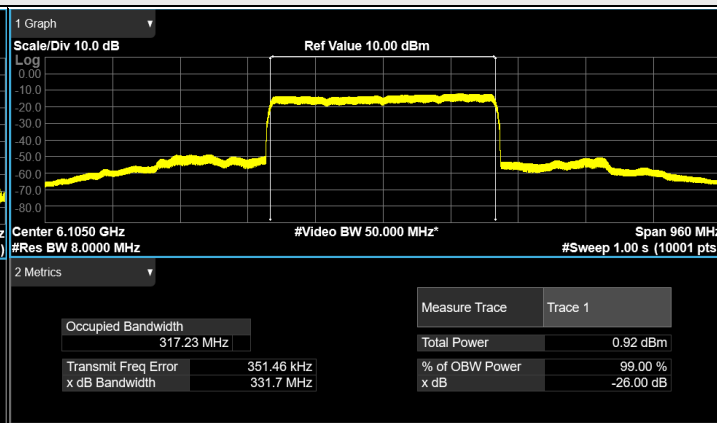

802.11be (EHT320) / CH31

Plots of Injected signal (AWGN) level

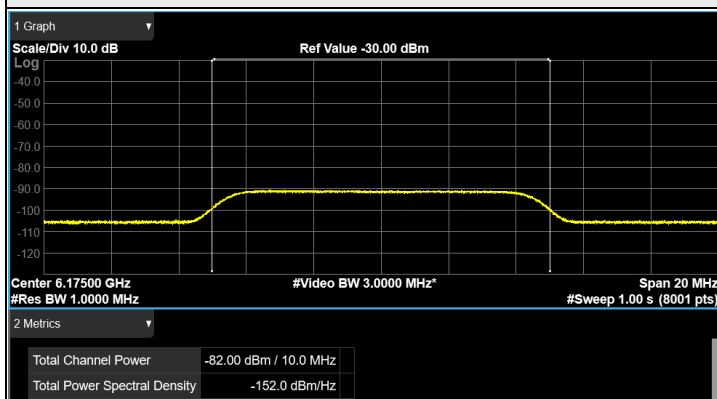

802.11be (EHT20) / CH45

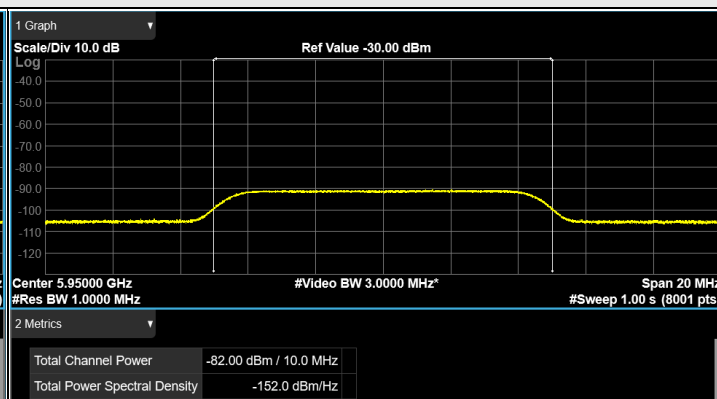

802.11be (EHT320) / CH31 (Low Edge)

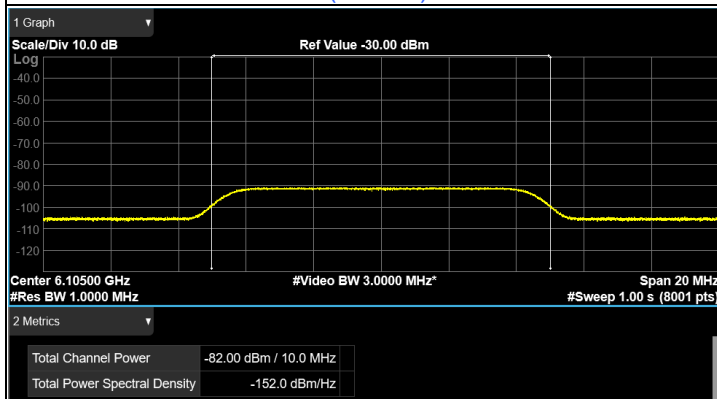

802.11be (EHT320) / CH31 (Middle)

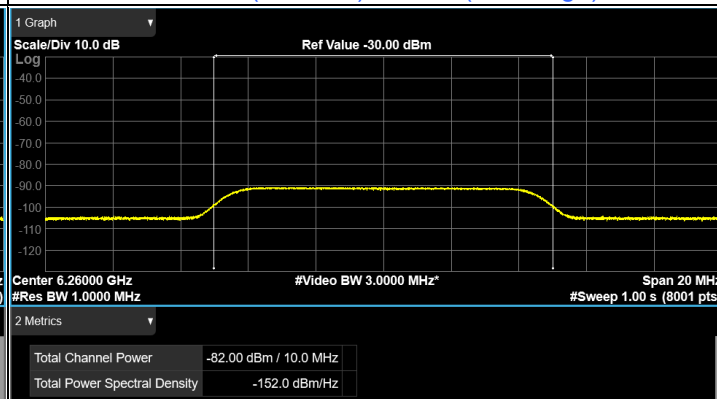

802.11be (EHT320) / CH31 (High Edge)

Plots of EUT ceased transmission in the time domain

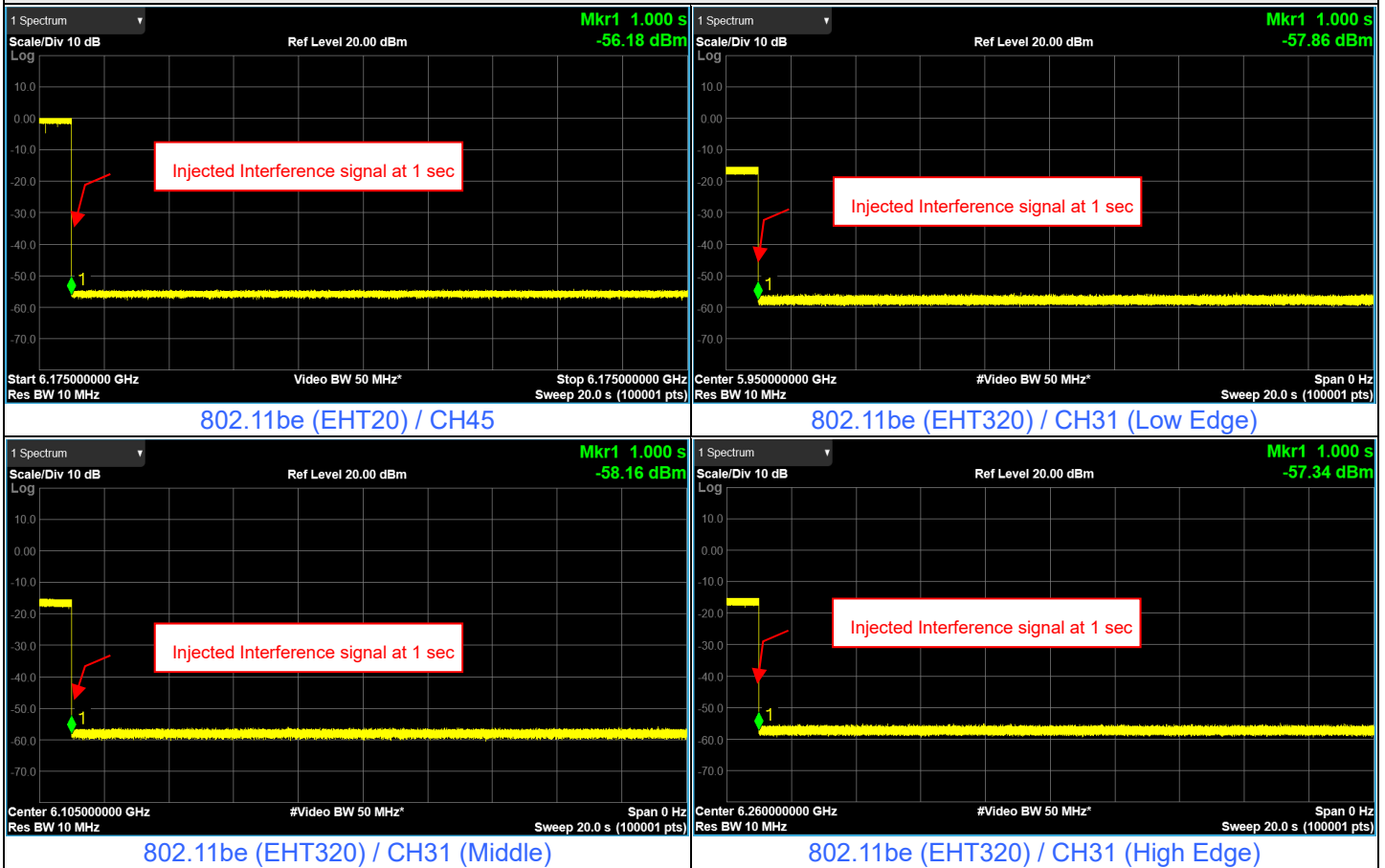

For U-NII-6

Contention Based Protocol Measurement										
Operation Mode	Channel Bandwidth (MHz)	Channel Number	Channel Freq. (MHz)	Injected Signal (AWGN)		Antenna Gain (dBi)	Path Loss (dB) (Note 2)	Adjusted Power (dBm)	Detection Limit	EUT TX Status
				Freq. (MHz)	Power (dBm)					
802.11be	20	105	6475	6475	-82	-4.99	0	-77.01	-62	OFF
					-82.5	-4.99	0	-77.51	-62	Minimal
					-86.99	-4.99	0	-82	-62	ON
	320	95	6425	6270	-82	-4.99	0	-77.01	-62	OFF
					-82.5	-4.99	0	-77.51	-62	Minimal
					-86.99	-4.99	0	-82	-62	ON
		6425	-82	-4.99	0	-77.01	-62	OFF		
			-82.5	-4.99	0	-77.51	-62	Minimal		
			-86.99	-4.99	0	-82	-62	ON		
			6580	-82	-4.99	0	-77.01	-62	OFF	
				-82.5	-4.99	0	-77.51	-62	Minimal	
				-86.99	-4.99	0	-82	-62	ON	

Notes:

- Adjusted Power (dBm) = Injected Signal (AWGN) Power (dBm) - Antenna Gain (dBi) + Path Loss (dB)
- Antenna gain values include all the applicable path losses.
- After evaluation, only the Chain 0 was chosen for test and presented in the test report.

Contention Based Protocol Detection Probability															
Operation Mode	Channel Bandwidth (MHz)	AWGN Signal Freq. (MHz)	#01	#02	#03	#04	#05	#06	#07	#08	#09	#10	Detection Probability	Detection Limit	Test Result
802.11be	20	6475	v	v	v	v	v	v	v	v	v	v	100%	90%	Pass
	320	6270	v	v	v	v	v	v	v	v	v	v	100%	90%	Pass
		6425	v	v	v	v	v	v	v	v	v	v	100%	90%	Pass
		6580	v	v	v	v	v	v	v	v	v	v	100%	90%	Pass