

Supplemental “Transmit Simultaneously” Test Report

Report No.: RFBARR-WTW-P22060042-5

FCC ID: RAS-MT7927

Test Model: MT7927

Received Date: 2022/6/6

Test Date: 2022/7/28 ~ 2022/8/30

Issued Date: 2022/9/8

Applicant: MediaTek Inc.

Address: No. 1, Dusing 1st Rd., Hsinchu Science Park, Hsinchu City, 30078 Taiwan

Issued By: Bureau Veritas Consumer Products Services (H.K.) Ltd., Taoyuan Branch
Hsin Chu Laboratory

Lab Address: E-2, No.1, Li Hsin 1st Road, Hsinchu Science Park, Hsinchu City 300,
Taiwan

Test Location: E-2, No.1, Li Hsin 1st Road, Hsinchu Science Park, Hsinchu City 300,
Taiwan

**FCC Registration /
Designation Number:** 723255 / TW2022



This report is governed by, and incorporates by reference, the Conditions of Testing as posted at the date of issuance of this report at <http://www.bureauveritas.com/home/about-us/our-business/cps/about-us/terms-conditions/> and is intended for your exclusive use. Any copying or replication of this report to or for any other person or entity, or use of our name or trademark, is permitted only with our prior written permission. This report sets forth our findings solely with respect to the test samples identified herein. The results set forth in this report are not indicative or representative of the quality or characteristics of the lot from which a test sample was taken or any similar or identical product unless specifically and expressly noted. Our report includes all of the tests requested by you and the results thereof based upon the information that you provided to us. Measurement uncertainty is only provided upon request for accredited tests. Statements of conformity are based on simple acceptance criteria without taking measurement uncertainty into account, unless otherwise requested in writing. You have 60 days from date of issuance of this report to notify us of any material error or omission caused by our negligence or if you require measurement uncertainty; provided, however, that such notice shall be in writing and shall specifically address the issue you wish to raise. A failure to raise such issue within the prescribed time shall constitute your unqualified acceptance of the completeness of this report, the tests conducted and the correctness of the report contents.

Table of Contents

Release Control Record	3
1 Certificate of Conformity	4
2 Summary of Test Results	5
2.1 Measurement Uncertainty	5
2.2 Modification Record	5
3 General Information	6
3.1 General Description of EUT	6
3.1.1 Test Mode Applicability and Tested Channel Detail	10
3.2 Description of Support Units	14
3.2.1 Configuration of System under Test	15
4 Test Types and Results	16
4.1 Radiated Emission and Bandedge Measurement	16
4.1.1 Limits of Radiated Emission and Bandedge Measurement	16
4.1.2 Test Instruments	18
4.1.3 Test Procedures	20
4.1.4 Deviation from Test Standard	20
4.1.5 Test Setup	21
4.1.6 EUT Operating Conditions	22
4.1.7 Test Results (Mode 1)	23
4.1.8 Test Results (Mode 2)	26
4.1.9 Test Results (Mode 3)	29
4.1.10 Test Results (Mode 4)	32
4.2 Conducted Emission Measurement	35
4.2.1 Limits of Conducted Emission Measurement	35
4.2.2 Test Instruments	35
4.2.3 Test Procedures	36
4.2.4 Deviation from Test Standard	36
4.2.5 Test Setup	36
4.2.6 EUT Operating Conditions	36
4.2.7 Test Results (Mode 1)	37
4.2.8 Test Results (Mode 2)	39
4.2.9 Test Results (Mode 3)	41
4.2.10 Test Results (Mode 4)	43
4.3 Conducted Out of Band Emission Measurement	45
4.3.1 Limits of Conducted Out of Band Emission Measurement	45
4.3.2 Test Setup	45
4.3.3 Test Instruments	45
4.3.4 Test Procedures	45
4.3.5 Deviation from Test Standard	45
4.3.6 EUT Operating Conditions	45
4.3.7 Test Results	45
5 Pictures of Test Arrangements	48
Appendix – Information of the Testing Laboratories	49

Release Control Record

Issue No.	Description	Date Issued
RFBARR-WTW-P22060042-5	Original release.	2022/9/8

1 Certificate of Conformity

Product: 2TX 11be (WiFi7) BW320 + BT/BLE Combo Card

Brand: MediaTek

Test Model: MT7927

Sample Status: Engineering sample

Applicant: MediaTek Inc.

Test Date: 2022/7/28 ~ 2022/8/30

Standards: 47 CFR FCC Part 15, Subpart C (Section 15.247)

47 CFR FCC Part 15, Subpart E (Section 15.407)

ANSI C63.10: 2013

The above equipment has been tested by **Bureau Veritas Consumer Products Services (H.K.) Ltd., Taoyuan Branch**, and found compliance with the requirement of the above standards. The test record, data evaluation & Equipment Under Test (EUT) configurations represented herein are true and accurate accounts of the measurements of the sample's EMC characteristics under the conditions specified in this report.

Prepared by : Cherry Chuo, **Date:** 2022/9/8
Cherry Chuo / Specialist

Approved by : May Chen, **Date:** 2022/9/8
May Chen / Manager

2 Summary of Test Results

47 CFR FCC Part 15, Subpart C, E (SECTION 15.247, 15.407)			
FCC Clause	Test Item	Result	Remarks
15.207 15.407(b)(8)	AC Power Conducted Emission	Pass	Meet the requirement of limit. Minimum passing margin is -12.89 dB at 0.19687 MHz.
15.205 / 15.209 / 15.247(d) 15.407(b) (1/2/3/4(i/ii)/8)	Radiated Emissions and Band Edge Measurement	Pass	Meet the requirement of limit. Minimum passing margin is -3.0 dB at 166.51, 166.45, 720.29 MHz.

Note:

Determining compliance based on the results of the compliance measurement, not taking into account measurement instrumentation uncertainty.

2.1 Measurement Uncertainty

Where relevant, the following measurement uncertainty levels have been estimated for tests performed on the EUT as specified in CISPR 16-4-2:

Measurement	Frequency	Expanded Uncertainty (k=2) (\pm)
Conducted Emissions at mains ports	150kHz ~ 30MHz	1.9 dB
Conducted emissions	-	2.5 dB
Radiated Emissions up to 1 GHz	9kHz ~ 30MHz	3.1 dB
	30MHz ~ 1GHz	5.5 dB
Radiated Emissions above 1 GHz	1GHz ~ 18GHz	5.1 dB
	18GHz ~ 40GHz	5.3 dB

2.2 Modification Record

There were no modifications required for compliance.

3 General Information

3.1 General Description of EUT

Product	2TX 11be (WiFi7) BW320 + BT/BLE Combo Card
Brand	MediaTek
Test Model	MT7927
Status of EUT	Engineering sample
Power Supply Rating	3.3Vdc from host equipment
Modulation Type	WLAN: CCK, DQPSK, DBPSK for DSSS 64QAM, 16QAM, QPSK, BPSK for OFDM 256QAM for OFDM in 11ac mode and VHT20/40 in 2.4GHz mode 1024QAM for OFDMA in 11ax mode 4096QAM for OFDMA in 11be mode BT-EDR: GFSK, $\pi/4$ -DQPSK, 8DPSK BT-LE: GFSK
Modulation Technology	WLAN: DSSS, OFDM, OFDMA BT-EDR: FHSS BT-LE: DTS
Transfer Rate	WLAN: 802.11b: up to 11Mbps 802.11a/g up to 54 Mbps 802.11n: up to 300 Mbps VHT: up to 400 Mbps 802.11ac: up to 1733.3 Mbps 802.11ax: up to 2401.9 Mbps 802.11be: up to 5764.8 Mbps BT-EDR: up to 3 Mbps BT-LE: up to 2 Mbps
Operating Frequency	WLAN: 2.4GHz: 2.412 ~ 2.472 GHz 5GHz: 5.18 ~ 5.25 GHz, 5.26 ~ 5.32 GHz, 5.50 ~ 5.72 GHz, 5.745 ~ 5.825 GHz 6GHz: 5.955 ~ 6.425GHz, 6.425 ~ 6.525GHz, 6.525 ~ 6.875GHz, 6.875 ~ 7.115GHz BT-EDR: 2.402 ~ 2.480 GHz BT-LE: 2.402 ~ 2.480 GHz
Antenna Type	Refer to Note
Antenna Connector	Refer to Note
Accessory Device	NA
Cable Supplied	NA

Note:

1. There are Bluetooth and WLAN (2.4GHz & 5GHz & 6GHz) technology used for the EUT.

2. Simultaneously transmission condition.

Condition	Technology	
1	WLAN (5GHz)	Bluetooth
2	WLAN (6GHz)	Bluetooth
3	WLAN (2.4GHz)	WLAN (5GHz)
4	WLAN (2.4GHz)	WLAN (6GHz)

Note: The emission of the simultaneous operation has been evaluated and no non-compliance was found.

3. The antennas provided to the EUT, please refer to the following table:

Antenna Set No	RF Chain No.	Brand	Model	Antenna Net Gain (dBi)	Frequency Range (GHz)	Antenna Type	Connector Type	Cable Length (mm)
1	Chain0	PSA	RFMTA340718EMLB302	3.18	2.4~2.4835	PIFA	ipex(MHF)	200
				4.92	5.15~5.895			
	Chain1	PSA	RFMTA340718EMLB302	3.18	2.4~2.4835	PIFA	ipex(MHF)	200
				4.92	5.15~5.895			
2	Chain0	PSA	RFMTA311020EMMB301	1.71	2.4~2.4835	PIFA	ipex(MHF)	200
				4.82	5.15~5.895			
				4.76	5.925~6.425			
				4.29	6.425~6.525			
				4.61	6.525~6.875			
	4.09	6.875~7.125						
	Chain1	PSA	RFMTA311020EMMB301	1.71	2.4~2.4835	PIFA	ipex(MHF)	200
				4.82	5.15~5.895			
				4.76	5.925~6.425			
				4.29	6.425~6.525			
4.61				6.525~6.875				
4.09	6.875~7.125							
3	Chain0	PSA	RFMTA421208IMMB701	-4.99	5.925~7.125	PIFA	i-pex(MHF)	300
	Chain1	PSA	RFMTA421208IMMB701	-4.99	5.925~7.125	PIFA	i-pex(MHF)	300

Note: Max. gain was selected for the final test.

4. The EUT incorporates a MIMO function:

2.4 GHz Band		
Modulation Mode	TX & RX Configuration	
802.11b	2TX	2RX
802.11g	2TX	2RX
802.11n (HT20)	2TX	2RX
802.11n (HT40)	2TX	2RX
VHT20	2TX	2RX
VHT40	2TX	2RX
802.11ax (HE20)	2TX	2RX
802.11ax (HE40)	2TX	2RX
802.11be (EHT20)	2TX	2RX
802.11be (EHT40)	2TX	2RX
5 GHz Band		
Modulation Mode	TX & RX Configuration	
802.11a	2TX	2RX
802.11n (HT20)	2TX	2RX
802.11n (HT40)	2TX	2RX
802.11ac (VHT20)	2TX	2RX
802.11ac (VHT40)	2TX	2RX
802.11ac (VHT80)	2TX	2RX
802.11ac (VHT160)	2TX	2RX
802.11ax (HE20)	2TX	2RX
802.11ax (HE40)	2TX	2RX
802.11ax (HE80)	2TX	2RX
802.11ax (HE160)	2TX	2RX
802.11be (EHT20)	2TX	2RX
802.11be (EHT40)	2TX	2RX
802.11be (EHT80)	2TX	2RX

6 GHz Band				
MODULATION MODE	TX configuration		CDD mode	Beamforming mode
802.11a	SISO	1TX	Not Support	Not Support
802.11ax (HE20)		1TX	Not Support	Not Support
802.11ax (HE40)		1TX	Not Support	Not Support
802.11ax (HE80)		1TX	Not Support	Not Support
802.11ax (HE160)		1TX	Not Support	Not Support
802.11be (EHT20)		1TX	Not Support	Not Support
802.11be (EHT40)		1TX	Not Support	Not Support
802.11be (EHT80)		1TX	Not Support	Not Support
802.11be (EHT160)		1TX	Not Support	Not Support
802.11be (EHT320)		1TX	Not Support	Not Support
802.11a		MIMO	2TX	Support
802.11ax (HE20)	2TX		Support NSS2	Not Support
802.11ax (HE40)	2TX		Support NSS2	Not Support
802.11ax (HE80)	2TX		Support NSS2	Not Support
802.11ax (HE160)	2TX		Support NSS2	Not Support
802.11be (EHT20)	2TX		Support NSS2	Not Support
802.11be (EHT40)	2TX		Support NSS2	Not Support
802.11be (EHT80)	2TX		Support NSS2	Not Support
802.11be (EHT160)	2TX		Support NSS2	Not Support
802.11be (EHT320)	2TX		Support NSS2	Not Support

5. The above EUT information is declared by manufacturer and for more detailed features description, please refer to the manufacturer's specifications or user's manual.
6. Detail antenna specification please refer to antenna datasheet and/or antenna measurement report.

3.1.1 Test Mode Applicability and Tested Channel Detail

EUT CONFIGURE MODE	APPLICABLE TO				DESCRIPTION
	RE \geq 1G	RE $<$ 1G	PLC	OB	
-	√	√	√	√	-

Where **RE \geq 1G**: Radiated Emission above 1GHz & Bandedge Measurement

RE $<$ 1G: Radiated Emission below 1GHz

PLC: Power Line Conducted Emission

OB: Conducted Out-Band Emission Measurement

Note: The EUT had been pre-tested on the positioned of each 3 axis. The worst case was found when positioned on Z-plane.

Radiated Emission Test (Above 1GHz):

The tested configurations represent the worst-case mode from all possible combinations by the maximum power.

Following channel(s) was (were) selected for the final test as listed below.

EUT CONFIGURE MODE	MODE	TESTED CHANNEL	MODULATION TECHNOLOGY	MODULATION TYPE
1	5GHz: 802.11be (EHT40) + BT-LE	159	OFDMA	BPSK
		0	DTS	GFSK
2	6GHz: 802.11be (EHT320) + BT-LE	143	OFDMA	BPSK
		0	DTS	GFSK
3	2.4GHz: 802.11b + 5GHz: 802.11be (EHT40)	1	DSSS	BPSK
		159	OFDMA	BPSK
4	2.4GHz: 802.11b + 6GHz: 802.11be (EHT320)	1	DSSS	BPSK
		143	OFDMA	BPSK

Radiated Emission Test (Below 1GHz):

The tested configurations represent the worst-case mode from all possible combinations by the maximum power.

Following channel(s) was (were) selected for the final test as listed below.

EUT CONFIGURE MODE	MODE	TESTED CHANNEL	MODULATION TECHNOLOGY	MODULATION TYPE
1	5GHz: 802.11be (EHT40) + BT-LE	159	OFDMA	BPSK
		0	DTS	GFSK
2	6GHz: 802.11be (EHT320) + BT-LE	143	OFDMA	BPSK
		0	DTS	GFSK
3	2.4GHz: 802.11b + 5GHz: 802.11be (EHT40)	1	DSSS	BPSK
		159	OFDMA	BPSK
4	2.4GHz: 802.11b + 6GHz: 802.11be (EHT320)	1	DSSS	BPSK
		143	OFDMA	BPSK

Power Line Conducted Emission Test:

The tested configurations represent the worst-case mode from all possible combinations by the maximum power.

Following channel(s) was (were) selected for the final test as listed below.

EUT CONFIGURE MODE	MODE	TESTED CHANNEL	MODULATION TECHNOLOGY	MODULATION TYPE
1	5GHz: 802.11be (EHT40) + BT-LE	159	OFDMA	BPSK
		0	DTS	GFSK
2	6GHz: 802.11be (EHT320) + BT-LE	143	OFDMA	BPSK
		0	DTS	GFSK
3	2.4GHz: 802.11b + 5GHz: 802.11be (EHT40)	1	DSSS	BPSK
		159	OFDMA	BPSK
4	2.4GHz: 802.11b + 6GHz: 802.11be (EHT320)	1	DSSS	BPSK
		143	OFDMA	BPSK

Conducted Out-Band Emission Measurement:

The tested configurations represent the worst-case mode from all possible combinations by the maximum power.

Following channel(s) was (were) selected for the final test as listed below.

EUT CONFIGURE MODE	MODE	TESTED CHANNEL	MODULATION TECHNOLOGY	MODULATION TYPE
1	5GHz: 802.11be (EHT40) + BT-LE	159	OFDMA	BPSK
		0	DTS	GFSK
2	6GHz: 802.11be (EHT320) + BT-LE	143	OFDMA	BPSK
		0	DTS	GFSK
3	2.4GHz: 802.11b + 5GHz: 802.11be (EHT40)	1	DSSS	BPSK
		159	OFDMA	BPSK
4	2.4GHz: 802.11b + 6GHz: 802.11be (EHT320)	1	DSSS	BPSK
		143	OFDMA	BPSK

Test Condition:

Applicable To	Environmental Conditions	Input Power (System)	Tested By
RE\geq1G	25deg. C, 75%RH	120Vac, 60Hz	Tom Yang
RE<1G	25deg. C, 66%RH	120Vac, 60Hz	Tom Yang
PLC	24deg. C, 71%RH	120Vac, 60Hz	Sampson Chen
OB	25deg. C, 63%RH	120Vac, 60Hz	Eric Peng

3.2 Description of Support Units

The EUT has been tested as an independent unit together with other necessary accessories or support units. The following support units or accessories were used to form a representative test configuration during the tests.

ID	Product	Brand	Model No.	Serial No.	FCC ID	Remarks
A	Laptop	DELL	E5430	HYV4VY1	DoC	Provided by Lab
B	Adapter	DELL	LLA65NS2-01	N/A	N/A	Provided by Lab
C	Test Tool	Mediatek	MTK1849	N/A	N/A	Supplied by applicant

ID	Cable Descriptions	Qty.	Length (m)	Shielding (Yes/No)	Cores (Qty.)	Remarks
1	DC Cable	1	1.8	No	1	Provided by Lab
2	AC Cable	1	1	No	0	Provided by Lab
3	RF Cable	1	0.2	No	0	Supplied by applicant
4	RF Cable	1	0.2	No	0	Supplied by applicant

3.2.1 Configuration of System under Test

For AC Power Conducted Emission test

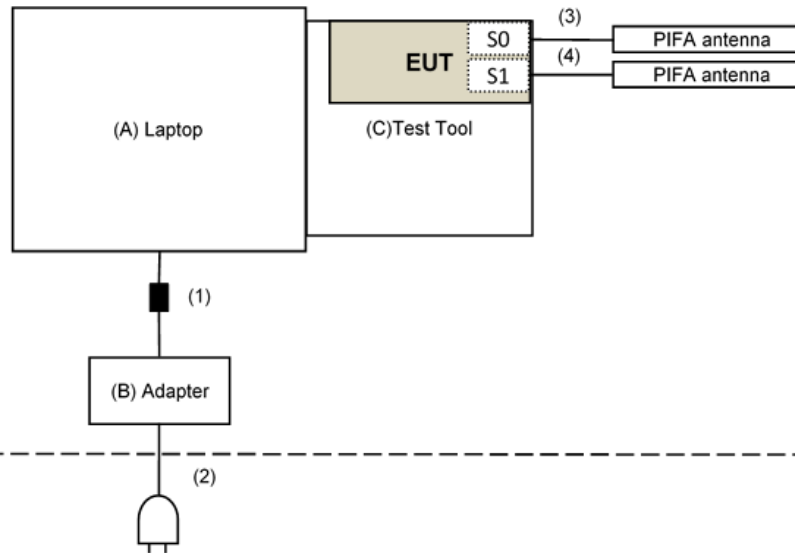

For Radiated Emission test

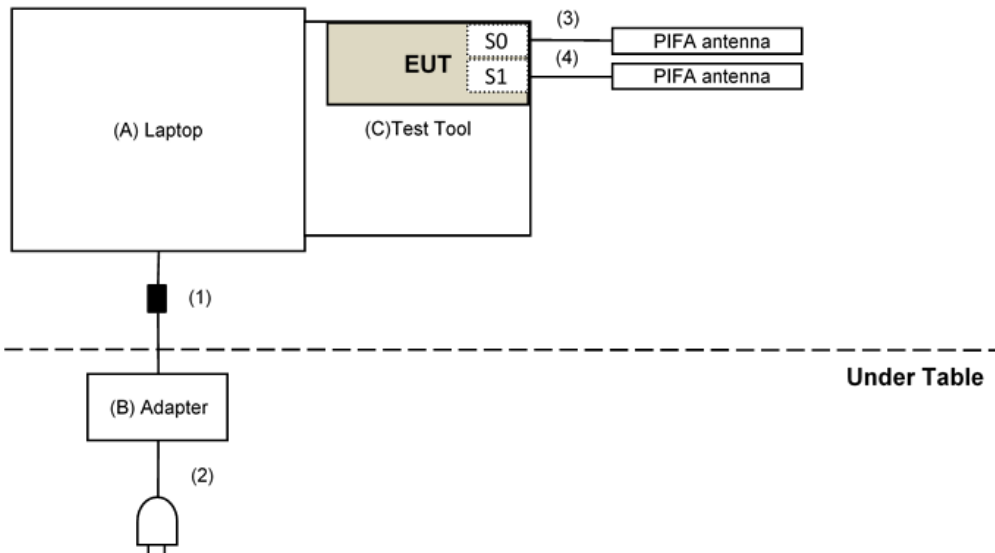

4 Test Types and Results

4.1 Radiated Emission and Bandedge Measurement

4.1.1 Limits of Radiated Emission and Bandedge Measurement

Radiated emissions which fall in the restricted bands must comply with the radiated emission limits specified as below table.

Frequencies (MHz)	Field Strength (microvolts/meter)	Measurement Distance (meters)
0.009 ~ 0.490	2400/F(kHz)	300
0.490 ~ 1.705	24000/F(kHz)	30
1.705 ~ 30.0	30	30
30 ~ 88	100	3
88 ~ 216	150	3
216 ~ 960	200	3
Above 960	500	3

Note:

1. The lower limit shall apply at the transition frequencies.
2. Emission level (dBuV/m) = 20 log Emission level (uV/m).
3. For frequencies above 1000MHz, the field strength limits are based on average detector, however, the peak field strength of any emission shall not exceed the maximum permitted average limits, specified above by more than 20dB under any condition of modulation.

Limits of unwanted emission out of the restricted bands

Applicable To		Limit	
789033 D02 General UNII Test Procedure New Rules v02r01		Field Strength at 3m	
		PK:74 (dBμV/m)	AV:54 (dBμV/m)
Frequency Band	Applicable To	EIRP Limit	Equivalent Field Strength at 3m
5150~5250 MHz	15.407(b)(1)	PK:-27 (dBm/MHz)	PK:68.2(dBμV/m)
5250~5350 MHz	15.407(b)(2)		
5470~5725 MHz	15.407(b)(3)		
5725~5850 MHz	15.407(b)(4)(i)	PK: -27 (dBm/MHz) ^{*1} PK: 10 (dBm/MHz) ^{*2} PK: 15.6 (dBm/MHz) ^{*3} PK: 27 (dBm/MHz) ^{*4}	PK: 68.2(dBμV/m) ^{*1} PK: 105.2 (dBμV/m) ^{*2} PK: 110.8(dBμV/m) ^{*3} PK: 122.2 (dBμV/m) ^{*4}
5725~5850 MHz	15.407(b)(4)(i)	PK: -27 (dBm/MHz) ^{*1} PK: 10 (dBm/MHz) ^{*2} PK: 15.6 (dBm/MHz) ^{*3} PK: 27 (dBm/MHz) ^{*4}	PK: 68.2(dBμV/m) ^{*1} PK: 105.2 (dBμV/m) ^{*2} PK: 110.8(dBμV/m) ^{*3} PK: 122.2 (dBμV/m) ^{*4}
^{*1} beyond 75 MHz or more above of the band edge. ^{*3} below the band edge increasing linearly to a level of 15.6 dBm/MHz at 5 MHz above.		^{*2} below the band edge increasing linearly to 10 dBm/MHz at 25 MHz above. ^{*4} from 5 MHz above or below the band edge increasing linearly to a level of 27 dBm/MHz at the band edge.	

Note:

The following formula is used to convert the equipment isotropic radiated power (eirp) to field strength:

$$E = \frac{1000000\sqrt{30P}}{3} \mu\text{V/m, where } P \text{ is the eirp (Watts).}$$

4.1.2 Test Instruments

For Radiated emission test:

Description & Manufacturer	Model No.	Serial No.	Calibrated Date	Calibrated Until
Test Receiver Agilent	N9038A	MY51210202	2021/11/19	2022/11/18
Software	ADT_Radiated_V8.7.08	NA	NA	NA
Boresight Antenna Tower & Turn Table Max-Full	MF-7802BS	MF780208530	NA	NA
Pre_Amplifier Agilent	8447D	2944A10636	2022/3/19	2023/3/18
LOOP ANTENNA Electro-Metrics	EM-6879	264	2022/3/18	2023/3/17
RF Coaxial Cable JYEBO	5D-FB	LOOPCAB-001	2022/1/6	2023/1/5
RF Coaxial Cable JYEBO	5D-FB	LOOPCAB-002	2022/1/6	2023/1/5
Pre_Amplifier EMCI	EMC330N	980701	2022/3/8	2023/3/7
Trilog Broadband Antenna Schwarzbeck	VULB 9168	9168-406	2021/10/27	2022/10/26
RF Coaxial Cable COMMATE/PEWC	8D	966-4-1	2022/3/8	2023/3/7
RF Coaxial Cable COMMATE/PEWC	8D	966-4-2	2022/3/8	2023/3/7
RF Coaxial Cable COMMATE/PEWC	8D	966-4-3	2022/3/8	2023/3/7
Fixed attenuator Mini-Circuits	UNAT-5+	PAD-ATT5-03	2022/1/10	2023/1/9
Test Receiver Agilent	N9038A	MY51210202	2021/11/19	2022/11/18
Software	ADT_Radiated_V8.7.08	NA	NA	NA
Boresight Antenna Tower & Turn Table Max-Full	MF-7802BS	MF780208530	NA	NA
Horn Antenna Schwarzbeck	BBHA 9120D	9120D-783	2021/11/14	2022/11/13
Pre_Amplifier EMCI	EMC 12630 SE	980638	2022/4/5	2023/4/4
RF Cable-Frequency Range : 1-26.5GHz EMCI	EMC104-SM-SM-1200	160922	2021/12/24	2022/12/23
RF Coaxial Cable EMCI	EMC104-SM-SM-2000	180502	2022/4/25	2023/4/24
RF Coaxial Cable EMCI	EMC104-SM-SM-6000	210704	2021/11/9	2022/11/8
Test Receiver Agilent	N9038A	MY51210202	2021/11/19	2022/11/18
Software	ADT_Radiated_V8.7.08	NA	NA	NA
Boresight Antenna Tower & Turn Table Max-Full	MF-7802BS	MF780208530	NA	NA
Pre_Amplifier EMCI	EMC184045SE	980387	2022/1/10	2023/1/9
Horn Antenna Schwarzbeck	BBHA 9170	9170-739	2021/11/14	2022/11/13

RF Cable-Frequency range: 1-40GHz EMCI	EMC102-KM-KM-1200	160924	2022/1/10	2023/1/9
RF Coaxial Cable EMCI	EMC-KM-KM-4000	200214	2022/3/8	2023/3/7

Note:

1. The calibration interval of the above test instruments is 12 months and the calibrations are traceable to NML/ROC and NIST/USA.
2. The test was performed in 966 Chamber No. 4.
3. Tested Date: 2022/7/29 ~ 2022/8/30

For other test items:

Description & Manufacturer	Model no.	Serial No.	Calibrated DATE	Calibrated Until
Spectrum Analyzer R&S	FSV40	101516	2022/3/7	2023/3/6
10dB Attenuator Woken	MDCS18N-10	MDCS18N-10-01	2022/4/5	2023/4/4
Software	ADT_RF Test Software V6.6.5.4	NA	NA	NA

NOTE:

1. The test was performed in Oven room 2.
2. The calibration interval of the above test instruments is 12 months and the calibrations are traceable to NML/ROC and NIST/USA.
3. Tested Date: 2022/7/28

4.1.3 Test Procedures

For Radiated emission below 30MHz

- a. The EUT was placed on the top of a rotating table 0.8 meters above the ground at a 3 meter chamber room. The table was rotated 360 degrees to determine the position of the highest radiation.
- b. The EUT was set 3 meters away from the interference-receiving antenna, which was mounted on the top of a variable-height antenna tower.
- c. Parallel, perpendicular, and ground-parallel orientations of the antenna are set to make the measurement.
- d. For each suspected emission, the EUT was arranged to its worst case and the rotatable table was turned from 0 degrees to 360 degrees to find the maximum reading.
- e. The test-receiver system was set to Quasi-Peak Detect Function and Specified Bandwidth with Maximum Hold Mode.

Note:

1. The resolution bandwidth and video bandwidth of test receiver/spectrum analyzer is 9kHz at frequency below 30MHz.

For Radiated emission above 30MHz

- a. The EUT was placed on the top of a rotating table 0.8 meters (for 30MHz ~ 1GHz) / 1.5 meters (for above 1GHz) above the ground at 3 meter chamber room for test. The table was rotated 360 degrees to determine the position of the highest radiation.
- b. The EUT was set 3 meters away from the interference-receiving antenna, which was mounted on the top of a variable-height antenna tower.
- c. The height of antenna is varied from one meter to four meters above the ground to determine the maximum value of the field strength. Both horizontal and vertical polarizations of the antenna are set to make the measurement.
- d. For each suspected emission, the EUT was arranged to its worst case and then the antenna was tuned to heights from 1 meter to 4 meters and the rotatable table was turned from 0 degrees to 360 degrees to find the maximum reading.
- e. The test-receiver system was set to quasi-peak detect function and specified bandwidth with maximum hold mode when the test frequency is below 1 GHz.
- f. The test-receiver system was set to peak and average detect function and specified bandwidth with maximum hold mode when the test frequency is above 1 GHz. If the peak reading value also meets average limit, measurement with the average detector is unnecessary.

Note:

1. The resolution bandwidth and video bandwidth of test receiver/spectrum analyzer is 120kHz for Quasi-peak detection (QP) at frequency below 1GHz.
2. The resolution bandwidth of test receiver/spectrum analyzer is 1 MHz and the video bandwidth is 3 MHz for Peak detection (PK) at frequency above 1GHz.
3. The resolution bandwidth of test receiver/spectrum analyzer is 1MHz and the video bandwidth is $\geq 1/T$ (Duty cycle < 98%) or 10Hz (Duty cycle $\geq 98\%$) for Average detection (AV) at frequency above 1GHz.
4. All modes of operation were investigated and the worst-case emissions are reported.

4.1.4 Deviation from Test Standard

No deviation.

4.1.5 Test Setup

For Radiated emission below 30MHz

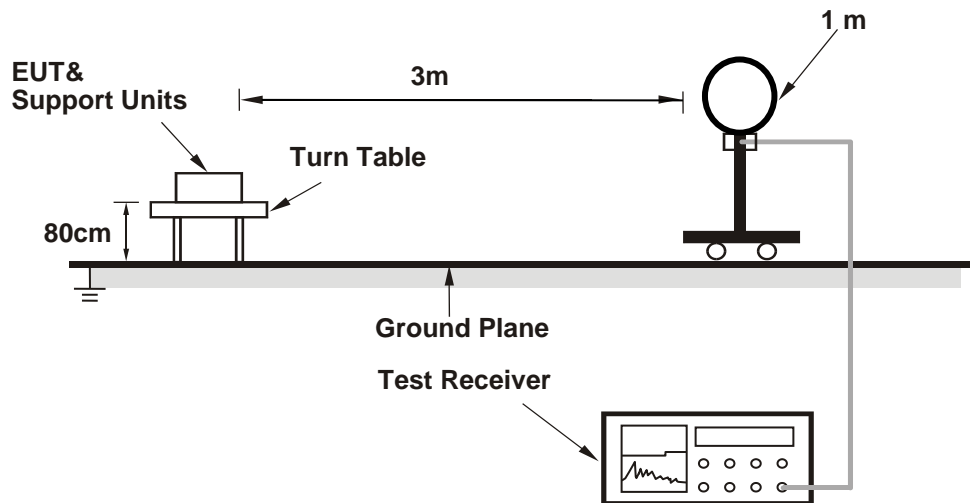

For Radiated emission 30MHz to 1GHz

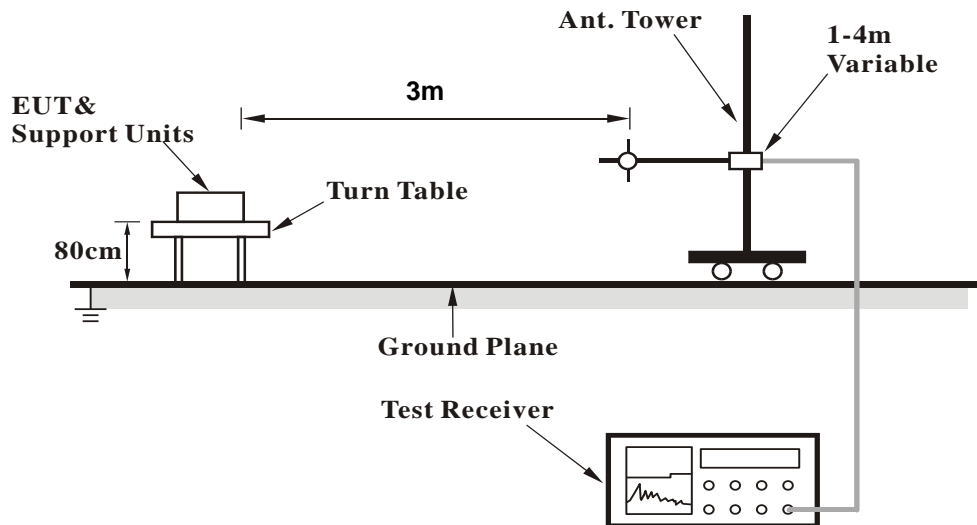

For Radiated emission above 1GHz

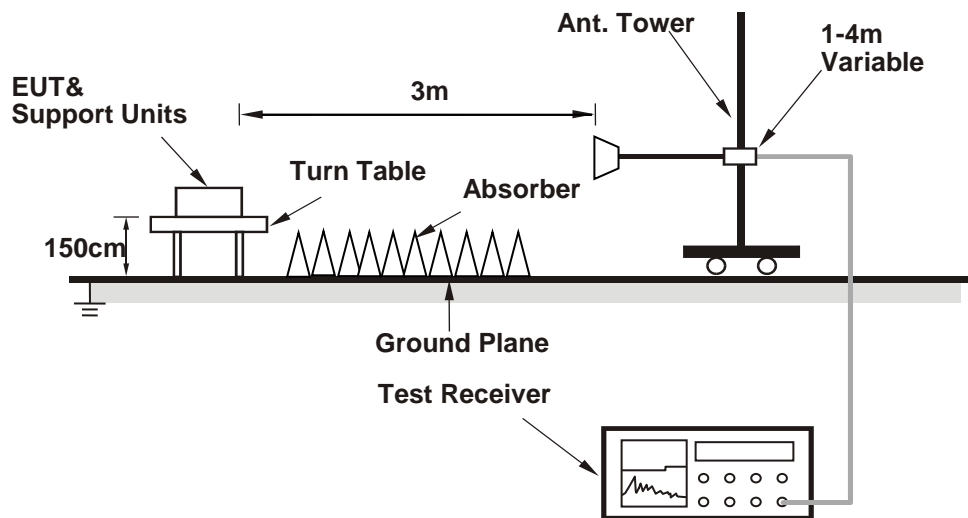

For the actual test configuration, please refer to the attached file (Test Setup Photo).

4.1.6 EUT Operating Conditions

- Placed the EUT on the testing table.
- Controlling software (WLAN: QATool_Dbg.exe (V19); BT: WCN_Combo_Tool) has been activated to set the EUT under transmission condition continuously at specific channel frequency.

4.1.7 Test Results (Mode 1)

Above 1GHz Data:

Frequency Range	1GHz ~ 40GHz	Detector Function	Peak (PK) Average (AV)
------------------------	--------------	--------------------------	---------------------------

Antenna Polarity & Test Distance : Horizontal at 3 m								
No	Frequency (MHz)	Emission Level (dBuV/m)	Limit (dBuV/m)	Margin (dB)	Antenna Height (m)	Table Angle (Degree)	Raw Value (dBuV)	Correction Factor (dB/m)
1	4804.00	51.4 PK	74.0	-22.6	2.01 H	90	51.6	-0.2
2	4804.00	46.8 AV	54.0	-7.2	2.01 H	90	47.0	-0.2
3	11590.00	47.2 PK	74.0	-26.8	2.12 H	276	35.8	11.4
4	11590.00	36.4 AV	54.0	-17.6	2.12 H	276	25.0	11.4
5	#17385.00	43.1 PK	68.2	-25.1	1.64 H	189	26.1	17.0

Antenna Polarity & Test Distance : Vertical at 3 m								
No	Frequency (MHz)	Emission Level (dBuV/m)	Limit (dBuV/m)	Margin (dB)	Antenna Height (m)	Table Angle (Degree)	Raw Value (dBuV)	Correction Factor (dB/m)
1	4804.00	46.9 PK	74.0	-27.1	1.43 V	146	47.1	-0.2
2	4804.00	42.8 AV	54.0	-11.2	1.43 V	146	43.0	-0.2
3	11590.00	46.9 PK	74.0	-27.1	3.76 V	236	35.5	11.4
4	11590.00	35.5 AV	54.0	-18.5	3.76 V	236	24.1	11.4
5	#17385.00	44.1 PK	68.2	-24.1	2.15 V	92	27.1	17.0

Remarks:

1. Emission Level(dBuV/m) = Raw Value(dBuV) + Correction Factor(dB/m)
2. Correction Factor(dB/m) = Antenna Factor(dB/m) + Cable Factor(dB) – Pre-Amplifier Factor(dB)
3. Margin value = Emission Level – Limit value
4. The other emission levels were very low against the limit.
5. " # ": The radiated frequency is out of the restricted band.

Below 1GHz Data:

Frequency Range	9kHz ~ 1GHz	Detector Function	Quasi-Peak (QP)
-----------------	-------------	-------------------	-----------------

Antenna Polarity & Test Distance : Horizontal at 3 m								
No	Frequency (MHz)	Emission Level (dBuV/m)	Limit (dBuV/m)	Margin (dB)	Antenna Height (m)	Table Angle (Degree)	Raw Value (dBuV)	Correction Factor (dB/m)
1	142.08	40.1 QP	43.5	-3.4	1.50 H	80	51.9	-11.8
2	166.45	40.5 QP	43.5	-3.0	1.00 H	90	52.5	-12.0
3	299.74	42.9 QP	46.0	-3.1	1.00 H	188	53.3	-10.4
4	697.25	42.7 QP	46.0	-3.3	1.00 H	84	43.1	-0.4
5	720.17	42.8 QP	46.0	-3.2	1.00 H	83	42.9	-0.1
6	798.53	42.8 QP	46.0	-3.2	2.00 H	124	41.2	1.6

Remarks:

1. Emission Level(dBuV/m) = Raw Value(dBuV) + Correction Factor(dB/m)
2. Correction Factor(dB/m) = Antenna Factor(dB/m) + Cable Factor(dB) – Pre-Amplifier Factor(dB)
3. Margin value = Emission Level – Limit value
4. The other emission levels were very low against the limit of frequency range 30 MHz ~ 1 GHz.
5. The emission levels were very low against the limit of frequency range 9 kHz ~ 30 MHz: the amplitude of spurious emissions attenuated more than 20 dB below the permissible value to be report.

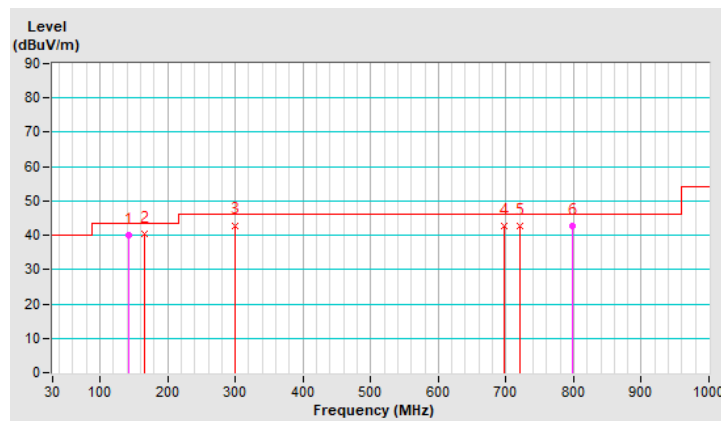

Frequency Range	9kHz ~ 1GHz	Detector Function	Quasi-Peak (QP)
-----------------	-------------	-------------------	-----------------

Antenna Polarity & Test Distance : Vertical at 3 m								
No	Frequency (MHz)	Emission Level (dBuV/m)	Limit (dBuV/m)	Margin (dB)	Antenna Height (m)	Table Angle (Degree)	Raw Value (dBuV)	Correction Factor (dB/m)
1	37.72	32.8 QP	40.0	-7.2	1.50 V	290	45.6	-12.8
2	166.21	39.7 QP	43.5	-3.8	1.00 V	285	51.7	-12.0
3	239.77	36.3 QP	46.0	-9.7	1.00 V	72	49.2	-12.9
4	299.08	41.8 QP	46.0	-4.2	1.50 V	150	52.2	-10.4
5	697.37	42.3 QP	46.0	-3.7	1.50 V	83	42.7	-0.4
6	720.14	42.0 QP	46.0	-4.0	1.00 V	77	42.1	-0.1

Remarks:

1. Emission Level(dBuV/m) = Raw Value(dBuV) + Correction Factor(dB/m)
2. Correction Factor(dB/m) = Antenna Factor(dB/m) + Cable Factor(dB) – Pre-Amplifier Factor(dB)
3. Margin value = Emission Level – Limit value
4. The other emission levels were very low against the limit of frequency range 30 MHz ~ 1 GHz.
5. The emission levels were very low against the limit of frequency range 9 kHz ~ 30 MHz: the amplitude of spurious emissions attenuated more than 20 dB below the permissible value to be report.

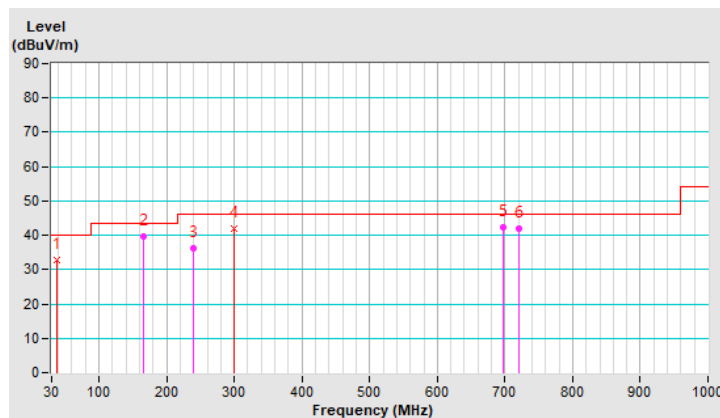

4.1.8 Test Results (Mode 2)

Above 1GHz Data:

Frequency Range	1GHz ~ 40GHz	Detector Function	Peak (PK) Average (AV)
-----------------	--------------	-------------------	---------------------------

Antenna Polarity & Test Distance : Horizontal at 3 m								
No	Frequency (MHz)	Emission Level (dBuV/m)	Limit (dBuV/m)	Margin (dB)	Antenna Height (m)	Table Angle (Degree)	Raw Value (dBuV)	Correction Factor (dB/m)
1	4804.00	52.3 PK	74.0	-21.7	2.09 H	97	52.5	-0.2
2	4804.00	47.4 AV	54.0	-6.6	2.09 H	97	47.6	-0.2
3	#13490.00	42.3 PK	88.2	-45.9	2.39 H	347	29.9	12.4
4	#13490.00	30.5 AV	68.2	-37.7	2.39 H	347	18.1	12.4
5	20235.00	43.4 PK	74.0	-30.6	1.59 H	118	48.9	-5.5
6	20235.00	33.3 AV	54.0	-20.7	1.59 H	118	38.8	-5.5
7	#26980.00	43.3 PK	88.2	-44.9	2.66 H	192	43.7	-0.4
8	#26980.00	34.0 AV	68.2	-34.2	2.66 H	192	34.4	-0.4
Antenna Polarity & Test Distance : Vertical at 3 m								
No	Frequency (MHz)	Emission Level (dBuV/m)	Limit (dBuV/m)	Margin (dB)	Antenna Height (m)	Table Angle (Degree)	Raw Value (dBuV)	Correction Factor (dB/m)
1	4804.00	47.9 PK	74.0	-26.1	1.34 V	145	48.1	-0.2
2	4804.00	43.4 AV	54.0	-10.6	1.34 V	145	43.6	-0.2
3	#13490.00	42.8 PK	88.2	-45.4	1.21 V	147	30.4	12.4
4	#13490.00	29.5 AV	68.2	-38.7	1.21 V	147	17.1	12.4
5	20235.00	42.5 PK	74.0	-31.5	1.74 V	236	48.0	-5.5
6	20235.00	31.7 AV	54.0	-22.3	1.74 V	236	37.2	-5.5
7	#26980.00	42.5 PK	88.2	-45.7	2.12 V	333	42.9	-0.4
8	#26980.00	33.2 AV	68.2	-35.0	2.12 V	333	33.6	-0.4

Remarks:

1. Emission Level(dBuV/m) = Raw Value(dBuV) + Correction Factor(dB/m)
2. Correction Factor(dB/m) = Antenna Factor(dB/m) + Cable Factor(dB) – Pre-Amplifier Factor(dB)
3. Margin value = Emission Level – Limit value
4. The other emission levels were very low against the limit.
5. " # ": The radiated frequency is out of the restricted band.

Below 1GHz Data:

Frequency Range	9kHz ~ 1GHz	Detector Function	Quasi-Peak (QP)
-----------------	-------------	-------------------	-----------------

Antenna Polarity & Test Distance : Horizontal at 3 m								
No	Frequency (MHz)	Emission Level (dBuV/m)	Limit (dBuV/m)	Margin (dB)	Antenna Height (m)	Table Angle (Degree)	Raw Value (dBuV)	Correction Factor (dB/m)
1	165.65	37.5 QP	43.5	-6.0	1.50 H	8	49.4	-11.9
2	199.95	39.7 QP	43.5	-3.8	1.00 H	135	54.4	-14.7
3	298.83	42.9 QP	46.0	-3.1	1.00 H	142	53.4	-10.5
4	696.89	42.4 QP	46.0	-3.6	1.00 H	67	42.8	-0.4
5	719.97	42.2 QP	46.0	-3.8	1.50 H	74	42.4	-0.2
6	798.24	38.0 QP	46.0	-8.0	1.00 H	58	36.4	1.6

Remarks:

1. Emission Level(dBuV/m) = Raw Value(dBuV) + Correction Factor(dB/m)
2. Correction Factor(dB/m) = Antenna Factor(dB/m) + Cable Factor(dB) – Pre-Amplifier Factor(dB)
3. Margin value = Emission Level – Limit value
4. The other emission levels were very low against the limit of frequency range 30 MHz ~ 1 GHz.
5. The emission levels were very low against the limit of frequency range 9 kHz ~ 30 MHz: the amplitude of spurious emissions attenuated more than 20 dB below the permissible value to be report.

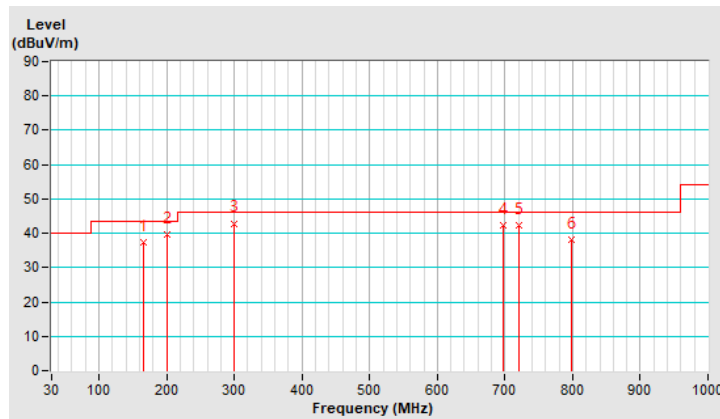

Frequency Range	9kHz ~ 1GHz	Detector Function	Quasi-Peak (QP)
-----------------	-------------	-------------------	-----------------

Antenna Polarity & Test Distance : Vertical at 3 m								
No	Frequency (MHz)	Emission Level (dBuV/m)	Limit (dBuV/m)	Margin (dB)	Antenna Height (m)	Table Angle (Degree)	Raw Value (dBuV)	Correction Factor (dB/m)
1	37.54	33.6 QP	40.0	-6.4	1.50 V	343	46.4	-12.8
2	165.93	40.1 QP	43.5	-3.4	1.00 V	338	52.0	-11.9
3	239.84	37.3 QP	46.0	-8.7	1.50 V	79	50.2	-12.9
4	298.85	42.3 QP	46.0	-3.7	1.00 V	123	52.8	-10.5
5	697.49	42.6 QP	46.0	-3.4	1.00 V	78	43.0	-0.4
6	720.37	42.4 QP	46.0	-3.6	1.00 V	89	42.5	-0.1

Remarks:

1. Emission Level(dBuV/m) = Raw Value(dBuV) + Correction Factor(dB/m)
2. Correction Factor(dB/m) = Antenna Factor(dB/m) + Cable Factor(dB) – Pre-Amplifier Factor(dB)
3. Margin value = Emission Level – Limit value
4. The other emission levels were very low against the limit of frequency range 30 MHz ~ 1 GHz.
5. The emission levels were very low against the limit of frequency range 9 kHz ~ 30 MHz: the amplitude of spurious emissions attenuated more than 20 dB below the permissible value to be report.

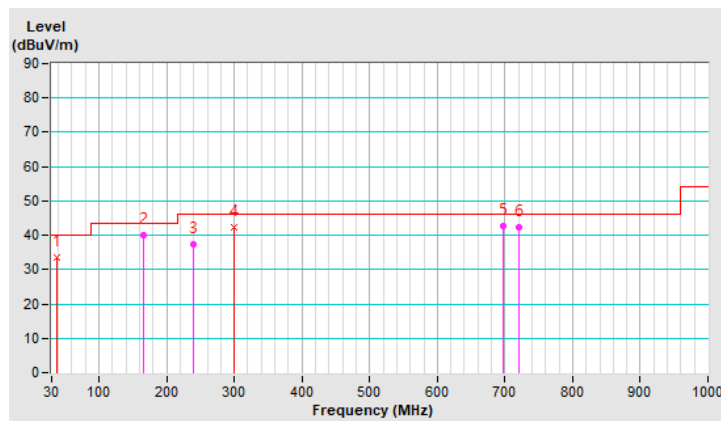

4.1.9 Test Results (Mode 3)

Above 1GHz Data:

Frequency Range	1GHz ~ 40GHz	Detector Function	Peak (PK) Average (AV)
------------------------	--------------	--------------------------	---------------------------

Antenna Polarity & Test Distance : Horizontal at 3 m								
No	Frequency (MHz)	Emission Level (dBuV/m)	Limit (dBuV/m)	Margin (dB)	Antenna Height (m)	Table Angle (Degree)	Raw Value (dBuV)	Correction Factor (dB/m)
1	4824.00	47.9 PK	74.0	-26.1	2.14 H	85	48.1	-0.2
2	4824.00	43.3 AV	54.0	-10.7	2.14 H	85	43.5	-0.2
3	11590.00	46.9 PK	74.0	-27.1	2.09 H	283	35.5	11.4
4	11590.00	36.3 AV	54.0	-17.7	2.09 H	283	24.9	11.4
5	#17385.00	42.8 PK	68.2	-25.4	1.67 H	200	25.8	17.0

Antenna Polarity & Test Distance : Vertical at 3 m								
No	Frequency (MHz)	Emission Level (dBuV/m)	Limit (dBuV/m)	Margin (dB)	Antenna Height (m)	Table Angle (Degree)	Raw Value (dBuV)	Correction Factor (dB/m)
1	4824.00	48.5 PK	74.0	-25.5	2.00 V	135	48.7	-0.2
2	4824.00	43.9 AV	54.0	-10.1	2.00 V	135	44.1	-0.2
3	11590.00	46.9 PK	74.0	-27.1	3.76 V	223	35.5	11.4
4	11590.00	35.5 AV	54.0	-18.5	3.76 V	223	24.1	11.4
5	#17385.00	43.4 PK	68.2	-24.8	2.04 V	95	26.4	17.0

Remarks:

1. Emission Level(dBuV/m) = Raw Value(dBuV) + Correction Factor(dB/m)
2. Correction Factor(dB/m) = Antenna Factor(dB/m) + Cable Factor(dB) – Pre-Amplifier Factor(dB)
3. Margin value = Emission Level – Limit value
4. The other emission levels were very low against the limit.
5. " # ": The radiated frequency is out of the restricted band.

Below 1GHz Data:

Frequency Range	9kHz ~ 1GHz	Detector Function	Quasi-Peak (QP)
-----------------	-------------	-------------------	-----------------

Antenna Polarity & Test Distance : Horizontal at 3 m								
No	Frequency (MHz)	Emission Level (dBuV/m)	Limit (dBuV/m)	Margin (dB)	Antenna Height (m)	Table Angle (Degree)	Raw Value (dBuV)	Correction Factor (dB/m)
1	143.98	40.0 QP	43.5	-3.5	2.00 H	79	51.8	-11.8
2	165.85	40.0 QP	43.5	-3.5	1.50 H	45	51.9	-11.9
3	239.91	42.8 QP	46.0	-3.2	1.00 H	198	55.7	-12.9
4	299.49	42.5 QP	46.0	-3.5	1.00 H	164	52.9	-10.4
5	697.25	42.9 QP	46.0	-3.1	1.00 H	64	43.3	-0.4
6	720.61	42.7 QP	46.0	-3.3	1.00 H	62	42.8	-0.1

Remarks:

1. Emission Level(dBuV/m) = Raw Value(dBuV) + Correction Factor(dB/m)
2. Correction Factor(dB/m) = Antenna Factor(dB/m) + Cable Factor(dB) – Pre-Amplifier Factor(dB)
3. Margin value = Emission Level – Limit value
4. The other emission levels were very low against the limit of frequency range 30 MHz ~ 1 GHz.
5. The emission levels were very low against the limit of frequency range 9 kHz ~ 30 MHz: the amplitude of spurious emissions attenuated more than 20 dB below the permissible value to be report.

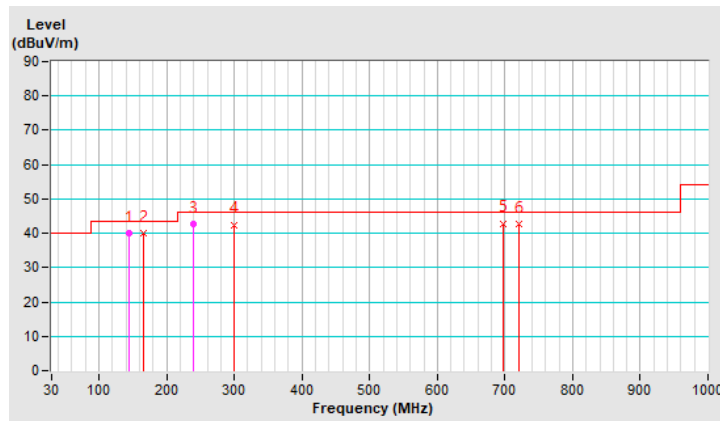

Frequency Range	9kHz ~ 1GHz	Detector Function	Quasi-Peak (QP)
-----------------	-------------	-------------------	-----------------

Antenna Polarity & Test Distance : Vertical at 3 m								
No	Frequency (MHz)	Emission Level (dBuV/m)	Limit (dBuV/m)	Margin (dB)	Antenna Height (m)	Table Angle (Degree)	Raw Value (dBuV)	Correction Factor (dB/m)
1	33.48	31.5 QP	40.0	-8.5	1.00 V	353	44.8	-13.3
2	166.73	40.2 QP	43.5	-3.3	1.00 V	143	52.2	-12.0
3	240.20	37.3 QP	46.0	-8.7	1.50 V	85	50.2	-12.9
4	299.40	42.6 QP	46.0	-3.4	1.00 V	122	53.0	-10.4
5	432.23	32.7 QP	46.0	-13.3	1.50 V	103	38.9	-6.2
6	720.14	41.5 QP	46.0	-4.5	1.00 V	75	41.6	-0.1

Remarks:

1. Emission Level(dBuV/m) = Raw Value(dBuV) + Correction Factor(dB/m)
2. Correction Factor(dB/m) = Antenna Factor(dB/m) + Cable Factor(dB) – Pre-Amplifier Factor(dB)
3. Margin value = Emission Level – Limit value
4. The other emission levels were very low against the limit of frequency range 30 MHz ~ 1 GHz.
5. The emission levels were very low against the limit of frequency range 9 kHz ~ 30 MHz: the amplitude of spurious emissions attenuated more than 20 dB below the permissible value to be report.

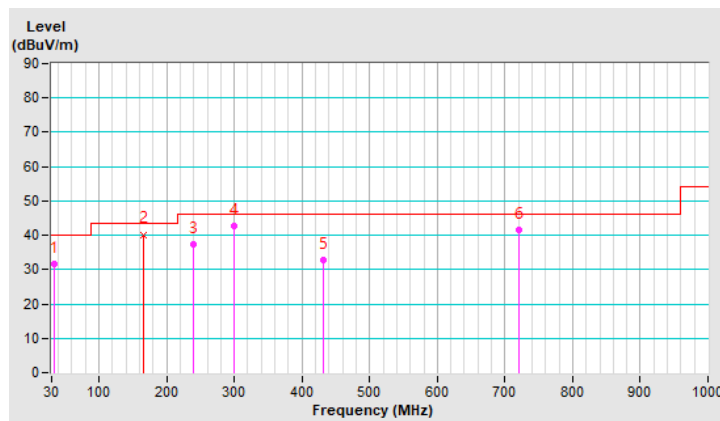

4.1.10 Test Results (Mode 4)

Above 1GHz Data:

Frequency Range	1GHz ~ 40GHz	Detector Function	Peak (PK) Average (AV)
------------------------	--------------	--------------------------	---------------------------

Antenna Polarity & Test Distance : Horizontal at 3 m								
No	Frequency (MHz)	Emission Level (dBuV/m)	Limit (dBuV/m)	Margin (dB)	Antenna Height (m)	Table Angle (Degree)	Raw Value (dBuV)	Correction Factor (dB/m)
1	4824.00	47.8 PK	74.0	-26.2	2.17 H	75	48.0	-0.2
2	4824.00	43.5 AV	54.0	-10.5	2.17 H	75	43.7	-0.2
3	#13490.00	41.7 PK	88.2	-46.5	2.48 H	341	29.3	12.4
4	#13490.00	29.8 AV	68.2	-38.4	2.48 H	341	17.4	12.4
5	20235.00	43.5 PK	74.0	-30.5	1.55 H	102	49.0	-5.5
6	20235.00	33.3 AV	54.0	-20.7	1.55 H	102	38.8	-5.5
7	#26980.00	43.9 PK	88.2	-44.3	2.77 H	190	44.3	-0.4
8	#26980.00	34.3 AV	68.2	-33.9	2.77 H	190	34.7	-0.4
Antenna Polarity & Test Distance : Vertical at 3 m								
No	Frequency (MHz)	Emission Level (dBuV/m)	Limit (dBuV/m)	Margin (dB)	Antenna Height (m)	Table Angle (Degree)	Raw Value (dBuV)	Correction Factor (dB/m)
1	4824.00	46.9 PK	74.0	-27.1	2.03 V	125	47.1	-0.2
2	4824.00	46.4 AV	54.0	-7.6	2.03 V	125	46.6	-0.2
3	#13490.00	42.4 PK	88.2	-45.8	1.11 V	143	30.0	12.4
4	#13490.00	29.6 AV	68.2	-38.6	1.11 V	143	17.2	12.4
5	20235.00	41.8 PK	74.0	-32.2	1.74 V	256	47.3	-5.5
6	20235.00	31.3 AV	54.0	-22.7	1.74 V	256	36.8	-5.5
7	#26980.00	42.0 PK	88.2	-46.2	2.13 V	336	42.4	-0.4
8	#26980.00	33.0 AV	68.2	-35.2	2.13 V	336	33.4	-0.4

Remarks:

1. Emission Level(dBuV/m) = Raw Value(dBuV) + Correction Factor(dB/m)
2. Correction Factor(dB/m) = Antenna Factor(dB/m) + Cable Factor(dB) – Pre-Amplifier Factor(dB)
3. Margin value = Emission Level – Limit value
4. The other emission levels were very low against the limit.
5. " # ": The radiated frequency is out of the restricted band.

Below 1GHz Data:

Frequency Range	9kHz ~ 1GHz	Detector Function	Quasi-Peak (QP)
-----------------	-------------	-------------------	-----------------

Antenna Polarity & Test Distance : Horizontal at 3 m								
No	Frequency (MHz)	Emission Level (dBuV/m)	Limit (dBuV/m)	Margin (dB)	Antenna Height (m)	Table Angle (Degree)	Raw Value (dBuV)	Correction Factor (dB/m)
1	142.16	40.3 QP	43.5	-3.2	1.50 H	89	52.1	-11.8
2	166.23	40.1 QP	43.5	-3.4	1.00 H	68	52.1	-12.0
3	299.96	42.3 QP	46.0	-3.7	1.00 H	176	52.7	-10.4
4	697.03	42.4 QP	46.0	-3.6	1.00 H	73	42.8	-0.4
5	720.29	43.0 QP	46.0	-3.0	1.00 H	85	43.1	-0.1
6	798.31	42.5 QP	46.0	-3.5	1.00 H	103	40.9	1.6

Remarks:

1. Emission Level(dBuV/m) = Raw Value(dBuV) + Correction Factor(dB/m)
2. Correction Factor(dB/m) = Antenna Factor(dB/m) + Cable Factor(dB) – Pre-Amplifier Factor(dB)
3. Margin value = Emission Level – Limit value
4. The other emission levels were very low against the limit of frequency range 30 MHz ~ 1 GHz.
5. The emission levels were very low against the limit of frequency range 9 kHz ~ 30 MHz: the amplitude of spurious emissions attenuated more than 20 dB below the permissible value to be report.

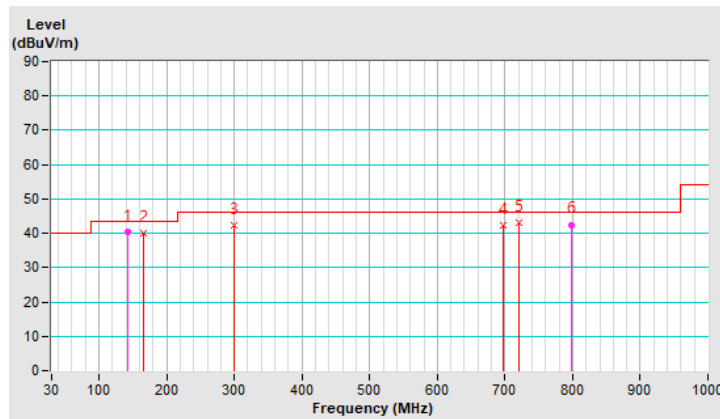

Frequency Range	9kHz ~ 1GHz	Detector Function	Quasi-Peak (QP)
-----------------	-------------	-------------------	-----------------

Antenna Polarity & Test Distance : Vertical at 3 m								
No	Frequency (MHz)	Emission Level (dBuV/m)	Limit (dBuV/m)	Margin (dB)	Antenna Height (m)	Table Angle (Degree)	Raw Value (dBuV)	Correction Factor (dB/m)
1	33.60	31.8 QP	40.0	-8.2	1.00 V	4	45.1	-13.3
2	166.51	40.5 QP	43.5	-3.0	1.00 V	135	52.5	-12.0
3	240.07	37.9 QP	46.0	-8.1	1.50 V	98	50.8	-12.9
4	299.27	42.2 QP	46.0	-3.8	1.00 V	111	52.6	-10.4
5	432.45	33.4 QP	46.0	-12.6	1.50 V	126	39.6	-6.2
6	720.37	41.9 QP	46.0	-4.1	1.00 V	92	42.0	-0.1

Remarks:

1. Emission Level(dBuV/m) = Raw Value(dBuV) + Correction Factor(dB/m)
2. Correction Factor(dB/m) = Antenna Factor(dB/m) + Cable Factor(dB) – Pre-Amplifier Factor(dB)
3. Margin value = Emission Level – Limit value
4. The other emission levels were very low against the limit of frequency range 30 MHz ~ 1 GHz.
5. The emission levels were very low against the limit of frequency range 9 kHz ~ 30 MHz: the amplitude of spurious emissions attenuated more than 20 dB below the permissible value to be report.

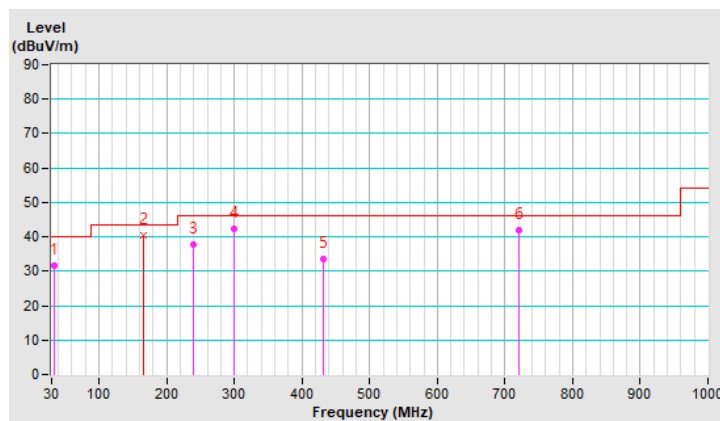

4.2 Conducted Emission Measurement

4.2.1 Limits of Conducted Emission Measurement

Frequency (MHz)	Conducted Limit (dBuV)	
	Quasi-peak	Average
0.15 - 0.5	66 - 56	56 - 46
0.50 - 5.0	56	46
5.0 - 30.0	60	50

Note: 1. The lower limit shall apply at the transition frequencies.

2. The limit decreases in line with the logarithm of the frequency in the range of 0.15 to 0.50MHz.

4.2.2 Test Instruments

Description Manufacturer	Model No.	Serial No.	Calibrated Date	Calibrated Until
50 ohms Terminator	50	3	2021/10/27	2022/10/26
Fixed attenuator STI	STI02-2200-10	005	2021/8/27	2022/8/26
LISN R&S	ESH3-Z5	848773/004	2021/10/29	2022/10/28
RF Coaxial Cable JYEBO	5D-FB	COCCAB-001	2021/9/25	2022/9/24
Software BVADT	BVADT_Cond_V7.3.7.4	N/A	N/A	N/A
TEST RECEIVER R&S	ESCS 30	847124/029	2021/10/13	2022/10/12

Note:

1. The calibration interval of the above test instruments are 12 months and the calibrations are traceable to NML/ROC and NIST/USA.
2. The test was performed in Conduction 1.
- 3 Tested Date: 2022/8/11

4.2.3 Test Procedures

- The EUT was placed 0.4 meters from the conducting wall of the shielded room with EUT being connected to the power mains through a line impedance stabilization network (LISN). Other support units were connected to the power mains through another LISN. The two LISNs provide 50 ohm/ 50uH of coupling impedance for the measuring instrument.
- Both lines of the power mains connected to the EUT were checked for maximum conducted interference.
- The frequency range from 150kHz to 30MHz was searched. Emission levels under (Limit - 20dB) was not recorded.

Note: The resolution bandwidth and video bandwidth of test receiver is 9kHz for quasi-peak detection (QP) and average detection (AV) at frequency 0.15MHz-30MHz.

4.2.4 Deviation from Test Standard

No deviation.

4.2.5 Test Setup

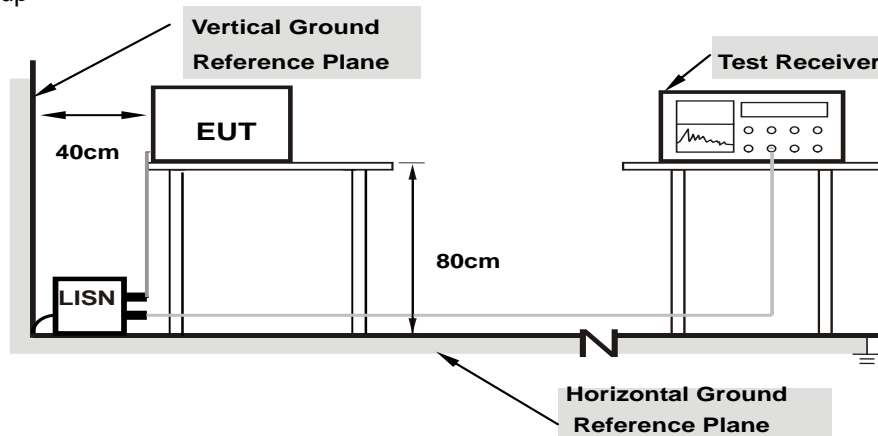

Note: 1.Support units were connected to second LISN.

For the actual test configuration, please refer to the attached file (Test Setup Photo).

4.2.6 EUT Operating Conditions

Same as 4.1.6.

4.2.7 Test Results (Mode 1)

Frequency Range	150kHz ~ 30MHz	Detector Function & Resolution Bandwidth	Quasi-Peak (QP) / Average (AV), 9kHz
------------------------	----------------	-----------------------------------------------------	--------------------------------------

Phase Of Power : Line (L)										
No	Frequency (MHz)	Correction Factor (dB)	Reading Value (dBuV)		Emission Level (dBuV)		Limit (dBuV)		Margin (dB)	
			Q.P.	AV.	Q.P.	AV.	Q.P.	AV.	Q.P.	AV.
1	0.16953	10.05	39.98	29.32	50.03	39.37	64.98	54.98	-14.95	-15.61
2	0.28672	10.06	27.88	9.39	37.94	19.45	60.62	50.62	-22.68	-31.17
3	0.79063	10.09	29.11	16.67	39.20	26.76	56.00	46.00	-16.80	-19.24
4	3.00391	10.21	18.78	13.81	28.99	24.02	56.00	46.00	-27.01	-21.98
5	10.91016	10.67	13.04	7.66	23.71	18.33	60.00	50.00	-36.29	-31.67
6	15.96875	10.98	12.82	7.24	23.80	18.22	60.00	50.00	-36.20	-31.78

Remarks:

1. Q.P. and AV. are abbreviations of quasi-peak and average individually.
2. The emission levels of other frequencies were very low against the limit.
3. Margin value = Emission level – Limit value
4. Correction factor = Insertion loss + Cable loss
5. Emission Level = Correction Factor + Reading Value

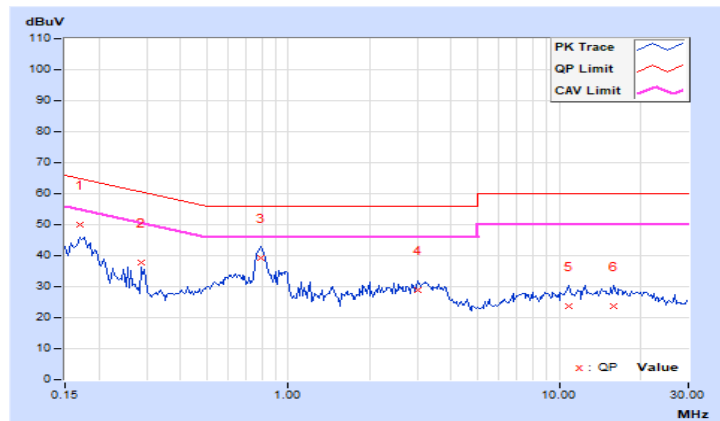

Frequency Range	150kHz ~ 30MHz	Detector Function & Resolution Bandwidth	Quasi-Peak (QP) / Average (AV), 9kHz
------------------------	----------------	-----------------------------------------------------	--------------------------------------

Phase Of Power : Neutral (N)										
No	Frequency (MHz)	Correction Factor (dB)	Reading Value (dBuV)		Emission Level (dBuV)		Limit (dBuV)		Margin (dB)	
			Q.P.	AV.	Q.P.	AV.	Q.P.	AV.	Q.P.	AV.
1	0.15000	10.02	29.16	16.02	39.18	26.04	66.00	56.00	-26.82	-29.96
2	0.17734	10.03	28.16	14.50	38.19	24.53	64.61	54.61	-26.42	-30.08
3	0.21641	10.03	34.39	10.79	44.42	20.82	62.96	52.96	-18.54	-32.14
4	0.79063	10.06	28.75	15.57	38.81	25.63	56.00	46.00	-17.19	-20.37
5	3.06250	10.17	18.76	13.45	28.93	23.62	56.00	46.00	-27.07	-22.38
6	12.48438	10.61	13.11	7.73	23.72	18.34	60.00	50.00	-36.28	-31.66

Remarks:

1. Q.P. and AV. are abbreviations of quasi-peak and average individually.
2. The emission levels of other frequencies were very low against the limit.
3. Margin value = Emission level – Limit value
4. Correction factor = Insertion loss + Cable loss
5. Emission Level = Correction Factor + Reading Value

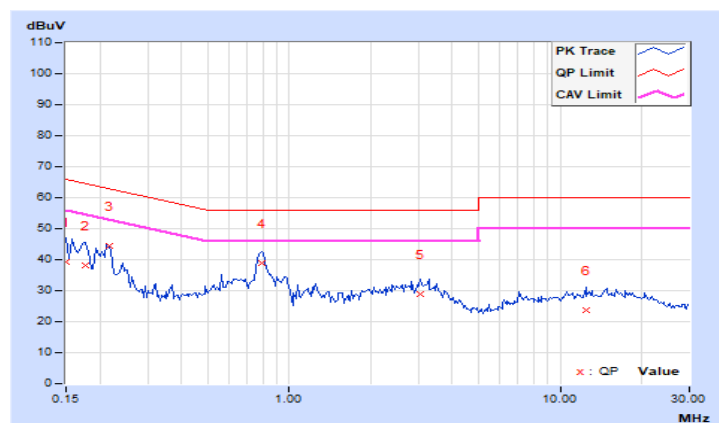

4.2.8 Test Results (Mode 2)

Frequency Range	150kHz ~ 30MHz	Detector Function & Resolution Bandwidth	Quasi-Peak (QP) / Average (AV), 9kHz
------------------------	----------------	-----------------------------------------------------	--------------------------------------

Phase Of Power : Line (L)										
No	Frequency (MHz)	Correction Factor (dB)	Reading Value (dBuV)		Emission Level (dBuV)		Limit (dBuV)		Margin (dB)	
			Q.P.	AV.	Q.P.	AV.	Q.P.	AV.	Q.P.	AV.
1	0.16172	10.05	33.93	18.99	43.98	29.04	65.38	55.38	-21.40	-26.34
2	0.20078	10.05	38.14	17.41	48.19	27.46	63.58	53.58	-15.39	-26.12
3	0.27109	10.06	25.60	8.54	35.66	18.60	61.08	51.08	-25.42	-32.48
4	0.63047	10.08	20.19	10.47	30.27	20.55	56.00	46.00	-25.73	-25.45
5	0.79844	10.10	27.81	16.27	37.91	26.37	56.00	46.00	-18.09	-19.63
6	2.61328	10.19	17.77	11.72	27.96	21.91	56.00	46.00	-28.04	-24.09

Remarks:

1. Q.P. and AV. are abbreviations of quasi-peak and average individually.
2. The emission levels of other frequencies were very low against the limit.
3. Margin value = Emission level – Limit value
4. Correction factor = Insertion loss + Cable loss
5. Emission Level = Correction Factor + Reading Value

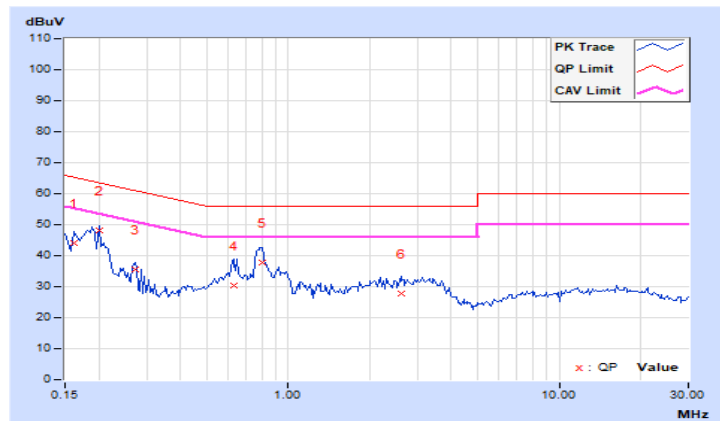

Frequency Range	150kHz ~ 30MHz	Detector Function & Resolution Bandwidth	Quasi-Peak (QP) / Average (AV), 9kHz
------------------------	----------------	-----------------------------------------------------	--------------------------------------

Phase Of Power : Neutral (N)										
No	Frequency (MHz)	Correction Factor (dB)	Reading Value (dBuV)		Emission Level (dBuV)		Limit (dBuV)		Margin (dB)	
			Q.P.	AV.	Q.P.	AV.	Q.P.	AV.	Q.P.	AV.
1	0.17734	10.03	31.02	12.49	41.05	22.52	64.61	54.61	-23.56	-32.09
2	0.21641	10.03	32.59	13.15	42.62	23.18	62.96	52.96	-20.34	-29.78
3	0.23984	10.03	30.15	18.63	40.18	28.66	62.10	52.10	-21.92	-23.44
4	0.79453	10.06	28.43	16.07	38.49	26.13	56.00	46.00	-17.51	-19.87
5	2.51953	10.15	17.71	12.44	27.86	22.59	56.00	46.00	-28.14	-23.41
6	3.47266	10.19	18.10	12.55	28.29	22.74	56.00	46.00	-27.71	-23.26

Remarks:

1. Q.P. and AV. are abbreviations of quasi-peak and average individually.
2. The emission levels of other frequencies were very low against the limit.
3. Margin value = Emission level – Limit value
4. Correction factor = Insertion loss + Cable loss
5. Emission Level = Correction Factor + Reading Value

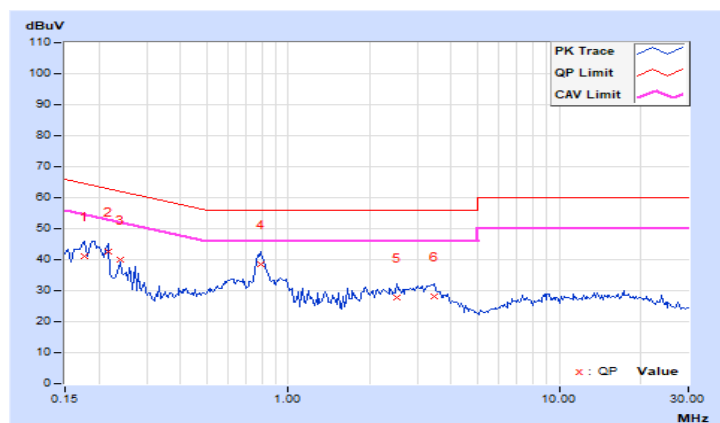

4.2.9 Test Results (Mode 3)

Frequency Range	150kHz ~ 30MHz	Detector Function & Resolution Bandwidth	Quasi-Peak (QP) / Average (AV), 9kHz
------------------------	----------------	-----------------------------------------------------	--------------------------------------

Phase Of Power : Line (L)										
No	Frequency (MHz)	Correction Factor (dB)	Reading Value (dBuV)		Emission Level (dBuV)		Limit (dBuV)		Margin (dB)	
			Q.P.	AV.	Q.P.	AV.	Q.P.	AV.	Q.P.	AV.
1	0.15781	10.05	32.14	15.13	42.19	25.18	65.58	55.58	-23.39	-30.40
2	0.20078	10.05	31.57	14.67	41.62	24.72	63.58	53.58	-21.96	-28.86
3	0.79063	10.09	28.95	16.11	39.04	26.20	56.00	46.00	-16.96	-19.80
4	1.68359	10.14	16.06	10.31	26.20	20.45	56.00	46.00	-29.80	-25.55
5	3.13672	10.22	18.93	13.50	29.15	23.72	56.00	46.00	-26.85	-22.28
6	11.37500	10.70	12.98	7.54	23.68	18.24	60.00	50.00	-36.32	-31.76

Remarks:

1. Q.P. and AV. are abbreviations of quasi-peak and average individually.
2. The emission levels of other frequencies were very low against the limit.
3. Margin value = Emission level – Limit value
4. Correction factor = Insertion loss + Cable loss
5. Emission Level = Correction Factor + Reading Value

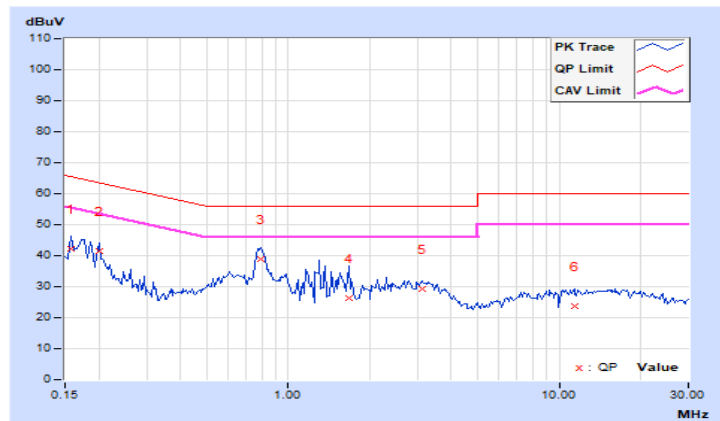

Frequency Range	150kHz ~ 30MHz	Detector Function & Resolution Bandwidth	Quasi-Peak (QP) / Average (AV), 9kHz
------------------------	----------------	-----------------------------------------------------	--------------------------------------

Phase Of Power : Neutral (N)										
No	Frequency (MHz)	Correction Factor (dB)	Reading Value (dBuV)		Emission Level (dBuV)		Limit (dBuV)		Margin (dB)	
			Q.P.	AV.	Q.P.	AV.	Q.P.	AV.	Q.P.	AV.
1	0.15000	10.02	31.24	13.12	41.26	23.14	66.00	56.00	-24.74	-32.86
2	0.18906	10.03	33.24	12.77	43.27	22.80	64.08	54.08	-20.81	-31.28
3	0.24375	10.03	28.75	19.10	38.78	29.13	61.97	51.97	-23.19	-22.84
4	0.77891	10.06	26.43	15.30	36.49	25.36	56.00	46.00	-19.51	-20.64
5	2.00391	10.13	17.18	12.09	27.31	22.22	56.00	46.00	-28.69	-23.78
6	14.21484	10.69	13.63	8.21	24.32	18.90	60.00	50.00	-35.68	-31.10

Remarks:

1. Q.P. and AV. are abbreviations of quasi-peak and average individually.
2. The emission levels of other frequencies were very low against the limit.
3. Margin value = Emission level – Limit value
4. Correction factor = Insertion loss + Cable loss
5. Emission Level = Correction Factor + Reading Value

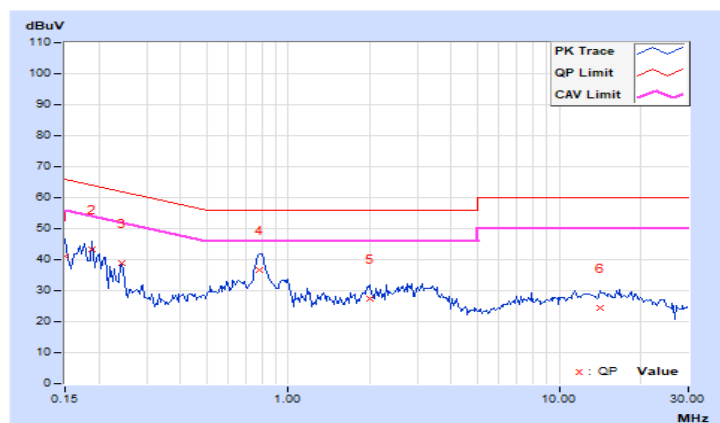

4.2.10 Test Results (Mode 4)

Frequency Range	150kHz ~ 30MHz	Detector Function & Resolution Bandwidth	Quasi-Peak (QP) / Average (AV), 9kHz
------------------------	----------------	-----------------------------------------------------	--------------------------------------

Phase Of Power : Line (L)										
No	Frequency (MHz)	Correction Factor (dB)	Reading Value (dBuV)		Emission Level (dBuV)		Limit (dBuV)		Margin (dB)	
			Q.P.	AV.	Q.P.	AV.	Q.P.	AV.	Q.P.	AV.
1	0.15000	10.05	29.14	13.18	39.19	23.23	66.00	56.00	-26.81	-32.77
2	0.20469	10.05	39.51	16.65	49.56	26.70	63.42	53.42	-13.86	-26.72
3	0.28281	10.06	24.73	7.78	34.79	17.84	60.73	50.73	-25.94	-32.89
4	0.61484	10.08	17.86	9.51	27.94	19.59	56.00	46.00	-28.06	-26.41
5	0.79453	10.09	29.03	16.81	39.12	26.90	56.00	46.00	-16.88	-19.10
6	2.61719	10.19	17.89	11.68	28.08	21.87	56.00	46.00	-27.92	-24.13

Remarks:

1. Q.P. and AV. are abbreviations of quasi-peak and average individually.
2. The emission levels of other frequencies were very low against the limit.
3. Margin value = Emission level – Limit value
4. Correction factor = Insertion loss + Cable loss
5. Emission Level = Correction Factor + Reading Value

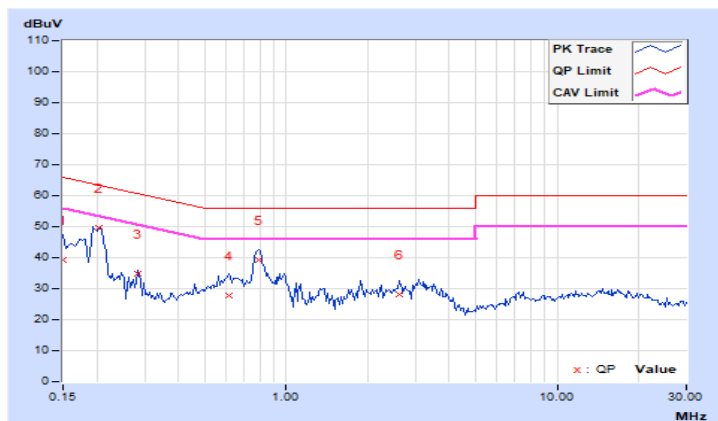

Frequency Range	150kHz ~ 30MHz	Detector Function & Resolution Bandwidth	Quasi-Peak (QP) / Average (AV), 9kHz
------------------------	----------------	-----------------------------------------------------	--------------------------------------

Phase Of Power : Neutral (N)										
No	Frequency (MHz)	Correction Factor (dB)	Reading Value (dBuV)		Emission Level (dBuV)		Limit (dBuV)		Margin (dB)	
			Q.P.	AV.	Q.P.	AV.	Q.P.	AV.	Q.P.	AV.
1	0.17734	10.03	34.81	30.22	44.84	40.25	64.61	54.61	-19.77	-14.36
2	0.19687	10.03	40.82	23.46	50.85	33.49	63.74	53.74	-12.89	-20.25
3	0.24375	10.03	28.50	19.68	38.53	29.71	61.97	51.97	-23.44	-22.26
4	0.79063	10.06	28.77	15.52	38.83	25.58	56.00	46.00	-17.17	-20.42
5	3.26563	10.18	18.77	13.40	28.95	23.58	56.00	46.00	-27.05	-22.42
6	10.39453	10.51	13.17	8.01	23.68	18.52	60.00	50.00	-36.32	-31.48

Remarks:

1. Q.P. and AV. are abbreviations of quasi-peak and average individually.
2. The emission levels of other frequencies were very low against the limit.
3. Margin value = Emission level – Limit value
4. Correction factor = Insertion loss + Cable loss
5. Emission Level = Correction Factor + Reading Value

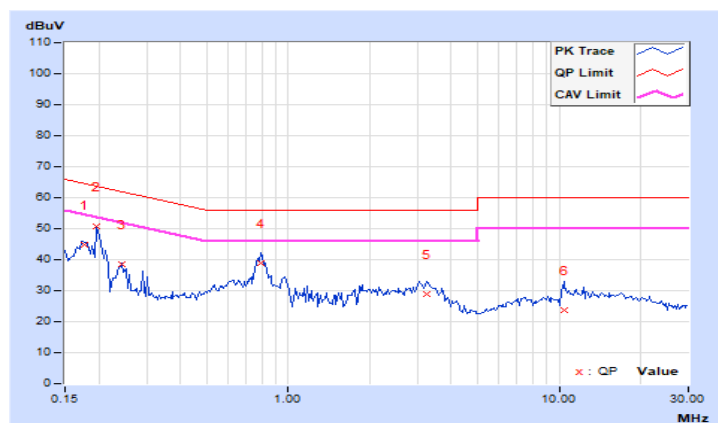

4.3 Conducted Out of Band Emission Measurement

4.3.1 Limits of Conducted Out of Band Emission Measurement

Below 30dB of the highest emission level of operating band (in 100kHz Resolution Bandwidth).

4.3.2 Test Setup

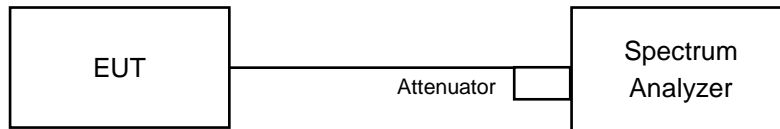

4.3.3 Test Instruments

Refer to section 4.1.2 to get information of above instrument.

4.3.4 Test Procedures

MEASUREMENT PROCEDURE REF

1. Set the RBW = 100 kHz.
2. Set the VBW \geq 300 kHz.
3. Detector = peak.
4. Sweep time = auto couple.
5. Trace mode = max hold.
6. Allow trace to fully stabilize.
7. Use the peak marker function to determine the maximum power level in any 100 kHz band segment within the fundamental EBW.

MEASUREMENT PROCEDURE OOBE

1. Set RBW = 100 kHz.
2. Set VBW \geq 300 kHz.
3. Detector = peak.
4. Sweep = auto couple.
5. Trace Mode = max hold.
6. Allow trace to fully stabilize.
7. Use the peak marker function to determine the maximum amplitude level.

4.3.5 Deviation from Test Standard

No deviation.

4.3.6 EUT Operating Conditions

The software provided by client to enable the EUT under transmission condition continuously at specific channel frequencies individually.

4.3.7 Test Results

The spectrum plots are attached on the following pages. D1 line indicates the highest level, and D2 line indicates the 30dB offset below D1. It shows compliance with the requirement.

Mode 1: 5GHz_ 802.11be (EHT40) CH159 + BT-LE CH0

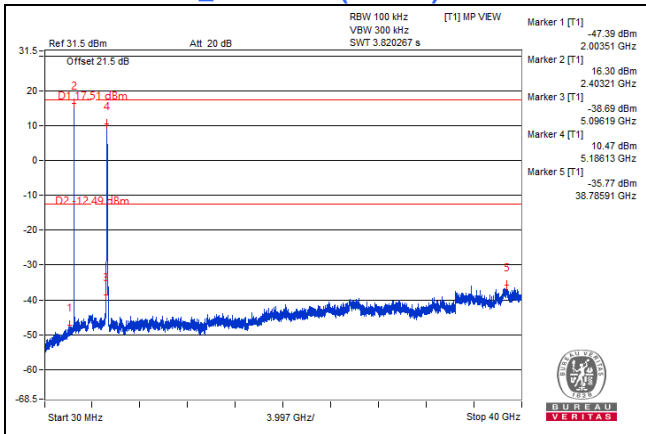

Mode 2:

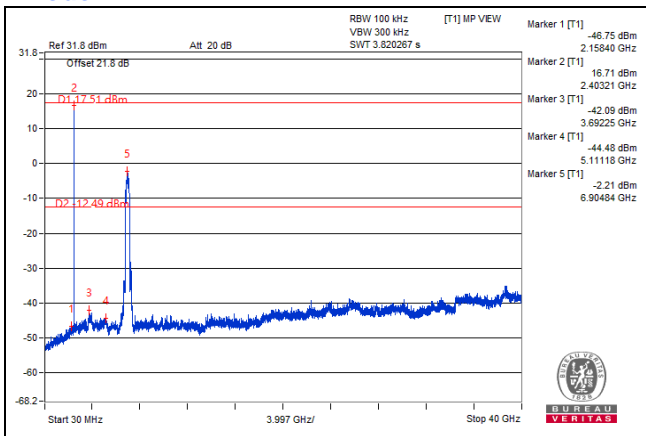

6GHz_ 802.11be (EHT320) CH143 + BT-LE CH0

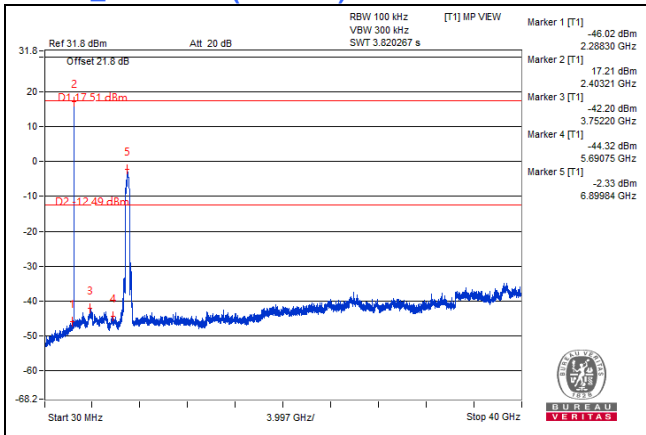

Mode 3: 2.4GHz_802.11b CH1 + 5GHz_802.11be (EHT40) CH159

Chain 0

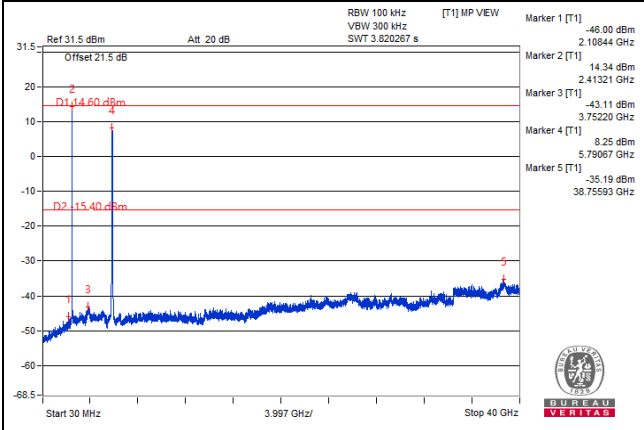

Chain 1

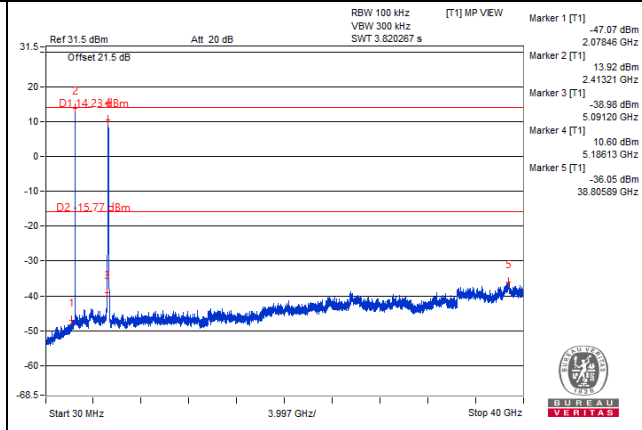

Mode 4:

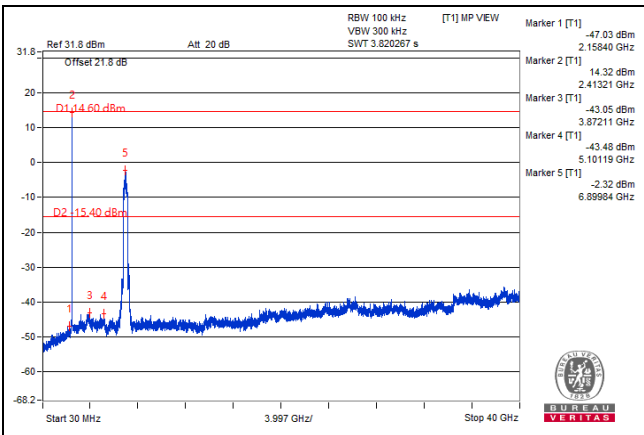

2.4GHz_802.11b CH1 + 6GHz_802.11be (EHT320) CH143

Chain 0

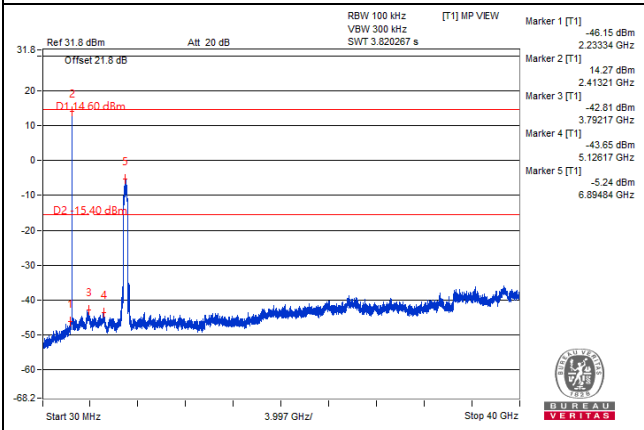

Chain 1

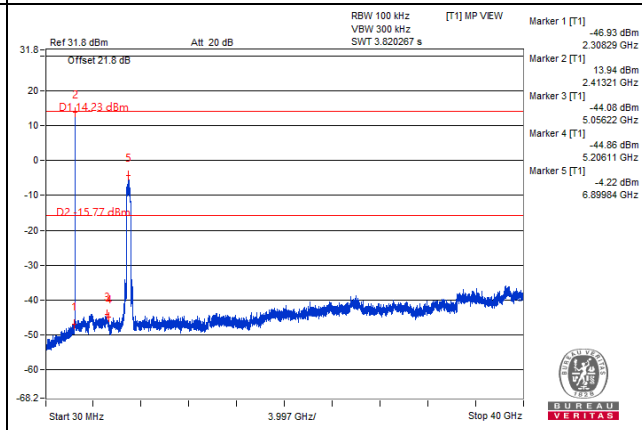

5 Pictures of Test Arrangements

Please refer to the attached file (Test Setup Photo).

Appendix – Information of the Testing Laboratories

We, Bureau Veritas Consumer Products Services (H.K.) Ltd., Taoyuan Branch, were founded in 1988 to provide our best service in EMC, Radio, Telecom and Safety consultation. Our laboratories are FCC recognized accredited test firms and accredited according to ISO/IEC 17025.

If you have any comments, please feel free to contact us at the following:

Lin Kou EMC/RF Lab

Tel: 886-2-26052180

Fax: 886-2-26051924

Hsin Chu EMC/RF/Telecom Lab

Tel: 886-3-6668565

Fax: 886-3-6668323

Hwa Ya EMC/RF/Safety Lab

Tel: 886-3-3183232

Fax: 886-3-3270892

Email: service.adt@tw.bureauveritas.com

Web Site: www.bureauveritas-adt.com

The address and road map of all our labs can be found in our web site also.

--- END ---