

# TEST REPORT

## CERTIFICATE OF CONFORMITY

**Standard:** 47 CFR FCC Part 15, Subpart C (Section 15.247)  
**Report No.:** RFBARR-WTW-P23110067  
**FCC ID:** RAS-MT7925B14L  
**Product:** 2TX 11be (WiFi7) BW160 + BT/BLE Combo Card  
**Brand:** MediaTek  
**Model No.:** MT7925B14L  
**Received Date:** 2023/11/6  
**Test Date:** 2023/12/4 ~ 2024/1/15  
**Issued Date:** 2024/2/22

**Applicant:** MediaTek Inc.  
**Address:** No. 1, Dusing 1st Rd., Hsinchu Science Park, Hsinchu City, 30078 Taiwan  
**Issued By:** Bureau Veritas Consumer Products Services (H.K.) Ltd., Taoyuan Branch  
Hsin Chu Laboratory  
**Lab Address:** E-2, No.1, Li Hsin 1st Road, Hsinchu Science Park, Hsinchu City 300, Taiwan  
**Test Location:** E-2, No.1, Li Hsin 1st Road, Hsinchu Science Park, Hsinchu City 300, Taiwan  
**FCC Registration /** 723255 / TW2022  
**Designation Number:**

Approved by: \_\_\_\_\_



, Date: \_\_\_\_\_

2024/2/22

Wen Yu / Assistant Manager

This test report consists of 455 pages in total. It may be duplicated completely for legal use with the approval of the applicant. It should not be reproduced except in full, without the written approval of our laboratory. The test results in the report only apply to the tested sample. The test results in this report are traceable to the national or international standards.



Prepared by : Phoenix Huang / Specialist

This report is governed by, and incorporates by reference, the Conditions of Testing as posted at the date of issuance of this report at <http://www.bureauveritas.com/home/about-us/our-business/cps/about-us/terms-conditions/> and is intended for your exclusive use. Any copying or replication of this report to or for any other person or entity, or use of our name or trademark, is permitted only with our prior written permission. This report sets forth our findings solely with respect to the test samples identified herein. The results set forth in this report are not indicative or representative of the quality or characteristics of the lot from which a test sample was taken or any similar or identical product unless specifically and expressly noted. Our report includes all of the tests requested by you and the results thereof based upon the information that you provided to us. Measurement uncertainty is only provided upon request for accredited tests. Statements of conformity are based on simple acceptance criteria without taking measurement uncertainty into account, unless otherwise requested in writing. You have 60 days from date of issuance of this report to notify us of any material error or omission caused by our negligence or if you require measurement uncertainty; provided, however, that such notice shall be in writing and shall specifically address the issue you wish to raise. A failure to raise such issue within the prescribed time shall constitute your unqualified acceptance of the completeness of this report, the tests conducted and the correctness of the report contents.

## Table of Contents

<b>Release Control Record</b> .....	<b>4</b>
<b>1 Certificate</b> .....	<b>5</b>
<b>2 Summary of Test Results</b> .....	<b>6</b>
2.1 Measurement Uncertainty .....	6
2.2 Supplementary Information .....	6
<b>3 General Information</b> .....	<b>7</b>
3.1 General Description .....	7
3.2 Antenna Description of EUT .....	8
3.3 Channel List .....	10
3.4 Test Mode Applicability and Tested Channel Detail .....	11
3.5 Duty Cycle of Test Signal .....	14
3.6 Test Program Used and Operation Descriptions .....	20
3.7 Connection Diagram of EUT and Peripheral Devices .....	20
3.8 Configuration of Peripheral Devices and Cable Connections .....	21
<b>4 Test Instruments</b> .....	<b>22</b>
4.1 RF Output Power .....	22
4.2 Power Spectral Density .....	22
4.3 6 dB Bandwidth .....	22
4.4 Conducted Out of Band Emissions .....	22
4.5 AC Power Conducted Emissions .....	22
4.6 Unwanted Emissions below 1 GHz .....	23
4.7 Unwanted Emissions above 1 GHz .....	24
<b>5 Limits of Test Items</b> .....	<b>25</b>
5.1 RF Output Power .....	25
5.2 Power Spectral Density .....	25
5.3 6 dB Bandwidth .....	25
5.4 Conducted Out of Band Emissions .....	25
5.5 AC Power Conducted Emissions .....	25
5.6 Unwanted Emissions below 1 GHz .....	26
5.7 Unwanted Emissions above 1 GHz .....	26
<b>6 Test Arrangements</b> .....	<b>27</b>
6.1 RF Output Power .....	27
6.1.1 Test Setup .....	27
6.1.2 Test Procedure .....	27
6.2 Power Spectral Density .....	27
6.2.1 Test Setup .....	27
6.2.2 Test Procedure .....	27
6.3 6 dB Bandwidth .....	28
6.3.1 Test Setup .....	28
6.3.2 Test Procedure .....	28
6.4 Conducted Out of Band Emissions .....	28
6.4.1 Test Setup .....	28
6.4.2 Test Procedure .....	28
6.5 AC Power Conducted Emissions .....	29
6.5.1 Test Setup .....	29
6.5.2 Test Procedure .....	29
6.6 Unwanted Emissions below 1 GHz .....	30
6.6.1 Test Setup .....	30
6.6.2 Test Procedure .....	31
6.7 Unwanted Emissions above 1 GHz .....	33
6.7.1 Test Setup .....	33
6.7.2 Test Procedure .....	33
<b>7 Test Results of Test Item</b> .....	<b>35</b>



7.1	RF Output Power.....	35
7.2	Power Spectral Density.....	43
7.3	6 dB Bandwidth.....	52
7.4	Conducted Out of Band Emissions.....	60
7.5	AC Power Conducted Emissions.....	84
7.6	Unwanted Emissions below 1 GHz.....	88
7.7	Unwanted Emissions above 1 GHz.....	94
<b>8</b>	<b>Pictures of Test Arrangements.....</b>	<b>454</b>
<b>9</b>	<b>Information of the Testing Laboratories.....</b>	<b>455</b>

## Release Control Record

Issue No.	Description	Date Issued
RFBARR-WTW-P23110067	Original release.	2024/2/22

## 1 Certificate

**Product:** 2TX 11be (WiFi7) BW160 + BT/BLE Combo Card

**Brand:** MediaTek

**Test Model:** MT7925B14L

**Sample Status:** Engineering sample

**Applicant:** MediaTek Inc.

**Test Date:** 2023/12/4 ~ 2024/1/15

**Standard:** 47 CFR FCC Part 15, Subpart C (Section 15.247)

**Measurement** ANSI C63.10-2013

**procedure:** KDB 558074 D01 15.247 Meas Guidance v05r02

KDB 662911 D01 Multiple Transmitter Output v02r01

The above equipment has been tested by **Bureau Veritas Consumer Products Services (H.K.) Ltd., Taoyuan Branch**, and found compliance with the requirement of the above standards. The test record, data evaluation & Equipment Under Test (EUT) configurations represented herein are true and accurate accounts of the measurements of the sample's RF characteristics under the conditions specified in this report.

## 2 Summary of Test Results

47 CFR FCC Part 15, Subpart C (Section 15.247)			
Standard / Clause	Test Item	Result	Remark
15.247(b)	RF Output Power	Pass	Meet the requirement of limit.
15.247(e)	Power Spectral Density	Pass	Meet the requirement of limit.
15.247(a)(2)	6 dB Bandwidth	Pass	Meet the requirement of limit.
15.247(d)	Conducted Out of Band Emissions	Pass	Meet the requirement of limit.
15.207	AC Power Conducted Emissions	Pass	Minimum passing margin is -10.81 dB at 0.16562 MHz
15.205 / 15.209 / 15.247(d)	Unwanted Emissions below 1 GHz	Pass	Minimum passing margin is -0.6 dB at 696.34 MHz
15.205 / 15.209 / 15.247(d)	Unwanted Emissions above 1 GHz	Pass	Minimum passing margin is -0.01 dB at 2483.5 MHz
15.203	Antenna Requirement	Pass	Antenna connector is i-pex(MHF) not a standard connector.

Note: Determining compliance based on the results of the compliance measurement, not taking into account measurement instrumentation uncertainty.

### 2.1 Measurement Uncertainty

Where relevant, the following measurement uncertainty levels have been estimated for tests performed on the EUT as specified in CISPR 16-4-2:

Measurement	Specification	Expanded Uncertainty (k=2) (±)
RF Output Power	-	1.1 dB
Power Spectral Density	-	1.3 dB
6 dB Bandwidth	-	1050.00 Hz
Conducted Out of Band Emissions	9 kHz ~ 40 GHz	2.6 dB
AC Power Conducted Emissions	150 kHz ~ 30 MHz	1.9 dB
Unwanted Emissions below 1 GHz	9 kHz ~ 30 MHz	3.1 dB
	30 MHz ~ 1 GHz	5.5 dB
Unwanted Emissions above 1 GHz	1 GHz ~ 18 GHz	5.1 dB
	18 GHz ~ 40 GHz	5.3 dB

The other instruments specified are routine verified to remain within the calibrated levels, no measurement uncertainty is required to be calculated.

### 2.2 Supplementary Information

There is not any deviation from the test standards for the test method, and no modifications required for compliance.

### 3 General Information

#### 3.1 General Description

Product	2TX 11be (WiFi7) BW160 + BT/BLE Combo Card
Brand	MediaTek
Test Model	MT7925B14L
Status of EUT	Engineering sample
Power Supply Rating	3.3 Vdc from host equipment
Modulation Type	CCK, DQPSK, DBPSK for DSSS 64QAM, 16QAM, QPSK, BPSK for OFDM 256QAM for OFDM in VHT mode 1024QAM for OFDMA in 11ax mode 4096QAM for OFDMA in 11be mode
Modulation Technology	DSSS, OFDM, OFDMA
Transfer Rate	802.11b: up to 11 Mbps 802.11g: up to 54 Mbps 802.11n: up to 300 Mbps VHT: up to 400 Mbps 802.11ax: up to 573.5 Mbps 802.11be: up to 688.2 Mbps
Operating Frequency	2.412 GHz ~ 2.472 GHz
Number of Channel	802.11b, 802.11g, 802.11n (HT20), VHT20, 802.11ax (HE20), 802.11be (EHT20): 13 802.11n (HT40), VHT40, 802.11ax (HE40), 802.11be (EHT40): 9
Resource Unit (RU)	Single RU: 26-tone, 52-tone, 106-tone, 242-tone, 484-tone Multi-RU (Small RU): 52-tone + 26-tone, 106-tone + 26-tone
Output Power	<b>1TX</b> : 259.418 mW (24.14 dBm) <b>2TX</b> : 303.063 mW (24.82 dBm)

Note:

1. There are Bluetooth and WLAN (2.4 GHz & 5 GHz & 5.9 GHz & 6 GHz) technology used for the EUT.
2. Simultaneously transmission condition.

Condition	Technology	
1	WLAN (5 GHz) (2TX)	Bluetooth
2	WLAN (5.9 GHz) (2TX)	Bluetooth
3	WLAN (6 GHz) (2TX)	Bluetooth
4	WLAN (2.4 GHz) (1TX)	WLAN (5 GHz) (1TX)
5	WLAN (2.4 GHz) (1TX)	WLAN (5.9 GHz) (1TX)
6	WLAN (2.4 GHz) (1TX)	WLAN (6 GHz) (1TX)

Note: The emission of the simultaneous operation has been evaluated and no non-compliance was found.

3. The EUT support OFDMA and Partial RU mode, therefore partial RU combination were investigated and the worst case scenario was identified.
4. The EUT support MRU mode is listed as below.

BW	Small size	
	52+26-tone MRU	106+26-tone MRU
20MHz	v	v
40MHz	v	v

5. The above EUT information is declared by manufacturer and for more detailed features description, please refer to the manufacturer's specifications or user's manual.

### 3.2 Antenna Description of EUT

1. The antenna information is listed as below.

Antenna Set	RF Chain No.	Brand	Model	Antenna Net Gain (dBi)	Frequency Range (GHz)	Antenna Type	Connector Type	Cable Length (mm)
1	Chain0	PSA	RFMTA340718EMLB302	3.18 4.92	2.4~2.4835 5.15~5.895	PIFA	i-pex(MHF)	200
	Chain1	PSA	RFMTA340718EMLB302	3.18 4.92	2.4~2.4835 5.15~5.895	PIFA	i-pex(MHF)	200
2	Chain0	PSA	RFMTA311020EMMB301	1.71 4.82 4.76 4.29 4.61 4.09	2.4~2.4835 5.15~5.895 5.925~6.425 6.425~6.525 6.525~6.875 6.875~7.125	PIFA	i-pex(MHF)	200
	Chain1	PSA	RFMTA311020EMMB301	1.71 4.82 4.76 4.29 4.61 4.09	2.4~2.4835 5.15~5.895 5.925~6.425 6.425~6.525 6.525~6.875 6.875~7.125	PIFA	i-pex(MHF)	200
3	Chain0	PSA	RFMTA421230IMMB701	-13.92 -13.91 -13.91 -14.46	5.925~6.425 6.425~6.525 6.525~6.875 6.875~7.125	PIFA	i-pex(MHF)	300
	Chain1	PSA	RFMTA421230IMMB701	-13.92 -13.91 -13.91 -14.46	5.925~6.425 6.425~6.525 6.525~6.875 6.875~7.125	PIFA	i-pex(MHF)	300

Note: Max. gain was selected for the final test.

\* Detail antenna specification please refer to antenna datasheet and/or antenna measurement report.



2. The EUT incorporates a MIMO function:

2.4 GHz Band					
Modulation Mode	TX & RX Configuration		CDD Mode	Beamforming Mode	
802.11b	SIMO	1TX (Diversity)	2RX	Not Support	Not Support
802.11g		1TX (Diversity)	2RX	Not Support	Not Support
802.11n (HT20)		1TX (Diversity)	2RX	Not Support	Not Support
802.11n (HT40)		1TX (Diversity)	2RX	Not Support	Not Support
VHT20		1TX (Diversity)	2RX	Not Support	Not Support
VHT40		1TX (Diversity)	2RX	Not Support	Not Support
802.11ax (HE20)		1TX (Diversity)	2RX	Not Support	Not Support
802.11ax (HE40)		1TX (Diversity)	2RX	Not Support	Not Support
802.11be (EHT20)		1TX (Diversity)	2RX	Not Support	Not Support
802.11be (EHT40)		1TX (Diversity)	2RX	Not Support	Not Support
802.11ax (RU26/52/106/242/484)		1TX (Diversity)	2RX	Not Support	Not Support
802.11be (RU26/52/106/242/484 MRU52+26/106+26)		1TX (Diversity)	2RX	Not Support	Not Support
802.11b		MIMO	2TX	2RX	Support
802.11g	2TX		2RX	Support NSS2	Not Support
802.11n (HT20)	2TX		2RX	Support NSS2	Not Support
802.11n (HT40)	2TX		2RX	Support NSS2	Not Support
VHT20	2TX		2RX	Support NSS2	Not Support
VHT40	2TX		2RX	Support NSS2	Not Support
802.11ax (HE20)	2TX		2RX	Support NSS2	Not Support
802.11ax (HE40)	2TX		2RX	Support NSS2	Not Support
802.11be (EHT20)	2TX		2RX	Support NSS2	Not Support
802.11be (EHT40)	2TX		2RX	Support NSS2	Not Support
802.11ax (RU26/52/106/242/484)	2TX		2RX	Support NSS2	Not Support
802.11be (RU26/52/106/242/484 MRU52+26/106+26)	2TX		2RX	Support NSS2	Not Support

Note: The modulation and bandwidth are similar for 802.11n mode for 20 MHz (40 MHz), VHT mode for 20 MHz (40 MHz), 802.11ax mode for 20 MHz (40 MHz) and 802.11be mode for 20 MHz (40 MHz) therefore the manufacturer will control the power for 802.11n/VHT/ax mode is same as the 802.11be mode or more lower than it and investigated worst case to representative mode in test report.

### 3.3 Channel List

13 channels are provided for 802.11b, 802.11g, 802.11n (HT20), VHT20, 802.11ax (HE20), 802.11be (EHT20):

Channel	Frequency	Channel	Frequency
1	2412 MHz	8	2447 MHz
2	2417 MHz	9	2452 MHz
3	2422 MHz	10	2457 MHz
4	2427 MHz	11	2462 MHz
5	2432 MHz	12	2467 MHz
6	2437 MHz	13	2472 MHz
7	2442 MHz		

9 channels are provided for 802.11n (HT40), VHT40, 802.11ax (HE40), 802.11be (EHT40):

Channel	Frequency	Channel	Frequency
3	2422 MHz	8	2447 MHz
4	2427 MHz	9	2452 MHz
5	2432 MHz	10	2457 MHz
6	2437 MHz	11	2462 MHz
7	2442 MHz		

### 3.4 Test Mode Applicability and Tested Channel Detail

Pre-Scan:	<ol style="list-style-type: none"> <li>For 1Tx diversity configuration. Pre-scan in these chain 0 and chain 1 and find the worst case as a representative test condition.</li> <li>The worst-case Partial RU modes across all supported bandwidth modes has been determined via pre-scan.</li> <li>Pre-Scan has been conducted to determine the worst-case mode from all possible combinations between available modulations and data rates.</li> </ol>
Worst Case:	<ol style="list-style-type: none"> <li>For 1Tx diversity configuration the worst chain is: Chain 0</li> <li>The worst case occurs in 20 MHz bandwidth (RU 26/52/106).</li> </ol>

Following channel(s) was (were) selected for the final test as listed below:

Test Item	EUT Configure Mode	Mode	Signal Mode	Tested Channel	Modulation	Data Rate Parameter	RU/MRU Index
RF Output Power	A	802.11b	1TX / 2TX	1, 6, 11, 12, 13	DBPSK	1Mb/s	NA
		802.11g	1TX / 2TX	1, 6, 11, 12, 13	BPSK	6Mb/s	NA
		VHT20	1S1T / 2S2T	1, 6, 11, 12, 13	BPSK	MCS0	NA
		VHT40	1S1T / 2S2T	3, 6, 9, 10, 11	BPSK	MCS0	NA
		802.11ax (HE20)	1S1T / 2S2T	1, 6, 11, 12, 13	BPSK	MCS0	NA
		802.11ax (HE40)	1S1T / 2S2T	3, 6, 9, 10, 11	BPSK	MCS0	NA
		802.11be (EHT20)	1S1T / 2S2T	1, 6, 11, 12, 13	BPSK	MCS0	NA
		802.11be (EHT40)	1S1T / 2S2T	3, 6, 9, 10, 11	BPSK	MCS0	NA
		802.11be (EHT20) 26-tone RU	1S1T / 2S2T	1, 6, 11, 12, 13	BPSK	MCS0	0, 0, 8, 8, 8
		802.11be (EHT20) 52-tone RU	1S1T / 2S2T	1, 6, 11, 12, 13	BPSK	MCS0	37, 37, 40, 40, 40
		802.11be (EHT20) 106-tone RU	1S1T / 2S2T	1, 6, 11, 12, 13	BPSK	MCS0	53, 53, 54, 54, 54
		802.11be (EHT20) 52+26-tone MRU	1S1T / 2S2T	1, 6, 11, 12, 13	BPSK	MCS0	70, 70, 72, 72, 72
		802.11be (EHT20) 106+26-tone MRU	1S1T / 2S2T	1, 6, 11, 12, 13	BPSK	MCS0	82, 82, 83, 83, 83

Test Item	EUT Configure Mode	Mode	Signal Mode	Tested Channel	Modulation	Data Rate Parameter	RU/MRU Index
Power Spectral Density / 6 dB Bandwidth	A	802.11b	1TX / 2TX	1, 6, 11, 12, 13	DBPSK	1Mb/s	NA
		802.11g	1TX / 2TX	1, 6, 11, 12, 13	BPSK	6Mb/s	NA
		802.11be (EHT20)	1S1T / 2S2T	1, 6, 11, 12, 13	BPSK	MCS0	NA
		802.11be (EHT40)	1S1T / 2S2T	3, 6, 9, 10, 11	BPSK	MCS0	NA
		802.11be (EHT20) 26-tone RU	1S1T / 2S2T	1, 6, 11, 12, 13	BPSK	MCS0	0, 0, 8, 8, 8
		802.11be (EHT20) 52-tone RU	1S1T / 2S2T	1, 6, 11, 12, 13	BPSK	MCS0	37, 37, 40, 40, 40
		802.11be (EHT20) 106-tone RU	1S1T / 2S2T	1, 6, 11, 12, 13	BPSK	MCS0	53, 53, 54, 54, 54
		802.11be (EHT20) 52+26-tone MRU	1S1T / 2S2T	1, 6, 11, 12, 13	BPSK	MCS0	70, 70, 72, 72, 72
		802.11be (EHT20) 106+26-tone MRU	1S1T / 2S2T	1, 6, 11, 12, 13	BPSK	MCS0	82, 82, 83, 83, 83
Conducted Out of Band Emissions	A	802.11b	1TX / 2TX	1, 6, 11, 12, 13	DBPSK	1Mb/s	NA
		802.11g	1TX / 2TX	1, 6, 11, 12, 13	BPSK	6Mb/s	NA
		802.11be (EHT20)	1S1T / 2S2T	1, 6, 11, 12, 13	BPSK	MCS0	NA
		802.11be (EHT40)	1S1T / 2S2T	3, 6, 9, 10, 11	BPSK	MCS0	NA
AC Power Conducted Emissions	C	802.11b	1TX	6	DBPSK	1Mb/s	NA
			2TX	1	DBPSK	1Mb/s	NA
Unwanted Emissions below 1 GHz	A, B	802.11b	1TX	6	DBPSK	1Mb/s	NA
			2TX	1	DBPSK	1Mb/s	NA

Test Item	EUT Configure Mode	Mode	Signal Mode	Tested Channel	Modulation	Data Rate Parameter	RU/MRU Index
Unwanted Emissions above 1 GHz	A, B	802.11b	1TX / 2TX	1, 6, 11, 12, 13	DBPSK	1Mb/s	NA
		802.11g	1TX / 2TX	1, 6, 11, 12, 13	BPSK	6Mb/s	NA
		802.11be (EHT20)	1S1T / 2S2T	1, 6, 11, 12, 13	BPSK	MCS0	NA
		802.11be (EHT40)	1S1T / 2S2T	3, 6, 9, 10, 11	BPSK	MCS0	NA
		802.11be (EHT20) 26-tone RU	1S1T / 2S2T	1, 6, 11, 12, 13	BPSK	MCS0	0, 0, 8, 8, 8
		802.11be (EHT20) 52-tone RU	1S1T / 2S2T	1, 6, 11, 12, 13	BPSK	MCS0	37, 37, 40, 40, 40
		802.11be (EHT20) 106-tone RU	1S1T / 2S2T	1, 6, 11, 12, 13	BPSK	MCS0	53, 53, 54, 54, 54
		802.11be (EHT20) 52+26-tone MRU	1S1T / 2S2T	1, 6, 11, 12, 13	BPSK	MCS0	70, 70, 72, 72, 72
		802.11be (EHT20) 106+26-tone MRU	1S1T / 2S2T	1, 6, 11, 12, 13	BPSK	MCS0	82, 82, 83, 83, 83
EUT Configure Mode:	A	EUT only (remove 50 ohm terminator and Connect to the appropriate equipment)					
	B	EUT with 50 ohm terminator.					
	C	EUT with antenna					
Note: Channel puncturing mechanism is not supported.							

### 3.5 Duty Cycle of Test Signal

**802.11b 1TX:** Duty cycle = 12.145 ms / 12.308 ms x 100% = 98.7%

**802.11g 1TX:** Duty cycle = 2.016 ms / 2.125 ms x 100% = 94.9%, duty factor =  $10 * \log (1/\text{Duty cycle}) = 0.23$  dB

**VHT20 1S1T:** Duty cycle = 5.165 ms / 5.3 ms x 100% = 97.5%, duty factor =  $10 * \log (1/\text{Duty cycle}) = 0.11$  dB

**VHT40 1S1T:** Duty cycle = 5.005 ms / 5.13 ms x 100% = 97.6%, duty factor =  $10 * \log (1/\text{Duty cycle}) = 0.11$  dB

**802.11ax (HE20) 1S1T:** Duty cycle = 3.94 ms / 4.06 ms x 100% = 97.0%, duty factor =  $10 * \log (1/\text{Duty cycle}) = 0.13$  dB

**802.11ax (HE40) 1S1T:** Duty cycle = 3.955 ms / 4.08 ms x 100% = 96.9%, duty factor =  $10 * \log (1/\text{Duty cycle}) = 0.14$  dB

**802.11be (EHT20) 1S1T:**

Duty cycle = 4.64 ms / 4.755 ms x 100% = 97.6%, duty factor =  $10 * \log (1/\text{Duty cycle}) = 0.11$  dB

**802.11be (EHT40) 1S1T:**

Duty cycle = 4.64 ms / 4.765 ms x 100% = 97.4%, duty factor =  $10 * \log (1/\text{Duty cycle}) = 0.12$  dB

**802.11be (EHT20) 26-tone RU 1S1T:**

Duty cycle = 4.64 ms / 4.755 ms x 100% = 97.6%, duty factor =  $10 * \log (1/\text{Duty cycle}) = 0.11$  dB

**802.11be (EHT20) 52-tone RU 1S1T:**

Duty cycle = 4.64 ms / 4.755 ms x 100% = 97.6%, duty factor =  $10 * \log (1/\text{Duty cycle}) = 0.11$  dB

**802.11be (EHT20) 106-tone RU 1S1T:**

Duty cycle = 4.64 ms / 4.755 ms x 100% = 97.6%, duty factor =  $10 * \log (1/\text{Duty cycle}) = 0.11$  dB

**802.11be (EHT20) 52+26-tone MRU 1S1T:**

Duty cycle = 4.64 ms / 4.755 ms x 100% = 97.6%, duty factor =  $10 * \log (1/\text{Duty cycle}) = 0.11$  dB

**802.11be (EHT20) 106+26-tone MRU 1S1T:**

Duty cycle = 4.64 ms / 4.755 ms x 100% = 97.6%, duty factor =  $10 * \log (1/\text{Duty cycle}) = 0.11$  dB

**802.11b 2TX:** Duty cycle = 12.145 ms / 12.308 ms x 100% = 98.7%

**802.11g 2TX:** Duty cycle = 2.016 ms / 2.125 ms x 100% = 94.9%, duty factor =  $10 * \log (1/\text{Duty cycle}) = 0.23$  dB

**VHT20 2S2T:** Duty cycle = 5.165 ms / 5.3 ms x 100% = 97.5%, duty factor =  $10 * \log (1/\text{Duty cycle}) = 0.11$  dB

**VHT40 2S2T:** Duty cycle = 5.005 ms / 5.13 ms x 100% = 97.6%, duty factor =  $10 * \log (1/\text{Duty cycle}) = 0.11$  dB

**802.11ax (HE20) 2S2T:** Duty cycle = 3.94 ms / 4.06 ms x 100% = 97.0%, duty factor =  $10 * \log (1/\text{Duty cycle}) = 0.13$  dB

**802.11ax (HE40) 2S2T:** Duty cycle = 3.955 ms / 4.08 ms x 100% = 96.9%, duty factor =  $10 * \log (1/\text{Duty cycle}) = 0.14$  dB

**802.11be (EHT20) 2S2T:**

Duty cycle = 4.64 ms / 4.755 ms x 100% = 97.6%, duty factor =  $10 * \log (1/\text{Duty cycle}) = 0.11$  dB

**802.11be (EHT40) 2S2T:**

Duty cycle = 4.64 ms / 4.765 ms x 100% = 97.4%, duty factor =  $10 * \log (1/\text{Duty cycle}) = 0.12$  dB

**802.11be (EHT20) 26-tone RU 2S2T:**

Duty cycle = 4.64 ms / 4.755 ms x 100% = 97.6%, duty factor =  $10 * \log (1/\text{Duty cycle}) = 0.11$  dB

**802.11be (EHT20) 52-tone RU 2S2T:**

Duty cycle = 4.64 ms / 4.755 ms x 100% = 97.6%, duty factor =  $10 * \log (1/\text{Duty cycle}) = 0.11$  dB

**802.11be (EHT20) 106-tone RU 2S2T:**

Duty cycle = 4.64 ms / 4.755 ms x 100% = 97.6%, duty factor =  $10 * \log (1/\text{Duty cycle}) = 0.11$  dB

**802.11be (EHT20) 52+26-tone MRU 2S2T:**

Duty cycle = 4.64 ms / 4.755 ms x 100% = 97.6%, duty factor =  $10 * \log (1/\text{Duty cycle}) = 0.11$  dB

**802.11be (EHT20) 106+26-tone MRU 2S2T:**

Duty cycle = 4.64 ms / 4.755 ms x 100% = 97.6%, duty factor =  $10 * \log (1/\text{Duty cycle}) = 0.11$  dB



BUREAU VERITAS

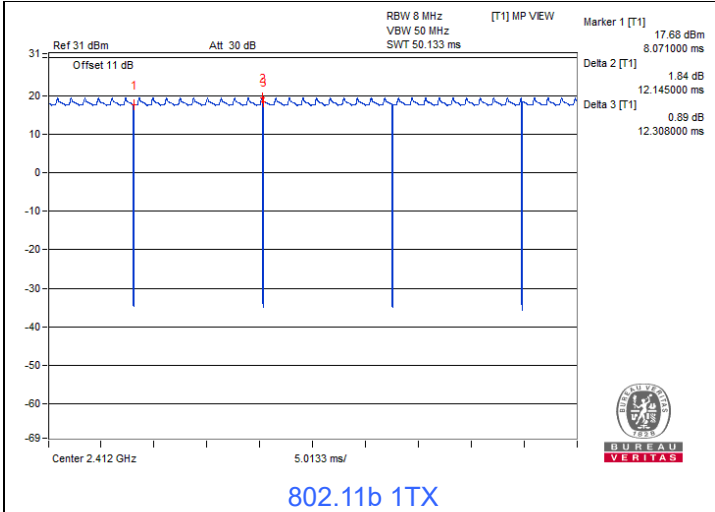

802.11b 1TX

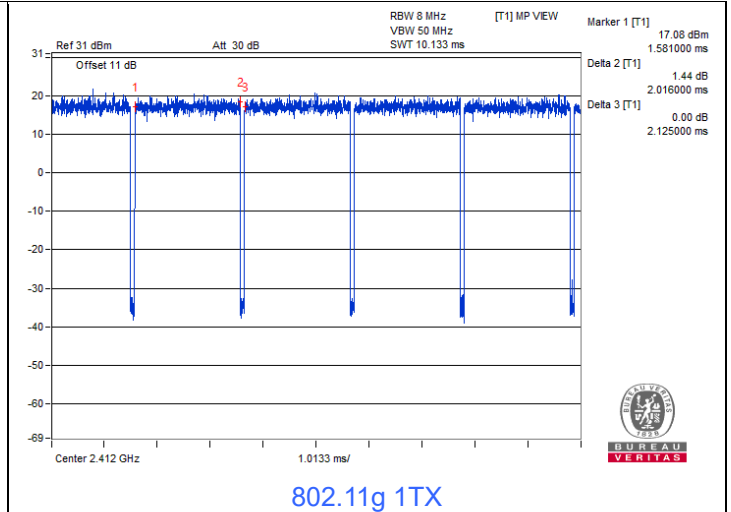

802.11g 1TX

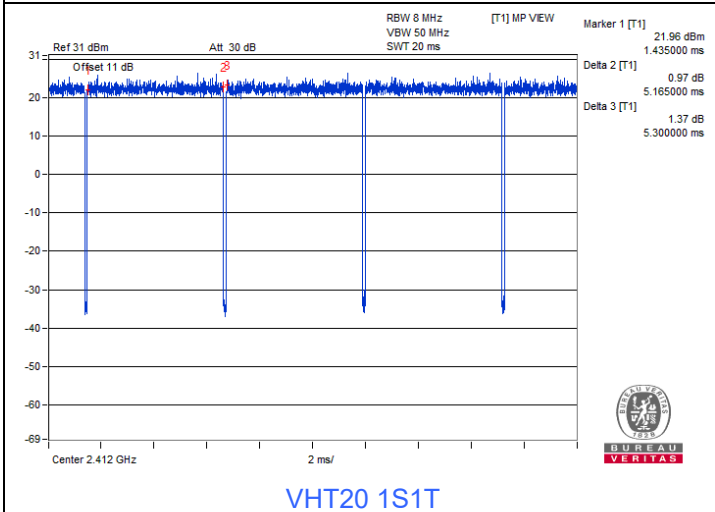

VHT20 1S1T

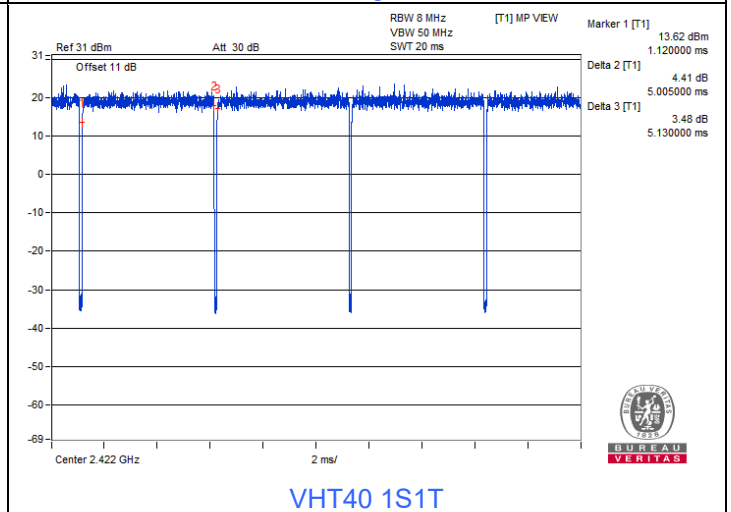

VHT40 1S1T

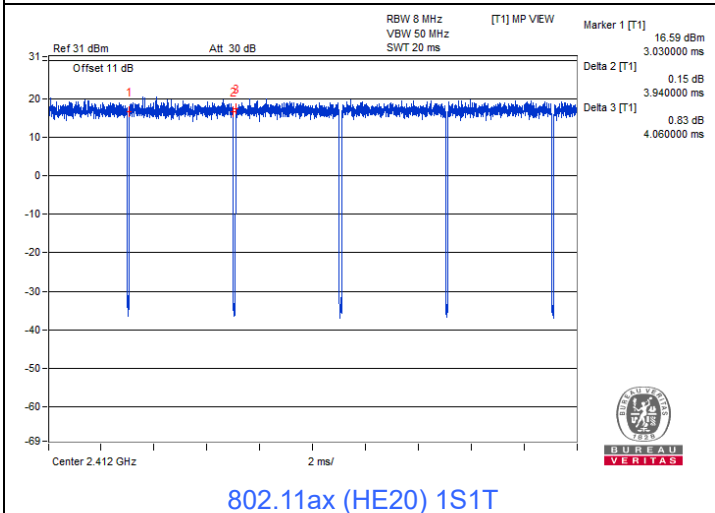

802.11ax (HE20) 1S1T

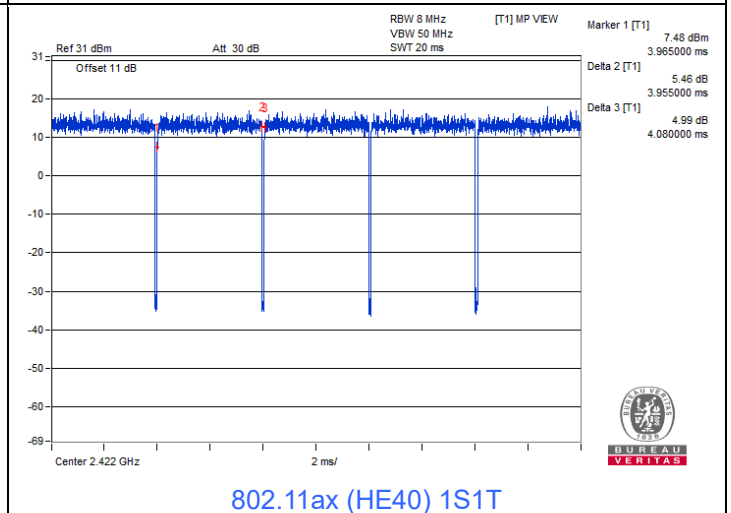

802.11ax (HE40) 1S1T

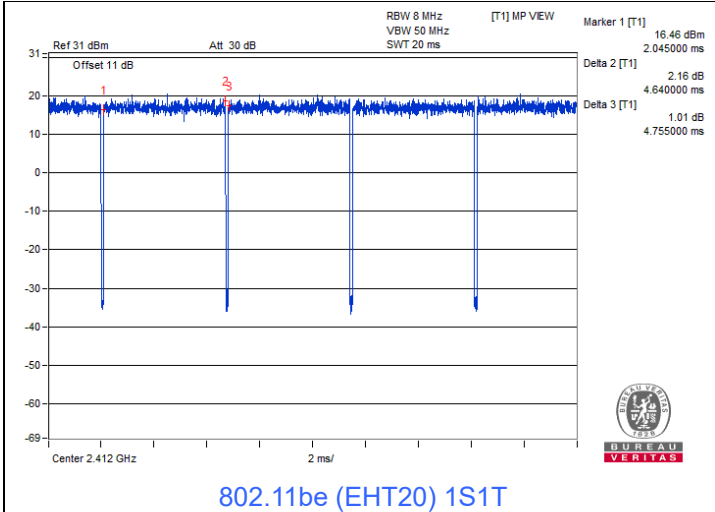

802.11be (EHT20) 1S1T

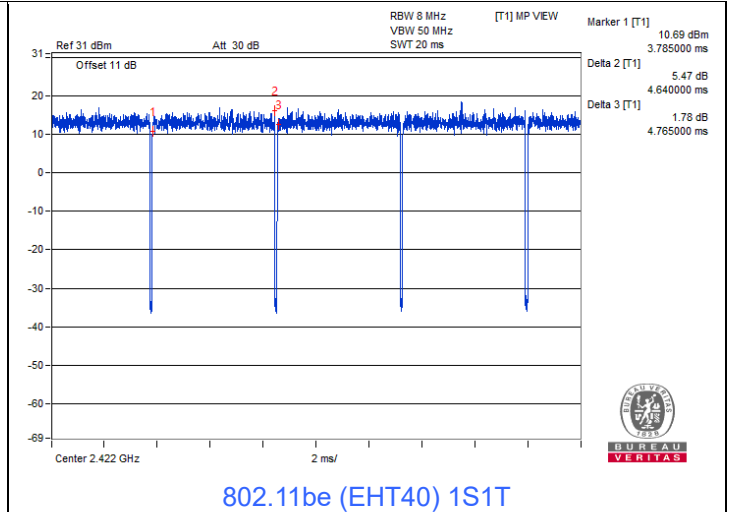

802.11be (EHT40) 1S1T

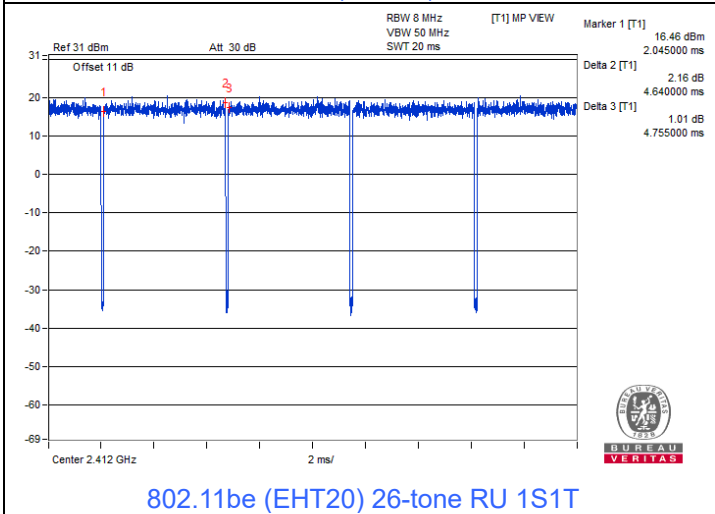

802.11be (EHT20) 26-tone RU 1S1T

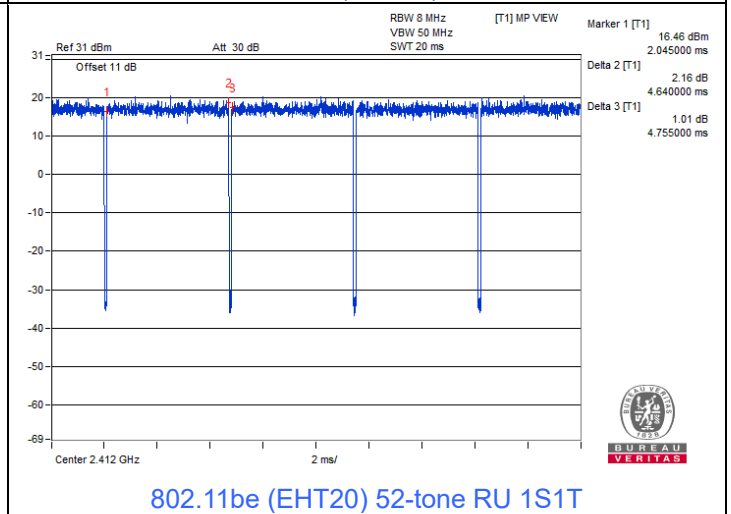

802.11be (EHT20) 52-tone RU 1S1T

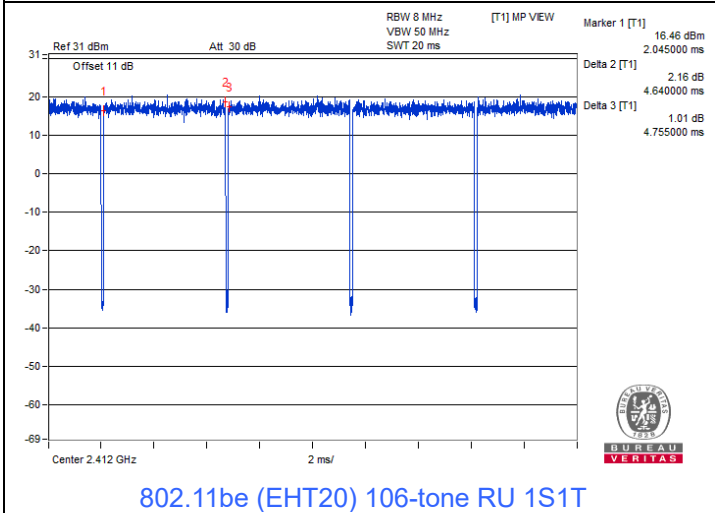

802.11be (EHT20) 106-tone RU 1S1T

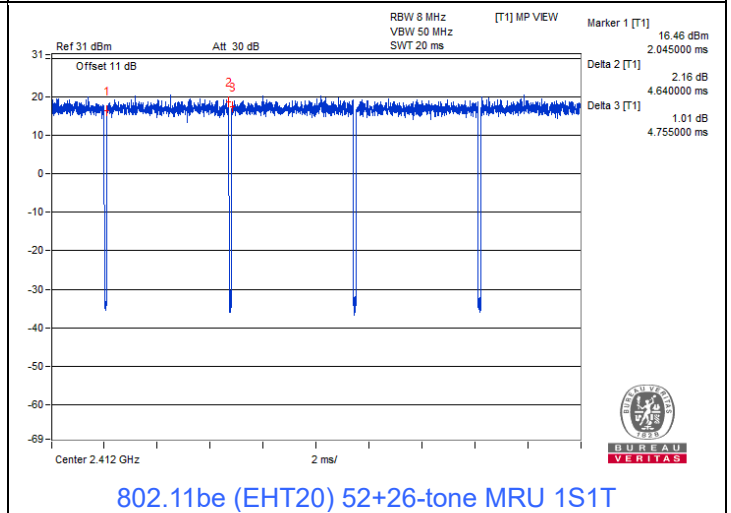

802.11be (EHT20) 52+26-tone MRU 1S1T





BUREAU VERITAS

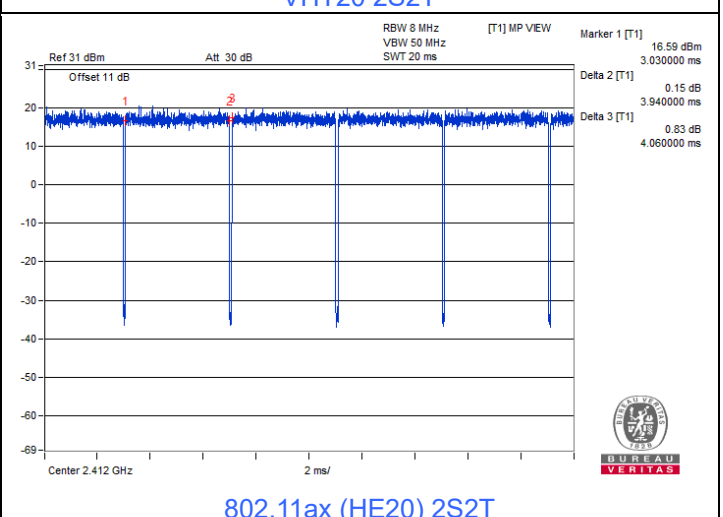
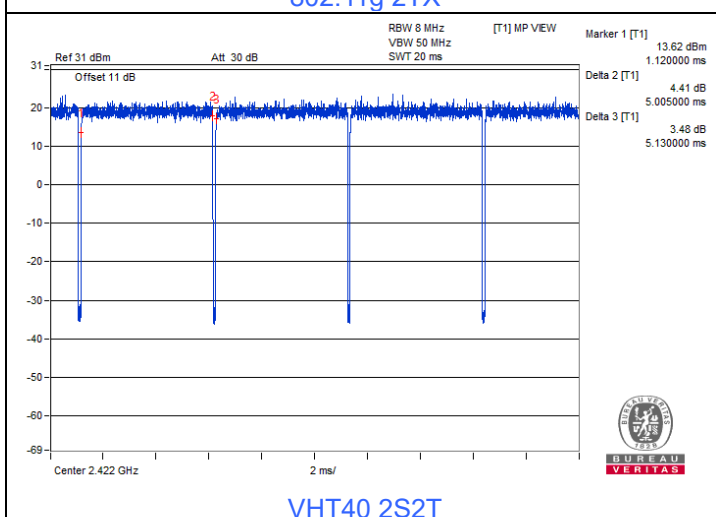
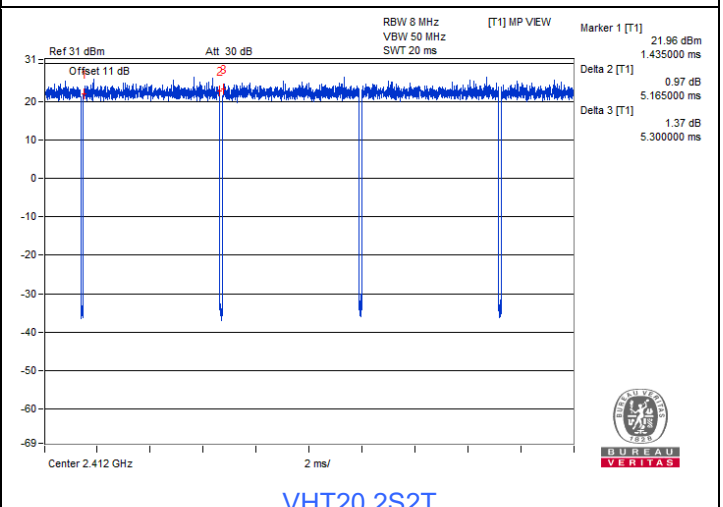
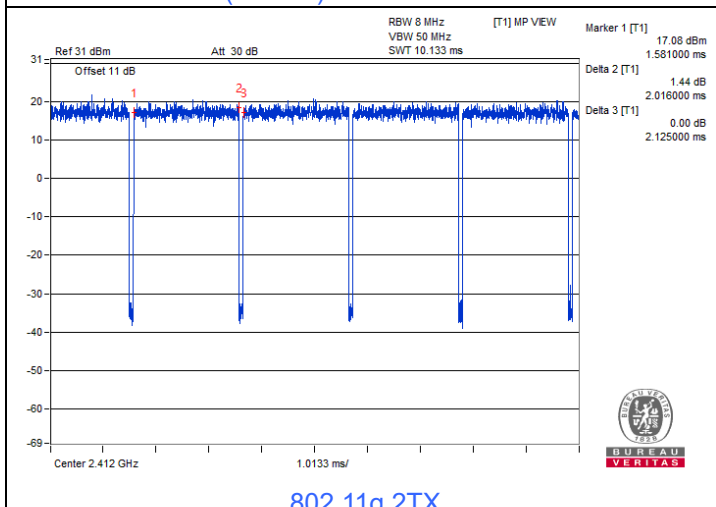
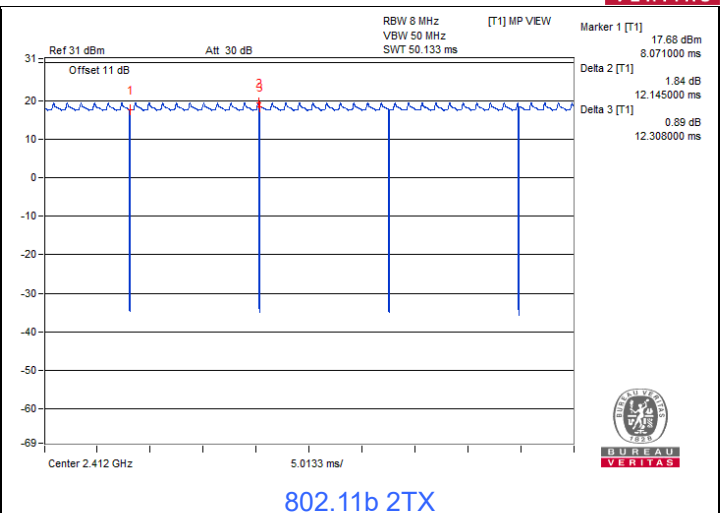
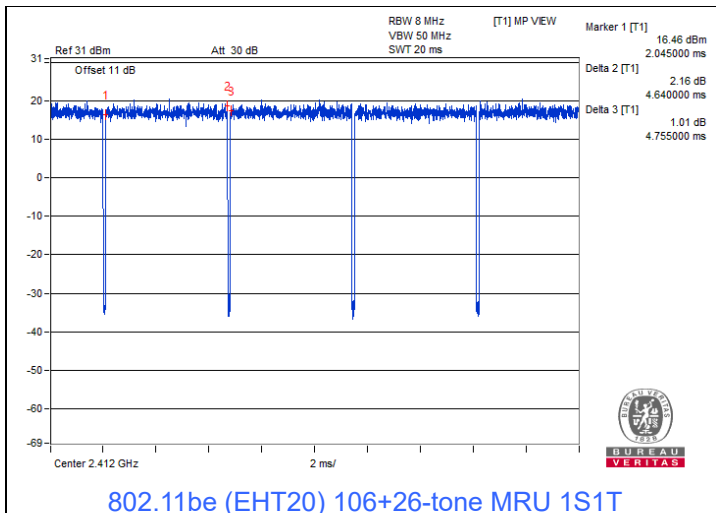



BUREAU VERITAS

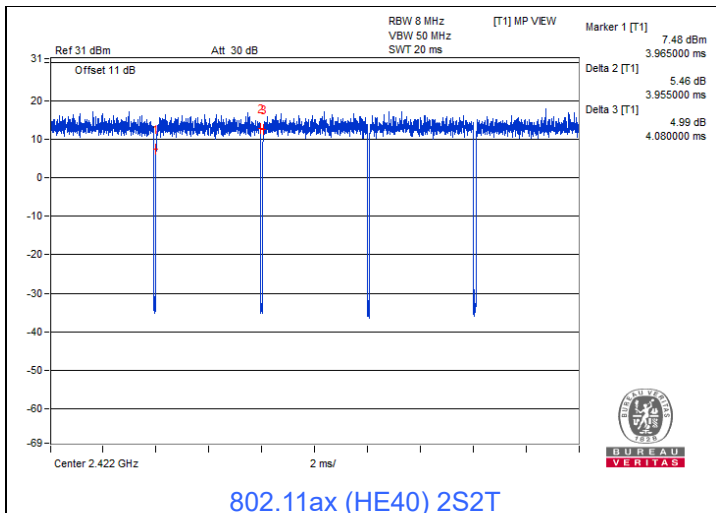

802.11ax (HE40) 2S2T

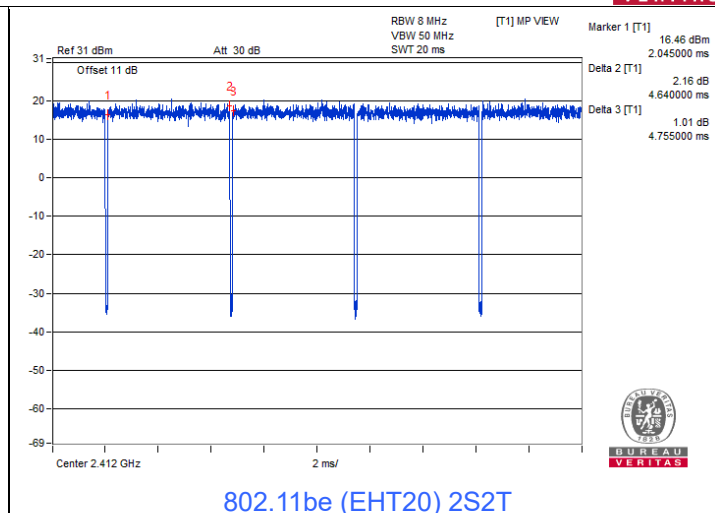

802.11be (EHT20) 2S2T

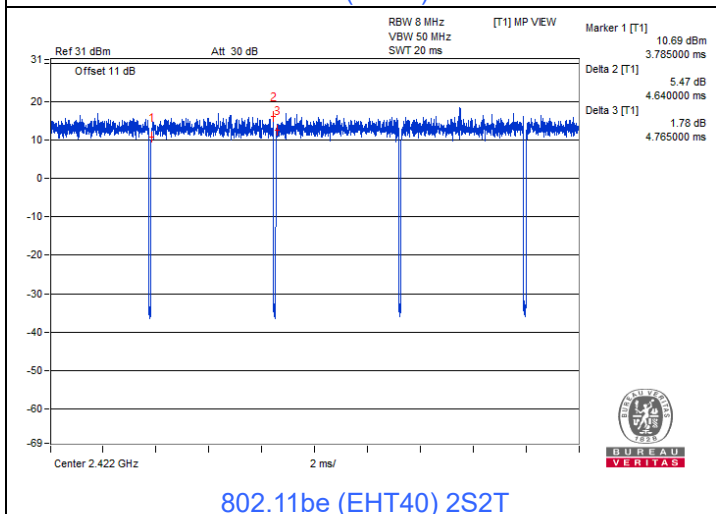

802.11be (EHT40) 2S2T

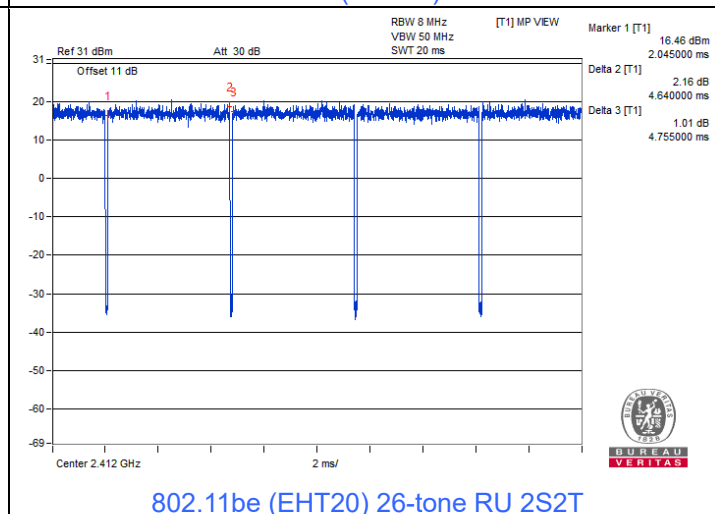

802.11be (EHT20) 26-tone RU 2S2T

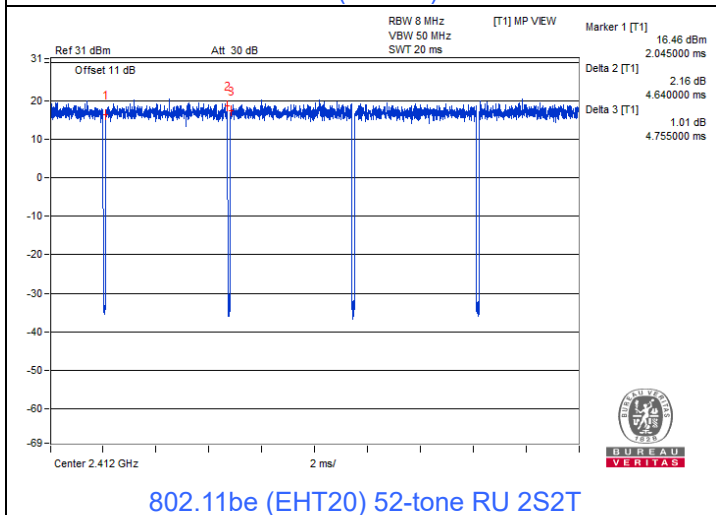

802.11be (EHT20) 52-tone RU 2S2T

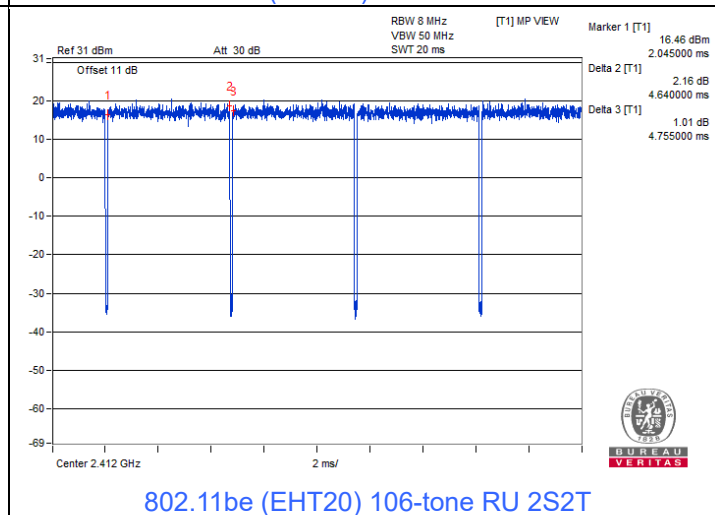

802.11be (EHT20) 106-tone RU 2S2T

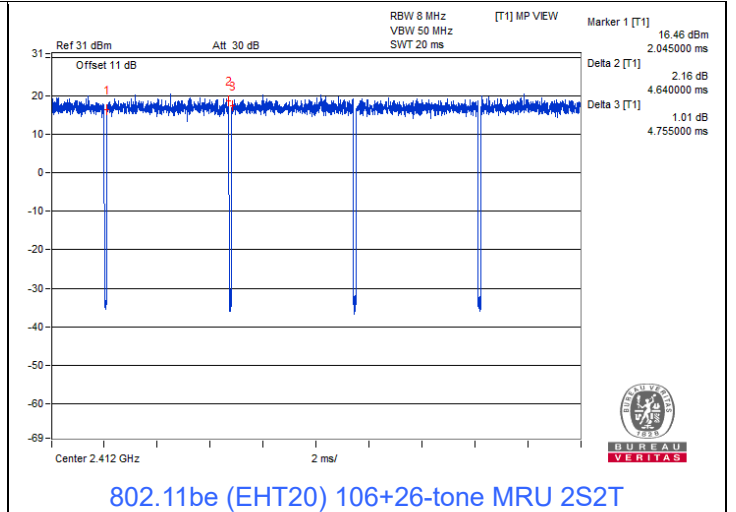
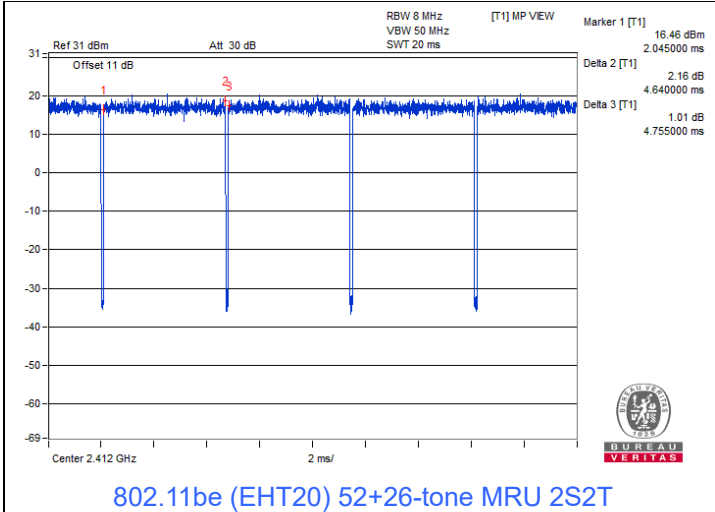

### 3.6 Test Program Used and Operation Descriptions

Controlling software (QAtool\_V16 (0.0.2.104)) has been activated to set the EUT under transmission condition continuously at specific channel frequency.

### 3.7 Connection Diagram of EUT and Peripheral Devices

#### For AC Power Conducted Emission test

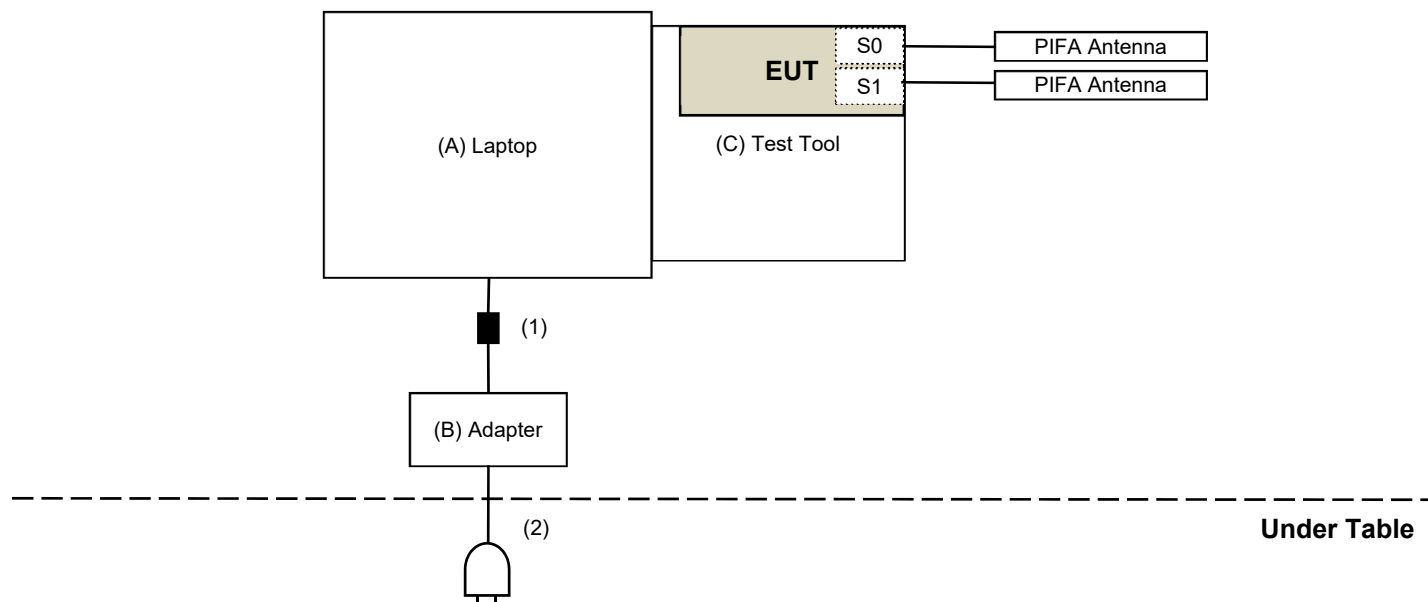

#### For Unwanted Emission test

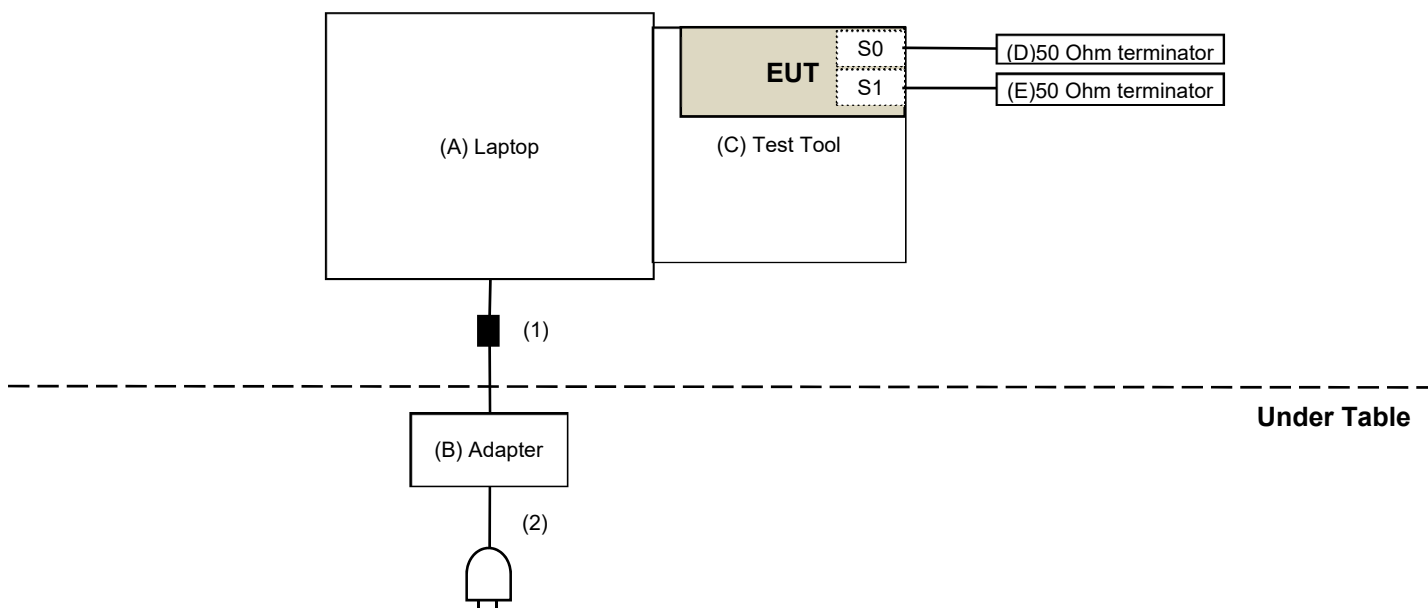

### 3.8 Configuration of Peripheral Devices and Cable Connections

ID	Product	Brand	Model No.	Serial No.	FCC ID	Remarks
A	Laptop	DELL	E5430	HYV4VY1	DoC	Provided by Lab
B	Adapter	DELL	LLA65NS2-01	N/A	N/A	Provided by Lab
C	Test Tool	Mediatek	MTK1849	N/A	N/A	Supplied by applicant
D	50 Ohm terminator	WOKEN	WTER-18S2	N/A	N/A	Provided by Lab
E	50 Ohm terminator	WOKEN	WTER-18S2	N/A	N/A	Provided by Lab

ID	Cable Descriptions	Qty.	Length (m)	Shielding (Yes/No)	Cores (Qty.)	Remarks
1	DC Cable	1	1.8	No	1	Provided by Lab
2	AC Cable	1	1	No	0	Provided by Lab

## 4 Test Instruments

The calibration interval of the all test instruments are 12 months and the calibrations are traceable to NML/ROC and NIST/USA.

### 4.1 RF Output Power

Description Manufacturer	Model No.	Serial No.	Calibrated Date	Calibrated Until
Power Meter Anritsu	ML2495A	1529002	2023/6/17	2024/6/16
Pulse Power Sensor Anritsu	MA2411B	1726434	2023/6/19	2024/6/18

Notes:

1. The test was performed in Oven room 2.
2. Tested Date: 2023/12/20

### 4.2 Power Spectral Density

Description Manufacturer	Model No.	Serial No.	Calibrated Date	Calibrated Until
MXA Signal Analyzer Keysight	N9020B	MY60112409	2023/2/18	2024/2/17
Software	ADT_RF Test Software V7.6.5.4	N/A	N/A	N/A

Notes:

1. The test was performed in Oven room 2.
2. Tested Date: 2023/12/20

### 4.3 6 dB Bandwidth

Refer to section 4.2 to get information of the instruments.

### 4.4 Conducted Out of Band Emissions

Refer to section 4.2 to get information of the instruments.

### 4.5 AC Power Conducted Emissions

Description Manufacturer	Model No.	Serial No.	Calibrated Date	Calibrated Until
50 ohm terminal resistance Telegartner	50 ohm	3	2023/10/20	2024/10/19
EMI Test Receiver R&S	ESCS 30	847124/029	2023/10/18	2024/10/17
Fixed Attenuator STI	STI02-2200-10	005	2023/7/1	2024/6/30
LISN R&S	ESH3-Z5	835239/001	2023/4/6	2024/4/5
		848773/004	2023/10/13	2024/10/12
RF Coaxial Cable JYEBAO	5D-FB	COCCAB-001	2023/7/1	2024/6/30
Software BVADT	BVADT_Cond_V7.3.7.4	N/A	N/A	N/A

Notes:

1. The test was performed in Conduction 1
2. Tested Date: 2024/1/15

#### 4.6 Unwanted Emissions below 1 GHz

##### Mode A

Description Manufacturer	Model No.	Serial No.	Calibrated Date	Calibrated Until
MXA Signal Analyzer Keysight	N9020B	MY60112409	2023/2/18	2024/2/17
Software	ADT_RF Test Software V7.6.5.4	N/A	N/A	N/A

##### Notes:

1. The test was performed in Oven room 2.
2. Tested Date: 2023/12/8 ~ 2023/12/20

##### Mode B

Description Manufacturer	Model No.	Serial No.	Calibrated Date	Calibrated Until
Bi_Log Antenna Schwarzbeck	VULB 9168	9168-406	2023/10/13	2024/10/12
Boresight Antenna Tower & Turn Table Max-Full	MF-7802BS	MF780208530	N/A	N/A
Fixed Attenuator Mini-Circuits	UNAT-5+	PAD-ATT5-03	2023/12/12	2024/12/11
Loop Antenna Electro-Metrics	EM-6879	264	2023/2/21	2024/2/20
MXA Signal Analyzer Keysight	N9020B	MY60112408	2023/3/6	2024/3/5
MXE EMI Receiver Keysight	N9038A	MY59050100	2023/6/13	2024/6/12
Preamplifier EMCI	EMC330N	980701	2023/2/18	2024/2/17
	EMC001340	980142	2023/5/8	2024/5/7
RF Coaxial Cable JYEBAO	5D-FB	LOOPCAB-001	2023/12/12	2024/12/11
		LOOPCAB-002	2023/12/12	2024/12/11
RF Coaxial Cable PEWC	8D	966-4-1	2023/2/18	2024/2/17
		966-4-2	2023/2/18	2024/2/17
		966-4-3	2023/2/18	2024/2/17
Software	ADT_Radiated_V8.7.08	N/A	N/A	N/A

##### Notes:

1. The test was performed in 966 Chamber No. 4.
2. Tested Date: 2024/1/15

#### 4.7 Unwanted Emissions above 1 GHz

##### Mode A

Description Manufacturer	Model No.	Serial No.	Calibrated Date	Calibrated Until
MXA Signal Analyzer Keysight	N9020B	MY60112409	2023/2/18	2024/2/17
Software	ADT_RF Test Software V7.6.5.4	N/A	N/A	N/A

Notes:

1. The test was performed in Oven room 2.
2. Tested Date: 2023/12/4 ~ 2023/12/7

##### Mode B

Description Manufacturer	Model No.	Serial No.	Calibrated Date	Calibrated Until
Boresight Antenna Tower & Turn Table Max-Full	MF-7802BS	MF780208530	N/A	N/A
Horn Antenna Schwarzbeck	BBHA 9120D	9120D-783	2023/11/12	2024/11/11
	BBHA 9170	9170-739	2023/11/12	2024/11/11
MXA Signal Analyzer Keysight	N9020B	MY60112408	2023/3/6	2024/3/5
Preamplifier EMCI	EMC12630SE	980688	2023/10/3	2024/10/2
	EMC184045SE	980387	2023/8/9	2024/8/8
RF Coaxial Cable EMCI	EMC-KM-KM-4000	200214	2023/2/20	2024/2/19
	EMC102-KM-KM-1200	160924	2023/8/9	2024/8/8
	EMC104-SM-SM-1200	160922	2023/8/9	2024/8/8
	EMC104-SM-SM-2000	180502	2023/3/27	2024/3/26
	EMC104-SM-SM-6000	210704	2023/11/2	2024/11/1
Software	ADT_Radiated_V8.7.08	N/A	N/A	N/A

Notes:

1. The test was performed in 966 Chamber No. 4.
2. Tested Date: 2024/1/4 ~ 2024/1/5



## 5 Limits of Test Items

### 5.1 RF Output Power

For systems using digital modulation in the 2400–2483.5 MHz bands: 1 Watt (30 dBm)

Per KDB 662911 D01 Multiple Transmitter Output Method of conducted output power measurement on IEEE 802.11 devices,

Array Gain = 0 dB (i.e., no array gain) for  $N_{ANT} \leq 4$ ;

Array Gain = 0 dB (i.e., no array gain) for channel widths  $\geq 40$  MHz for any  $N_{ANT}$ ;

Array Gain =  $5 \log(N_{ANT}/N_{SS})$  dB or 3 dB, whichever is less, for 20-MHz channel widths with  $N_{ANT} \geq 5$ .

For power measurements on all other devices: Array Gain =  $10 \log(N_{ANT}/N_{SS})$  dB.

### 5.2 Power Spectral Density

The Maximum of Power Spectral Density Measurement is 8 dBm in any 3 kHz.

### 5.3 6 dB Bandwidth

The minimum of 6 dB Bandwidth Measurement is 0.5 MHz.

### 5.4 Conducted Out of Band Emissions

Below 30 dB of the highest emission level of operating band (in 100 kHz Resolution Bandwidth).

### 5.5 AC Power Conducted Emissions

Frequency (MHz)	Conducted Limit (dBuV)	
	Quasi-peak	Average
0.15 - 0.5	66 - 56	56 - 46
0.50 - 5.0	56	46
5.0 - 30.0	60	50

Notes:

1. The lower limit shall apply at the transition frequencies.
2. The limit decreases in line with the logarithm of the frequency in the range of 0.15 to 0.50 MHz.

## 5.6 Unwanted Emissions below 1 GHz

Radiated emissions up to 1 GHz which fall in the restricted bands must comply with the radiated emission limits specified as below table. Other emissions shall be at least 30 dB below the highest level of the desired power:

Frequencies (MHz)	Field Strength (microvolts/meter)	Measurement Distance (meters)
0.009 ~ 0.490	2400/F(kHz)	300
0.490 ~ 1.705	24000/F(kHz)	30
1.705 ~ 30.0	30	30
30 ~ 88	100	3
88 ~ 216	150	3
216 ~ 960	200	3
Above 960	500	3

Notes:

1. The lower limit shall apply at the transition frequencies.
2. Emission level (dBuV/m) = 20 log Emission level (uV/m).

## 5.7 Unwanted Emissions above 1 GHz

Radiated emissions above 1 GHz which fall in the restricted bands must comply with the radiated emission limits specified as below table. Other emissions shall be at least 30 dB below the highest level of the desired power:

Frequencies (MHz)	Field Strength (microvolts/meter)	Measurement Distance (meters)
Above 960	500	3

Notes:

1. The lower limit shall apply at the transition frequencies.
2. Emission level (dBuV/m) = 20 log Emission level (uV/m).
3. For frequencies above 1000 MHz, the field strength limits are based on average detector, however, the peak field strength of any emission shall not exceed the maximum permitted average limits, specified above by more than 20 dB under any condition of modulation.

## 6 Test Arrangements

### 6.1 RF Output Power

#### 6.1.1 Test Setup

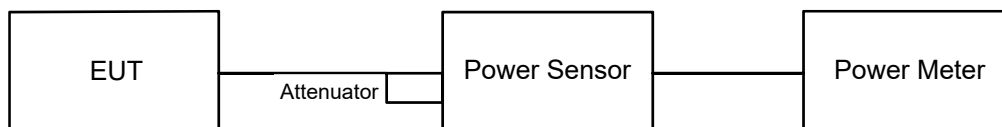

#### 6.1.2 Test Procedure

Average Power:

Average power sensor was used to perform output power measurement, trigger and gating function of wide band power meter is enabled to measure max output power of TX on burst. Duty factor is not added to measured value.

### 6.2 Power Spectral Density

#### 6.2.1 Test Setup

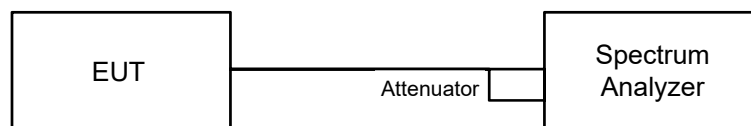

#### 6.2.2 Test Procedure

- a. Measure the duty cycle (x).
- b. Set instrument center frequency to DTS channel center frequency.
- c. Set span to at least 1.5 times the OBW.
- d. Set RBW to: 3 kHz.
- e. Set VBW  $\geq 3 \times$  RBW.
- f. Detector = power averaging (RMS) or sample detector (when RMS not available).
- g. Ensure that the number of measurement points in the sweep  $\geq 2 \times$  span/RBW.
- h. Sweep time = auto couple.
- i. Do not use sweep triggering. Allow sweep to "free run".
- j. Employ trace averaging (RMS) mode over a minimum of 100 traces.
- k. Use the peak marker function to determine the maximum amplitude level.

Note: If Duty cycle < 98%, Add  $10 \log (1/x)$ , where x is the duty cycle measured in step (a), to the measured PSD to compute the average PSD during the actual transmission time.

### 6.3 6 dB Bandwidth

#### 6.3.1 Test Setup

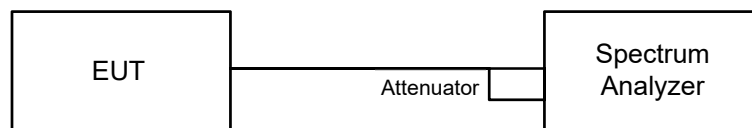

#### 6.3.2 Test Procedure

- Set resolution bandwidth (RBW) = 100 kHz.
- Set the video bandwidth (VBW)  $\geq 3 \times$  RBW, Detector = Peak.
- Trace mode = max hold.
- Sweep = auto couple.
- Measure the maximum width of the emission that is constrained by the frequencies associated with the two amplitude points (upper and lower) that are attenuated by 6 dB relative to the maximum level measured in the fundamental emission.

### 6.4 Conducted Out of Band Emissions

#### 6.4.1 Test Setup

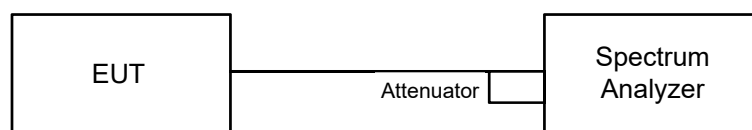

#### 6.4.2 Test Procedure

##### MEASUREMENT PROCEDURE REF

- Set the RBW = 100 kHz.
- Set the VBW  $\geq 300$  kHz.
- Detector = peak.
- Sweep time = auto couple.
- Trace mode = max hold.
- Allow trace to fully stabilize.
- Use the peak marker function to determine the maximum power level in any 100 kHz band segment within the fundamental EBW.

##### MEASUREMENT PROCEDURE OOB

- Set RBW = 100 kHz.
- Set VBW  $\geq 300$  kHz.
- Detector = peak.
- Sweep = auto couple.
- Trace Mode = max hold.
- Allow trace to fully stabilize.
- Use the peak marker function to determine the maximum amplitude level.

## 6.5 AC Power Conducted Emissions

### 6.5.1 Test Setup

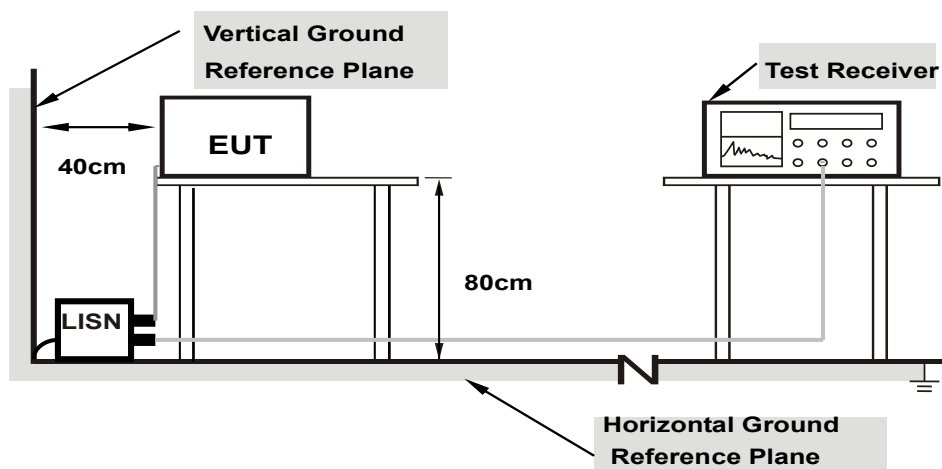

**Note: 1.Support units were connected to second LISN.**

For the actual test configuration, please refer to the attached file (Test Setup Photo).

### 6.5.2 Test Procedure

- The EUT was placed on a 0.8 meter to the top of table and placed 0.4 meters from the conducting wall of the shielded room with EUT being connected to the power mains through a line impedance stabilization network (LISN). Other support units were connected to the power mains through another LISN. The two LISNs provide 50 ohm/ 50 uH of coupling impedance for the measuring instrument.
- Both lines of the power mains connected to the EUT were checked for maximum conducted interference.
- The frequency range from 150 kHz to 30 MHz was searched. Emission levels under (Limit – 20 dB) was not recorded.

Note: The resolution bandwidth and video bandwidth of test receiver is 9 kHz for quasi-peak detection (QP) and average detection (AV) at frequency 0.15 MHz-30 MHz.

## 6.6 Unwanted Emissions below 1 GHz

### 6.6.1 Test Setup

**For Radiated Configuration:**

**For Radiated emission below 30 MHz**

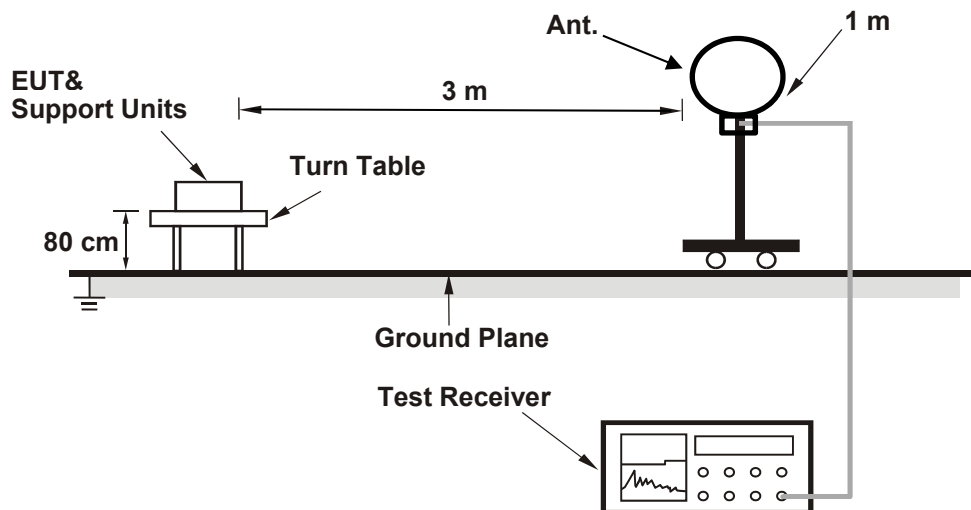

**For Radiated emission above 30 MHz**

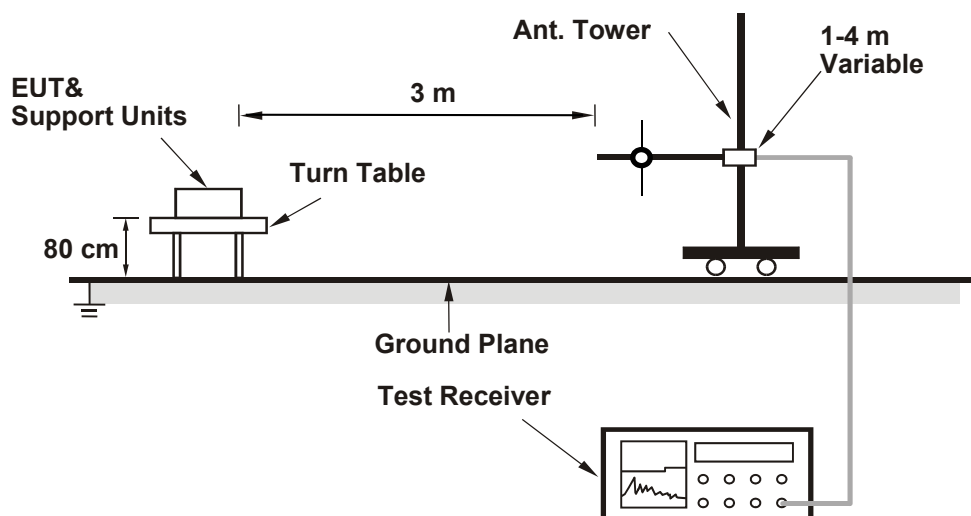

**For Conducted Configuration:**



For the actual test configuration, please refer to the attached file (Test Setup Photo).

## 6.6.2 Test Procedure

### Radiated versus Conducted Measurement.

The unwanted emission limits in both the restricted and non-restricted bands are based on antenna-port conducted measurements in conjunction with cabinet emissions tests are permitted to demonstrate compliance.

The following steps was performed:

- a. Cabinet emissions measurements. Radiated measurement was performed to ensure that cabinet emissions are below the emission limits. For the cabinet-emission measurements the antenna was replaced by a termination matching the nominal impedance of the antenna.
- b. Conducted tests was performed using equipment that matches the nominal impedance of the antenna assembly used with the EUT.
- c. EIRP calculation. A value representative of an upper bound on out-of-band antenna gain (in dBi) shall be added to the measured antenna-port conducted emission power to compute EIRP within the specified measurement bandwidth. (For emissions in the restricted bands, additional calculations are required to convert EIRP to field strength at the specified distance.) The upper bound on antenna gain for a device with a single RF output shall be selected as the maximum in-band gain of the antenna across all operating bands or 2 dBi, whichever is greater.
- d. EIRP adjustments for multiple outputs. (Follow the procedures specified in FCC KDB Publication 662911)
- e. For all of Radiation emission test

#### **For Radiated emission below 30 MHz**

- e-1.1. The EUT was placed on the top of a rotating table 0.8 meters above the ground at 3 meter chamber room for test. The table was rotated 360 degrees to determine the position of the highest radiation.
- e-1.2. The EUT was set 3 meters away from the interference-receiving antenna, which was mounted on the top of a variable-height antenna tower.
- e-1.3. Parallel, perpendicular, and ground-parallel orientations of the antenna are set to make the measurement.
- e-1.4. For each suspected emission, the EUT was arranged to its worst case and the rotatable table was turned from 0 degrees to 360 degrees to find the maximum reading.
- e-1.5. The test-receiver system was set to Quasi-Peak Detect Function and Specified Bandwidth with Maximum Hold Mode, except for the frequency band (9 kHz to 90 kHz and 110 kHz to 490 kHz) set to average detect function and peak detect function.

#### Notes:

1. The resolution bandwidth and video bandwidth of test receiver/spectrum analyzer is 200 Hz at frequency below 150 kHz.
2. The resolution bandwidth and video bandwidth of test receiver/spectrum analyzer is 9 kHz or 10 kHz at frequency (150 kHz to 30 MHz).
3. All modes of operation were investigated and the worst-case emissions are reported.

#### **For Radiated emission above 30 MHz**

- e-2.1. The EUT was placed on the top of a rotating table 0.8 meters above the ground at 3 meter chamber room for test. The table was rotated 360 degrees to determine the position of the highest radiation.
- e-2.2. The EUT was set 3 meters away from the interference-receiving antenna, which was mounted on the top of a variable-height antenna tower.
- e-2.3. The height of antenna is varied from one meter to four meters above the ground to determine the maximum value of the field strength. Both horizontal and vertical polarizations of the antenna are set to make the measurement.
- e-2.4. For each suspected emission, the EUT was arranged to its worst case and then the antenna was tuned to heights from 1 meter to 4 meters and the rotatable table was turned from 0 degrees to 360 degrees to find the maximum reading.
- e-2.5. The test-receiver system was set to quasi-peak detect function and specified bandwidth with maximum hold mode when the test frequency is below 1 GHz.

#### Notes:

1. The resolution bandwidth and video bandwidth of test receiver/spectrum analyzer is 120 kHz for Quasi-peak detection (QP) at frequency below 1 GHz.
2. All modes of operation were investigated and the worst-case emissions are reported.

### **Radiated versus Conducted Measurement**

#### For Radiated measurement:

The level of unwanted emissions was measured when radiated by the cabinet or structure of the equipment with the antenna connector(s) terminated by a specified load (cabinet radiation).

#### For Conducted measurement:

The level of unwanted emissions was measured as their power in a specified load (conducted spurious emissions).

### **Conducted Unwanted Emission Convert Formula**

- a. Emission Level (dBuV/m) = EIRP Level (dBm) – 20log(d) + 104.8  
d = measurement distance in 3 meters.
- b. EIRP Level (dBm) = Raw Value(dBm) + Correction Factor(dB)
- c. Correction Factor is directional gain, and the composite gain will be used when signal support the correlated signal  
For the out of band spurious the gain for the specific band may have been used rather than the highest gain across all bands.  
For the band edge the gain for the specific band may have been used.

#### Notes:

1. In restricted bands below 1000 MHz, add upper bound on ground plane reflection:  
For frequencies between 30 MHz and 1000 MHz, add 4.7 dB.
2. The conducted emission test was considered some factor to compute test result.



## 6.7 Unwanted Emissions above 1 GHz

### 6.7.1 Test Setup

#### For Radiated Configuration:

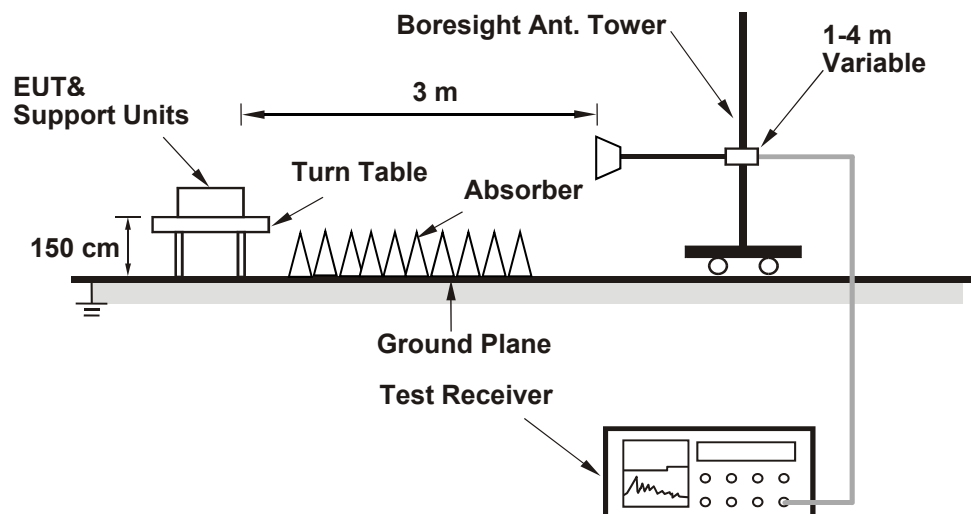

#### For Conducted Configuration:

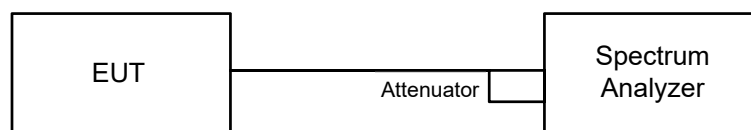

For the actual test configuration, please refer to the attached file (Test Setup Photo).

### 6.7.2 Test Procedure

#### Radiated versus Conducted Measurement.

The unwanted emission limits in both the restricted and non-restricted bands are based on antenna-port conducted measurements in conjunction with cabinet emissions tests are permitted to demonstrate compliance.

The following steps was performed:

- a. Cabinet emissions measurements. Radiated measurement was performed to ensure that cabinet emissions are below the emission limits. For the cabinet-emission measurements the antenna was replaced by a termination matching the nominal impedance of the antenna.
- b. Conducted tests was performed using equipment that matches the nominal impedance of the antenna assembly used with the EUT.
- c. EIRP calculation. A value representative of an upper bound on out-of-band antenna gain (in dBi) shall be added to the measured antenna-port conducted emission power to compute EIRP within the specified measurement bandwidth. (For emissions in the restricted bands, additional calculations are required to convert EIRP to field strength at the specified distance.) The upper bound on antenna gain for a device with a single RF output shall be selected as the maximum in-band gain of the antenna across all operating bands or 2 dBi, whichever is greater.
- d. EIRP adjustments for multiple outputs. (Follow the procedures specified in FCC KDB Publication 662911)
- e. For all of Radiation emission test
  - e-1. The EUT was placed on the top of a rotating table 1.5 meters above the ground at 3 meter chamber room for test. The table was rotated 360 degrees to determine the position of the highest radiation.
  - e-2. The EUT was set 3 meters away from the interference-receiving antenna, which was mounted on the top of a variable-height antenna tower.

- e-3. The height of antenna is varied from one meter to four meters above the ground to determine the maximum value of the field strength. Both horizontal and vertical polarizations of the antenna are set to make the measurement.
- e-4. For each suspected emission, the EUT was arranged to its worst case and then the antenna was tuned to heights from 1 meter to 4 meters and the rotatable table was turned from 0 degrees to 360 degrees to find the maximum reading.
- e-5. The test-receiver system was set to peak and average detects function and specified bandwidth with maximum hold mode when the test frequency is above 1 GHz. If the peak reading value also meets average limit, measurement with the average detector is unnecessary.

Notes:

1. The resolution bandwidth of test receiver/spectrum analyzer is 1 MHz and the video bandwidth is 3 MHz for Peak detection (PK) and Average detection (AV) at frequency above 1 GHz.
2. For fundamental and harmonic signal measurement, the resolution bandwidth of test receiver/spectrum analyzer is 1 MHz and the video bandwidth is  $\geq 1/T$  (Duty cycle < 98%) or 10 Hz (Duty cycle  $\geq 98\%$ ) for Average detection (AV) at frequency above 1 GHz.
3. All modes of operation were investigated and the worst-case emissions are reported.

<b>Radiated versus Conducted Measurement</b>
<p><u>For Radiated measurement:</u> The level of unwanted emissions was measured when radiated by the cabinet or structure of the equipment with the antenna connector(s) terminated by a specified load (cabinet radiation).</p> <p><u>For Conducted measurement:</u> The level of unwanted emissions was measured as their power in a specified load (conducted spurious emissions).</p> <p><u>For Verified radiated measurement:</u> The level of unwanted emissions was measured when radiated by the cabinet or structure of the equipment with the antenna connector(s) terminated by a specified load (cabinet radiation).</p>
<b>Conducted Unwanted Emission Convert Formula</b>
<p>a. Emission Level (dBuV/m) = EIRP Level (dBm) – 20log(d) + 104.8 d = measurement distance in 3 meters.</p> <p>b. EIRP Level (dBm) = Raw Value(dBm) + Correction Factor(dB).</p> <p>c. Correction Factor is directional gain, and the composite gain will be used when signal support the correlated signal For the out of band spurious the gain for the specific band may have been used rather than the highest gain across all bands. For the band edge the gain for the specific band may have been used.</p> <p>Note: The conducted emission test was considered some factor to compute test result.</p>

## 7 Test Results of Test Item

### 7.1 RF Output Power

Input Power:	3.3 Vdc	Environmental Conditions:	25°C, 76% RH	Tested By:	Waydi Tuan
--------------	---------	---------------------------	--------------	------------	------------

#### 802.11b 1TX

Chan.	Chan. Freq. (MHz)	Average Power (mW)	Average Power (dBm)	Power Limit (dBm)	Test Result
1	2412	237.137	23.75	30	Pass
6	2437	259.418	24.14	30	Pass
11	2462	229.087	23.60	30	Pass
12	2467	110.662	20.44	30	Pass
13	2472	41.783	16.21	30	Pass

Note: The antenna gain is 3.18 dBi < 6 dBi, so the output power limit shall not be reduced.

#### 802.11g 1TX

Chan.	Chan. Freq. (MHz)	Average Power (mW)	Average Power (dBm)	Power Limit (dBm)	Test Result
1	2412	80.353	19.05	30	Pass
6	2437	184.077	22.65	30	Pass
11	2462	89.95	19.54	30	Pass
12	2467	63.241	18.01	30	Pass
13	2472	45.814	16.61	30	Pass

Note: The antenna gain is 3.18 dBi < 6 dBi, so the output power limit shall not be reduced.

#### VHT20 1S1T

Chan.	Chan. Freq. (MHz)	Average Power (mW)	Average Power (dBm)	Power Limit (dBm)	Test Result
1	2412	78.524	18.95	30	Pass
6	2437	160.694	22.06	30	Pass
11	2462	88.105	19.45	30	Pass
12	2467	70.795	18.50	30	Pass
13	2472	43.954	16.43	30	Pass

Note: The antenna gain is 3.18 dBi < 6 dBi, so the output power limit shall not be reduced.

### VHT40 1S1T

Chan.	Chan. Freq. (MHz)	Average Power (mW)	Average Power (dBm)	Power Limit (dBm)	Test Result
3	2422	72.444	18.60	30	Pass
6	2437	88.308	19.46	30	Pass
9	2452	73.282	18.65	30	Pass
10	2457	64.863	18.12	30	Pass
11	2462	56.105	17.49	30	Pass

Note: The antenna gain is 3.18 dBi < 6 dBi, so the output power limit shall not be reduced.

### 802.11ax (HE20) 1S1T

Chan.	Chan. Freq. (MHz)	Average Power (mW)	Average Power (dBm)	Power Limit (dBm)	Test Result
1	2412	79.616	19.01	30	Pass
6	2437	165.577	22.19	30	Pass
11	2462	89.331	19.51	30	Pass
12	2467	71.779	18.56	30	Pass
13	2472	45.082	16.54	30	Pass

Note: The antenna gain is 3.18 dBi < 6 dBi, so the output power limit shall not be reduced.

### 802.11ax (HE40) 1S1T

Chan.	Chan. Freq. (MHz)	Average Power (mW)	Average Power (dBm)	Power Limit (dBm)	Test Result
3	2422	73.621	18.67	30	Pass
6	2437	88.716	19.48	30	Pass
9	2452	73.79	18.68	30	Pass
10	2457	66.374	18.22	30	Pass
11	2462	56.234	17.50	30	Pass

Note: The antenna gain is 3.18 dBi < 6 dBi, so the output power limit shall not be reduced.

### 802.11be (EHT20) 1S1T

Chan.	Chan. Freq. (MHz)	Average Power (mW)	Average Power (dBm)	Power Limit (dBm)	Test Result
1	2412	81.658	19.12	30	Pass
6	2437	165.959	22.20	30	Pass
11	2462	90.991	19.59	30	Pass
12	2467	73.114	18.64	30	Pass
13	2472	45.92	16.62	30	Pass

Note: The antenna gain is 3.18 dBi < 6 dBi, so the output power limit shall not be reduced.

### 802.11be (EHT40) 1S1T

Chan.	Chan. Freq. (MHz)	Average Power (mW)	Average Power (dBm)	Power Limit (dBm)	Test Result
3	2422	75.336	18.77	30	Pass
6	2437	91.201	19.60	30	Pass
9	2452	75.509	18.78	30	Pass
10	2457	67.92	18.32	30	Pass
11	2462	58.21	17.65	30	Pass

Note: The antenna gain is 3.18 dBi < 6 dBi, so the output power limit shall not be reduced.

### 802.11be (EHT20) 26-tone RU 1S1T

Chan.	Chan. Freq. (MHz)	Average Power (mW)	Average Power (dBm)	Power Limit (dBm)	Test Result
1	2412	73.451	18.66	30	Pass
6	2437	161.065	22.07	30	Pass
11	2462	83.946	19.24	30	Pass
12	2467	75.162	18.76	30	Pass
13	2472	26.122	14.17	30	Pass

Note: The antenna gain is 3.18 dBi < 6 dBi, so the output power limit shall not be reduced.

### 802.11be (EHT20) 52-tone RU 1S1T

Chan.	Chan. Freq. (MHz)	Average Power (mW)	Average Power (dBm)	Power Limit (dBm)	Test Result
1	2412	74.473	18.72	30	Pass
6	2437	162.181	22.10	30	Pass
11	2462	85.114	19.30	30	Pass
12	2467	72.611	18.61	30	Pass
13	2472	26.002	14.15	30	Pass

Note: The antenna gain is 3.18 dBi < 6 dBi, so the output power limit shall not be reduced.

### 802.11be (EHT20) 106-tone RU 1S1T

Chan.	Chan. Freq. (MHz)	Average Power (mW)	Average Power (dBm)	Power Limit (dBm)	Test Result
1	2412	71.945	18.57	30	Pass
6	2437	161.808	22.09	30	Pass
11	2462	80.538	19.06	30	Pass
12	2467	69.663	18.43	30	Pass
13	2472	25.882	14.13	30	Pass

Note: The antenna gain is 3.18 dBi < 6 dBi, so the output power limit shall not be reduced.

### 802.11be (EHT20) 52+26-tone MRU 1S1T

Chan.	Chan. Freq. (MHz)	Average Power (mW)	Average Power (dBm)	Power Limit (dBm)	Test Result
1	2412	72.946	18.63	30	Pass
6	2437	157.761	21.98	30	Pass
11	2462	92.47	19.66	30	Pass
12	2467	82.985	19.19	30	Pass
13	2472	52.24	17.18	30	Pass

Note: The antenna gain is 3.18 dBi < 6 dBi, so the output power limit shall not be reduced.

### 802.11be (EHT20) 106+26-tone MRU 1S1T

Chan.	Chan. Freq. (MHz)	Average Power (mW)	Average Power (dBm)	Power Limit (dBm)	Test Result
1	2412	72.611	18.61	30	Pass
6	2437	160.694	22.06	30	Pass
11	2462	87.7	19.43	30	Pass
12	2467	73.79	18.68	30	Pass
13	2472	40.926	16.12	30	Pass

Note: The antenna gain is 3.18 dBi < 6 dBi, so the output power limit shall not be reduced.

### 802.11b 2TX

Chan.	Chan. Freq. (MHz)	Average Power (dBm)		Total Power (mW)	Total Power (dBm)	Power Limit (dBm)	Test Result
		Chain 0	Chain 1				
1	2412	21.82	21.79	303.063	24.82	30	Pass
6	2437	21.10	21.00	254.717	24.06	30	Pass
11	2462	21.20	21.06	259.47	24.14	30	Pass
12	2467	14.83	14.80	60.608	17.83	30	Pass
13	2472	10.30	10.77	22.655	13.55	30	Pass

Notes:

1. Directional gain is the maximum gain of antennas.
2. The maximum gain is 3.18 dBi < 6 dBi, so the output power limit shall not be reduced.

### 802.11g 2TX

Chan.	Chan. Freq. (MHz)	Average Power (dBm)		Total Power (mW)	Total Power (dBm)	Power Limit (dBm)	Test Result
		Chain 0	Chain 1				
1	2412	17.61	17.85	118.63	20.74	30	Pass
6	2437	21.07	21.01	254.121	24.05	30	Pass
11	2462	18.27	18.10	131.708	21.20	30	Pass
12	2467	16.35	16.40	86.803	19.39	30	Pass
13	2472	13.41	13.43	43.957	16.43	30	Pass

**Notes:**

1. Directional gain is the maximum gain of antennas.
2. The maximum gain is 3.18 dBi < 6 dBi, so the output power limit shall not be reduced.

### VHT20 2S2T

Chan.	Chan. Freq. (MHz)	Average Power (dBm)		Total Power (mW)	Total Power (dBm)	Power Limit (dBm)	Test Result
		Chain 0	Chain 1				
1	2412	18.46	18.36	138.694	21.42	30	Pass
6	2437	21.25	21.31	268.559	24.29	30	Pass
11	2462	18.97	18.74	153.703	21.87	30	Pass
12	2467	17.88	17.60	118.92	20.75	30	Pass
13	2472	17.07	17.10	102.219	20.10	30	Pass

Note: The directional gain is 3.18 dBi < 6 dBi, so the output power limit shall not be reduced.

### VHT40 2S2T

Chan.	Chan. Freq. (MHz)	Average Power (dBm)		Total Power (mW)	Total Power (dBm)	Power Limit (dBm)	Test Result
		Chain 0	Chain 1				
3	2422	17.80	18.05	124.082	20.94	30	Pass
6	2437	19.34	19.34	171.803	22.35	30	Pass
9	2452	18.48	17.97	133.131	21.24	30	Pass
10	2457	17.60	17.36	111.994	20.49	30	Pass
11	2462	17.19	17.00	102.479	20.11	30	Pass

Note: The directional gain is 3.18 dBi < 6 dBi, so the output power limit shall not be reduced.

### 802.11ax (HE20) 2S2T

Chan.	Chan. Freq. (MHz)	Average Power (dBm)		Total Power (mW)	Total Power (dBm)	Power Limit (dBm)	Test Result
		Chain 0	Chain 1				
1	2412	18.50	18.35	139.186	21.44	30	Pass
6	2437	21.32	21.47	275.8	24.41	30	Pass
11	2462	19.03	18.85	156.72	21.95	30	Pass
12	2467	18.02	17.67	121.866	20.86	30	Pass
13	2472	17.24	17.21	105.568	20.24	30	Pass

Note: The directional gain is 3.18 dBi < 6 dBi, so the output power limit shall not be reduced.

### 802.11ax (HE40) 2S2T

Chan.	Chan. Freq. (MHz)	Average Power (dBm)		Total Power (mW)	Total Power (dBm)	Power Limit (dBm)	Test Result
		Chain 0	Chain 1				
3	2422	17.87	18.13	126.248	21.01	30	Pass
6	2437	19.41	19.43	174.997	22.43	30	Pass
9	2452	18.54	18.10	136.015	21.34	30	Pass
10	2457	17.62	17.52	114.303	20.58	30	Pass
11	2462	17.15	17.07	102.813	20.12	30	Pass

Note: The directional gain is 3.18 dBi < 6 dBi, so the output power limit shall not be reduced.

### 802.11be (EHT20) 2S2T

Chan.	Chan. Freq. (MHz)	Average Power (dBm)		Total Power (mW)	Total Power (dBm)	Power Limit (dBm)	Test Result
		Chain 0	Chain 1				
1	2412	18.60	18.47	142.751	21.55	30	Pass
6	2437	21.41	21.61	283.234	24.52	30	Pass
11	2462	19.14	18.90	159.66	22.03	30	Pass
12	2467	18.09	17.80	124.673	20.96	30	Pass
13	2472	17.30	17.26	106.914	20.29	30	Pass

Note: The directional gain is 3.18 dBi < 6 dBi, so the output power limit shall not be reduced.

### 802.11be (EHT40) 2S2T

Chan.	Chan. Freq. (MHz)	Average Power (dBm)		Total Power (mW)	Total Power (dBm)	Power Limit (dBm)	Test Result
		Chain 0	Chain 1				
3	2422	17.96	18.16	127.981	21.07	30	Pass
6	2437	19.56	19.51	179.695	22.55	30	Pass
9	2452	18.64	18.21	139.336	21.44	30	Pass
10	2457	17.77	17.60	117.385	20.70	30	Pass
11	2462	17.30	17.20	106.184	20.26	30	Pass

Note: The directional gain is 3.18 dBi < 6 dBi, so the output power limit shall not be reduced.



### 802.11be (EHT20) 26-tone RU 2S2T

Chan.	Chan. Freq. (MHz)	Average Power (dBm)		Total Power (mW)	Total Power (dBm)	Power Limit (dBm)	Test Result
		Chain 0	Chain 1				
1	2412	18.30	17.93	129.695	21.13	30	Pass
6	2437	21.38	21.35	273.863	24.38	30	Pass
11	2462	17.74	17.66	117.774	20.71	30	Pass
12	2467	17.20	17.02	102.831	20.12	30	Pass
13	2472	12.30	12.12	33.275	15.22	30	Pass

Note: The directional gain is 3.18 dBi < 6 dBi, so the output power limit shall not be reduced.

### 802.11be (EHT20) 52-tone RU 2S2T

Chan.	Chan. Freq. (MHz)	Average Power (dBm)		Total Power (mW)	Total Power (dBm)	Power Limit (dBm)	Test Result
		Chain 0	Chain 1				
1	2412	17.66	17.57	115.492	20.63	30	Pass
6	2437	21.37	21.33	272.92	24.36	30	Pass
11	2462	18.24	18.09	131.098	21.18	30	Pass
12	2467	17.41	17.08	106.131	20.26	30	Pass
13	2472	12.30	12.13	33.313	15.23	30	Pass

Note: The directional gain is 3.18 dBi < 6 dBi, so the output power limit shall not be reduced.

### 802.11be (EHT20) 106-tone RU 2S2T

Chan.	Chan. Freq. (MHz)	Average Power (dBm)		Total Power (mW)	Total Power (dBm)	Power Limit (dBm)	Test Result
		Chain 0	Chain 1				
1	2412	18.39	18.11	133.738	21.26	30	Pass
6	2437	21.26	21.37	270.748	24.33	30	Pass
11	2462	18.28	18.04	130.977	21.17	30	Pass
12	2467	17.70	17.66	117.229	20.69	30	Pass
13	2472	12.47	12.21	34.295	15.35	30	Pass

Note: The directional gain is 3.18 dBi < 6 dBi, so the output power limit shall not be reduced.

### 802.11be (EHT20) 52+26-tone MRU 2S2T

Chan.	Chan. Freq. (MHz)	Average Power (dBm)		Total Power (mW)	Total Power (dBm)	Power Limit (dBm)	Test Result
		Chain 0	Chain 1				
1	2412	18.35	18.12	133.255	21.25	30	Pass
6	2437	21.33	21.39	273.552	24.37	30	Pass
11	2462	19.04	18.85	156.904	21.96	30	Pass
12	2467	18.63	18.45	142.93	21.55	30	Pass
13	2472	16.11	15.92	79.916	19.03	30	Pass

Note: The directional gain is 3.18 dBi < 6 dBi, so the output power limit shall not be reduced.

**802.11be (EHT20) 106+26-tone MRU 2S2T**

Chan.	Chan. Freq. (MHz)	Average Power (dBm)		Total Power (mW)	Total Power (dBm)	Power Limit (dBm)	Test Result
		Chain 0	Chain 1				
1	2412	18.29	18.12	132.316	21.22	30	Pass
6	2437	21.20	21.45	271.463	24.34	30	Pass
11	2462	18.70	18.53	145.416	21.63	30	Pass
12	2467	17.59	17.37	111.987	20.49	30	Pass
13	2472	14.71	14.47	57.57	17.60	30	Pass

Note: The directional gain is 3.18 dBi < 6 dBi, so the output power limit shall not be reduced.

## 7.2 Power Spectral Density

Input Power:	3.3 Vdc	Environmental Conditions:	25°C, 76% RH	Tested By:	Waydi Tuan
--------------	---------	---------------------------	--------------	------------	------------

### 802.11b 1TX

Chan.	Chan. Freq. (MHz)	PSD (dBm/3kHz)	PSD Limit (dBm/3kHz)	Test Result
1	2412	-7.77	8	Pass
6	2437	-7.40	8	Pass
11	2462	-8.06	8	Pass
12	2467	-10.81	8	Pass
13	2472	-15.14	8	Pass

Note: The antenna gain is 3.18 dBi < 6 dBi, so the power density limit shall not be reduced.

### 802.11g 1TX

Chan.	Chan. Freq. (MHz)	PSD w/o Duty Factor (dBm/3kHz)	Duty Factor (dB)	PSD (dBm/3kHz)	PSD Limit (dBm/3kHz)	Test Result
1	2412	-15.15	0.23	-14.92	8	Pass
6	2437	-11.21	0.23	-10.98	8	Pass
11	2462	-14.39	0.23	-14.16	8	Pass
12	2467	-16.39	0.23	-16.16	8	Pass
13	2472	-17.28	0.23	-17.05	8	Pass

Note: The antenna gain is 3.18 dBi < 6 dBi, so the power density limit shall not be reduced.

### 802.11be (EHT20) 1S1T

Chan.	Chan. Freq. (MHz)	PSD w/o Duty Factor (dBm/3kHz)	Duty Factor (dB)	PSD (dBm/3kHz)	PSD Limit (dBm/3kHz)	Test Result
1	2412	-16.55	0.11	-16.44	8	Pass
6	2437	-13.15	0.11	-13.04	8	Pass
11	2462	-15.33	0.11	-15.22	8	Pass
12	2467	-16.75	0.11	-16.64	8	Pass
13	2472	-18.87	0.11	-18.76	8	Pass

Note: The antenna gain is 3.18 dBi < 6 dBi, so the power density limit shall not be reduced.

### 802.11be (EHT40) 1S1T

Chan.	Chan. Freq. (MHz)	PSD w/o Duty Factor (dBm/3kHz)	Duty Factor (dB)	PSD (dBm/3kHz)	PSD Limit (dBm/3kHz)	Test Result
3	2422	-20	0.12	-19.88	8	Pass
6	2437	-19.31	0.12	-19.19	8	Pass
9	2452	-19.58	0.12	-19.47	8	Pass
10	2457	-20.04	0.12	-19.92	8	Pass
11	2462	-20.41	0.12	-20.29	8	Pass

Note: The antenna gain is 3.18 dBi < 6 dBi, so the power density limit shall not be reduced.

### 802.11be (EHT20) 26-tone RU 1S1T

Chan.	Chan. Freq. (MHz)	PSD w/o Duty Factor (dBm/3kHz)	Duty Factor (dB)	PSD (dBm/3kHz)	PSD Limit (dBm/3kHz)	Test Result
1	2412	-8.69	0.11	-8.58	8	Pass
6	2437	-5.5	0.11	-5.39	8	Pass
11	2462	-9.31	0.11	-9.20	8	Pass
12	2467	-8.86	0.11	-8.75	8	Pass
13	2472	-13.28	0.11	-13.17	8	Pass

Note: The antenna gain is 3.18 dBi < 6 dBi, so the power density limit shall not be reduced.

### 802.11be (EHT20) 52-tone RU 1S1T

Chan.	Chan. Freq. (MHz)	PSD w/o Duty Factor (dBm/3kHz)	Duty Factor (dB)	PSD (dBm/3kHz)	PSD Limit (dBm/3kHz)	Test Result
1	2412	-11.62	0.11	-11.51	8	Pass
6	2437	-8.35	0.11	-8.24	8	Pass
11	2462	-11.23	0.11	-11.12	8	Pass
12	2467	-11.91	0.11	-11.80	8	Pass
13	2472	-15.64	0.11	-15.53	8	Pass

Note: The antenna gain is 3.18 dBi < 6 dBi, so the power density limit shall not be reduced.

### 802.11be (EHT20) 106-tone RU 1S1T

Chan.	Chan. Freq. (MHz)	PSD w/o Duty Factor (dBm/3kHz)	Duty Factor (dB)	PSD (dBm/3kHz)	PSD Limit (dBm/3kHz)	Test Result
1	2412	-14.6	0.11	-14.49	8	Pass
6	2437	-11.52	0.11	-11.41	8	Pass
11	2462	-13.66	0.11	-13.55	8	Pass
12	2467	-14.88	0.11	-14.77	8	Pass
13	2472	-18.75	0.11	-18.64	8	Pass

Note: The antenna gain is 3.18 dBi < 6 dBi, so the power density limit shall not be reduced.

### 802.11be (EHT20) 52+26-tone MRU 1S1T

Chan.	Chan. Freq. (MHz)	PSD w/o Duty Factor (dBm/3kHz)	Duty Factor (dB)	PSD (dBm/3kHz)	PSD Limit (dBm/3kHz)	Test Result
1	2412	-13.09	0.11	-12.98	8	Pass
6	2437	-9.95	0.11	-9.84	8	Pass
11	2462	-12.74	0.11	-12.63	8	Pass
12	2467	-13.29	0.11	-13.18	8	Pass
13	2472	-14.35	0.11	-14.24	8	Pass

Note: The antenna gain is 3.18 dBi < 6 dBi, so the power density limit shall not be reduced.

### 802.11be (EHT20) 106+26-tone MRU 1S1T

Chan.	Chan. Freq. (MHz)	PSD w/o Duty Factor (dBm/3kHz)	Duty Factor (dB)	PSD (dBm/3kHz)	PSD Limit (dBm/3kHz)	Test Result
1	2412	-13.6	0.11	-13.49	8	Pass
6	2437	-11.64	0.11	-11.53	8	Pass
11	2462	-13.67	0.11	-13.56	8	Pass
12	2467	-14.41	0.11	-14.30	8	Pass
13	2472	-16.96	0.11	-16.85	8	Pass

Note: The antenna gain is 3.18 dBi < 6 dBi, so the power density limit shall not be reduced.

### 802.11b 2TX

Chan.	Chan. Freq. (MHz)	PSD (dBm/3kHz)		Total PSD (dBm/3kHz)	PSD Limit (dBm/3kHz)	Test Result
		Chain 0	Chain 1			
1	2412	-9.50	-10.10	-6.78	7.81	Pass
6	2437	-10.12	-10.40	-7.25	7.81	Pass
11	2462	-10.40	-10.12	-7.25	7.81	Pass
12	2467	-16.79	-17.49	-14.12	7.81	Pass
13	2472	-21.19	-20.64	-17.90	7.81	Pass

Notes:

- Method E) 2) b) Measure and sum spectral maxima across the outputs of KDB 662911 is using for calculating total power density.
- Directional gain = gain of antenna element + 10 log (2 of TX antenna elements)
- The directional gain is 6.19 dBi > 6 dBi, so the power density limit shall be reduced to  $8 - (6.19 - 6) = 7.81$  dBm/3kHz.

### 802.11g 2TX

Chan.	Chan. Freq. (MHz)	PSD w/o Duty Factor (dBm/3kHz)		Duty Factor (dB)	Total PSD (dBm/3kHz)	PSD Limit (dBm/3kHz)	Test Result
		Chain 0	Chain 1				
1	2412	-16.88	-17.04	0.23	-13.72	7.81	Pass
6	2437	-13.04	-12.67	0.23	-9.61	7.81	Pass
11	2462	-15.87	-16.37	0.23	-12.87	7.81	Pass
12	2467	-18.29	-18.68	0.23	-15.24	7.81	Pass
13	2472	-21.60	-21.51	0.23	-18.32	7.81	Pass

Notes:

- Method E) 2) b) Measure and sum spectral maxima across the outputs of KDB 662911 is using for calculating total power density.
- Directional gain = gain of antenna element + 10 log (2 of TX antenna elements)
- The directional gain is 6.19 dBi > 6 dBi, so the power density limit shall be reduced to  $8 - (6.19 - 6) = 7.81$  dBm/3kHz.

### 802.11be (EHT20) 2S2T

Chan.	Chan. Freq. (MHz)	PSD w/o Duty Factor (dBm/3kHz)		Duty Factor (dB)	Total PSD (dBm/3kHz)	PSD Limit (dBm/3kHz)	Test Result
		Chain 0	Chain 1				
1	2412	-17.10	-16.92	0.11	-13.89	8	Pass
6	2437	-14.54	-13.76	0.11	-11.02	8	Pass
11	2462	-16.17	-16.28	0.11	-13.11	8	Pass
12	2467	-18.16	-17.86	0.11	-14.89	8	Pass
13	2472	-18.17	-18.49	0.11	-15.21	8	Pass

Notes:

- Method E) 2) b) Measure and sum spectral maxima across the outputs of KDB 662911 is using for calculating total power density.
- Directional gain = gain of antenna element + 10 log (2 of TX antenna elements/NSS 2) = gain of antenna element + 0 dB
- The directional gain is 3.18 dBi < 6 dBi, so the power density limit shall not be reduced.

### 802.11be (EHT40) 2S2T

Chan.	Chan. Freq. (MHz)	PSD w/o Duty Factor (dBm/3kHz)		Duty Factor (dB)	Total PSD (dBm/3kHz)	PSD Limit (dBm/3kHz)	Test Result
		Chain 0	Chain 1				
3	2422	-21.48	-21.91	0.12	-18.56	8	Pass
6	2437	-19.21	-18.52	0.12	-15.73	8	Pass
9	2452	-20.09	-20.09	0.12	-16.96	8	Pass
10	2457	-20.49	-20.59	0.12	-17.41	8	Pass
11	2462	-21.69	-21.19	0.12	-18.31	8	Pass

Notes:

- Method E) 2) b) Measure and sum spectral maxima across the outputs of KDB 662911 is using for calculating total power density.
- Directional gain = gain of antenna element + 10 log (2 of TX antenna elements/NSS 2) = gain of antenna element + 0 dB
- The directional gain is 3.18 dBi < 6 dBi, so the power density limit shall not be reduced.

### 802.11be (EHT20) 26-tone RU 2S2T

Chan.	Chan. Freq. (MHz)	PSD w/o Duty Factor (dBm/3kHz)		Duty Factor (dB)	Total PSD (dBm/3kHz)	PSD Limit (dBm/3kHz)	Test Result
		Chain 0	Chain 1				
1	2412	-9.55	-9.70	0.11	-6.51	8	Pass
6	2437	-7.12	-6.47	0.11	-3.67	8	Pass
11	2462	-10.24	-9.92	0.11	-6.96	8	Pass
12	2467	-10.28	-10.82	0.11	-7.42	8	Pass
13	2472	-16.36	-16.27	0.11	-13.20	8	Pass

Notes:

1. Method E) 2) b) Measure and sum spectral maxima across the outputs of KDB 662911 is using for calculating total power density.
2. Directional gain = gain of antenna element + 10 log (2 of TX antenna elements/NSS 2) = gain of antenna element + 0 dB
3. The directional gain is 3.18 dBi < 6 dBi, so the power density limit shall not be reduced.

### 802.11be (EHT20) 52-tone RU 2S2T

Chan.	Chan. Freq. (MHz)	PSD w/o Duty Factor (dBm/3kHz)		Duty Factor (dB)	Total PSD (dBm/3kHz)	PSD Limit (dBm/3kHz)	Test Result
		Chain 0	Chain 1				
1	2412	-13.10	-13.19	0.11	-10.03	8	Pass
6	2437	-9.17	-9.66	0.11	-6.29	8	Pass
11	2462	-12.41	-12.55	0.11	-9.36	8	Pass
12	2467	-13.84	-13.29	0.11	-10.44	8	Pass
13	2472	-18.25	-18.45	0.11	-15.23	8	Pass

Notes:

1. Method E) 2) b) Measure and sum spectral maxima across the outputs of KDB 662911 is using for calculating total power density.
2. Directional gain = gain of antenna element + 10 log (2 of TX antenna elements/NSS 2) = gain of antenna element + 0 dB
3. The directional gain is 3.18 dBi < 6 dBi, so the power density limit shall not be reduced.

### 802.11be (EHT20) 106-tone RU 2S2T

Chan.	Chan. Freq. (MHz)	PSD w/o Duty Factor (dBm/3kHz)		Duty Factor (dB)	Total PSD (dBm/3kHz)	PSD Limit (dBm/3kHz)	Test Result
		Chain 0	Chain 1				
1	2412	-15.31	-15.58	0.11	-12.33	8	Pass
6	2437	-12.34	-12.67	0.11	-9.39	8	Pass
11	2462	-15.33	-15.47	0.11	-12.28	8	Pass
12	2467	-16.11	-15.85	0.11	-12.86	8	Pass
13	2472	-21.07	-21.51	0.11	-18.17	8	Pass

**Notes:**

- Method E) 2) b) Measure and sum spectral maxima across the outputs of KDB 662911 is using for calculating total power density.
- Directional gain = gain of antenna element + 10 log (2 of TX antenna elements/NSS 2) = gain of antenna element + 0 dB
- The directional gain is 3.18 dBi < 6 dBi, so the power density limit shall not be reduced.

### 802.11be (EHT20) 52+26-tone MRU 2S2T

Chan.	Chan. Freq. (MHz)	PSD w/o Duty Factor (dBm/3kHz)		Duty Factor (dB)	Total PSD (dBm/3kHz)	PSD Limit (dBm/3kHz)	Test Result
		Chain 0	Chain 1				
1	2412	-13.72	-13.83	0.11	-10.66	8	Pass
6	2437	-11.19	-11.22	0.11	-8.09	8	Pass
11	2462	-12.96	-13.03	0.11	-9.88	8	Pass
12	2467	-14.28	-14.04	0.11	-11.04	8	Pass
13	2472	-16.02	-16.22	0.11	-13.00	8	Pass

**Notes:**

- Method E) 2) b) Measure and sum spectral maxima across the outputs of KDB 662911 is using for calculating total power density.
- Directional gain = gain of antenna element + 10 log (2 of TX antenna elements/NSS 2) = gain of antenna element + 0 dB
- The directional gain is 3.18 dBi < 6 dBi, so the power density limit shall not be reduced.

### 802.11be (EHT20) 106+26-tone MRU 2S2T

Chan.	Chan. Freq. (MHz)	PSD w/o Duty Factor (dBm/3kHz)		Duty Factor (dB)	Total PSD (dBm/3kHz)	PSD Limit (dBm/3kHz)	Test Result
		Chain 0	Chain 1				
1	2412	-15.30	-15.47	0.11	-12.27	8	Pass
6	2437	-12.31	-12.72	0.11	-9.39	8	Pass
11	2462	-14.99	-14.72	0.11	-11.74	8	Pass
12	2467	-15.81	-16.02	0.11	-12.80	8	Pass
13	2472	-18.89	-19.11	0.11	-15.88	8	Pass

**Notes:**

- Method E) 2) b) Measure and sum spectral maxima across the outputs of KDB 662911 is using for calculating total power density.
- Directional gain = gain of antenna element + 10 log (2 of TX antenna elements/NSS 2) = gain of antenna element + 0 dB
- The directional gain is 3.18 dBi < 6 dBi, so the power density limit shall not be reduced.





### Spectrum Plot of Maximum Value

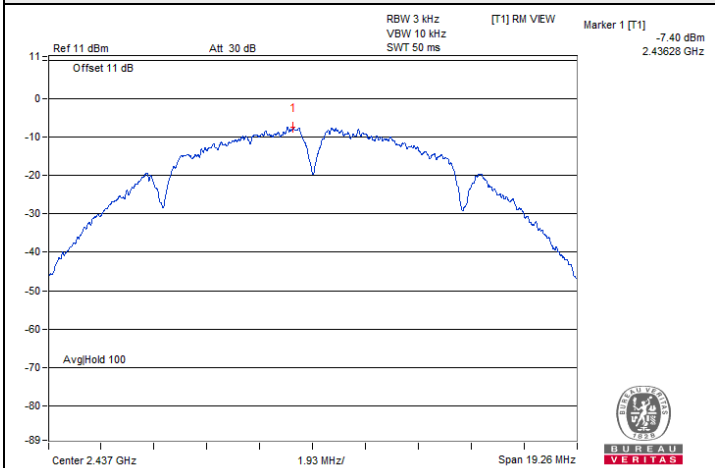

802.11b 1TX / Chain 0 : CH 6

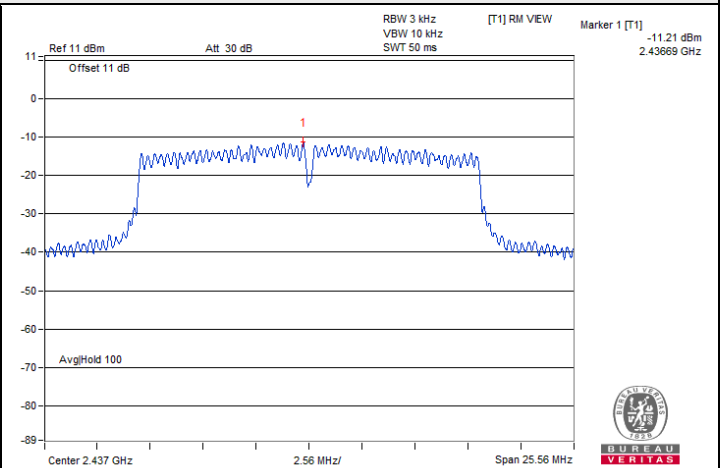

802.11g 1TX / Chain 0 : CH 6

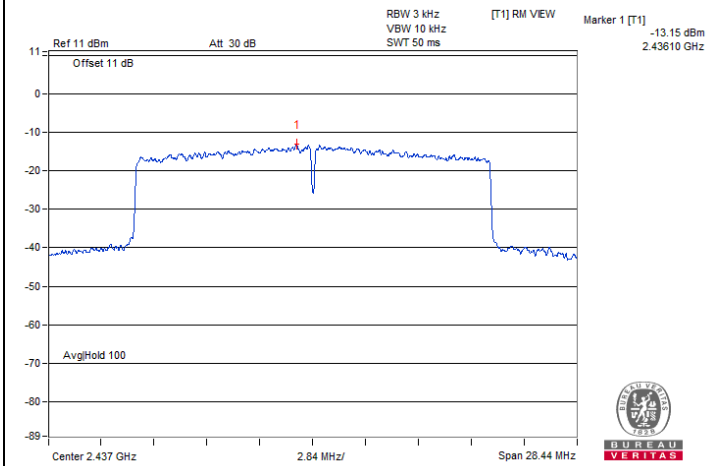

802.11be (EHT20) 1S1T / Chain 0 : CH 6

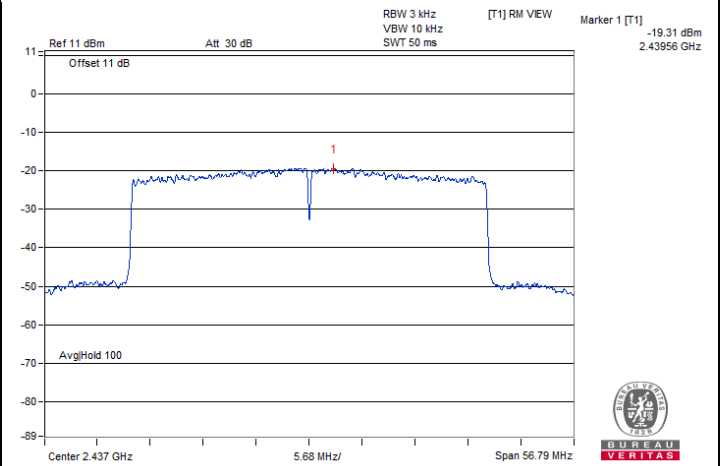

802.11be (EHT40) 1S1T / Chain 0 : CH 6

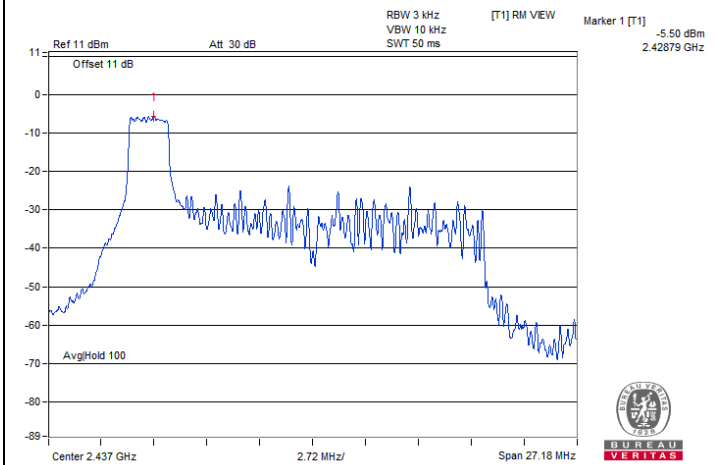

802.11be (EHT20) 26-tone RU 1S1T / Chain 0 : CH 6@0

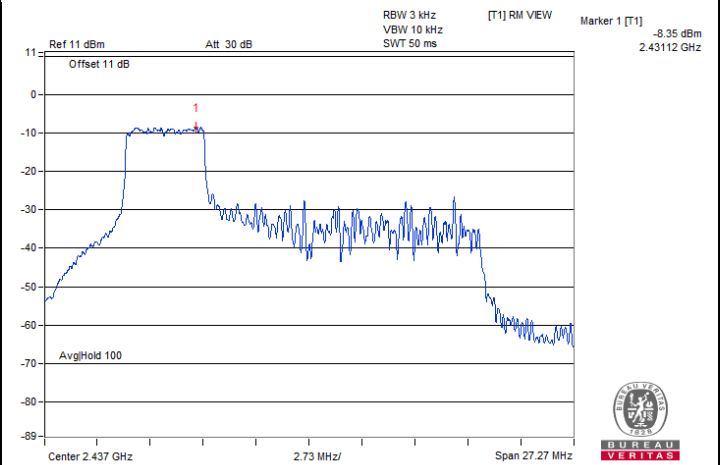

802.11be (EHT20) 52-tone RU 1S1T / Chain 0 : CH 6@37



### Spectrum Plot of Maximum Value

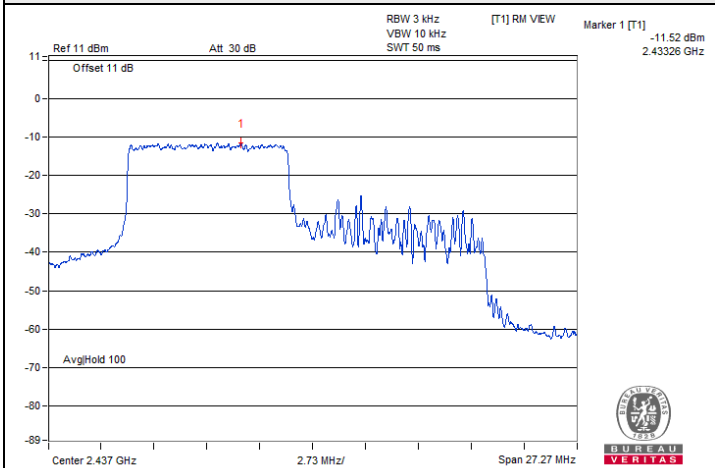

802.11be (EHT20) 106-tone RU 1S1T / Chain 0 : CH 6@53

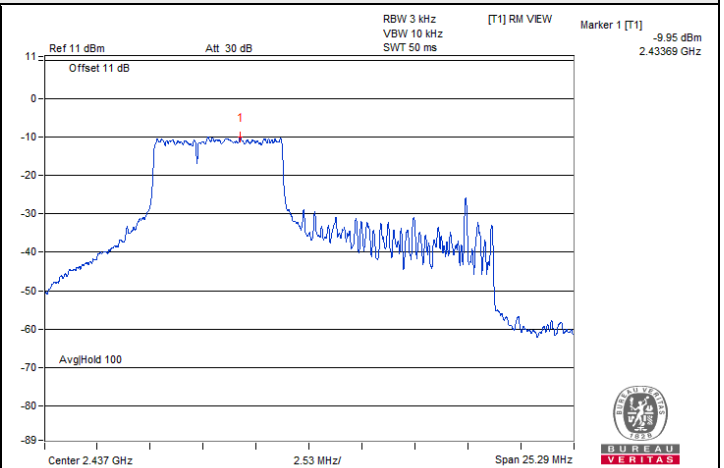

802.11be (EHT20) 52+26-tone MRU 1S1T / Chain 0 : CH 6@70

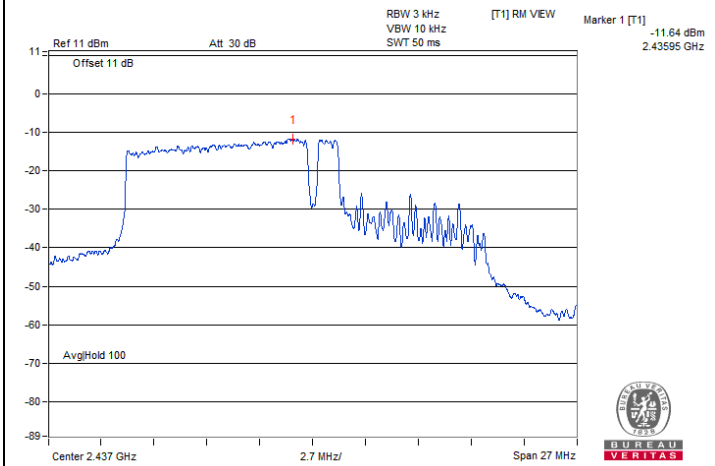

802.11be (EHT20) 106+26-tone MRU 1S1T / Chain 0 : CH 6@82

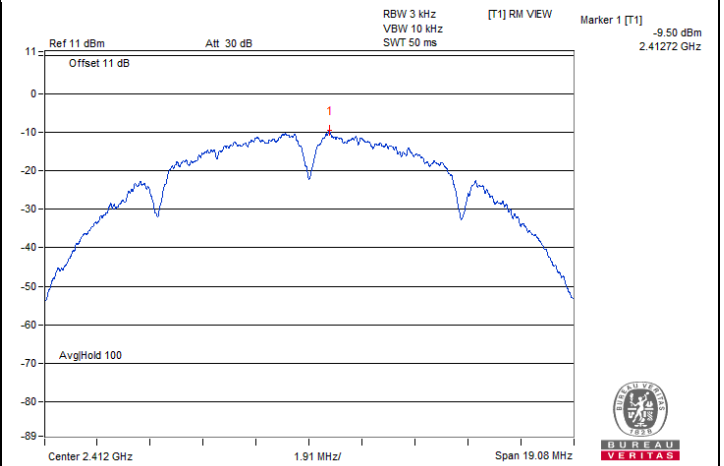

802.11b 2TX / Chain 0 : CH 1

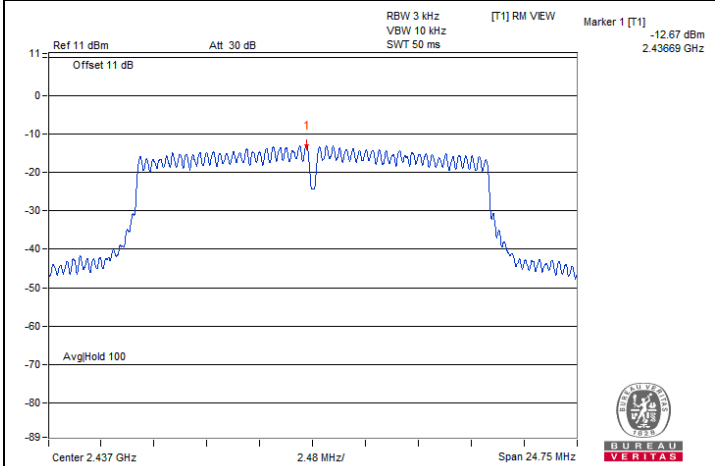

802.11g 2TX / Chain 1 : CH 6

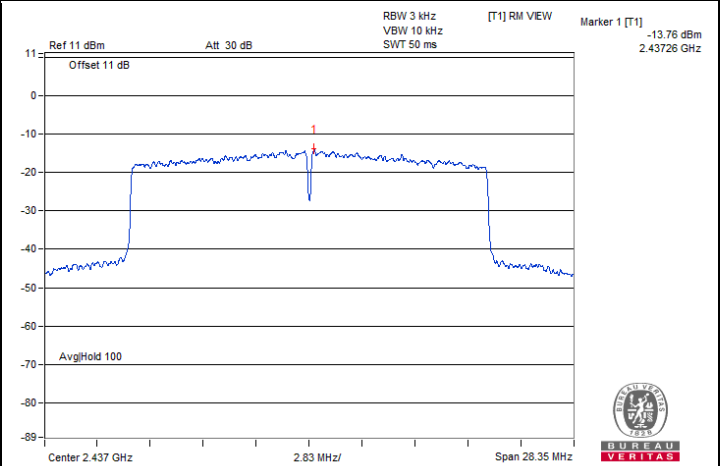

802.11be (EHT20) 2S2T / Chain 1 : CH 6

### Spectrum Plot of Maximum Value

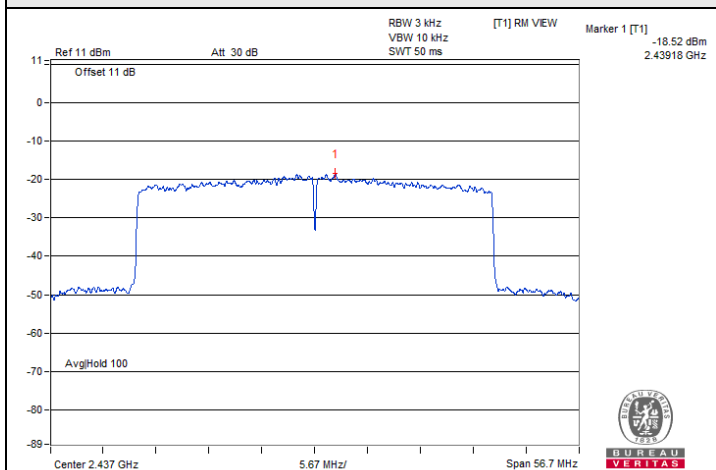

802.11be (EHT40) 2S2T / Chain 1 : CH 6

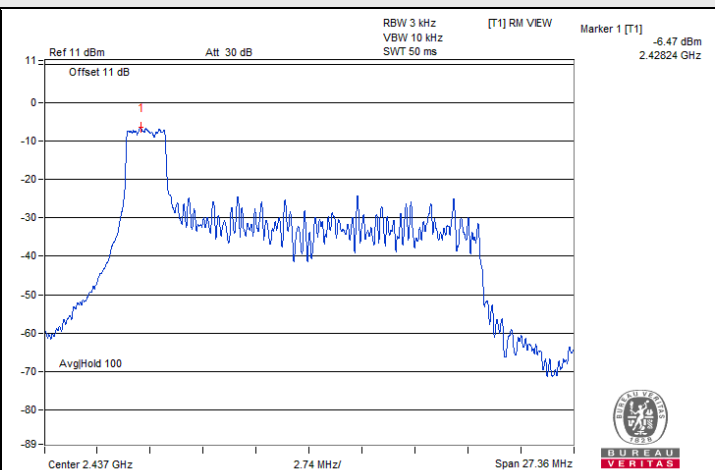

802.11be (EHT20) 26-tone RU 2S2T / Chain 1 : CH 6@0

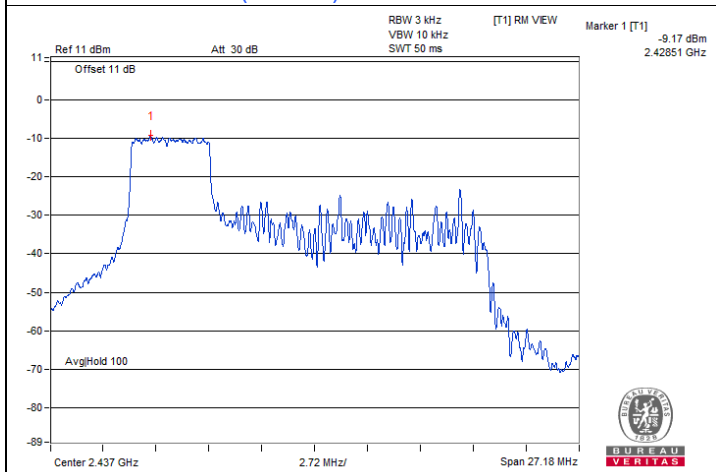

802.11be (EHT20) 52-tone RU 2S2T / Chain 0 : CH 6@37

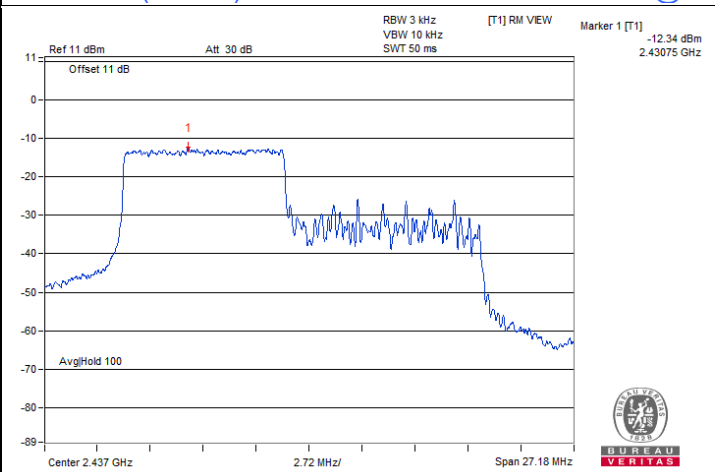

802.11be (EHT20) 106-tone RU 2S2T / Chain 0 : CH 6@53

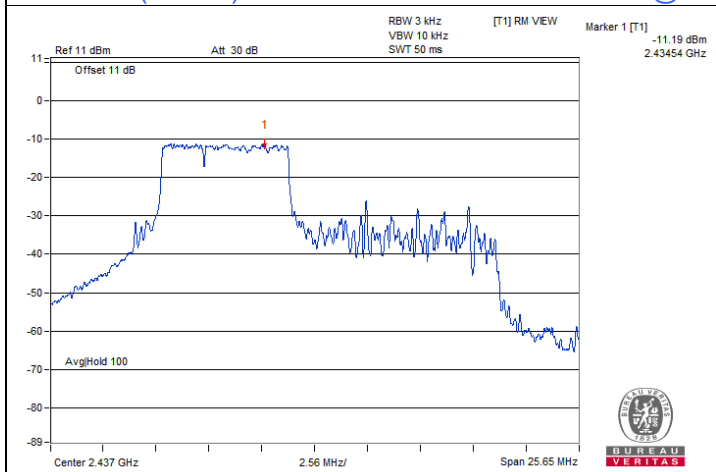

802.11be (EHT20) 52+26-tone MRU 2S2T / Chain 0 : CH 6@70

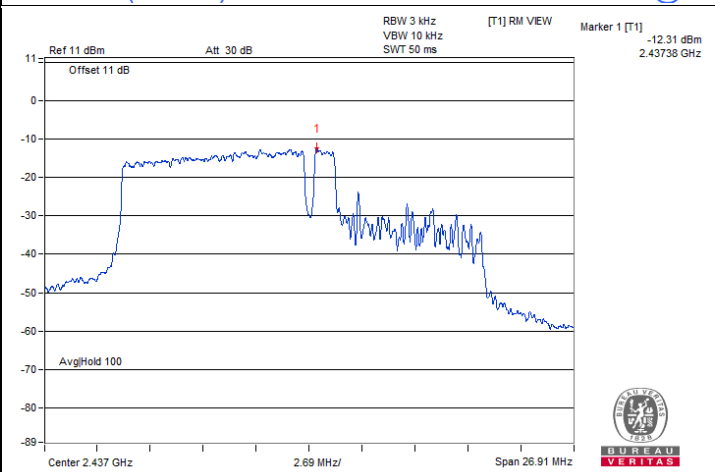

802.11be (EHT20) 106+26-tone MRU 2S2T / Chain 0 : CH 6@82

### 7.3 6 dB Bandwidth

Input Power:	3.3 Vdc	Environmental Conditions:	25°C, 76% RH	Tested By:	Waydi Tuan
--------------	---------	---------------------------	--------------	------------	------------

#### 802.11b 1TX

Channel	Frequency (MHz)	6 dB Bandwidth (MHz)	Minimum Limit (MHz)	Test Result
1	2412	8.07	0.5	Pass
6	2437	8.08	0.5	Pass
11	2462	8.06	0.5	Pass
12	2467	8.09	0.5	Pass
13	2472	8.08	0.5	Pass

#### 802.11g 1TX

Channel	Frequency (MHz)	6 dB Bandwidth (MHz)	Minimum Limit (MHz)	Test Result
1	2412	16.32	0.5	Pass
6	2437	16.31	0.5	Pass
11	2462	16.3	0.5	Pass
12	2467	16.31	0.5	Pass
13	2472	16.33	0.5	Pass

#### 802.11be (EHT20) 1S1T

Channel	Frequency (MHz)	6 dB Bandwidth (MHz)	Minimum Limit (MHz)	Test Result
1	2412	18.86	0.5	Pass
6	2437	18.69	0.5	Pass
11	2462	18.8	0.5	Pass
12	2467	18.76	0.5	Pass
13	2472	18.88	0.5	Pass

#### 802.11be (EHT40) 1S1T

Channel	Frequency (MHz)	6 dB Bandwidth (MHz)	Minimum Limit (MHz)	Test Result
3	2422	37.63	0.5	Pass
6	2437	37.77	0.5	Pass
9	2452	37.46	0.5	Pass
10	2457	37.83	0.5	Pass
11	2462	37.82	0.5	Pass

**802.11be (EHT20) 26-tone RU 1S1T**

Channel	Frequency (MHz)	6 dB Bandwidth (MHz)	Minimum Limit (MHz)	Test Result
1	2412	2.13	0.5	Pass
6	2437	2.12	0.5	Pass
11	2462	2.12	0.5	Pass
12	2467	2.1	0.5	Pass
13	2472	2.11	0.5	Pass

**802.11be (EHT20) 52-tone RU 1S1T**

Channel	Frequency (MHz)	6 dB Bandwidth (MHz)	Minimum Limit (MHz)	Test Result
1	2412	17.07	0.5	Pass
6	2437	17.08	0.5	Pass
11	2462	17.04	0.5	Pass
12	2467	17.05	0.5	Pass
13	2472	16.99	0.5	Pass

**802.11be (EHT20) 106-tone RU 1S1T**

Channel	Frequency (MHz)	6 dB Bandwidth (MHz)	Minimum Limit (MHz)	Test Result
1	2412	17.17	0.5	Pass
6	2437	17.15	0.5	Pass
11	2462	17.16	0.5	Pass
12	2467	17.16	0.5	Pass
13	2472	17.16	0.5	Pass

**802.11be (EHT20) 52+26-tone MRU 1S1T**

Channel	Frequency (MHz)	6 dB Bandwidth (MHz)	Minimum Limit (MHz)	Test Result
1	2412	15.12	0.5	Pass
6	2437	15.1	0.5	Pass
11	2462	15.03	0.5	Pass
12	2467	15.09	0.5	Pass
13	2472	15.09	0.5	Pass

**802.11be (EHT20) 106+26-tone MRU 1S1T**

Channel	Frequency (MHz)	6 dB Bandwidth (MHz)	Minimum Limit (MHz)	Test Result
1	2412	17.12	0.5	Pass
6	2437	17.1	0.5	Pass
11	2462	17.05	0.5	Pass
12	2467	17.1	0.5	Pass
13	2472	17.09	0.5	Pass

**802.11b 2TX**

Channel	Frequency (MHz)	6 dB Bandwidth (MHz)		Minimum Limit (MHz)	Test Result
		Chain 0	Chain 1		
1	2412	8.09	8.09	0.5	Pass
6	2437	8.07	8.09	0.5	Pass
11	2462	8.05	8.04	0.5	Pass
12	2467	8.04	8.04	0.5	Pass
13	2472	8.07	8.07	0.5	Pass

**802.11g 2TX**

Channel	Frequency (MHz)	6 dB Bandwidth (MHz)		Minimum Limit (MHz)	Test Result
		Chain 0	Chain 1		
1	2412	16.32	16.32	0.5	Pass
6	2437	16.31	16.31	0.5	Pass
11	2462	16.31	16.30	0.5	Pass
12	2467	16.32	16.31	0.5	Pass
13	2472	16.33	16.32	0.5	Pass

**802.11be (EHT20) 2S2T**

Channel	Frequency (MHz)	6 dB Bandwidth (MHz)		Minimum Limit (MHz)	Test Result
		Chain 0	Chain 1		
1	2412	18.76	18.85	0.5	Pass
6	2437	18.76	18.70	0.5	Pass
11	2462	18.85	18.79	0.5	Pass
12	2467	18.81	18.85	0.5	Pass
13	2472	18.77	18.85	0.5	Pass

### 802.11be (EHT40) 2S2T

Channel	Frequency (MHz)	6 dB Bandwidth (MHz)		Minimum Limit (MHz)	Test Result
		Chain 0	Chain 1		
3	2422	37.73	37.57	0.5	Pass
6	2437	37.78	37.57	0.5	Pass
9	2452	37.47	37.78	0.5	Pass
10	2457	37.78	37.66	0.5	Pass
11	2462	37.77	37.51	0.5	Pass

### 802.11be (EHT20) 26-tone RU 2S2T

Channel	Frequency (MHz)	6 dB Bandwidth (MHz)		Minimum Limit (MHz)	Test Result
		Chain 0	Chain 1		
1	2412	2.14	2.13	0.5	Pass
6	2437	2.11	2.13	0.5	Pass
11	2462	2.11	2.11	0.5	Pass
12	2467	2.11	2.14	0.5	Pass
13	2472	2.12	2.15	0.5	Pass

### 802.11be (EHT20) 52-tone RU 2S2T

Channel	Frequency (MHz)	6 dB Bandwidth (MHz)		Minimum Limit (MHz)	Test Result
		Chain 0	Chain 1		
1	2412	17.05	17.08	0.5	Pass
6	2437	17.05	17.08	0.5	Pass
11	2462	17.09	17.05	0.5	Pass
12	2467	17.04	17.07	0.5	Pass
13	2472	17.06	17.04	0.5	Pass

### 802.11be (EHT20) 106-tone RU 2S2T

Channel	Frequency (MHz)	6 dB Bandwidth (MHz)		Minimum Limit (MHz)	Test Result
		Chain 0	Chain 1		
1	2412	17.16	17.18	0.5	Pass
6	2437	17.16	17.15	0.5	Pass
11	2462	17.18	17.16	0.5	Pass
12	2467	17.16	17.15	0.5	Pass
13	2472	17.16	17.15	0.5	Pass

**802.11be (EHT20) 52+26-tone MRU 2S2T**

Channel	Frequency (MHz)	6 dB Bandwidth (MHz)		Minimum Limit (MHz)	Test Result
		Chain 0	Chain 1		
1	2412	15.13	15.12	0.5	Pass
6	2437	15.12	15.14	0.5	Pass
11	2462	15.13	15.14	0.5	Pass
12	2467	15.13	15.13	0.5	Pass
13	2472	15.14	15.13	0.5	Pass

**802.11be (EHT20) 106+26-tone MRU 2S2T**

Channel	Frequency (MHz)	6 dB Bandwidth (MHz)		Minimum Limit (MHz)	Test Result
		Chain 0	Chain 1		
1	2412	17.10	17.12	0.5	Pass
6	2437	17.10	17.12	0.5	Pass
11	2462	17.11	17.07	0.5	Pass
12	2467	17.10	17.10	0.5	Pass
13	2472	17.12	17.11	0.5	Pass



### Spectrum Plot of Minimum Value

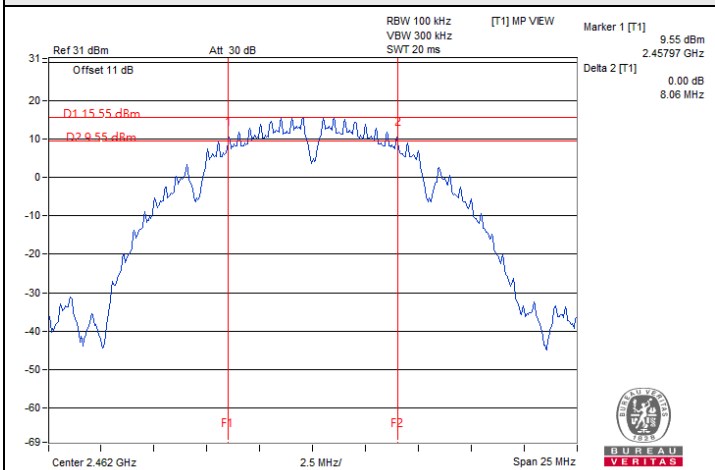

802.11b 1TX / Chain 0 : CH 11

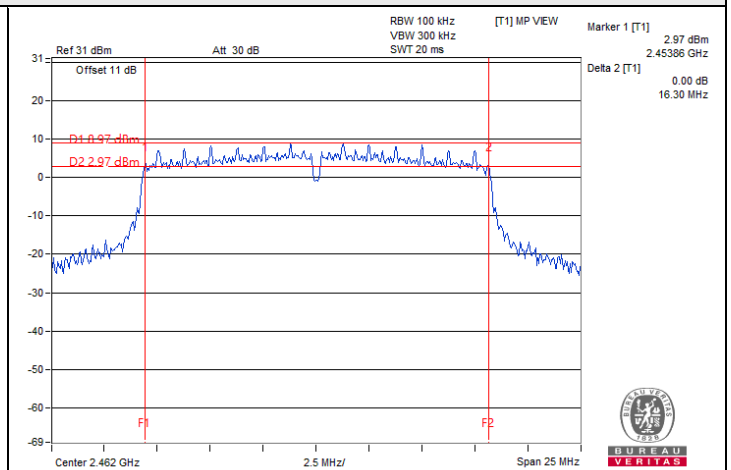

802.11g 1TX / Chain 0 : CH 11

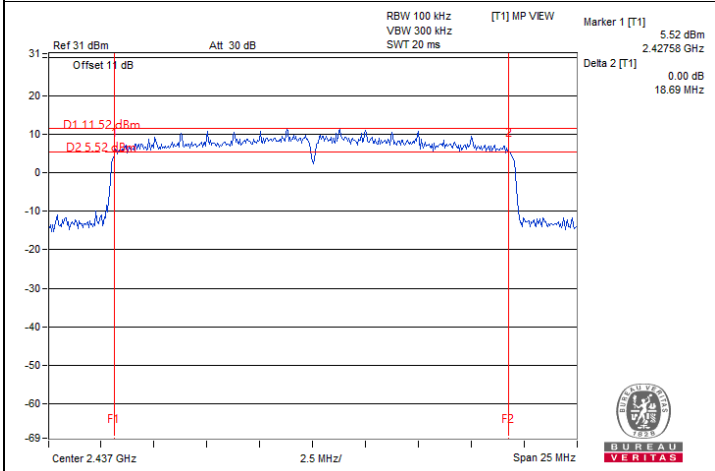

802.11be (EHT20) 1S1T / Chain 0 : CH 6

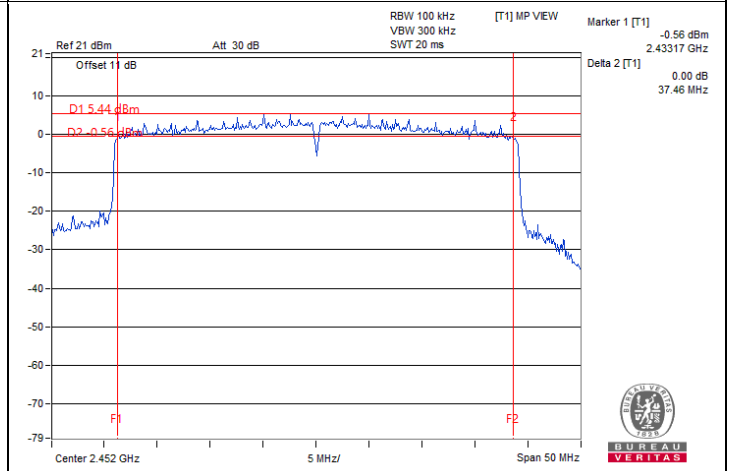

802.11be (EHT40) 1S1T / Chain 0 : CH 9

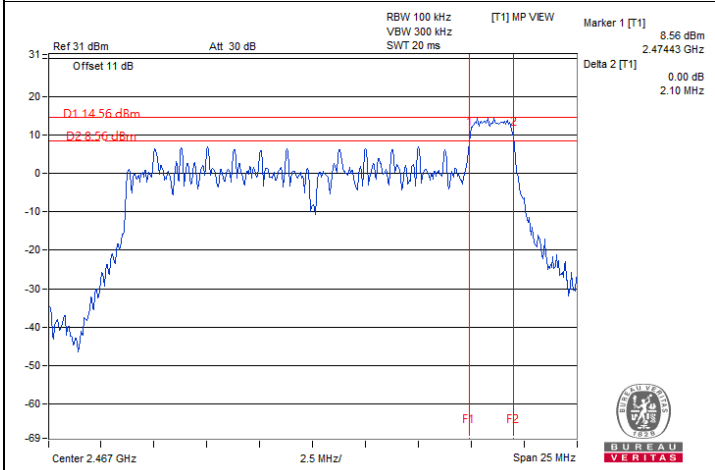

802.11be (EHT20) 26-tone RU 1S1T / Chain 0 : CH 12@8

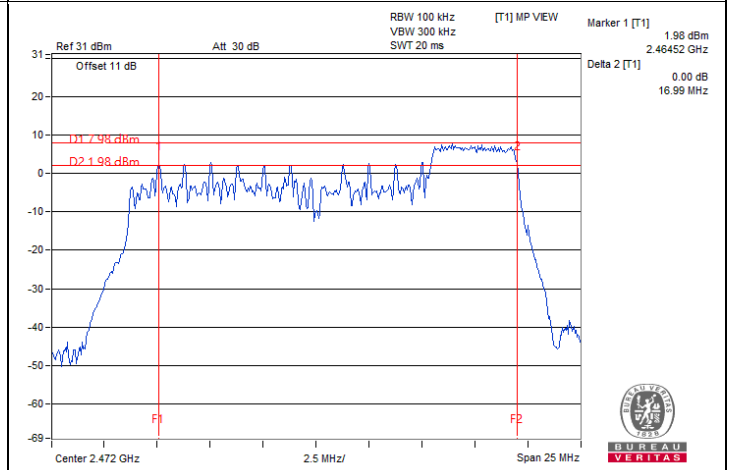

802.11be (EHT20) 52-tone RU 1S1T / Chain 0 : CH 13@40

### Spectrum Plot of Minimum Value

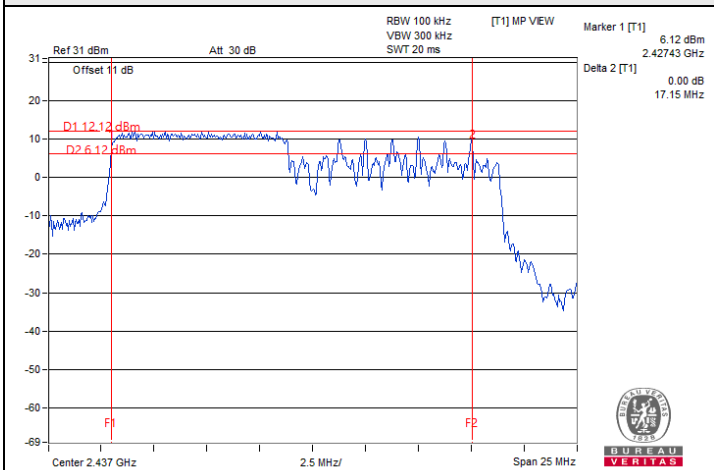

802.11be (EHT20) 106-tone RU 1S1T / Chain 0 : CH 6@53

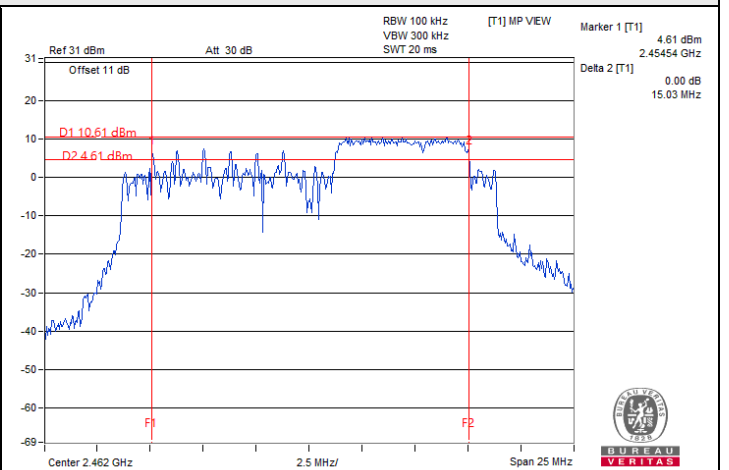

802.11be (EHT20) 52+26-tone MRU 1S1T / Chain 0 : CH 11@72

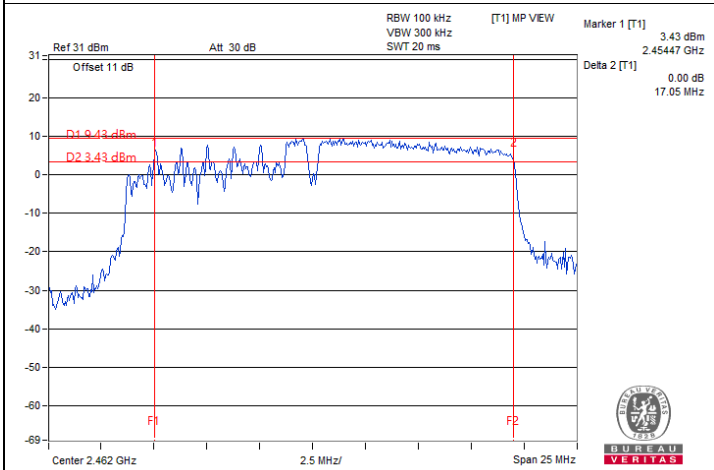

802.11be (EHT20) 106+26-tone MRU 1S1T / Chain 0 : CH 11@83

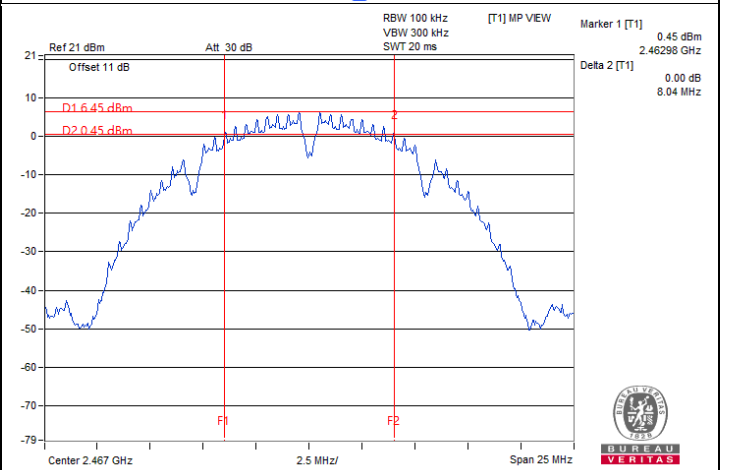

802.11b 2TX / Chain 0 : CH 12

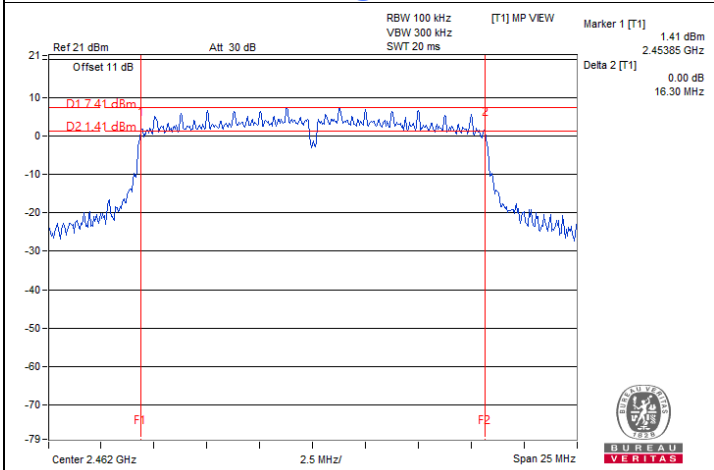

802.11g 2TX / Chain 1 : CH 11

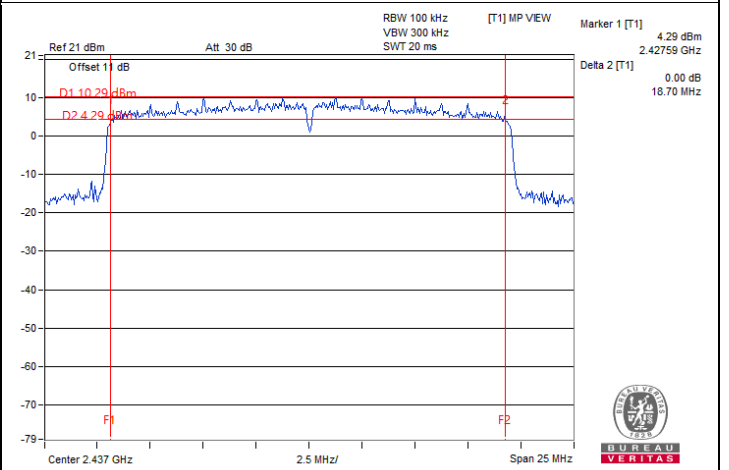

802.11be (EHT20) 2S2T / Chain 1 : CH 6



### Spectrum Plot of Minimum Value

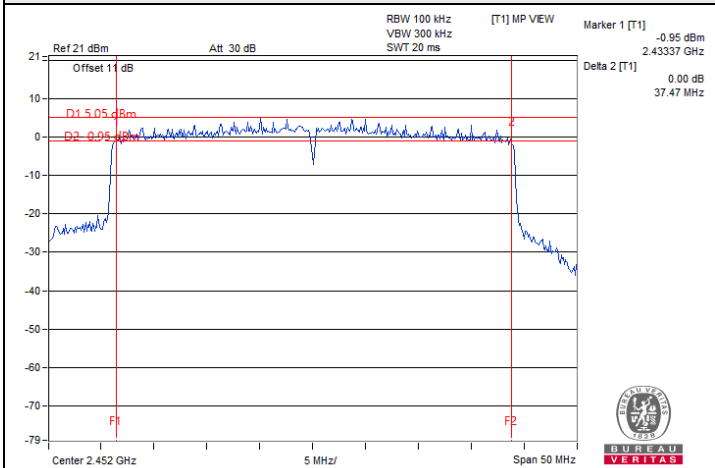

802.11be (EHT40) 2S2T / Chain 0 : CH 9

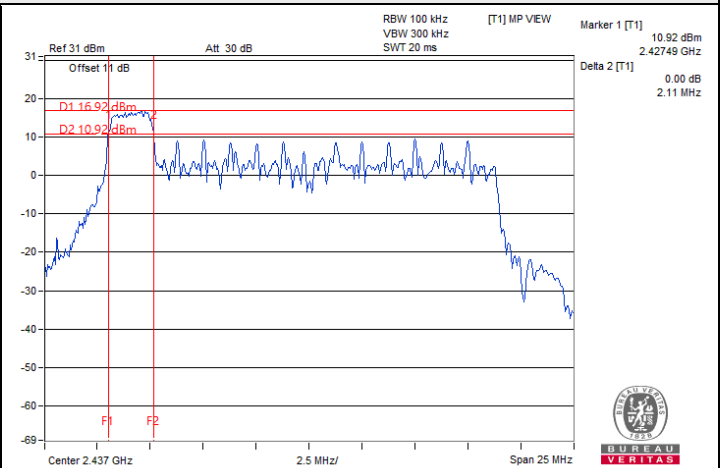

802.11be (EHT20) 26-tone RU 2S2T / Chain 0 : CH 6@0

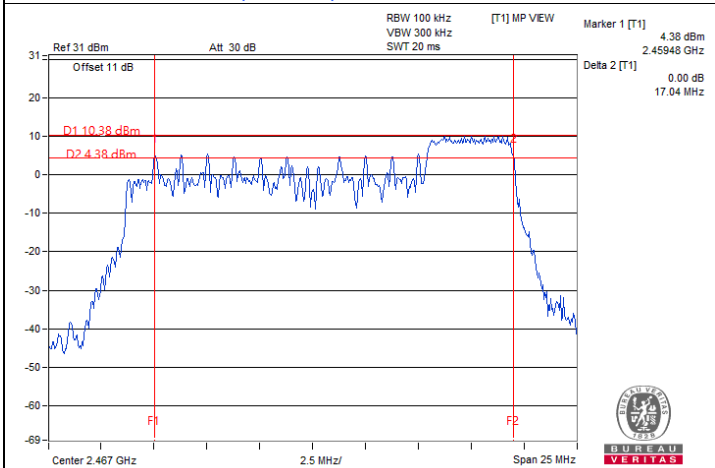

802.11be (EHT20) 52-tone RU 2S2T / Chain 0 : CH 12@40

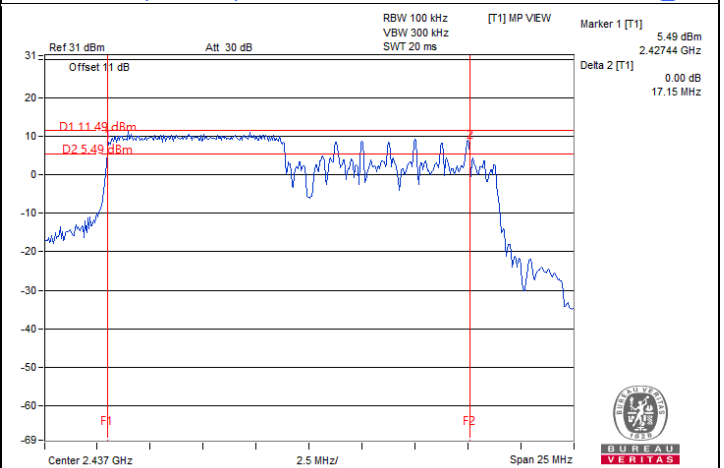

802.11be (EHT20) 106-tone RU 2S2T / Chain 1 : CH 6@53

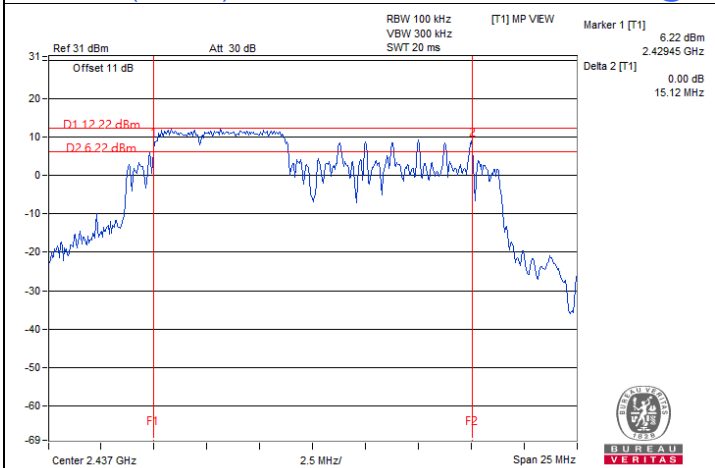

802.11be (EHT20) 52+26-tone MRU 2S2T / Chain 0 : CH 6@70

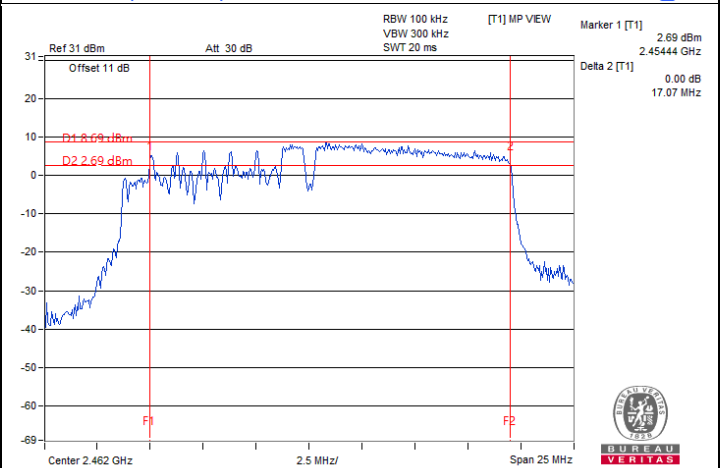

802.11be (EHT20) 106+26-tone MRU 2S2T / Chain 1 : CH 11@83



BUREAU VERITAS

### 7.4 Conducted Out of Band Emissions

Input Power:	3.3 Vdc	Environmental Conditions:	25°C, 76% RH	Tested By:	Waydi Tuan
--------------	---------	---------------------------	--------------	------------	------------

#### 802.11b 1TX



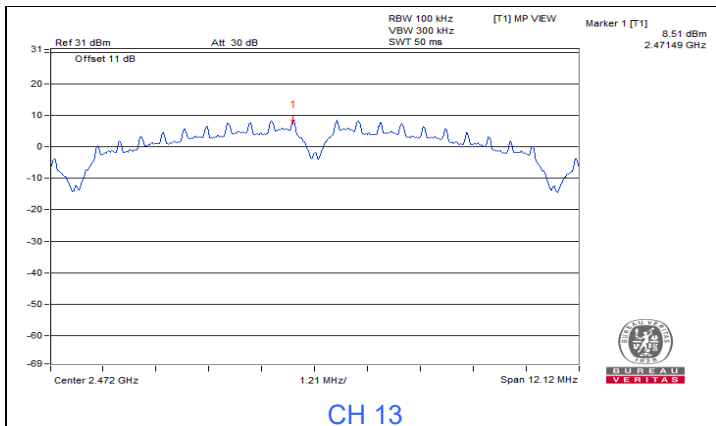

CH 13

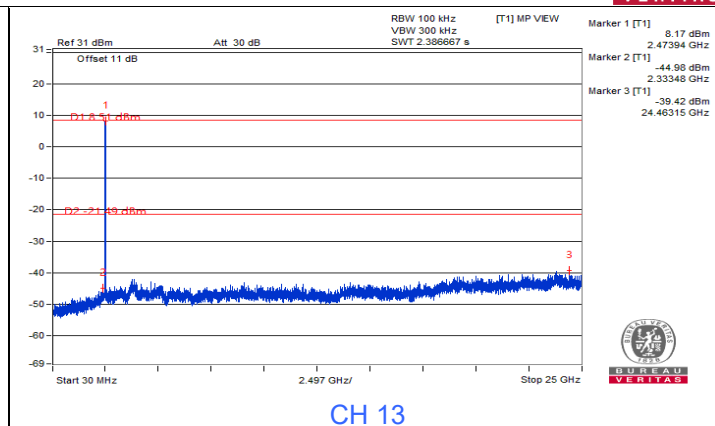

CH 13

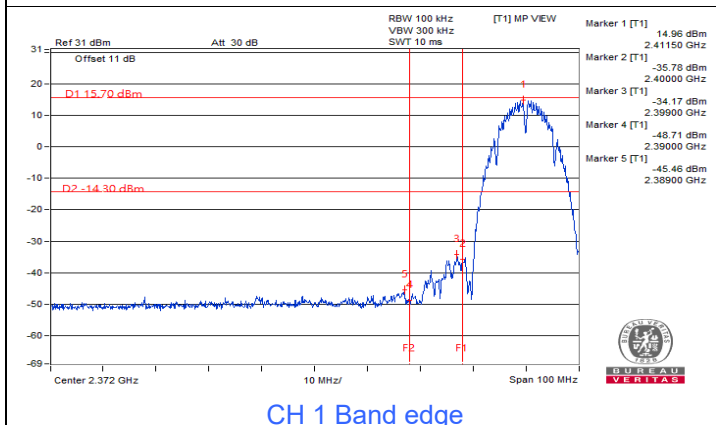

CH 1 Band edge

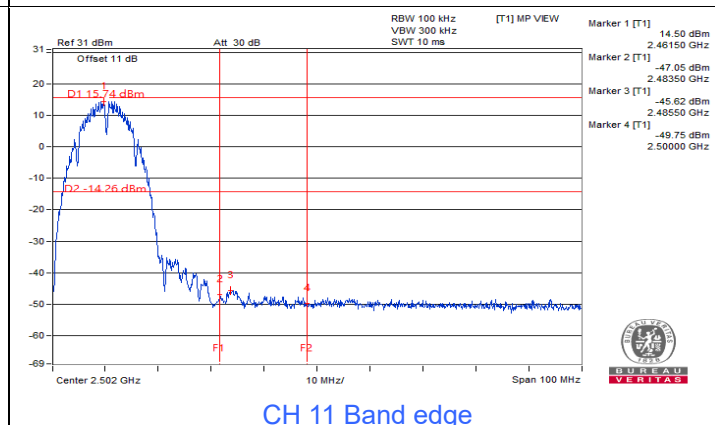

CH 11 Band edge

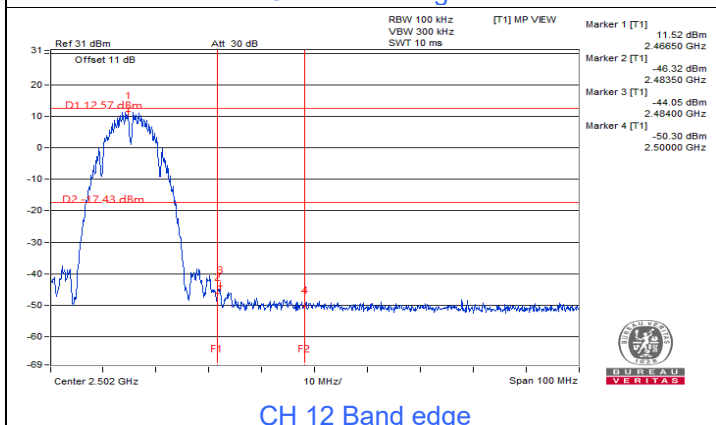

CH 12 Band edge

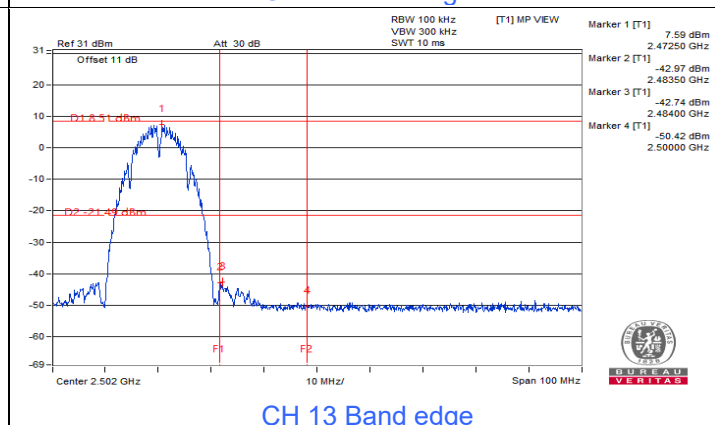

CH 13 Band edge



# 802.11g 1TX

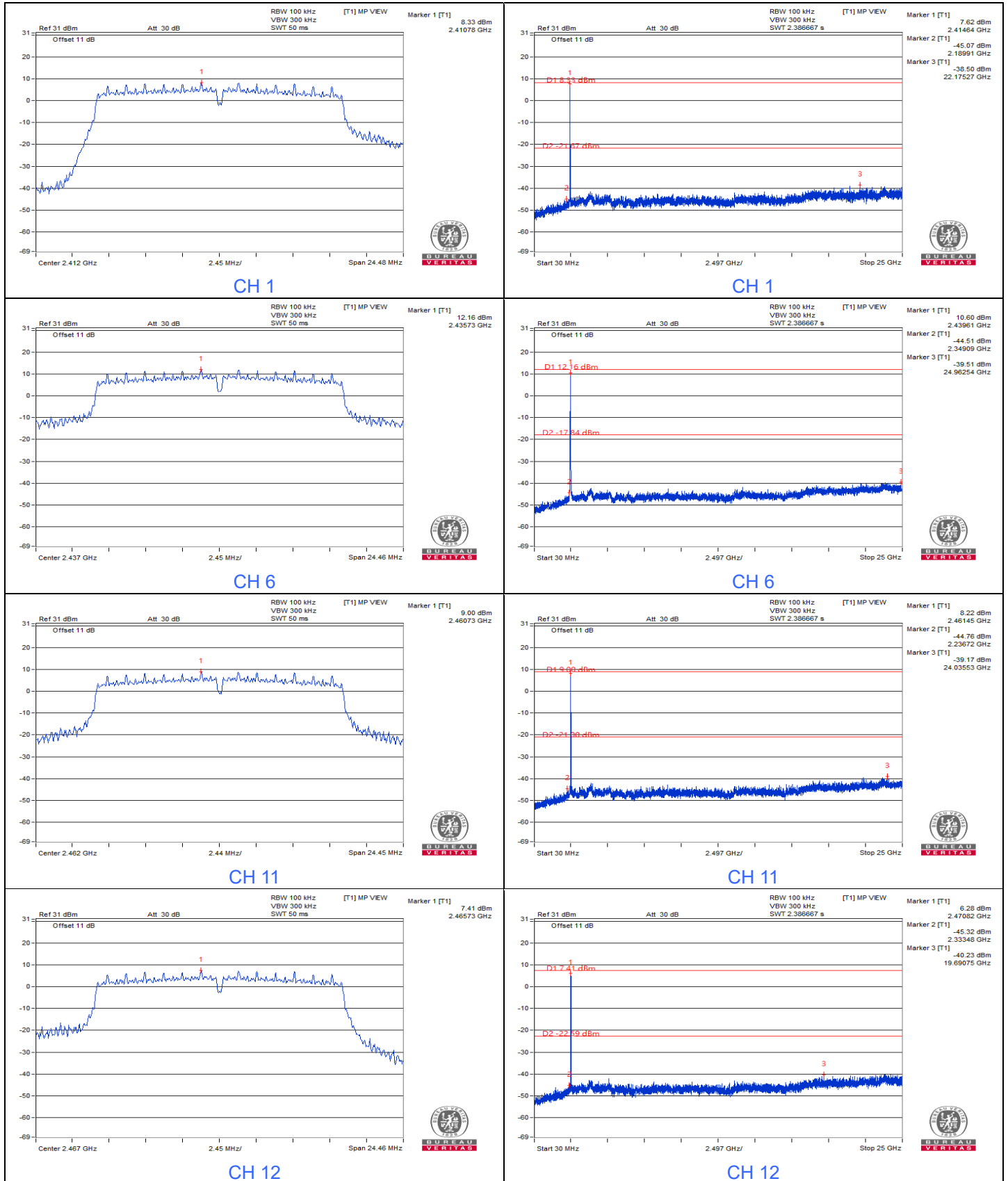

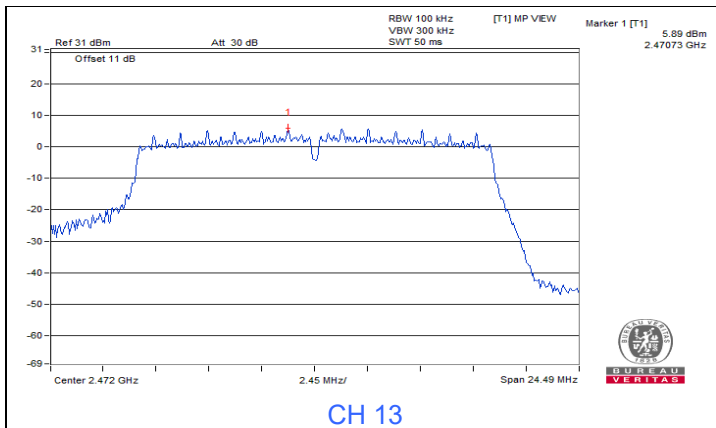

CH 13

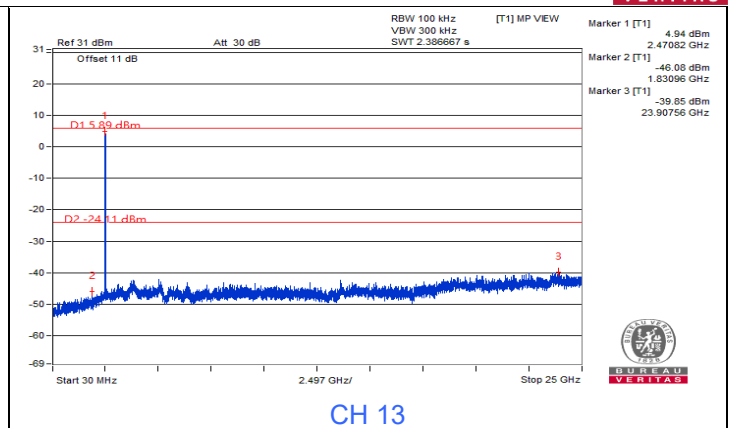

CH 13

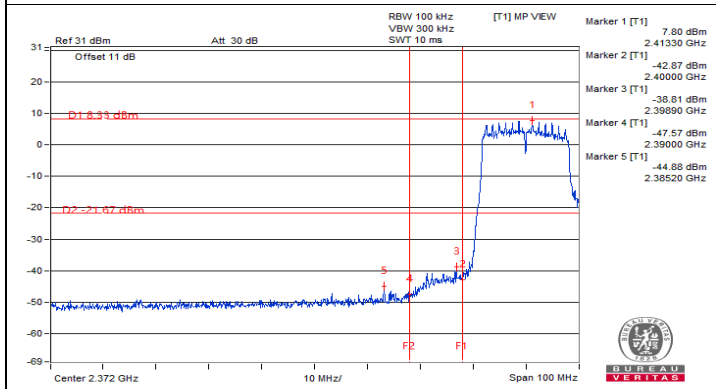

CH 1 Band edge

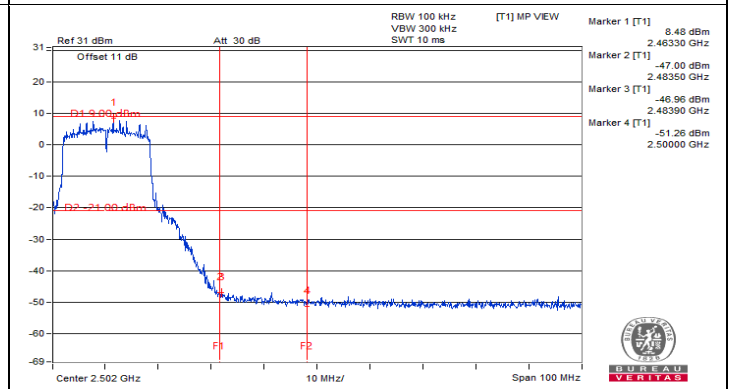

CH 11 Band edge

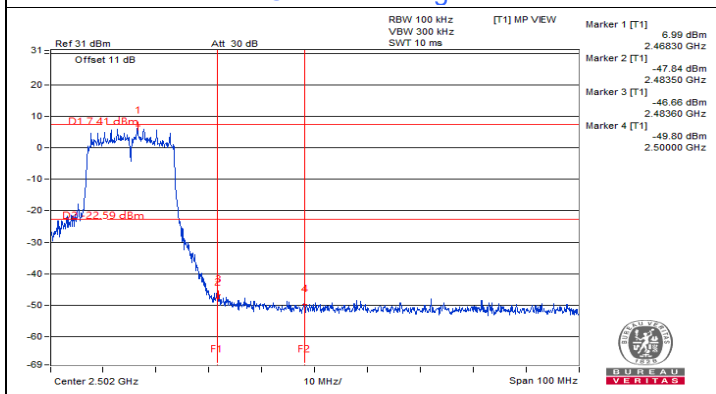

CH 12 Band edge

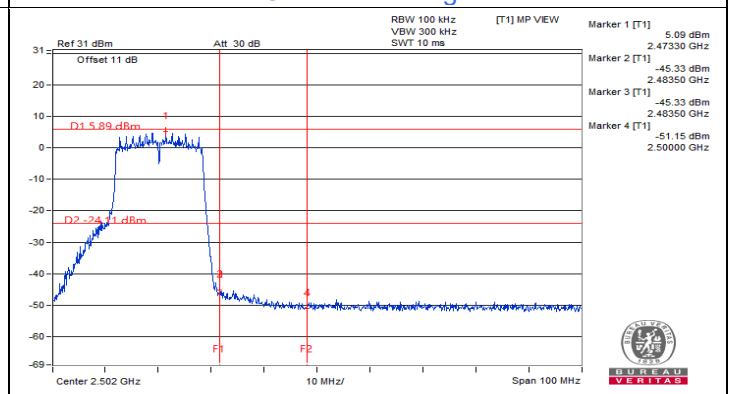

CH 13 Band edge



# 802.11be (EHT20) 1S1T

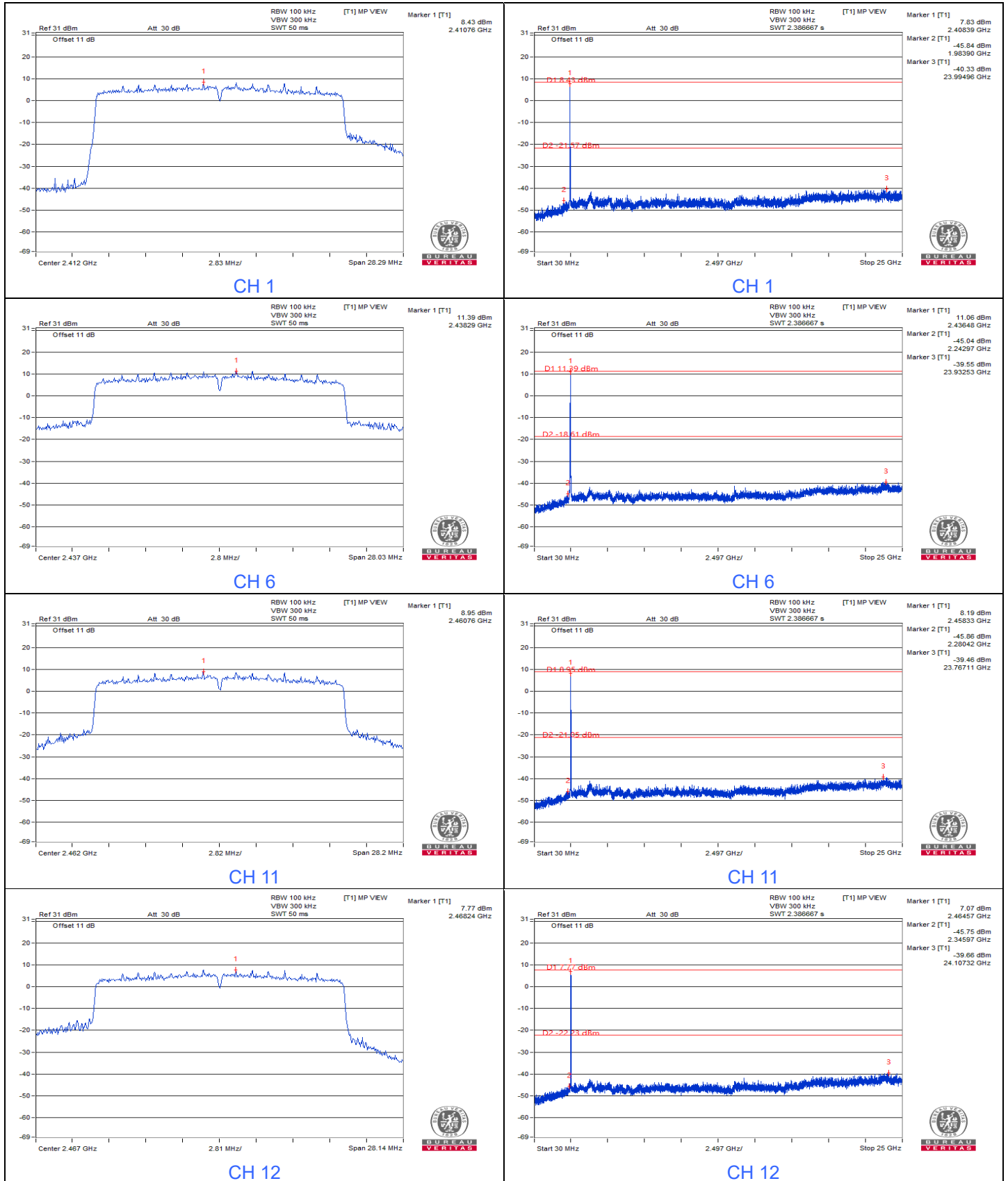



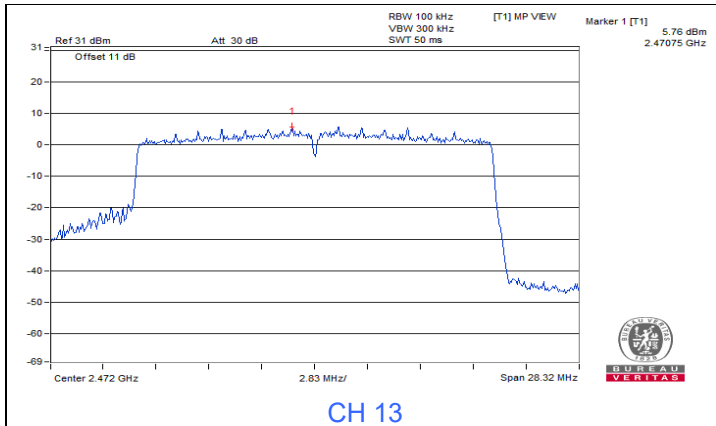

CH 13

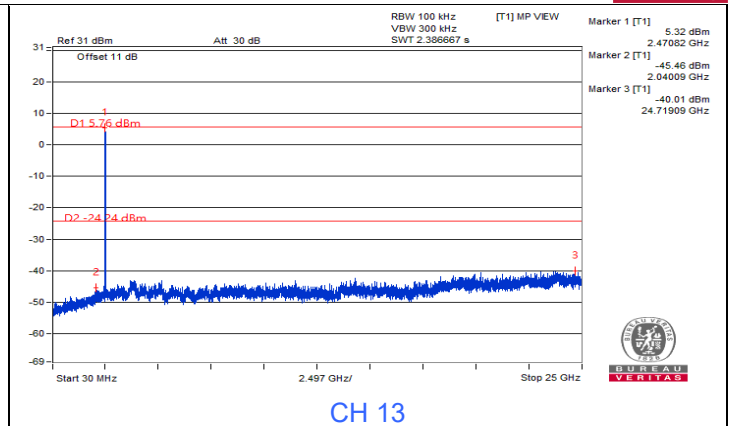

CH 13

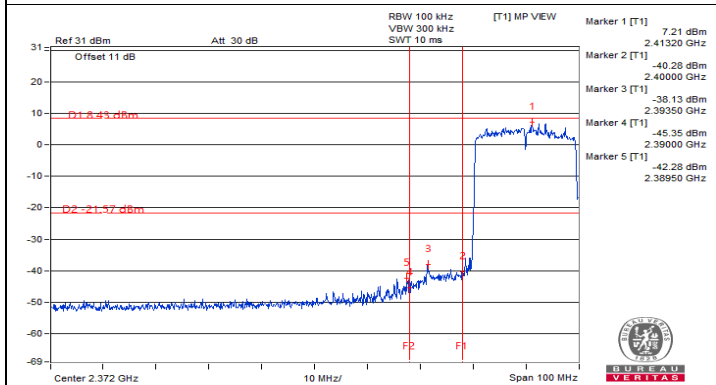

CH 1 Band edge

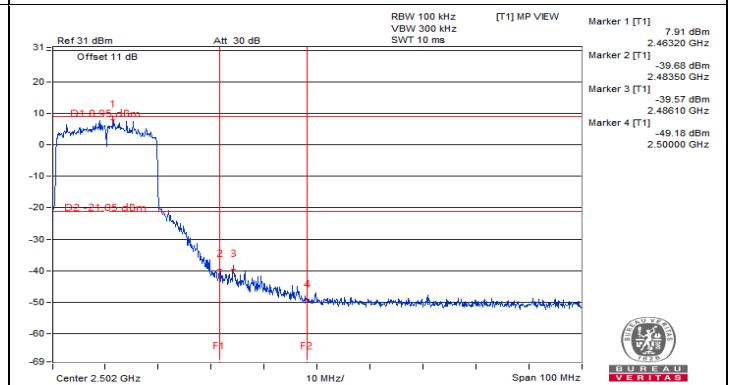

CH 11 Band edge

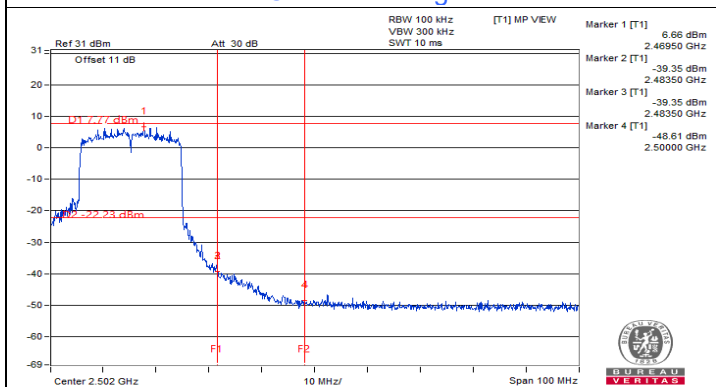

CH 12 Band edge

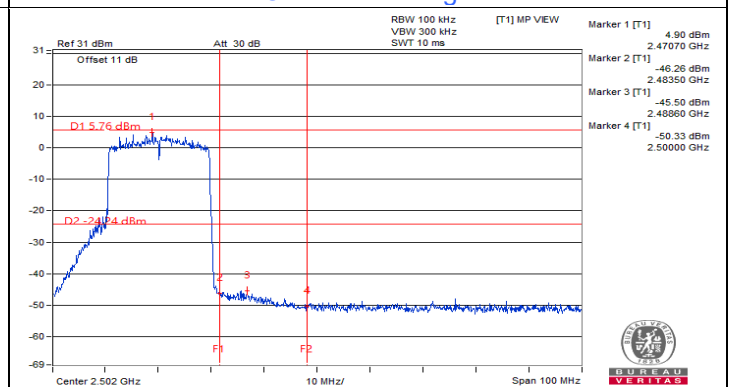

CH 13 Band edge



# 802.11be (EHT40) 1S1T

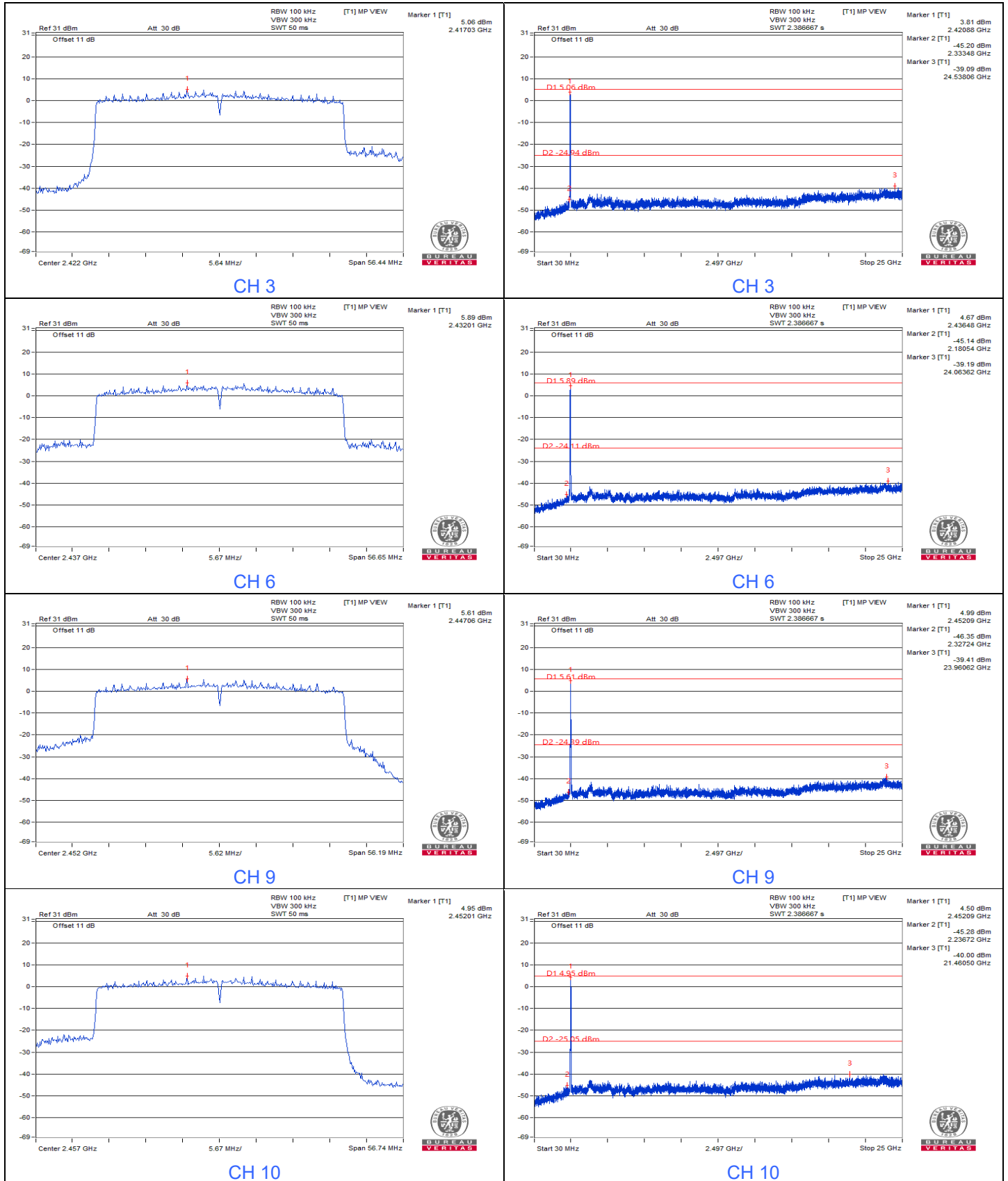

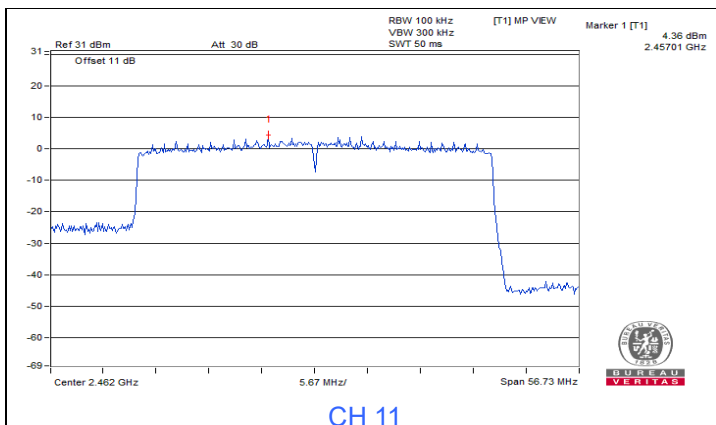

CH 11

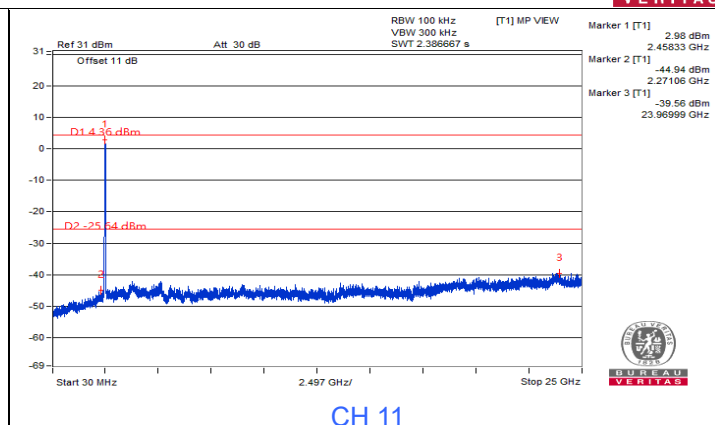

CH 11

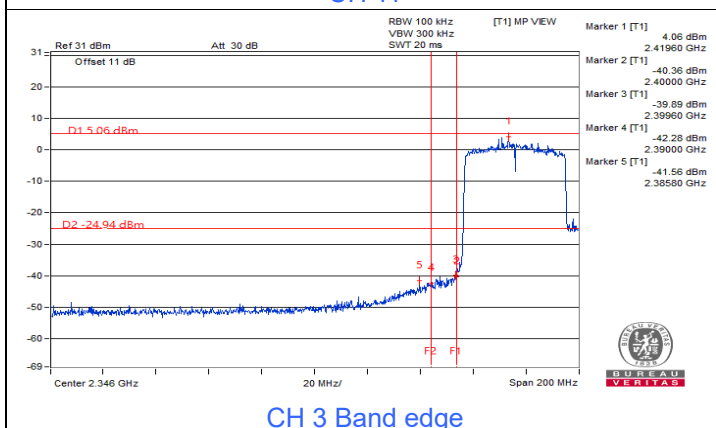

CH 3 Band edge

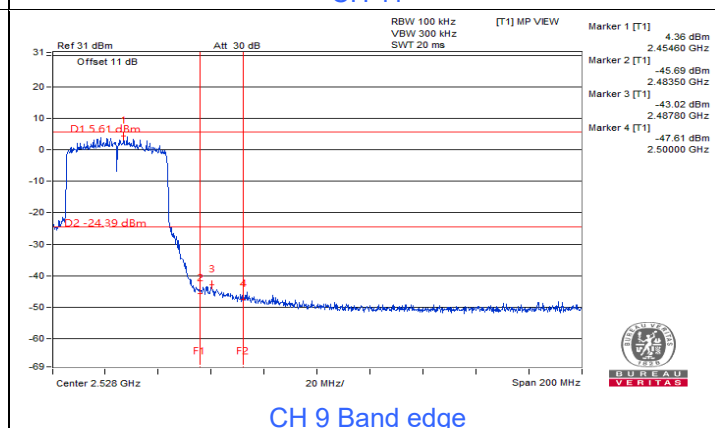

CH 9 Band edge

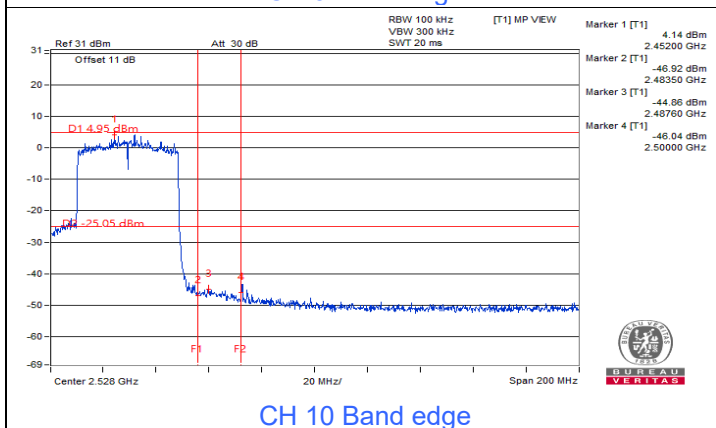

CH 10 Band edge

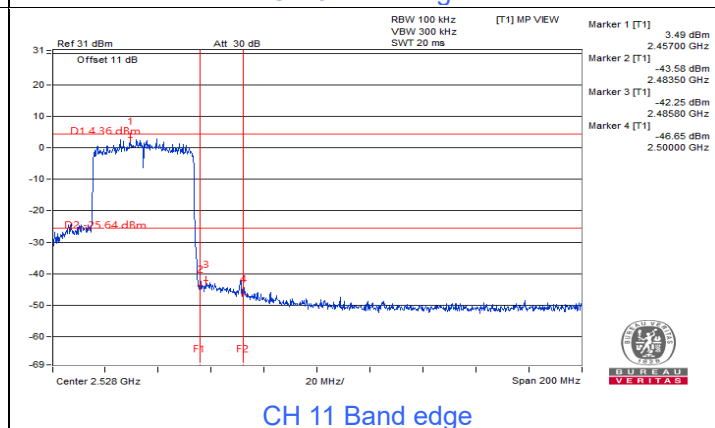

CH 11 Band edge



### 802.11b 2TX

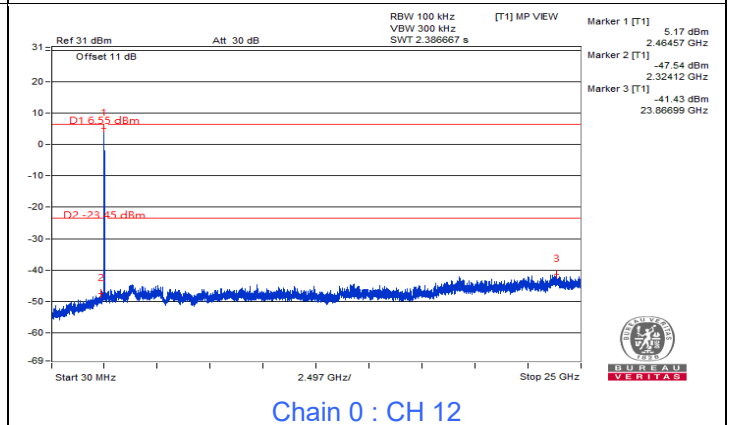
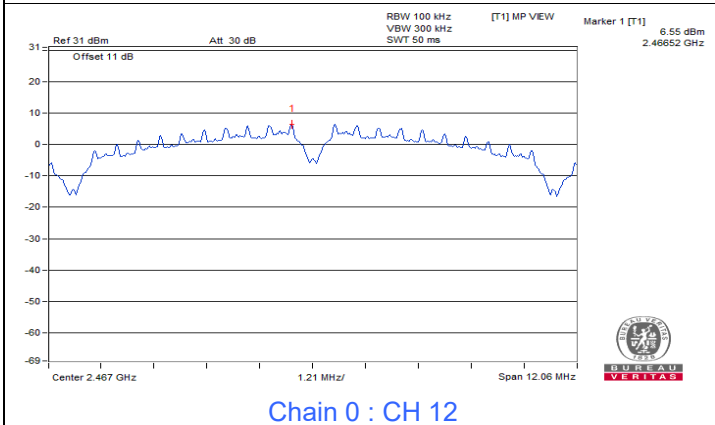
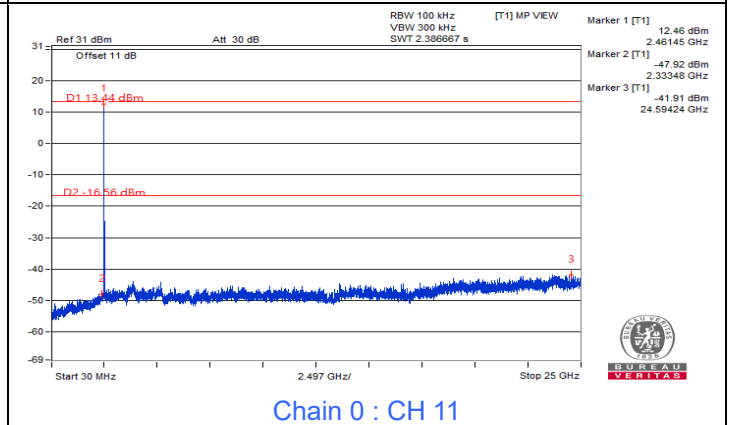
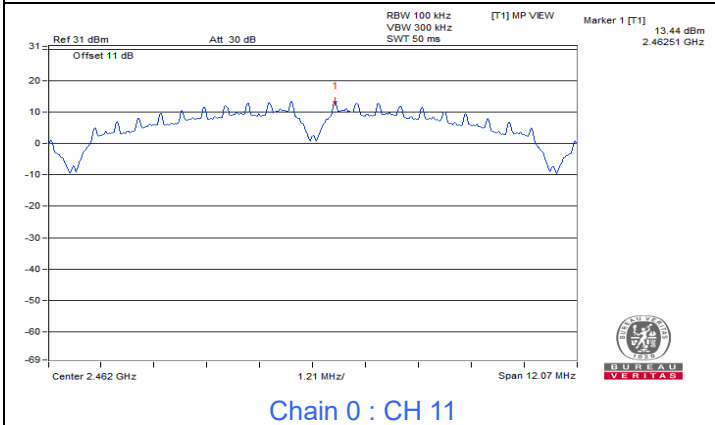
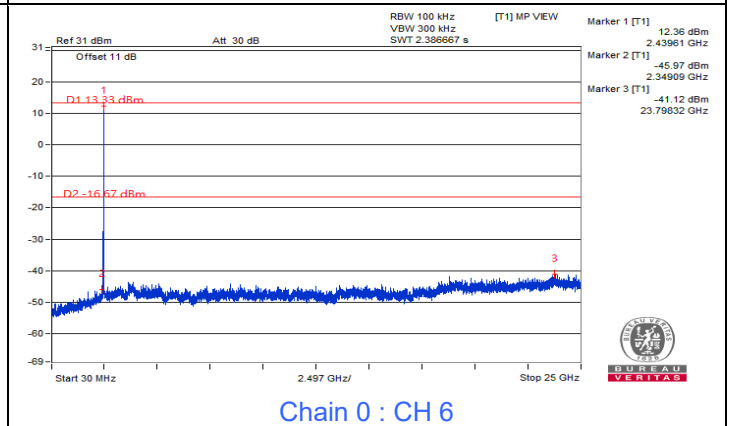
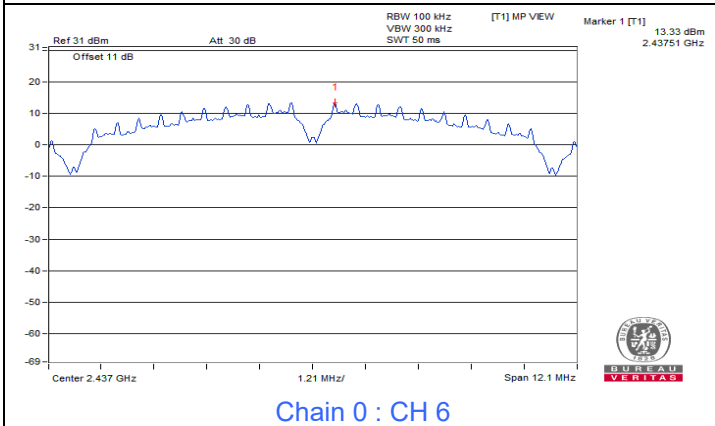
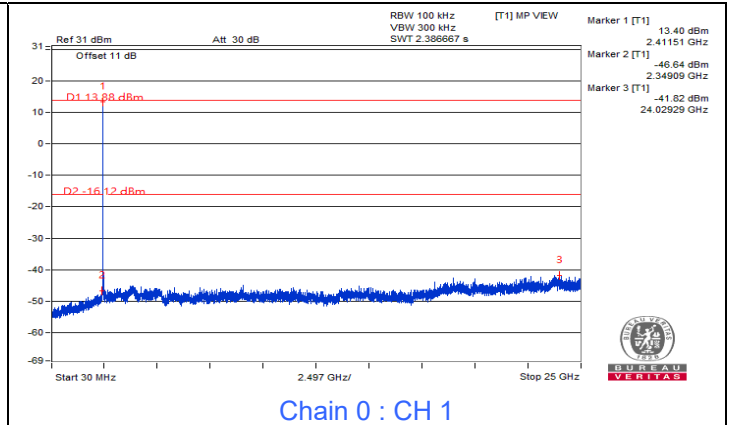
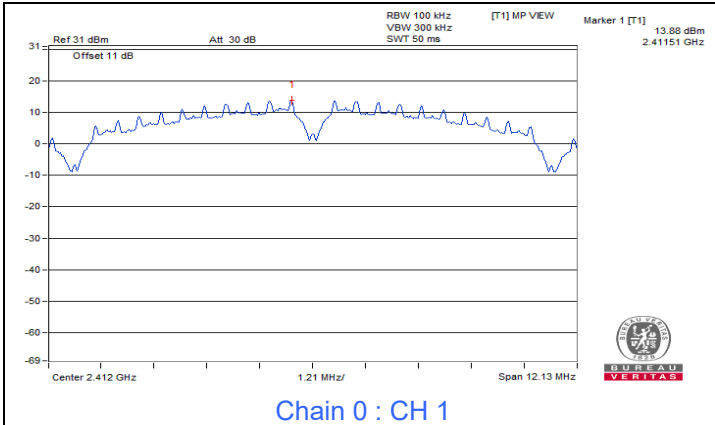

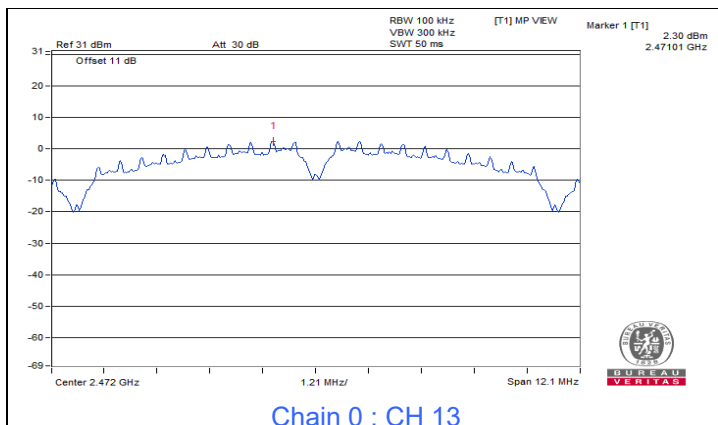

Chain 0 : CH 13

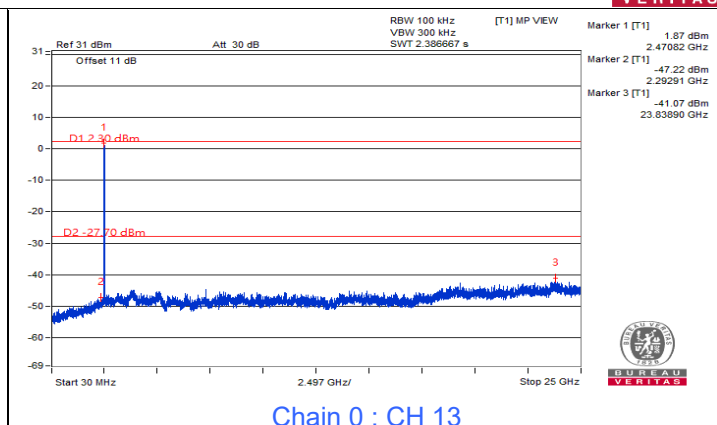

Chain 0 : CH 13

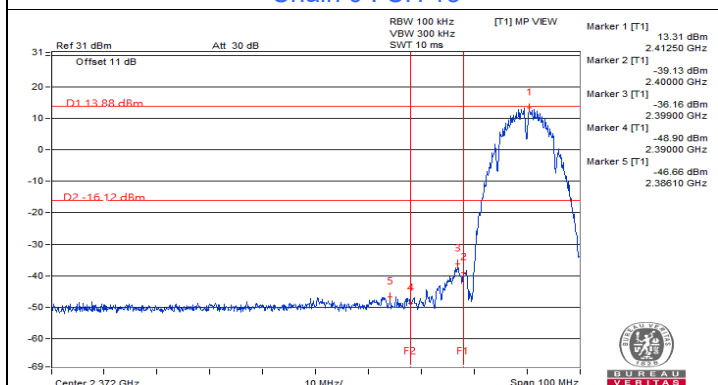

Chain 0 : CH 1 Band edge

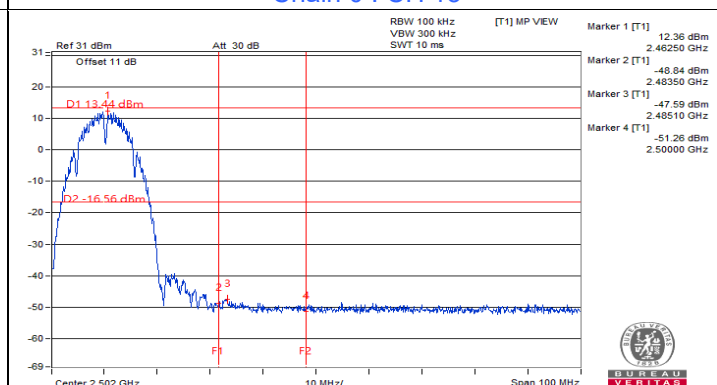

Chain 0 : CH 11 Band edge

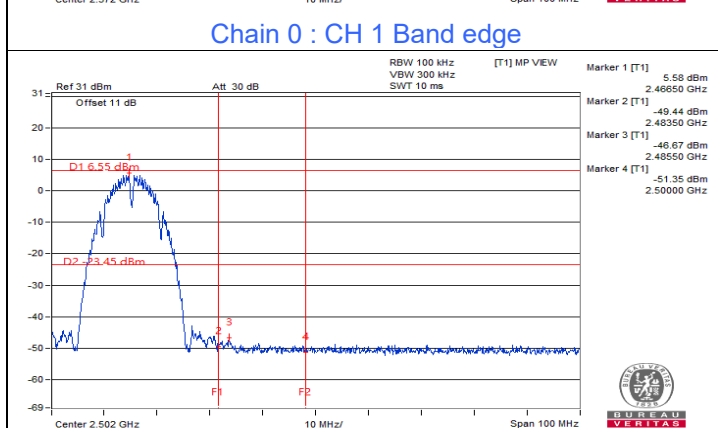

Chain 0 : CH 12 Band edge

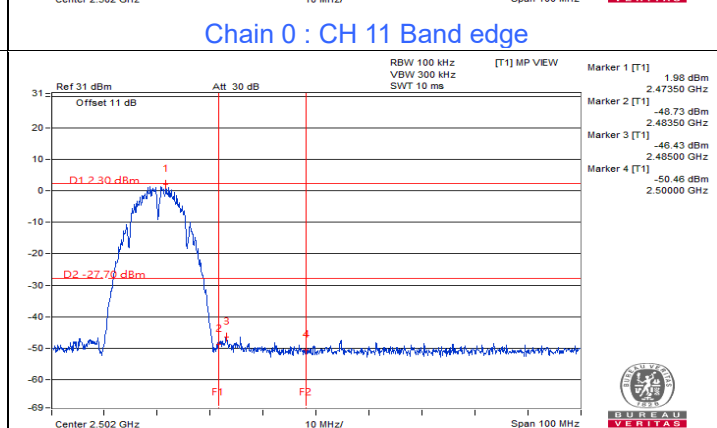

Chain 0 : CH 13 Band edge

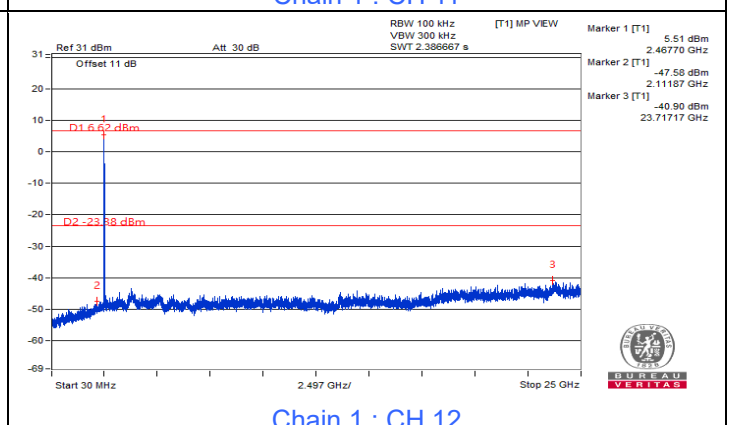
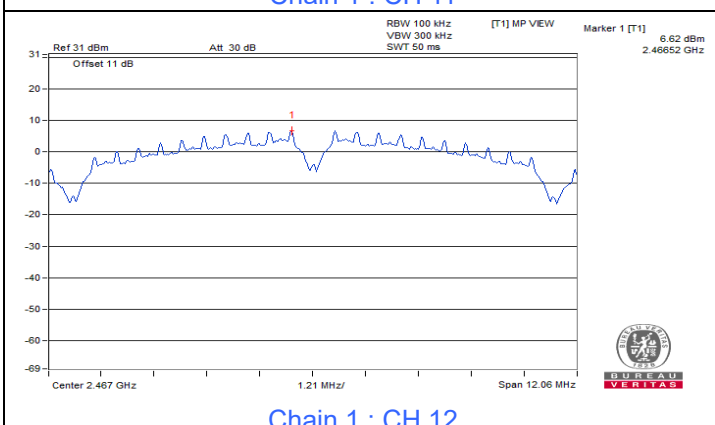
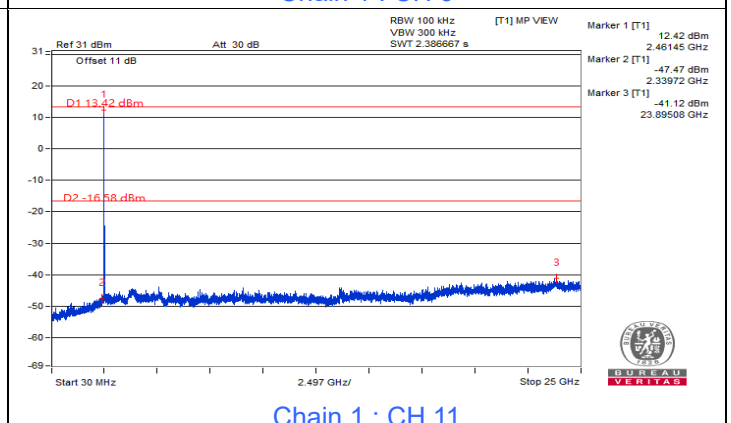
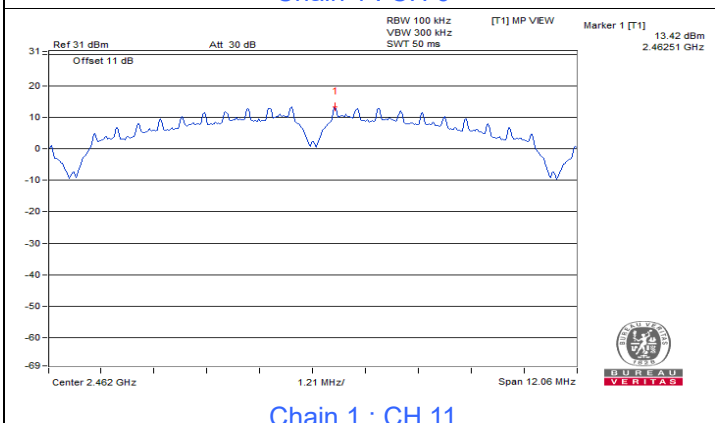
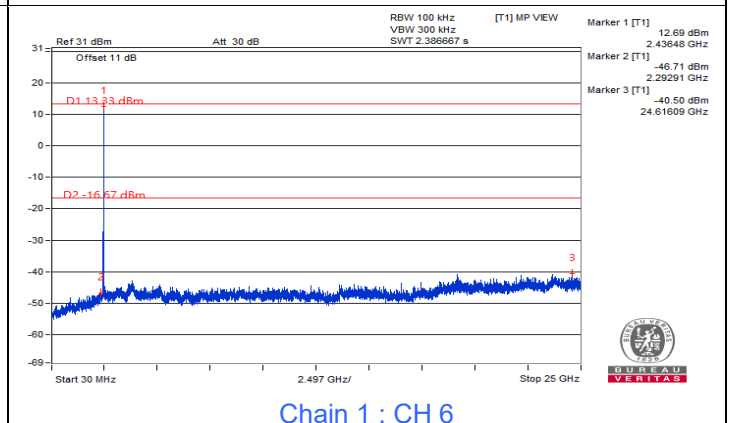
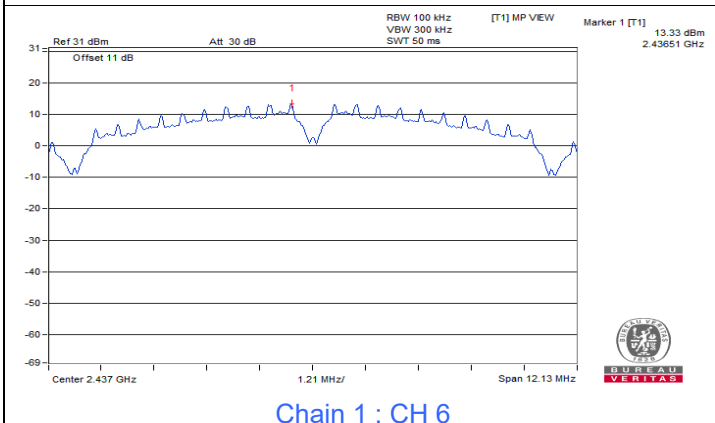
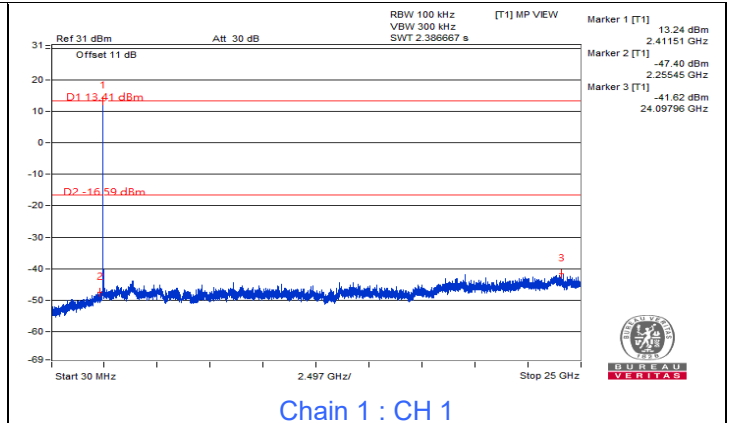
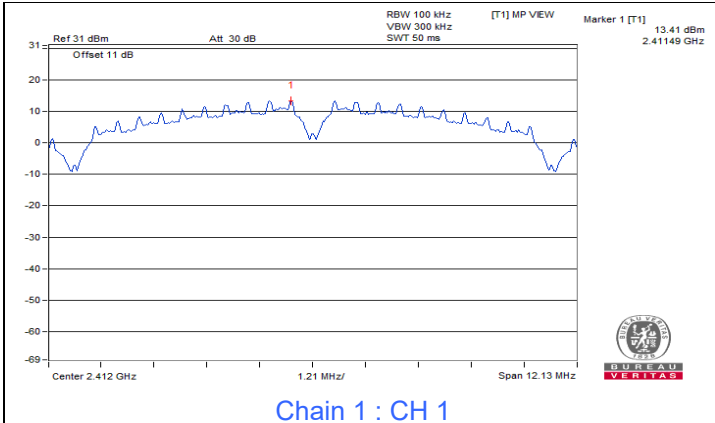

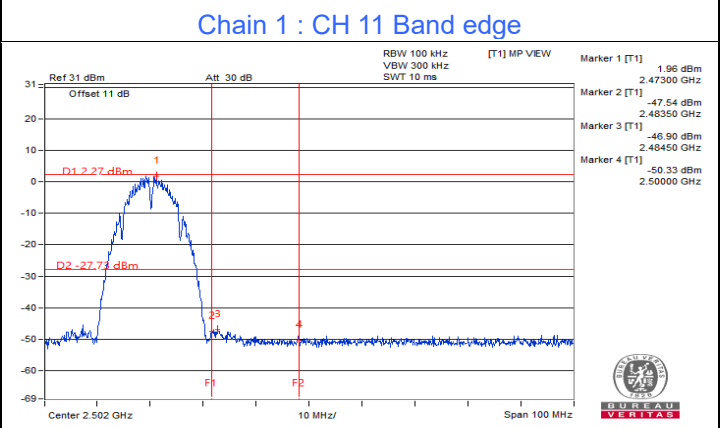
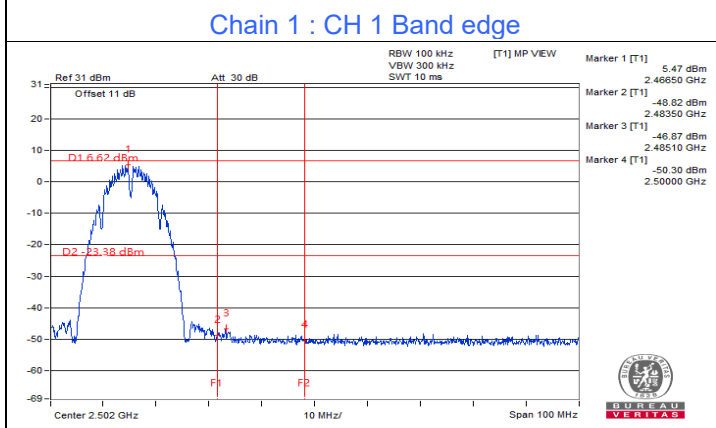
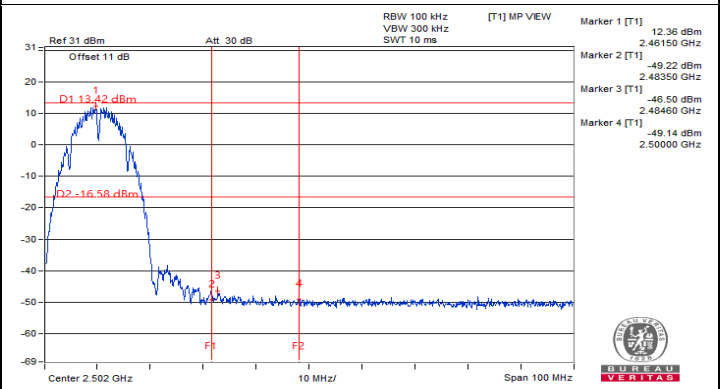
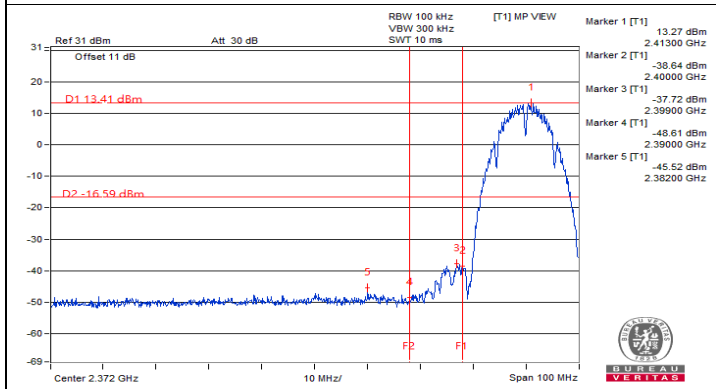
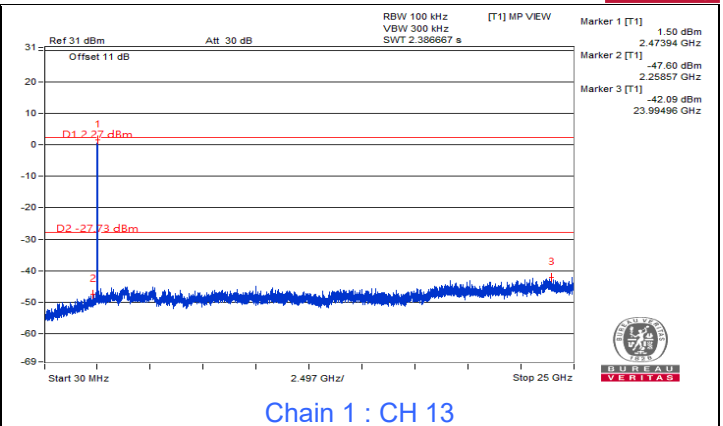
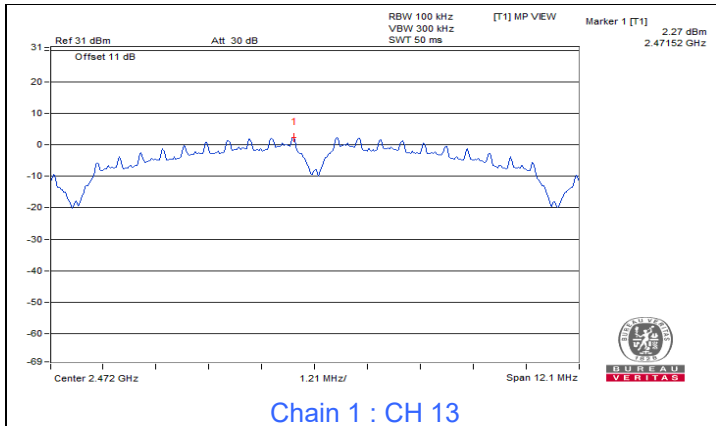



# 802.11g 2TX

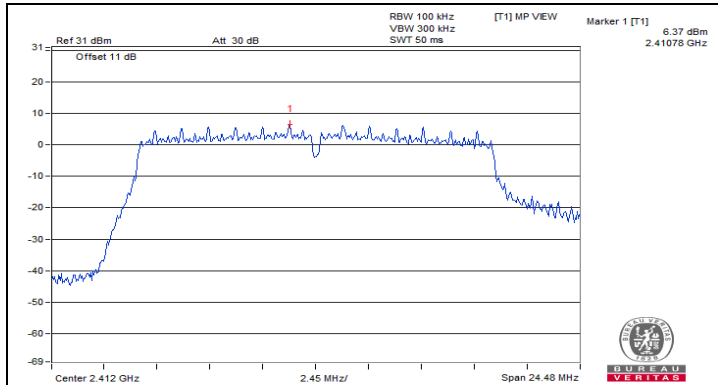

Chain 0 : CH 1

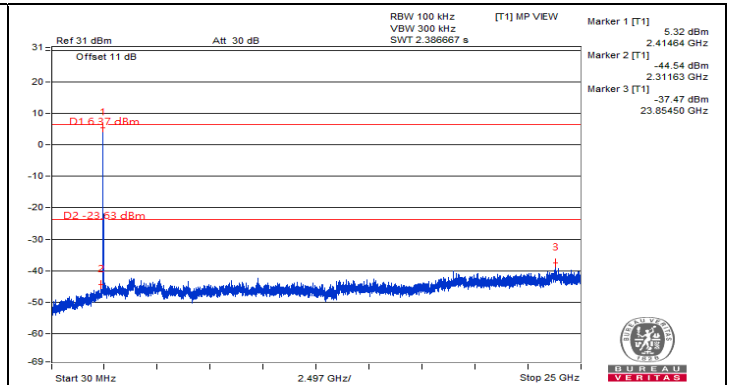

Chain 0 : CH 1

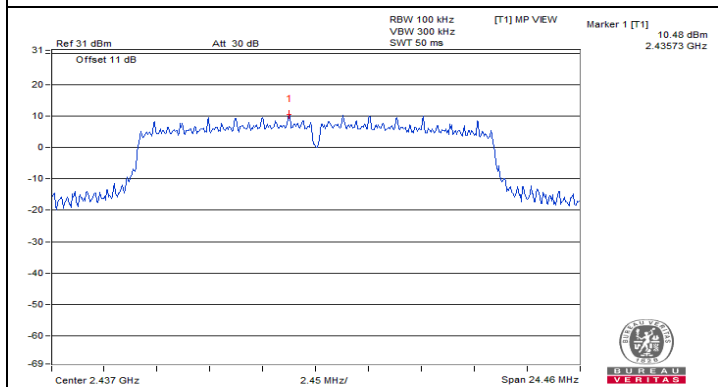

Chain 0 : CH 6

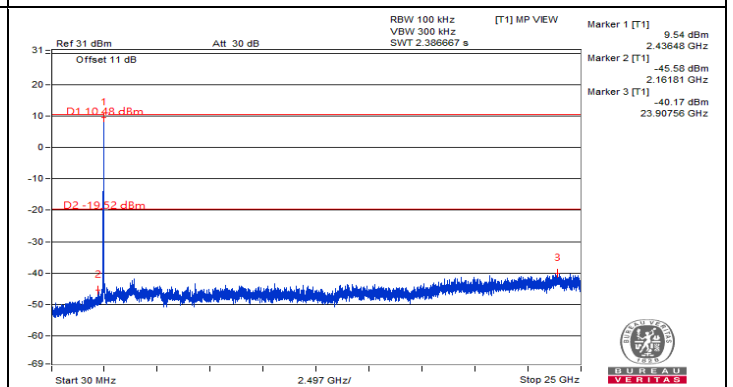

Chain 0 : CH 6

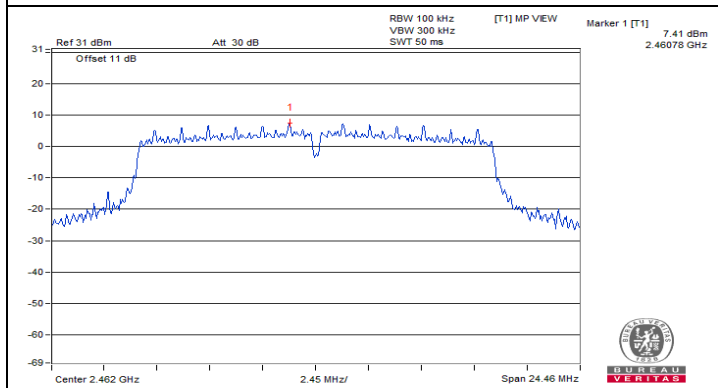

Chain 0 : CH 11

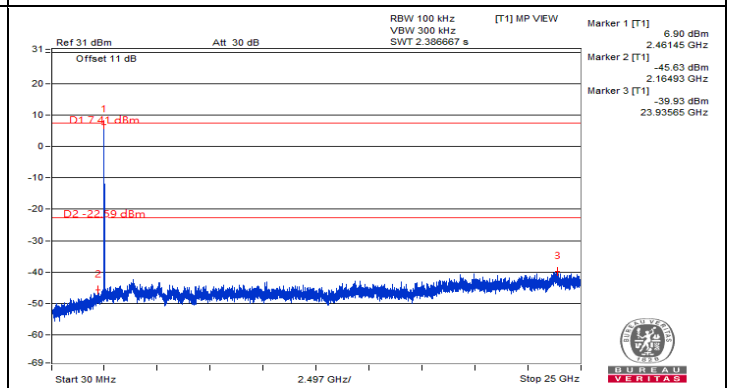

Chain 0 : CH 11

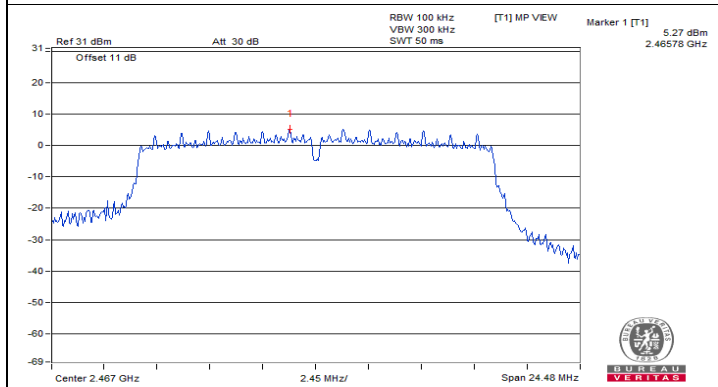

Chain 0 : CH 12

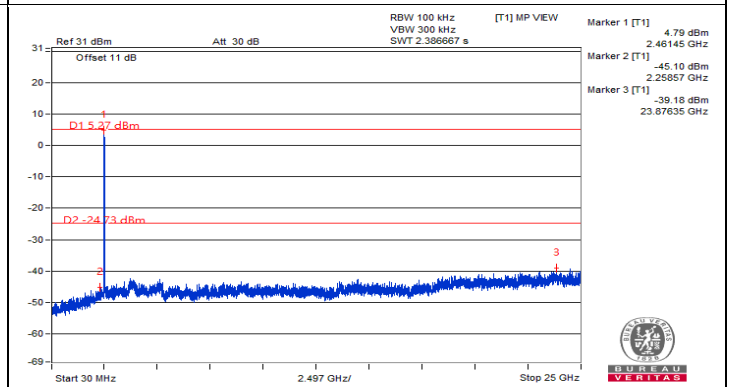

Chain 0 : CH 12



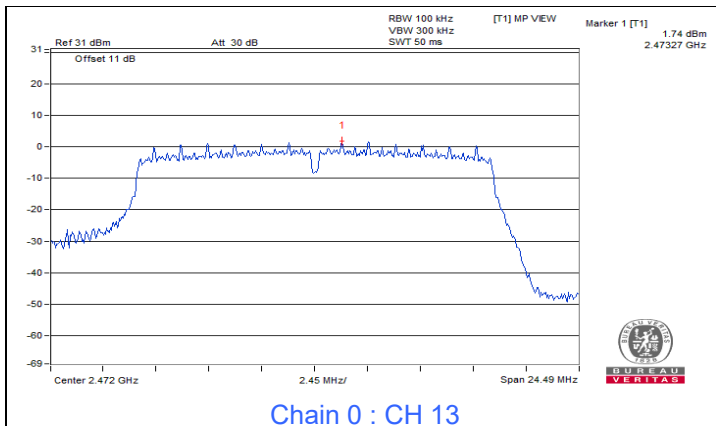

Chain 0 : CH 13

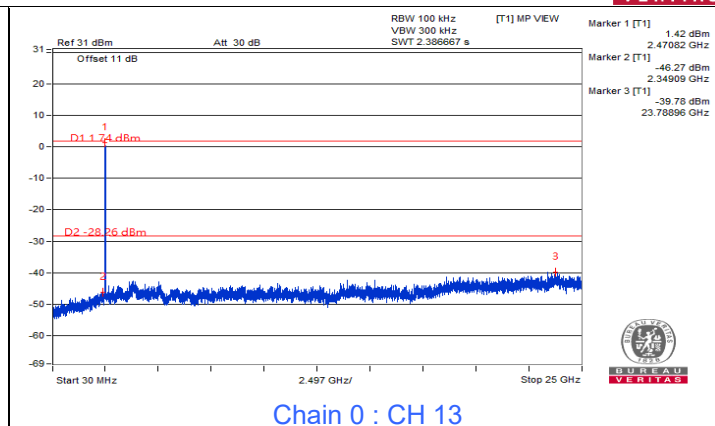

Chain 0 : CH 13

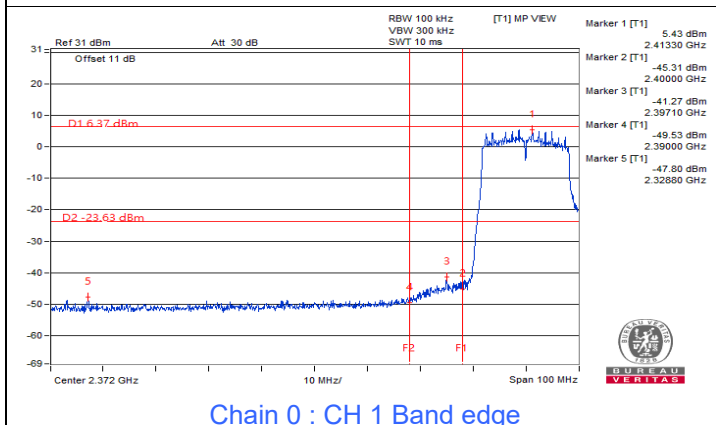

Chain 0 : CH 1 Band edge

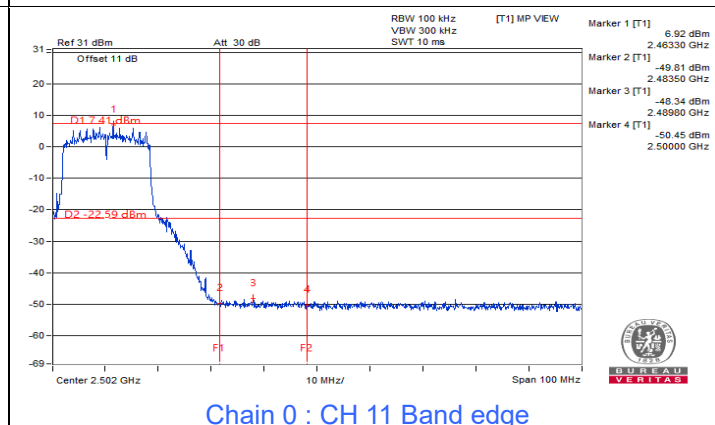

Chain 0 : CH 11 Band edge

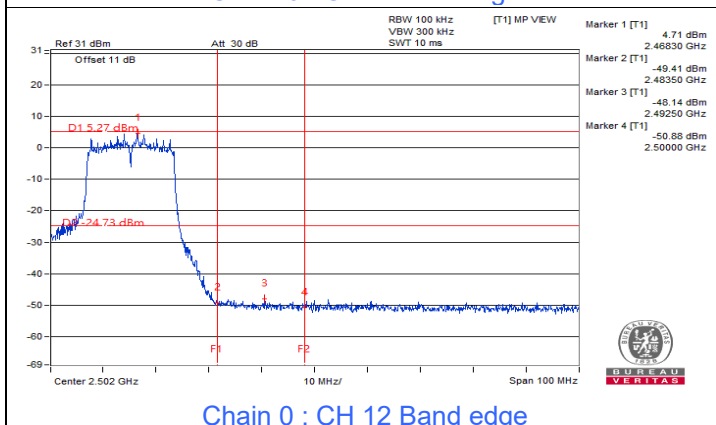

Chain 0 : CH 12 Band edge

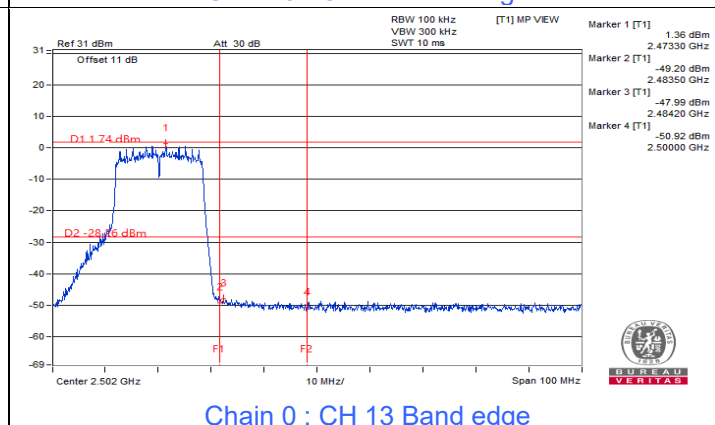

Chain 0 : CH 13 Band edge

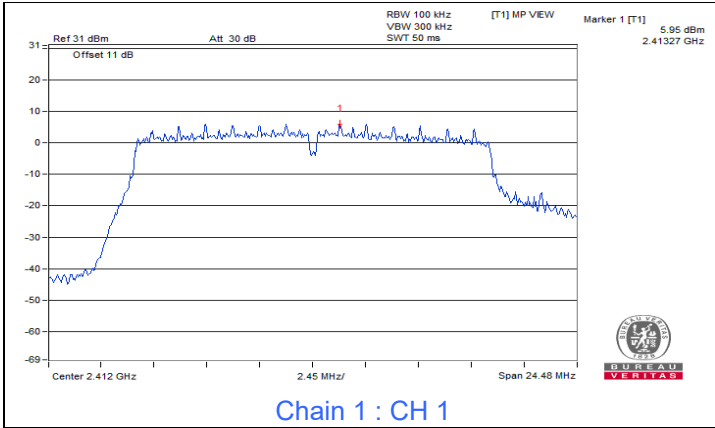

Chain 1 : CH 1

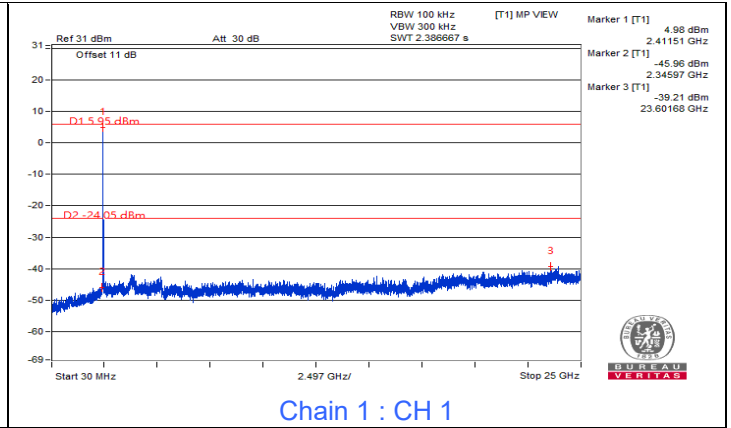

Chain 1 : CH 1

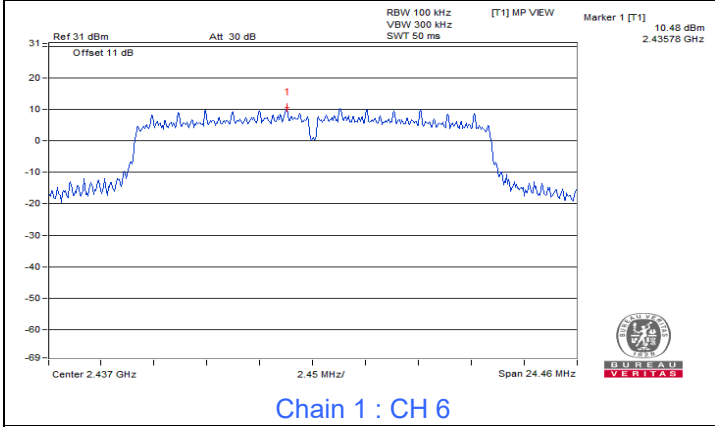

Chain 1 : CH 6

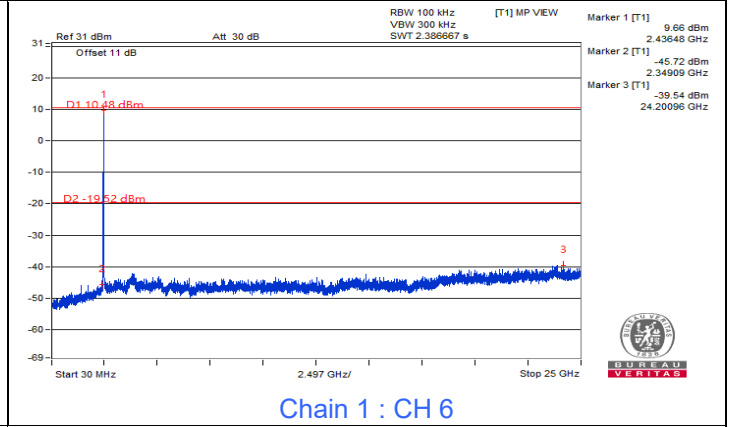

Chain 1 : CH 6

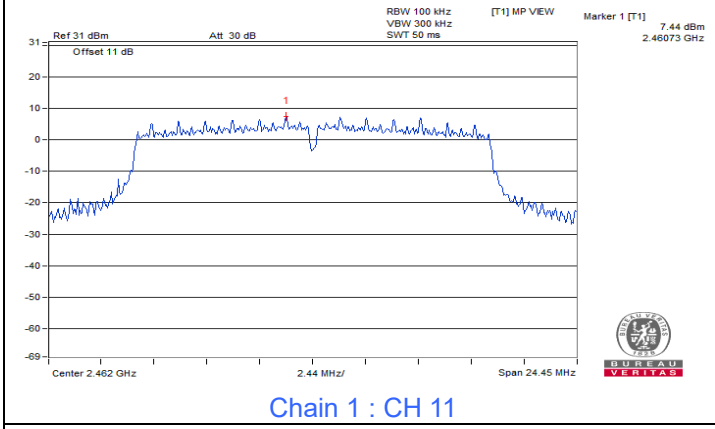

Chain 1 : CH 11

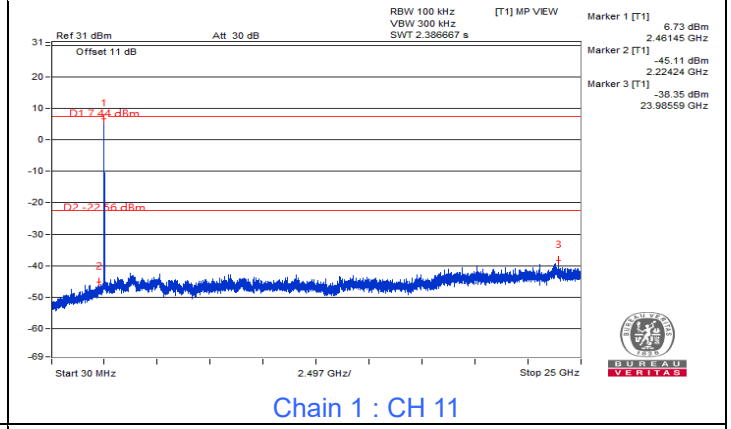

Chain 1 : CH 11

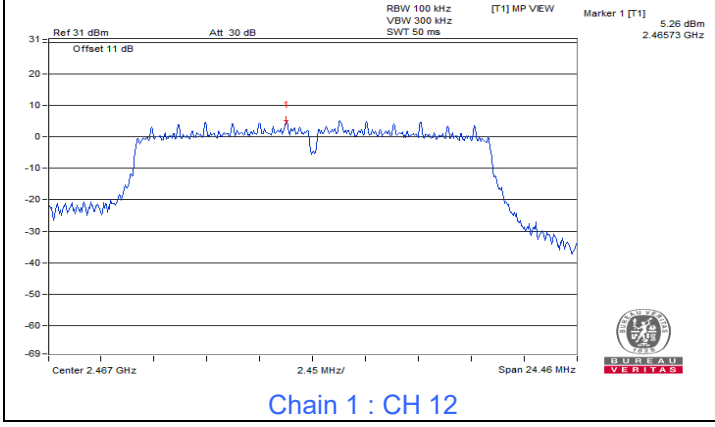

Chain 1 : CH 12

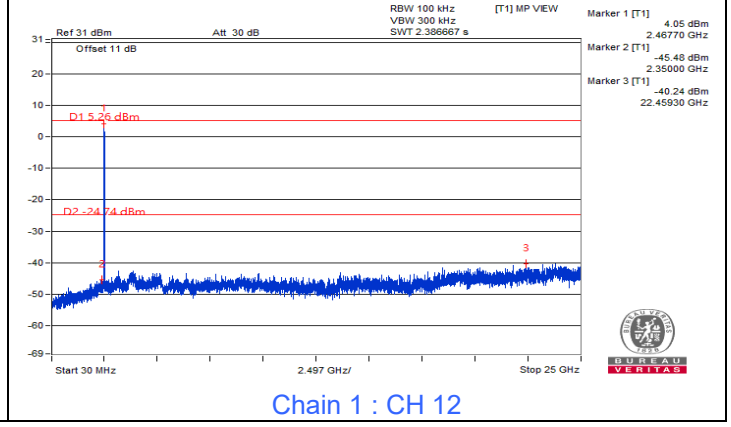

Chain 1 : CH 12

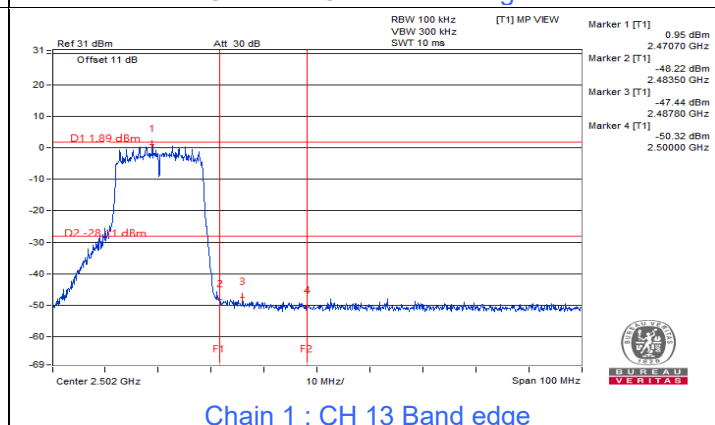
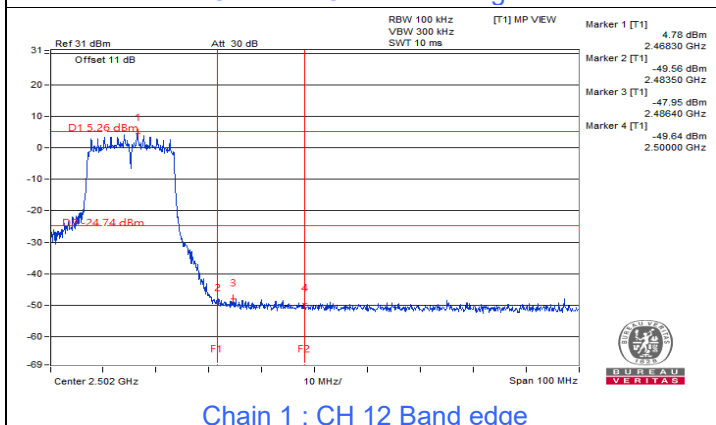
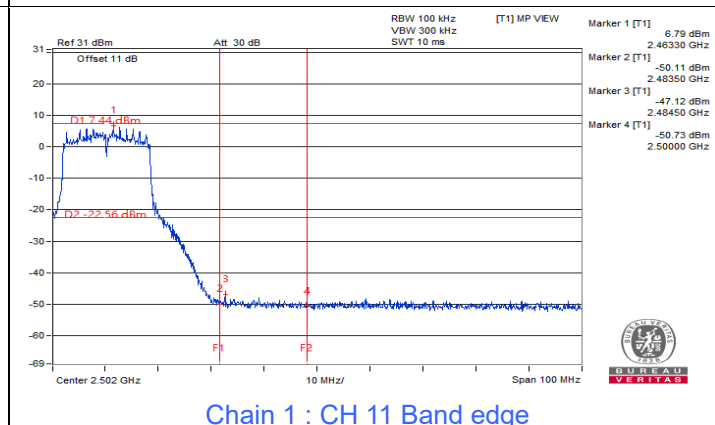
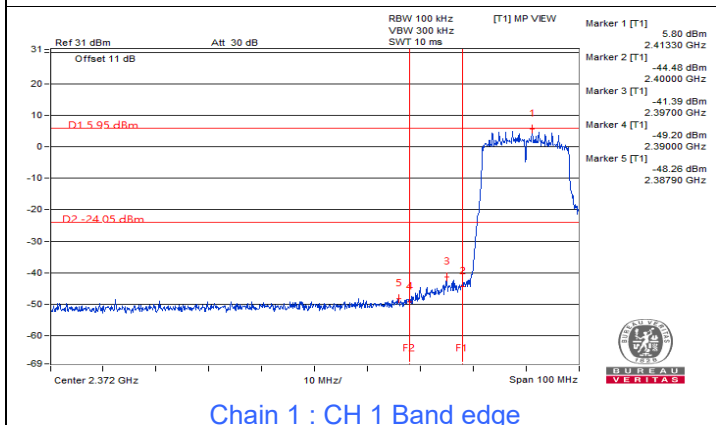
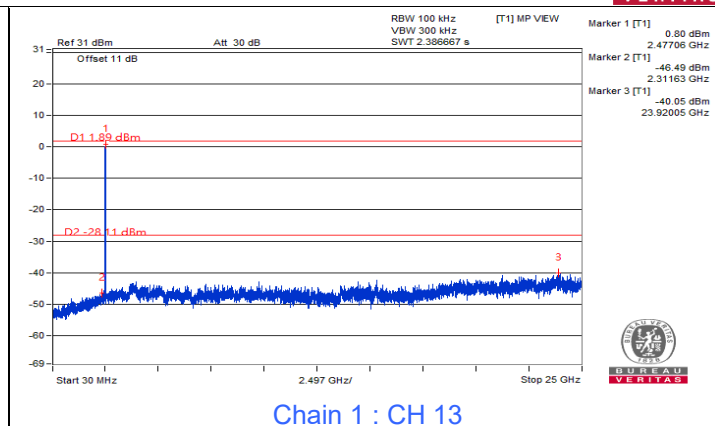
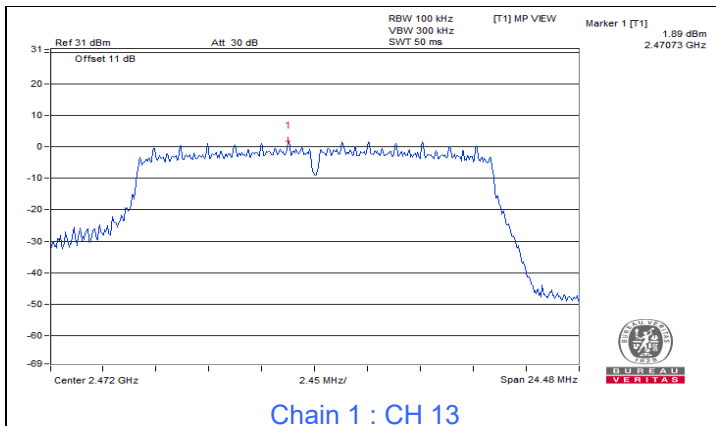



# 802.11be (EHT20) 2S2T

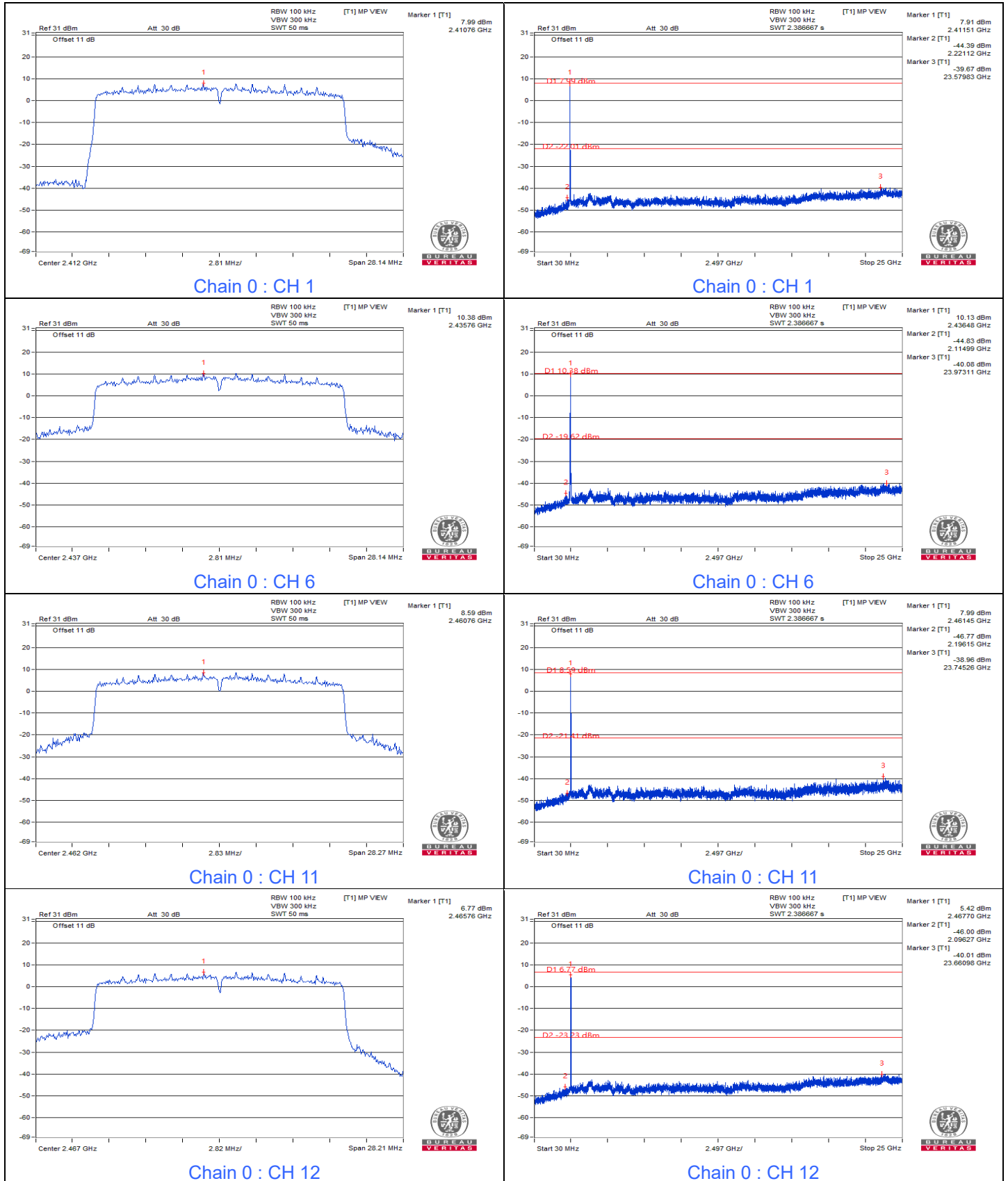

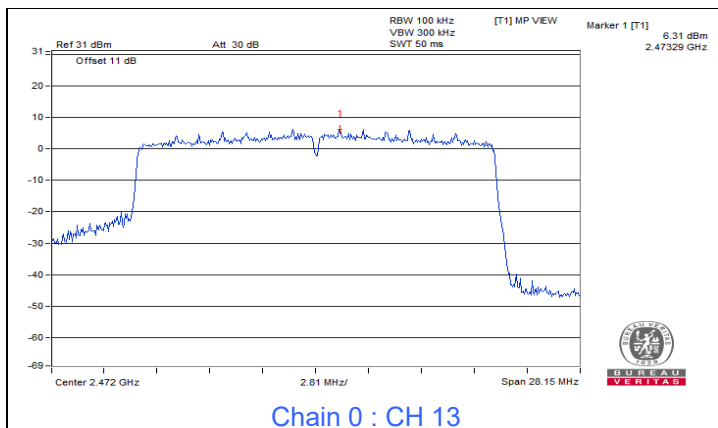

Chain 0 : CH 13

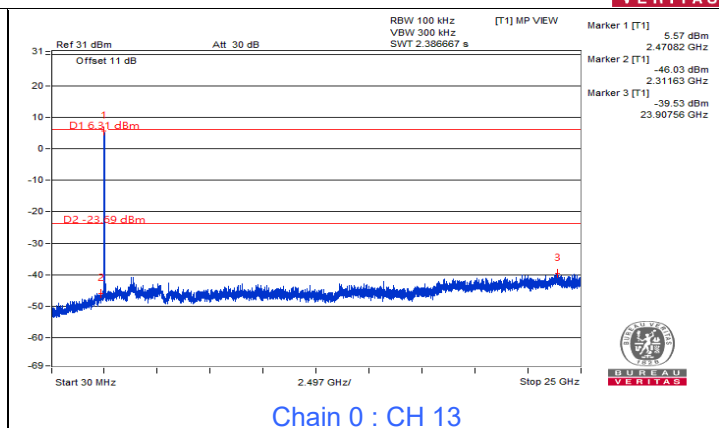

Chain 0 : CH 13

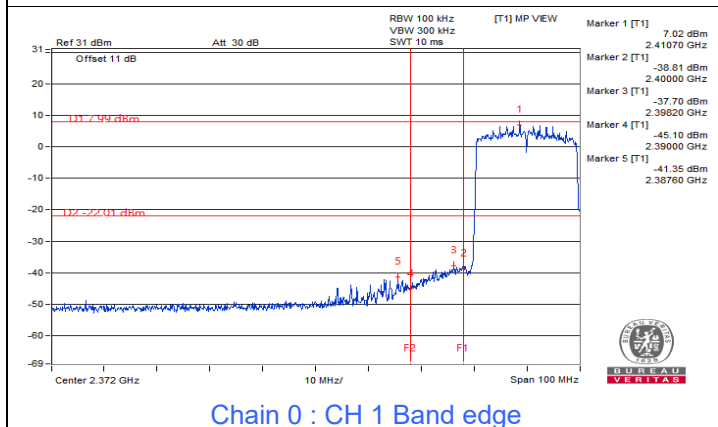

Chain 0 : CH 1 Band edge

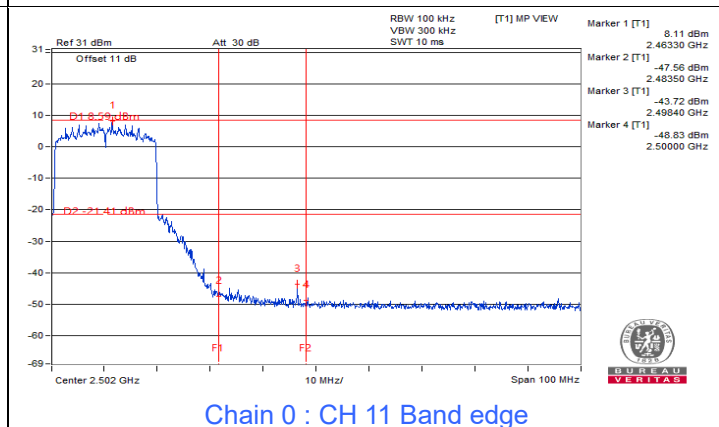

Chain 0 : CH 11 Band edge

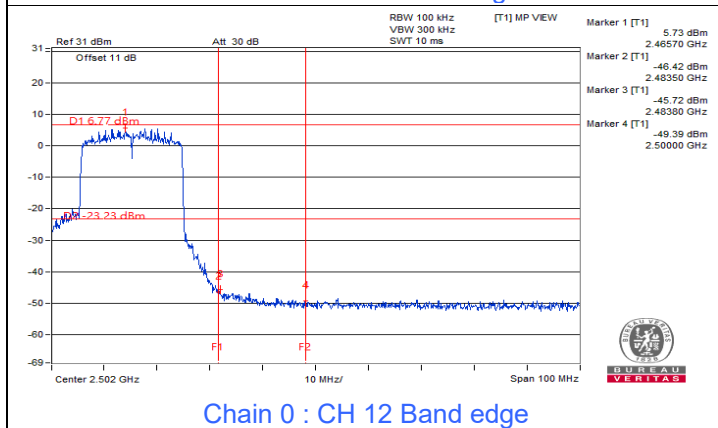

Chain 0 : CH 12 Band edge

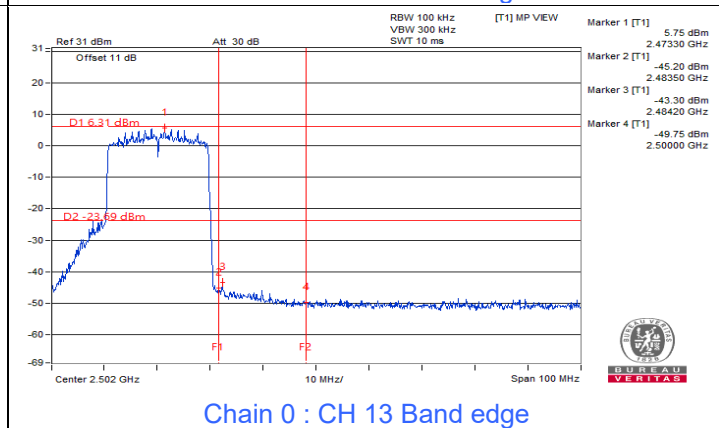

Chain 0 : CH 13 Band edge

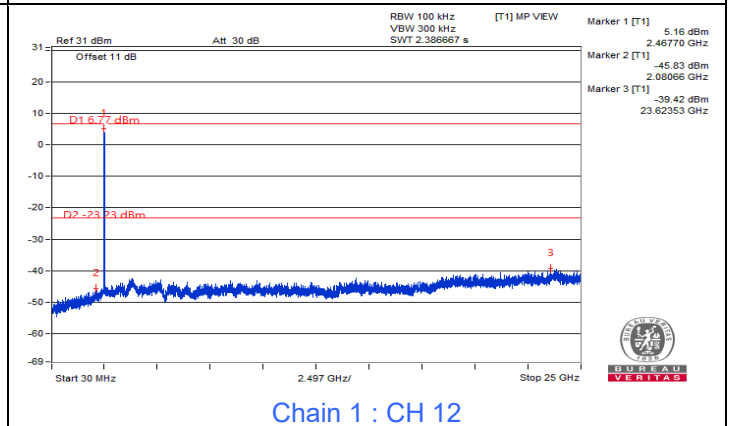
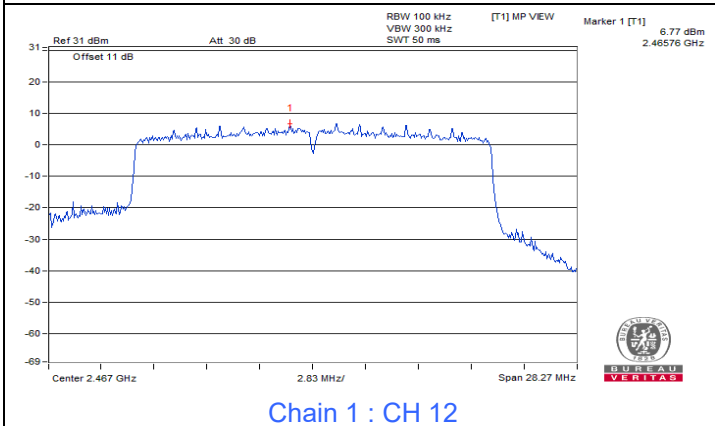
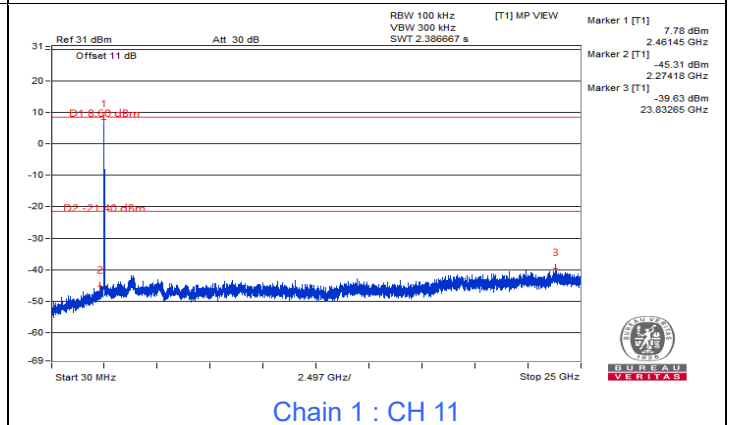
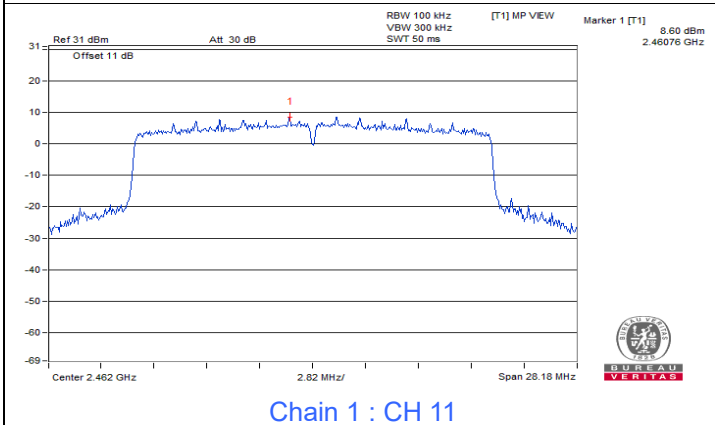
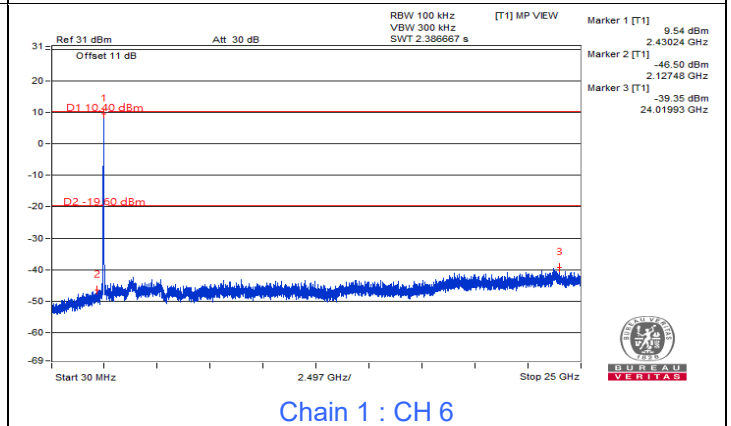
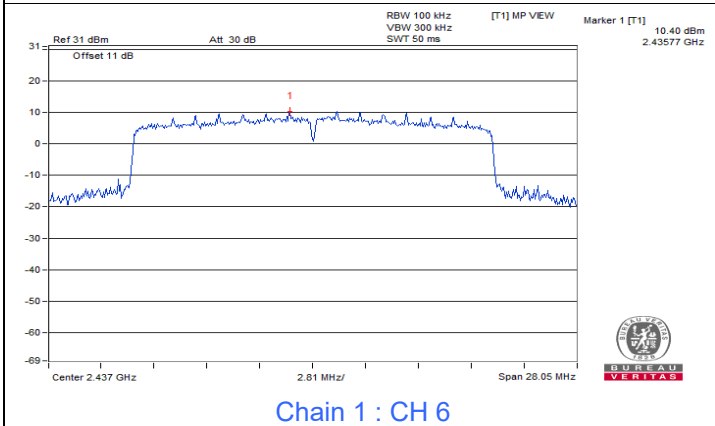
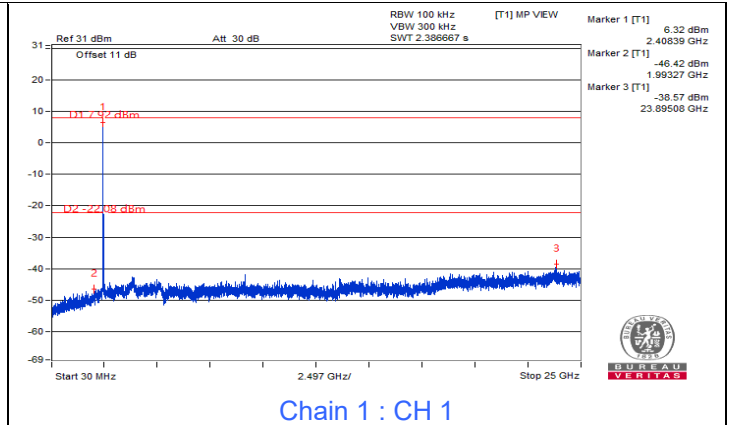
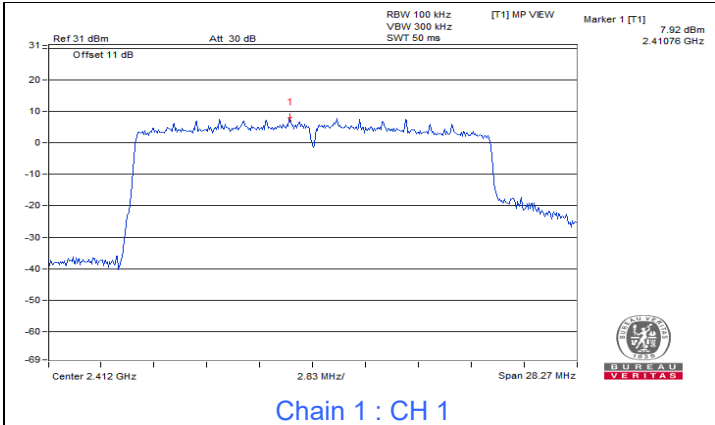

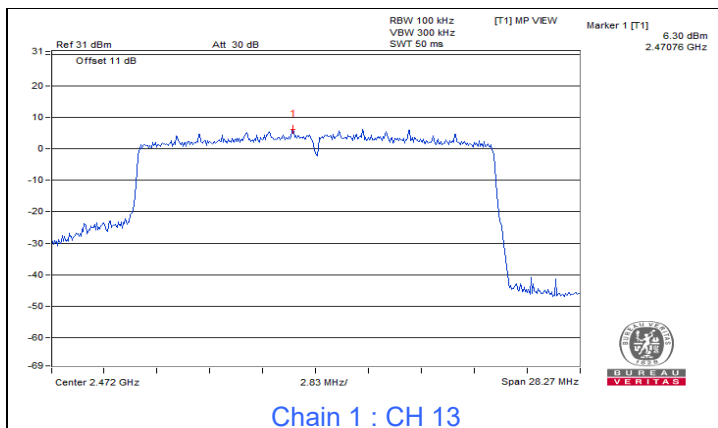

Chain 1 : CH 13

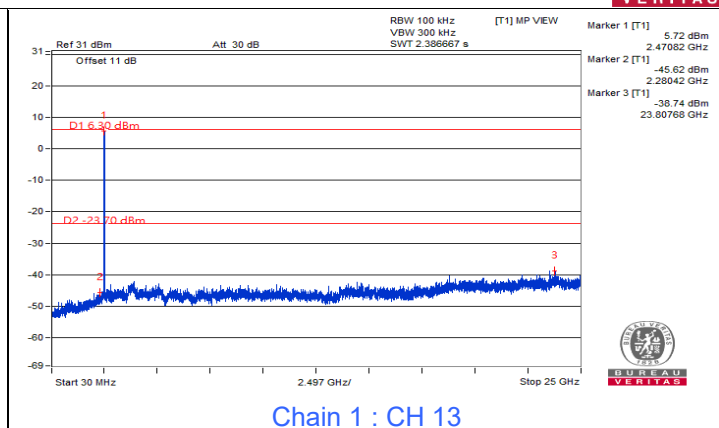

Chain 1 : CH 13

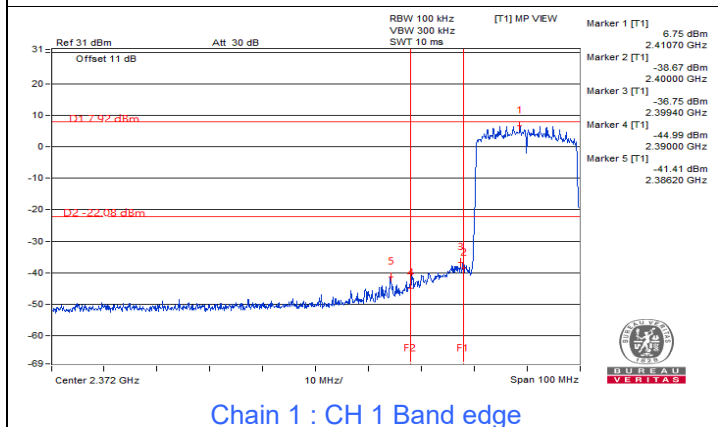

Chain 1 : CH 1 Band edge

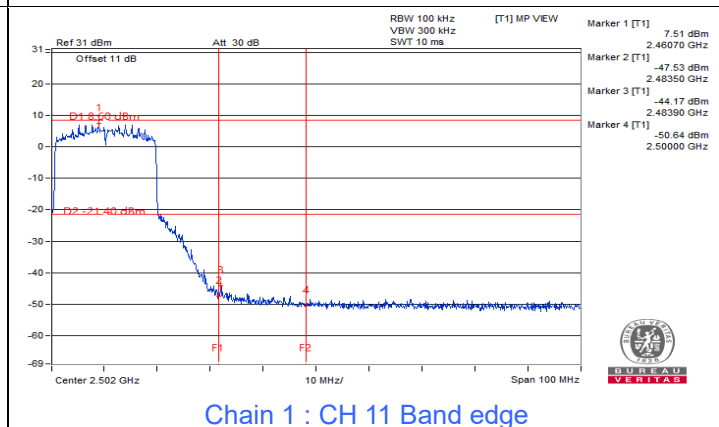

Chain 1 : CH 11 Band edge

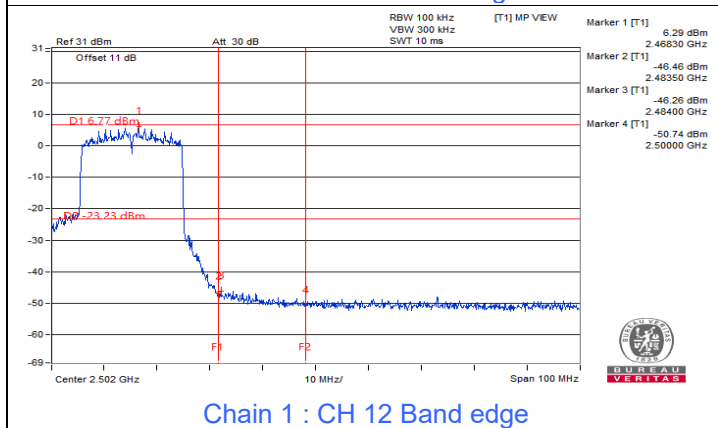

Chain 1 : CH 12 Band edge

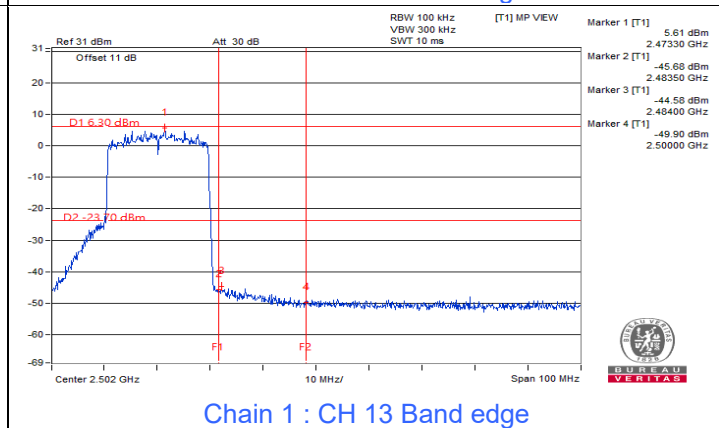

Chain 1 : CH 13 Band edge



# 802.11be (EHT40) 2S2T

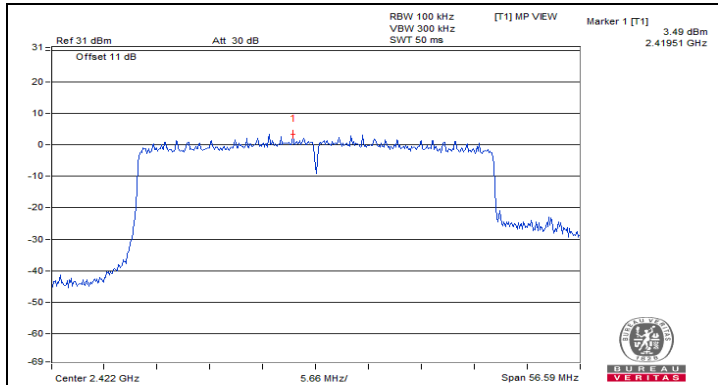

Chain 0 : CH 3

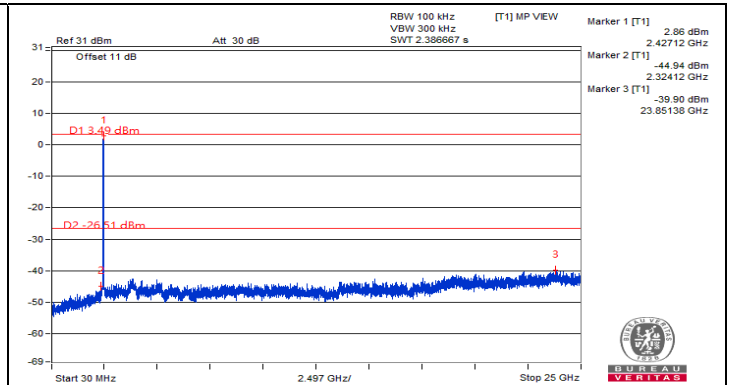

Chain 0 : CH 3

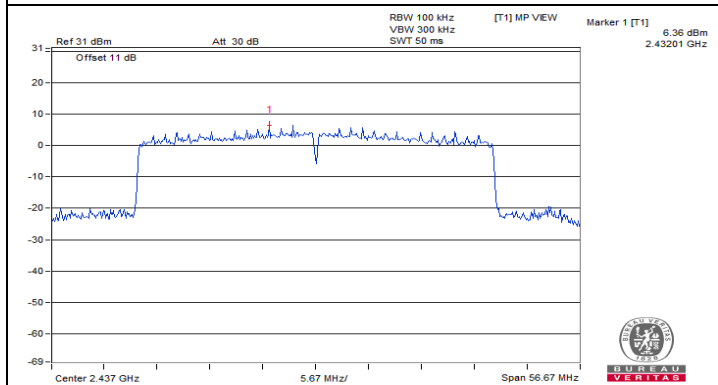

Chain 0 : CH 6

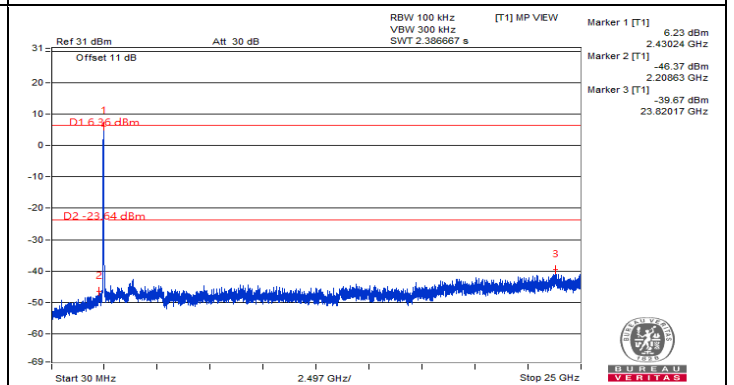

Chain 0 : CH 6

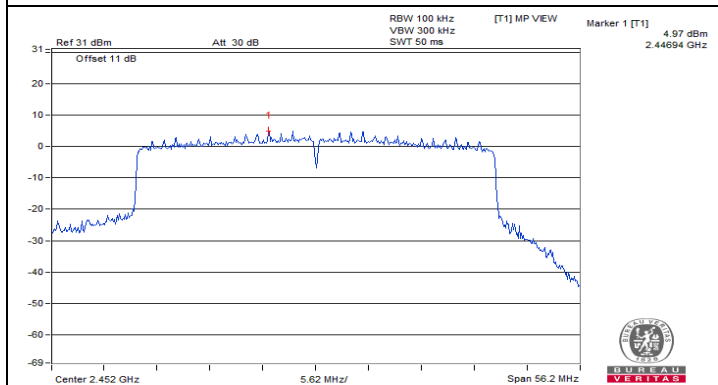

Chain 0 : CH 9

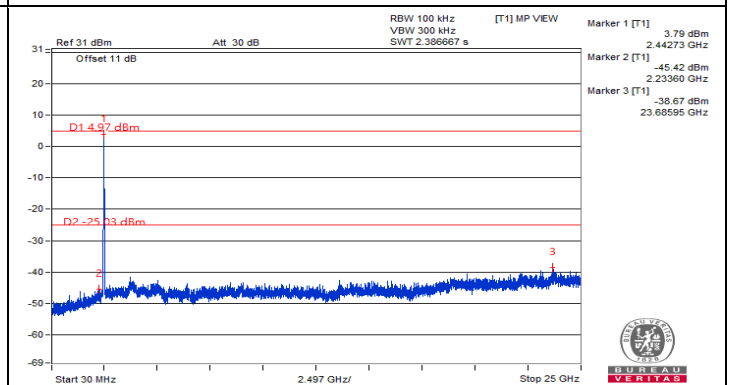

Chain 0 : CH 9

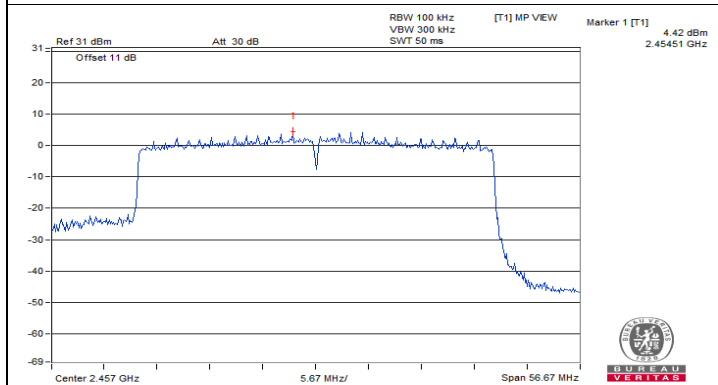

Chain 0 : CH 10

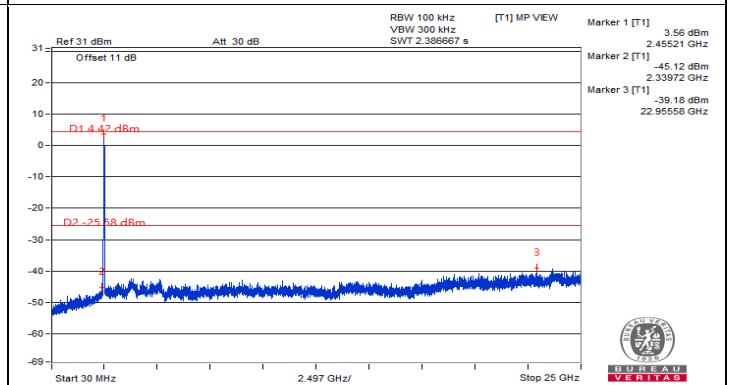

Chain 0 : CH 10



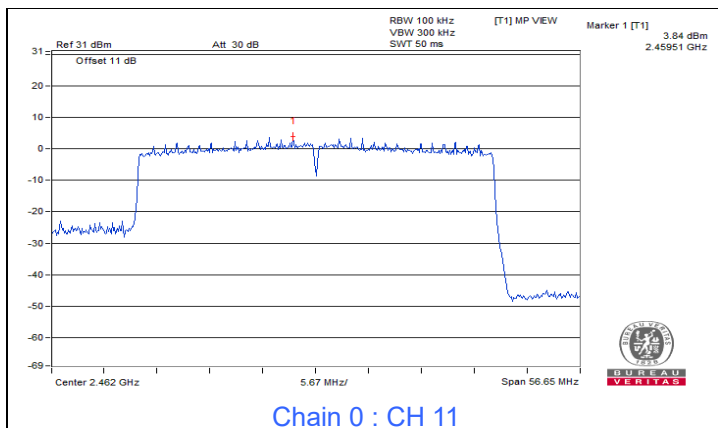

Chain 0 : CH 11

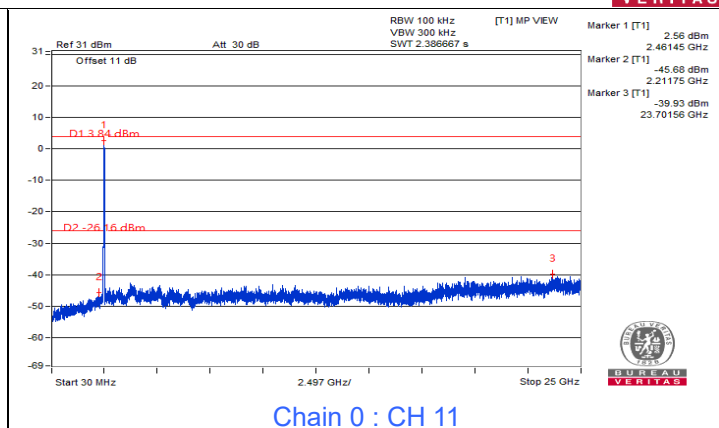

Chain 0 : CH 11

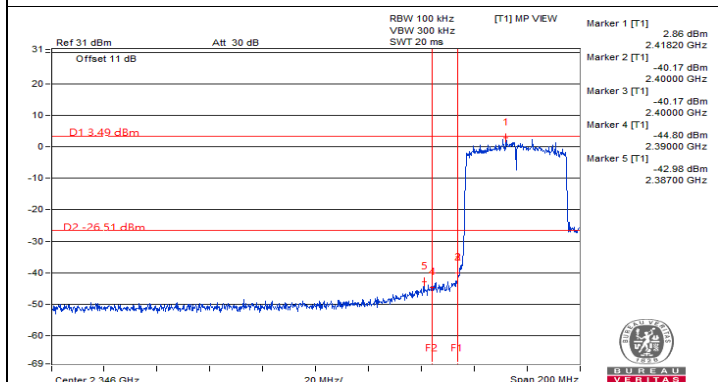

Chain 0 : CH 3 Band edge

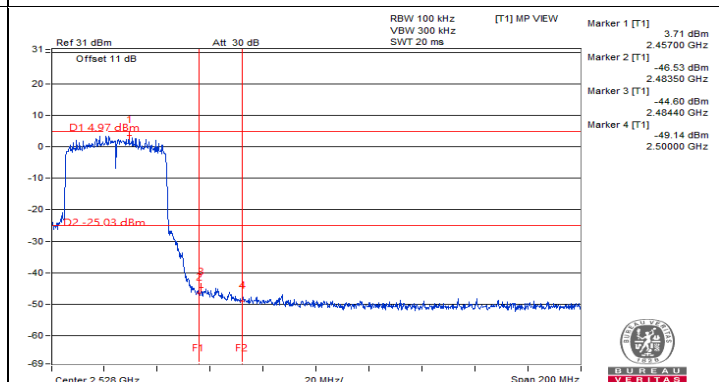

Chain 0 : CH 9 Band edge

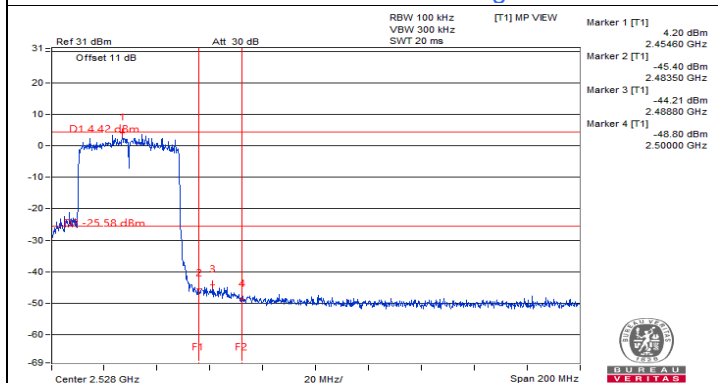

Chain 0 : CH 10 Band edge

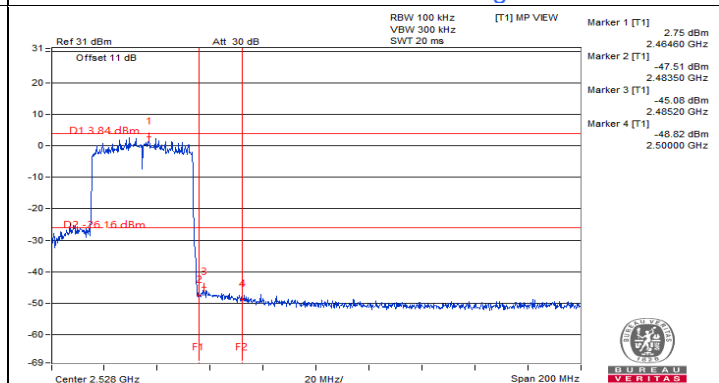

Chain 0 : CH 11 Band edge

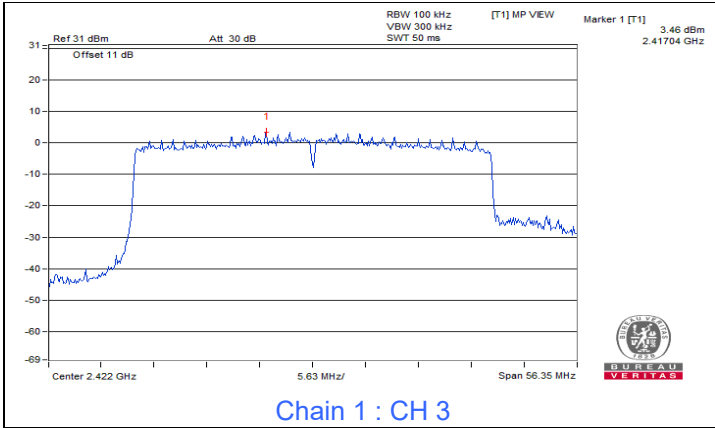

Chain 1 : CH 3

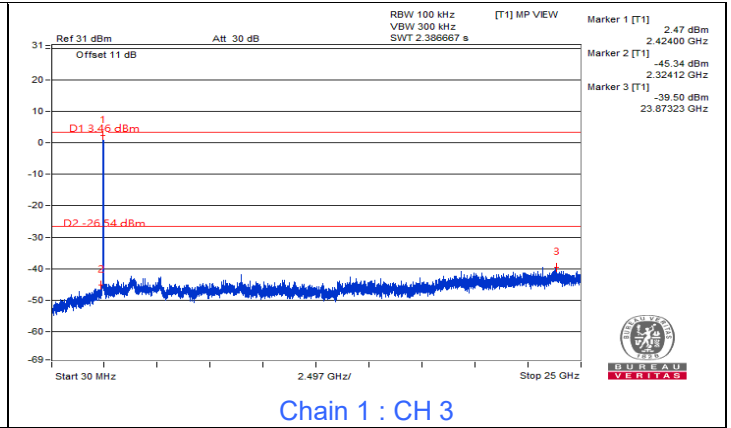

Chain 1 : CH 3

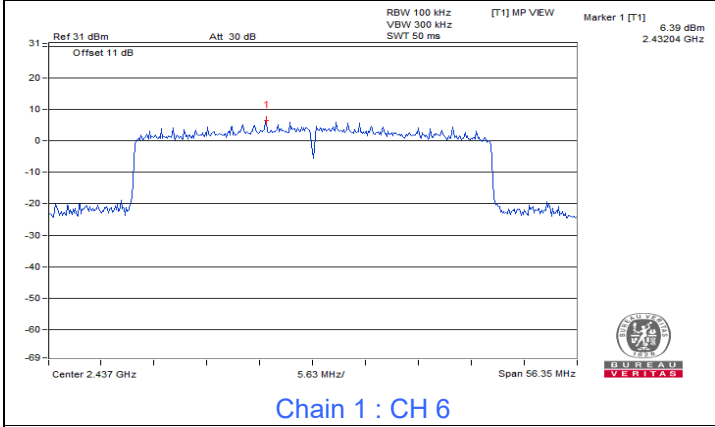

Chain 1 : CH 6

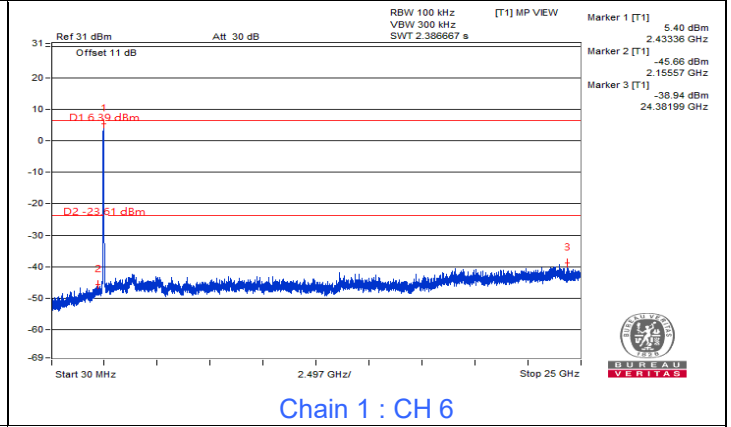

Chain 1 : CH 6

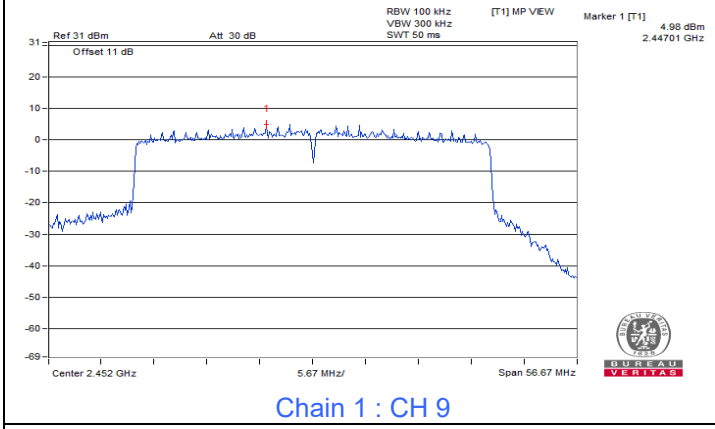

Chain 1 : CH 9

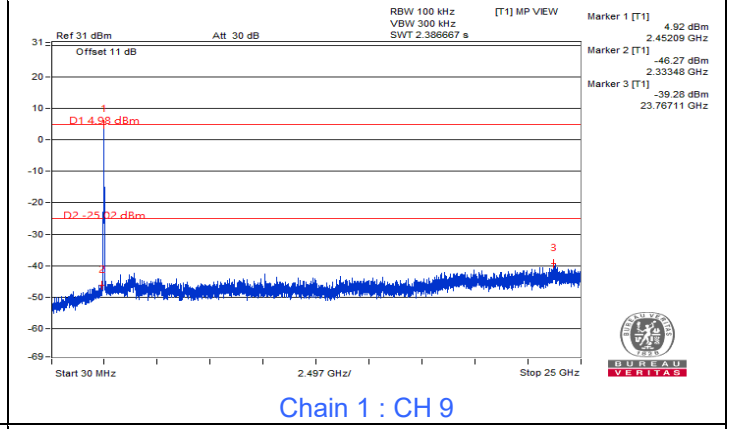

Chain 1 : CH 9

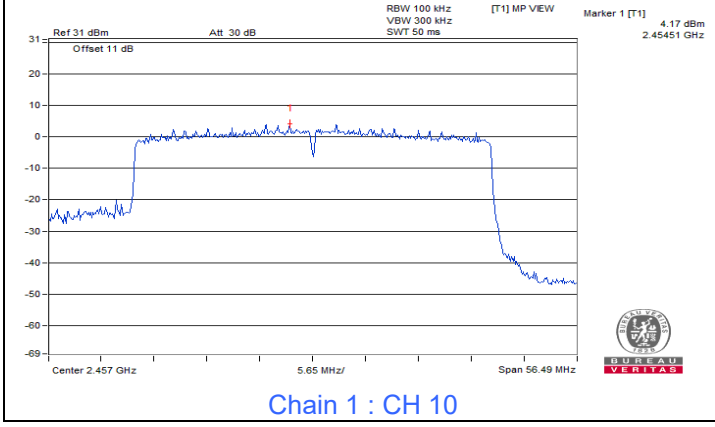

Chain 1 : CH 10

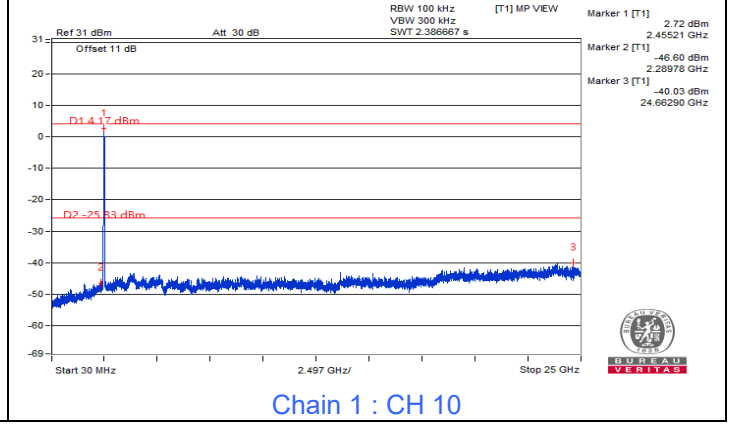

Chain 1 : CH 10

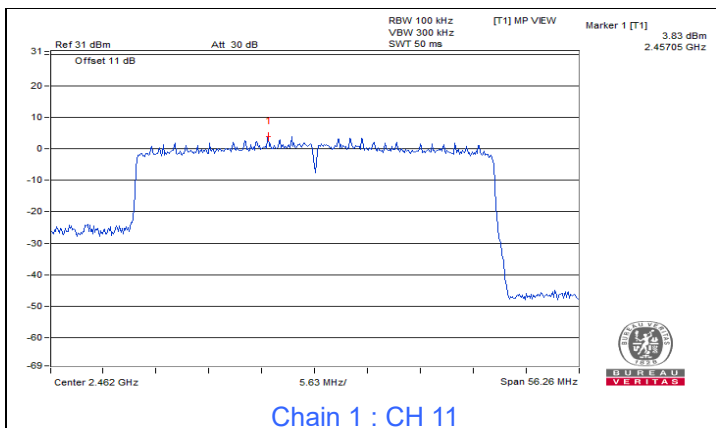

Chain 1 : CH 11

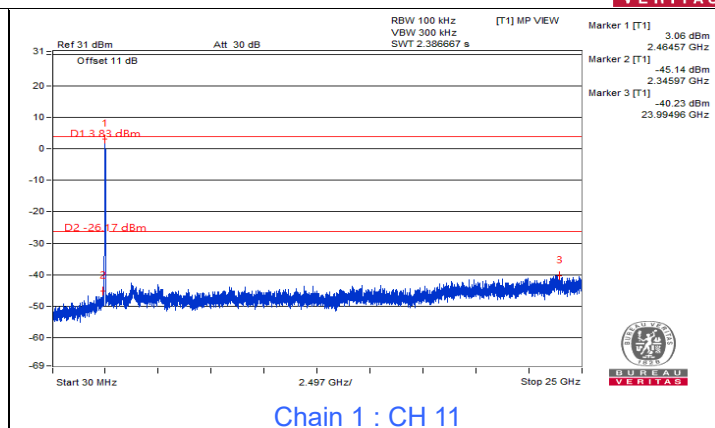

Chain 1 : CH 11

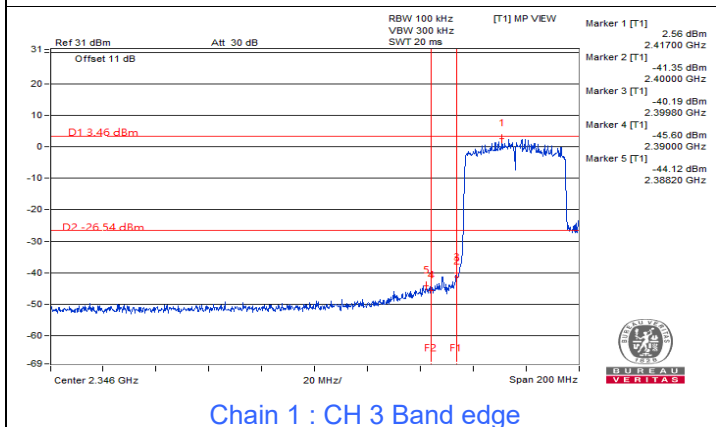

Chain 1 : CH 3 Band edge

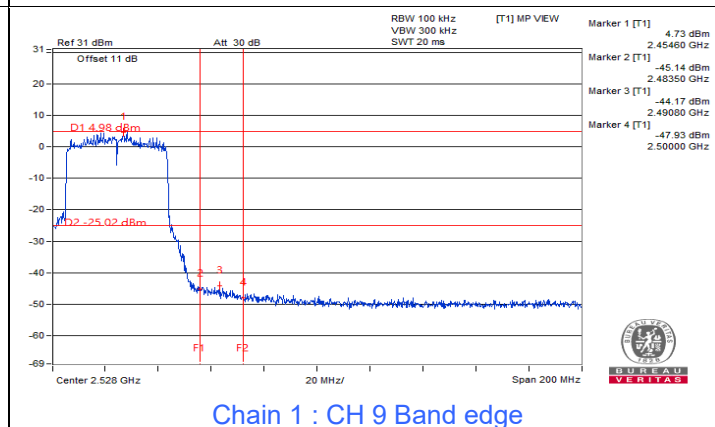

Chain 1 : CH 9 Band edge

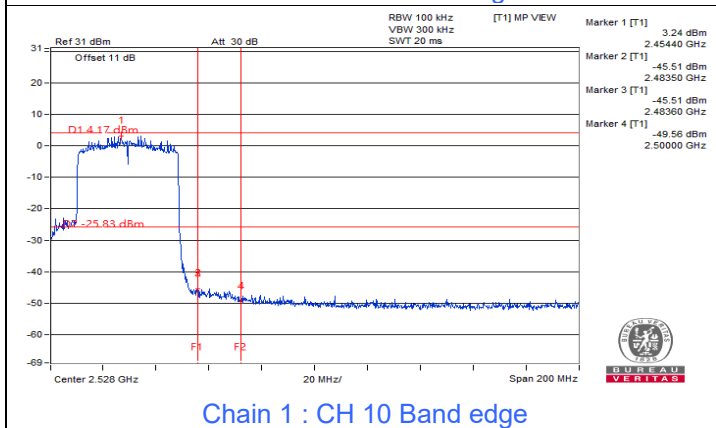

Chain 1 : CH 10 Band edge

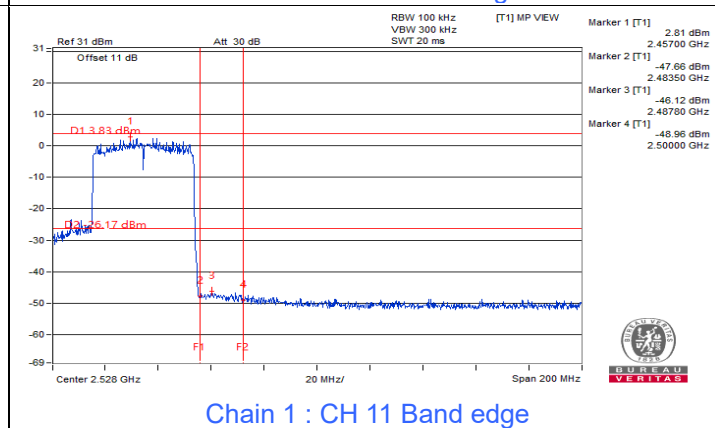

Chain 1 : CH 11 Band edge

## 7.5 AC Power Conducted Emissions

<b>RF Mode</b>	802.11b	<b>Channel</b>	CH 6 : 2437 MHz
<b>Frequency Range</b>	150 kHz ~ 30 MHz	<b>Detector Function &amp; Resolution Bandwidth</b>	Quasi-Peak (QP) / Average (AV), 9 kHz
<b>Input Power (System)</b>	120 Vac, 60 Hz	<b>Environmental Conditions</b>	20°C, 70% RH
<b>Tested By</b>	Willy Lin		

Phase Of Power : Line (L)										
No	Frequency (MHz)	Correction Factor (dB)	Reading Value (dBuV)		Emission Level (dBuV)		Limit (dBuV)		Margin (dB)	
			Q.P.	AV.	Q.P.	AV.	Q.P.	AV.	Q.P.	AV.
1	0.15781	9.93	44.80	24.44	54.73	34.37	65.58	55.58	-10.85	-21.21
2	0.25547	9.93	30.55	7.53	40.48	17.46	61.58	51.58	-21.10	-34.12
3	0.53672	9.95	19.32	9.12	29.27	19.07	56.00	46.00	-26.73	-26.93
4	3.53125	10.08	26.21	17.59	36.29	27.67	56.00	46.00	-19.71	-18.33
5	8.37891	10.36	17.58	12.78	27.94	23.14	60.00	50.00	-32.06	-26.86
6	23.07031	11.26	20.91	15.10	32.17	26.36	60.00	50.00	-27.83	-23.64

### Remarks:

1. Q.P. and AV. are abbreviations of quasi-peak and average individually.
2. The emission levels of other frequencies were very low against the limit.
3. Margin value = Emission level – Limit value
4. Correction factor = Insertion loss + Cable loss
5. Emission Level = Correction Factor + Reading Value

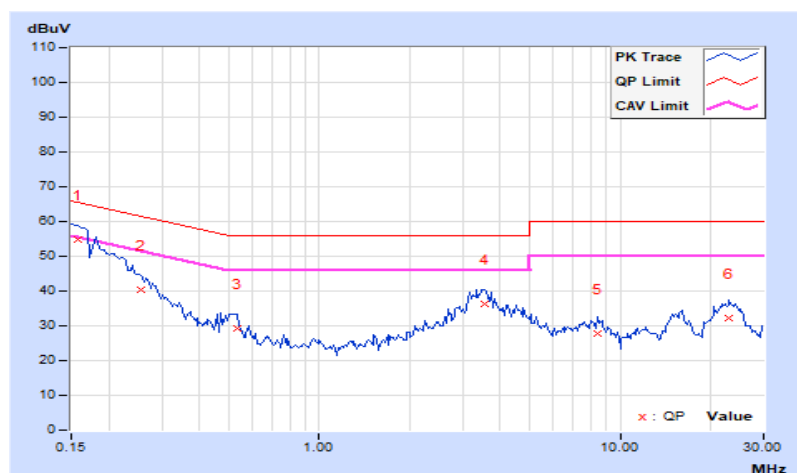

<b>RF Mode</b>	802.11b	<b>Channel</b>	CH 6 : 2437 MHz
<b>Frequency Range</b>	150 kHz ~ 30 MHz	<b>Detector Function &amp; Resolution Bandwidth</b>	Quasi-Peak (QP) / Average (AV), 9 kHz
<b>Input Power (System)</b>	120 Vac, 60 Hz	<b>Environmental Conditions</b>	20°C, 70% RH
<b>Tested By</b>	Willy Lin		

Phase Of Power : Neutral (N)										
No	Frequency (MHz)	Correction Factor (dB)	Reading Value (dBuV)		Emission Level (dBuV)		Limit (dBuV)		Margin (dB)	
			Q.P.	AV.	Q.P.	AV.	Q.P.	AV.	Q.P.	AV.
1	0.15781	9.99	44.72	24.03	54.71	34.02	65.58	55.58	-10.87	-21.56
2	0.20859	9.99	36.88	14.21	46.87	24.20	63.26	53.26	-16.39	-29.06
3	0.53672	10.00	19.28	9.14	29.28	19.14	56.00	46.00	-26.72	-26.86
4	3.34375	10.12	24.94	16.84	35.06	26.96	56.00	46.00	-20.94	-19.04
5	15.52734	10.67	20.28	11.19	30.95	21.86	60.00	50.00	-29.05	-28.14
6	25.12891	11.00	21.13	20.30	32.13	31.30	60.00	50.00	-27.87	-18.70

**Remarks:**

1. Q.P. and AV. are abbreviations of quasi-peak and average individually.
2. The emission levels of other frequencies were very low against the limit.
3. Margin value = Emission level – Limit value
4. Correction factor = Insertion loss + Cable loss
5. Emission Level = Correction Factor + Reading Value

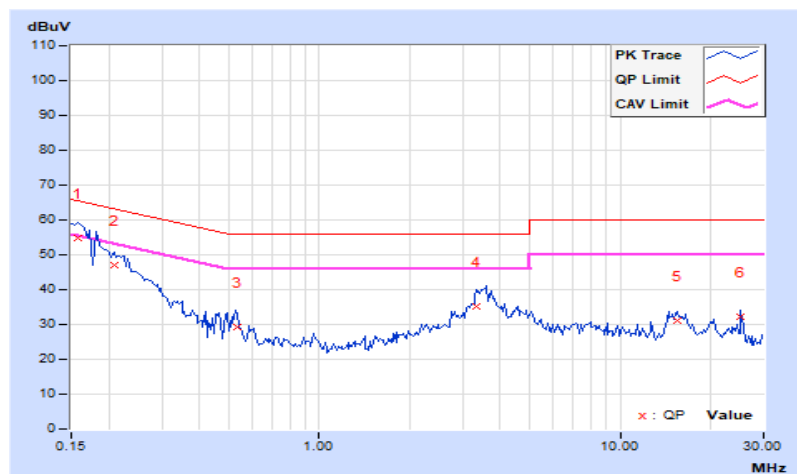

RF Mode	802.11b	Channel	CH 1 : 2412 MHz
Frequency Range	150 kHz ~ 30 MHz	Detector Function & Resolution Bandwidth	Quasi-Peak (QP) / Average (AV), 9 kHz
Input Power (System)	120 Vac, 60 Hz	Environmental Conditions	20°C, 70% RH
Tested By	Willy Lin		

Phase Of Power : Line (L)										
No	Frequency (MHz)	Correction Factor (dB)	Reading Value (dBuV)		Emission Level (dBuV)		Limit (dBuV)		Margin (dB)	
			Q.P.	AV.	Q.P.	AV.	Q.P.	AV.	Q.P.	AV.
1	0.16562	9.93	44.34	21.77	54.27	31.70	65.18	55.18	-10.91	-23.48
2	0.22031	9.93	35.38	13.88	45.31	23.81	62.81	52.81	-17.50	-29.00
3	0.52500	9.95	19.42	7.86	29.37	17.81	56.00	46.00	-26.63	-28.19
4	3.57813	10.09	25.91	17.72	36.00	27.81	56.00	46.00	-20.00	-18.19
5	15.51953	10.84	18.23	7.25	29.07	18.09	60.00	50.00	-30.93	-31.91
6	23.00781	11.26	21.19	15.56	32.45	26.82	60.00	50.00	-27.55	-23.18

**Remarks:**

1. Q.P. and AV. are abbreviations of quasi-peak and average individually.
2. The emission levels of other frequencies were very low against the limit.
3. Margin value = Emission level – Limit value
4. Correction factor = Insertion loss + Cable loss
5. Emission Level = Correction Factor + Reading Value



RF Mode	802.11b	Channel	CH 1 : 2412 MHz
Frequency Range	150 kHz ~ 30 MHz	Detector Function & Resolution Bandwidth	Quasi-Peak (QP) / Average (AV), 9 kHz
Input Power (System)	120 Vac, 60 Hz	Environmental Conditions	20°C, 70% RH
Tested By	Willy Lin		

Phase Of Power : Neutral (N)										
No	Frequency (MHz)	Correction Factor (dB)	Reading Value (dBuV)		Emission Level (dBuV)		Limit (dBuV)		Margin (dB)	
			Q.P.	AV.	Q.P.	AV.	Q.P.	AV.	Q.P.	AV.
1	0.16562	9.99	44.38	22.22	54.37	32.21	65.18	55.18	-10.81	-22.97
2	0.22422	9.99	36.32	14.37	46.31	24.36	62.66	52.66	-16.35	-28.30
3	0.50547	10.00	18.75	4.11	28.75	14.11	56.00	46.00	-27.25	-31.89
4	3.44922	10.12	25.90	17.81	36.02	27.93	56.00	46.00	-19.98	-18.07
5	14.22266	10.61	17.09	8.64	27.70	19.25	60.00	50.00	-32.30	-30.75
6	25.12891	11.00	21.68	20.74	32.68	31.74	60.00	50.00	-27.32	-18.26

**Remarks:**

1. Q.P. and AV. are abbreviations of quasi-peak and average individually.
2. The emission levels of other frequencies were very low against the limit.
3. Margin value = Emission level – Limit value
4. Correction factor = Insertion loss + Cable loss
5. Emission Level = Correction Factor + Reading Value

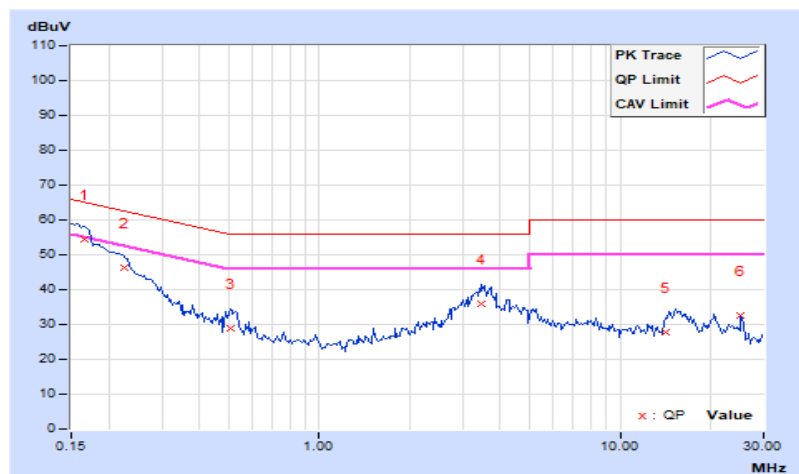

## 7.6 Unwanted Emissions below 1 GHz

### Mode A For 1TX

RF Mode	802.11b	Channel	CH 6 : 2437 MHz
Frequency Range	30 MHz ~ 1 GHz	Environmental Conditions	25°C, 76% RH
Tested By	Waydi Tuan		

#### Conducted Unwanted Emissions

No.	Frequency (MHz)	Emission Level (dBuV/m)	Limit (dBuV/m)	Margin (dB)	Raw Value Chain 0 (dBm)	Correction Factor (dB)	EIRP Level (dBm)
1	79.11	32.51 PK	40	-7.49	-72.37	9.62	-62.75
2	94.5	34.46 PK	43.5	-9.04	-70.42	9.62	-60.8
3	250.43	33.7 PK	46	-12.3	-71.18	9.62	-61.56
4	464.68	35.03 PK	46	-10.97	-69.85	9.62	-60.23
5	711.18	34.61 PK	46	-11.39	-70.27	9.62	-60.65
6	923.61	36.02 PK	46	-9.98	-68.86	9.62	-59.24

#### Notes:

- Margin value = Emission Level - Limit value
- The frequency range 9 kHz ~ 30 MHz: all emissions are more than 20 dB below the limit, therefore do not be recorded in this report.

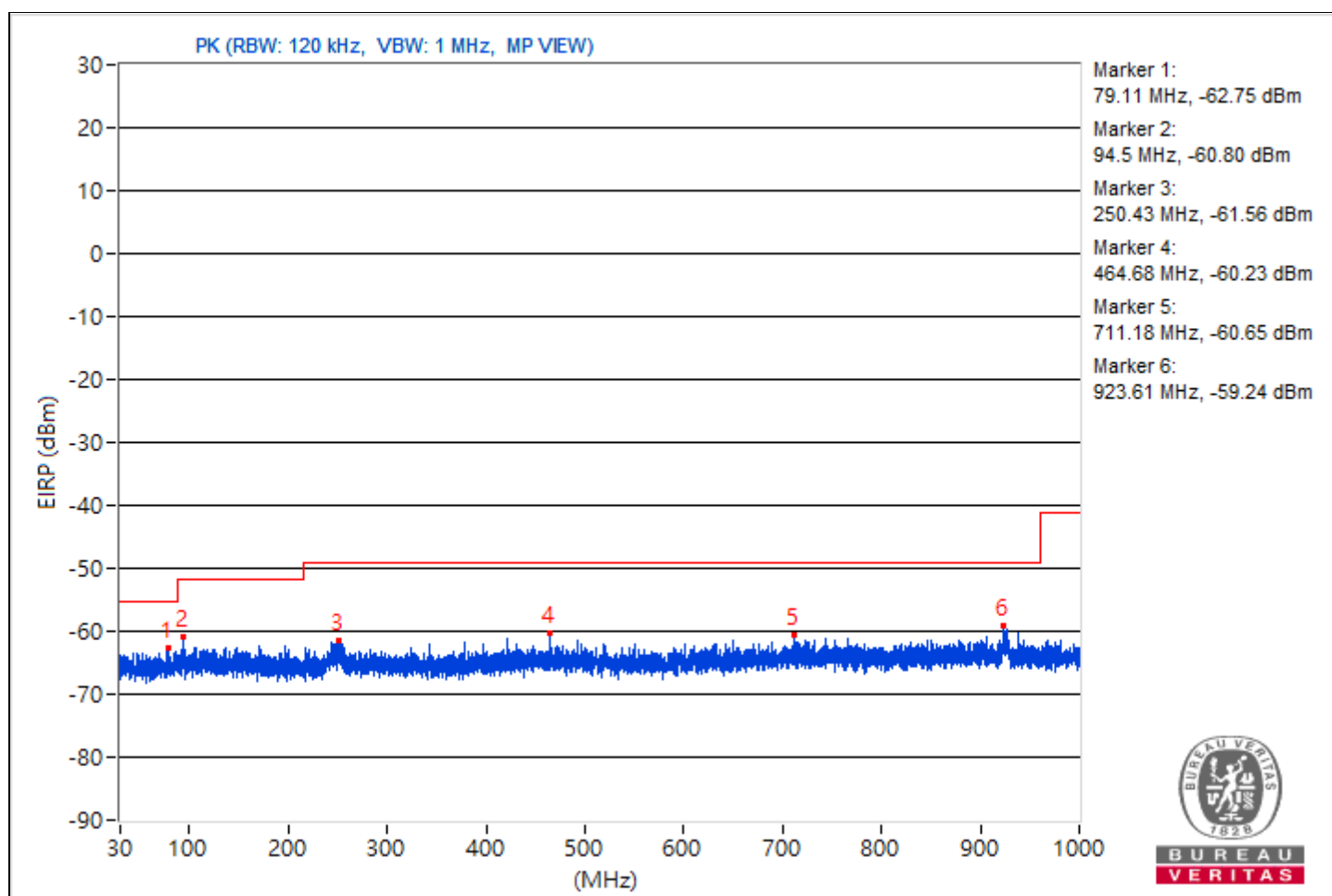



For 2TX

RF Mode	802.11b	Channel	CH 1 : 2412 MHz
Frequency Range	30 MHz ~ 1 GHz	Environmental Conditions	25°C, 76% RH
Tested By	Waydi Tuan		

Conducted Unwanted Emissions								
No.	Frequency (MHz)	Emission Level (dBuV/m)	Limit (dBuV/m)	Margin (dB)	Raw Value Chain 0 (dBm)	Raw Value Chain 1 (dBm)	Correction Factor (dB)	EIRP Level (dBm)
1	44.19	37.53 PK	40	-2.47	-75.09	-72.15	12.63	-57.73
2	178.05	37.4 PK	43.5	-6.1	-74.39	-72.75	12.63	-57.86
3	287.17	37.71 PK	46	-8.29	-71.75	-74.69	12.63	-57.55
4	508.45	38.07 PK	46	-7.93	-74.32	-71.72	12.63	-57.19
5	744.16	38.52 PK	46	-7.48	-70.75	-74.86	12.63	-56.74
6	896.45	39.86 PK	46	-6.14	-73.36	-69.22	12.63	-55.4

Notes:

1. Margin value = Emission Level - Limit value
2. The frequency range 9 kHz ~ 30 MHz: all emissions are more than 20 dB below the limit, therefore do not be recorded in this report.

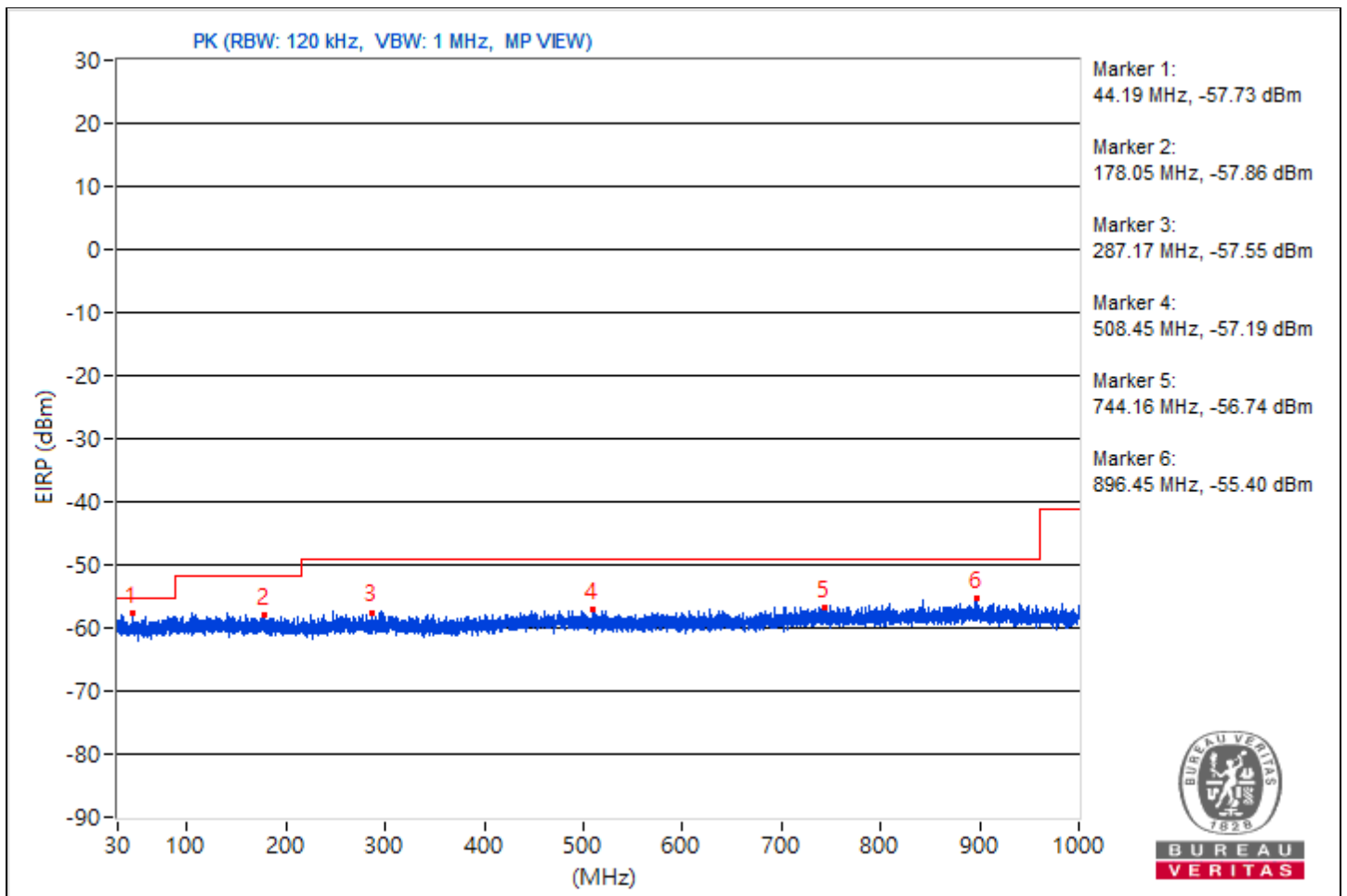

**Mode B  
For 1TX**

<b>RF Mode</b>	802.11b	<b>Channel</b>	CH 6 : 2437 MHz
<b>Frequency Range</b>	30 MHz ~ 1 GHz	<b>Detector Function &amp; Bandwidth</b>	QP: RB=120kHz, DET=Quasi-Peak
<b>Input Power (System)</b>	120 Vac, 60 Hz	<b>Environmental Conditions</b>	20°C, 70% RH
<b>Tested By</b>	Willy Lin		

Antenna Polarity & Test Distance : Horizontal at 3 m								
No	Frequency (MHz)	Emission Level (dBuV/m)	Limit (dBuV/m)	Margin (dB)	Antenna Height (m)	Table Angle (Degree)	Raw Value (dBuV)	Correction Factor (dB/m)
1	104.59	24.5 QP	43.5	-19.0	1.00 H	329	41.1	-16.6
2	239.86	35.9 QP	46.0	-10.1	1.00 H	235	50.6	-14.7
3	293.32	39.0 QP	46.0	-7.0	3.00 H	288	51.7	-12.7
4	433.64	41.7 QP	46.0	-4.3	2.00 H	327	50.5	-8.8
<b>5</b>	<b>696.34</b>	<b>45.4 QP</b>	<b>46.0</b>	<b>-0.6</b>	<b>1.00 H</b>	<b>250</b>	<b>49.4</b>	<b>-4.0</b>
6	899.72	42.2 QP	46.0	-3.8	1.00 H	258	43.4	-1.2

**Remarks:**

1. Emission Level(dBuV/m) = Raw Value(dBuV) + Correction Factor(dB/m)
2. Correction Factor(dB/m) = Antenna Factor(dB/m) + Cable Factor(dB) – Pre-Amplifier Factor(dB)
3. Margin value = Emission Level – Limit value
4. The other emission levels were very low against the limit of frequency range 30 MHz ~ 1 GHz.
5. The frequency range 9 kHz ~ 30 MHz: all emissions are more than 20 dB below the limit, therefore do not be recorded in this report.

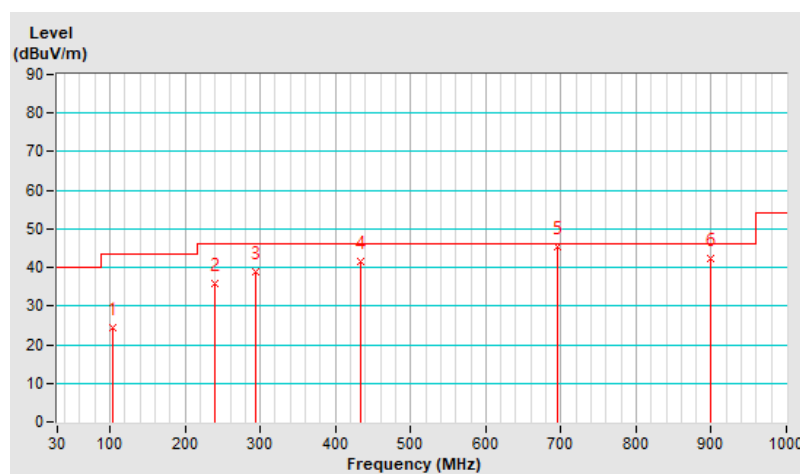

<b>RF Mode</b>	802.11b	<b>Channel</b>	CH 6 : 2437 MHz
<b>Frequency Range</b>	30 MHz ~ 1 GHz	<b>Detector Function &amp; Bandwidth</b>	QP: RB=120kHz, DET=Quasi-Peak
<b>Input Power (System)</b>	120 Vac, 60 Hz	<b>Environmental Conditions</b>	20°C, 70% RH
<b>Tested By</b>	Willy Lin		

Antenna Polarity & Test Distance : Vertical at 3 m								
No	Frequency (MHz)	Emission Level (dBuV/m)	Limit (dBuV/m)	Margin (dB)	Antenna Height (m)	Table Angle (Degree)	Raw Value (dBuV)	Correction Factor (dB/m)
1	33.23	28.7 QP	40.0	-11.3	1.50 V	268	42.6	-13.9
2	99.92	34.6 QP	43.5	-8.9	1.00 V	316	52.0	-17.4
3	215.89	41.0 QP	43.5	-2.5	1.00 V	145	57.5	-16.5
4	241.64	29.5 QP	46.0	-16.5	2.00 V	39	44.1	-14.6
5	287.75	38.0 QP	46.0	-8.0	1.00 V	262	50.8	-12.8
6	694.14	34.3 QP	46.0	-11.7	2.00 V	34	38.3	-4.0

**Remarks:**

1. Emission Level(dBuV/m) = Raw Value(dBuV) + Correction Factor(dB/m)
2. Correction Factor(dB/m) = Antenna Factor(dB/m) + Cable Factor(dB) – Pre-Amplifier Factor(dB)
3. Margin value = Emission Level – Limit value
4. The other emission levels were very low against the limit of frequency range 30 MHz ~ 1 GHz.
5. The frequency range 9 kHz ~ 30 MHz: all emissions are more than 20 dB below the limit, therefore do not be recorded in this report.

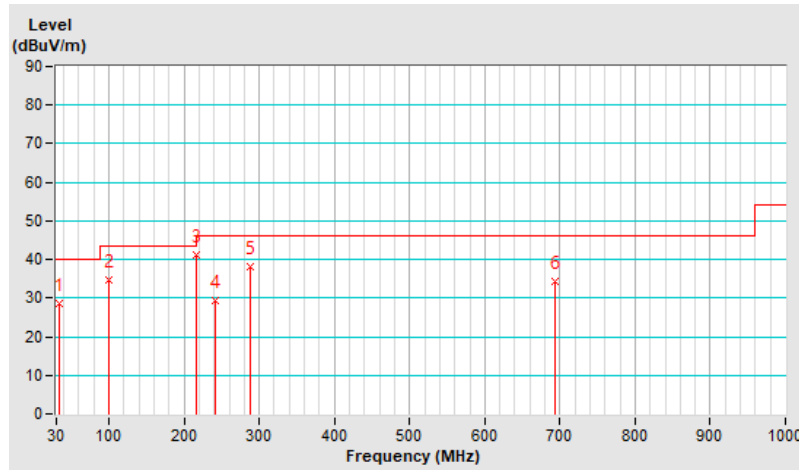

For 2TX

<b>RF Mode</b>	802.11b	<b>Channel</b>	CH 1 : 2412 MHz
<b>Frequency Range</b>	30 MHz ~ 1 GHz	<b>Detector Function &amp; Bandwidth</b>	QP: RB=120kHz, DET=Quasi-Peak
<b>Input Power (System)</b>	120 Vac, 60 Hz	<b>Environmental Conditions</b>	20°C, 70% RH
<b>Tested By</b>	Willy Lin		

Antenna Polarity & Test Distance : Horizontal at 3 m								
No	Frequency (MHz)	Emission Level (dBuV/m)	Limit (dBuV/m)	Margin (dB)	Antenna Height (m)	Table Angle (Degree)	Raw Value (dBuV)	Correction Factor (dB/m)
1	104.47	24.4 QP	43.5	-19.1	1.00 H	317	41.0	-16.6
2	239.83	36.4 QP	46.0	-9.6	2.00 H	223	51.1	-14.7
3	289.40	38.3 QP	46.0	-7.7	1.50 H	275	51.1	-12.8
4	436.48	41.6 QP	46.0	-4.4	3.00 H	336	50.3	-8.7
5	696.32	45.1 QP	46.0	-0.9	1.00 H	266	49.1	-4.0
6	900.92	41.8 QP	46.0	-4.2	3.00 H	249	42.9	-1.1

**Remarks:**

1. Emission Level(dBuV/m) = Raw Value(dBuV) + Correction Factor(dB/m)
2. Correction Factor(dB/m) = Antenna Factor(dB/m) + Cable Factor(dB) – Pre-Amplifier Factor(dB)
3. Margin value = Emission Level – Limit value
4. The other emission levels were very low against the limit of frequency range 30 MHz ~ 1 GHz.
5. The frequency range 9 kHz ~ 30 MHz: all emissions are more than 20 dB below the limit, therefore do not be recorded in this report.

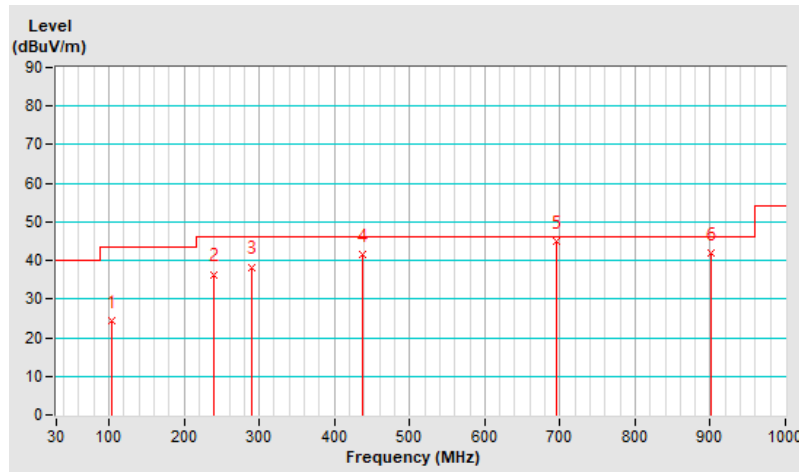

<b>RF Mode</b>	802.11b	<b>Channel</b>	CH 1 : 2412 MHz
<b>Frequency Range</b>	30 MHz ~ 1 GHz	<b>Detector Function &amp; Bandwidth</b>	QP: RB=120kHz, DET=Quasi-Peak
<b>Input Power (System)</b>	120 Vac, 60 Hz	<b>Environmental Conditions</b>	20°C, 70% RH
<b>Tested By</b>	Willy Lin		

Antenna Polarity & Test Distance : Vertical at 3 m								
No	Frequency (MHz)	Emission Level (dBuV/m)	Limit (dBuV/m)	Margin (dB)	Antenna Height (m)	Table Angle (Degree)	Raw Value (dBuV)	Correction Factor (dB/m)
1	32.84	30.2 QP	40.0	-9.8	1.50 V	265	44.1	-13.9
2	100.71	34.9 QP	43.5	-8.6	1.50 V	325	52.2	-17.3
3	216.86	42.7 QP	46.0	-3.3	2.00 V	133	59.2	-16.5
4	242.37	29.4 QP	46.0	-16.6	1.00 V	48	44.0	-14.6
5	287.63	38.4 QP	46.0	-7.6	1.00 V	249	51.2	-12.8
6	693.85	34.7 QP	46.0	-11.3	1.00 V	31	38.7	-4.0

**Remarks:**

1. Emission Level(dBuV/m) = Raw Value(dBuV) + Correction Factor(dB/m)
2. Correction Factor(dB/m) = Antenna Factor(dB/m) + Cable Factor(dB) – Pre-Amplifier Factor(dB)
3. Margin value = Emission Level – Limit value
4. The other emission levels were very low against the limit of frequency range 30 MHz ~ 1 GHz.
5. The frequency range 9 kHz ~ 30 MHz: all emissions are more than 20 dB below the limit, therefore do not be recorded in this report.

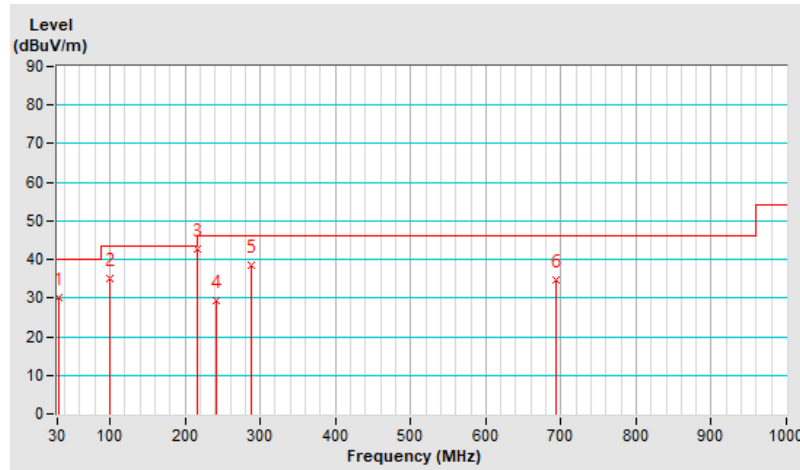

## 7.7 Unwanted Emissions above 1 GHz

Mode A

For 1TX

### Conducted Unwanted Emissions

RF Mode	802.11b	Channel	CH 1 : 2412 MHz
Frequency Range	1 GHz ~ 25 GHz	Environmental Conditions	25°C, 76% RH
Tested By	Waydi Tuan		

Conducted Unwanted Emissions							
No.	Frequency (MHz)	Emission Level (dBuV/m)	Limit (dBuV/m)	Margin (dB)	Raw Value Chain 0 (dBm)	Correction Factor (dB)	EIRP Level (dBm)
1	2338.63	52.68 PK	74	-21.32	-47.5	4.92	-42.58
2	2333.34	42.56 AV	54	-11.44	-57.62	4.92	-52.7
3	3906.09	55.02 PK	74	-18.98	-45.16	4.92	-40.24
4	4824.02	51.94 AV	54	-2.06	-48.24	4.92	-43.32
5	9000.53	53.01 PK	74	-20.99	-47.17	4.92	-42.25
6	14492.98	41.59 AV	54	-12.41	-58.59	4.92	-53.67
7	23699.6	56.63 PK	74	-17.37	-43.55	4.92	-38.63
8	23822.2	45.5 AV	54	-8.5	-54.68	4.92	-49.76

Note: Margin value = Emission Level - Limit value

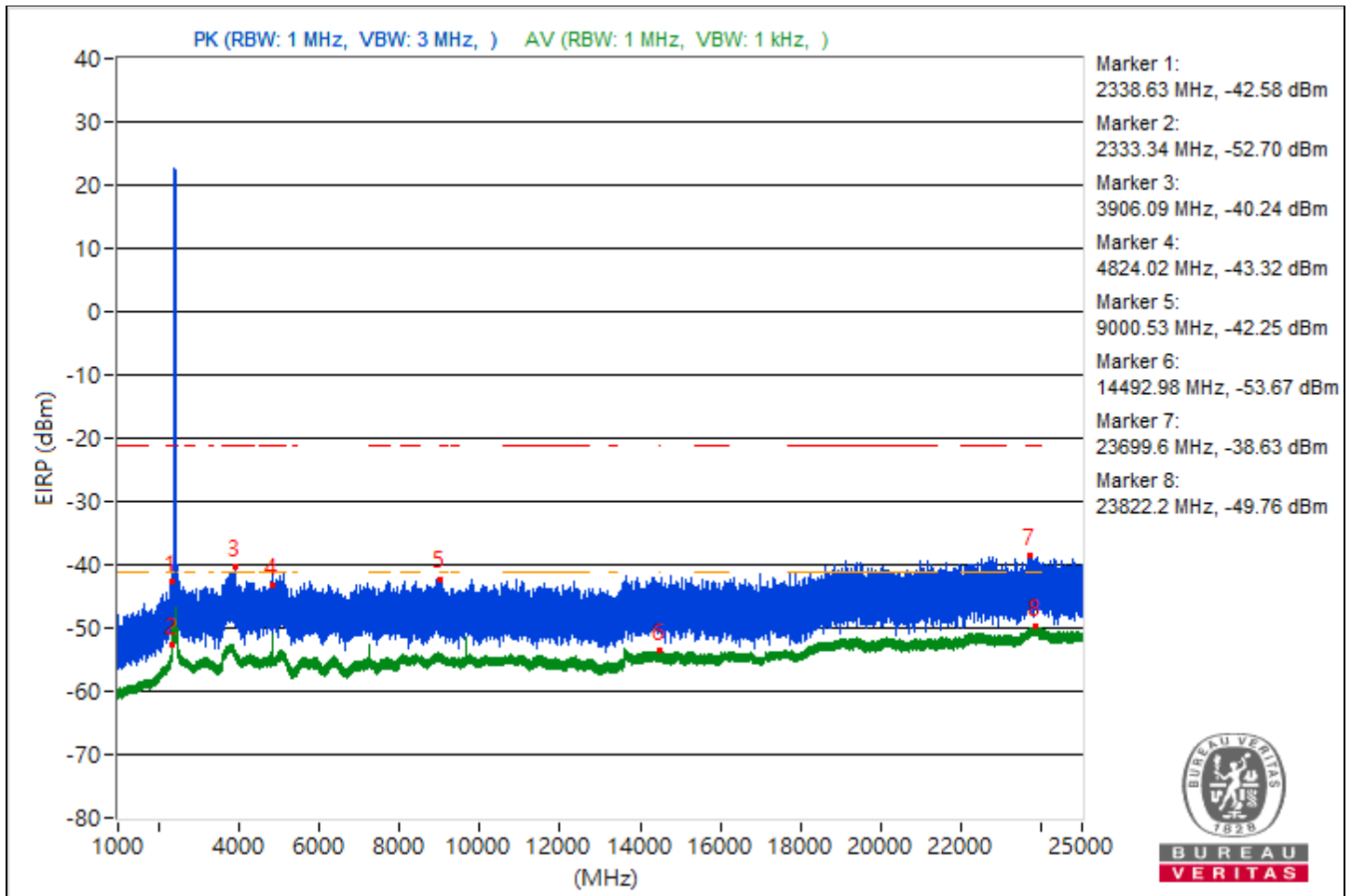

RF Mode	802.11b	Channel	CH 6 : 2437 MHz
Frequency Range	1 GHz ~ 25 GHz	Environmental Conditions	25°C, 76% RH
Tested By	Waydi Tuan		

Conducted Unwanted Emissions

No.	Frequency (MHz)	Emission Level (dBuV/m)	Limit (dBuV/m)	Margin (dB)	Raw Value Chain 0 (dBm)	Correction Factor (dB)	EIRP Level (dBm)
1	2322.84	51.36 PK	74	-22.64	-48.82	4.92	-43.9
2	2337.16	40.71 AV	54	-13.29	-59.47	4.92	-54.55
3	4874.34	54.96 PK	74	-19.04	-45.22	4.92	-40.3
4	4874.03	50.21 AV	54	-3.79	-49.97	4.92	-45.05
5	8386.58	53.27 PK	74	-20.73	-46.91	4.92	-41.99
6	14497.07	41.33 AV	54	-12.67	-58.85	4.92	-53.93
7	21173.9	57.01 PK	74	-16.99	-43.17	4.92	-38.25
8	23755.4	45.55 AV	54	-8.45	-54.63	4.92	-49.71

Note: Margin value = Emission Level - Limit value

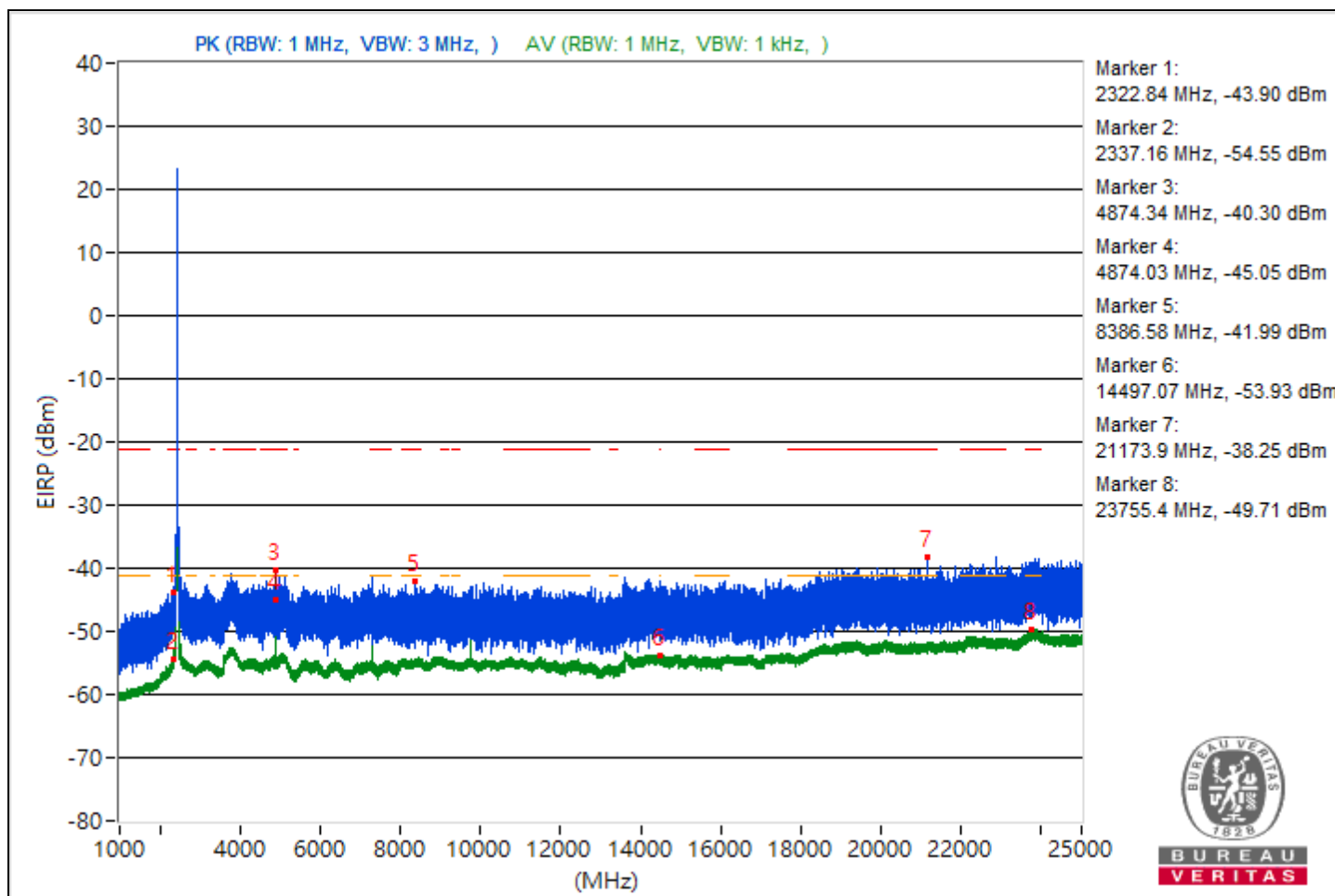

RF Mode	802.11b	Channel	CH 11 : 2462 MHz
Frequency Range	1 GHz ~ 25 GHz	Environmental Conditions	25°C, 76% RH
Tested By	Waydi Tuan		

Conducted Unwanted Emissions							
No.	Frequency (MHz)	Emission Level (dBuV/m)	Limit (dBuV/m)	Margin (dB)	Raw Value Chain 0 (dBm)	Correction Factor (dB)	EIRP Level (dBm)
1	2325.1	51.11 PK	74	-22.89	-49.07	4.92	-44.15
2	2339.64	40.54 AV	54	-13.46	-59.64	4.92	-54.72
3	3845.89	54.61 PK	74	-19.39	-45.57	4.92	-40.65
4	4924.04	49.11 AV	54	-4.89	-51.07	4.92	-46.15
5	15708	53.16 PK	74	-20.84	-47.02	4.92	-42.1
6	9008.27	41.42 AV	54	-12.58	-58.76	4.92	-53.84
7	23682.7	59.17 PK	74	-14.83	-41.01	4.92	-36.09
8	23889.3	45.67 AV	54	-8.33	-54.51	4.92	-49.59

Note: Margin value = Emission Level - Limit value

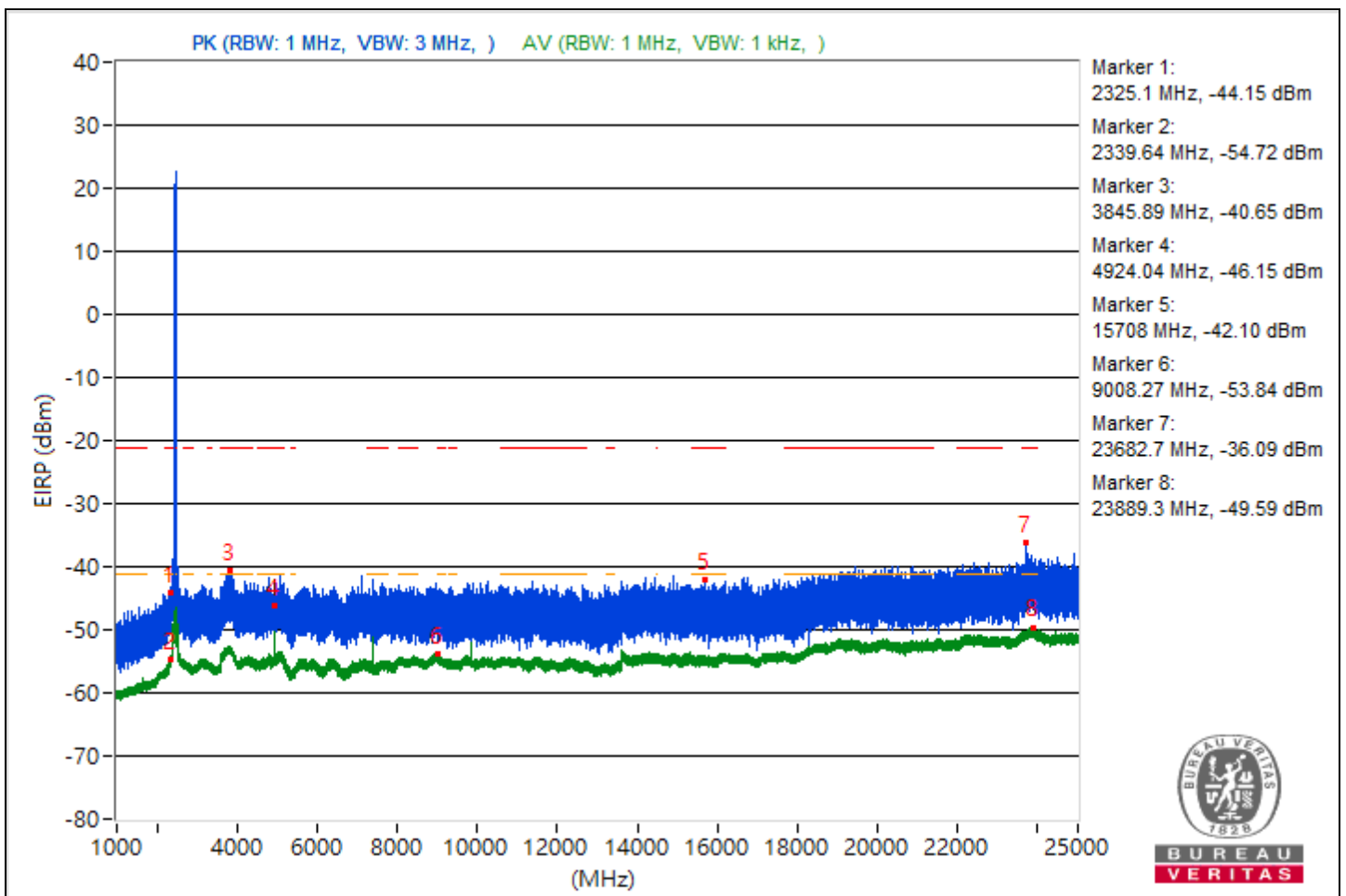



RF Mode	802.11b	Channel	CH 12 : 2467 MHz
Frequency Range	1 GHz ~ 25 GHz	Environmental Conditions	25°C, 76% RH
Tested By	Waydi Tuan		

Conducted Unwanted Emissions							
No.	Frequency (MHz)	Emission Level (dBuV/m)	Limit (dBuV/m)	Margin (dB)	Raw Value Chain 0 (dBm)	Correction Factor (dB)	EIRP Level (dBm)
1	2320.43	52.07 PK	74	-21.93	-48.11	4.92	-43.19
2	2335.44	40.43 AV	54	-13.57	-59.75	4.92	-54.83
3	3756.99	55.6 PK	74	-18.4	-44.58	4.92	-39.66
4	4934	46.76 AV	54	-7.24	-53.42	4.92	-48.5
5	15596.8	53.45 PK	74	-20.55	-46.73	4.92	-41.81
6	14493.16	41.39 AV	54	-12.61	-58.79	4.92	-53.87
7	23886.5	56.95 PK	74	-17.05	-43.23	4.92	-38.31
8	23844.8	45.81 AV	54	-8.19	-54.37	4.92	-49.45

Note: Margin value = Emission Level - Limit value

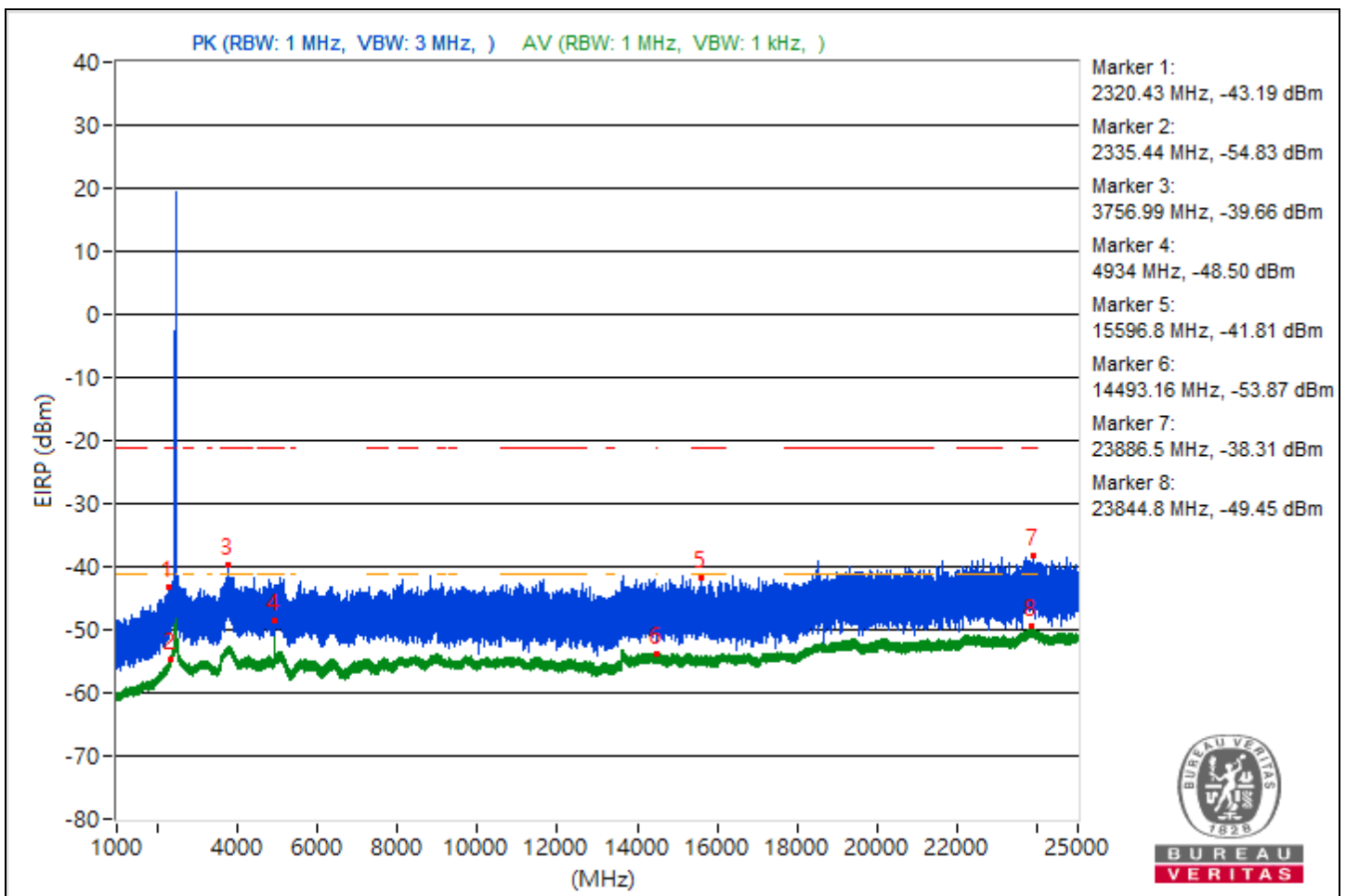



RF Mode	802.11b	Channel	CH 13 : 2472 MHz
Frequency Range	1 GHz ~ 25 GHz	Environmental Conditions	25°C, 76% RH
Tested By	Waydi Tuan		

Conducted Unwanted Emissions							
No.	Frequency (MHz)	Emission Level (dBuV/m)	Limit (dBuV/m)	Margin (dB)	Raw Value Chain 0 (dBm)	Correction Factor (dB)	EIRP Level (dBm)
1	2290.18	50.42 PK	74	-23.58	-49.76	4.92	-44.84
2	2336.84	40.57 AV	54	-13.43	-59.61	4.92	-54.69
3	3765	54.67 PK	74	-19.33	-45.51	4.92	-40.59
4	3858.18	42.78 AV	54	-11.22	-57.4	4.92	-52.48
5	15864.53	53.32 PK	74	-20.68	-46.86	4.92	-41.94
6	14483.11	41.31 AV	54	-12.69	-58.87	4.92	-53.95
7	23797.9	56.42 PK	74	-17.58	-43.76	4.92	-38.84
8	23790.9	45.68 AV	54	-8.32	-54.5	4.92	-49.58

Note: Margin value = Emission Level - Limit value

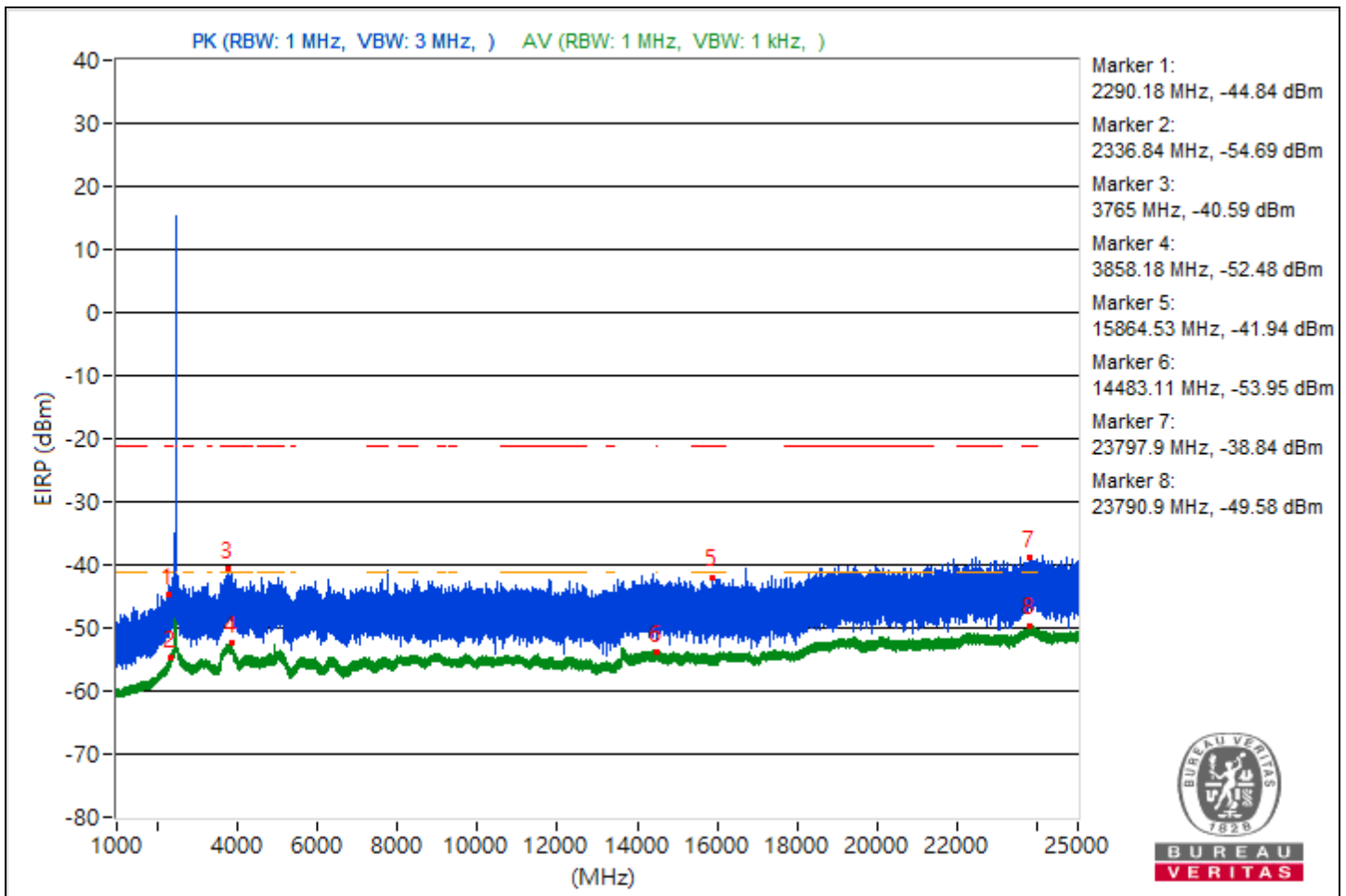



RF Mode	802.11g	Channel	CH 1 : 2412 MHz
Frequency Range	1 GHz ~ 25 GHz	Environmental Conditions	25°C, 76% RH
Tested By	Waydi Tuan		

Conducted Unwanted Emissions							
No.	Frequency (MHz)	Emission Level (dBuV/m)	Limit (dBuV/m)	Margin (dB)	Raw Value Chain 0 (dBm)	Correction Factor (dB)	EIRP Level (dBm)
1	2318.1	51.56 PK	74	-22.44	-48.62	4.92	-43.7
2	2338.48	41.55 AV	54	-12.45	-58.63	4.92	-53.71
3	5032.93	53.98 PK	74	-20.02	-46.2	4.92	-41.28
4	3768.66	42.72 AV	54	-11.28	-57.46	4.92	-52.54
5	11456.36	53.79 PK	74	-20.21	-46.39	4.92	-41.47
6	14496.36	41.28 AV	54	-12.72	-58.9	4.92	-53.98
7	23682	57.29 PK	74	-16.71	-42.89	4.92	-37.97
8	23831.6	45.49 AV	54	-8.51	-54.69	4.92	-49.77

Note: Margin value = Emission Level - Limit value

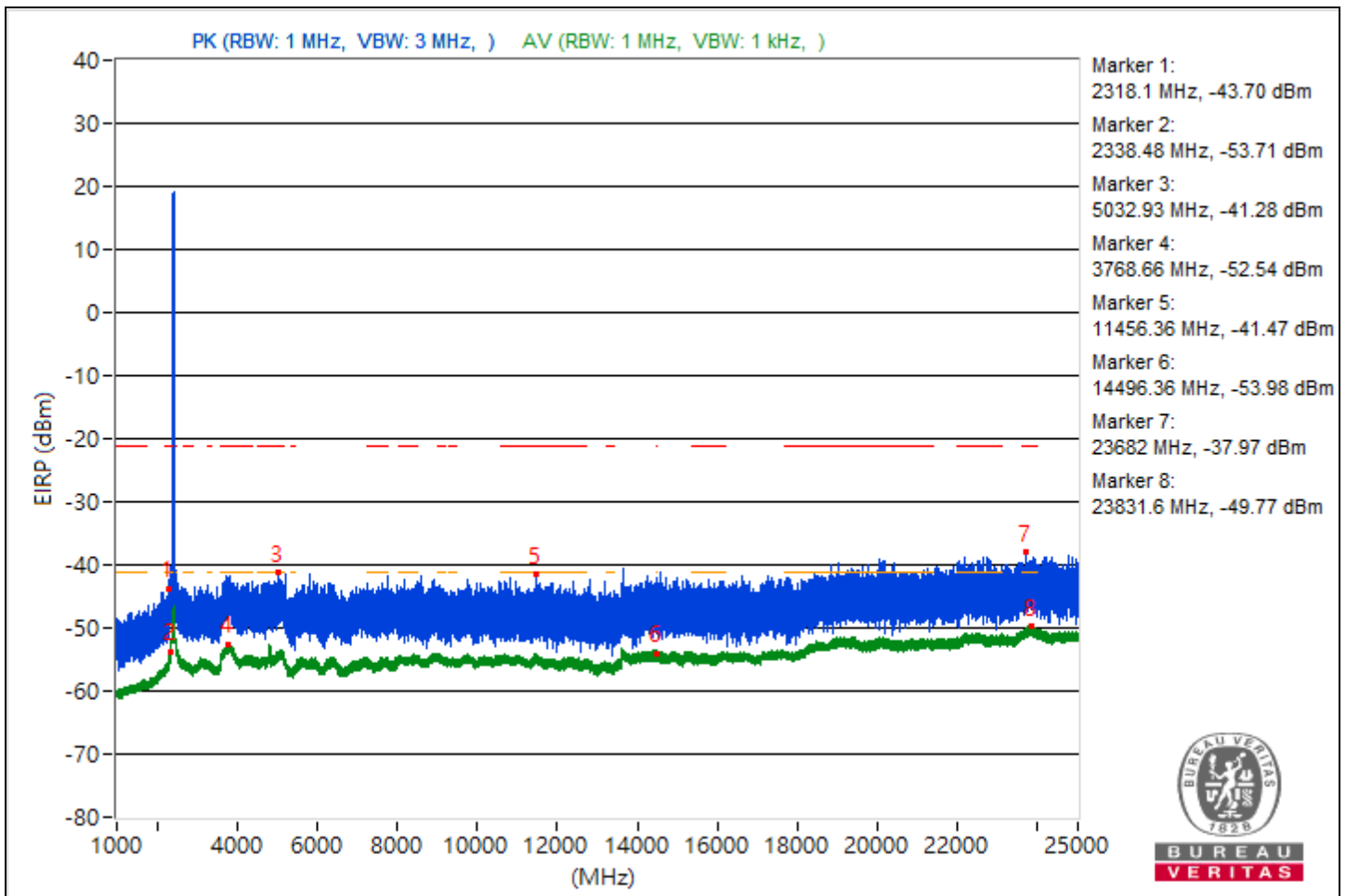

RF Mode	802.11g	Channel	CH 6 : 2437 MHz
Frequency Range	1 GHz ~ 25 GHz	Environmental Conditions	25°C, 76% RH
Tested By	Waydi Tuan		

Conducted Unwanted Emissions							
No.	Frequency (MHz)	Emission Level (dBuV/m)	Limit (dBuV/m)	Margin (dB)	Raw Value Chain 0 (dBm)	Correction Factor (dB)	EIRP Level (dBm)
1	2336.53	51.91 PK	74	-22.09	-48.27	4.92	-43.35
2	2339.88	42.11 AV	54	-11.89	-58.07	4.92	-53.15
3	3807.23	54.59 PK	74	-19.41	-45.59	4.92	-40.67
4	4872.24	42.85 AV	54	-11.15	-57.33	4.92	-52.41
5	14476.44	53.69 PK	74	-20.31	-46.49	4.92	-41.57
6	14472.18	41.55 AV	54	-12.45	-58.63	4.92	-53.71
7	23948.6	56.74 PK	74	-17.26	-43.44	4.92	-38.52
8	23842.9	45.79 AV	54	-8.21	-54.39	4.92	-49.47

Note: Margin value = Emission Level - Limit value

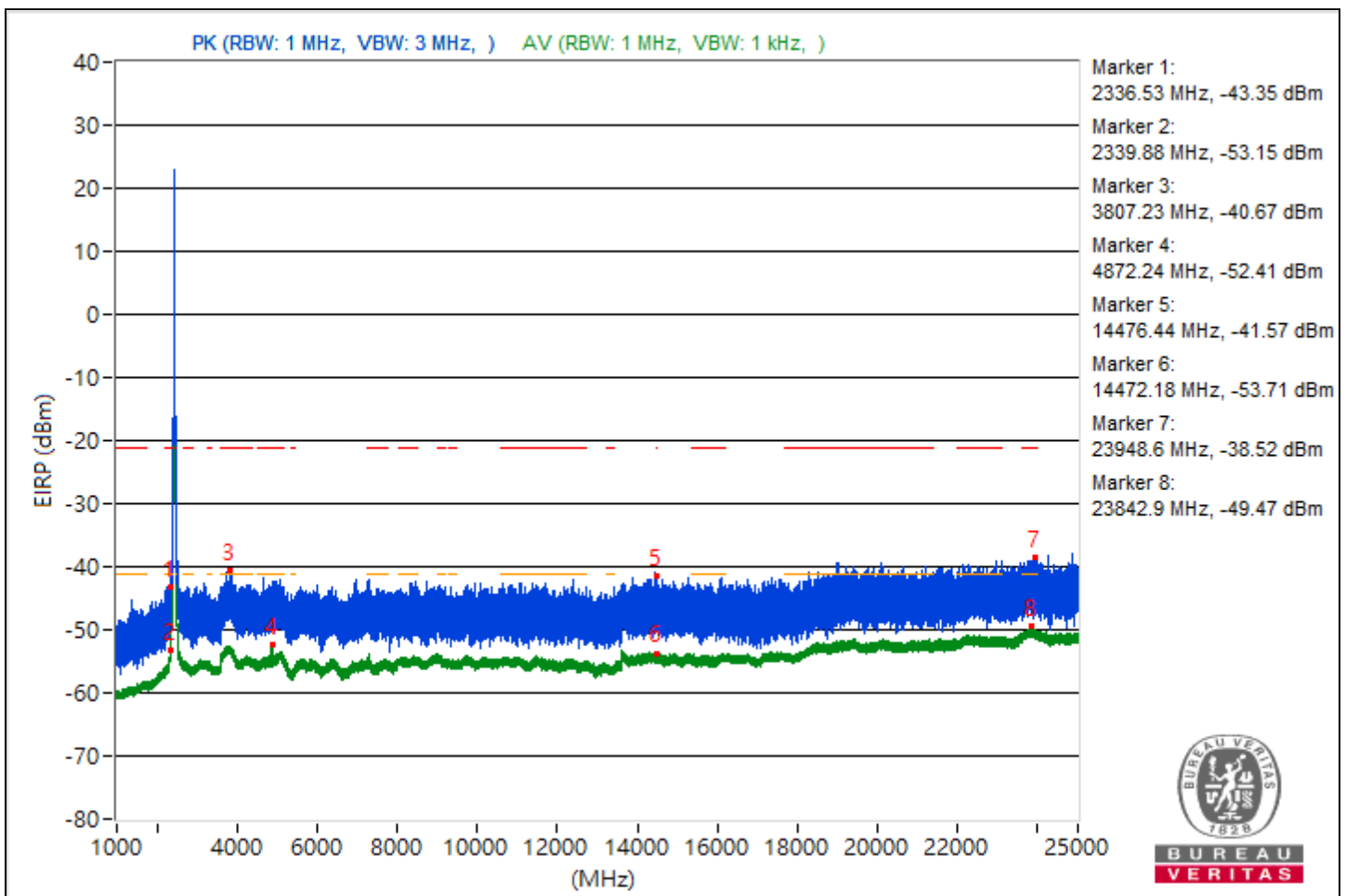

RF Mode	802.11g	Channel	CH 11 : 2462 MHz
Frequency Range	1 GHz ~ 25 GHz	Environmental Conditions	25°C, 76% RH
Tested By	Waydi Tuan		

Conducted Unwanted Emissions							
No.	Frequency (MHz)	Emission Level (dBuV/m)	Limit (dBuV/m)	Margin (dB)	Raw Value Chain 0 (dBm)	Correction Factor (dB)	EIRP Level (dBm)
1	2310.56	52.79 PK	74	-21.21	-47.39	4.92	-42.47
2	2338.63	40.64 AV	54	-13.36	-59.54	4.92	-54.62
3	3731.32	54.15 PK	74	-19.85	-46.03	4.92	-41.11
4	3798.44	42.7 AV	54	-11.3	-57.48	4.92	-52.56
5	8028.36	52.92 PK	74	-21.08	-47.26	4.92	-42.34
6	14494.67	41.43 AV	54	-12.57	-58.75	4.92	-53.83
7	23911.8	57.56 PK	74	-16.44	-42.62	4.92	-37.7
8	23810.4	45.57 AV	54	-8.43	-54.61	4.92	-49.69

Note: Margin value = Emission Level - Limit value

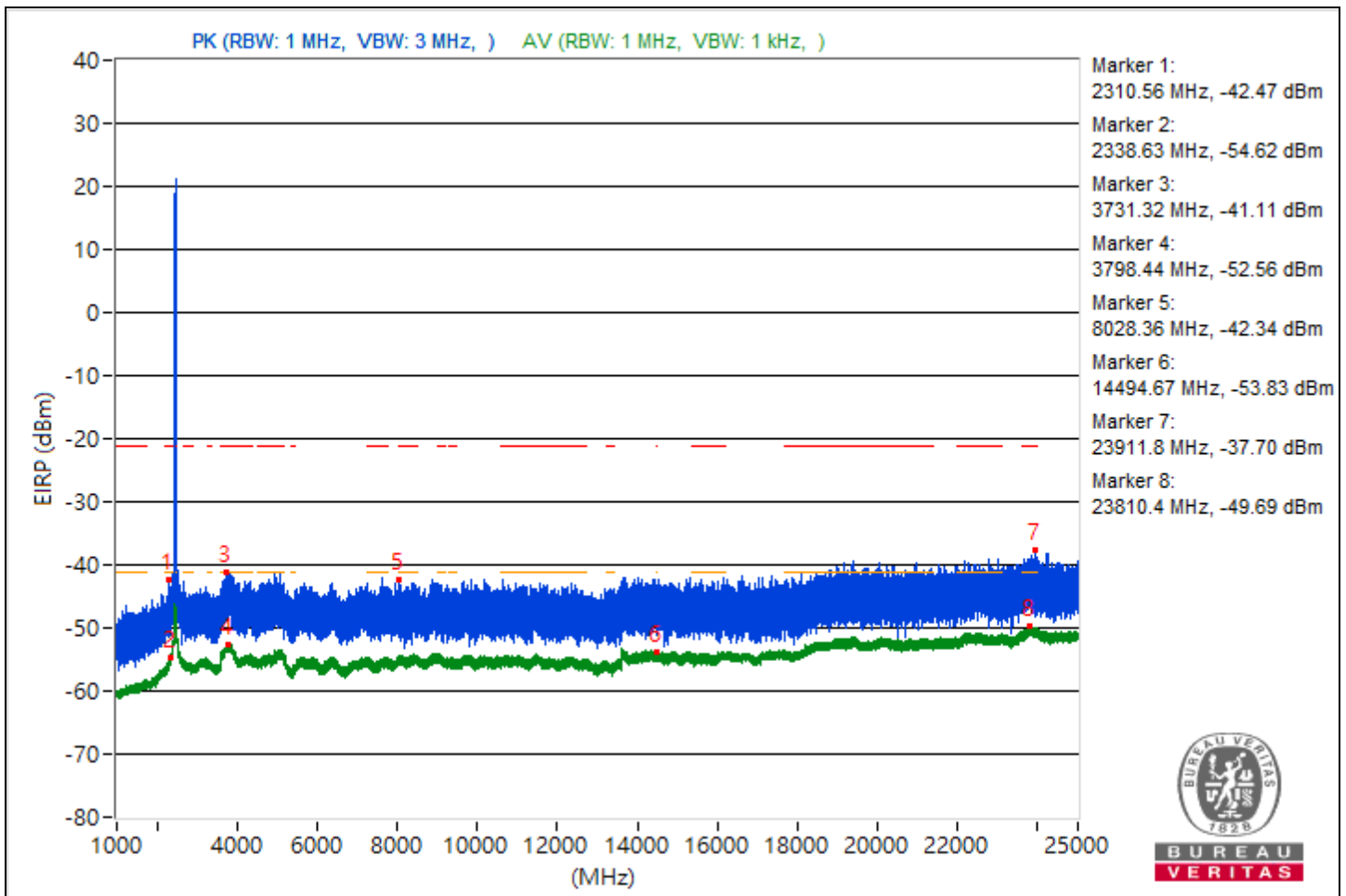



RF Mode	802.11g	Channel	CH 12 : 2467 MHz
Frequency Range	1 GHz ~ 25 GHz	Environmental Conditions	25°C, 76% RH
Tested By	Waydi Tuan		

Conducted Unwanted Emissions							
No.	Frequency (MHz)	Emission Level (dBuV/m)	Limit (dBuV/m)	Margin (dB)	Raw Value Chain 0 (dBm)	Correction Factor (dB)	EIRP Level (dBm)
1	2251.37	52.19 PK	74	-21.81	-47.99	4.92	-43.07
2	2334.2	40.32 AV	54	-13.68	-59.86	4.92	-54.94
3	3738.56	53.91 PK	74	-20.09	-46.27	4.92	-41.35
4	3782.81	42.78 AV	54	-11.22	-57.4	4.92	-52.48
5	8339.02	53.41 PK	74	-20.59	-46.77	4.92	-41.85
6	14474.84	41.44 AV	54	-12.56	-58.74	4.92	-53.82
7	23819	57.3 PK	74	-16.7	-42.88	4.92	-37.96
8	23841	45.54 AV	54	-8.46	-54.64	4.92	-49.72

Note: Margin value = Emission Level - Limit value

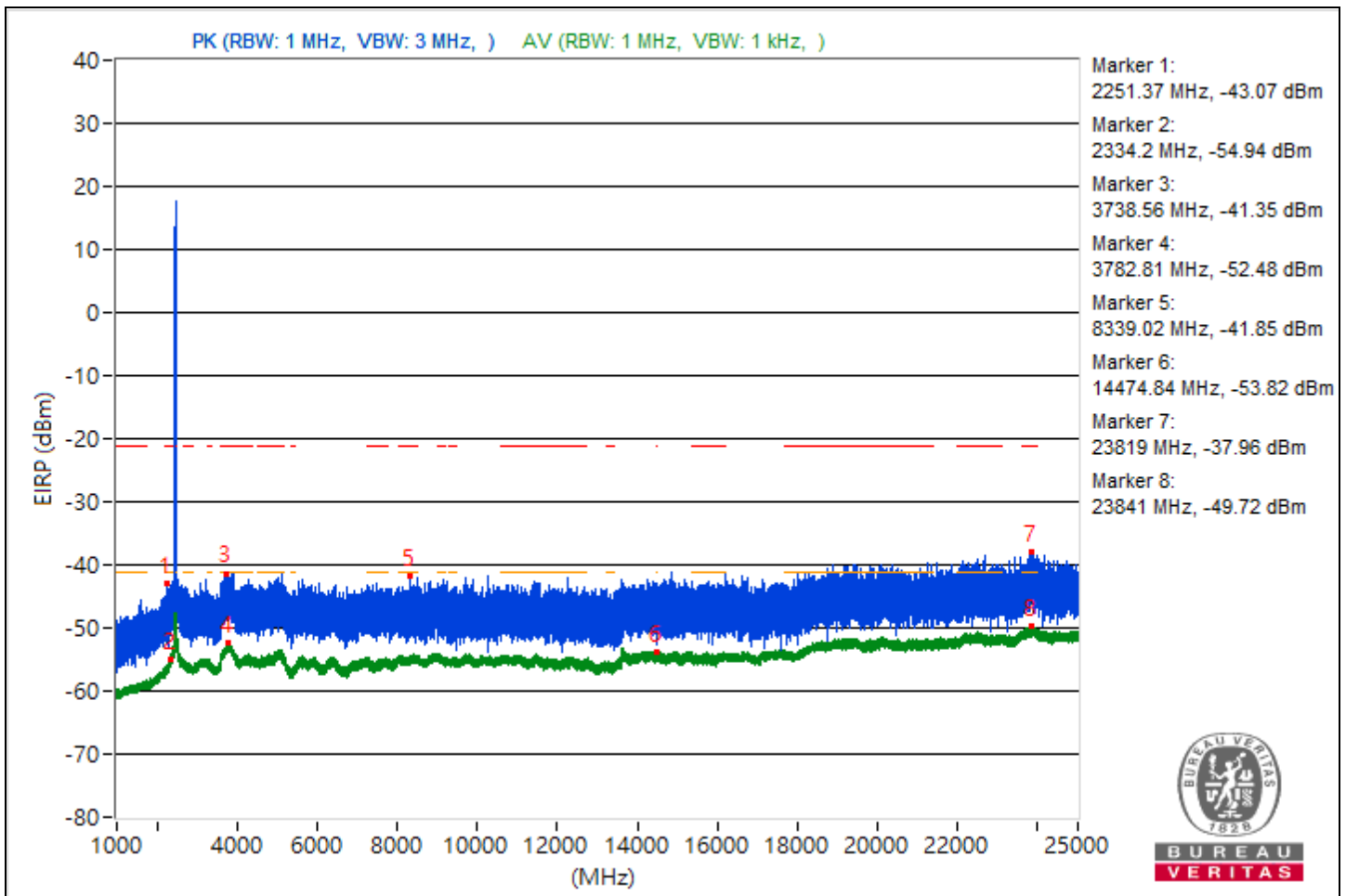



RF Mode	802.11g	Channel	CH 13 : 2472 MHz
Frequency Range	1 GHz ~ 25 GHz	Environmental Conditions	25°C, 76% RH
Tested By	Waydi Tuan		

Conducted Unwanted Emissions							
No.	Frequency (MHz)	Emission Level (dBuV/m)	Limit (dBuV/m)	Margin (dB)	Raw Value Chain 0 (dBm)	Correction Factor (dB)	EIRP Level (dBm)
1	2287.14	50.62 PK	74	-23.38	-49.56	4.92	-44.64
2	2338.4	40.18 AV	54	-13.82	-60	4.92	-55.08
3	3741.98	54.57 PK	74	-19.43	-45.61	4.92	-40.69
4	3835.39	42.9 AV	54	-11.1	-57.28	4.92	-52.36
5	11582.93	52.83 PK	74	-21.17	-47.35	4.92	-42.43
6	14495.56	41.39 AV	54	-12.61	-58.79	4.92	-53.87
7	23883.8	57.49 PK	74	-16.51	-42.69	4.92	-37.77
8	23799.5	45.56 AV	54	-8.44	-54.62	4.92	-49.7

Note: Margin value = Emission Level - Limit value

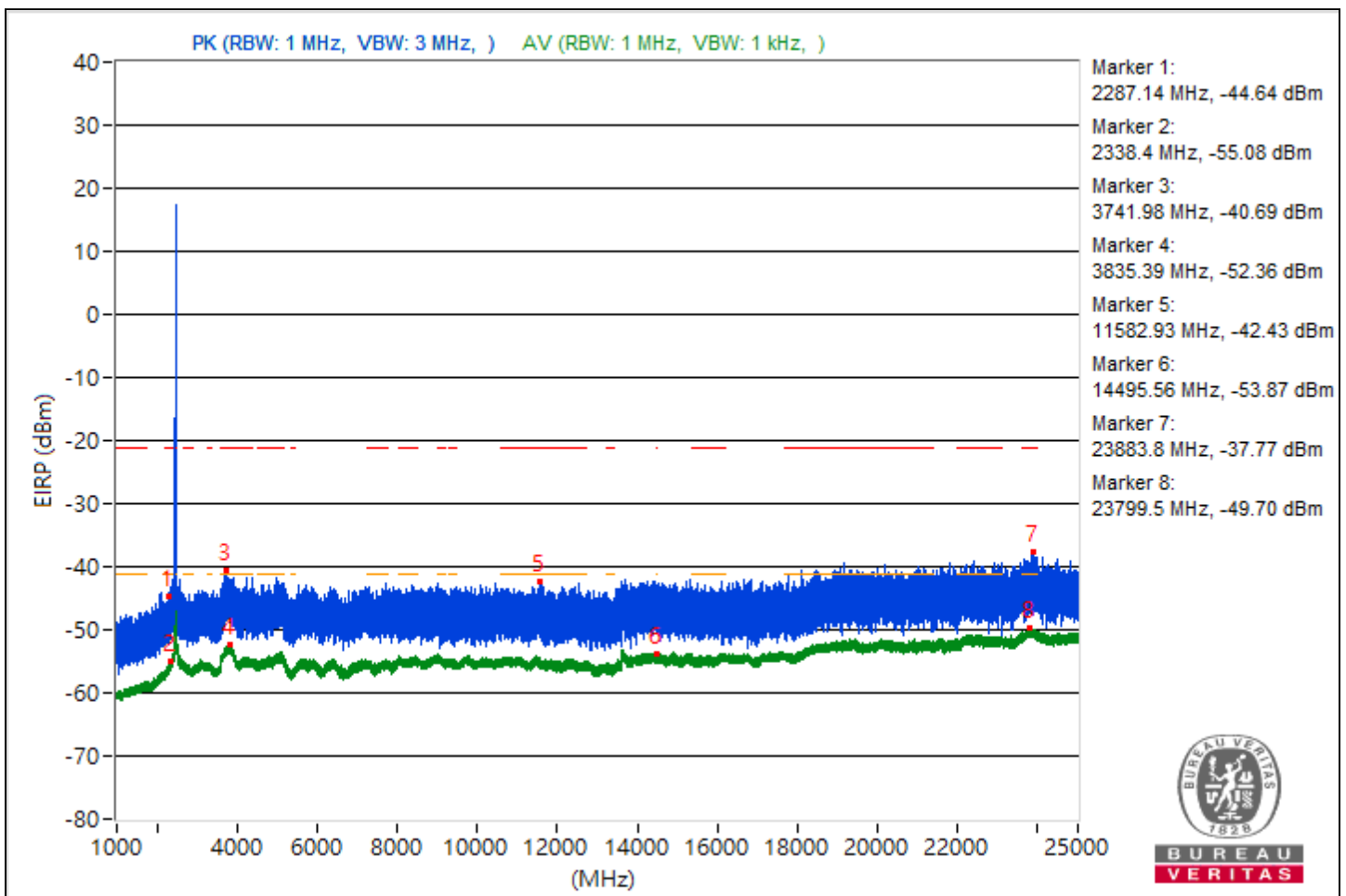

## Conducted Band Edges

RF Mode	802.11b	Channel	CH 1 : 2412 MHz
Frequency Range	2.31 GHz ~ 2.5 GHz	Environmental Conditions	25°C, 76% RH
Tested By	Waydi Tuan		

Conducted Band Edge							
No.	Frequency (MHz)	Emission Level (dBuV/m)	Limit (dBuV/m)	Margin (dB)	Raw Value Chain 0 (dBm)	Correction Factor (dB)	EIRP Level (dBm)
1	*2413.03	115.58 PK			17.14	3.18	20.32
2	*2411.18	112.58 AV			14.14	3.18	17.32
3	2388.09	59.98 PK	74	-14.02	-38.46	3.18	-35.28
4	2381.53	49.21 AV	54	-4.79	-49.23	3.18	-46.05
5	2494.49	59.35 PK	74	-14.65	-39.09	3.18	-35.91
6	2486.03	46.34 AV	54	-7.66	-52.1	3.18	-48.92

Notes:

1. Margin value = Emission Level - Limit value
2. " \* " : Fundamental frequency, the limit was restricted at the RF Output Power.

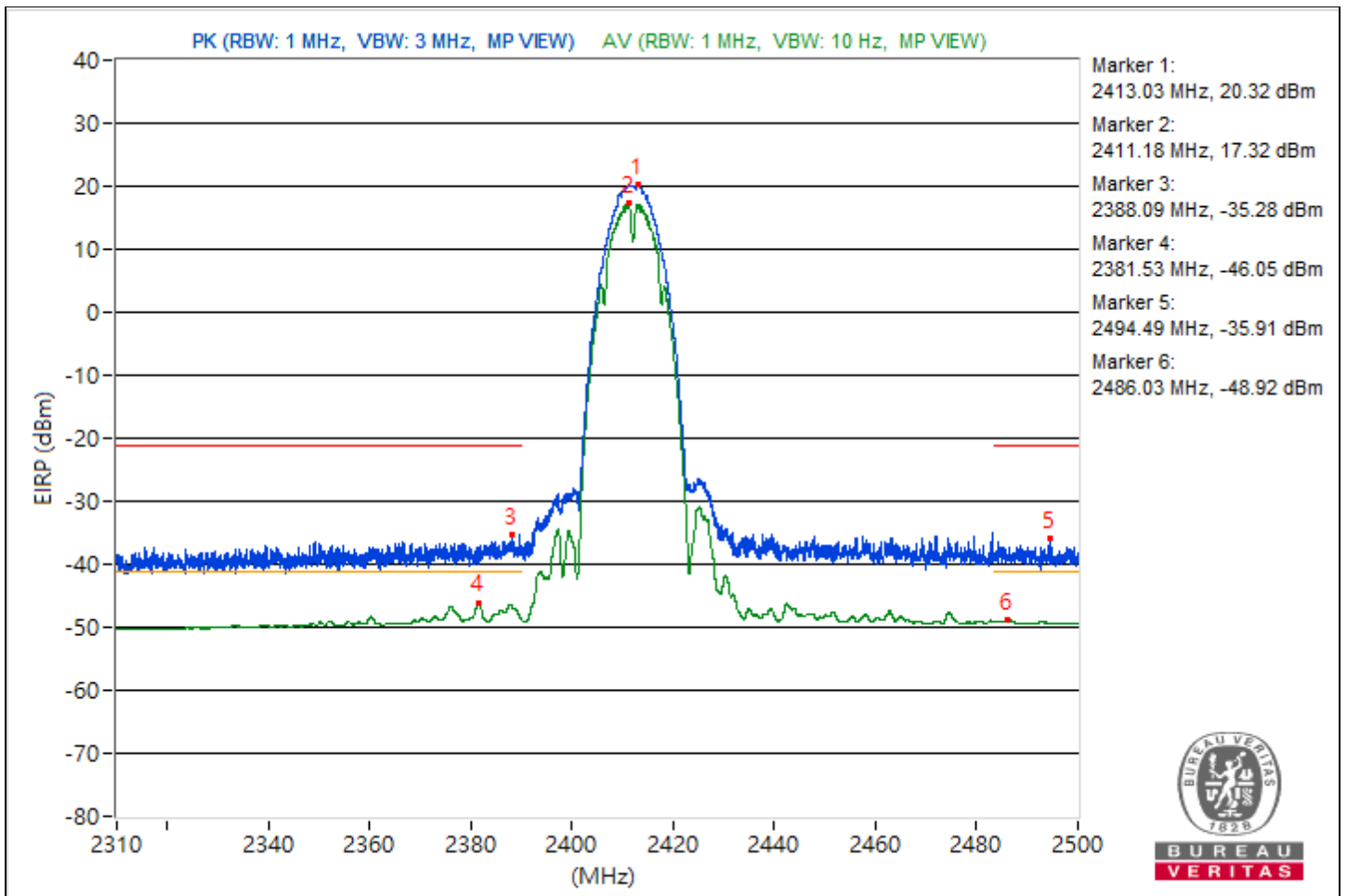



RF Mode	802.11b	Channel	CH 6 : 2437 MHz
Frequency Range	2.31 GHz ~ 2.5 GHz	Environmental Conditions	25°C, 76% RH
Tested By	Waydi Tuan		

Conducted Band Edge							
No.	Frequency (MHz)	Emission Level (dBuV/m)	Limit (dBuV/m)	Margin (dB)	Raw Value Chain 0 (dBm)	Correction Factor (dB)	EIRP Level (dBm)
1	*2436.23	116.14 PK			17.7	3.18	20.88
2	*2436.21	113.2 AV			14.76	3.18	17.94
3	2354.74	59.27 PK	74	-14.73	-39.17	3.18	-35.99
4	2388.14	47.12 AV	54	-6.88	-51.32	3.18	-48.14
5	2499.53	58.91 PK	74	-15.09	-39.53	3.18	-36.35
6	2485.89	47.86 AV	54	-6.14	-50.58	3.18	-47.4

Notes:

1. Margin value = Emission Level - Limit value
2. " \* " : Fundamental frequency, the limit was restricted at the RF Output Power.

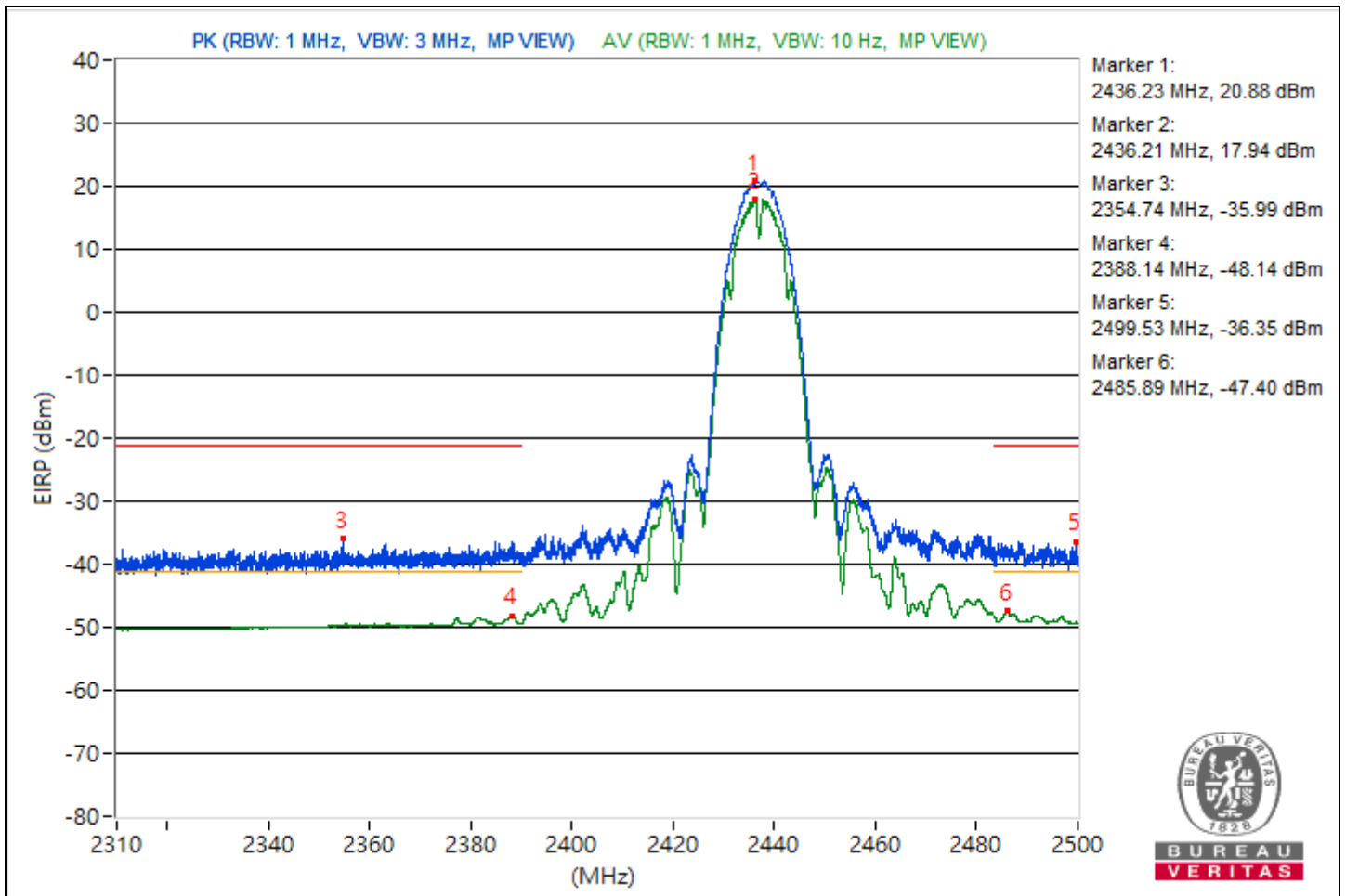

RF Mode	802.11b	Channel	CH 11 : 2462 MHz
Frequency Range	2.31 GHz ~ 2.5 GHz	Environmental Conditions	25°C, 76% RH
Tested By	Waydi Tuan		

Conducted Band Edge							
No.	Frequency (MHz)	Emission Level (dBuV/m)	Limit (dBuV/m)	Margin (dB)	Raw Value Chain 0 (dBm)	Correction Factor (dB)	EIRP Level (dBm)
1	*2461.19	115.6 PK			17.16	3.18	20.34
2	*2461.29	112.61 AV			14.17	3.18	17.35
3	2386.33	58.96 PK	74	-15.04	-39.48	3.18	-36.3
4	2389.04	46.12 AV	54	-7.88	-52.32	3.18	-49.14
5	2485.82	60.96 PK	74	-13.04	-37.48	3.18	-34.3
6	2486.06	49.98 AV	54	-4.02	-48.46	3.18	-45.28

Notes:

1. Margin value = Emission Level - Limit value
2. " \* " : Fundamental frequency, the limit was restricted at the RF Output Power.

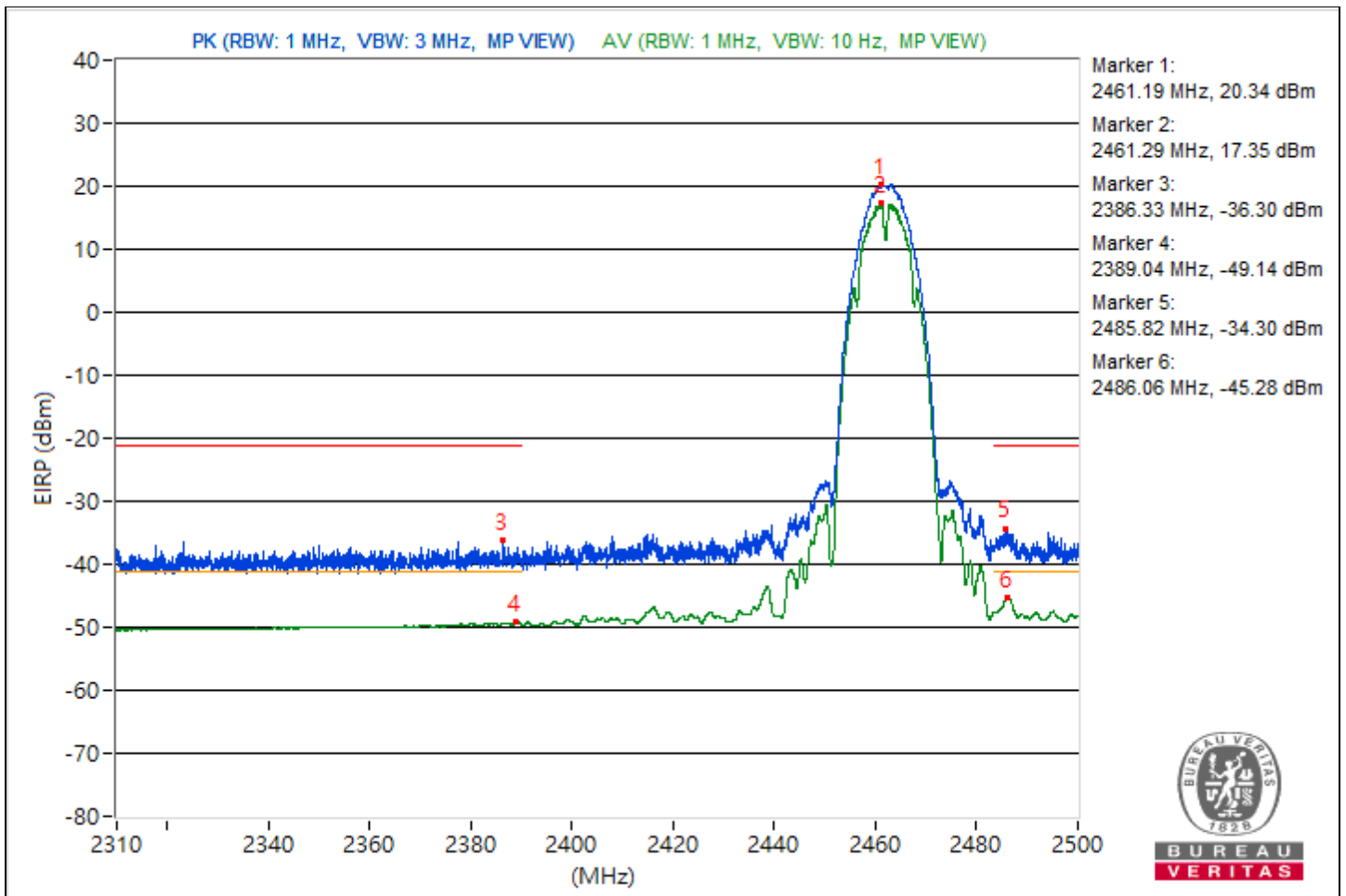

RF Mode	802.11b	Channel	CH 12 : 2467 MHz
Frequency Range	2.31 GHz ~ 2.5 GHz	Environmental Conditions	25°C, 76% RH
Tested By	Waydi Tuan		

Conducted Band Edge							
No.	Frequency (MHz)	Emission Level (dBuV/m)	Limit (dBuV/m)	Margin (dB)	Raw Value Chain 0 (dBm)	Correction Factor (dB)	EIRP Level (dBm)
1	*2466.18	112.43 PK			13.99	3.18	17.17
2	*2466.18	109.49 AV			11.05	3.18	14.23
3	2378.02	58.96 PK	74	-15.04	-39.48	3.18	-36.3
4	2388.16	45.47 AV	54	-8.53	-52.97	3.18	-49.79
5	2483.99	60.74 PK	74	-13.26	-37.7	3.18	-34.52
6	2483.68	51.48 AV	54	-2.52	-46.96	3.18	-43.78

Notes:

1. Margin value = Emission Level - Limit value
2. " \* " : Fundamental frequency, the limit was restricted at the RF Output Power.

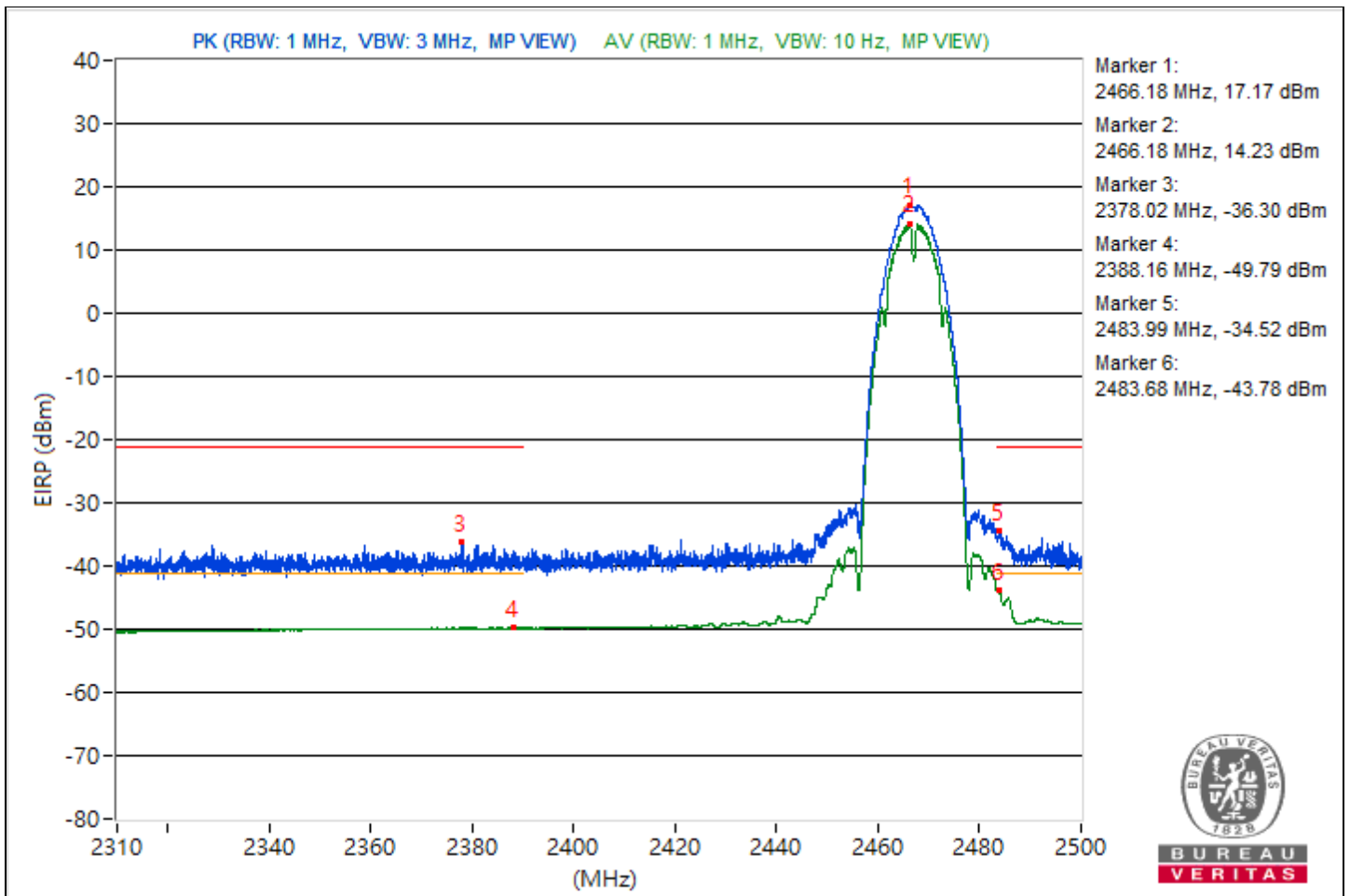

RF Mode	802.11b	Channel	CH 13 : 2472 MHz
Frequency Range	2.31 GHz ~ 2.5 GHz	Environmental Conditions	25°C, 76% RH
Tested By	Waydi Tuan		

Conducted Band Edge							
No.	Frequency (MHz)	Emission Level (dBuV/m)	Limit (dBuV/m)	Margin (dB)	Raw Value Chain 0 (dBm)	Correction Factor (dB)	EIRP Level (dBm)
1	*2471.22	108.13 PK			9.69	3.18	12.87
2	*2471.22	105.32 AV			6.88	3.18	10.06
3	2330.02	58.18 PK	74	-15.82	-40.26	3.18	-37.08
4	2384.98	45.43 AV	54	-8.57	-53.01	3.18	-49.83
5	2483.78	61.81 PK	74	-12.19	-36.63	3.18	-33.45
6	2483.78	53.84 AV	54	-0.16	-44.6	3.18	-41.42

Notes:

1. Margin value = Emission Level - Limit value
2. " \* " : Fundamental frequency, the limit was restricted at the RF Output Power.

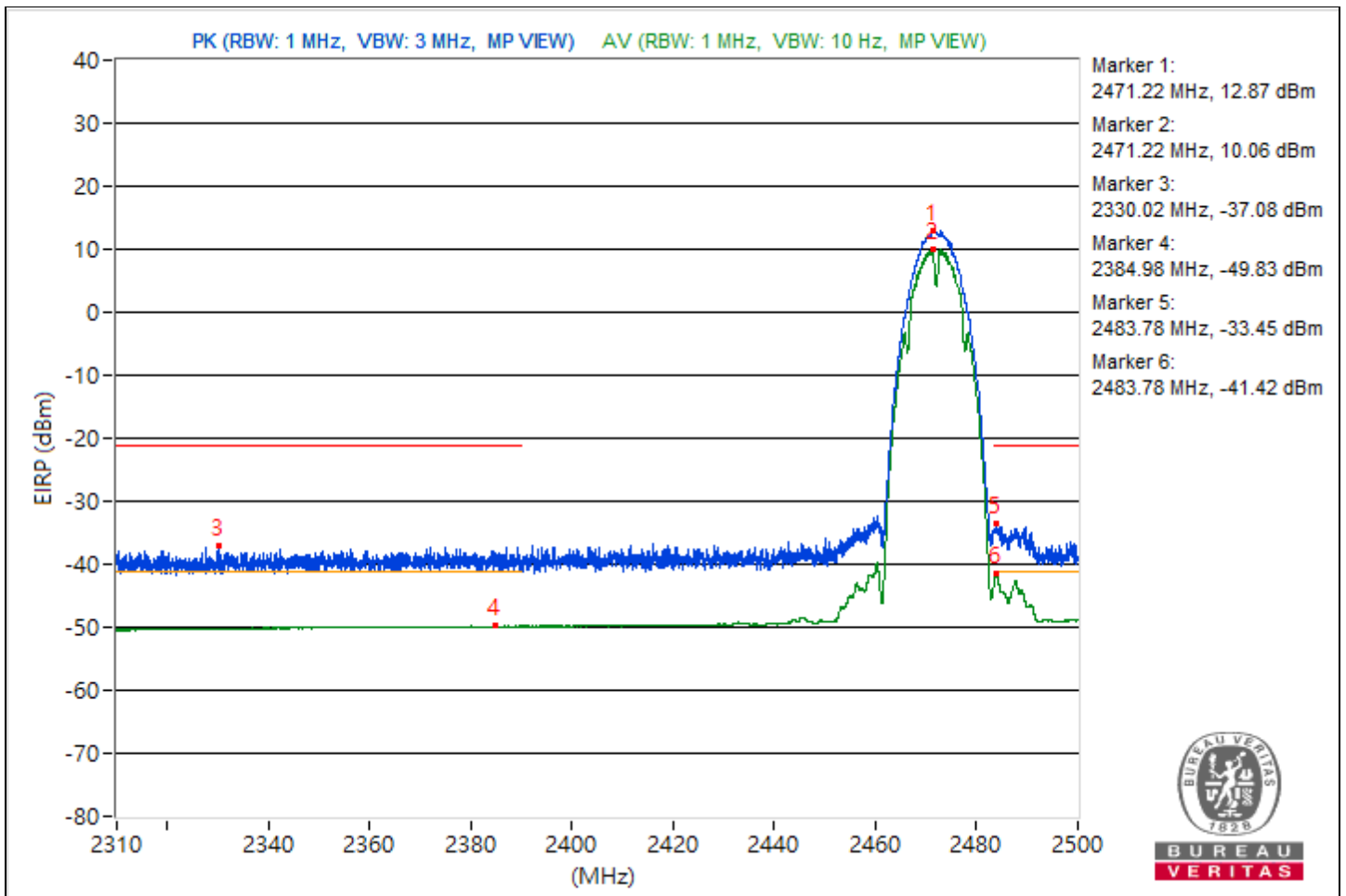



RF Mode	802.11g	Channel	CH 1 : 2412 MHz
Frequency Range	2.31 GHz ~ 2.5 GHz	Environmental Conditions	25°C, 76% RH
Tested By	Waydi Tuan		

Conducted Band Edge							
No.	Frequency (MHz)	Emission Level (dBuV/m)	Limit (dBuV/m)	Margin (dB)	Raw Value Chain 0 (dBm)	Correction Factor (dB)	EIRP Level (dBm)
1	*2410.49	114.56 PK			16.12	3.18	19.3
2	*2410.53	103.74 AV			5.3	3.18	8.48
3	2382.56	61.89 PK	74	-12.11	-36.55	3.18	-33.37
4	2389.68	48.9 AV	54	-5.1	-49.54	3.18	-46.36
5	2490.86	58.46 PK	74	-15.54	-39.98	3.18	-36.8
6	2489.84	46.52 AV	54	-7.48	-51.92	3.18	-48.74

Notes:

1. Margin value = Emission Level - Limit value
2. " \* " : Fundamental frequency, the limit was restricted at the RF Output Power.

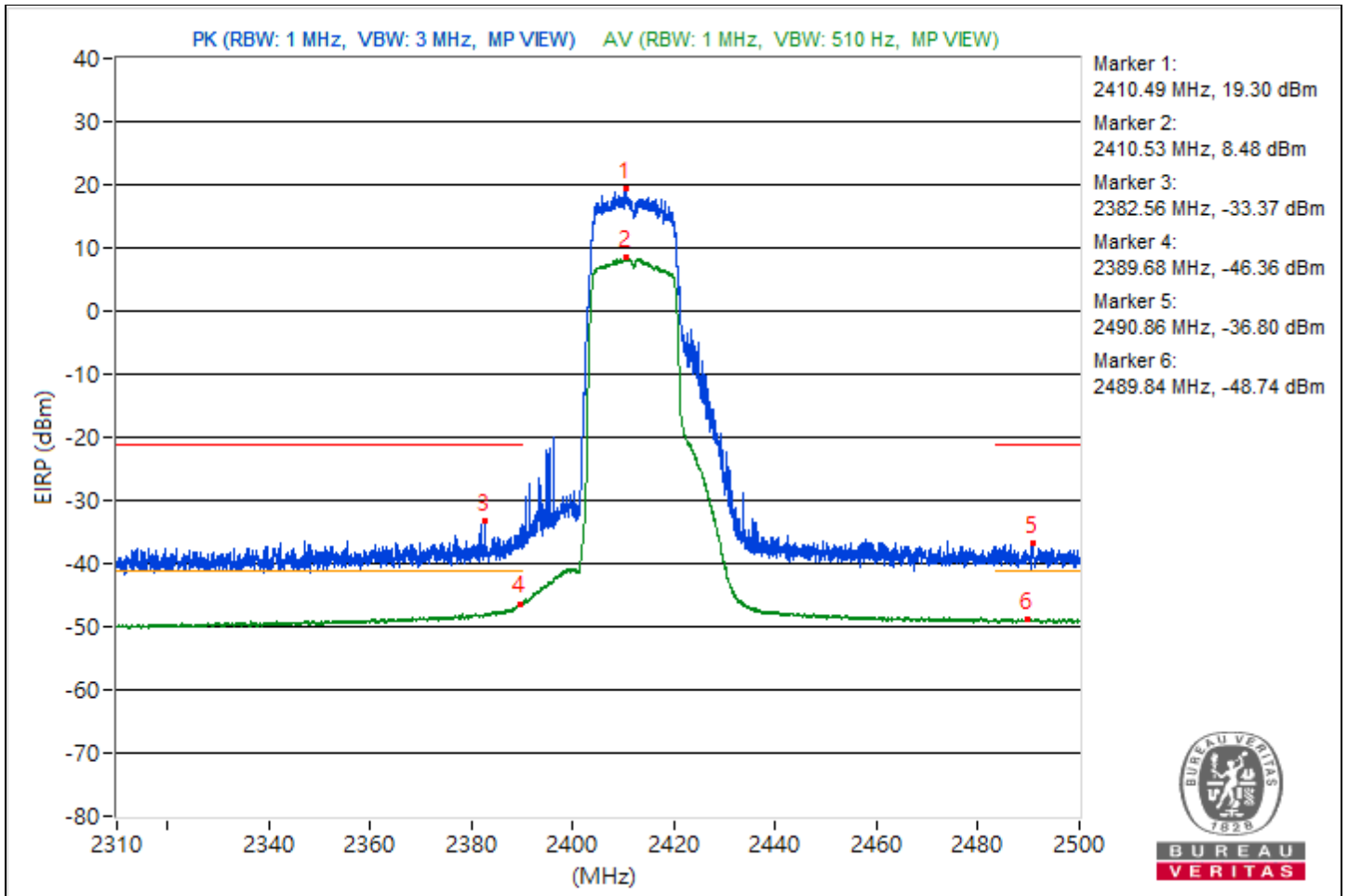

RF Mode	802.11g	Channel	CH 6 : 2437 MHz
Frequency Range	2.31 GHz ~ 2.5 GHz	Environmental Conditions	25°C, 76% RH
Tested By	Waydi Tuan		

Conducted Band Edge							
No.	Frequency (MHz)	Emission Level (dBuV/m)	Limit (dBuV/m)	Margin (dB)	Raw Value Chain 0 (dBm)	Correction Factor (dB)	EIRP Level (dBm)
1	*2436.4	117.96 PK			19.52	3.18	22.7
2	*2436.21	107.33 AV			8.89	3.18	12.07
3	2389.94	70.43 PK	74	-3.57	-28.01	3.18	-24.83
4	2389.42	50.97 AV	54	-3.03	-47.47	3.18	-44.29
5	2485.28	70.3 PK	74	-3.7	-28.14	3.18	-24.96
6	2484.49	51.2 AV	54	-2.8	-47.24	3.18	-44.06

Notes:

1. Margin value = Emission Level - Limit value
2. " \* " : Fundamental frequency, the limit was restricted at the RF Output Power.

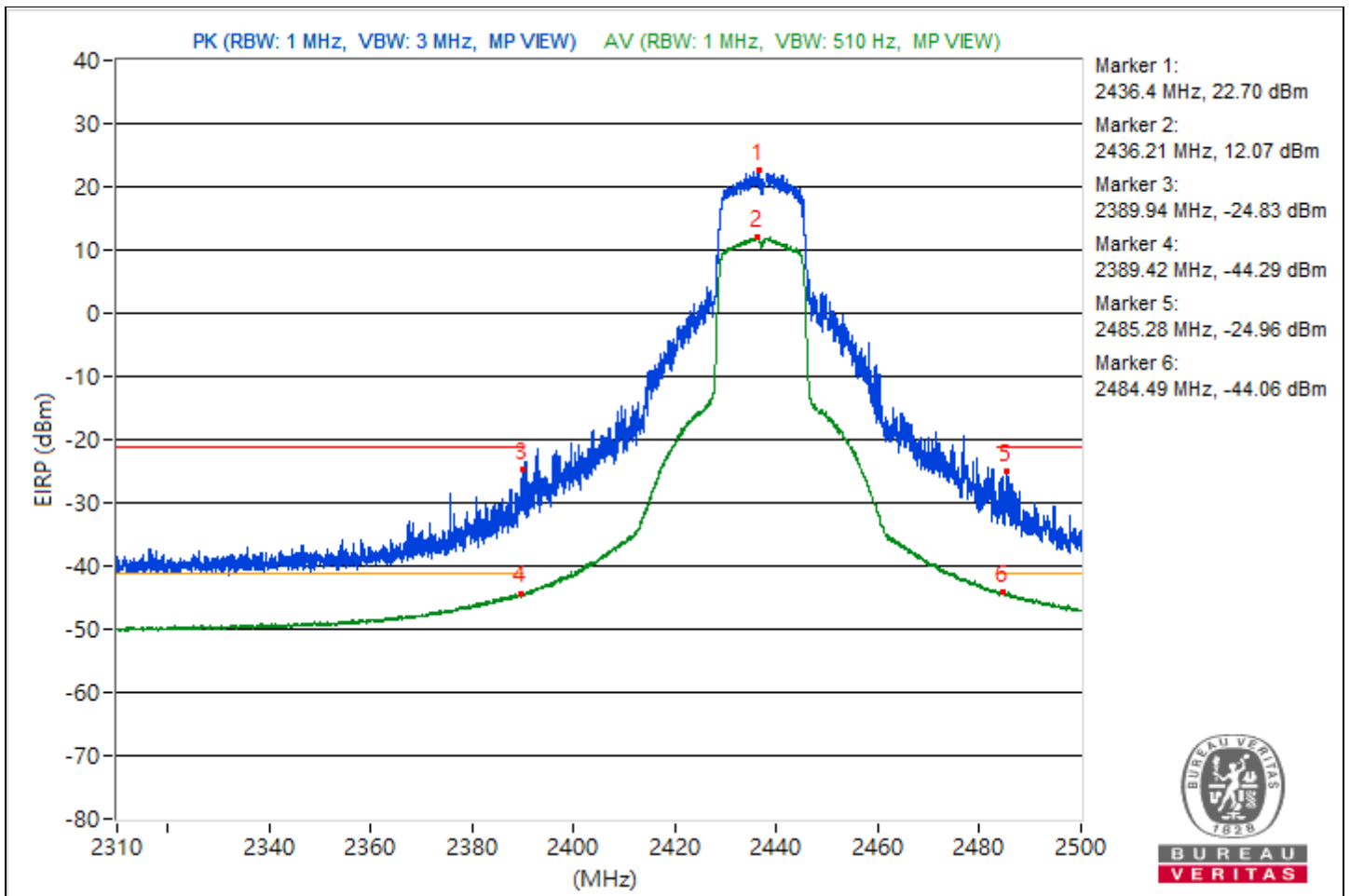

RF Mode	802.11g	Channel	CH 11 : 2462 MHz
Frequency Range	2.31 GHz ~ 2.5 GHz	Environmental Conditions	25°C, 76% RH
Tested By	Waydi Tuan		

Conducted Band Edge							
No.	Frequency (MHz)	Emission Level (dBuV/m)	Limit (dBuV/m)	Margin (dB)	Raw Value Chain 0 (dBm)	Correction Factor (dB)	EIRP Level (dBm)
1	*2465.16	115.83 PK			17.39	3.18	20.57
2	*2463	104.42 AV			5.98	3.18	9.16
3	2388.87	59.02 PK	74	-14.98	-39.42	3.18	-36.24
4	2385.83	46.18 AV	54	-7.82	-52.26	3.18	-49.08
5	2483.97	62.71 PK	74	-11.29	-35.73	3.18	-32.55
6	2483.5	48.73 AV	54	-5.27	-49.71	3.18	-46.53

Notes:

1. Margin value = Emission Level - Limit value
2. " \* " : Fundamental frequency, the limit was restricted at the RF Output Power.

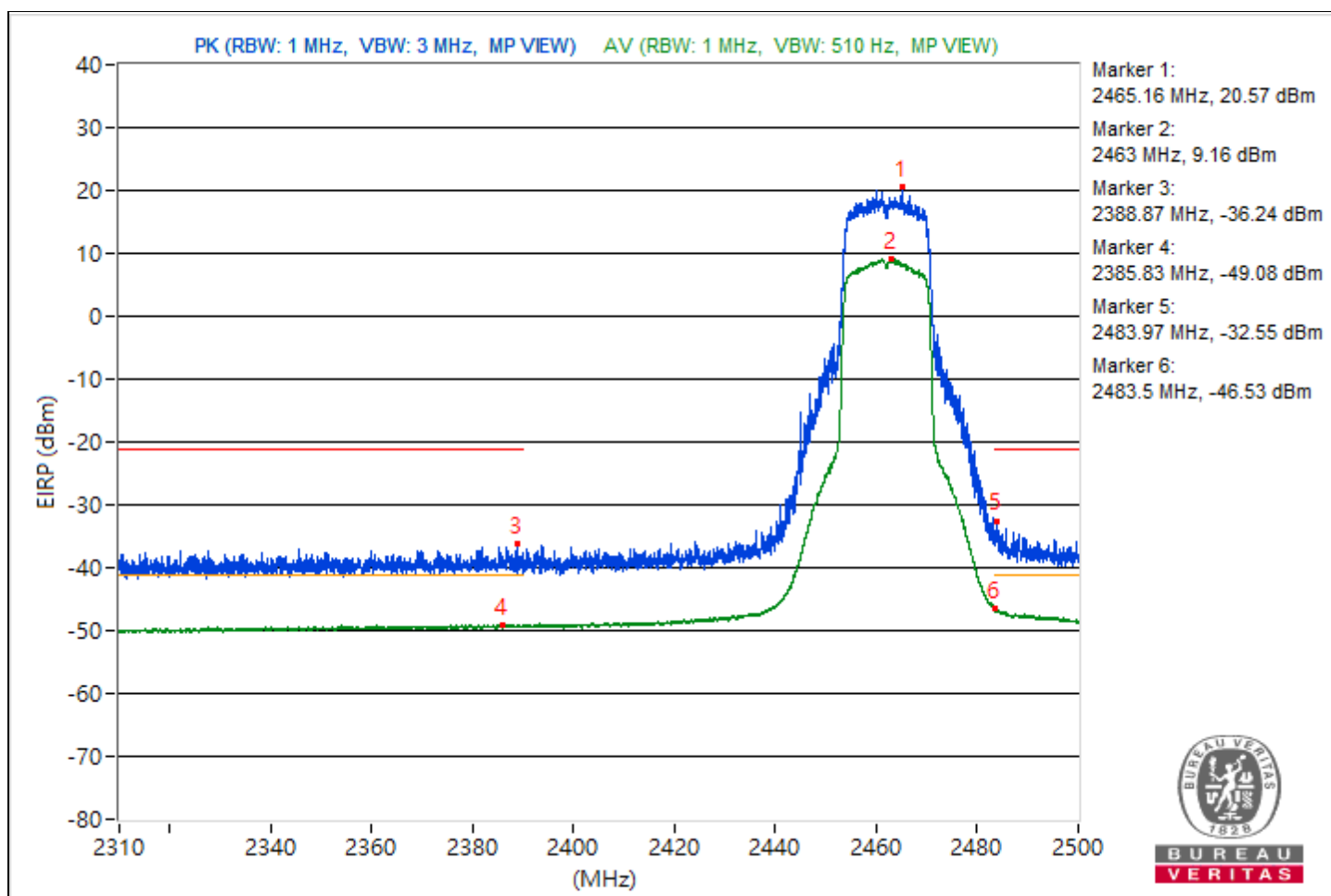



RF Mode	802.11g	Channel	CH 12 : 2467 MHz
Frequency Range	2.31 GHz ~ 2.5 GHz	Environmental Conditions	25°C, 76% RH
Tested By	Waydi Tuan		

Conducted Band Edge							
No.	Frequency (MHz)	Emission Level (dBuV/m)	Limit (dBuV/m)	Margin (dB)	Raw Value Chain 0 (dBm)	Correction Factor (dB)	EIRP Level (dBm)
1	*2469.01	112.85 PK			14.41	3.18	17.59
2	*2465.32	102.77 AV			4.33	3.18	7.51
3	2360.45	58.35 PK	74	-15.65	-40.09	3.18	-36.91
4	2389.11	46.11 AV	54	-7.89	-52.33	3.18	-49.15
5	2483.57	61.39 PK	74	-12.61	-37.05	3.18	-33.87
6	2483.8	49.29 AV	54	-4.71	-49.15	3.18	-45.97

Notes:

- Margin value = Emission Level - Limit value
- " \* " : Fundamental frequency, the limit was restricted at the RF Output Power.

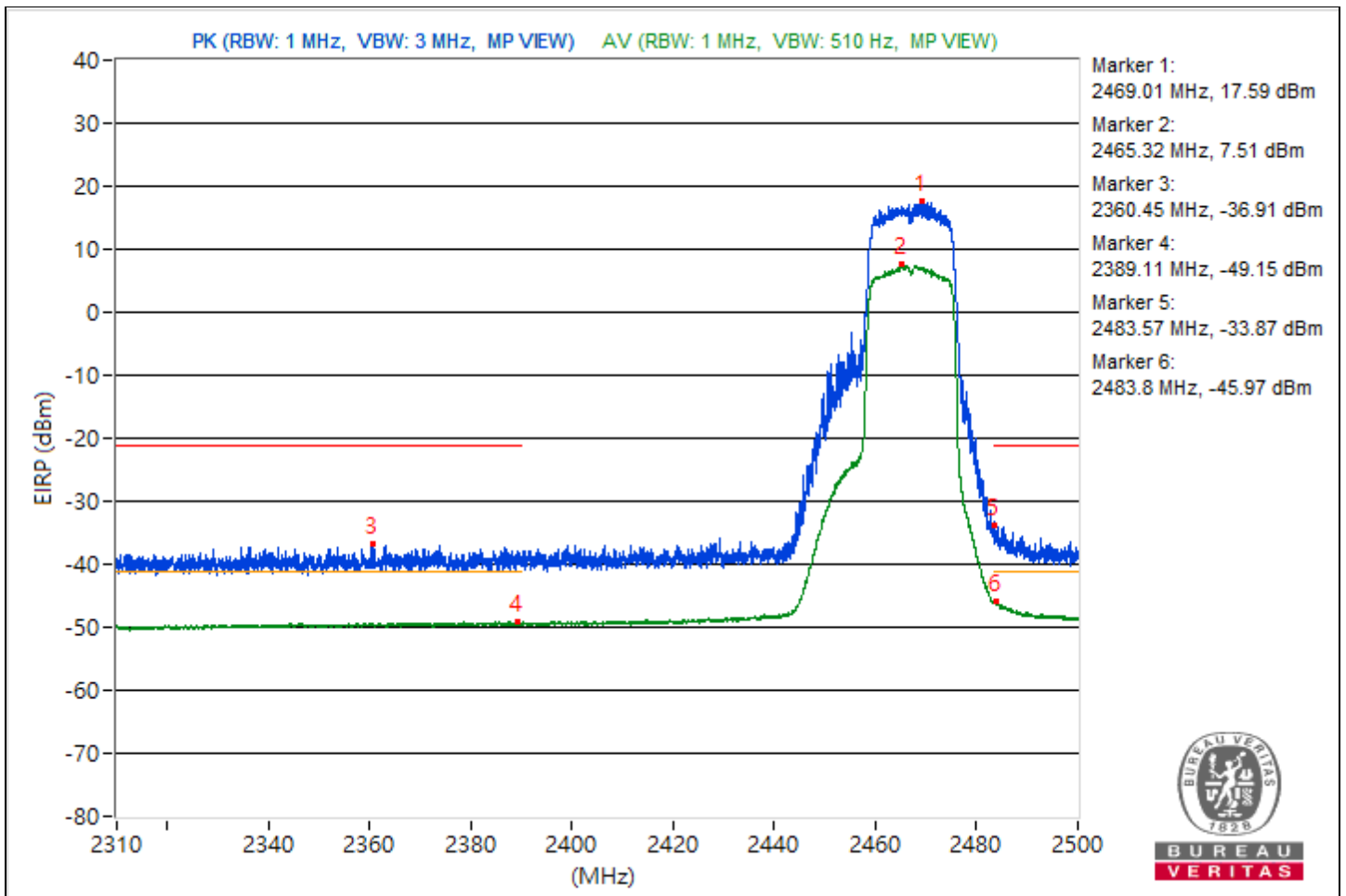



RF Mode	802.11g	Channel	CH 13 : 2472 MHz
Frequency Range	2.31 GHz ~ 2.5 GHz	Environmental Conditions	25°C, 76% RH
Tested By	Waydi Tuan		

Conducted Band Edge							
No.	Frequency (MHz)	Emission Level (dBuV/m)	Limit (dBuV/m)	Margin (dB)	Raw Value Chain 0 (dBm)	Correction Factor (dB)	EIRP Level (dBm)
1	*2475.01	111.77 PK			13.33	3.18	16.51
2	*2472.97	101.1 AV			2.66	3.18	5.84
3	2383.84	58.39 PK	74	-15.61	-40.05	3.18	-36.87
4	2389.44	46.01 AV	54	-7.99	-52.43	3.18	-49.25
5	2489.74	63.09 PK	74	-10.91	-35.35	3.18	-32.17
6	2483.5	49.54 AV	54	-4.46	-48.9	3.18	-45.72

Notes:

1. Margin value = Emission Level - Limit value
2. " \* " : Fundamental frequency, the limit was restricted at the RF Output Power.

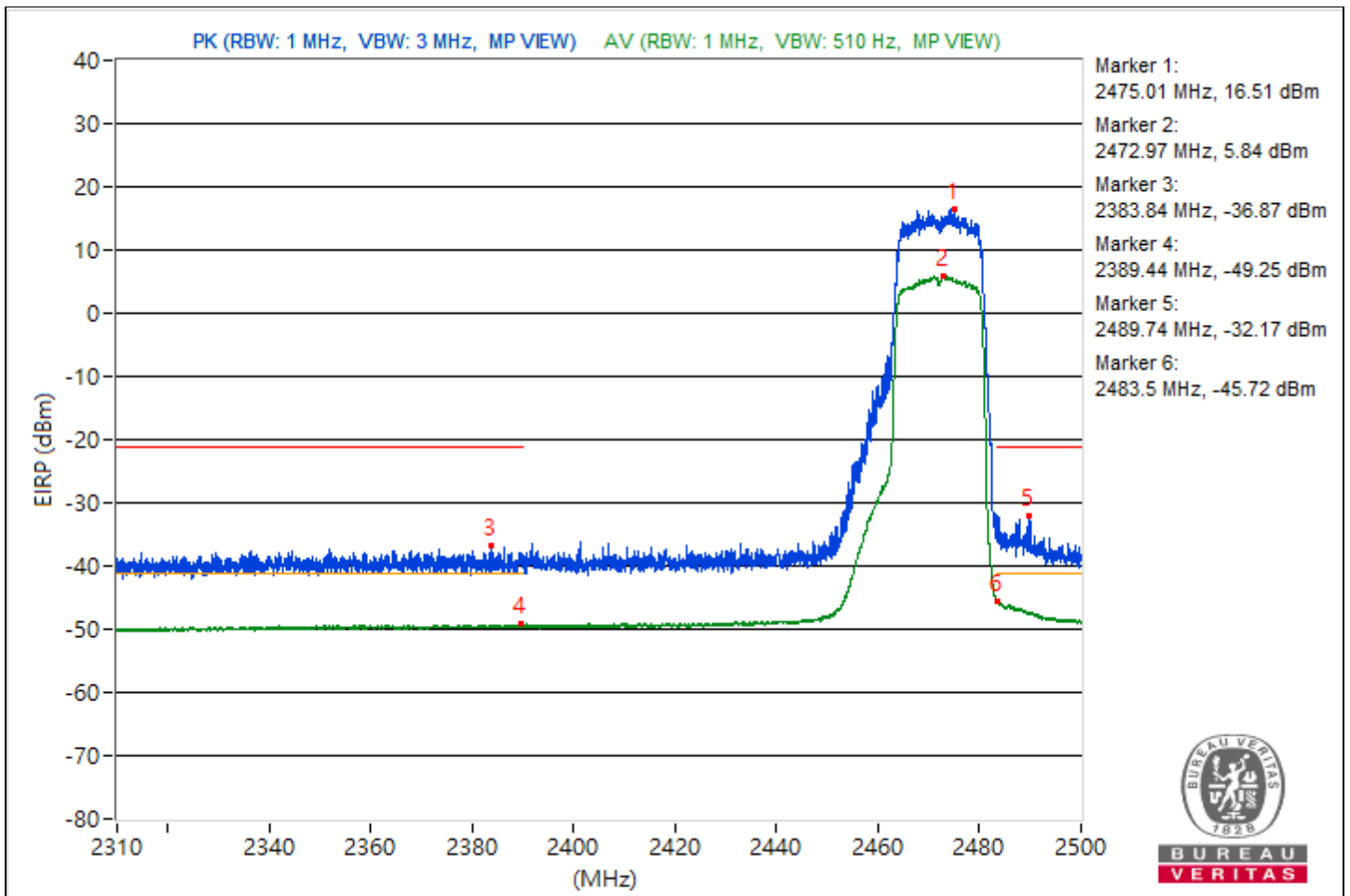

For 1S1T

Conducted Unwanted Emissions

RF Mode	802.11be (EHT20)	Channel	CH 1 : 2412 MHz
Frequency Range	1 GHz ~ 25 GHz	Environmental Conditions	25°C, 76% RH
Tested By	Waydi Tuan		

Conducted Unwanted Emissions							
No.	Frequency (MHz)	Emission Level (dBuV/m)	Limit (dBuV/m)	Margin (dB)	Raw Value Chain 0 (dBm)	Correction Factor (dB)	EIRP Level (dBm)
1	2335.21	52.44 PK	74	-21.56	-47.74	4.92	-42.82
2	2337.39	41.47 AV	54	-12.53	-58.71	4.92	-53.79
3	3839.98	53.58 PK	74	-20.42	-46.6	4.92	-41.68
4	3799.07	42.72 AV	54	-11.28	-57.46	4.92	-52.54
5	8419.73	53.27 PK	74	-20.73	-46.91	4.92	-41.99
6	14481.33	41.58 AV	54	-12.42	-58.6	4.92	-53.68
7	23735.6	57.05 PK	74	-16.95	-43.13	4.92	-38.21
8	23824.6	45.55 AV	54	-8.45	-54.63	4.92	-49.71

Note: Margin value = Emission Level - Limit value

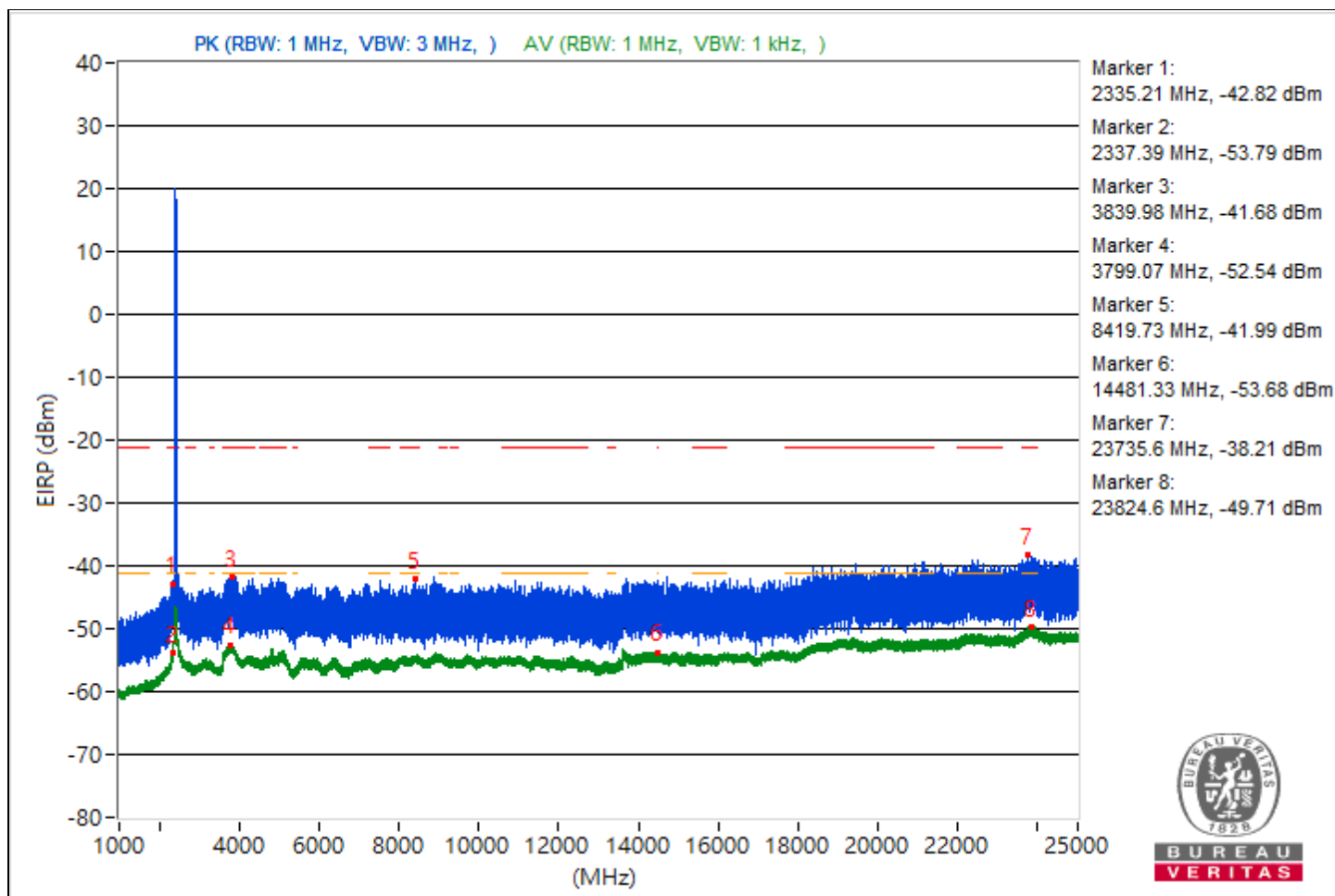

RF Mode	802.11be (EHT20)	Channel	CH 6 : 2437 MHz
Frequency Range	1 GHz ~ 25 GHz	Environmental Conditions	25°C, 76% RH
Tested By	Waydi Tuan		

Conducted Unwanted Emissions							
No.	Frequency (MHz)	Emission Level (dBuV/m)	Limit (dBuV/m)	Margin (dB)	Raw Value Chain 0 (dBm)	Correction Factor (dB)	EIRP Level (dBm)
1	2242.34	52.54 PK	74	-21.46	-47.64	4.92	-42.72
2	2337.54	41.94 AV	54	-12.06	-58.24	4.92	-53.32
3	3729.46	54.07 PK	74	-19.93	-46.11	4.92	-41.19
4	3856.78	42.64 AV	54	-11.36	-57.54	4.92	-52.62
5	12310.58	52.67 PK	74	-21.33	-47.51	4.92	-42.59
6	14494.31	41.48 AV	54	-12.52	-58.7	4.92	-53.78
7	23855.7	56.86 PK	74	-17.14	-43.32	4.92	-38.4
8	23804	45.51 AV	54	-8.49	-54.67	4.92	-49.75

Note: Margin value = Emission Level - Limit value

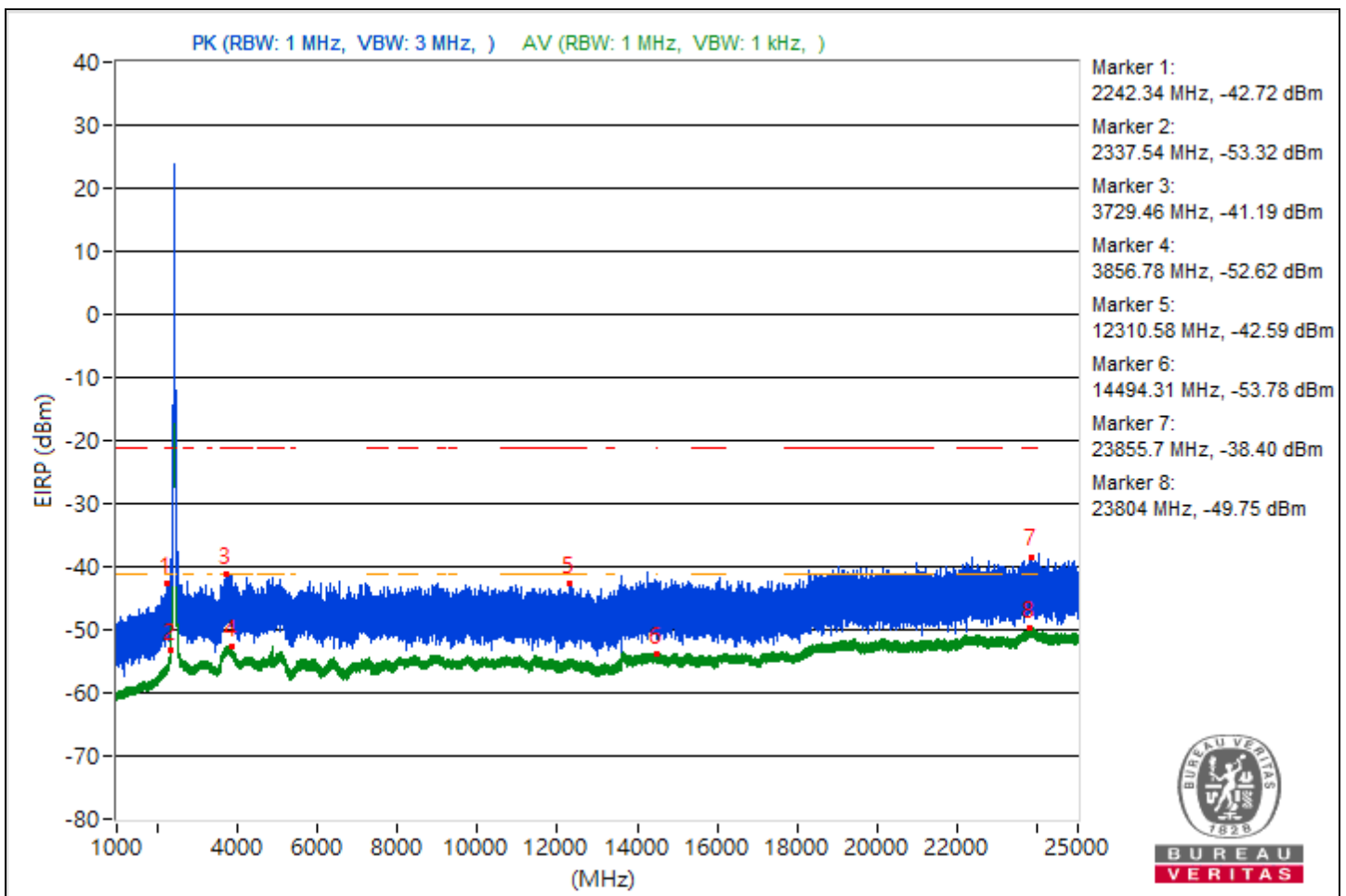

RF Mode	802.11be (EHT20)	Channel	CH 11 : 2462 MHz
Frequency Range	1 GHz ~ 25 GHz	Environmental Conditions	25°C, 76% RH
Tested By	Waydi Tuan		

Conducted Unwanted Emissions							
No.	Frequency (MHz)	Emission Level (dBuV/m)	Limit (dBuV/m)	Margin (dB)	Raw Value Chain 0 (dBm)	Correction Factor (dB)	EIRP Level (dBm)
1	2265.44	51.97 PK	74	-22.03	-48.21	4.92	-43.29
2	2335.76	40.59 AV	54	-13.41	-59.59	4.92	-54.67
3	3797.51	54.49 PK	74	-19.51	-45.69	4.92	-40.77
4	3802.57	42.9 AV	54	-11.1	-57.28	4.92	-52.36
5	15773.24	53.23 PK	74	-20.77	-46.95	4.92	-42.03
6	14499.47	41.33 AV	54	-12.67	-58.85	4.92	-53.93
7	23997.6	56.89 PK	74	-17.11	-43.29	4.92	-38.37
8	23834.9	45.69 AV	54	-8.31	-54.49	4.92	-49.57

Note: Margin value = Emission Level - Limit value

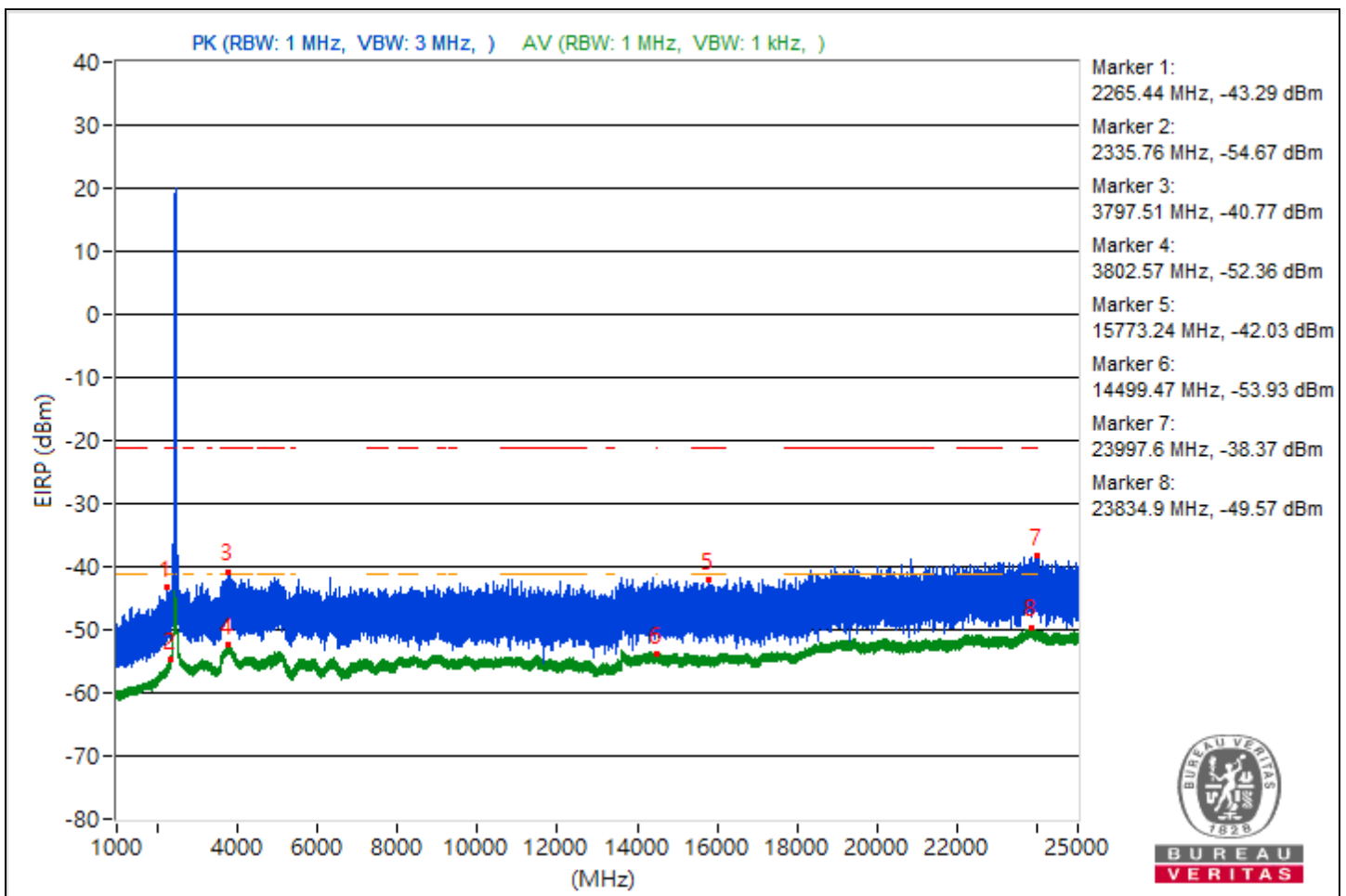

RF Mode	802.11be (EHT20)	Channel	CH 12 : 2467 MHz
Frequency Range	1 GHz ~ 25 GHz	Environmental Conditions	25°C, 76% RH
Tested By	Waydi Tuan		

Conducted Unwanted Emissions							
No.	Frequency (MHz)	Emission Level (dBuV/m)	Limit (dBuV/m)	Margin (dB)	Raw Value Chain 0 (dBm)	Correction Factor (dB)	EIRP Level (dBm)
1	2339.57	50.88 PK	74	-23.12	-49.3	4.92	-44.38
2	2337	40.64 AV	54	-13.36	-59.54	4.92	-54.62
3	3725.26	53.88 PK	74	-20.12	-46.3	4.92	-41.38
4	3790.04	42.71 AV	54	-11.29	-57.47	4.92	-52.55
5	9040	53.43 PK	74	-20.57	-46.75	4.92	-41.83
6	14475.29	41.37 AV	54	-12.63	-58.81	4.92	-53.89
7	23798.2	56.87 PK	74	-17.13	-43.31	4.92	-38.39
8	23859.9	45.51 AV	54	-8.49	-54.67	4.92	-49.75

Note: Margin value = Emission Level - Limit value

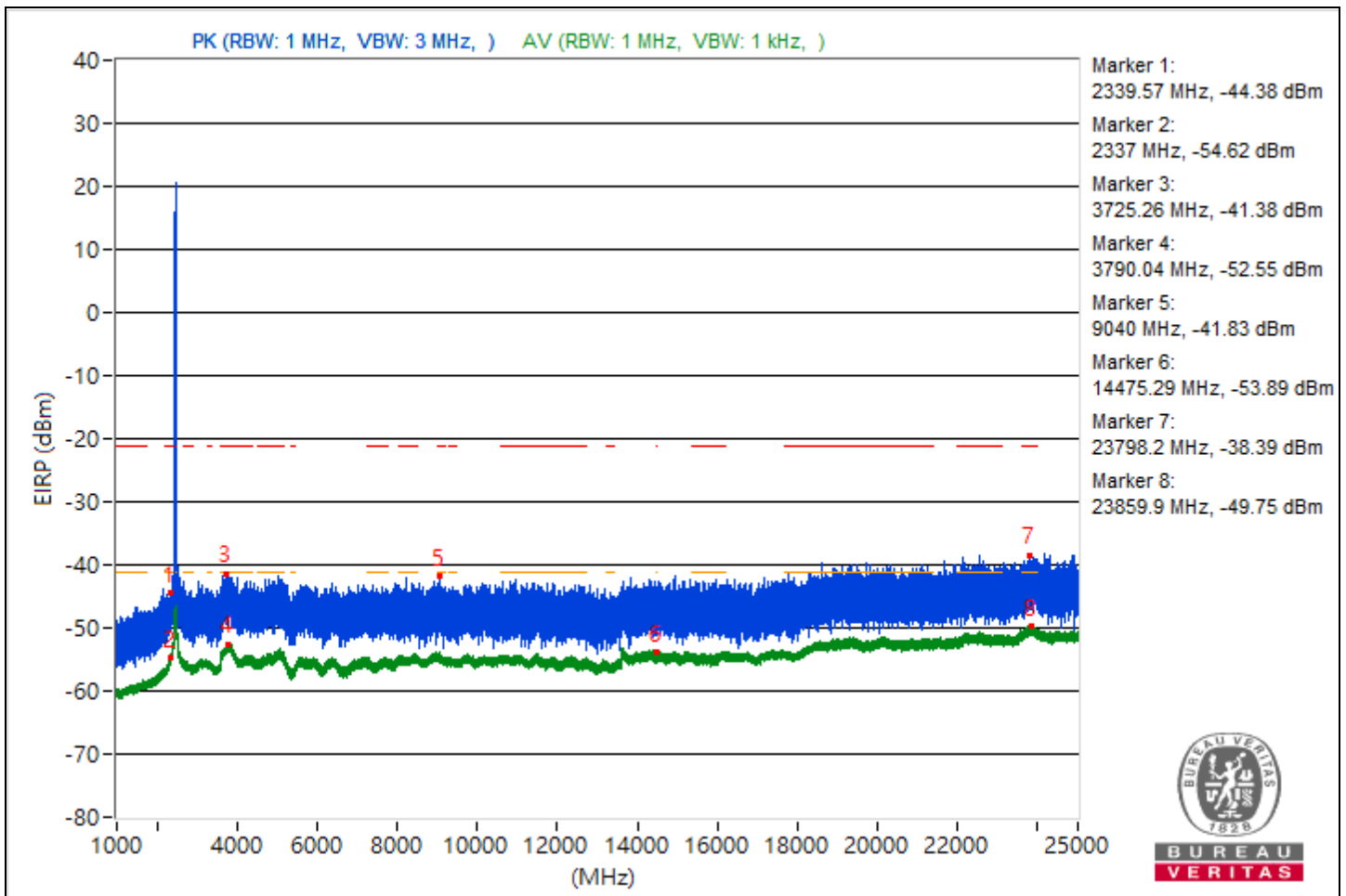

RF Mode	802.11be (EHT20)	Channel	CH 13 : 2472 MHz
Frequency Range	1 GHz ~ 25 GHz	Environmental Conditions	25°C, 76% RH
Tested By	Waydi Tuan		

Conducted Unwanted Emissions							
No.	Frequency (MHz)	Emission Level (dBuV/m)	Limit (dBuV/m)	Margin (dB)	Raw Value Chain 0 (dBm)	Correction Factor (dB)	EIRP Level (dBm)
1	2243.51	50.36 PK	74	-23.64	-49.82	4.92	-44.9
2	2335.13	40.15 AV	54	-13.85	-60.03	4.92	-55.11
3	3784.68	54.79 PK	74	-19.21	-45.39	4.92	-40.47
4	3818.12	42.77 AV	54	-11.23	-57.41	4.92	-52.49
5	15393.24	54.21 PK	74	-19.79	-45.97	4.92	-41.05
6	14485.87	41.36 AV	54	-12.64	-58.82	4.92	-53.9
7	23785.2	56.83 PK	74	-17.17	-43.35	4.92	-38.43
8	23795.1	45.48 AV	54	-8.52	-54.7	4.92	-49.78

Note: Margin value = Emission Level - Limit value

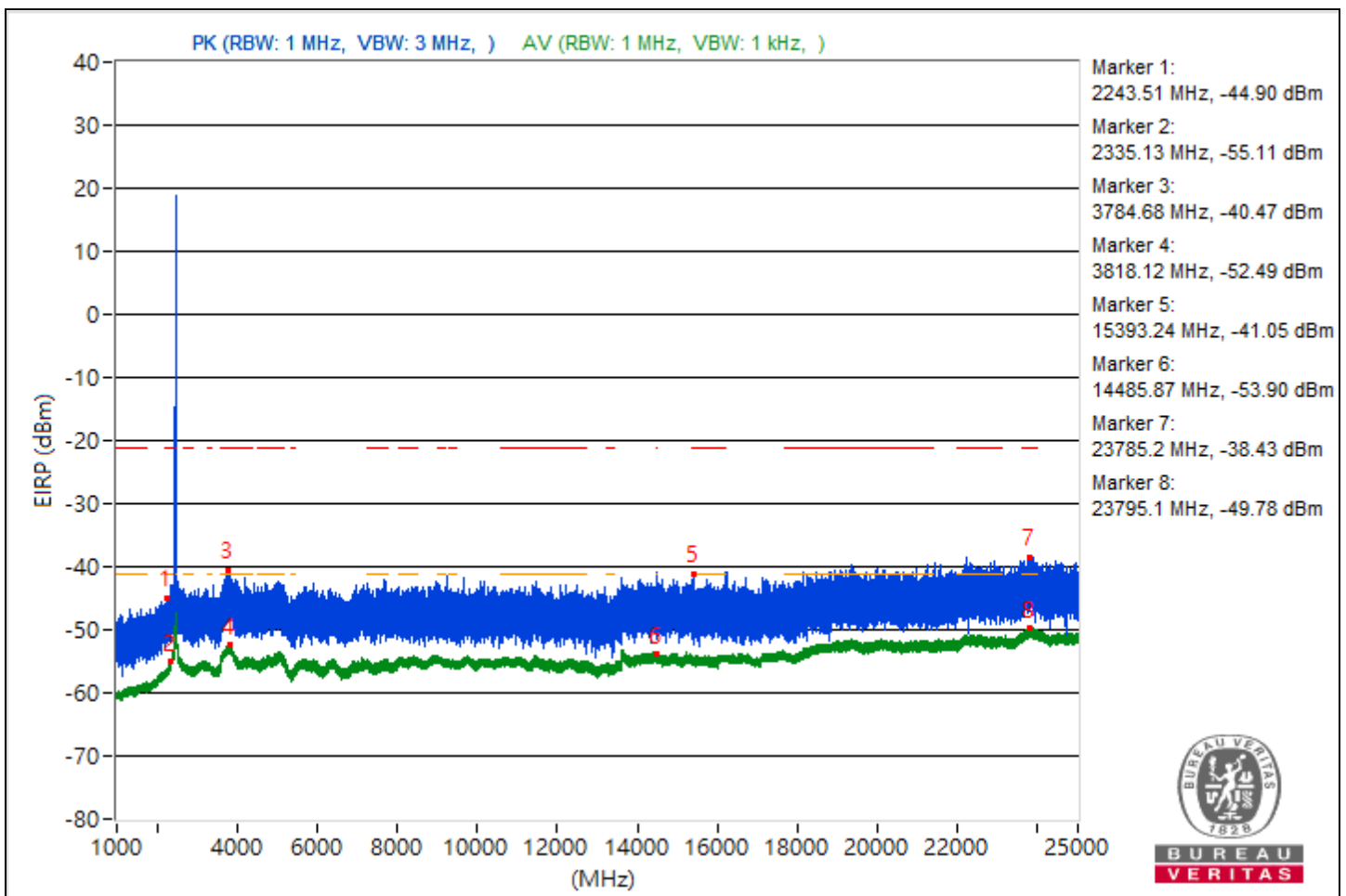

RF Mode	802.11be (EHT40)	Channel	CH 3 : 2422 MHz
Frequency Range	1 GHz ~ 25 GHz	Environmental Conditions	25°C, 76% RH
Tested By	Waydi Tuan		

Conducted Unwanted Emissions							
No.	Frequency (MHz)	Emission Level (dBuV/m)	Limit (dBuV/m)	Margin (dB)	Raw Value Chain 0 (dBm)	Correction Factor (dB)	EIRP Level (dBm)
1	2251.13	51.44 PK	74	-22.56	-48.74	4.92	-43.82
2	2337.54	41.57 AV	54	-12.43	-58.61	4.92	-53.69
3	3702.47	55.53 PK	74	-18.47	-44.65	4.92	-39.73
4	3816.33	42.66 AV	54	-11.34	-57.52	4.92	-52.6
5	15352.98	54.32 PK	74	-19.68	-45.86	4.92	-40.94
6	14497.96	41.42 AV	54	-12.58	-58.76	4.92	-53.84
7	22863.8	57.42 PK	74	-16.58	-42.76	4.92	-37.84
8	23842.7	45.58 AV	54	-8.42	-54.6	4.92	-49.68

Note: Margin value = Emission Level - Limit value

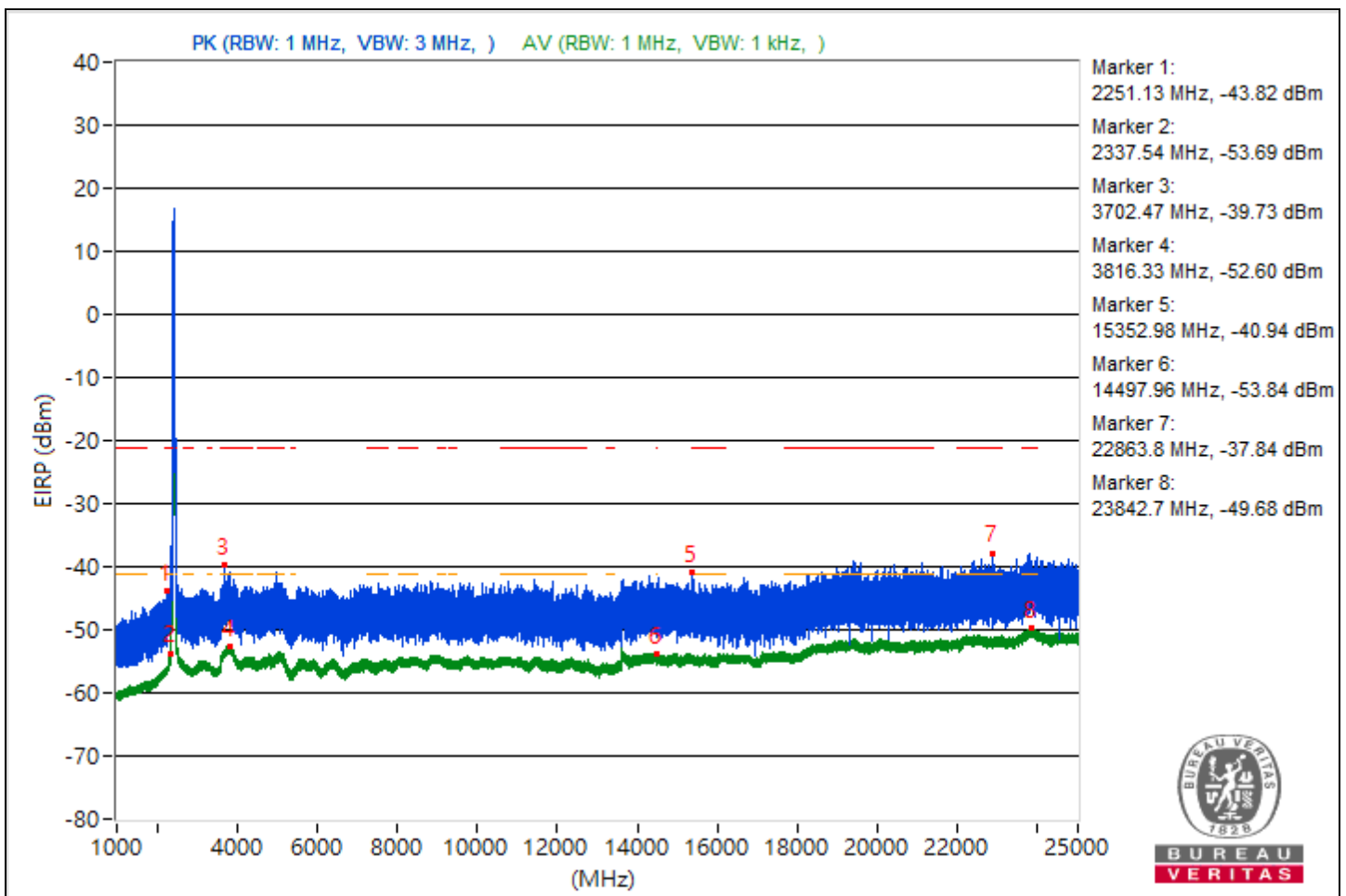

RF Mode	802.11be (EHT40)	Channel	CH 6 : 2437 MHz
Frequency Range	1 GHz ~ 25 GHz	Environmental Conditions	25°C, 76% RH
Tested By	Waydi Tuan		

Conducted Unwanted Emissions							
No.	Frequency (MHz)	Emission Level (dBuV/m)	Limit (dBuV/m)	Margin (dB)	Raw Value Chain 0 (dBm)	Correction Factor (dB)	EIRP Level (dBm)
1	2339.33	52.31 PK	74	-21.69	-47.87	4.92	-42.95
2	2338.79	41.64 AV	54	-12.36	-58.54	4.92	-53.62
3	3779.47	54.09 PK	74	-19.91	-46.09	4.92	-41.17
4	3801.01	42.71 AV	54	-11.29	-57.47	4.92	-52.55
5	11050.84	53.19 PK	74	-20.81	-46.99	4.92	-42.07
6	14488.09	41.48 AV	54	-12.52	-58.7	4.92	-53.78
7	18861.6	56.85 PK	74	-17.15	-43.33	4.92	-38.41
8	23802.3	45.75 AV	54	-8.25	-54.43	4.92	-49.51

Note: Margin value = Emission Level - Limit value

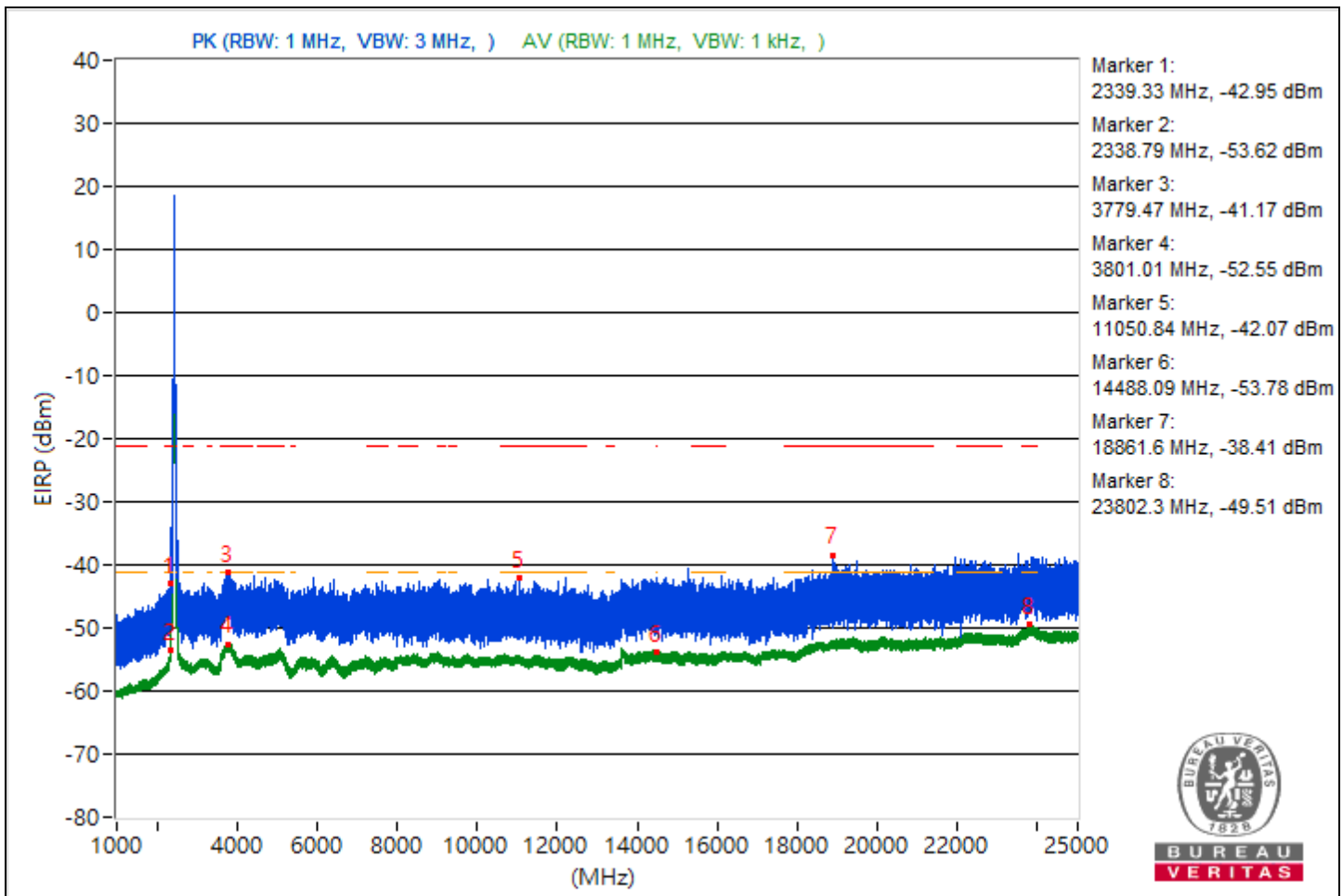



RF Mode	802.11be (EHT40)	Channel	CH 9 : 2452 MHz
Frequency Range	1 GHz ~ 25 GHz	Environmental Conditions	25°C, 76% RH
Tested By	Waydi Tuan		

Conducted Unwanted Emissions							
No.	Frequency (MHz)	Emission Level (dBuV/m)	Limit (dBuV/m)	Margin (dB)	Raw Value Chain 0 (dBm)	Correction Factor (dB)	EIRP Level (dBm)
1	2338.94	50.94 PK	74	-23.06	-49.24	4.92	-44.32
2	2331.24	40.76 AV	54	-13.24	-59.42	4.92	-54.5
3	3723.54	54.3 PK	74	-19.7	-45.88	4.92	-40.96
4	3784.44	42.7 AV	54	-11.3	-57.48	4.92	-52.56
5	15495.02	52.99 PK	74	-21.01	-47.19	4.92	-42.27
6	14492.27	41.4 AV	54	-12.6	-58.78	4.92	-53.86
7	23698.6	57.1 PK	74	-16.9	-43.08	4.92	-38.16
8	23830.3	45.57 AV	54	-8.43	-54.61	4.92	-49.69

Note: Margin value = Emission Level - Limit value

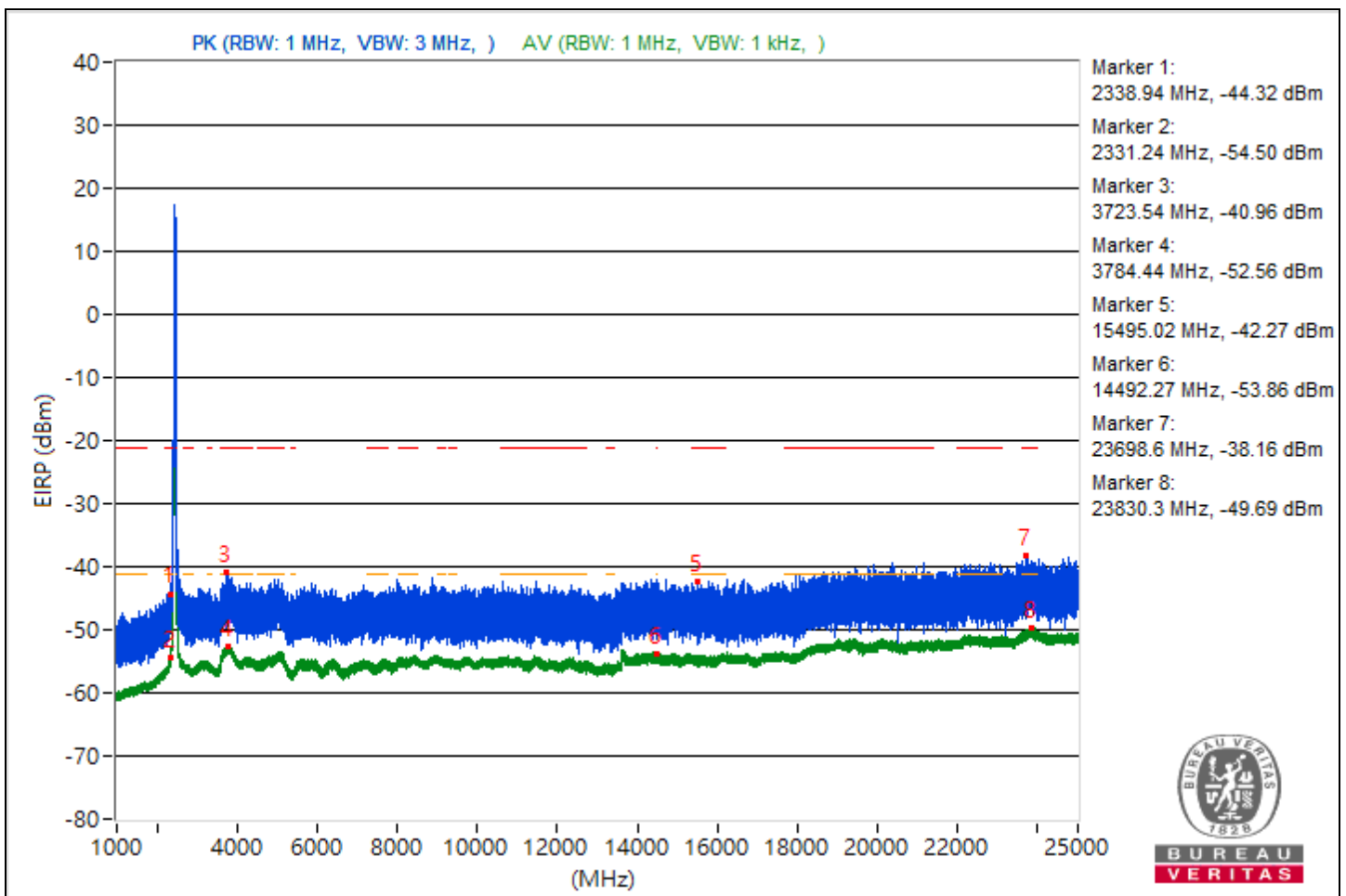



RF Mode	802.11be (EHT40)	Channel	CH 10 : 2457 MHz
Frequency Range	1 GHz ~ 25 GHz	Environmental Conditions	25°C, 76% RH
Tested By	Waydi Tuan		

Conducted Unwanted Emissions							
No.	Frequency (MHz)	Emission Level (dBuV/m)	Limit (dBuV/m)	Margin (dB)	Raw Value Chain 0 (dBm)	Correction Factor (dB)	EIRP Level (dBm)
1	2316.62	51.13 PK	74	-22.87	-49.05	4.92	-44.13
2	2339.49	40.48 AV	54	-13.52	-59.7	4.92	-54.78
3	3758.31	54.26 PK	74	-19.74	-45.92	4.92	-41
4	3802.57	42.64 AV	54	-11.36	-57.54	4.92	-52.62
5	11061.16	53.89 PK	74	-20.11	-46.29	4.92	-41.37
6	14478.76	41.48 AV	54	-12.52	-58.7	4.92	-53.78
7	23622.3	57.32 PK	74	-16.68	-42.86	4.92	-37.94
8	23862.5	45.67 AV	54	-8.33	-54.51	4.92	-49.59

Note: Margin value = Emission Level - Limit value

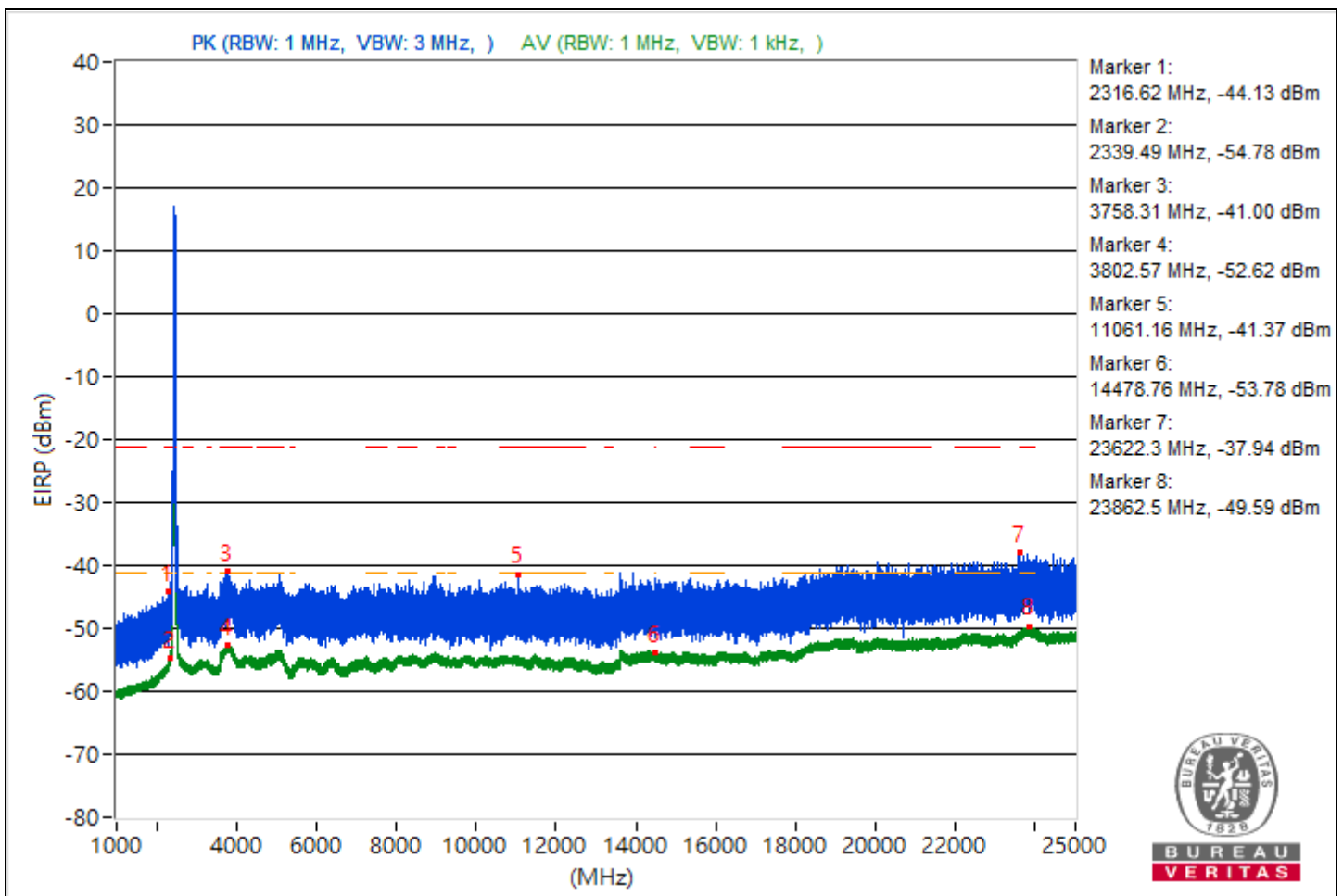



RF Mode	802.11be (EHT40)	Channel	CH 11 : 2462 MHz
Frequency Range	1 GHz ~ 25 GHz	Environmental Conditions	25°C, 76% RH
Tested By	Waydi Tuan		

Conducted Unwanted Emissions							
No.	Frequency (MHz)	Emission Level (dBuV/m)	Limit (dBuV/m)	Margin (dB)	Raw Value Chain 0 (dBm)	Correction Factor (dB)	EIRP Level (dBm)
1	2334.59	51.96 PK	74	-22.04	-48.22	4.92	-43.3
2	2339.8	40.16 AV	54	-13.84	-60.02	4.92	-55.1
3	3780.71	55.21 PK	74	-18.79	-44.97	4.92	-40.05
4	3810.34	42.7 AV	54	-11.3	-57.48	4.92	-52.56
5	12633.96	53.59 PK	74	-20.41	-46.59	4.92	-41.67
6	14493.51	41.43 AV	54	-12.57	-58.75	4.92	-53.83
7	23762.7	57.03 PK	74	-16.97	-43.15	4.92	-38.23
8	23849	45.6 AV	54	-8.4	-54.58	4.92	-49.66

Note: Margin value = Emission Level - Limit value

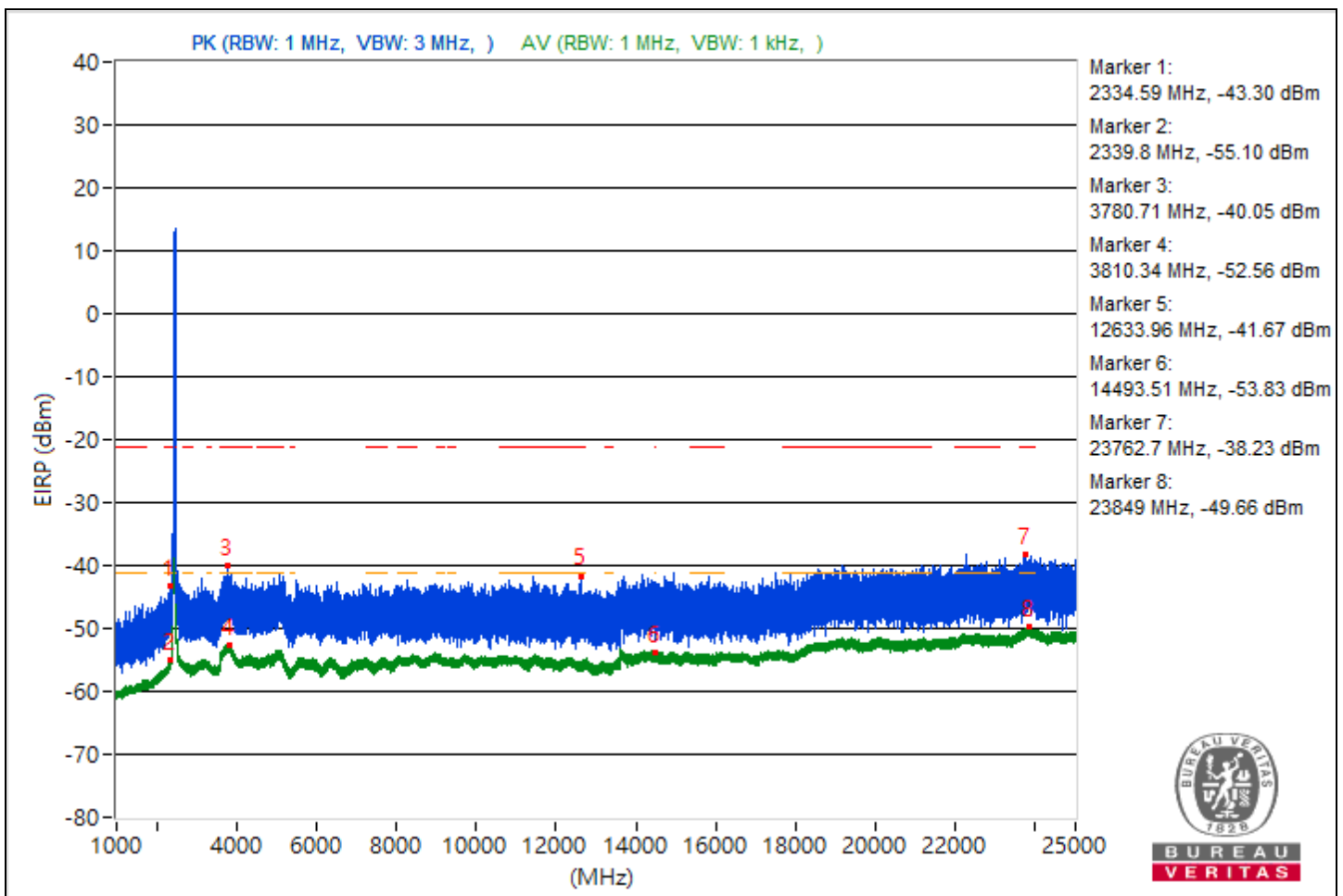

RF Mode	802.11be (EHT20) 26-tone RU	Channel	CH 1 : 2412 MHz
Frequency Range	1 GHz ~ 25 GHz	Environmental Conditions	25°C, 76% RH
Tested By	Waydi Tuan		

Conducted Unwanted Emissions							
No.	Frequency (MHz)	Emission Level (dBuV/m)	Limit (dBuV/m)	Margin (dB)	Raw Value Chain 0 (dBm)	Correction Factor (dB)	EIRP Level (dBm)
1	2311.02	51.51 PK	74	-22.49	-48.67	4.92	-43.75
2	2339.96	40.87 AV	54	-13.13	-59.31	4.92	-54.39
3	4808.54	55.04 PK	74	-18.96	-45.14	4.92	-40.22
4	4807.69	44.48 AV	54	-9.52	-55.7	4.92	-50.78
5	11735.64	53.46 PK	74	-20.54	-46.72	4.92	-41.8
6	14480	41.61 AV	54	-12.39	-58.57	4.92	-53.65
7	23731.5	57 PK	74	-17	-43.18	4.92	-38.26
8	23860.6	45.47 AV	54	-8.53	-54.71	4.92	-49.79

Note: Margin value = Emission Level - Limit value

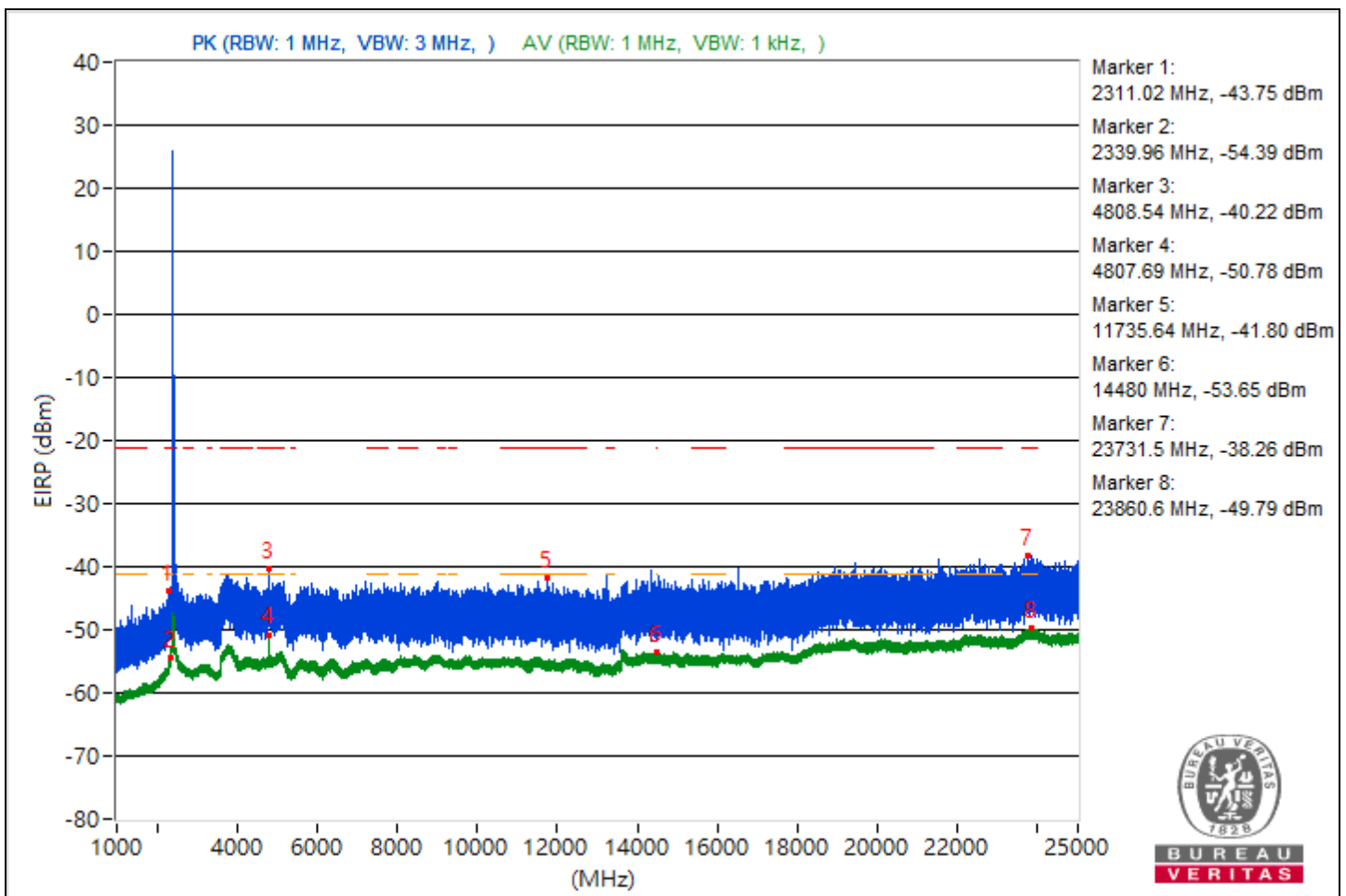



RF Mode	802.11be (EHT20) 26-tone RU	Channel	CH 6 : 2437 MHz
Frequency Range	1 GHz ~ 25 GHz	Environmental Conditions	25°C, 76% RH
Tested By	Waydi Tuan		

Conducted Unwanted Emissions							
No.	Frequency (MHz)	Emission Level (dBuV/m)	Limit (dBuV/m)	Margin (dB)	Raw Value Chain 0 (dBm)	Correction Factor (dB)	EIRP Level (dBm)
1	2292.74	52.67 PK	74	-21.33	-47.51	4.92	-42.59
2	2338.63	40.99 AV	54	-13.01	-59.19	4.92	-54.27
3	4855.99	55.36 PK	74	-18.64	-44.82	4.92	-39.9
4	4856.14	45.4 AV	54	-8.6	-54.78	4.92	-49.86
5	8084.89	53.36 PK	74	-20.64	-46.82	4.92	-41.9
6	14480.44	41.66 AV	54	-12.34	-58.52	4.92	-53.6
7	23893.8	56.7 PK	74	-17.3	-43.48	4.92	-38.56
8	23804.9	45.55 AV	54	-8.45	-54.63	4.92	-49.71

Note: Margin value = Emission Level - Limit value

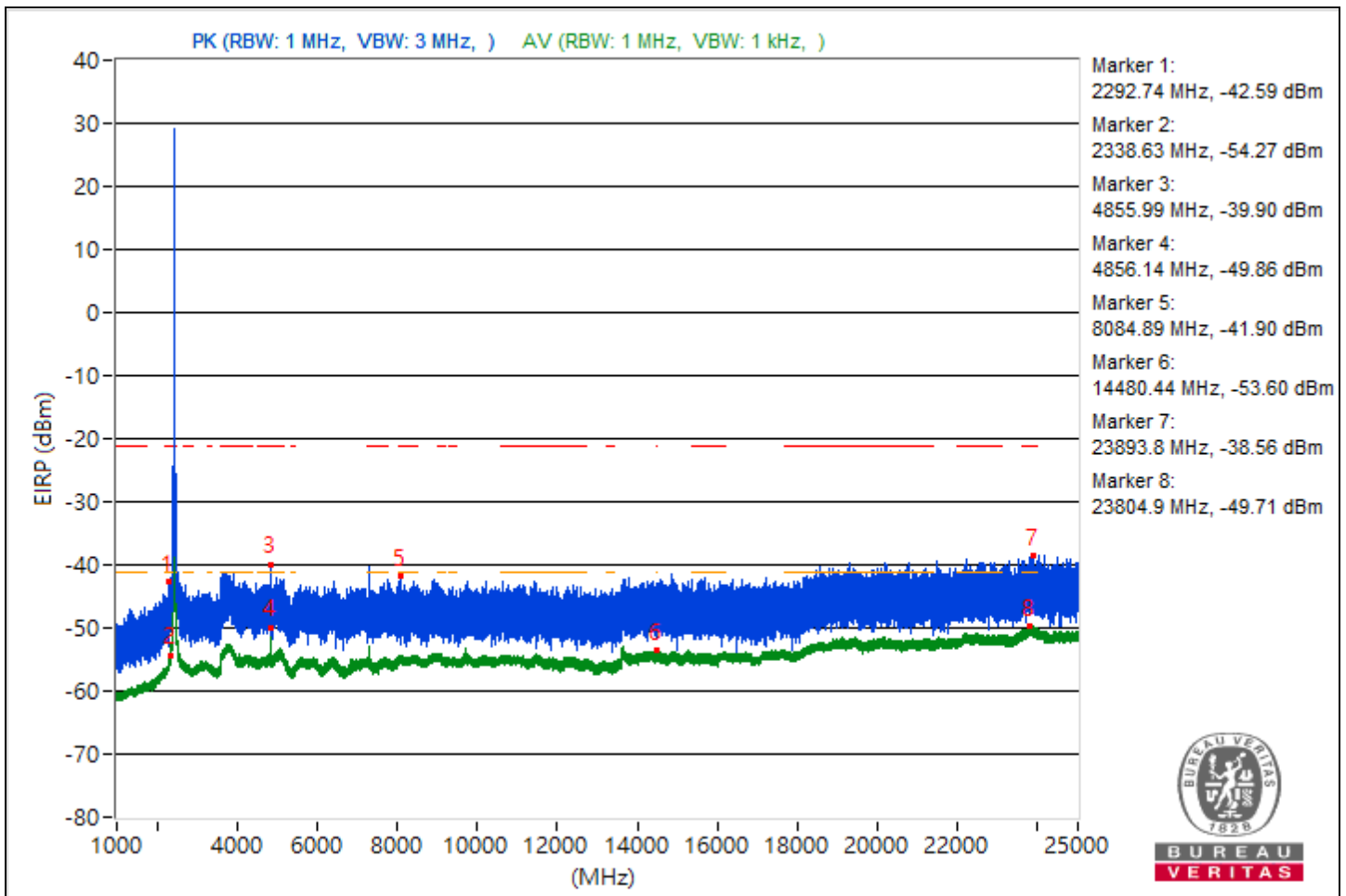

RF Mode	802.11be (EHT20) 26-tone RU	Channel	CH 11 : 2462 MHz
Frequency Range	1 GHz ~ 25 GHz	Environmental Conditions	25°C, 76% RH
Tested By	Waydi Tuan		

Conducted Unwanted Emissions							
No.	Frequency (MHz)	Emission Level (dBuV/m)	Limit (dBuV/m)	Margin (dB)	Raw Value Chain 0 (dBm)	Correction Factor (dB)	EIRP Level (dBm)
1	2329.53	51.63 PK	74	-22.37	-48.55	4.92	-43.63
2	2336.69	39.96 AV	54	-14.04	-60.22	4.92	-55.3
3	3789.42	54.1 PK	74	-19.9	-46.08	4.92	-41.16
4	4941	44.47 AV	54	-9.53	-55.71	4.92	-50.79
5	9042.4	53.3 PK	74	-20.7	-46.88	4.92	-41.96
6	14470.04	41.34 AV	54	-12.66	-58.84	4.92	-53.92
7	23855	57.36 PK	74	-16.64	-42.82	4.92	-37.9
8	23806	45.62 AV	54	-8.38	-54.56	4.92	-49.64

Note: Margin value = Emission Level - Limit value

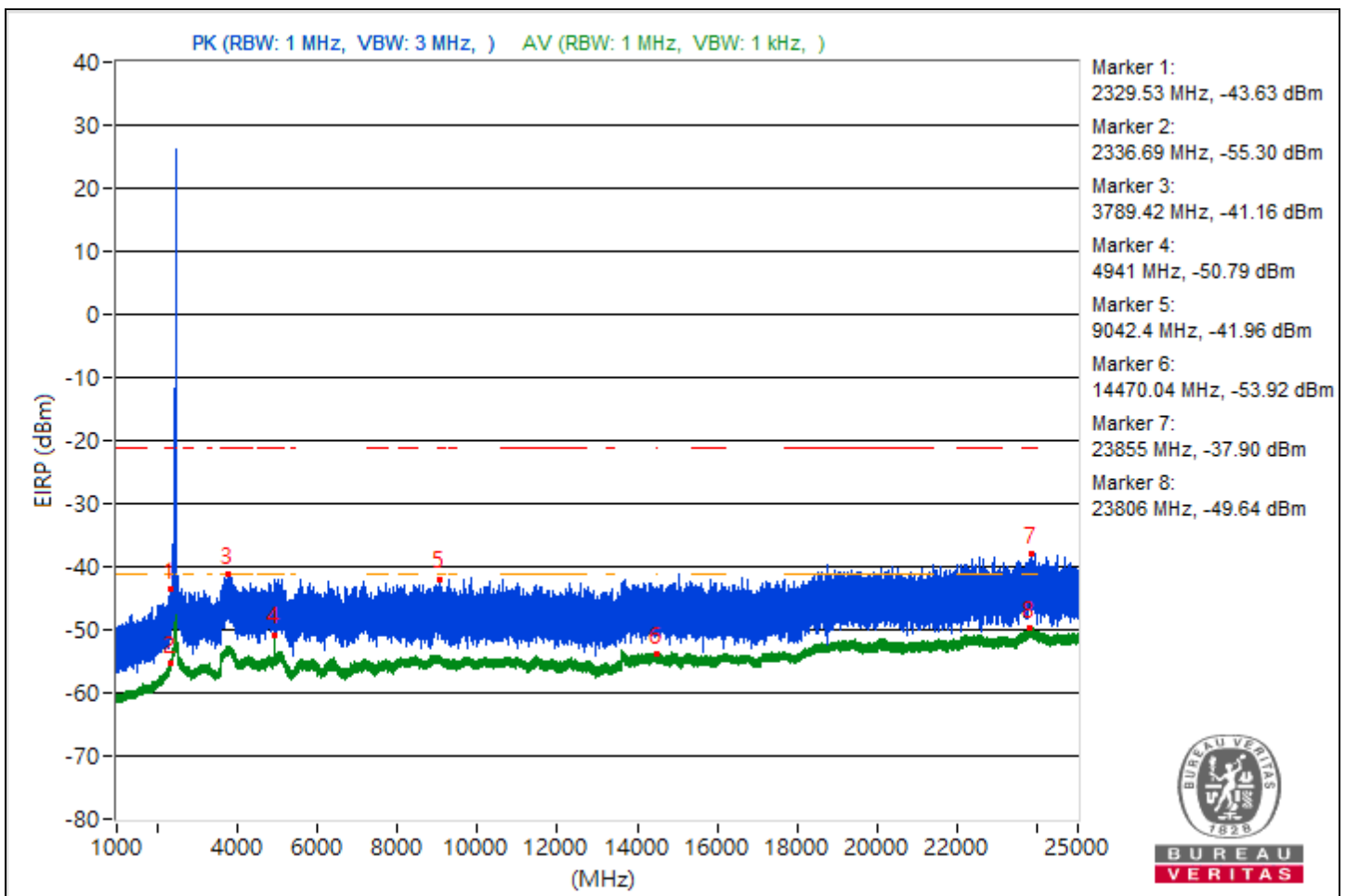

RF Mode	802.11be (EHT20) 26-tone RU	Channel	CH 12 : 2467 MHz
Frequency Range	1 GHz ~ 25 GHz	Environmental Conditions	25°C, 76% RH
Tested By	Waydi Tuan		

Conducted Unwanted Emissions							
No.	Frequency (MHz)	Emission Level (dBuV/m)	Limit (dBuV/m)	Margin (dB)	Raw Value Chain 0 (dBm)	Correction Factor (dB)	EIRP Level (dBm)
1	2338.63	51.09 PK	74	-22.91	-49.09	4.92	-44.17
2	2333.58	40.06 AV	54	-13.94	-60.12	4.92	-55.2
3	4951.27	55.5 PK	74	-18.5	-44.68	4.92	-39.76
4	4950.8	44.45 AV	54	-9.55	-55.73	4.92	-50.81
5	8381.42	53.06 PK	74	-20.94	-47.12	4.92	-42.2
6	14481.51	41.46 AV	54	-12.54	-58.72	4.92	-53.8
7	23740.9	57.08 PK	74	-16.92	-43.1	4.92	-38.18
8	23787.5	45.71 AV	54	-8.29	-54.47	4.92	-49.55

Note: Margin value = Emission Level - Limit value

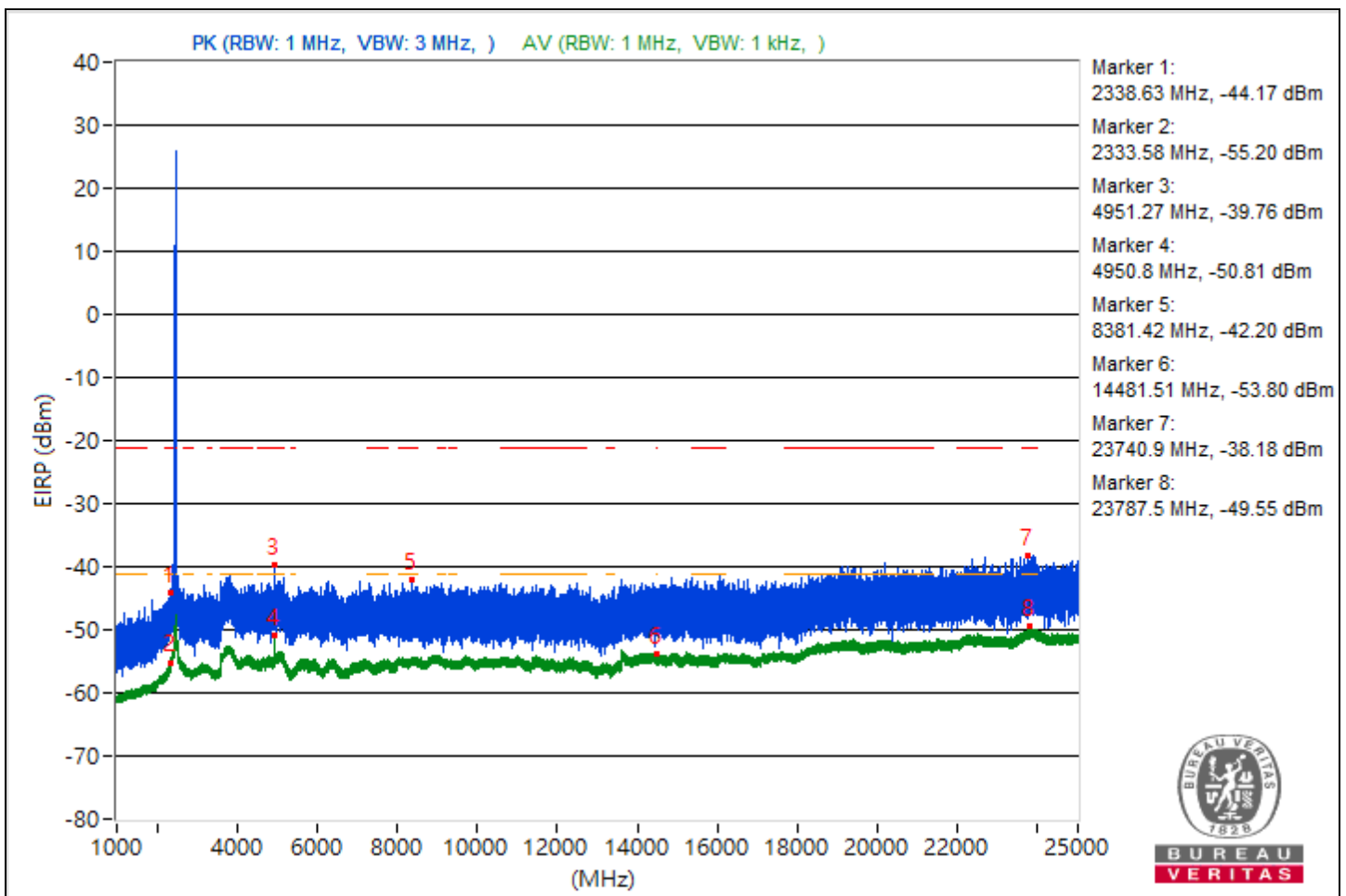

RF Mode	802.11be (EHT20) 26-tone RU	Channel	CH 13 : 2472 MHz
Frequency Range	1 GHz ~ 25 GHz	Environmental Conditions	25°C, 76% RH
Tested By	Waydi Tuan		

Conducted Unwanted Emissions							
No.	Frequency (MHz)	Emission Level (dBuV/m)	Limit (dBuV/m)	Margin (dB)	Raw Value Chain 0 (dBm)	Correction Factor (dB)	EIRP Level (dBm)
1	2272.06	50.32 PK	74	-23.68	-49.86	4.92	-44.94
2	2338.87	39.57 AV	54	-14.43	-60.61	4.92	-55.69
3	3842.86	54.14 PK	74	-19.86	-46.04	4.92	-41.12
4	3810.58	42.66 AV	54	-11.34	-57.52	4.92	-52.6
5	15900.36	53.54 PK	74	-20.46	-46.64	4.92	-41.72
6	14478.04	41.61 AV	54	-12.39	-58.57	4.92	-53.65
7	23698.9	56.99 PK	74	-17.01	-43.19	4.92	-38.27
8	23806.6	45.45 AV	54	-8.55	-54.73	4.92	-49.81

Note: Margin value = Emission Level - Limit value

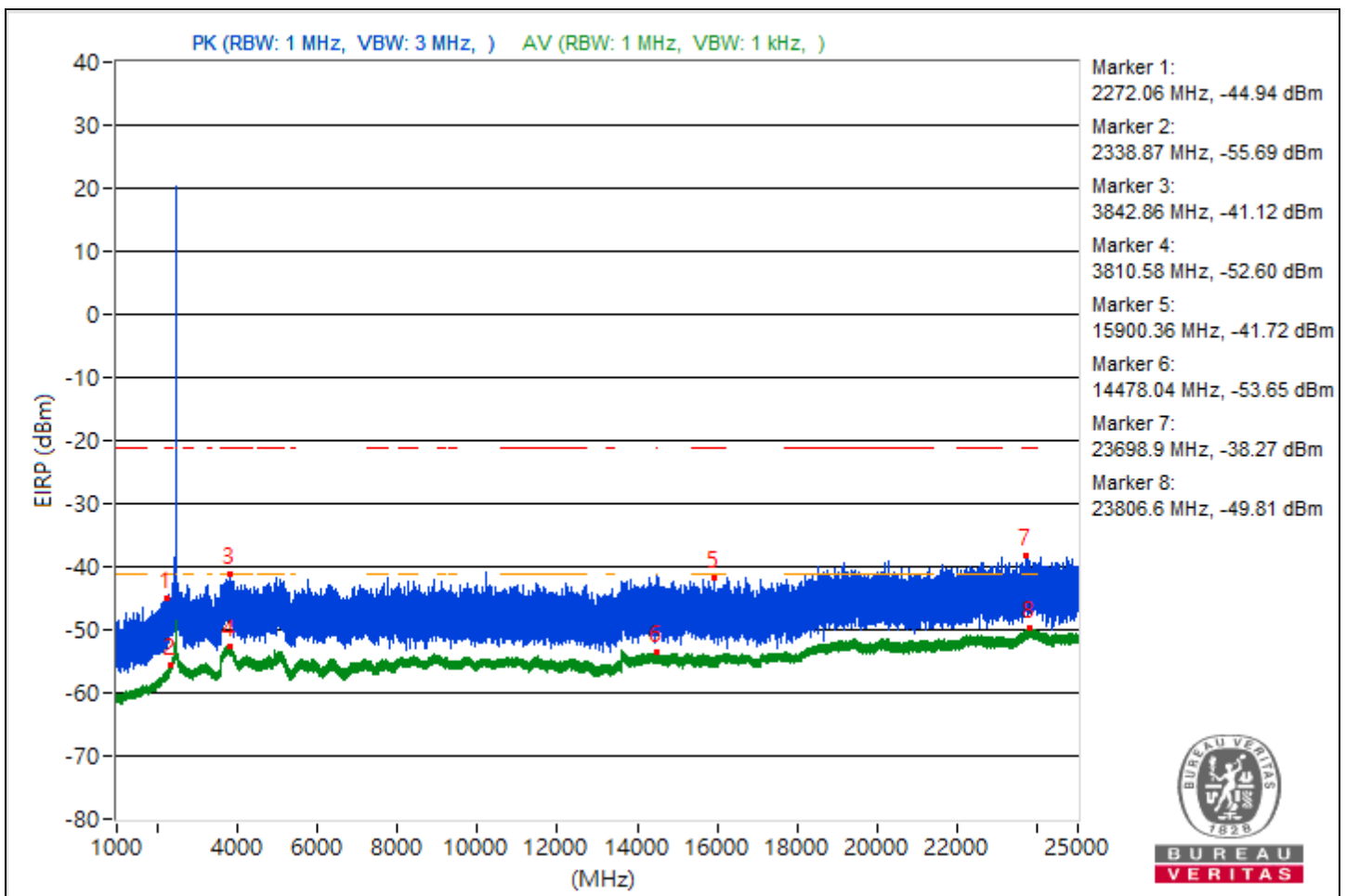



RF Mode	802.11be (EHT20) 52-tone RU	Channel	CH 1 : 2412 MHz
Frequency Range	1 GHz ~ 25 GHz	Environmental Conditions	25°C, 76% RH
Tested By	Waydi Tuan		

Conducted Unwanted Emissions							
No.	Frequency (MHz)	Emission Level (dBuV/m)	Limit (dBuV/m)	Margin (dB)	Raw Value Chain 0 (dBm)	Correction Factor (dB)	EIRP Level (dBm)
1	2335.76	51.37 PK	74	-22.63	-48.81	4.92	-43.89
2	2339.8	40.8 AV	54	-13.2	-59.38	4.92	-54.46
3	4808.31	54.66 PK	74	-19.34	-45.52	4.92	-40.6
4	4808.31	44.65 AV	54	-9.35	-55.53	4.92	-50.61
5	15525.6	54.24 PK	74	-19.76	-45.94	4.92	-41.02
6	14482.31	41.44 AV	54	-12.56	-58.74	4.92	-53.82
7	23786.3	57.37 PK	74	-16.63	-42.81	4.92	-37.89
8	23799.7	45.59 AV	54	-8.41	-54.59	4.92	-49.67

Note: Margin value = Emission Level - Limit value

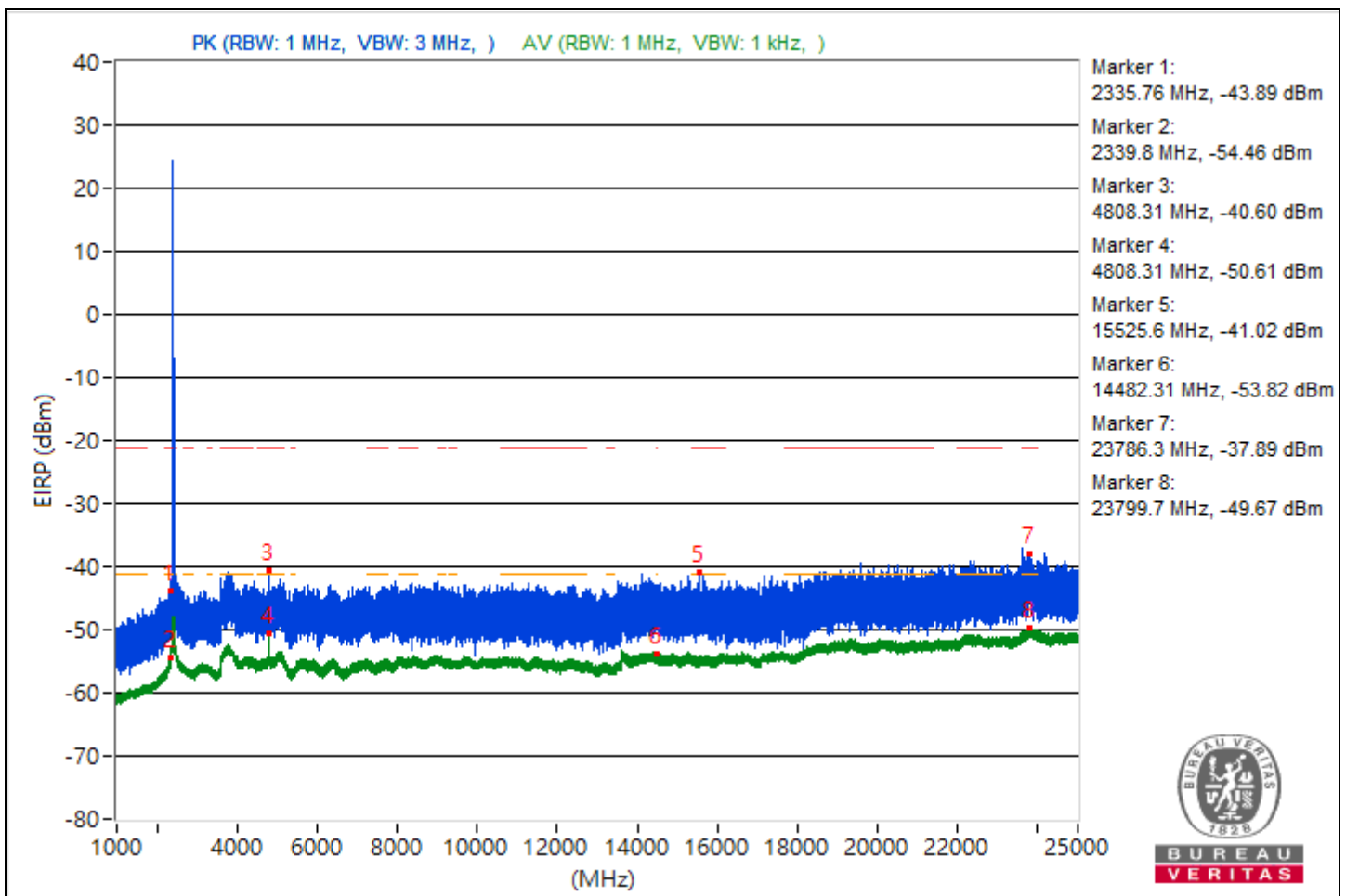

RF Mode	802.11be (EHT20) 52-tone RU	Channel	CH 6 : 2437 MHz
Frequency Range	1 GHz ~ 25 GHz	Environmental Conditions	25°C, 76% RH
Tested By	Waydi Tuan		

Conducted Unwanted Emissions							
No.	Frequency (MHz)	Emission Level (dBuV/m)	Limit (dBuV/m)	Margin (dB)	Raw Value Chain 0 (dBm)	Correction Factor (dB)	EIRP Level (dBm)
1	2327.43	51.15 PK	74	-22.85	-49.03	4.92	-44.11
2	2338.48	41.26 AV	54	-12.74	-58.92	4.92	-54
3	3722.77	55.43 PK	74	-18.57	-44.75	4.92	-39.83
4	4858.48	45.64 AV	54	-8.36	-54.54	4.92	-49.62
5	15966.4	54.58 PK	74	-19.42	-45.6	4.92	-40.68
6	14494.84	41.45 AV	54	-12.55	-58.73	4.92	-53.81
7	23957.1	57.78 PK	74	-16.22	-42.4	4.92	-37.48
8	23840.1	45.7 AV	54	-8.3	-54.48	4.92	-49.56

Note: Margin value = Emission Level - Limit value

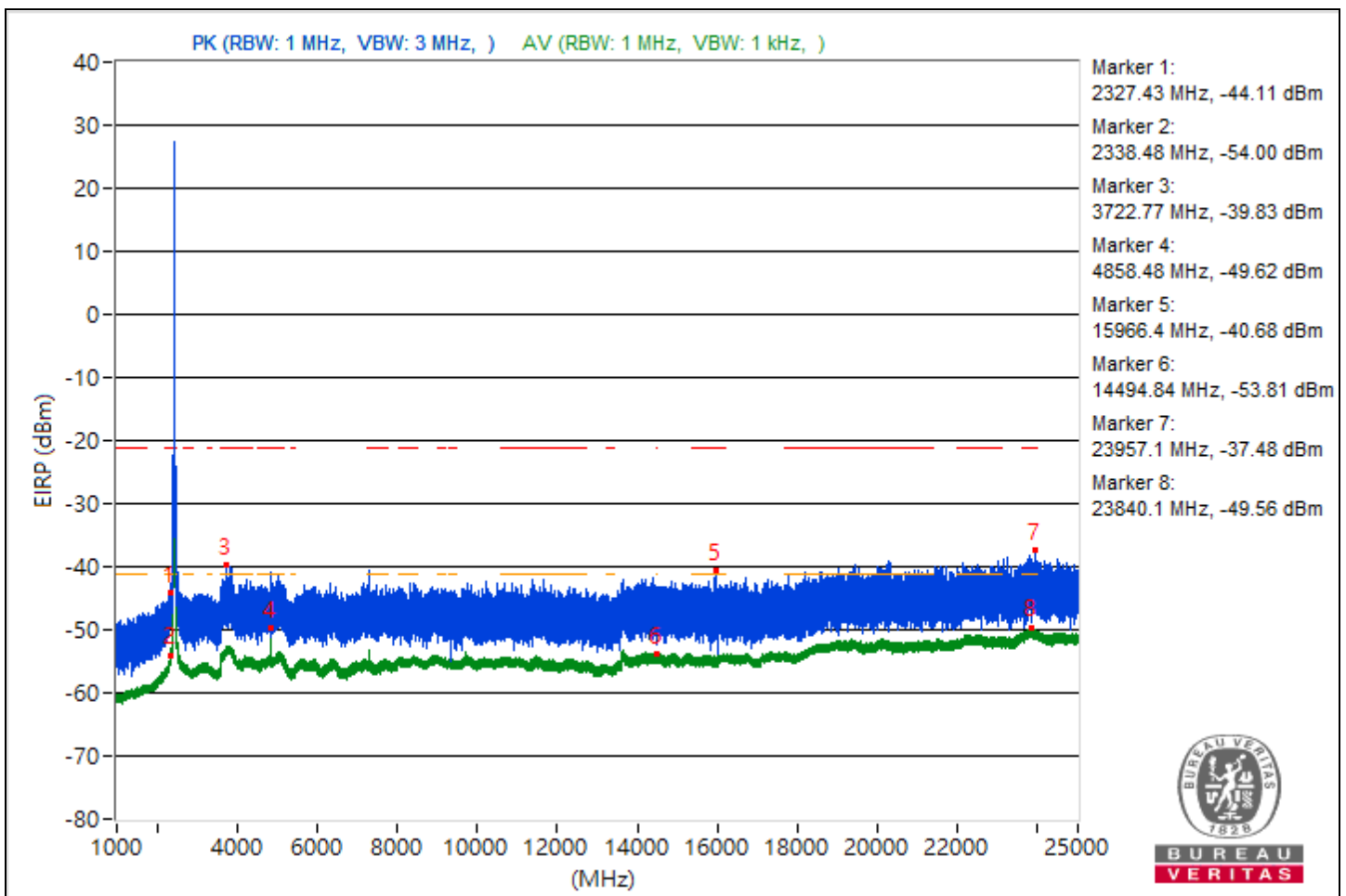

RF Mode	802.11be (EHT20) 52-tone RU	Channel	CH 11 : 2462 MHz
Frequency Range	1 GHz ~ 25 GHz	Environmental Conditions	25°C, 76% RH
Tested By	Waydi Tuan		

Conducted Unwanted Emissions							
No.	Frequency (MHz)	Emission Level (dBuV/m)	Limit (dBuV/m)	Margin (dB)	Raw Value Chain 0 (dBm)	Correction Factor (dB)	EIRP Level (dBm)
1	2339.02	50.73 PK	74	-23.27	-49.45	4.92	-44.53
2	2335.68	40.31 AV	54	-13.69	-59.87	4.92	-54.95
3	3728.99	53.8 PK	74	-20.2	-46.38	4.92	-41.46
4	4938.51	43.38 AV	54	-10.62	-56.8	4.92	-51.88
5	11542.93	53.05 PK	74	-20.95	-47.13	4.92	-42.21
6	14486.22	41.4 AV	54	-12.6	-58.78	4.92	-53.86
7	23640.7	56.73 PK	74	-17.27	-43.45	4.92	-38.53
8	23812.6	45.61 AV	54	-8.39	-54.57	4.92	-49.65

Note: Margin value = Emission Level - Limit value

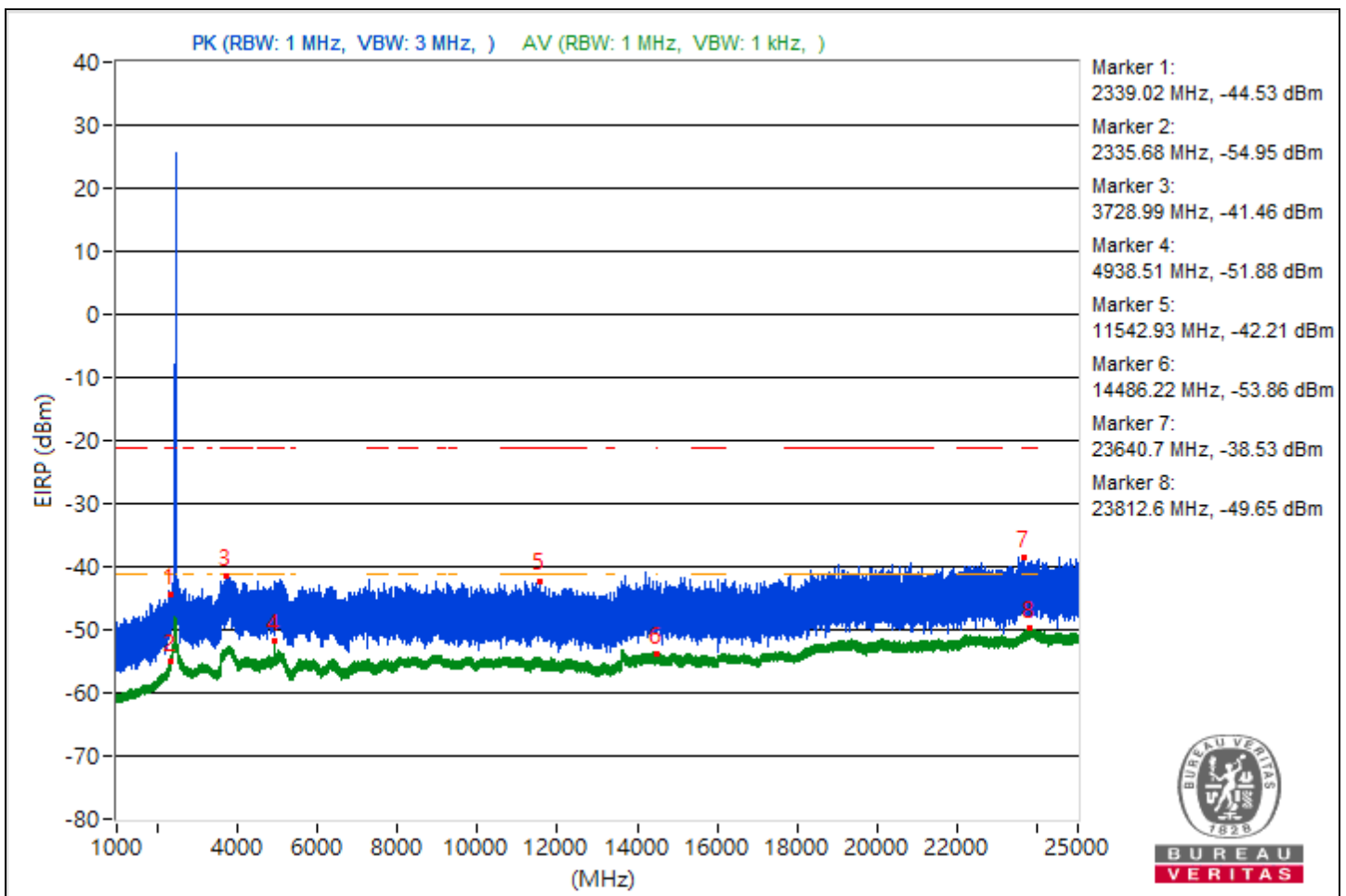

RF Mode	802.11be (EHT20) 52-tone RU	Channel	CH 12 : 2467 MHz
Frequency Range	1 GHz ~ 25 GHz	Environmental Conditions	25°C, 76% RH
Tested By	Waydi Tuan		

Conducted Unwanted Emissions							
No.	Frequency (MHz)	Emission Level (dBuV/m)	Limit (dBuV/m)	Margin (dB)	Raw Value Chain 0 (dBm)	Correction Factor (dB)	EIRP Level (dBm)
1	2322.3	50.76 PK	74	-23.24	-49.42	4.92	-44.5
2	2338.01	40.08 AV	54	-13.92	-60.1	4.92	-55.18
3	3763.21	54.76 PK	74	-19.24	-45.42	4.92	-40.5
4	4948.62	43.02 AV	54	-10.98	-57.16	4.92	-52.24
5	14497.96	52.85 PK	74	-21.15	-47.33	4.92	-42.41
6	14480.89	41.34 AV	54	-12.66	-58.84	4.92	-53.92
7	23896.7	56.8 PK	74	-17.2	-43.38	4.92	-38.46
8	23825.9	45.58 AV	54	-8.42	-54.6	4.92	-49.68

Note: Margin value = Emission Level - Limit value

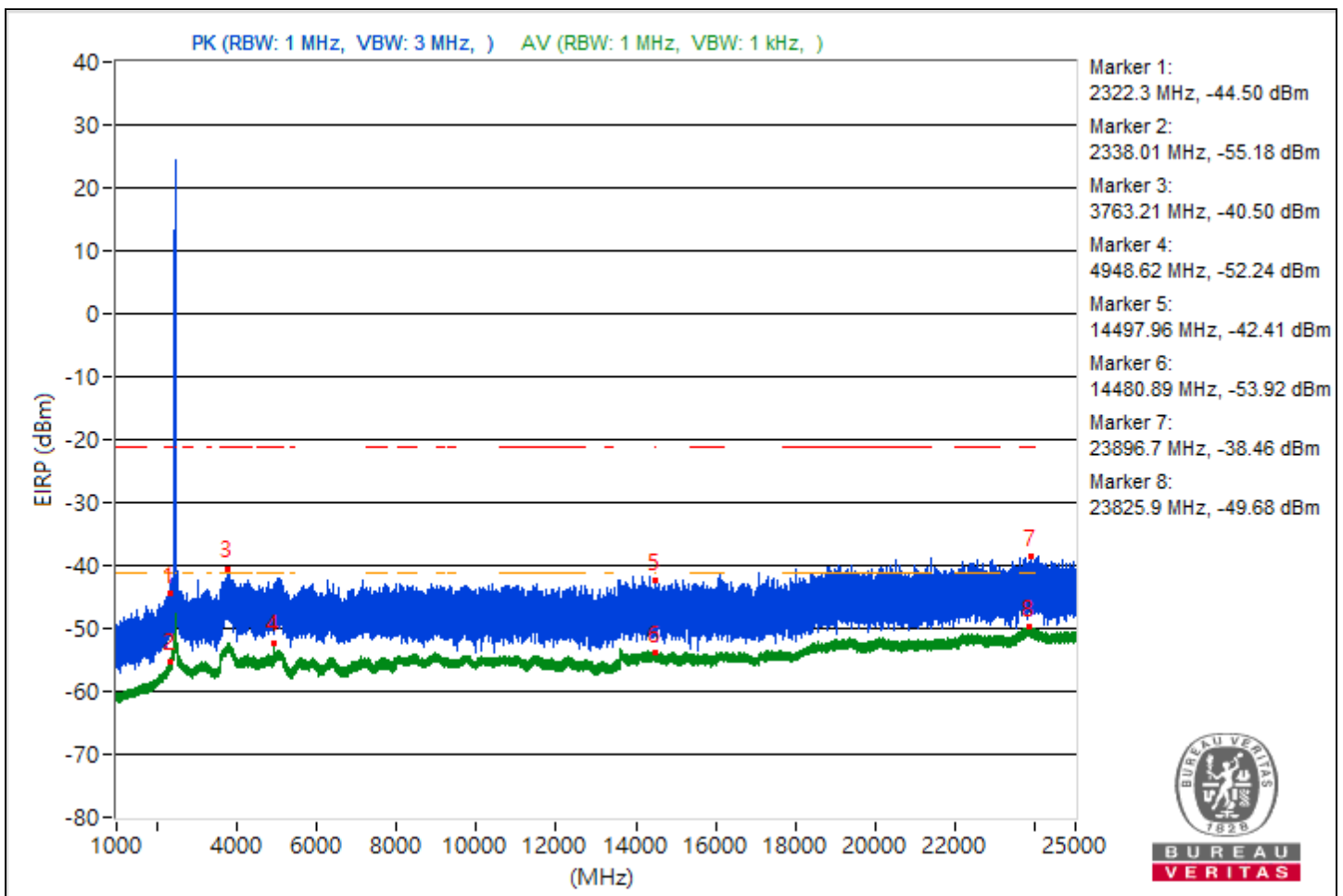

RF Mode	802.11be (EHT20) 52-tone RU	Channel	CH 13 : 2472 MHz
Frequency Range	1 GHz ~ 25 GHz	Environmental Conditions	25°C, 76% RH
Tested By	Waydi Tuan		

Conducted Unwanted Emissions							
No.	Frequency (MHz)	Emission Level (dBuV/m)	Limit (dBuV/m)	Margin (dB)	Raw Value Chain 0 (dBm)	Correction Factor (dB)	EIRP Level (dBm)
1	2294.53	51.39 PK	74	-22.61	-48.79	4.92	-43.87
2	2339.02	39.7 AV	54	-14.3	-60.48	4.92	-55.56
3	3845.58	54.25 PK	74	-19.75	-45.93	4.92	-41.01
4	3807.54	42.85 AV	54	-11.15	-57.33	4.92	-52.41
5	15869.87	53.13 PK	74	-20.87	-47.05	4.92	-42.13
6	14476	41.69 AV	54	-12.31	-58.49	4.92	-53.57
7	23790.7	57.45 PK	74	-16.55	-42.73	4.92	-37.81
8	23801.4	45.64 AV	54	-8.36	-54.54	4.92	-49.62

Note: Margin value = Emission Level - Limit value

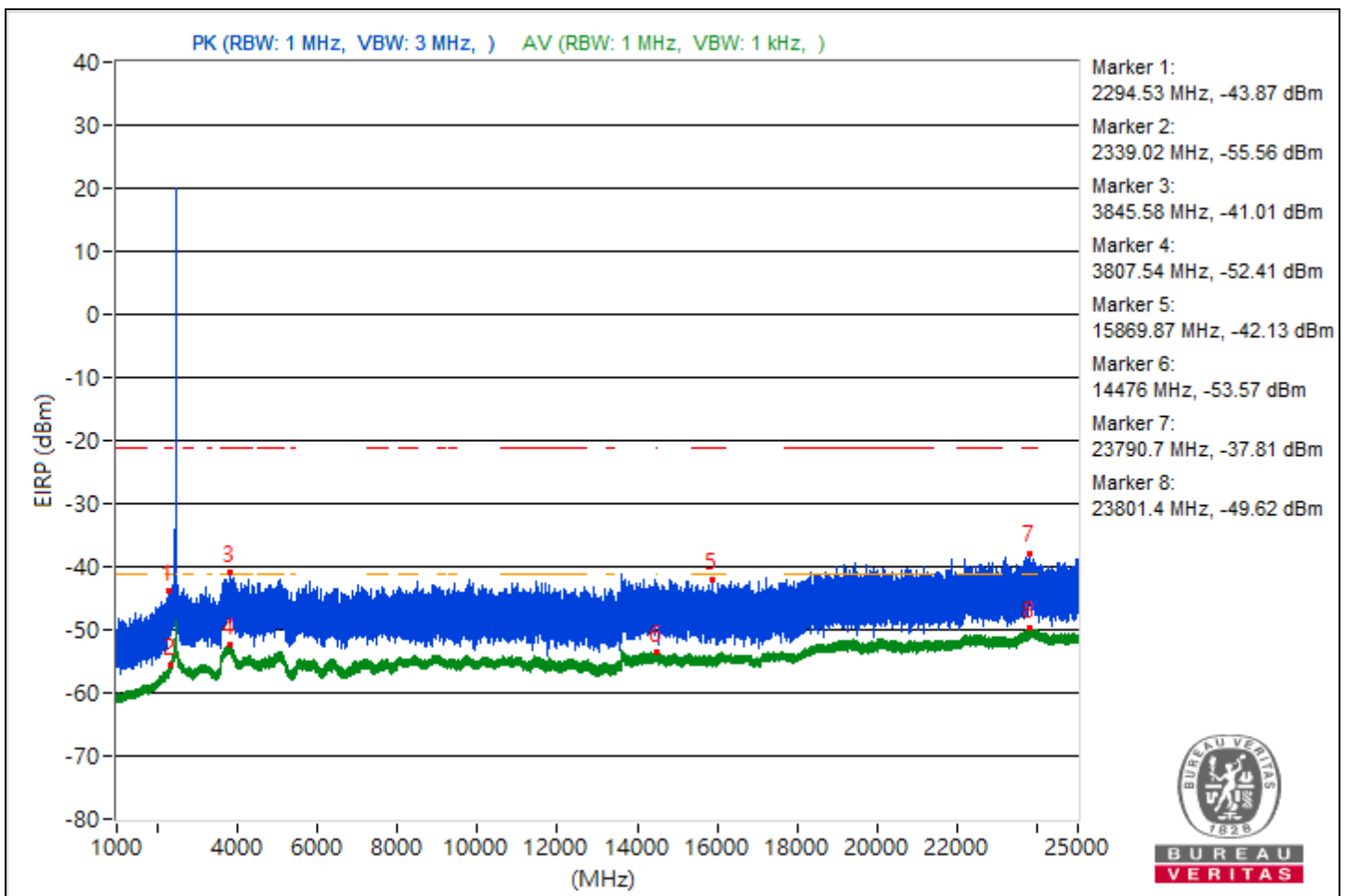



RF Mode	802.11be (EHT20) 106-tone RU	Channel	CH 1 : 2412 MHz
Frequency Range	1 GHz ~ 25 GHz	Environmental Conditions	25°C, 76% RH
Tested By	Waydi Tuan		

Conducted Unwanted Emissions							
No.	Frequency (MHz)	Emission Level (dBuV/m)	Limit (dBuV/m)	Margin (dB)	Raw Value Chain 0 (dBm)	Correction Factor (dB)	EIRP Level (dBm)
1	2297.33	51.69 PK	74	-22.31	-48.49	4.92	-43.57
2	2339.72	41.37 AV	54	-12.63	-58.81	4.92	-53.89
3	3786.16	55.19 PK	74	-18.81	-44.99	4.92	-40.07
4	4813.21	43.19 AV	54	-10.81	-56.99	4.92	-52.07
5	10947.82	53.2 PK	74	-20.8	-46.98	4.92	-42.06
6	14481.96	41.55 AV	54	-12.45	-58.63	4.92	-53.71
7	23815.6	57.33 PK	74	-16.67	-42.85	4.92	-37.93
8	23828.9	45.51 AV	54	-8.49	-54.67	4.92	-49.75

Note: Margin value = Emission Level - Limit value

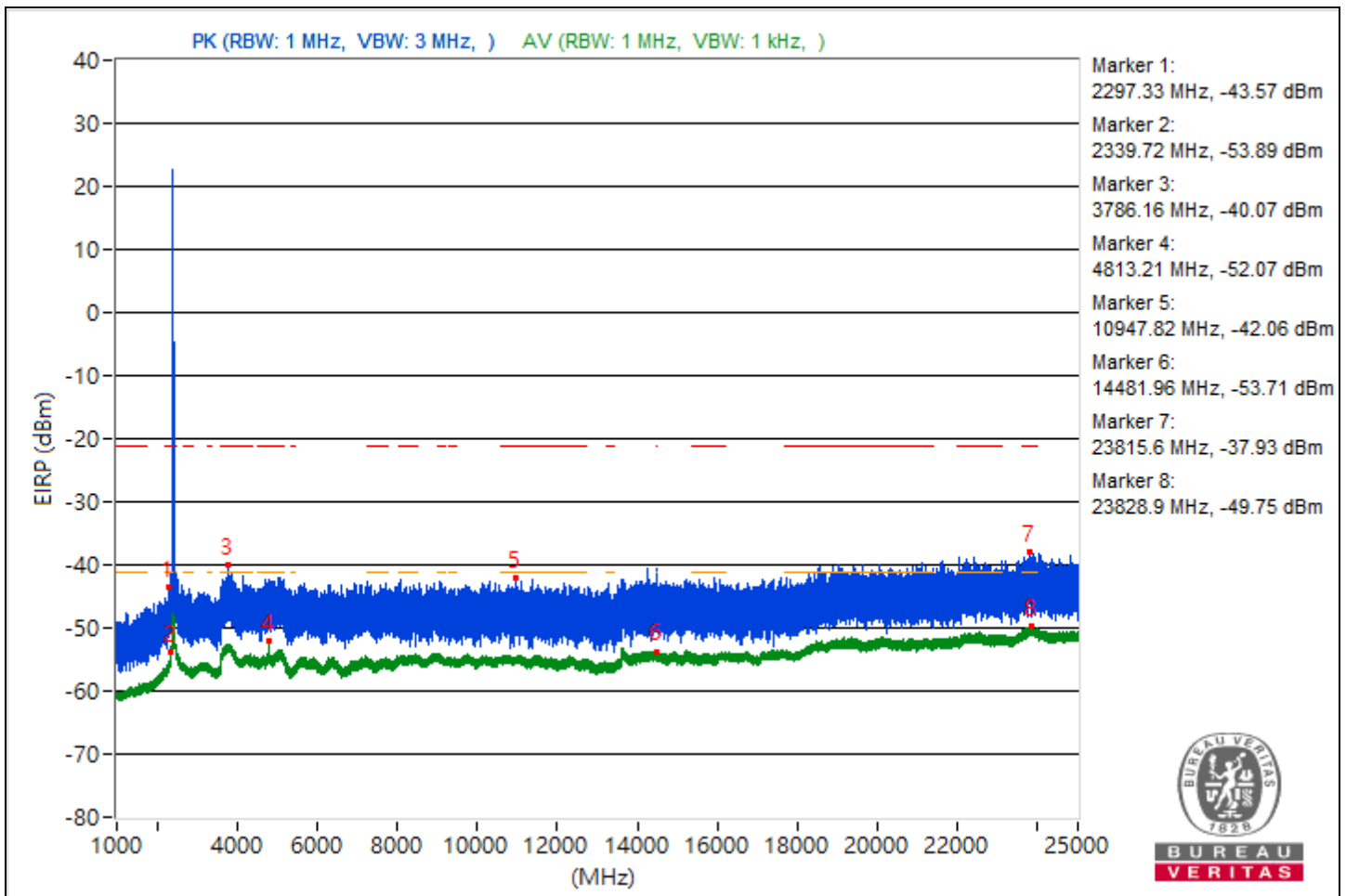

RF Mode	802.11be (EHT20) 106-tone RU	Channel	CH 6 : 2437 MHz
Frequency Range	1 GHz ~ 25 GHz	Environmental Conditions	25°C, 76% RH
Tested By	Waydi Tuan		

Conducted Unwanted Emissions							
No.	Frequency (MHz)	Emission Level (dBuV/m)	Limit (dBuV/m)	Margin (dB)	Raw Value Chain 0 (dBm)	Correction Factor (dB)	EIRP Level (dBm)
1	2265.29	51.56 PK	74	-22.44	-48.62	4.92	-43.7
2	2338.94	41.27 AV	54	-12.73	-58.91	4.92	-53.99
3	3814.78	54.31 PK	74	-19.69	-45.87	4.92	-40.95
4	4860.66	43.6 AV	54	-10.4	-56.58	4.92	-51.66
5	15907.02	53.56 PK	74	-20.44	-46.62	4.92	-41.7
6	14487.73	41.52 AV	54	-12.48	-58.66	4.92	-53.74
7	23739.7	56.72 PK	74	-17.28	-43.46	4.92	-38.54
8	23800.9	45.52 AV	54	-8.48	-54.66	4.92	-49.74

Note: Margin value = Emission Level - Limit value

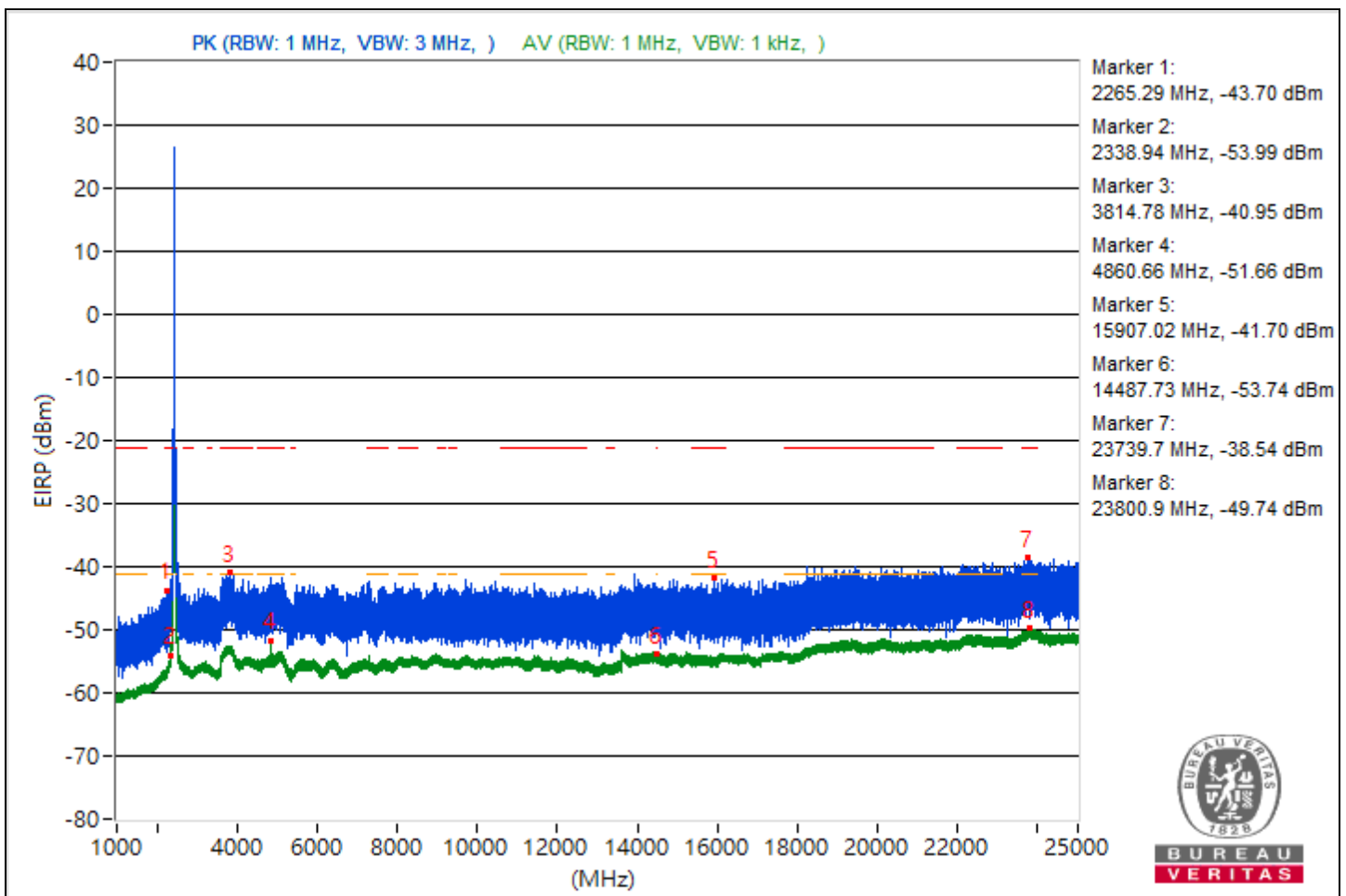

RF Mode	802.11be (EHT20) 106-tone RU	Channel	CH 11 : 2462 MHz
Frequency Range	1 GHz ~ 25 GHz	Environmental Conditions	25°C, 76% RH
Tested By	Waydi Tuan		

Conducted Unwanted Emissions							
No.	Frequency (MHz)	Emission Level (dBuV/m)	Limit (dBuV/m)	Margin (dB)	Raw Value Chain 0 (dBm)	Correction Factor (dB)	EIRP Level (dBm)
1	2329.92	50.8 PK	74	-23.2	-49.38	4.92	-44.46
2	2330.16	40.13 AV	54	-13.87	-60.05	4.92	-55.13
3	3626.63	54.66 PK	74	-19.34	-45.52	4.92	-40.6
4	3788.33	42.63 AV	54	-11.37	-57.55	4.92	-52.63
5	12433.07	54.46 PK	74	-19.54	-45.72	4.92	-40.8
6	14495.73	41.26 AV	54	-12.74	-58.92	4.92	-54
7	23834.1	57.85 PK	74	-16.15	-42.33	4.92	-37.41
8	23828.1	45.6 AV	54	-8.4	-54.58	4.92	-49.66

Note: Margin value = Emission Level - Limit value

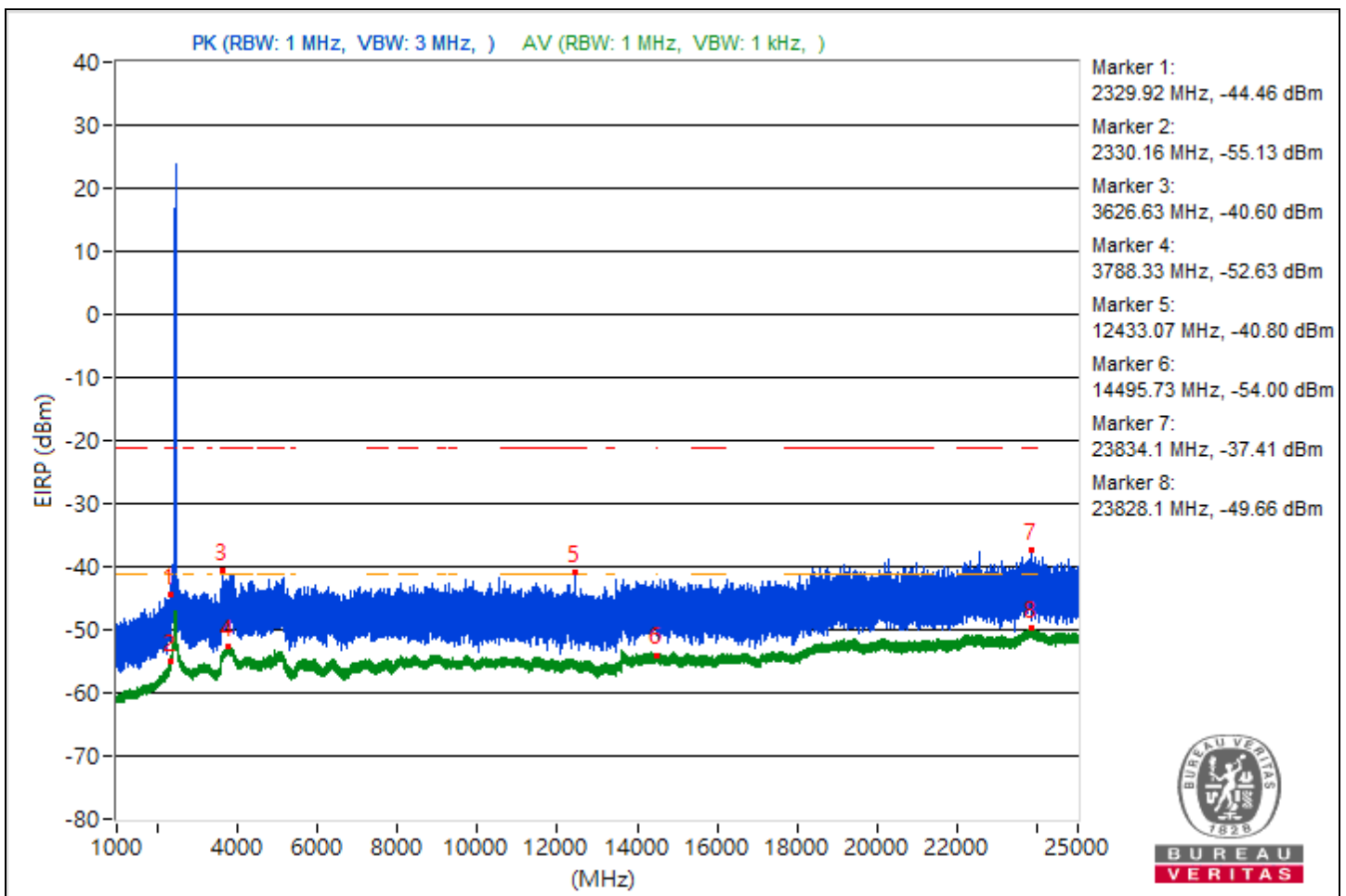





RF Mode	802.11be (EHT20) 106-tone RU	Channel	CH 12 : 2467 MHz
Frequency Range	1 GHz ~ 25 GHz	Environmental Conditions	25°C, 76% RH
Tested By	Waydi Tuan		

Conducted Unwanted Emissions							
No.	Frequency (MHz)	Emission Level (dBuV/m)	Limit (dBuV/m)	Margin (dB)	Raw Value Chain 0 (dBm)	Correction Factor (dB)	EIRP Level (dBm)
1	2257.43	50.63 PK	74	-23.37	-49.55	4.92	-44.63
2	2338.32	40.05 AV	54	-13.95	-60.13	4.92	-55.21
3	3728.44	54.47 PK	74	-19.53	-45.71	4.92	-40.79
4	3813.3	42.72 AV	54	-11.28	-57.46	4.92	-52.54
5	15687.64	54.35 PK	74	-19.65	-45.83	4.92	-40.91
6	14499.2	41.44 AV	54	-12.56	-58.74	4.92	-53.82
7	23752.6	57.2 PK	74	-16.8	-42.98	4.92	-38.06
8	23789.7	45.47 AV	54	-8.53	-54.71	4.92	-49.79

Note: Margin value = Emission Level - Limit value

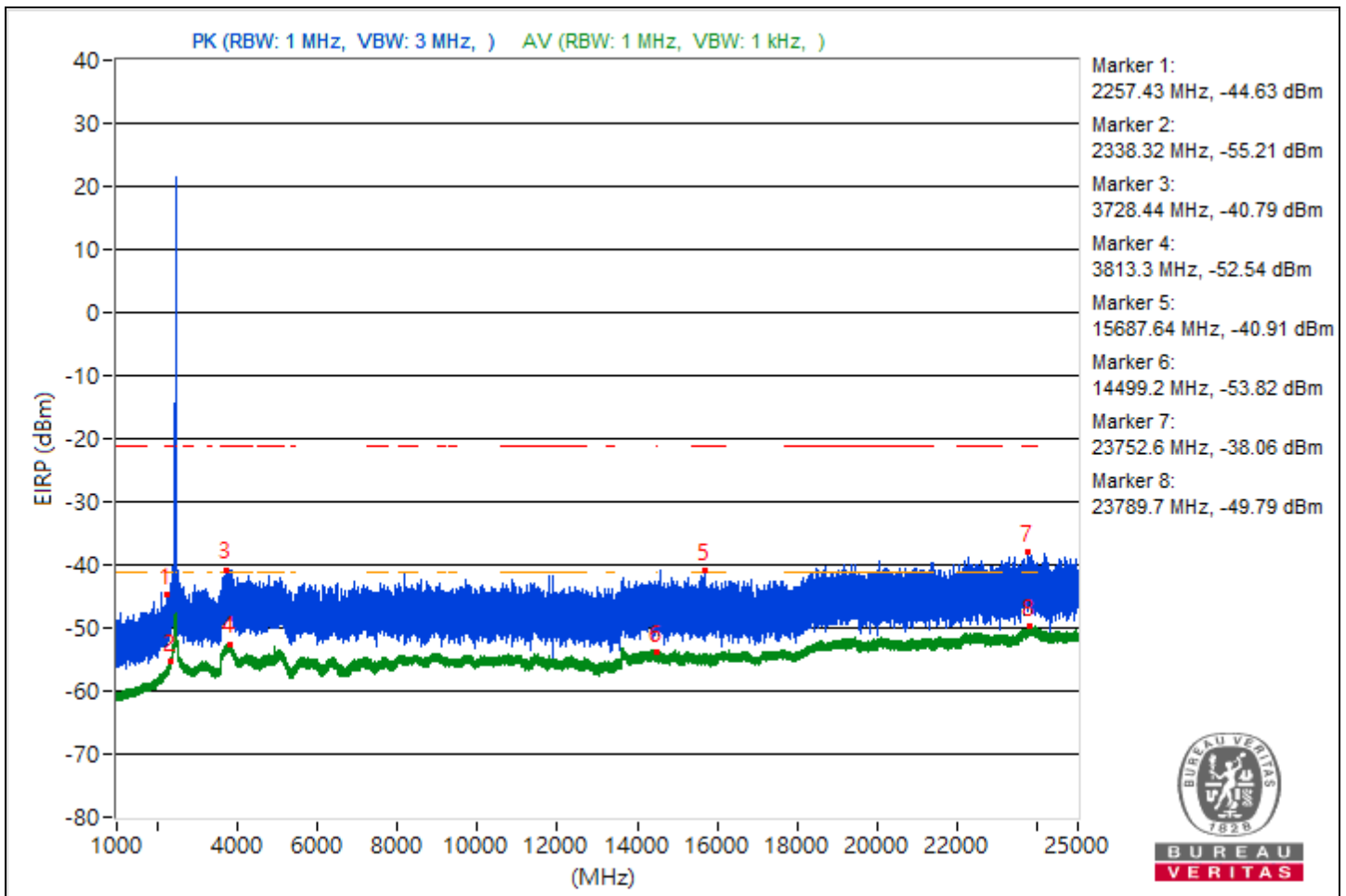

RF Mode	802.11be (EHT20) 106-tone RU	Channel	CH 13 : 2472 MHz
Frequency Range	1 GHz ~ 25 GHz	Environmental Conditions	25°C, 76% RH
Tested By	Waydi Tuan		

Conducted Unwanted Emissions							
No.	Frequency (MHz)	Emission Level (dBuV/m)	Limit (dBuV/m)	Margin (dB)	Raw Value Chain 0 (dBm)	Correction Factor (dB)	EIRP Level (dBm)
1	2316.16	50.54 PK	74	-23.46	-49.64	4.92	-44.72
2	2337.93	39.71 AV	54	-14.29	-60.47	4.92	-55.55
3	3818.59	54.34 PK	74	-19.66	-45.84	4.92	-40.92
4	3804.51	42.67 AV	54	-11.33	-57.51	4.92	-52.59
5	11518.84	53.98 PK	74	-20.02	-46.2	4.92	-41.28
6	14474.49	41.59 AV	54	-12.41	-58.59	4.92	-53.67
7	23897.9	57.29 PK	74	-16.71	-42.89	4.92	-37.97
8	23808.3	45.58 AV	54	-8.42	-54.6	4.92	-49.68

Note: Margin value = Emission Level - Limit value

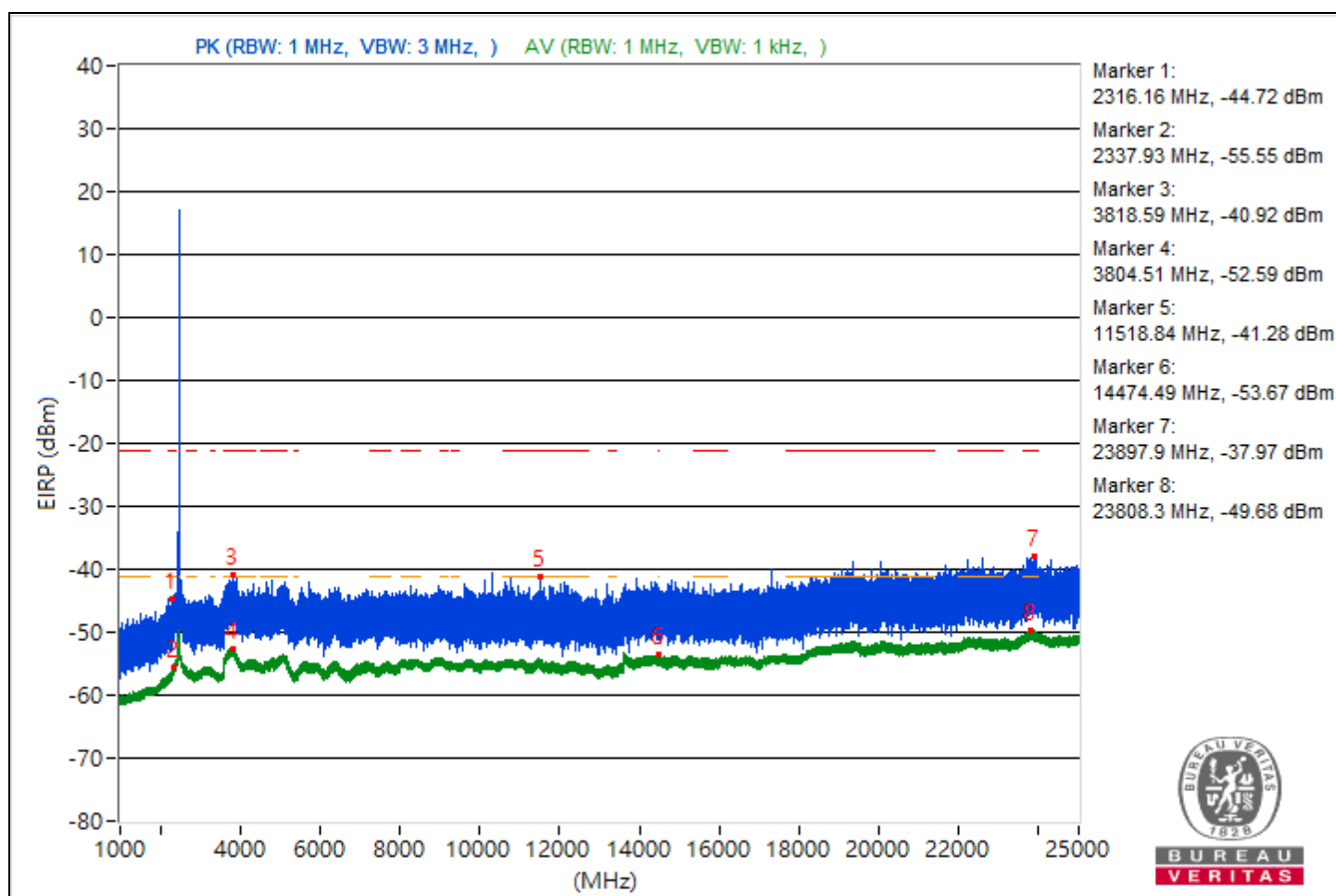

RF Mode	802.11be (EHT20) 52+26-tone MRU	Channel	CH 1 : 2412 MHz
Frequency Range	1 GHz ~ 25 GHz	Environmental Conditions	25°C, 76% RH
Tested By	Waydi Tuan		

Conducted Unwanted Emissions							
No.	Frequency (MHz)	Emission Level (dBuV/m)	Limit (dBuV/m)	Margin (dB)	Raw Value Chain 0 (dBm)	Correction Factor (dB)	EIRP Level (dBm)
1	2327.74	51.25 PK	74	-22.75	-48.93	4.92	-44.01
2	2333.27	41.03 AV	54	-12.97	-59.15	4.92	-54.23
3	3825.43	54.11 PK	74	-19.89	-46.07	4.92	-41.15
4	4815.7	43.64 AV	54	-10.36	-56.54	4.92	-51.62
5	15657.69	53.35 PK	74	-20.65	-46.83	4.92	-41.91
6	14497.96	41.4 AV	54	-12.6	-58.78	4.92	-53.86
7	23716.2	57.4 PK	74	-16.6	-42.78	4.92	-37.86
8	23826.9	45.54 AV	54	-8.46	-54.64	4.92	-49.72

Note: Margin value = Emission Level - Limit value

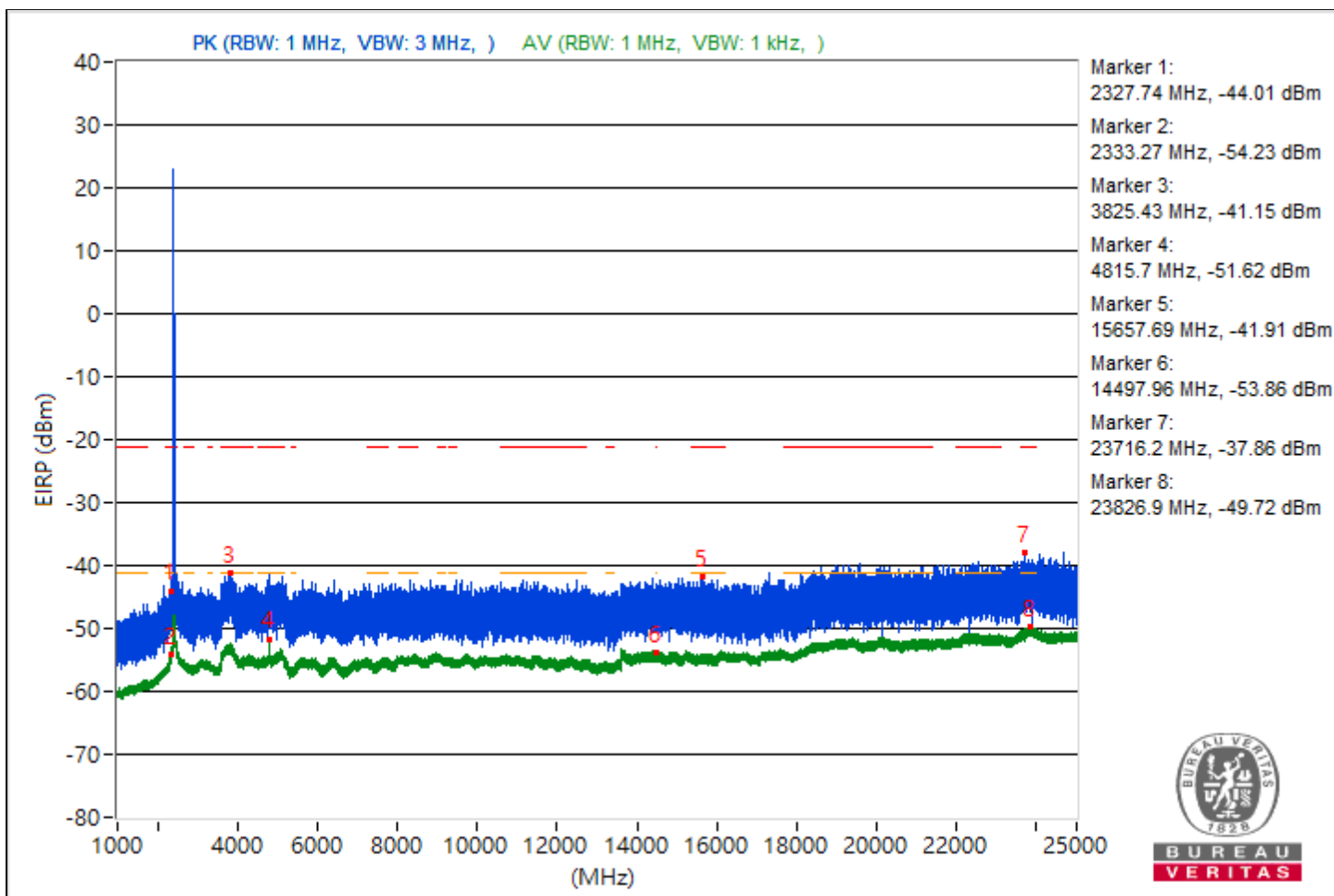



RF Mode	802.11be (EHT20) 52+26-tone MRU	Channel	CH 6 : 2437 MHz
Frequency Range	1 GHz ~ 25 GHz	Environmental Conditions	25°C, 76% RH
Tested By	Waydi Tuan		

Conducted Unwanted Emissions							
No.	Frequency (MHz)	Emission Level (dBuV/m)	Limit (dBuV/m)	Margin (dB)	Raw Value Chain 0 (dBm)	Correction Factor (dB)	EIRP Level (dBm)
1	2330.54	51.88 PK	74	-22.12	-48.3	4.92	-43.38
2	2339.02	41.22 AV	54	-12.78	-58.96	4.92	-54.04
3	4832.34	54.34 PK	74	-19.66	-45.84	4.92	-40.92
4	4865.94	44.51 AV	54	-9.49	-55.67	4.92	-50.75
5	15397.24	53.85 PK	74	-20.15	-46.33	4.92	-41.41
6	14493.07	41.48 AV	54	-12.52	-58.7	4.92	-53.78
7	23765.2	56.93 PK	74	-17.07	-43.25	4.92	-38.33
8	23819	45.54 AV	54	-8.46	-54.64	4.92	-49.72

Note: Margin value = Emission Level - Limit value

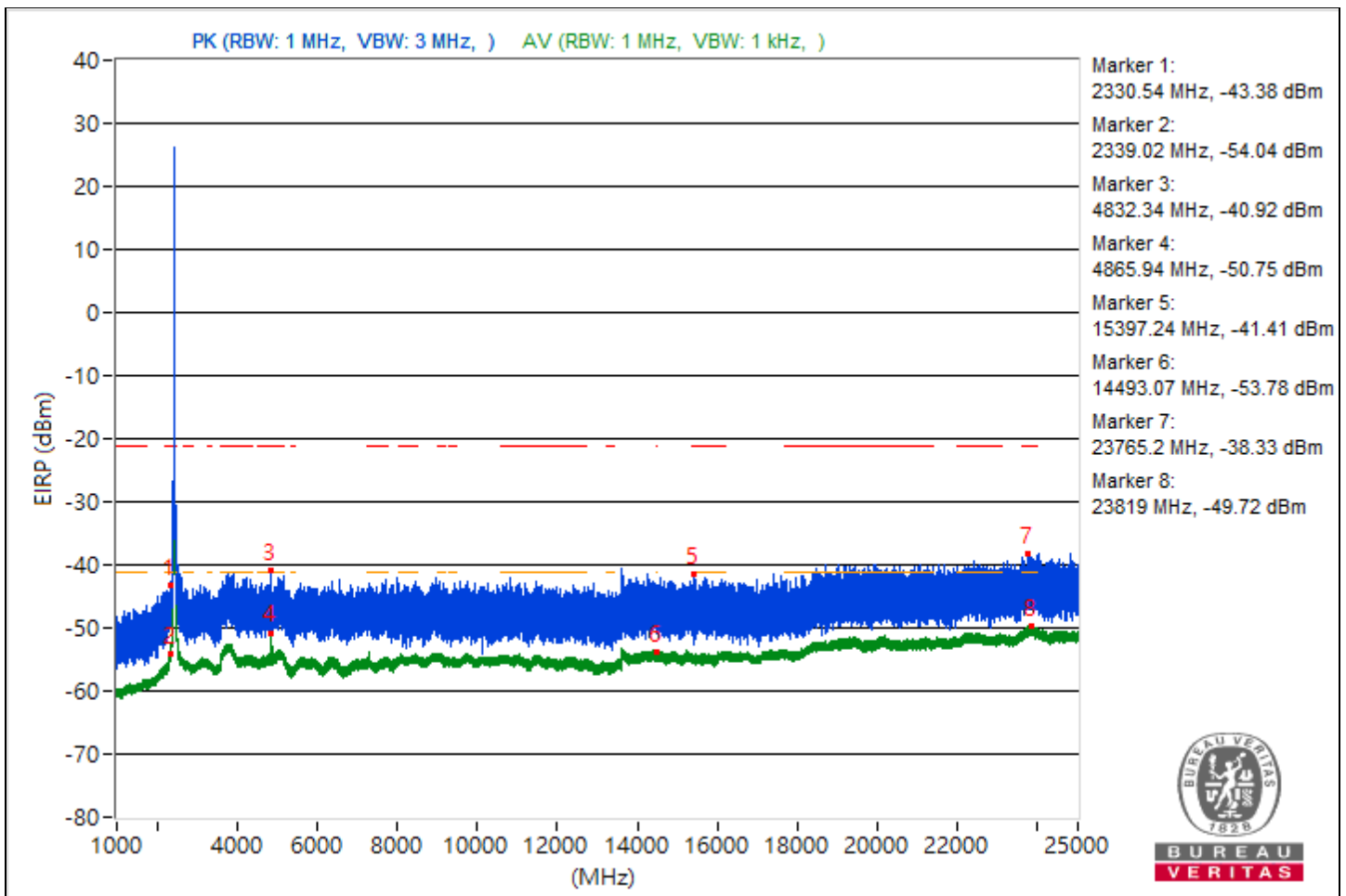

RF Mode	802.11be (EHT20) 52+26-tone MRU	Channel	CH 11 : 2462 MHz
Frequency Range	1 GHz ~ 25 GHz	Environmental Conditions	25°C, 76% RH
Tested By	Waydi Tuan		

Conducted Unwanted Emissions							
No.	Frequency (MHz)	Emission Level (dBuV/m)	Limit (dBuV/m)	Margin (dB)	Raw Value Chain 0 (dBm)	Correction Factor (dB)	EIRP Level (dBm)
1	2323.86	50.99 PK	74	-23.01	-49.19	4.92	-44.27
2	2339.96	40.49 AV	54	-13.51	-59.69	4.92	-54.77
3	3790.59	54.95 PK	74	-19.05	-45.23	4.92	-40.31
4	3796.34	42.67 AV	54	-11.33	-57.51	4.92	-52.59
5	11393.51	53.05 PK	74	-20.95	-47.13	4.92	-42.21
6	14478.13	41.4 AV	54	-12.6	-58.78	4.92	-53.86
7	23804.7	57.2 PK	74	-16.8	-42.98	4.92	-38.06
8	23820.4	45.47 AV	54	-8.53	-54.71	4.92	-49.79

Note: Margin value = Emission Level - Limit value

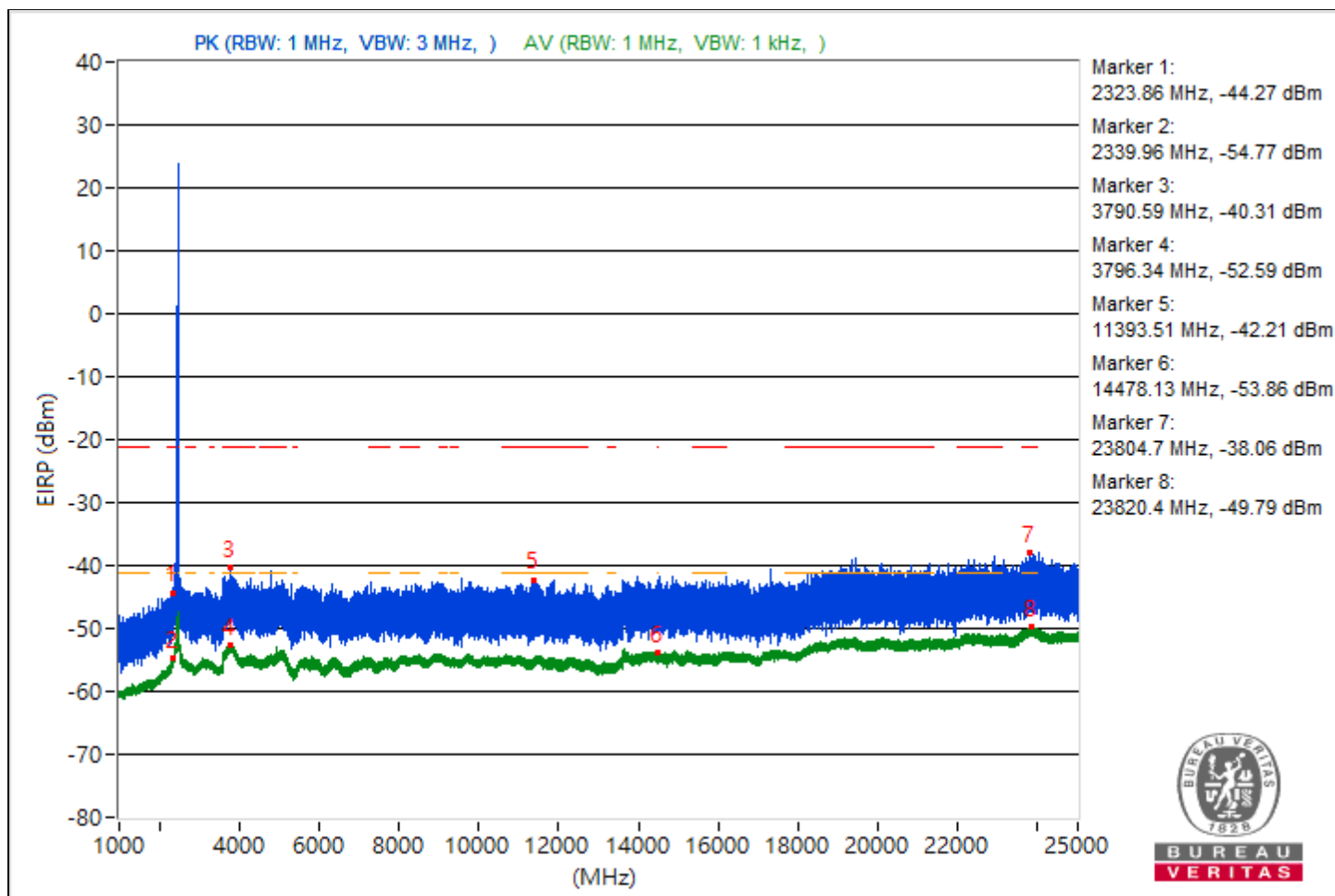

RF Mode	802.11be (EHT20) 52+26-tone MRU	Channel	CH 12 : 2467 MHz
Frequency Range	1 GHz ~ 25 GHz	Environmental Conditions	25°C, 76% RH
Tested By	Waydi Tuan		

Conducted Unwanted Emissions							
No.	Frequency (MHz)	Emission Level (dBuV/m)	Limit (dBuV/m)	Margin (dB)	Raw Value Chain 0 (dBm)	Correction Factor (dB)	EIRP Level (dBm)
1	2275.48	50.76 PK	74	-23.24	-49.42	4.92	-44.5
2	2327.2	40.1 AV	54	-13.9	-60.08	4.92	-55.16
3	3889.21	53.77 PK	74	-20.23	-46.41	4.92	-41.49
4	3767.26	42.75 AV	54	-11.25	-57.43	4.92	-52.51
5	8151.56	53.6 PK	74	-20.4	-46.58	4.92	-41.66
6	14490.04	41.53 AV	54	-12.47	-58.65	4.92	-53.73
7	23946.4	57.63 PK	74	-16.37	-42.55	4.92	-37.63
8	23867.9	45.66 AV	54	-8.34	-54.52	4.92	-49.6

Note: Margin value = Emission Level - Limit value

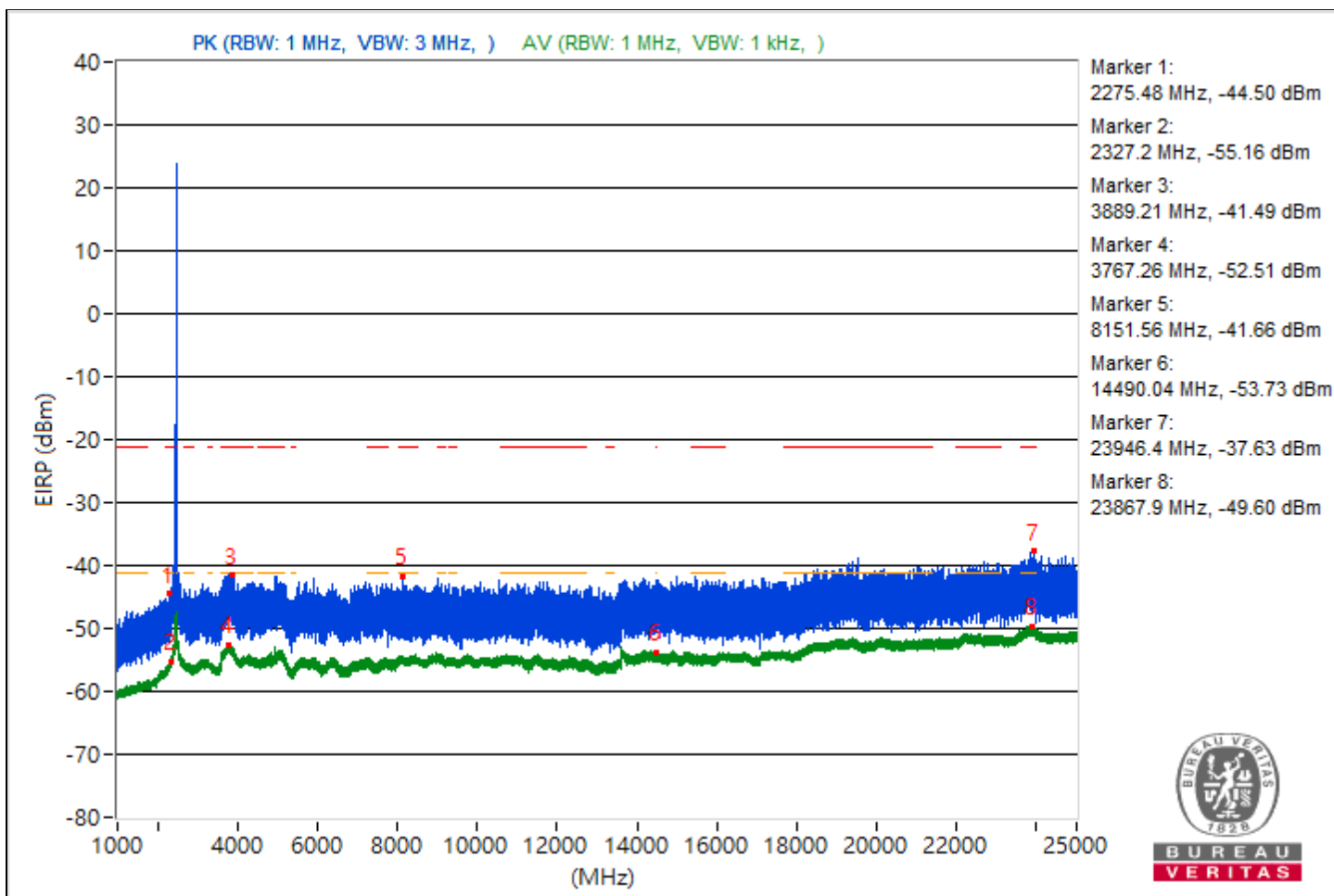



RF Mode	802.11be (EHT20) 52+26-tone MRU	Channel	CH 13 : 2472 MHz
Frequency Range	1 GHz ~ 25 GHz	Environmental Conditions	25°C, 76% RH
Tested By	Waydi Tuan		

Conducted Unwanted Emissions							
No.	Frequency (MHz)	Emission Level (dBuV/m)	Limit (dBuV/m)	Margin (dB)	Raw Value Chain 0 (dBm)	Correction Factor (dB)	EIRP Level (dBm)
1	2333.66	50.29 PK	74	-23.71	-49.89	4.92	-44.97
2	2338.87	40.41 AV	54	-13.59	-59.77	4.92	-54.85
3	3763.91	54.95 PK	74	-19.05	-45.23	4.92	-40.31
4	3779.16	42.74 AV	54	-11.26	-57.44	4.92	-52.52
5	15710.13	53.95 PK	74	-20.05	-46.23	4.92	-41.31
6	14481.69	41.45 AV	54	-12.55	-58.73	4.92	-53.81
7	23743.9	57.26 PK	74	-16.74	-42.92	4.92	-38
8	23680.2	45.56 AV	54	-8.44	-54.62	4.92	-49.7

Note: Margin value = Emission Level - Limit value

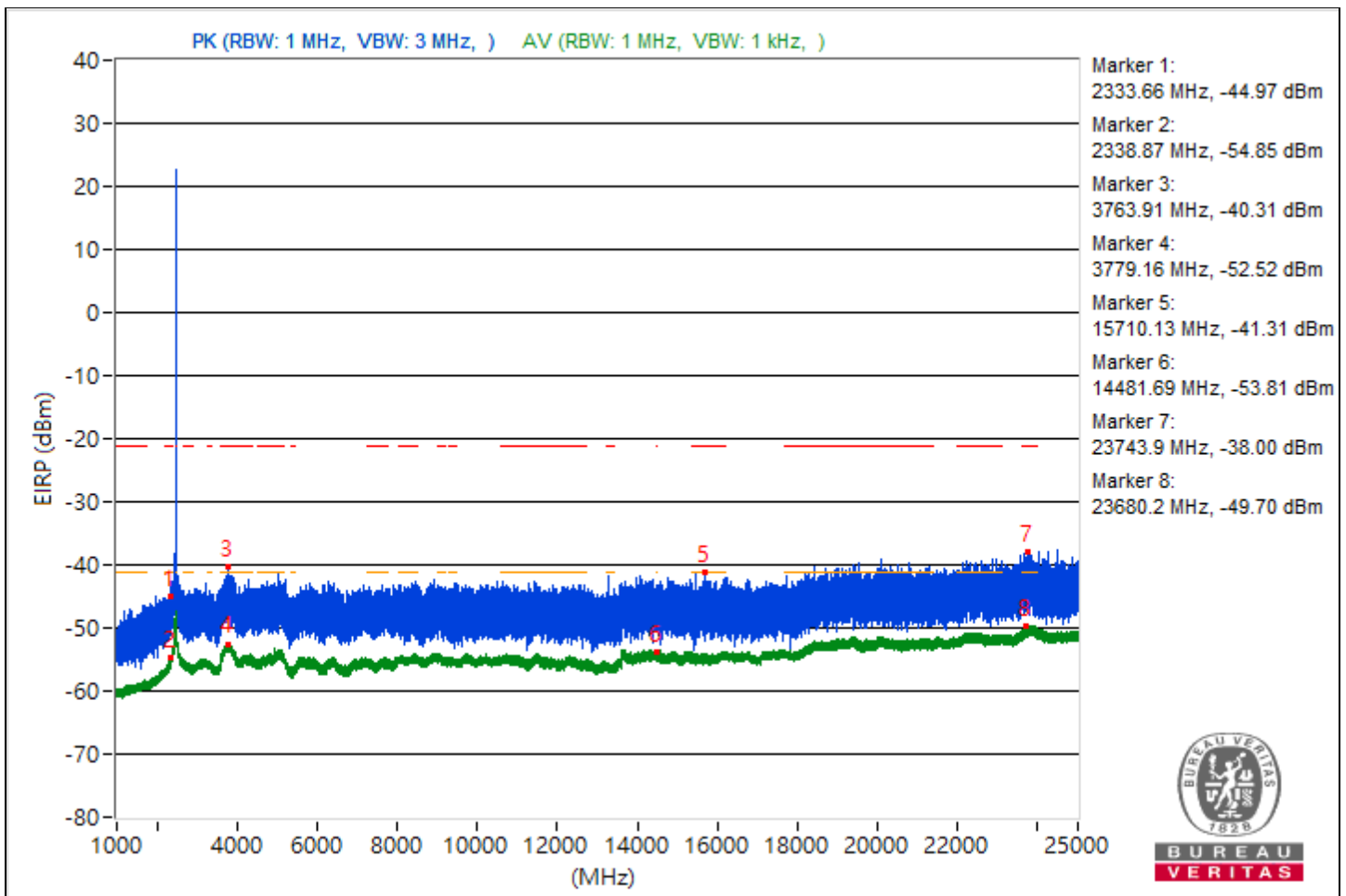

RF Mode	802.11be (EHT20) 106+26-tone MRU	Channel	CH 1 : 2412 MHz
Frequency Range	1 GHz ~ 25 GHz	Environmental Conditions	25°C, 76% RH
Tested By	Waydi Tuan		

Conducted Unwanted Emissions							
No.	Frequency (MHz)	Emission Level (dBuV/m)	Limit (dBuV/m)	Margin (dB)	Raw Value Chain 0 (dBm)	Correction Factor (dB)	EIRP Level (dBm)
1	2335.83	53.21 PK	74	-20.79	-46.97	4.92	-42.05
2	2338.71	41.61 AV	54	-12.39	-58.57	4.92	-53.65
3	5053.47	55.32 PK	74	-18.68	-44.86	4.92	-39.94
4	4818.11	42.8 AV	54	-11.2	-57.38	4.92	-52.46
5	15585.87	53.7 PK	74	-20.3	-46.48	4.92	-41.56
6	14478.22	41.43 AV	54	-12.57	-58.75	4.92	-53.83
7	23857.7	57.13 PK	74	-16.87	-43.05	4.92	-38.13
8	23837.1	45.75 AV	54	-8.25	-54.43	4.92	-49.51

Note: Margin value = Emission Level - Limit value

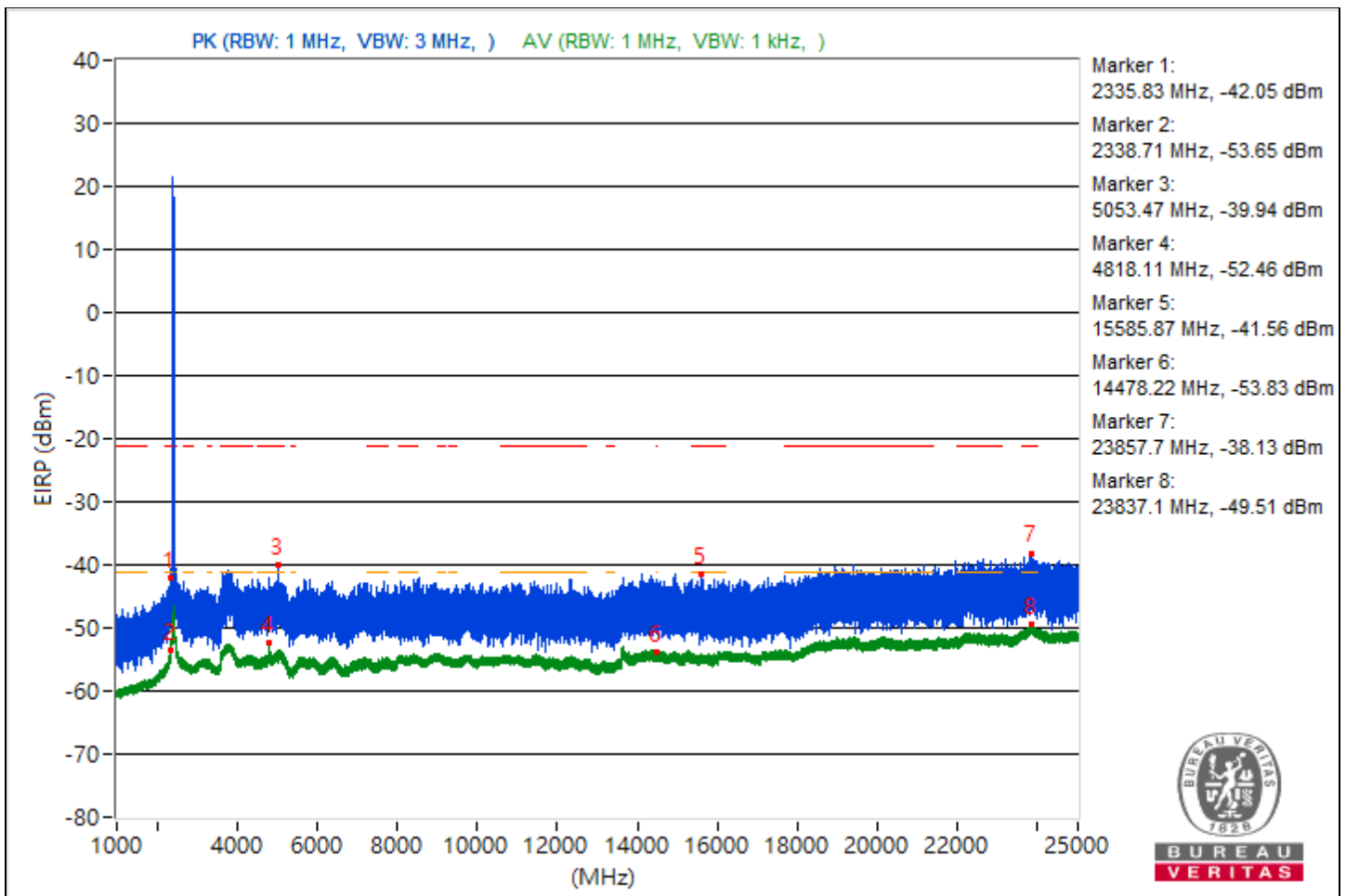



RF Mode	802.11be (EHT20) 106+26-tone MRU	Channel	CH 6 : 2437 MHz
Frequency Range	1 GHz ~ 25 GHz	Environmental Conditions	25°C, 76% RH
Tested By	Waydi Tuan		

Conducted Unwanted Emissions							
No.	Frequency (MHz)	Emission Level (dBuV/m)	Limit (dBuV/m)	Margin (dB)	Raw Value Chain 0 (dBm)	Correction Factor (dB)	EIRP Level (dBm)
1	2332.64	52.03 PK	74	-21.97	-48.15	4.92	-43.23
2	2339.88	41.51 AV	54	-12.49	-58.67	4.92	-53.75
3	3819.37	54.08 PK	74	-19.92	-46.1	4.92	-41.18
4	4863.22	43.2 AV	54	-10.8	-56.98	4.92	-52.06
5	14472.8	53.25 PK	74	-20.75	-46.93	4.92	-42.01
6	14475.02	41.58 AV	54	-12.42	-58.6	4.92	-53.68
7	23733	57.12 PK	74	-16.88	-43.06	4.92	-38.14
8	23856	45.58 AV	54	-8.42	-54.6	4.92	-49.68

Note: Margin value = Emission Level - Limit value

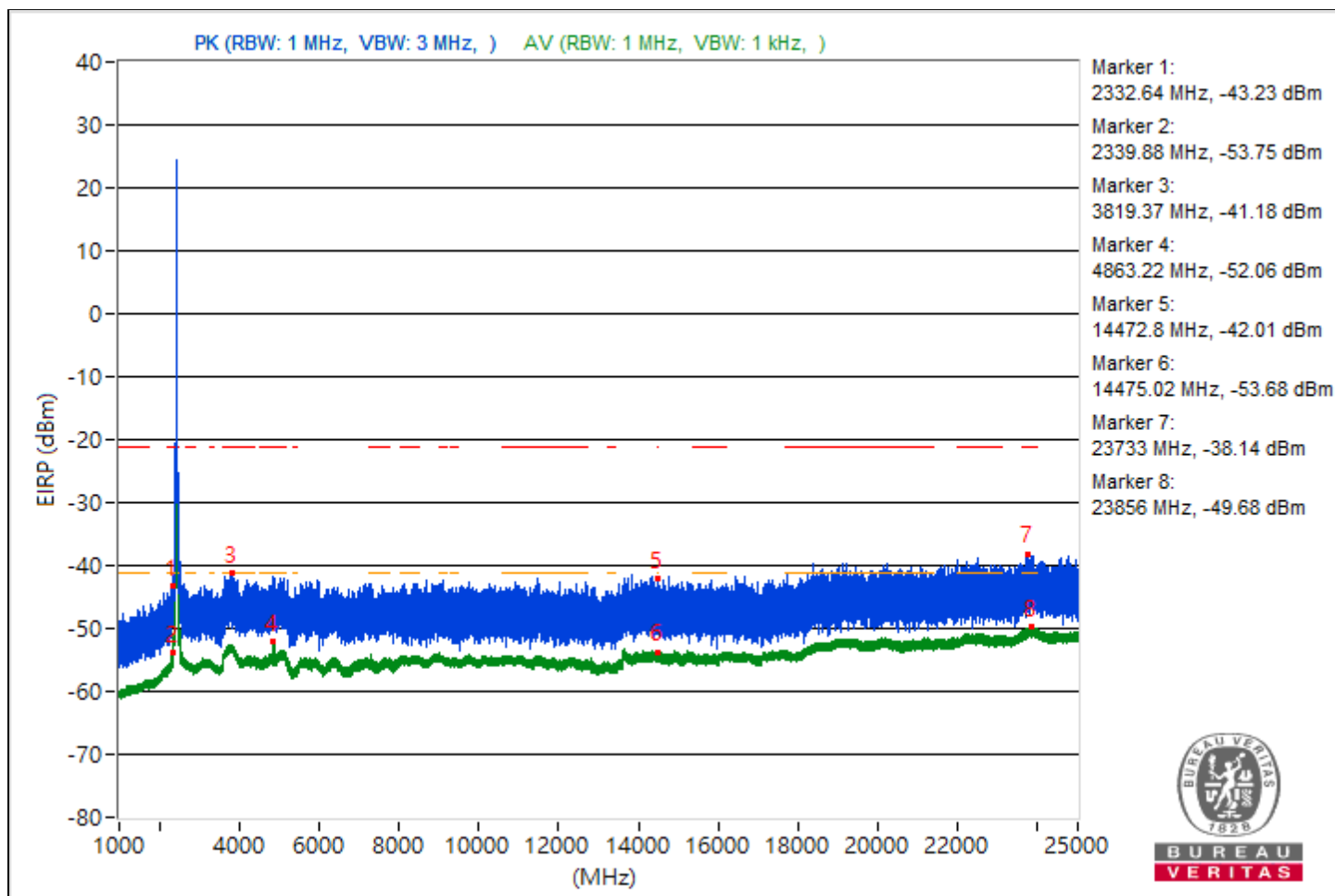

RF Mode	802.11be (EHT20) 106+26-tone MRU	Channel	CH 11 : 2462 MHz
Frequency Range	1 GHz ~ 25 GHz	Environmental Conditions	25°C, 76% RH
Tested By	Waydi Tuan		

Conducted Unwanted Emissions							
No.	Frequency (MHz)	Emission Level (dBuV/m)	Limit (dBuV/m)	Margin (dB)	Raw Value Chain 0 (dBm)	Correction Factor (dB)	EIRP Level (dBm)
1	2331.4	50.76 PK	74	-23.24	-49.42	4.92	-44.5
2	2335.91	40.45 AV	54	-13.55	-59.73	4.92	-54.81
3	3797.51	55.29 PK	74	-18.71	-44.89	4.92	-39.97
4	3801.09	42.78 AV	54	-11.22	-57.4	4.92	-52.48
5	8281.6	53.55 PK	74	-20.45	-46.63	4.92	-41.71
6	14471.02	41.47 AV	54	-12.53	-58.71	4.92	-53.79
7	22686.2	56.83 PK	74	-17.17	-43.35	4.92	-38.43
8	23796.2	45.67 AV	54	-8.33	-54.51	4.92	-49.59

Note: Margin value = Emission Level - Limit value

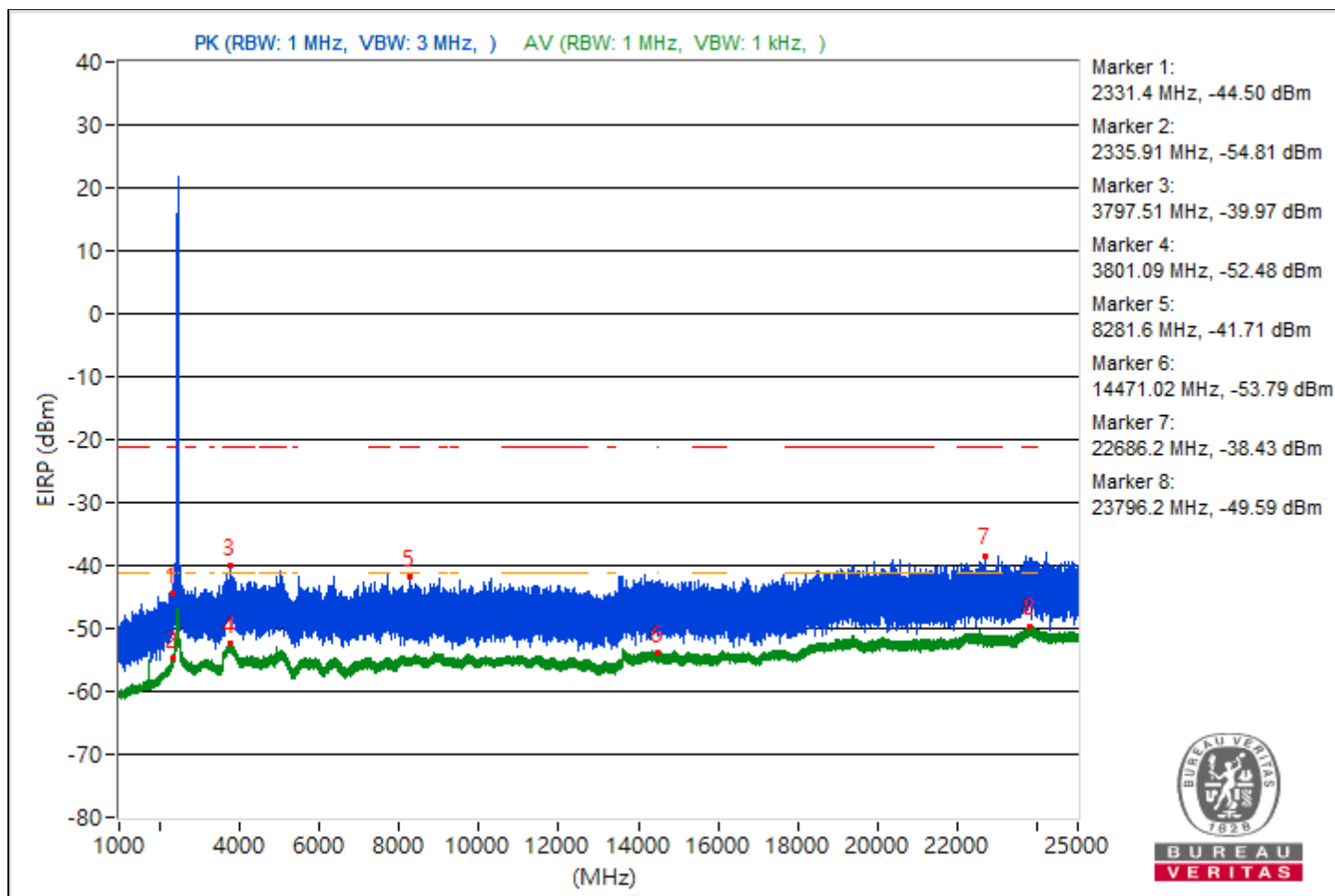



RF Mode	802.11be (EHT20) 106+26-tone MRU	Channel	CH 12 : 2467 MHz
Frequency Range	1 GHz ~ 25 GHz	Environmental Conditions	25°C, 76% RH
Tested By	Waydi Tuan		

Conducted Unwanted Emissions							
No.	Frequency (MHz)	Emission Level (dBUV/m)	Limit (dBUV/m)	Margin (dB)	Raw Value Chain 0 (dBm)	Correction Factor (dB)	EIRP Level (dBm)
1	2336.07	51.54 PK	74	-22.46	-48.64	4.92	-43.72
2	2331.17	40.3 AV	54	-13.7	-59.88	4.92	-54.96
3	3643.59	54.56 PK	74	-19.44	-45.62	4.92	-40.7
4	3787.48	42.66 AV	54	-11.34	-57.52	4.92	-52.6
5	11495.38	53.04 PK	74	-20.96	-47.14	4.92	-42.22
6	14493.87	41.29 AV	54	-12.71	-58.89	4.92	-53.97
7	23756.5	58 PK	74	-16	-42.18	4.92	-37.26
8	23863.2	45.56 AV	54	-8.44	-54.62	4.92	-49.7

Note: Margin value = Emission Level - Limit value

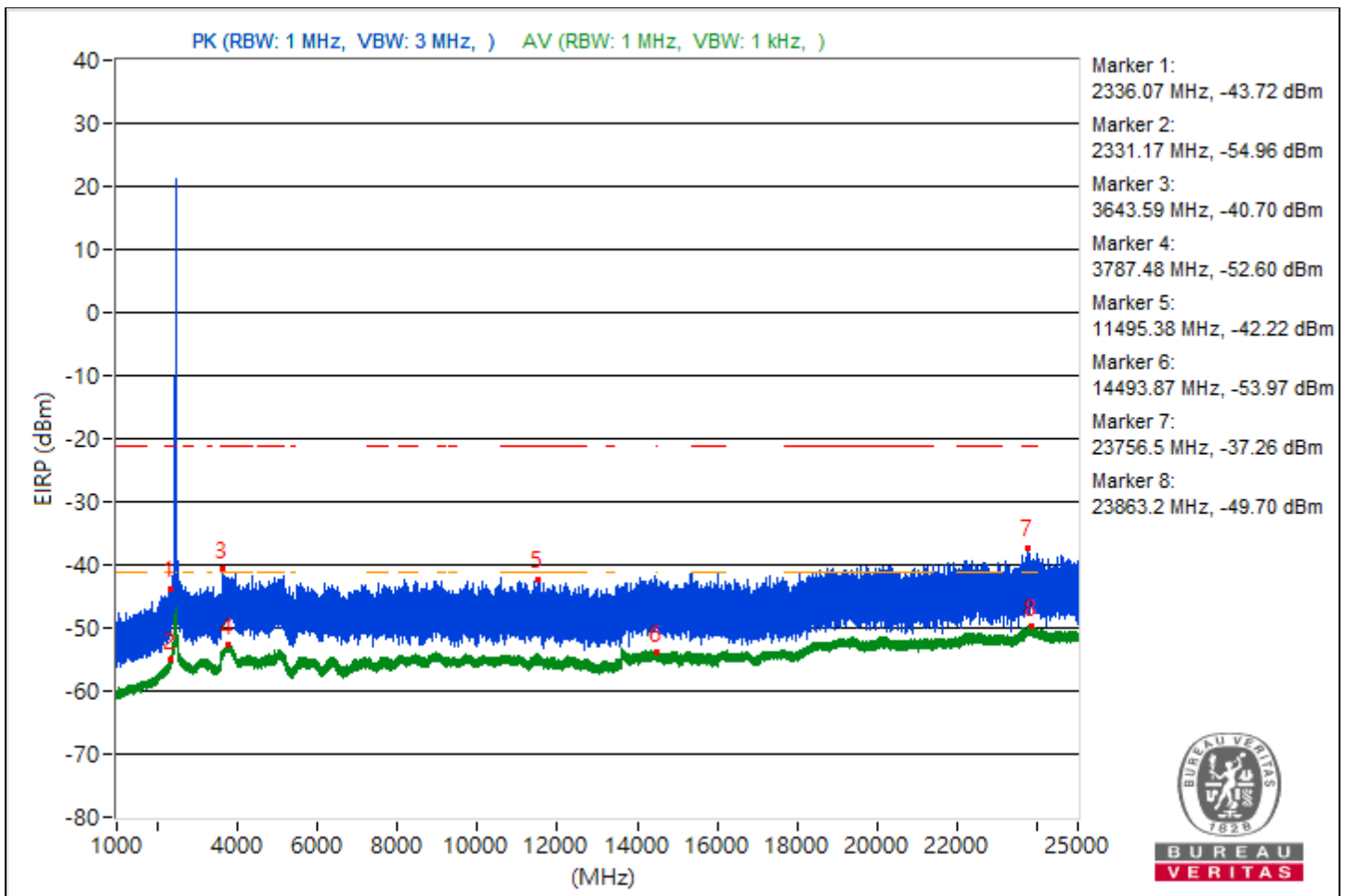



RF Mode	802.11be (EHT20) 106+26-tone MRU	Channel	CH 13 : 2472 MHz
Frequency Range	1 GHz ~ 25 GHz	Environmental Conditions	25°C, 76% RH
Tested By	Waydi Tuan		

Conducted Unwanted Emissions							
No.	Frequency (MHz)	Emission Level (dBuV/m)	Limit (dBuV/m)	Margin (dB)	Raw Value Chain 0 (dBm)	Correction Factor (dB)	EIRP Level (dBm)
1	2321.6	51.9 PK	74	-22.1	-48.28	4.92	-43.36
2	2338.09	40.28 AV	54	-13.72	-59.9	4.92	-54.98
3	3780.01	54.57 PK	74	-19.43	-45.61	4.92	-40.69
4	3778.92	42.68 AV	54	-11.32	-57.5	4.92	-52.58
5	11561.07	53.18 PK	74	-20.82	-47	4.92	-42.08
6	14470.67	41.46 AV	54	-12.54	-58.72	4.92	-53.8
7	23891.1	57.74 PK	74	-16.26	-42.44	4.92	-37.52
8	23806.3	45.6 AV	54	-8.4	-54.58	4.92	-49.66

Note: Margin value = Emission Level - Limit value

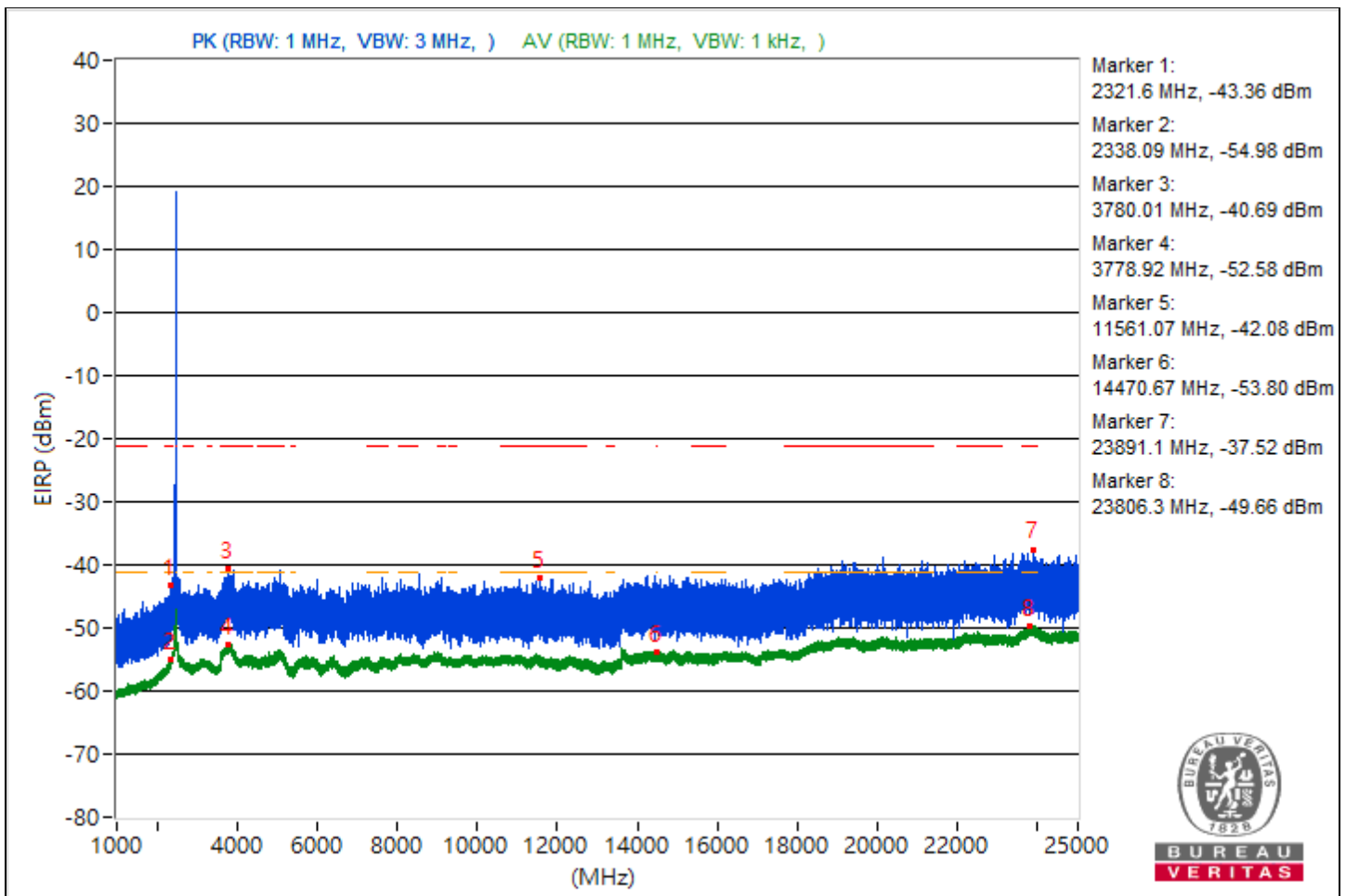

## Conducted Band Edges

RF Mode	802.11be (EHT20)	Channel	CH 1 : 2412 MHz
Frequency Range	2.31 GHz ~ 2.5 GHz	Environmental Conditions	25°C, 76% RH
Tested By	Waydi Tuan		

Conducted Band Edge							
No.	Frequency (MHz)	Emission Level (dBuV/m)	Limit (dBuV/m)	Margin (dB)	Raw Value Chain 0 (dBm)	Correction Factor (dB)	EIRP Level (dBm)
1	*2414.55	115.07 PK			16.63	3.18	19.81
2	*2410.8	103.31 AV			4.87	3.18	8.05
3	2389.32	68.85 PK	74	-5.15	-29.59	3.18	-26.41
4	2390	50.14 AV	54	-3.86	-48.3	3.18	-45.12
5	2487.03	59.63 PK	74	-14.37	-38.81	3.18	-35.63
6	2485.06	46.38 AV	54	-7.62	-52.06	3.18	-48.88

Notes:

1. Margin value = Emission Level - Limit value
2. " \* \* ": Fundamental frequency, the limit was restricted at the RF Output Power.

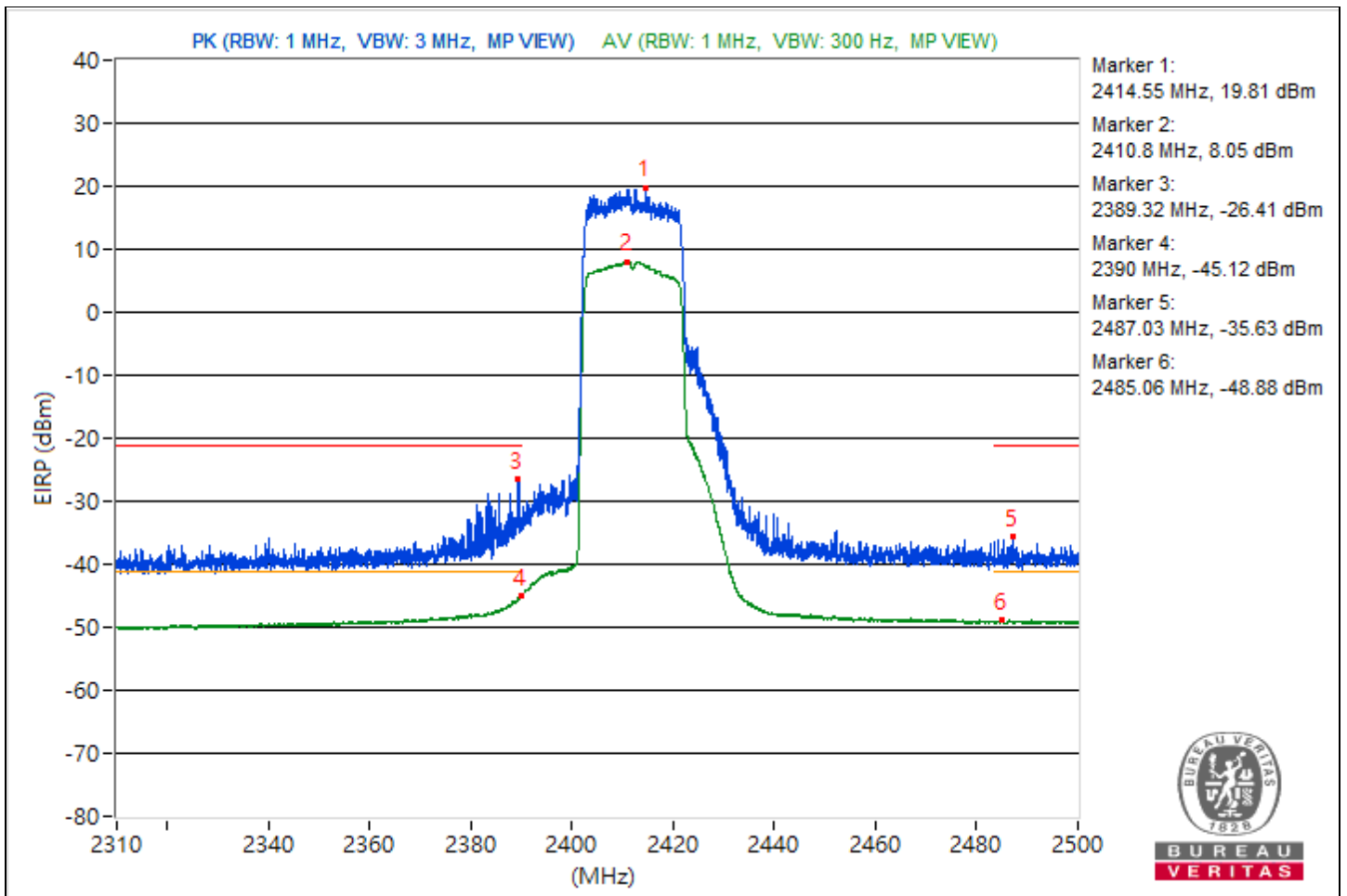

RF Mode	802.11be (EHT20)	Channel	CH 6 : 2437 MHz
Frequency Range	2.31 GHz ~ 2.5 GHz	Environmental Conditions	25°C, 76% RH
Tested By	Waydi Tuan		

Conducted Band Edge							
No.	Frequency (MHz)	Emission Level (dBuV/m)	Limit (dBuV/m)	Margin (dB)	Raw Value Chain 0 (dBm)	Correction Factor (dB)	EIRP Level (dBm)
1	*2436.26	118.95 PK			20.51	3.18	23.69
2	*2435.99	106.63 AV			8.19	3.18	11.37
3	2387.38	70.49 PK	74	-3.51	-27.95	3.18	-24.77
4	2390	52.37 AV	54	-1.63	-46.07	3.18	-42.89
5	2484.28	69.14 PK	74	-4.86	-29.3	3.18	-26.12
6	2483.5	52.65 AV	54	-1.35	-45.79	3.18	-42.61

Notes:

1. Margin value = Emission Level - Limit value
2. " \* " : Fundamental frequency, the limit was restricted at the RF Output Power.

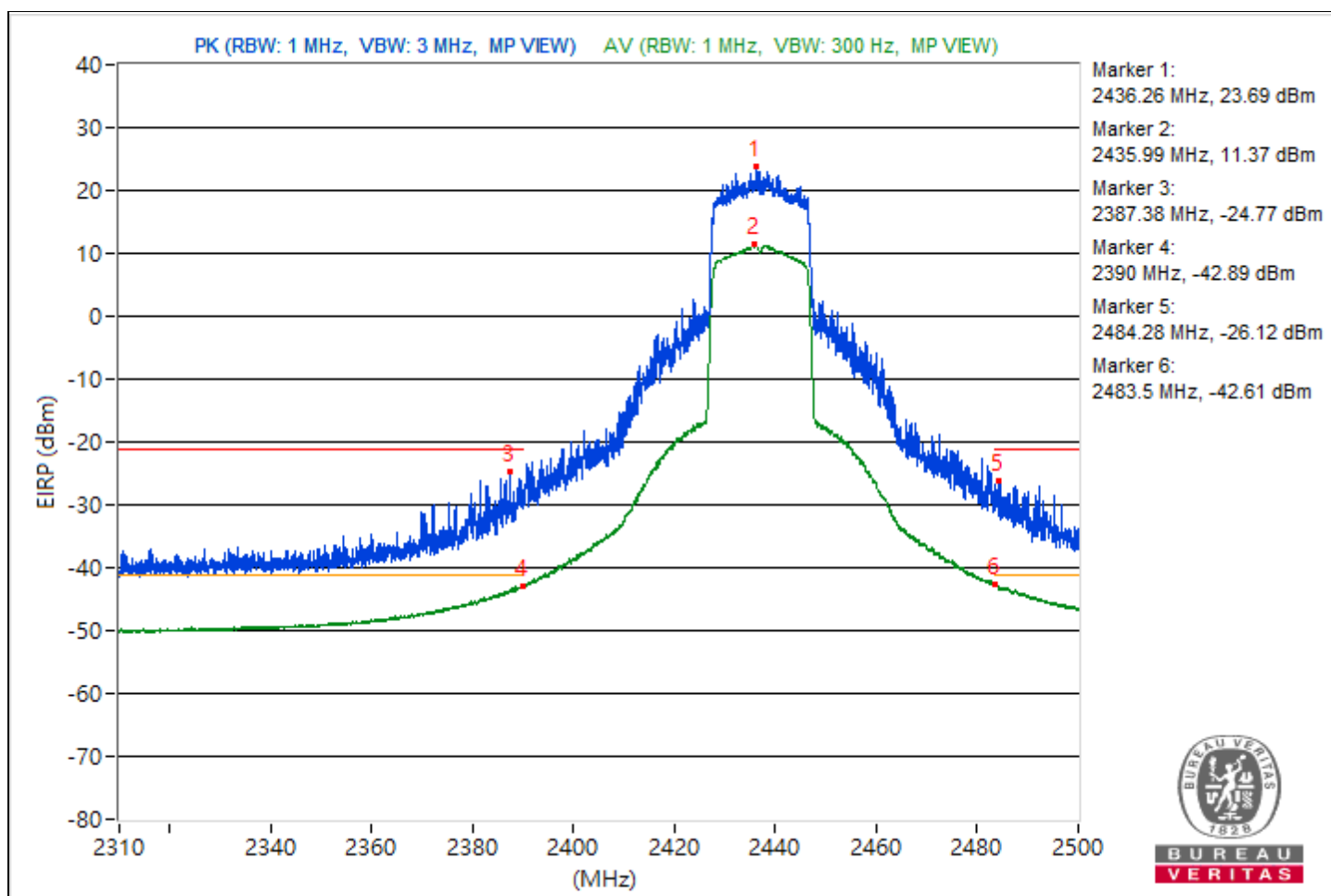

RF Mode	802.11be (EHT20)	Channel	CH 11 : 2462 MHz
Frequency Range	2.31 GHz ~ 2.5 GHz	Environmental Conditions	25°C, 76% RH
Tested By	Waydi Tuan		

Conducted Band Edge							
No.	Frequency (MHz)	Emission Level (dBuV/m)	Limit (dBuV/m)	Margin (dB)	Raw Value Chain 0 (dBm)	Correction Factor (dB)	EIRP Level (dBm)
1	*2458.79	116.1 PK			17.66	3.18	20.84
2	*2463.16	104.03 AV			5.59	3.18	8.77
3	2354.13	58.63 PK	74	-15.37	-39.81	3.18	-36.63
4	2389.99	46.02 AV	54	-7.98	-52.42	3.18	-49.24
5	2484.14	70.5 PK	74	-3.5	-27.94	3.18	-24.76
6	2483.54	50.47 AV	54	-3.53	-47.97	3.18	-44.79

Notes:

1. Margin value = Emission Level - Limit value
2. " \* " : Fundamental frequency, the limit was restricted at the RF Output Power.

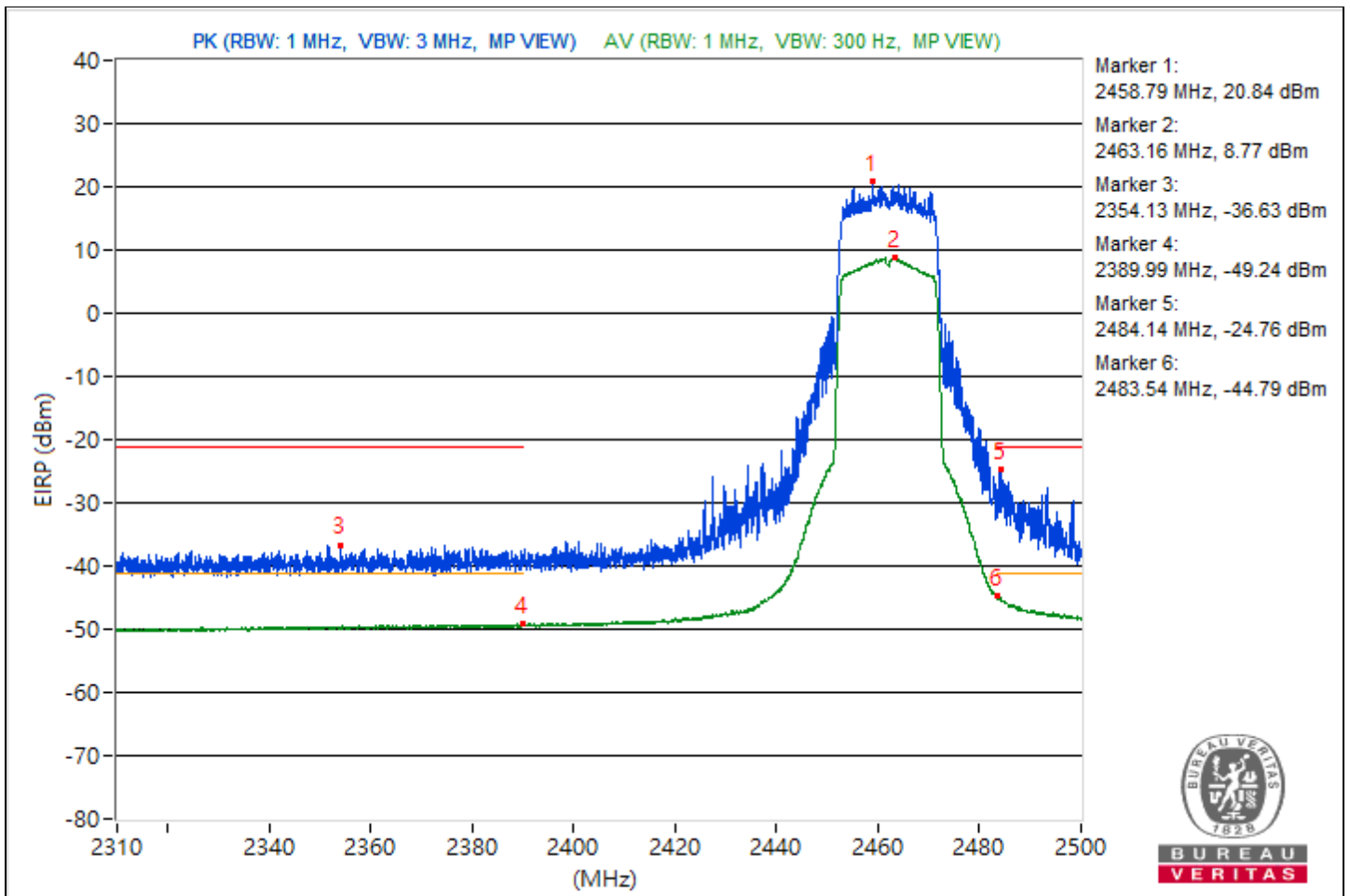

RF Mode	802.11be (EHT20)	Channel	CH 12 : 2467 MHz
Frequency Range	2.31 GHz ~ 2.5 GHz	Environmental Conditions	25°C, 76% RH
Tested By	Waydi Tuan		

Conducted Band Edge							
No.	Frequency (MHz)	Emission Level (dBuV/m)	Limit (dBuV/m)	Margin (dB)	Raw Value Chain 0 (dBm)	Correction Factor (dB)	EIRP Level (dBm)
1	*2467.8	114.84 PK			16.4	3.18	19.58
2	*2466.28	103 AV			4.56	3.18	7.74
3	2376.26	58.42 PK	74	-15.58	-40.02	3.18	-36.84
4	2389.8	46.01 AV	54	-7.99	-52.43	3.18	-49.25
5	2486.94	65.56 PK	74	-8.44	-32.88	3.18	-29.7
6	2483.61	50.86 AV	54	-3.14	-47.58	3.18	-44.4

Notes:

1. Margin value = Emission Level - Limit value
2. " \* " : Fundamental frequency, the limit was restricted at the RF Output Power.

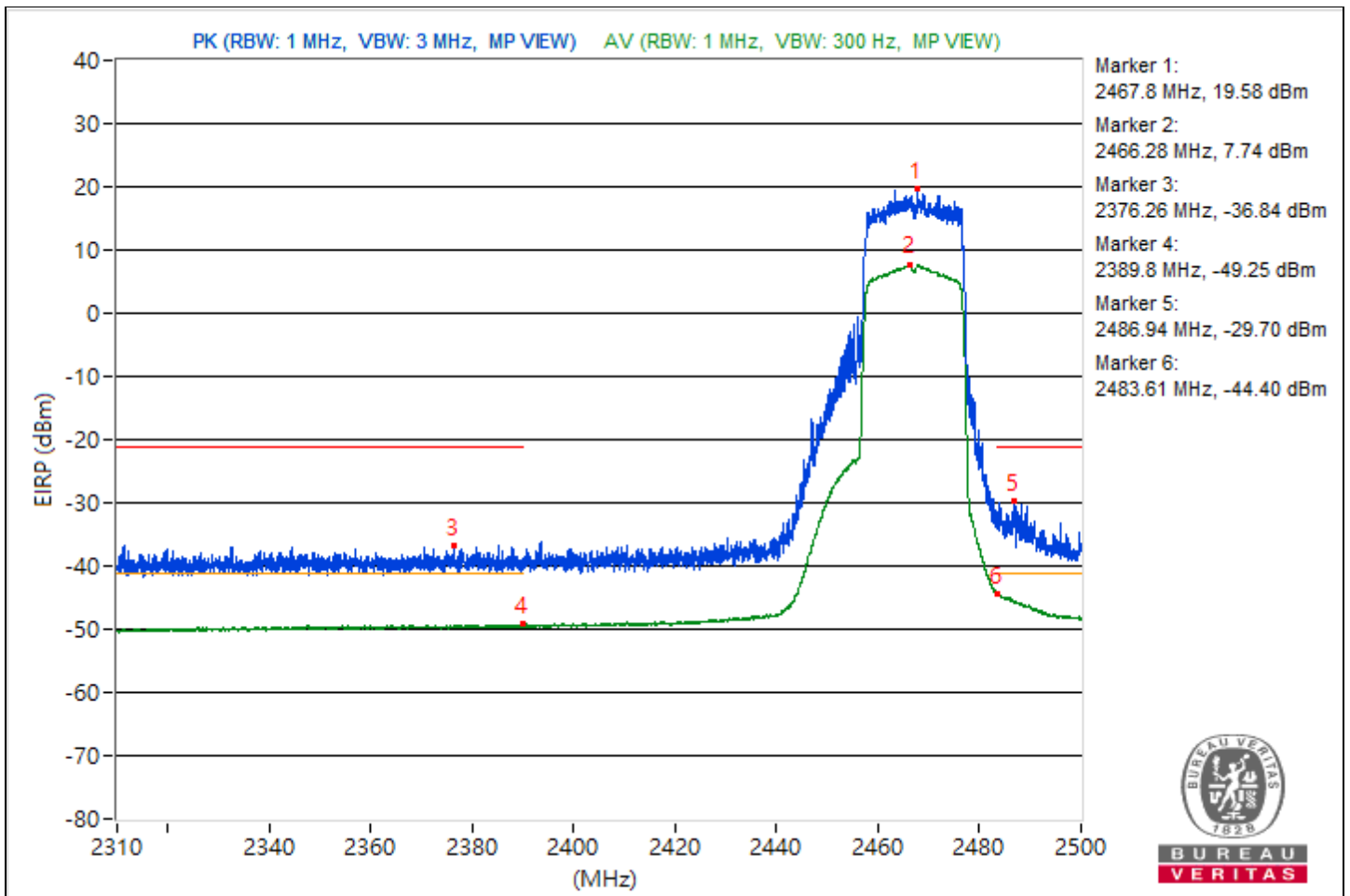



RF Mode	802.11be (EHT20)	Channel	CH 13 : 2472 MHz
Frequency Range	2.31 GHz ~ 2.5 GHz	Environmental Conditions	25°C, 76% RH
Tested By	Waydi Tuan		

Conducted Band Edge							
No.	Frequency (MHz)	Emission Level (dBuV/m)	Limit (dBuV/m)	Margin (dB)	Raw Value Chain 0 (dBm)	Correction Factor (dB)	EIRP Level (dBm)
1	*2475.28	112.8 PK			14.36	3.18	17.54
2	*2471.14	100.9 AV			2.46	3.18	5.64
3	2381.08	58.66 PK	74	-15.34	-39.78	3.18	-36.6
4	2379.14	45.82 AV	54	-8.18	-52.62	3.18	-49.44
5	2484.42	65 PK	74	-9	-33.44	3.18	-30.26
6	2483.61	49.65 AV	54	-4.35	-48.79	3.18	-45.61

Notes:

1. Margin value = Emission Level - Limit value
2. " \* " : Fundamental frequency, the limit was restricted at the RF Output Power.

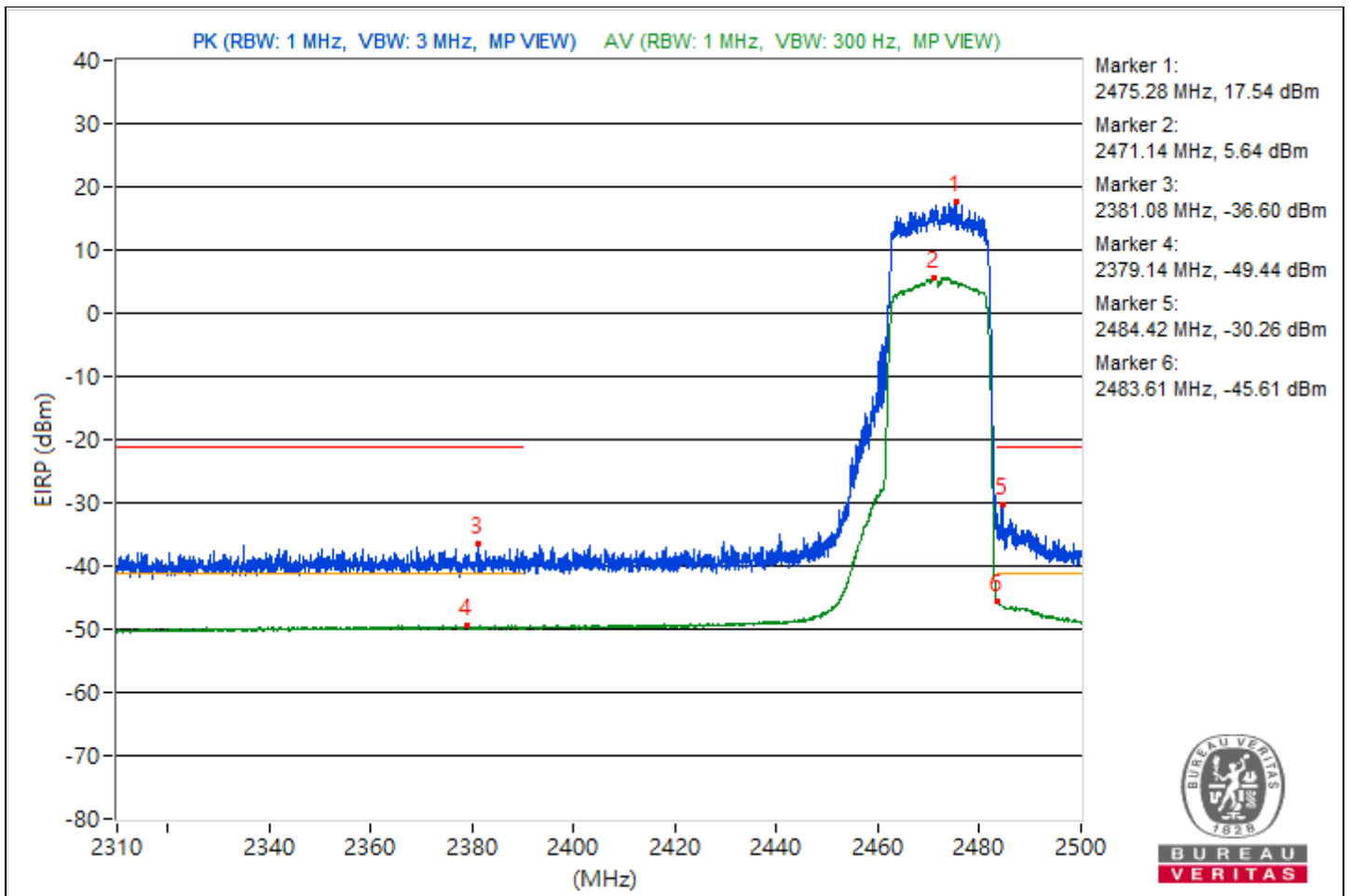

RF Mode	802.11be (EHT40)	Channel	CH 3 : 2422 MHz
Frequency Range	2.31 GHz ~ 2.5 GHz	Environmental Conditions	25°C, 76% RH
Tested By	Waydi Tuan		

Conducted Band Edge							
No.	Frequency (MHz)	Emission Level (dBuV/m)	Limit (dBuV/m)	Margin (dB)	Raw Value Chain 0 (dBm)	Correction Factor (dB)	EIRP Level (dBm)
1	*2420.91	112.02 PK			13.58	3.18	16.76
2	*2421.1	99.89 AV			1.45	3.18	4.63
3	2388.52	66.96 PK	74	-7.04	-31.48	3.18	-28.3
4	2388.99	52.9 AV	54	-1.1	-45.54	3.18	-42.36
5	2496.82	59.15 PK	74	-14.85	-39.29	3.18	-36.11
6	2484.92	46.98 AV	54	-7.02	-51.46	3.18	-48.28

Notes:

1. Margin value = Emission Level - Limit value
2. " \* " : Fundamental frequency, the limit was restricted at the RF Output Power.

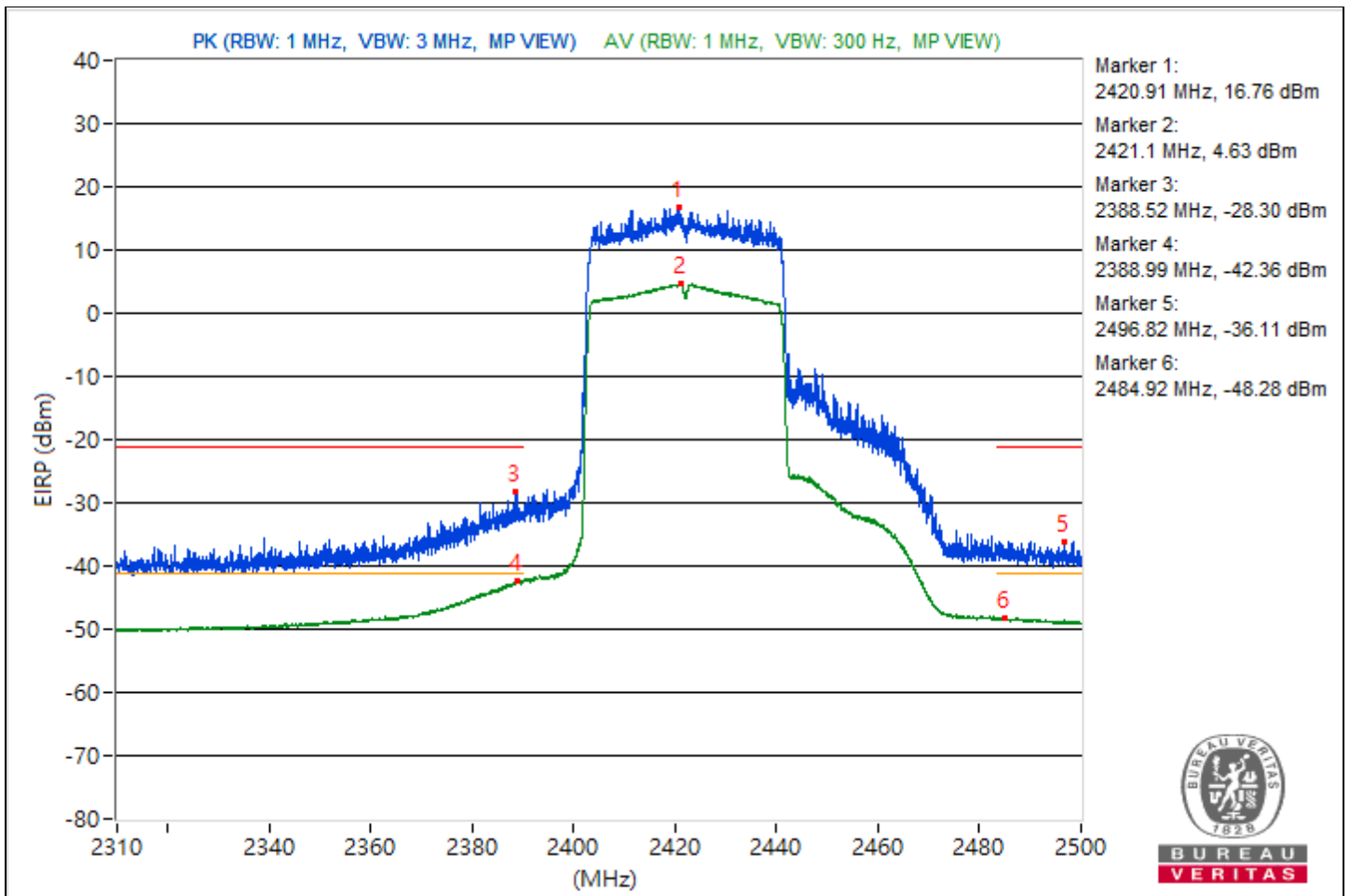

RF Mode	802.11be (EHT40)	Channel	CH 6 : 2437 MHz
Frequency Range	2.31 GHz ~ 2.5 GHz	Environmental Conditions	25°C, 76% RH
Tested By	Waydi Tuan		

Conducted Band Edge							
No.	Frequency (MHz)	Emission Level (dBuV/m)	Limit (dBuV/m)	Margin (dB)	Raw Value Chain 0 (dBm)	Correction Factor (dB)	EIRP Level (dBm)
1	*2445.71	113.24 PK			14.8	3.18	17.98
2	*2438.13	101.06 AV			2.62	3.18	5.8
3	2387.54	65.93 PK	74	-8.07	-32.51	3.18	-29.33
4	2389.99	50.89 AV	54	-3.11	-47.55	3.18	-44.37
5	2483.61	64.85 PK	74	-9.15	-33.59	3.18	-30.41
6	2483.61	50.7 AV	54	-3.3	-47.74	3.18	-44.56

Notes:

1. Margin value = Emission Level - Limit value
2. " \* " : Fundamental frequency, the limit was restricted at the RF Output Power.

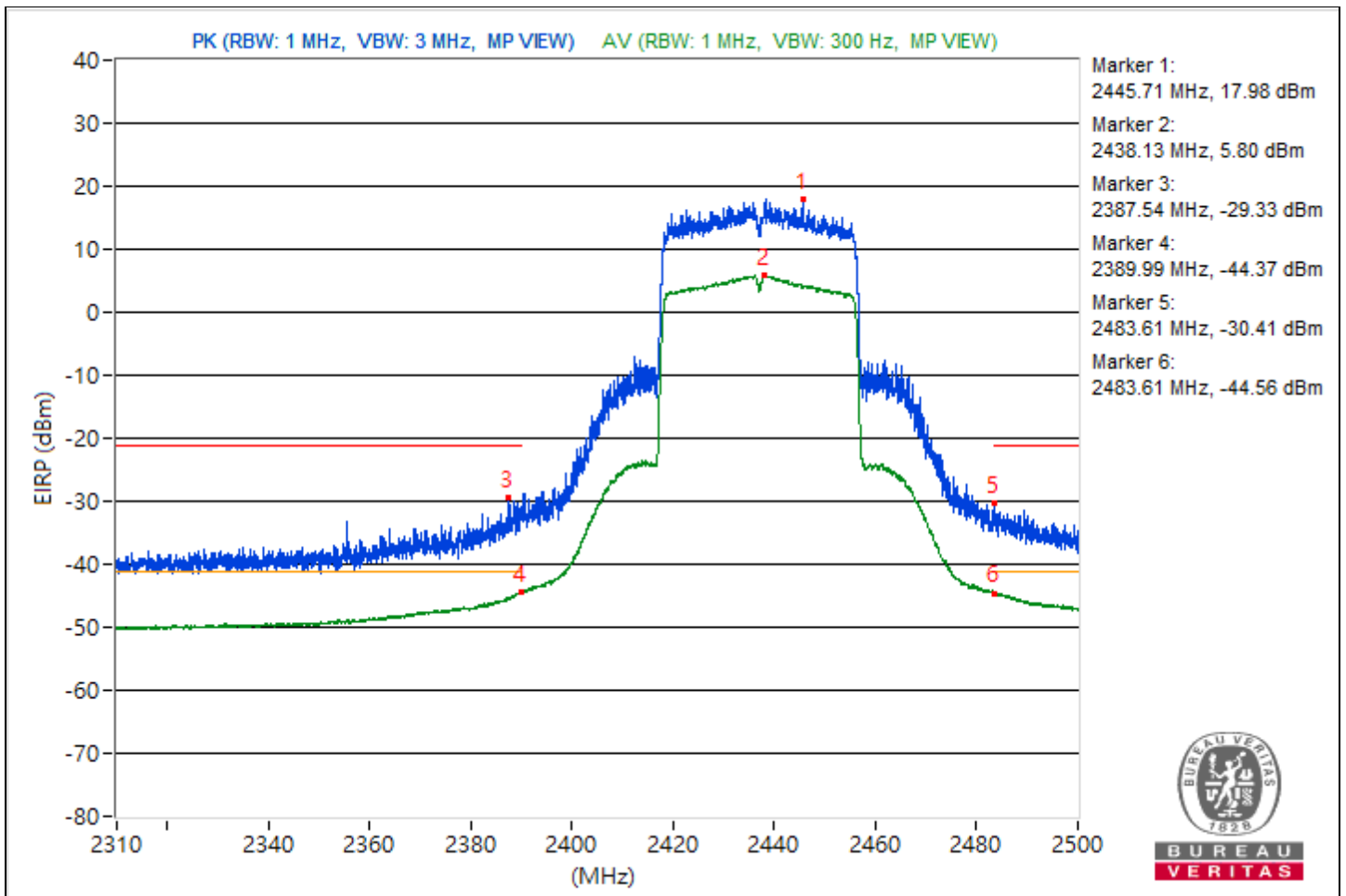

RF Mode	802.11be (EHT40)	Channel	CH 9 : 2452 MHz
Frequency Range	2.31 GHz ~ 2.5 GHz	Environmental Conditions	25°C, 76% RH
Tested By	Waydi Tuan		

Conducted Band Edge							
No.	Frequency (MHz)	Emission Level (dBuV/m)	Limit (dBuV/m)	Margin (dB)	Raw Value Chain 0 (dBm)	Correction Factor (dB)	EIRP Level (dBm)
1	*2443.88	113.16 PK			14.72	3.18	17.9
2	*2451.12	100.38 AV			1.94	3.18	5.12
3	2383.86	59.53 PK	74	-14.47	-38.91	3.18	-35.73
4	2389.32	47.34 AV	54	-6.66	-51.1	3.18	-47.92
5	2485.23	66.01 PK	74	-7.99	-32.43	3.18	-29.25
6	2484.21	51.31 AV	54	-2.69	-47.13	3.18	-43.95

Notes:

1. Margin value = Emission Level - Limit value
2. " \* " : Fundamental frequency, the limit was restricted at the RF Output Power.

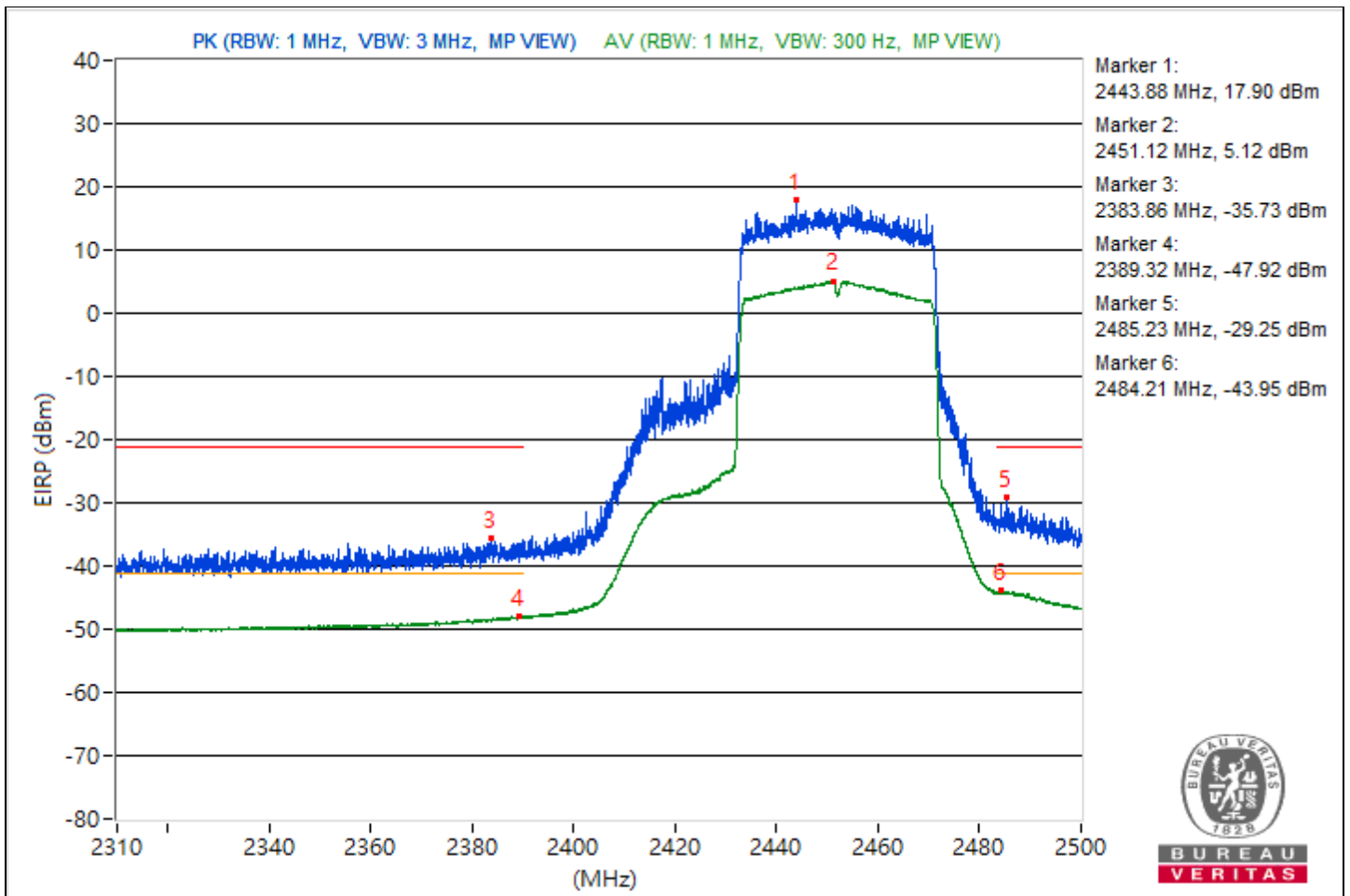

RF Mode	802.11be (EHT40)	Channel	CH 10 : 2457 MHz
Frequency Range	2.31 GHz ~ 2.5 GHz	Environmental Conditions	25°C, 76% RH
Tested By	Waydi Tuan		

Conducted Band Edge							
No.	Frequency (MHz)	Emission Level (dBuV/m)	Limit (dBuV/m)	Margin (dB)	Raw Value Chain 0 (dBm)	Correction Factor (dB)	EIRP Level (dBm)
1	*2456.13	112.18 PK			13.74	3.18	16.92
2	*2455.82	99.96 AV			1.52	3.18	4.7
3	2388.18	59.59 PK	74	-14.41	-38.85	3.18	-35.67
4	2389.94	46.77 AV	54	-7.23	-51.67	3.18	-48.49
5	2485.56	64.05 PK	74	-9.95	-34.39	3.18	-31.21
6	2486.01	50.4 AV	54	-3.6	-48.04	3.18	-44.86

Notes:

1. Margin value = Emission Level - Limit value
2. " \* " : Fundamental frequency, the limit was restricted at the RF Output Power.

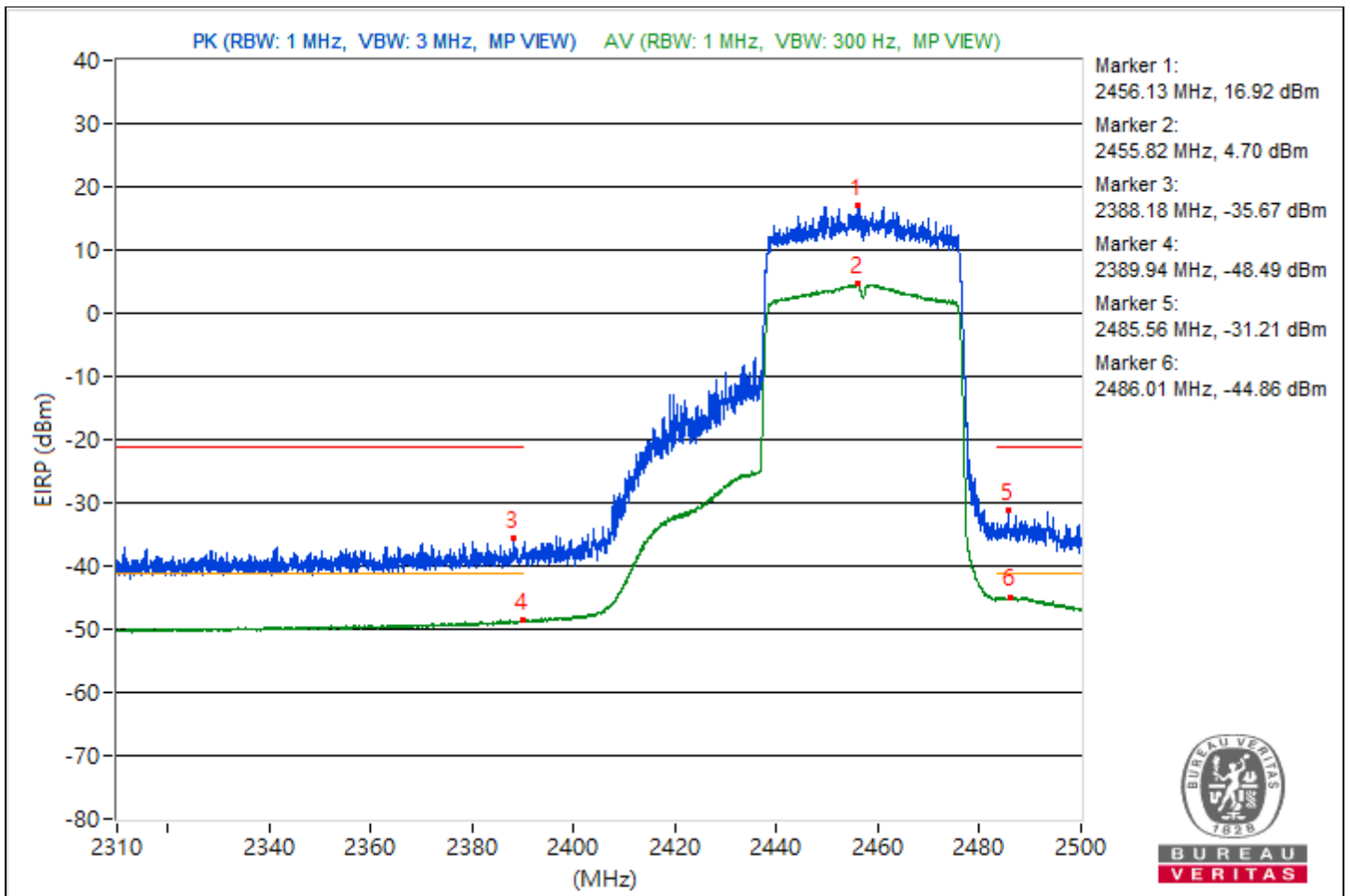

RF Mode	802.11be (EHT40)	Channel	CH 11 : 2462 MHz
Frequency Range	2.31 GHz ~ 2.5 GHz	Environmental Conditions	25°C, 76% RH
Tested By	Waydi Tuan		

Conducted Band Edge							
No.	Frequency (MHz)	Emission Level (dBuV/m)	Limit (dBuV/m)	Margin (dB)	Raw Value Chain 0 (dBm)	Correction Factor (dB)	EIRP Level (dBm)
1	*2456.92	108.74 PK			10.3	3.18	13.48
2	*2460.5	96.67 AV			-1.77	3.18	1.41
3	2359.14	58.42 PK	74	-15.58	-40.02	3.18	-36.84
4	2389.42	45.83 AV	54	-8.17	-52.61	3.18	-49.43
5	2486.96	60.27 PK	74	-13.73	-38.17	3.18	-34.99
6	2484.02	47.85 AV	54	-6.15	-50.59	3.18	-47.41

Notes:

1. Margin value = Emission Level - Limit value
2. " \* " : Fundamental frequency, the limit was restricted at the RF Output Power.

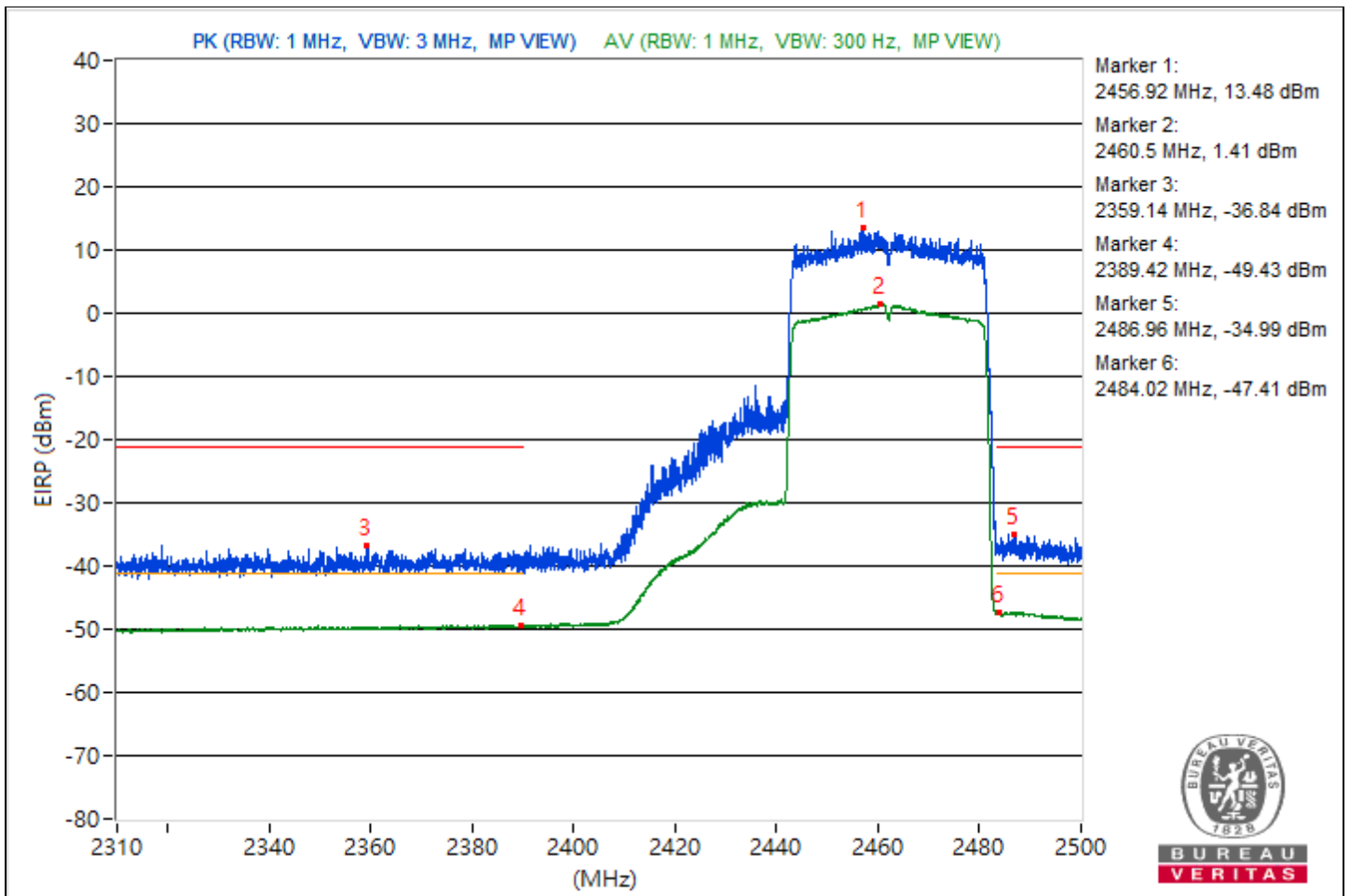

RF Mode	802.11be (EHT20) 26-tone RU	Channel	CH 1 : 2412 MHz
Frequency Range	2.31 GHz ~ 2.5 GHz	Environmental Conditions	25°C, 76% RH
Tested By	Waydi Tuan		

Conducted Band Edge							
No.	Frequency (MHz)	Emission Level (dBuV/m)	Limit (dBuV/m)	Margin (dB)	Raw Value Chain 0 (dBm)	Correction Factor (dB)	EIRP Level (dBm)
1	*2403.34	121.84 PK			23.4	3.18	26.58
2	*2403.39	110.53 AV			12.09	3.18	15.27
3	2388.09	71.55 PK	74	-2.45	-26.89	3.18	-23.71
4	2386.62	51.18 AV	54	-2.82	-47.26	3.18	-44.08
5	2498.17	58.78 PK	74	-15.22	-39.66	3.18	-36.48
6	2489.34	46.19 AV	54	-7.81	-52.25	3.18	-49.07

Notes:

1. Margin value = Emission Level - Limit value
2. " \* " : Fundamental frequency, the limit was restricted at the RF Output Power.

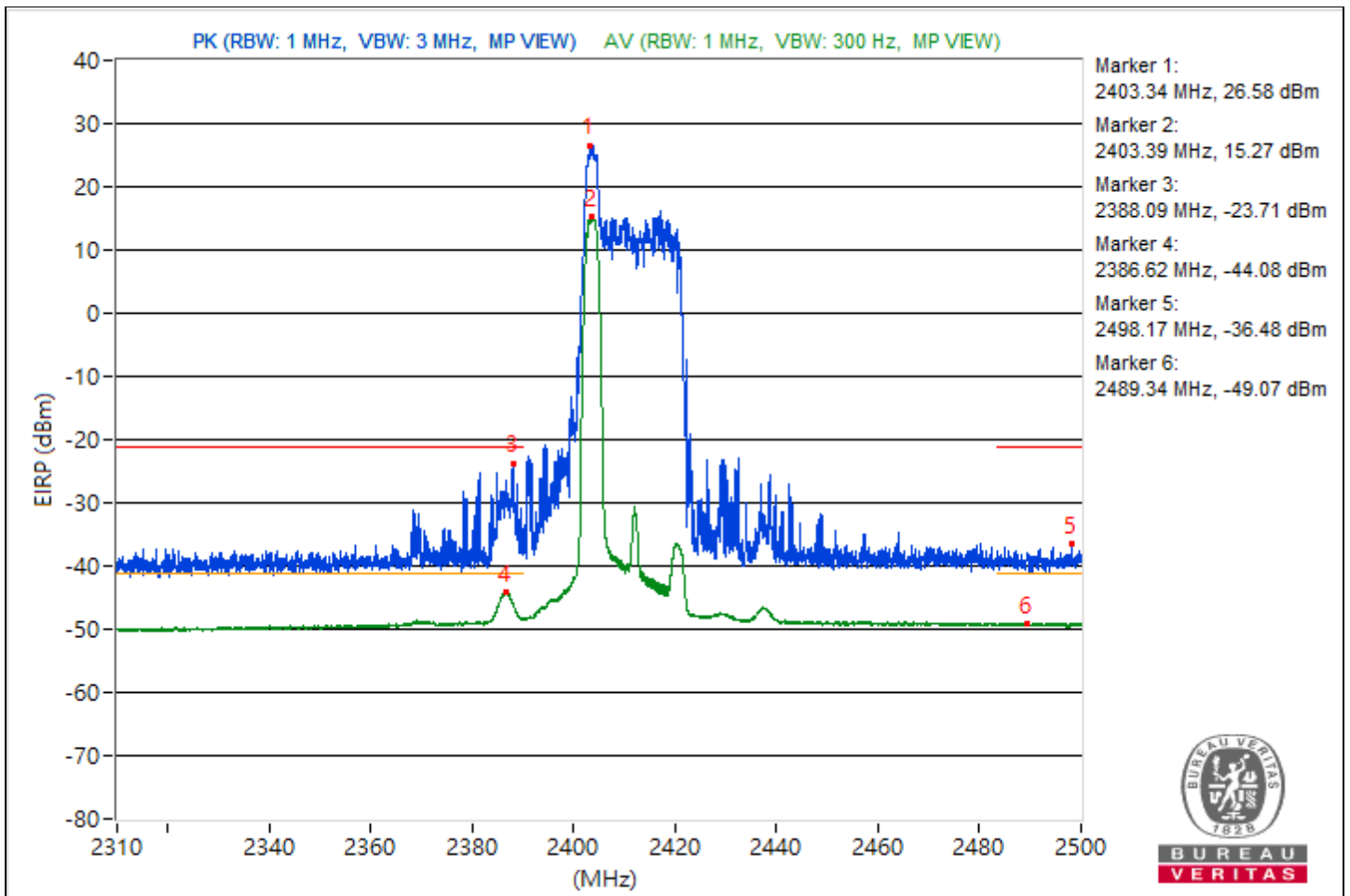

RF Mode	802.11be (EHT20) 26-tone RU	Channel	CH 6 : 2437 MHz
Frequency Range	2.31 GHz ~ 2.5 GHz	Environmental Conditions	25°C, 76% RH
Tested By	Waydi Tuan		

Conducted Band Edge							
No.	Frequency (MHz)	Emission Level (dBuV/m)	Limit (dBuV/m)	Margin (dB)	Raw Value Chain 0 (dBm)	Correction Factor (dB)	EIRP Level (dBm)
1	*2429.25	124.37 PK			25.93	3.18	29.11
2	*2428.49	113.92 AV			15.48	3.18	18.66
3	2388.4	63.86 PK	74	-10.14	-34.58	3.18	-31.4
4	2389.94	46.92 AV	54	-7.08	-51.52	3.18	-48.34
5	2489.91	63.86 PK	74	-10.14	-34.58	3.18	-31.4
6	2484.85	47.36 AV	54	-6.64	-51.08	3.18	-47.9

Notes:

1. Margin value = Emission Level - Limit value
2. " \* " : Fundamental frequency, the limit was restricted at the RF Output Power.

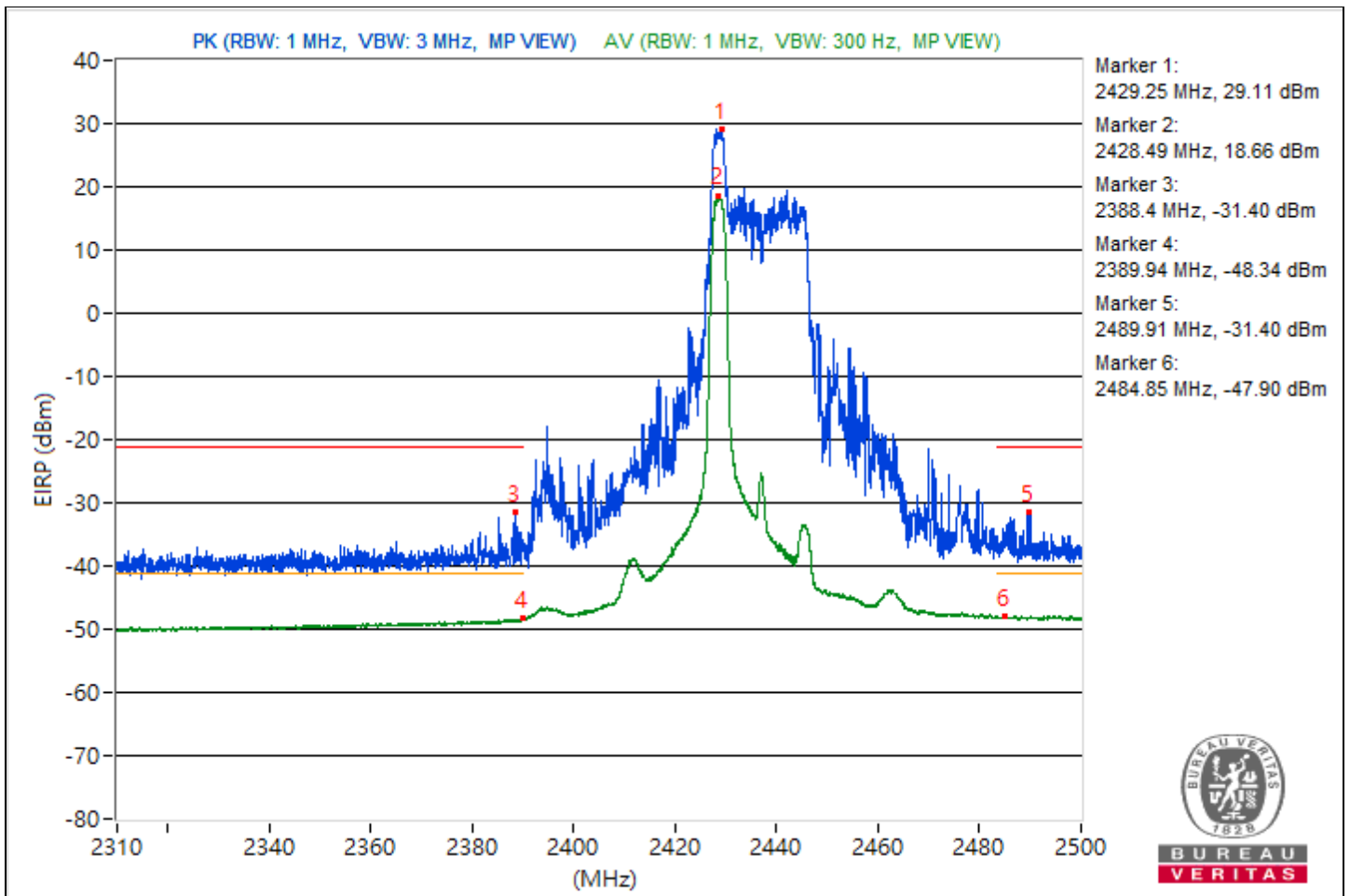



RF Mode	802.11be (EHT20) 26-tone RU	Channel	CH 11 : 2462 MHz
Frequency Range	2.31 GHz ~ 2.5 GHz	Environmental Conditions	25°C, 76% RH
Tested By	Waydi Tuan		

Conducted Band Edge							
No.	Frequency (MHz)	Emission Level (dBuV/m)	Limit (dBuV/m)	Margin (dB)	Raw Value Chain 0 (dBm)	Correction Factor (dB)	EIRP Level (dBm)
1	*2470.41	122.82 PK			24.38	3.18	27.56
2	*2470.43	110.56 AV			12.12	3.18	15.3
3	2389.25	58.37 PK	74	-15.63	-40.07	3.18	-36.89
4	2370.8	46 AV	54	-8	-52.44	3.18	-49.26
5	2488.89	70.68 PK	74	-3.32	-27.76	3.18	-24.58
6	2487.08	50.64 AV	54	-3.36	-47.8	3.18	-44.62

Notes:

1. Margin value = Emission Level - Limit value
2. " \* " : Fundamental frequency, the limit was restricted at the RF Output Power.

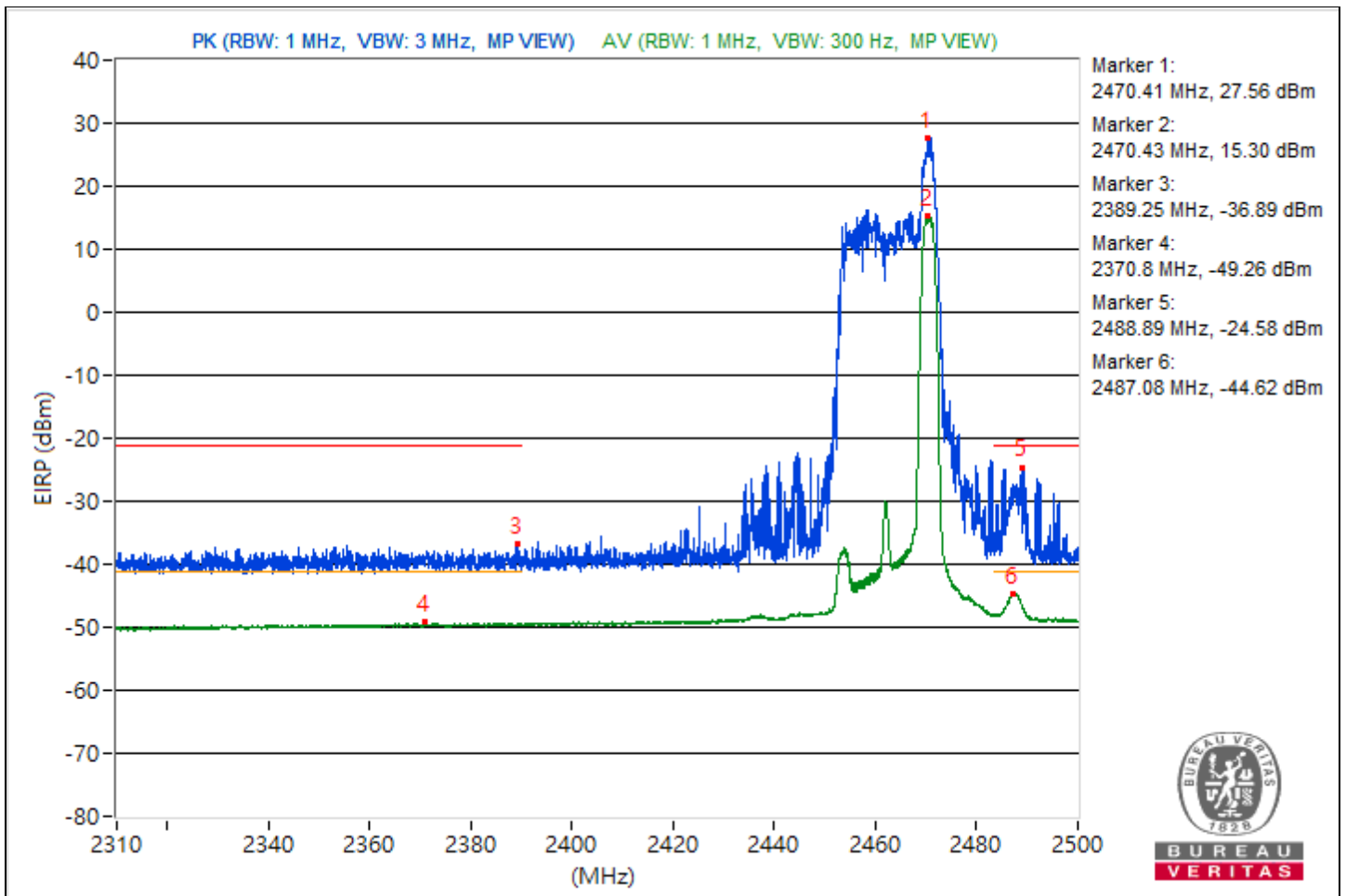

RF Mode	802.11be (EHT20) 26-tone RU	Channel	CH 12 : 2467 MHz
Frequency Range	2.31 GHz ~ 2.5 GHz	Environmental Conditions	25°C, 76% RH
Tested By	Waydi Tuan		

Conducted Band Edge							
No.	Frequency (MHz)	Emission Level (dBuV/m)	Limit (dBuV/m)	Margin (dB)	Raw Value Chain 0 (dBm)	Correction Factor (dB)	EIRP Level (dBm)
1	*2475.25	121.72 PK			23.28	3.18	26.46
2	*2475.44	110.48 AV			12.04	3.18	15.22
3	2382.49	58.51 PK	74	-15.49	-39.93	3.18	-36.75
4	2386.21	45.85 AV	54	-8.15	-52.59	3.18	-49.41
5	2487.51	72.05 PK	74	-1.95	-26.39	3.18	-23.21
6	2492.71	50.81 AV	54	-3.19	-47.63	3.18	-44.45

Notes:

1. Margin value = Emission Level - Limit value
2. " \* " : Fundamental frequency, the limit was restricted at the RF Output Power.

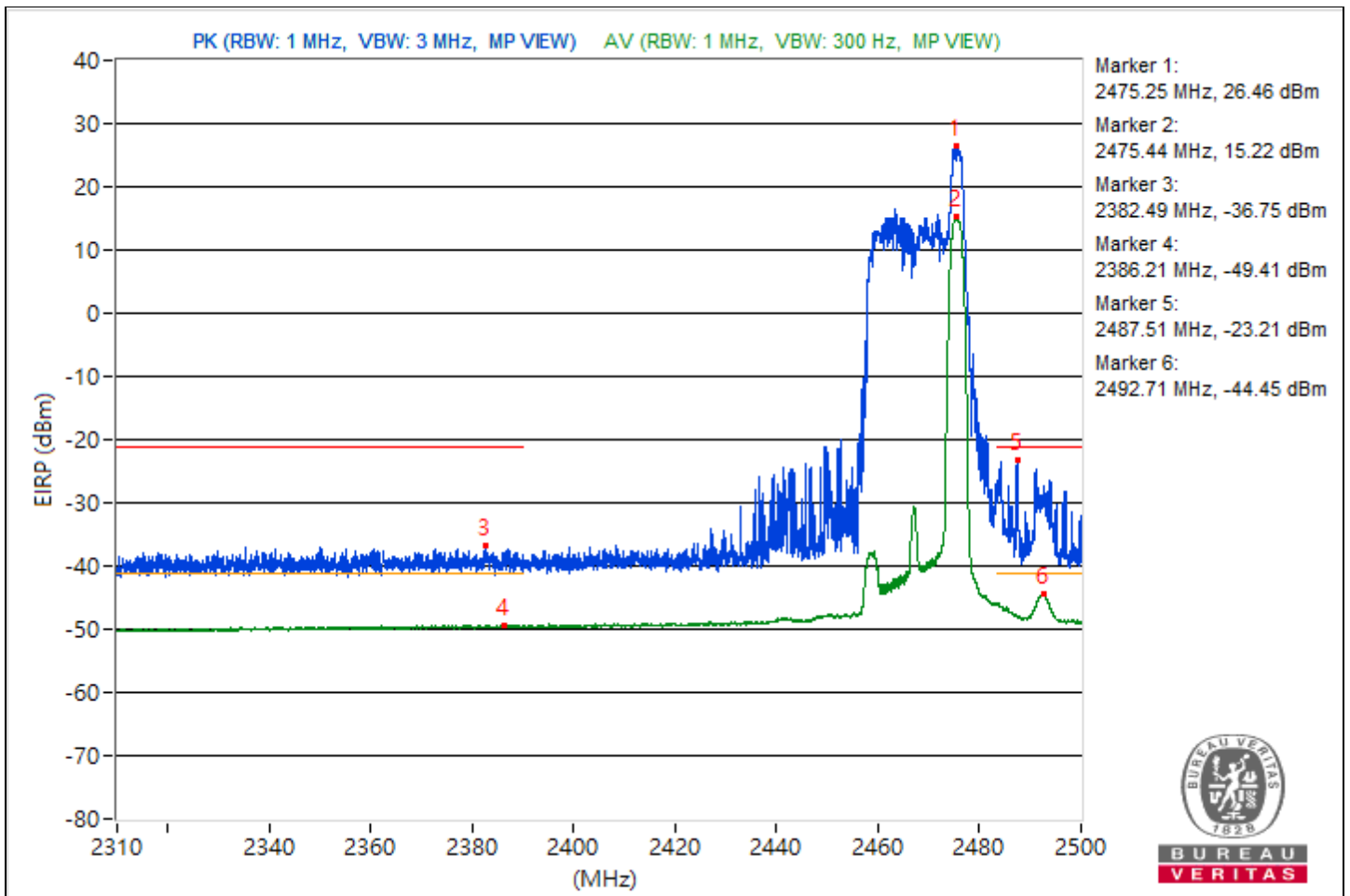

RF Mode	802.11be (EHT20) 26-tone RU	Channel	CH 13 : 2472 MHz
Frequency Range	2.31 GHz ~ 2.5 GHz	Environmental Conditions	25°C, 76% RH
Tested By	Waydi Tuan		

Conducted Band Edge							
No.	Frequency (MHz)	Emission Level (dBuV/m)	Limit (dBuV/m)	Margin (dB)	Raw Value Chain 0 (dBm)	Correction Factor (dB)	EIRP Level (dBm)
1	*2480.53	117.3 PK			18.86	3.18	22.04
2	*2480.34	105.9 AV			7.46	3.18	10.64
3	2365.48	58.24 PK	74	-15.76	-40.2	3.18	-37.02
4	2388.95	45.69 AV	54	-8.31	-52.75	3.18	-49.57
5	2483.59	73 PK	74	-1	-25.44	3.18	-22.26
6	2483.5	51.58 AV	54	-2.42	-46.86	3.18	-43.68

Notes:

1. Margin value = Emission Level - Limit value
2. " \* " : Fundamental frequency, the limit was restricted at the RF Output Power.

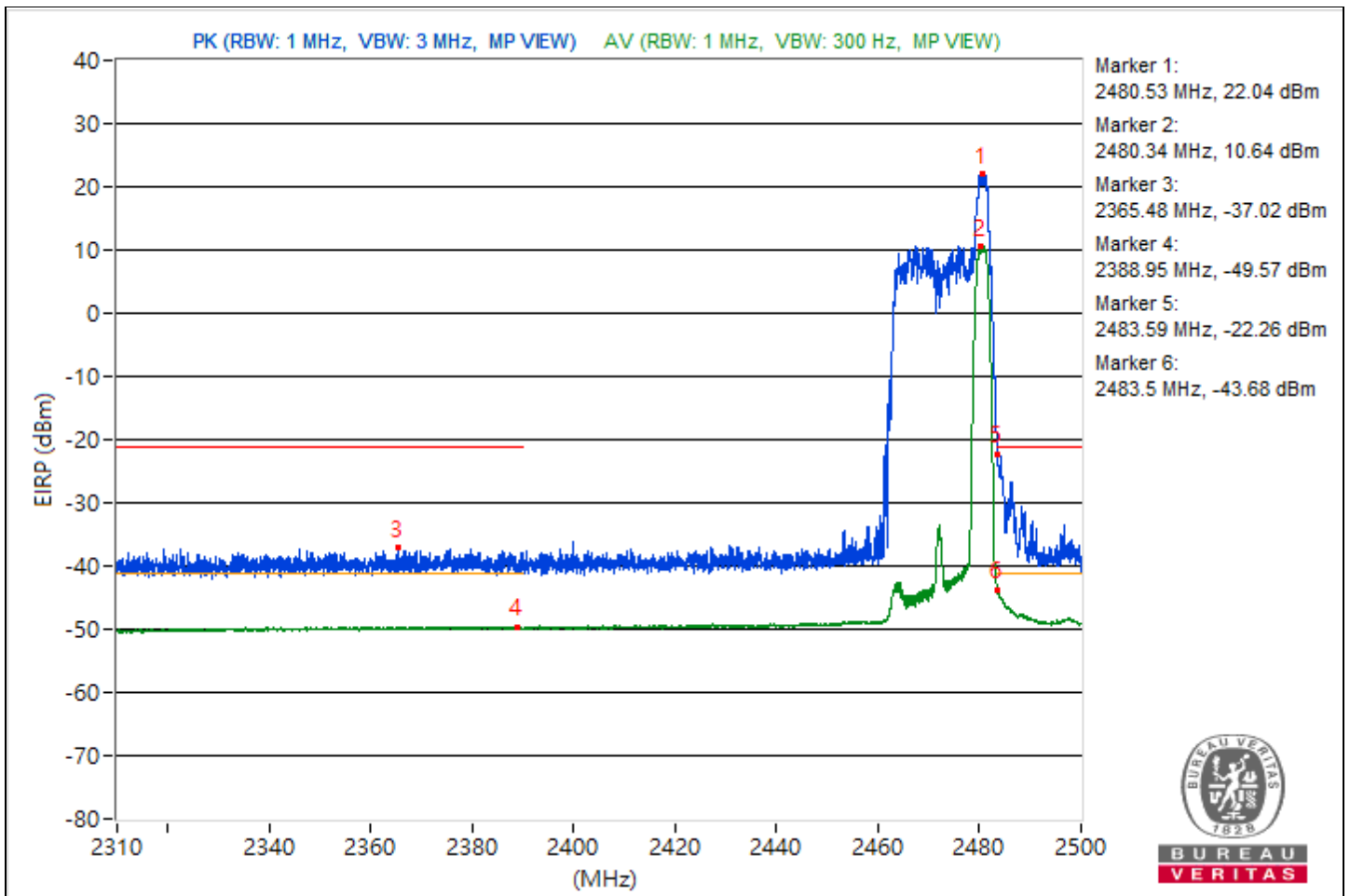

RF Mode	802.11be (EHT20) 52-tone RU	Channel	CH 1 : 2412 MHz
Frequency Range	2.31 GHz ~ 2.5 GHz	Environmental Conditions	25°C, 76% RH
Tested By	Waydi Tuan		

Conducted Band Edge							
No.	Frequency (MHz)	Emission Level (dBuV/m)	Limit (dBuV/m)	Margin (dB)	Raw Value Chain 0 (dBm)	Correction Factor (dB)	EIRP Level (dBm)
1	#2405.09	120.31 PK			21.87	3.18	25.05
2	#2405.55	108.22 AV			9.78	3.18	12.96
3	2388.14	73.64 PK	74	-0.36	-24.8	3.18	-21.62
4	2389.56	50.17 AV	54	-3.83	-48.27	3.18	-45.09
5	2493.45	59.07 PK	74	-14.93	-39.37	3.18	-36.19
6	2490.62	46.3 AV	54	-7.7	-52.14	3.18	-48.96

- Notes:
1. Margin value = Emission Level - Limit value
  2. " # ": The radiated frequency is out of the restricted band, the limit was restricted at the Conducted Out of Band Emissions.

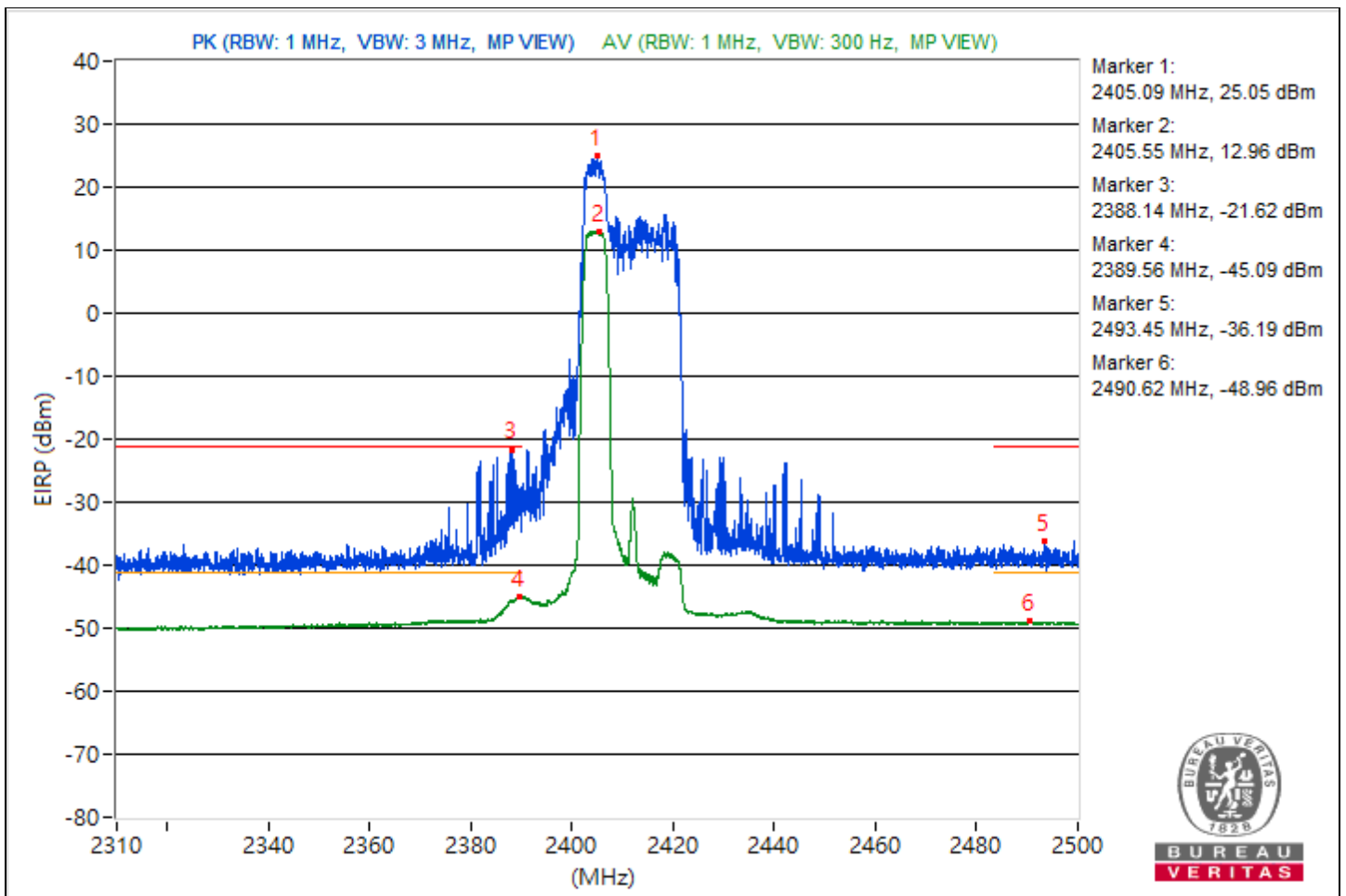

RF Mode	802.11be (EHT20) 52-tone RU	Channel	CH 6 : 2437 MHz
Frequency Range	2.31 GHz ~ 2.5 GHz	Environmental Conditions	25°C, 76% RH
Tested By	Waydi Tuan		

Conducted Band Edge							
No.	Frequency (MHz)	Emission Level (dBuV/m)	Limit (dBuV/m)	Margin (dB)	Raw Value Chain 0 (dBm)	Correction Factor (dB)	EIRP Level (dBm)
1	#2429.22	122.25 PK			23.81	3.18	26.99
2	#2429.3	111.32 AV			12.88	3.18	16.06
3	2384.57	65.16 PK	74	-8.84	-33.28	3.18	-30.1
4	2388.45	47.45 AV	54	-6.55	-50.99	3.18	-47.81
5	2489.31	65.16 PK	74	-8.84	-33.28	3.18	-30.1
6	2484.87	47.38 AV	54	-6.62	-51.06	3.18	-47.88

- Notes:
- Margin value = Emission Level - Limit value
  - " # ": The radiated frequency is out of the restricted band, the limit was restricted at the Conducted Out of Band Emissions.

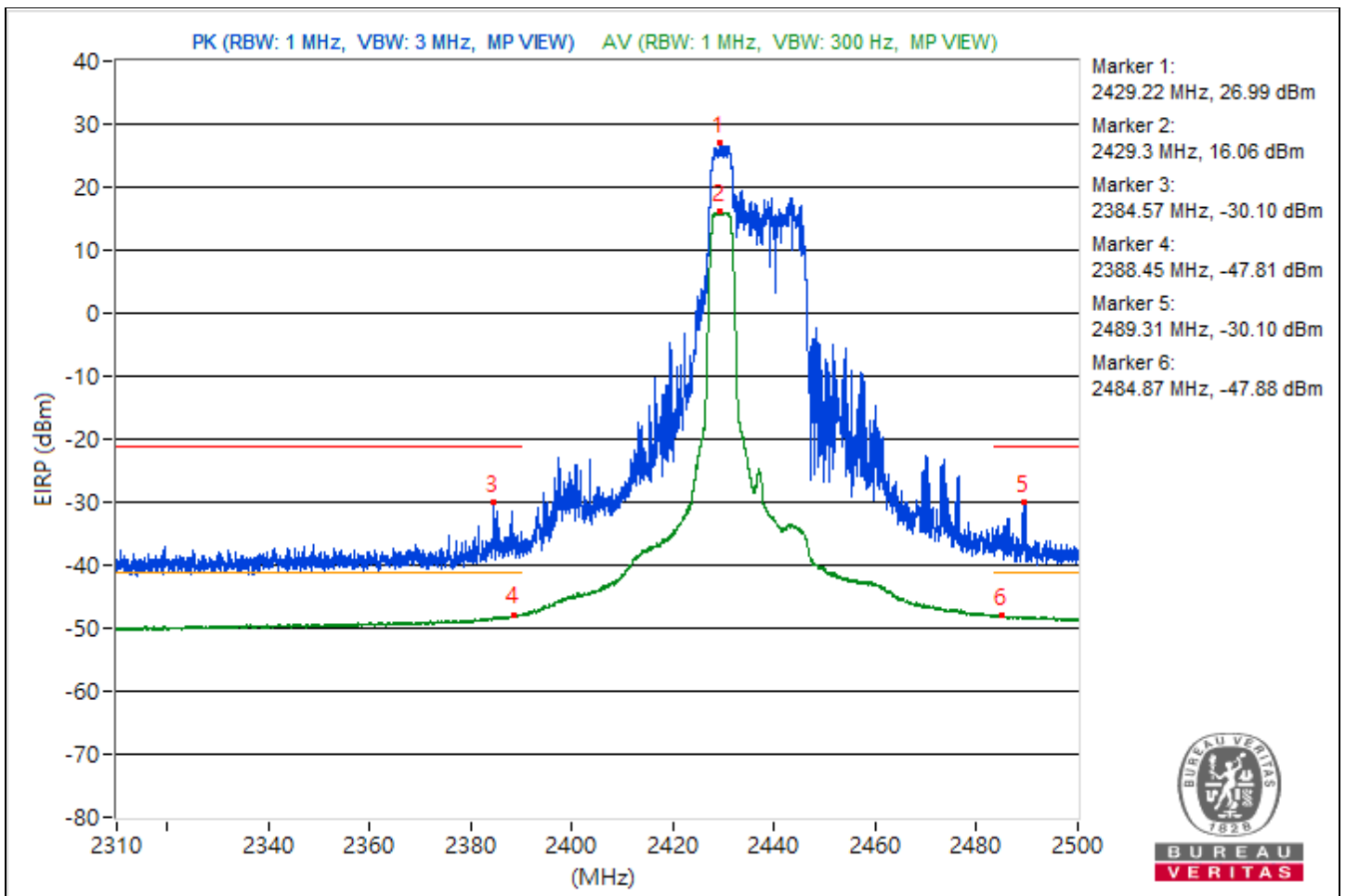

RF Mode	802.11be (EHT20) 52-tone RU	Channel	CH 11 : 2462 MHz
Frequency Range	2.31 GHz ~ 2.5 GHz	Environmental Conditions	25°C, 76% RH
Tested By	Waydi Tuan		

Conducted Band Edge							
No.	Frequency (MHz)	Emission Level (dBuV/m)	Limit (dBuV/m)	Margin (dB)	Raw Value Chain 0 (dBm)	Correction Factor (dB)	EIRP Level (dBm)
1	#2468.2	120.33 PK			21.89	3.18	25.07
2	#2470.38	108.5 AV			10.06	3.18	13.24
3	2360.11	59.57 PK	74	-14.43	-38.87	3.18	-35.69
4	2383.55	45.98 AV	54	-8.02	-52.46	3.18	-49.28
5	2486.2	73.78 PK	74	-0.22	-24.66	3.18	-21.48
6	2484.23	50.62 AV	54	-3.38	-47.82	3.18	-44.64

- Notes:
1. Margin value = Emission Level - Limit value
  2. "#": The radiated frequency is out of the restricted band, the limit was restricted at the Conducted Out of Band Emissions.

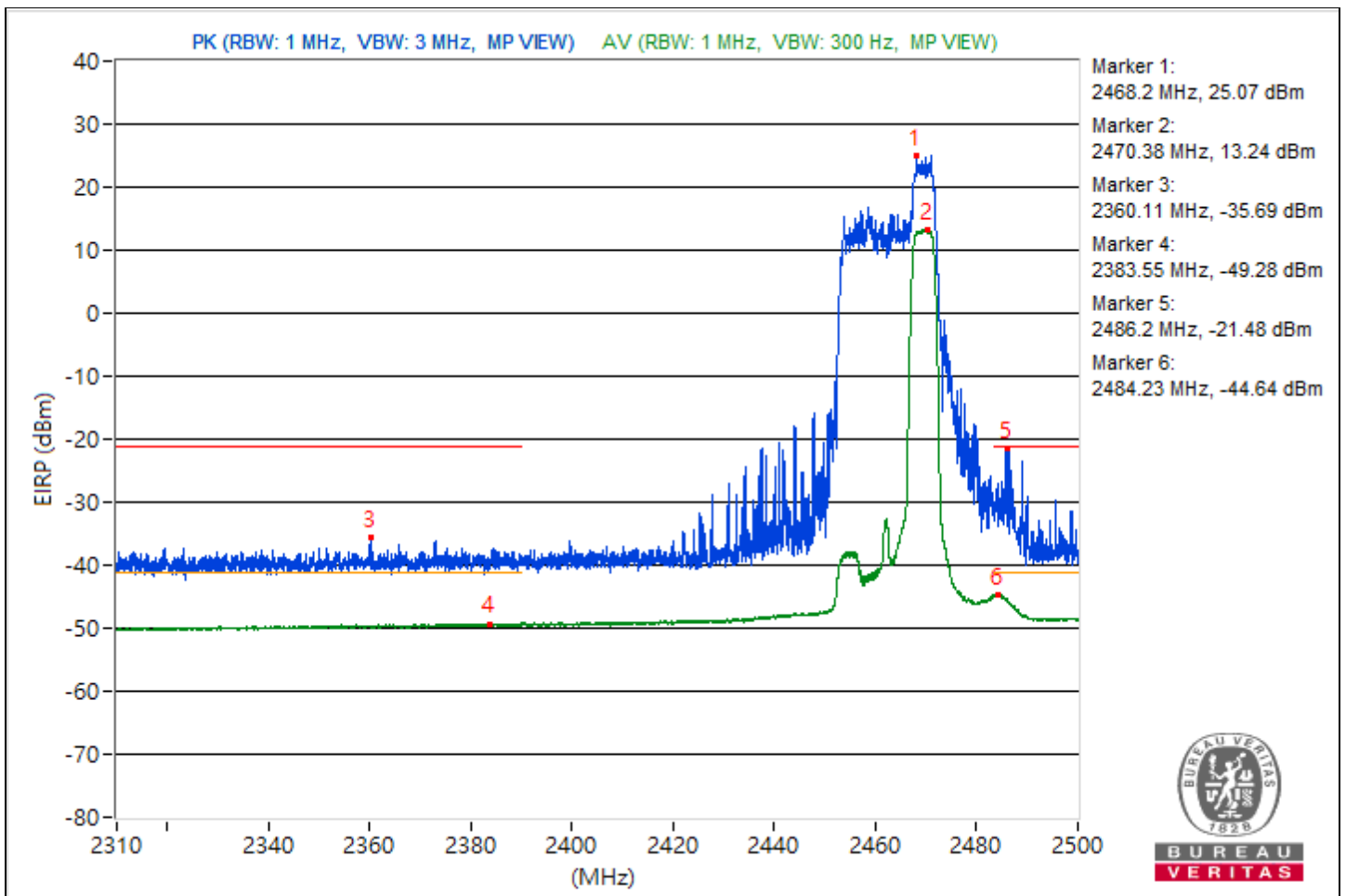

RF Mode	802.11be (EHT20) 52-tone RU	Channel	CH 12 : 2467 MHz
Frequency Range	2.31 GHz ~ 2.5 GHz	Environmental Conditions	25°C, 76% RH
Tested By	Waydi Tuan		

Conducted Band Edge							
No.	Frequency (MHz)	Emission Level (dBuV/m)	Limit (dBuV/m)	Margin (dB)	Raw Value Chain 0 (dBm)	Correction Factor (dB)	EIRP Level (dBm)
1	#2473.45	120.19 PK			21.75	3.18	24.93
2	#2474.18	108.09 AV			9.65	3.18	12.83
3	2382.51	58.45 PK	74	-15.55	-39.99	3.18	-36.81
4	2389.28	45.9 AV	54	-8.1	-52.54	3.18	-49.36
5	2484.92	69.75 PK	74	-4.25	-28.69	3.18	-25.51
6	2488.84	50.17 AV	54	-3.83	-48.27	3.18	-45.09

- Notes:
- Margin value = Emission Level - Limit value
  - " # ": The radiated frequency is out of the restricted band, the limit was restricted at the Conducted Out of Band Emissions.

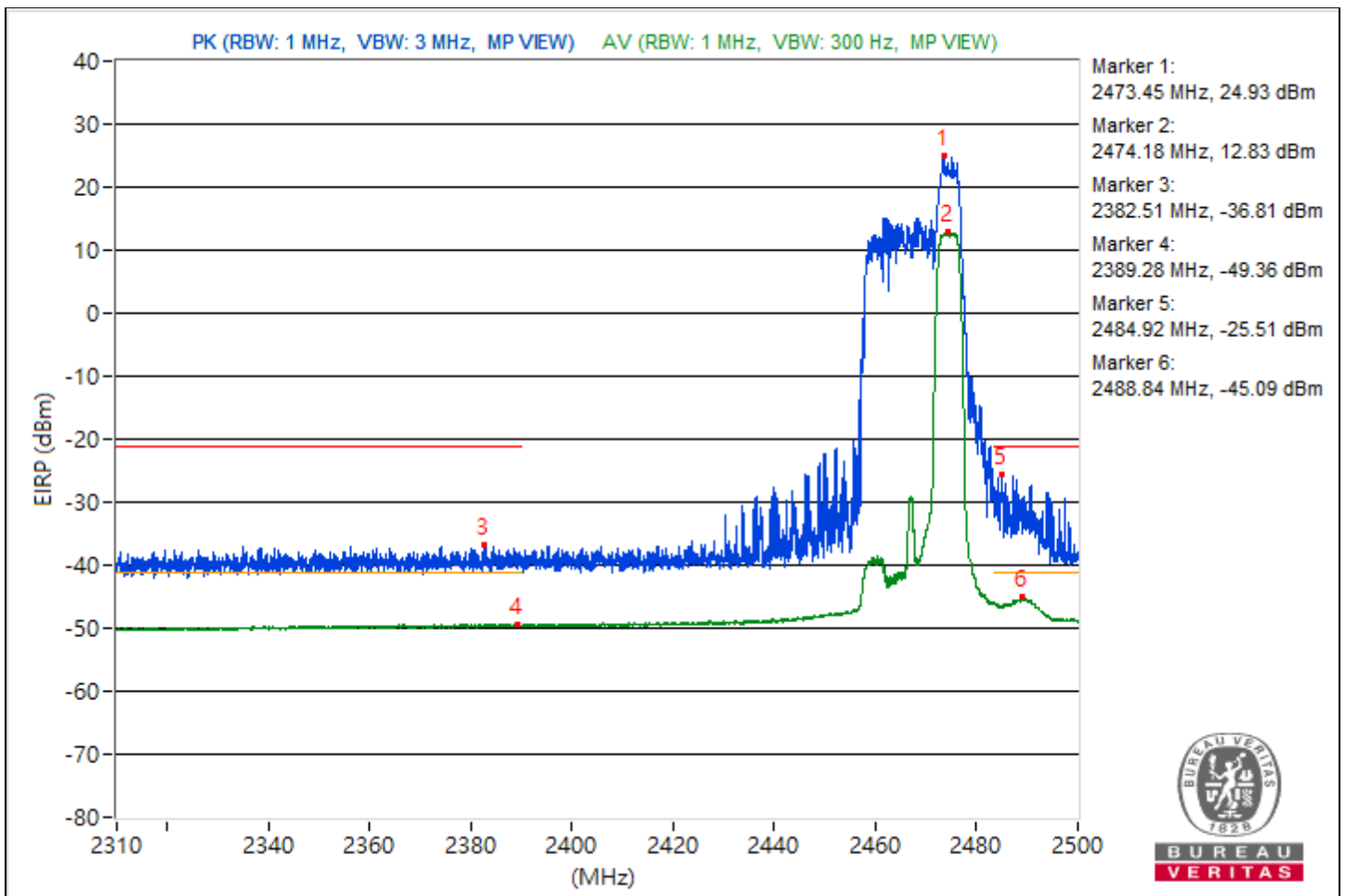

RF Mode	802.11be (EHT20) 52-tone RU	Channel	CH 13 : 2472 MHz
Frequency Range	2.31 GHz ~ 2.5 GHz	Environmental Conditions	25°C, 76% RH
Tested By	Waydi Tuan		

Conducted Band Edge							
No.	Frequency (MHz)	Emission Level (dBuV/m)	Limit (dBuV/m)	Margin (dB)	Raw Value Chain 0 (dBm)	Correction Factor (dB)	EIRP Level (dBm)
1	#2478.39	117.06 PK			18.62	3.18	21.8
2	#2479.36	104.03 AV			5.59	3.18	8.77
3	2339.43	58.96 PK	74	-15.04	-39.48	3.18	-36.3
4	2371.28	45.81 AV	54	-8.19	-52.63	3.18	-49.45
5	2483.61	73.78 PK	74	-0.22	-24.66	3.18	-21.48
6	2483.5	51.68 AV	54	-2.32	-46.76	3.18	-43.58

- Notes:
1. Margin value = Emission Level - Limit value
  2. "#": The radiated frequency is out of the restricted band, the limit was restricted at the Conducted Out of Band Emissions.

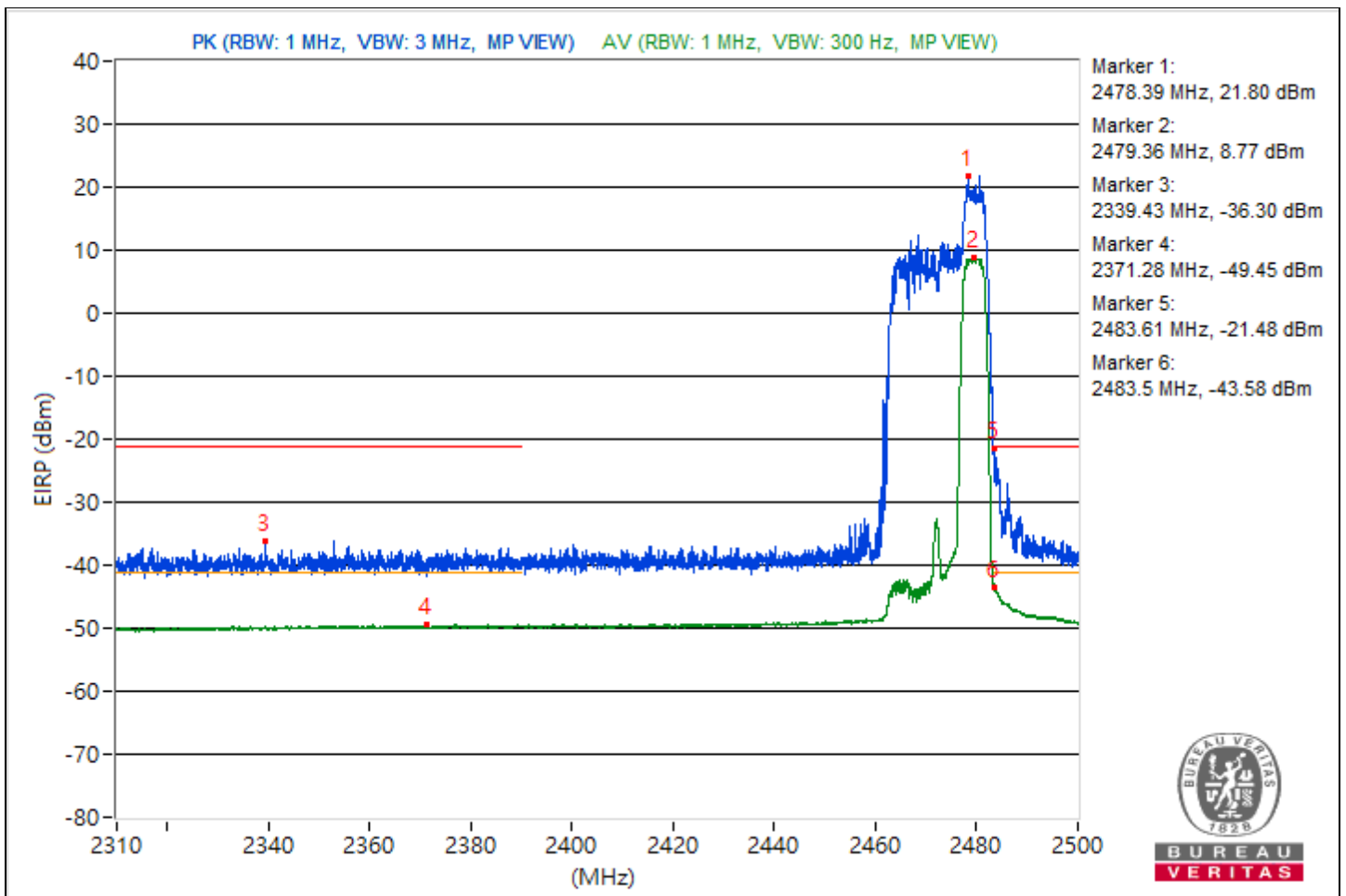



RF Mode	802.11be (EHT20) 106-tone RU	Channel	CH 1 : 2412 MHz
Frequency Range	2.31 GHz ~ 2.5 GHz	Environmental Conditions	25°C, 76% RH
Tested By	Waydi Tuan		

Conducted Band Edge							
No.	Frequency (MHz)	Emission Level (dBuV/m)	Limit (dBuV/m)	Margin (dB)	Raw Value Chain 0 (dBm)	Correction Factor (dB)	EIRP Level (dBm)
1	*2406.66	118.9 PK			20.46	3.18	23.64
2	*2404.48	105.23 AV			6.79	3.18	9.97
3	2384.72	68.24 PK	74	-5.76	-30.2	3.18	-27.02
4	2389.78	48.53 AV	54	-5.47	-49.91	3.18	-46.73
5	2491	58.24 PK	74	-15.76	-40.2	3.18	-37.02
6	2487.27	46.33 AV	54	-7.67	-52.11	3.18	-48.93

Notes:

1. Margin value = Emission Level - Limit value
2. " \* " : Fundamental frequency, the limit was restricted at the RF Output Power.

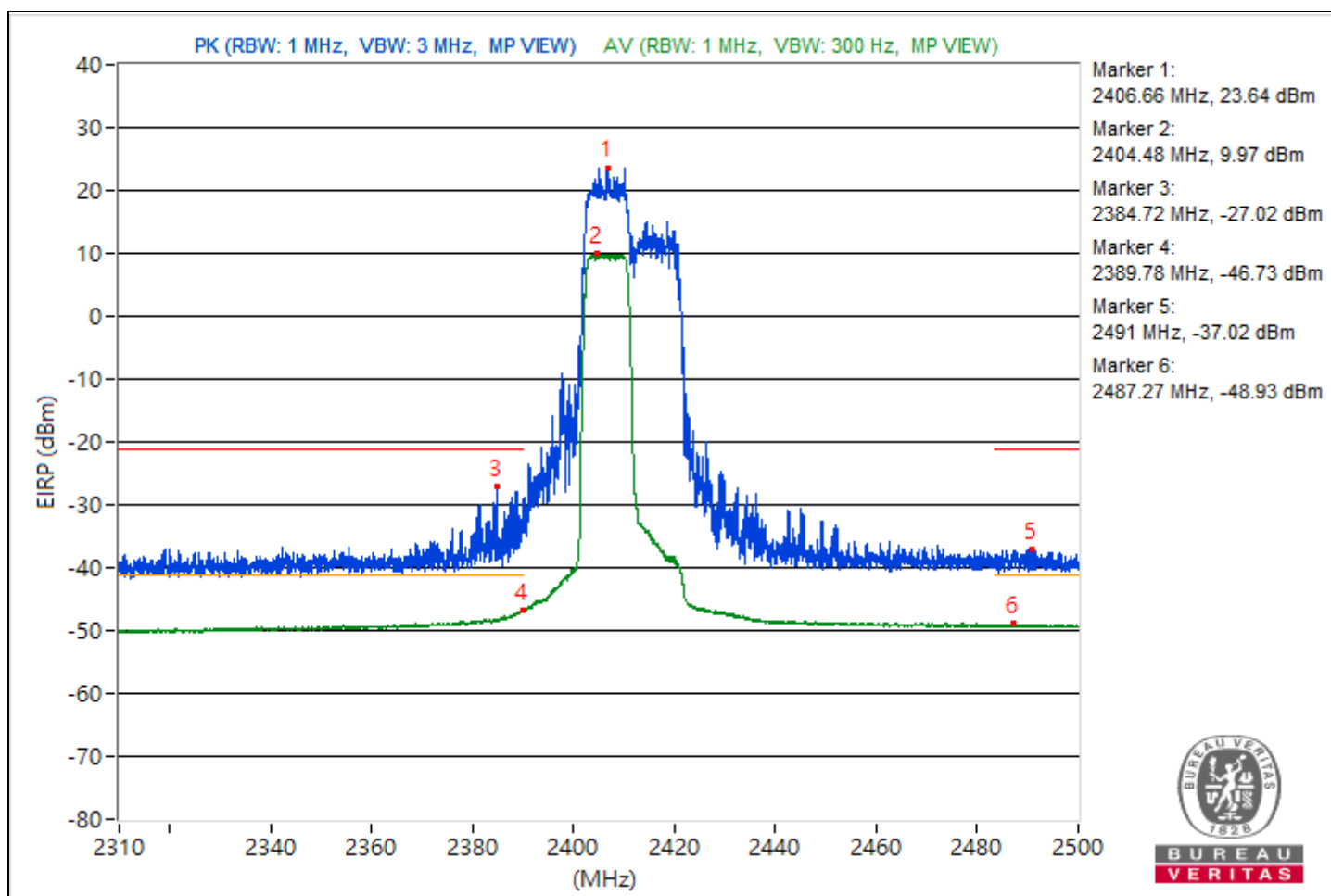

RF Mode	802.11be (EHT20) 106-tone RU	Channel	CH 6 : 2437 MHz
Frequency Range	2.31 GHz ~ 2.5 GHz	Environmental Conditions	25°C, 76% RH
Tested By	Waydi Tuan		

Conducted Band Edge							
No.	Frequency (MHz)	Emission Level (dBuV/m)	Limit (dBuV/m)	Margin (dB)	Raw Value Chain 0 (dBm)	Correction Factor (dB)	EIRP Level (dBm)
1	*2431.89	120.03 PK			21.59	3.18	24.77
2	*2433.95	108.29 AV			9.85	3.18	13.03
3	2386.95	62.85 PK	74	-11.15	-35.59	3.18	-32.41
4	2390	49.07 AV	54	-4.93	-49.37	3.18	-46.19
5	2484.54	62.77 PK	74	-11.23	-35.67	3.18	-32.49
6	2483.59	48.68 AV	54	-5.32	-49.76	3.18	-46.58

Notes:

1. Margin value = Emission Level - Limit value
2. " \* " : Fundamental frequency, the limit was restricted at the RF Output Power.

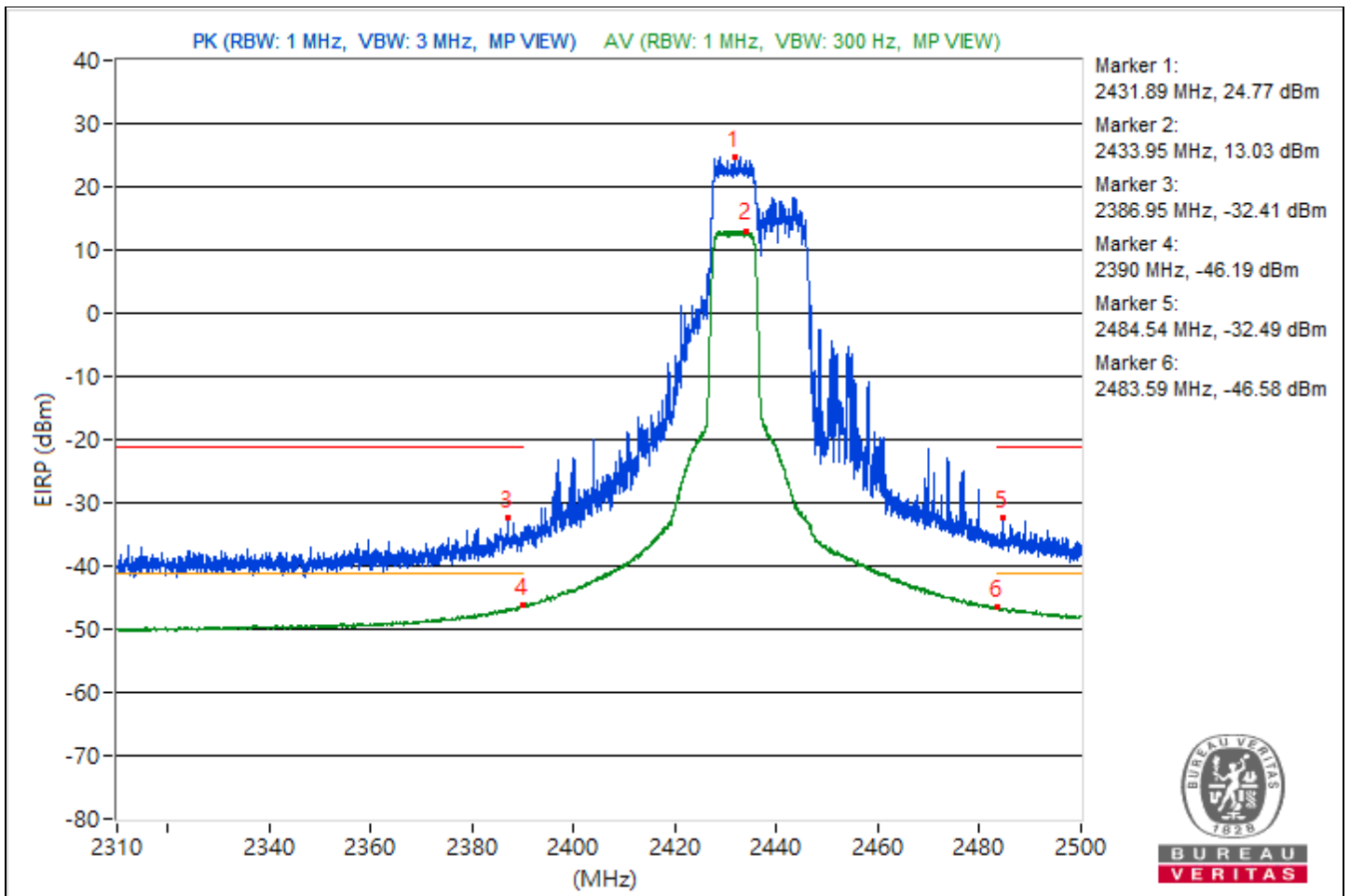

RF Mode	802.11be (EHT20) 106-tone RU	Channel	CH 11 : 2462 MHz
Frequency Range	2.31 GHz ~ 2.5 GHz	Environmental Conditions	25°C, 76% RH
Tested By	Waydi Tuan		

Conducted Band Edge							
No.	Frequency (MHz)	Emission Level (dBuV/m)	Limit (dBuV/m)	Margin (dB)	Raw Value Chain 0 (dBm)	Correction Factor (dB)	EIRP Level (dBm)
1	*2468.63	118.54 PK			20.1	3.18	23.28
2	*2465.87	105.44 AV			7	3.18	10.18
3	2347.79	58.92 PK	74	-15.08	-39.52	3.18	-36.34
4	2389.8	46.04 AV	54	-7.96	-52.4	3.18	-49.22
5	2485.68	71.33 PK	74	-2.67	-27.11	3.18	-23.93
6	2483.54	48.61 AV	54	-5.39	-49.83	3.18	-46.65

Notes:

1. Margin value = Emission Level - Limit value
2. " \* " : Fundamental frequency, the limit was restricted at the RF Output Power.

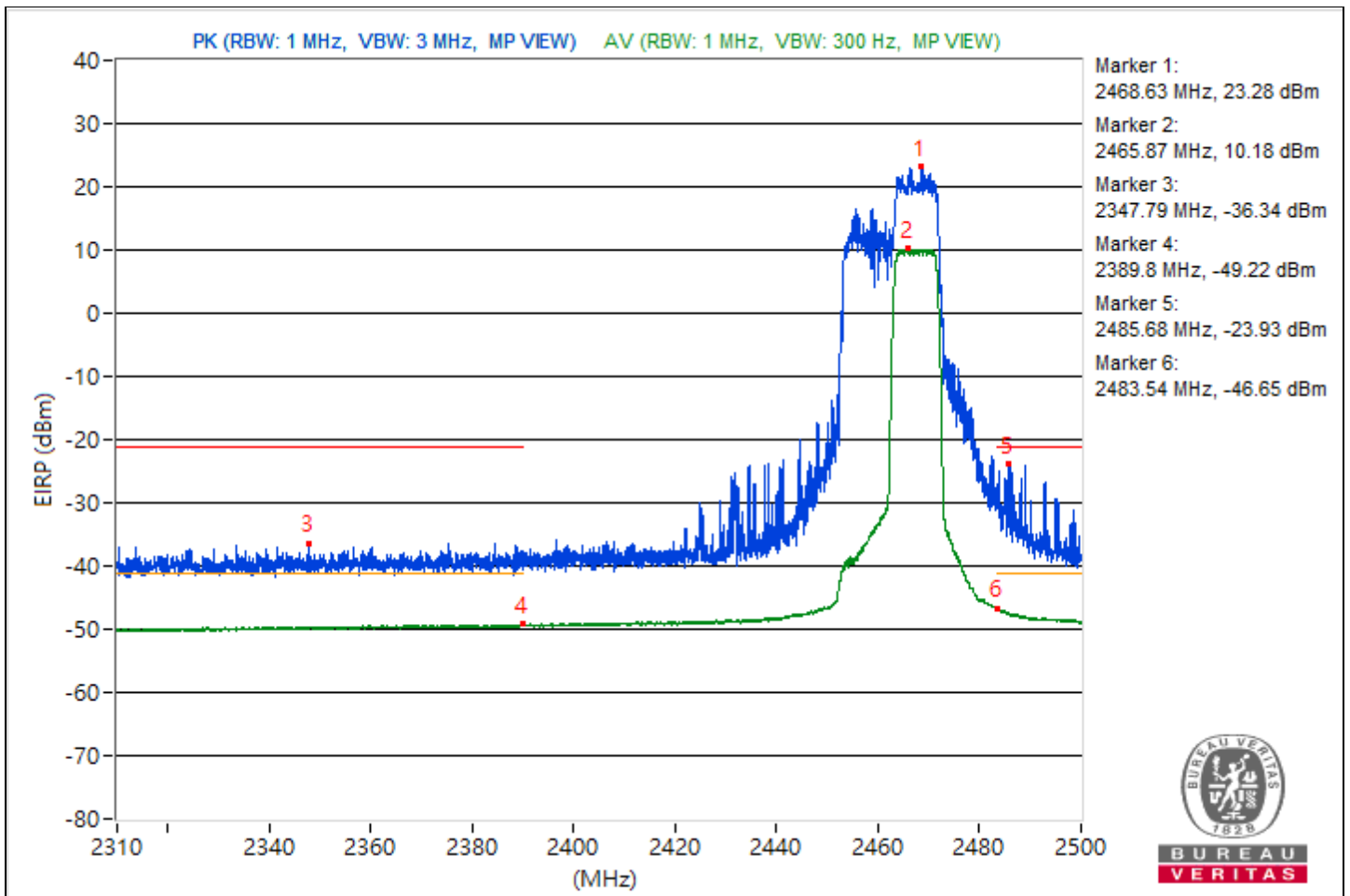

RF Mode	802.11be (EHT20) 106-tone RU	Channel	CH 12 : 2467 MHz
Frequency Range	2.31 GHz ~ 2.5 GHz	Environmental Conditions	25°C, 76% RH
Tested By	Waydi Tuan		

Conducted Band Edge							
No.	Frequency (MHz)	Emission Level (dBuV/m)	Limit (dBuV/m)	Margin (dB)	Raw Value Chain 0 (dBm)	Correction Factor (dB)	EIRP Level (dBm)
1	*2469.41	119.08 PK			20.64	3.18	23.82
2	*2469.32	104.93 AV			6.49	3.18	9.67
3	2384.53	58.51 PK	74	-15.49	-39.93	3.18	-36.75
4	2389.3	45.81 AV	54	-8.19	-52.63	3.18	-49.45
5	2484.02	67.15 PK	74	-6.85	-31.29	3.18	-28.11
6	2483.61	50.73 AV	54	-3.27	-47.71	3.18	-44.53

Notes:

1. Margin value = Emission Level - Limit value
2. " \* " : Fundamental frequency, the limit was restricted at the RF Output Power.

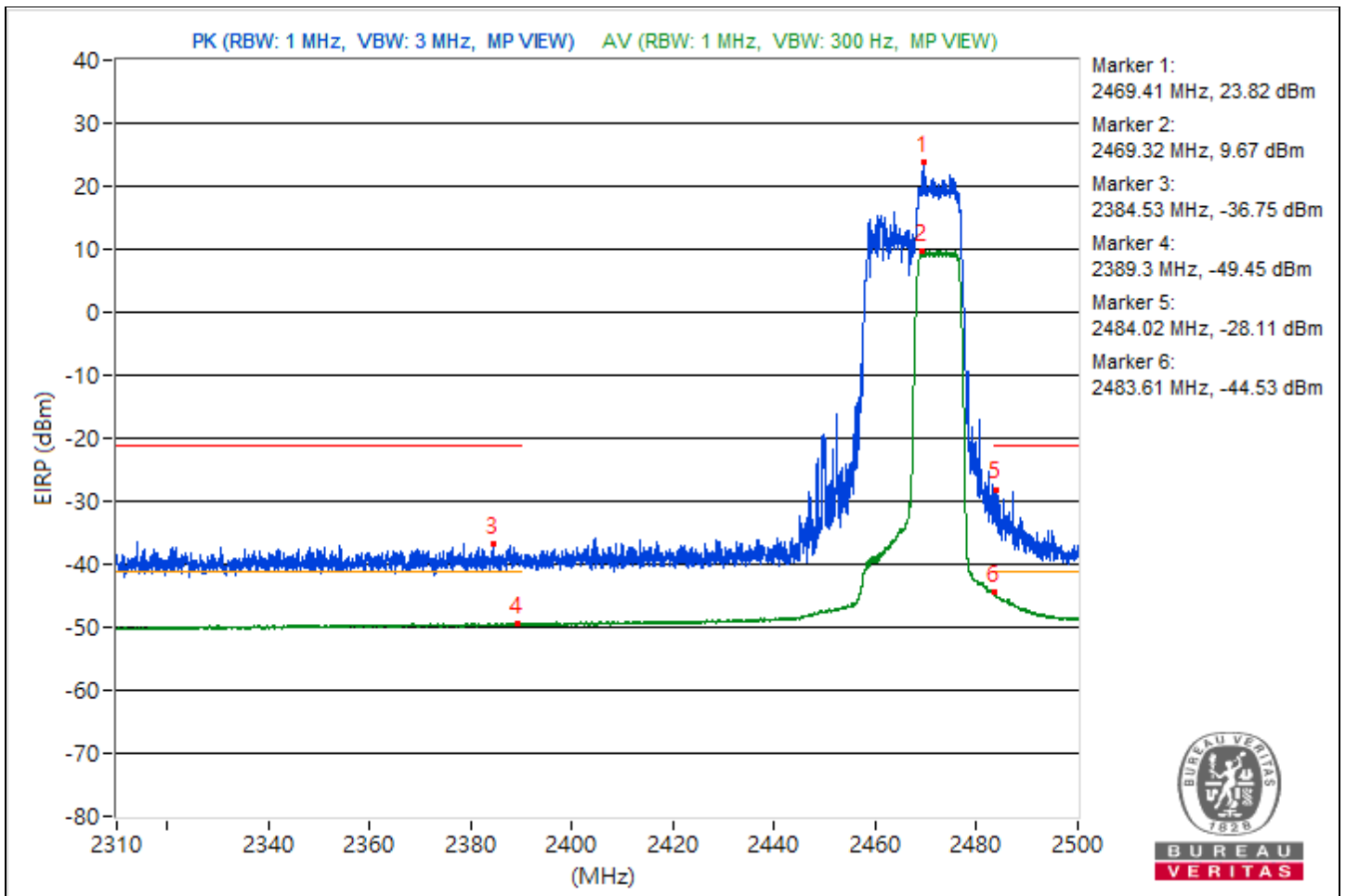

RF Mode	802.11be (EHT20) 106-tone RU	Channel	CH 13 : 2472 MHz
Frequency Range	2.31 GHz ~ 2.5 GHz	Environmental Conditions	25°C, 76% RH
Tested By	Waydi Tuan		

Conducted Band Edge							
No.	Frequency (MHz)	Emission Level (dBuV/m)	Limit (dBuV/m)	Margin (dB)	Raw Value Chain 0 (dBm)	Correction Factor (dB)	EIRP Level (dBm)
1	*2477.13	114.36 PK			15.92	3.18	19.1
2	*2480.26	100.89 AV			2.45	3.18	5.63
3	2369.54	59.06 PK	74	-14.94	-39.38	3.18	-36.2
4	2387.59	45.73 AV	54	-8.27	-52.71	3.18	-49.53
5	2483.5	70.76 PK	74	-3.24	-27.68	3.18	-24.5
6	2483.57	49.96 AV	54	-4.04	-48.48	3.18	-45.3

Notes:

1. Margin value = Emission Level - Limit value
2. " \* " : Fundamental frequency, the limit was restricted at the RF Output Power.

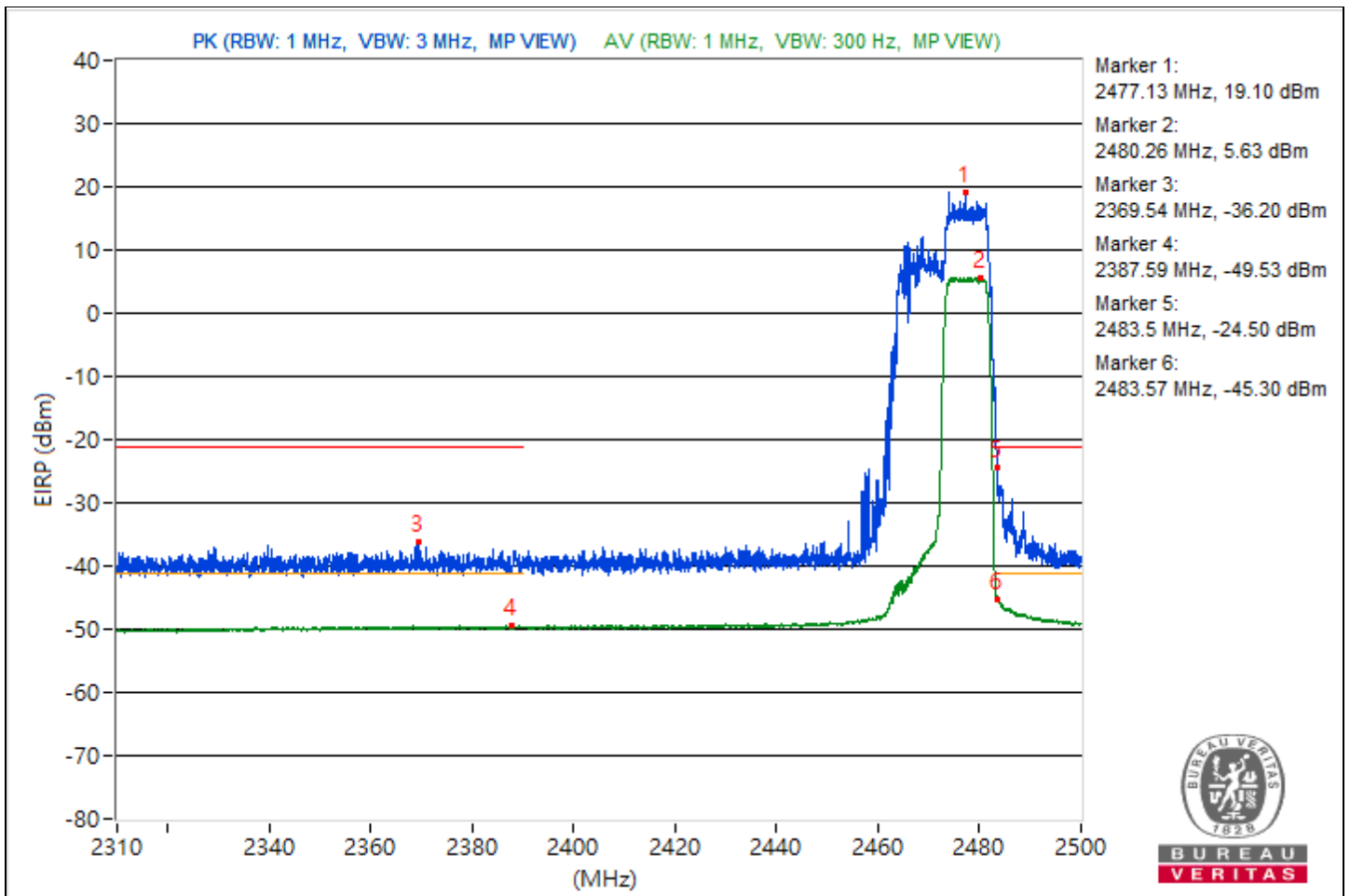

RF Mode	802.11be (EHT20) 52+26-tone MRU	Channel	CH 1 : 2412 MHz
Frequency Range	2.31 GHz ~ 2.5 GHz	Environmental Conditions	25°C, 76% RH
Tested By	Waydi Tuan		

Conducted Band Edge							
No.	Frequency (MHz)	Emission Level (dBuV/m)	Limit (dBuV/m)	Margin (dB)	Raw Value Chain 0 (dBm)	Correction Factor (dB)	EIRP Level (dBm)
1	*2406.9	118.96 PK			20.52	3.18	23.7
2	*2407.37	106.69 AV			8.25	3.18	11.43
3	2388.68	66.08 PK	74	-7.92	-32.36	3.18	-29.18
4	2389.99	47.64 AV	54	-6.36	-50.8	3.18	-47.62
5	2487.39	57.99 PK	74	-16.01	-40.45	3.18	-37.27
6	2496.46	46.26 AV	54	-7.74	-52.18	3.18	-49

Notes:

1. Margin value = Emission Level - Limit value
2. " \* " : Fundamental frequency, the limit was restricted at the RF Output Power.

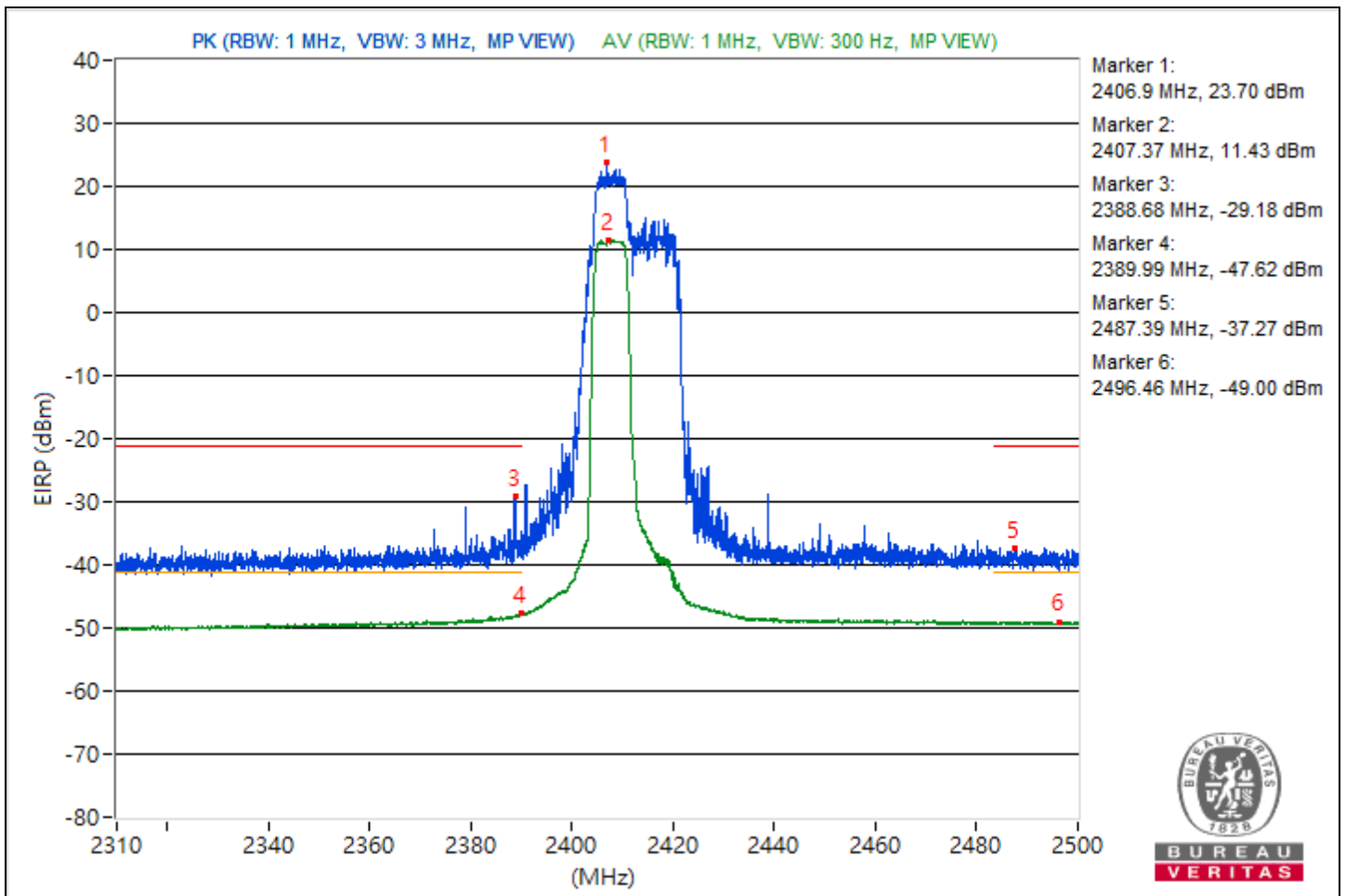

RF Mode	802.11be (EHT20) 52+26-tone MRU	Channel	CH 6 : 2437 MHz
Frequency Range	2.31 GHz ~ 2.5 GHz	Environmental Conditions	25°C, 76% RH
Tested By	Waydi Tuan		

Conducted Band Edge							
No.	Frequency (MHz)	Emission Level (dBuV/m)	Limit (dBuV/m)	Margin (dB)	Raw Value Chain 0 (dBm)	Correction Factor (dB)	EIRP Level (dBm)
1	*2433.64	121.24 PK			22.8	3.18	25.98
2	*2434.02	109.7 AV			11.26	3.18	14.44
3	2384.98	62.52 PK	74	-11.48	-35.92	3.18	-32.74
4	2389.25	48.17 AV	54	-5.83	-50.27	3.18	-47.09
5	2486.89	63.55 PK	74	-10.45	-34.89	3.18	-31.71
6	2484.14	48.26 AV	54	-5.74	-50.18	3.18	-47

Notes:

1. Margin value = Emission Level - Limit value
2. " \* " : Fundamental frequency, the limit was restricted at the RF Output Power.

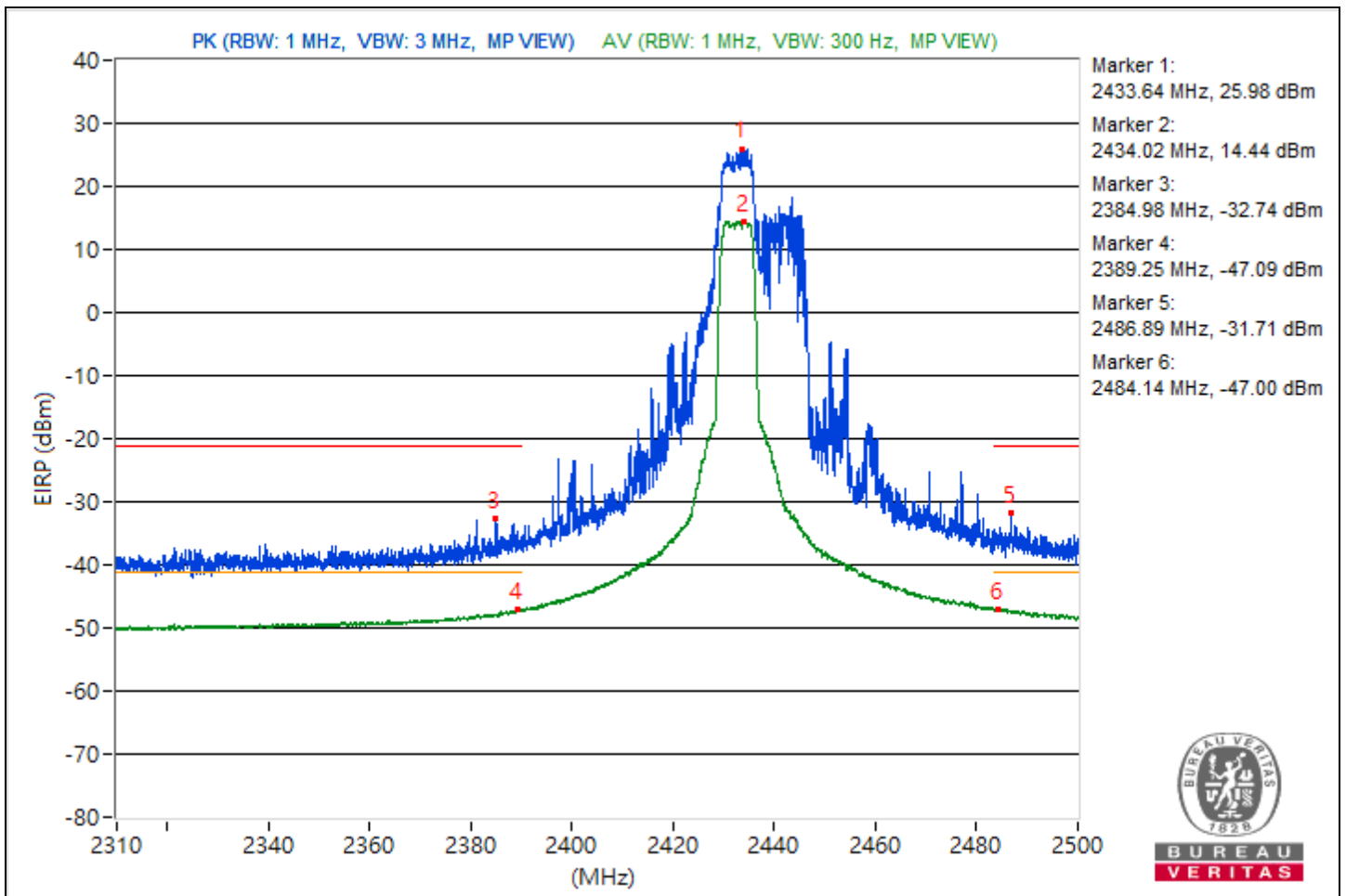

RF Mode	802.11be (EHT20) 52+26-tone MRU	Channel	CH 11 : 2462 MHz
Frequency Range	2.31 GHz ~ 2.5 GHz	Environmental Conditions	25°C, 76% RH
Tested By	Waydi Tuan		

Conducted Band Edge							
No.	Frequency (MHz)	Emission Level (dBuV/m)	Limit (dBuV/m)	Margin (dB)	Raw Value Chain 0 (dBm)	Correction Factor (dB)	EIRP Level (dBm)
1	*2466.2	119.94 PK			21.5	3.18	24.68
2	*2465.85	107.11 AV			8.67	3.18	11.85
3	2375.36	58.83 PK	74	-15.17	-39.61	3.18	-36.43
4	2388.95	45.92 AV	54	-8.08	-52.52	3.18	-49.34
5	2489.57	63.78 PK	74	-10.22	-34.66	3.18	-31.48
6	2483.76	47.72 AV	54	-6.28	-50.72	3.18	-47.54

Notes:

1. Margin value = Emission Level - Limit value
2. " \* \* ": Fundamental frequency, the limit was restricted at the RF Output Power.

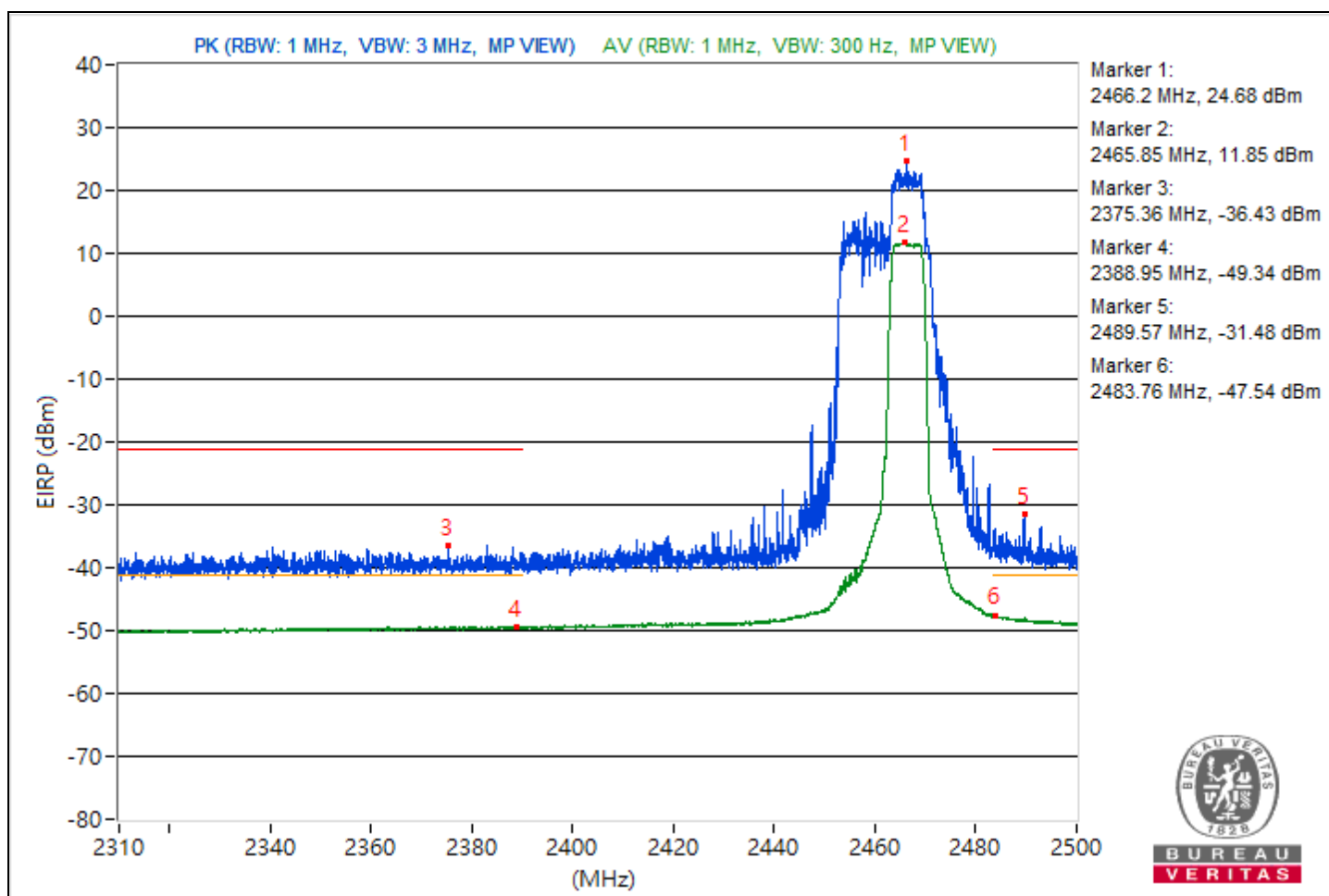



RF Mode	802.11be (EHT20) 52+26-tone MRU	Channel	CH 12 : 2467 MHz
Frequency Range	2.31 GHz ~ 2.5 GHz	Environmental Conditions	25°C, 76% RH
Tested By	Waydi Tuan		

Conducted Band Edge							
No.	Frequency (MHz)	Emission Level (dBuV/m)	Limit (dBuV/m)	Margin (dB)	Raw Value Chain 0 (dBm)	Correction Factor (dB)	EIRP Level (dBm)
1	*2470.72	118.11 PK			19.67	3.18	22.85
2	*2473.61	106.38 AV			7.94	3.18	11.12
3	2343.63	59.08 PK	74	-14.92	-39.36	3.18	-36.18
4	2389.25	45.87 AV	54	-8.13	-52.57	3.18	-49.39
5	2483.85	64.26 PK	74	-9.74	-34.18	3.18	-31
6	2483.5	49.43 AV	54	-4.57	-49.01	3.18	-45.83

Notes:

1. Margin value = Emission Level - Limit value
2. " \* " : Fundamental frequency, the limit was restricted at the RF Output Power.

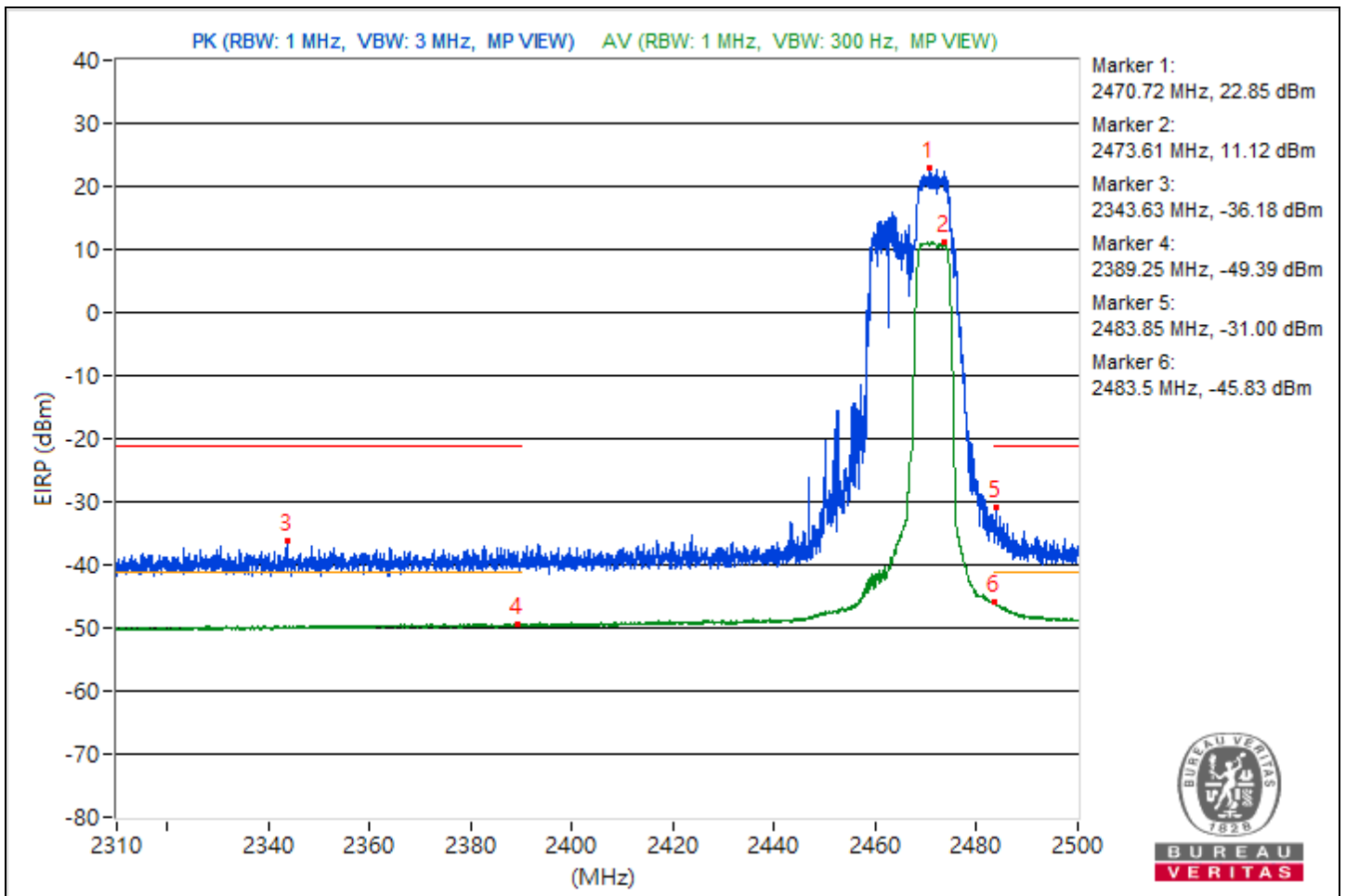

RF Mode	802.11be (EHT20) 52+26-tone MRU	Channel	CH 13 : 2472 MHz
Frequency Range	2.31 GHz ~ 2.5 GHz	Environmental Conditions	25°C, 76% RH
Tested By	Waydi Tuan		

Conducted Band Edge							
No.	Frequency (MHz)	Emission Level (dBuV/m)	Limit (dBuV/m)	Margin (dB)	Raw Value Chain 0 (dBm)	Correction Factor (dB)	EIRP Level (dBm)
1	*2474.59	118.42 PK			19.98	3.18	23.16
2	*2476.23	105.51 AV			7.07	3.18	10.25
3	2382.53	58.19 PK	74	-15.81	-40.25	3.18	-37.07
4	2381.32	45.97 AV	54	-8.03	-52.47	3.18	-49.29
5	2483.52	67.92 PK	74	-6.08	-30.52	3.18	-27.34
6	2483.5	50.82 AV	54	-3.18	-47.62	3.18	-44.44

- Notes:
- Margin value = Emission Level - Limit value
  - " \* " : Fundamental frequency, the limit was restricted at the RF Output Power.

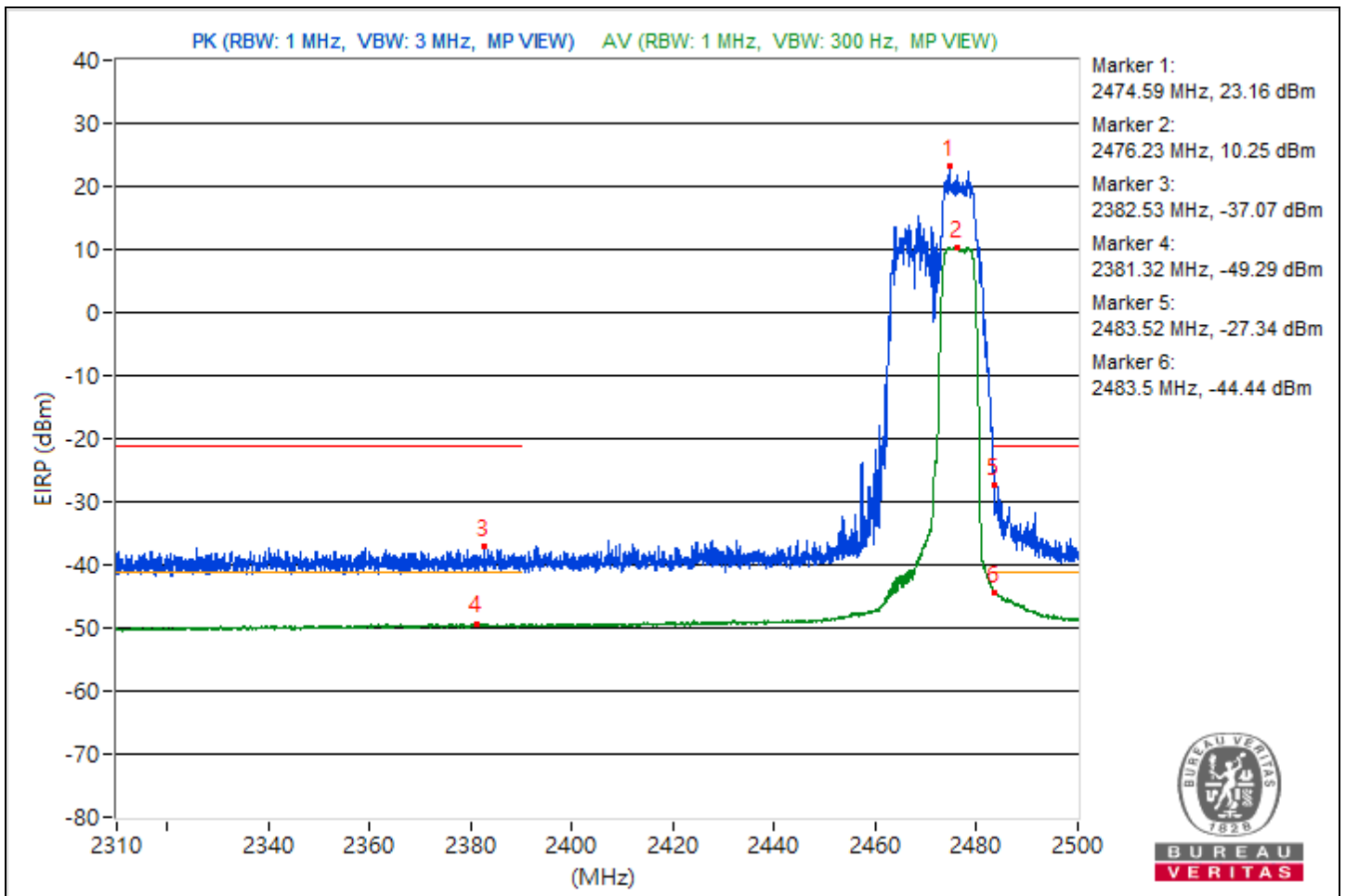

RF Mode	802.11be (EHT20) 106+26-tone MRU	Channel	CH 1 : 2412 MHz
Frequency Range	2.31 GHz ~ 2.5 GHz	Environmental Conditions	25°C, 76% RH
Tested By	Waydi Tuan		

Conducted Band Edge							
No.	Frequency (MHz)	Emission Level (dBUV/m)	Limit (dBUV/m)	Margin (dB)	Raw Value Chain 0 (dBm)	Correction Factor (dB)	EIRP Level (dBm)
1	*2411.46	116.81 PK			18.37	3.18	21.55
2	*2411.27	105.48 AV			7.04	3.18	10.22
3	2389.42	73.53 PK	74	-0.47	-24.91	3.18	-21.73
4	2389.99	49.24 AV	54	-4.76	-49.2	3.18	-46.02
5	2498.12	59.21 PK	74	-14.79	-39.23	3.18	-36.05
6	2484.06	46.41 AV	54	-7.59	-52.03	3.18	-48.85

Notes:

1. Margin value = Emission Level - Limit value
2. " \* " : Fundamental frequency, the limit was restricted at the RF Output Power.

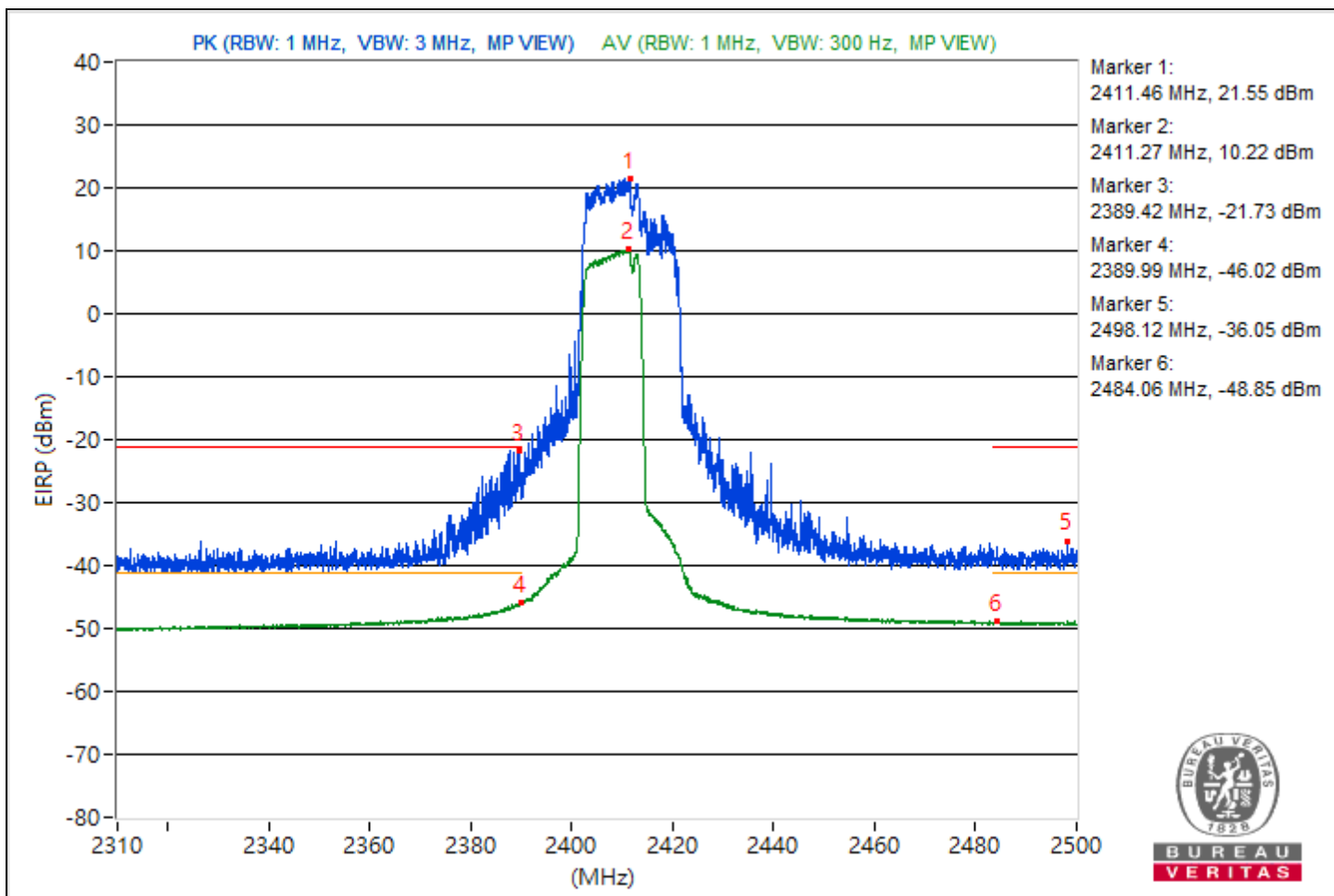

RF Mode	802.11be (EHT20) 106+26-tone MRU	Channel	CH 6 : 2437 MHz
Frequency Range	2.31 GHz ~ 2.5 GHz	Environmental Conditions	25°C, 76% RH
Tested By	Waydi Tuan		

Conducted Band Edge							
No.	Frequency (MHz)	Emission Level (dBuV/m)	Limit (dBuV/m)	Margin (dB)	Raw Value Chain 0 (dBm)	Correction Factor (dB)	EIRP Level (dBm)
1	*2434.62	119.33 PK			20.89	3.18	24.07
2	*2435.9	108.05 AV			9.61	3.18	12.79
3	2389.56	62.01 PK	74	-11.99	-36.43	3.18	-33.25
4	2389.51	49.63 AV	54	-4.37	-48.81	3.18	-45.63
5	2483.97	62.76 PK	74	-11.24	-35.68	3.18	-32.5
6	2483.61	49.68 AV	54	-4.32	-48.76	3.18	-45.58

- Notes:
1. Margin value = Emission Level - Limit value
  2. " \* " : Fundamental frequency, the limit was restricted at the RF Output Power.

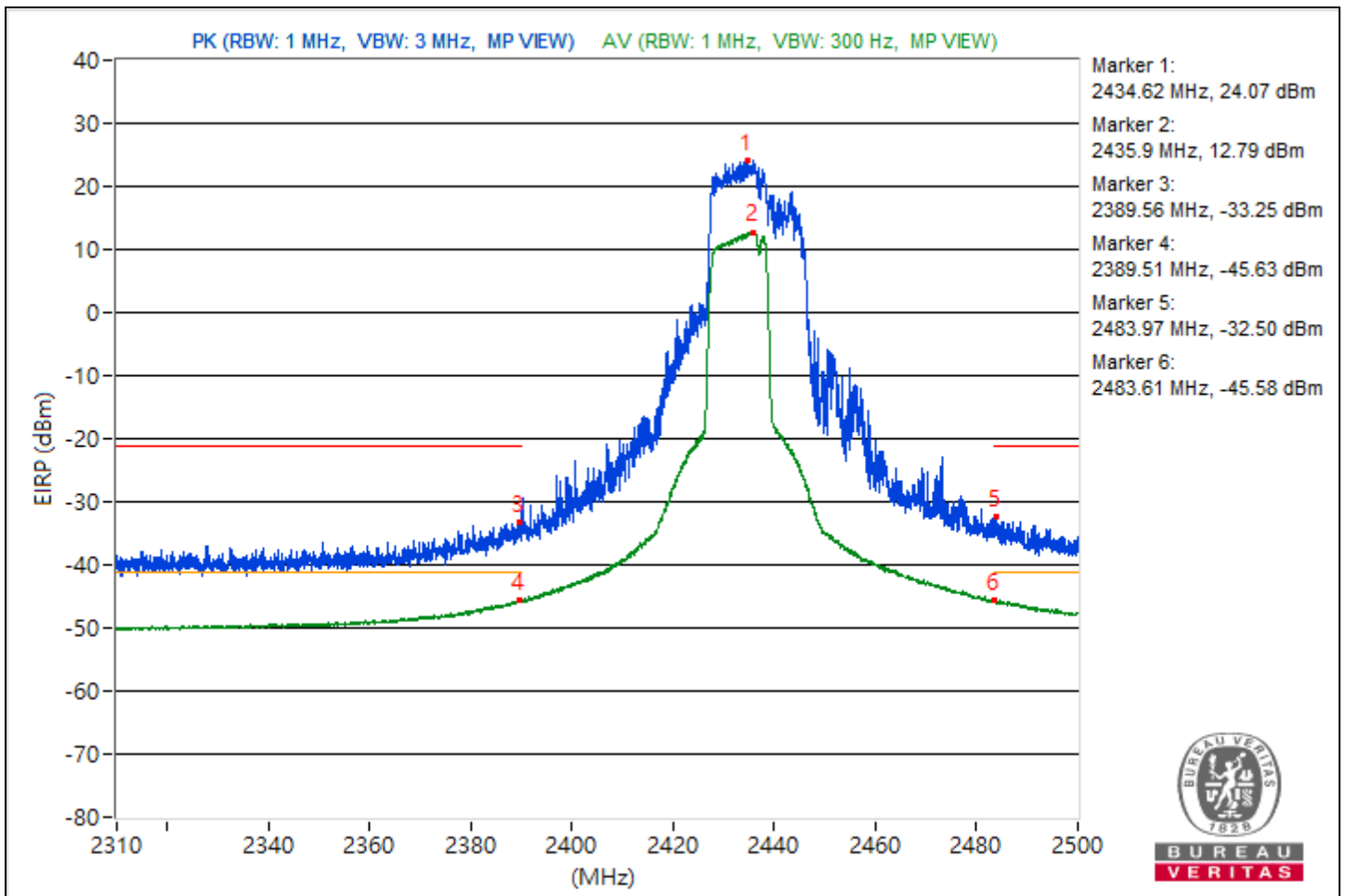

RF Mode	802.11be (EHT20) 106+26-tone MRU	Channel	CH 11 : 2462 MHz
Frequency Range	2.31 GHz ~ 2.5 GHz	Environmental Conditions	25°C, 76% RH
Tested By	Waydi Tuan		

Conducted Band Edge							
No.	Frequency (MHz)	Emission Level (dBuV/m)	Limit (dBuV/m)	Margin (dB)	Raw Value Chain 0 (dBm)	Correction Factor (dB)	EIRP Level (dBm)
1	*2463.35	117.64 PK			19.2	3.18	22.38
2	*2463.05	105.81 AV			7.37	3.18	10.55
3	2363.2	58.58 PK	74	-15.42	-39.86	3.18	-36.68
4	2383.39	46.14 AV	54	-7.86	-52.3	3.18	-49.12
5	2485.84	69.76 PK	74	-4.24	-28.68	3.18	-25.5
6	2483.68	49.26 AV	54	-4.74	-49.18	3.18	-46

Notes:

1. Margin value = Emission Level - Limit value
2. " \* " : Fundamental frequency, the limit was restricted at the RF Output Power.

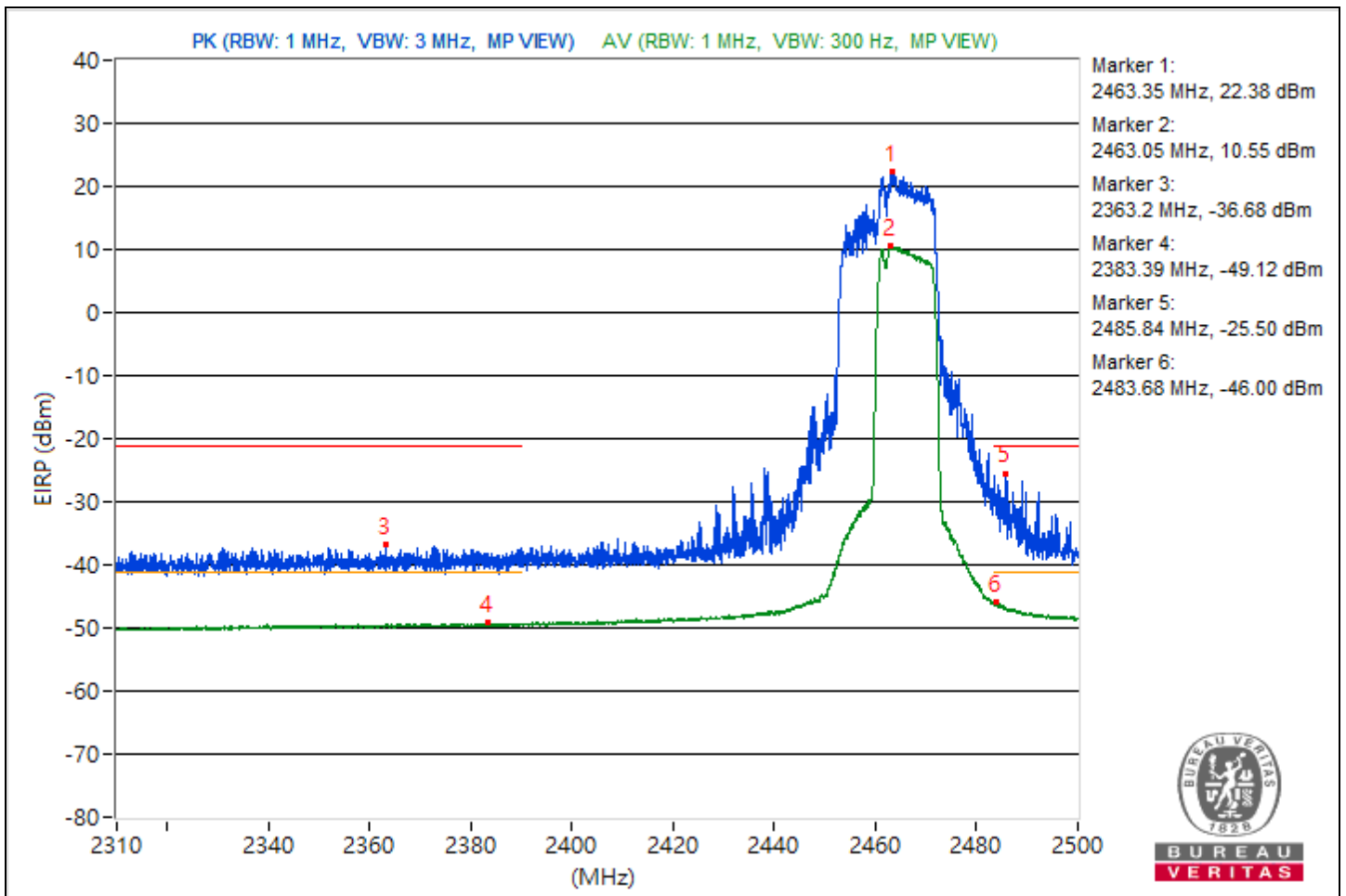

RF Mode	802.11be (EHT20) 106+26-tone MRU	Channel	CH 12 : 2467 MHz
Frequency Range	2.31 GHz ~ 2.5 GHz	Environmental Conditions	25°C, 76% RH
Tested By	Waydi Tuan		

Conducted Band Edge							
No.	Frequency (MHz)	Emission Level (dBuV/m)	Limit (dBuV/m)	Margin (dB)	Raw Value Chain 0 (dBm)	Correction Factor (dB)	EIRP Level (dBm)
1	*2467.94	116.99 PK			18.55	3.18	21.73
2	*2468.36	105.31 AV			6.87	3.18	10.05
3	2361.99	58.43 PK	74	-15.57	-40.01	3.18	-36.83
4	2388.68	45.99 AV	54	-8.01	-52.45	3.18	-49.27
5	2485.96	72.17 PK	74	-1.83	-26.27	3.18	-23.09
6	2483.66	50.84 AV	54	-3.16	-47.6	3.18	-44.42

Notes:

1. Margin value = Emission Level - Limit value
2. " \* " : Fundamental frequency, the limit was restricted at the RF Output Power.

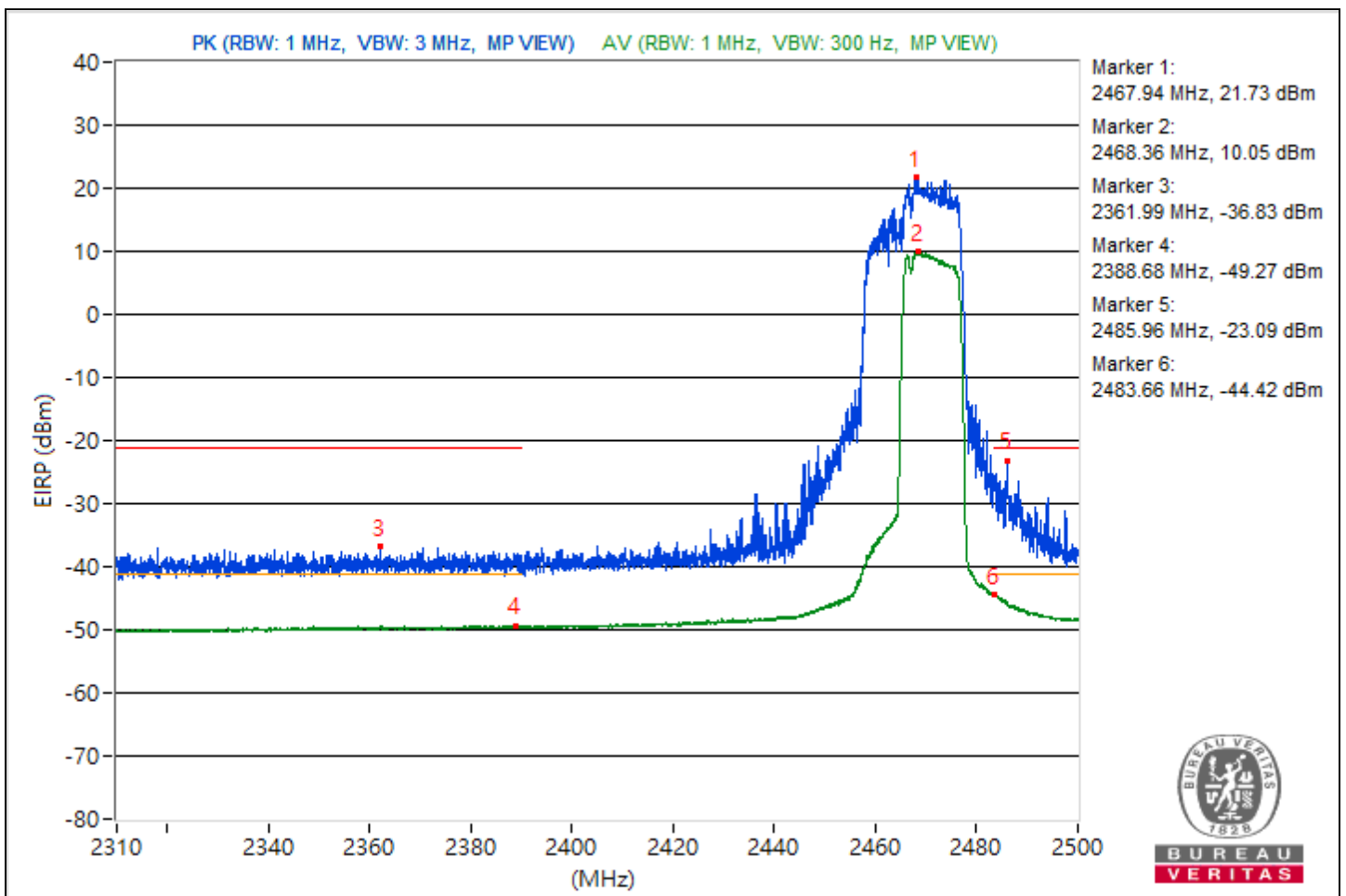

RF Mode	802.11be (EHT20) 106+26-tone MRU	Channel	CH 13 : 2472 MHz
Frequency Range	2.31 GHz ~ 2.5 GHz	Environmental Conditions	25°C, 76% RH
Tested By	Waydi Tuan		

Conducted Band Edge							
No.	Frequency (MHz)	Emission Level (dBuV/m)	Limit (dBuV/m)	Margin (dB)	Raw Value Chain 0 (dBm)	Correction Factor (dB)	EIRP Level (dBm)
1	*2472.81	114.45 PK			16.01	3.18	19.19
2	*2473.28	102.68 AV			4.24	3.18	7.42
3	2376.48	58.43 PK	74	-15.57	-40.01	3.18	-36.83
4	2388.73	45.8 AV	54	-8.2	-52.64	3.18	-49.46
5	2484.23	69.28 PK	74	-4.72	-29.16	3.18	-25.98
6	2483.52	50.19 AV	54	-3.81	-48.25	3.18	-45.07

Notes:

1. Margin value = Emission Level - Limit value
2. " \* " : Fundamental frequency, the limit was restricted at the RF Output Power.

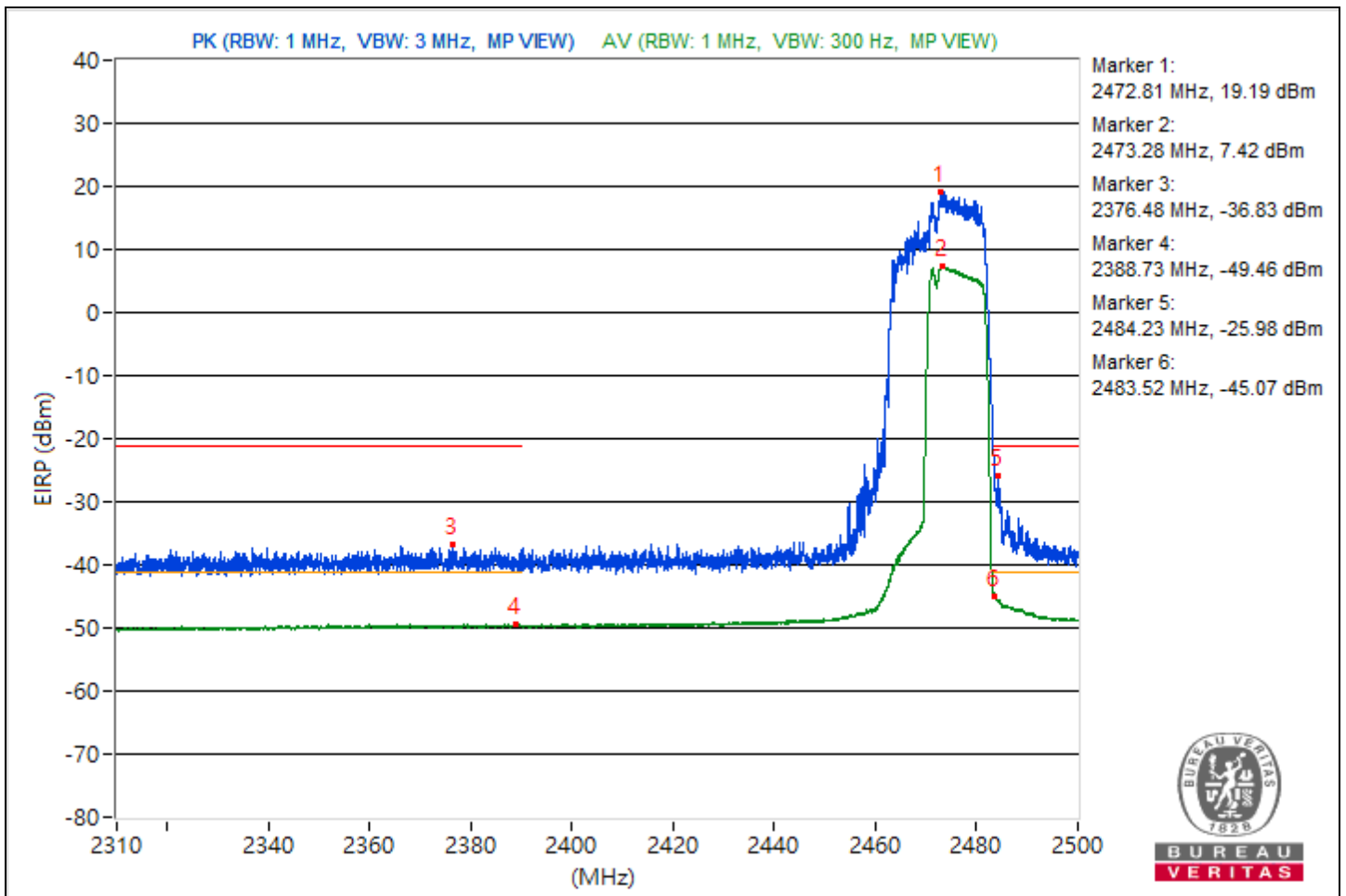

For 2TX

Conducted Unwanted Emissions

RF Mode	802.11b	Channel	CH 1 : 2412 MHz
Frequency Range	1 GHz ~ 25 GHz	Environmental Conditions	25°C, 76% RH
Tested By	Waydi Tuan		

Conducted Unwanted Emissions								
No.	Frequency (MHz)	Emission Level (dBuV/m)	Limit (dBuV/m)	Margin (dB)	Raw Value Chain 0 (dBm)	Raw Value Chain 1 (dBm)	Correction Factor (dB)	EIRP Level (dBm)
1	2313.67	57.64 PK	74	-16.36	-46.6	-51.15	7.93	-37.62
2	2339.88	47.16 AV	54	-6.84	-58.97	-59.1	7.93	-48.1
3	4824.41	59.3 PK	74	-14.7	-50.26	-45.01	7.93	-35.96
4	4824.02	53.95 AV	54	-0.05	-56.16	-50.21	7.93	-41.31
5	14481.69	57.78 PK	74	-16.22	-47.05	-50.44	7.93	-37.48
6	14472.89	47.4 AV	54	-6.6	-58.69	-58.91	7.93	-47.86
7	23745.2	61.46 PK	74	-12.54	-42.19	-51.67	7.93	-33.8
8	23833.7	51.31 AV	54	-2.69	-54.56	-55.24	7.93	-43.95

Note: Margin value = Emission Level - Limit value

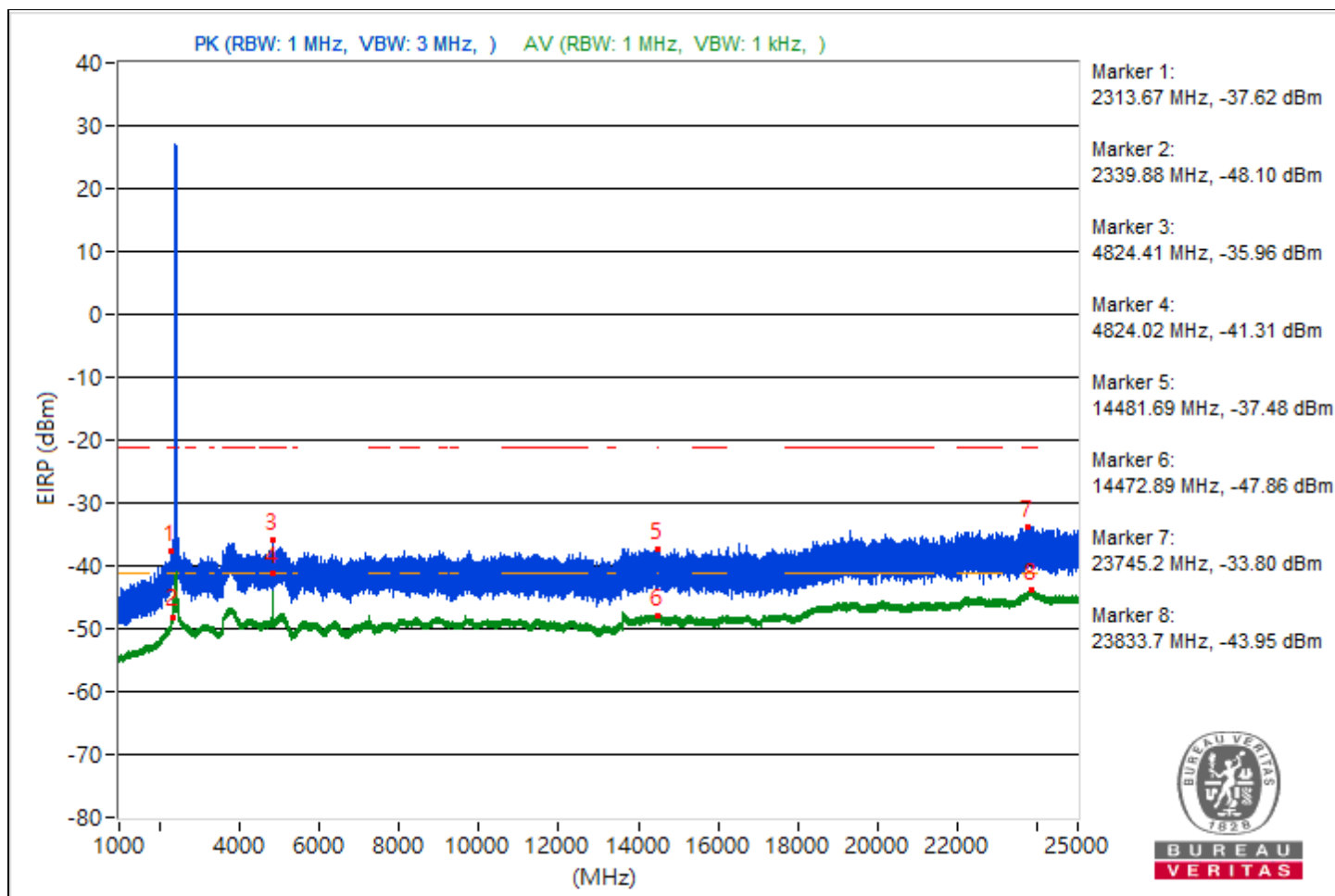



RF Mode	802.11b	Channel	CH 6 : 2437 MHz
Frequency Range	1 GHz ~ 25 GHz	Environmental Conditions	25°C, 76% RH
Tested By	Waydi Tuan		

Conducted Unwanted Emissions								
No.	Frequency (MHz)	Emission Level (dBuV/m)	Limit (dBuV/m)	Margin (dB)	Raw Value Chain 0 (dBm)	Raw Value Chain 1 (dBm)	Correction Factor (dB)	EIRP Level (dBm)
1	2339.18	56.88 PK	74	-17.12	-48.45	-50.41	7.93	-38.38
2	2338.4	46.6 AV	54	-7.4	-59.19	-60.03	7.93	-48.66
3	3837.41	58.84 PK	74	-15.16	-45.73	-50.02	7.93	-36.42
4	4873.96	53.31 AV	54	-0.69	-59.03	-50.37	7.93	-41.95
5	15628.8	57.55 PK	74	-16.45	-47.14	-50.97	7.93	-37.71
6	14470.4	47.26 AV	54	-6.74	-58.47	-59.22	7.93	-48
7	23957	61.98 PK	74	-12.02	-45.26	-42.98	7.93	-33.28
8	23838.2	51.48 AV	54	-2.52	-54.49	-54.98	7.93	-43.78

Note: Margin value = Emission Level - Limit value

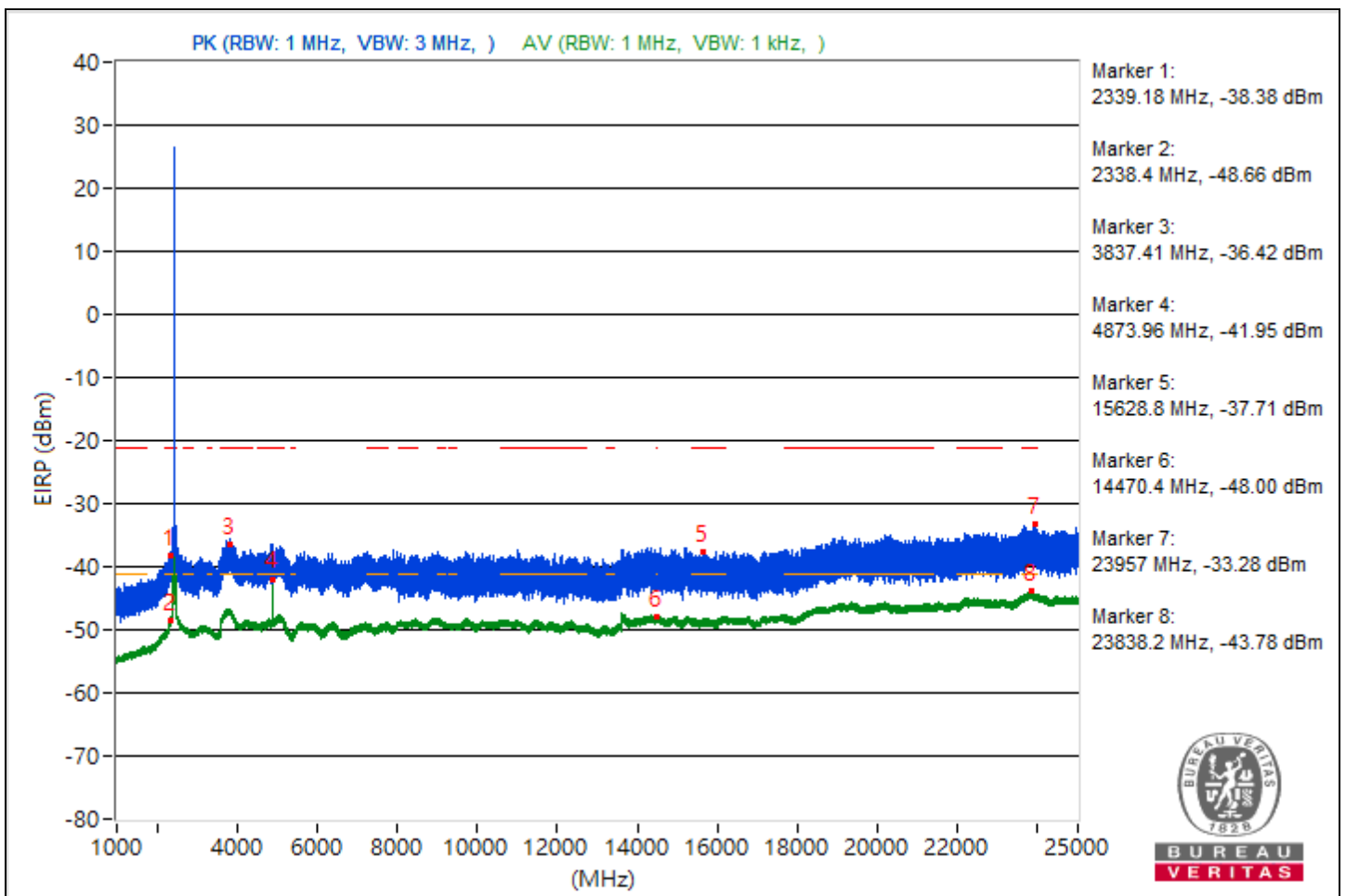

RF Mode	802.11b	Channel	CH 11 : 2462 MHz
Frequency Range	1 GHz ~ 25 GHz	Environmental Conditions	25°C, 76% RH
Tested By	Waydi Tuan		

Conducted Unwanted Emissions								
No.	Frequency (MHz)	Emission Level (dBuV/m)	Limit (dBuV/m)	Margin (dB)	Raw Value Chain 0 (dBm)	Raw Value Chain 1 (dBm)	Correction Factor (dB)	EIRP Level (dBm)
1	2328.68	56.04 PK	74	-17.96	-53.57	-48.28	7.93	-39.22
2	2337.39	46.15 AV	54	-7.85	-59.82	-60.29	7.93	-49.11
3	3797.67	59.08 PK	74	-14.92	-45.09	-51.05	7.93	-36.18
4	4924.04	53.59 AV	54	-0.41	-52.57	-52.65	7.93	-41.67
5	14471.38	58.66 PK	74	-15.34	-46.52	-48.86	7.93	-36.6
6	14483.2	47.24 AV	54	-6.76	-59.22	-58.71	7.93	-48.02
7	23961.7	61.37 PK	74	-12.63	-43.27	-47.27	7.93	-33.89
8	23808.4	51.24 AV	54	-2.76	-55.41	-54.55	7.93	-44.02

Note: Margin value = Emission Level - Limit value

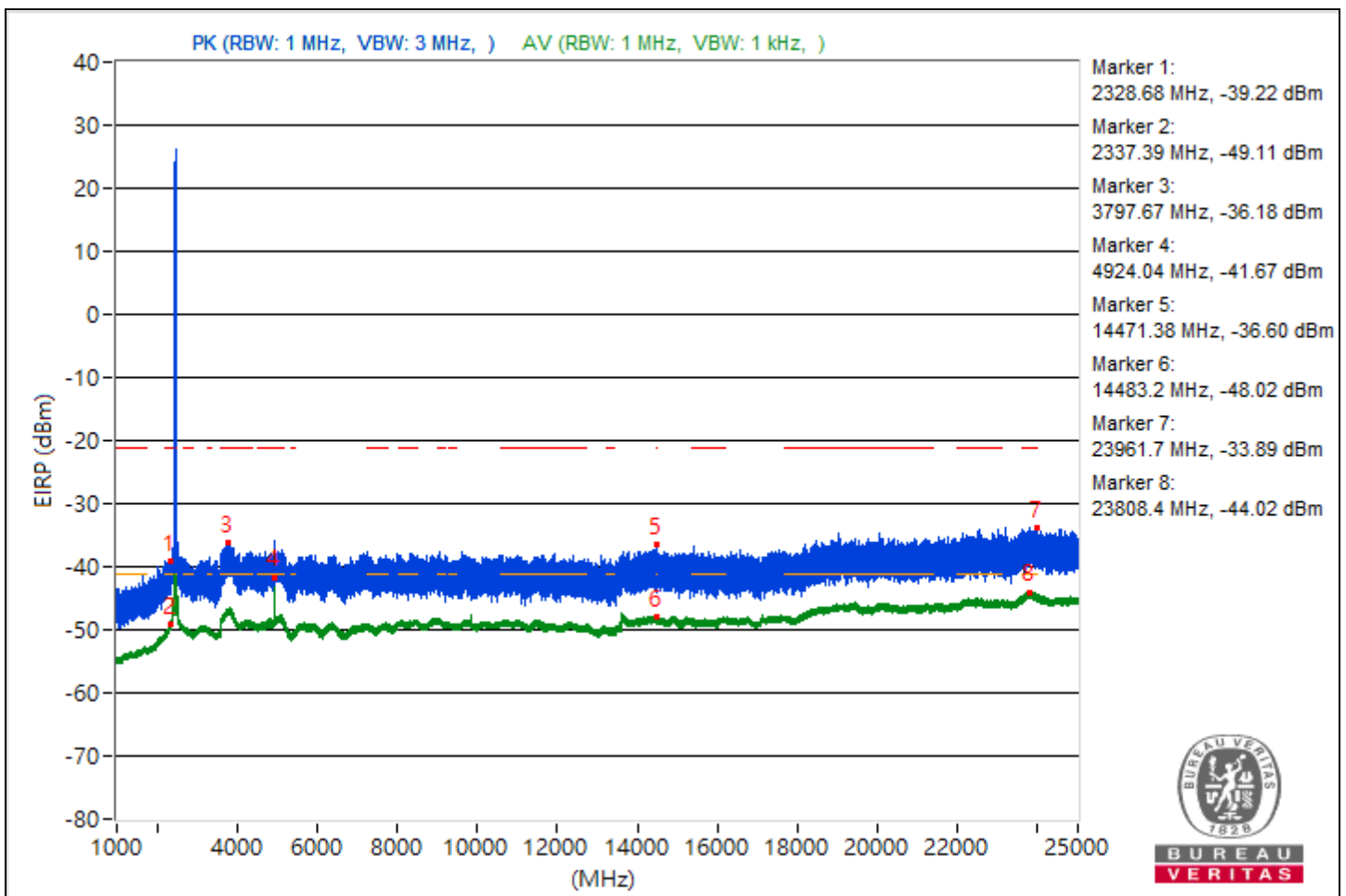

RF Mode	802.11b	Channel	CH 12 : 2467 MHz
Frequency Range	1 GHz ~ 25 GHz	Environmental Conditions	25°C, 76% RH
Tested By	Waydi Tuan		

Conducted Unwanted Emissions								
No.	Frequency (MHz)	Emission Level (dBuV/m)	Limit (dBuV/m)	Margin (dB)	Raw Value Chain 0 (dBm)	Raw Value Chain 1 (dBm)	Correction Factor (dB)	EIRP Level (dBm)
1	2333.03	56.24 PK	74	-17.76	-50.69	-49.34	7.93	-39.02
2	2338.56	46.19 AV	54	-7.81	-59.89	-60.14	7.93	-49.07
3	3825.04	58.68 PK	74	-15.32	-46.3	-49.23	7.93	-36.58
4	3795.72	48.4 AV	54	-5.6	-58.2	-57.43	7.93	-46.86
5	8434.13	57.48 PK	74	-16.52	-53.31	-46.54	7.93	-37.78
6	14485.96	47.25 AV	54	-6.75	-58.76	-59.14	7.93	-48.01
7	23864.9	61.81 PK	74	-12.19	-47.2	-42.69	7.93	-33.45
8	23807.4	51.46 AV	54	-2.54	-54.79	-54.69	7.93	-43.8

Note: Margin value = Emission Level - Limit value

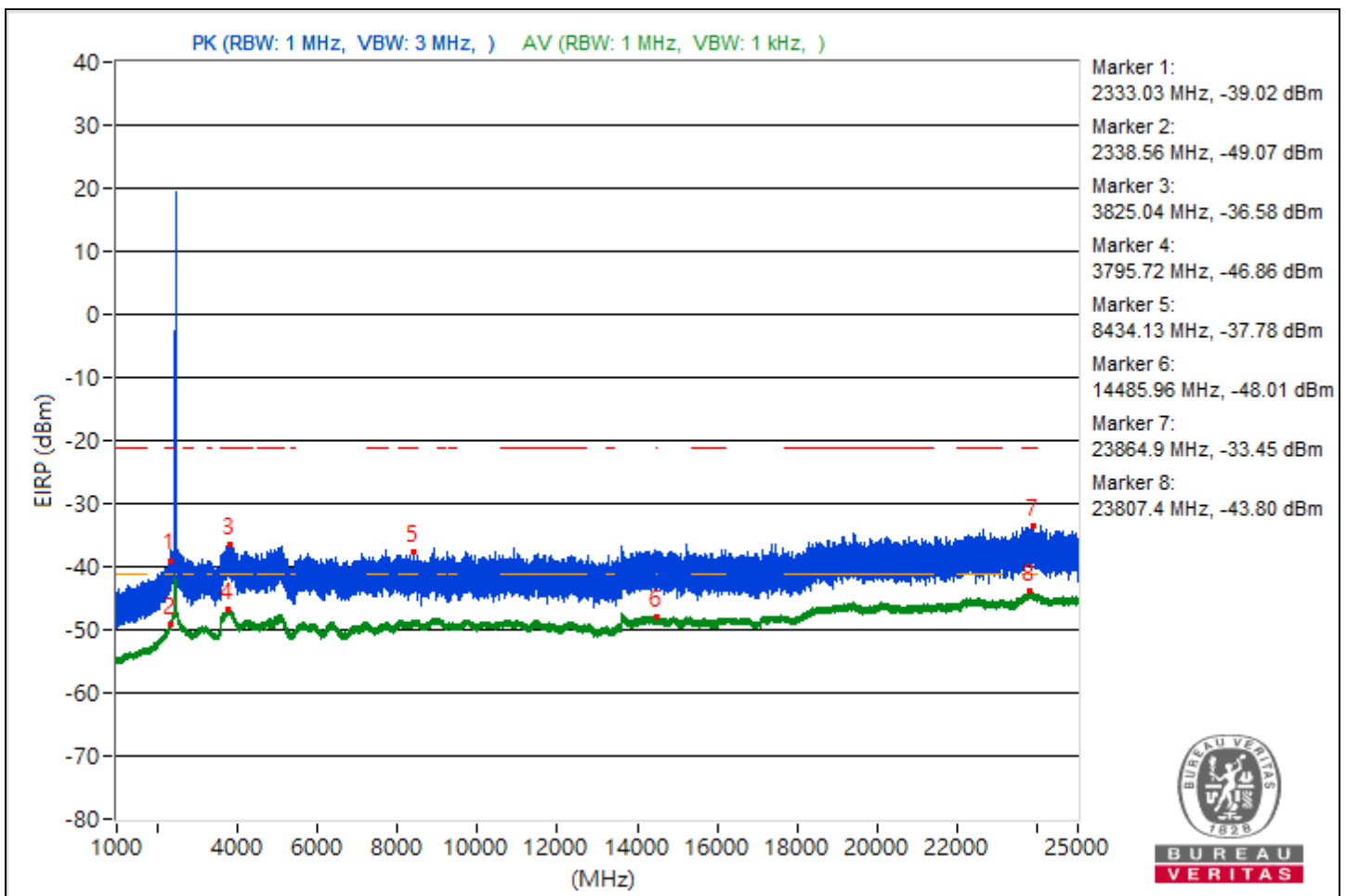

RF Mode	802.11b	Channel	CH 13 : 2472 MHz
Frequency Range	1 GHz ~ 25 GHz	Environmental Conditions	25°C, 76% RH
Tested By	Waydi Tuan		

Conducted Unwanted Emissions								
No.	Frequency (MHz)	Emission Level (dBuV/m)	Limit (dBuV/m)	Margin (dB)	Raw Value Chain 0 (dBm)	Raw Value Chain 1 (dBm)	Correction Factor (dB)	EIRP Level (dBm)
1	2247.79	54.73 PK	74	-19.27	-55.31	-49.46	7.93	-40.53
2	2338.17	44.64 AV	54	-9.36	-61.22	-61.93	7.93	-50.62
3	3782.81	59.16 PK	74	-14.84	-45.19	-50.32	7.93	-36.1
4	3812.91	48.44 AV	54	-5.56	-57.91	-57.61	7.93	-46.82
5	15817.87	57.76 PK	74	-16.24	-52.93	-46.28	7.93	-37.5
6	14472.18	47.08 AV	54	-6.92	-58.78	-59.48	7.93	-48.18
7	23857	61.66 PK	74	-12.34	-43.56	-45.81	7.93	-33.6
8	23802.6	51.35 AV	54	-2.65	-55.18	-54.55	7.93	-43.91

Note: Margin value = Emission Level - Limit value

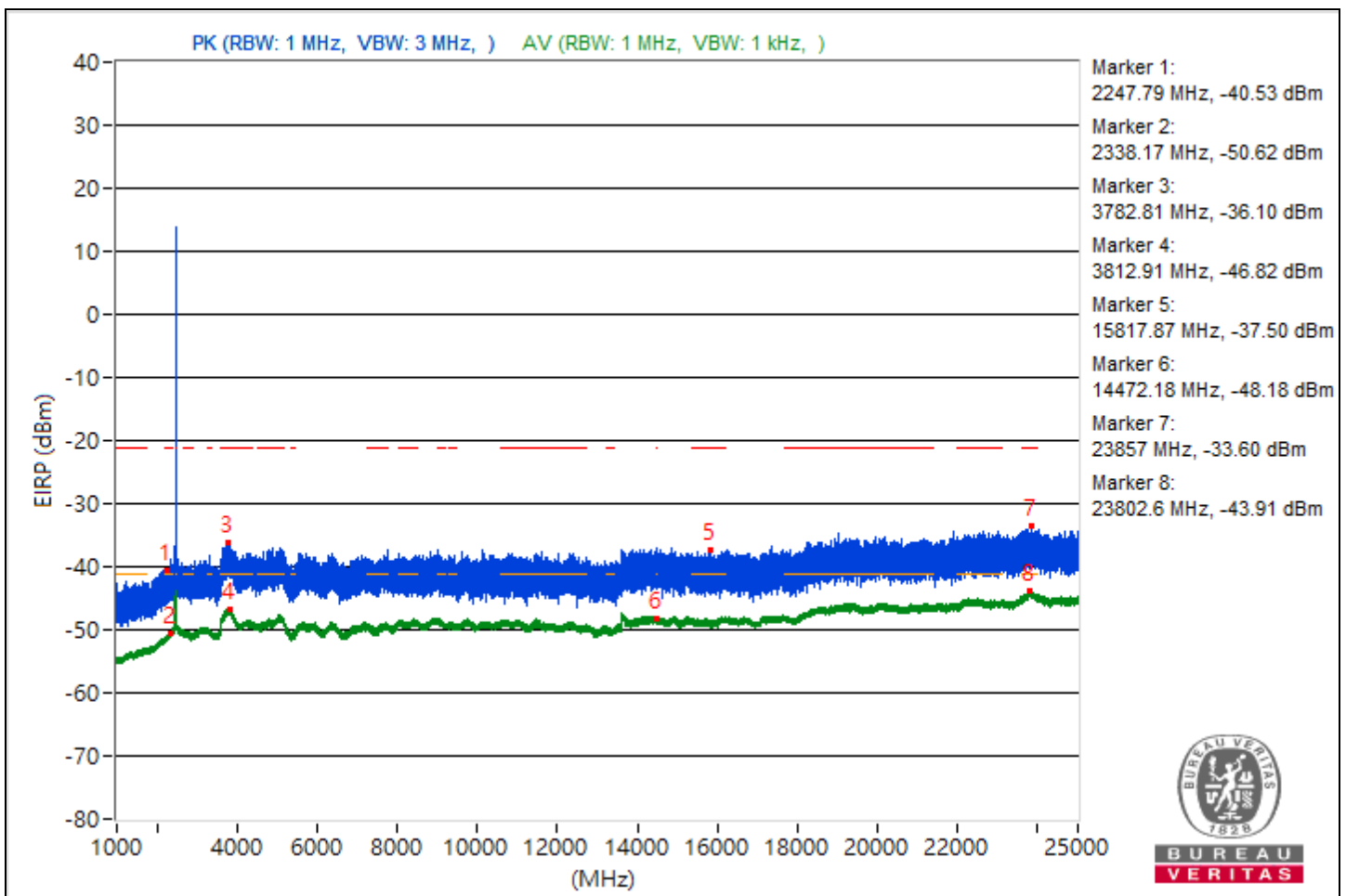

RF Mode	802.11g	Channel	CH 1 : 2412 MHz
Frequency Range	1 GHz ~ 25 GHz	Environmental Conditions	25°C, 76% RH
Tested By	Waydi Tuan		

Conducted Unwanted Emissions								
No.	Frequency (MHz)	Emission Level (dBuV/m)	Limit (dBuV/m)	Margin (dB)	Raw Value Chain 0 (dBm)	Raw Value Chain 1 (dBm)	Correction Factor (dB)	EIRP Level (dBm)
1	2334.04	56.65 PK	74	-17.35	-48.07	-51.81	7.93	-38.61
2	2338.48	46.52 AV	54	-7.48	-59.53	-59.83	7.93	-48.74
3	3817.89	58.49 PK	74	-15.51	-50.05	-46.19	7.93	-36.77
4	3804.82	48.38 AV	54	-5.62	-58.28	-57.41	7.93	-46.88
5	8484.44	58.17 PK	74	-15.83	-49.06	-47.19	7.93	-37.09
6	14471.82	47.09 AV	54	-6.91	-59.46	-58.79	7.93	-48.17
7	22263.4	61.54 PK	74	-12.46	-42.48	-49.21	7.93	-33.72
8	23811.5	51.35 AV	54	-2.65	-54.38	-55.38	7.93	-43.91

Note: Margin value = Emission Level - Limit value

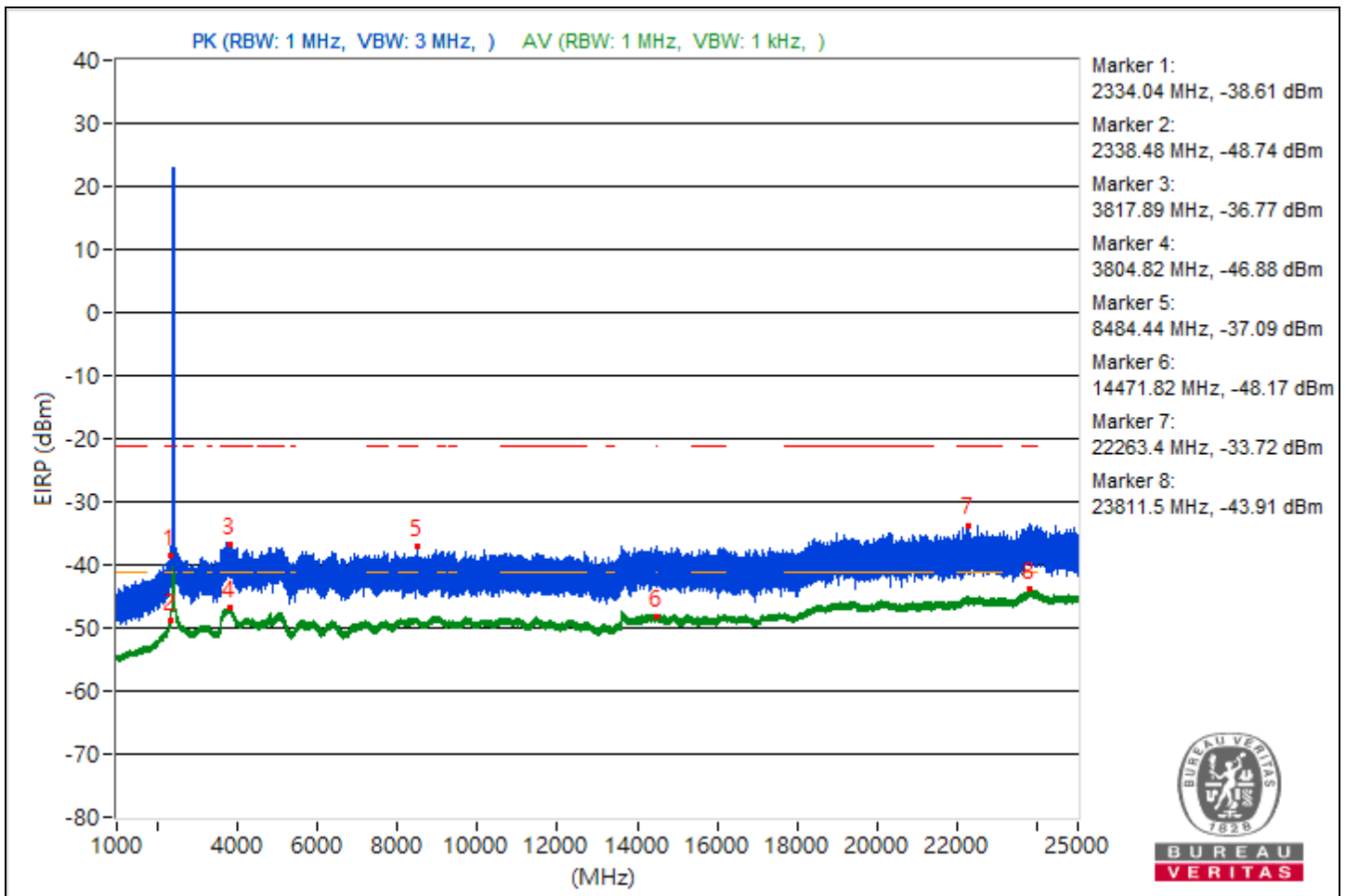

RF Mode	802.11g	Channel	CH 6 : 2437 MHz
Frequency Range	1 GHz ~ 25 GHz	Environmental Conditions	25°C, 76% RH
Tested By	Waydi Tuan		

Conducted Unwanted Emissions								
No.	Frequency (MHz)	Emission Level (dBuV/m)	Limit (dBuV/m)	Margin (dB)	Raw Value Chain 0 (dBm)	Raw Value Chain 1 (dBm)	Correction Factor (dB)	EIRP Level (dBm)
1	2339.96	56.05 PK	74	-17.95	-52.35	-48.7	7.93	-39.21
2	2337.39	46.81 AV	54	-7.19	-59.12	-59.67	7.93	-48.45
3	3803.19	58.65 PK	74	-15.35	-50.56	-45.78	7.93	-36.61
4	3814.16	48.37 AV	54	-5.63	-57.56	-58.11	7.93	-46.89
5	8379.38	58.34 PK	74	-15.66	-46.68	-49.47	7.93	-36.92
6	14472.18	47.14 AV	54	-6.86	-58.83	-59.29	7.93	-48.12
7	19133	60.84 PK	74	-13.16	-50.39	-43.09	7.93	-34.42
8	23830.2	51.25 AV	54	-2.75	-55.47	-54.49	7.93	-44.01

Note: Margin value = Emission Level - Limit value

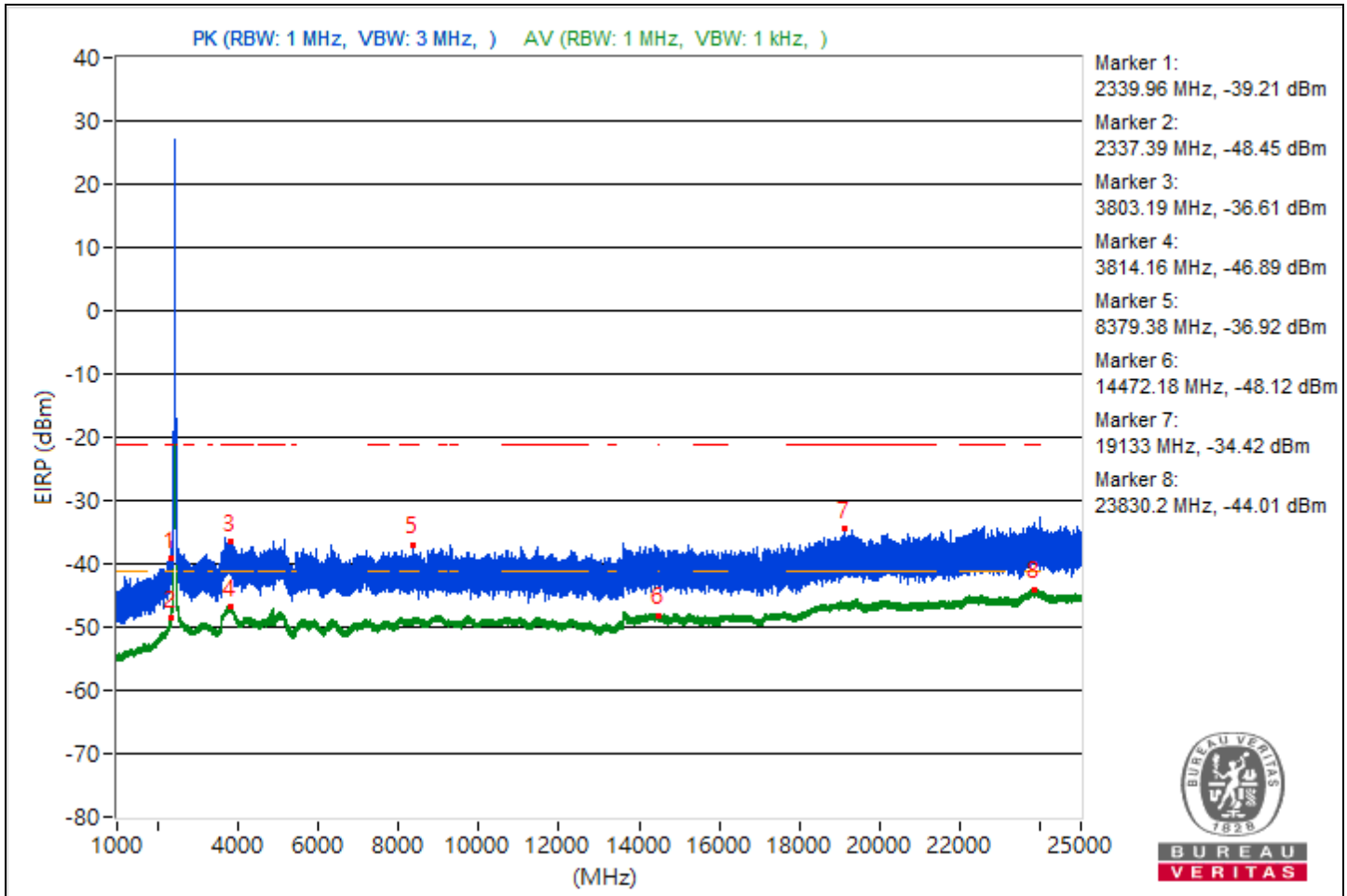

RF Mode	802.11g	Channel	CH 11 : 2462 MHz
Frequency Range	1 GHz ~ 25 GHz	Environmental Conditions	25°C, 76% RH
Tested By	Waydi Tuan		

Conducted Unwanted Emissions								
No.	Frequency (MHz)	Emission Level (dBuV/m)	Limit (dBuV/m)	Margin (dB)	Raw Value Chain 0 (dBm)	Raw Value Chain 1 (dBm)	Correction Factor (dB)	EIRP Level (dBm)
1	2225.31	55.96 PK	74	-18.04	-52.96	-48.58	7.93	-39.3
2	2329.53	45.97 AV	54	-8.03	-60.38	-60.08	7.93	-49.29
3	3781.02	58.49 PK	74	-15.51	-45.66	-51.75	7.93	-36.77
4	3787.56	48.63 AV	54	-5.37	-57.25	-57.93	7.93	-46.63
5	15965.6	57.48 PK	74	-16.52	-51.41	-47.07	7.93	-37.78
6	14473.6	47.23 AV	54	-6.77	-58.44	-59.56	7.93	-48.03
7	22304.5	61.48 PK	74	-12.52	-42.66	-48.78	7.93	-33.78
8	23854.5	51.22 AV	54	-2.78	-54.46	-55.57	7.93	-44.04

Note: Margin value = Emission Level - Limit value

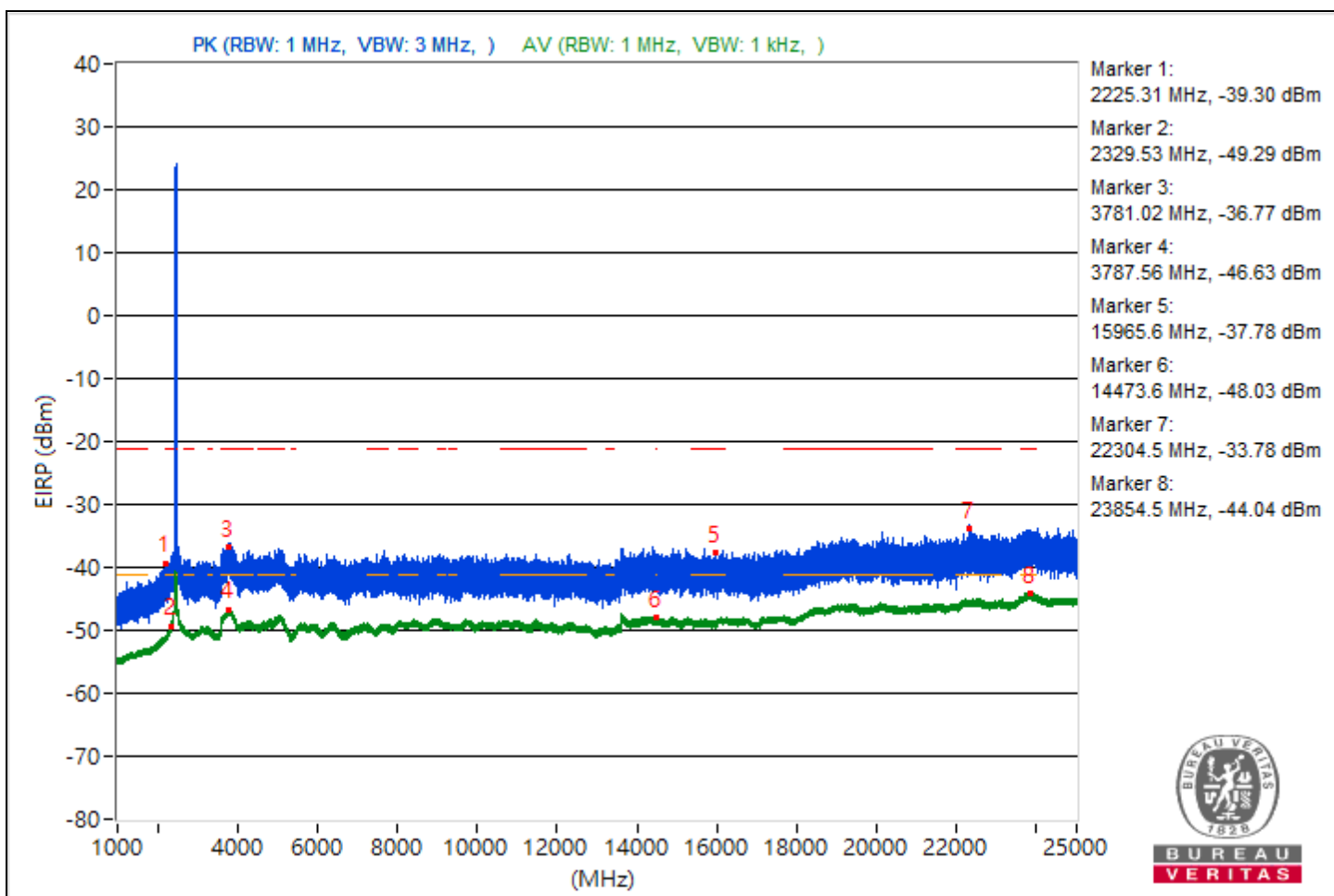

RF Mode	802.11g	Channel	CH 12 : 2467 MHz
Frequency Range	1 GHz ~ 25 GHz	Environmental Conditions	25°C, 76% RH
Tested By	Waydi Tuan		

Conducted Unwanted Emissions								
No.	Frequency (MHz)	Emission Level (dBuV/m)	Limit (dBuV/m)	Margin (dB)	Raw Value Chain 0 (dBm)	Raw Value Chain 1 (dBm)	Correction Factor (dB)	EIRP Level (dBm)
1	2240.71	54.7 PK	74	-19.3	-49.88	-54.12	7.93	-40.56
2	2327.51	45.79 AV	54	-8.21	-60.1	-60.75	7.93	-49.47
3	3818.51	58.59 PK	74	-15.41	-50.2	-46	7.93	-36.67
4	3821.62	48.49 AV	54	-5.51	-57.42	-58.01	7.93	-46.77
5	10925.51	57.67 PK	74	-16.33	-51.96	-46.64	7.93	-37.59
6	14490.58	47.21 AV	54	-6.79	-59.19	-58.8	7.93	-48.05
7	23765	61.33 PK	74	-12.67	-43.31	-47.33	7.93	-33.93
8	23835	51.4 AV	54	-2.6	-54.59	-55.02	7.93	-43.86

Note: Margin value = Emission Level - Limit value

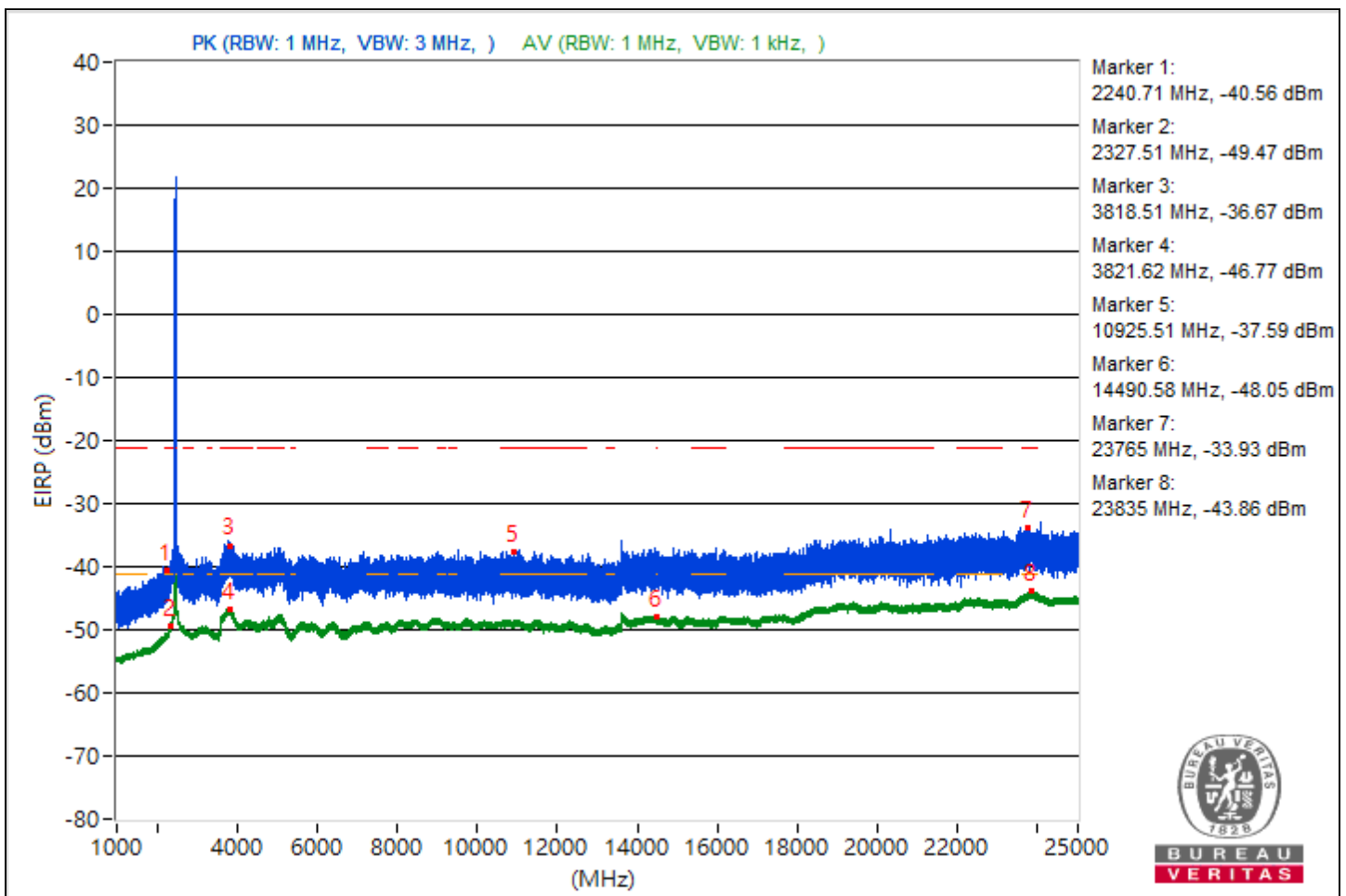



RF Mode	802.11g	Channel	CH 13 : 2472 MHz
Frequency Range	1 GHz ~ 25 GHz	Environmental Conditions	25°C, 76% RH
Tested By	Waydi Tuan		

Conducted Unwanted Emissions								
No.	Frequency (MHz)	Emission Level (dBuV/m)	Limit (dBuV/m)	Margin (dB)	Raw Value Chain 0 (dBm)	Raw Value Chain 1 (dBm)	Correction Factor (dB)	EIRP Level (dBm)
1	2339.1	55.37 PK	74	-18.63	-49.32	-53.16	7.93	-39.89
2	2338.17	45.5 AV	54	-8.5	-61.01	-60.42	7.93	-49.76
3	3815.17	58.69 PK	74	-15.31	-50.92	-45.62	7.93	-36.57
4	3817.42	48.4 AV	54	-5.6	-58.15	-57.48	7.93	-46.86
5	8068.36	57.99 PK	74	-16.01	-46.22	-51.98	7.93	-37.27
6	14476.53	47.13 AV	54	-6.87	-58.74	-59.43	7.93	-48.13
7	21242.4	60.81 PK	74	-13.19	-50.95	-43.03	7.93	-34.45
8	23833.6	51.52 AV	54	-2.48	-54.53	-54.84	7.93	-43.74

Note: Margin value = Emission Level - Limit value

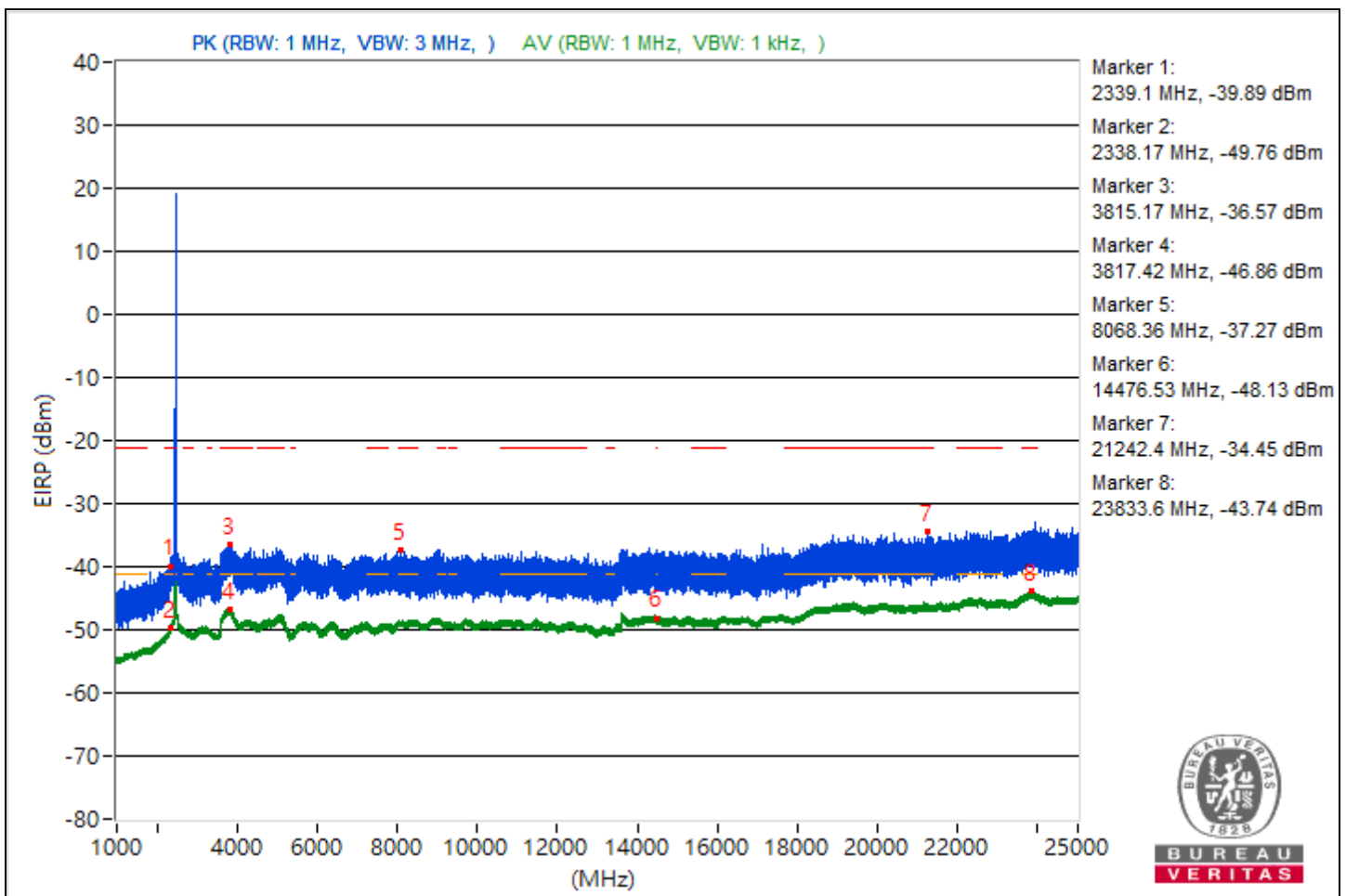

### Conducted Band Edges

RF Mode	802.11b	Channel	CH 1 : 2412 MHz
Frequency Range	2.31 GHz ~ 2.5 GHz	Environmental Conditions	25°C, 76% RH
Tested By	Waydi Tuan		

Conducted Band Edge								
No.	Frequency (MHz)	Emission Level (dBuV/m)	Limit (dBuV/m)	Margin (dB)	Raw Value Chain 0 (dBm)	Raw Value Chain 1 (dBm)	Correction Factor (dB)	EIRP Level (dBm)
1	*2411.22	119.61 PK			15.13	15.17	6.19	24.35
2	*2411.18	116.67 AV			12.28	12.25	6.19	21.41
3	2384.17	65.45 PK	74	-8.55	-40.39	-37.97	6.19	-29.81
4	2382.75	53.61 AV	54	-0.39	-50.85	-50.84	6.19	-41.65
5	2489.41	64.55 PK	74	-9.45	-39.22	-40.69	6.19	-30.71
6	2492.64	52.13 AV	54	-1.87	-52.32	-52.35	6.19	-43.13

Notes:

1. Margin value = Emission Level - Limit value
2. " \* " : Fundamental frequency, the limit was restricted at the RF Output Power.

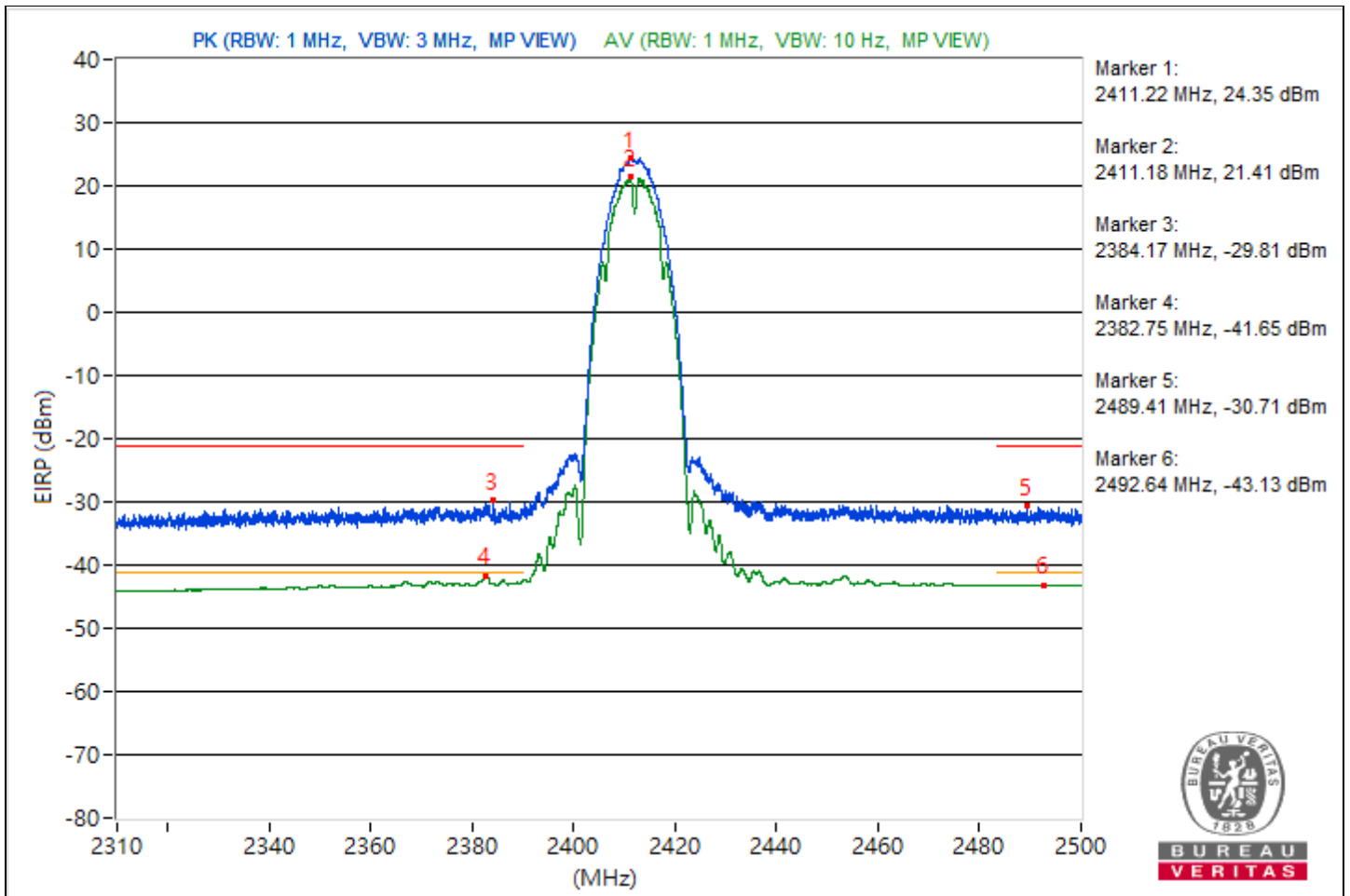

RF Mode	802.11b	Channel	CH 6 : 2437 MHz
Frequency Range	2.31 GHz ~ 2.5 GHz	Environmental Conditions	25°C, 76% RH
Tested By	Waydi Tuan		

Conducted Band Edge								
No.	Frequency (MHz)	Emission Level (dBuV/m)	Limit (dBuV/m)	Margin (dB)	Raw Value Chain 0 (dBm)	Raw Value Chain 1 (dBm)	Correction Factor (dB)	EIRP Level (dBm)
1	*2436.18	119.11 PK			14.65	14.65	6.19	23.85
2	*2436.23	116.28 AV			11.85	11.8	6.19	21.02
3	2385.24	64.49 PK	74	-9.51	-41.26	-38.97	6.19	-30.77
4	2386.17	52.04 AV	54	-1.96	-52.42	-52.41	6.19	-43.22
5	2486.75	64.7 PK	74	-9.3	-40.56	-39.09	6.19	-30.56
6	2487.34	52.39 AV	54	-1.61	-52.05	-52.1	6.19	-42.87

Notes:

1. Margin value = Emission Level - Limit value
2. " \* " : Fundamental frequency, the limit was restricted at the RF Output Power.

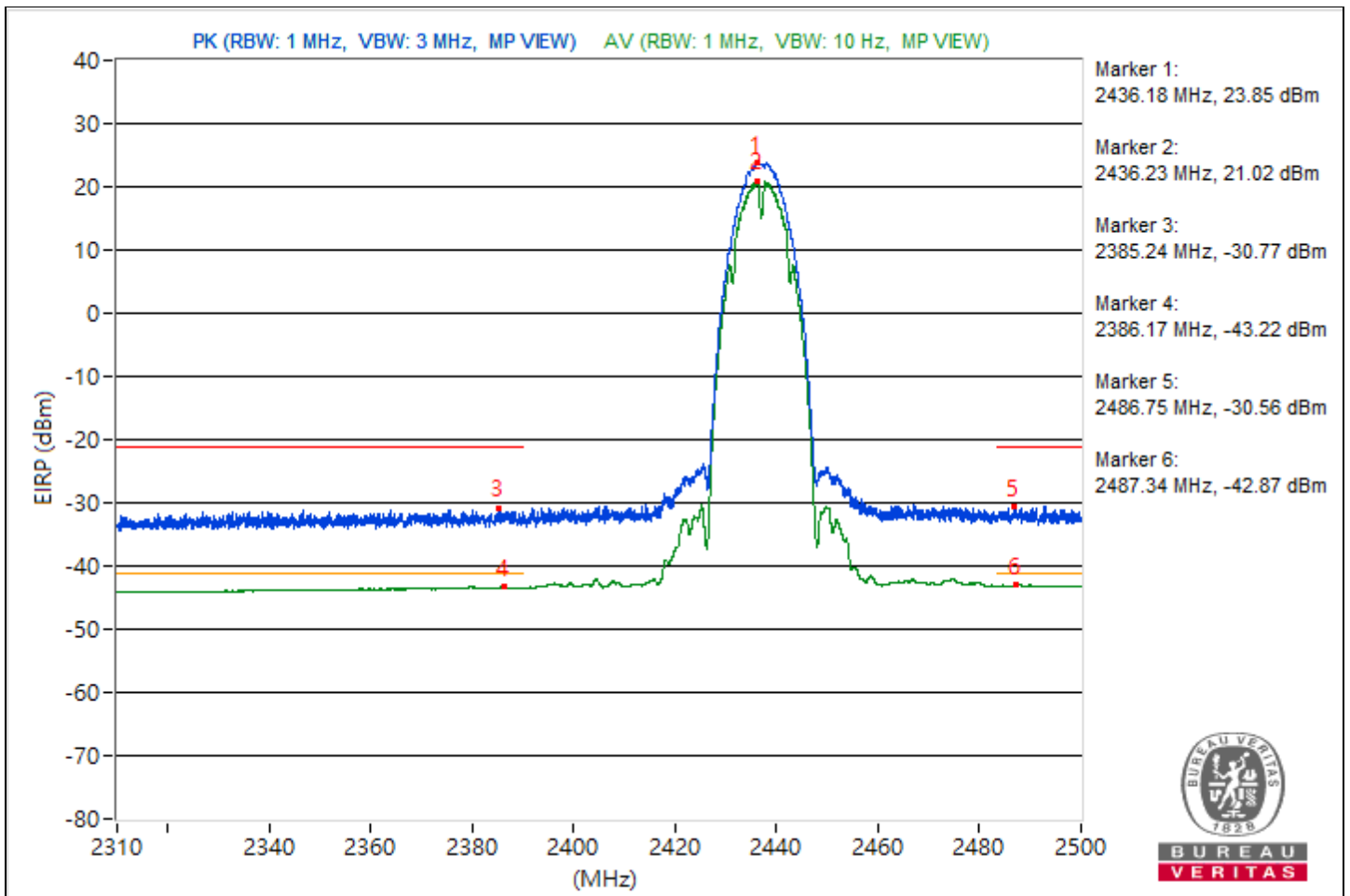

RF Mode	802.11b	Channel	CH 11 : 2462 MHz
Frequency Range	2.31 GHz ~ 2.5 GHz	Environmental Conditions	25°C, 76% RH
Tested By	Waydi Tuan		

Conducted Band Edge								
No.	Frequency (MHz)	Emission Level (dBuV/m)	Limit (dBuV/m)	Margin (dB)	Raw Value Chain 0 (dBm)	Raw Value Chain 1 (dBm)	Correction Factor (dB)	EIRP Level (dBm)
1	*2461.19	119.12 PK			14.64	14.68	6.19	23.86
2	*2461.24	116.32 AV			11.84	11.89	6.19	21.06
3	2388.92	63.51 PK	74	-10.49	-42.41	-39.86	6.19	-31.75
4	2388.07	51.6 AV	54	-2.4	-52.81	-52.91	6.19	-43.66
5	2486.41	64.98 PK	74	-9.02	-39.08	-39.92	6.19	-30.28
6	2486.08	53.87 AV	54	-0.13	-50.62	-50.56	6.19	-41.39

Notes:

1. Margin value = Emission Level - Limit value
2. " \* " : Fundamental frequency, the limit was restricted at the RF Output Power.

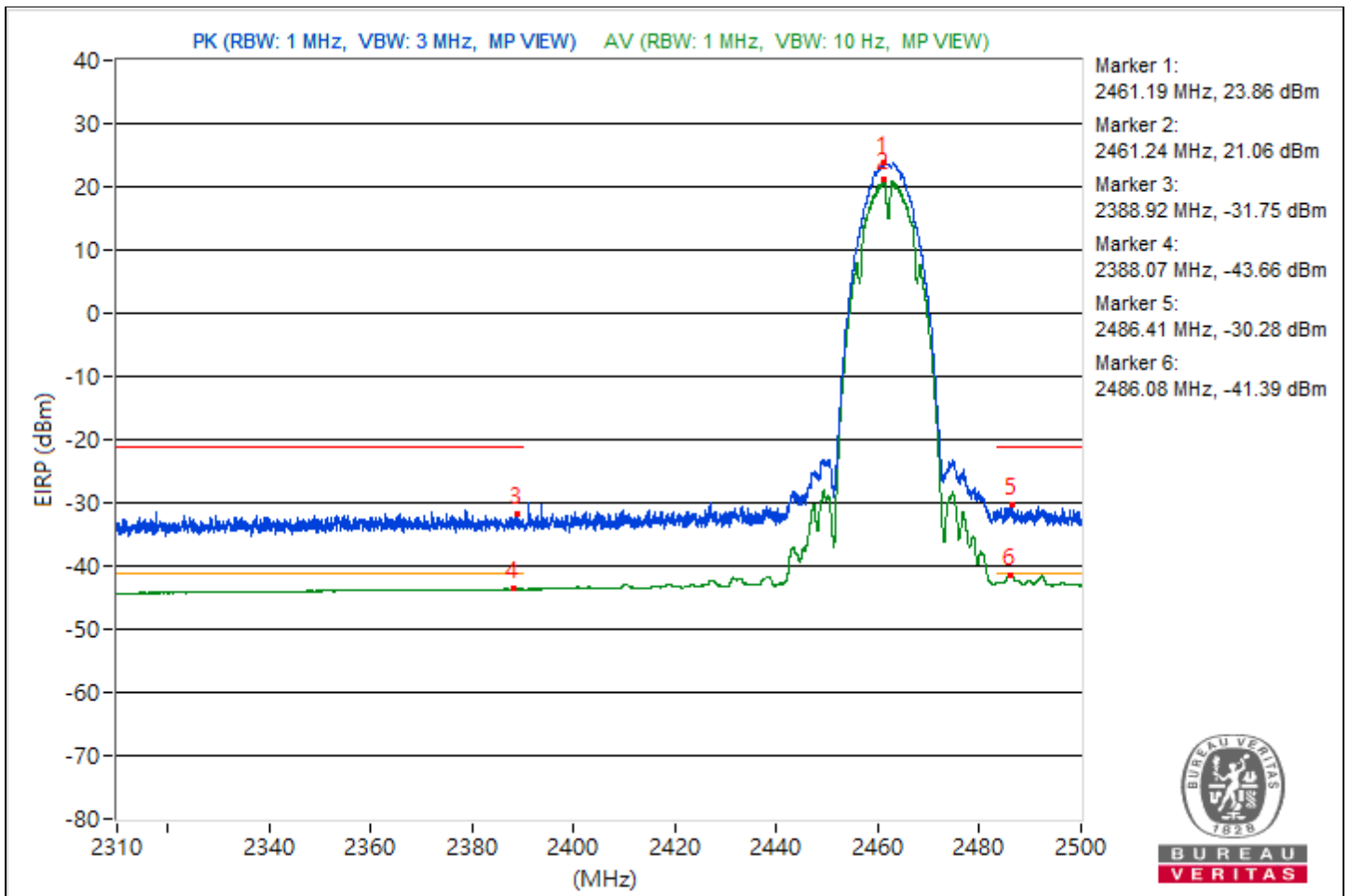

RF Mode	802.11b	Channel	CH 12 : 2467 MHz
Frequency Range	2.31 GHz ~ 2.5 GHz	Environmental Conditions	25°C, 76% RH
Tested By	Waydi Tuan		

Conducted Band Edge								
No.	Frequency (MHz)	Emission Level (dBuV/m)	Limit (dBuV/m)	Margin (dB)	Raw Value Chain 0 (dBm)	Raw Value Chain 1 (dBm)	Correction Factor (dB)	EIRP Level (dBm)
1	*2466.23	112.34 PK			7.89	7.87	6.19	17.08
2	*2466.2	109.43 AV			4.87	5.07	6.19	14.17
3	2333.51	64.07 PK	74	-9.93	-39.24	-41.95	6.19	-31.19
4	2386.86	51.56 AV	54	-2.44	-52.93	-52.87	6.19	-43.7
5	2483.64	64.86 PK	74	-9.14	-39.94	-39.28	6.19	-30.4
6	2483.59	53.34 AV	54	-0.66	-51.01	-51.23	6.19	-41.92

Notes:

1. Margin value = Emission Level - Limit value
2. " \* " : Fundamental frequency, the limit was restricted at the RF Output Power.

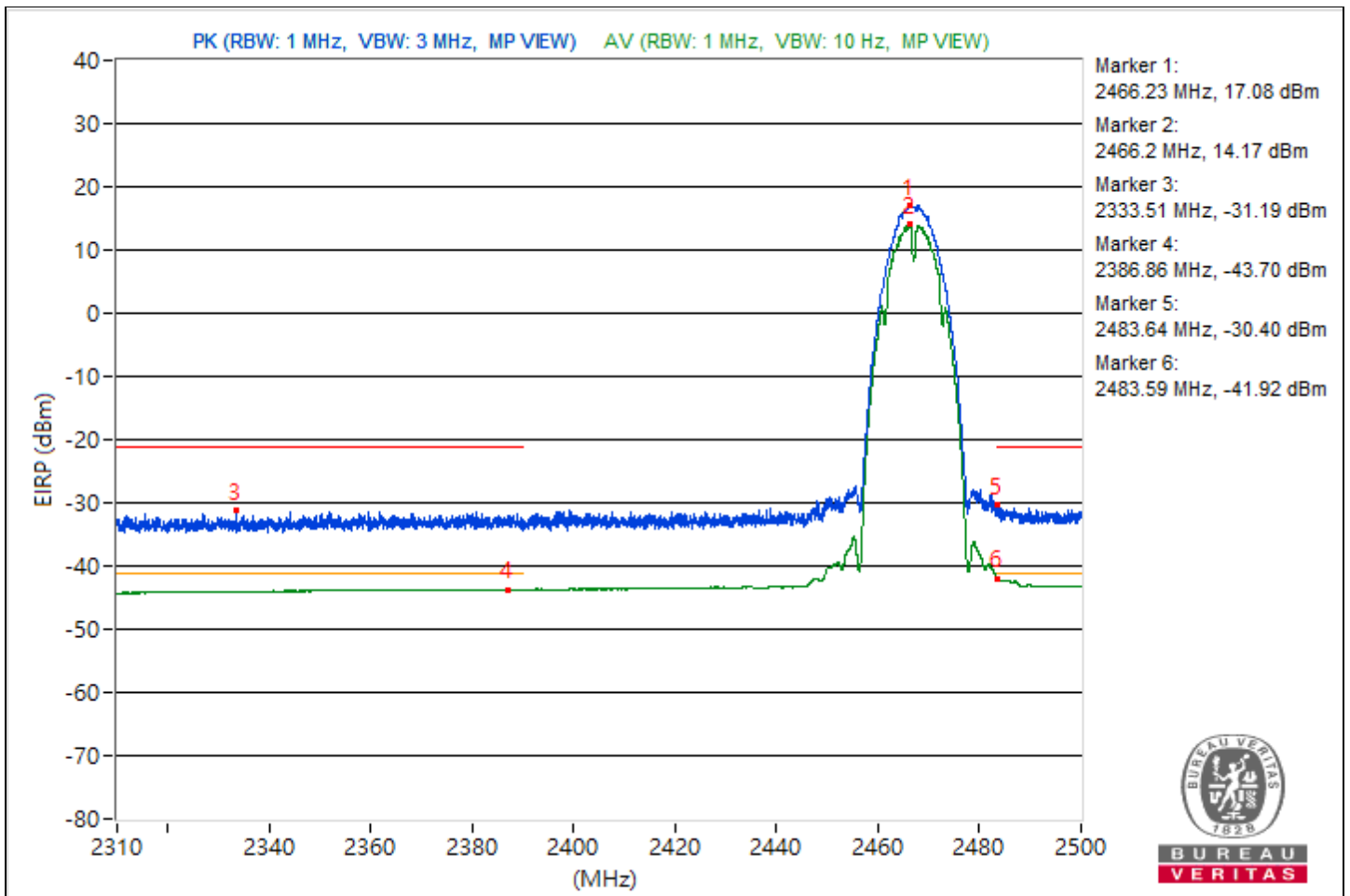

RF Mode	802.11b	Channel	CH 13 : 2472 MHz
Frequency Range	2.31 GHz ~ 2.5 GHz	Environmental Conditions	25°C, 76% RH
Tested By	Waydi Tuan		

Conducted Band Edge								
No.	Frequency (MHz)	Emission Level (dBuV/m)	Limit (dBuV/m)	Margin (dB)	Raw Value Chain 0 (dBm)	Raw Value Chain 1 (dBm)	Correction Factor (dB)	EIRP Level (dBm)
1	*2471.24	106.77 PK			2.3	2.32	6.19	11.51
2	*2471.24	103.87 AV			-0.65	-0.54	6.19	8.61
3	2334.11	63.85 PK	74	-10.15	-39.26	-42.58	6.19	-31.41
4	2378.64	51.2 AV	54	-2.8	-53.3	-53.21	6.19	-44.06
5	2486.39	64.56 PK	74	-9.44	-41.98	-38.5	6.19	-30.7
6	2483.85	53.97 AV	54	-0.03	-50.46	-50.52	6.19	-41.39

Notes:

1. Margin value = Emission Level - Limit value
2. " \* " : Fundamental frequency, the limit was restricted at the RF Output Power.

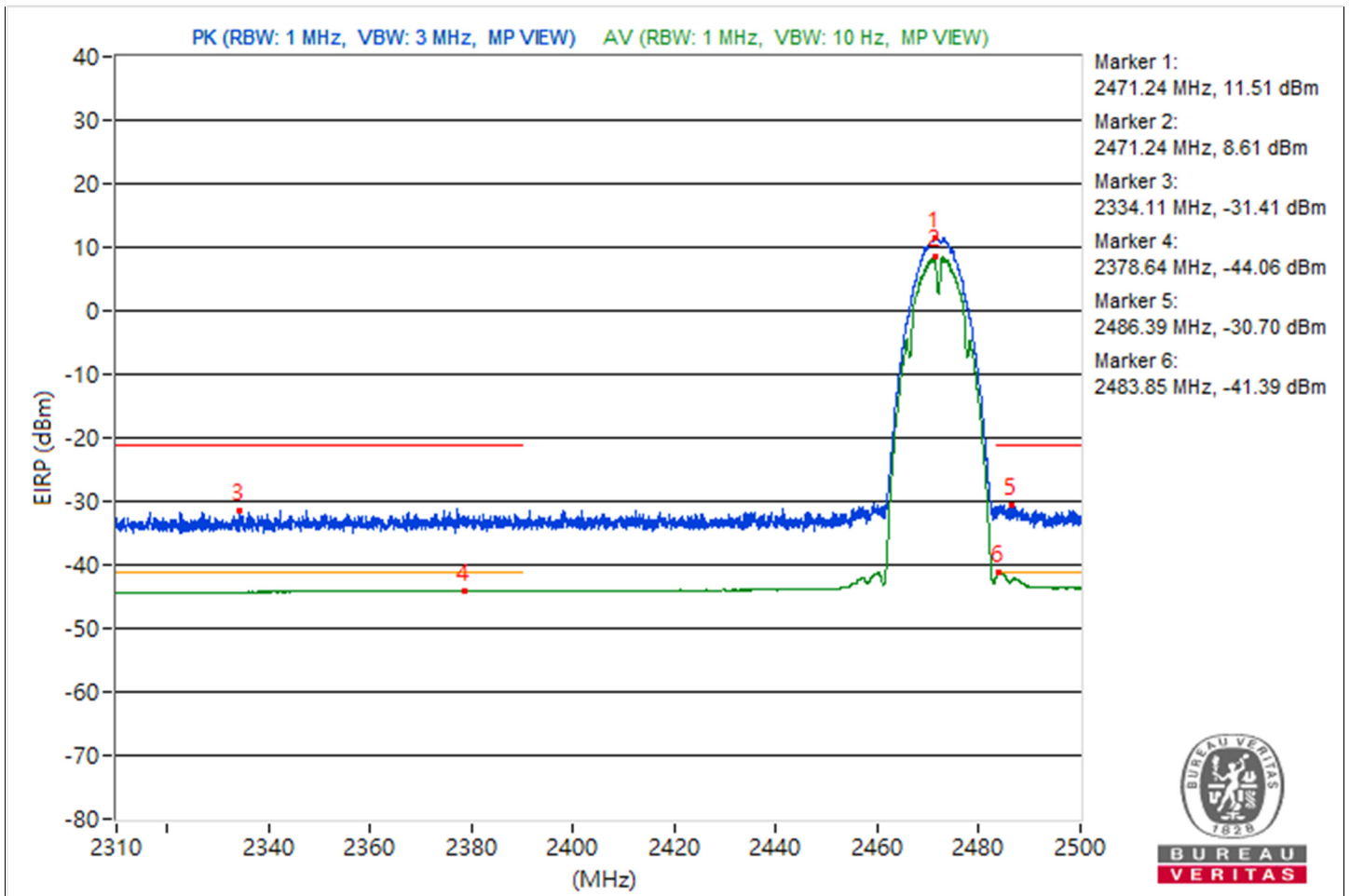

RF Mode	802.11g	Channel	CH 1 : 2412 MHz
Frequency Range	2.31 GHz ~ 2.5 GHz	Environmental Conditions	25°C, 76% RH
Tested By	Waydi Tuan		

Conducted Band Edge								
No.	Frequency (MHz)	Emission Level (dBuV/m)	Limit (dBuV/m)	Margin (dB)	Raw Value Chain 0 (dBm)	Raw Value Chain 1 (dBm)	Correction Factor (dB)	EIRP Level (dBm)
1	*2411.15	117.29 PK			11.48	13.86	6.19	22.03
2	*2410.61	107.68 AV			3.41	3.01	6.19	12.42
3	2389.87	65.29 PK	74	-8.71	-38.88	-39.48	6.19	-29.97
4	2389.92	53.93 AV	54	-0.07	-50.65	-50.42	6.19	-41.33
5	2486.34	64.24 PK	74	-9.76	-42.25	-38.84	6.19	-31.02
6	2491.26	52.36 AV	54	-1.64	-51.93	-52.28	6.19	-42.9

Notes:

1. Margin value = Emission Level - Limit value
2. " \* " : Fundamental frequency, the limit was restricted at the RF Output Power.

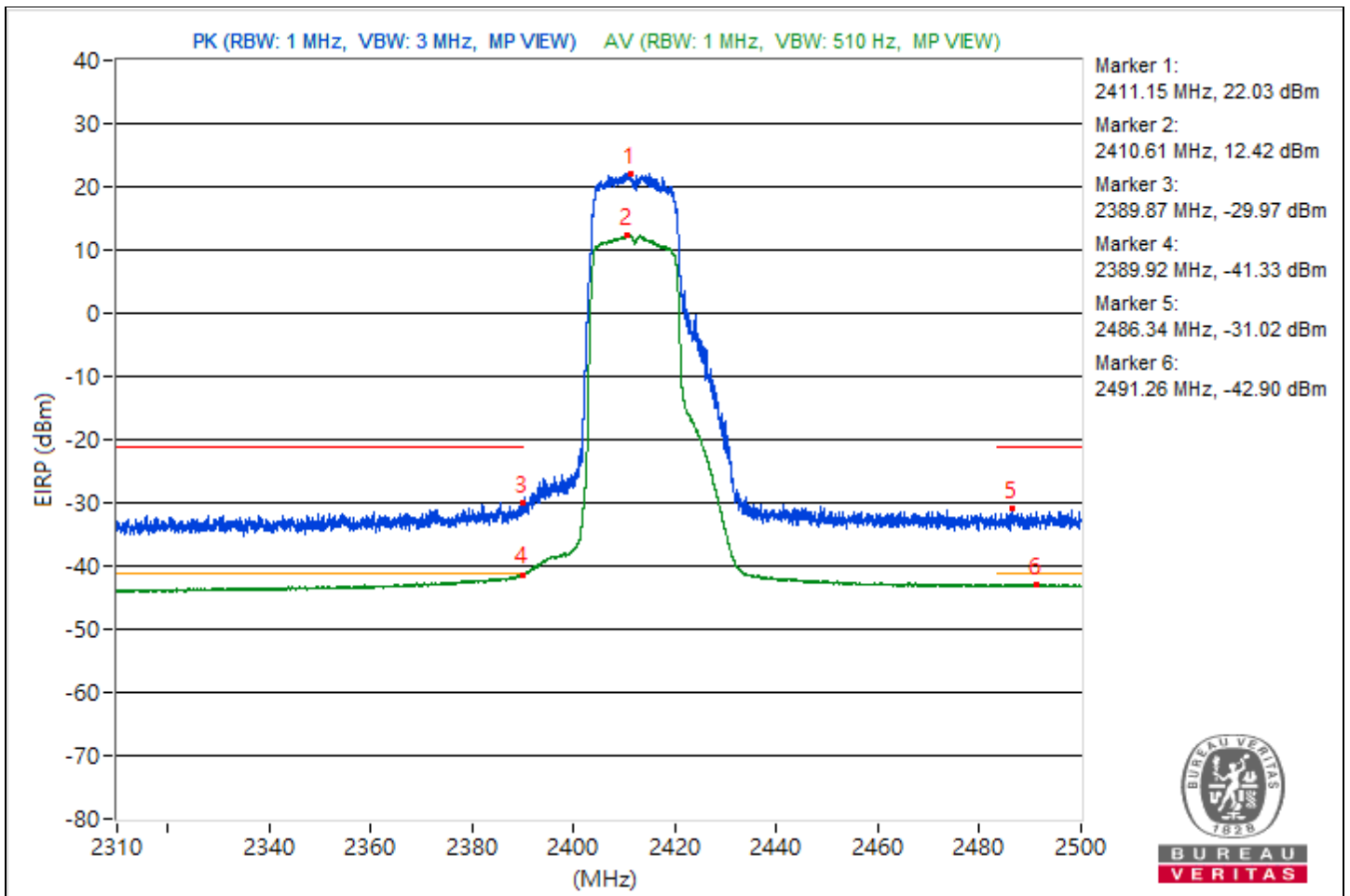

RF Mode	802.11g	Channel	CH 6 : 2437 MHz
Frequency Range	2.31 GHz ~ 2.5 GHz	Environmental Conditions	25°C, 76% RH
Tested By	Waydi Tuan		

Conducted Band Edge								
No.	Frequency (MHz)	Emission Level (dBuV/m)	Limit (dBuV/m)	Margin (dB)	Raw Value Chain 0 (dBm)	Raw Value Chain 1 (dBm)	Correction Factor (dB)	EIRP Level (dBm)
1	*2435.66	121.87 PK			16.34	18.27	6.19	26.61
2	*2438.27	111.7 AV			6.91	7.55	6.19	16.44
3	2389.59	64.51 PK	74	-9.49	-38.62	-41.88	6.19	-30.75
4	2389.47	52.87 AV	54	-1.13	-51.87	-51.33	6.19	-42.39
5	2484.82	65 PK	74	-9	-39.84	-39.11	6.19	-30.26
6	2485.32	53.04 AV	54	-0.96	-51.66	-51.18	6.19	-42.22

Notes:

1. Margin value = Emission Level - Limit value
2. " \* " : Fundamental frequency, the limit was restricted at the RF Output Power.

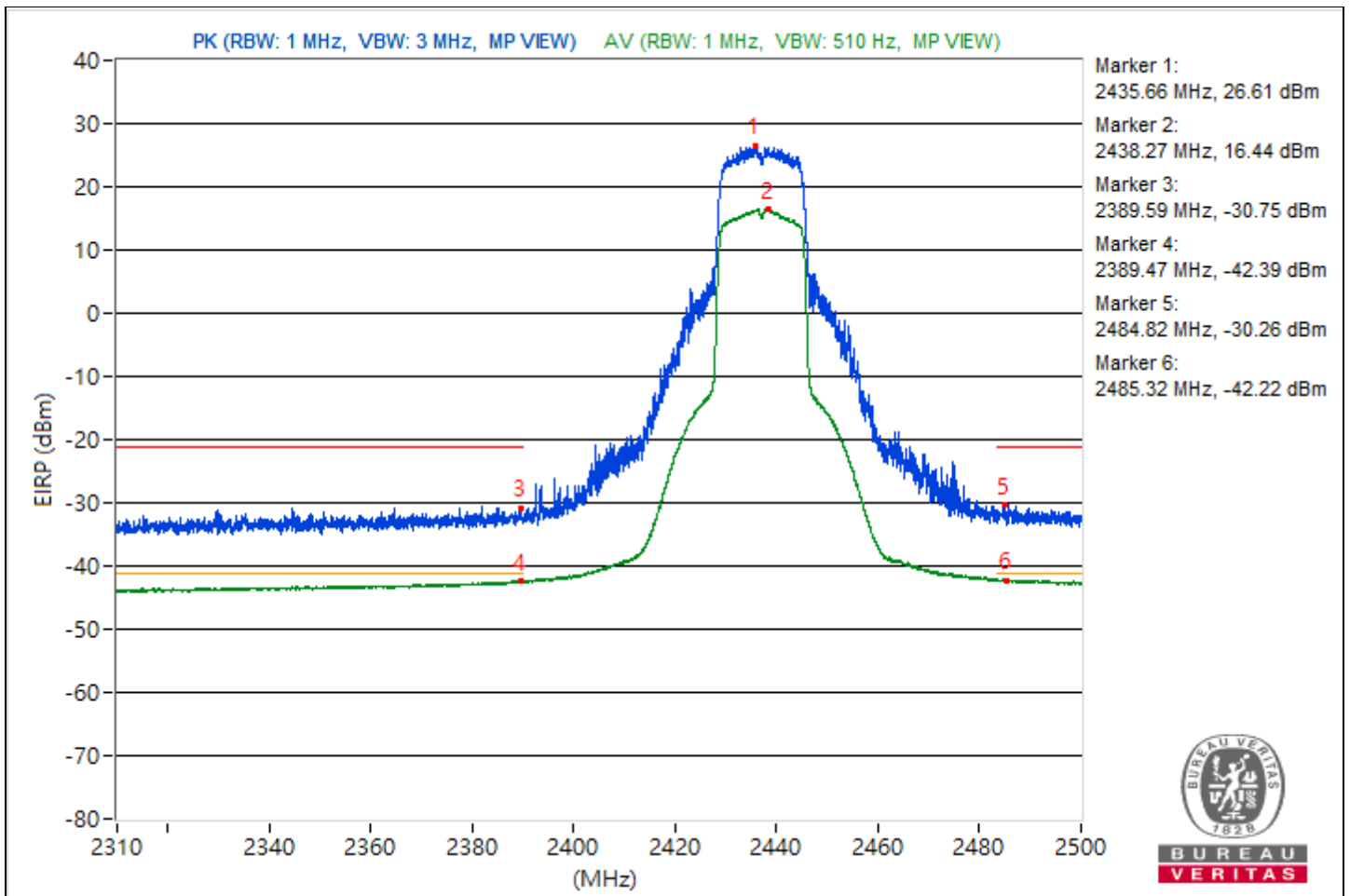



RF Mode	802.11g	Channel	CH 11 : 2462 MHz
Frequency Range	2.31 GHz ~ 2.5 GHz	Environmental Conditions	25°C, 76% RH
Tested By	Waydi Tuan		

Conducted Band Edge								
No.	Frequency (MHz)	Emission Level (dBuV/m)	Limit (dBuV/m)	Margin (dB)	Raw Value Chain 0 (dBm)	Raw Value Chain 1 (dBm)	Correction Factor (dB)	EIRP Level (dBm)
1	*2460.31	118.81 PK			13.14	15.3	6.19	23.55
2	*2461.12	108.79 AV			4.37	4.28	6.19	13.53
3	2367.31	63.86 PK	74	-10.14	-42.22	-39.42	6.19	-31.4
4	2389.47	52.07 AV	54	-1.93	-52.62	-52.18	6.19	-43.19
5	2483.52	65.12 PK	74	-8.88	-40.33	-38.54	6.19	-30.14
6	2483.76	53.87 AV	54	-0.13	-50.5	-50.67	6.19	-41.39

Notes:

1. Margin value = Emission Level - Limit value
2. " \* " : Fundamental frequency, the limit was restricted at the RF Output Power.

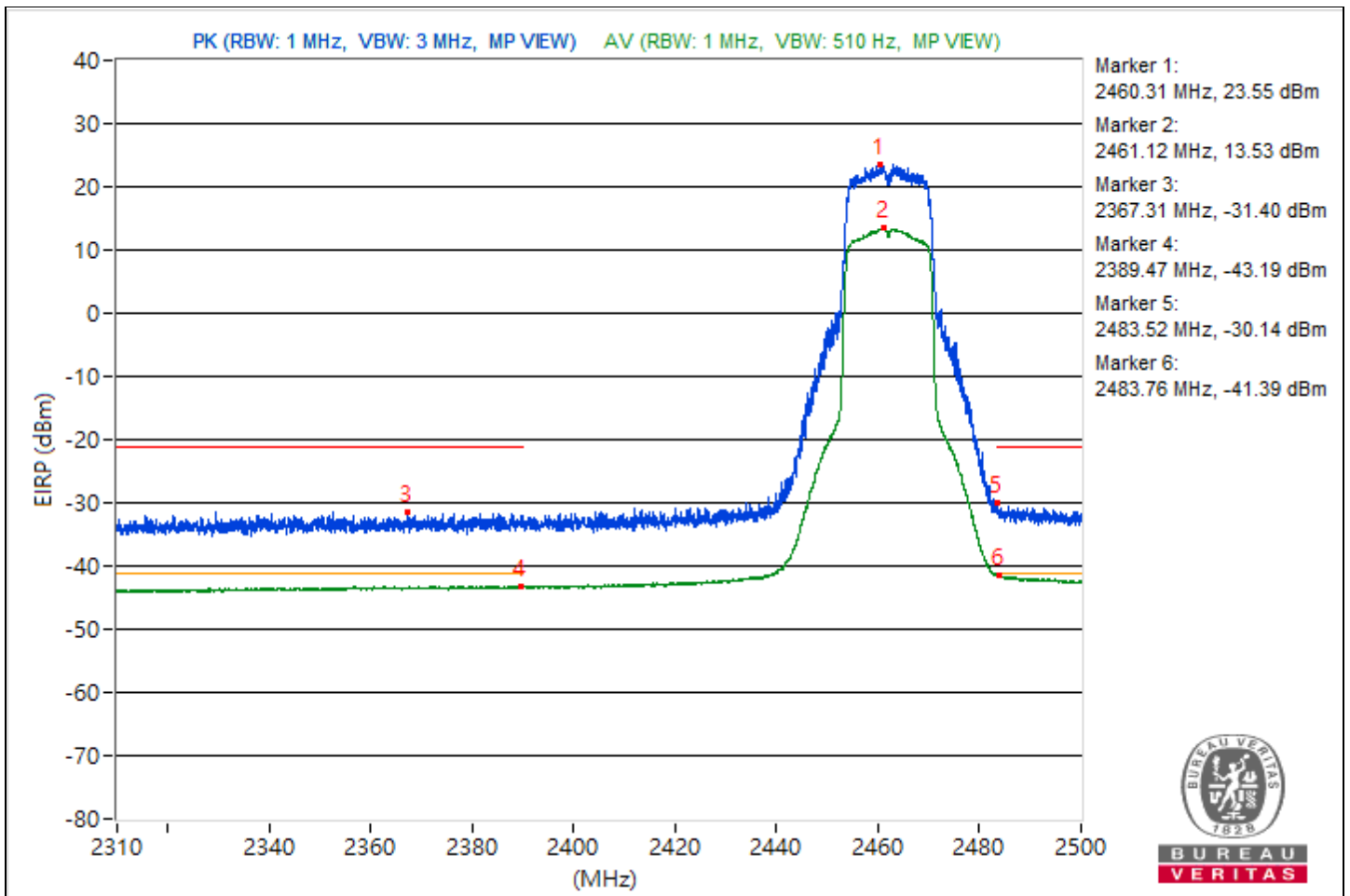

RF Mode	802.11g	Channel	CH 12 : 2467 MHz
Frequency Range	2.31 GHz ~ 2.5 GHz	Environmental Conditions	25°C, 76% RH
Tested By	Waydi Tuan		

Conducted Band Edge								
No.	Frequency (MHz)	Emission Level (dBuV/m)	Limit (dBuV/m)	Margin (dB)	Raw Value Chain 0 (dBm)	Raw Value Chain 1 (dBm)	Correction Factor (dB)	EIRP Level (dBm)
1	*2465.66	116.48 PK			13.01	10.73	6.19	21.22
2	*2466.16	106.63 AV			2.09	2.24	6.19	11.37
3	2337.26	63.9 PK	74	-10.1	-43.08	-38.97	6.19	-31.36
4	2364.91	51.98 AV	54	-2.02	-52.27	-52.71	6.19	-43.28
5	2483.71	65.51 PK	74	-8.49	-38.15	-39.94	6.19	-29.75
<b>6</b>	<b>2483.5</b>	<b>53.99 AV</b>	<b>54</b>	<b>-0.01</b>	<b>-50.62</b>	<b>-50.33</b>	<b>6.19</b>	<b>-41.31</b>

Notes:

1. Margin value = Emission Level - Limit value
2. " \* " : Fundamental frequency, the limit was restricted at the RF Output Power.

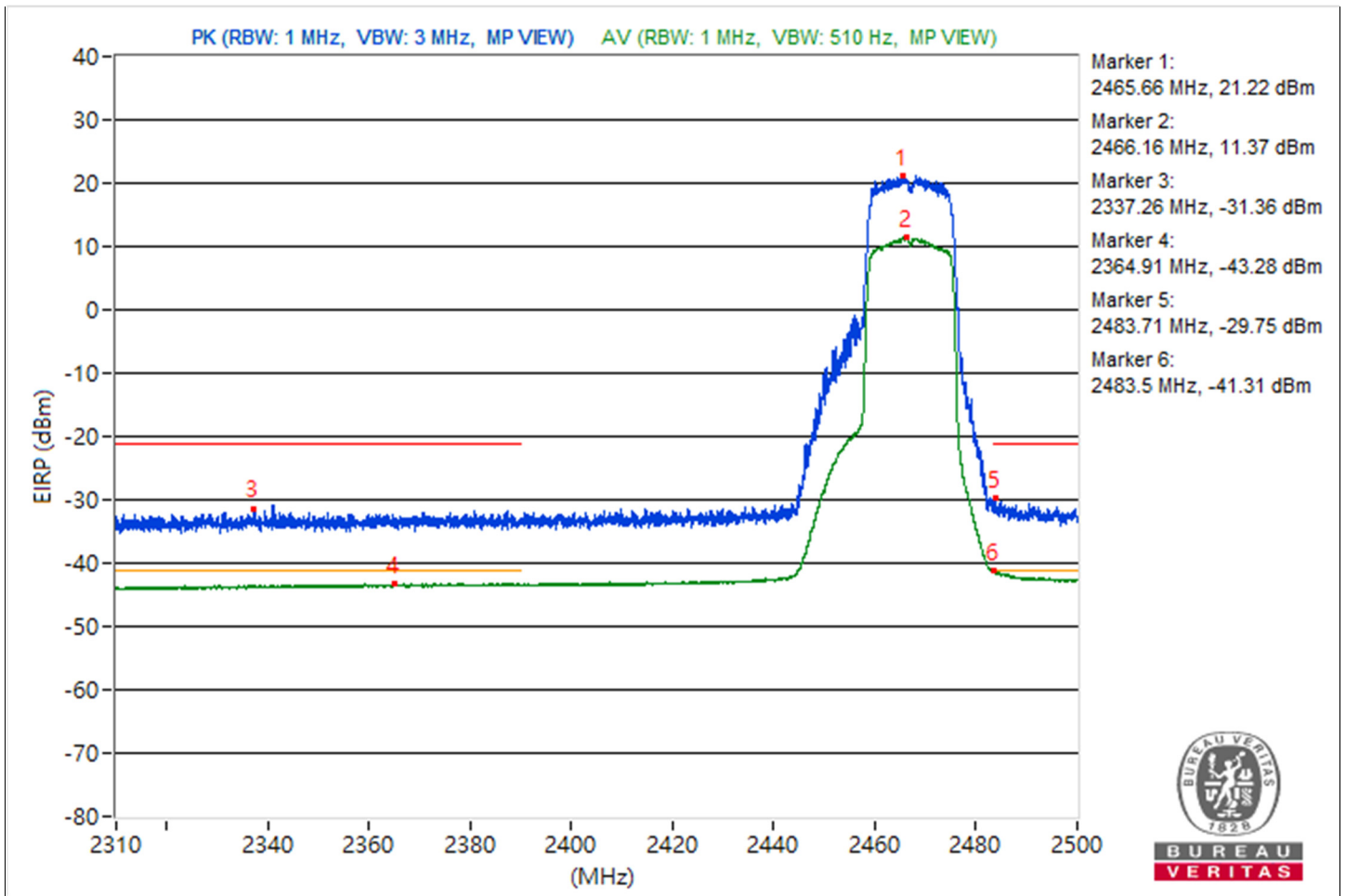

RF Mode	802.11g	Channel	CH 13 : 2472 MHz
Frequency Range	2.31 GHz ~ 2.5 GHz	Environmental Conditions	25°C, 76% RH
Tested By	Waydi Tuan		

Conducted Band Edge								
No.	Frequency (MHz)	Emission Level (dBuV/m)	Limit (dBuV/m)	Margin (dB)	Raw Value Chain 0 (dBm)	Raw Value Chain 1 (dBm)	Correction Factor (dB)	EIRP Level (dBm)
1	*2472.57	113.44 PK			10	7.66	6.19	18.18
2	*2472.85	103.32 AV			-1.35	-0.94	6.19	8.06
3	2374.27	63.84 PK	74	-10.16	-39.25	-42.63	6.19	-31.42
4	2388.28	51.89 AV	54	-2.11	-52.33	-52.82	6.19	-43.37
5	2486.06	64.86 PK	74	-9.14	-39	-40.3	6.19	-30.4
6	2483.54	53.85 AV	54	-0.15	-50.38	-50.86	6.19	-41.41

Notes:

1. Margin value = Emission Level - Limit value
2. " \* " : Fundamental frequency, the limit was restricted at the RF Output Power.

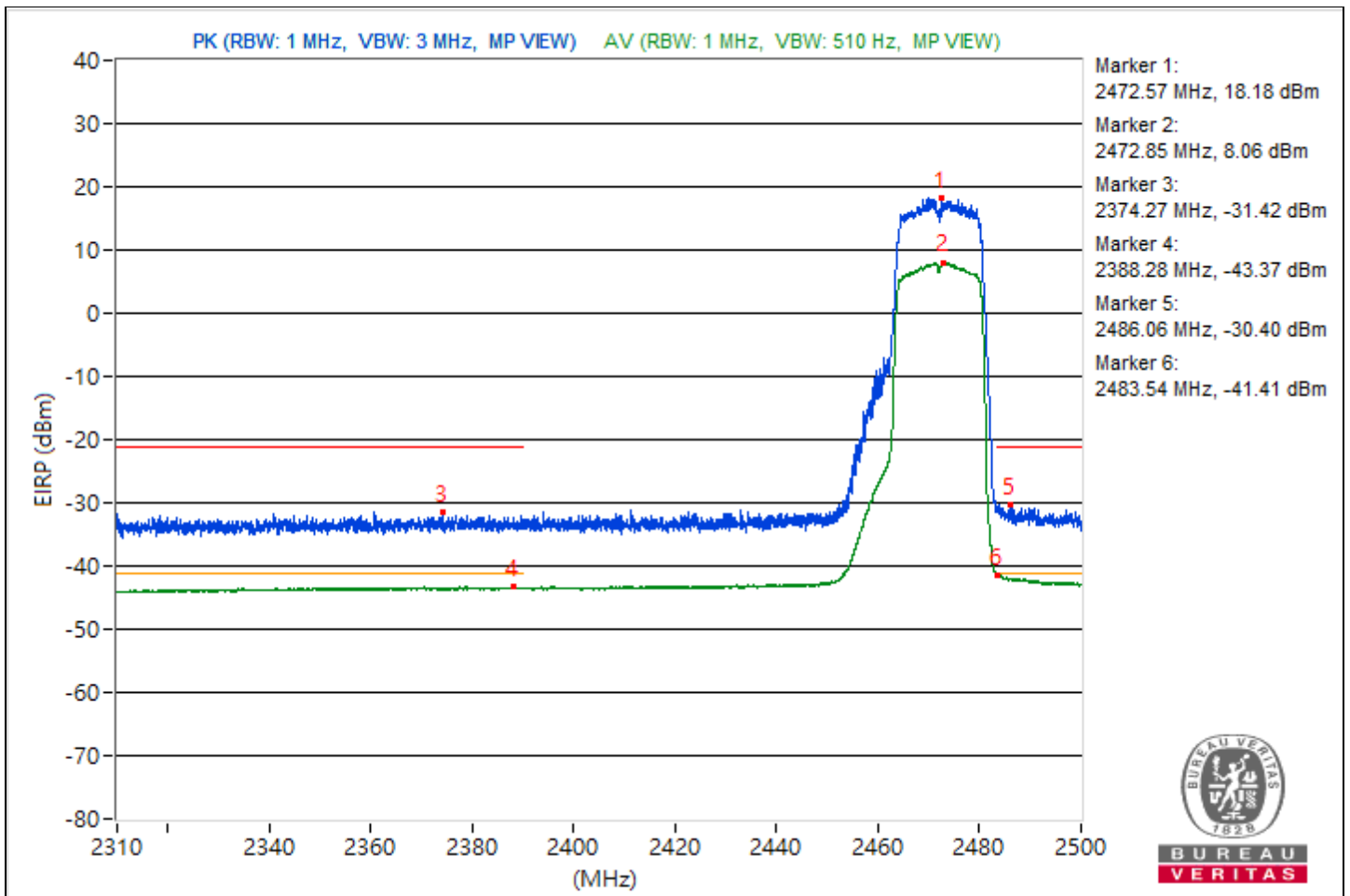



For 2S2T

Conducted Unwanted Emissions

RF Mode	802.11be (EHT20)	Channel	CH 1 : 2412 MHz
Frequency Range	1 GHz ~ 25 GHz	Environmental Conditions	25°C, 76% RH
Tested By	Waydi Tuan		

Conducted Unwanted Emissions								
No.	Frequency (MHz)	Emission Level (dBuV/m)	Limit (dBuV/m)	Margin (dB)	Raw Value Chain 0 (dBm)	Raw Value Chain 1 (dBm)	Correction Factor (dB)	EIRP Level (dBm)
1	2339.41	54.17 PK	74	-19.83	-50.34	-48	4.92	-41.09
2	2332.41	44.14 AV	54	-9.86	-58.8	-59.31	4.92	-51.12
3	3767.8	56.52 PK	74	-17.48	-48.54	-45.37	4.92	-38.74
4	3735.06	45.49 AV	54	-8.51	-57.97	-57.44	4.92	-49.77
5	8192.36	55.07 PK	74	-18.93	-51.23	-46.34	4.92	-40.19
6	14477.51	44.26 AV	54	-9.74	-58.76	-59.11	4.92	-51
7	22533.1	58.91 PK	74	-15.09	-42.95	-46.22	4.92	-36.35
8	23760.4	48.21 AV	54	-5.79	-55.45	-54.55	4.92	-47.05

Note: Margin value = Emission Level - Limit value

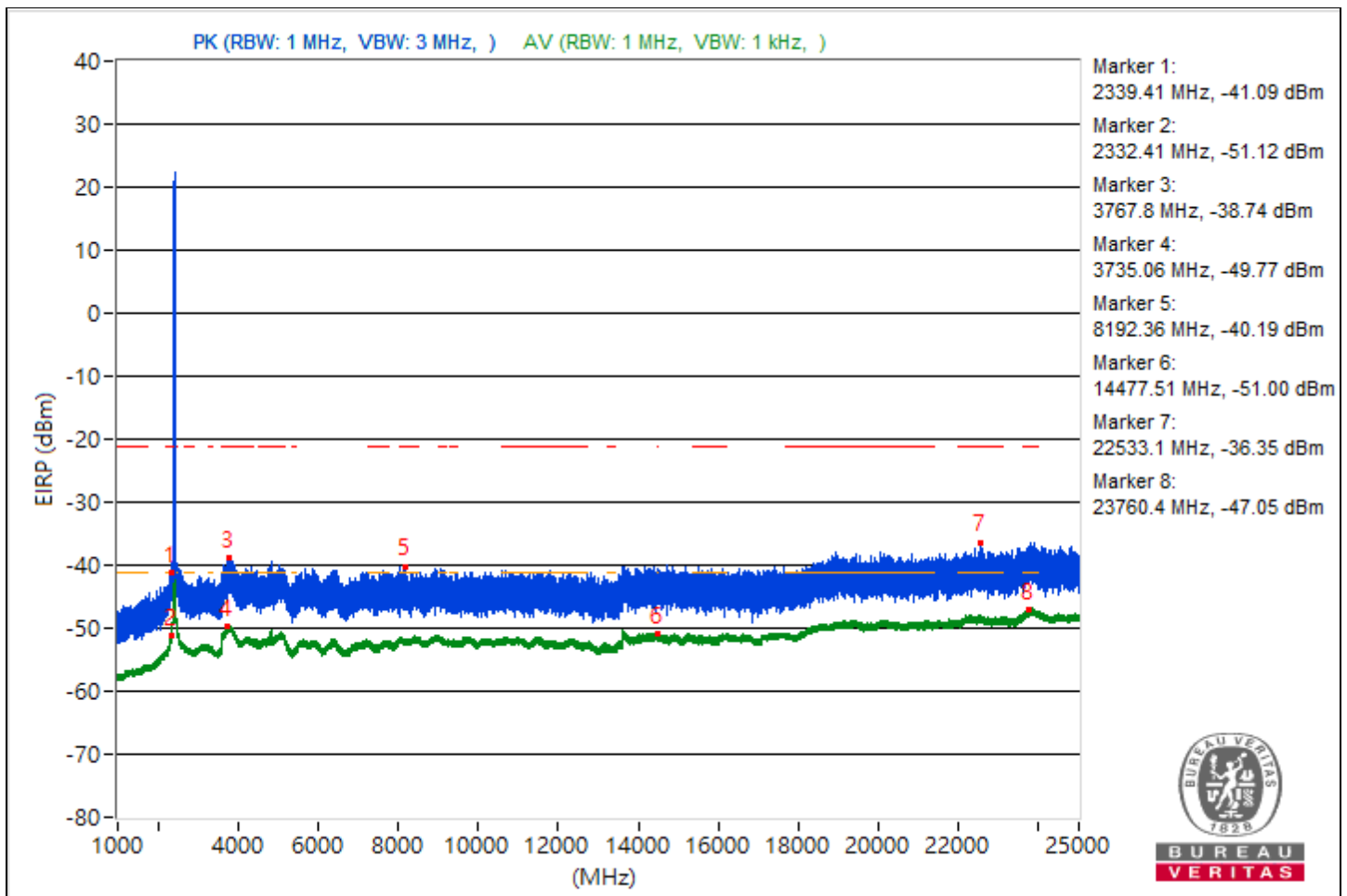

RF Mode	802.11be (EHT20)	Channel	CH 6 : 2437 MHz
Frequency Range	1 GHz ~ 25 GHz	Environmental Conditions	25°C, 76% RH
Tested By	Waydi Tuan		

Conducted Unwanted Emissions								
No.	Frequency (MHz)	Emission Level (dBuV/m)	Limit (dBuV/m)	Margin (dB)	Raw Value Chain 0 (dBm)	Raw Value Chain 1 (dBm)	Correction Factor (dB)	EIRP Level (dBm)
1	2335.21	54.48 PK	74	-19.52	-51.22	-47.13	4.92	-40.78
2	2339.88	44.01 AV	54	-9.99	-59.35	-59.03	4.92	-51.25
3	3878.87	57.32 PK	74	-16.68	-47.29	-44.81	4.92	-37.94
4	3785.07	45.57 AV	54	-8.43	-58.07	-57.21	4.92	-49.69
5	8439.02	54.99 PK	74	-19.01	-46.61	-50.73	4.92	-40.27
6	14498.31	44.21 AV	54	-9.79	-59.32	-58.68	4.92	-51.05
7	23807	59.37 PK	74	-14.63	-47.35	-41.9	4.92	-35.89
8	23843.7	48.31 AV	54	-5.69	-55.27	-54.52	4.92	-46.95

Note: Margin value = Emission Level - Limit value

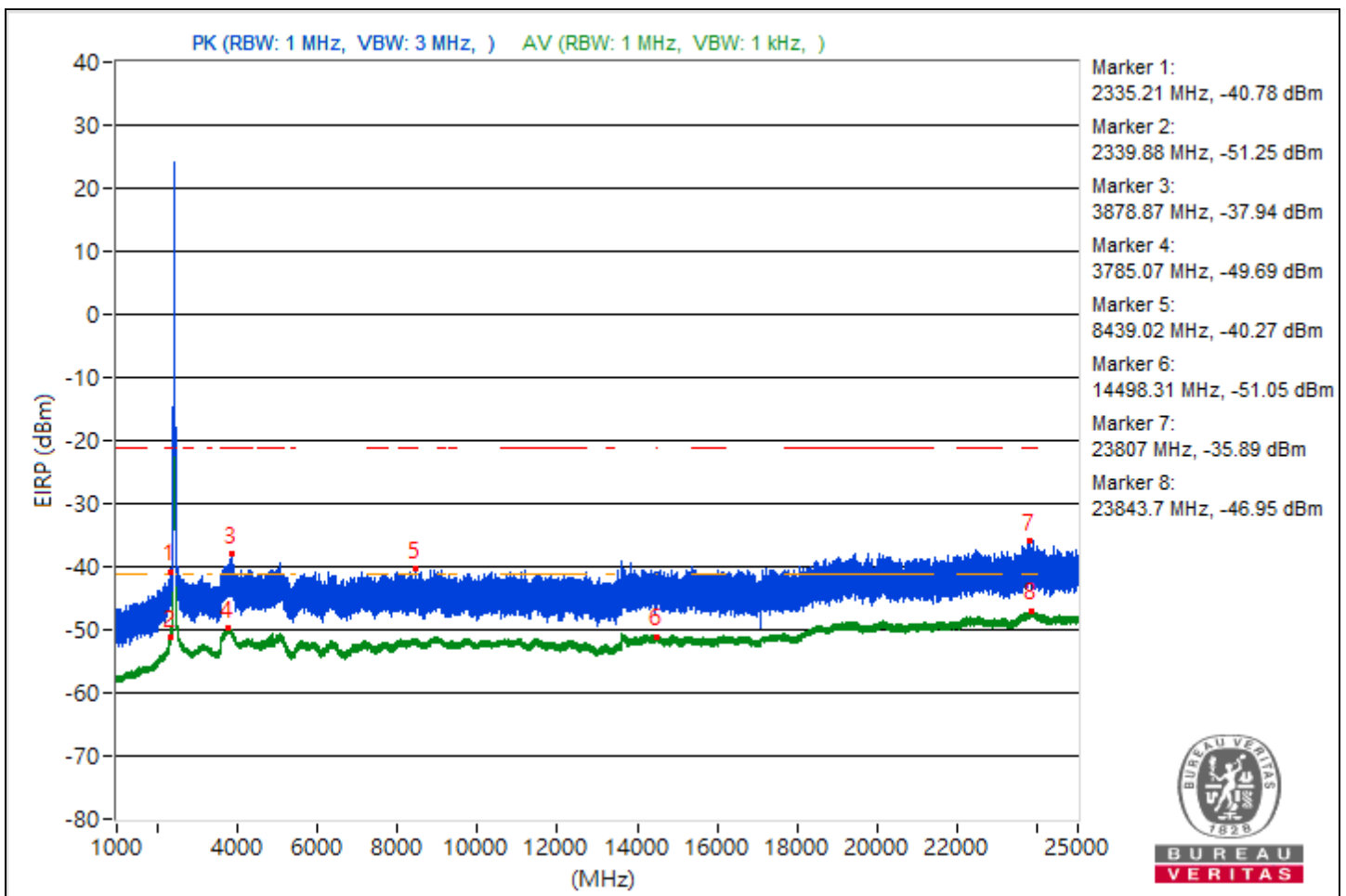

RF Mode	802.11be (EHT20)	Channel	CH 11 : 2462 MHz
Frequency Range	1 GHz ~ 25 GHz	Environmental Conditions	25°C, 76% RH
Tested By	Waydi Tuan		

Conducted Unwanted Emissions								
No.	Frequency (MHz)	Emission Level (dBuV/m)	Limit (dBuV/m)	Margin (dB)	Raw Value Chain 0 (dBm)	Raw Value Chain 1 (dBm)	Correction Factor (dB)	EIRP Level (dBm)
1	2327.12	52.17 PK	74	-21.83	-49.36	-53.74	4.92	-43.09
2	2336.07	43.15 AV	54	-10.85	-60.29	-59.8	4.92	-52.11
3	3854.13	56.76 PK	74	-17.24	-47.59	-45.52	4.92	-38.5
4	3821.31	45.57 AV	54	-8.43	-57.3	-57.98	4.92	-49.69
5	9105.24	54.33 PK	74	-19.67	-46.6	-53.83	4.92	-40.93
6	14495.73	44.36 AV	54	-9.64	-58.97	-58.69	4.92	-50.9
7	23769.8	57.8 PK	74	-16.2	-50.36	-43.13	4.92	-37.46
8	23818.4	48.35 AV	54	-5.65	-55.01	-54.67	4.92	-46.91

Note: Margin value = Emission Level - Limit value

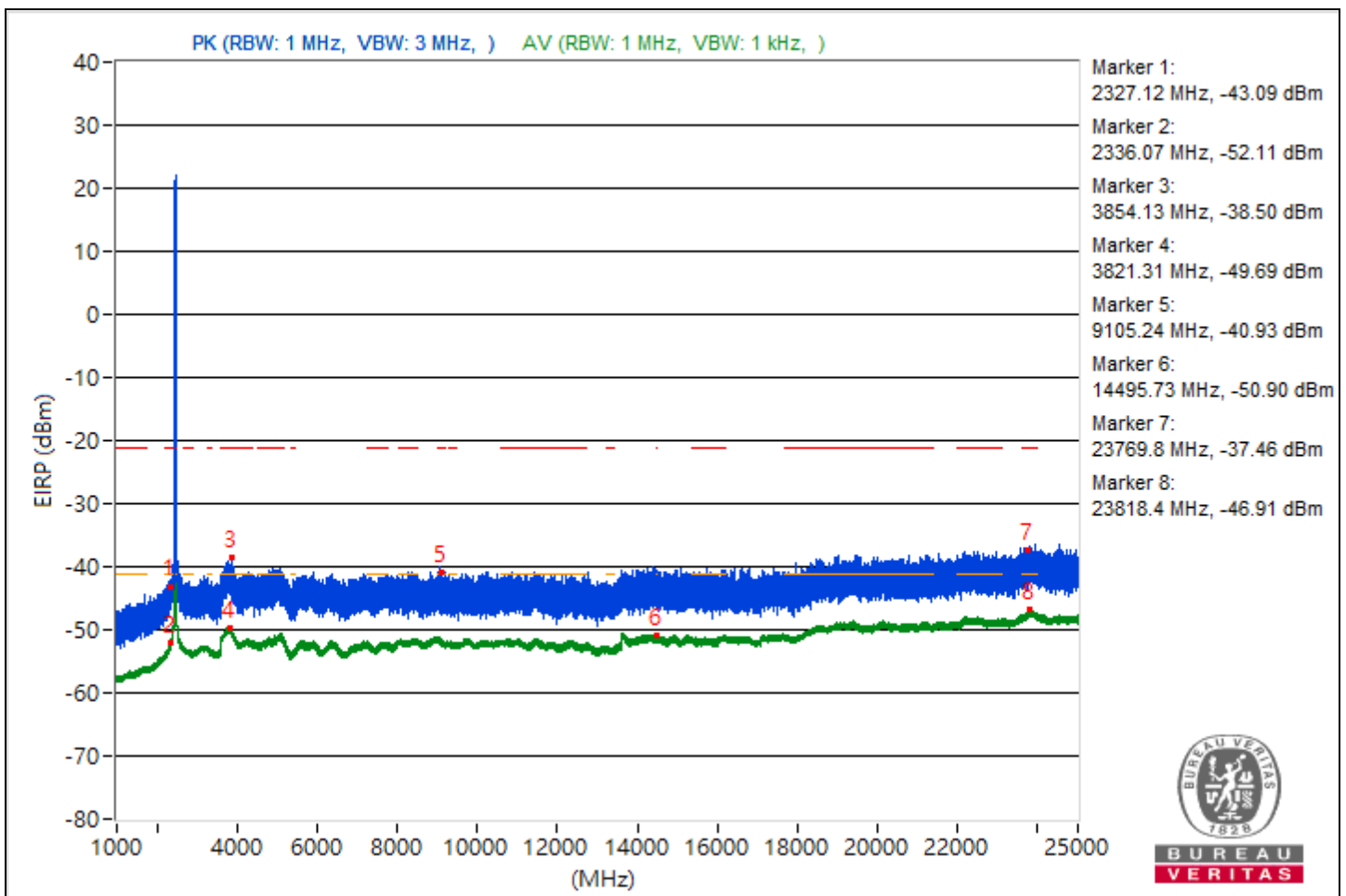

RF Mode	802.11be (EHT20)	Channel	CH 12 : 2467 MHz
Frequency Range	1 GHz ~ 25 GHz	Environmental Conditions	25°C, 76% RH
Tested By	Waydi Tuan		

Conducted Unwanted Emissions								
No.	Frequency (MHz)	Emission Level (dBuV/m)	Limit (dBuV/m)	Margin (dB)	Raw Value Chain 0 (dBm)	Raw Value Chain 1 (dBm)	Correction Factor (dB)	EIRP Level (dBm)
1	2325.96	53.02 PK	74	-20.98	-52.2	-48.79	4.92	-42.24
2	2338.24	42.82 AV	54	-11.18	-60.06	-60.69	4.92	-52.44
3	3766.17	55.82 PK	74	-18.18	-51.18	-45.37	4.92	-39.44
4	3806.3	45.53 AV	54	-8.47	-57.47	-57.86	4.92	-49.73
5	11764.09	54.36 PK	74	-19.64	-54.66	-46.43	4.92	-40.9
6	14477.6	44.28 AV	54	-9.72	-58.68	-59.15	4.92	-50.98
7	23912.2	58.67 PK	74	-15.33	-47.76	-42.68	4.92	-36.59
8	23846.7	48.32 AV	54	-5.68	-54.53	-55.25	4.92	-46.94

Note: Margin value = Emission Level - Limit value

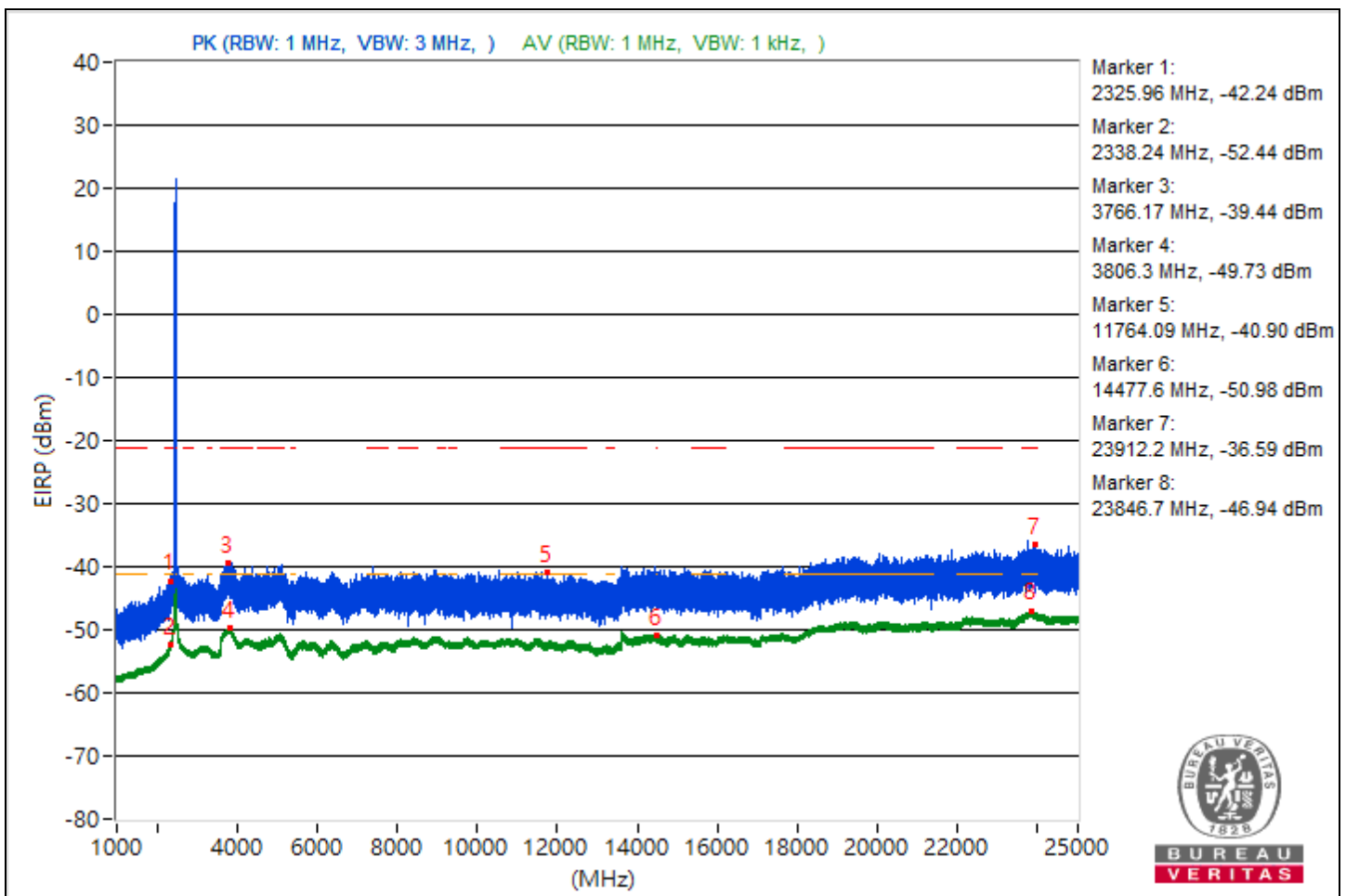

RF Mode	802.11be (EHT20)	Channel	CH 13 : 2472 MHz
Frequency Range	1 GHz ~ 25 GHz	Environmental Conditions	25°C, 76% RH
Tested By	Waydi Tuan		

Conducted Unwanted Emissions								
No.	Frequency (MHz)	Emission Level (dBuV/m)	Limit (dBuV/m)	Margin (dB)	Raw Value Chain 0 (dBm)	Raw Value Chain 1 (dBm)	Correction Factor (dB)	EIRP Level (dBm)
1	2331.24	54.29 PK	74	-19.71	-47.93	-50.15	4.92	-40.97
2	2337.86	42.79 AV	54	-11.21	-60.31	-60.49	4.92	-52.47
3	3860.74	55.95 PK	74	-18.05	-45.89	-49.2	4.92	-39.31
4	3804.51	45.43 AV	54	-8.57	-57.5	-58.04	4.92	-49.83
5	9052.71	55.58 PK	74	-18.42	-46.1	-49.94	4.92	-39.68
6	14497.24	44.33 AV	54	-9.67	-59.06	-58.67	4.92	-50.93
7	23641	59.14 PK	74	-14.86	-42.59	-46.27	4.92	-36.12
8	23795.4	48.46 AV	54	-5.54	-54.99	-54.49	4.92	-46.8

Note: Margin value = Emission Level - Limit value

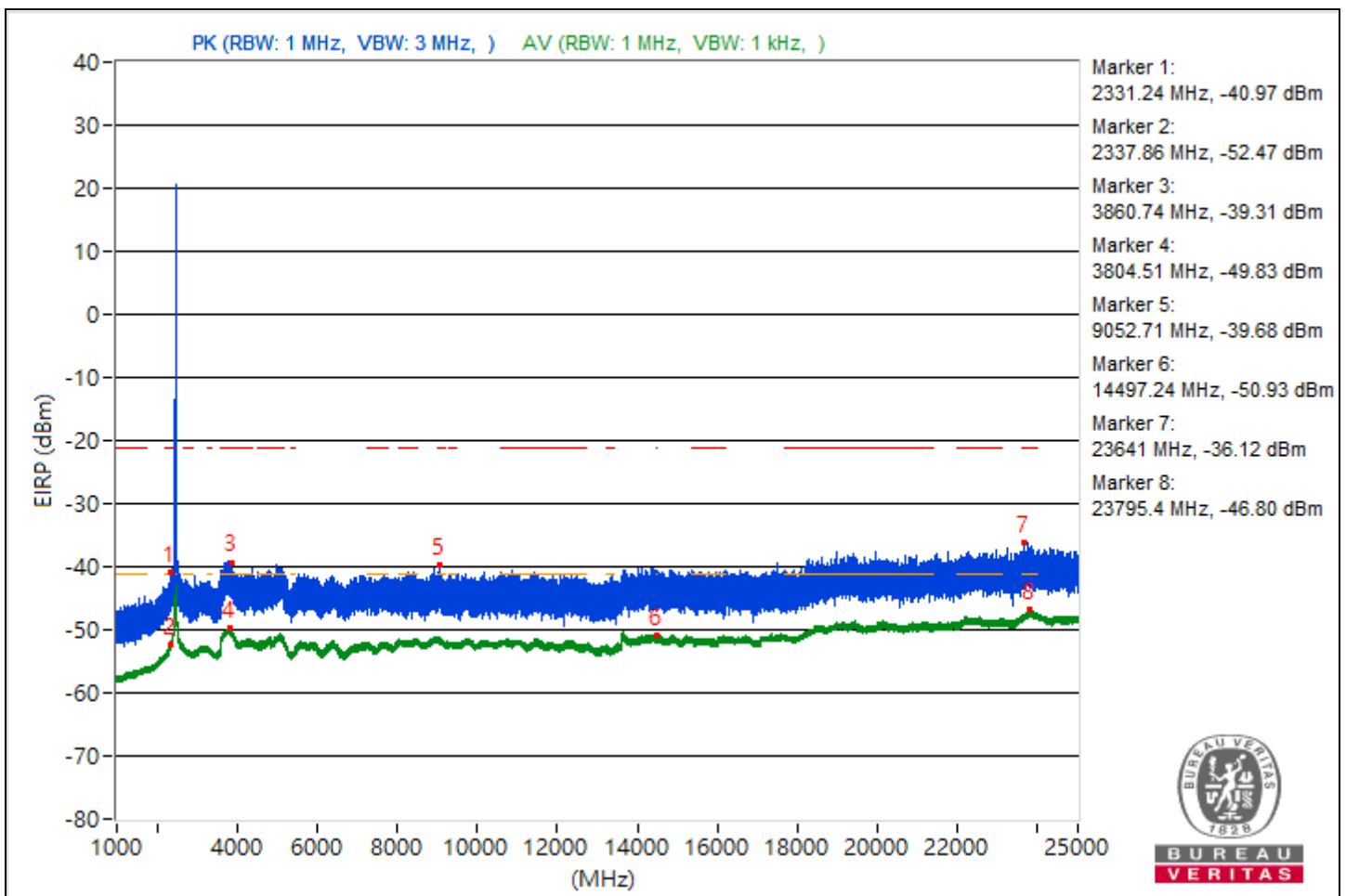



RF Mode	802.11be (EHT40)	Channel	CH 3 : 2422 MHz
Frequency Range	1 GHz ~ 25 GHz	Environmental Conditions	25°C, 76% RH
Tested By	Waydi Tuan		

Conducted Unwanted Emissions								
No.	Frequency (MHz)	Emission Level (dBuV/m)	Limit (dBuV/m)	Margin (dB)	Raw Value Chain 0 (dBm)	Raw Value Chain 1 (dBm)	Correction Factor (dB)	EIRP Level (dBm)
1	2339.64	54.38 PK	74	-19.62	-51.93	-47.01	4.92	-40.88
2	2338.32	43.65 AV	54	-10.35	-59.34	-59.74	4.92	-51.61
3	3695.54	56.1 PK	74	-17.9	-49.46	-45.56	4.92	-39.16
4	3807.16	45.52 AV	54	-8.48	-57.91	-57.45	4.92	-49.74
5	9060.36	54.96 PK	74	-19.04	-51.44	-46.41	4.92	-40.3
6	15731.56	44.15 AV	54	-9.85	-58.62	-59.51	4.92	-51.11
7	23956.5	58.78 PK	74	-15.22	-45.78	-43.37	4.92	-36.48
8	23894	48.3 AV	54	-5.7	-54.69	-55.09	4.92	-46.96

Note: Margin value = Emission Level - Limit value

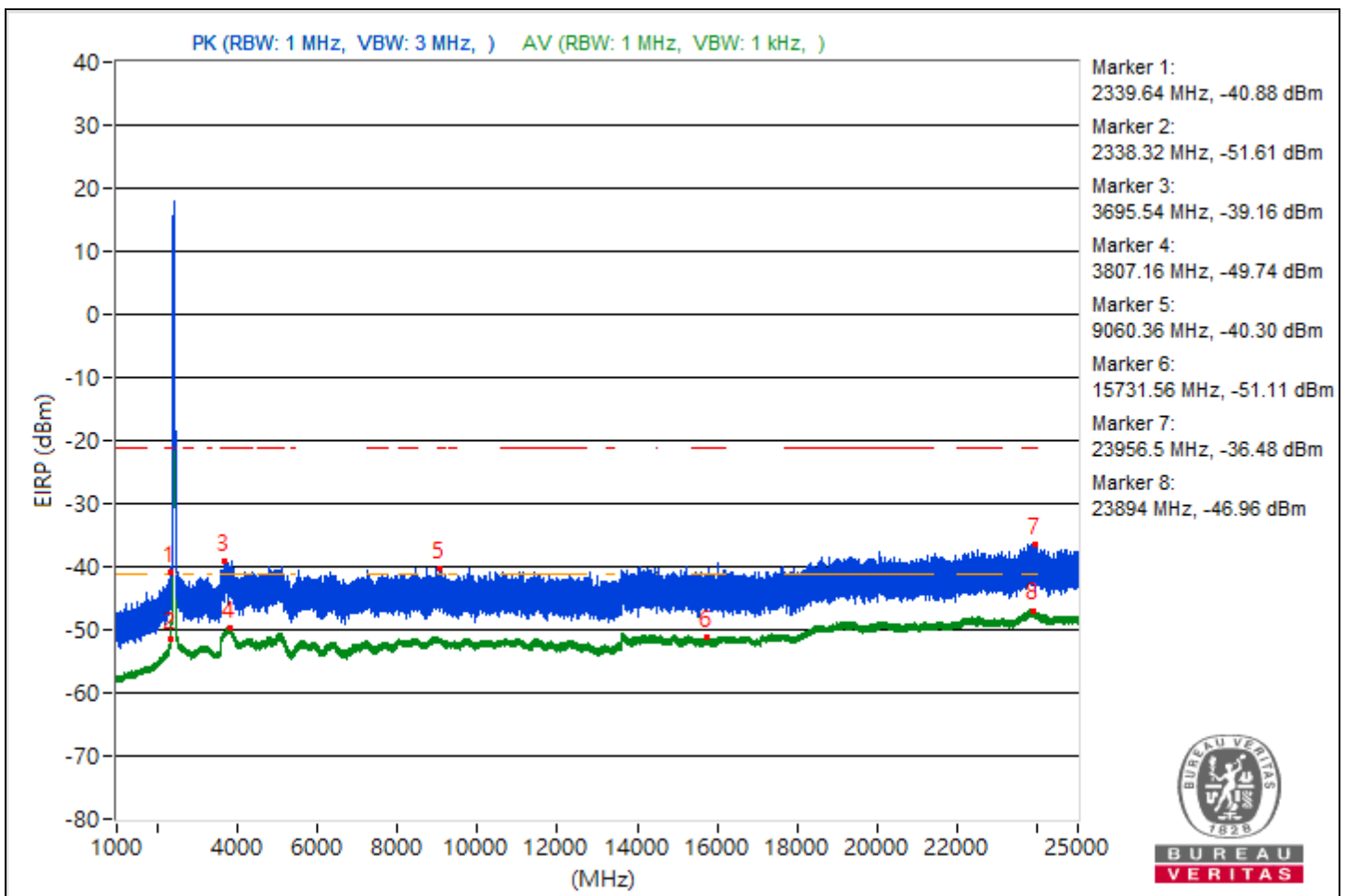

RF Mode	802.11be (EHT40)	Channel	CH 6 : 2437 MHz
Frequency Range	1 GHz ~ 25 GHz	Environmental Conditions	25°C, 76% RH
Tested By	Waydi Tuan		

Conducted Unwanted Emissions								
No.	Frequency (MHz)	Emission Level (dBuV/m)	Limit (dBuV/m)	Margin (dB)	Raw Value Chain 0 (dBm)	Raw Value Chain 1 (dBm)	Correction Factor (dB)	EIRP Level (dBm)
1	2289.79	53.23 PK	74	-20.77	-48.2	-52.95	4.92	-42.03
2	2338.56	44.31 AV	54	-9.69	-58.98	-58.77	4.92	-50.95
3	3770.76	55.86 PK	74	-18.14	-51.06	-45.35	4.92	-39.4
4	3799.14	45.53 AV	54	-8.47	-57.41	-57.91	4.92	-49.73
5	15601.87	55.18 PK	74	-18.82	-45.94	-52.08	4.92	-40.08
6	14485.42	44.02 AV	54	-9.98	-58.71	-59.68	4.92	-51.24
7	23892.5	59.03 PK	74	-14.97	-42.2	-47.84	4.92	-36.23
8	23837.4	48.39 AV	54	-5.61	-55.07	-54.55	4.92	-46.87

Note: Margin value = Emission Level - Limit value

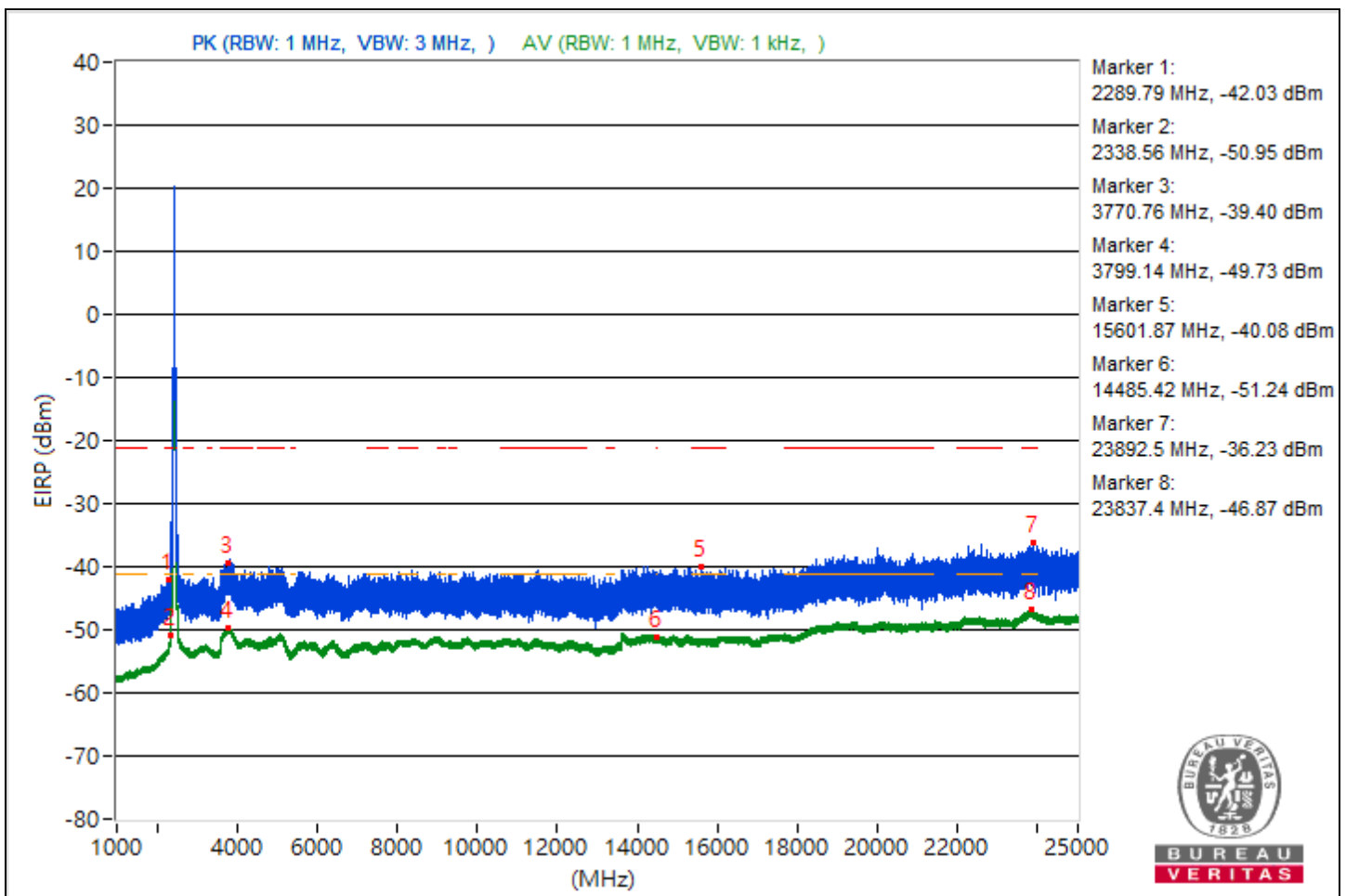



RF Mode	802.11be (EHT40)	Channel	CH 9 : 2452 MHz
Frequency Range	1 GHz ~ 25 GHz	Environmental Conditions	25°C, 76% RH
Tested By	Waydi Tuan		

Conducted Unwanted Emissions								
No.	Frequency (MHz)	Emission Level (dBuV/m)	Limit (dBuV/m)	Margin (dB)	Raw Value Chain 0 (dBm)	Raw Value Chain 1 (dBm)	Correction Factor (dB)	EIRP Level (dBm)
1	2339.96	53.2 PK	74	-20.8	-52.12	-48.56	4.92	-42.06
2	2339.96	43.35 AV	54	-10.65	-59.69	-59.99	4.92	-51.91
3	3823.8	57.02 PK	74	-16.98	-47.32	-45.26	4.92	-38.24
4	3786.78	45.38 AV	54	-8.62	-58.34	-57.34	4.92	-49.88
5	15414.4	54.7 PK	74	-19.3	-46.81	-51.28	4.92	-40.56
6	14488.27	44.22 AV	54	-9.78	-58.75	-59.19	4.92	-51.04
7	23874.8	58.5 PK	74	-15.5	-48.11	-42.8	4.92	-36.76
8	23808.3	48.35 AV	54	-5.65	-54.56	-55.14	4.92	-46.91

Note: Margin value = Emission Level - Limit value

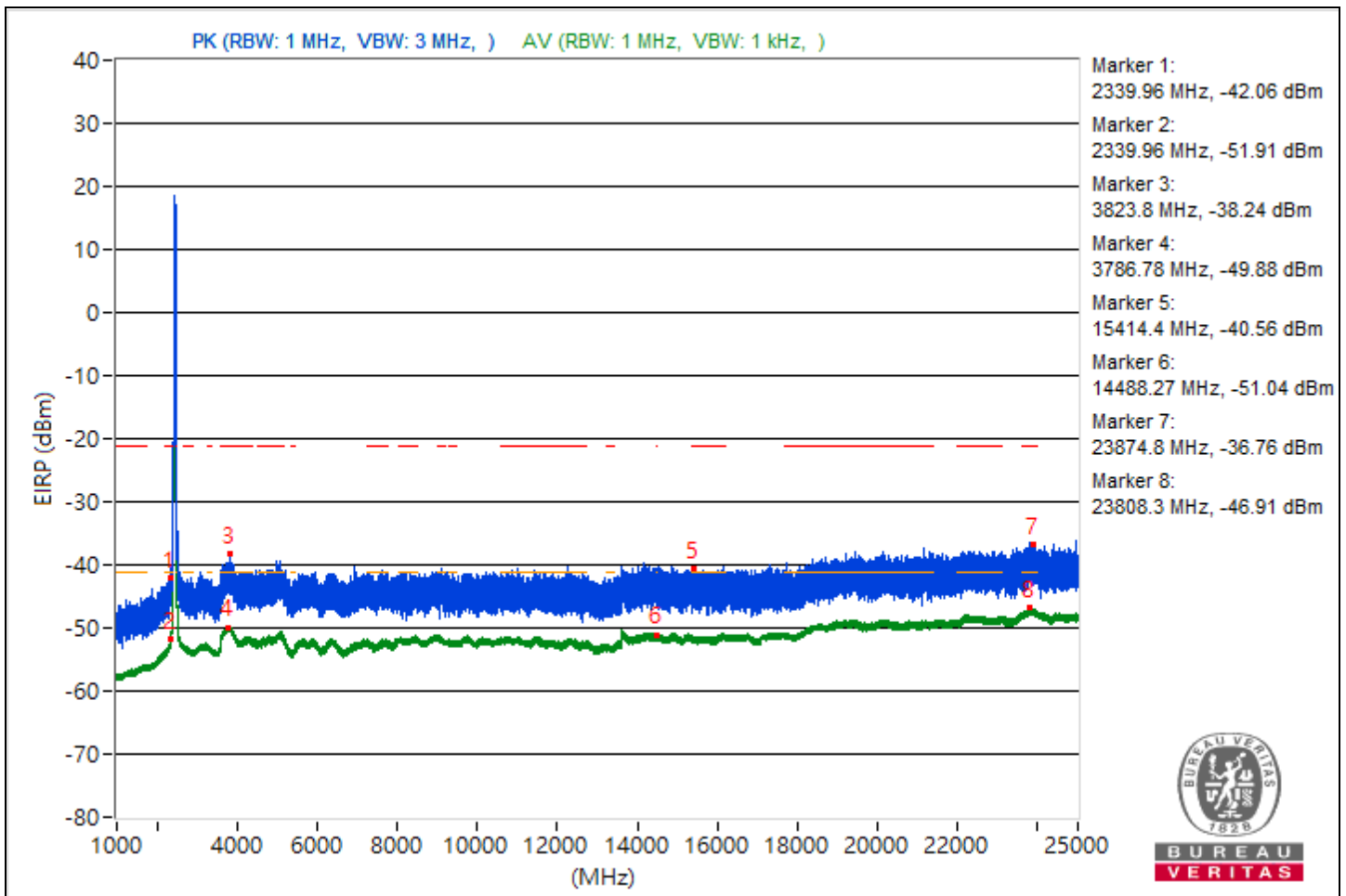

RF Mode	802.11be (EHT40)	Channel	CH 10 : 2457 MHz
Frequency Range	1 GHz ~ 25 GHz	Environmental Conditions	25°C, 76% RH
Tested By	Waydi Tuan		

Conducted Unwanted Emissions								
No.	Frequency (MHz)	Emission Level (dBuV/m)	Limit (dBuV/m)	Margin (dB)	Raw Value Chain 0 (dBm)	Raw Value Chain 1 (dBm)	Correction Factor (dB)	EIRP Level (dBm)
1	2335.83	53.14 PK	74	-20.86	-51.79	-48.82	4.92	-42.12
2	2339.02	43.1 AV	54	-10.9	-60.15	-60.02	4.92	-52.16
3	3821.31	57.32 PK	74	-16.68	-46.54	-45.29	4.92	-37.94
4	3810.89	45.41 AV	54	-8.59	-57.49	-58.09	4.92	-49.85
5	15782.13	54.91 PK	74	-19.09	-51.84	-46.35	4.92	-40.35
6	14480	44.24 AV	54	-9.76	-58.81	-59.1	4.92	-51.02
7	23917.3	58.56 PK	74	-15.44	-42.98	-47.35	4.92	-36.7
8	23859.7	48.31 AV	54	-5.69	-54.59	-55.19	4.92	-46.95

Note: Margin value = Emission Level - Limit value

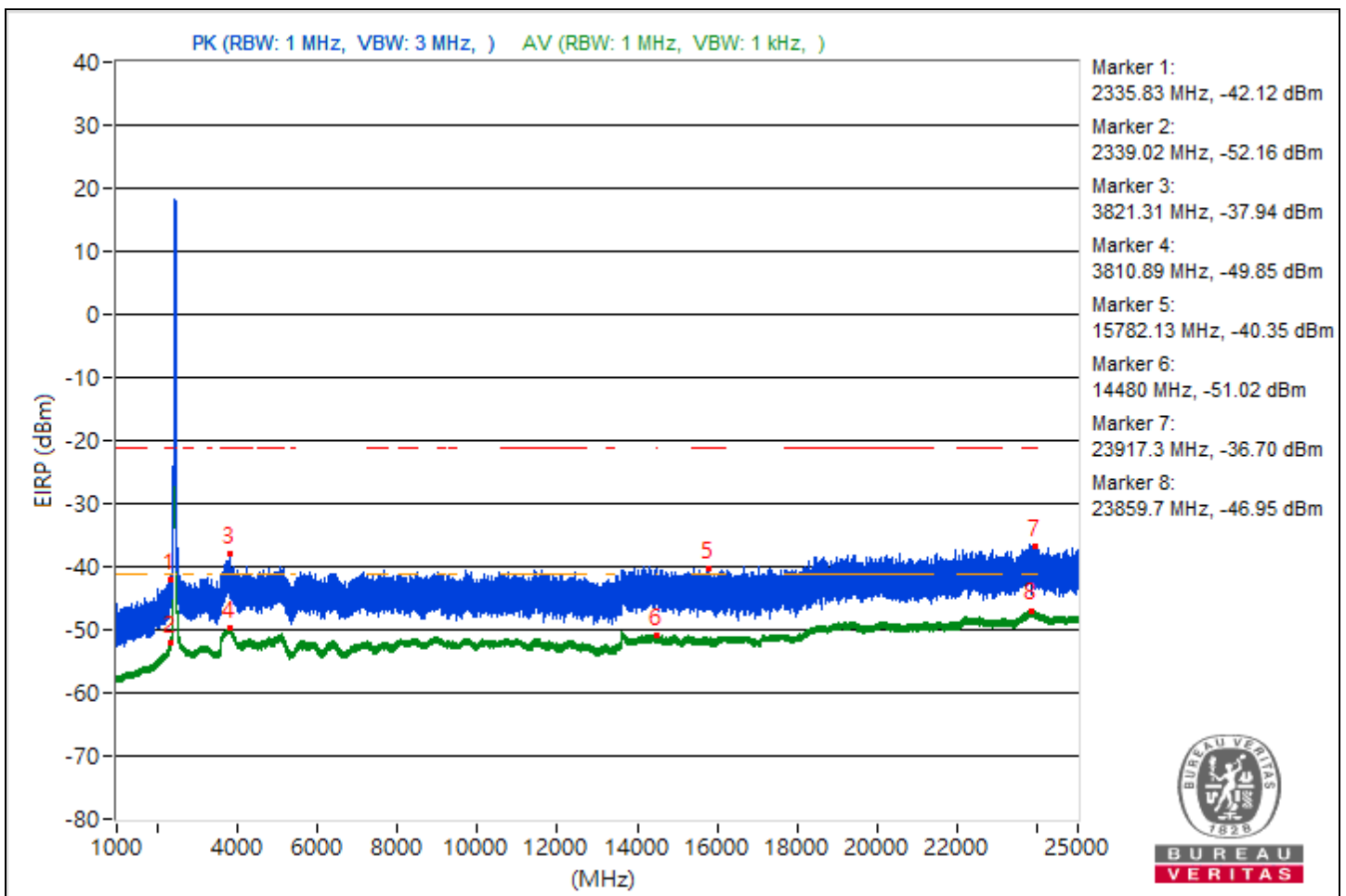

RF Mode	802.11be (EHT40)	Channel	CH 11 : 2462 MHz
Frequency Range	1 GHz ~ 25 GHz	Environmental Conditions	25°C, 76% RH
Tested By	Waydi Tuan		

Conducted Unwanted Emissions								
No.	Frequency (MHz)	Emission Level (dBuV/m)	Limit (dBuV/m)	Margin (dB)	Raw Value Chain 0 (dBm)	Raw Value Chain 1 (dBm)	Correction Factor (dB)	EIRP Level (dBm)
1	2227.26	53.12 PK	74	-20.88	-48.11	-53.74	4.92	-42.14
2	2330.23	42.75 AV	54	-11.25	-60.85	-60.06	4.92	-52.51
3	3869.84	55.32 PK	74	-18.68	-51.75	-45.85	4.92	-39.94
4	3782.89	45.57 AV	54	-8.43	-57.52	-57.72	4.92	-49.69
5	12432.27	54.93 PK	74	-19.07	-53.09	-46.03	4.92	-40.33
6	14473.24	44.21 AV	54	-9.79	-59.29	-58.7	4.92	-51.05
7	23822.4	58.44 PK	74	-15.56	-50.07	-42.43	4.92	-36.82
8	23786.1	48.32 AV	54	-5.68	-54.58	-55.17	4.92	-46.94

Note: Margin value = Emission Level - Limit value

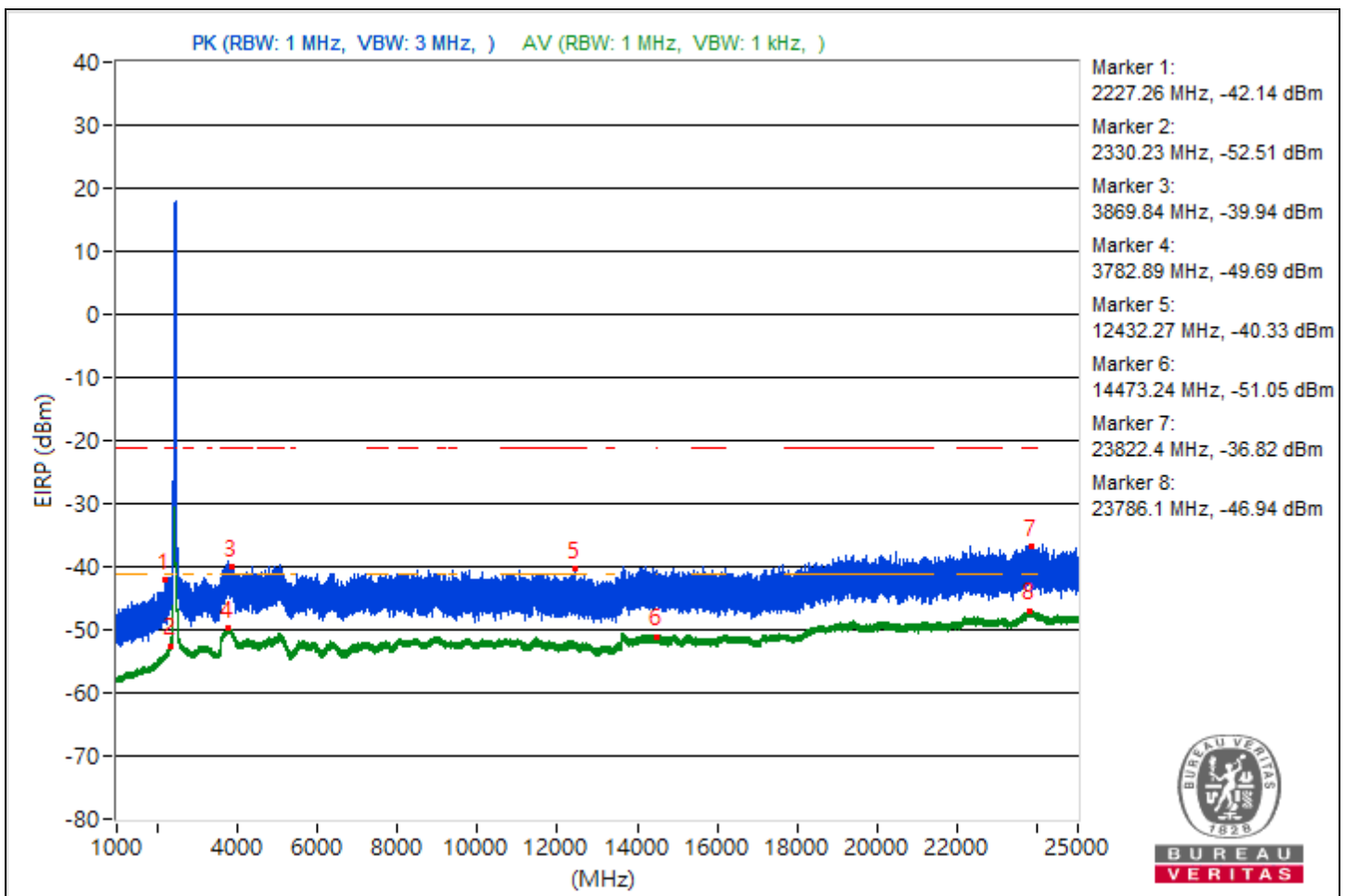

RF Mode	802.11be (EHT20) 26-tone RU	Channel	CH 1 : 2412 MHz
Frequency Range	1 GHz ~ 25 GHz	Environmental Conditions	25°C, 76% RH
Tested By	Waydi Tuan		

Conducted Unwanted Emissions								
No.	Frequency (MHz)	Emission Level (dBuV/m)	Limit (dBuV/m)	Margin (dB)	Raw Value Chain 0 (dBm)	Raw Value Chain 1 (dBm)	Correction Factor (dB)	EIRP Level (dBm)
1	2325.02	53.38 PK	74	-20.62	-52.06	-48.34	4.92	-41.88
2	2338.4	43.56 AV	54	-10.44	-59.51	-59.74	4.92	-51.7
3	4807.38	58.43 PK	74	-15.57	-45.79	-43.92	4.92	-36.83
4	4807.07	48.34 AV	54	-5.66	-54.7	-55.02	4.92	-46.92
5	9036.71	54.77 PK	74	-19.23	-51.08	-46.78	4.92	-40.49
6	14497.33	44.1 AV	54	-9.9	-59.47	-58.75	4.92	-51.16
7	23871.4	57.88 PK	74	-16.12	-49.36	-43.25	4.92	-37.38
8	23861	48.2 AV	54	-5.8	-54.67	-55.34	4.92	-47.06

Note: Margin value = Emission Level - Limit value

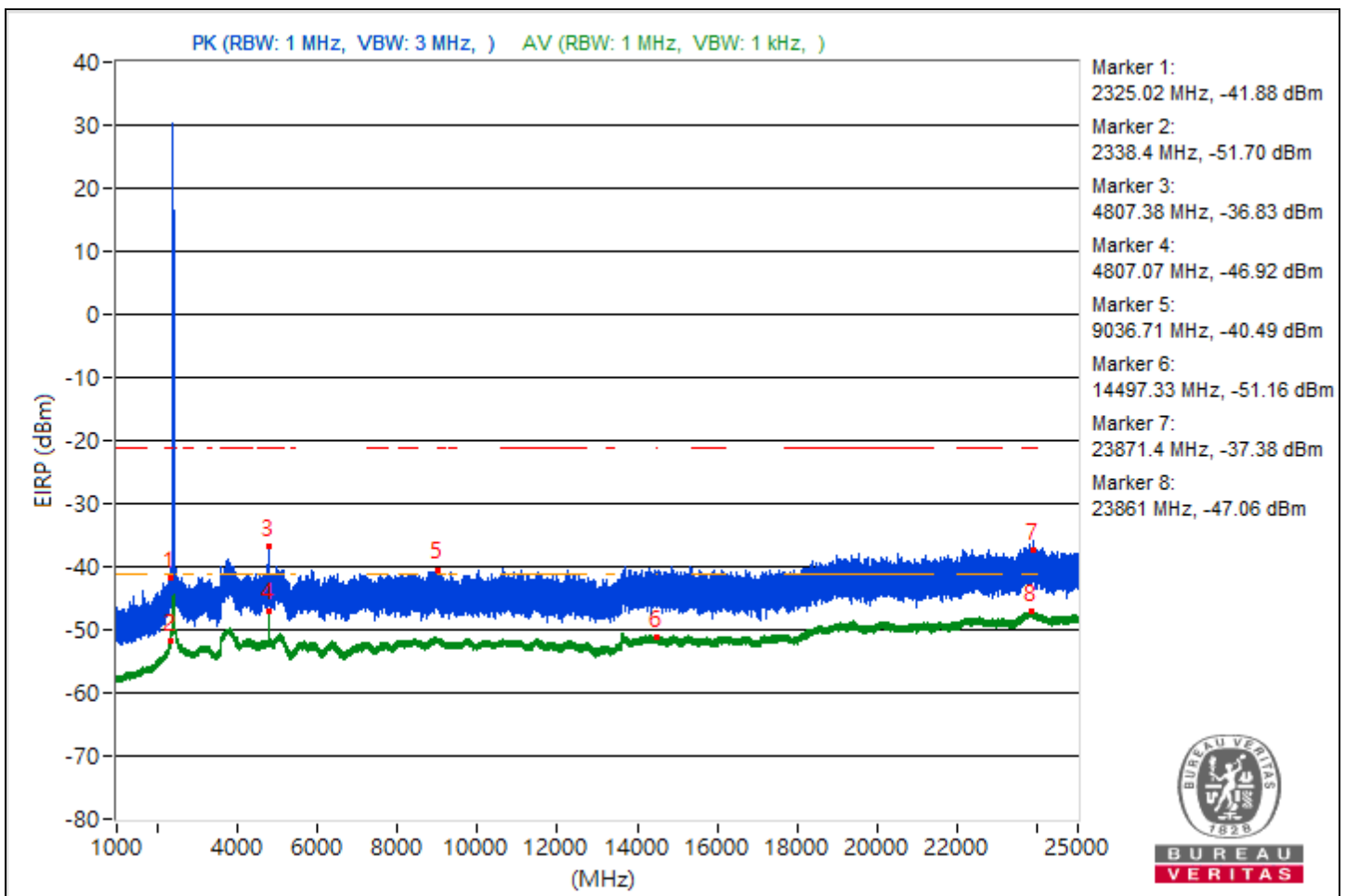

RF Mode	802.11be (EHT20) 26-tone RU	Channel	CH 6 : 2437 MHz
Frequency Range	1 GHz ~ 25 GHz	Environmental Conditions	25°C, 76% RH
Tested By	Waydi Tuan		

Conducted Unwanted Emissions								
No.	Frequency (MHz)	Emission Level (dBuV/m)	Limit (dBuV/m)	Margin (dB)	Raw Value Chain 0 (dBm)	Raw Value Chain 1 (dBm)	Correction Factor (dB)	EIRP Level (dBm)
1	2321.99	53.52 PK	74	-20.48	-47.7	-53.37	4.92	-41.74
2	2338.94	43.66 AV	54	-10.34	-59.53	-59.53	4.92	-51.6
3	7284.76	57.47 PK	74	-16.53	-44.45	-47.51	4.92	-37.79
4	4857.31	48.48 AV	54	-5.52	-54.13	-55.38	4.92	-46.78
5	10975.64	54.27 PK	74	-19.73	-46.74	-53.51	4.92	-40.99
6	14482.76	44.26 AV	54	-9.74	-58.77	-59.09	4.92	-51
7	23931.5	59.21 PK	74	-14.79	-46.33	-42.46	4.92	-36.05
8	23845	48.37 AV	54	-5.63	-54.33	-55.36	4.92	-46.89

Note: Margin value = Emission Level - Limit value

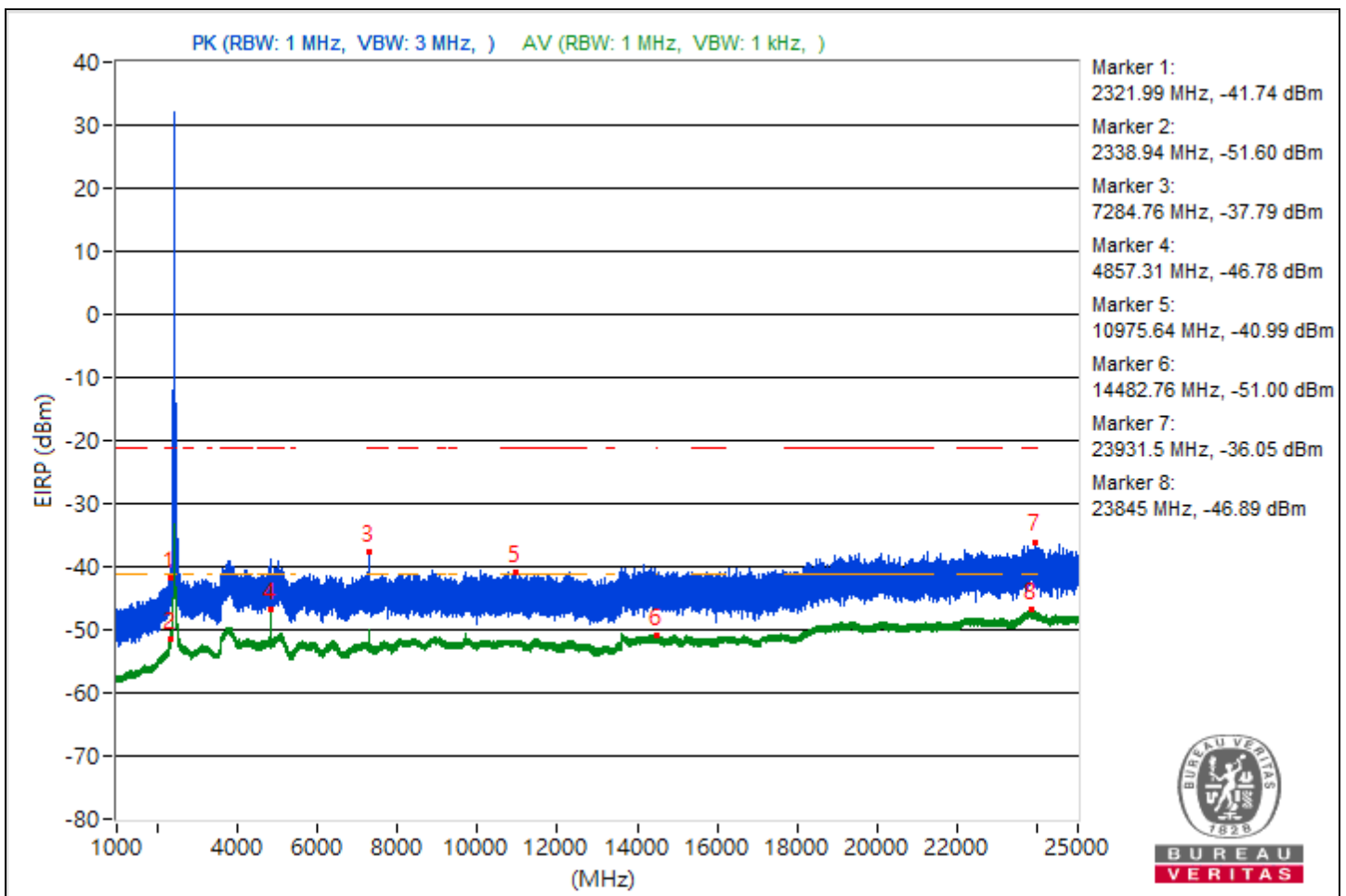

RF Mode	802.11be (EHT20) 26-tone RU	Channel	CH 11 : 2462 MHz
Frequency Range	1 GHz ~ 25 GHz	Environmental Conditions	25°C, 76% RH
Tested By	Waydi Tuan		

Conducted Unwanted Emissions								
No.	Frequency (MHz)	Emission Level (dBuV/m)	Limit (dBuV/m)	Margin (dB)	Raw Value Chain 0 (dBm)	Raw Value Chain 1 (dBm)	Correction Factor (dB)	EIRP Level (dBm)
1	2284.58	52.44 PK	74	-21.56	-53.82	-48.97	4.92	-42.82
2	2330.62	42.75 AV	54	-11.25	-61.12	-59.85	4.92	-52.51
3	3848.14	57.19 PK	74	-16.81	-47.44	-44.92	4.92	-38.07
4	4941.47	45.71 AV	54	-8.29	-57.4	-57.56	4.92	-49.55
5	9006.04	55.52 PK	74	-18.48	-48.55	-46.94	4.92	-39.74
6	14478.84	44.08 AV	54	-9.92	-59.61	-58.66	4.92	-51.18
7	23679.1	57.84 PK	74	-16.16	-48.99	-43.4	4.92	-37.42
8	23790.4	48.42 AV	54	-5.58	-54.94	-54.61	4.92	-46.84

Note: Margin value = Emission Level - Limit value

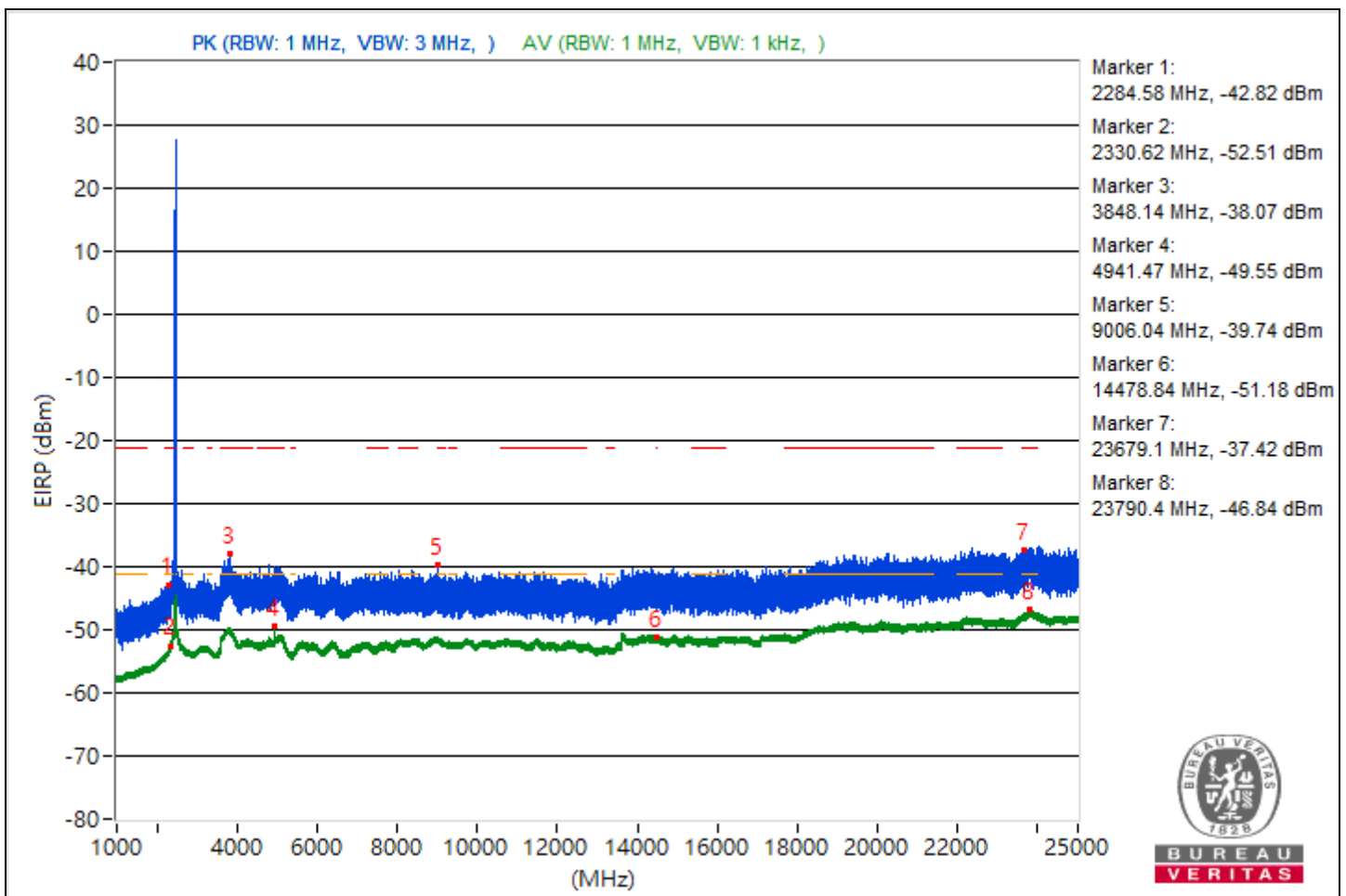



RF Mode	802.11be (EHT20) 26-tone RU	Channel	CH 12 : 2467 MHz
Frequency Range	1 GHz ~ 25 GHz	Environmental Conditions	25°C, 76% RH
Tested By	Waydi Tuan		

Conducted Unwanted Emissions								
No.	Frequency (MHz)	Emission Level (dBuV/m)	Limit (dBuV/m)	Margin (dB)	Raw Value Chain 0 (dBm)	Raw Value Chain 1 (dBm)	Correction Factor (dB)	EIRP Level (dBm)
1	2326.58	53.19 PK	74	-20.81	-48.64	-51.98	4.92	-42.07
2	2337.78	42.62 AV	54	-11.38	-60.88	-60.29	4.92	-52.64
3	3812.6	57.06 PK	74	-16.94	-44.98	-47.71	4.92	-38.2
4	4950.72	45.53 AV	54	-8.47	-57.89	-57.44	4.92	-49.73
5	10638.31	54.63 PK	74	-19.37	-52.32	-46.57	4.92	-40.63
6	14472	44.35 AV	54	-9.65	-58.96	-58.72	4.92	-50.91
7	23818.5	58.95 PK	74	-15.05	-42.43	-47.4	4.92	-36.31
8	23892.2	48.23 AV	54	-5.77	-55.27	-54.67	4.92	-47.03

Note: Margin value = Emission Level - Limit value

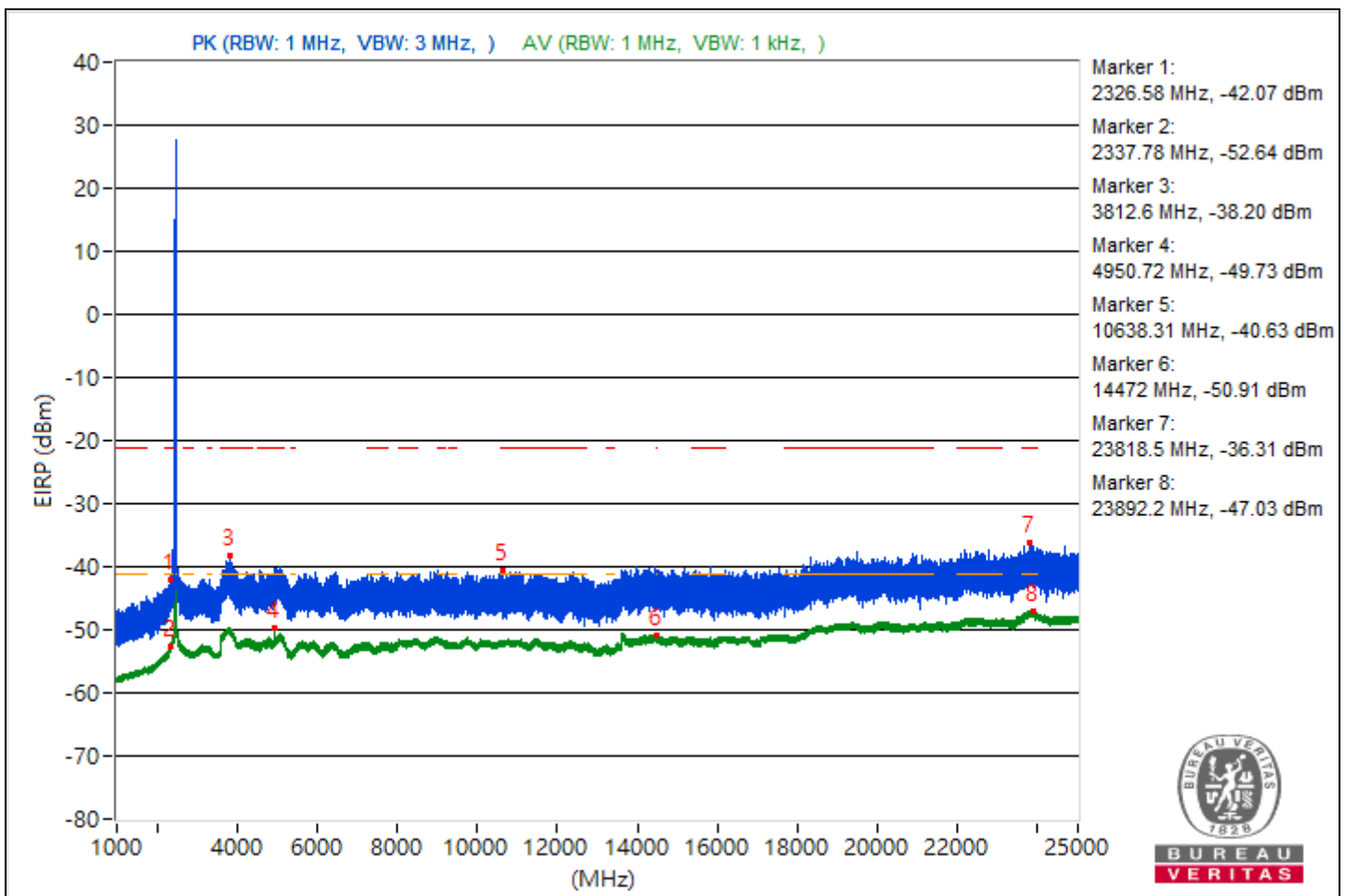

RF Mode	802.11be (EHT20) 26-tone RU	Channel	CH 13 : 2472 MHz
Frequency Range	1 GHz ~ 25 GHz	Environmental Conditions	25°C, 76% RH
Tested By	Waydi Tuan		

Conducted Unwanted Emissions								
No.	Frequency (MHz)	Emission Level (dBuV/m)	Limit (dBuV/m)	Margin (dB)	Raw Value Chain 0 (dBm)	Raw Value Chain 1 (dBm)	Correction Factor (dB)	EIRP Level (dBm)
1	2242.66	52.64 PK	74	-21.36	-49.39	-52.13	4.92	-42.62
2	2330.16	42.32 AV	54	-11.68	-61.13	-60.64	4.92	-52.94
3	3735.44	56.15 PK	74	-17.85	-45.41	-49.68	4.92	-39.11
4	3801.71	45.42 AV	54	-8.58	-58.16	-57.42	4.92	-49.84
5	15415.64	55.16 PK	74	-18.84	-50.14	-46.62	4.92	-40.1
6	14486.22	44.27 AV	54	-9.73	-58.61	-59.25	4.92	-50.99
7	20149.2	58.08 PK	74	-15.92	-42.91	-49.79	4.92	-37.18
8	23837.6	48.25 AV	54	-5.75	-54.63	-55.28	4.92	-47.01

Note: Margin value = Emission Level - Limit value

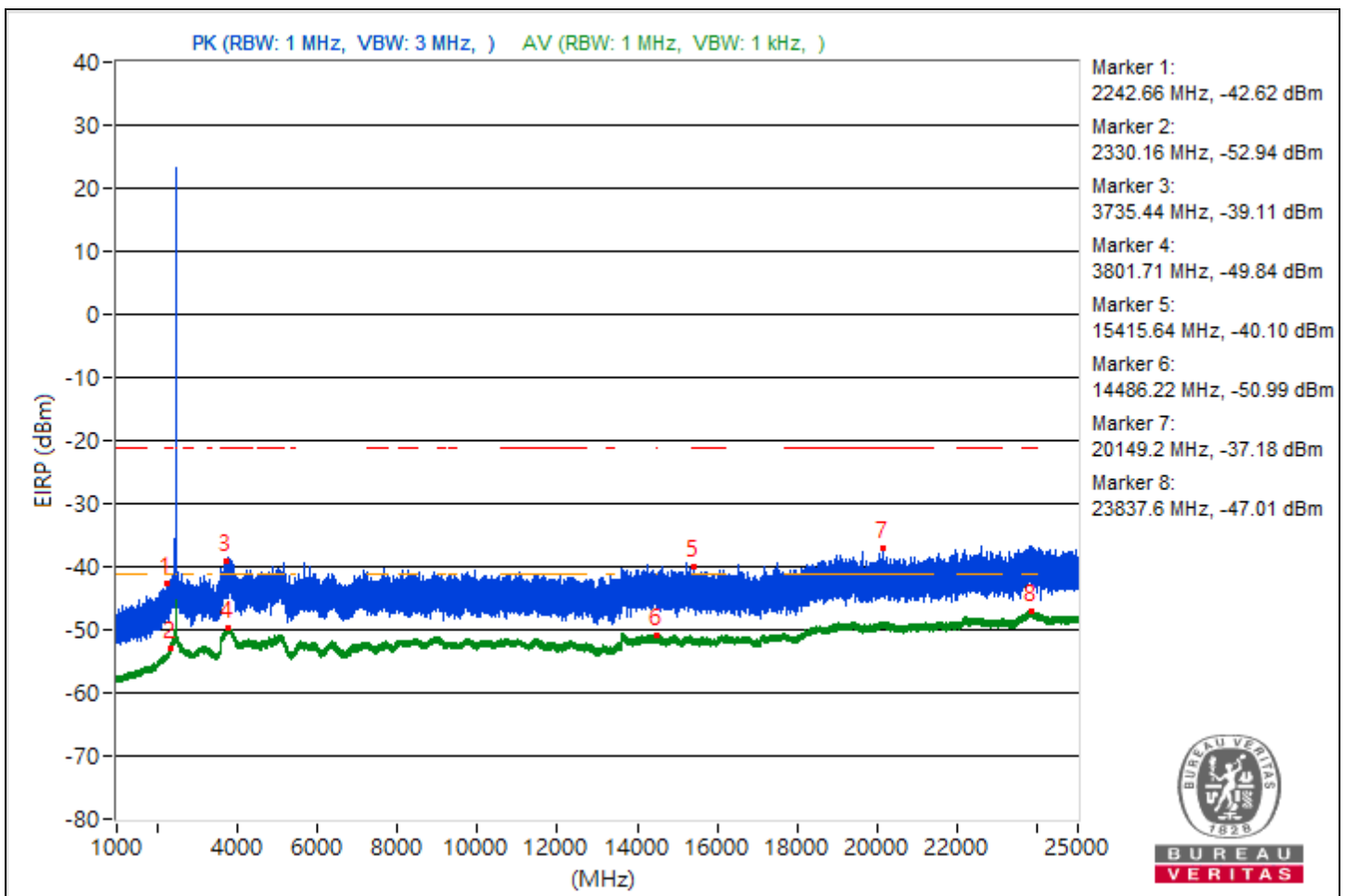

RF Mode	802.11be (EHT20) 52-tone RU	Channel	CH 1 : 2412 MHz
Frequency Range	1 GHz ~ 25 GHz	Environmental Conditions	25°C, 76% RH
Tested By	Waydi Tuan		

Conducted Unwanted Emissions								
No.	Frequency (MHz)	Emission Level (dBuV/m)	Limit (dBuV/m)	Margin (dB)	Raw Value Chain 0 (dBm)	Raw Value Chain 1 (dBm)	Correction Factor (dB)	EIRP Level (dBm)
1	2322.77	54.04 PK	74	-19.96	-47.61	-51.56	4.92	-41.22
2	2336.84	43.66 AV	54	-10.34	-59.82	-59.25	4.92	-51.6
3	3695.86	56.67 PK	74	-17.33	-48.29	-45.26	4.92	-38.59
4	4809.56	45.98 AV	54	-8.02	-57.17	-57.25	4.92	-49.28
5	9318.04	54.85 PK	74	-19.15	-53.54	-46.04	4.92	-40.41
6	14494.31	44.15 AV	54	-9.85	-58.78	-59.33	4.92	-51.11
7	23907.1	58.39 PK	74	-15.61	-42.47	-50.2	4.92	-36.87
8	23802.8	48.25 AV	54	-5.75	-55.31	-54.6	4.92	-47.01

Note: Margin value = Emission Level - Limit value

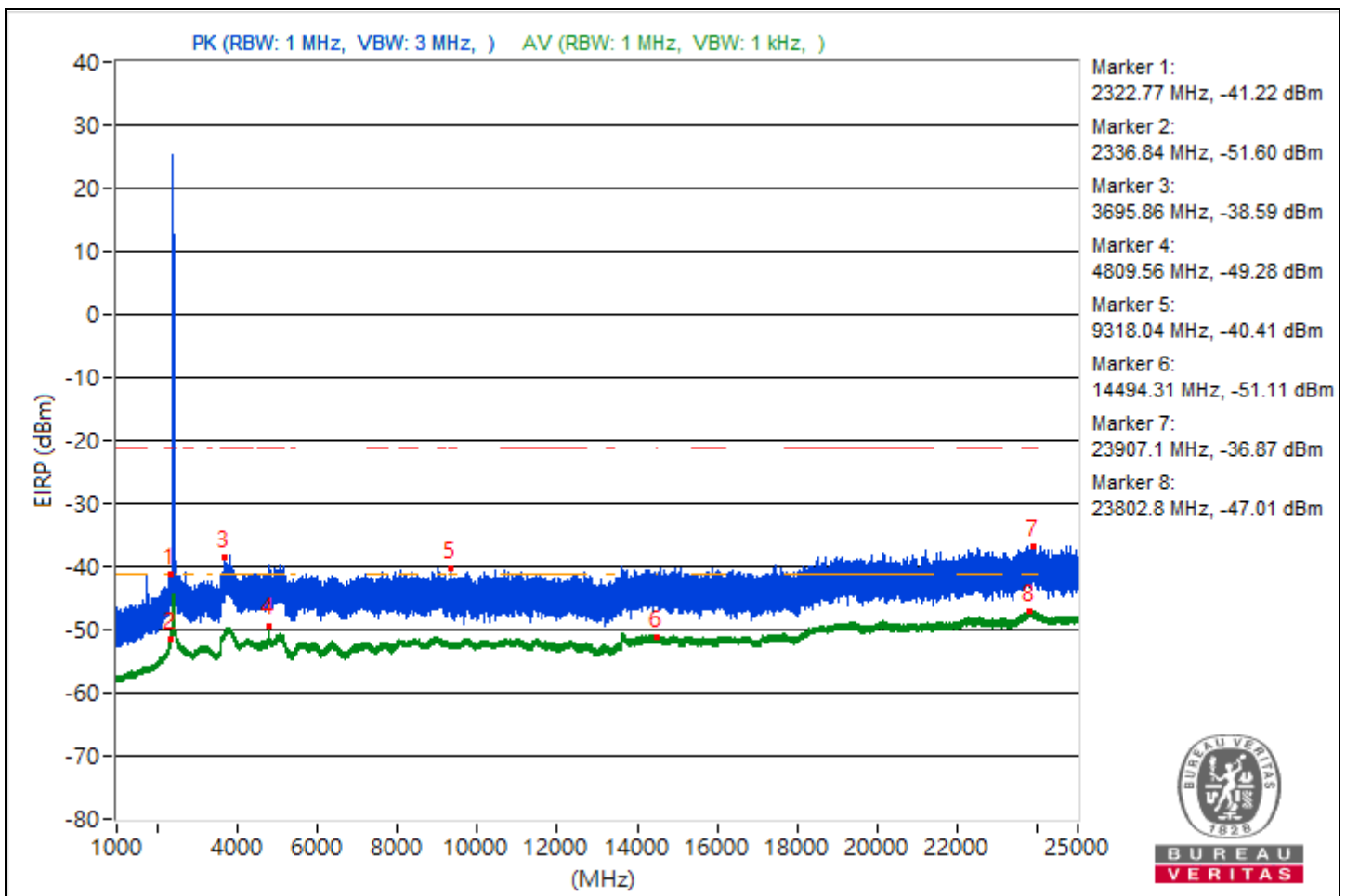

RF Mode	802.11be (EHT20) 52-tone RU	Channel	CH 6 : 2437 MHz
Frequency Range	1 GHz ~ 25 GHz	Environmental Conditions	25°C, 76% RH
Tested By	Waydi Tuan		

Conducted Unwanted Emissions								
No.	Frequency (MHz)	Emission Level (dBuV/m)	Limit (dBuV/m)	Margin (dB)	Raw Value Chain 0 (dBm)	Raw Value Chain 1 (dBm)	Correction Factor (dB)	EIRP Level (dBm)
1	2317.17	53.2 PK	74	-20.8	-52.2	-48.53	4.92	-42.06
2	2335.91	43.52 AV	54	-10.48	-60.04	-59.32	4.92	-51.74
3	4859.8	56.95 PK	74	-17.05	-46.87	-45.7	4.92	-38.31
4	4859.64	47.06 AV	54	-6.94	-55.89	-56.38	4.92	-48.2
5	9065.51	54.14 PK	74	-19.86	-46.82	-53.88	4.92	-41.12
6	14476.98	44.27 AV	54	-9.73	-58.58	-59.29	4.92	-50.99
7	23811.7	58.55 PK	74	-15.45	-42.86	-47.72	4.92	-36.71
8	23817.9	48.5 AV	54	-5.5	-55.03	-54.37	4.92	-46.76

Note: Margin value = Emission Level - Limit value

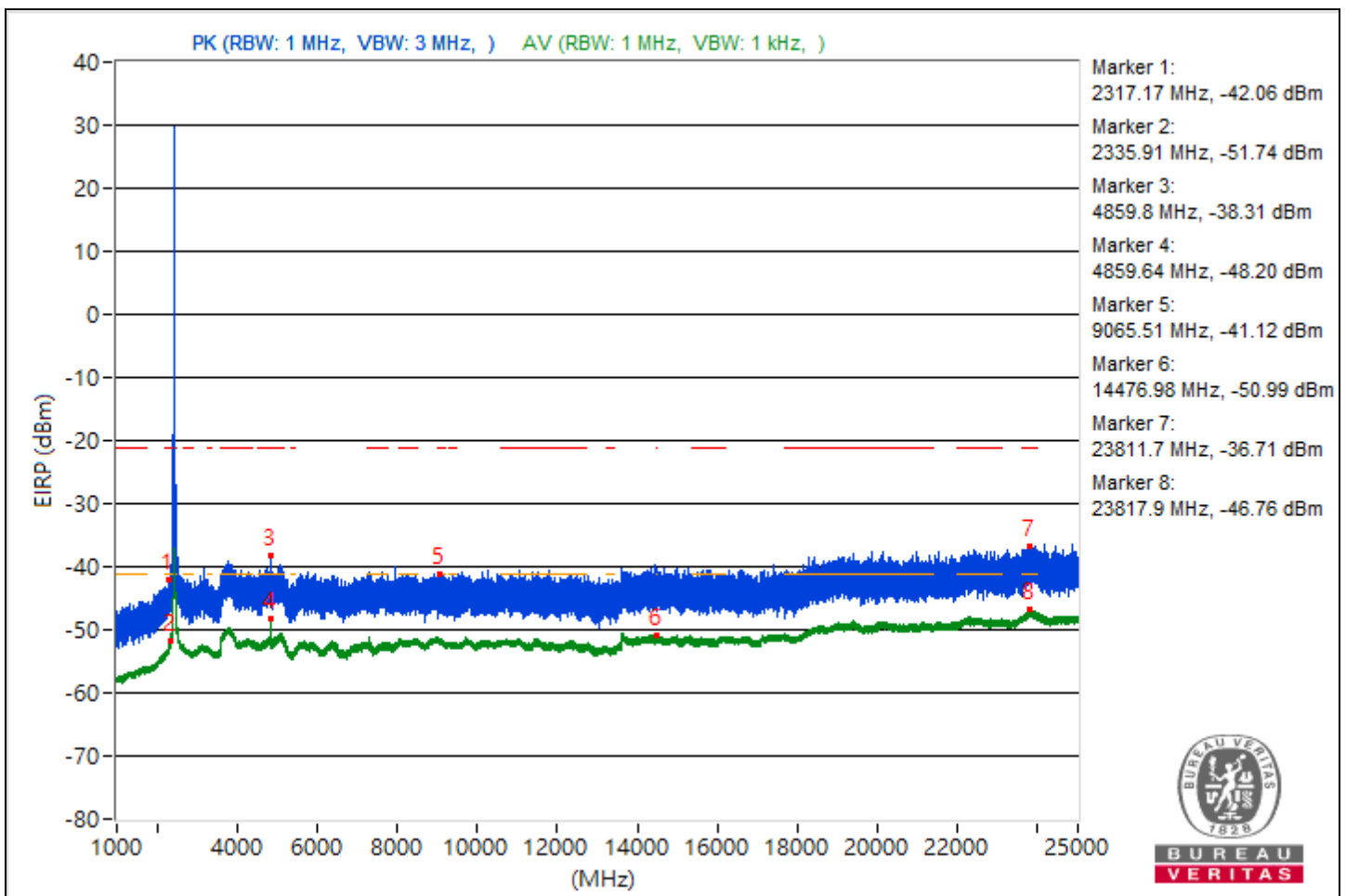



RF Mode	802.11be (EHT20) 52-tone RU	Channel	CH 11 : 2462 MHz
Frequency Range	1 GHz ~ 25 GHz	Environmental Conditions	25°C, 76% RH
Tested By	Waydi Tuan		

Conducted Unwanted Emissions								
No.	Frequency (MHz)	Emission Level (dBuV/m)	Limit (dBuV/m)	Margin (dB)	Raw Value Chain 0 (dBm)	Raw Value Chain 1 (dBm)	Correction Factor (dB)	EIRP Level (dBm)
1	2337.47	53.15 PK	74	-20.85	-52.86	-48.35	4.92	-42.11
2	2339.96	42.96 AV	54	-11.04	-60.54	-59.93	4.92	-52.3
3	4998.09	55.69 PK	74	-18.31	-51.48	-45.46	4.92	-39.57
4	3799.53	45.49 AV	54	-8.51	-58.01	-57.4	4.92	-49.77
5	14478.4	54.6 PK	74	-19.4	-47.04	-51.04	4.92	-40.66
6	14498.13	44.1 AV	54	-9.9	-58.67	-59.55	4.92	-51.16
7	23823.2	58.72 PK	74	-15.28	-42.94	-46.85	4.92	-36.54
8	23826.4	48.27 AV	54	-5.73	-54.57	-55.29	4.92	-46.99

Note: Margin value = Emission Level - Limit value

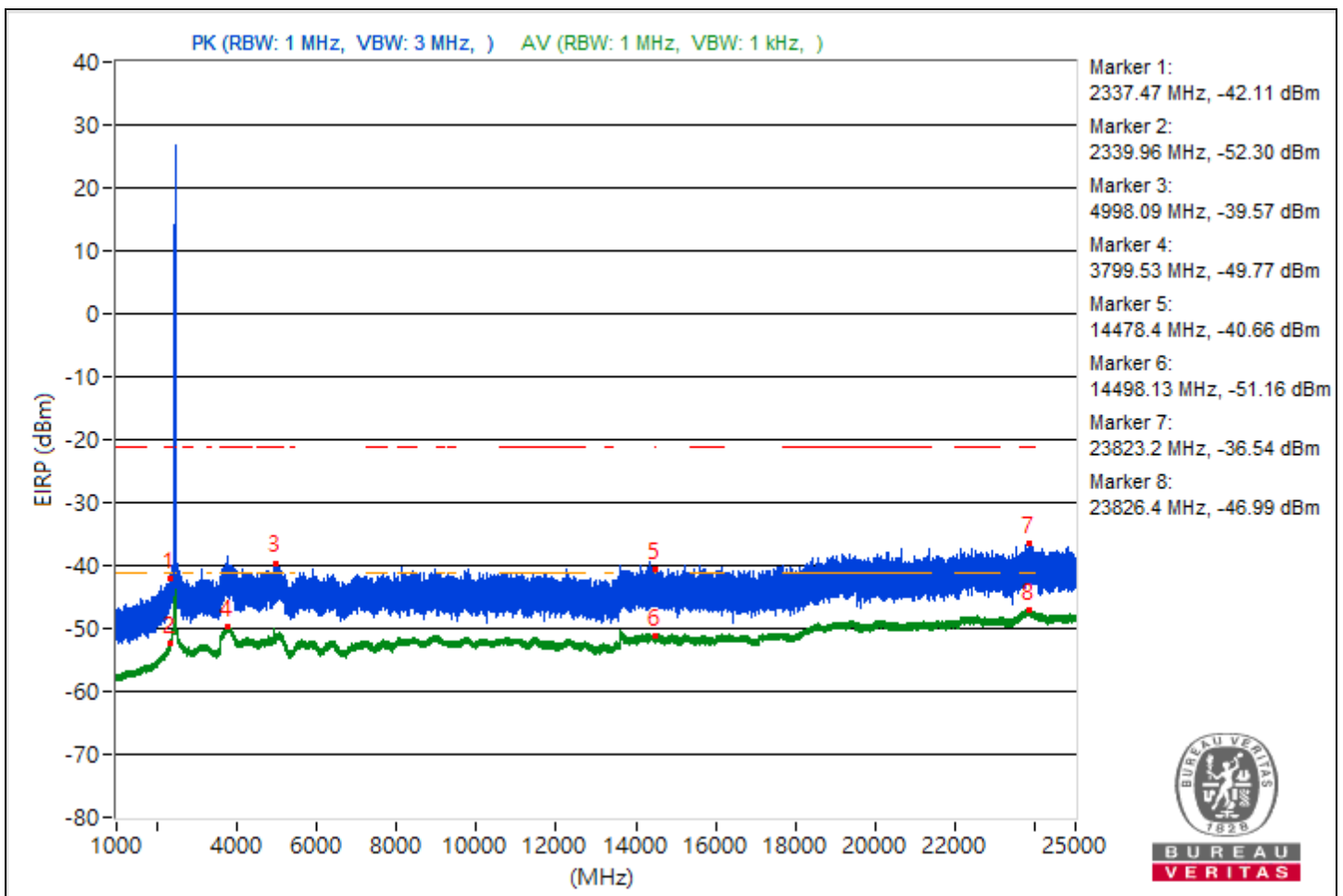

RF Mode	802.11be (EHT20) 52-tone RU	Channel	CH 12 : 2467 MHz
Frequency Range	1 GHz ~ 25 GHz	Environmental Conditions	25°C, 76% RH
Tested By	Waydi Tuan		

Conducted Unwanted Emissions								
No.	Frequency (MHz)	Emission Level (dBuV/m)	Limit (dBuV/m)	Margin (dB)	Raw Value Chain 0 (dBm)	Raw Value Chain 1 (dBm)	Correction Factor (dB)	EIRP Level (dBm)
1	2314.99	52.63 PK	74	-21.37	-52.58	-49.19	4.92	-42.63
2	2334.59	42.72 AV	54	-11.28	-60.73	-60.23	4.92	-52.54
3	3743.77	56.31 PK	74	-17.69	-49.9	-45.12	4.92	-38.95
4	3811.28	45.6 AV	54	-8.4	-57.76	-57.44	4.92	-49.66
5	8253.69	55.1 PK	74	-18.9	-45.87	-52.9	4.92	-40.16
6	14473.6	44.18 AV	54	-9.82	-59.57	-58.52	4.92	-51.08
7	23935.2	58.11 PK	74	-15.89	-50.99	-42.66	4.92	-37.15
8	23820.3	48.26 AV	54	-5.74	-55.33	-54.56	4.92	-47

Note: Margin value = Emission Level - Limit value

