

# Regulatory WLAN Antenna Information (Template)

*English Language Required for Intel Regulatory Review / Approval*

**(OEM/ODM or antenna vendor is required to complete this document with platform antenna information.**

**Remove Intel references and make this your own document)**

Platform information											
Brand	ODM	****End product model name	Intel platform (ex: Yes, No or NA)	Platform type (ex: regular NB, convertible PC, AIO...etc)	*SAR minimum separation (mm)						
ASUS	Huaqin	TN3604YA	NO	Regular NB							
****Please fill in exact product model name and make sure the model name is visible on product cover or any parts for end users recognize for authority inspection.											
Antenna information											
Vendor	Type	Antenna Part number (Main)				Antenna Part number (Aux)					
INPAQ	PIFA	WA-P-LE-02-113 (HQ20605068000)				WA-P-LE-03-010 (HQ20605071000)					
Peak gain w/ cable loss (dBi)*											
	2.4GHz 2400-2483.5 MHz	5.2GHz 5150-5250MHz	5.3GHz 5250-5350MHz	5.6GHz 5470-5725MHz	5.8GHz 5725-5850MHz	5.9GHz 5850-5895MHz	6.2GHz 5925-6425MHz	6.5GHz 6425-6525MHz	6.7GHz 6525-6875MHz	7.0 GHz 6875-7125MHz	
Main	2.33	2.96	2.36	2.52	2.48	3.79	4.23	2.82	3.63	4.61	
Aux	2.06	2.16	2.98	3.71	2.62	3.25	3.09	3.09	2.61	3.07	
Intel Reference Gain/Type/ Separation distance											
Antenna Type	Antenna Peak gain (In dBi)*										Distance to the end user (mm)
	2.4GHz 2400-2483.5 MHz	5.2GHz 5150-5250MHz	5.3GHz 5250-5350MHz	5.6GHz 5470-5725MHz	5.8GHz 5725-5850MHz	5.9GHz 5850-5895MHz	6.2GHz 5925-6425MHz	6.5GHz 6425-6525MHz	6.7GHz 6525-6875MHz	7.0GHz 6875-7125MHz	
Design	3.00	5.00	5.00	5.00	5.00	5.00	5.00	5.00	5.00	5.00	Generic: refer to modular FCC SAR report Mid-power: ≥ 8 mm Low power: ≥ 5 mm
PIFA	3.24	3.64	3.73	4.77	4.97	4.72	4.83	4.30	5.37	5.59	
Dipole	2.89	2.92	3.19	4.41	4.22	4.22	4.83	4.30	4.49	5.34	
Notes (marked with *)											
* SAR minimum separation (mm)											
- Regular NB: Minimum antenna-to-body (from antenna bottom to the bottom of the device)											
- Tablet / Convertible PC: Minimum antenna-to-edge (5 sides of the device)											
- Mini-tablet: Minimum antenna-to-edge (6 sides of the device)											
* 3D Peak Antenna gain should be equal or greater than -2 dBi											
- If a host integrator plans to use a lower gain antenna of the same type, additional CBP(FCC)/EDT(EU) testing need to be performed while the module is installed in the host.											

# Table of contents

1. Applicable test method
2. Test & System Description
  - a. Test setup
  - b. Equipment list

3. Setup photo

[Section 1. Antenna Assembly Specifications](#)

[Section 2. Dimensioned Photos or Drawings of Antennas](#)

[Section 3. Radiation characteristics of antenna loaded in Host Platform](#)

[Section 4. Antenna Host Platform Location Information](#)

[Section 5. Antenna dimensional information for SAR evaluation](#)

[Section 6. Diagram Example of Co-Location Antenna Separation](#)

1. **Applicable test methods**

ETS-Lindgren AMS-8500 system is 3D fully anechoic chamber, it is applied to the “Conical Cut test method”, the detail description is described as below.

The Conical Cut method requires the ability of the Measurement Antenna to be physically rotated in the theta plane (overhead) of the EUT for implementations using a single Measurement Antenna, Eleven conical cuts are required to capture data at every 15 degrees from the EUT, with the top (0 degrees) and bottom (180 degrees) cuts not being measured. Typically, the EUT will remain affixed to a turntable during the entire measurement process. The Measurement Antenna will be positioned at a starting theta angle. The EUT will then be rotated around the full 360 degrees of phi rotation. The Measurement Antenna will then be positioned at the next theta angle, and the process repeated.

		$\theta$ -Axis	$\Phi$ -Axis
Passive	Step size	15°~165° step: 15°	0°~345° step: 15°
	N / M (Points)	12	24

2. **Test & System Description**

a. Test setup

Typical Setup for ETS-Lindgren AMS-8500:

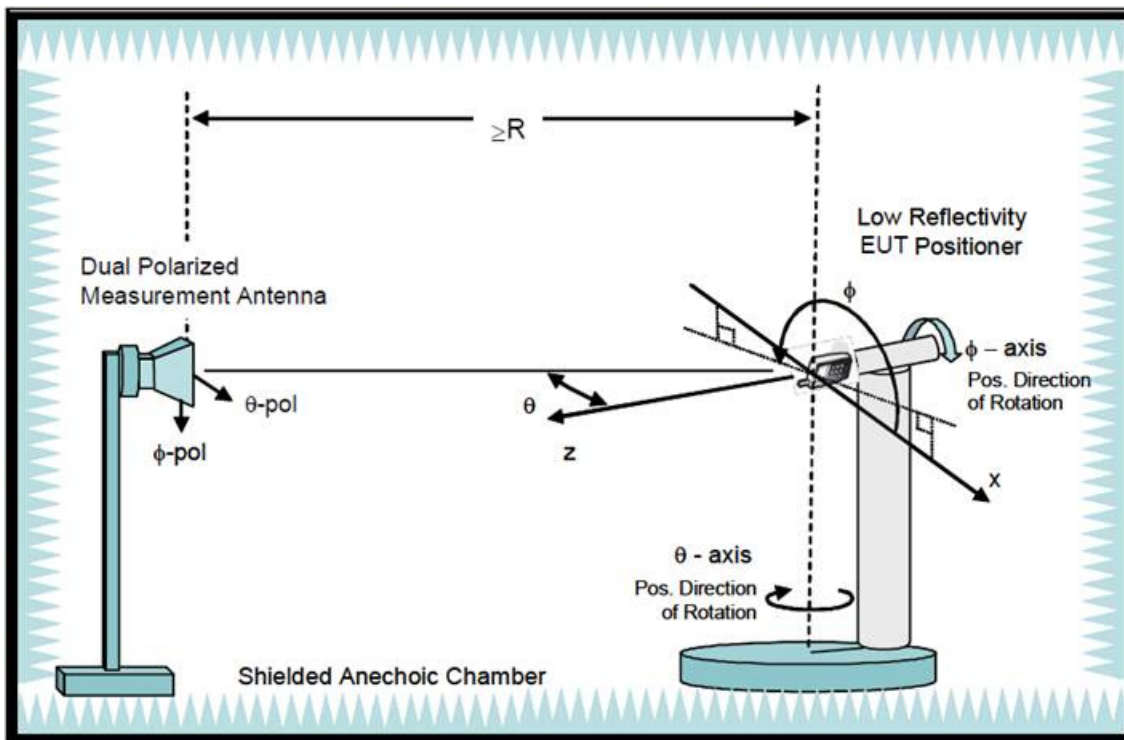

## b. Equipment list

## Anechoic Chamber

Equipment Description	Manufacturer	Identification no.	Current calibration date	Next calibration date
Network analyzer	Agilent	E5071C	2022/01/07	2023/01/06
Measurement software	ETS-Lindgren	EMQuest	2022/03/03	2023/03/03
Multi axis positioning system(MAPSTM)	ETS-Lindgren	EMCO 2115	2022/03/03	2023/03/03
Multi axis positioning system(MAPSTM)	ETS-Lindgren	EMCO 2110	2022/03/03	2023/03/03
MAPSTM controller	ETS-Lindgren	EMCO 2090	2022/03/03	2023/03/03
Horn antenna	ETS-Lindgren	3164-10	2022/03/03	2023/03/03
Cable 40cm 18 GHz	Jmtt	201EH012010400	2022/04/07	2023/04/07
Cable 6m 18 GHz	Jmtt	201EH012016000	2022/04/07	2023/04/07
Cable 6m 18 GHz	Jmtt	201EH012016000	2022/04/07	2023/04/07
Cable 3.5m 18 GHz	Jmtt	201EH012013500	2022/04/07	2023/04/07
Cable 1.5m 18 GHz	Jmtt	201EH012011500	2022/04/07	2023/04/07

3. Setup photo

# Antenna Information

## Section 1. Antenna Assembly Specifications

1A Antenna Part Number	1B Manufacturer	1C Antenna Type	1D Cable Assembly Part Number and Information	Freq Range MHz	1E * Peak Gain W/ Cable loss (dBi)	1F Peak Gain w/o Cable Loss (dBi)	1G Max VSWR	1H Cable Loss (dB)
(P/N: WA-P-LE-02-113) Main Antenna	INAPQ	PIFA	50 ohm Coaxial length: 206mm diameter: 1.13mm lowloss Connector :I-PEX MHF-4L	2400-2483.5	2.33	2.90	3.00 Max	0.57
				5150-5250	2.96	3.81	3.00 Max	0.85
				5250-5350	2.36	3.21	3.00 Max	0.85
				5470-5725	2.52	2.40	3.00 Max	0.88
				5725-5850	2.48	3.37	3.00 Max	0.89
				5850-5895	3.79	4.69	3.00 Max	0.90
				5925-6425	4.23	5.16	3.00 Max	0.93
				6425-6525	2.82	2.37	3.00 Max	0.95
				6525-6875	3.63	4.61	3.00 Max	0.98
6875-7125	4.61	5.67	3.00 Max	1.01				
(P/N: WA-P-LE-03-010) Main Antenna	INAPQ	PIFA	50 ohm Coaxial length: 317mm diameter: 1.13mm lowloss Connector :I-PEX MHF-4L	2400-2483.5	2.06	2.94	3.00 Max	0.88
				5150-5250	2.16	3.47	3.00 Max	1.31
				5250-5350	2.98	4.29	3.00 Max	1.31
				5470-5725	3.71	5.06	3.00 Max	1.35
				5725-5850	2.62	3.99	3.00 Max	1.37
				5850-5895	3.25	4.63	3.00 Max	1.38
				5925-6425	3.09	4.53	3.00 Max	1.44
				6425-6525	3.09	4.56	3.00 Max	1.47
				6525-6875	2.61	4.11	3.00 Max	1.50
6875-7125	3.07	4.62	3.00 Max	1.55				

- 3D Antenna Peak Gain required being test in system basis.

## Section 2. Dimensioned Photos and Drawings of Antennas

Include the dimensioned photo and drawing of Main antenna here.

### Main Antenna Drawing:

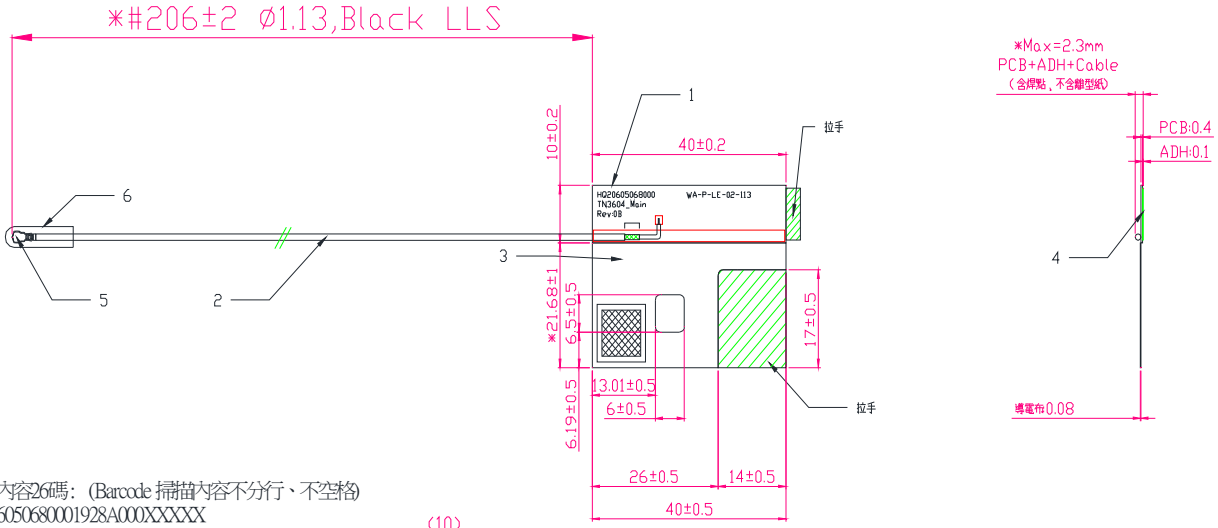

Code 內容26碼: (Barcode 掃描內容不分行、不空格)  
 HQ206050680001928A000XXXXX

編碼規則如下:

HQ20605068000: 客戶半號

2: 表示2022年尾碼

9: 9月份,10/11/12月份用A/C/D代替

28: 生產日期

A: 生產班別、白班為D,夜班為N

0: 1表示第一套模具,依此類推、無模具請以0表示

00: 表示設備版本碼, 規則為00-99, 例圖檔 P0 即00、P6 即06

XXXXX: 流水碼, 規格SN從00000-99999

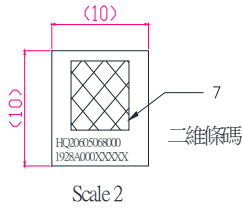

NOTE:

- 外觀標準: 需完整無瑕, 不可有變形、變形、毛邊、褶皺、裂紋、破損等情形。  
 Appearance standard: They must be complete. It means those must not have the deformations, dirt, burrs, warps, cracks, folds, etc.
- 工程圖上"※"號為重點尺寸標註指示  
 Mark "※" are the key dimensions.
- 工程圖上"卄"號為CPK量測尺寸標註指示  
 Mark "卄" are CPK dimensions.

Main Antenna Photo (Front/Back):

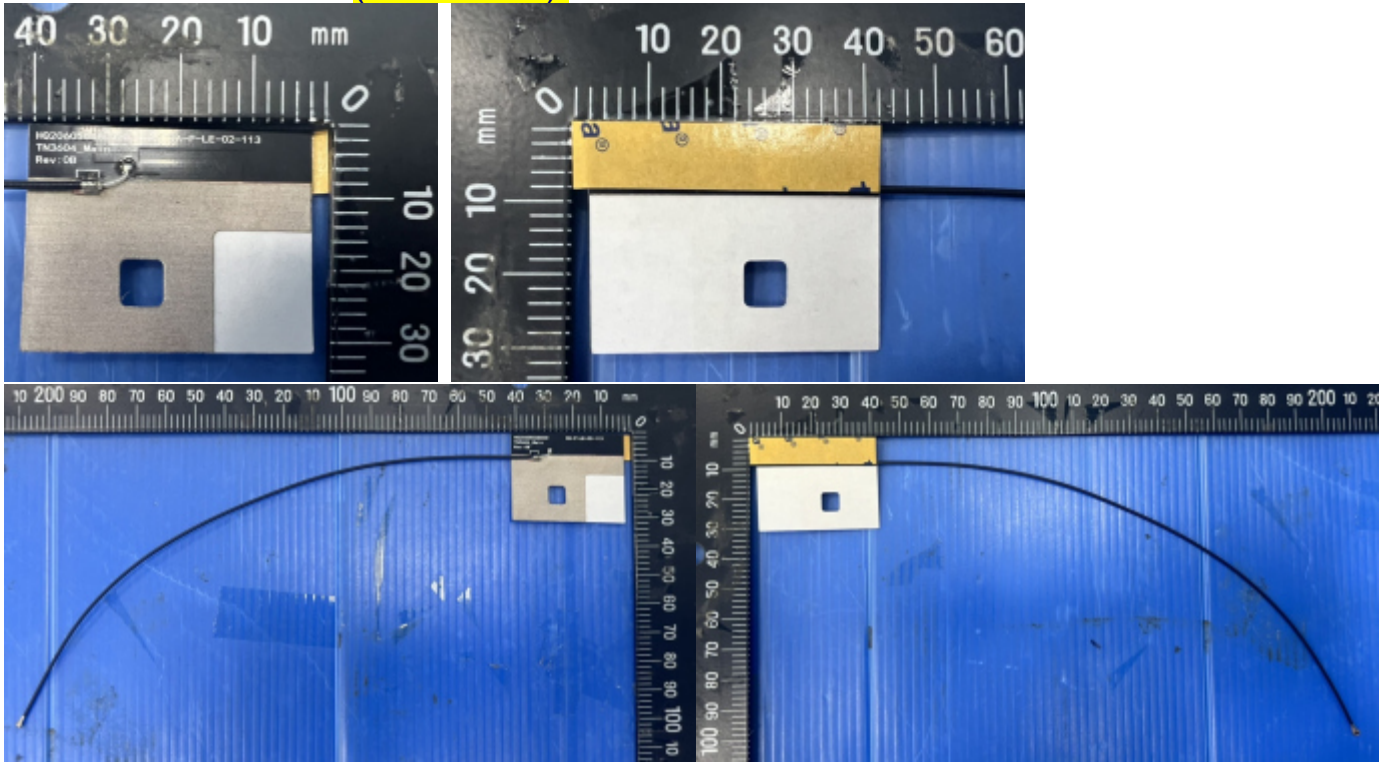

Note: antenna photo should include L type ruler



Include the dimensioned photo and drawing of Aux antenna here.

Aux Antenna Drawing:

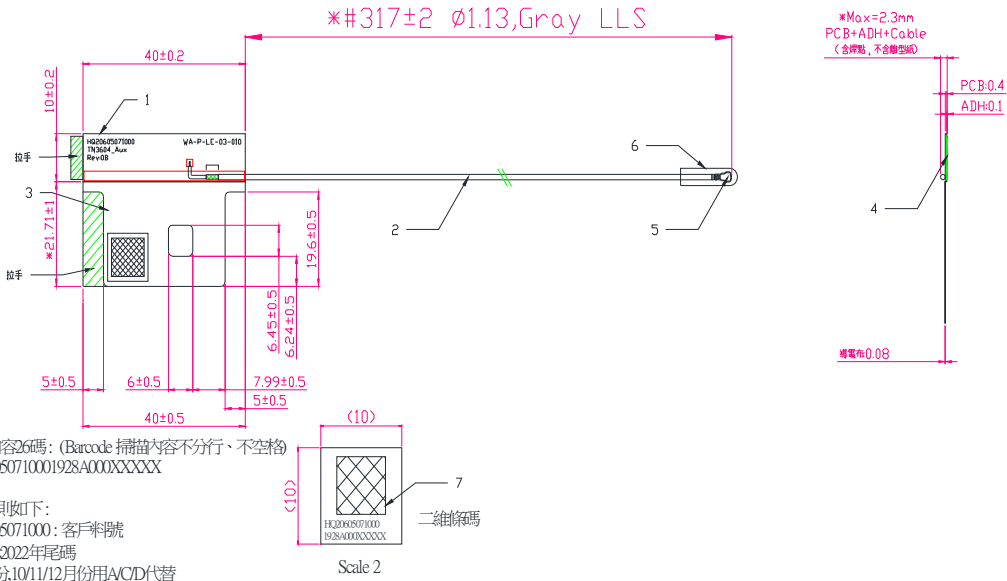

Code 內容26碼: (Barcode 掃描內容不分行、不空格)  
 HQ206050710001928A000XXXXXX

編碼原則如下:

HQ20605071000: 客戶準碼

2: 表示2022年尾碼

9: 9月份,10/11/12月份用A/C/D代替

28: 生產日期

A: 生產班別、白班為D,夜班為N

0: 1表示第一套模具,依此類推、無模具請以0表示

00: 表示設備版本碼, 規則從00-99, 例圖檔 P0 即 00、P6 即 06

XXXXX: 流水碼, 規格SN從 00000-99999

NOTE:

- 外觀標準: 表面無雜質, 不可有變形、劃傷、毛邊、毛刺、裂紋、破損等情形。  
 Appearance standard: They must be complete. It means those must not have the deformations, dirt, burrs, warps, cracks, folds, etc.
- 工程圖上 \* 均為關鍵尺寸標註指示  
 Mark \* \* are the key dimensions.
- 工程圖上 # 均為CPK 量測尺寸標註指示  
 Mark # # are CPK dimensions.

Aux Antenna Photo (Front/Back):

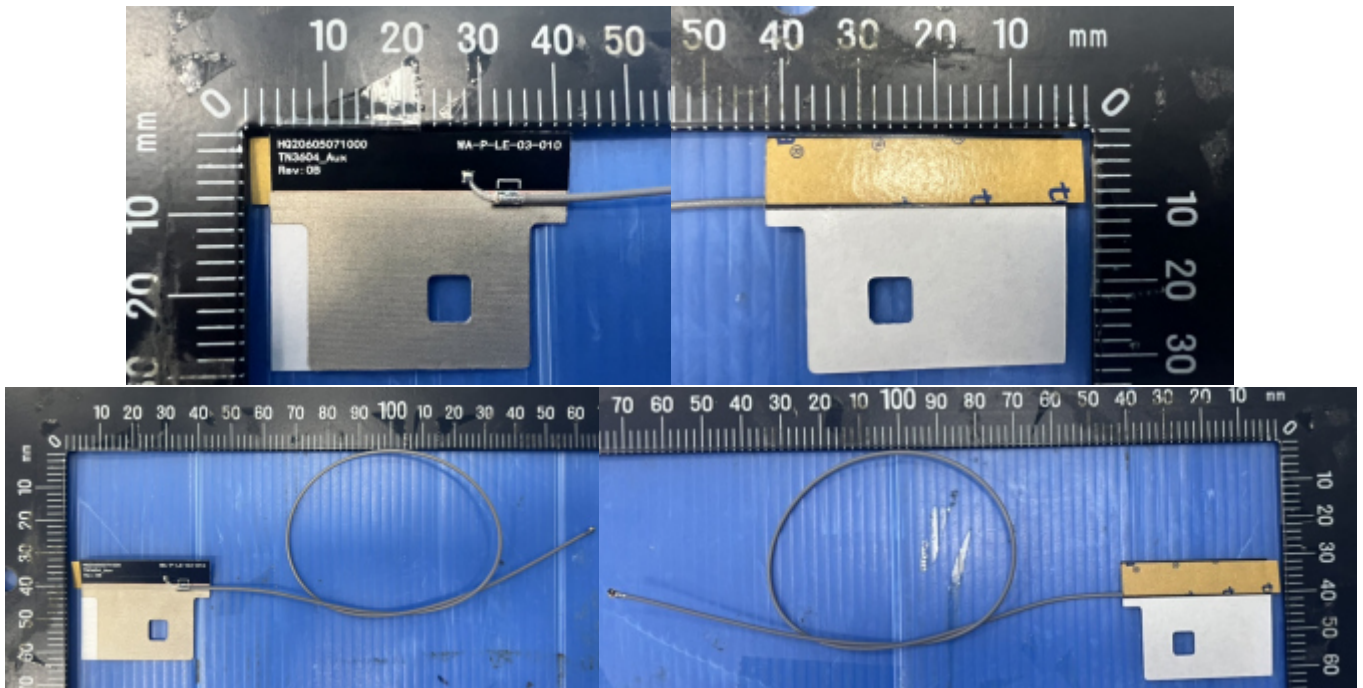

Note: antenna photo should include L type ruler



## Section 3. Radiation characteristics of antenna loaded in Host Platform

### Main Antenna

Max Antenna 3D Radiation Pattern 2400 – 2483.5 MHz

Frequency (MHz)	Peak Gain w/ Cable Loss (dBi)
2400-2483.5	2.33

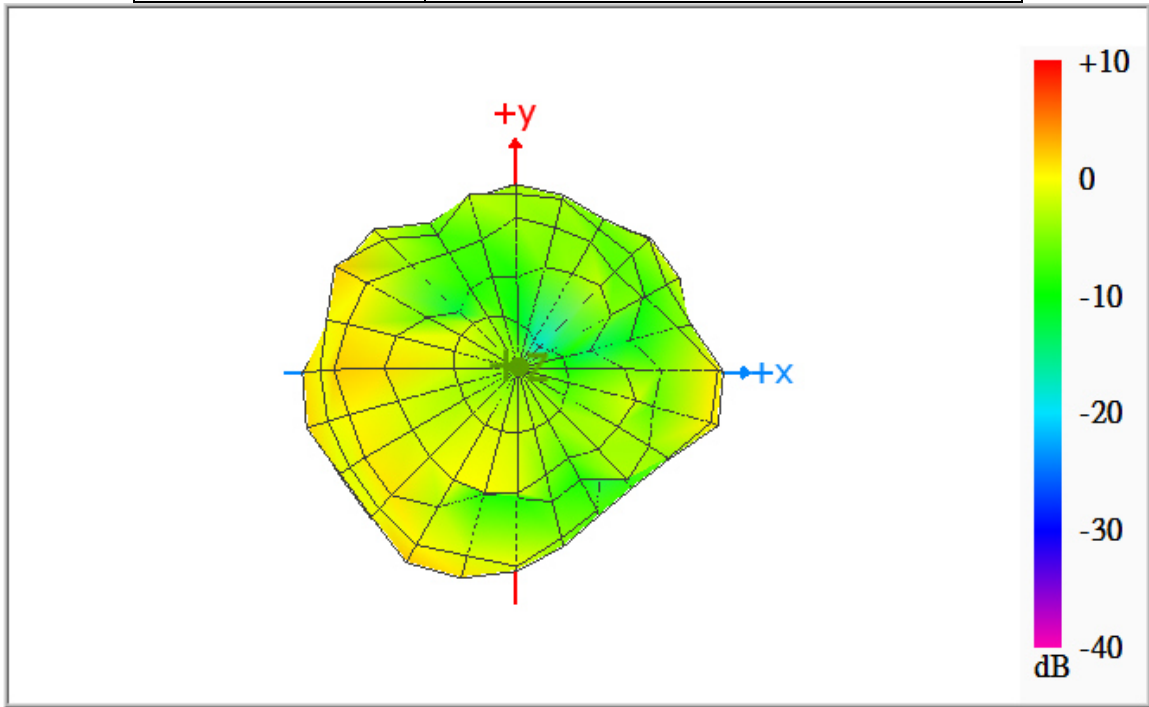

### Max Antenna 3D Radiation Pattern 5150-5250 MHz

Frequency (MHz)	Peak Gain w/ Cable Loss (dBi)
5150-5250	2.96

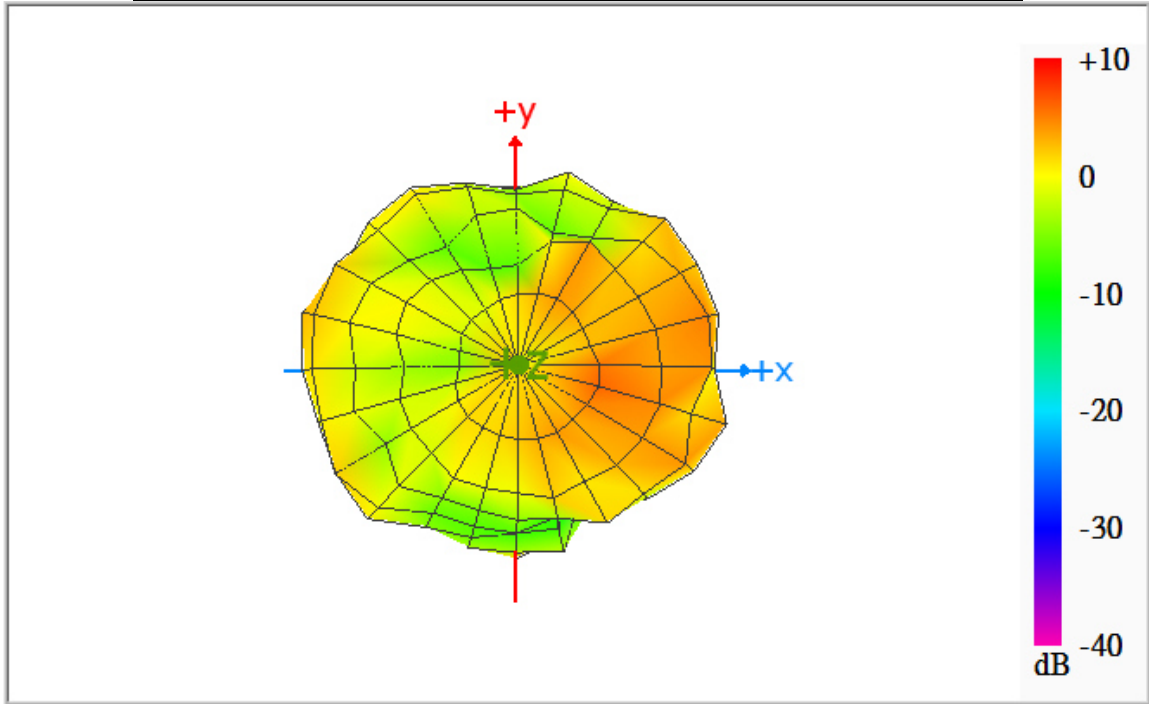

### Max Antenna 3D Radiation Pattern 5250-5350 MHz

Frequency (MHz)	Peak Gain w/ Cable Loss (dBi)
5250-5350	2.36

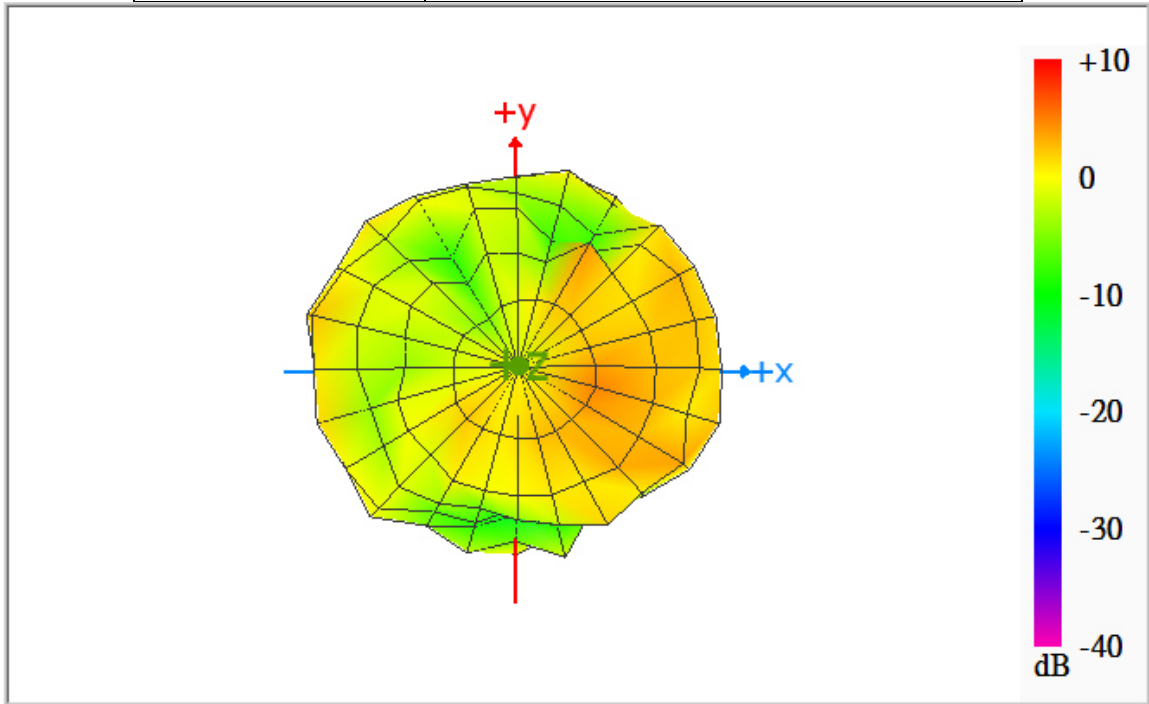

### Max Antenna 3D Radiation Pattern 5470-5725 MHz

Frequency (MHz)	Peak Gain w/ Cable Loss (dBi)
5470-5725	2.52

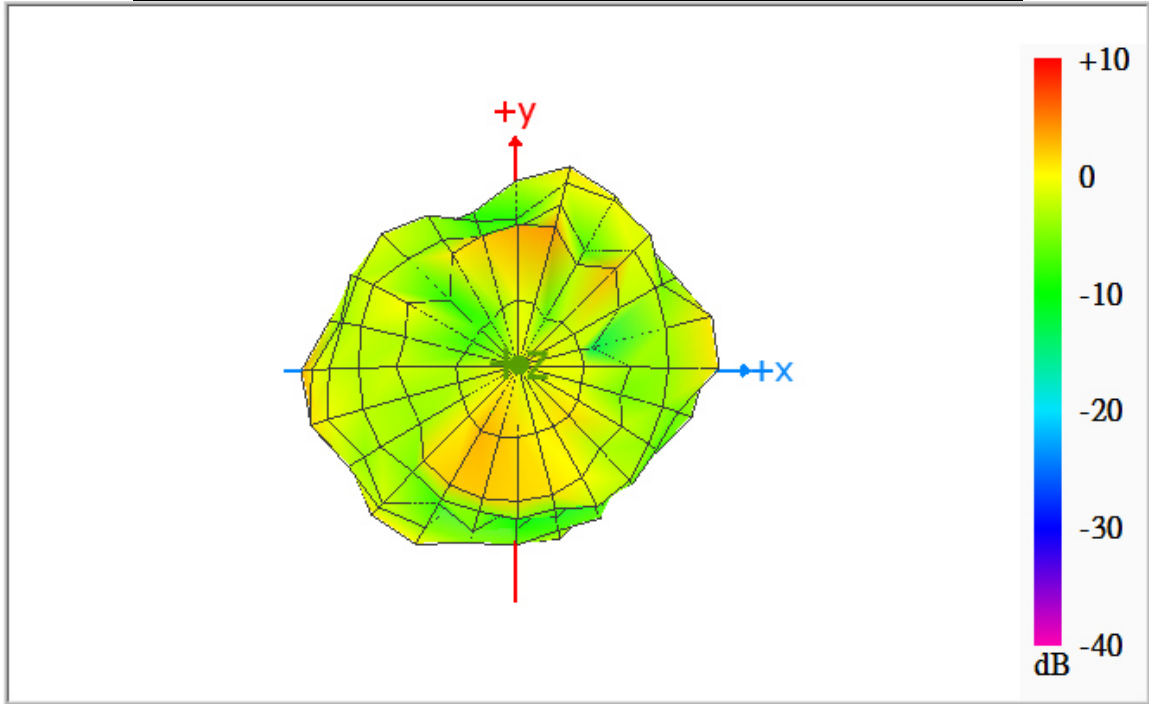

### Max Antenna 3D Radiation Pattern 5725-5850 MHz

Frequency (MHz)	Peak Gain w/ Cable Loss (dBi)
5725-5850	2.48

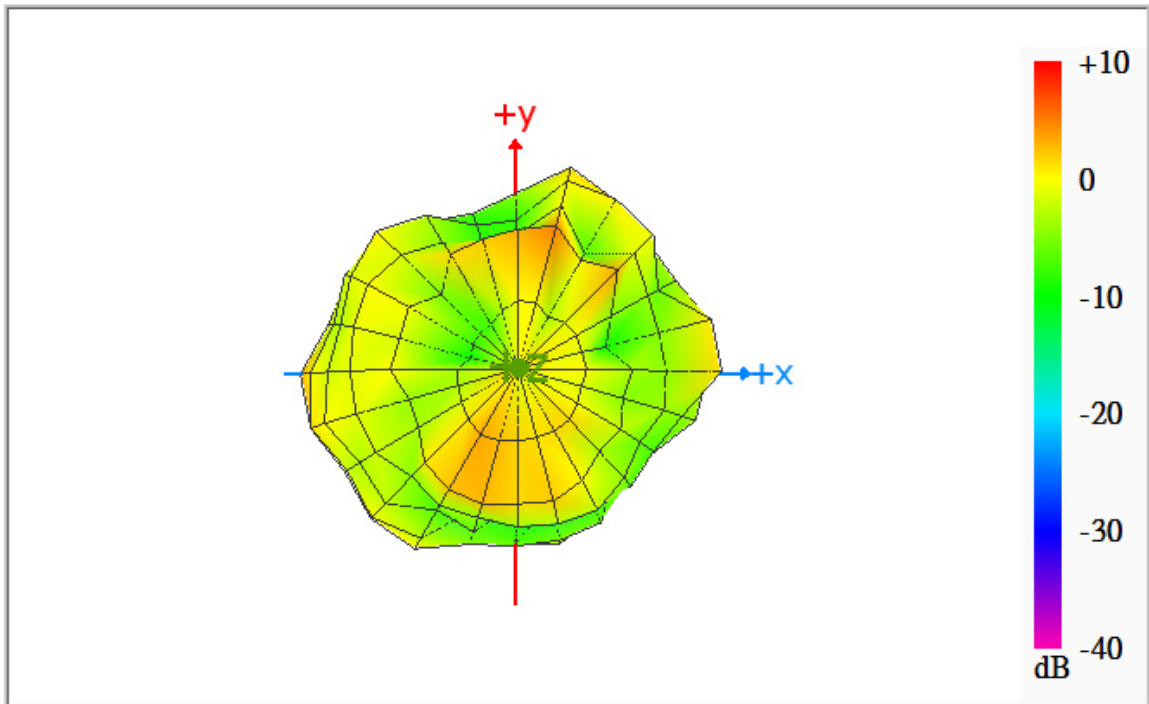

### Max Antenna 3D Radiation Pattern 5850-5895 MHz

Frequency (MHz)	Peak Gain w/ Cable Loss (dBi)
5850-5895	3.79

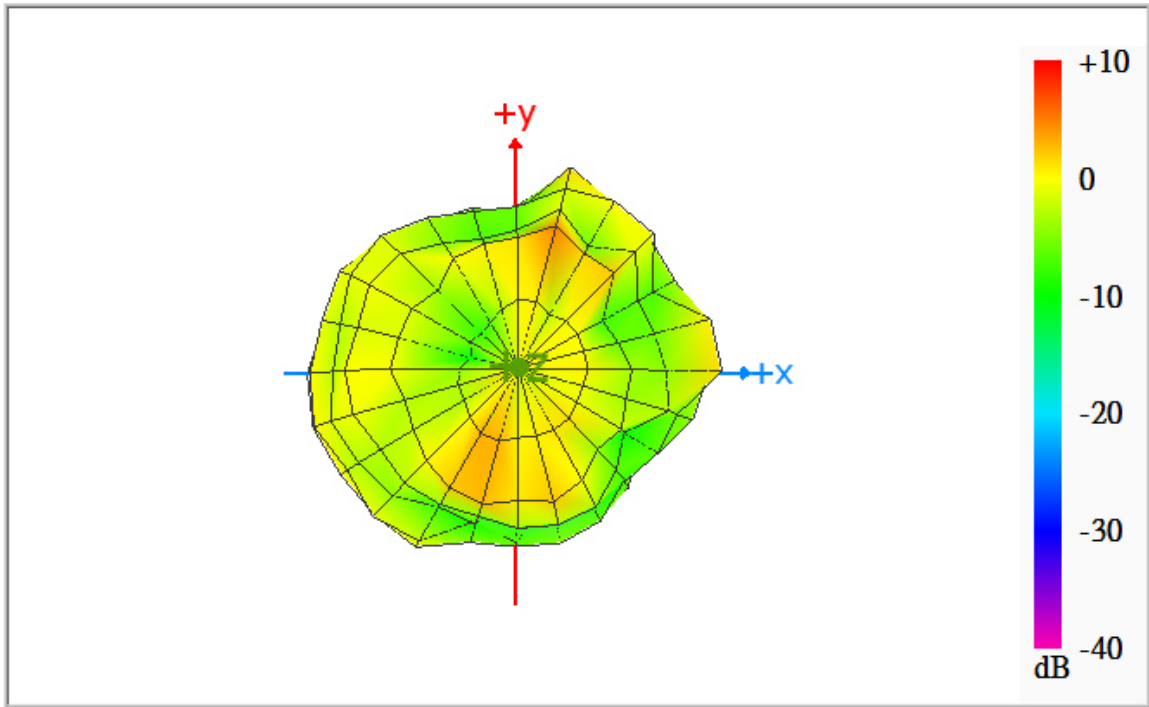

### Max Antenna 3D Radiation Pattern 5925-6425 MHz

Frequency (MHz)	Peak Gain w/ Cable Loss (dBi)
5925-6425	4.23

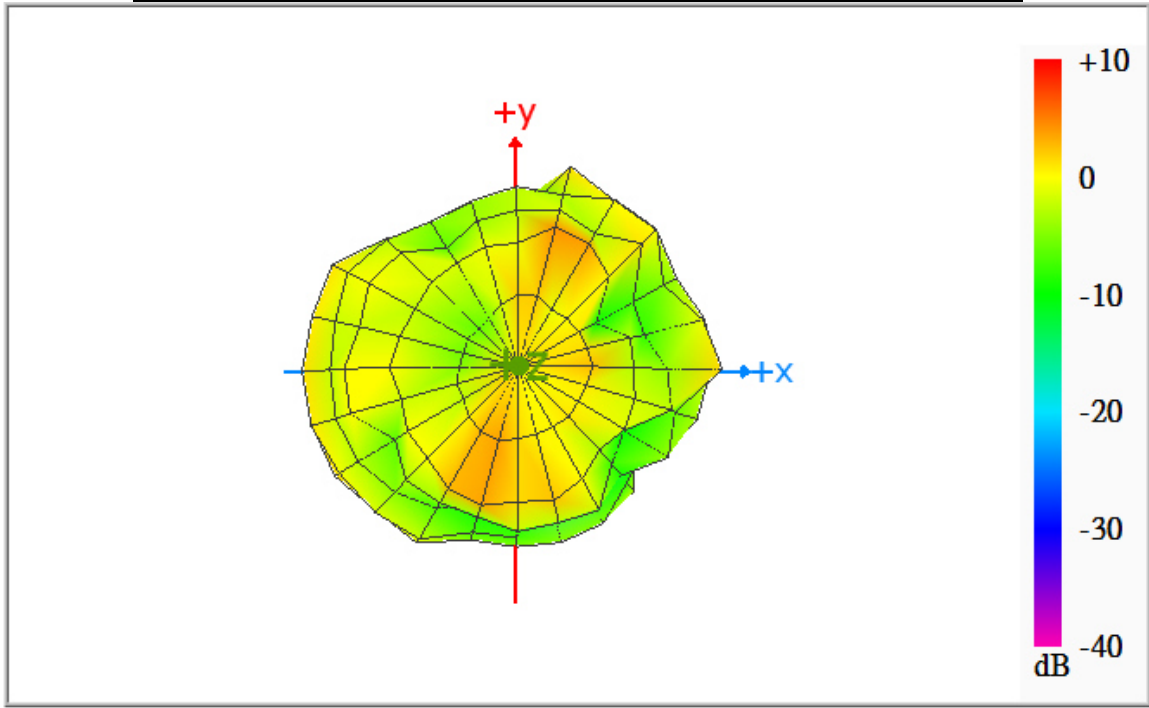

### Max Antenna 3D Radiation Pattern 6425-6525 MHz

Frequency (MHz)	Peak Gain w/ Cable Loss (dBi)
6425-6525	2.82

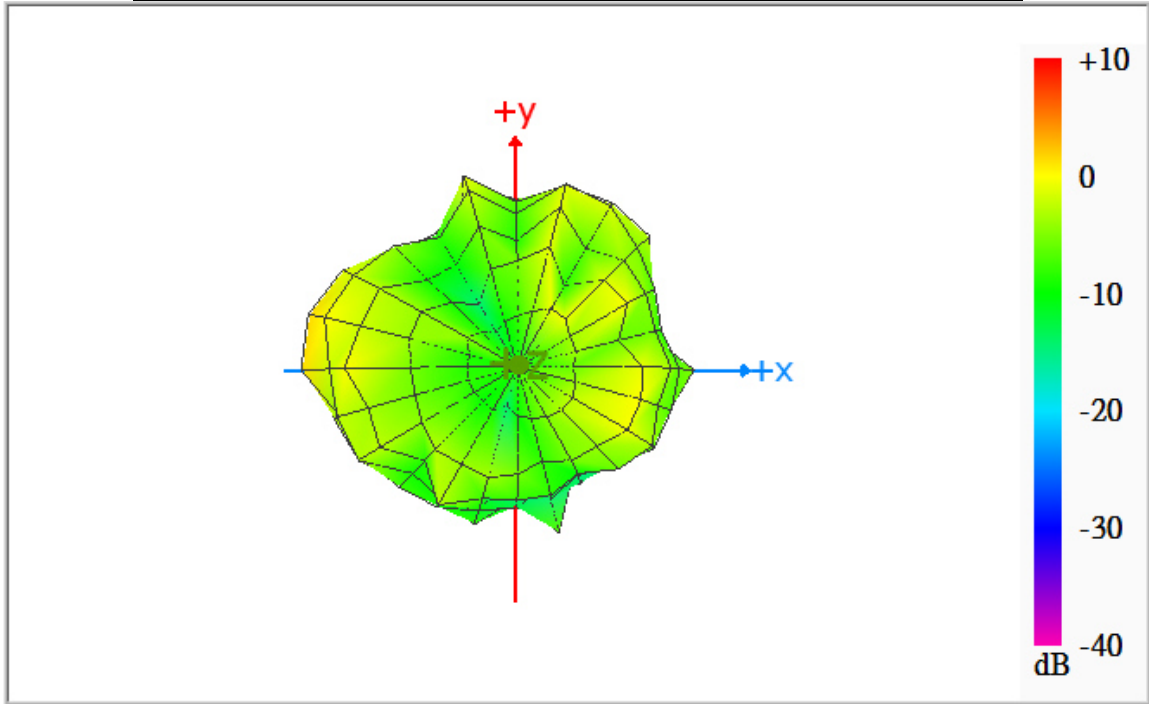

### Max Antenna 3D Radiation Pattern 6525-6875 MHz

Frequency (MHz)	Peak Gain w/ Cable Loss (dBi)
6525-6875	3.63

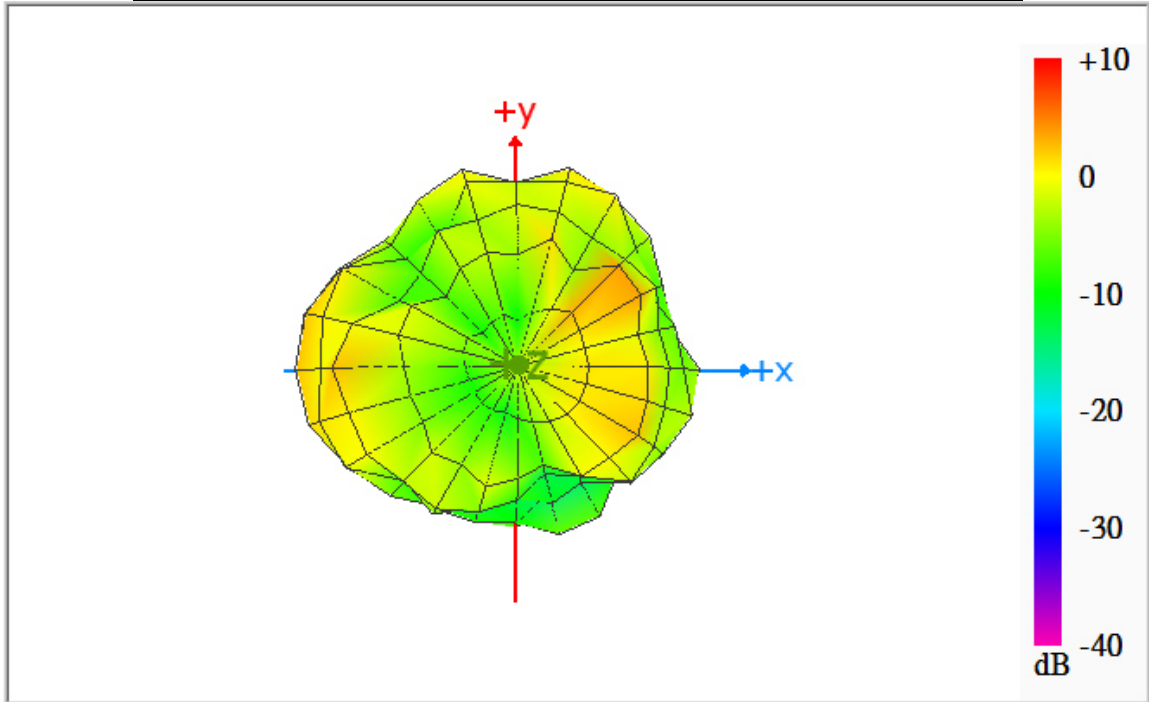

### Max Antenna 3D Radiation Pattern 6875-7125 MHz

Frequency (MHz)	Peak Gain w/ Cable Loss (dBi)
6875-7125	4.61

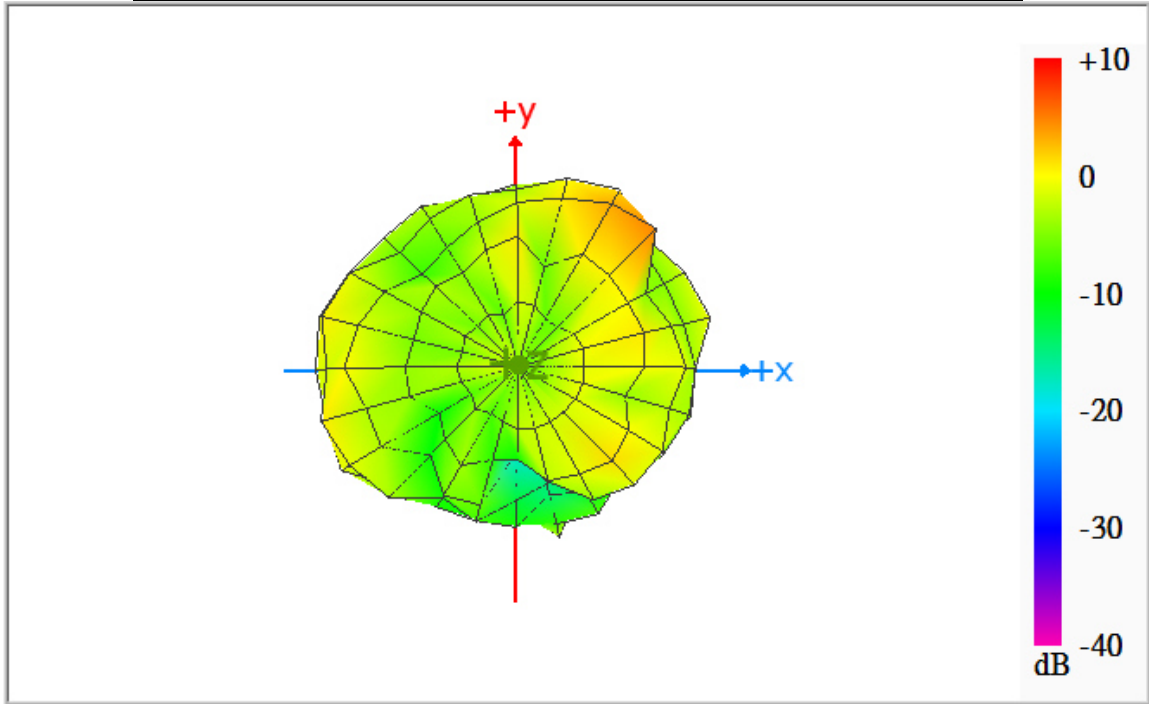

### Auxiliary Antenna

### Max Antenna 3D Radiation Pattern 2400 – 2483.5 MHz

Frequency (MHz)	Peak Gain w/ Cable Loss (dBi)
2400-2483.5	2.06

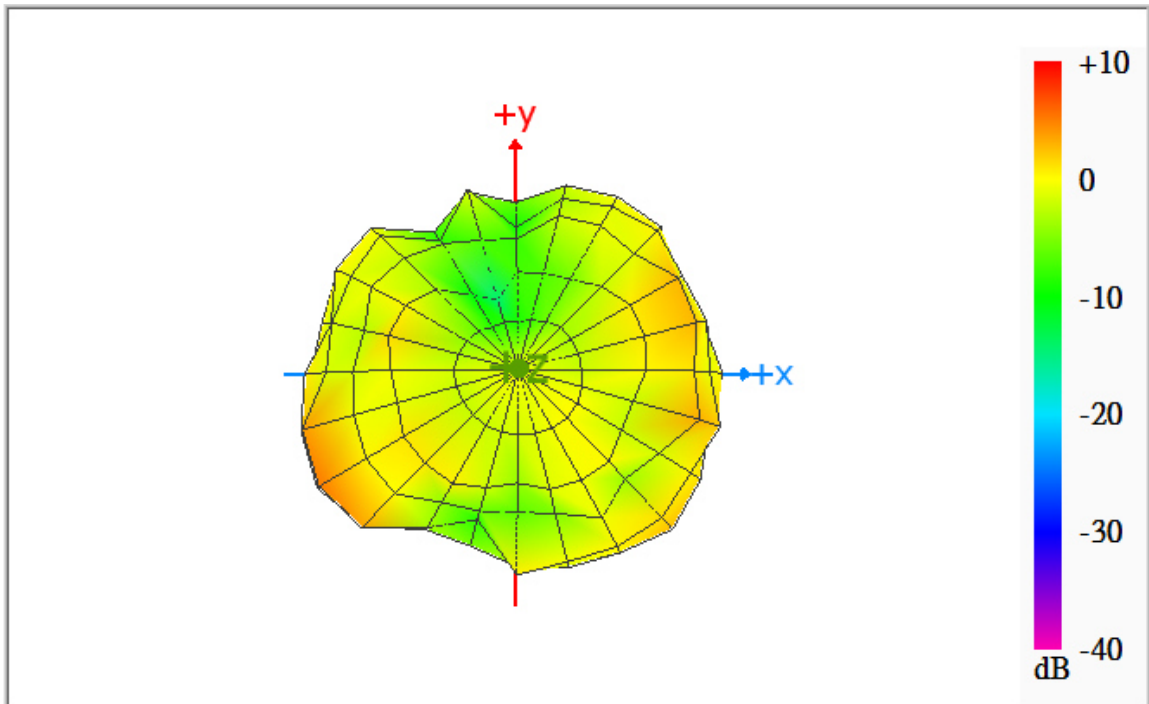

### Max Antenna 3D Radiation Pattern 5150-5250 MHz

Frequency (MHz)	Peak Gain w/ Cable Loss (dBi)
5150-5250	2.16

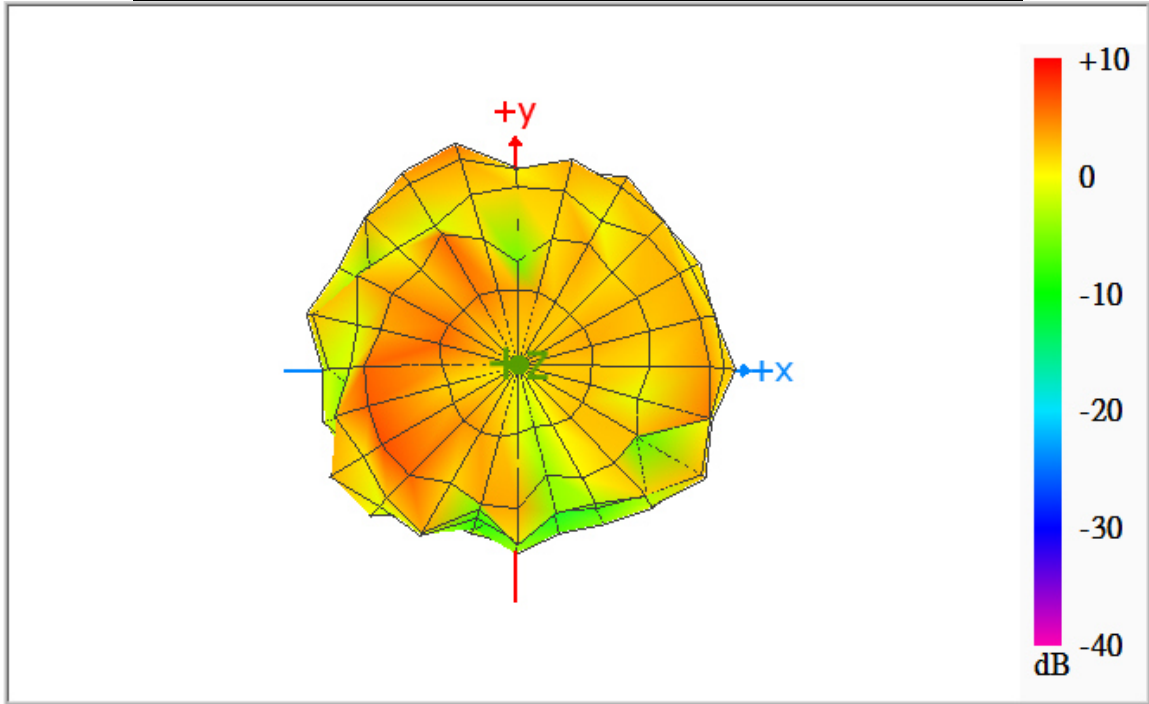

### Max Antenna 3D Radiation Pattern 5250-5350 MHz

Frequency (MHz)	Peak Gain w/ Cable Loss (dBi)
5250-5350	2.98

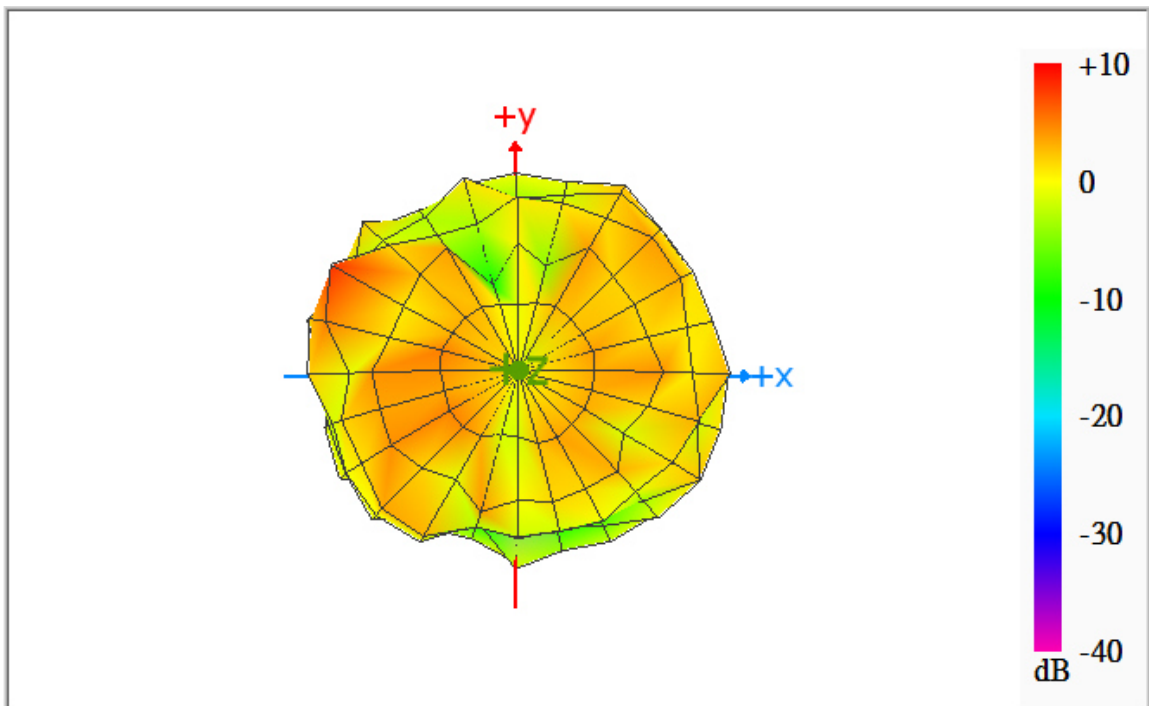



### Max Antenna 3D Radiation Pattern 5470-5725 MHz

Frequency (MHz)	Peak Gain w/ Cable Loss (dBi)
5470-5725	3.71

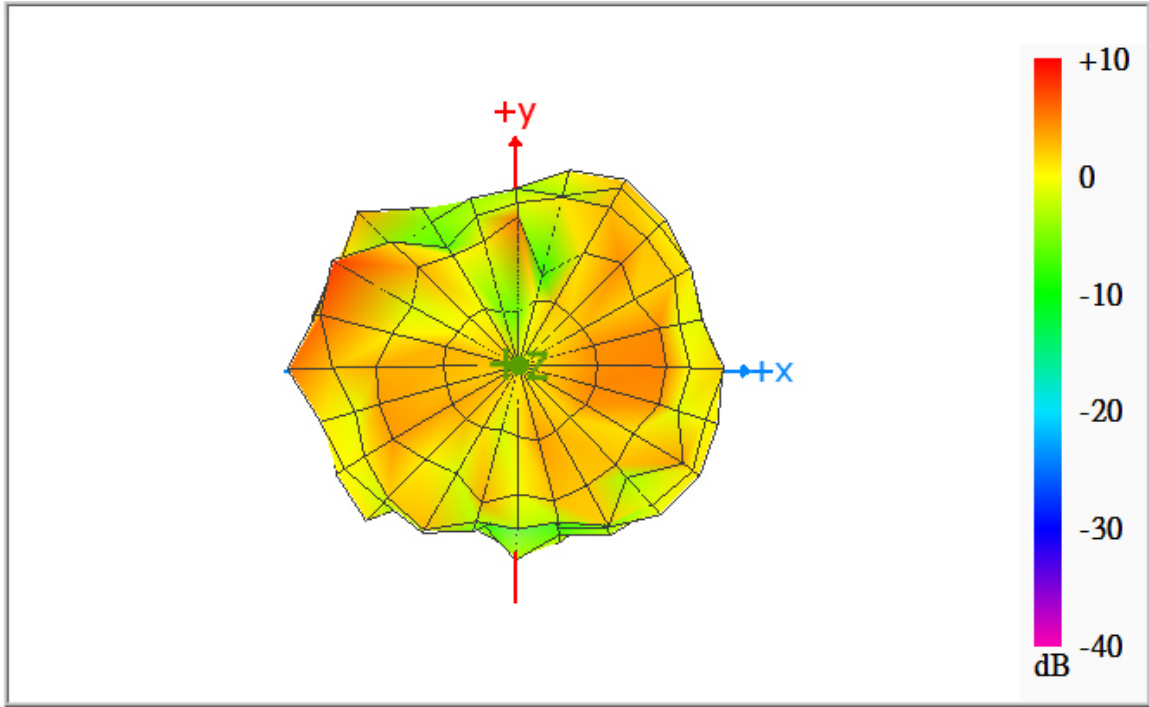

### Max Antenna 3D Radiation Pattern 5725-5850 MHz

Frequency (MHz)	Peak Gain w/ Cable Loss (dBi)
5725-5850	2.62

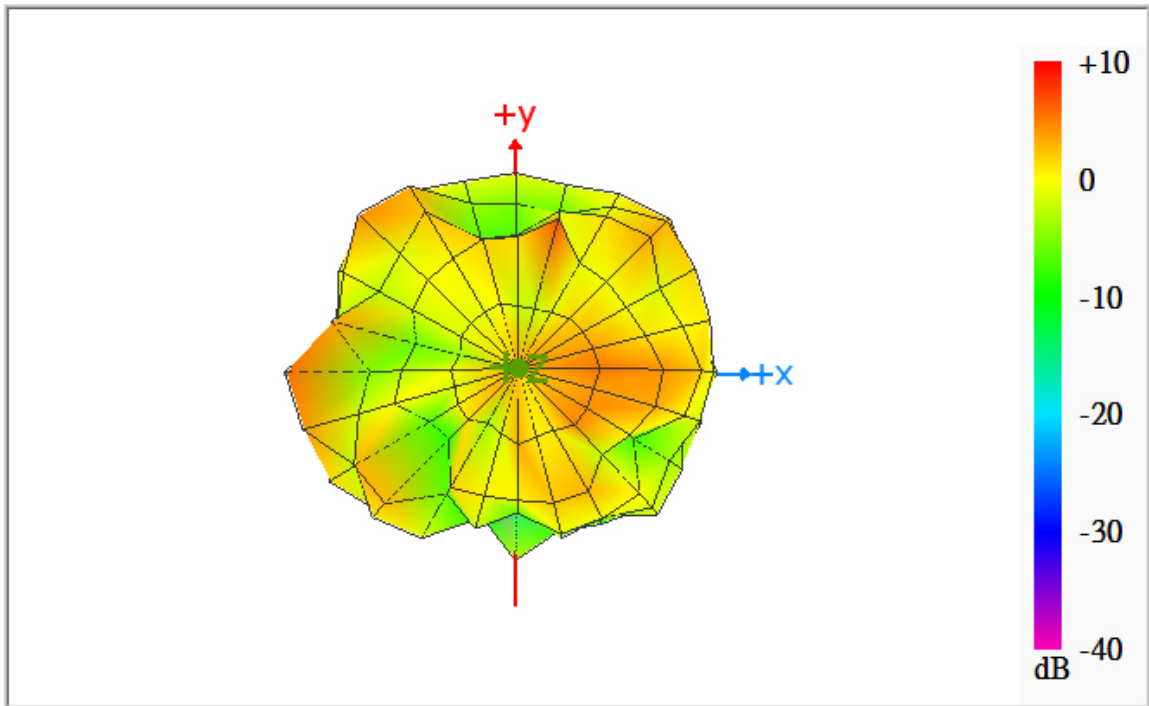

### Max Antenna 3D Radiation Pattern 5850-5895 MHz

Frequency (MHz)	Peak Gain w/ Cable Loss (dBi)
5850-5895	3.25

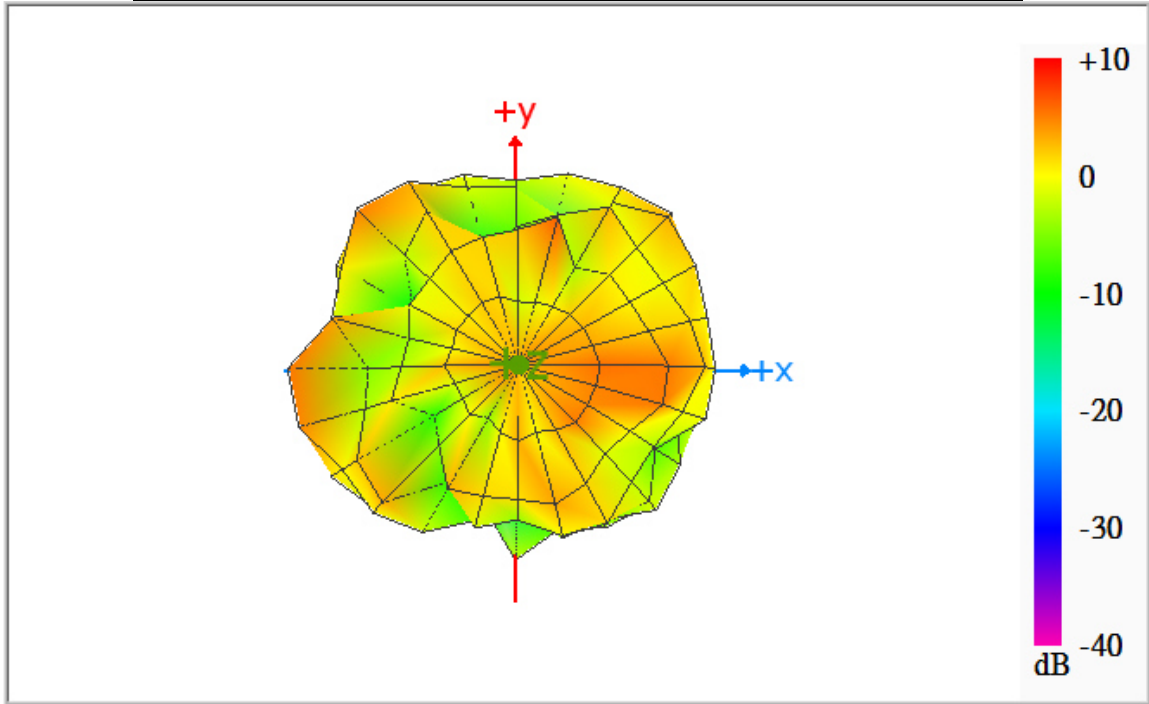

### Max Antenna 3D Radiation Pattern 5925-6425 MHz

Frequency (MHz)	Peak Gain w/ Cable Loss (dBi)
5925-6425	3.09

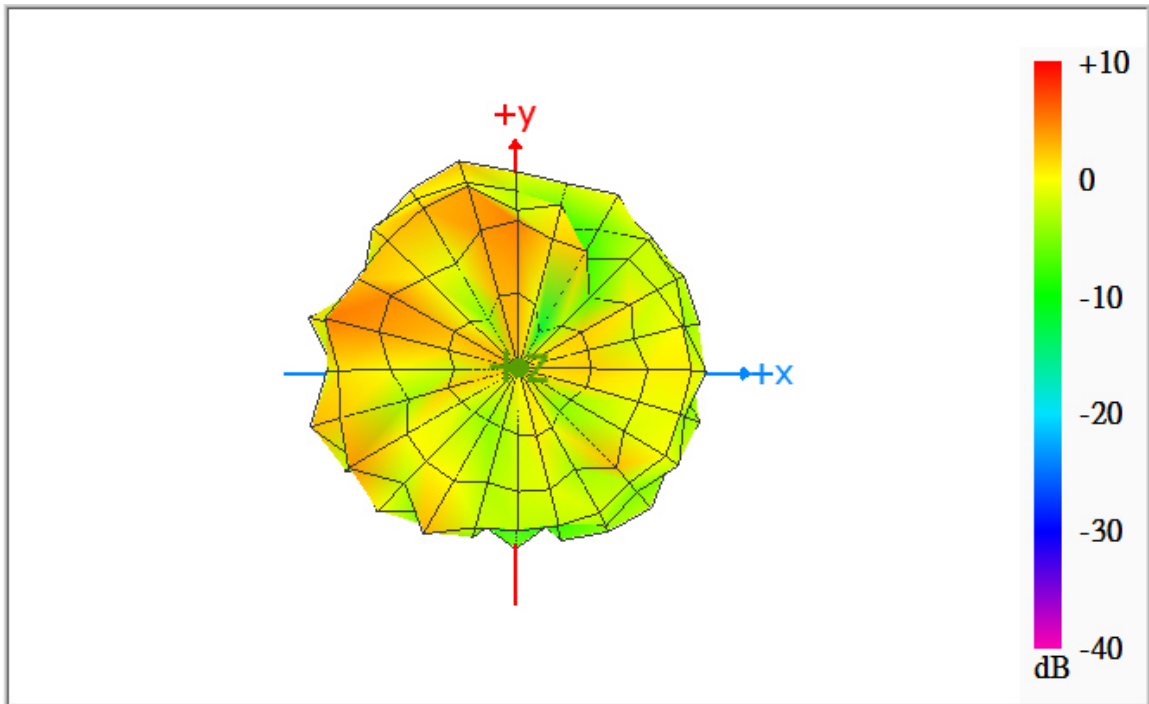

### Max Antenna 3D Radiation Pattern 6425-6525 MHz

Frequency (MHz)	Peak Gain w/ Cable Loss (dBi)
6425-6525	3.09

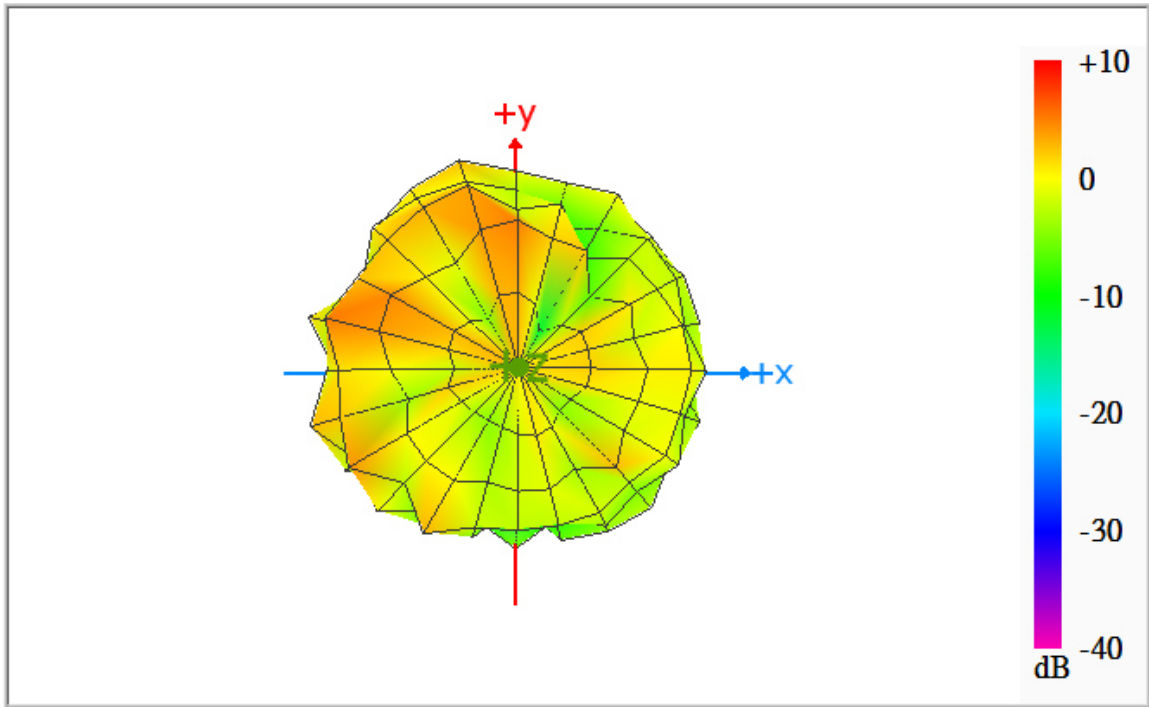

### Max Antenna 3D Radiation Pattern 6525-6875 MHz

Frequency (MHz)	Peak Gain w/ Cable Loss (dBi)
6525-6875	2.61

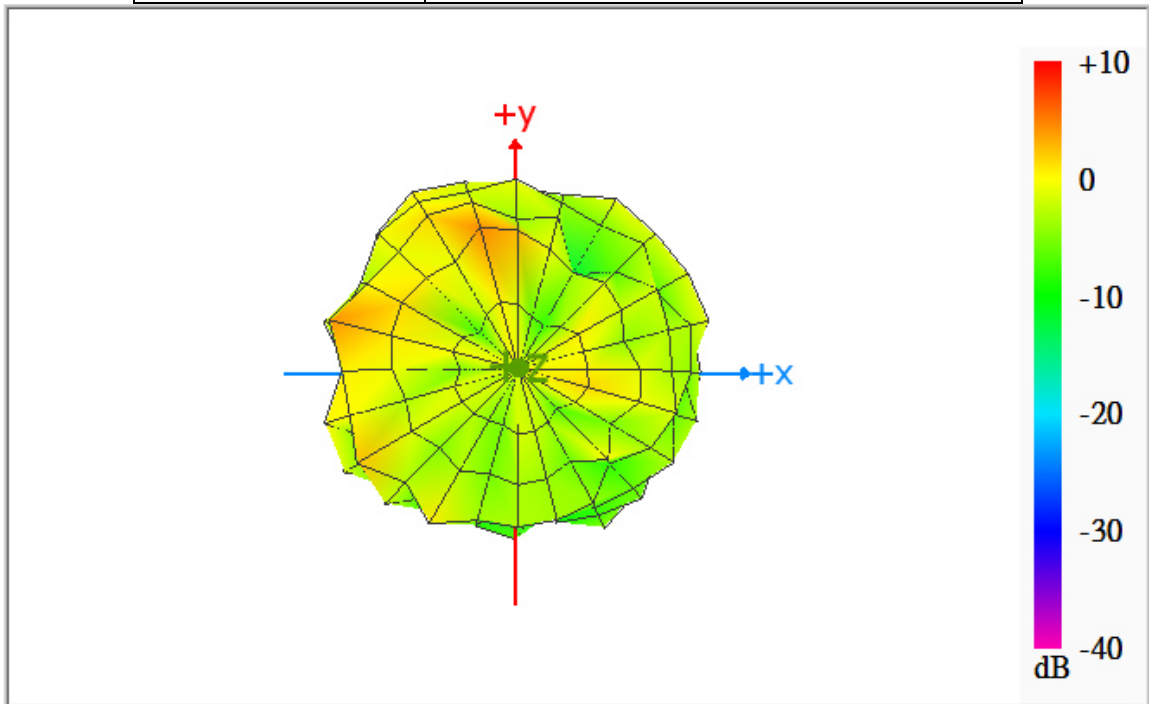

## Max Antenna 3D Radiation Pattern 6875-7125 MHz

Frequency (MHz)	Peak Gain w/ Cable Loss (dBi)
6875-7125	3.07

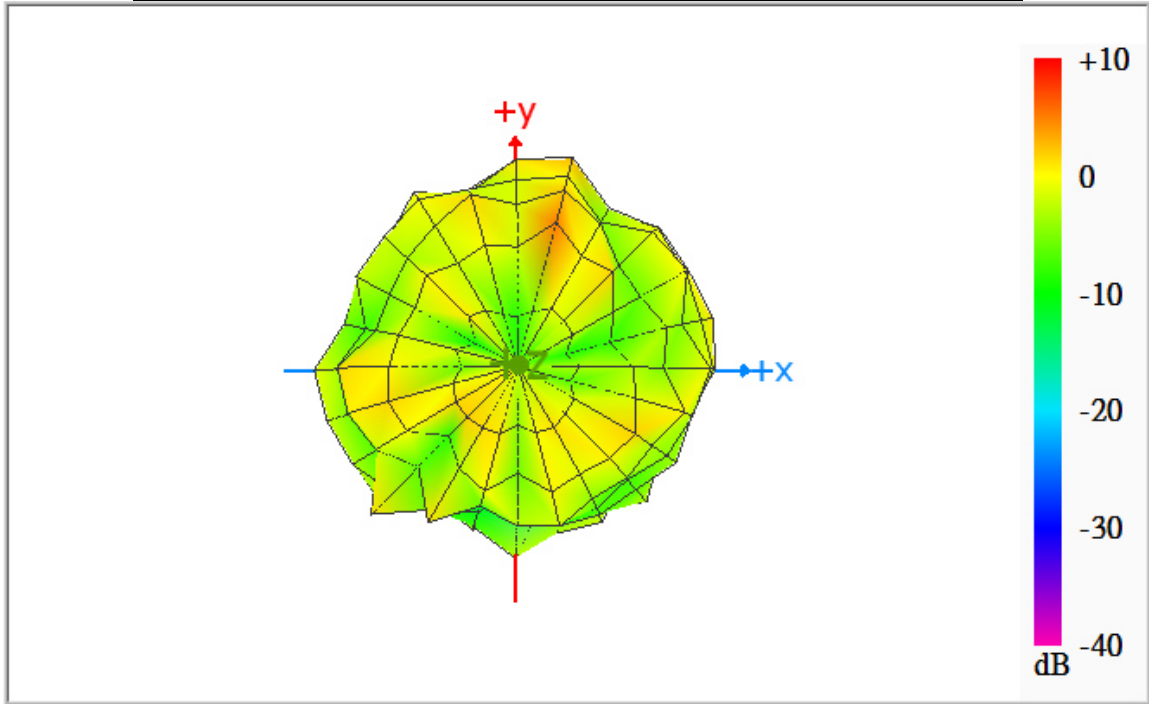

## Section 4. Antenna Host Platform Location Information

Include a **dimensioned photo(s) or dimensioned drawing(s)** of Main and Aux antenna placements (measurements are not required for receive-only antenna).

Any antenna that transmits must show dimensions to bottom of laptop. Provide a description of the materials that are used for supporting or surrounding transmit antennas; for example, non-conductive plastics vs. conductive coated plastic or metallic materials.

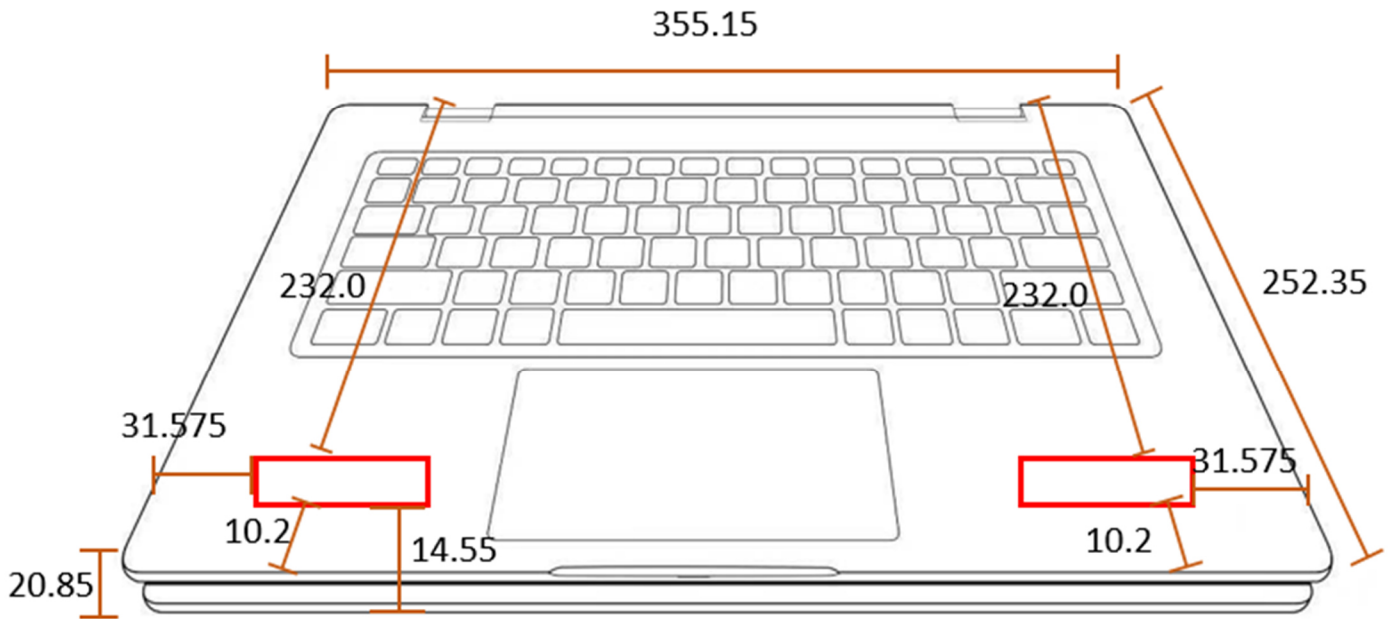

## Section 5. Antenna dimensional information for SAR evaluation

Include a **dimensioned photo(s) or dimensioned drawing(s)** showing the distance (mm) between the transmit antennas and the user. For notebook/laptop hosts show lapheld position (example below). For tablet hosts show all orientations including lapheld, primary & secondary portrait, primary & secondary landscape positions. Include a description of any proximity sensors or power throttling implementations that limit or exclude use of any host orientation.

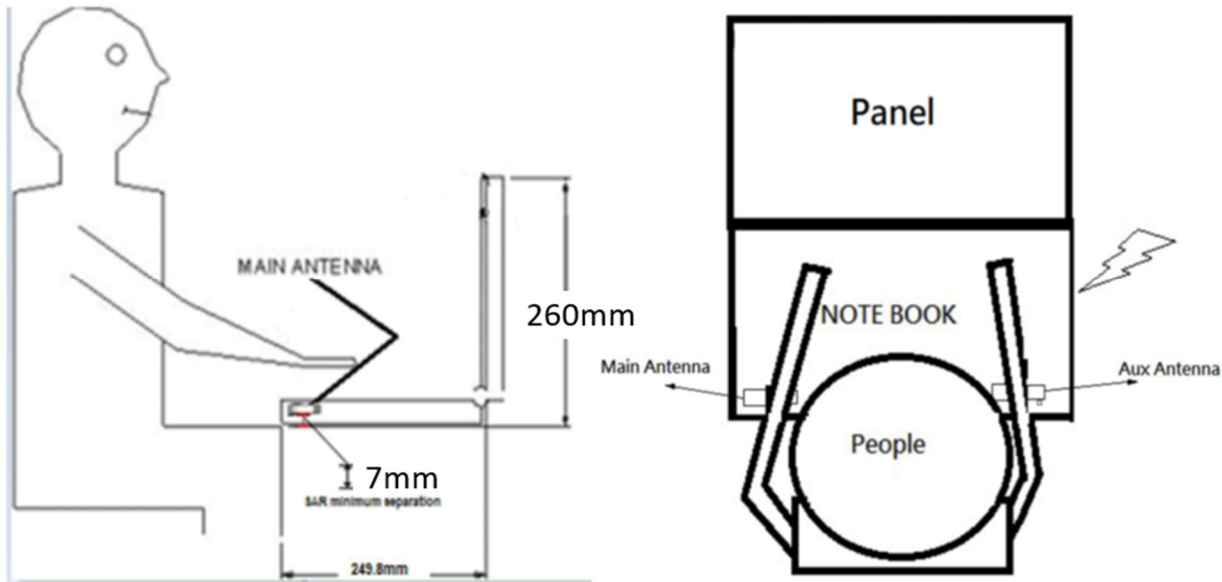

## Section 6. Diagram Example of Co-Location Antenna Separation

Include a **dimensioned photo or dimensioned drawing** showing the distance (mm) between all WLAN transmit antennas and other co-located radiator transmit antenna such as Bluetooth, WWAN,..

(Note: Due to the evolving rules regarding co-location, each platform will need to be reviewed on a case by case basis)

<b>Revision</b>	<b>Description</b>	<b>Date</b>
10.3	<u>Page2-5</u> Add Applicable test method, Test & System Description and Setup photo	July 24, 2022
10.4	<u>Cover page</u> Add Intel 5.9GHz reference antenna gain <u>Cover page/Section1/Section3</u> Add 5.9GHz antenna gain information	September 15, 2022