

# FCC Test Report

**EQUIPMENT** : 3G Broadband Router  
**BRAND NAME** : Alcatel  
**MODEL NAME** : One Touch Y200  
**FCC ID** : RAD902  
**STANDARD** : 47 CFR Part 2, 22(H), 24(E)  
**CLASSIFICATION** : PCS Licensed Transmitter (PCB)  
**Tx/Rx FREQUENCY RANGE** : GSM850 : 824.2 ~ 848.8 MHz /  
869.2 ~ 893.8 MHz  
GSM1900 : 1850.2 ~ 1909.8 MHz /  
1930.2 ~ 1989.8 MHz  
WCDMA Band V : 826.4 ~ 846.6 MHz /  
871.4 ~ 891.6 MHz  
WCDMA Band II : 1852.4 ~ 1907.6 MHz /  
1932.4 ~ 1987.6 MHz  
**MAX. ERP/EIRP POWER** : GSM850(GPRS) : 1.32 W  
GSM850(EDGE) : 0.37 W  
GSM1900(GPRS) : 1.24 W  
GSM1900(EDGE) : 0.60 W  
WCDMA Band V (WCDMA) : 0.27 W  
WCDMA Band II (HSDPA) : 0.30 W  
**EMISSION DESIGNATOR** : GSM : 244KGXW  
EDGE : 240KG7W  
WCDMA : 4M18F9W  
**APPLICANT** : TCT Mobile Limited

4/F South Building, No. 2966, Jinke Road, Zhangjiang  
High-Tech Park, Pudong, Shanghai 201203, P.R.China

The product sample received on Mar. 23, 2009 and completely tested on Mar. 24, 2009. We, SPORTON INTERNATIONAL INC., would like to declare that the tested sample has been evaluated in accordance with the procedures given in ANSI C63.4-2003 and shown compliance with the applicable technical standards.

The test results in this report apply exclusively to the tested model / sample. Without written approval of SPORTON INTERNATIONAL INC., the test report shall not be reproduced except in full.

Reviewed by:

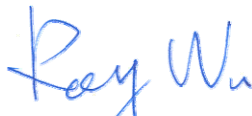

Roy Wu / Manager



**SPORTON INTERNATIONAL (KUNSHAN) INC.**  
**No. 3-2, PingXiang Road, Kunshan, Jiangsu Province, P.R.C.**



# TABLE OF CONTENTS

REVISION HISTORY..... 3

SUMMARY OF TEST RESULT ..... 4

1 GENERAL DESCRIPTION ..... 5

    1.1 Applicant..... 5

    1.2 Manufacturer ..... 5

    1.3 Feature of Equipment Under Test..... 6

    1.4 Testing Site ..... 7

    1.5 Applied Standards ..... 7

    1.6 Ancillary Equipment List..... 8

2 TEST CONFIGURATION OF EQUIPMENT UNDER TEST ..... 9

    2.1 Test Mode..... 9

    2.2 Connection Diagram of Test System ..... 10

3 TEST RESULT..... 11

    3.1 Conducted Output Power Measurement..... 11

    3.2 Effective Radiated Power and Effective Isotropic Radiated Power Measurement ..... 14

    3.3 Occupied Bandwidth and Band Edge Measurement ..... 20

    3.4 Conducted Emission Measurement ..... 33

    3.5 Field Strength of Spurious Radiation Measurement ..... 49

    3.6 Frequency Stability Measurement..... 73

4 LIST OF MEASURING EQUIPMENT ..... 77

5 UNCERTAINTY OF EVALUATION ..... 78

6 CERTIFICATION OF TAF ACCREDITATION ..... 79

APPENDIX A. PHOTOGRAPHS OF EUT

APPENDIX B. SETUP PHOTOGRAPHS



### REVISION HISTORY

REPORT NO.	VERSION	DESCRIPTION	ISSUED DATE
FG932302	Rev. 01	Initial issue of report	Apr. 08, 2009



### SUMMARY OF TEST RESULT

Report Section	FCC Rule	IC Rule	Description	Limit	Result
3.1	§2.1046	N/A	Conducted Output Power	N/A	PASS
3.2	§22.913(a)(2)	RSS-132(4.4) SRSP-503(5.1.3)	Effective Radiated Power	< 7 Watts for FCC (<6.3 Watts for IC)	PASS
3.2	§24.232(c)	RSS-133 (6.4) SRSP-510(5.1.2)	Equivalent Isotropic Radiated Power	< 2 Watts	PASS
3.3	§2.1049 §22.917(a) §24.238(a)	N/A	Occupied Bandwidth	N/A	PASS
3.4	§2.1051 §22.917(a) §24.238(a)	RSS-132 (4.5.1) RSS-133 (6.5.1)	Band Edge Measurement	< 43+10log <sub>10</sub> (P[Watts])	PASS
3.5	§2.1051 §22.917(a) §24.238(a)	RSS-132 (4.5.1) RSS-133 (6.5.1)	Conducted Emission	< 43+10log <sub>10</sub> (P[Watts])	PASS
3.6	§2.1053 §22.917(a) §24.238(a)	RSS-132 (4.5.1) RSS-133 (6.5.1)	Field Strength of Spurious Radiation	< 43+10log <sub>10</sub> (P[Watts])	PASS
3.7	§2.1055 §22.355 §24.235	RSS-132(4.3) RSS-133(6.3)	Frequency Stability for Temperature & Voltage	< 2.5 ppm	PASS



# **1 General Description**

## **1.1 Applicant**

**TCT Mobile Limited**

4/F South Building, No. 2966, Jinke Road, Zhangjiang High-Tech Park, Pudong, Shanghai 201203,  
P.R.China

## **1.2 Manufacturer**

**TCL Mobile Communication Co., Ltd.**

No. 23 Zone, Zhongkai High-Technology Development Zone, Huizhou, Guangdong 516006, China

### 1.3 Feature of Equipment Under Test

Product Feature & Specification	
<b>Equipment</b>	3G Broadband Router
<b>Brand Name</b>	Alcatel
<b>Model Name</b>	One Touch Y200
<b>FCC ID</b>	RAD902
<b>Tx Frequency</b>	GSM850 : 824 MHz ~ 849 MHz GSM1900 : 1850 MHz ~ 1910 MHz WCDMA Band V : 824 MHz ~ 849 MHz WCDMA Band II : 1850 MHz ~ 1910 MHz WLAN : 2400 MHz ~ 2483.5 MHz
<b>Rx Frequency</b>	GSM850 : 869 MHz ~ 894 MHz GSM1900 : 1930 MHz ~ 1990 MHz WCDMA Band V : 869 MHz ~ 894 MHz WCDMA Band II : 1930 MHz ~ 1990 MHz WLAN : 2400 MHz ~ 2483.5 MHz
<b>Maximum Output Power to Antenna</b>	GSM850: 32.26 dBm (GPRS 8), 26.74 dBm (EDGE 8) GSM1900: 29.18 dBm (GPRS 8), 25.65 dBm (EDGE 8) WCDMA Band V: 23.31 dBm (WCDMA) WCDMA Band II: 22.80 dBm (HSDPA)
<b>Maximum ERP/EIRP</b>	GSM850(GPRS) : 1.32 W ( 31.19 dBm ) GSM850(EDGE) : 0.37 W ( 25.69 dBm ) GSM1900(GPRS) : 1.24 W ( 30.95 dBm ) GSM1900(EDGE) : 0.60 W ( 27.76 dBm ) WCDMA Band V (WCDMA) : 0.27 W ( 24.38 dBm ) WCDMA Band II (HSDPA) : 0.30 W ( 24.70 dBm )
<b>Antenna Type</b>	Fixed Internal Antenna
<b>HW Version</b>	LRAMH92A6-1
<b>SW Version</b>	LQA0009.1.2_MH92A
<b>Type of Modulation</b>	GSM / GPRS : GMSK EDGE : 8PSK WCDMA : QPSK HSDPA : QPSK / 16QAM HSUPA : BPSK
<b>Type of Emission</b>	GSM : 244KGXW EDGE : 240KG7W WCDMA : 4M18F9W
<b>EUT Stage</b>	Identical Prototype

List of Accessory:

Specification of Accessory		
AC Adapter	Brand Name	AQUIL STAR
	Model Name	ASSA2-052300
	Power Rating	I/P:100-240Vac, 50-60Hz, 0.68A; O/P: 5.2Vdc, 3000mA
	AC Power Cord Type	1.93 meter non-shielded cable with ferrite core

Remark:

1. The above EUT's information was declared by manufacturer. Please refer to the specifications or user's manual for more detailed description.
2. For accessories equipped with this EUT, please refer to the appendix of the external photo.

### 1.4 Testing Site

Test Site	SPORTON INTERNATIONAL (KUNSHAN) INC.	
Test Site Location	No. 3-2, PingXiang Road, Kunshan, Jiangsu Province, P.R.C. TEL: +86-0512-5790-0158 FAX: +86-0512-5790-0958	
Test Site No.	<b>Sporton Site No.</b>	
	TH01-KS	03CH01-KS

### 1.5 Applied Standards

According to the specifications of the manufacturer, the EUT must comply with the requirements of the following standards:

- Preliminary Guidance for Receiving Applications for Certification of 3G Device. May 9, 2006.
- 47 CFR Part 2, 22(H), 24(E)
- ANSI C63.4-2003
- ANSI / TIA / EIA-603-C-2004
- IC RSS-132 Issue 2
- IC RSS-133 Issue 5

Remark:

1. All test items were verified and recorded according to the standards and without any deviation during the test.
2. This EUT has also been tested and complied with the requirements of FCC Part 15, Subpart B (DoC), recorded in a separate test report.



## 1.6 Ancillary Equipment List

Item	Equipment	Trade Name	Model No.	FCC ID	Data Cable	Power Cord
1.	System Simulator	R&S	CMU200	N/A	N/A	Unshielded, 1.8 m



## 2 Test Configuration of Equipment Under Test

### 2.1 Test Mode

During all testing, EUT is in link mode with base station emulator at maximum power level. The spurious emission measurements were carried out in semi-anechoic chamber with 3-meter test range, and EUT is rotated on three test planes to find out the worst emission.

Frequency range investigated for radiated emission is as follows:

1. 30 MHz to 9000 MHz for GSM850 and WCDMA Band V.
2. 30MHz to 19000 MHz for GSM1900 and WCDMA Band II.

Test Modes		
Band	Radiated TCs	Conducted TCs
<b>GSM 850</b>	<ul style="list-style-type: none"> <li>■ GPRS Link</li> <li>■ EDGE Link</li> <li>■ GPRS Link + WLAN Link</li> </ul>	<ul style="list-style-type: none"> <li>■ GSM Link</li> <li>■ GPRS Link</li> <li>■ EDGE Link</li> </ul>
<b>GSM 1900</b>	<ul style="list-style-type: none"> <li>■ GPRS Link</li> <li>■ EDGE Link</li> </ul>	<ul style="list-style-type: none"> <li>■ GSM Link</li> <li>■ GPRS Link</li> <li>■ EDGE Link</li> </ul>
<b>WCDMA Band V</b>	<ul style="list-style-type: none"> <li>■ WCDMA Link</li> <li>■ HSDPA Link</li> <li>■ HSUPA Link</li> </ul>	<ul style="list-style-type: none"> <li>■ WCDMA Link</li> <li>■ HSDPA Link</li> <li>■ HSUPA Link</li> </ul>
<b>WCDMA Band II</b>	<ul style="list-style-type: none"> <li>■ WCDMA Link</li> <li>■ HSDPA Link</li> <li>■ HSUPA Link</li> </ul>	<ul style="list-style-type: none"> <li>■ WCDMA Link</li> <li>■ HSDPA Link</li> <li>■ HSUPA Link</li> </ul>

**Note:** The maximum power levels are GPRS/EDGE multi-slot class 8 modes for GSM, RMC 12.2K mode for WCDMA band V, and HSDPA mode for WCDMA band II, only these modes used for all testing. The power levels lists are as follow:

Mode	GSM 850			GSM 1900		
	128	189	251	512	661	810
<b>GSM</b>	32.14	32.21	32.22	28.89	29.05	28.64
<b>GPRS 8</b>	32.17	<b>32.26</b>	32.23	28.94	<b>29.18</b>	28.98
<b>GPRS 10</b>	29.55	29.66	29.62	26.33	26.57	26.37
<b>GPRS 12</b>	26.53	26.62	26.60	23.32	23.51	23.35
<b>EGPRS 8</b>	26.60	26.73	<b>26.74</b>	25.47	<b>25.65</b>	25.48
<b>EGPRS 10</b>	23.65	23.84	23.70	22.40	22.61	22.40
<b>EGPRS 12</b>	21.61	21.74	21.72	21.41	21.56	21.39

Mode		WCDMA Band V			WCDMA Band II		
		4132	4182	4233	9262	9400	9538
RMC 12.2K		22.34	22.08	<b>23.31</b>	21.93	22.03	22.36
HSDPA	Subtest-1	22.39	22.03	23.18	22.02	21.94	22.36
	Subtest-2	22.07	21.88	22.91	21.75	21.97	<b>22.80</b>
	Subtest-3	21.62	21.49	22.42	21.51	21.31	21.94
	Subtest-4	21.66	21.32	22.44	21.25	21.37	22.37
HSUPA	Subtest-1	22.03	21.21	22.14	21.81	21.68	20.98
	Subtest-2	19.59	19.43	20.47	20.09	19.67	20.47
	Subtest-3	20.64	20.39	21.52	21.04	19.98	20.67
	Subtest-4	20.11	19.90	20.97	19.61	19.75	20.85
	Subtest-5	21.96	21.88	22.35	21.56	21.85	22.32

## 2.2 Connection Diagram of Test System

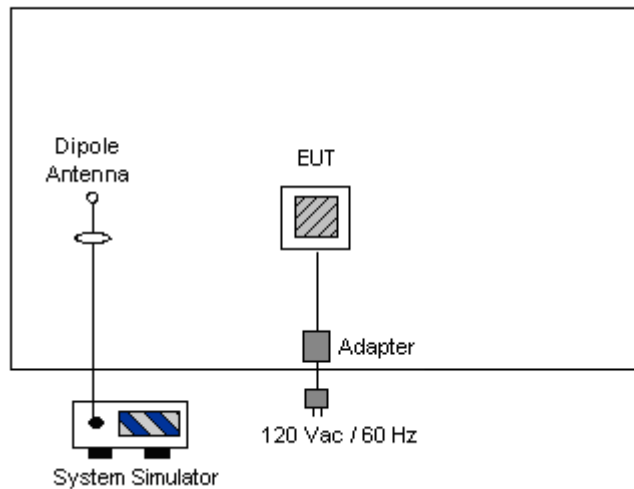

### 3 Test Result

#### 3.1 Conducted Output Power Measurement

##### 3.1.1 Description of the Conducted Output Power Measurement

A base station simulator was used to establish communication with the EUT. Its parameters were set to transmit the maximum power on the EUT. The measured power in the radio frequency on the transmitter output terminals shall be reported.

##### 3.1.2 Measuring Instruments

See list of measuring instruments of this test report.

##### 3.1.3 Test Procedures

1. The transmitter output port was connected to base station.
2. Set EUT at maximum power through base station.
3. Select lowest, middle, and highest channels for each band and different modulation.

##### 3.1.4 Test Setup

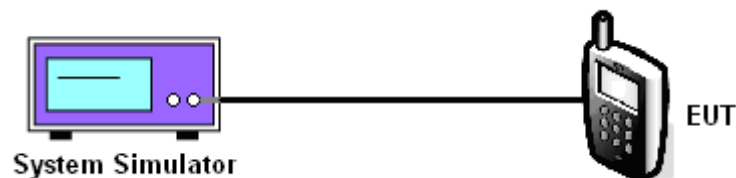



3.1.5 Test Result of Conducted Output Power

Cellular Band					
Modes	Channel	Frequency (MHz)	Conducted Power		
			(dBm)	(Watts)	
GPRS 8	128 (Low)	824.2	32.17	1.65	
	189 (Mid)	836.4	32.26	1.68	
	251 (High)	848.8	32.23	1.67	
EDGE 8	128 (Low)	824.2	26.60	0.46	
	189 (Mid)	836.4	26.73	0.47	
	251 (High)	848.8	26.74	0.47	
WCDMA Band V	12.2k bps	4132 (Low)	826.4	22.34	0.17
		4182 (Mid)	836.4	22.08	0.16
		4233 (High)	846.6	23.31	0.21
	HSDPA Subtest-1	4132 (Low)	826.4	22.39	0.17
		4182 (Mid)	836.4	22.03	0.16
		4233 (High)	846.6	23.18	0.21
	HSDPA Subtest-2	4132 (Low)	826.4	22.07	0.16
		4182 (Mid)	836.4	21.88	0.15
		4233 (High)	846.6	22.91	0.20
	HSDPA Subtest-3	4132 (Low)	826.4	21.62	0.15
		4182 (Mid)	836.4	21.49	0.14
		4233 (High)	846.6	22.42	0.17
	HSDPA Subtest-4	4132 (Low)	826.4	21.66	0.15
		4182 (Mid)	836.4	21.32	0.14
		4233 (High)	846.6	22.44	0.18
	HSUPA Subtest-1	4132 (Low)	826.4	22.03	0.16
		4182 (Mid)	836.4	21.21	0.13
		4233 (High)	846.6	22.14	0.16
	HSUPA Subtest-2	4132 (Low)	826.4	19.59	0.09
		4182 (Mid)	836.4	19.43	0.09
		4233 (High)	846.6	20.47	0.11
	HSUPA Subtest-3	4132 (Low)	826.4	20.64	0.12
		4182 (Mid)	836.4	20.39	0.11
		4233 (High)	846.6	21.52	0.14
	HSUPA Subtest-4	4132 (Low)	826.4	20.11	0.10
		4182 (Mid)	836.4	19.90	0.10
		4233 (High)	846.6	20.97	0.13
	HSUPA Subtest-5	4132 (Low)	826.4	21.96	0.16
		4182 (Mid)	836.4	21.88	0.15
		4233 (High)	846.6	22.35	0.17



PCS Band					
Modes	Channel	Frequency (MHz)	Conducted Power		
			(dBm)	(Watts)	
GPRS 8	512 (Low)	1850.2	28.94	0.78	
	661 (Mid)	1880.0	29.18	0.83	
	810 (High)	1909.8	28.98	0.79	
EDGE 8	512 (Low)	1850.2	25.47	0.35	
	661 (Mid)	1880.0	25.65	0.37	
	810 (High)	1909.8	25.48	0.35	
WCDMA Band II	12.2k bps	9262 (Low)	1852.4	21.93	0.16
		9400 (Mid)	1880.0	22.03	0.16
		9538 (High)	1907.6	22.36	0.17
	HSDPA Subtest-1	9262 (Low)	1852.4	22.02	0.16
		9400 (Mid)	1880.0	21.94	0.16
		9538 (High)	1907.6	22.36	0.17
	HSDPA Subtest-2	9262 (Low)	1852.4	21.75	0.15
		9400 (Mid)	1880.0	21.97	0.16
		9538 (High)	1907.6	22.80	0.19
	HSDPA Subtest-3	9262 (Low)	1852.4	21.51	0.14
		9400 (Mid)	1880.0	21.31	0.14
		9538 (High)	1907.6	21.94	0.16
	HSDPA Subtest-4	9262 (Low)	1852.4	21.25	0.13
		9400 (Mid)	1880.0	21.37	0.14
		9538 (High)	1907.6	22.37	0.17
	HSUPA Subtest-1	9262 (Low)	1852.4	21.81	0.15
		9400 (Mid)	1880.0	21.68	0.15
		9538 (High)	1907.6	20.98	0.13
	HSUPA Subtest-2	9262 (Low)	1852.4	20.09	0.10
		9400 (Mid)	1880.0	19.67	0.09
		9538 (High)	1907.6	20.47	0.11
	HSUPA Subtest-3	9262 (Low)	1852.4	21.04	0.13
		9400 (Mid)	1880.0	19.98	0.10
		9538 (High)	1907.6	20.67	0.12
	HSUPA Subtest-4	9262 (Low)	1852.4	19.61	0.09
		9400 (Mid)	1880.0	19.75	0.09
		9538 (High)	1907.6	20.85	0.12
	HSUPA Subtest-5	9262 (Low)	1852.4	21.56	0.14
		9400 (Mid)	1880.0	21.85	0.15
		9538 (High)	1907.6	22.32	0.17

## 3.2 Effective Radiated Power and Effective Isotropic Radiated Power Measurement

### 3.2.1 Description of the ERP/EIRP Measurement

ERP/EIRP is measured by substitution method according to ANSI / TIA / EIA-603-C-2004. The ERP of mobile transmitters must not exceed 7 Watts and the EIRP of mobile transmitters are limited to 2 Watts.

### 3.2.2 Measuring Instruments

See list of measuring instruments of this test report.

### 3.2.3 Test Procedures

1. The EUT was placed on a turntable with 1.0 meter height in a fully anechoic chamber.
2. The EUT was set at 1.2 meters from the receiving antenna, which was mounted on the antenna tower.
3. The table was rotated 360 degrees to determine the position of the highest radiated power.
4. The height of the receiving antenna is adjusted to look for the maximum ERP/EIRP.
5. Taking the record of maximum ERP/EIRP.
6. A dipole antenna was substituted in place of the EUT and was driven by a signal generator.
7. The conducted power at the terminal of the dipole antenna is measured.
8. Repeat step 3 to step 5 to get the maximum ERP/EIRP of the substitution antenna.
9.  $ERP/EIRP = P_s + E_t - E_s + G_s = P_s + R_t - R_s + G_s$   
 $P_s$  (dBm) : Input power to substitution antenna.  
 $G_s$  (dBi or dBd) : Substitution antenna Gain.  
 $E_t = R_t + AF$   
 $E_s = R_s + AF$   
 $AF$  (dB/m) : Receive antenna factor  
 $R_t$  : The highest received signal in spectrum analyzer for EUT.  
 $R_s$  : The highest received signal in spectrum analyzer for substitution antenna.

### 3.2.4 Test Setup

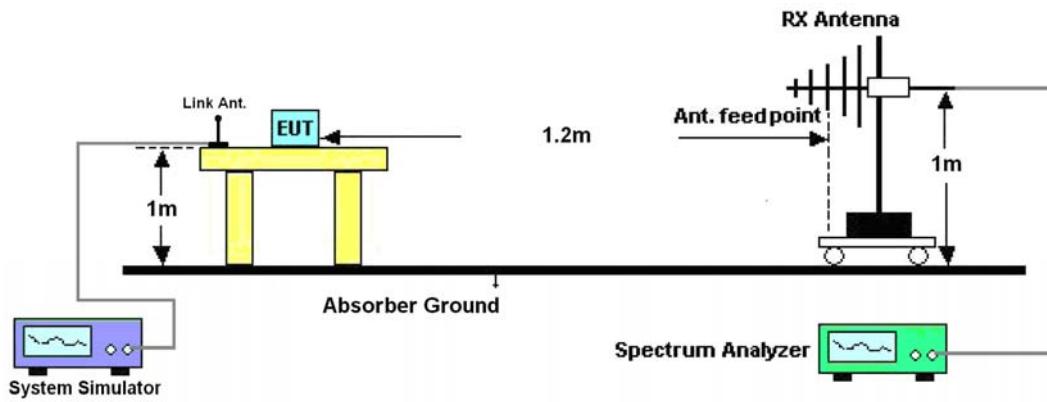

3.2.5 Test Result of ERP

GSM850 (GPRS 8) Radiated Power ERP						
Horizontal Polarization						
Frequency (MHz)	Rt (dBm)	Rs (dBm)	Ps (dBm)	Gs (dBd)	ERP (dBm)	ERP (W)
824.2	-16.01	-48.12	0.00	-1.08	31.03	1.27
836.4	-17.60	-48.28	0.00	-0.93	29.75	0.94
848.8	-18.68	-48.35	0.00	-0.76	28.91	0.78
Vertical Polarization						
Frequency (MHz)	Rt (dBm)	Rs (dBm)	Ps (dBm)	Gs (dBd)	ERP (dBm)	ERP (W)
824.2	-15.70	-47.97	0.00	-1.08	31.19	1.32
836.4	-17.19	-48.01	0.00	-0.93	29.89	0.97
848.8	-17.94	-48.05	0.00	-0.76	29.35	0.86

GSM850 (EDGE 8) Radiated Power ERP						
Horizontal Polarization						
Frequency (MHz)	Rt (dBm)	Rs (dBm)	Ps (dBm)	Gs (dBd)	ERP (dBm)	ERP (W)
824.2	-21.46	-48.12	0.00	-1.08	25.58	0.36
836.4	-22.73	-48.28	0.00	-0.93	24.62	0.29
848.8	-23.50	-48.35	0.00	-0.76	24.09	0.26
Vertical Polarization						
Frequency (MHz)	Rt (dBm)	Rs (dBm)	Ps (dBm)	Gs (dBd)	ERP (dBm)	ERP (W)
824.2	-21.20	-47.97	0.00	-1.08	25.69	0.37
836.4	-22.63	-48.01	0.00	-0.93	24.45	0.28
848.8	-23.44	-48.05	0.00	-0.76	23.85	0.24





WCDMA Band V (WCDMA) Radiated Power ERP						
Horizontal Polarization						
Frequency (MHz)	Rt (dBm)	Rs (dBm)	Ps (dBm)	Gs (dBd)	ERP (dBm)	ERP (W)
826.4	-22.66	-48.12	0.00	-1.08	24.38	0.27
836.4	-24.17	-48.28	0.00	-0.93	23.18	0.21
846.6	-25.21	-48.35	0.00	-0.76	22.38	0.17
Vertical Polarization						
Frequency (MHz)	Rt (dBm)	Rs (dBm)	Ps (dBm)	Gs (dBd)	ERP (dBm)	ERP (W)
826.4	-22.57	-47.97	0.00	-1.08	24.32	0.27
836.4	-24.07	-48.01	0.00	-0.93	23.01	0.20
846.6	-24.78	-48.05	0.00	-0.76	22.51	0.18

3.2.6 Test Result of EIRP

GSM1900 (GPRS 8) Radiated Power EIRP						
Horizontal Polarization						
Frequency (MHz)	Rt (dBm)	Rs (dBm)	Ps (dBm)	Gs (dBi)	EIRP (dBm)	EIRP (W)
1850.2	-25.74	-51.88	0.00	1.96	28.10	0.65
1880.0	-27.72	-52.99	0.00	2.00	27.27	0.53
1909.8	-30.02	-54.28	0.00	1.98	26.24	0.42
Vertical Polarization						
Frequency (MHz)	Rt (dBm)	Rs (dBm)	Ps (dBm)	Gs (dBi)	EIRP (dBm)	EIRP (W)
1850.2	-23.14	-52.13	0.00	1.96	30.95	1.24
1880.0	-24.84	-53.17	0.00	2.00	30.33	1.08
1909.8	-26.66	-54.13	0.00	1.98	29.45	0.88

GSM1900 (EDGE 8) Radiated Power EIRP						
Horizontal Polarization						
Frequency (MHz)	Rt (dBm)	Rs (dBm)	Ps (dBm)	Gs (dBi)	EIRP (dBm)	EIRP (W)
1850.2	-28.97	-51.88	0.00	1.96	24.87	0.31
1880.0	-31.12	-52.99	0.00	2.00	23.87	0.24
1909.8	-33.09	-54.28	0.00	1.98	23.17	0.21
Vertical Polarization						
Frequency (MHz)	Rt (dBm)	Rs (dBm)	Ps (dBm)	Gs (dBi)	EIRP (dBm)	EIRP (W)
1850.2	-26.33	-52.13	0.00	1.96	27.76	0.60
1880.0	-27.86	-53.17	0.00	2.00	27.31	0.54
1909.8	-28.95	-54.13	0.00	1.98	27.16	0.52



WCDMA Band II (HSDPA) Radiated Power EIRP						
Horizontal Polarization						
Frequency (MHz)	Rt (dBm)	Rs (dBm)	Ps (dBm)	Gs (dBi)	EIRP (dBm)	EIRP (W)
1852.4	-32.67	-51.88	0.00	1.96	21.17	0.13
1880.0	-37.31	-52.99	0.00	2.00	17.68	0.06
1907.6	-37.84	-54.28	0.00	1.98	18.42	0.07
Vertical Polarization						
Frequency (MHz)	Rt (dBm)	Rs (dBm)	Ps (dBm)	Gs (dBi)	EIRP (dBm)	EIRP (W)
1852.4	-29.39	-52.13	0.00	1.96	24.70	0.30
1880.0	-32.91	-53.17	0.00	2.00	22.26	0.17
1907.6	-33.79	-54.13	0.00	1.98	22.32	0.17

### 3.3 Occupied Bandwidth and Band Edge Measurement

#### 3.3.1 Description of Occupied Bandwidth and Band Edge Measurement

The power of any emission outside of the authorized operating frequency ranges must be lower than the transmitter power (P) by a factor of at least  $43 + 10 \log (P)$  dB.

The emission bandwidth is defined as the width of the signal between two points, located at the 2 sides of the carrier frequency, outside of which all emissions are attenuated at least 26 dB below the transmitter power.

#### 3.3.2 Measuring Instruments

See list of measuring instruments of this test report.

#### 3.3.3 Test Procedures

1. The EUT was connected to Spectrum Analyzer and Base Station via power divider.
2. The 99% and 26 dB occupied bandwidth (BW) of the middle channel for the highest RF powers were measured.
3. The band edges of low and high channels for the highest RF powers were measured. Setting RBW as roughly BW/100.
4. The RBW was replaced by 10 kHz, due to the spectrum analyzer IF-Filter including an excess of the limit. A worst case correction factor of  $10 \log (1\% \text{ BW}/\text{measurement RBW})$  was implemented.

#### 3.3.4 Test Setup

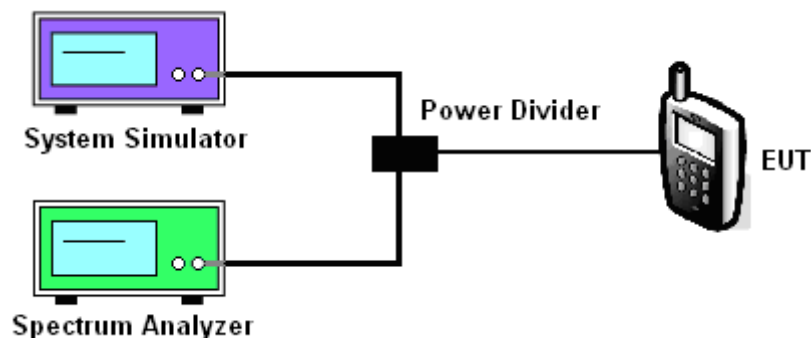



3.3.5 Test Result (Plots) of Occupied Bandwidth

Band :	GSM 850	Power Stage :	High
Test Mode :	GPRS 8 Link		

99% Occupied Bandwidth Plot on Channel 189

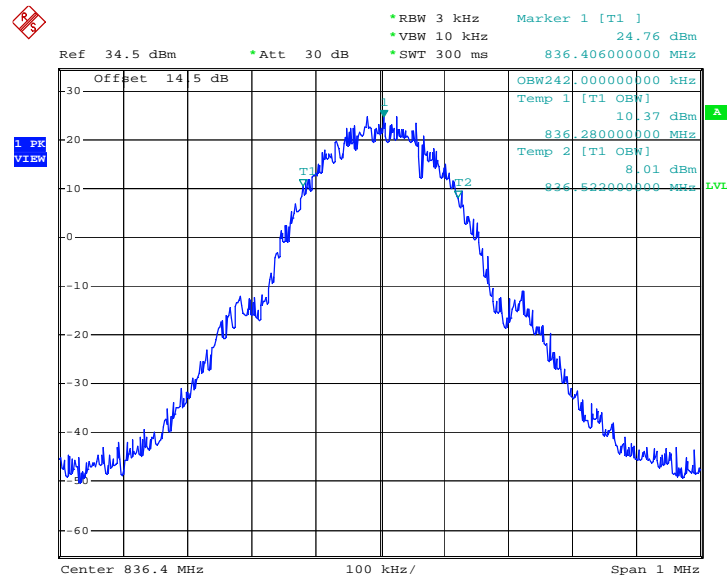

Date: 22.MAR.2009 08:06:18

26dB Bandwidth Plot on Channel 189

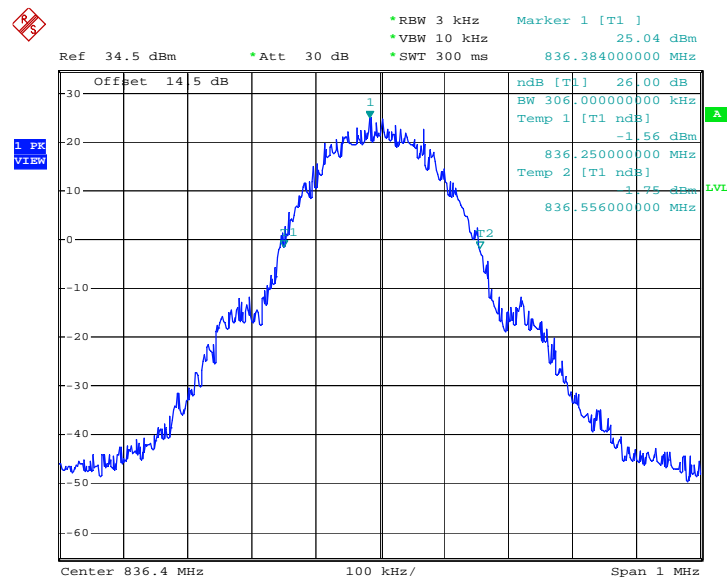

Date: 22.MAR.2009 08:00:46



<b>Band :</b>	GSM 850	<b>Power Stage :</b>	High
<b>Test Mode :</b>	EDGE 8 Link		

99% Occupied Bandwidth Plot on Channel 189

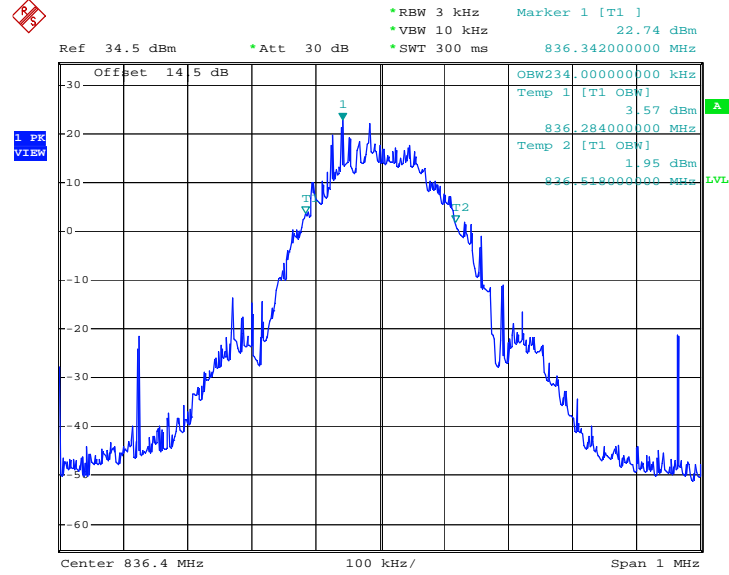

Date: 22.MAR.2009 09:33:45

26dB Bandwidth Plot on Channel 189

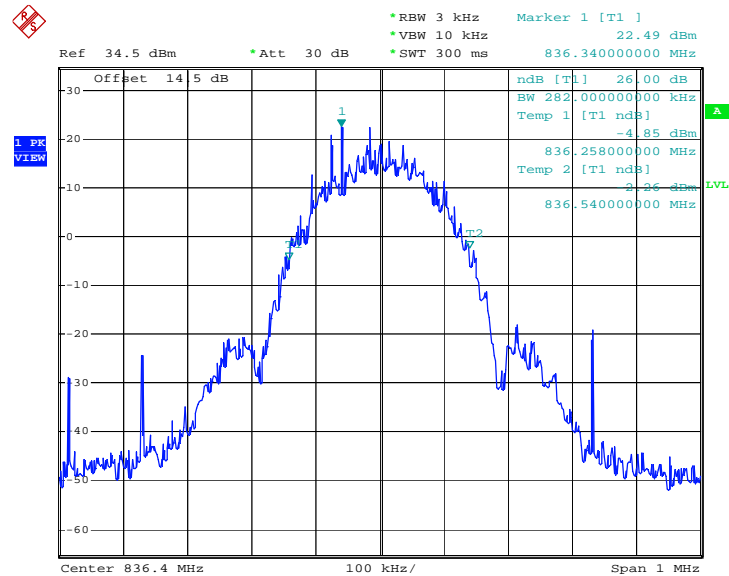

Date: 22.MAR.2009 08:50:52



<b>Band :</b>	GSM 1900	<b>Power Stage :</b>	High
<b>Test Mode :</b>	GPRS 8 Link		

99% Occupied Bandwidth Plot on Channel 661

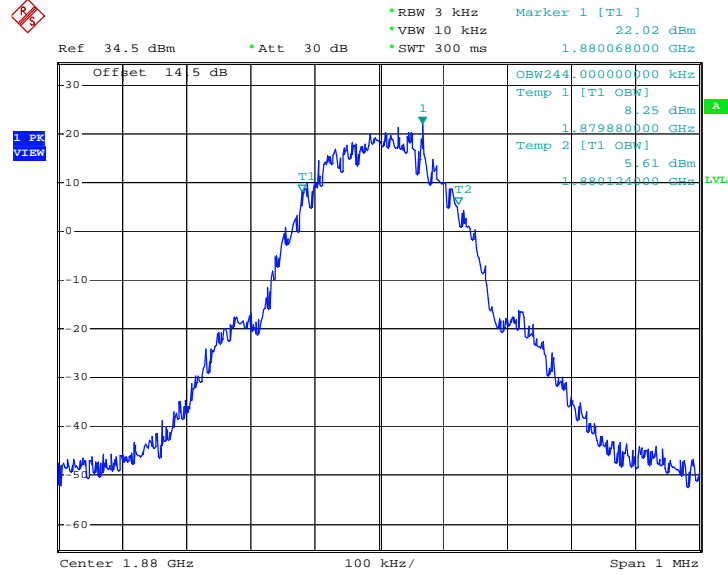

Date: 22.MAR.2009 09:59:50

26dB Bandwidth Plot on Channel 661

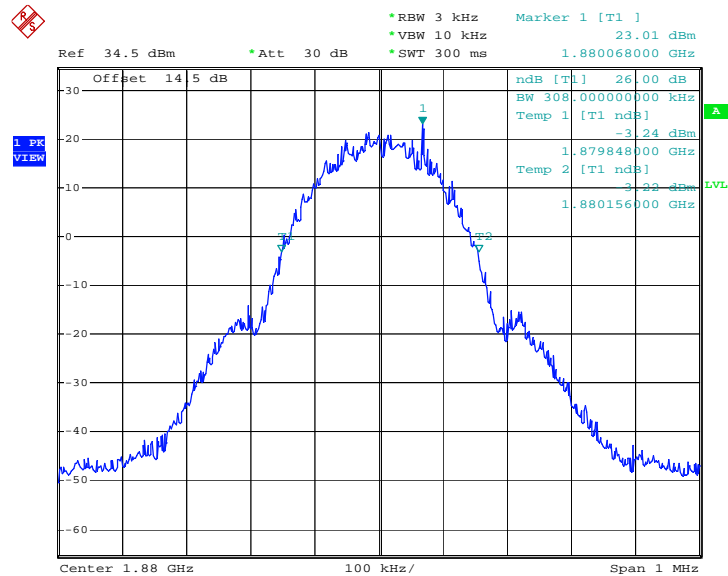

Date: 22.MAR.2009 09:50:54



<b>Band :</b>	GSM 1900	<b>Power Stage :</b>	High
<b>Test Mode :</b>	EDGE 8 Link		

99% Occupied Bandwidth Plot on Channel 661

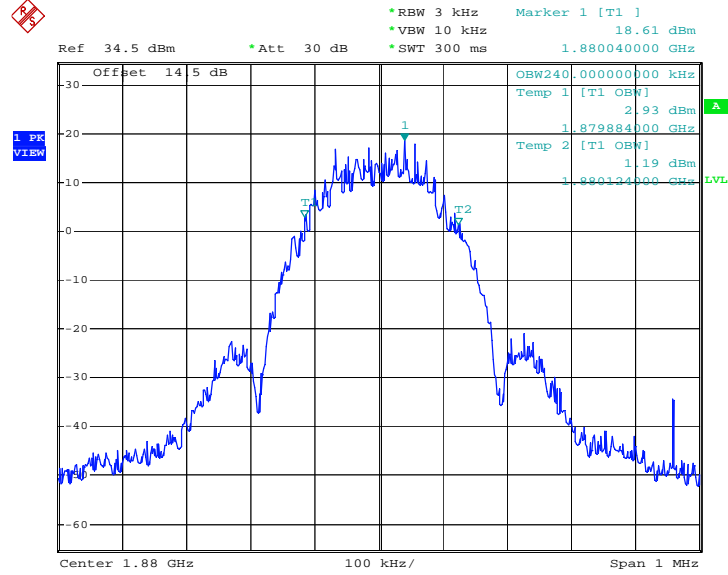

Date: 22.MAR.2009 11:13:39

26dB Bandwidth Plot on Channel 661

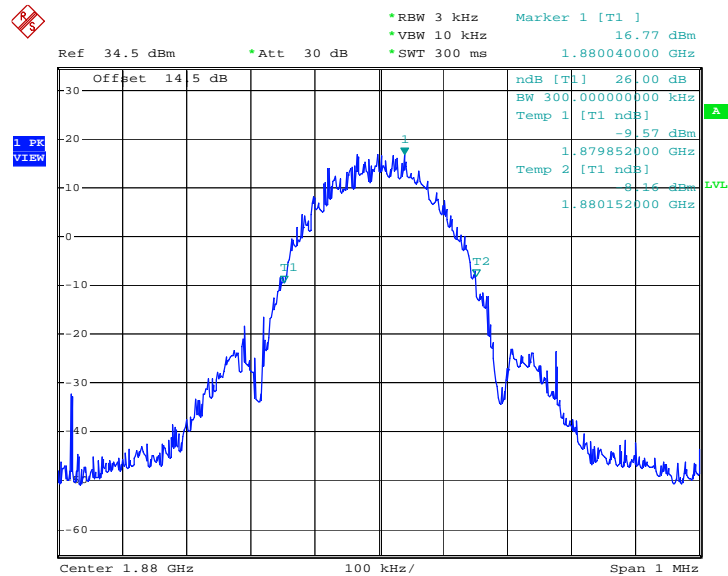

Date: 22.MAR.2009 10:50:09





Band :	WCDMA Band V	Power Stage :	High
Test Mode :	WCDMA Link		

99% Occupied Bandwidth Plot on Channel 4182

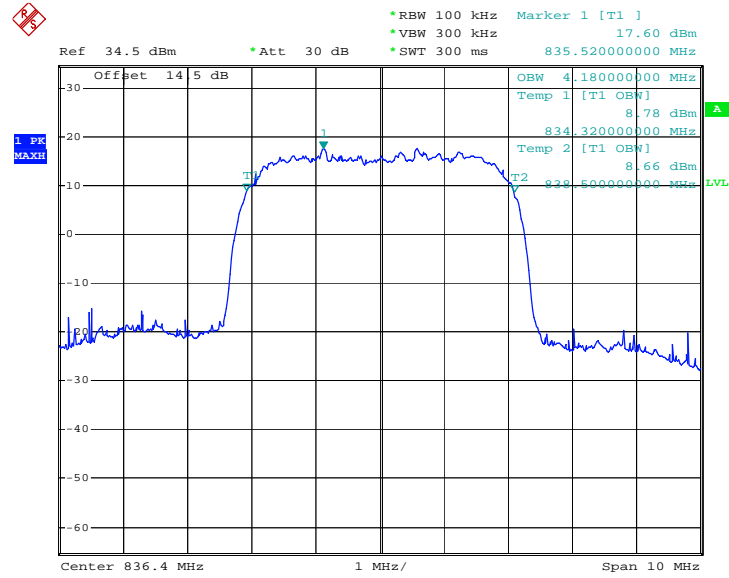

Date: 22.MAR.2009 12:07:55

26dB Bandwidth Plot on Channel 4182

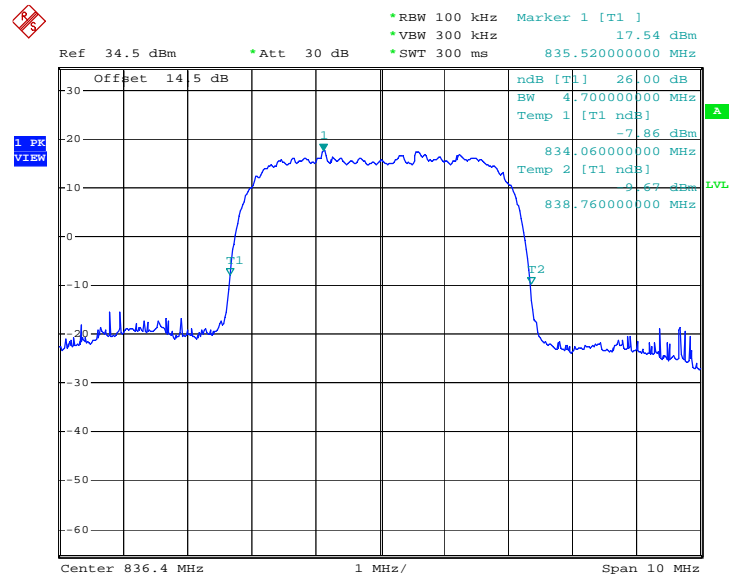

Date: 22.MAR.2009 11:58:02



<b>Band :</b>	WCDMA Band II	<b>Power Stage :</b>	High
<b>Test Mode :</b>	HSDPA Link		

99% Occupied Bandwidth Plot on Channel 9400

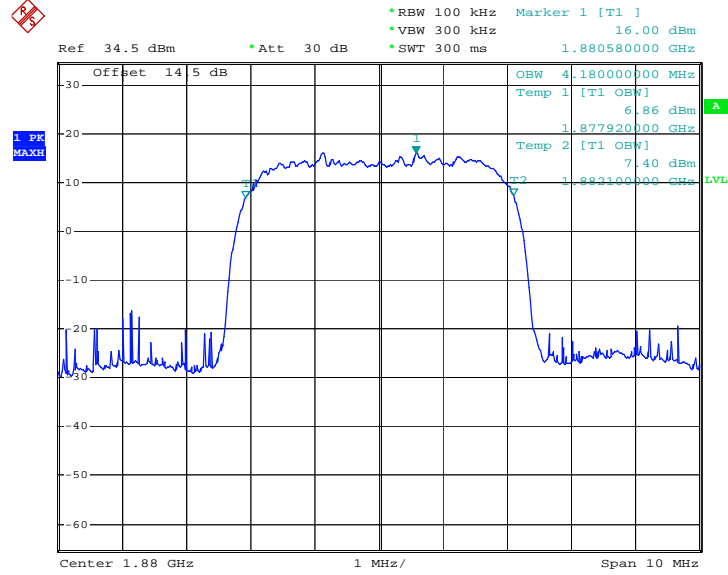

Date: 23.MAR.2009 10:49:24

26dB Bandwidth Plot on Channel 9400

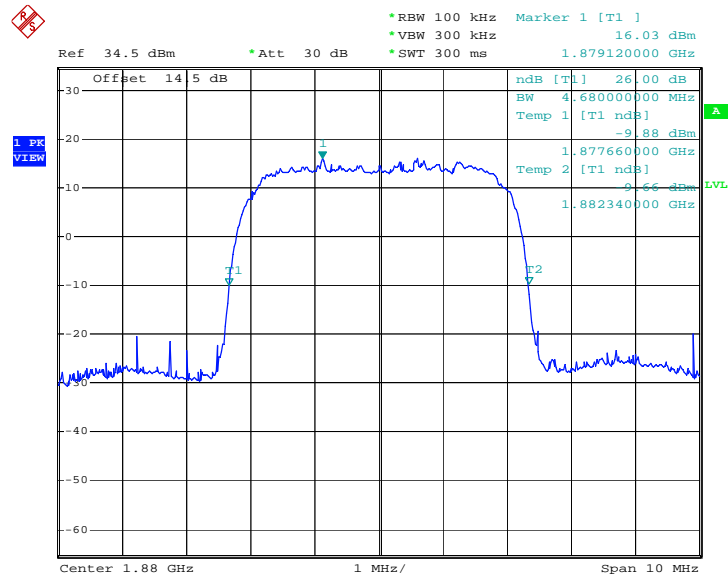

Date: 23.MAR.2009 10:41:21



### 3.3.6 Test Result (Plots) of Conducted Band Edges

Band :	GSM850	Power Stage :	High
Test Mode :	GPRS 8 Link		

Lower Band Edge Plot on Channel 128

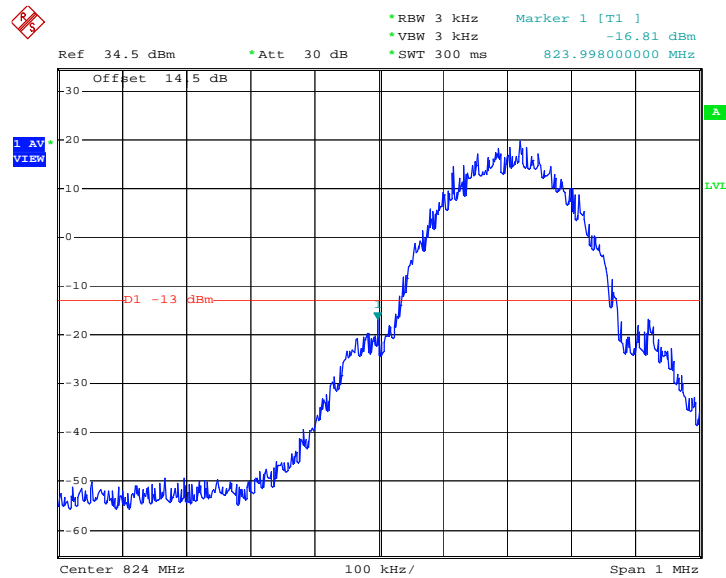

Date: 22.MAR.2009 08:02:37

Higher Band Edge Plot on Channel 251

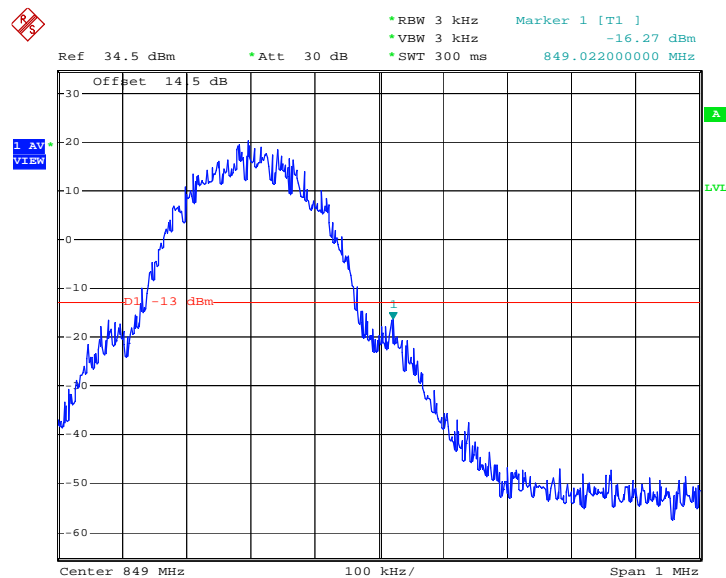

Date: 22.MAR.2009 08:03:31



Band :	GSM850	Power Stage :	High
Test Mode :	EDGE 8 Link		

Lower Band Edge Plot on Channel 128

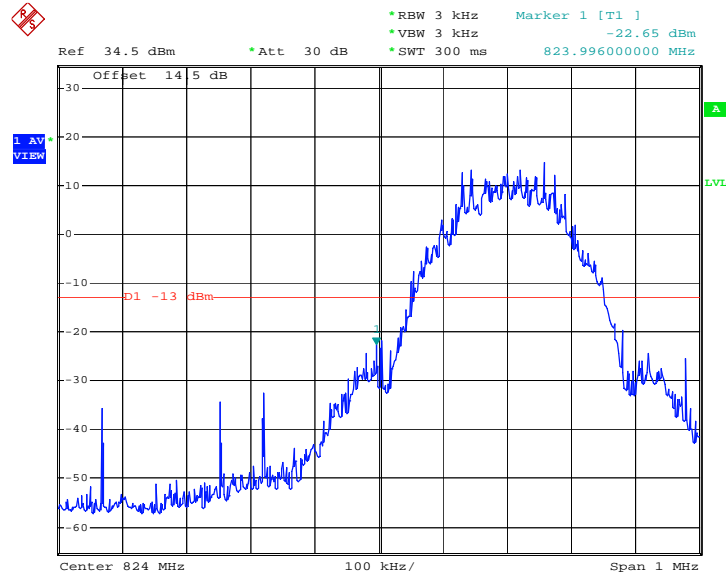

Date: 22.MAR.2009 08:54:13

Higher Band Edge Plot on Channel 251

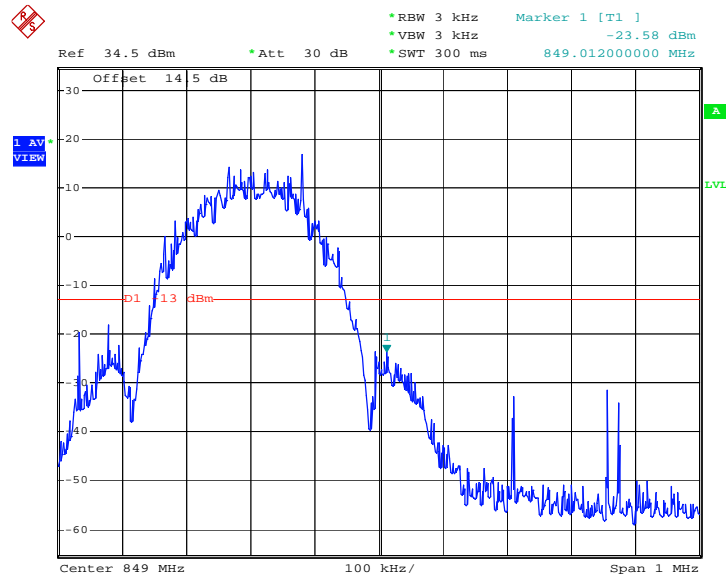

Date: 22.MAR.2009 08:55:59



Band :	GSM1900	Power Stage :	High
Test Mode :	GPRS 8 Link		

Lower Band Edge Plot on Channel 512

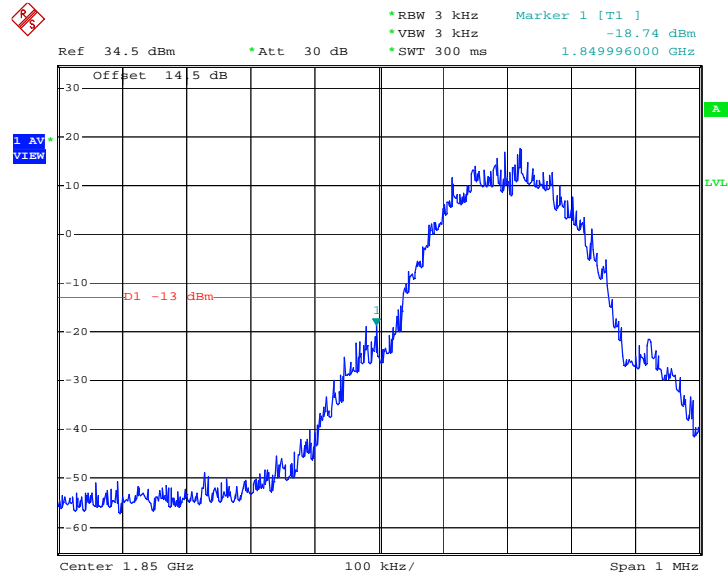

Date: 22.MAR.2009 09:53:32

Higher Band Edge Plot on Channel 810

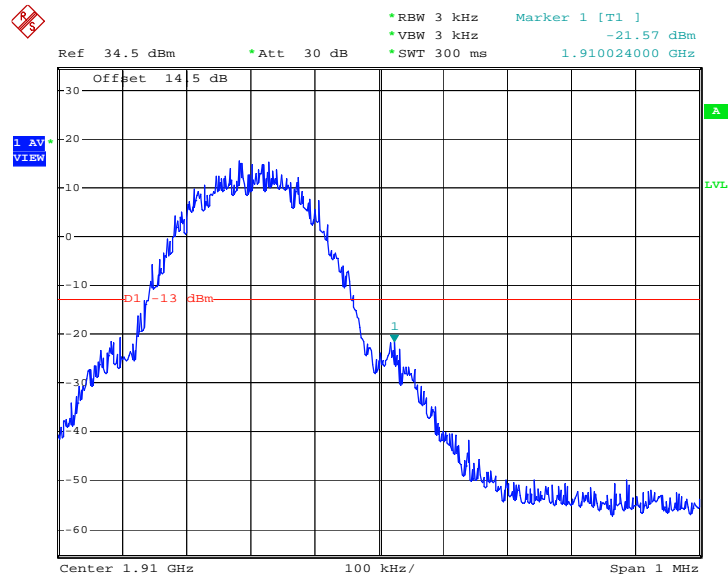

Date: 22.MAR.2009 09:54:16



Band :	GSM1900	Power Stage :	High
Test Mode :	EDGE 8 Link		

Lower Band Edge Plot on Channel 512

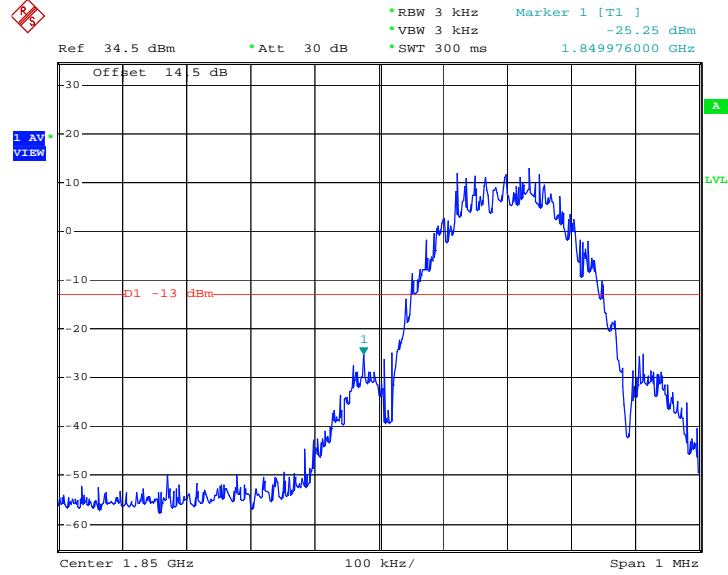

Date: 22.MAR.2009 10:54:43

Higher Band Edge Plot on Channel 810

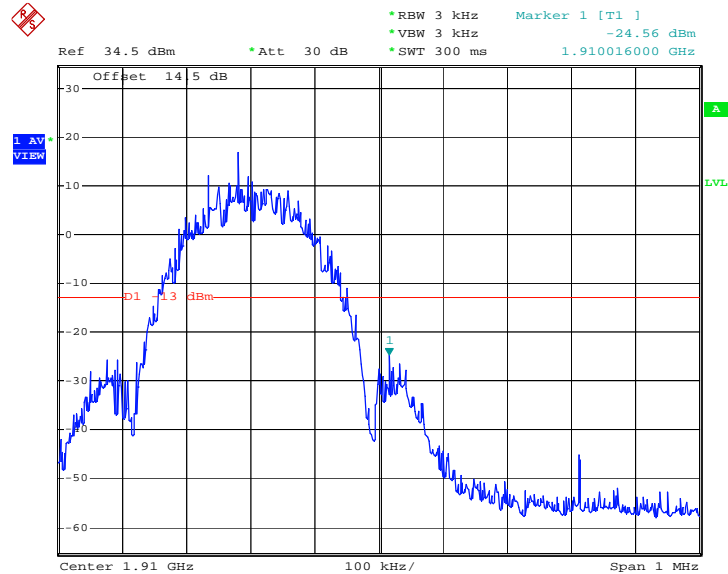

Date: 22.MAR.2009 10:55:31



Band :	WCDMA Band V	Power Stage :	High
Test Mode :	WCDMA Link		

Lower Band Edge Plot on Channel 4132

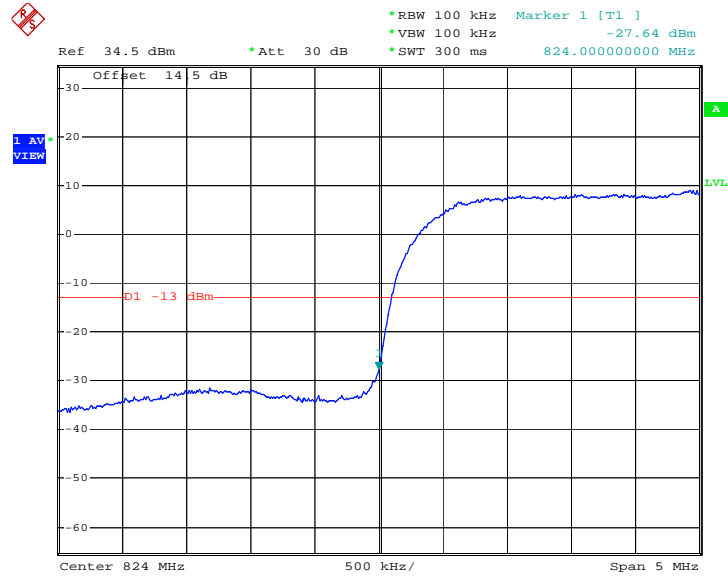

Date: 22.MAR.2009 12:02:29

Higher Band Edge Plot on Channel 4233

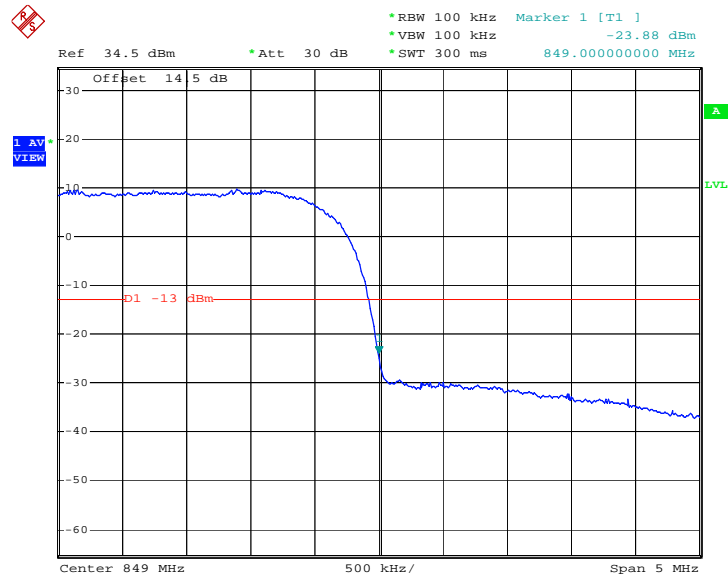

Date: 22.MAR.2009 12:03:07



Band :	WCDMA Band II	Power Stage :	High
Test Mode :	HSDPA Link		

Lower Band Edge Plot on Channel 9262

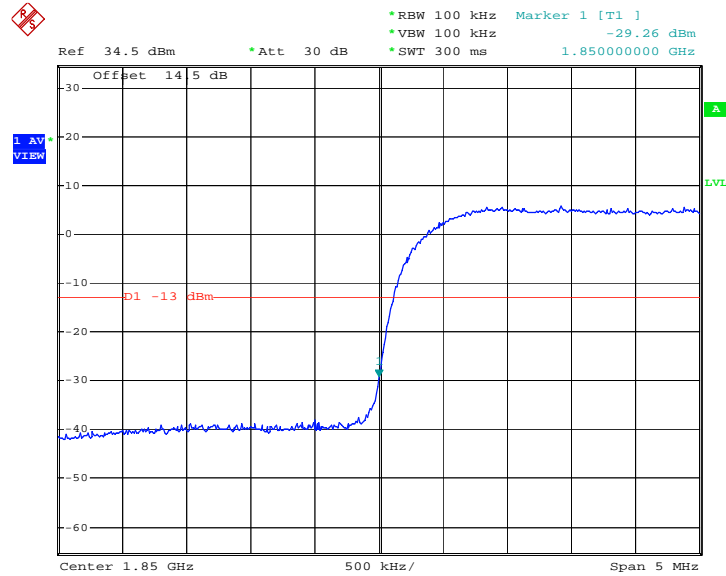

Date: 23.MAR.2009 11:04:11

Higher Band Edge Plot on Channel 9538

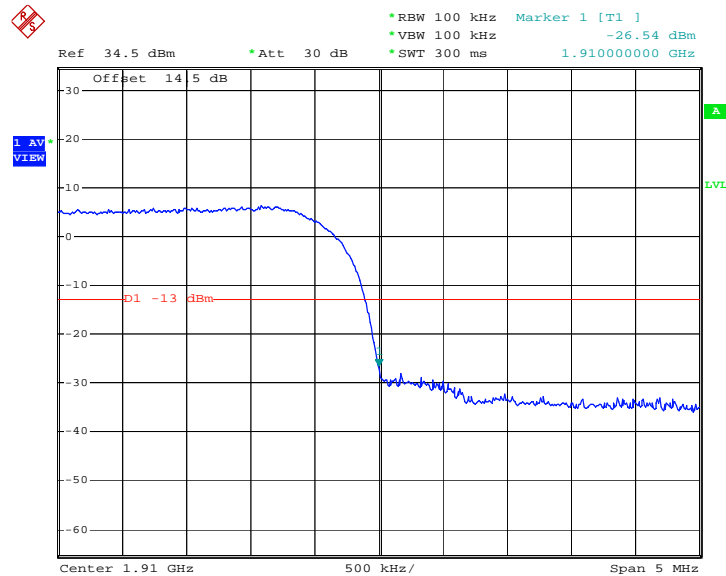

Date: 23.MAR.2009 11:05:07



### 3.4 Conducted Emission Measurement

#### 3.4.1 Description of Conducted Emission Measurement

The power of any emission outside of the authorized operating frequency ranges must be lower than the transmitter power (P) by a factor of at least  $43 + 10 \log (P)$  dB.

It is measured by means of a calibrated spectrum analyzer and scanned from 30 MHz up to a frequency including its 10<sup>th</sup> harmonic.

#### 3.4.2 Measuring Instruments

See list of measuring instruments of this test report.

#### 3.4.3 Test Procedures

1. The EUT was connected to spectrum analyzer and base station via power divider.
2. The middle channel for the highest RF power within the transmitting frequency was measured.
3. The conducted spurious emission for the whole frequency range was taken.

#### 3.4.4 Test Setup

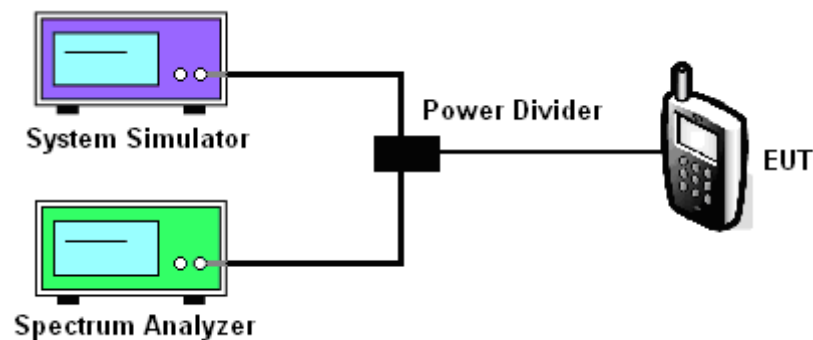



### 3.4.5 Test Result (Plots) of Conducted Emission

Band :	GSM850	Channel :	CH189
Test Mode :	GPRS 8 Link		

Conducted Emission Plot between 30M-1G

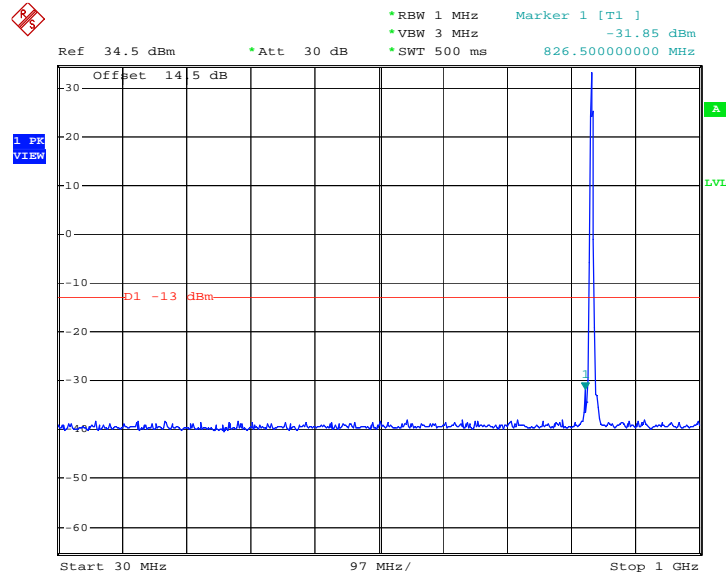

Date: 29.MAR.2009 08:03:27

Conducted Emission Plot between 1GHz ~ 3GHz

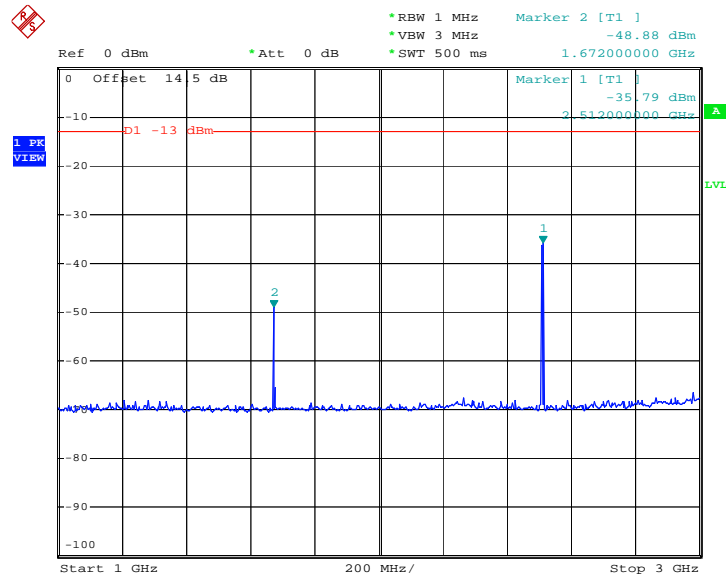

Date: 29.MAR.2009 08:06:39



### Conducted Emission Plot between 3GHz ~ 7GHz

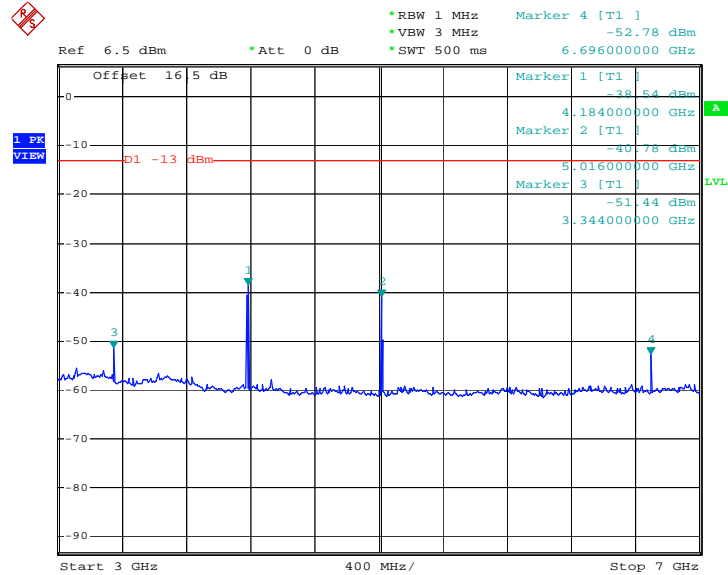

Date: 22.MAR.2009 08:26:14

### Conducted Emission Plot between 7GHz ~ 9GHz

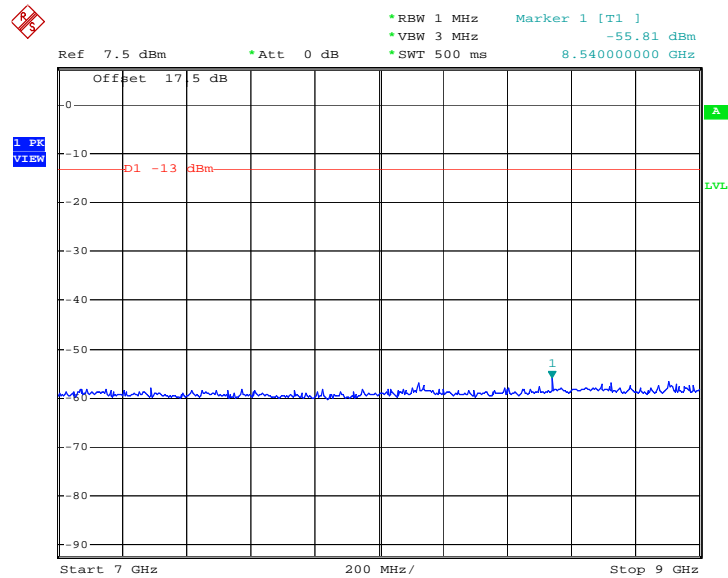

Date: 22.MAR.2009 08:27:16



Band :	GSM850	Channel :	CH189
Test Mode :	EDGE 8 Link		

Conducted Emission Plot between 30M-1G

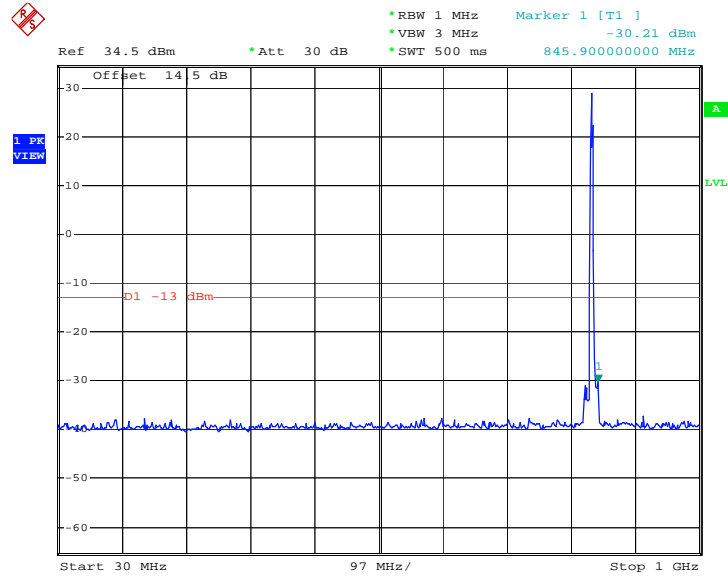

Date: 29.MAR.2009 08:01:41

Conducted Emission Plot between 1GHz ~ 3GHz

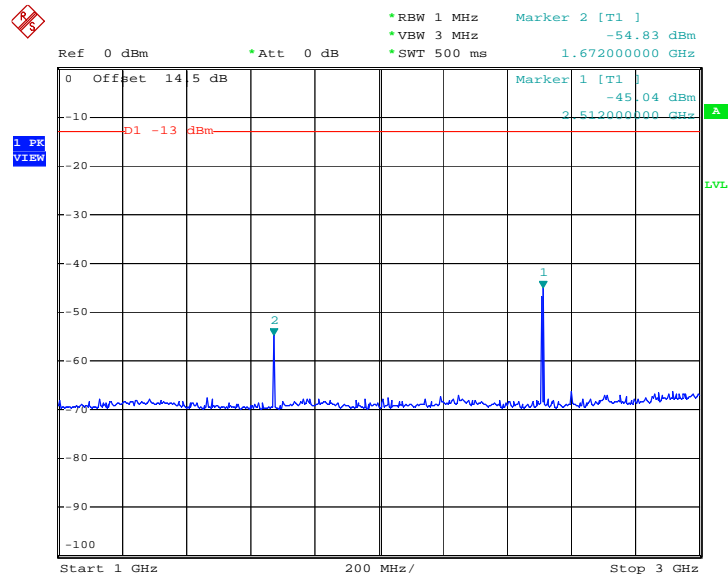

Date: 22.MAR.2009 08:41:07



### Conducted Emission Plot between 3GHz ~ 7GHz

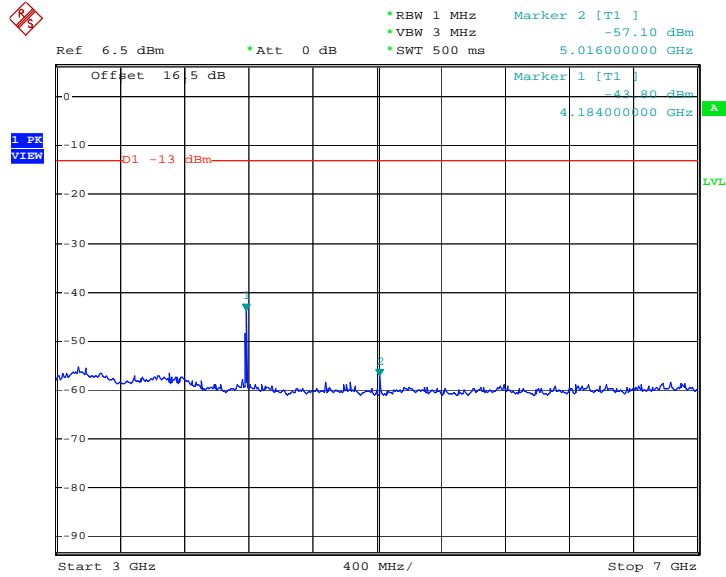

Date: 22.MAR.2009 08:34:58

### Conducted Emission Plot between 7GHz ~ 9GHz

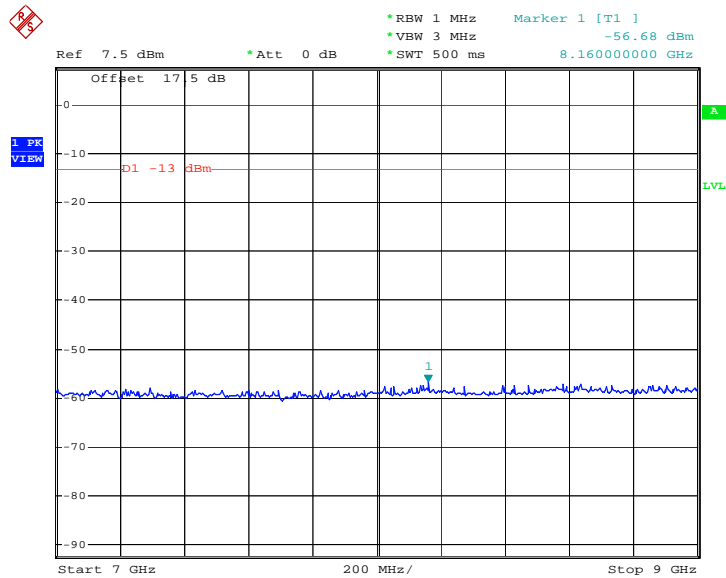

Date: 22.MAR.2009 08:33:44



Band :	GSM1900	Channel :	CH661
Test Mode :	GPRS 8 Link		

Conducted Emission Plot between 30M-1G

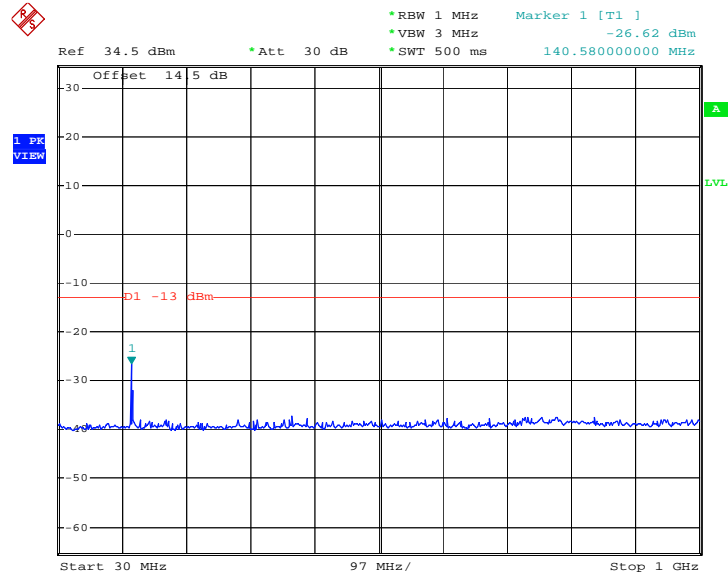

Date: 22.MAR.2009 10:19:55

Conducted Emission Plot between 1GHz ~ 3GHz

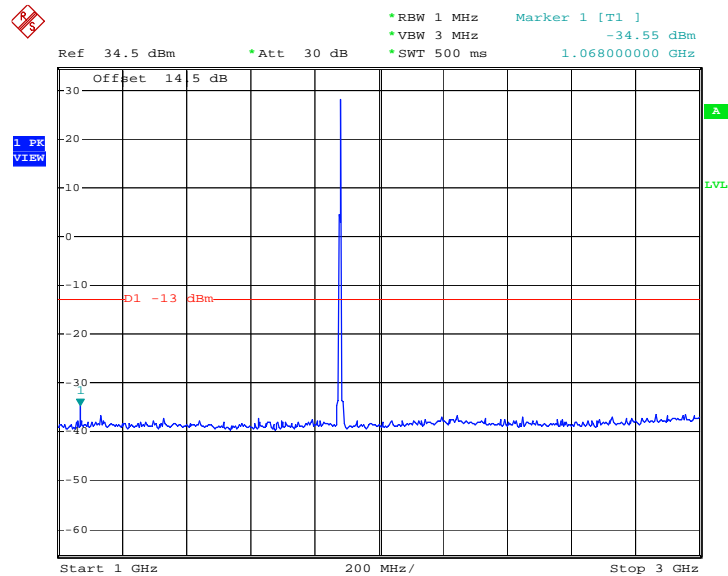

Date: 29.MAR.2009 08:11:06



### Conducted Emission Plot between 3G-7G

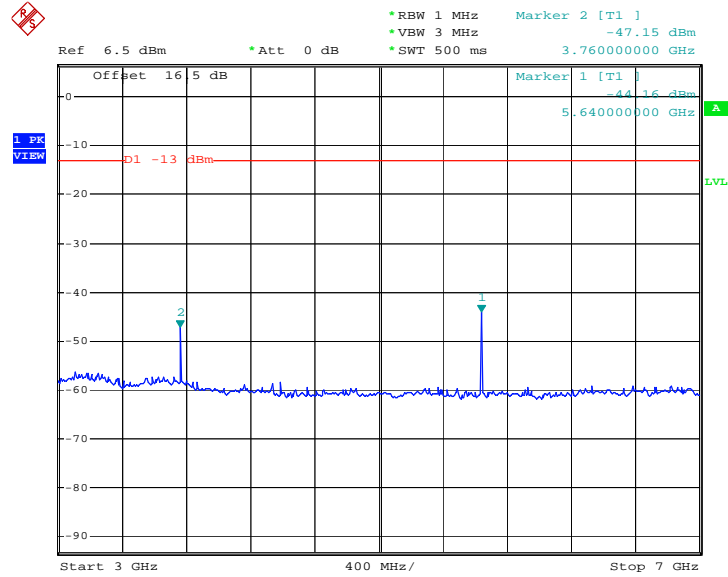

Date: 22.MAR.2009 10:28:37

### Conducted Emission Plot between 7G-13.6G

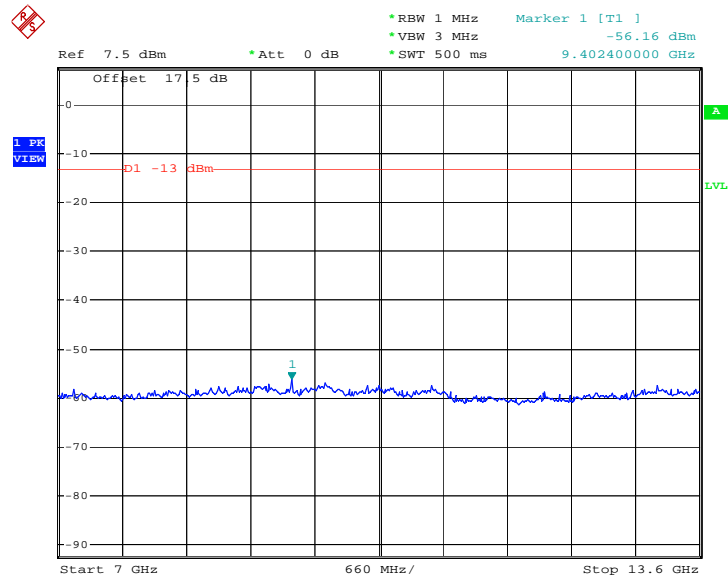

Date: 22.MAR.2009 10:29:45



Conducted Emission Plot between 13.6G-19.1G

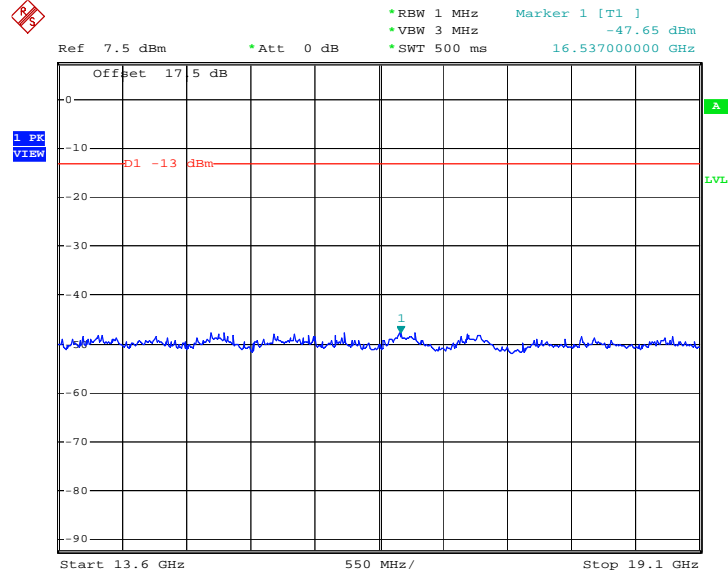

Date: 22.MAR.2009 10:30:19





Band :	GSM1900	Channel :	CH661
Test Mode :	EDGE 8 Link		

Conducted Emission Plot between 30M-1G

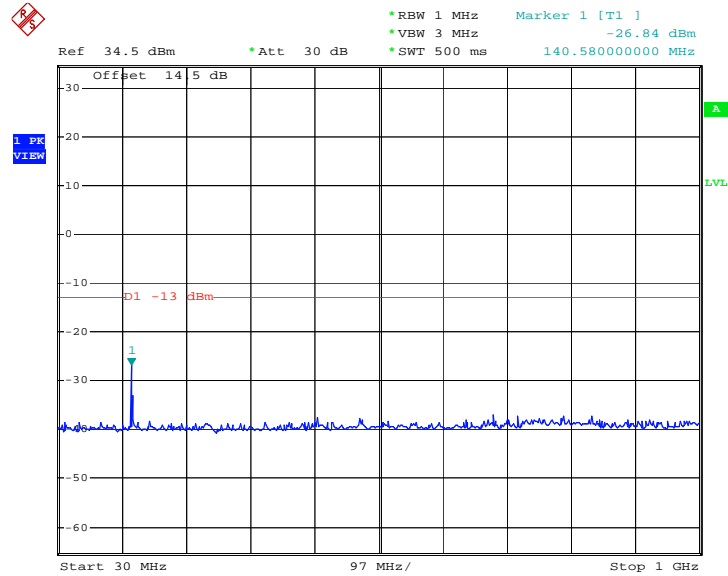

Date: 22.MAR.2009 10:43:49

Conducted Emission Plot between 1GHz ~ 3GHz

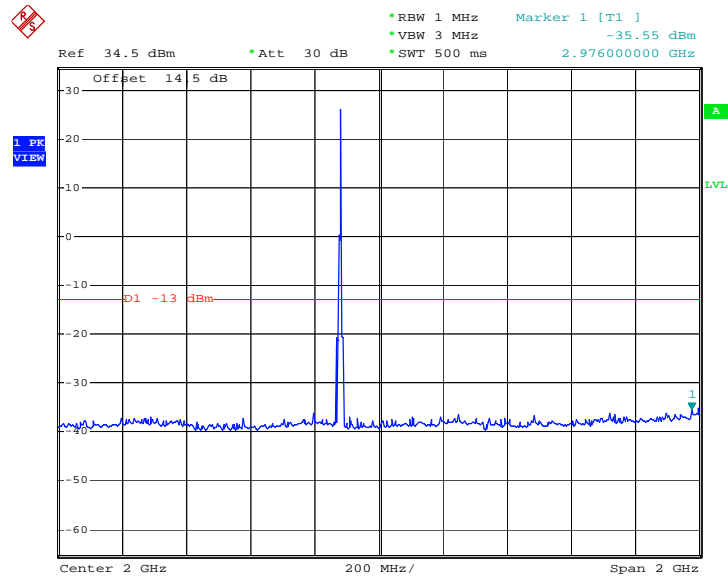

Date: 3.APR.2009 07:53:13



### Conducted Emission Plot between 3G-7G

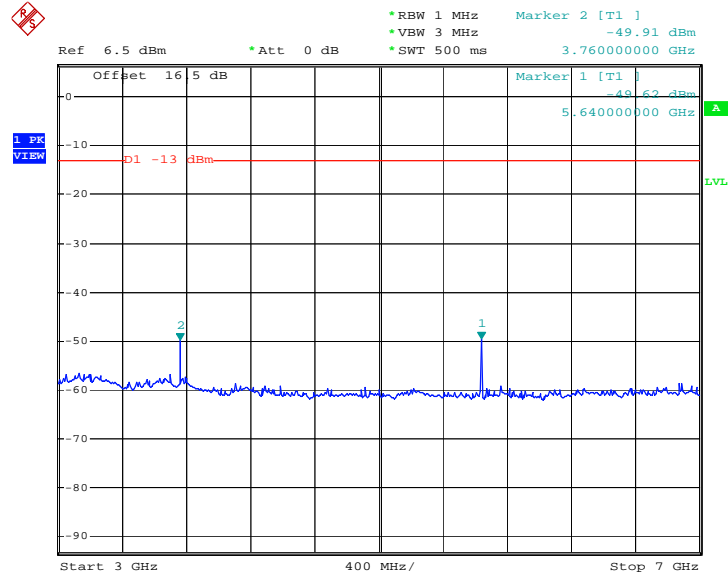

Date: 22.MAR.2009 10:41:30

### Conducted Emission Plot between 7G-13.6G

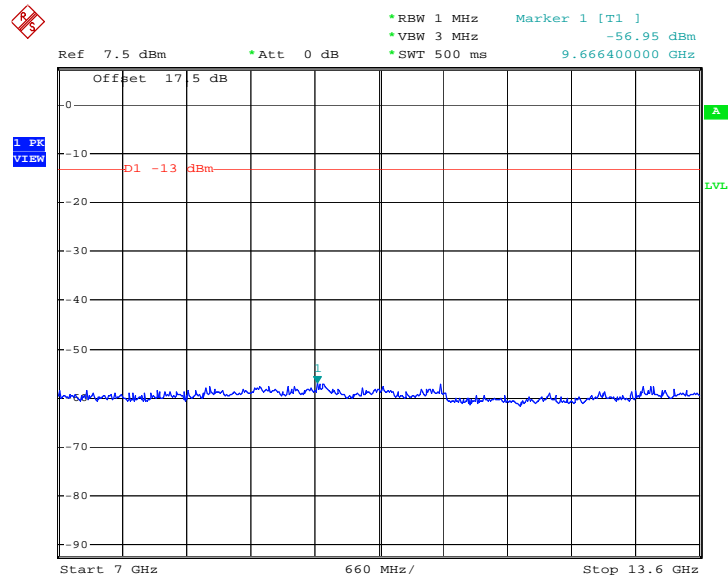

Date: 22.MAR.2009 10:40:38



Conducted Emission Plot between 13.6G-19.1G

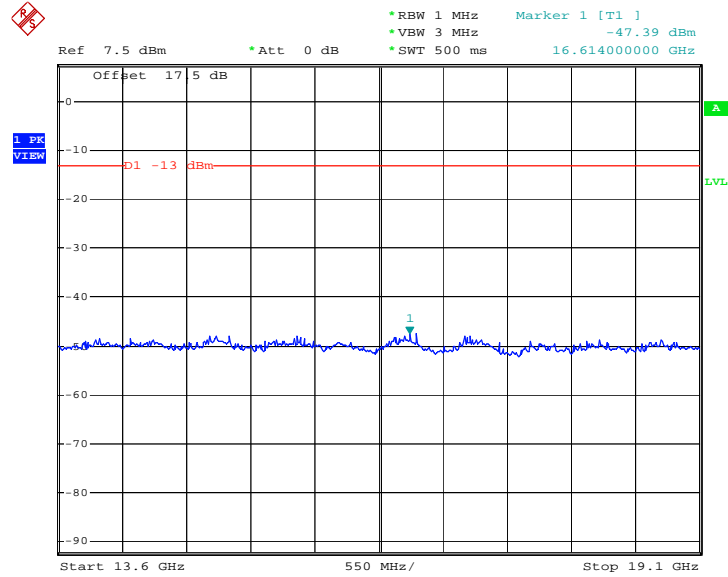

Date: 22.MAR.2009 10:39:05



Band :	WCDMA Band V	Channel :	CH4182
Test Mode :	WCDMA Link		

Conducted Emission Plot between 30M-1G

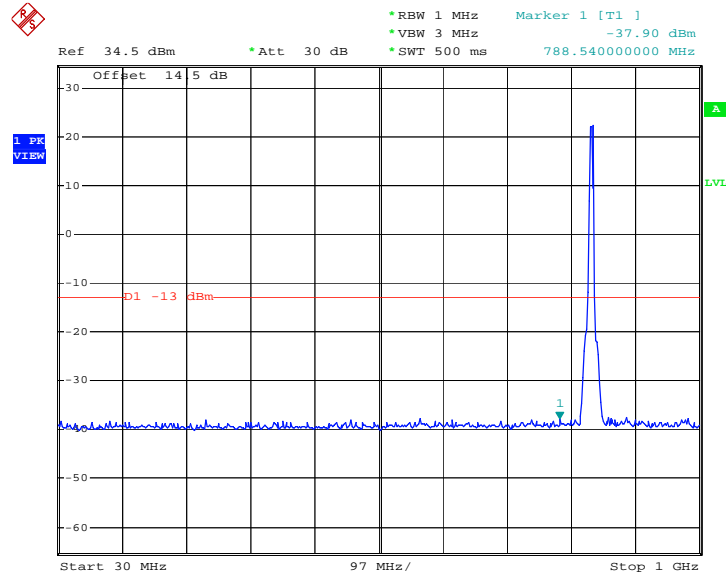

Date: 29.MAR.2009 08:15:35

Conducted Emission Plot between 1GHz ~ 3GHz

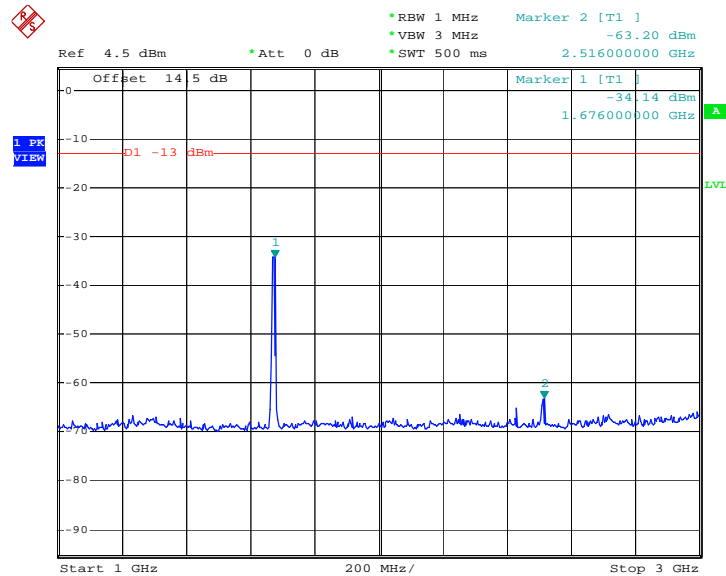

Date: 23.MAR.2009 10:10:15



### Conducted Emission Plot between 3GHz ~ 7GHz

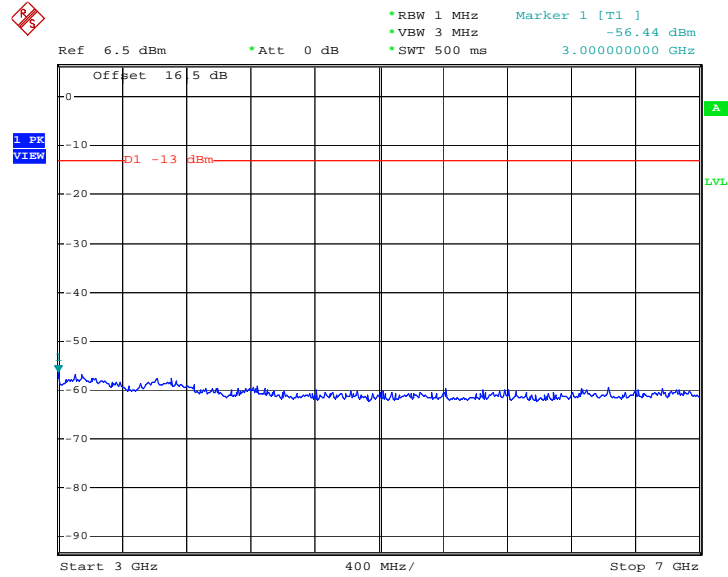

Date: 23.MAR.2009 10:11:27

### Conducted Emission Plot between 7GHz ~ 9GHz

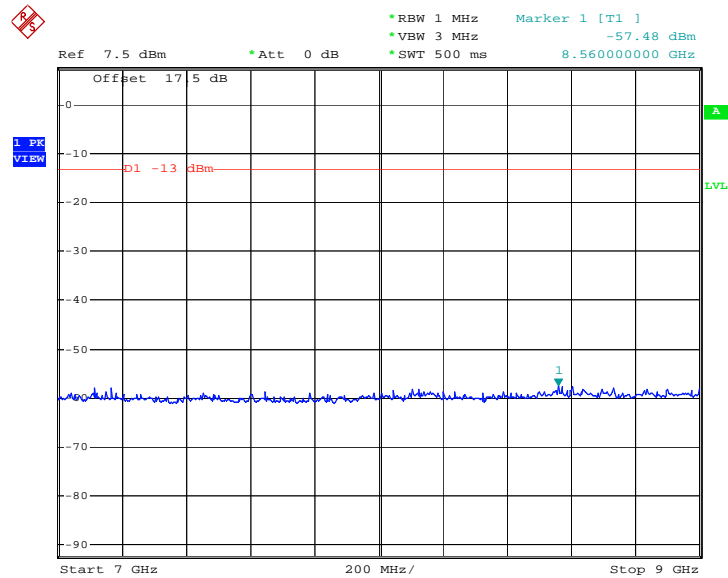

Date: 23.MAR.2009 10:35:58



Band :	WCDMA Band II	Channel :	CH9400
Test Mode :	HSDPA Link		

Conducted Emission Plot between 30M-1G

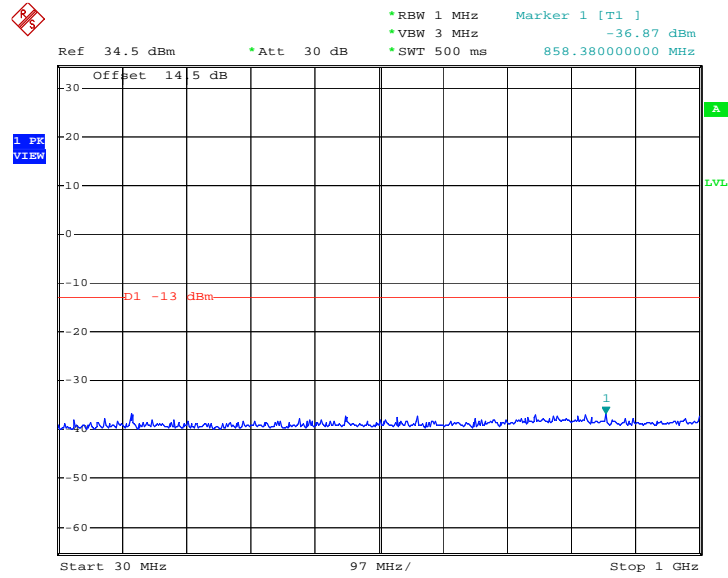

Date: 23.MAR.2009 11:29:08

Conducted Emission Plot between 1GHz ~ 3GHz

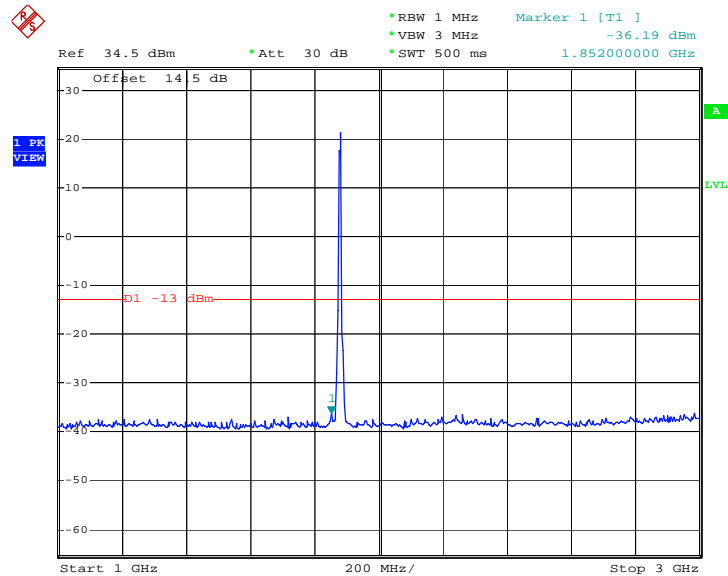

Date: 29.MAR.2009 08:14:01



### Conducted Emission Plot between 3G-7G

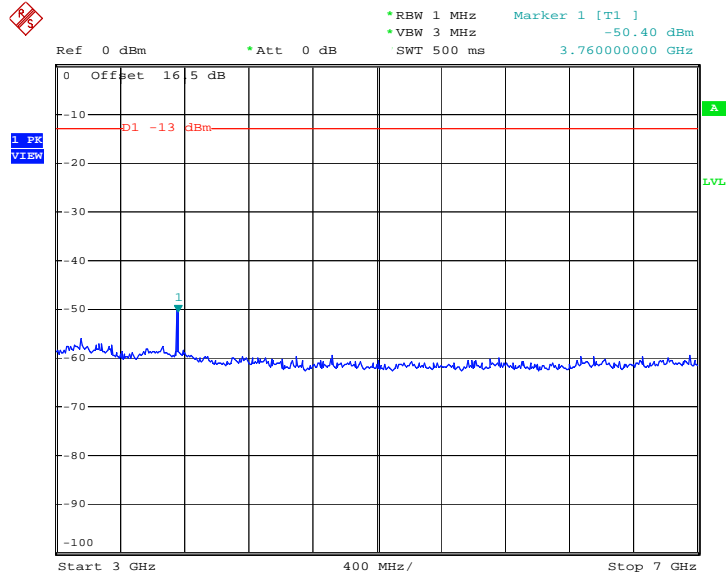

Date: 23.MAR.2009 11:32:33

### Conducted Emission Plot between 7G-13.6G

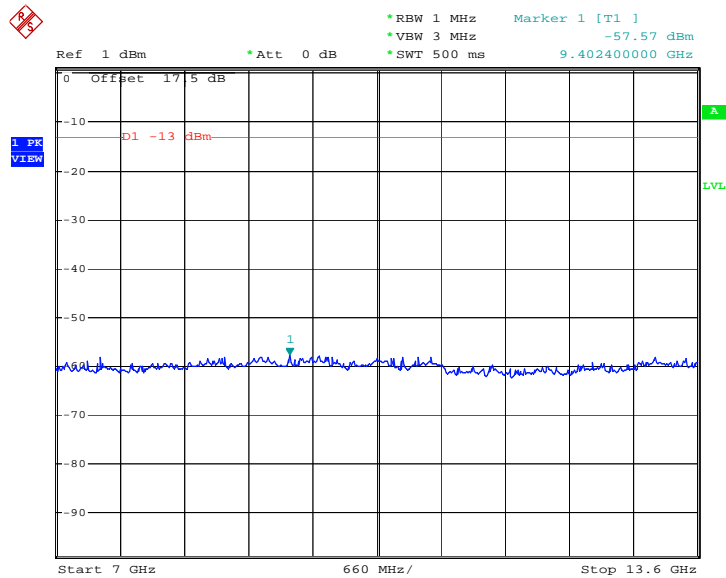

Date: 23.MAR.2009 11:33:35



Conducted Emission Plot between 13.6G-19.1G

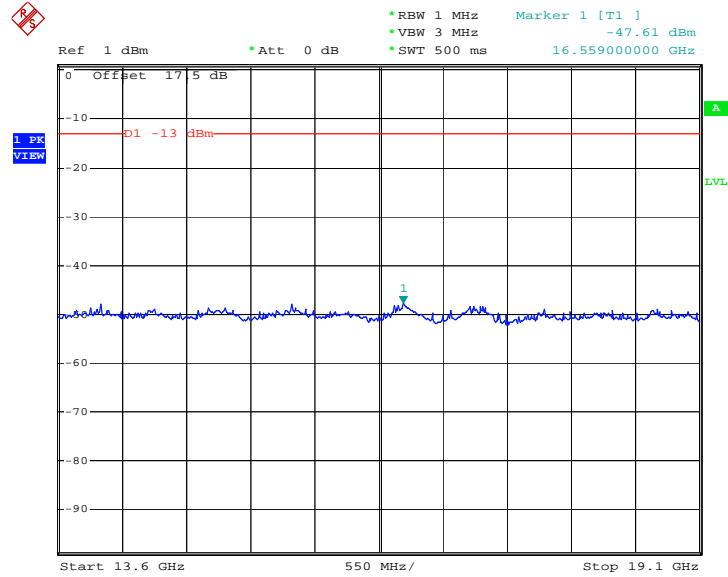

Date: 23.MAR.2009 11:34:21



## 3.5 Field Strength of Spurious Radiation Measurement

### 3.5.1 Description of Field Strength of Spurious Radiated Measurement

The radiated spurious emission was measured by substitution method according to ANSI / TIA / EIA-603-C-2004. The power of any emission outside of the authorized operating frequency ranges must be attenuated below the transmitter power (P) by a factor of at least  $43 + 10 \log (P)$  dB. The spectrum is scanned from 30 MHz up to a frequency including its 10th harmonic.

### 3.5.2 Measuring Instruments

See list of measuring instruments of this test report.

### 3.5.3 Test Procedures

1. The EUT was placed on a rotatable wooden table with 0.8 meter about ground.
2. The EUT was set 3 meters from the receiving antenna, which was mounted on the antenna tower.
3. The table was rotated 360 degrees to determine the position of the highest spurious emission.
4. The height of the receiving antenna is varied between one meter and four meters to search the maximum spurious emission for both horizontal and vertical polarizations.
5. Taking the record of maximum spurious emission.
6. A horn antenna was substituted in place of the EUT and was driven by a signal generator.
7. Tune the output power of signal generator to the same emission level with EUT maximum spurious emission.
8. Taking the record of output power at antenna port.
9. Repeat step 7 to step 8 for another polarization.
10. Emission level (dBm) = output power + substitution Gain.

### 3.5.4 Test Setup

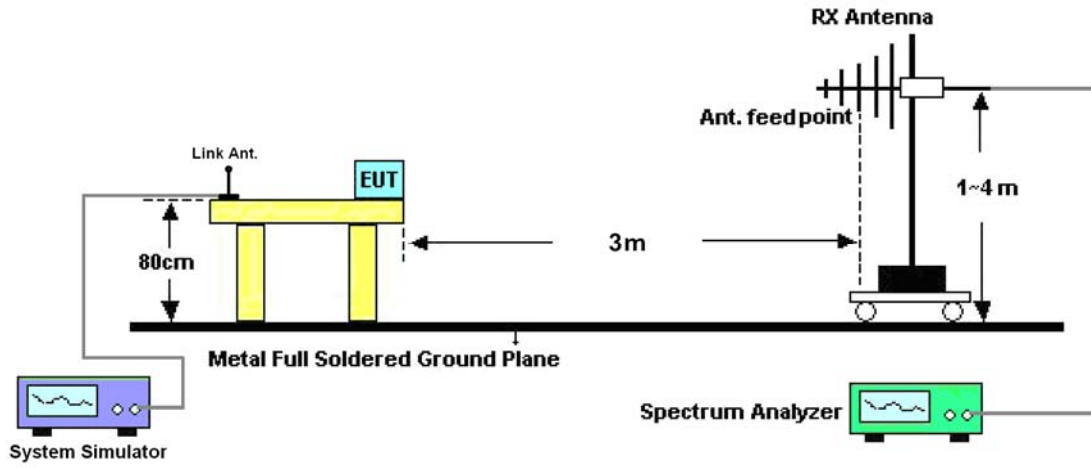



3.5.5 Test Result of Field Strength of Spurious Radiated

Band :	GSM850	Temperature :	18~19°C
Test Mode :	GPRS 8 Link	Relative Humidity :	38~39%
Test Engineer :	Peter Qiu	Polarization :	Horizontal
Remark :	Spurious emissions within 30-1000MHz were found more than 20dB below limit line.		

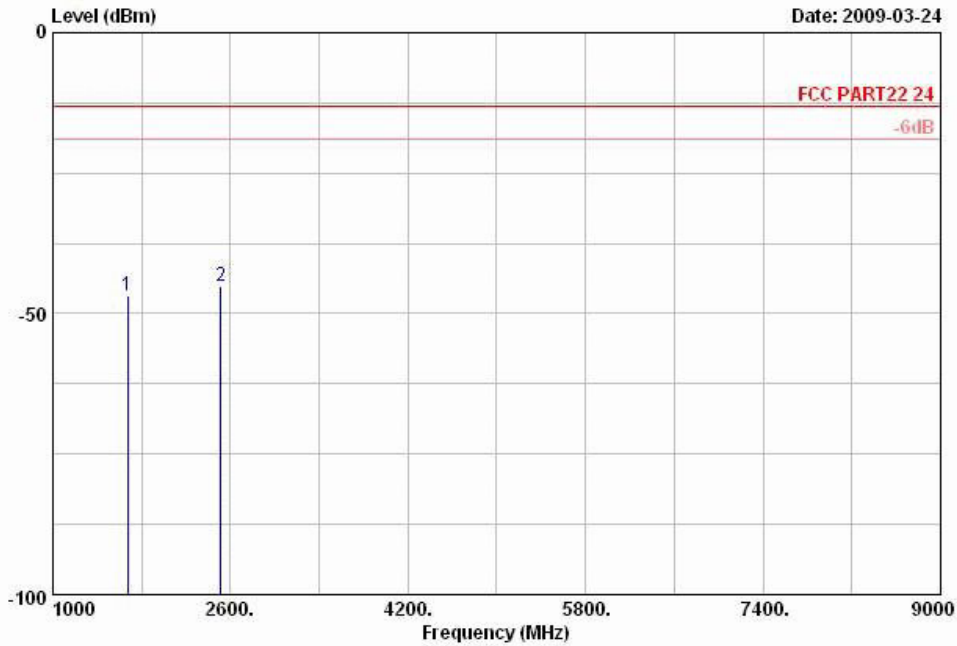

Site : 03CH01-KS  
 Condition: FCC PART22 24 HF EIRP FACTOR-09020 HORIZONTAL

Frequency ( MHz )	ERP ( dBm )	Limit ( dBm )	Over Limit ( dB )	SPA Reading ( dBm )	S.G. Power ( dBm )	TX Cable loss ( dB )	TX Antenna Gain ( dBi )	Polarization ( H/V )	Result
1674	-46.81	-13	-33.81	-54.61	-50.02	0.69	6.05	H	Pass
2510	-45.23	-13	-32.23	-53.64	-48.03	0.82	5.77	H	Pass



<b>Band :</b>	GSM850	<b>Temperature :</b>	18~19°C
<b>Test Mode :</b>	GPRS 8 Link	<b>Relative Humidity :</b>	38~39%
<b>Test Engineer :</b>	Peter Qiu	<b>Polarization :</b>	Vertical
<b>Remark :</b>	Spurious emissions within 30-1000MHz were found more than 20dB below limit line.		

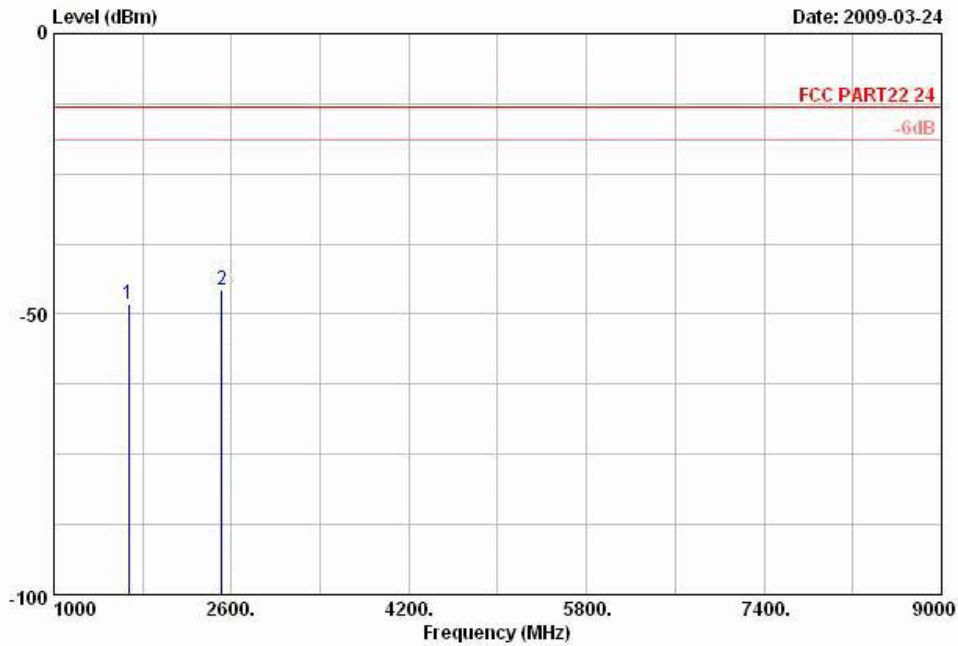

Site : 03CH01-K5  
 Condition: FCC PART22 24 HF EIRP FACTOR-09020 VERTICAL

Frequency ( MHz )	ERP ( dBm )	Limit ( dBm )	Over Limit ( dB )	SPA Reading ( dBm )	S.G. Power ( dBm )	TX Cable loss ( dB )	TX Antenna Gain ( dBi )	Polarization ( H/V )	Result
1672	-48.18	-13	-35.18	-55.98	-51.39	0.69	6.05	V	Pass
2510	-45.81	-13	-32.81	-54.22	-48.61	0.82	5.77	V	Pass



<b>Band :</b>	GSM850	<b>Temperature :</b>	18~19°C
<b>Test Mode :</b>	EDGE 8 Link	<b>Relative Humidity :</b>	38~39%
<b>Test Engineer :</b>	Peter Qiu	<b>Polarization :</b>	Horizontal
<b>Remark :</b>	Spurious emissions within 30-1000MHz were found more than 20dB below limit line.		

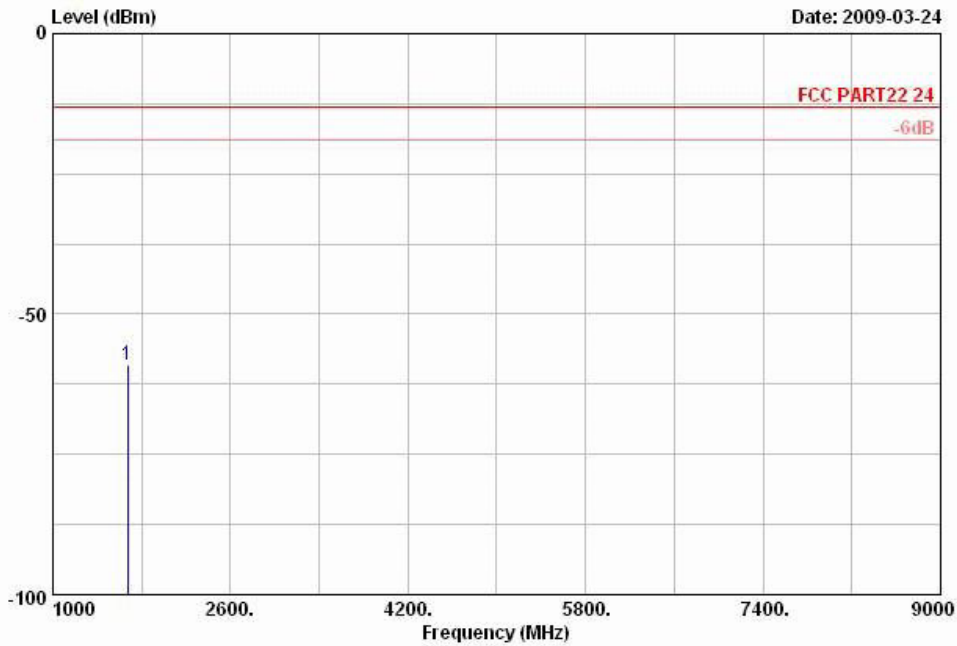

Site : 03CH01-K5  
 Condition: FCC PART22 24 HF EIRP FACTOR-09020 HORIZONTAL

Frequency ( MHz )	ERP ( dBm )	Limit ( dBm )	Over Limit ( dB )	SPA Reading ( dBm )	S.G. Power ( dBm )	TX Cable loss ( dB )	TX Antenna Gain ( dBi )	Polarization ( H/V )	Result
1674	-58.97	-13	-45.97	-66.77	-62.18	0.69	6.05	H	Pass



<b>Band :</b>	GSM850	<b>Temperature :</b>	18~19°C
<b>Test Mode :</b>	EDGE 8 Link	<b>Relative Humidity :</b>	38~39%
<b>Test Engineer :</b>	Peter Qiu	<b>Polarization :</b>	Vertical
<b>Remark :</b>	Spurious emissions within 30-1000MHz were found more than 20dB below limit line.		

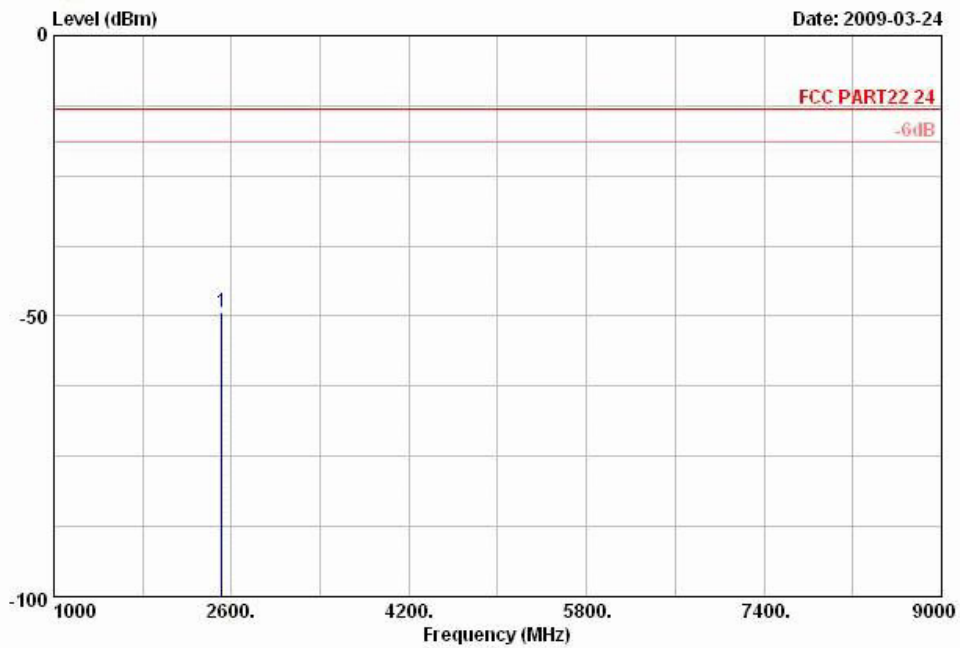

Site : 03CH01-K5  
 Condition: FCC PART22 24 HF EIRP FACTOR-09020 VERTICAL

Frequency ( MHz )	ERP ( dBm )	Limit ( dBm )	Over Limit ( dB )	SPA Reading ( dBm )	S.G. Power ( dBm )	TX Cable loss ( dB )	TX Antenna Gain ( dBi )	Polarization ( H/V )	Result
2510	-49.25	-13	-36.25	-57.66	-52.05	0.82	5.77	V	Pass



<b>Band :</b>	GSM1900	<b>Temperature :</b>	18~19°C
<b>Test Mode :</b>	GPRS 8 Link	<b>Relative Humidity :</b>	38~39%
<b>Test Engineer :</b>	Peter Qiu	<b>Polarization :</b>	Horizontal
<b>Remark :</b>	Spurious emissions within 30-1000MHz were found more than 20dB below limit line.		

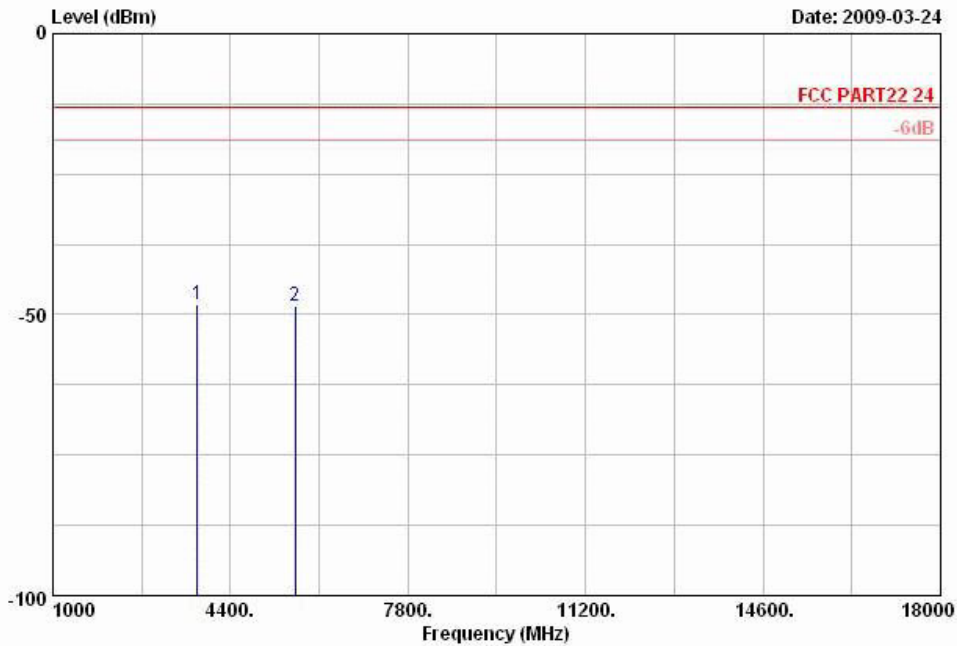

Site : 03CH01-KS  
 Condition: FCC PART22 24 HF EIRP FACTOR-09020 HORIZONTAL

Frequency ( MHz )	EIRP ( dBm )	Limit ( dBm )	Over Limit ( dB )	SPA Reading ( dBm )	S.G. Power ( dBm )	TX Cable loss ( dB )	TX Antenna Gain ( dBi )	Polarization ( H/V )	Result
3760	-48.18	-13	-35.18	-61.89	-56.11	0.11	8.04	H	Pass
5639	-48.43	-13	-35.43	-62.84	-57.21	1.22	10.00	H	Pass



<b>Band :</b>	GSM1900	<b>Temperature :</b>	18~19°C
<b>Test Mode :</b>	GPRS 8 Link	<b>Relative Humidity :</b>	38~39%
<b>Test Engineer :</b>	Peter Qiu	<b>Polarization :</b>	Vertical
<b>Remark :</b>	Spurious emissions within 30-1000MHz were found more than 20dB below limit line.		

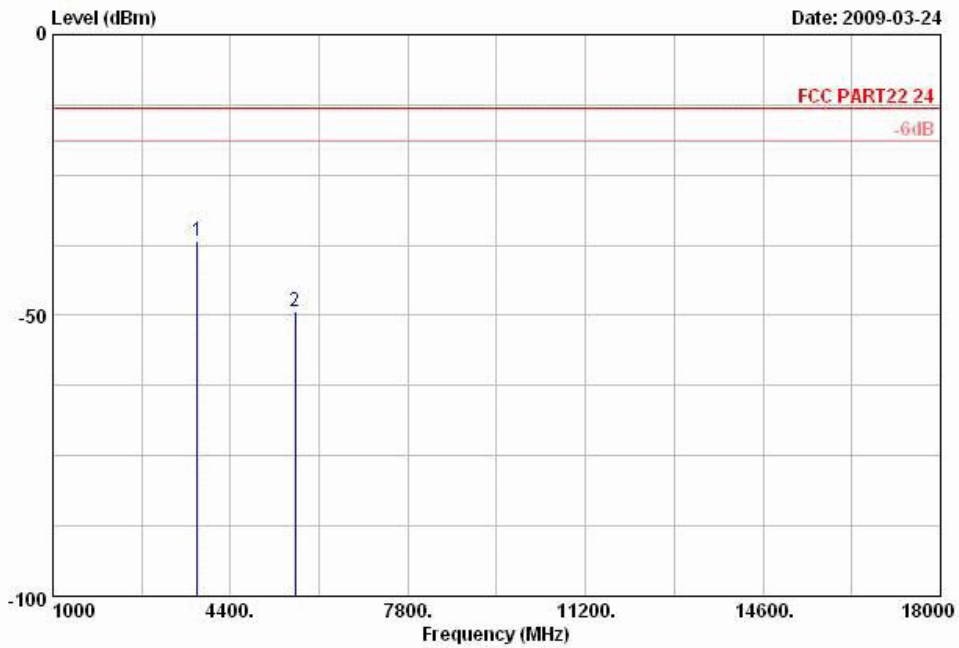

Site : 03CH01-KS  
 Condition: FCC PART22 24 HF EIRP FACTOR-09020 VERTICAL

Frequency ( MHz )	EIRP ( dBm )	Limit ( dBm )	Over Limit ( dB )	SPA Reading ( dBm )	S.G. Power ( dBm )	TX Cable loss ( dB )	TX Antenna Gain ( dBi )	Polarization ( H/V )	Result
3760	-36.90	-13	-23.90	-50.61	-44.83	0.11	8.04	V	Pass
5639	-49.39	-13	-36.39	-63.80	-58.17	1.22	10.00	V	Pass





<b>Band :</b>	GSM1900	<b>Temperature :</b>	18~19°C
<b>Test Mode :</b>	EDGE 8 Link	<b>Relative Humidity :</b>	38~39%
<b>Test Engineer :</b>	Peter Qiu	<b>Polarization :</b>	Horizontal
<b>Remark :</b>	Spurious emissions within 30-1000MHz were found more than 20dB below limit line.		

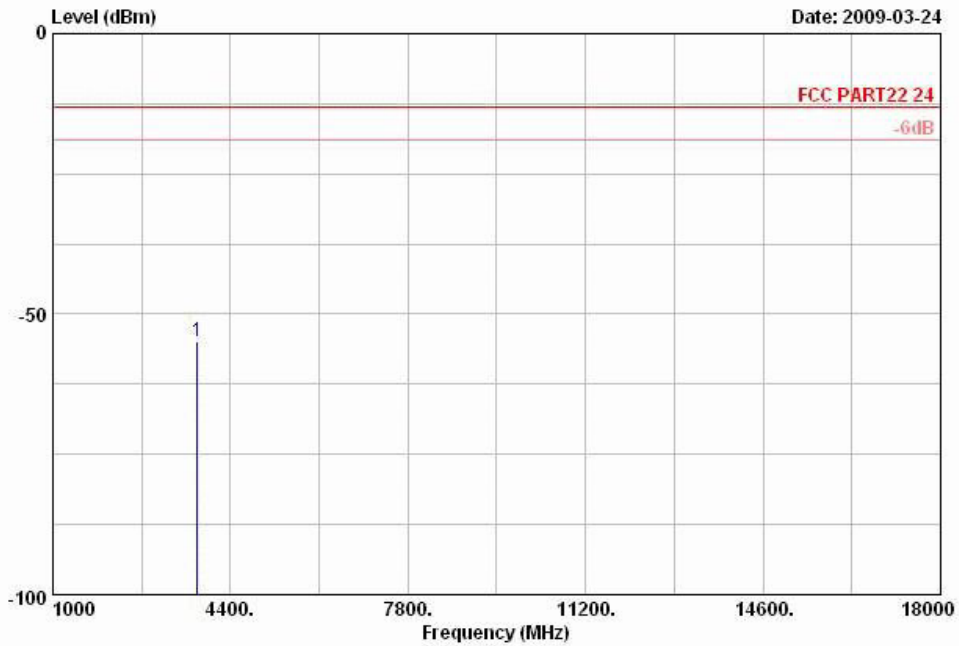

Site : 03CH01-K5  
 Condition: FCC PART22 24 HF EIRP FACTOR-09020 HORIZONTAL

Frequency ( MHz )	EIRP ( dBm )	Limit ( dBm )	Over Limit ( dB )	SPA Reading ( dBm )	S.G. Power ( dBm )	TX Cable loss ( dB )	TX Antenna Gain ( dBi )	Polarization ( H/V )	Result
3760	-54.85	-13	-41.85	-68.56	-62.78	0.11	8.04	H	Pass



<b>Band :</b>	GSM1900	<b>Temperature :</b>	18~19°C
<b>Test Mode :</b>	EDGE 8 Link	<b>Relative Humidity :</b>	38~39%
<b>Test Engineer :</b>	Peter Qiu	<b>Polarization :</b>	Vertical
<b>Remark :</b>	Spurious emissions within 30-1000MHz were found more than 20dB below limit line.		

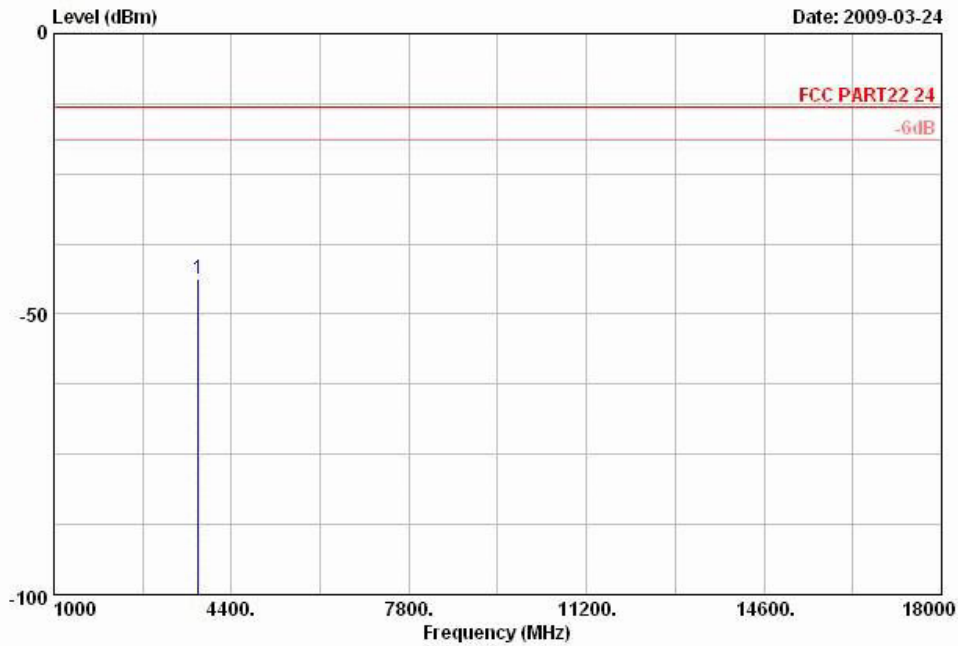

Site : 03CH01-K5  
 Condition: FCC PART22 24 HF EIRP FACTOR-09020 VERTICAL

Frequency ( MHz )	EIRP ( dBm )	Limit ( dBm )	Over Limit ( dB )	SPA Reading ( dBm )	S.G. Power ( dBm )	TX Cable loss ( dB )	TX Antenna Gain ( dBi )	Polarization ( H/V )	Result
3760	-43.61	-13	-30.61	-57.32	-51.54	0.11	8.04	V	Pass



<b>Band :</b>	WCDMA Band V	<b>Temperature :</b>	18~19°C
<b>Test Mode :</b>	WCDMA Link	<b>Relative Humidity :</b>	38~39%
<b>Test Engineer :</b>	Peter Qiu	<b>Polarization :</b>	Horizontal
<b>Remark :</b>	Spurious emissions within 30-1000MHz were found more than 20dB below limit line.		

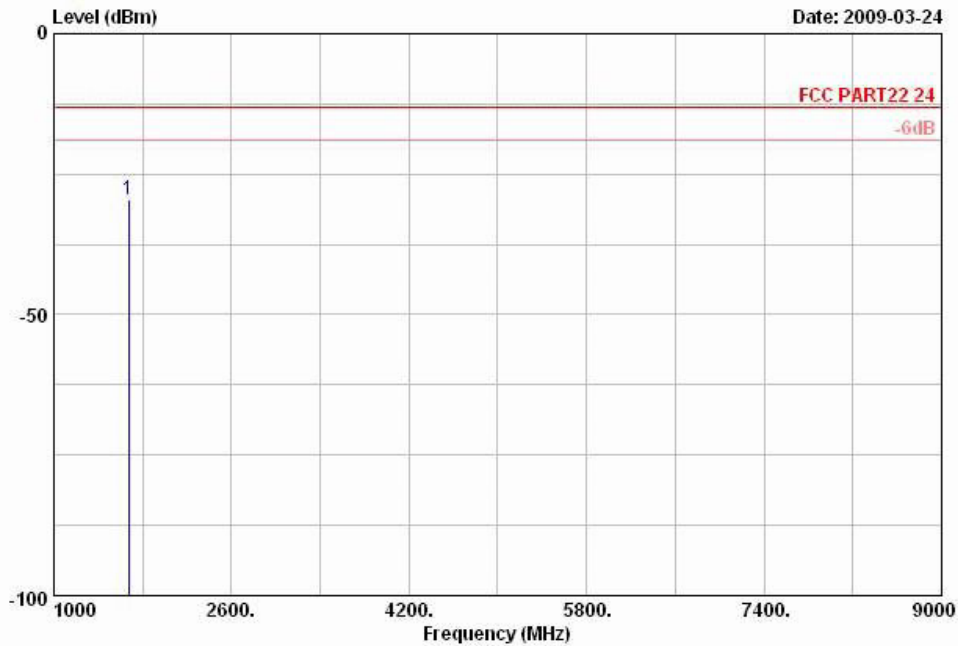

Site : 03CH01-KS  
 Condition: FCC PART22 24 HF EIRP FACTOR-09020 HORIZONTAL

Frequency ( MHz )	ERP ( dBm )	Limit ( dBm )	Over Limit ( dB )	SPA Reading ( dBm )	S.G. Power ( dBm )	TX Cable loss ( dB )	TX Antenna Gain ( dBi )	Polarization ( H/V )	Result
1676	-29.50	-13	-16.50	-37.30	-32.71	0.69	6.05	H	Pass



<b>Band :</b>	WCDMA Band V	<b>Temperature :</b>	18~19°C
<b>Test Mode :</b>	WCDMA Link	<b>Relative Humidity :</b>	38~39%
<b>Test Engineer :</b>	Peter Qiu	<b>Polarization :</b>	Vertical
<b>Remark :</b>	Spurious emissions within 30-1000MHz were found more than 20dB below limit line.		

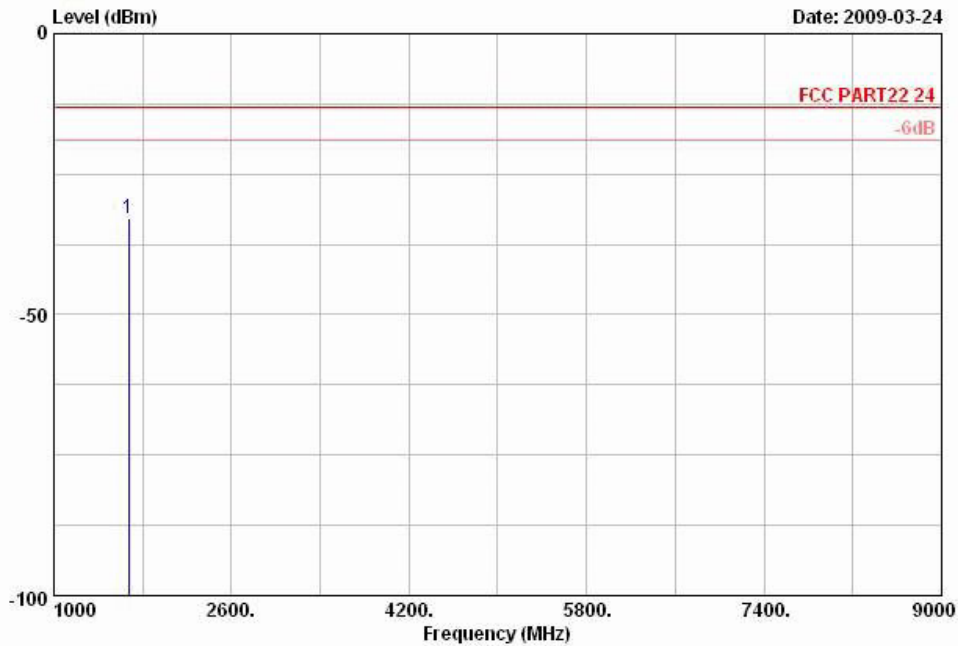

Site : 03CH01-KS  
 Condition: FCC PART22 24 HF EIRP FACTOR-09020 VERTICAL

Frequency ( MHz )	ERP ( dBm )	Limit ( dBm )	Over Limit ( dB )	SPA Reading ( dBm )	S.G. Power ( dBm )	TX Cable loss ( dB )	TX Antenna Gain ( dBi )	Polarization ( H/V )	Result
1674	-32.77	-13	-19.77	-40.57	-35.98	0.69	6.05	V	Pass



<b>Band :</b>	WCDMA Band V	<b>Temperature :</b>	18~19°C
<b>Test Mode :</b>	HSDPA Link	<b>Relative Humidity :</b>	38~39%
<b>Test Engineer :</b>	Peter Qiu	<b>Polarization :</b>	Horizontal
<b>Remark :</b>	Spurious emissions within 30-1000MHz were found more than 20dB below limit line.		

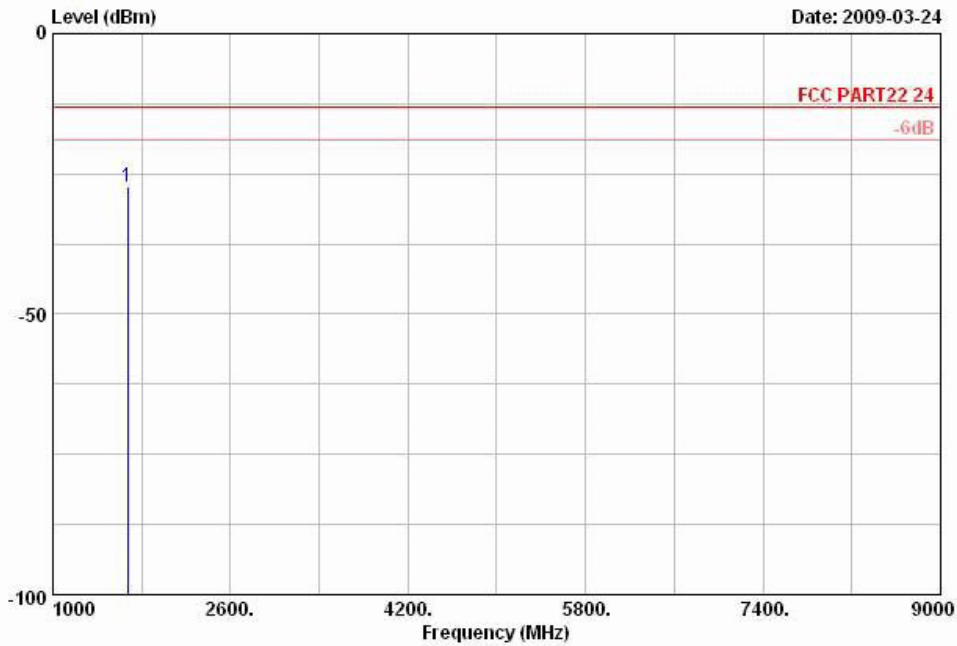

Site : 03CH01-K5  
 Condition: FCC PART22 24 HF EIRP FACTOR-09020 HORIZONTAL

Frequency ( MHz )	ERP ( dBm )	Limit ( dBm )	Over Limit ( dB )	SPA Reading ( dBm )	S.G. Power ( dBm )	TX Cable loss ( dB )	TX Antenna Gain ( dBi )	Polarization ( H/V )	Result
1676	-27.41	-13	-14.41	-35.21	-30.62	0.69	6.05	H	Pass



<b>Band :</b>	WCDMA Band V	<b>Temperature :</b>	18~19°C
<b>Test Mode :</b>	HSDPA Link	<b>Relative Humidity :</b>	38~39%
<b>Test Engineer :</b>	Peter Qiu	<b>Polarization :</b>	Vertical
<b>Remark :</b>	Spurious emissions within 30-1000MHz were found more than 20dB below limit line.		

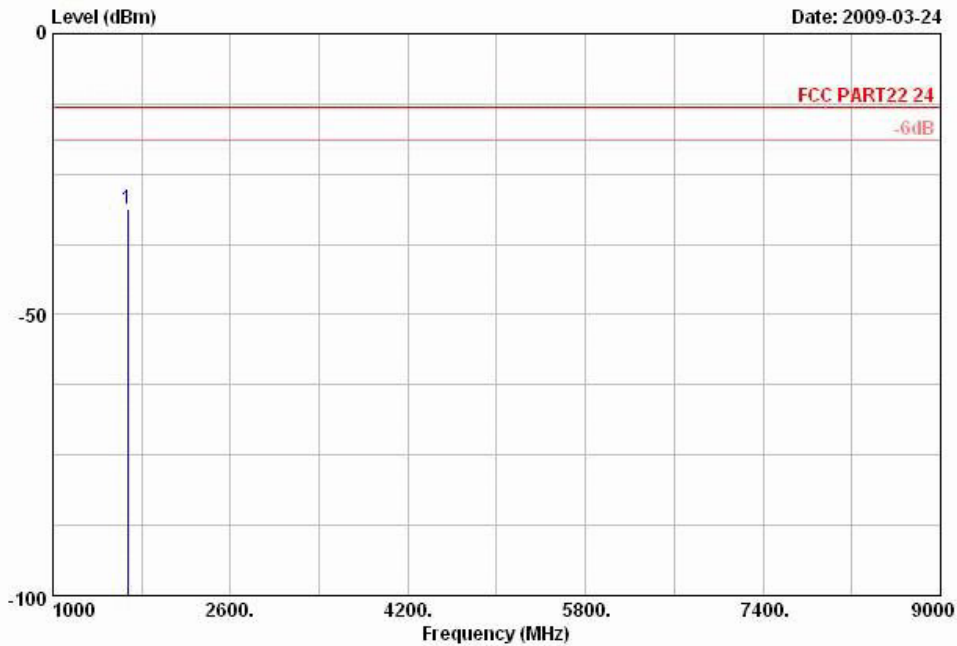

Site : 03CH01-KS  
 Condition: FCC PART22 24 HF EIRP FACTOR-09020 VERTICAL

Frequency ( MHz )	ERP ( dBm )	Limit ( dBm )	Over Limit ( dB )	SPA Reading ( dBm )	S.G. Power ( dBm )	TX Cable loss ( dB )	TX Antenna Gain ( dBi )	Polarization ( H/V )	Result
1674	-31.29	-13	-18.29	-39.09	-34.50	0.69	6.05	V	Pass



<b>Band :</b>	WCDMA Band V	<b>Temperature :</b>	18~19°C
<b>Test Mode :</b>	HSUPA Link	<b>Relative Humidity :</b>	38~39%
<b>Test Engineer :</b>	Peter Qiu	<b>Polarization :</b>	Horizontal
<b>Remark :</b>	Spurious emissions within 30-1000MHz were found more than 20dB below limit line.		

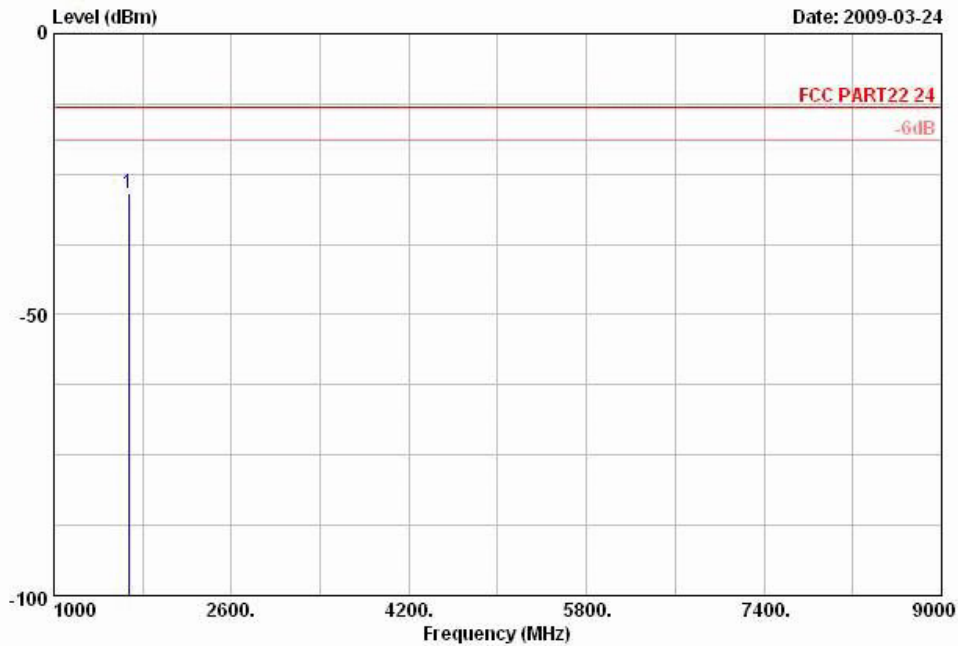

Site : 03CH01-KS  
 Condition: FCC PART22 24 HF EIRP FACTOR-09020 HORIZONTAL

Frequency ( MHz )	ERP ( dBm )	Limit ( dBm )	Over Limit ( dB )	SPA Reading ( dBm )	S.G. Power ( dBm )	TX Cable loss ( dB )	TX Antenna Gain ( dBi )	Polarization ( H/V )	Result
1676	-28.28	-13	-15.28	-36.08	-31.49	0.69	6.05	H	Pass



<b>Band :</b>	WCDMA Band V	<b>Temperature :</b>	18~19°C
<b>Test Mode :</b>	HSUPA Link	<b>Relative Humidity :</b>	38~39%
<b>Test Engineer :</b>	Peter Qiu	<b>Polarization :</b>	Vertical
<b>Remark :</b>	Spurious emissions within 30-1000MHz were found more than 20dB below limit line.		

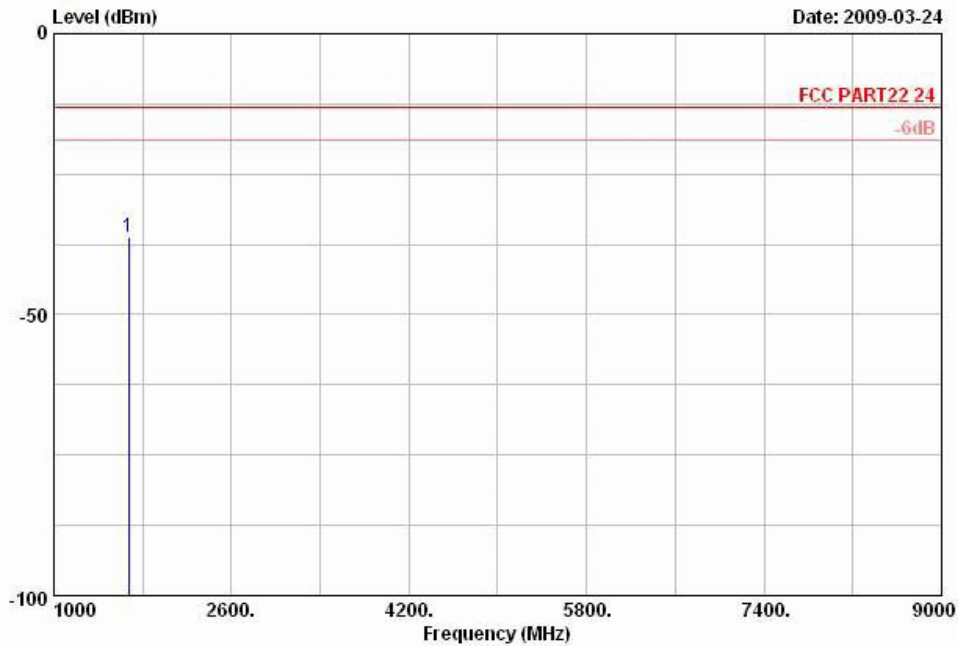

Site : 03CH01-KS  
 Condition: FCC PART22 24 HF EIRP FACTOR-09020 VERTICAL

Frequency ( MHz )	ERP ( dBm )	Limit ( dBm )	Over Limit ( dB )	SPA Reading ( dBm )	S.G. Power ( dBm )	TX Cable loss ( dB )	TX Antenna Gain ( dBi )	Polarization ( H/V )	Result
1674	-36.13	-13	-23.13	-43.93	-39.34	0.69	6.05	V	Pass





<b>Band :</b>	WCDMA Band II	<b>Temperature :</b>	18~19°C
<b>Test Mode :</b>	WCDMA Link	<b>Relative Humidity :</b>	38~39%
<b>Test Engineer :</b>	Peter Qiu	<b>Polarization :</b>	Horizontal
<b>Remark :</b>	Spurious emissions within 30-1000MHz were found more than 20dB below limit line.		

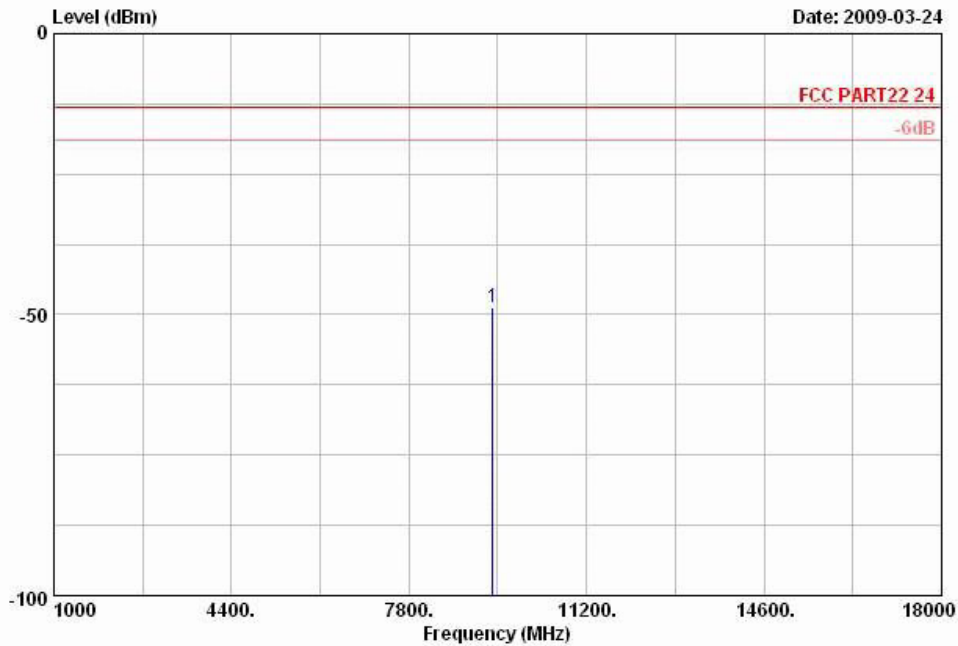

Site : 03CH01-KS  
 Condition: FCC PART22 24 HF EIRP FACTOR-09020 HORIZONTAL

Frequency ( MHz )	EIRP ( dBm )	Limit ( dBm )	Over Limit ( dB )	SPA Reading ( dBm )	S.G. Power ( dBm )	TX Cable loss ( dB )	TX Antenna Gain ( dBi )	Polarization ( H/V )	Result
9407	-48.81	-13	-35.81	-68.38	-60.22	1.55	12.96	H	Pass



<b>Band :</b>	WCDMA Band II	<b>Temperature :</b>	18~19°C
<b>Test Mode :</b>	WCDMA Link	<b>Relative Humidity :</b>	38~39%
<b>Test Engineer :</b>	Peter Qiu	<b>Polarization :</b>	Vertical
<b>Remark :</b>	Spurious emissions within 30-1000MHz were found more than 20dB below limit line.		

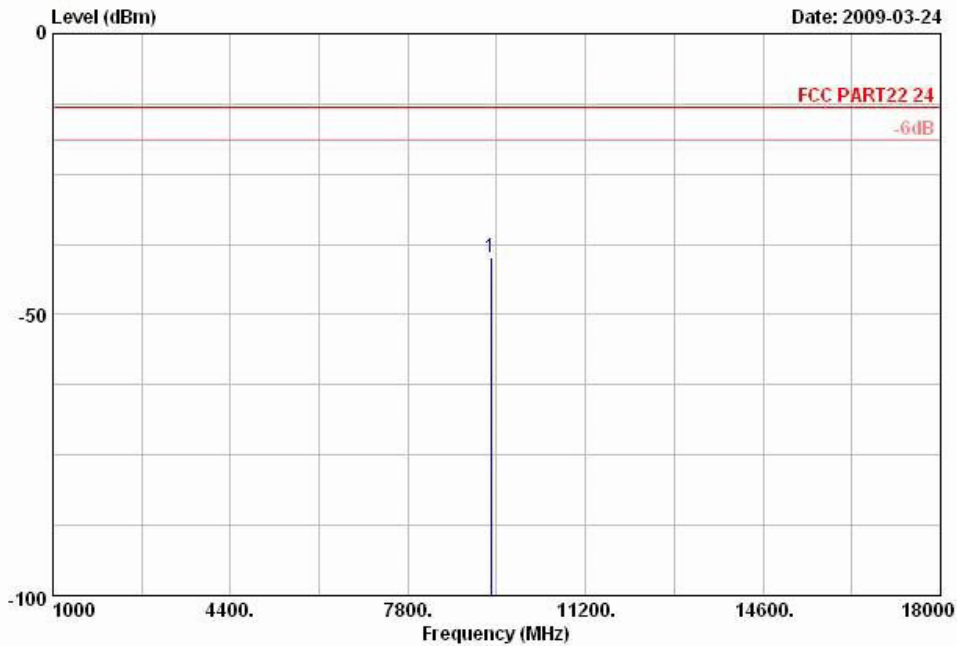

Site : 03CH01-KS  
 Condition: FCC PART22 24 HF EIRP FACTOR-09020 VERTICAL

Frequency ( MHz )	EIRP ( dBm )	Limit ( dBm )	Over Limit ( dB )	SPA Reading ( dBm )	S.G. Power ( dBm )	TX Cable loss ( dB )	TX Antenna Gain ( dBi )	Polarization ( H/V )	Result
9395	-39.71	-13	-26.71	-59.28	-51.12	1.55	12.96	V	Pass



<b>Band :</b>	WCDMA Band II	<b>Temperature :</b>	18~19°C
<b>Test Mode :</b>	HSDPA Link	<b>Relative Humidity :</b>	38~39%
<b>Test Engineer :</b>	Peter Qiu	<b>Polarization :</b>	Horizontal
<b>Remark :</b>	Spurious emissions within 30-1000MHz were found more than 20dB below limit line.		

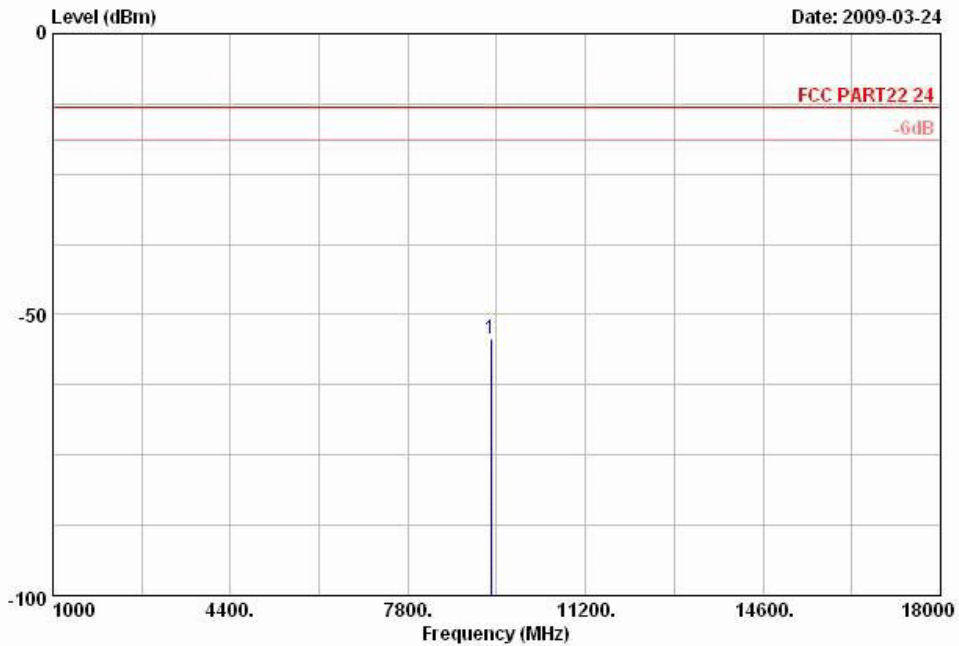

Site : 03CH01-KS  
 Condition: FCC PART22 24 HF EIRP FACTOR-09020 HORIZONTAL

Frequency ( MHz )	EIRP ( dBm )	Limit ( dBm )	Over Limit ( dB )	SPA Reading ( dBm )	S.G. Power ( dBm )	TX Cable loss ( dB )	TX Antenna Gain ( dBi )	Polarization ( H/V )	Result
9395	-54.26	-13	-41.26	-73.83	-65.67	1.55	12.96	H	Pass



<b>Band :</b>	WCDMA Band II	<b>Temperature :</b>	18~19°C
<b>Test Mode :</b>	HSDPA Link	<b>Relative Humidity :</b>	38~39%
<b>Test Engineer :</b>	Peter Qiu	<b>Polarization :</b>	Vertical
<b>Remark :</b>	Spurious emissions within 30-1000MHz were found more than 20dB below limit line.		

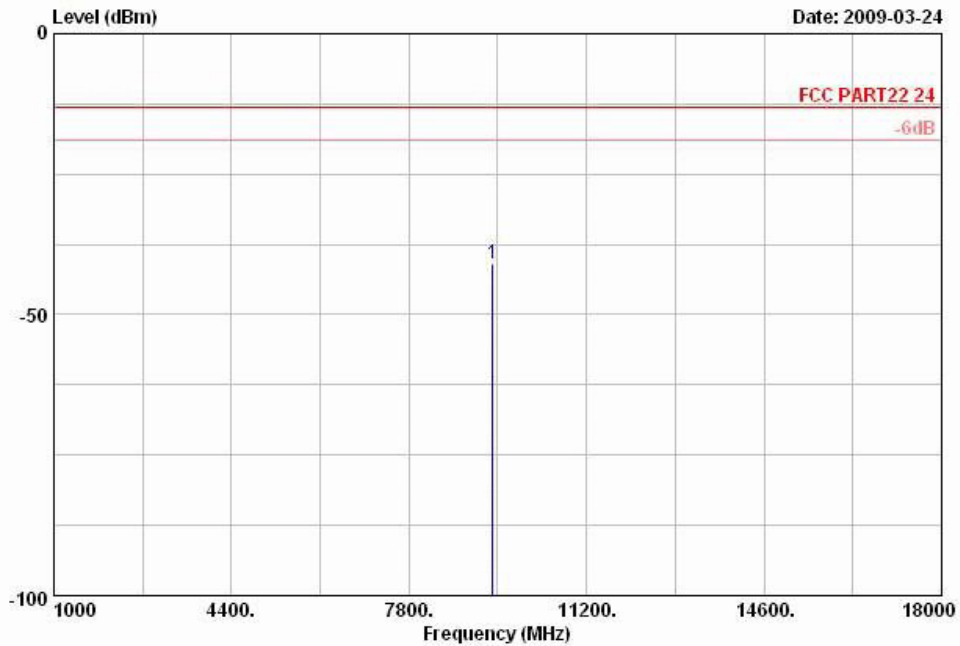

Site : 03CH01-KS  
 Condition: FCC PART22 24 HF EIRP FACTOR-09020 VERTICAL

Frequency ( MHz )	EIRP ( dBm )	Limit ( dBm )	Over Limit ( dB )	SPA Reading ( dBm )	S.G. Power ( dBm )	TX Cable loss ( dB )	TX Antenna Gain ( dBi )	Polarization ( H/V )	Result
9407	-40.97	-13	-27.97	-60.54	-52.38	1.55	12.96	V	Pass



<b>Band :</b>	WCDMA Band II	<b>Temperature :</b>	18~19°C
<b>Test Mode :</b>	HSUPA Link	<b>Relative Humidity :</b>	38~39%
<b>Test Engineer :</b>	Peter Qiu	<b>Polarization :</b>	Horizontal
<b>Remark :</b>	Spurious emissions within 30-1000MHz were found more than 20dB below limit line.		

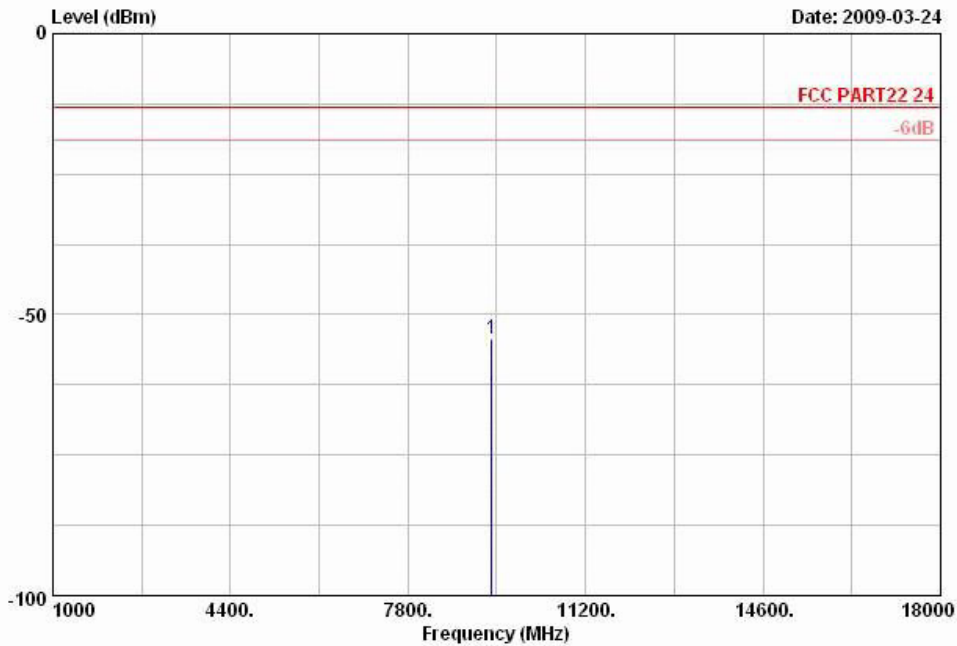

Site : 03CH01-KS  
 Condition: FCC PART22 24 HF EIRP FACTOR-09020 HORIZONTAL

Frequency ( MHz )	EIRP ( dBm )	Limit ( dBm )	Over Limit ( dB )	SPA Reading ( dBm )	S.G. Power ( dBm )	TX Cable loss ( dB )	TX Antenna Gain ( dBi )	Polarization ( H/V )	Result
9407	-54.40	-13	-41.40	-73.97	-65.81	1.55	12.96	H	Pass



<b>Band :</b>	WCDMA Band II	<b>Temperature :</b>	18~19°C
<b>Test Mode :</b>	HSUPA Link	<b>Relative Humidity :</b>	38~39%
<b>Test Engineer :</b>	Peter Qiu	<b>Polarization :</b>	Vertical
<b>Remark :</b>	Spurious emissions within 30-1000MHz were found more than 20dB below limit line.		

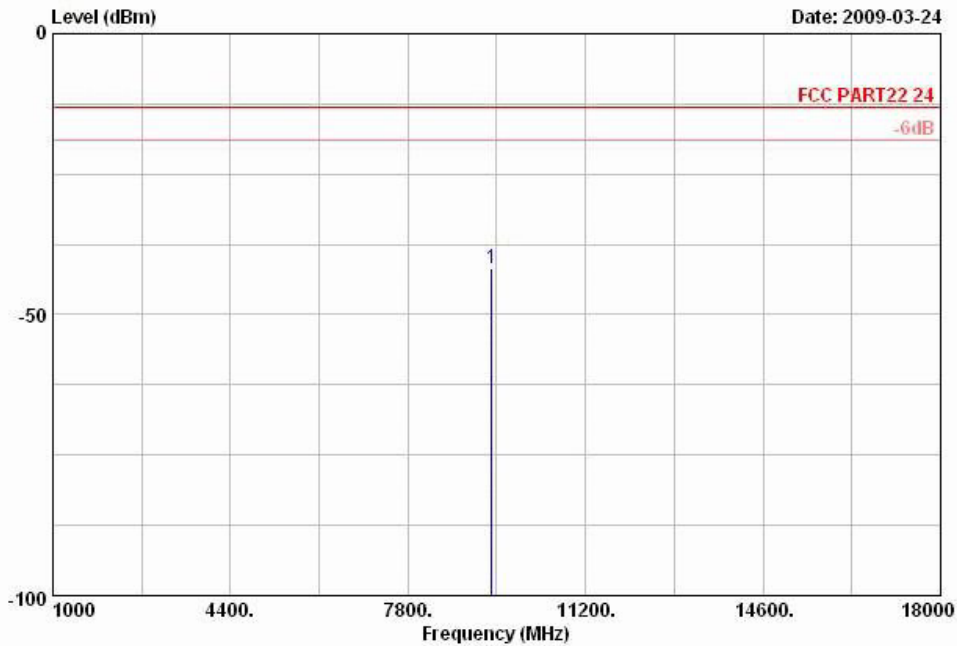

Site : 03CH01-KS  
 Condition: FCC PART22 24 HF EIRP FACTOR-09020 VERTICAL

Frequency ( MHz )	EIRP ( dBm )	Limit ( dBm )	Over Limit ( dB )	SPA Reading ( dBm )	S.G. Power ( dBm )	TX Cable loss ( dB )	TX Antenna Gain ( dBi )	Polarization ( H/V )	Result
9407	-41.67	-13	-28.67	-61.24	-53.08	1.55	12.96	V	Pass



<b>Band :</b>	GSM850	<b>Temperature :</b>	18~19°C
<b>Test Mode :</b>	GPRS Link + WLAN Link	<b>Relative Humidity :</b>	38~39%
<b>Test Engineer :</b>	Peter Qiu	<b>Polarization :</b>	Horizontal
<b>Remark :</b>	Spurious emissions within 30-1000MHz were found more than 20dB below limit line.		

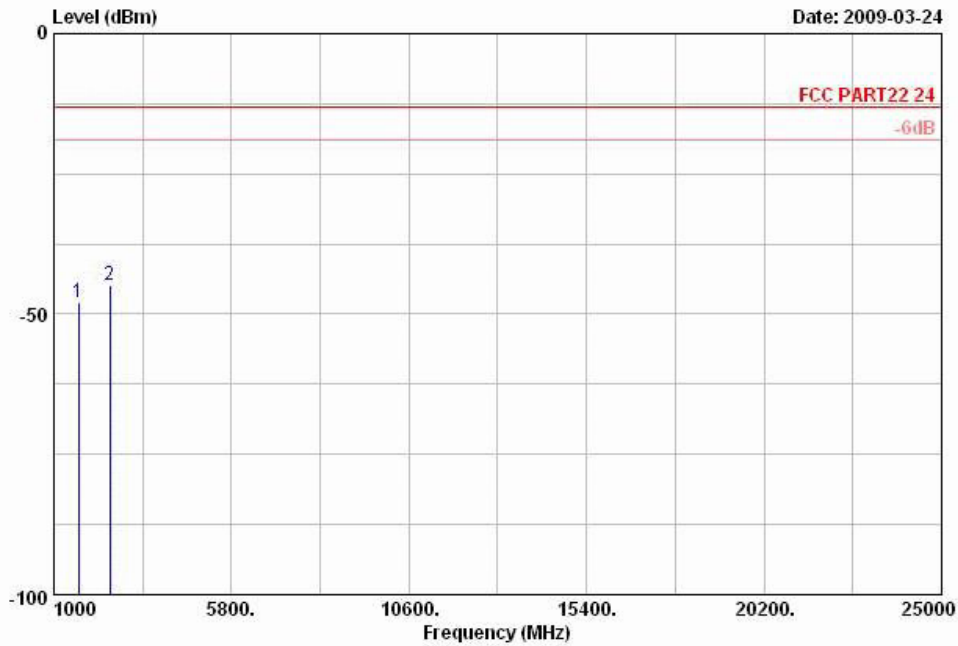

Site : 03CH01-K5  
 Condition: FCC PART22 24 HF EIRP FACTOR-09020 HORIZONTAL

Frequency ( MHz )	ERP ( dBm )	Limit ( dBm )	Over Limit ( dB )	SPA Reading ( dBm )	S.G. Power ( dBm )	TX Cable loss ( dB )	TX Antenna Gain ( dBi )	Polarization ( H/V )	Result
1674	-47.95	-13	-34.95	-55.75	-51.16	0.69	6.05	H	Pass
2510	-44.79	-13	-31.79	-53.20	-47.59	0.82	5.77	H	Pass



<b>Band :</b>	GSM850	<b>Temperature :</b>	18~19°C
<b>Test Mode :</b>	GPRS Link + WLAN Link	<b>Relative Humidity :</b>	38~39%
<b>Test Engineer :</b>	Peter Qiu	<b>Polarization :</b>	Vertical
<b>Remark :</b>	Spurious emissions within 30-1000MHz were found more than 20dB below limit line.		

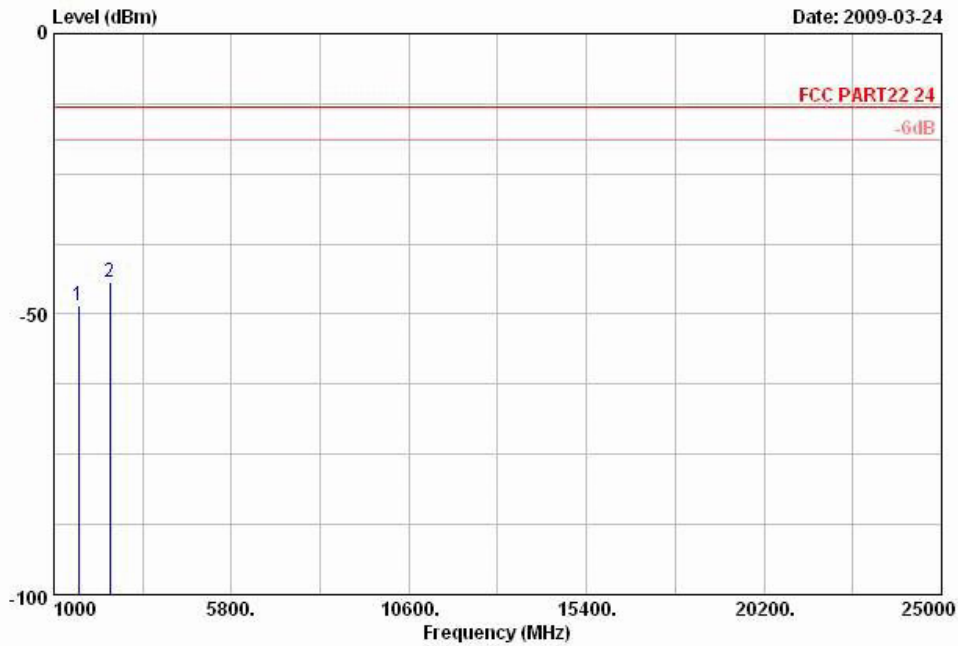

Site : 03CH01-K5  
 Condition: FCC PART22 24 HF EIRP FACTOR-09020 VERTICAL

Frequency ( MHz )	ERP ( dBm )	Limit ( dBm )	Over Limit ( dB )	SPA Reading ( dBm )	S.G. Power ( dBm )	TX Cable loss ( dB )	TX Antenna Gain ( dBi )	Polarization ( H/V )	Result
1674	-48.48	-13	-35.48	-56.28	-51.69	0.69	6.05	V	Pass
2510	-44.25	-13	-31.25	-52.66	-47.05	0.82	5.77	V	Pass



## 3.6 Frequency Stability Measurement

### 3.6.1 Description of Frequency Stability Measurement

The frequency stability shall be measured by variation of ambient temperature and variation of primary supply voltage to ensure that the fundamental emission stays within the authorized frequency block. The frequency stability of the transmitter shall be maintained within  $\pm 0.00025\%$  ( $\pm 2.5\text{ppm}$ ) of the center frequency.

### 3.6.2 Measuring Instruments

See list of measuring instruments of this test report.

### 3.6.3 Test Procedures for Temperature Variation

1. The EUT was set up in the thermal chamber and connected with the base station.
2. With power OFF, the temperature was decreased to  $-30^{\circ}\text{C}$  and the EUT was stabilized for three hours. Power was applied and the maximum change in frequency was recorded within one minute.
3. With power OFF, the temperature was raised in  $10^{\circ}\text{C}$  step up to  $50^{\circ}\text{C}$ . The EUT was stabilized at each step for at least half an hour. Power was applied and the maximum frequency change was recorded within one minute.
4. If the EUT can not be turned on at  $-30^{\circ}\text{C}$ , the testing lowest temperature will be raised in  $10^{\circ}\text{C}$  step until the EUT can be turned on.

### 3.6.4 Test Procedures for Voltage Variation

1. The EUT was placed in a temperature chamber at  $25\pm 5^{\circ}\text{C}$  and connected with the base station.
2. The power supply voltage to the EUT was varied from BEP to 115% of the nominal value measured at the input to the EUT.
3. The variation in frequency was measured for the worst case.

### 3.6.5 Test Setup

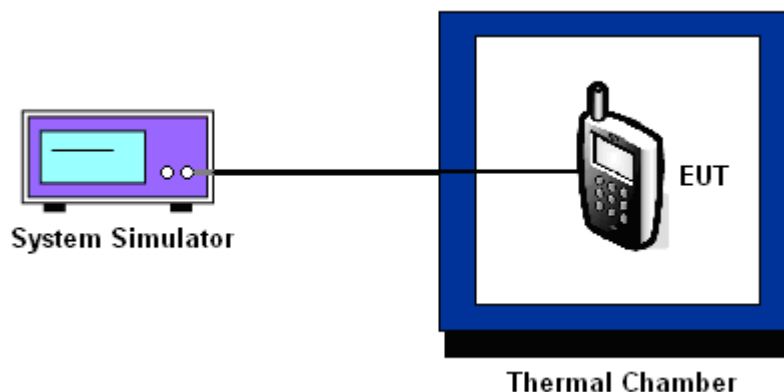



3.6.6 Test Result of Temperature Variation

Band :	GSM 850	Channel :	189
Limit (ppm) :	2.5		

Temperature (°C)	GPRS 8		EDGE 8		Result
	Freq. Dev. (Hz)	Deviation (ppm)	Freq. Dev. (Hz)	Deviation (ppm)	
-30	-26	-0.03	-79	-0.09	PASS
-20	-28	-0.03	-61	-0.07	
-10	-24	-0.03	-53	-0.06	
0	-25	-0.03	-35	-0.04	
10	-24	-0.03	37	0.04	
20	34	0.04	34	0.04	
30	30	0.04	25	0.03	
40	-23	-0.03	16	0.02	
50	-27	-0.03	-33	-0.04	

Band :	GSM 1900	Channel :	661
Limit (ppm) :	2.5		

Temperature (°C)	GPRS 8		EDGE 8		Result
	Freq. Dev. (Hz)	Deviation (ppm)	Freq. Dev. (Hz)	Deviation (ppm)	
-30	-34	-0.02	-68	-0.04	PASS
-20	-26	-0.01	-79	-0.04	
-10	-18	-0.01	-38	-0.02	
0	11	0.01	30	0.02	
10	-16	-0.01	18	0.01	
20	-20	-0.01	23	0.01	
30	-36	-0.02	14	0.01	
40	-39	-0.02	24	0.01	
50	-77	-0.04	17	0.01	



<b>Band :</b>	WCDMA Band V	<b>Channel :</b>	4182
<b>Limit (ppm) :</b>	2.5		

Temperature (°C)	WCDMA		Result
	Freq. Dev. (Hz)	Deviation (ppm)	
-30	13	0.02	PASS
-20	-18	-0.02	
-10	-12	-0.01	
0	15	0.02	
10	18	0.02	
20	21	0.02	
30	-12	-0.01	
40	14	0.02	
50	-19	-0.02	

<b>Band :</b>	WCDMA Band II	<b>Channel :</b>	9400
<b>Limit (ppm) :</b>	2.5		

Temperature (°C)	HSDPA		Result
	Freq. Dev. (Hz)	Deviation (ppm)	
-30	27	0.01	PASS
-20	29	0.02	
-10	-31	-0.02	
0	-38	-0.02	
10	-32	-0.02	
20	39	0.02	
30	24	0.01	
40	39	0.02	
50	34	0.02	



3.6.7 Test Result of Voltage Variation

Band & Channel	Mode	Voltage (Volt)	Freq. Dev. (Hz)	Deviation (ppm)	Limit (ppm)	Result
GSM 850 CH189	GPRS 8	120	37.0	0.04	2.5	PASS
		102	-33.0	-0.04		
		138	-33.0	-0.04		
	EDGE 8	120	36.0	0.04		
		102	-34.0	-0.04		
		138	-59.0	-0.07		
GSM 1900 CH661	GPRS 8	120	-21.0	-0.01		
		102	-55.0	-0.03		
		138	-70.0	-0.04		
	EDGE 8	120	-23.0	-0.01		
		102	10.0	0.01		
		138	-62.0	-0.03		
WCDMA Band V CH4182	WCDMA	120	37.0	0.04		
		102	-33.0	-0.04		
		138	-33.0	-0.04		
WCDMA Band II CH9400	HSDPA	120	33.0	0.02		
		102	34.0	0.02		
		138	-33.0	-0.02		



## 4 List of Measuring Equipment

Instrument	Manufacturer	Model No.	Serial No.	Characteristics	Calibration Date	Due Date	Remark
Spectrum Analyzer	R&S	FSP40	100319	9kHz~40GHz	Dec. 08, 2008	Dec. 07, 2009	Conducted (TH01-KS)
Power Meter	Agilent	E4416A	MY45101555	N/A	Jun. 18, 2007	Jun. 17, 2009	Conducted (TH01-KS)
Power Sensor	Agilent	E9327A	MY44421198	N/A	Jun. 12, 2007	Jun. 11, 2009	Conducted (TH01-KS)
Thermal Chamber	Ten Billion	TTC-B3S	TBN-930701	N/A	Dec. 15, 2008	Dec. 14, 2009	Conducted (TH01-KS)
DC Power Supply	TOPWARD	3306D	N/A	N/A	N/A	N/A	Conducted (TH01-KS)
System Simulator	R&S	CMU200	837587/066	Full-Band/BT	Jan. 08, 2009	Jan. 07, 2011	Radiation (03CH01-KS)
Spectrum Analyzer	R&S	ESCI	100534	9kHz – 2.75GHz	Dec. 08, 2008	Dec. 07, 2009	Radiation (03CH01-KS)
Spectrum Analyzer	R&S	FSP40	100319	9kHz~40GHz	Dec. 08, 2008	Dec. 07, 2009	Radiation (03CH01-KS)
Bilog Antenna	SCHAFFNER	CBL6112D	23182	25MHz~2GHz	Dec. 17, 2008	Dec. 16, 2009	Radiation (03CH01-KS)
Double Ridge Horn Antenna	EMCO	3117	75959	1GHz~18GHz	Dec. 17, 2008	Dec. 16, 2009	Radiation (03CH01-KS)
Amplifier	Wireless	FPA6592G	600006	30MHz~2GHz	Dec. 17, 2008	Dec. 16, 2009	Radiation (03CH01-KS)
Amplifier	Agilent	8449B	3008A02370	1GHz~26.5GHz	Dec. 17, 2008	Dec. 16, 2009	Radiation (03CH01-KS)
Signal Generator	R&S	SMR40	100455	10MHz~40GHz	Aug. 29, 2007	Aug. 28, 2009	Radiation (03CH01-KS)

## 5 Uncertainty of Evaluation

### Uncertainty of Radiated Emission Measurement (30 MHz ~ 1000 MHz)

Contribution	Uncertainty of $x_i$		$u(x_i)$
	dB	Probability Distribution	
Receiver reading	0.41	Normal(k=2)	0.21
Antenna factor calibration	0.83	Normal(k=2)	0.42
Cable loss calibration	0.25	Normal(k=2)	0.13
Pre Amplifier Gain calibration	0.27	Normal(k=2)	0.14
RCV/SPA specification	2.50	Rectangular	0.72
Antenna Factor Interpolation for Frequency	1.00	Rectangular	0.29
Site imperfection	1.43	Rectangular	0.83
Mismatch	+0.39/-0.41	U-shaped	0.28
<b>Combined standard uncertainty Uc(y)</b>	<b>1.27</b>		
<b>Measuring uncertainty for a level of confidence of 95% U=2Uc(y)</b>	<b>2.54</b>		

### Uncertainty of Radiated Emission Measurement (1 GHz ~ 40 GHz)

Contribution	Uncertainty of $x_i$		$u(x_i)$	$C_i$	$C_i * u(x_i)$
	dB	Probability Distribution			
Receiver reading	±0.10	Normal(k=1)	0.10	1	0.10
Antenna factor calibration	±1.70	Normal(k=2)	0.85	1	0.85
Cable loss calibration	±0.50	Normal(k=2)	0.25	1	0.25
Receiver Correction	±2.00	Rectangular	1.15	1	1.15
Antenna Factor Directional	±1.50	Rectangular	0.87	1	0.87
Site imperfection	±2.80	Triangular	1.14	1	1.14
Mismatch Receiver VSWR $\Gamma_1 = 0.197$ Antenna VSWR $\Gamma_2 = 0.194$ Uncertainty = $20 \log(1 - \Gamma_1 * \Gamma_2)$	+0.34/-0.35	U-shaped	0.244	1	0.244
<b>Combined standard uncertainty Uc(y)</b>	<b>2.36</b>				
<b>Measuring uncertainty for a level of confidence of 95% U=2Uc(y)</b>	<b>4.72</b>				

## 6 Certification of TAF Accreditation



Certificate No. : I.1190-081212

財團法人全國認證基金會  
Taiwan Accreditation Foundation

### Certificate of Accreditation

This is to certify that

**Sporton International Inc.**  
**EMC & Wireless Communications Laboratory**  
No.52, Hwa Ya 1st Rd., Hwa Ya Technology Park, Kwei-Shan Hsiang, Tao Yuan Hsien,  
Taiwan, R.O.C.

**is accredited in respect of laboratory**

<b>Accreditation Criteria</b>	: ISO/IEC 17025:2005
<b>Accreditation Number</b>	: 1190
<b>Originally Accredited</b>	: December 15, 2003
<b>Effective Period</b>	: January 10, 2007 to January 09, 2010
<b>Accredited Scope</b>	: Testing Field, see described in the Appendix
<b>Specific Accreditation Program</b>	: Accreditation Program for Designated Testing Laboratory for Commodities Inspection Accreditation Program for Telecommunication Equipment Testing Laboratory Accreditation Program for BSMI Mutual Recognition Arrangement with Foreign Authorities

  
Jay-San Chen  
President, Taiwan Accreditation Foundation  
Date : December 12, 2008

PI, total 18 pages

The Appendix forms an integral part of this Certificate, which shall be invalid when use without the Appendix



## **Appendix A. Photographs of EUT**

Please refer to Sporton report number EP932302 as below.