



# SAR TEST REPORT

No. I15Z40869-SEM01

For

**TCT Mobile Limited**

**HSUPA/HSDPA/UMTS triband/GSM quadband mobile phone**

**Model Name: A463BG**

With

**Hardware Version: PIO**

**Software Version: v3B15**

**FCC ID: RAD549**

**Issued Date: 2015-05-12**

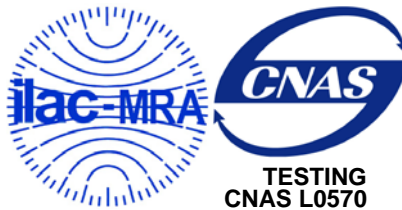

**Note:**

The test results in this test report relate only to the devices specified in this report. This report shall not be reproduced except in full without the written approval of CTTL.

**Test Laboratory:**

CTTL, Telecommunication Technology Labs, Academy of Telecommunication Research, MIIT  
No. 51 Shouxiang Science Building, Xueyuan Road, Haidian District, Beijing, P. R. China100191  
Tel:+86(0)10-62304633-2512,Fax:+86(0)10-62304633-2504  
Email:[ctl\\_terminals@catr.cn](mailto:ctl_terminals@catr.cn), website:[www.chinattl.com](http://www.chinattl.com)



## **REPORT HISTORY**

<b>Report Number</b>	<b>Revision</b>	<b>Issue Date</b>	<b>Description</b>
I15Z40869-SEM01	Rev.0	2015-05-12	Initial creation of test report



## TABLE OF CONTENT

<b>1 TEST LABORATORY</b> .....	<b>5</b>
1.1 TESTING LOCATION .....	5
1.2 TESTING ENVIRONMENT.....	5
1.3 PROJECT DATA .....	5
1.4 SIGNATURE.....	5
<b>2 STATEMENT OF COMPLIANCE</b> .....	<b>6</b>
<b>3 CLIENT INFORMATION</b> .....	<b>8</b>
3.1 APPLICANT INFORMATION .....	8
3.2 MANUFACTURER INFORMATION .....	8
<b>4 EQUIPMENT UNDER TEST (EUT) AND ANCILLARY EQUIPMENT (AE)</b> .....	<b>9</b>
4.1 ABOUT EUT .....	9
4.2 INTERNAL IDENTIFICATION OF EUT USED DURING THE TEST .....	9
4.3 INTERNAL IDENTIFICATION OF AE USED DURING THE TEST .....	9
<b>5 TEST METHODOLOGY</b> .....	<b>10</b>
5.1 APPLICABLE LIMIT REGULATIONS .....	10
5.2 APPLICABLE MEASUREMENT STANDARDS.....	10
<b>6 SPECIFIC ABSORPTION RATE (SAR)</b> .....	<b>11</b>
6.1 INTRODUCTION.....	11
6.2 SAR DEFINITION.....	11
<b>7 TISSUE SIMULATING LIQUIDS</b> .....	<b>12</b>
7.1 TARGETS FOR TISSUE SIMULATING LIQUID .....	12
7.2 DIELECTRIC PERFORMANCE .....	12
<b>8 SYSTEM VERIFICATION</b> .....	<b>17</b>
8.1 SYSTEM SETUP.....	17
8.2 SYSTEM VERIFICATION.....	18
<b>9 MEASUREMENT PROCEDURES</b> .....	<b>19</b>
9.1 TESTS TO BE PERFORMED .....	19
9.2 GENERAL MEASUREMENT PROCEDURE.....	20
9.3 WCDMA MEASUREMENT PROCEDURES FOR SAR .....	21
9.4 BLUETOOTH & WI-FI MEASUREMENT PROCEDURES FOR SAR .....	22
9.5 POWER DRIFT.....	23
<b>10 AREA SCAN BASED 1-G SAR</b> .....	<b>23</b>
10.1 REQUIREMENT OF KDB.....	23
10.2 FAST SAR ALGORITHMS .....	23
<b>11 CONDUCTED OUTPUT POWER</b> .....	<b>24</b>



11.1 MANUFACTURING TOLERANCE .....	24
11.2 GSM MEASUREMENT RESULT .....	27
11.3 WCDMA MEASUREMENT RESULT.....	28
11.4 WI-FI AND BT MEASUREMENT RESULT .....	29
<b>12 SIMULTANEOUS TX SAR CONSIDERATIONS.....</b>	<b>30</b>
12.1 INTRODUCTION.....	30
12.2 TRANSMIT ANTENNA SEPARATION DISTANCES .....	30
12.3 STANDALONE SAR TEST EXCLUSION CONSIDERATIONS .....	31
<b>13 EVALUATION OF SIMULTANEOUS.....</b>	<b>32</b>
<b>14 SAR TEST RESULT .....</b>	<b>33</b>
14.1 THE EVALUATION OF MULTI-BATTERIES .....	33
14.2 SAR RESULTS FOR FAST SAR.....	34
14.3 SAR RESULTS FOR STANDARD PROCEDURE.....	38
<b>15 SAR MEASUREMENT VARIABILITY.....</b>	<b>41</b>
<b>16 MEASUREMENT UNCERTAINTY .....</b>	<b>43</b>
<b>17 MAIN TEST INSTRUMENTS.....</b>	<b>47</b>
<b>ANNEX A GRAPH RESULTS.....</b>	<b>48</b>
<b>ANNEX B SYSTEMVERIFICATION RESULTS .....</b>	<b>72</b>
<b>ANNEX C SAR MEASUREMENT SETUP .....</b>	<b>81</b>
<b>ANNEX D POSITION OF THE WIRELESS DEVICE IN RELATION TO THE PHANTOM .....</b>	<b>87</b>
<b>ANNEX E EQUIVALENT MEDIA RECIPES.....</b>	<b>90</b>
<b>ANNEX F SYSTEM VALIDATION .....</b>	<b>91</b>
<b>ANNEX G PROBE CALIBRATION CERTIFICATE.....</b>	<b>92</b>
<b>ANNEX H DIPOLE CALIBRATION CERTIFICATE .....</b>	<b>103</b>
<b>ANNEX I ACCREDITATION CERTIFICATE.....</b>	<b>135</b>

## 1 Test Laboratory

### 1.1 Testing Location

Company Name:	CTTL(Shouxiang)
Address:	No. 51 Shouxiang Science Building, Xueyuan Road, Haidian District, Beijing, P. R. China100191

### 1.2 Testing Environment

Temperature:	18°C~25°C,
Relative humidity:	30%~ 70%
Ground system resistance:	< 0.5 $\Omega$
Ambient noise & Reflection:	< 0.012 W/kg

### 1.3 Project Data

Project Leader:	Qi Dianyuan
Test Engineer:	Lin Xiaojun
Testing Start Date:	April 17, 2015
Testing End Date:	April 30, 2015

### 1.4 Signature



---

Lin Xiaojun  
(Prepared this test report)

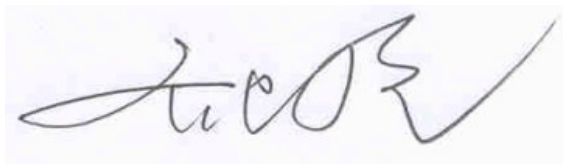

---

Qi Dianyuan  
(Reviewed this test report)



---

Xiao Li  
Deputy Director of the laboratory  
(Approved this test report)

## 2 Statement of Compliance

The maximum results of SAR found during testing for TCT Mobile Limited HSUPA/HSDPA/UMTS triband/GSM quadband mobile phone A463BG are as follows:

**Table 2.1: Highest Reported SAR (1g)**

Exposure Configuration	Technology Band	Highest Reported SAR 1g(W/Kg)	Equipment Class
Head (Separation Distance 0mm)	GSM 850	0.59	PCE
	PCS 1900	0.50	
	UMTS FDD 5	1.12	
	UMTS FDD 4	0.94	
	UMTS FDD 2	1.07	
	WLAN 2.4 GHz	0.35	DTS
Body-worn (Separation Distance 10mm)	GSM 850	1.05	PCE
	PCS 1900	0.56	
	UMTS FDD 5	1.28	
	UMTS FDD 4	1.02	
	UMTS FDD 2	0.75	
	WLAN 2.4 GHz	0.11	DTS

The SAR values found for the Mobile Phone are below the maximum recommended levels of 1.6 W/Kg as averaged over any 1g tissue according to the ANSI C95.1-1999.

For body worn operation, this device has been tested and meets FCC RF exposure guidelines when used with any accessory that contains no metal and which provides a minimum separation distance of 10 mm between this device and the body of the user. Use of other accessories may not ensure compliance with FCC RF exposure guidelines.

The EUT battery must be fully charged and checked periodically during the test to ascertain uniform power output.

The measurement together with the test system set-up is described in annex C of this test report. A detailed description of the equipment under test can be found in chapter 4 of this test report.

The highest reported SAR value is obtained at the case of **(Table 2.1)**, and the values are: **1.28 W/kg(1g)**.

**Table 2.2: The sum of reported SAR values for main antenna and WiFi**

	<b>Position</b>	<b>Main antenna</b>	<b>WiFi</b>	<b>Sum</b>
<b>Highest reported SAR value for Head</b>	Left hand, Touch cheek	1.12	0.35	<b>1.47</b>
<b>Highest reported SAR value for Body</b>	Rear	1.28	0.11	<b>1.39</b>

**Table 2.3: The sum of reported SAR values for main antenna and Bluetooth**

	<b>Position</b>	<b>Main antenna</b>	<b>BT*</b>	<b>Sum</b>
<b>Highest reported SAR value for Head</b>	Left hand, Touch cheek	1.12	0.23	<b>1.35</b>
<b>Highest reported SAR value for Body</b>	Rear	1.28	0.12	<b>1.40</b>

BT\* - Estimated SAR for Bluetooth (see the table 13.3)

According to the above tables, the highest sum of reported SAR values is **1.47 W/kg (1g)**. The detail for simultaneous transmission consideration is described in chapter 13.



### 3 Client Information

#### 3.1 Applicant Information

Company Name:	TCT Mobile Limited
Address /Post:	5F, C building, No. 232, Liang Jing Road ZhangJiang High-Tech Park, Pudong Area Shanghai, P.R. China. 201203
City:	Shanghai
Postal Code:	201203
Country:	P.R.China
Contact:	Gong Zhizhou
Email:	zhizhou.gong@jrdcom.com
Telephone:	0086-21- 51798260
Fax:	0086-21-61460602

#### 3.2 Manufacturer Information

Company Name:	TCT Mobile Limited
Address /Post:	5F, C building, No. 232, Liang Jing Road ZhangJiang High-Tech Park, Pudong Area Shanghai, P.R. China. 201203
City:	Shanghai
Postal Code:	201203
Country:	P.R.China
Contact:	Gong Zhizhou
Email:	zhizhou.gong@jrdcom.com
Telephone:	0086-21- 51798260
Fax:	0086-21-61460602



## 4 Equipment Under Test (EUT) and Ancillary Equipment (AE)

### 4.1 About EUT

Description:	HSUPA/HSDPA/UMTS triband/GSM quadband mobile phone
Model name:	A463BG
Operating mode(s):	GSM 850/900/1800/1900, WCDMA 850/1700/1900, BT, WiFi
Tested Tx Frequency:	825 – 848.8 MHz (GSM 850)
	1850.2 – 1910 MHz (GSM 1900)
	826.4–846.6 MHz (WCDMA850 Band V)
	1712.4 – 1752.6 MHz (WCDMA 1700 Band IV)
	1852.4–1907.6 MHz (WCDMA1900 Band II)
	2412 – 2462 MHz (Wi-Fi 2.4G)
GPRS/EGPRS Multislot Class:	10
GPRS capability Class:	B
Test device Production information:	Production unit
Device type:	Portable device
Antenna type:	Integrated antenna
Hotspot mode:	/

### 4.2 Internal Identification of EUT used during the test

EUT ID*	IMEI	HW	SW Version
EUT1	014389000001066	PIO	v3B15
EUT2	014389000000811	PIO	v3B15
EUT3	014389000000753	PIO	v3B15
EUT4	014389000001181	PIO	v3B15
EUT5	014389000060039	PIO	v3B15

\*EUT ID: is used to identify the test sample in the lab internally.

**Note:** It is performed to test SAR with the EUT1~4 and conducted power with the EUT5.

### 4.3 Internal Identification of AE used during the test

AE ID*	Description	Model	SN	Manufacturer
AE1	Battery	CAB1150000C1	/	BYD
AE2	Battery	CAB1400002C1	/	BYD
AE3	Battery	CAB1400002C2	/	SCUD

\*AE ID: is used to identify the test sample in the lab internally.



## 5 TEST METHODOLOGY

### 5.1 Applicable Limit Regulations

**ANSI C95.1:1999** IEEE Standard for Safety Levels with Respect to Human Exposure to Radio Frequency Electromagnetic Fields, 3 kHz to 300 GHz.

It specifies the maximum exposure limit of **1.6 W/kg** as averaged over any 1 gram of tissue for portable devices being used within 20 cm of the user in the uncontrolled environment.

### 5.2 Applicable Measurement Standards

**IEEE 1528:2003** Recommended Practice for Determining the Peak Spatial-Average Specific Absorption Rate (SAR) in the Human Body Due to Wireless Communications Devices: Experimental Techniques.

**KDB 447498 D01: General RF Exposure Guidance v05r02** Mobile and Portable Devices RF Exposure Procedures and Equipment Authorization Policies.

**KDB 648474 D04 Handset SAR v01r02:** SAR Evaluation Considerations for Wireless Handsets.

**KDB 941225 D01 SAR test for 3G devices v03:** SAR Measurement Procedures for 3G Devices

**KDB 248227 D01 SAR meas for 802 11 a b g v01r02:** SAR measurement procedures for 802.112abg transmitters.

**KDB 865664 D01 SAR measurement 100 MHz to 6 GHz v01r03:** SAR Measurement Requirements for 100 MHz to 6 GHz.

**KDB 865664 D02 RF Exposure Reporting v01r01:** RF Exposure Compliance Reporting and Documentation Considerations

## 6 Specific Absorption Rate (SAR)

### 6.1 Introduction

SAR is related to the rate at which energy is absorbed per unit mass in an object exposed to a radio field. The SAR distribution in a biological body is complicated and is usually carried out by experimental techniques or numerical modeling. The standard recommends limits for two tiers of groups, occupational/controlled and general population/uncontrolled, based on a person's awareness and ability to exercise control over his or her exposure. In general, occupational/controlled exposure limits are higher than the limits for general population/uncontrolled.

### 6.2 SAR Definition

The SAR definition is the time derivative (rate) of the incremental energy ( $dW$ ) absorbed by (dissipated in) an incremental mass ( $dm$ ) contained in a volume element ( $dv$ ) of a given density ( $\rho$ ). The equation description is as below:

$$SAR = \frac{d}{dt} \left( \frac{dW}{dm} \right) = \frac{d}{dt} \left( \frac{dW}{\rho dv} \right)$$

SAR is expressed in units of Watts per kilogram (W/kg)

SAR measurement can be either related to the temperature elevation in tissue by

$$SAR = c \left( \frac{\delta T}{\delta t} \right)$$

Where:  $C$  is the specific heat capacity,  $\delta T$  is the temperature rise and  $\delta t$  is the exposure duration, or related to the electrical field in the tissue by

$$SAR = \frac{\sigma |E|^2}{\rho}$$

Where:  $\sigma$  is the conductivity of the tissue,  $\rho$  is the mass density of tissue and  $E$  is the RMS electrical field strength.

However for evaluating SAR of low power transmitter, electrical field measurement is typically applied.

## 7 Tissue Simulating Liquids

### 7.1 Targets for tissue simulating liquid

**Table 7.1: Targets for tissue simulating liquid**

Frequency(MHz)	Liquid Type	Conductivity( $\sigma$ )	$\pm 5\%$ Range	Permittivity( $\epsilon$ )	$\pm 5\%$ Range
835	Head	0.90	0.86~0.95	41.5	39.4~43.6
835	Body	0.97	0.92~1.02	55.2	52.4~58.0
1750	Head	1.37	1.30~1.44	40.08	38.1~42.1
1750	Body	1.49	1.42~1.56	53.4	50.7~56.1
1900	Head	1.40	1.33~1.47	40.0	38.0~42.0
1900	Body	1.52	1.44~1.60	53.3	50.6~56.0
2450	Head	1.80	1.71~1.89	39.2	37.2~41.2
2450	Body	1.95	1.85~2.05	52.7	50.1~55.3

### 7.2 Dielectric Performance

**Table 7.2: Dielectric Performance of Tissue Simulating Liquid**

Measurement Date (yyyy-mm-dd)	Type	Frequency	Permittivity $\epsilon$	Drift (%)	Conductivity $\sigma$ (S/m)	Drift (%)
2015-04-30	Head	835 MHz	41.5	0.00	0.914	1.56
	Body	835 MHz	55.41	0.38	0.943	-2.78
2015-04-17	Head	1750 MHz	38.42	-4.14	1.367	-0.22
	Body	1750 MHz	54.54	2.13	1.493	0.20
2015-04-27	Head	1900 MHz	41.63	4.08	1.409	0.64
	Body	1900 MHz	52.88	-0.79	1.514	-0.39
2015-04-25	Head	2450 MHz	39.41	0.54	1.802	0.11
	Body	2450 MHz	50.62	-3.95	2.02	3.59

Note: The liquid temperature is 22.0°C

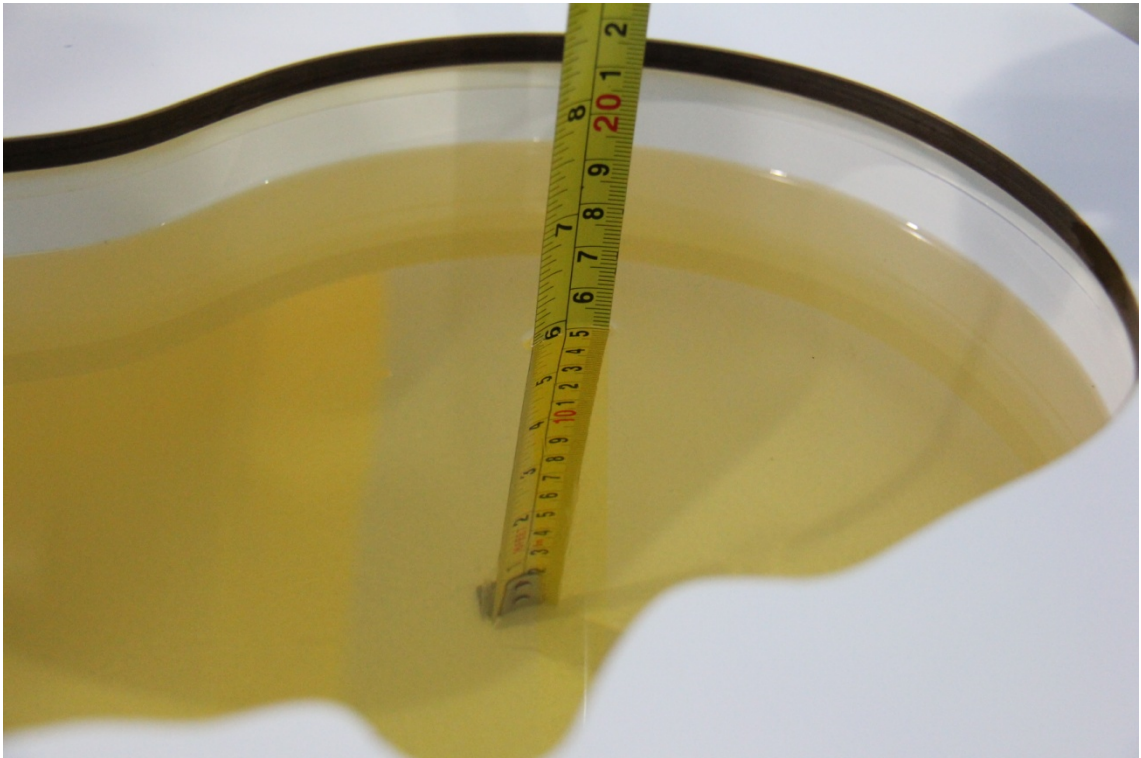

**Picture 7-1 Liquid depth in the Head Phantom (835MHz)**

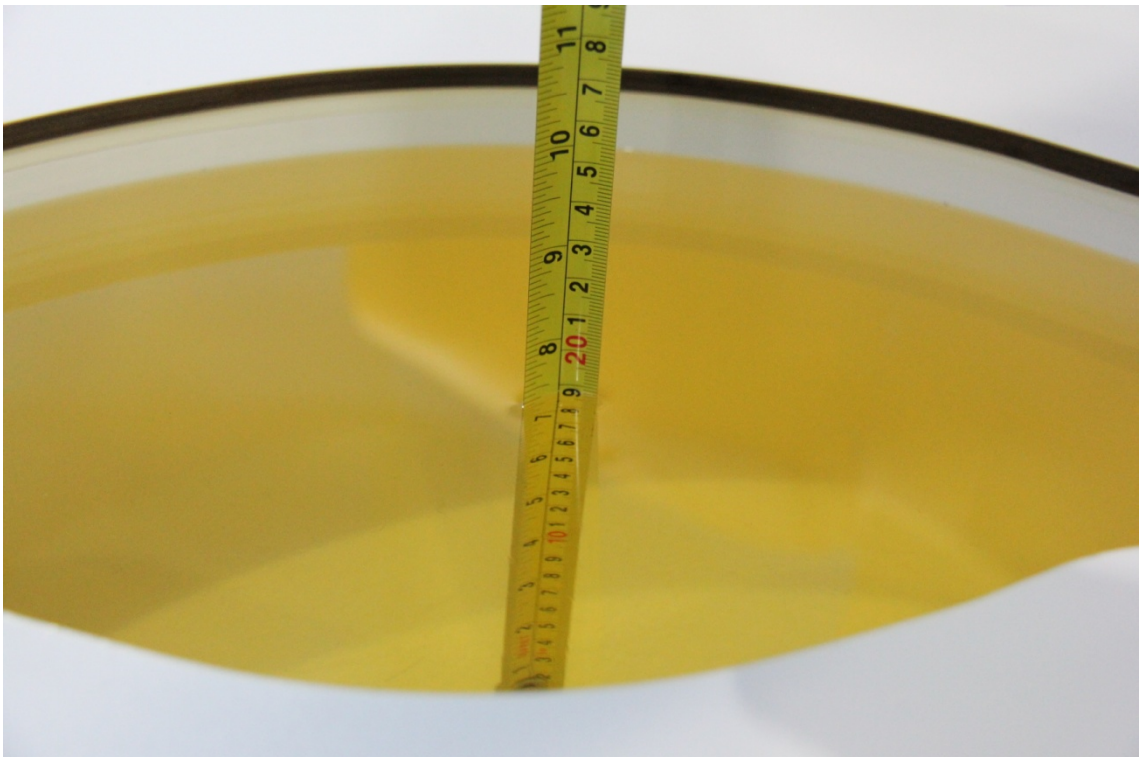

**Picture 7-2 Liquid depth in the Flat Phantom (835MHz)**

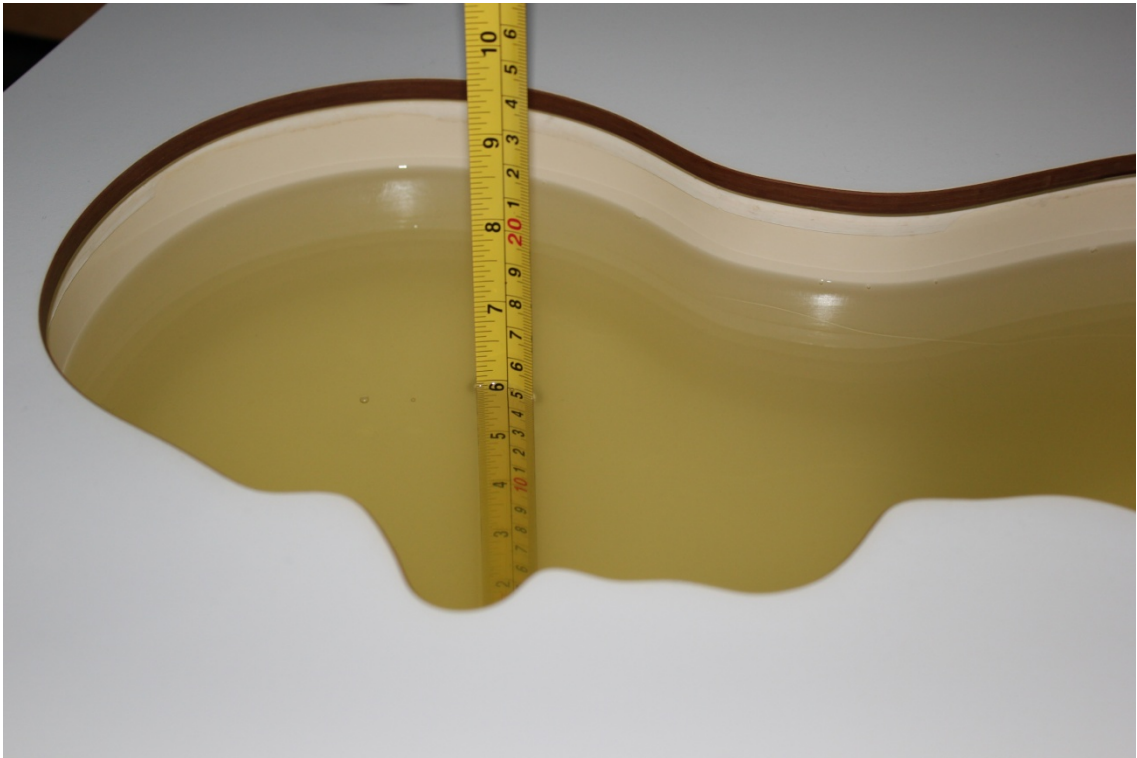

**Picture 7-3 Liquid depth in the Head Phantom (1750 MHz)**

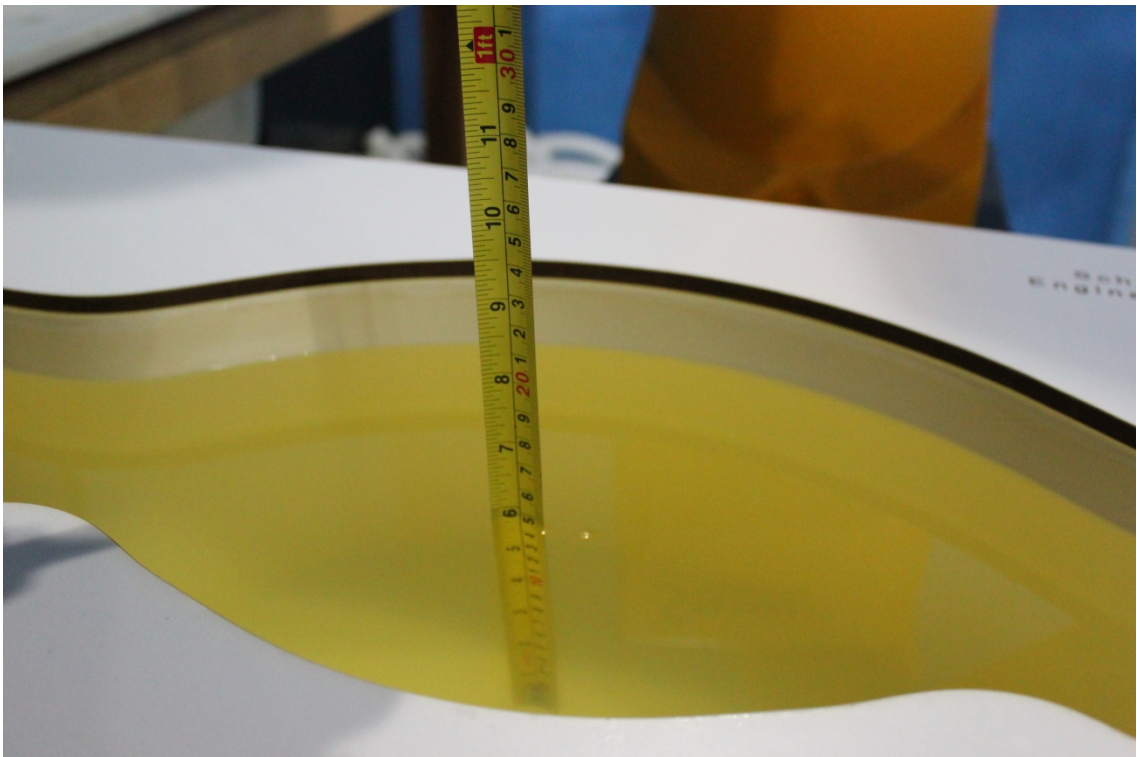

**Picture 7-4 Liquid depth in the Flat Phantom (1750MHz)**

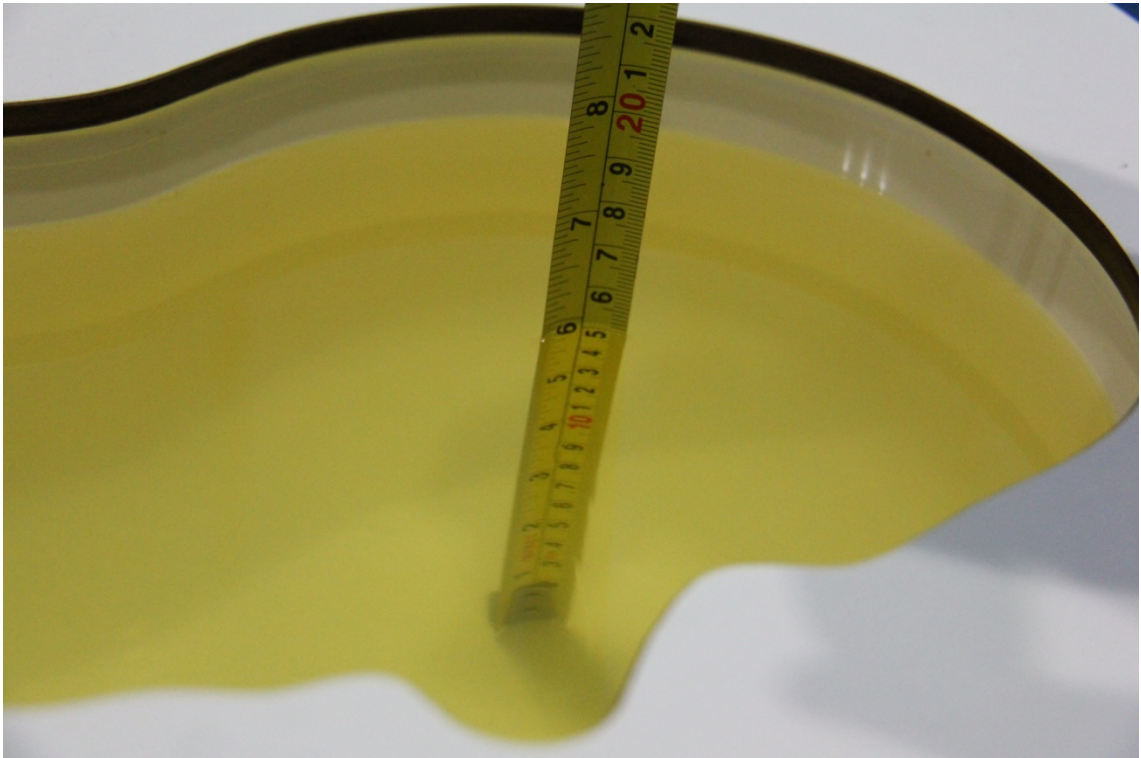

**Picture 7-5 Liquid depth in the Head Phantom (1900 MHz)**

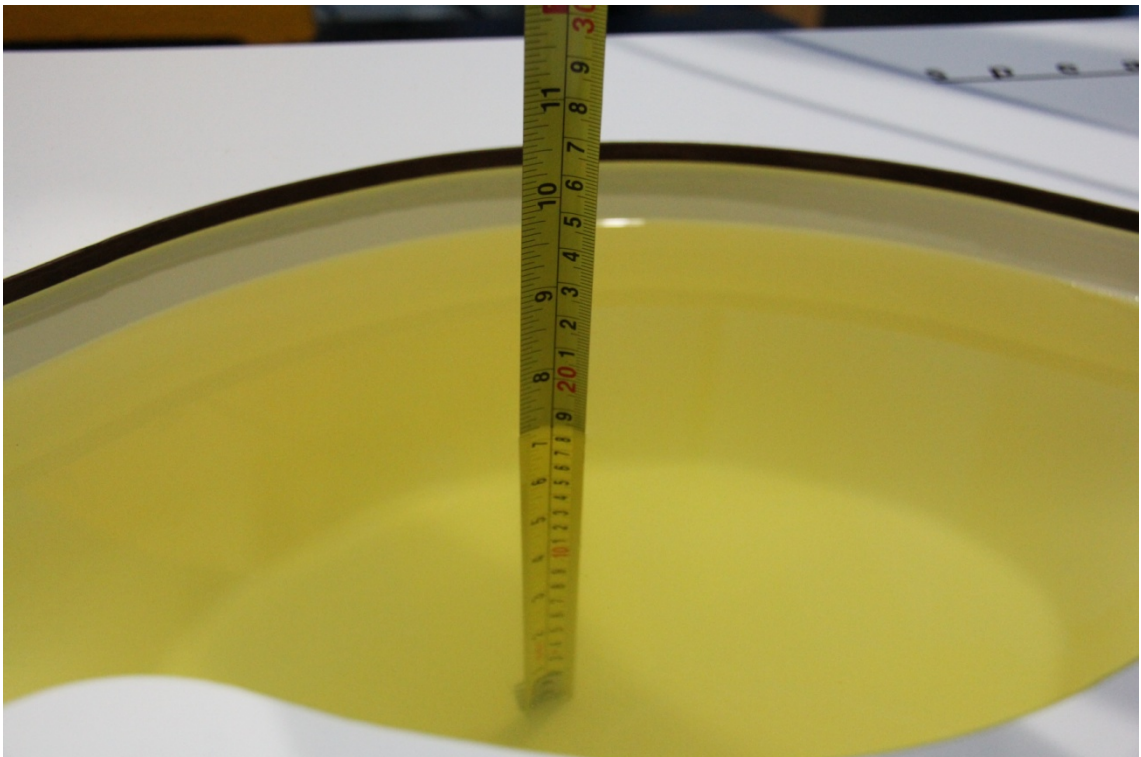

**Picture 7-6 Liquid depth in the Flat Phantom (1900MHz)**

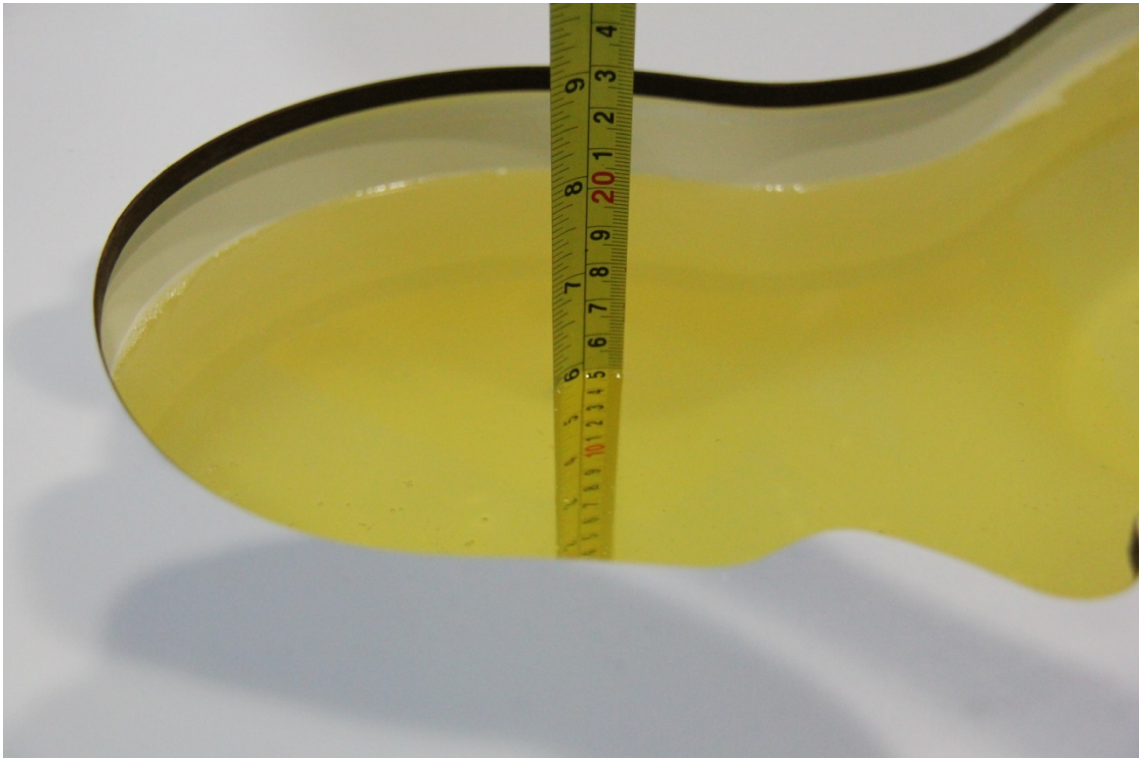

**Picture 7-7 Liquid depth in the Head Phantom (2450MHz)**

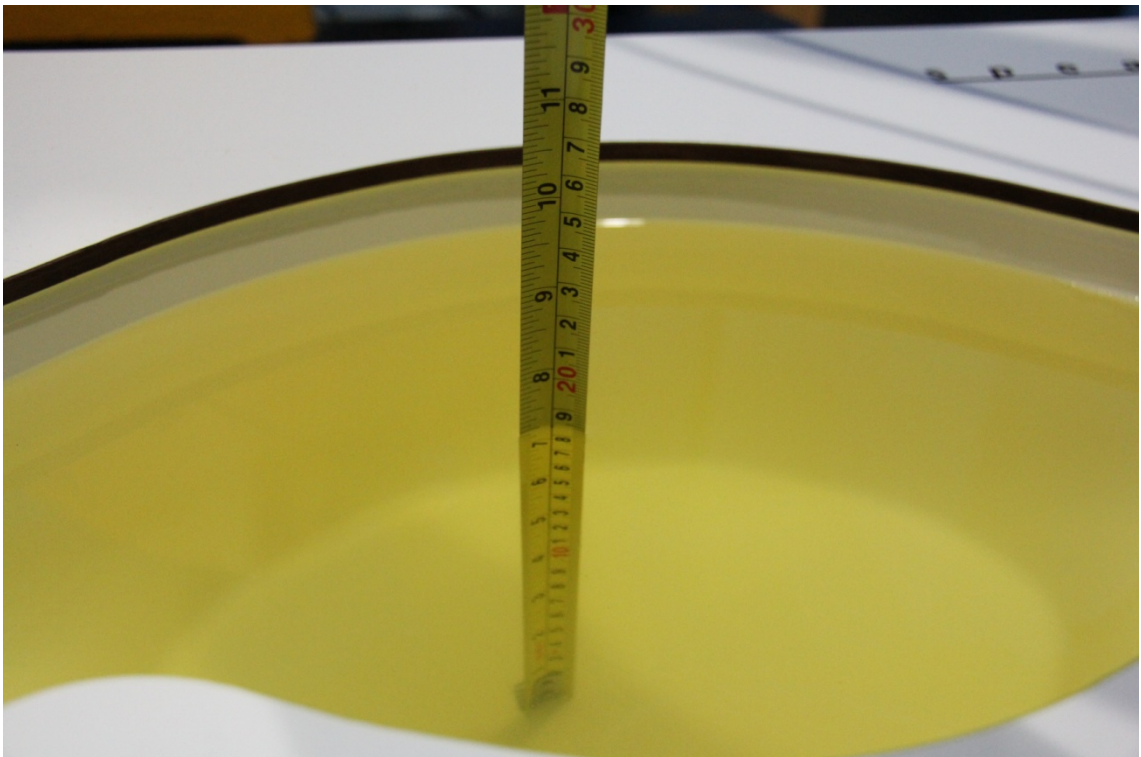

**Picture 7-8 Liquid depth in the Flat Phantom (2450MHz)**



## 8 System verification

### 8.1 System Setup

In the simplified setup for system evaluation, the DUT is replaced by a calibrated dipole and the power source is replaced by a continuous wave that comes from a signal generator. The calibrated dipole must be placed beneath the flat phantom section of the SAM twin phantom with the correct distance holder. The distance holder should touch the phantom surface with a light pressure at the reference marking and be oriented parallel to the long side of the phantom. The equipment setup is shown below:

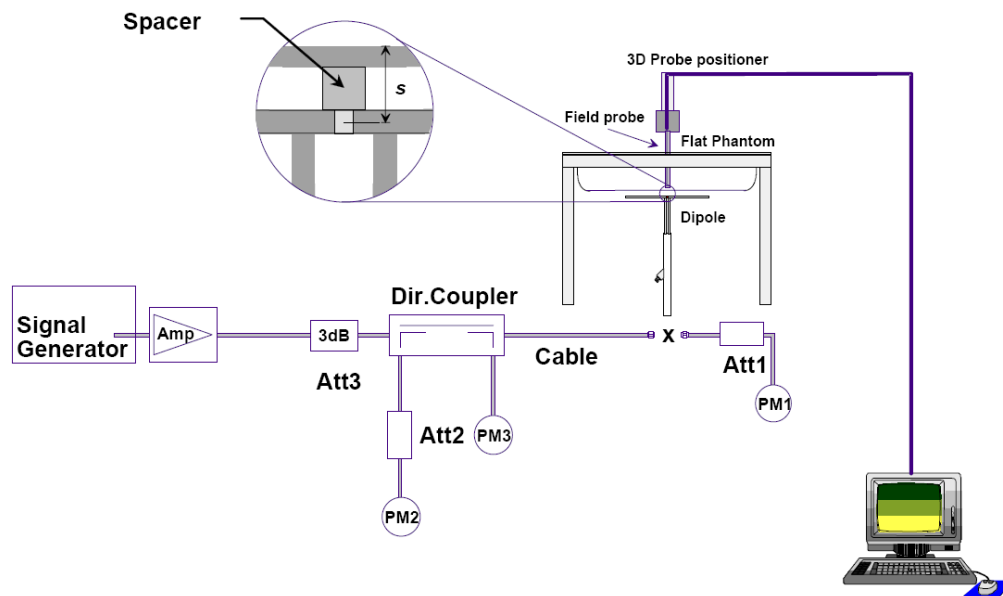

Picture 8.1 System Setup for System Evaluation

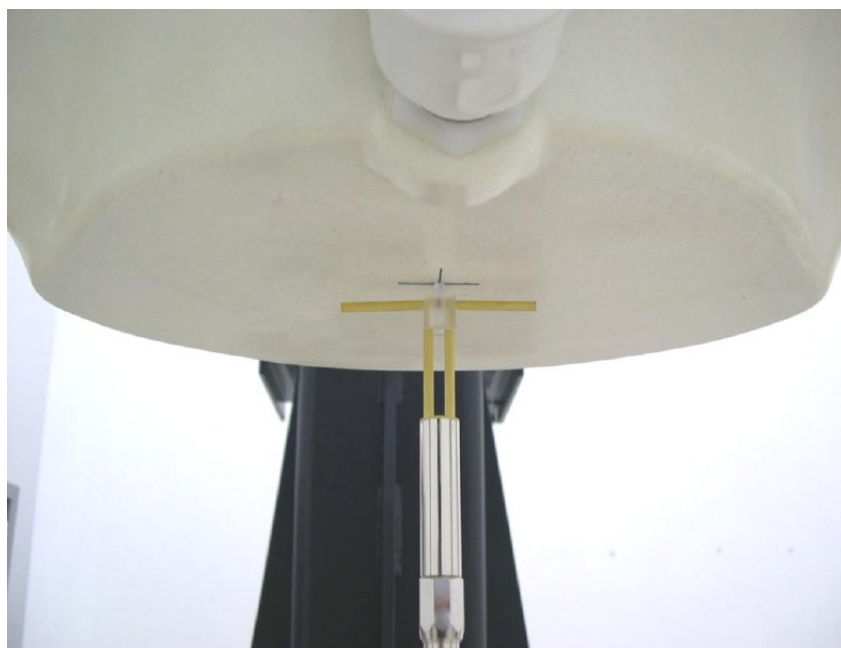

Picture 8.2 Photo of Dipole Setup

## 8.2 System Verification

SAR system verification is required to confirm measurement accuracy, according to the tissue dielectric media, probe calibration points and other system operating parameters required for measuring the SAR of a test device. The system verification must be performed for each frequency band and within the valid range of each probe calibration point required for testing the device.

The system verification results are required that the area scan estimated 1-g SAR is within 3% of the zoom scan 1-g SAR. The details are presented in annex B.

**Table 8.1: System Verification of Head**

Measurement Date (yyyy-mm-dd)	Frequency	Target value (W/kg)		Measured value(W/kg)		Deviation	
		10 g Average	1 g Average	10 g Average	1 g Average	10 g Average	1 g Average
2015-04-30	835 MHz	6.17	9.43	6.32	9.68	2.43%	2.65%
2015-04-17	1750 MHz	19.7	36.9	19.20	36.08	-2.54%	-2.22%
2015-04-27	1900 MHz	21.1	40.6	21.08	40.00	-0.09%	-1.48%
2015-04-25	2450 MHz	24.7	53.2	24.20	52.40	-2.02%	-1.50%

**Table 8.2: System Verification of Body**

Measurement Date (yyyy-mm-dd)	Frequency	Target value (W/kg)		Measured value (W/kg)		Deviation	
		10 g Average	1 g Average	10 g Average	1 g Average	10 g Average	1 g Average
2015-04-30	835 MHz	6.33	9.55	6.20	9.32	-2.05%	-2.41%
2015-04-17	1750 MHz	20.3	37.7	20.04	37.28	-1.28%	-1.11%
2015-04-27	1900 MHz	21.4	40.4	21.84	41.20	2.06%	1.98%
2015-04-25	2450 MHz	23.9	51.3	23.52	50.40	-1.59%	-1.75%

## 9 Measurement Procedures

### 9.1 Tests to be performed

In order to determine the highest value of the peak spatial-average SAR of a handset, all device positions, configurations and operational modes shall be tested for each frequency band according to steps 1 to 3 below. A flowchart of the test process is shown in picture 9.1.

**Step 1:** The tests described in 9.2 shall be performed at the channel that is closest to the centre of the transmit frequency band ( $f_c$ ) for:

- a) all device positions (cheek and tilt, for both left and right sides of the SAM phantom, as described in annex D),
- b) all configurations for each device position in a), e.g., antenna extended and retracted, and
- c) all operational modes, e.g., analogue and digital, for each device position in a) and configuration in b) in each frequency band.

If more than three frequencies need to be tested according to 11.1 (i.e.,  $N_c > 3$ ), then all frequencies, configurations and modes shall be tested for all of the above test conditions.

**Step 2:** For the condition providing highest peak spatial-average SAR determined in Step 1, perform all tests described in 9.2 at all other test frequencies, i.e., lowest and highest frequencies. In addition, for all other conditions (device position, configuration and operational mode) where the peak spatial-average SAR value determined in Step 1 is within 3 dB of the applicable SAR limit, it is recommended that all other test frequencies shall be tested as well.

**Step 3:** Examine all data to determine the highest value of the peak spatial-average SAR found in Steps 1 to 2.

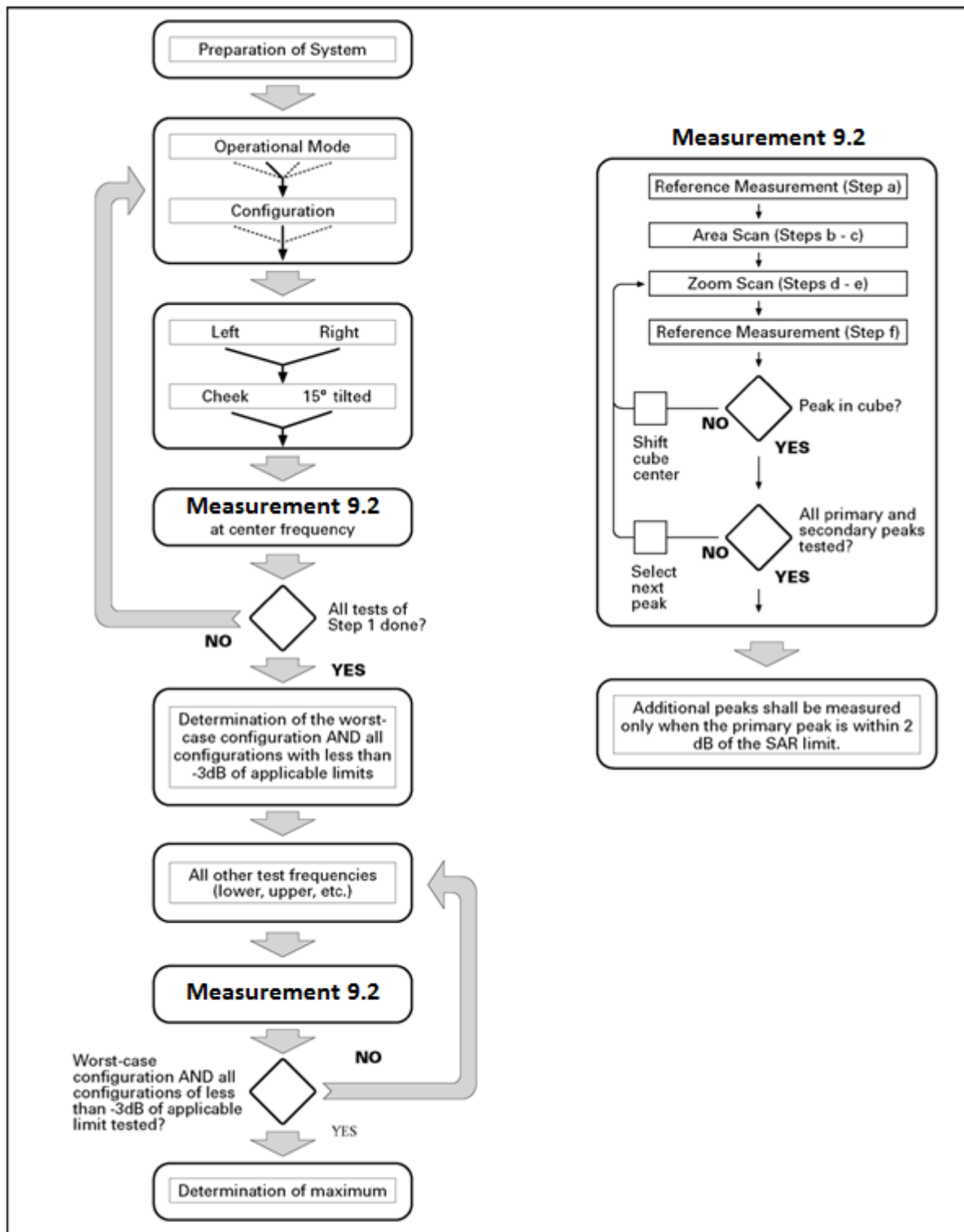

Picture 9.1 Block diagram of the tests to be performed

## 9.2 General Measurement Procedure

The area and zoom scan resolutions specified in the table below must be applied to the SAR measurements and fully documented in SAR reports to qualify for TCB approval. Probe boundary effect error compensation is required for measurements with the probe tip closer than half a probe

tip diameter to the phantom surface. Both the probe tip diameter and sensor offset distance must satisfy measurement protocols; to ensure probe boundary effect errors are minimized and the higher fields closest to the phantom surface can be correctly measured and extrapolated to the phantom surface for computing 1-g SAR. Tolerances of the post-processing algorithms must be verified by the test laboratory for the scan resolutions used in the SAR measurements, according to the reference distribution functions specified in IEEE Std 1528-2003. The results should be documented as part of the system validation records and may be requested to support test results when all the measurement parameters in the following table are not satisfied.

		$\leq 3$ GHz	$> 3$ GHz
Maximum distance from closest measurement point (geometric center of probe sensors) to phantom surface		$5 \pm 1$ mm	$\frac{1}{2} \cdot \delta \cdot \ln(2) \pm 0.5$ mm
Maximum probe angle from probe axis to phantom surface normal at the measurement location		$30^\circ \pm 1^\circ$	$20^\circ \pm 1^\circ$
Maximum area scan spatial resolution: $\Delta x_{Area}, \Delta y_{Area}$		$\leq 2$ GHz: $\leq 15$ mm 2 – 3 GHz: $\leq 12$ mm	3 – 4 GHz: $\leq 12$ mm 4 – 6 GHz: $\leq 10$ mm
		When the x or y dimension of the test device, in the measurement plane orientation, is smaller than the above, the measurement resolution must be $\leq$ the corresponding x or y dimension of the test device with at least one measurement point on the test device.	
Maximum zoom scan spatial resolution: $\Delta x_{Zoom}, \Delta y_{Zoom}$		$\leq 2$ GHz: $\leq 8$ mm 2 – 3 GHz: $\leq 5$ mm*	3 – 4 GHz: $\leq 5$ mm* 4 – 6 GHz: $\leq 4$ mm*
Maximum zoom scan spatial resolution, normal to phantom surface	uniform grid: $\Delta z_{Zoom}(n)$	$\leq 5$ mm	3 – 4 GHz: $\leq 4$ mm 4 – 5 GHz: $\leq 3$ mm 5 – 6 GHz: $\leq 2$ mm
	graded grid $\Delta z_{Zoom}(1)$ : between 1 <sup>st</sup> two points closest to phantom surface	$\leq 4$ mm	3 – 4 GHz: $\leq 3$ mm 4 – 5 GHz: $\leq 2.5$ mm 5 – 6 GHz: $\leq 2$ mm
	$\Delta z_{Zoom}(n>1)$ : between subsequent points	$\leq 1.5 \cdot \Delta z_{Zoom}(n-1)$	
Minimum zoom scan volume	x, y, z	$\geq 30$ mm	3 – 4 GHz: $\geq 28$ mm 4 – 5 GHz: $\geq 25$ mm 5 – 6 GHz: $\geq 22$ mm
<p>Note: <math>\delta</math> is the penetration depth of a plane-wave at normal incidence to the tissue medium; see draft standard IEEE P1528-2011 for details.</p> <p>* When zoom scan is required and the <i>reported</i> SAR from the area scan based 1-g SAR estimation procedures of KDB 447498 is <math>\leq 1.4</math> W/kg, <math>\leq 8</math> mm, <math>\leq 7</math> mm and <math>\leq 5</math> mm zoom scan resolution may be applied, respectively, for 2 GHz to 3 GHz, 3 GHz to 4 GHz and 4 GHz to 6 GHz.</p>			

### 9.3 WCDMA Measurement Procedures for SAR

The following procedures are applicable to WCDMA handsets operating under 3GPP Release99, Release 5 and Release 6. The default test configuration is to measure SAR with an established radio link between the DUT and a communication test set using a 12.2kbps RMC (reference measurement channel) configured in Test Loop Mode 1. SAR is selectively confirmed for other

physical channel configurations (DPCCH & DPDCH<sub>n</sub>), HSDPA and HSPA (HSUPA/HSDPA) modes according to output power, exposure conditions and device operating capabilities. Both uplink and downlink should be configured with the same RMC or AMR, when required. SAR for Release 5 HSDPA and Release 6 HSPA are measured using the applicable FRC (fixed reference channel) and E-DCH reference channel configurations. Maximum output power is verified according to applicable versions of 3GPP TS 34.121 and SAR must be measured according to these maximum output conditions. When Maximum Power Reduction (MPR) is not implemented according to Cubic Metric (CM) requirements for Release 6 HSPA, the following procedures do not apply.

**For Release 5 HSDPA Data Devices:**

Sub-test	$\beta_c$	$\beta_d$	$\beta_d$ (SF)	$\beta_c / \beta_d$	$\beta_{hs}$	CM/dB
1	2/15	15/15	64	2/15	4/15	0.0
2	12/15	15/15	64	12/15	24/25	1.0
3	15/15	8/15	64	15/8	30/15	1.5
4	15/15	4/15	64	15/4	30/15	1.5

**For Release 6 HSPA Data Devices**

Sub-test	$\beta_c$	$\beta_d$	$\beta_d$ (SF)	$\beta_c / \beta_d$	$\beta_{hs}$	$\beta_{ec}$	$\beta_{ed}$	$\beta_{ed}$ (SF)	$\beta_{ed}$ (codes)	CM (dB)	MPR (dB)	AG Index	E-TFCI
1	11/15	15/15	64	11/15	22/15	209/225	1039/225	4	1	3.0	3.0	20	75
2	6/15	15/15	64	6/15	12/15	12/15	12/15	4	1	3.0	3.0	12	67
3	15/15	9/15	64	15/9	30/15	30/15	$\beta_{ed1}:47/15$ $\beta_{ed2}:47/15$	4	2	3.0	3.0	15	92
4	2/15	15/15	64	2/15	4/15	4/15	56/75	4	1	3.0	3.0	17	71
5	15/15	15/15	64	15/15	24/15	30/15	134/15	4	1	1.0	1.0	21	81

**9.4 Bluetooth & Wi-Fi Measurement Procedures for SAR**

Normal network operating configurations are not suitable for measuring the SAR of 802.11 transmitters in general. Unpredictable fluctuations in network traffic and antenna diversity conditions can introduce undesirable variations in SAR results. The SAR for these devices should be measured using chipset based test mode software to ensure that the results are consistent and reliable.

Chipset based test mode software is hardware dependent and generally varies among manufacturers. The device operating parameters established in a test mode for SAR measurements must be identical to those programmed in production units, including output power levels, amplifier gain settings and other RF performance tuning parameters. The test frequencies should correspond to actual channel frequencies defined for domestic use. SAR for devices with switched diversity should be measured with only one antenna transmitting at a time during each SAR measurement, according to a fixed modulation and data rate. The same data pattern should be used for all measurements.

## 9.5 Power Drift

To control the output power stability during the SAR test, DASY4 system calculates the power drift by measuring the E-field at the same location at the beginning and at the end of the measurement for each test position. These drift values can be found in Table 14.2 to Table 14.29 labeled as: (Power Drift [dB]). This ensures that the power drift during one measurement is within 5%.

## 10 Area Scan Based 1-g SAR

### 10.1 Requirement of KDB

According to the KDB447498 D01 v05, when the implementation is based the specific polynomial fit algorithm as presented at the 29th Bioelectromagnetics Society meeting (2007) and the estimated 1-gSAR is  $\leq 1.2$  W/kg, a zoom scan measurement is not required provided it is also not needed for any other purpose; for example, if the peak SAR location required for simultaneous transmission SAR test exclusion can be determined accurately by the SAR system or manually to discriminate between distinctive peaks and scattered noisy SAR distributions from area scans.

There must not be any warning or alert messages due to various measurement concerns identified by the SAR system; for example, noise in measurements, peaks too close to scan boundary, peaks are too sharp, spatial resolution and uncertainty issues etc. The SAR system verification must also demonstrate that the area scan estimated 1-g SAR is within 3% of the zoom scan 1-g SAR (See Annex B). When all the SAR results for each exposure condition in a frequency band and wireless mode are based on estimated 1-g SAR, the 1-g SAR for the highest SAR configuration must be determined by a zoom scan.

### 10.2 Fast SAR Algorithms

The approach is based on the area scan measurement applying a frequency dependent attenuation parameter. This attenuation parameter was empirically determined by analyzing a large number of phones. The MOTOROLA FAST SAR was developed and validated by the MOTOROLA Research Group in Ft. Lauderdale.

In the initial study, an approximation algorithm based on Linear fit was developed. The accuracy of the algorithm has been demonstrated across a broad frequency range (136-2450 MHz) and for both 1- and 10-g averaged SAR using a sample of 264 SAR measurements from 55 wireless handsets. For the sample size studied, the root-mean-squared errors of the algorithm are 1.2% and 5.8% for 1- and 10-g averaged SAR, respectively. The paper describing the algorithm in detail is expected to be published in August 2004 within the Special Issue of Transactions on MTT.

In the second step, the same research group optimized the fitting algorithm to an Polynomial fit whereby the frequency validity was extended to cover the range 30-6000MHz. Details of this study can be found in the BEMS 2007 Proceedings.

Both algorithms are implemented in DASY software.

## 11 Conducted Output Power

### 11.1 Manufacturing tolerance

**Table 11.1: GSM Speech**

GSM 850			
Channel	Channel 251	Channel 190	Channel 128
Target (dBm)	32.3	32.3	32.3
Tune-up(dBm)	33.3	33.3	33.3
GSM 1900			
Channel	Channel 810	Channel 661	Channel 512
Target (dBm)	29.3	29.3	29.3
Tune-up(dBm)	30.3	30.3	30.3

**Table 11.2: GPRS and EGPRS**

GSM 850 GPRS (GMSK)				
Channel		251	190	128
1 Txslot	Target (dBm)	32.3	32.3	32.3
	Tune-up(dBm)	33.3	33.3	33.3
2 Txslots	Target (dBm)	29.5	29.5	29.5
	Tune-up(dBm)	30.5	30.5	30.5
GSM 850 EGPRS (GMSK)				
Channel		251	190	128
1 Txslot	Target (dBm)	32.3	32.3	32.3
	Tune-up(dBm)	33.3	33.3	33.3
2 Txslots	Target (dBm)	29.5	29.5	29.5
	Tune-up(dBm)	30.5	30.5	30.5
GSM 1900 GPRS (GMSK)				
Channel		810	661	512
1 Txslot	Target (dBm)	29.3	29.3	29.3
	Tune-up(dBm)	30.3	30.3	30.3
2 Txslots	Target (dBm)	27	27	27
	Tune-up(dBm)	28	28	28
GSM 1900 EGPRS (GMSK)				
Channel		810	661	512
1 Txslot	Target (dBm)	29.3	29.3	29.3
	Tune-up(dBm)	30.3	30.3	30.3
2 Txslots	Target (dBm)	27	27	27
	Tune-up(dBm)	28	28	28



**Table 11.3: WCDMA**

WCDMA 850 CS			
Channel	Channel 4233	Channel 4182	Channel 4132
Target (dBm)	22.5	22.5	22.5
Tune-up(dBm)	23.5	23.5	23.5
HSUPA (sub-test 1/2)			
Channel	Channel 4233	Channel 4182	Channel 4132
Target (dBm)	19.5	19.5	19.5
Tune-up(dBm)	20.5	20.5	20.5
HSUPA (sub-test 3)			
Channel	Channel 4233	Channel 4182	Channel 4132
Target (dBm)	20.5	20.5	20.5
Tune-up(dBm)	21.5	21.5	21.5
HSUPA (sub-test 4)			
Channel	Channel 4233	Channel 4182	Channel 4132
Target (dBm)	19	19	19
Tune-up(dBm)	20	20	20
HSUPA (sub-test 5)			
Channel	Channel 4233	Channel 4182	Channel 4132
Target (dBm)	21.5	21.5	21.5
Tune-up(dBm)	22.5	22.5	22.5
WCDMA 1700 CS			
Channel	Channel 1513	Channel 1412	Channel 1312
Target (dBm)	22.5	22.5	22.5
Tune-up(dBm)	23.5	23.5	23.5
HSUPA (sub-test 1/2)			
Channel	Channel 1513	Channel 1412	Channel 1312
Target (dBm)	20	20	20
Tune-up(dBm)	21	21	21
HSUPA (sub-test 3)			
Channel	Channel 1513	Channel 1412	Channel 1312
Target (dBm)	20.5	20.5	20.5
Tune-up(dBm)	21.5	21.5	21.5
HSUPA (sub-test 4)			
Channel	Channel 1513	Channel 1412	Channel 1312
Target (dBm)	19.5	19.5	19.5
Tune-up(dBm)	20.5	20.5	20.5
HSUPA (sub-test 5)			
Channel	Channel 1513	Channel 1412	Channel 1312
Target (dBm)	21.5	21.5	21.5
Tune-up(dBm)	22.5	22.5	22.5

WCDMA 1900 CS			
Channel	Channel 9538	Channel 9400	Channel 9262
Target (dBm)	22.5	22.5	22.5
Tune-up(dBm)	23.5	23.5	23.5
HSUPA (sub-test 1/2)			
Channel	Channel 9538	Channel 9400	Channel 9262
Target (dBm)	20	20	20
Tune-up(dBm)	21	21	21
HSUPA (sub-test 3)			
Channel	Channel 9538	Channel 9400	Channel 9262
Target (dBm)	20.5	20.5	20.5
Tune-up(dBm)	21.5	21.5	21.5
HSUPA (sub-test 4)			
Channel	Channel 9538	Channel 9400	Channel 9262
Target (dBm)	19.5	19.5	19.5
Tune-up(dBm)	20.5	20.5	20.5
HSUPA (sub-test 5)			
Channel	Channel 9538	Channel 9400	Channel 9262
Target (dBm)	21.5	21.5	21.5
Tune-up(dBm)	22.5	22.5	22.5

**Table 11.4: Bluetooth**

Channel	Target (dBm)	Tune-up(dBm)
GFSK	5.5	6.5
$\pi/4$ DQPSK	4.5	5.5
8DPSK	4.5	5.5

**Table 11.5: WiFi**

Mode	Target (dBm)	Tune-up(dBm)
802.11b	15.5	16.5
802.11g 6Mbps~24Mbps	14.5	15.5
802.11g 36Mbps~54Mbps	13	14
802.11n (20M) MCS0~MCS3	13	14
802.11n (20M) MCS4~MCS7	11	12
802.11n (40M) MCS0~MCS2	10	11
802.11n (40M) MCS3~MCS7	8.5	9.5

## 11.2 GSM Measurement result

During the process of testing, the EUT was controlled via Agilent Digital Radio Communication tester (E5515C) to ensure the maximum power transmission and proper modulation. This result contains conducted output power for the EUT. In all cases, the measured peak output power should be greater and within 5% than EMI measurement.

**Table 11.6: The conducted power measurement results for GSM850/1900**

GSM 850MHz	Conducted Power (dBm)		
	Channel 251(848.8MHz)	Channel 190(836.6MHz)	Channel 128(824.2MHz)
	32.68	32.64	32.62
GSM 1900MHz	Conducted Power(dBm)		
	Channel 810(1909.8MHz)	Channel 661(1880MHz)	Channel 512(1850.2MHz)
	29.26	29.40	29.62

**Table 11.7: The conducted power measurement results for GPRS and EGPRS**

GSM 850 GPRS (GMSK)	Measured Power (dBm)			calculation	Averaged Power (dBm)		
	251	190	128		251	190	128
1 Txslot	32.67	32.63	32.61	-9.03dB	23.64	23.60	23.58
<b>2 Txslots</b>	29.68	29.63	29.61	-6.02dB	<b>23.66</b>	<b>23.61</b>	<b>23.59</b>
GSM 850 EGPRS (GMSK)	Measured Power (dBm)			calculation	Averaged Power (dBm)		
	251	190	128		251	190	128
1 Txslot	32.68	32.64	32.62	-9.03dB	23.65	23.61	23.59
<b>2 Txslots</b>	29.69	29.63	29.63	-6.02dB	<b>23.67</b>	<b>23.61</b>	<b>23.61</b>
PCS1900 GPRS (GMSK)	Measured Power (dBm)			calculation	Averaged Power (dBm)		
	810	661	512		810	661	512
1 Txslot	29.21	29.35	29.58	-9.03dB	20.18	20.32	20.55
<b>2 Txslots</b>	26.95	27.08	27.29	-6.02dB	<b>20.93</b>	<b>21.06</b>	<b>21.27</b>
PCS1900 EGPRS (GMSK)	Measured Power (dBm)			calculation	Averaged Power (dBm)		
	810	661	512		810	661	512
1 Txslot	29.23	29.38	29.58	-9.03dB	20.20	20.35	20.55
<b>2 Txslots</b>	26.96	27.09	27.30	-6.02dB	<b>20.94</b>	<b>21.07</b>	<b>21.28</b>

NOTES:

1) Division Factors

To average the power, the division factor is as follows:

1TX-slot = 1 transmit time slot out of 8 time slots=> conducted power divided by (8/1) => -9.03dB

2TX-slots = 2 transmit time slots out of 8 time slots=> conducted power divided by (8/2) => -6.02dB

3TX-slots = 3 transmit time slots out of 8 time slots=> conducted power divided by (8/3) => -4.26dB

4TX-slots = 4 transmit time slots out of 8 time slots=> conducted power divided by (8/4) => -3.01dB

**According to the conducted power as above, the body measurements are performed with 2Txslots for GPRS and EGPRS.**

### 11.3 WCDMA Measurement result

**Table 11.8: The conducted Power for WCDMA**

Item	band	FDDV result		
	ARFCN	4233(846.6MHz)	4182(836.4MHz)	4132(826.4MHz)
WCDMA	\	23.06	22.87	23.11
HSUPA	1	19.73	19.73	19.61
	2	19.74	19.72	19.61
	3	20.71	20.70	20.60
	4	19.20	19.18	19.08
	5	21.69	21.68	21.58
Item	band	FDDIV result		
	ARFCN	1513 (1752.6MHz)	1412 (1732.4MHz)	1312 (1712.4MHz)
WCDMA	\	23.29	22.89	23.39
HSUPA	1	19.96	20.01	19.79
	2	19.94	20.00	19.77
	3	20.92	21.00	20.78
	4	19.31	19.37	19.25
	5	21.90	21.96	21.75
Item	band	FDDII result		
	ARFCN	9538(1907.6MHz)	9400(1880MHz)	9262(1852.4MHz)
WCDMA	\	22.67	22.73	22.61
HSUPA	1	19.87	19.97	19.77
	2	19.89	19.97	19.78
	3	20.84	20.96	20.78
	4	19.33	19.45	19.25
	5	21.79	21.91	21.74

### 11.4 Wi-Fi and BT Measurement result

The output power of BT antenna is as following:

Mode	Conducted Power (dBm)		
	Channel 0 (2402MHz)	Channel 39 (2441MHz)	Channel 78(2480MHz)
GFSK	6.6	6.95	7.05
$\pi/4$ DQPSK	4.25	4.82	4.77
8DPSK	4.25	4.82	4.77

The average conducted power for Wi-Fi is as following:

802.11b (dBm)

Channel\data rate	1Mbps	2Mbps	5.5Mbps	11Mbps
1	15.95	/	/	/
6	16.13	/	/	/
11	16.43	16.24	16.23	15.91

802.11g (dBm)

Channel\data rate	6Mbps	9Mbps	12Mbps	18Mbps	24Mbps	36Mbps	48Mbps	54Mbps
1	14.09	/	/	/	/	/	/	/
6	14.50	/	/	/	/	/	/	/
11	14.87	14.65	14.24	13.91	13.56	13.03	12.57	12.41

802.11n (dBm) - HT20 (2.4G)

Channel\data rate	MCS0	MCS1	MCS2	MCS3	MCS4	MCS5	MCS6	MCS7
1	13.08	/	/	/	/	/	/	/
6	13.32	/	/	/	/	/	/	/
11	13.69	13.28	12.96	12.64	11.90	11.50	11.32	11.13

802.11n (dBm) – HT40 (2.4G)

Channel\data rate	MCS0	MCS1	MCS2	MCS3	MCS4	MCS5	MCS6	MCS7
3	10.68	/	/	/	/	/	/	/
6	10.76	/	/	/	/	/	/	/
9	11.12	10.25	9.71	9.31	8.65	8.19	7.96	7.84

## 12 Simultaneous TX SAR Considerations

### 12.1 Introduction

The following procedures adopted from “FCC SAR Considerations for Cell Phones with Multiple Transmitters” are applicable to handsets with built-in unlicensed transmitters such as 802.11 a/b/g and Bluetooth devices which may simultaneously transmit with the licensed transmitter.

For this device, the BT and Wi-Fi can transmit simultaneous with other transmitters.

### 12.2 Transmit Antenna Separation Distances

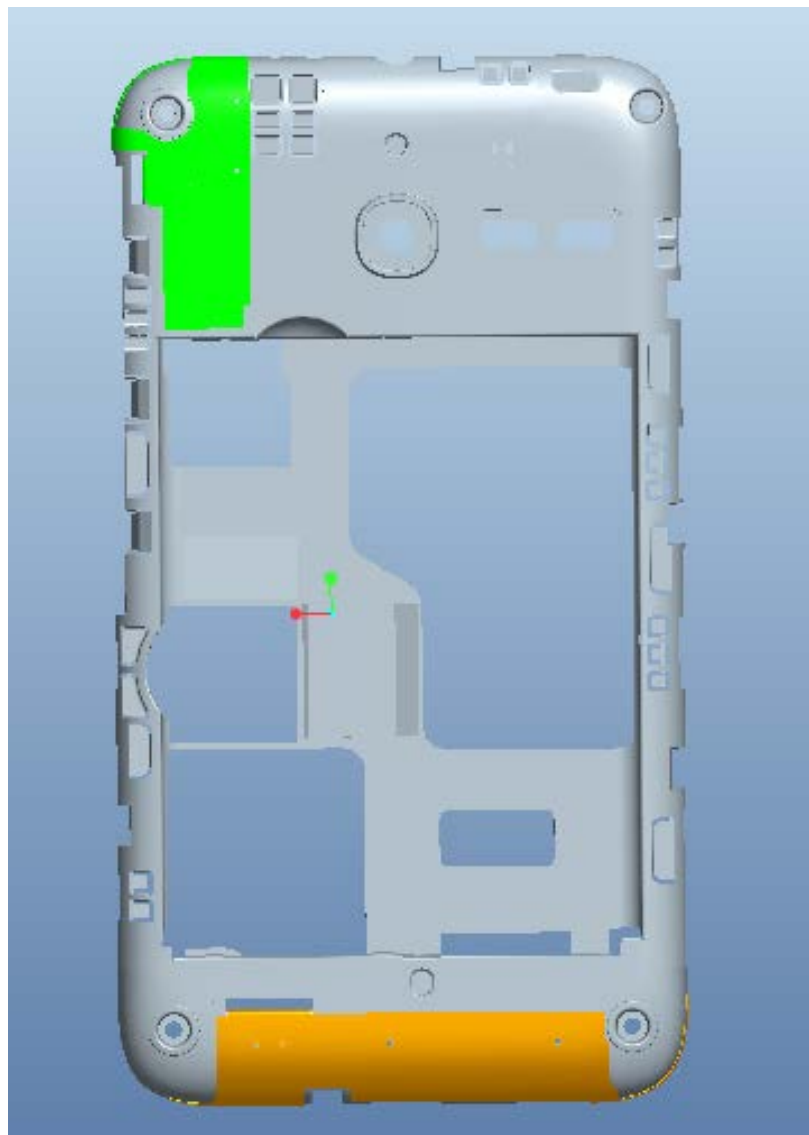

Picture 12.1 Antenna Locations

### 12.3 Standalone SAR Test Exclusion Considerations

Standalone 1-g head or body SAR evaluation by measurement or numerical simulation is not required when the corresponding SAR Exclusion Threshold condition, listed below, is satisfied. The 1-g SAR test exclusion threshold for 100 MHz to 6 GHz at test separation distances  $\leq 50$  mm are determined by:

$$\left[ \frac{\text{max. power of channel, including tune-up tolerance, mW}}{\text{min. test separation distance, mm}} \right] \cdot \sqrt{f(\text{GHz})} \leq 3.0$$
 for 1-g SAR, where

- f(GHz) is the RF channel transmit frequency in GHz
- Power and distance are rounded to the nearest mW and mm before calculation
- The result is rounded to one decimal place for comparison

**Table 12.1: Standalone SAR test exclusion considerations**

Band/Mode	F(GHz)	Position	SAR test exclusion threshold(mW)	RF output power		SAR test exclusion
				dBm	mW	
Bluetooth	2.441	Head	9.60	7.5	5.62	Yes
		Body	19.20	7.5	5.62	Yes
2.4GHz WLAN 802.11 b	2.45	Head	9.58	16.5	44.67	No
		Body	19.17	16.5	44.67	No

### 13 Evaluation of Simultaneous

**Table 13.1: The sum of reported SAR values for main antenna and WiFi**

	Position	Main antenna	WiFi	Sum
Highest reported SAR value for Head	Left hand, Touch cheek	1.12	0.35	1.47
Highest reported SAR value for Body	Rear	1.28	0.11	1.39

**Table 13.2: The sum of reported SAR values for main antenna and Bluetooth**

	Position	Main antenna	BT*	Sum
Highest reported SAR value for Head	Left hand, Touch cheek	1.12	0.23	1.35
Highest reported SAR value for Body	Rear	1.28	0.12	1.40

BT\* - Estimated SAR for Bluetooth (see the table 13.3)

**Table 13.3: Estimated SAR for Bluetooth**

Position	F (GHz)	Distance (mm)	Upper limit of power *		Estimated <sub>1g</sub> (W/kg)
			dBm	mW	
Head	2.441	5	7.5	5.62	0.23
Body	2.441	10	7.5	5.62	0.12

\* - Maximum possible output power declared by manufacturer

When standalone SAR test exclusion applies to an antenna that transmits simultaneously with other antennas, the standalone SAR must be estimated according to following to determine simultaneous transmission SAR test exclusion:

$(\text{max. power of channel, including tune-up tolerance, mW}) / (\text{min. test separation distance, mm}) \cdot [\sqrt{f(\text{GHz})} / x] \text{ W/kg}$  for test separation distances  $\leq 50 \text{ mm}$ ;

where  $x = 7.5$  for 1-g SAR.

When the minimum test separation distance is  $< 5 \text{ mm}$ , a distance of  $5 \text{ mm}$  is applied to determine SAR test exclusion

#### Conclusion:

According to the above tables, the sum of reported SAR values is  $< 1.6 \text{ W/kg}$ . So the simultaneous transmission SAR with volume scans is not required.



## 14 SAR Test Result

It is performed for all SAR measurements with area scan based 1-g SAR estimation (Fast SAR). A zoom scan measurement is added when the estimated 1-gSAR is the highest measured SAR in each exposure configuration, wireless mode and frequency band combination or more than 1.2W/kg.

The calculated SAR is obtained by the following formula:

$$\text{Reported SAR} = \text{Measured SAR} \times 10^{(P_{\text{Target}} - P_{\text{Measured}})/10}$$

Where  $P_{\text{Target}}$  is the power of manufacturing upper limit;

$P_{\text{Measured}}$  is the measured power in chapter 11.

**Table 14.1: Duty Cycle**

Mode	Duty Cycle
Speech for GSM850/1900	1:8.3
GPRS&EGPRS	1:4
WCDMA & WiFi	1:1

### 14.1 The evaluation of multi-batteries

We'll perform the head measurement in all bands with the primary battery depending on the evaluation of multi-batteries and retest on highest value point with other batteries. Then, repeat the measurement in the Body test.

**Table 14.2: The evaluation of multi-batteries for Head Test**

Frequency		Mode/Band	Side	Test Position	Battery Type	SAR(1g)	Power Drift(dB)
MHz	Ch.					(W/kg)	
1732.4	1412	WCDMA1700	Left	Touch	CAB1150000C1	0.767	-0.13
1732.4	1412	WCDMA1700	Left	Touch	CAB1400002C1	0.831	-0.18
1732.4	1412	WCDMA1700	Left	Touch	CAB1400002C2	0.619	0.09

Note: According to the values in the above table, the battery, CAB1400002C1, is the primary battery. We'll perform the head measurement with this battery and retest on highest value point with others.

**Table 14.3: The evaluation of multi-batteries for Body Test**

Frequency		Mode/Band	Test Position	Spacing (mm)	Battery Type	SAR(1g)	Power Drift(dB)
MHz	Ch.					(W/kg)	
1732.4	1412	WCDMA1700	Front	10	CAB1150000C1	0.641	0.07
1732.4	1412	WCDMA1700	Front	10	CAB1400002C1	0.699	-0.05
1732.4	1412	WCDMA1700	Front	10	CAB1400002C2	0.524	-0.03

Note: According to the values in the above table, the battery, CAB1400002C1, is the primary battery. We'll perform the Body measurement with this battery and retest on highest value point with others.

## 14.2 SAR results for Fast SAR

**Table 14.4: SAR Values (GSM 850 MHz Band - Head) - CAB1400002C1**

Frequency		Side	Test Position	Figure No.	Conducted Power (dBm)	Max. tune-up Power (dBm)	Measured SAR(10g) (W/kg)	Reported SAR(10g) (W/kg)	Measured SAR(1g) (W/kg)	Reported SAR(1g) (W/kg)	Power Drift (dB)
MHz	Ch.										
848.8	251	Left	Touch	Fig.1	32.68	33.3	0.381	<b>0.44</b>	0.514	<b>0.59</b>	0.13
836.6	190	Left	Touch	/	32.64	33.3	0.293	<b>0.34</b>	0.429	<b>0.50</b>	-0.15
824.2	128	Left	Touch	/	32.62	33.3	0.178	<b>0.21</b>	0.260	<b>0.30</b>	0.12
836.6	190	Left	Tilt	/	32.64	33.3	0.131	<b>0.15</b>	0.189	<b>0.22</b>	-0.14
836.6	190	Right	Touch	/	32.64	33.3	0.270	<b>0.31</b>	0.394	<b>0.46</b>	0.17
836.6	190	Right	Tilt	/	32.64	33.3	0.090	<b>0.11</b>	0.130	<b>0.15</b>	0.06

**Table 14.5: SAR Values (GSM 850 MHz Band-Body) - CAB1400002C1**

Frequency		Mode (number of timeslots)	Test Position	Figure No.	Conducted Power (dBm)	Max. tune-up Power (dBm)	Measured SAR(10g) (W/kg)	Reported SAR(10g) (W/kg)	Measured SAR(1g) (W/kg)	Reported SAR(1g) (W/kg)	Power Drift (dB)
MHz	Ch.										
836.6	190	GPRS (2)	Front	/	29.63	30.5	0.367	<b>0.45</b>	0.516	<b>0.63</b>	0.00
848.8	251	GPRS (2)	Rear	Fig.2	29.68	30.5	0.634	<b>0.77</b>	0.870	<b>1.05</b>	0.01
836.6	190	GPRS (2)	Rear	/	29.63	30.5	0.495	<b>0.60</b>	0.694	<b>0.85</b>	-0.01
824.2	128	GPRS (2)	Rear	/	29.61	30.5	0.382	<b>0.47</b>	0.534	<b>0.66</b>	0.00
848.8	251	EGPRS (2)	Rear	/	29.69	30.5	0.559	<b>0.67</b>	0.795	<b>0.96</b>	-0.07

Note: The distance between the EUT and the phantom bottom is 10mm.

**Table 14.6: SAR Values (GSM1900 MHz Band - Head) - CAB1400002C1**

Frequency		Side	Test Position	Figure No.	Conducted Power (dBm)	Max. tune-up Power (dBm)	Measured SAR(10g) (W/kg)	Reported SAR(10g) (W/kg)	Measured SAR(1g) (W/kg)	Reported SAR(1g) (W/kg)	Power Drift (dB)
MHz	Ch.										
1880	661	Left	Touch	/	29.40	30.3	0.210	<b>0.26</b>	0.365	<b>0.45</b>	-0.12
1880	661	Left	Tilt	/	29.40	30.3	0.090	<b>0.11</b>	0.158	<b>0.19</b>	-0.01
1909.8	810	Right	Touch	Fig.3	29.26	30.3	0.231	<b>0.29</b>	0.396	<b>0.50</b>	-0.16
1880	661	Right	Touch	/	29.40	30.3	0.210	<b>0.26</b>	0.369	<b>0.45</b>	0.00
1850.2	512	Right	Touch	/	29.62	30.3	0.217	<b>0.25</b>	0.376	<b>0.44</b>	0.06
1880	661	Right	Tilt	/	29.40	30.3	0.099	<b>0.12</b>	0.169	<b>0.21</b>	-0.19

**Table 14.7: SAR Values (GSM 1900 MHz Band-Body) - CAB1400002C1**

Frequency		Mode (number of timeslots)	Test Position	Figure No.	Conducted Power (dBm)	Max. tune-up Power (dBm)	Measured SAR(10g) (W/kg)	Reported SAR(10g) (W/kg)	Measured SAR(1g) (W/kg)	Reported SAR(1g)( W/kg)	Power Drift (dB)
MHz	Ch.										
1880	661	GPRS (2)	Front	/	27.08	28.0	0.180	<b>0.22</b>	0.300	<b>0.37</b>	-0.19
1909.8	810	GPRS (2)	Rear	/	26.95	28.0	0.249	<b>0.32</b>	0.424	<b>0.54</b>	-0.05
1880	661	GPRS (2)	Rear	/	27.08	28.0	0.251	<b>0.31</b>	0.424	<b>0.52</b>	-0.10
1850.2	512	GPRS (2)	Rear	Fig.4	27.29	28.0	0.275	<b>0.32</b>	0.472	<b>0.56</b>	-0.13
1850.2	512	EGPRS (2)	Rear	/	27.29	28.0	0.264	<b>0.31</b>	0.454	<b>0.53</b>	-0.12

Note: The distance between the EUT and the phantom bottom is 10mm.

**Table 14.8: SAR Values (WCDMA850 MHz Band - Head) - CAB1400002C1**

Frequency		Side	Test Position	Figure No.	Conducted Power (dBm)	Max. tune-up Power (dBm)	Measured SAR(10g) (W/kg)	Reported SAR(10g) (W/kg)	Measured SAR(1g) (W/kg)	Reported SAR(1g)( W/kg)	Power Drift (dB)
MHz	Ch.										
846.6	4233	Left	Touch	/	23.06	23.5	0.397	<b>0.44</b>	0.578	<b>0.64</b>	0.04
836.4	4182	Left	Touch	Fig.5	22.67	23.5	0.709	<b>0.86</b>	0.929	<b>1.12</b>	-0.04
826.4	4132	Left	Touch	/	23.11	23.5	0.457	<b>0.50</b>	0.662	<b>0.72</b>	0.07
836.4	4182	Left	Tilt	/	22.67	23.5	0.337	<b>0.41</b>	0.486	<b>0.59</b>	0.06
846.6	4233	Right	Touch	/	23.06	23.5	0.358	<b>0.40</b>	0.519	<b>0.57</b>	-0.12
836.4	4182	Right	Touch	/	22.67	23.5	0.566	<b>0.69</b>	0.818	<b>0.99</b>	0.13
826.4	4132	Right	Touch	/	23.11	23.5	0.426	<b>0.47</b>	0.616	<b>0.67</b>	-0.17
836.4	4182	Right	Tilt	/	22.67	23.5	0.329	<b>0.40</b>	0.473	<b>0.57</b>	0.04

**Table 14.9: SAR Values (WCDMA 850 MHz Band-Body) - CAB1400002C1**

Frequency		Test Position	Figure No.	Conducted Power (dBm)	Max. tune-up Power (dBm)	Measured SAR(10g) (W/kg)	Reported SAR(10g) (W/kg)	Measured SAR(1g) (W/kg)	Reported SAR(1g)( W/kg)	Power Drift (dB)
MHz	Ch.									
846.6	4233	Front	/	23.06	23.5	0.356	<b>0.39</b>	0.515	<b>0.57</b>	-0.01
836.4	4182	Front	/	22.87	23.5	0.634	<b>0.73</b>	0.844	<b>0.98</b>	-0.16
826.4	4132	Front	/	23.11	23.5	0.414	<b>0.45</b>	0.597	<b>0.65</b>	-0.01
846.6	4233	Rear	/	23.06	23.5	0.518	<b>0.57</b>	0.754	<b>0.83</b>	0.03
836.4	4182	Rear	Fig.6	22.87	23.5	0.808	<b>0.93</b>	1.11	<b>1.28</b>	-0.11
826.4	4132	Rear	/	23.11	23.5	0.565	<b>0.62</b>	0.814	<b>0.89</b>	0.02

Note: The distance between the EUT and the phantom bottom is 10mm.

**Table 14.10: SAR Values (WCDMA1700 MHz Band - Head) - CAB1400002C1**

Ambient Temperature: 22.6 °C						Liquid Temperature: 22.1 °C					
Frequency		Side	Test Position	Figure No.	Conducted Power (dBm)	Max. tune-up Power (dBm)	Measured SAR(10g) (W/kg)	Reported SAR(10g) (W/kg)	Measured SAR(1g) (W/kg)	Reported SAR(1g)(W/kg)	Power Drift (dB)
MHz	Ch.										
1752.6	1513	Left	Touch	/	23.29	23.5	0.449	<b>0.47</b>	0.776	<b>0.81</b>	-0.04
1732.4	1412	Left	Touch	/	23.09	23.5	0.503	<b>0.55</b>	0.831	<b>0.91</b>	-0.18
1712.4	1312	Left	Touch	Fig.7	23.39	23.5	0.558	<b>0.57</b>	0.913	<b>0.94</b>	0.08
1732.4	1412	Left	Tilt	/	23.09	23.5	0.136	<b>0.15</b>	0.225	<b>0.25</b>	-0.08
1752.6	1513	Right	Touch	/	23.29	23.5	0.396	<b>0.42</b>	0.684	<b>0.72</b>	0.01
1732.4	1412	Right	Touch	/	23.09	23.5	0.450	<b>0.49</b>	0.760	<b>0.84</b>	0.10
1712.4	1312	Right	Touch	/	23.39	23.5	0.417	<b>0.43</b>	0.715	<b>0.73</b>	0.11
1732.4	1412	Right	Tilt	/	23.09	23.5	0.192	<b>0.21</b>	0.323	<b>0.35</b>	0.02

**Table 14.11: SAR Values (WCDMA1700 MHz Band-Body) - CAB1400002C1**

Ambient Temperature: 22.6 °C						Liquid Temperature: 22.1 °C				
Frequency		Test Position	Figure No.	Conducted Power (dBm)	Max. tune-up Power (dBm)	Measured SAR(10g) (W/kg)	Reported SAR(10g) (W/kg)	Measured SAR(1g) (W/kg)	Reported SAR(1g)(W/kg)	Power Drift (dB)
MHz	Ch.									
1732.4	1412	Front	/	23.09	23.5	0.414	<b>0.45</b>	0.699	<b>0.77</b>	-0.05
1752.6	1513	Rear	/	23.29	23.5	0.423	<b>0.44</b>	0.763	<b>0.80</b>	-0.01
1732.4	1412	Rear	Fig.8	23.09	23.5	0.539	<b>0.59</b>	0.929	<b>1.02</b>	0.00
1712.4	1312	Rear	/	23.39	23.5	0.431	<b>0.44</b>	0.775	<b>0.79</b>	-0.01

Note: The distance between the EUT and the phantom bottom is 10mm.

**Table 14.12: SAR Values (WCDMA1900 MHz Band - Head) - CAB1400002C1**

Ambient Temperature: 22.7 °C						Liquid Temperature: 22.2 °C					
Frequency		Side	Test Position	Figure No.	Conducted Power (dBm)	Max. tune-up Power (dBm)	Measured SAR(10g) (W/kg)	Reported SAR(10g) (W/kg)	Measured SAR(1g) (W/kg)	Reported SAR(1g)(W/kg)	Power Drift (dB)
MHz	Ch.										
1907.6	9538	Left	Touch	/	22.67	23.5	0.469	<b>0.57</b>	0.820	<b>0.99</b>	-0.02
1880	9400	Left	Touch	/	22.73	23.5	0.504	<b>0.60</b>	0.880	<b>1.05</b>	-0.10
1852.4	9262	Left	Touch	/	22.61	23.5	0.411	<b>0.50</b>	0.718	<b>0.88</b>	-0.20
1880	9400	Left	Tilt	/	22.73	23.5	0.200	<b>0.24</b>	0.347	<b>0.41</b>	-0.02
1907.6	9538	Right	Touch	/	22.67	23.5	0.472	<b>0.57</b>	0.824	<b>1.00</b>	-0.12
1880	9400	Right	Touch	Fig.9	22.73	23.5	0.526	<b>0.63</b>	0.894	<b>1.07</b>	-0.17
1852.4	9262	Right	Touch	/	22.61	23.5	0.431	<b>0.53</b>	0.756	<b>0.93</b>	-0.11
1880	9400	Right	Tilt	/	22.73	23.5	0.236	<b>0.28</b>	0.416	<b>0.50</b>	-0.07

**Table 14.13: SAR Values (WCDMA1900 MHz Band-Body) - CAB1400002C1**

Ambient Temperature: 22.7 °C						Liquid Temperature: 22.2 °C				
Frequency		Test Position	Figure No.	Conducted Power (dBm)	Max. tune-up Power (dBm)	Measured SAR(10g) (W/kg)	Reported SAR(10g) (W/kg)	Measured SAR(1g) (W/kg)	Reported SAR(1g)(W/kg)	Power Drift (dB)
MHz	Ch.									
1880	9400	Front	/	22.73	23.5	0.353	<b>0.42</b>	0.584	<b>0.70</b>	-0.06
1907.6	9538	Rear	/	22.67	23.5	0.352	<b>0.43</b>	0.623	<b>0.75</b>	-0.05
1880	9400	Rear	Fig.10	22.73	23.5	0.363	<b>0.43</b>	0.631	<b>0.75</b>	-0.07
1852.4	9262	Rear	/	22.61	23.5	0.338	<b>0.41</b>	0.583	<b>0.72</b>	-0.01

Note: The distance between the EUT and the phantom bottom is 10mm.

**Table 14.14: SAR Values (Wi-Fi 802.11b - Head) - CAB1400002C1**

Ambient Temperature: 22.5 °C						Liquid Temperature: 22.0 °C					
Frequency		Side	Test Position	Figure No.	Conducted Power (dBm)	Max. tune-up Power (dBm)	Measured SAR(10g) (W/kg)	Reported SAR(10g) (W/kg)	Measured SAR(1g) (W/kg)	Reported SAR(1g)(W/kg)	Power Drift (dB)
MHz	Ch.										
2462	11	Left	Touch	Fig.11	16.43	16.5	0.169	<b>0.17</b>	0.342	<b>0.35</b>	-0.03
2462	11	Left	Tilt	/	16.43	16.5	0.093	<b>0.09</b>	0.189	<b>0.19</b>	-0.12
2462	11	Right	Touch	/	16.43	16.5	0.100	<b>0.10</b>	0.189	<b>0.19</b>	0.02
2462	11	Right	Tilt	/	16.43	16.5	0.059	<b>0.06</b>	0.108	<b>0.11</b>	0.18

**Table 14.15: SAR Values (Wi-Fi 802.11b - Body) - CAB1400002C1**

Ambient Temperature: 22.5 °C						Liquid Temperature: 22.0 °C				
Frequency		Test Position	Figure No.	Conducted Power (dBm)	Max. tune-up Power (dBm)	Measured SAR(10g) (W/kg)	Reported SAR(10g) (W/kg)	Measured SAR(1g) (W/kg)	Reported SAR(1g)(W/kg)	Power Drift (dB)
MHz	Ch.									
2462	11	Front	/	16.43	16.5	0.023	<b>0.02</b>	0.044	<b>0.05</b>	0.07
2462	11	Rear	Fig.12	16.43	16.5	0.045	<b>0.05</b>	0.106	<b>0.11</b>	0.10

Note1: The distance between the EUT and the phantom bottom is 10mm.

**Table 14.16: SAR Values (WCDMA850 MHz Band - Head) – other batteries**

Ambient Temperature: 22.7 °C						Liquid Temperature: 22.2 °C					
Frequency		Side	Test Position	Headset	Conducted Power (dBm)	Max. tune-up Power (dBm)	Measured SAR(10g) (W/kg)	Reported SAR(10g) (W/kg)	Measured SAR(1g) (W/kg)	Reported SAR(1g)(W/kg)	Power Drift (dB)
MHz	Ch.										
836.4	4182	Left	Touch	1	22.67	23.5	0.651	<b>0.79</b>	0.855	<b>1.04</b>	0.07
836.4	4182	Left	Touch	2	22.67	23.5	0.537	<b>0.65</b>	0.698	<b>0.84</b>	0.03

Note: the headset 1 is CAB1150000C1, the headset 2 is CAB1400002C2.

**Table 14.17: SAR Values (WCDMA 850 MHz Band-Body) - other batteries**

Ambient Temperature: 22.7 °C					Liquid Temperature: 22.2 °C					
Frequency		Test Position	Headset	Conducted Power (dBm)	Max. tune-up Power (dBm)	Measured SAR(10g) (W/kg)	Reported SAR(10g) (W/kg)	Measured SAR(1g) (W/kg)	Reported SAR(1g)(W/kg)	Power Drift (dB)
MHz	Ch.									
836.4	4182	Rear	1	22.87	23.5	0.752	<b>0.87</b>	1.04	<b>1.20</b>	-0.05
836.4	4182	Rear	2	22.87	23.5	0.616	<b>0.71</b>	0.856	<b>0.99</b>	-0.06

Note1: The distance between the EUT and the phantom bottom is 10mm.

Note2: the headset 1 is CAB1150000C1, the headset 2 is CAB1400002C2.

### 14.3 SAR results for Standard procedure

There is zoom scan measurement to be added for the highest measured SAR in each exposure configuration/band.

**Table 14.18: SAR Values (GSM 850 MHz Band - Head) - CAB1400002C1**

Ambient Temperature: 22.7 °C					Liquid Temperature: 22.2 °C						
Frequency		Side	Test Position	Figure No.	Conducted Power (dBm)	Max. tune-up Power (dBm)	Measured SAR(10g) (W/kg)	Reported SAR(10g) (W/kg)	Measured SAR(1g) (W/kg)	Reported SAR(1g)(W/kg)	Power Drift (dB)
MHz	Ch.										
848.8	251	Left	Touch	Fig.1	32.68	33.3	0.381	<b>0.44</b>	0.514	<b>0.59</b>	0.13

**Table 14.19: SAR Values (GSM 850 MHz Band-Body) - CAB1400002C1**

Ambient Temperature: 22.7 °C					Liquid Temperature: 22.2 °C						
Frequency		Mode (number of timeslots)	Test Position	Figure No.	Conducted Power (dBm)	Max. tune-up Power (dBm)	Measured SAR(10g) (W/kg)	Reported SAR(10g) (W/kg)	Measured SAR(1g) (W/kg)	Reported SAR(1g)(W/kg)	Power Drift (dB)
MHz	Ch.										
848.8	251	GPRS (2)	Rear	Fig.2	29.68	30.5	0.634	<b>0.77</b>	0.870	<b>1.05</b>	0.01

Note: The distance between the EUT and the phantom bottom is 10mm.

**Table 14.20: SAR Values (GSM1900 MHz Band - Head) - CAB1400002C1**

Ambient Temperature: 22.7 °C					Liquid Temperature: 22.2 °C						
Frequency		Side	Test Position	Figure No.	Conducted Power (dBm)	Max. tune-up Power (dBm)	Measured SAR(10g) (W/kg)	Reported SAR(10g) (W/kg)	Measured SAR(1g) (W/kg)	Reported SAR(1g)(W/kg)	Power Drift (dB)
MHz	Ch.										
1909.8	810	Right	Touch	Fig.3	29.26	30.3	0.231	<b>0.29</b>	0.396	<b>0.50</b>	-0.16

**Table 14.21: SAR Values (GSM 1900 MHz Band-Body) - CAB1400002C1**

Ambient Temperature: 22.7 °C					Liquid Temperature: 22.2 °C						
Frequency		Mode (number of timeslots)	Test Position	Figure No.	Conducted Power (dBm)	Max. tune-up Power (dBm)	Measured SAR(10g) (W/kg)	Reported SAR(10g) (W/kg)	Measured SAR(1g) (W/kg)	Reported SAR(1g)(W/kg)	Power Drift (dB)
MHz	Ch.										
1850.2	512	GPRS (2)	Rear	Fig.4	27.29	28.0	0.275	<b>0.32</b>	0.472	<b>0.56</b>	-0.13

Note: The distance between the EUT and the phantom bottom is 10mm.

**Table 14.22: SAR Values (WCDMA850 MHz Band - Head) - CAB1400002C1**

Frequency		Side	Test Position	Figure No.	Conducted Power (dBm)	Max. tune-up Power (dBm)	Ambient Temperature: 22.7 °C		Liquid Temperature: 22.2 °C		Power Drift (dB)
MHz	Ch.						Measured SAR(10g) (W/kg)	Reported SAR(10g) (W/kg)	Measured SAR(1g) (W/kg)	Reported SAR(1g) (W/kg)	
836.4	4182	Left	Touch	Fig.5	22.67	23.5	0.709	<b>0.86</b>	0.929	<b>1.12</b>	-0.04

**Table 14.23: SAR Values (WCDMA 850 MHz Band-Body) - CAB1400002C1**

Frequency		Test Position	Figure No.	Conducted Power (dBm)	Max. tune-up Power (dBm)	Ambient Temperature: 22.7 °C		Liquid Temperature: 22.2 °C		Power Drift (dB)
MHz	Ch.					Measured SAR(10g) (W/kg)	Reported SAR(10g) (W/kg)	Measured SAR(1g) (W/kg)	Reported SAR(1g) (W/kg)	
836.4	4182	Rear	Fig.6	22.87	23.5	0.808	<b>0.93</b>	1.11	<b>1.28</b>	-0.11

Note: The distance between the EUT and the phantom bottom is 10mm.

**Table 14.24: SAR Values (WCDMA1700 MHz Band - Head) - CAB1400002C1**

Frequency		Side	Test Position	Figure No.	Conducted Power (dBm)	Max. tune-up Power (dBm)	Ambient Temperature: 22.6 °C		Liquid Temperature: 22.1 °C		Power Drift (dB)
MHz	Ch.						Measured SAR(10g) (W/kg)	Reported SAR(10g) (W/kg)	Measured SAR(1g) (W/kg)	Reported SAR(1g) (W/kg)	
1712.4	1312	Left	Touch	Fig.7	23.39	23.5	0.558	<b>0.57</b>	0.913	<b>0.94</b>	0.08

**Table 14.25: SAR Values (WCDMA1700 MHz Band-Body) - CAB1400002C1**

Frequency		Test Position	Figure No.	Conducted Power (dBm)	Max. tune-up Power (dBm)	Ambient Temperature: 22.6 °C		Liquid Temperature: 22.1 °C		Power Drift (dB)
MHz	Ch.					Measured SAR(10g) (W/kg)	Reported SAR(10g) (W/kg)	Measured SAR(1g) (W/kg)	Reported SAR(1g) (W/kg)	
1732.4	1412	Rear	Fig.8	23.09	23.5	0.539	<b>0.59</b>	0.929	<b>1.02</b>	0.00

Note: The distance between the EUT and the phantom bottom is 10mm.

**Table 14.26: SAR Values (WCDMA1900 MHz Band - Head) - CAB1400002C1**

Frequency		Side	Test Position	Figure No.	Conducted Power (dBm)	Max. tune-up Power (dBm)	Ambient Temperature: 22.7 °C		Liquid Temperature: 22.2 °C		Power Drift (dB)
MHz	Ch.						Measured SAR(10g) (W/kg)	Reported SAR(10g) (W/kg)	Measured SAR(1g) (W/kg)	Reported SAR(1g) (W/kg)	
1880	9400	Right	Touch	Fig.9	22.73	23.5	0.526	<b>0.63</b>	0.894	<b>1.07</b>	-0.17

**Table 14.27: SAR Values (WCDMA1900 MHz Band-Body) - CAB1400002C1**

Frequency		Test Position	Figure No.	Conducted Power (dBm)	Max. tune-up Power (dBm)	Measured SAR(10g) (W/kg)	Reported SAR(10g) (W/kg)	Measured SAR(1g) (W/kg)	Reported SAR(1g)(W/kg)	Power Drift (dB)
MHz	Ch.									
		Ambient Temperature: 22.7 °C				Liquid Temperature: 22.2 °C				
1880	9400	Rear	Fig.10	22.73	23.5	0.363	<b>0.43</b>	0.631	<b>0.75</b>	-0.07

Note: The distance between the EUT and the phantom bottom is 10mm.

**Table 14.28: SAR Values (Wi-Fi 802.11b - Head) - CAB1400002C1**

Frequency		Side	Test Position	Figure No.	Conducted Power (dBm)	Max. tune-up Power (dBm)	Measured SAR(10g) (W/kg)	Reported SAR(10g) (W/kg)	Measured SAR(1g) (W/kg)	Reported SAR(1g)(W/kg)	Power Drift (dB)
MHz	Ch.										
		Ambient Temperature: 22.5 °C				Liquid Temperature: 22.0 °C					
2462	11	Left	Touch	Fig.11	16.43	16.5	0.169	<b>0.17</b>	0.342	<b>0.35</b>	-0.03

**Table 14.29: SAR Values (Wi-Fi 802.11b - Body) - CAB1400002C1**

Frequency		Test Position	Figure No.	Conducted Power (dBm)	Max. tune-up Power (dBm)	Measured SAR(10g) (W/kg)	Reported SAR(10g) (W/kg)	Measured SAR(1g) (W/kg)	Reported SAR(1g)(W/kg)	Power Drift (dB)
MHz	Ch.									
		Ambient Temperature: 22.5 °C				Liquid Temperature: 22.0 °C				
2462	11	Rear	Fig.12	16.43	16.5	0.045	<b>0.05</b>	0.106	<b>0.11</b>	0.10

Note1: The distance between the EUT and the phantom bottom is 10mm.



## 15 SAR Measurement Variability

SAR measurement variability must be assessed for each frequency band, which is determined by the SAR probe calibration point and tissue-equivalent medium used for the device measurements. When both head and body tissue-equivalent media are required for SAR measurements in a frequency band, the variability measurement procedures should be applied to the tissue medium with the highest measured SAR, using the highest measured SAR configuration for that tissue-equivalent medium.

The following procedures are applied to determine if repeated measurements are required.

- 1) Repeated measurement is not required when the original highest measured SAR is  $< 0.80$  W/kg; steps 2) through 4) do not apply.
- 2) When the original highest measured SAR is  $\geq 0.80$  W/kg, repeat that measurement once.
- 3) Perform a second repeated measurement only if the ratio of largest to smallest SAR for the original and first repeated measurements is  $> 1.20$  or when the original or repeated measurement is  $\geq 1.45$  W/kg ( $\sim 10\%$  from the 1-g SAR limit).
- 4) Perform a third repeated measurement only if the original, first or second repeated measurement is  $\geq 1.5$  W/kg and the ratio of largest to smallest SAR for the original, first and second repeated measurements is  $> 1.20$ .

**Table 15.1: SAR Measurement Variability for Body GSM850 (1g)**

Frequency		Test Position	Spacing (mm)	Original SAR (W/kg)	First Repeated SAR (W/kg)	The Ratio	Second Repeated SAR (W/kg)
MHz	Ch.						
848.8	251	Rear	10	0.870	0.856	1.02	/

**Table 15.2: SAR Measurement Variability for Head WCDMA850 (1g)**

Frequency		Side	Test Position	Original SAR (W/kg)	First Repeated SAR (W/kg)	The Ratio	Second Repeated SAR (W/kg)
MHz	Ch.						
836.4	4182	Left	Touch	0.929	0.913	1.02	/

**Table 15.3: SAR Measurement Variability for Body WCDMA850 (1g)**

Frequency		Test Position	Spacing (mm)	Original SAR (W/kg)	First Repeated SAR (W/kg)	The Ratio	Second Repeated SAR (W/kg)
MHz	Ch.						
836.4	4182	Rear	10	1.11	1.09	1.02	/

**Table 15.4: SAR Measurement Variability for Head WCDMA1700 (1g)**

Frequency		Side	Test Position	Original SAR (W/kg)	First Repeated SAR (W/kg)	The Ratio	Second Repeated SAR (W/kg)
MHz	Ch.						
1712.4	1312	Left	Touch	0.913	0.902	1.01	/

**Table 15.5: SAR Measurement Variability for Body WCDMA1700 (1g)**

Frequency		Test Position	Spacing (mm)	Original SAR (W/kg)	First Repeated SAR (W/kg)	The Ratio	Second Repeated SAR (W/kg)
MHz	Ch.						
1732.4	1412	Rear	10	0.929	0.923	1.01	/

**Table 15.6: SAR Measurement Variability for Head WCDMA1900 (1g)**

Frequency		Side	Test Position	Original SAR (W/kg)	First Repeated SAR (W/kg)	The Ratio	Second Repeated SAR (W/kg)
MHz	Ch.						
1880	9400	Right	Touch	0.894	0.885	1.01	/

## 16 Measurement Uncertainty

### 16.1 Measurement Uncertainty for Normal SAR Tests (300MHz~3GHz)

No.	Error Description	Type	Uncertainty value	Probably Distribution	Div.	(Ci) 1g	(Ci) 10g	Std. Unc. (1g)	Std. Unc. (10g)	Degree of freedom
<b>Measurement system</b>										
1	Probe calibration	B	5.5	N	1	1	1	5.5	5.5	∞
2	Isotropy	B	4.7	R	$\sqrt{3}$	0.7	0.7	1.9	1.9	∞
3	Boundary effect	B	1.0	R	$\sqrt{3}$	1	1	0.6	0.6	∞
4	Linearity	B	4.7	R	$\sqrt{3}$	1	1	2.7	2.7	∞
5	Detection limit	B	1.0	R	$\sqrt{3}$	1	1	0.6	0.6	∞
6	Readout electronics	B	0.3	R	$\sqrt{3}$	1	1	0.3	0.3	∞
7	Response time	B	0.8	R	$\sqrt{3}$	1	1	0.5	0.5	∞
8	Integration time	B	2.6	R	$\sqrt{3}$	1	1	1.5	1.5	∞
9	RF ambient conditions-noise	B	0	R	$\sqrt{3}$	1	1	0	0	∞
10	RF ambient conditions-reflection	B	0	R	$\sqrt{3}$	1	1	0	0	∞
11	Probe positioned mech. restrictions	B	0.4	R	$\sqrt{3}$	1	1	0.2	0.2	∞
12	Probe positioning with respect to phantom shell	B	2.9	R	$\sqrt{3}$	1	1	1.7	1.7	∞
13	Post-processing	B	1.0	R	$\sqrt{3}$	1	1	0.6	0.6	∞
<b>Test sample related</b>										
14	Test sample positioning	A	3.3	N	1	1	1	3.3	3.3	71
15	Device holder uncertainty	A	3.4	N	1	1	1	3.4	3.4	5
16	Drift of output power	B	5.0	R	$\sqrt{3}$	1	1	2.9	2.9	∞
<b>Phantom and set-up</b>										
17	Phantom uncertainty	B	4.0	R	$\sqrt{3}$	1	1	2.3	2.3	∞
18	Liquid conductivity (target)	B	5.0	R	$\sqrt{3}$	0.64	0.43	1.8	1.2	∞
19	Liquid conductivity (meas.)	A	2.06	N	1	0.64	0.43	1.32	0.89	43
20	Liquid permittivity (target)	B	5.0	R	$\sqrt{3}$	0.6	0.49	1.7	1.4	∞
21	Liquid permittivity (meas.)	A	1.6	N	1	0.6	0.49	1.0	0.8	521

Combined standard uncertainty	$u_c = \sqrt{\sum_{i=1}^{21} c_i^2 u_i^2}$							9.25	9.12	257
Expanded uncertainty (confidence interval of 95 %)	$u_e = 2u_c$							18.5	18.2	

### 16.2 Measurement Uncertainty for Normal SAR Tests (3~6GHz)

No.	Error Description	Type	Uncertainty value	Probably Distribution	Div.	(Ci) 1g	(Ci) 10g	Std. Unc. (1g)	Std. Unc. (10g)	Degree of freedom
<b>Measurement system</b>										
1	Probe calibration	B	6.5	N	1	1	1	6.5	6.5	∞
2	Isotropy	B	4.7	R	$\sqrt{3}$	0.7	0.7	1.9	1.9	∞
3	Boundary effect	B	2.0	R	$\sqrt{3}$	1	1	1.2	1.2	∞
4	Linearity	B	4.7	R	$\sqrt{3}$	1	1	2.7	2.7	∞
5	Detection limit	B	1.0	R	$\sqrt{3}$	1	1	0.6	0.6	∞
6	Readout electronics	B	0.3	R	$\sqrt{3}$	1	1	0.3	0.3	∞
7	Response time	B	0.8	R	$\sqrt{3}$	1	1	0.5	0.5	∞
8	Integration time	B	2.6	R	$\sqrt{3}$	1	1	1.5	1.5	∞
9	RF ambient conditions-noise	B	0	R	$\sqrt{3}$	1	1	0	0	∞
10	RFambient conditions-reflection	B	0	R	$\sqrt{3}$	1	1	0	0	∞
11	Probe positioned mech. restrictions	B	0.8	R	$\sqrt{3}$	1	1	0.5	0.5	∞
12	Probe positioning with respect to phantom shell	B	6.7	R	$\sqrt{3}$	1	1	3.9	3.9	∞
13	Post-processing	B	4.0	R	$\sqrt{3}$	1	1	2.3	2.3	∞
<b>Test sample related</b>										
14	Test sample positioning	A	3.3	N	1	1	1	3.3	3.3	71
15	Device holder uncertainty	A	3.4	N	1	1	1	3.4	3.4	5
16	Drift of output power	B	5.0	R	$\sqrt{3}$	1	1	2.9	2.9	∞
<b>Phantom and set-up</b>										
17	Phantom uncertainty	B	4.0	R	$\sqrt{3}$	1	1	2.3	2.3	∞
18	Liquid conductivity (target)	B	5.0	R	$\sqrt{3}$	0.64	0.43	1.8	1.2	∞
19	Liquid conductivity (meas.)	A	2.06	N	1	0.64	0.43	1.32	0.89	43

20	Liquid permittivity (target)	B	5.0	R	$\sqrt{3}$	0.6	0.49	1.7	1.4	$\infty$
21	Liquid permittivity (meas.)	A	1.6	N	1	0.6	0.49	1.0	0.8	521
Combined standard uncertainty		$u_c = \sqrt{\sum_{i=1}^{21} c_i^2 u_i^2}$						10.8	10.7	257
Expanded uncertainty (confidence interval of 95 %)		$u_e = 2u_c$						21.6	21.4	

### 16.3 Measurement Uncertainty for Fast SAR Tests (300MHz~3GHz)

No.	Error Description	Type	Uncertainty value	Probably Distribution	Div.	(Ci) 1g	(Ci) 10g	Std. Unc. (1g)	Std. Unc. (10g)	Degree of freedom
<b>Measurement system</b>										
1	Probe calibration	B	5.5	N	1	1	1	5.5	5.5	$\infty$
2	Isotropy	B	4.7	R	$\sqrt{3}$	0.7	0.7	1.9	1.9	$\infty$
3	Boundary effect	B	1.0	R	$\sqrt{3}$	1	1	0.6	0.6	$\infty$
4	Linearity	B	4.7	R	$\sqrt{3}$	1	1	2.7	2.7	$\infty$
5	Detection limit	B	1.0	R	$\sqrt{3}$	1	1	0.6	0.6	$\infty$
6	Readout electronics	B	0.3	R	$\sqrt{3}$	1	1	0.3	0.3	$\infty$
7	Response time	B	0.8	R	$\sqrt{3}$	1	1	0.5	0.5	$\infty$
8	Integration time	B	2.6	R	$\sqrt{3}$	1	1	1.5	1.5	$\infty$
9	RF ambient conditions-noise	B	0	R	$\sqrt{3}$	1	1	0	0	$\infty$
10	RFambient conditions-reflection	B	0	R	$\sqrt{3}$	1	1	0	0	$\infty$
11	Probe positioned mech. Restrictions	B	0.4	R	$\sqrt{3}$	1	1	0.2	0.2	$\infty$
12	Probe positioning with respect to phantom shell	B	2.9	R	$\sqrt{3}$	1	1	1.7	1.7	$\infty$
13	Post-processing	B	1.0	R	$\sqrt{3}$	1	1	0.6	0.6	$\infty$
14	Fast SAR z-Approximation	B	7.0	R	$\sqrt{3}$	1	1	4.0	4.0	$\infty$
<b>Test sample related</b>										
15	Test sample positioning	A	3.3	N	1	1	1	3.3	3.3	71
16	Device holder uncertainty	A	3.4	N	1	1	1	3.4	3.4	5
17	Drift of output power	B	5.0	R	$\sqrt{3}$	1	1	2.9	2.9	$\infty$

Phantom and set-up										
18	Phantom uncertainty	B	4.0	R	$\sqrt{3}$	1	1	2.3	2.3	$\infty$
19	Liquid conductivity (target)	B	5.0	R	$\sqrt{3}$	0.64	0.43	1.8	1.2	$\infty$
20	Liquid conductivity (meas.)	A	2.06	N	1	0.64	0.43	1.32	0.89	43
21	Liquid permittivity (target)	B	5.0	R	$\sqrt{3}$	0.6	0.49	1.7	1.4	$\infty$
22	Liquid permittivity (meas.)	A	1.6	N	1	0.6	0.49	1.0	0.8	521
Combined standard uncertainty		$u_c = \sqrt{\sum_{i=1}^{22} c_i^2 u_i^2}$						10.1	9.95	257
Expanded uncertainty (confidence interval of 95 %)		$u_e = 2u_c$						20.2	19.9	

#### 16.4 Measurement Uncertainty for Fast SAR Tests (3~6GHz)

No.	Error Description	Type	Uncertainty value	Probably Distribution	Div.	(Ci) 1g	(Ci) 10g	Std. Unc. (1g)	Std. Unc. (10g)	Degree of freedom
<b>Measurement system</b>										
1	Probe calibration	B	6.5	N	1	1	1	6.5	6.5	$\infty$
2	Isotropy	B	4.7	R	$\sqrt{3}$	0.7	0.7	1.9	1.9	$\infty$
3	Boundary effect	B	2.0	R	$\sqrt{3}$	1	1	1.2	1.2	$\infty$
4	Linearity	B	4.7	R	$\sqrt{3}$	1	1	2.7	2.7	$\infty$
5	Detection limit	B	1.0	R	$\sqrt{3}$	1	1	0.6	0.6	$\infty$
6	Readout electronics	B	0.3	R	$\sqrt{3}$	1	1	0.3	0.3	$\infty$
7	Response time	B	0.8	R	$\sqrt{3}$	1	1	0.5	0.5	$\infty$
8	Integration time	B	2.6	R	$\sqrt{3}$	1	1	1.5	1.5	$\infty$
9	RF ambient conditions-noise	B	0	R	$\sqrt{3}$	1	1	0	0	$\infty$
10	RFambient conditions-reflection	B	0	R	$\sqrt{3}$	1	1	0	0	$\infty$
11	Probe positioned mech. Restrictions	B	0.8	R	$\sqrt{3}$	1	1	0.5	0.5	$\infty$
12	Probe positioning with respect to phantom shell	B	6.7	R	$\sqrt{3}$	1	1	3.9	3.9	$\infty$
13	Post-processing	B	1.0	R	$\sqrt{3}$	1	1	0.6	0.6	$\infty$
14	Fast SAR z-Approximation	B	14.0	R	$\sqrt{3}$	1	1	8.1	8.1	$\infty$
<b>Test sample related</b>										

15	Test sample positioning	A	3.3	N	1	1	1	3.3	3.3	71
16	Device holder uncertainty	A	3.4	N	1	1	1	3.4	3.4	5
17	Drift of output power	B	5.0	R	$\sqrt{3}$	1	1	2.9	2.9	$\infty$
<b>Phantom and set-up</b>										
18	Phantom uncertainty	B	4.0	R	$\sqrt{3}$	1	1	2.3	2.3	$\infty$
19	Liquid conductivity (target)	B	5.0	R	$\sqrt{3}$	0.64	0.43	1.8	1.2	$\infty$
20	Liquid conductivity (meas.)	A	2.06	N	1	0.64	0.43	1.32	0.89	43
21	Liquid permittivity (target)	B	5.0	R	$\sqrt{3}$	0.6	0.49	1.7	1.4	$\infty$
22	Liquid permittivity (meas.)	A	1.6	N	1	0.6	0.49	1.0	0.8	521
Combined standard uncertainty		$u_c = \sqrt{\sum_{i=1}^{22} c_i^2 u_i^2}$						13.3	13.2	257
Expanded uncertainty (confidence interval of 95 %)		$u_e = 2u_c$						26.6	26.4	

## 17 MAIN TEST INSTRUMENTS

Table 17.1: List of Main Instruments

No.	Name	Type	Serial Number	Calibration Date	Valid Period
01	Network analyzer	E5071C	MY46110673	February 03, 2015	One year
02	Power meter	NRVD	102196	March 03, 2015	One year
03	Power sensor	NRV-Z5	100596		
04	Signal Generator	E4438C	MY49071430	February 02, 2015	One Year
05	Amplifier	60S1G4	0331848	No Calibration Requested	
06	BTS	E5515C	MY50263375	January 30, 2015	One year
07	E-field Probe	SPEAG EX3DV4	3846	September 24, 2014	One year
08	DAE	SPEAG DAE4	777	September 17, 2014	One year
09	Dipole Validation Kit	SPEAG D835V2	4d069	August 28, 2014	One year
10	Dipole Validation Kit	SPEAG D1750V2	1003	August 18, 2014	One year
11	Dipole Validation Kit	SPEAG D1900V2	5d101	July 23, 2014	One year
12	Dipole Validation Kit	SPEAG D2450V2	853	July 24, 2014	One year

\*\*\*END OF REPORT BODY\*\*\*

## ANNEX A Graph Results

### 850 Left Cheek High

Date: 2015-4-30

Electronics: DAE4 Sn777

Medium: Head 850 MHz

Medium parameters used (interpolated):  $f = 848.8$  MHz;  $\sigma = 0.929$  S/m;  $\epsilon_r = 41.304$ ;  $\rho = 1000$  kg/m<sup>3</sup>

Ambient Temperature: 22.7 °C      Liquid Temperature: 22.2 °C

Communication System: GSM 850 Frequency: 848.8 MHz Duty Cycle: 1:8.3

Probe: EX3DV4 - SN3846 ConvF(9.18, 9.18, 9.18)

**Cheek High/Area Scan (61x91x1):** Interpolated grid: dx=1.000 mm, dy=1.000 mm

Maximum value of SAR (interpolated) = 0.570 W/kg

**Cheek High/Zoom Scan (7x7x7)/Cube 0:** Measurement grid: dx=5mm, dy=5mm, dz=5mm

Reference Value = 9.083 V/m; Power Drift = 0.13 dB

Peak SAR (extrapolated) = 0.659 W/kg

**SAR(1 g) = 0.514 W/kg; SAR(10 g) = 0.381 W/kg**

Maximum value of SAR (measured) = 0.569 W/kg

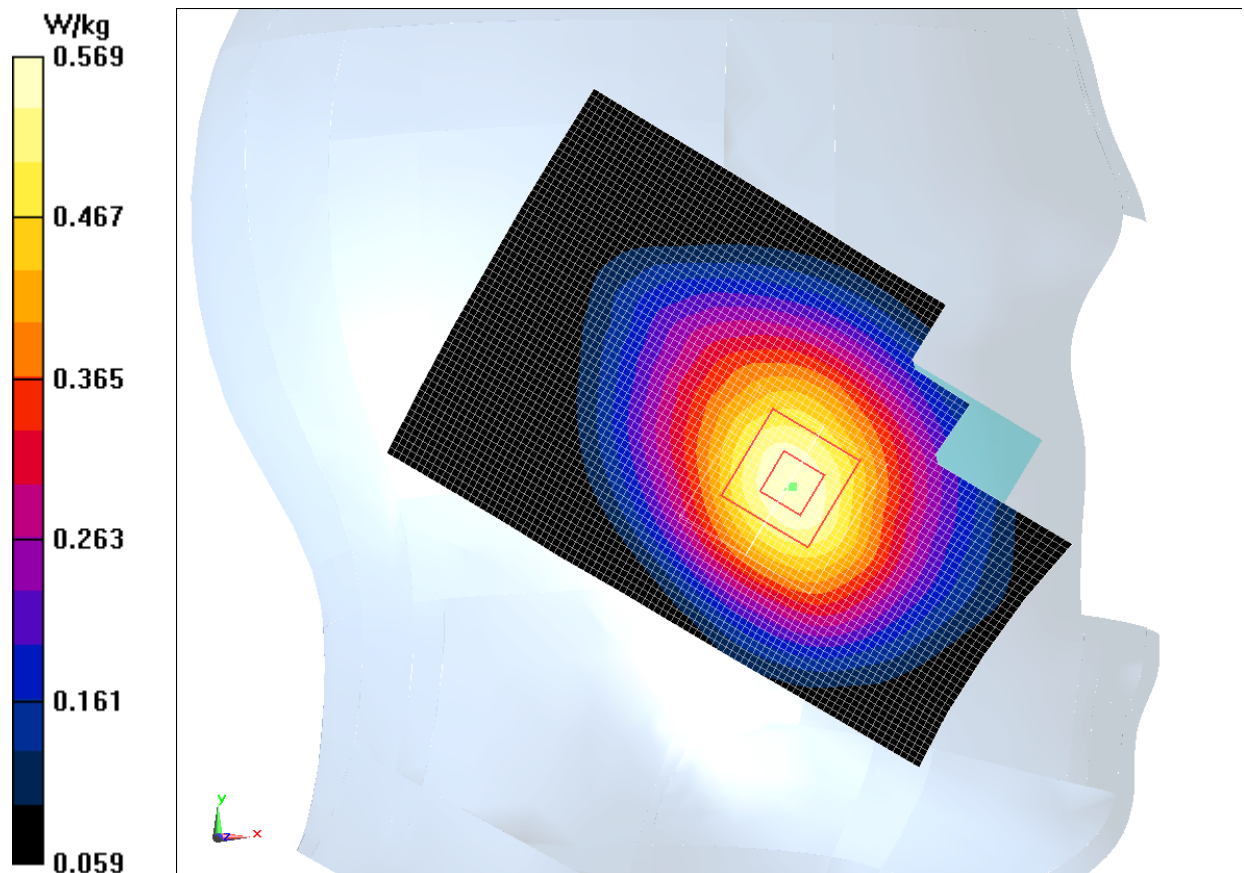

Fig.1 850MHz



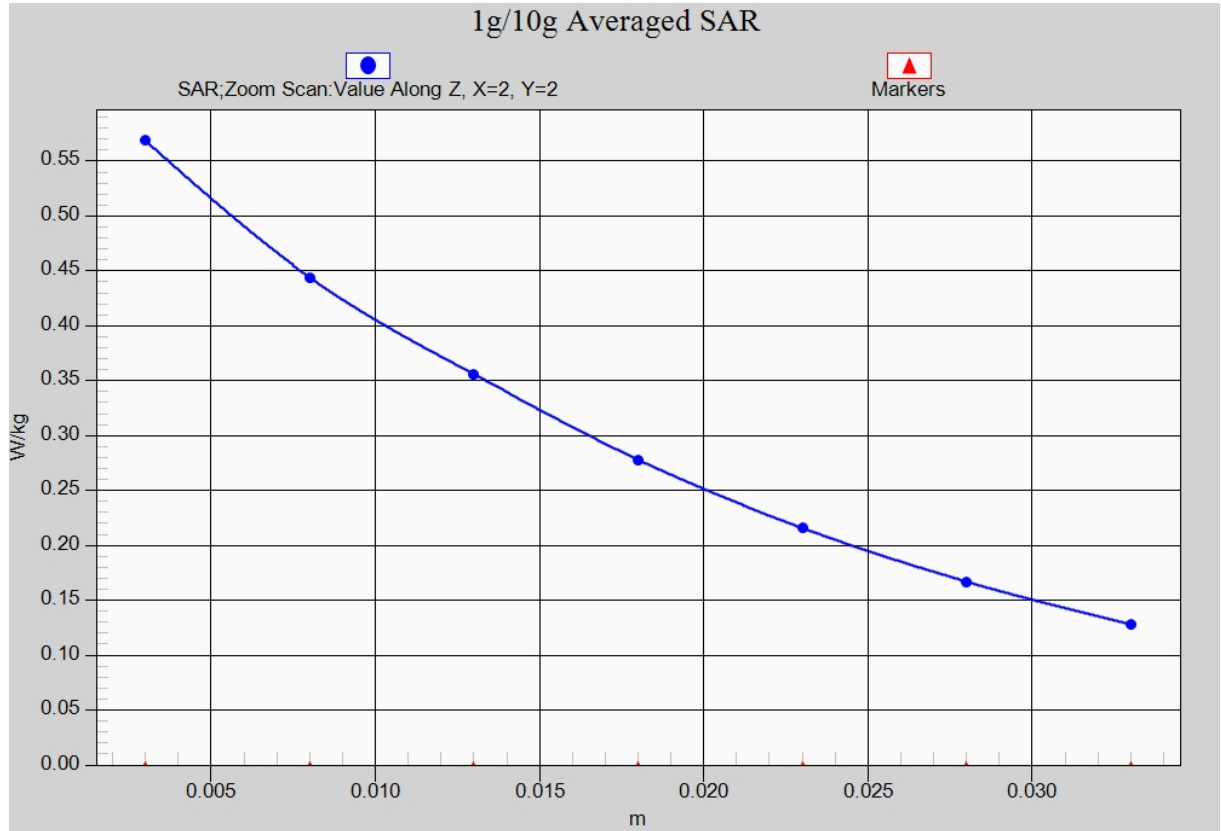

Fig. 1-1 Z-Scan at power reference point (850 MHz)

### 850 Body Rear High

Date: 2015-4-30

Electronics: DAE4 Sn777

Medium: Body 850 MHz

Medium parameters used (interpolated):  $f = 848.8$  MHz;  $\sigma = 0.957$  S/m;  $\epsilon_r = 55.281$ ;  $\rho = 1000$  kg/m<sup>3</sup>

Ambient Temperature: 22.7 °C      Liquid Temperature: 22.2 °C

Communication System: GSM 850 GPRS Frequency: 848.8 MHz Duty Cycle: 1:4

Probe: EX3DV4 - SN3846 ConvF(9.09, 9.09, 9.09)

**Rear High/Area Scan (101x61x1):** Interpolated grid: dx=1.000 mm, dy=1.000 mm

Maximum value of SAR (interpolated) = 0.966 W/kg

**Rear High/Zoom Scan (7x7x7)/Cube 0:** Measurement grid: dx=5mm, dy=5mm, dz=5mm

Reference Value = 30.64 V/m; Power Drift = 0.01 dB

Peak SAR (extrapolated) = 1.16 W/kg

**SAR(1 g) = 0.870 W/kg; SAR(10 g) = 0.634 W/kg**

Maximum value of SAR (measured) = 0.969 W/kg

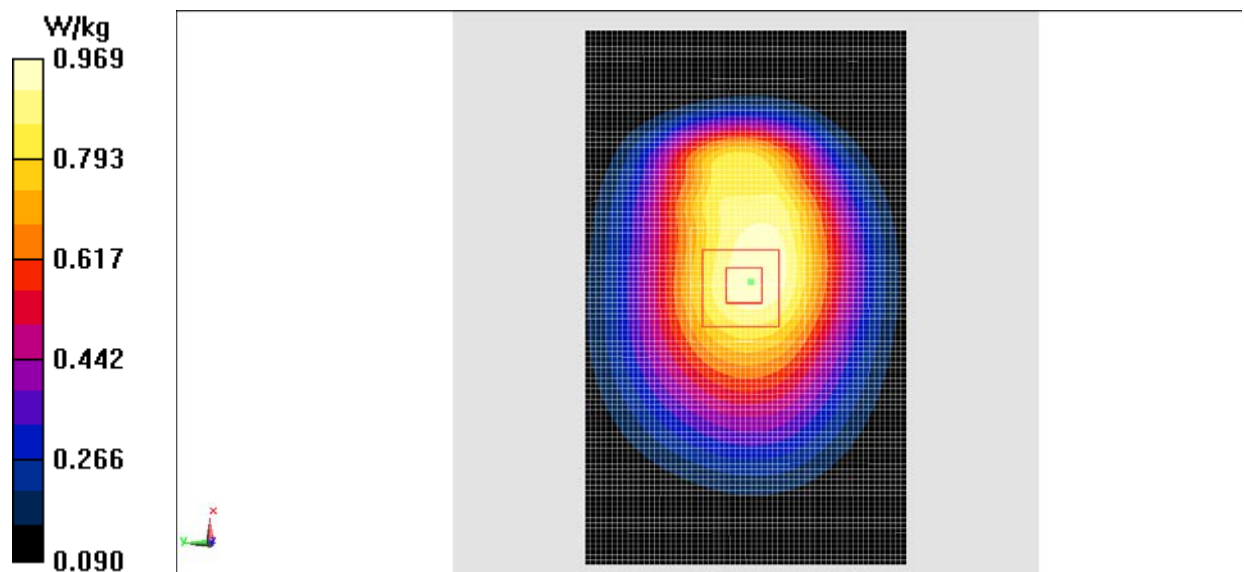

Fig.2 850 MHz

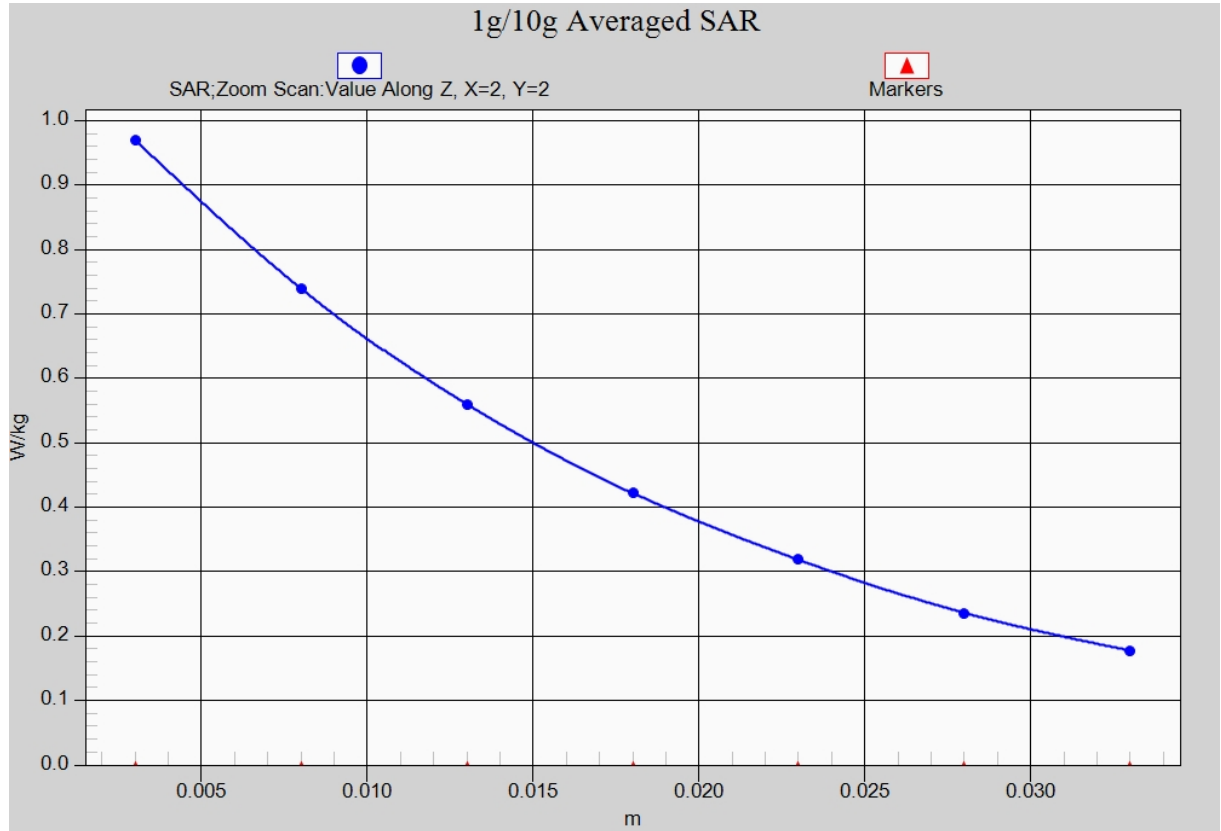

Fig. 2-1 Z-Scan at power reference point (850 MHz)

### 1900 Right Cheek High

Date: 2015-4-27

Electronics: DAE4 Sn777

Medium: Head 1900 MHz

Medium parameters used:  $f = 1910$  MHz;  $\sigma = 1.418$  S/m;  $\epsilon_r = 41.584$ ;  $\rho = 1000$  kg/m<sup>3</sup>

Ambient Temperature: 22.7 °C      Liquid Temperature: 22.2 °C

Communication System: GSM 1900MHz Frequency: 1909.8 MHz Duty Cycle: 1:8.3

Probe: EX3DV4 - SN3846 ConvF(7.26, 7.26, 7.26)

**Cheek High/Area Scan (61x91x1):** Interpolated grid: dx=1.000 mm, dy=1.000 mm

Maximum value of SAR (interpolated) = 0.443 W/kg

**Cheek High/Zoom Scan (7x7x7)/Cube 0:** Measurement grid: dx=5mm, dy=5mm, dz=5mm

Reference Value = 9.971 V/m; Power Drift = -0.16 dB

Peak SAR (extrapolated) = 0.654 W/kg

**SAR(1 g) = 0.396 W/kg; SAR(10 g) = 0.231 W/kg**

Maximum value of SAR (measured) = 0.447 W/kg

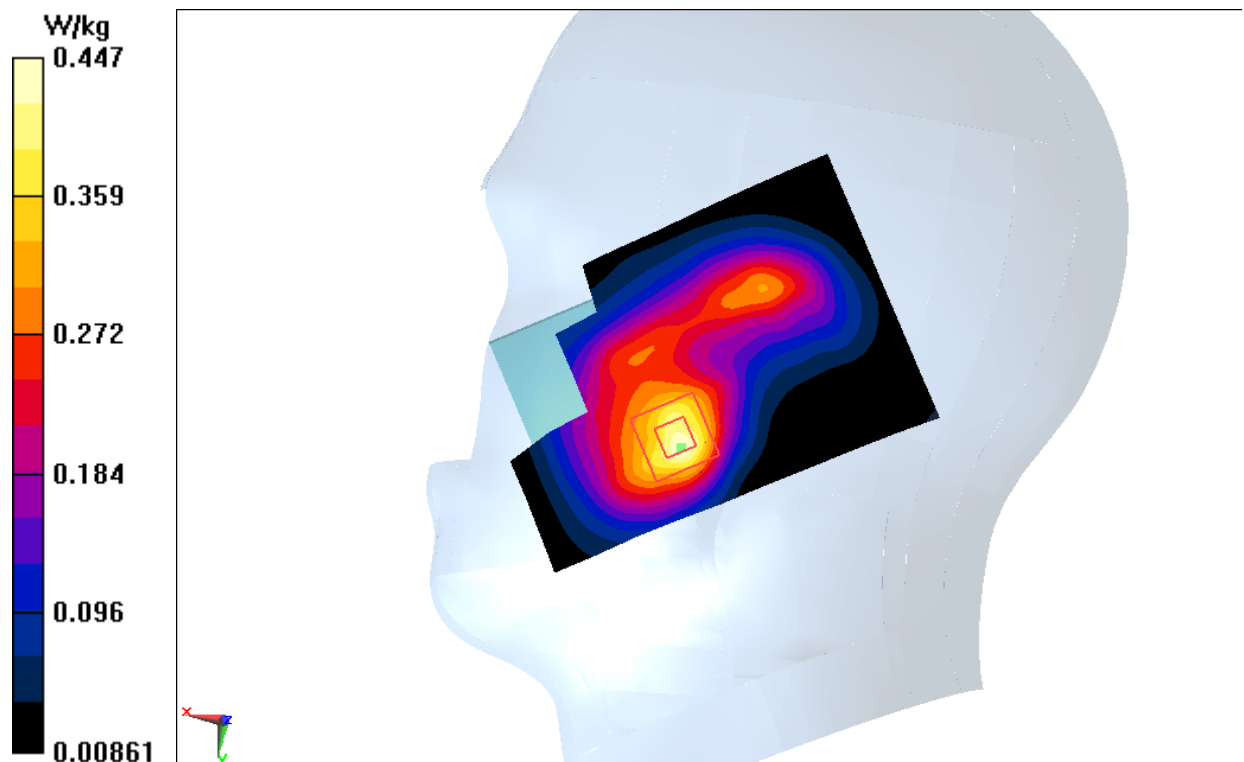

Fig.3 1900 MHz

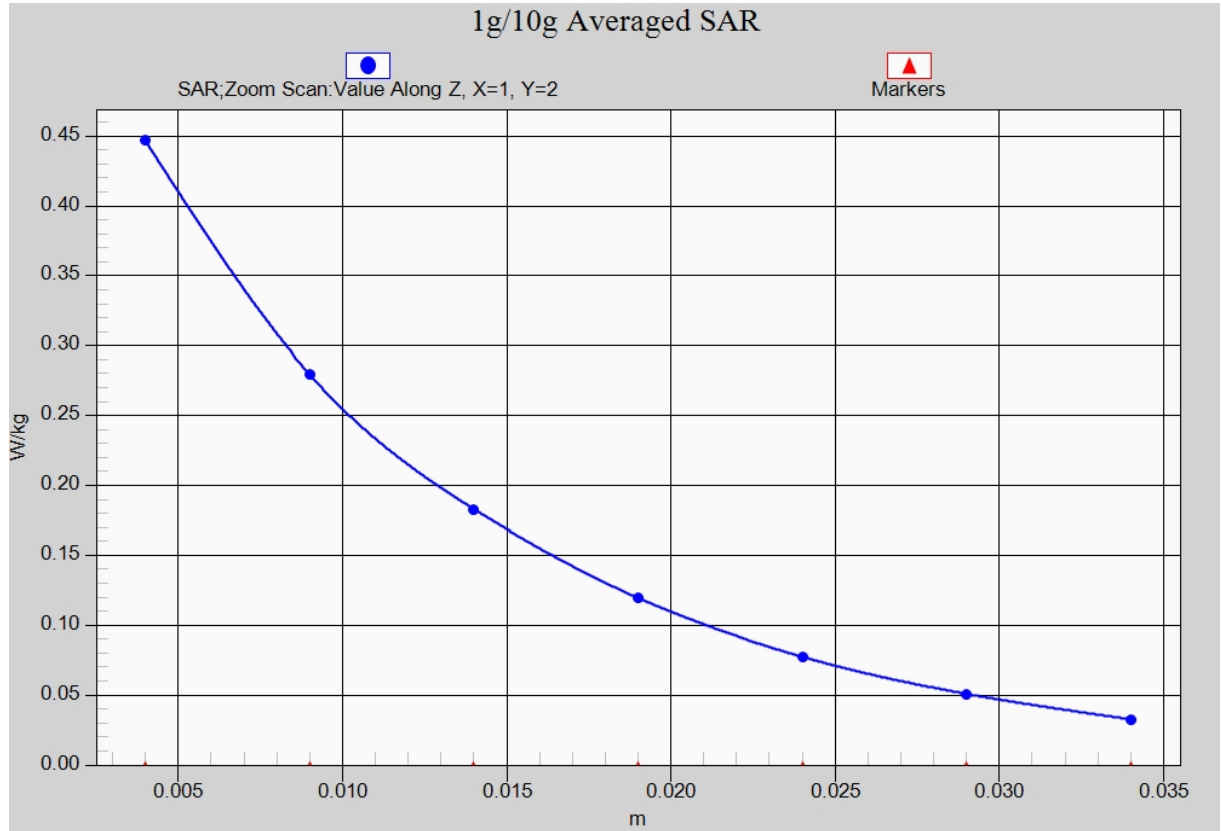

Fig. 3-1 Z-Scan at power reference point (1900 MHz)

### 1900 Body Rear Low

Date: 2015-4-27

Electronics: DAE4 Sn777

Medium: Body 1900 MHz

Medium parameters used (interpolated):  $f = 1850.2$  MHz;  $\sigma = 1.465$  S/m;  $\epsilon_r = 53.038$ ;  $\rho = 1000$  kg/m<sup>3</sup>

Ambient Temperature: 22.7 °C      Liquid Temperature: 22.2 °C

Communication System: GSM 1900MHz GPRS Frequency: 1850.2 MHz Duty Cycle: 1:4

Probe: EX3DV4 - SN3846 ConvF(7.15, 7.15, 7.15)

**Rear Low/Area Scan (91x61x1):** Interpolated grid: dx=1.000 mm, dy=1.000 mm

Maximum value of SAR (interpolated) = 0.644 W/kg

**Rear Low/Zoom Scan (7x7x7)/Cube 0:** Measurement grid: dx=5mm, dy=5mm, dz=5mm

Reference Value = 12.83 V/m; Power Drift = -0.13 dB

Peak SAR (extrapolated) = 0.812 W/kg

**SAR(1 g) = 0.472 W/kg; SAR(10 g) = 0.275 W/kg**

Maximum value of SAR (measured) = 0.614 W/kg

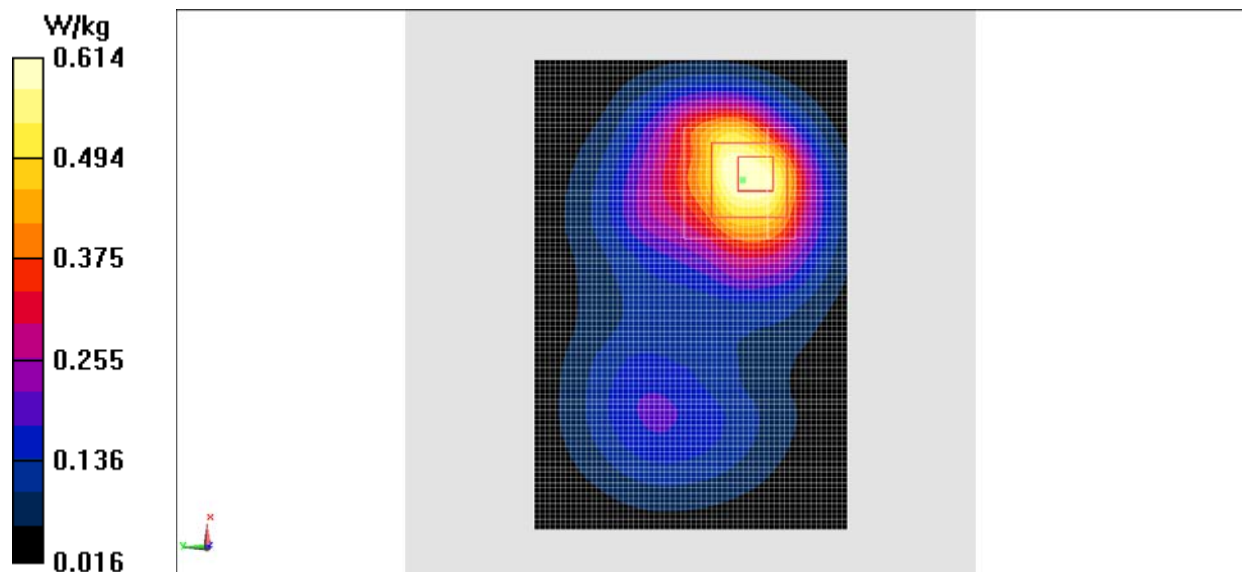

Fig.4 1900 MHz

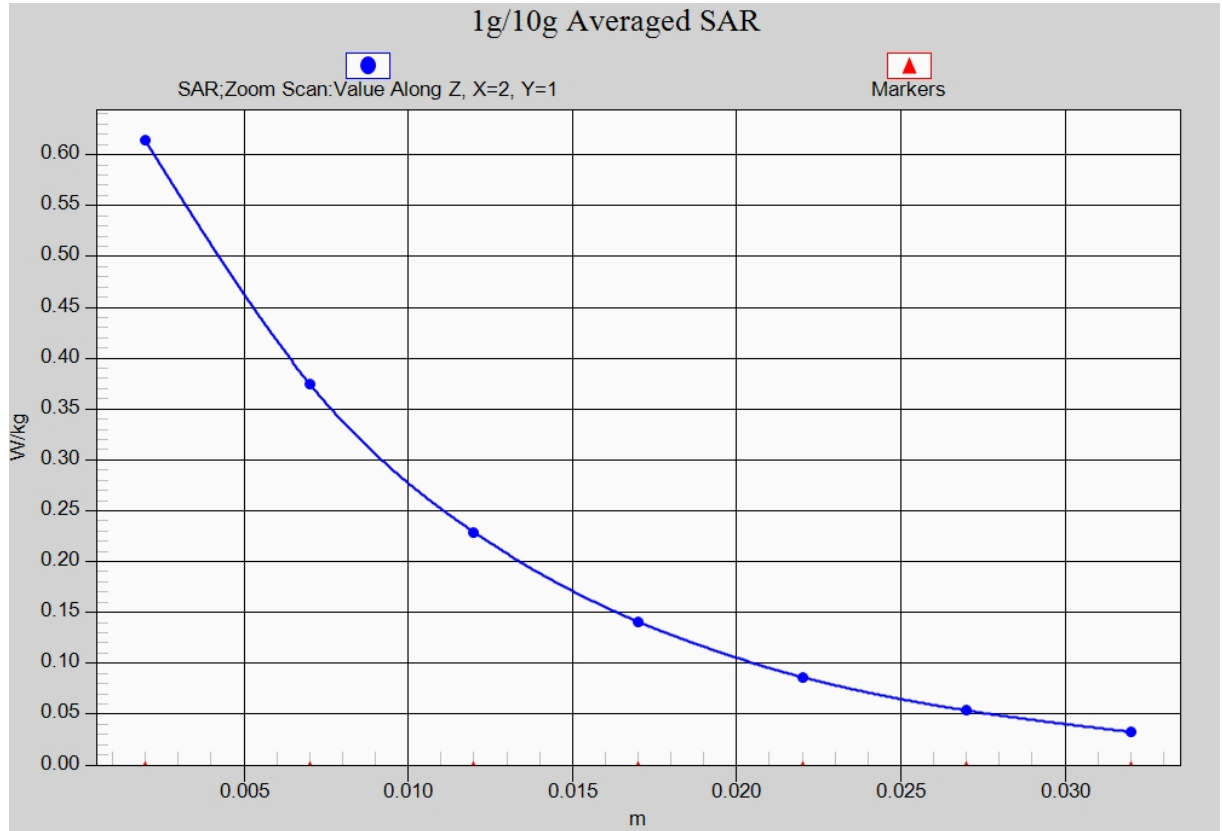

Fig.4-1 Z-Scan at power reference point (1900 MHz)

### WCDMA 850 Left Cheek Middle

Date: 2015-4-30

Electronics: DAE4 Sn777

Medium: Head 850 MHz

Medium parameters used (interpolated):  $f = 836.4$  MHz;  $\sigma = 0.915$  S/m;  $\epsilon_r = 41.514$ ;  $\rho = 1000$  kg/m<sup>3</sup>

Ambient Temperature: 22.7 °C      Liquid Temperature: 22.2 °C

Communication System: WCDMA; Frequency: 836.4 MHz; Duty Cycle: 1:1

Probe: EX3DV4 - SN3846 ConvF(9.18, 9.18, 9.18)

**Cheek Middle/Area Scan (61x91x1):** Interpolated grid: dx=1.000 mm, dy=1.000 mm

Maximum value of SAR (interpolated) = 0.997 W/kg

**Cheek Middle/Zoom Scan (7x7x7)/Cube 0:** Measurement grid: dx=5mm, dy=5mm, dz=5mm

Reference Value = 11.63 V/m; Power Drift = -0.04 dB

Peak SAR (extrapolated) = 1.11 W/kg

**SAR(1 g) = 0.929 W/kg; SAR(10 g) = 0.709 W/kg**

Maximum value of SAR (measured) = 1.01 W/kg

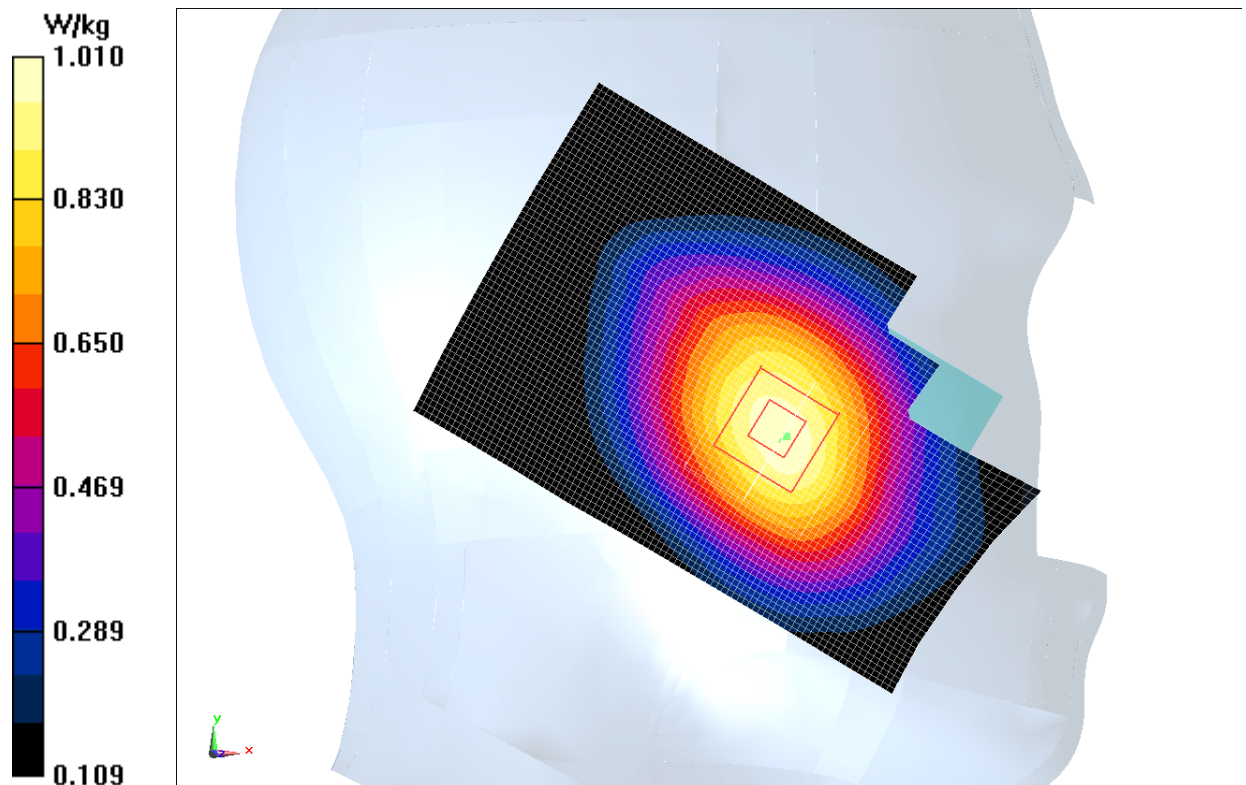

Fig.5 WCDMA 850



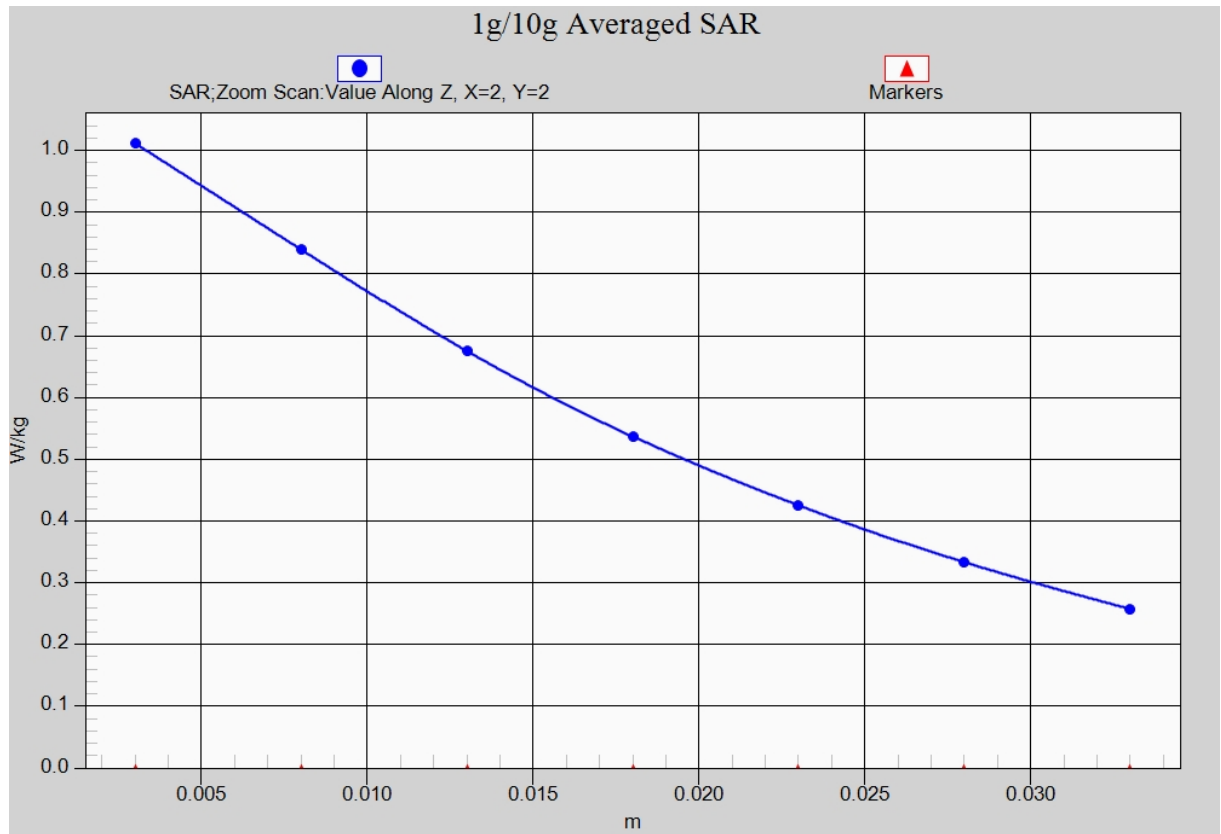

Fig. 5-1 Z-Scan at power reference point (WCDMA 850)

### WCDMA 850 Body Rear Middle

Date: 2015-4-30

Electronics: DAE4 Sn777

Medium: Body 850 MHz

Medium parameters used (interpolated):  $f = 836.4$  MHz;  $\sigma = 0.944$  S/m;  $\epsilon_r = 55.394$ ;  $\rho = 1000$  kg/m<sup>3</sup>

Ambient Temperature: 22.7 °C      Liquid Temperature: 22.2 °C

Communication System: WCDMA; Frequency: 836.4 MHz; Duty Cycle: 1:1

Probe: EX3DV4 - SN3846 ConvF(9.09, 9.09, 9.09)

**Rear Middle/Area Scan (91x61x1):** Interpolated grid: dx=1.000 mm, dy=1.000 mm

Maximum value of SAR (interpolated) = 1.33 W/kg

**Rear Middle/Zoom Scan (7x7x7)/Cube 0:** Measurement grid: dx=5mm, dy=5mm, dz=5mm

Reference Value = 33.77 V/m; Power Drift = -0.11 dB

Peak SAR (extrapolated) = 1.48 W/kg

**SAR(1 g) = 1.11 W/kg; SAR(10 g) = 0.808 W/kg**

Maximum value of SAR (measured) = 1.30 W/kg

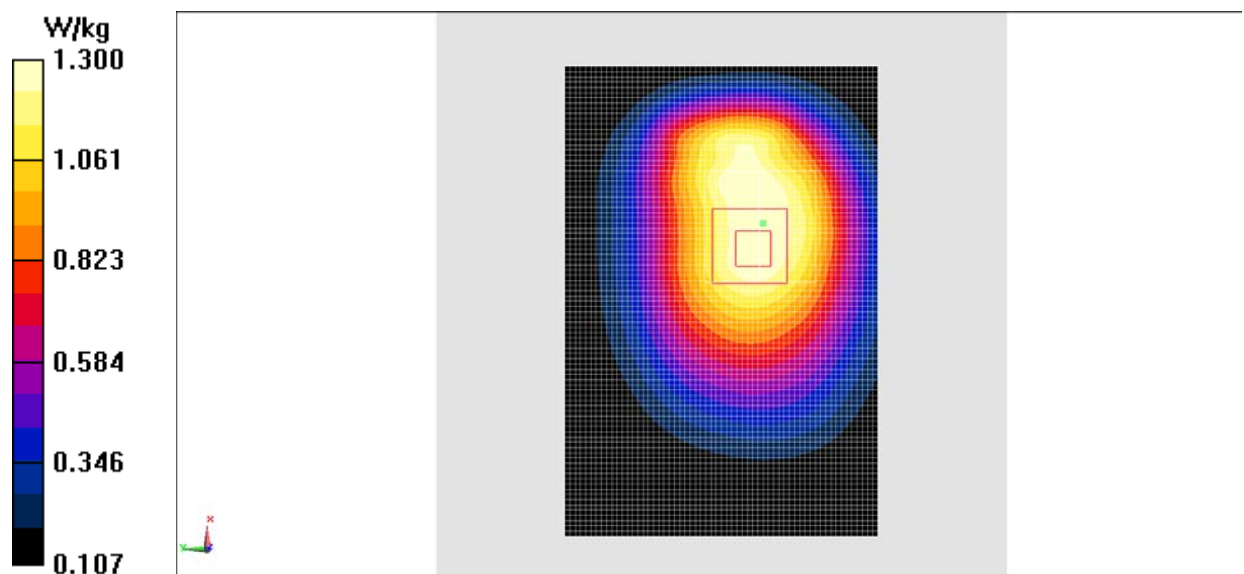

Fig.6 WCDMA 850

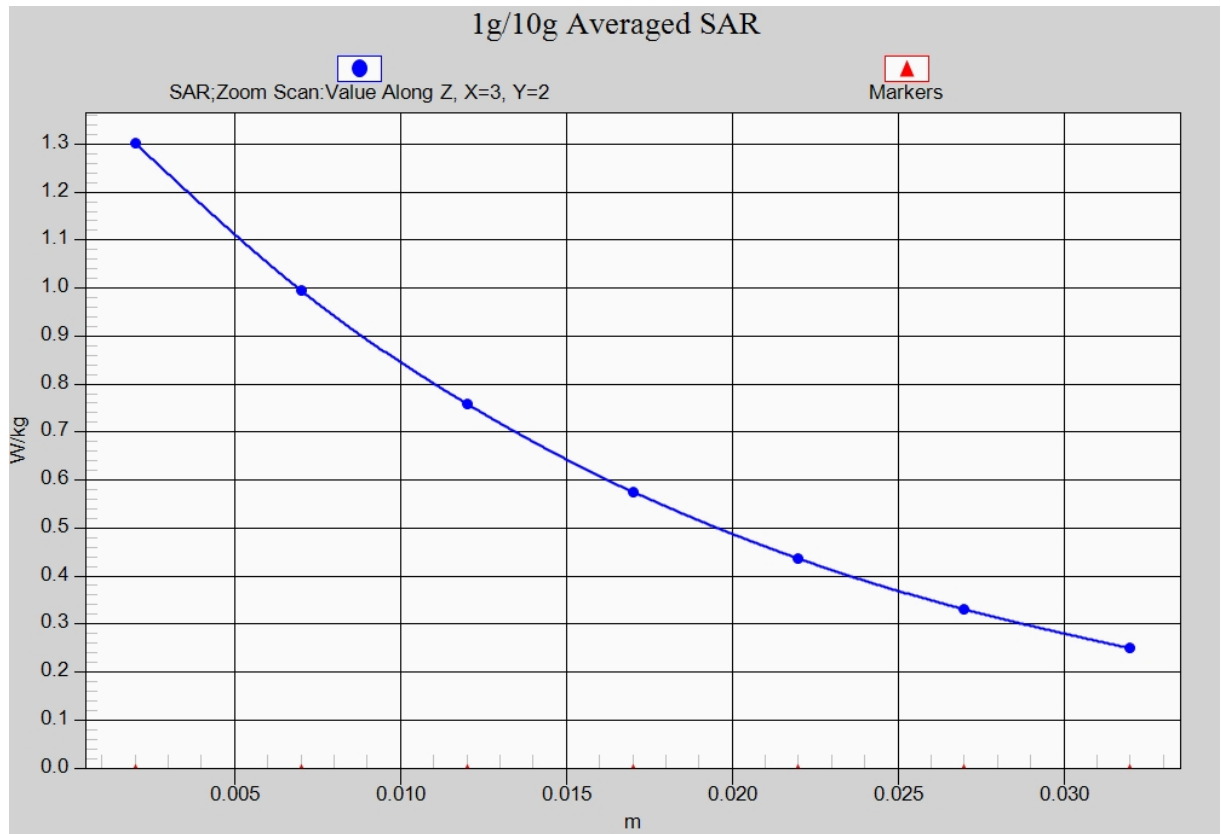

Fig. 6-1 Z-Scan at power reference point (WCDMA850)

### WCDMA 1700 Left Cheek Low

Date: 2015-4-17

Electronics: DAE4 Sn777

Medium: Head 1750 MHz

Medium parameters used (interpolated):  $f = 1712.4$  MHz;  $\sigma = 1.317$  S/m;  $\epsilon_r = 38.686$ ;  $\rho = 1000$  kg/m<sup>3</sup>

Ambient Temperature: 22.6 °C      Liquid Temperature: 22.1 °C

Communication System: WCDMA 1700 Frequency: 1712.4 MHz Duty Cycle: 1:1

Probe: EX3DV4 - SN3846 ConvF(7.64, 7.64, 7.64)

**Cheek Low/Area Scan (61x101x1):** Interpolated grid: dx=1.000 mm, dy=1.000 mm

Maximum value of SAR (interpolated) = 1.07 W/kg

**Cheek Low/Zoom Scan (7x7x7)/Cube 0:** Measurement grid: dx=5mm, dy=5mm, dz=5mm

Reference Value = 9.172 V/m; Power Drift = 0.08 dB

Peak SAR (extrapolated) = 1.32 W/kg

**SAR(1 g) = 0.913 W/kg; SAR(10 g) = 0.558 W/kg**

Maximum value of SAR (measured) = 1.07 W/kg

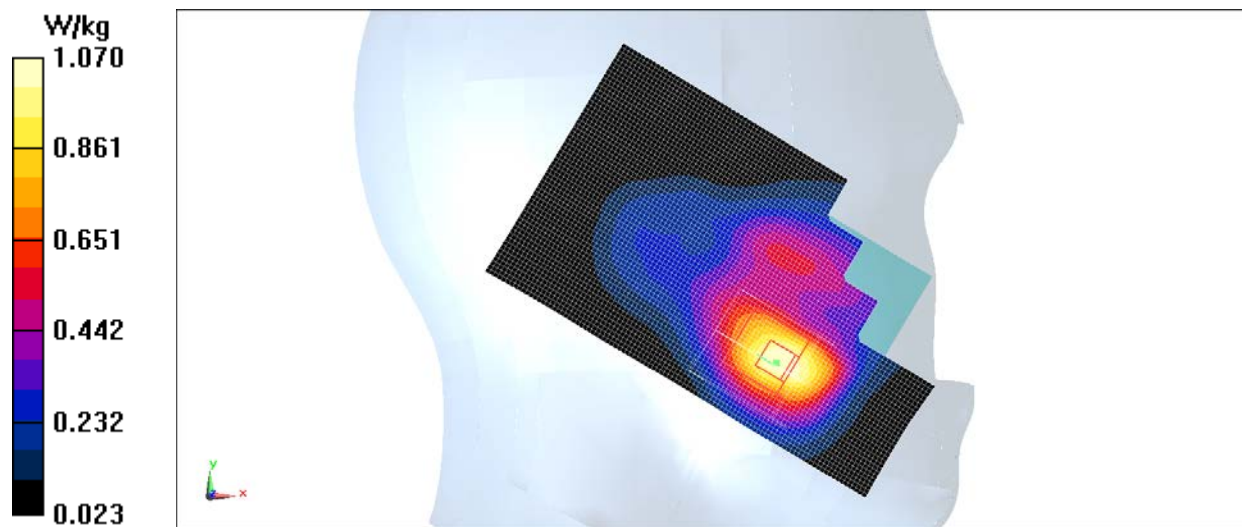

Fig.7 WCDMA1700

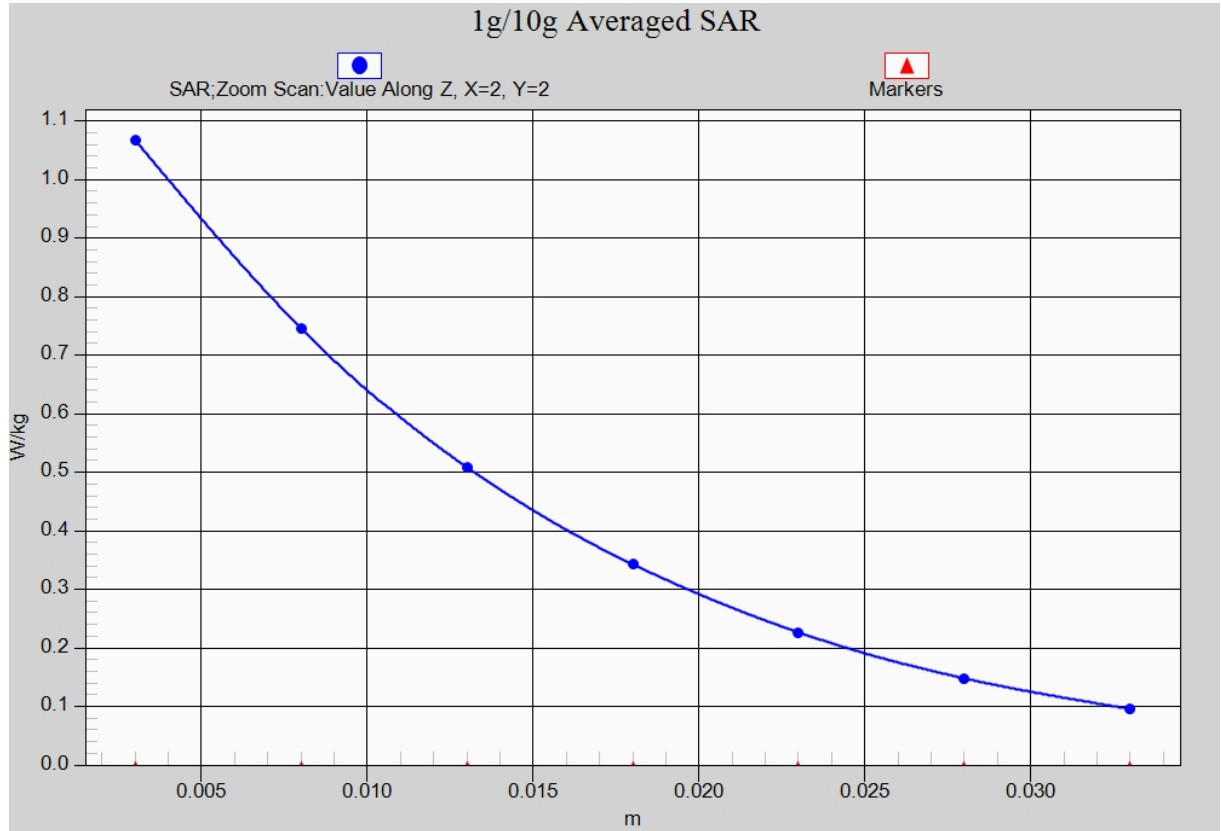

Fig. 7-1 Z-Scan at power reference point (WCDMA1700)

### WCDMA 1700 Body Rear Middle

Date: 2015-4-17

Electronics: DAE4 Sn777

Medium: Body 1750 MHz

Medium parameters used (interpolated):  $f = 1732.4$  MHz;  $\sigma = 1.465$  S/m;  $\epsilon_r = 54.611$ ;  $\rho = 1000$  kg/m<sup>3</sup>

Ambient Temperature: 22.6 °C      Liquid Temperature: 22.1 °C

Communication System: WCDMA 1700 Frequency: 1732.4 MHz Duty Cycle: 1:1

Probe: EX3DV4 - SN3846 ConvF(7.43, 7.43, 7.43)

**Rear Middle/Area Scan (91x61x1):** Interpolated grid: dx=1.000 mm, dy=1.000 mm

Maximum value of SAR (interpolated) = 1.28 W/kg

**Rear Middle/Zoom Scan (7x7x7)/Cube 0:** Measurement grid: dx=5mm, dy=5mm, dz=5mm

Reference Value = 21.55 V/m; Power Drift = 0.00 dB

Peak SAR (extrapolated) = 1.54 W/kg

**SAR(1 g) = 0.929 W/kg; SAR(10 g) = 0.539 W/kg**

Maximum value of SAR (measured) = 1.15 W/kg

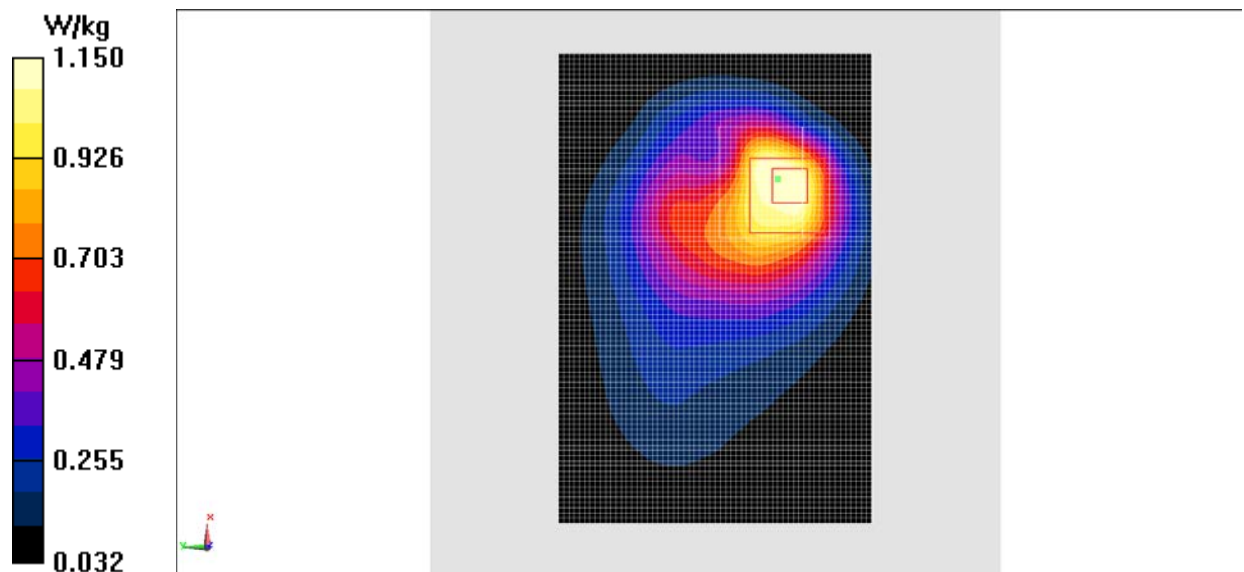

Fig.8 WCDMA1900

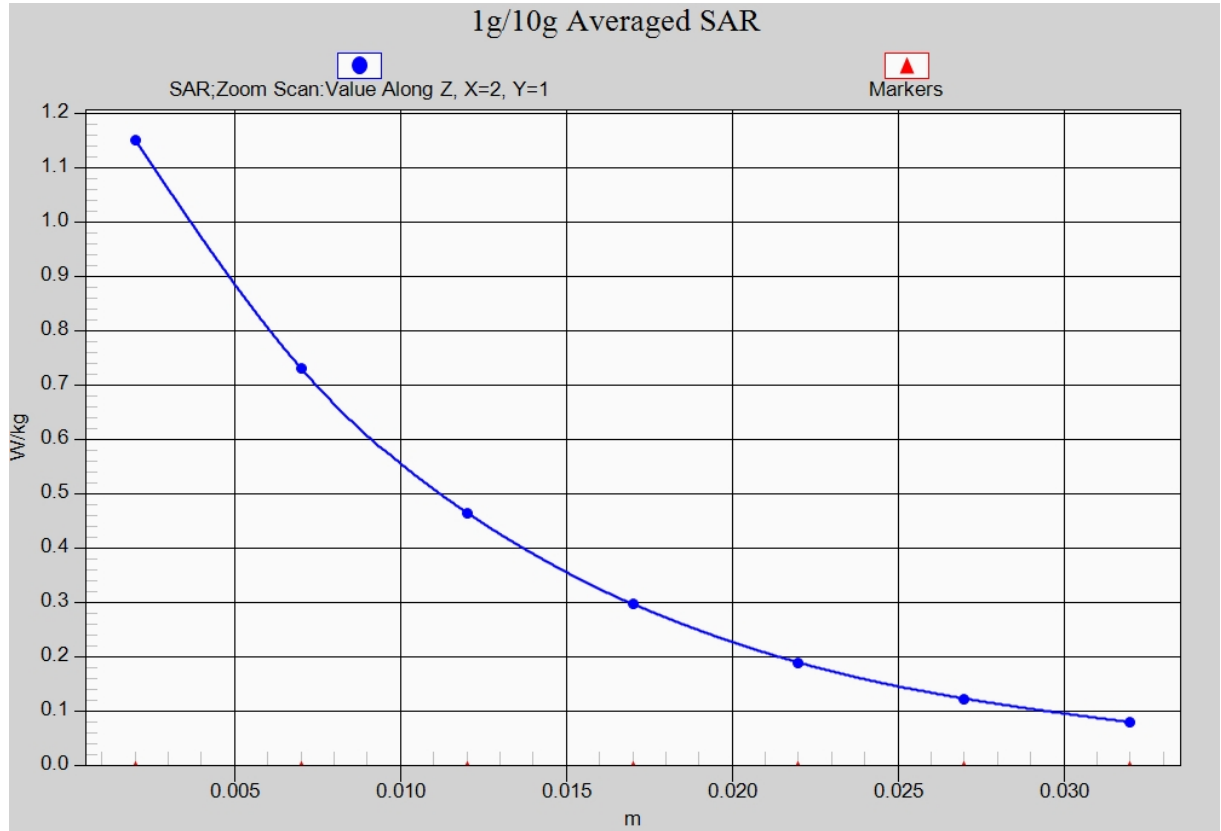

Fig. 8-1 Z-Scan at power reference point (WCDMA1900)