



# Hearing Aid Compatibility (HAC) RF Emissions Test Report

**APPLICANT** : TCT Mobile Limited  
**EQUIPMENT** : HSUPA / HSDPA / UMTS triband / GSM  
quadband mobile phone  
**BRAND NAME** : ALCATEL ONETOUCH  
**MODEL NAME** : TCL D55  
**MARKETING NAME** : TCL D55  
**FCC ID** : RAD548  
**STANDARD** : FCC 47 CFR §20.19  
ANSI C63.19-2011  
**HAC RATING** : M4

The product was completely tested on Mar. 07, 2015. We, SPORTON INTERNATIONAL (SHENZHEN) INC., would like to declare that the tested sample has been evaluated in accordance with the procedures and shown the compliance with the applicable technical standards.

The test results in this report apply exclusively to the tested model / sample. Without written approval of SPORTON INTERNATIONAL (SHENZHEN) INC., the test report shall not be reproduced except in full.

Reviewed by: Eric Huang / Deputy Manager

Approved by: Jones Tsai / Manager



Testing Laboratory  
2353

**SPORTON INTERNATIONAL (SHENZHEN) INC.**  
1F & 2F, Building A, Morning Business Center, No. 4003 ShiGu Rd., Xili Town,  
Nanshan District, Shenzhen, Guangdong, P. R. China



Table of Contents

Revision History ..... 3
1. Statement of Compliance ..... 4
2. Administration Data ..... 5
3. General Information ..... 6
3.1 Description of Equipment Under Test (EUT) ..... 6
3.2 Air Interface and Operating Mode ..... 7
3.3 Applied Standards ..... 7
4. HAC RF Emission ..... 8
5. Measurement System Specification ..... 9
5.1 Test Arch Phantom ..... 9
5.2 E-Field Probe System ..... 10
E-Field Probe Specification ..... 10
Probe Tip Description: ..... 10
5.3 System Hardware ..... 10
5.4 Data Storage and Evaluation ..... 11
5.5 Test Equipment List ..... 12
6. Measurement System Validation ..... 13
6.1 Purpose of System Performance Check ..... 13
6.2 System Setup ..... 13
6.3 Verification Results ..... 14
7. Modulation Interference Factor ..... 15
8. RF Emissions Test Procedure ..... 17
9. Conducted RF Output Power (Unit: dBm) ..... 20
10. Low-power Exemption ..... 21
11. HAC RF Emission Test Results ..... 22
11.1 E-Field Emission ..... 22
12. Uncertainty Assessment ..... 23
13. References ..... 25
Appendix A. Plots of System Performance Check
Appendix B. Plots of RF Emission Measurement
Appendix C. DASy Calibration Certificate
Appendix D. Test Setup Photos



**Revision History**

| REPORT NO. | VERSION | DESCRIPTION             | ISSUED DATE   |
|------------|---------|-------------------------|---------------|
| HA521301   | Rev. 01 | Initial issue of report | Mar. 18, 2015 |
|            |         |                         |               |
|            |         |                         |               |
|            |         |                         |               |
|            |         |                         |               |
|            |         |                         |               |
|            |         |                         |               |
|            |         |                         |               |
|            |         |                         |               |
|            |         |                         |               |
|            |         |                         |               |
|            |         |                         |               |
|            |         |                         |               |
|            |         |                         |               |
|            |         |                         |               |
|            |         |                         |               |
|            |         |                         |               |
|            |         |                         |               |
|            |         |                         |               |
|            |         |                         |               |
|            |         |                         |               |
|            |         |                         |               |
|            |         |                         |               |
|            |         |                         |               |



### 1. Statement of Compliance

The HAC Rating of each air interface found during testing for the **ALCATEL ONETOUCH, TCL D55** are follows:

| Band          | M Rating |
|---------------|----------|
| GSM850        | M4       |
| GSM1900       | M4       |
| WCDMA Band V  | M4       |
| WCDMA Band II | M4       |

They are in compliance with HAC limits specified in guidelines FCC 47 CFR §20.19 and ANSI Standard ANSI C63.19.

**HAC Rating = M4 (ANSI C63.19-2011)**



**2. Administration Data**

| Testing Laboratory            |   |
|-------------------------------|---|
| Test Site                     | SPORTON INTERNATIONAL (SHENZHEN) INC.   |
| Test Site Location            | 1F & 2F, Building A, Morning Business Center, No. 4003 ShiGu Rd., Xili Town, Nanshan District, Shenzhen, Guangdong, P. R. China<br>TEL: +86-755-8637-9589<br>FAX: +86-755-8637-9595 |
| Test Site No.                 | <b>Sporton Site No. :</b><br>SAR01-SZ   |
| Applicant                     |   |
| Company Name                  | TCT Mobile Limited  |
| Address                       | 5F, C building, No. 232, Liang Jing Road, ZhangJiang High-Tech Park, Pudong Area, Shanghai, P.R. China. 201203  |
| Manufacturer                  |   |
| Company Name                  | TCT Mobile Limited  |
| Address                       | 5F, C building, No. 232, Liang Jing Road, ZhangJiang High-Tech Park, Pudong Area, Shanghai, P.R. China. 201203  |
| Application Details           |   |
| Date of Start during the Test | Mar. 07, 2015   |
| Date of End during the Test   | Mar. 07, 2015   |

### **3. General Information**

#### **3.1 Description of Equipment Under Test (EUT)**

| <b>Product Feature &amp; Specification</b> |   |
|--|---|
| <b>EUT Type</b>                            | HSUPA / HSDPA / UMTS triband / GSM quadband mobile phone  |
| <b>Brand Name</b>                          | ALCATEL ONETOUCH  |
| <b>Model Name</b>                          | TCL D55   |
| <b>FCC ID</b>                              | RAD548  |
| <b>IMEI Code</b>                           | SIM1: 865430020060037<br>SIM2: 865430020060045  |
| <b>Tx Frequency</b>                        | GSM850: 824.2 MHz ~ 848.8 MHz<br>GSM1900: 1850.2 MHz ~ 1909.8 MHz<br>WCDMA Band V: 826.4 MHz ~ 846.6 MHz<br>WCDMA Band II: 1852.4 MHz ~ 1907.6 MHz<br>WLAN 2.4GHz Band: 2412 MHz ~ 2462 MHz<br>Bluetooth: 2402 MHz ~ 2480 MHz                           |
| <b>Antenna Type</b>                        | WWAN PIFA Antenna<br>WLAN PIFA Antenna<br>Bluetooth: PIFA Antenna   |
| <b>HW Version</b>                          | PIO   |
| <b>SW Version</b>                          | 01001   |
| <b>Mode</b>                                | <ul style="list-style-type: none"> <li>• GSM/GPRS/EGPRS(Downlink Only)</li> <li>• WCDMA</li> <li>• HSDPA</li> <li>• HSUPA</li> <li>• HSPA+ (Downlink Only)</li> <li>• 802.11b/g/n HT20/HT40</li> <li>• Bluetooth v3.0+EDR, Bluetooth v4.0 LE</li> </ul> |
| <b>EUT Stage</b>                           | Production Unit   |



3.2 Air Interface and Operating Mode

| Air Interface | Band MHz  | Type | C63.19 Tested     | Simultaneous Transmitter | OTT | Power Reduction |
|---------------|-----------|------|-------------------|--------------------------|-----|-----------------|
| GSM           | 850       | VO   | Yes               | WLAN, BT                 | NA  | No              |
|               | 1900      |      |                   | WLAN, BT                 | NA  | No              |
|               | GPRS/EDGE | DT   | No                | WLAN, BT                 | Yes | No              |
| WCDMA         | Band V    | VO   | No <sup>(1)</sup> | WLAN, BT                 | NA  | No              |
|               | Band II   |      |                   | WLAN, BT                 | NA  | No              |
|               | HSPA      | DT   | No                | WLAN, BT                 | Yes | No              |
| WLAN          | 2450      | DT   | No                | GSM WCDMA                | Yes | No              |
| BT            | 2450      | DT   | No                | GSM WCDMA                | NA  | No              |

VO=CMRS Voice Service  
DT=Digital Transport  
VD=CMRS IP Voice Service and Digital Transport  
(\*)No Associated T-Coil measurement has been made in accordance with 285076 D02 T-Coil testing for CMRS IP

Remark:  
1. WCDMA is exempted from testing by low power exemption that its average antenna input power plus its MIF is ≤17 dBm, and is rated as M4

3.3 Applied Standards

- FCC CFR47 Part 20.19
- ANSI C63.19 2011-version
- FCC KDB 285076 D01 HAC Guidance v04
- FCC KDB 285076 D02 T Coil testing for CMRS IP v01r01



#### 4. HAC RF Emission

FCC wireless hearing aid compatibility rules ensure that consumers with hearing loss are able to access wireless communications services through a wide selection of handsets without experiencing disabling radio frequency (RF) interference or other technical obstacles.

To define and measure the hearing aid compatibility of handsets, in CFR47 part 20.19 ANSI C63.19 is referenced. A handset is considered hearing aid-compatible for acoustic coupling if it meets a rating of at least M3 under ANSI C63.19, and A handset is considered hearing aid compatible for inductive coupling if it meets a rating of at least T3.

According to ANSI C63.19 2011 version, for acoustic coupling, the RF electric field emissions of wireless communication devices should be measured and rated according to the emission level as below.

| Emission Categories | E-field emissions |                   |
|---------------------|-------------------|-------------------|
|                     | <960Mhz           | >960Mhz           |
| M1                  | 50 to 55 dB (V/m) | 40 to 45 dB (V/m) |
| M2                  | 45 to 50 dB (V/m) | 35 to 40 dB (V/m) |
| M3                  | 40 to 45 dB (V/m) | 30 to 35 dB (V/m) |
| M4                  | <40 dB (V/m)      | <30 dB (V/m)      |

Table 4.1 Telephone near-field categories in linear units



### 5. Measurement System Specification

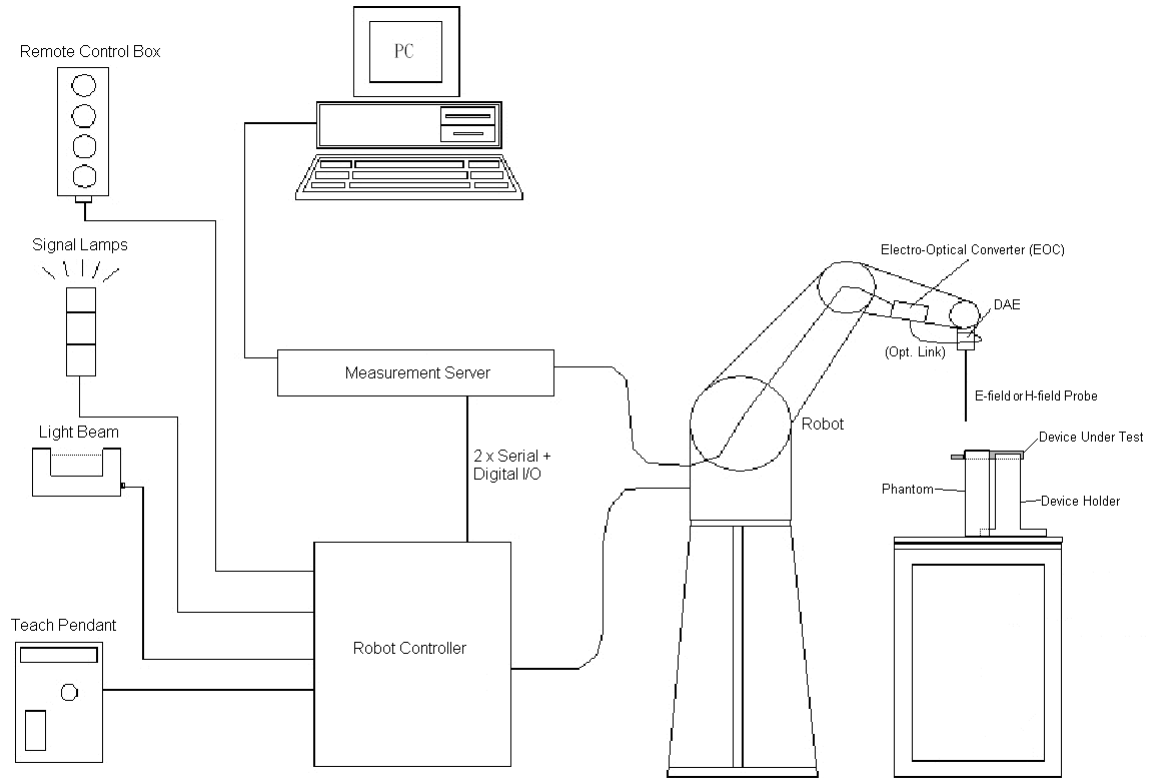

Fig 5.1 SPEAG DASY5 System Configurations

#### 5.1 Test Arch Phantom

|                              |   |  |
|------------------------------|---|--|
| <p><b>Construction :</b></p> | <p>Enables easy and well defined positioning of the phone and validation dipoles as well as simple teaching of the robot.</p> |  |
| <p><b>Dimensions :</b></p>   | <p>370x 370 x 370 mm</p>  |  |

Fig 5.8 Photo of Arch Phantom

**5.2 E-Field Probe System**

**E-Field Probe Specification**

<ER3DV6>

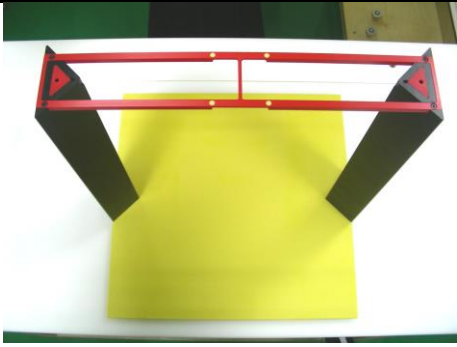
|                      |  |
|----------------------|--|
| <b>Construction</b>  | One dipole parallel, two dipoles normal to probe axis Built-in shielding against static charges                              |
| <b>Calibration</b>   | In air from 100 MHz to 3.0 GHz (absolute accuracy $\pm 6.0\%$ , $k=2$ )  |
| <b>Frequency</b>     | 100 MHz to 6 GHz;<br>Linearity: $\pm 2.0$ dB (100 MHz to 3 GHz)  |
| <b>Directivity</b>   | $\pm 0.2$ dB in air (rotation around probe axis)<br>$\pm 0.4$ dB in air (rotation normal to probe axis)                      |
| <b>Dynamic Range</b> | 2 V/m to 1000 V/m<br>(M3 or better device readings fall well below diode compression point)                                  |
| <b>Linearity</b>     | $\pm 0.2$ dB   |
| <b>Dimensions</b>    | Overall length: 330 mm (Tip: 16 mm)<br>Tip diameter: 8 mm (Body: 12 mm)<br>Distance from probe tip to dipole centers: 2.5 mm |



**Fig 5.2 Photo of E-field Probe**

**Probe Tip Description:**

HAC field measurements take place in the close near field with high gradients. Increasing the measuring distance from the source will generally decrease the measured field values (in case of the validation dipole approx. 10% per mm).

**5.3 System Hardware**

|   |
|---|
| <b>DAE</b>  |
| The data acquisition electronics (DAE) consists of a highly sensitive electrometer-grade preamplifier with auto-zeroing, a channel and gain-switching multiplexer, a fast 16 bit AD-converter and a command decoder and control logic unit. |
| <b>Robot</b>  |
| The SPEAG DASY system uses the high precision robots (DASY5: TX90XL) type from Stäubli SA (France). For the 6-axis controller system, the robot controller version (DASY5: CS8c) from Stäubli is used.                                      |

### 5.4 Data Storage and Evaluation

The DASY software stores the assessed data from the data acquisition electronics as raw data (in microvolt readings from the probe sensors), together with all the necessary software parameters for the data evaluation (probe calibration data, and device frequency and modulation data) in measurement files.

|                            |                           |   |
|----------------------------|---------------------------|---|
| <b>Probe parameters :</b>  | - Sensitivity             | Norm <sub>i</sub> , a <sub>i0</sub> , a <sub>i1</sub> , a <sub>i2</sub> |
|                            | - Conversion factor       | ConvF <sub>i</sub>  |
|                            | - Diode compression point | dcp <sub>i</sub>  |
| <b>Device parameters :</b> | - Frequency               | f   |
|                            | - Crest factor            | cf  |
| <b>Media parameters :</b>  | - Conductivity            | σ   |
|                            | - Density                 | ρ   |

The formula for each channel can be given as :

$$V_i = U_i + U_i^2 \cdot \frac{cf}{dcp_i}$$

with V<sub>i</sub> = compensated signal of channel i, (i = x, y, z)  
 U<sub>i</sub> = input signal of channel i, (i = x, y, z)  
 cf = crest factor of exciting field (DASY parameter)  
 dcp<sub>i</sub> = diode compression point (DASY parameter)

From the compensated input signals, the primary field data for each channel can be evaluated :

$$\text{E-field Probes : } E_i = \sqrt{\frac{V_i}{\text{Norm}_i \cdot \text{ConvF}}}$$

with V<sub>i</sub> = compensated signal of channel i, (i = x, y, z)  
 Norm<sub>i</sub> = sensor sensitivity of channel i, (i = x, y, z), μV/(V/m)<sup>2</sup> for E-field Probes  
 ConvF = sensitivity enhancement in solution  
 f = carrier frequency [GHz]  
 E<sub>i</sub> = electric field strength of channel i in V/m

The RSS value of the field components gives the total field strength (Hermitian magnitude) :

$$E_{\text{tot}} = \sqrt{E_x^2 + E_y^2 + E_z^2}$$

The primary field data are used to calculate the derived field units.



5.5 Test Equipment List

| Manufacturer | Name of Equipment            | Type/Model  | Serial Number | Calibration   |               |
|--------------|------------------------------|-------------|---------------|---------------|---------------|
|              |                              |             |               | Last Cal.     | Due Date      |
| SPEAG*       | Dipole                       | CD835V3     | 1171          | Jan. 22, 2013 | Jan. 21, 2016 |
| SPEAG*       | Dipole                       | CD1880V3    | 1155          | Jan. 22, 2013 | Jan. 21, 2016 |
| SPEAG        | Data Acquisition Electronics | DAE4        | 1303          | Dec. 11, 2014 | Dec. 10, 2015 |
| SPEAG        | Probe                        | ER3DV6      | 2528          | Mar. 24, 2014 | Mar. 23, 2015 |
| SPEAG        | Test Arch Phantom            | Par phantom | 1105          | NCR           | NCR           |
| SPEAG        | Phone Positioner             | N/A         | N/A           | NCR           | NCR           |
| Agilent      | Base Station                 | E5515C      | MY50267224    | Sep. 29, 2014 | Sep. 28, 2015 |
| AR           | Amplifier                    | 551G4       | 333096        | NCR           | NCR           |
| Anritsu      | Power Meter                  | ML2495A     | 1218010       | Jan. 28, 2015 | Jan. 27, 2016 |
| Anritsu      | Power Sensor                 | MA2411B     | 1207253       | Jan. 28, 2015 | Jan. 27, 2016 |
| ARRA         | Power Divider                | A3200-2     | N/A           | NA            | NA            |
| MCL          | Attenuation                  | BW-S10W5    | N/A           | NA            | NA            |
| R&S          | Spectrum Analyzer            | FSP30       | 101045        | Sep. 29, 2014 | Sep. 28, 2015 |

Table 5.1 Test Equipment List

Note:

- 1. “\*” Means calibration interval of instruments listed above is three years.
- 2. NCR: “No-Calibration Required”

## 6. Measurement System Validation

Each DASY system is equipped with one or more system validation kits. These units, together with the predefined measurement procedures within the DASY software, enable the user to conduct the system performance check and system validation. System validation kit includes a dipole, tripod holder to fix it underneath the test Arch and a corresponding distance holder.

### 6.1 Purpose of System Performance Check

The system performance check verifies that the system operates within its specifications. System and operator errors can be detected and corrected. It is recommended that the system performance check be performed prior to any usage of the system in order to guarantee reproducible results. The system performance check uses normal HAC measurements in a simplified setup with a well characterized source. This setup was selected to give a high sensitivity to all parameters that might fail or vary over time. The system check does not intend to replace the calibration of the components, but indicates situations where the system uncertainty is exceeded due to drift or failure.

### 6.2 System Setup

1. In the simplified setup for system evaluation, the EUT is replaced by a calibrated dipole and the power source is replaced by a continuous wave which comes from a signal generator.
2. The center point of the probe element(s) is 15mm from the closest surface of the dipole elements.
3. The calibrated dipole must be placed beneath the arch phantom. The equipment setup is shown below:

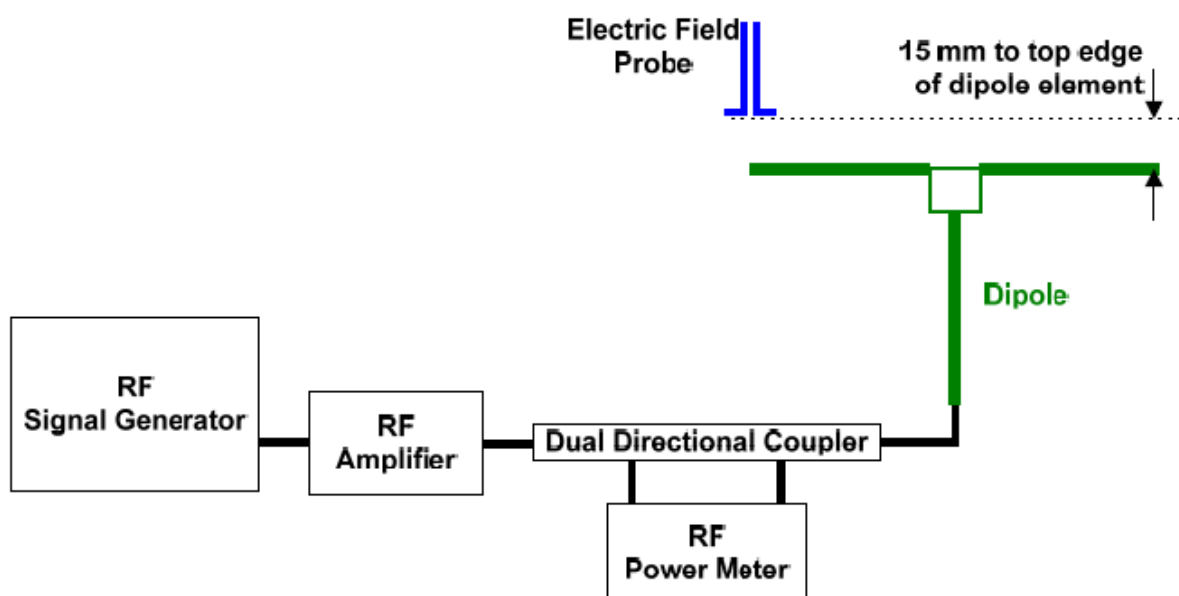
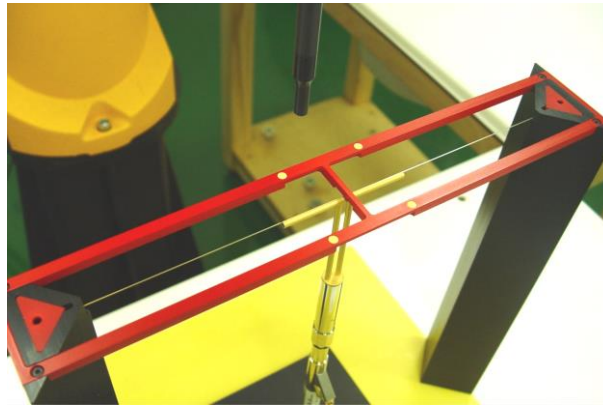

Fig. 6.1 System Validation Setup

The output power on dipole port must be calibrated to 20dBm (100mW) before dipole is connected.



**Fig 7.2 Dipole Setup**

**6.3 Verification Results**

Comparing to the original E-field value provided by SPEAG, the verification data should be within its specification of 25 %. Table 6.1 shows the target value and measured value. The table below indicates the system performance check can meet the variation criterion and the plots can be referred to appendix A of this report.

| Frequency (MHz) | Input Power (dBm) | Target Value (V/m) | E-Field above high end (V/m) | E-Field above low end (V/m) | Average Value (V/m) | Deviation (%) | Date          |
|-----------------|-------------------|--------------------|------------------------------|-----------------------------|---------------------|---------------|---------------|
| 835             | 20                | 109                | 106.5                        | 106                         | 106.25              | -2.52         | Mar. 07, 2015 |
| 1880            | 20                | 90.5               | 88.11                        | 83.2                        | 85.655              | -5.35         | Mar. 07, 2015 |

**Table 6.1 Test Results of System Validation**

**Note: Deviation = ((Average E-field Value) - (Target value)) / (Target value) \* 100%**



## 7. Modulation Interference Factor

The HAC Standard ANSI C63.19-2011 defines a new scaling using the Modulation Interference Factor (MIF).

For any specific fixed and repeatable modulated signal, a modulation interference factor (MIF, expressed in dB) may be developed that relates its interference potential to its steady-state rms signal level or average power level. This factor is a function only of the audio-frequency amplitude modulation characteristics of the signal and is the same for field-strength and conducted power measurements. It is important to emphasize that the MIF is valid only for a specific repeatable audio-frequency amplitude modulation characteristic. Any change in modulation characteristic requires determination and application of a new MIF

The Modulation Interference factor (MIF, in dB) is added to the measured average E-field (in dBV/m) and converts it to the RF Audio Interference level (in dBV/m). This level considers the audible amplitude modulation components in the RF E-field. CW fields without amplitude modulation are assumed to not interfere with the hearing aid electronics. Modulations without time slots and low fluctuations at low frequencies have low MIF values, TDMA modulations with narrow transmission and repetition rates of few 100 Hz have high MIF values and give similar classifications as ANSI C63.19-2007.

ER3D, EF3D and EU2D E-field probes have a bandwidth <10 kHz and can therefore not evaluate the RF envelope in the full audio band. DASY52 is therefore using the indirect measurement method according to ANSI C63.19-2011 which is the primary method. These near field probes read the averaged E-field measurement. Especially for the new high peak-to-average (PAR) signal types, the probes shall be linearized by PMR calibration in order to not overestimate the field reading. Probe Modulation Response (PMR) calibration linearizes the probe response over its dynamic range for specific modulations which are characterized by their UID and result in an uncertainty specified in the probe calibration certificate. The MIF is characteristic for a given waveform envelope and can be used as a constant conversion factor if the probe has been PMR calibrated.

The evaluation method for the MIF is defined in ANSI C63.19-2011 section D.7. An RMS demodulated RF signal is fed to a spectral filter (similar to an A weighting filter) and forwarded to a temporal filter acting as a quasi-peak detector. The averaged output of these filtering is scaled to a 1 kHz 80% AM signal as reference. MIF measurement requires additional instrumentation and is not well suited for evaluation by the end user with reasonable uncertainty. It may alternatively be determined through analysis and simulation, because it is constant and characteristic for a communication signal. DASY52 uses well-defined signals for PMR calibration. The MIF of these signals has been determined by simulation and it is automatically applied.



MIF values applied in this test report were provided by the HAC equipment provider, SPEAG, and the values are listed below

| UID   | Communication System Name | MIF(dB) |
|-------|---------------------------|---------|
| 10021 | GSM-FDD(TDMA,GMSK)        | 3.63    |
| 10011 | UMTS-FDD(WCDMA)           | -27.23  |

The MIF measurement uncertainty is estimated as follows, declared by HAC equipment provider SPEAG, for modulation frequencies from slotted waveforms with fundamental frequency and at least 2 harmonics within 10 kHz:

- i) 0.2 dB for MIF: -7 to +5 dB,
- ii) 0.5 dB for MIF: -13 to +11 dB
- iii) 1 dB for MIF: > -20 dB





## 8. RF Emissions Test Procedure

Referenced from ANSI C63.19 -2011 section 5.5.1

- a) Confirm the proper operation of the field probe, probe measurement system, and other instrumentation and the positioning system.
- b) Position the WD in its intended test position.
- c) Set the WD to transmit a fixed and repeatable combination of signal power and modulation characteristic that is representative of the worst case (highest interference potential) encountered in normal use. Transiently occurring start-up, changeover, or termination conditions, or other operations likely to occur less than 1% of the time during normal operation, may be excluded from consideration.
- d) The center sub-grid shall be centered on the T-Coil mode perpendicular measurement point or the acoustic output, as appropriate. Locate the field probe at the initial test position in the 50 mm by 50 mm grid, which is contained in the measurement plane, refer to illustrated in Figure 8.2. If the field alignment method is used, align the probe for maximum field reception.
- e) Record the reading at the output of the measurement system.
- f) Scan the entire 50 mm by 50 mm region in equality spaced increments and record the reading at each measurement point, The distance between measurement points shall be sufficient to assure the identification of the maximum reading.
- g) Identify the five contiguous sub-grids around the center sub-grid whose maximum reading is the lowest of all available choices. This eliminates the three sub-grids with the maximum readings. Thus, the six areas to be used to determine the WD's highest emissions are identified.
- h) Identify the maximum reading within the non-excluded sub-grids identified in step g).
- i) *Indirect measurement method*  
The RF audio interference level in dB (V/m) is obtained by adding the MIF (in dB) to the maximum steady-state rms field-strength reading, in dB (V/m)
- j) Compare this RF audio interference level with the categories in ANSI C63.19-2011 clause 8 and record the resulting WD category rating.
- k) For the T-Coil mode M-rating assessment, determine whether the chosen perpendicular measurement point is contained in an included sub-grid of the first scan. If so, then a second scan is not necessary. The first scan and resultant category rating may be used for the T-Coil mode M rating.

Otherwise, repeat step a) through step i), with the grid shifted so that it is centered on the perpendicular measurement point. Record the WD category rating.

### Test Instructions

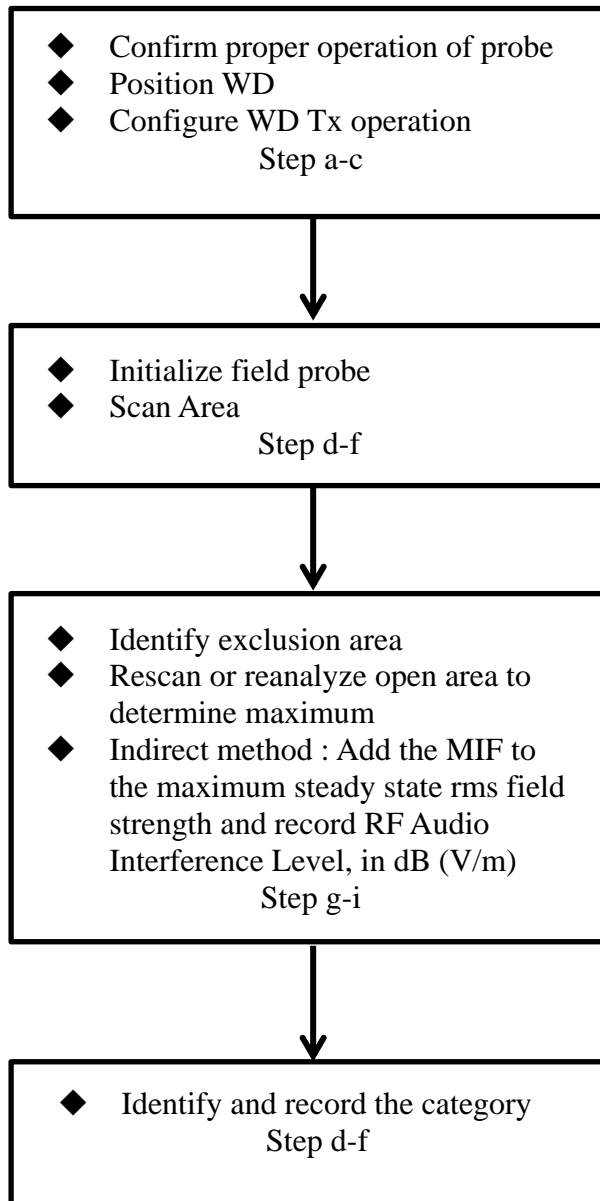

Fig 8.1 Flow Chart of HAC RF Emission



Fig 8.2 EUT reference and plane for HAC RF emission measurements

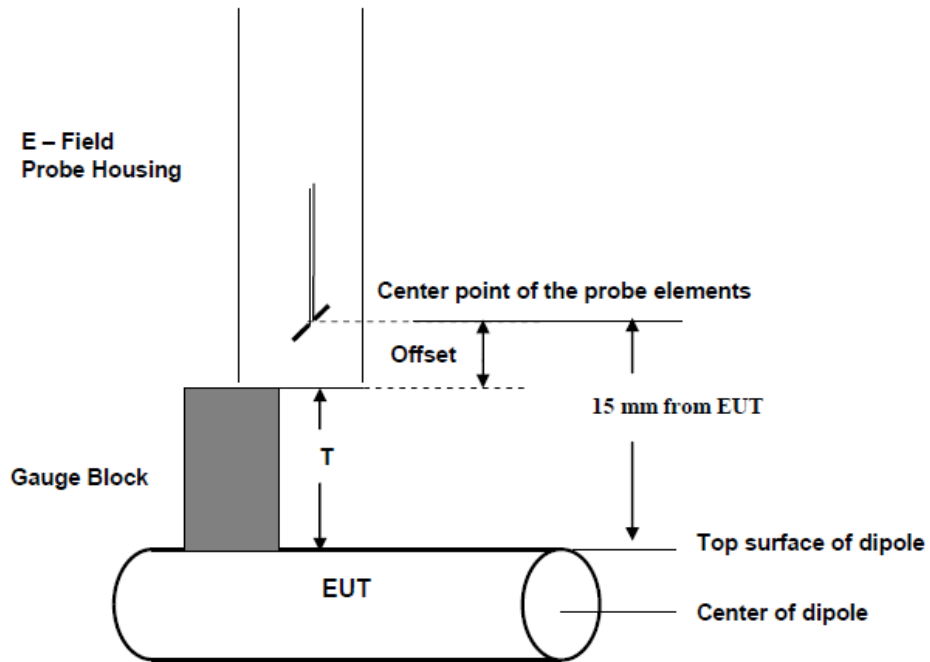

Fig. 8.3 Gauge block with E-field probe



**9. Conducted RF Output Power (Unit: dBm)**

SIM1:

| Air Interface                    | GSM850       |       |       | GSM1900 |        |              |
|----------------------------------|--------------|-------|-------|---------|--------|--------------|
| Channel                          | 128          | 189   | 251   | 512     | 661    | 810          |
| Frequency (MHz)                  | 824.2        | 836.4 | 848.8 | 1850.2  | 1880.0 | 1909.8       |
| Average Antenna Input Power(dBm) | <b>32.55</b> | 32.53 | 32.39 | 29.74   | 29.99  | <b>30.15</b> |

| Air Interface                    | WCDMA Band V |       |              | WCDMA Band II |        |              |
|----------------------------------|--------------|-------|--------------|---------------|--------|--------------|
| Channel                          | 4132         | 4182  | 4233         | 9262          | 9400   | 9538         |
| Frequency (MHz)                  | 826.4        | 836.4 | 846.6        | 1852.4        | 1880.0 | 1907.6       |
| Average Antenna Input Power(dBm) | 22.84        | 22.78 | <b>22.85</b> | 22.86         | 22.90  | <b>23.21</b> |

SIM2:

| Air Interface                    | GSM850       |       |       | GSM1900 |        |              |
|----------------------------------|--------------|-------|-------|---------|--------|--------------|
| Channel                          | 128          | 189   | 251   | 512     | 661    | 810          |
| Frequency (MHz)                  | 824.2        | 836.4 | 848.8 | 1850.2  | 1880.0 | 1909.8       |
| Average Antenna Input Power(dBm) | <b>32.50</b> | 32.46 | 32.33 | 29.65   | 29.87  | <b>30.06</b> |

| Air Interface                    | WCDMA Band V |       |              | WCDMA Band II |        |              |
|----------------------------------|--------------|-------|--------------|---------------|--------|--------------|
| Channel                          | 4132         | 4182  | 4233         | 9262          | 9400   | 9538         |
| Frequency (MHz)                  | 826.4        | 836.4 | 846.6        | 1852.4        | 1880.0 | 1907.6       |
| Average Antenna Input Power(dBm) | 22.80        | 22.73 | <b>22.81</b> | 22.85         | 22.86  | <b>23.12</b> |



### 10. Low-power Exemption

According to ANSI C63.19 2011-version, an RF air interface technology of a device is exempt from testing when its average antenna input power plus its MIF is  $\leq 17$  dBm for any of its operating modes.

| Air Interface | Operating Mode | Average Antenna Input Power (dBm) | MIF (dB) | Power + MIF(dB) | C63.19 test required |
|---------------|----------------|-----------------------------------|----------|-----------------|----------------------|
| GSM850        | GSM            | 32.55                             | 3.63     | 36.18           | Yes                  |
| GSM1900       | GSM            | 30.15                             | 3.63     | 33.78           | Yes                  |
| WCDMA Band V  | RMC 12.2Kbps   | 22.85                             | -27.23   | -4.38           | No                   |
| WCDMA Band II | RMC 12.2Kbps   | 23.21                             | -27.23   | -4.02           | No                   |

**Conclusion:** HAC RF rating is M4 for the air interface which meets the low power exemption.



## 11. HAC RF Emission Test Results

### 11.1 E-Field Emission

| Emission Categories | E-field emissions |                   |
|---------------------|-------------------|-------------------|
|                     | <960Mhz           | >960Mhz           |
| M1                  | 50 to 55 dB (V/m) | 40 to 45 dB (V/m) |
| M2                  | 45 to 50 dB (V/m) | 35 to 40 dB (V/m) |
| M3                  | 40 to 45 dB (V/m) | 30 to 35 dB (V/m) |
| M4                  | <40 dB (V/m)      | <30 dB (V/m)      |

| Plot No. | Air Interface | Operating Mode | Channel | Average Antenna Input Power (dBm) | MIF  | RF audio interference level dB(V/m) | Margin to FCC M3 limit (dB) | M-Rating |
|----------|---------------|----------------|---------|-----------------------------------|------|-------------------------------------|-----------------------------|----------|
| 1        | GSM850        | GSM Voice      | 128     | 32.55                             | 3.63 | 37.66                               | 7.34                        | M4       |
| 2        | GSM850        | GSM Voice      | 189     | 32.53                             | 3.63 | 37.38                               | 7.62                        | M4       |
| 3        | GSM850        | GSM Voice      | 251     | 32.39                             | 3.63 | 36.64                               | 8.36                        | M4       |
| 4        | GSM1900       | GSM Voice      | 512     | 29.74                             | 3.63 | 26.84                               | 8.16                        | M4       |
| 5        | GSM1900       | GSM Voice      | 661     | 29.99                             | 3.63 | 25.91                               | 9.09                        | M4       |
| 6        | GSM1900       | GSM Voice      | 810     | 30.15                             | 3.63 | 25.92                               | 9.08                        | M4       |

**Remark:**

1. The HAC measurement system applies MIF value onto the measured RMS E-field, which is indirect method in ANSI C63.19 2011 version, and reports the RF audio interference level.
2. The uncertainty is 0.2dB of MIF ranges from -7dB to +5dB. GSM850 band with rating M4, GSM1900 band with rating M4 would not be affected considering the MIF uncertainty.
3. There is no special HAC mode software on this EUT.

Test Engineer : Luke Lu.



## **12. Uncertainty Assessment**

The component of uncertainty may generally be categorized according to the methods used to evaluate them. The evaluation of uncertainty by the statistical analysis of a series of observations is termed a Type A evaluation of uncertainty. The evaluation of uncertainty by means other than the statistical analysis of a series of observation is termed a Type B evaluation of uncertainty. Each component of uncertainty, however evaluated, is represented by an estimated standard deviation, termed standard uncertainty, which is determined by the positive square root of the estimated variance.

The combined standard uncertainty of the measurement result represents the estimated standard deviation of the result. It is obtained by combining the individual standard uncertainties of both Type A and Type B evaluation using the usual "root-sum-squares" (RSS) methods of combining standard deviations by taking the positive square root of the estimated variances. Expanded uncertainty is a measure of uncertainty that defines an interval about the measurement result within which the measured value is confidently believed to lie. It is obtained by multiplying the combined standard uncertainty by a coverage factor. For purpose of this document, a coverage factor two is used, which corresponds to confidence interval of about 95 %. The DASY uncertainty Budget is showed in Table 12.1.

| Error Description                         | Uncertainty Value (±%) | Probability Distribution | Divisor    | Ci (E) | Standard Uncertainty (E) |
|---|------------------------|--------------------------|------------|--------|--------------------------|
| <b>Measurement System</b>                 |                        |                          |            |        |                          |
| Probe Calibration                         | 5.1                    | Normal                   | 1          | 1      | ± 5.1 %                  |
| Axial Isotropy                            | 4.7                    | Rectangular              | $\sqrt{3}$ | 1      | ± 2.7 %                  |
| Sensor Displacement                       | 16.5                   | Rectangular              | $\sqrt{3}$ | 1      | ± 9.5 %                  |
| Boundary Effects                          | 2.4                    | Rectangular              | $\sqrt{3}$ | 1      | ± 1.4 %                  |
| Phantom Boundary Effects                  | 7.2                    | Rectangular              | $\sqrt{3}$ | 1      | ± 4.1 %                  |
| Linearity                                 | 4.7                    | Rectangular              | $\sqrt{3}$ | 1      | ± 2.7 %                  |
| Scaling with PMF Calibration              | 10.0                   | Rectangular              | $\sqrt{3}$ | 1      | ± 5.77 %                 |
| System Detection Limit                    | 1.0                    | Rectangular              | $\sqrt{3}$ | 1      | ± 0.6 %                  |
| Readout Electronics                       | 0.3                    | Normal                   | 1          | 1      | ± 0.3 %                  |
| Response Time                             | 0.8                    | Rectangular              | $\sqrt{3}$ | 1      | ± 0.5 %                  |
| Integration Time                          | 2.6                    | Rectangular              | $\sqrt{3}$ | 1      | ± 1.5 %                  |
| RF Ambient Conditions                     | 3.0                    | Rectangular              | $\sqrt{3}$ | 1      | ± 1.7 %                  |
| RF Reflections                            | 12.0                   | Rectangular              | $\sqrt{3}$ | 1      | ± 6.9 %                  |
| Probe Positioner                          | 1.2                    | Rectangular              | $\sqrt{3}$ | 1      | ± 0.7 %                  |
| Probe Positioning                         | 4.7                    | Rectangular              | $\sqrt{3}$ | 1      | ± 2.7 %                  |
| Extrap. and Interpolation                 | 1.0                    | Rectangular              | $\sqrt{3}$ | 1      | ± 0.6 %                  |
| <b>Test Sample Related</b>                |                        |                          |            |        |                          |
| Device Positioning Vertical               | 4.7                    | Rectangular              | $\sqrt{3}$ | 1      | ± 2.7 %                  |
| Device Positioning Lateral                | 1.0                    | Rectangular              | $\sqrt{3}$ | 1      | ± 0.6 %                  |
| Device Holder and Phantom                 | 2.4                    | Rectangular              | $\sqrt{3}$ | 1      | ± 1.4 %                  |
| Power Drift                               | 5.0                    | Rectangular              | $\sqrt{3}$ | 1      | ± 2.9 %                  |
| <b>Phantom and Setup Related</b>          |                        |                          |            |        |                          |
| Phantom Thickness                         | 2.4                    | Rectangular              | $\sqrt{3}$ | 1      | ± 1.4 %                  |
| <b>Combined Standard Uncertainty</b>      |                        |                          |            |        | ± 16.30 %                |
| <b>Coverage Factor for 95 %</b>           |                        |                          |            |        | K = 2                    |
| <b>Expanded Std. Uncertainty on Power</b> |                        |                          |            |        | ± 32.6 %                 |
| <b>Expanded Std. Uncertainty on Field</b> |                        |                          |            |        | ± 16.3 %                 |

**Table 12.1 Uncertainty Budget of HAC free field assessment**
**Remark:**

Worst-Case uncertainty budget for HAC free field assessment according to ANSIC63.19 [1], [2]. The budget is valid for the frequency range 700 MHz - 3 GHz and represents a worst case analysis.





### **13. References**

- [1] ANSI C63.19-2011, "American National Standard for Methods of Measurement of Compatibility between Wireless Communications Devices and Hearing Aids", 27 May 2011
- [2] SPEAG DASY System Handbook



## **Appendix A. Plots of System Performance Check**

The plots are shown as follows.

**HAC\_E\_Dipole\_835\_150307**

**DUT: HAC-Dipole 835 MHz**

Communication System: UID 0, CW; Frequency: 835 MHz; Duty Cycle: 1:1

Medium: Air Medium parameters used:  $\sigma = 0 \text{ S/m}$ ,  $\epsilon_r = 1$ ;  $\rho = 0 \text{ kg/m}^3$

Ambient Temperature : 23.5 °C

**DASY5 Configuration:**

- Probe: ER3DV6 - SN2528; ConvF(1, 1, 1); Calibrated: 2014.03.24;
- Sensor-Surface: (Fix Surface)
- Electronics: DAE4 Sn1303; Calibrated: 2014.12.11
- Phantom: HAC Test Arch with AMCC; Type: SD HAC P01 BA;
- Measurement SW: DASY52, Version 52.8 (7); SEMCAD X Version 14.6.10 (7164)

**E Scan - measurement distance from the probe sensor center to CD835 = 15mm/Hearing Aid Compatibility Test at 15mm distance (41x361x1): Interpolated grid:**

dx=5 mm, dy=5 mm

E-field emissions = 106.5 V/m

Reference Value = 103.4 V/m; Power Drift = 0.01 dB

Average value of Total=(106.5+106.0)/2=106.25 V/m

PMF scaled E-field

|                                      |                                      |                                      |
|--------------------------------------|--------------------------------------|--------------------------------------|
| Grid 1 <b>M4</b><br><b>105.2 V/m</b> | Grid 2 <b>M4</b><br><b>106.5 V/m</b> | Grid 3 <b>M4</b><br><b>104.8 V/m</b> |
| Grid 4 <b>M4</b><br><b>63.12 V/m</b> | Grid 5 <b>M4</b><br><b>63.78 V/m</b> | Grid 6 <b>M4</b><br><b>62.46 V/m</b> |
| Grid 7 <b>M4</b><br><b>104.6 V/m</b> | Grid 8 <b>M4</b><br><b>106.0 V/m</b> | Grid 9 <b>M4</b><br><b>104.1 V/m</b> |

**Cursor:**

Total = 106.5 V/m

E Category: M4

Location: 0, -70, 9.7 mm

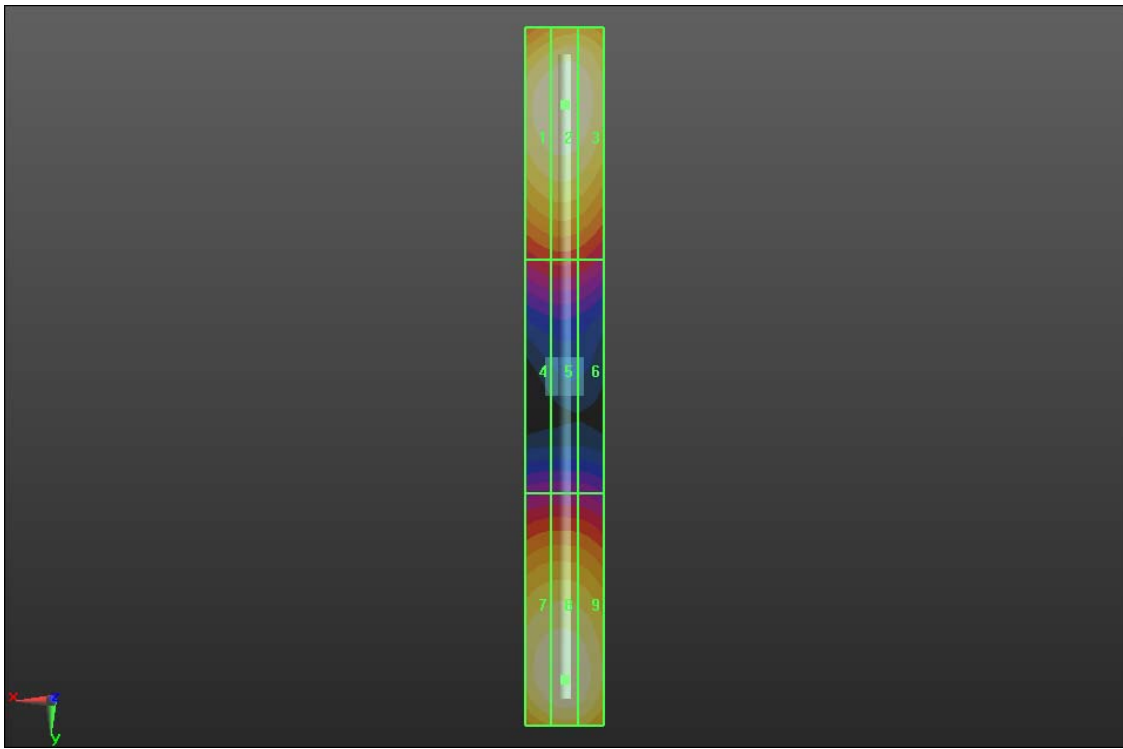
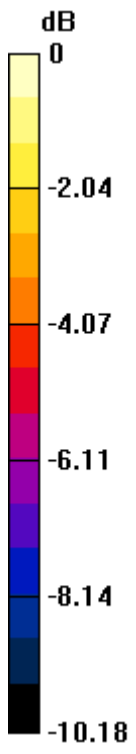

0 dB = 106.5 V/m = 40.55 dBV/m

**HAC\_E\_Dipole\_1880\_150307**

**DUT: HAC Dipole 1880 MHz**

Communication System: UID 0, CW; Frequency: 1880 MHz; Duty Cycle: 1:1

Medium: Air Medium parameters used:  $\sigma = 0 \text{ S/m}$ ,  $\epsilon_r = 1$ ;  $\rho = 0 \text{ kg/m}^3$

Ambient Temperature : 23.5 °C

**DASY5 Configuration:**

- Probe: ER3DV6 - SN2528; ConvF(1, 1, 1); Calibrated: 2014.03.24;
- Sensor-Surface: (Fix Surface)
- Electronics: DAE4 Sn1303; Calibrated: 2014.12.11
- Phantom: HAC Test Arch with AMCC; Type: SD HAC P01 BA;
- Measurement SW: DASY52, Version 52.8 (7); SEMCAD X Version 14.6.10 (7164)

**E Scan - measurement distance from the probe sensor center to CD1880 = 15mm/Hearing Aid Compatibility Test at 15mm distance (41x181x1): Interpolated grid:**

dx=5 mm, dy=5 mm

E-field emissions = 88.11 V/m

Reference Value = 143.2 V/m; Power Drift = -0.02 dB

Average value of Total=(88.11+83.2)/2=85.655 V/m

PMF scaled E-field

|                                      |                                      |                                      |
|--------------------------------------|--------------------------------------|--------------------------------------|
| <b>Grid 1 M3</b><br><b>86.46 V/m</b> | <b>Grid 2 M3</b><br><b>88.11 V/m</b> | <b>Grid 3 M3</b><br><b>87.01 V/m</b> |
| <b>Grid 4 M3</b><br><b>69.55 V/m</b> | <b>Grid 5 M3</b><br><b>70.29 V/m</b> | <b>Grid 6 M3</b><br><b>69.13 V/m</b> |
| <b>Grid 7 M3</b><br><b>81.75 V/m</b> | <b>Grid 8 M3</b><br><b>83.20 V/m</b> | <b>Grid 9 M3</b><br><b>82.14 V/m</b> |

**Cursor:**

Total = 88.11 V/m

E Category: M3

Location: 0, -31, 9.7 mm

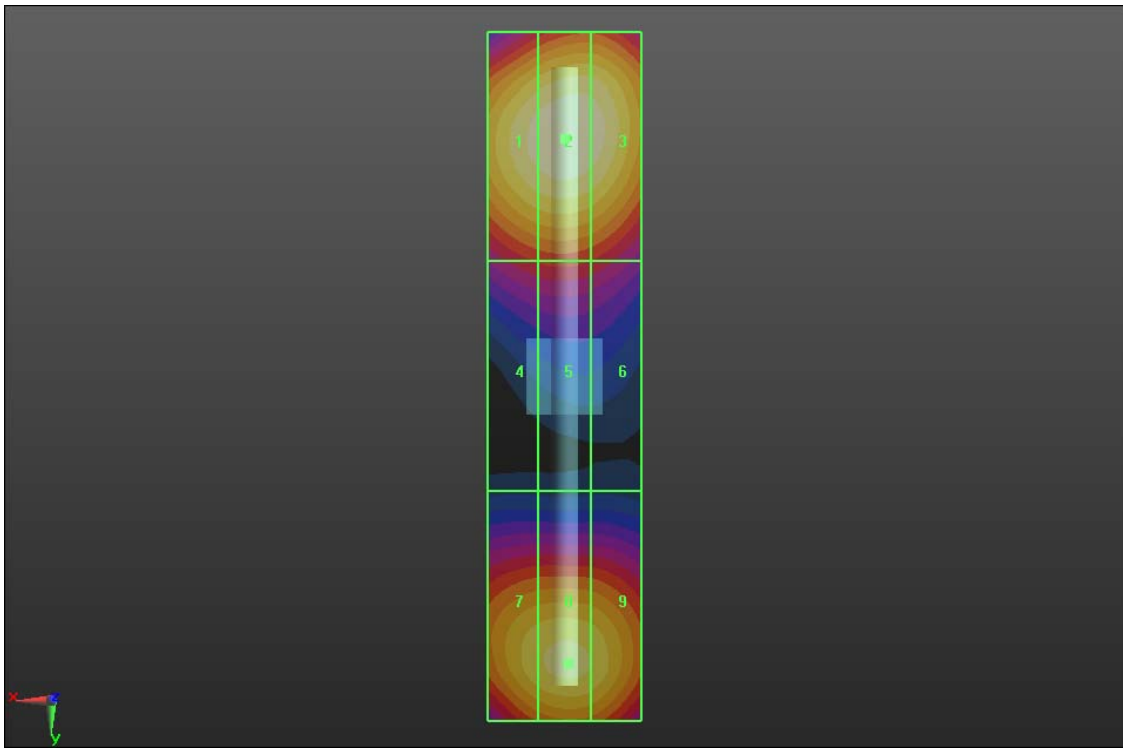
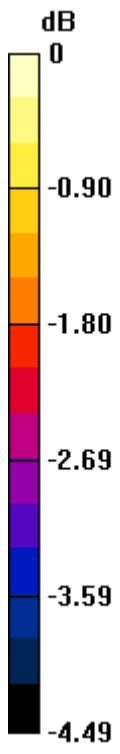

0 dB = 88.11 V/m = 38.90 dBV/m



## **Appendix B. Plots of RF Emission Measurement**

The plots are shown as follows.

**01\_HAC RF\_GSM850\_GSM Voice\_Ch128\_E**

Communication System: UID 10021 - DAA, GSM-FDD (TDMA, GMSK); Frequency: 824.2 MHz; Duty Cycle: 1:8.3

Medium: Air Medium parameters used:  $\sigma = 0$  S/m,  $\epsilon_r = 1$ ;  $\rho = 1000$  kg/m<sup>3</sup>  
 Ambient Temperature : 23.5 °C

DASY5 Configuration:

- Probe: ER3DV6 - SN2528; ConvF(1, 1, 1); Calibrated: 2014.03.24;
- Sensor-Surface: (Fix Surface)
- Electronics: DAE4 Sn1303; Calibrated: 2014.12.11
- Phantom: HAC Test Arch with AMCC; Type: SD HAC P01 BA;
- Measurement SW: DASY52, Version 52.8 (7); SEMCAD X Version 14.6.10 (7164)

**Ch128/Hearing Aid Compatibility Test (101x101x1):** Interpolated grid: dx=0.5000 mm, dy=0.5000 mm

Device Reference Point: 0, 0, -6.3 mm

Reference Value = 63.64 V/m; Power Drift = -0.10 dB

Applied MIF = 3.63 dB

RF audio interference level = 37.66 dBV/m

**Emission category: M4**

MIF scaled E-field

|  |  |  |
|--|--|--|
| Grid 1 <b>M4</b><br><b>35.88 dBV/m</b> | Grid 2 <b>M4</b><br><b>36.9 dBV/m</b>  | Grid 3 <b>M4</b><br><b>36.71 dBV/m</b> |
| Grid 4 <b>M4</b><br><b>36.68 dBV/m</b> | Grid 5 <b>M4</b><br><b>37.66 dBV/m</b> | Grid 6 <b>M4</b><br><b>37.46 dBV/m</b> |
| Grid 7 <b>M4</b><br><b>37.21 dBV/m</b> | Grid 8 <b>M4</b><br><b>38 dBV/m</b>    | Grid 9 <b>M4</b><br><b>37.59 dBV/m</b> |

**Cursor:**

Total = 38.00 dBV/m

E Category: M4

Location: -2.5, 25, 8.7 mm



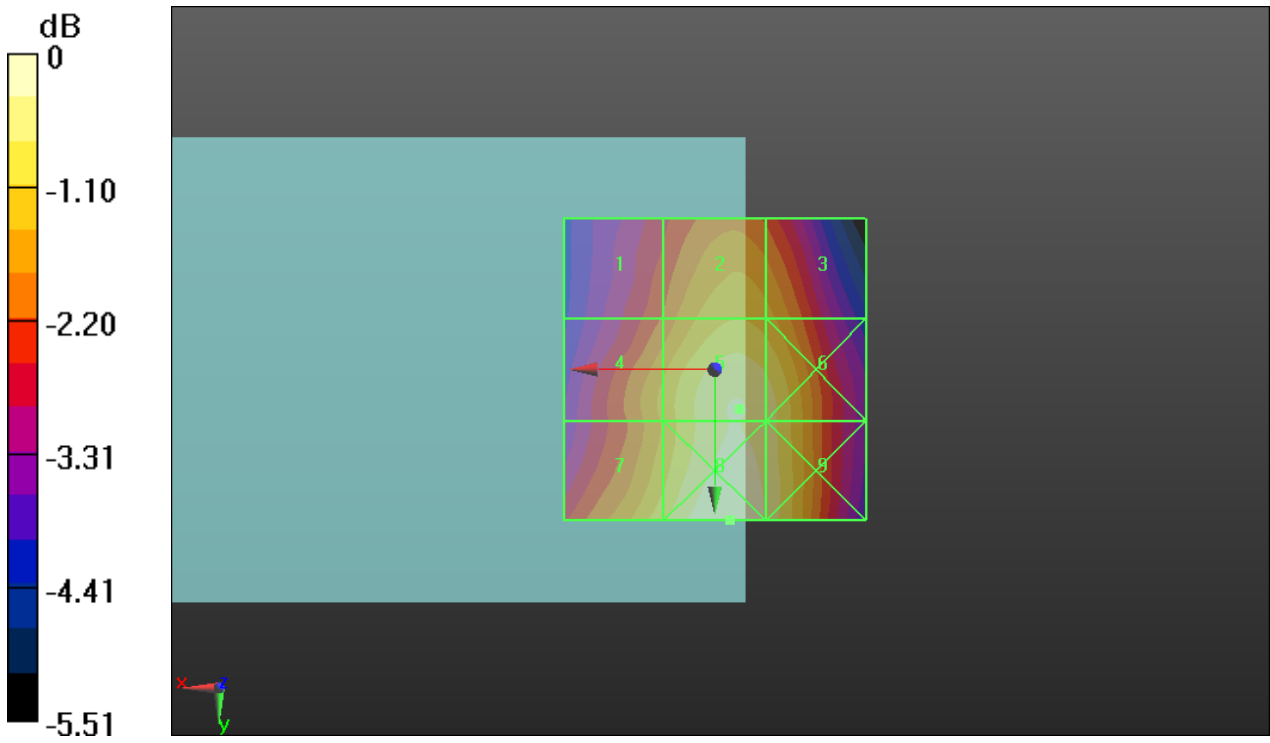

0 dB = 79.45 V/m

**02\_HAC RF\_GSM850\_GSM Voice\_Ch189\_E**

Communication System: UID 10021 - DAA, GSM-FDD (TDMA, GMSK); Frequency: 836.4 MHz; Duty Cycle: 1:8.3

Medium: Air Medium parameters used:  $\sigma = 0$  S/m,  $\epsilon_r = 1$ ;  $\rho = 1000$  kg/m<sup>3</sup>  
 Ambient Temperature : 23.5 °C

DASY5 Configuration:

- Probe: ER3DV6 - SN2528; ConvF(1, 1, 1); Calibrated: 2014.03.24;
- Sensor-Surface: (Fix Surface)
- Electronics: DAE4 Sn1303; Calibrated: 2014.12.11
- Phantom: HAC Test Arch with AMCC; Type: SD HAC P01 BA;
- Measurement SW: DASY52, Version 52.8 (7); SEMCAD X Version 14.6.10 (7164)

**Ch189/Hearing Aid Compatibility Test (101x101x1):** Interpolated grid: dx=0.5000 mm, dy=0.5000 mm

Device Reference Point: 0, 0, -6.3 mm

Reference Value = 61.02 V/m; Power Drift = 0.02 dB

Applied MIF = 3.63 dB

RF audio interference level = 37.38 dBV/m

**Emission category: M4**

MIF scaled E-field

|  |  |  |
|--|--|--|
| Grid 1 <b>M4</b><br><b>35.58 dBV/m</b> | Grid 2 <b>M4</b><br><b>36.63 dBV/m</b> | Grid 3 <b>M4</b><br><b>36.43 dBV/m</b> |
| Grid 4 <b>M4</b><br><b>36.33 dBV/m</b> | Grid 5 <b>M4</b><br><b>37.38 dBV/m</b> | Grid 6 <b>M4</b><br><b>37.18 dBV/m</b> |
| Grid 7 <b>M4</b><br><b>36.88 dBV/m</b> | Grid 8 <b>M4</b><br><b>37.71 dBV/m</b> | Grid 9 <b>M4</b><br><b>37.33 dBV/m</b> |

**Cursor:**

Total = 37.71 dBV/m

E Category: M4

Location: -3, 25, 8.7 mm

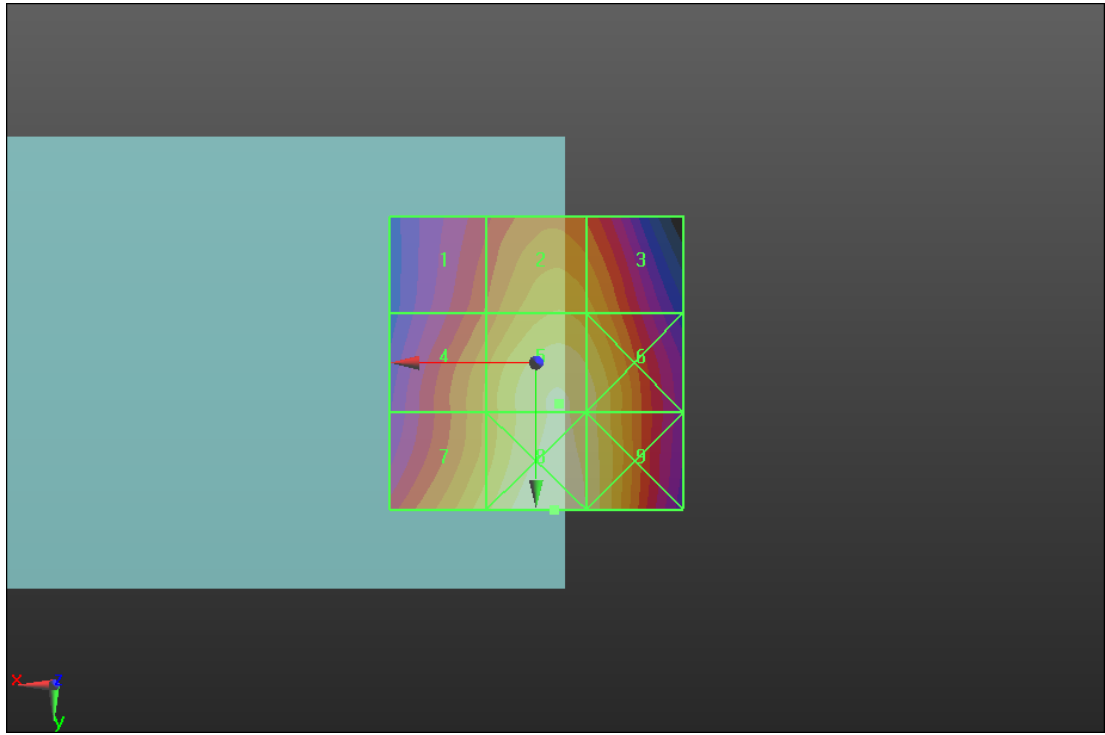
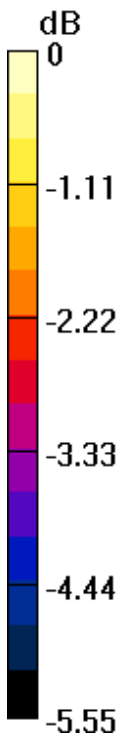

0 dB = 76.80 V/m

**03\_HAC RF\_GSM850\_GSM Voice\_Ch251\_E**

Communication System: UID 10021 - DAA, GSM-FDD (TDMA, GMSK); Frequency: 848.8 MHz; Duty Cycle: 1:8.3

Medium: Air Medium parameters used:  $\sigma = 0$  S/m,  $\epsilon_r = 1$ ;  $\rho = 1000$  kg/m<sup>3</sup>  
 Ambient Temperature : 23.5 °C

DASY5 Configuration:

- Probe: ER3DV6 - SN2528; ConvF(1, 1, 1); Calibrated: 2014.03.24;
- Sensor-Surface: (Fix Surface)
- Electronics: DAE4 Sn1303; Calibrated: 2014.12.11
- Phantom: HAC Test Arch with AMCC; Type: SD HAC P01 BA;
- Measurement SW: DASY52, Version 52.8 (7); SEMCAD X Version 14.6.10 (7164)

**Ch251/Hearing Aid Compatibility Test (101x101x1):** Interpolated grid: dx=0.5000 mm, dy=0.5000 mm

Device Reference Point: 0, 0, -6.3 mm

Reference Value = 56.20 V/m; Power Drift = -0.02 dB

Applied MIF = 3.63 dB

RF audio interference level = 36.64 dBV/m

**Emission category: M4**

MIF scaled E-field

|  |  |  |
|--|--|--|
| Grid 1 <b>M4</b><br><b>34.77 dBV/m</b> | Grid 2 <b>M4</b><br><b>35.87 dBV/m</b> | Grid 3 <b>M4</b><br><b>35.67 dBV/m</b> |
| Grid 4 <b>M4</b><br><b>35.55 dBV/m</b> | Grid 5 <b>M4</b><br><b>36.64 dBV/m</b> | Grid 6 <b>M4</b><br><b>36.45 dBV/m</b> |
| Grid 7 <b>M4</b><br><b>36.06 dBV/m</b> | Grid 8 <b>M4</b><br><b>36.93 dBV/m</b> | Grid 9 <b>M4</b><br><b>36.6 dBV/m</b>  |

**Cursor:**

Total = 36.93 dBV/m

E Category: M4

Location: -3, 25, 8.7 mm

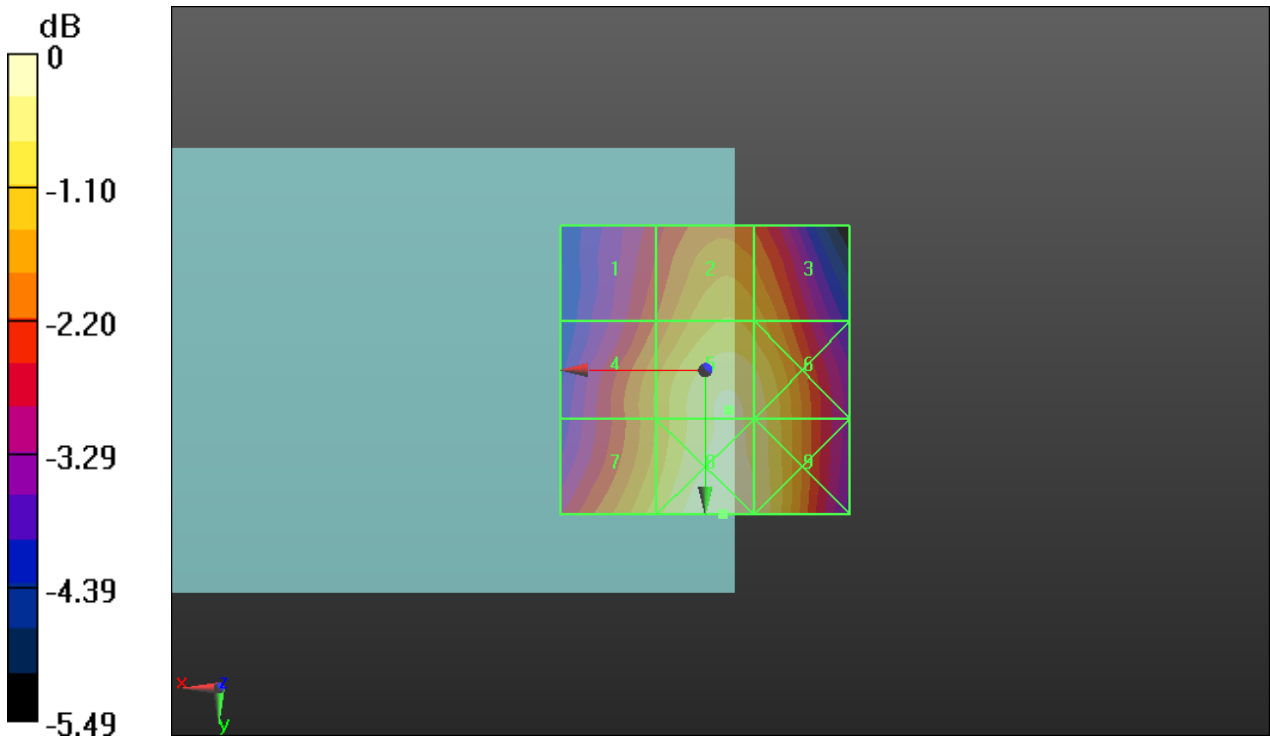

**04\_HAC RF\_GSM1900\_GSM Voice\_Ch512\_E**

Communication System: UID 10021 - DAA, GSM-FDD (TDMA, GMSK); Frequency: 1850.2 MHz; Duty Cycle: 1:8.3

Medium: Air Medium parameters used:  $\sigma = 0$  S/m,  $\epsilon_r = 1$ ;  $\rho = 1000$  kg/m<sup>3</sup>  
 Ambient Temperature : 23.5 °C

DASY5 Configuration:

- Probe: ER3DV6 - SN2528; ConvF(1, 1, 1); Calibrated: 2014.03.24;
- Sensor-Surface: (Fix Surface)
- Electronics: DAE4 Sn1303; Calibrated: 2014.12.11
- Phantom: HAC Test Arch with AMCC; Type: SD HAC P01 BA;
- Measurement SW: DASY52, Version 52.8 (7); SEMCAD X Version 14.6.10 (7164)

**Ch512/Hearing Aid Compatibility Test (101x101x1):** Interpolated grid: dx=0.5000 mm, dy=0.5000 mm

Device Reference Point: 0, 0, -6.3 mm

Reference Value = 8.253 V/m; Power Drift = 0.22 dB

Applied MIF = 3.63 dB

RF audio interference level = 26.84 dBV/m

**Emission category: M4**

MIF scaled E-field

|  |  |  |
|--|--|--|
| <b>Grid 1 M4</b><br><b>27.15 dBV/m</b> | <b>Grid 2 M4</b><br><b>29.04 dBV/m</b> | <b>Grid 3 M4</b><br><b>28.78 dBV/m</b> |
| <b>Grid 4 M4</b><br><b>21.95 dBV/m</b> | <b>Grid 5 M4</b><br><b>24.5 dBV/m</b>  | <b>Grid 6 M4</b><br><b>24.43 dBV/m</b> |
| <b>Grid 7 M4</b><br><b>25.28 dBV/m</b> | <b>Grid 8 M4</b><br><b>26.84 dBV/m</b> | <b>Grid 9 M4</b><br><b>26.58 dBV/m</b> |

**Cursor:**

Total = 29.04 dBV/m

E Category: M4

Location: -3, -25, 8.7 mm

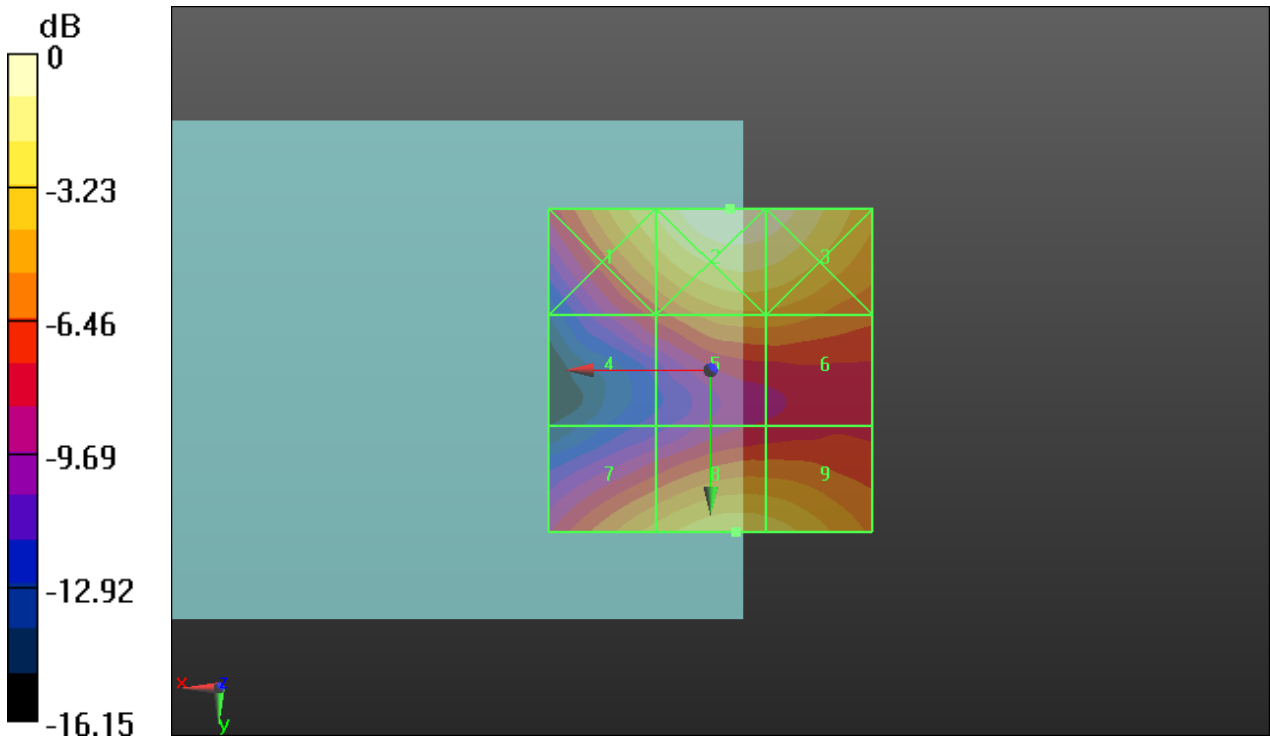

**05\_HAC RF\_GSM1900\_GSM Voice\_Ch661\_E**

Communication System: UID 10021 - DAA, GSM-FDD (TDMA, GMSK); Frequency: 1880 MHz; Duty Cycle: 1:8.3

Medium: Air Medium parameters used:  $\sigma = 0$  S/m,  $\epsilon_r = 1$ ;  $\rho = 1000$  kg/m<sup>3</sup>  
 Ambient Temperature : 23.5 °C

DASY5 Configuration:

- Probe: ER3DV6 - SN2528; ConvF(1, 1, 1); Calibrated: 2014.03.24;
- Sensor-Surface: (Fix Surface)
- Electronics: DAE4 Sn1303; Calibrated: 2014.12.11
- Phantom: HAC Test Arch with AMCC; Type: SD HAC P01 BA;
- Measurement SW: DASY52, Version 52.8 (7); SEMCAD X Version 14.6.10 (7164)

**Ch661/Hearing Aid Compatibility Test (101x101x1):** Interpolated grid: dx=0.5000 mm, dy=0.5000 mm

Device Reference Point: 0, 0, -6.3 mm

Reference Value = 9.773 V/m; Power Drift = -0.04 dB

Applied MIF = 3.63 dB

RF audio interference level = 25.91 dBV/m

**Emission category: M4**

MIF scaled E-field

|  |  |  |
|--|--|--|
| Grid 1 <b>M4</b><br><b>27.05 dBV/m</b> | Grid 2 <b>M4</b><br><b>29.54 dBV/m</b> | Grid 3 <b>M4</b><br><b>29.36 dBV/m</b> |
| Grid 4 <b>M4</b><br><b>22.49 dBV/m</b> | Grid 5 <b>M4</b><br><b>25.59 dBV/m</b> | Grid 6 <b>M4</b><br><b>25.53 dBV/m</b> |
| Grid 7 <b>M4</b><br><b>24.32 dBV/m</b> | Grid 8 <b>M4</b><br><b>25.91 dBV/m</b> | Grid 9 <b>M4</b><br><b>25.7 dBV/m</b>  |

**Cursor:**

Total = 29.54 dBV/m

E Category: M4

Location: -5, -25, 8.7 mm



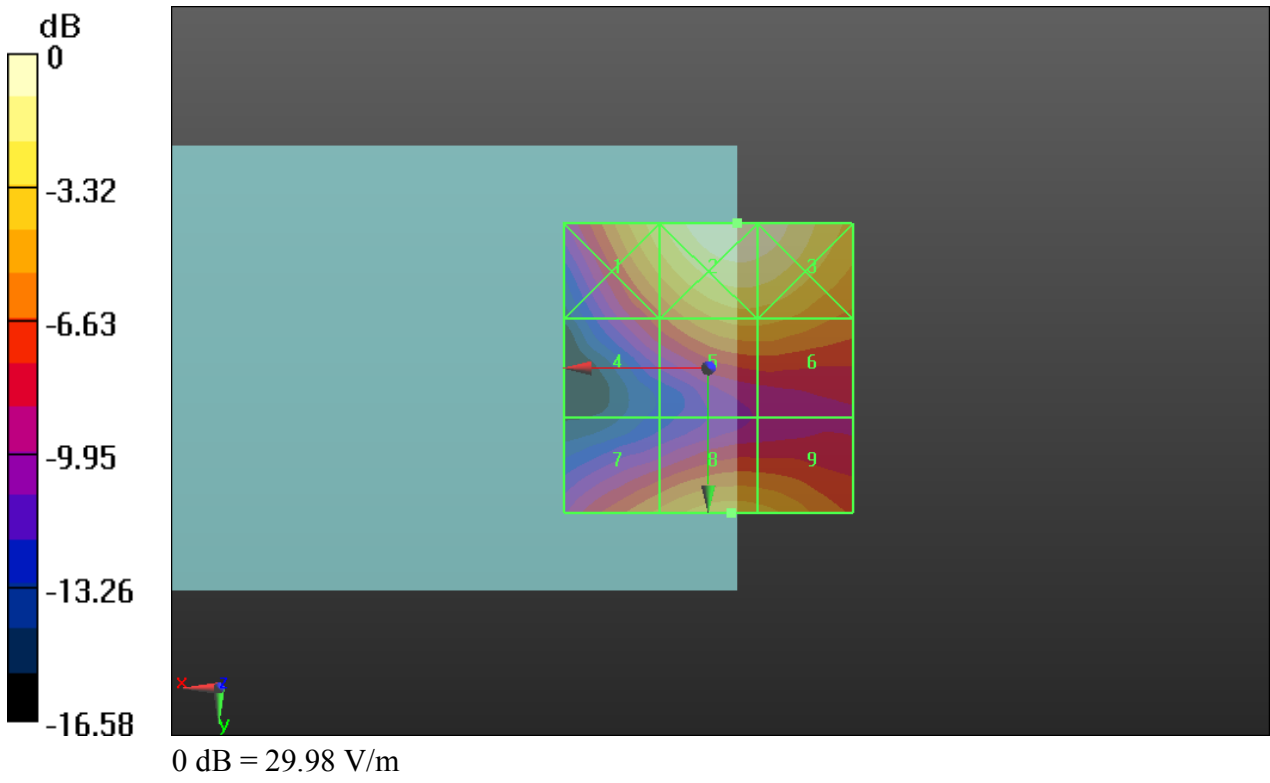

**06\_HAC RF\_GSM1900\_GSM Voice\_Ch810\_E**

Communication System: UID 10021 - DAA, GSM-FDD (TDMA, GMSK); Frequency: 1909.8 MHz; Duty Cycle: 1:8.3

Medium: Air Medium parameters used:  $\sigma = 0$  S/m,  $\epsilon_r = 1$ ;  $\rho = 1000$  kg/m<sup>3</sup>  
 Ambient Temperature : 23.5 °C

DASY5 Configuration:

- Probe: ER3DV6 - SN2528; ConvF(1, 1, 1); Calibrated: 2014.03.24;
- Sensor-Surface: (Fix Surface)
- Electronics: DAE4 Sn1303; Calibrated: 2014.12.11
- Phantom: HAC Test Arch with AMCC; Type: SD HAC P01 BA;
- Measurement SW: DASY52, Version 52.8 (7); SEMCAD X Version 14.6.10 (7164)

**Ch810/Hearing Aid Compatibility Test (101x101x1):** Interpolated grid: dx=0.5000 mm, dy=0.5000 mm

Device Reference Point: 0, 0, -6.3 mm

Reference Value = 8.859 V/m; Power Drift = -0.02 dB

Applied MIF = 3.63 dB

RF audio interference level = 25.92 dBV/m

**Emission category: M4**

MIF scaled E-field

|  |  |  |
|--|--|--|
| Grid 1 <b>M4</b><br><b>26.49 dBV/m</b> | Grid 2 <b>M4</b><br><b>29.09 dBV/m</b> | Grid 3 <b>M4</b><br><b>28.9 dBV/m</b>  |
| Grid 4 <b>M4</b><br><b>21.63 dBV/m</b> | Grid 5 <b>M4</b><br><b>24.91 dBV/m</b> | Grid 6 <b>M4</b><br><b>24.85 dBV/m</b> |
| Grid 7 <b>M4</b><br><b>24.3 dBV/m</b>  | Grid 8 <b>M4</b><br><b>25.92 dBV/m</b> | Grid 9 <b>M4</b><br><b>25.62 dBV/m</b> |

**Cursor:**

Total = 29.09 dBV/m

E Category: M4

Location: -5, -25, 8.7 mm

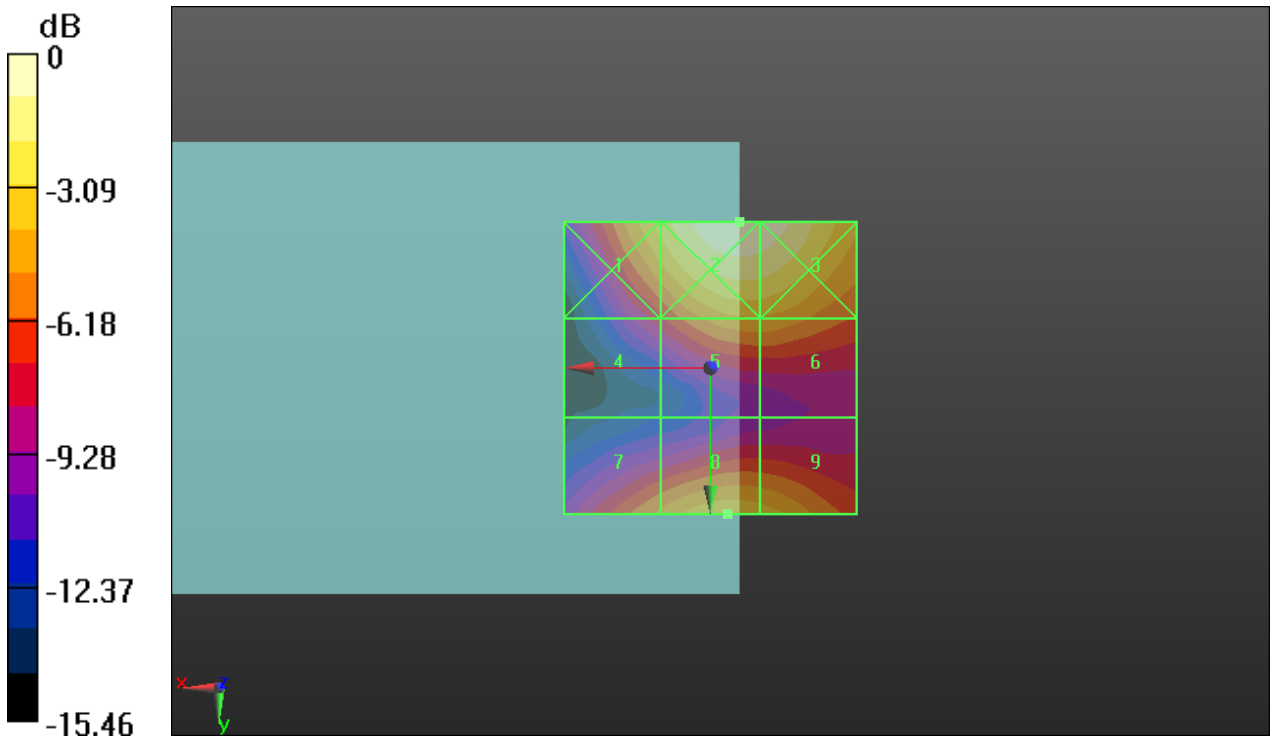

0 dB = 28.48 V/m



## **Appendix C. DASY Calibration Certificate**

The DASY calibration certificates are shown as follows.



Accredited by the Swiss Accreditation Service (SAS)  
 The Swiss Accreditation Service is one of the signatories to the EA  
 Multilateral Agreement for the recognition of calibration certificates

Accreditation No.: **SCS 108**

Client **Sporton-CN (Auden)**

Certificate No: **CD835V3-1171\_Jan13**

**CALIBRATION CERTIFICATE**

Object **CD835V3 - SN: 1171**

Calibration procedure(s) **QA CAL-20.v6  
 Calibration procedure for dipoles in air**

Calibration date: **January 22, 2013**

This calibration certificate documents the traceability to national standards, which realize the physical units of measurements (SI).  
 The measurements and the uncertainties with confidence probability are given on the following pages and are part of the certificate.

All calibrations have been conducted in the closed laboratory facility: environment temperature (22 ± 3)°C and humidity < 70%.

Calibration Equipment used (M&TE critical for calibration)

| Primary Standards          | ID #             | Cal Date (Certificate No.)     | Scheduled Calibration |
|----------------------------|------------------|--------------------------------|-----------------------|
| Power meter EPM-442A       | GB37480704       | 01-Nov-12 (No. 217-01640)      | Oct-13                |
| Power sensor HP 8481A      | US37292783       | 01-Nov-12 (No. 217-01640)      | Oct-13                |
| Reference 10 dB Attenuator | SN: 5047.2 (10q) | 27-Mar-12 (No. 217-01527)      | Apr-13                |
| Probe ER3DV6               | SN: 2336         | 28-Dec-12 (No. ER3-2336_Dec12) | Dec-13                |
| Probe H3DV6                | SN: 6065         | 28-Dec-12 (No. H3-6065_Dec12)  | Dec-13                |
| DAE4                       | SN: 781          | 29-May-12 (No. DAE4-781_May12) | May-13                |

| Secondary Standards       | ID #           | Check Date (in house)             | Scheduled Check        |
|---------------------------|----------------|-----------------------------------|------------------------|
| Power meter Agilent 4419B | SN: GB42420191 | 09-Oct-09 (in house check Oct-12) | In house check: Oct-13 |
| Power sensor HP E4412A    | SN: MY41495277 | 01-Apr-08 (in house check Oct-12) | In house check: Oct-13 |
| Power sensor HP 8482A     | SN: US37295597 | 09-Oct-09 (in house check Oct-12) | In house check: Oct-13 |
| Network Analyzer HP 8753E | US37390585     | 18-Oct-01 (in house check Oct-12) | In house check: Oct-13 |
| RF generator R&S SMT-06   | SN: 832283/011 | 27-Aug-12 (in house check Oct-12) | In house check: Oct-14 |

|                |                                |   |               |
|----------------|--------------------------------|---|---------------|
| Calibrated by: | Name<br><b>Claudio Leubler</b> | Function<br><b>Laboratory Technician</b>    | Signature<br> |
| Approved by:   | Name<br><b>Fin Bomholt</b>     | Function<br><b>Deputy Technical Manager</b> | Signature<br> |

Issued: January 24, 2013

This calibration certificate shall not be reproduced except in full without written approval of the laboratory.



Accredited by the Swiss Accreditation Service (SAS)

The Swiss Accreditation Service is one of the signatories to the EA  
Multilateral Agreement for the recognition of calibration certificates

Accreditation No.: **SCS 108**

## References

- [1] ANSI-C63.19-2007  
American National Standard for Methods of Measurement of Compatibility between Wireless Communications Devices and Hearing Aids.
- [2] ANSI-C63.19-2011  
American National Standard, Methods of Measurement of Compatibility between Wireless Communications Devices and Hearing Aids.

## Methods Applied and Interpretation of Parameters:

- *Coordinate System:* y-axis is in the direction of the dipole arms. z-axis is from the basis of the antenna (mounted on the table) towards its feed point between the two dipole arms. x-axis is normal to the other axes. In coincidence with the standards [1], the measurement planes (probe sensor center) are selected to be at a distance of 10 mm (15 mm for [2]) above the top metal edge of the dipole arms.
- *Measurement Conditions:* Further details are available from the hardcopies at the end of the certificate. All figures stated in the certificate are valid at the frequency indicated. The forward power to the dipole connector is set with a calibrated power meter connected and monitored with an auxiliary power meter connected to a directional coupler. While the dipole under test is connected, the forward power is adjusted to the same level.
- *Antenna Positioning:* The dipole is mounted on a HAC Test Arch phantom using the matching dipole positioner with the arms horizontal and the feeding cable coming from the floor. The measurements are performed in a shielded room with absorbers around the setup to reduce the reflections. It is verified before the mounting of the dipole under the Test Arch phantom, that its arms are perfectly in a line. It is installed on the HAC dipole positioner with its arms parallel below the dielectric reference wire and able to move elastically in vertical direction without changing its relative position to the top center of the Test Arch phantom. The vertical distance to the probe is adjusted after dipole mounting with a DASY5 Surface Check job. Before the measurement, the distance between phantom surface and probe tip is verified. The proper measurement distance is selected by choosing the matching section of the HAC Test Arch phantom with the proper device reference point (upper surface of the dipole) and the matching grid reference point (tip of the probe) considering the probe sensor offset. The vertical distance to the probe is essential for the accuracy.
- *Feed Point Impedance and Return Loss:* These parameters are measured using a HP 8753E Vector Network Analyzer. The impedance is specified at the SMA connector of the dipole. The influence of reflections was eliminated by applying the averaging function while moving the dipole in the air, at least 70cm away from any obstacles.
- *E-field distribution:* E field is measured in the x-y-plane with an isotropic ER3D-field probe with 100 mW forward power to the antenna feed point. In accordance with [1] and [2], the scan area is 20mm wide, its length exceeds the dipole arm length (180 or 90mm). The sensor center is 10 mm (15 mm for [2]) (in z) above the metal top of the dipole arms. Two 3D maxima are available near the end of the dipole arms. Assuming the dipole arms are perfectly in one line, the average of these two maxima (in subgrid 2 and subgrid 8) is determined to compensate for any non-parallelity to the measurement plane as well as the sensor displacement. The E-field value stated as calibration value represents the maximum of the interpolated 3D-E-field, in the plane above the dipole surface.
- *H-field distribution:* H-field is measured with an isotropic H-field probe with 100mW forward power to the antenna feed point, in the x-y-plane. The scan area and sensor distance is equivalent to the E-field scan. The maximum of the field is available at the center (subgrid 5) above the feed point. The H-field value stated as calibration value represents the maximum of the interpolated H-field, 10mm above the dipole surface at the feed point.

The reported uncertainty of measurement is stated as the standard uncertainty of measurement multiplied by the coverage factor  $k=2$ , which for a normal distribution corresponds to a coverage probability of approximately 95%.

## Measurement Conditions

DASY system configuration, as far as not given on page 1.

|                                    |                        |         |
|------------------------------------|------------------------|---------|
| DASY Version                       | DASY5                  | V52.8.5 |
| Extrapolation                      | Advanced Extrapolation |         |
| Phantom                            | HAC Test Arch          |         |
| Distance Dipole Top - Probe Center | 10mm<br>15mm           |         |
| Scan resolution                    | dx, dy = 5 mm          |         |
| Frequency                          | 835 MHz $\pm$ 1 MHz    |         |
| Input power drift                  | < 0.05 dB              |         |

## Maximum Field values at 835 MHz

| H-field 10 mm above dipole surface | condition          | interpolated maximum                            |
|------------------------------------|--------------------|---|
| Maximum measured                   | 100 mW input power | <b>0.470 A / m <math>\pm</math> 8.2 % (k=2)</b> |

| E-field 10 mm above dipole surface | condition          | Interpolated maximum                             |
|------------------------------------|--------------------|--|
| Maximum measured above high end    | 100 mW input power | 170.7 V / m                                      |
| Maximum measured above low end     | 100 mW input power | 168.2 V / m                                      |
| Averaged maximum above arm         | 100 mW input power | <b>169.5 V / m <math>\pm</math> 12.8 % (k=2)</b> |

| E-field 15 mm above dipole surface | condition          | Interpolated maximum                             |
|------------------------------------|--------------------|--|
| Maximum measured above high end    | 100 mW input power | 109.4 V / m                                      |
| Maximum measured above low end     | 100 mW input power | 108.6 V / m                                      |
| Averaged maximum above arm         | 100 mW input power | <b>109.0 V / m <math>\pm</math> 12.8 % (k=2)</b> |

## Appendix

### Antenna Parameters

| Frequency | Return Loss | Impedance                       |
|-----------|-------------|---------------------------------|
| 800 MHz   | 16.1 dB     | 41.8 $\Omega$ - 12.0 j $\Omega$ |
| 835 MHz   | 24.7 dB     | 50.6 $\Omega$ + 5.9 j $\Omega$  |
| 900 MHz   | 16.2 dB     | 57.1 $\Omega$ - 15.2 j $\Omega$ |
| 950 MHz   | 19.8 dB     | 44.5 $\Omega$ + 8.1 j $\Omega$  |
| 960 MHz   | 15.3 dB     | 52.9 $\Omega$ + 17.7 j $\Omega$ |

### 3.2 Antenna Design and Handling

The calibration dipole has a symmetric geometry with a built-in two stub matching network, which leads to the enhanced bandwidth.

The dipole is built of standard semirigid coaxial cable. The internal matching line is open ended. The antenna is therefore open for DC signals.

Do not apply force to dipole arms, as they are liable to bend. The soldered connections near the feedpoint may be damaged. After excessive mechanical stress or overheating, check the impedance characteristics to ensure that the internal matching network is not affected.

After long term use with 40W radiated power, only a slight warming of the dipole near the feedpoint can be measured.



# Impedance Measurement Plot

22 Jan 2013 17:10:47

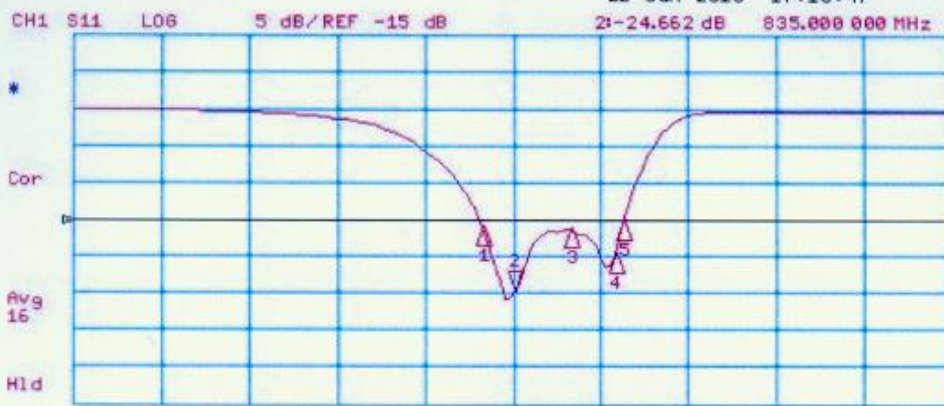

CH1 Markers

- 1: -16.073 dB  
800.000 MHz
- 3: -16.178 dB  
900.000 MHz
- 4: -19.750 dB  
950.000 MHz
- 5: -15.300 dB  
960.000 MHz

CH2 S11 1 U FS 2: 50.623  $\Omega$  5: 8594  $\Omega$  1.1168 nH 835.000 000 MHz

Del  
Cor  
Avg 16  
H1d

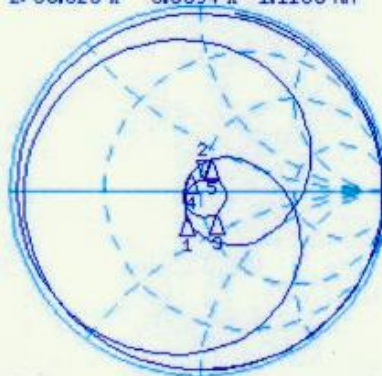

CH2 Markers

- 1: 41.775  $\Omega$   
-11.996  $\Omega$   
800.000 MHz
- 3: 57.135  $\Omega$   
-15.209  $\Omega$   
900.000 MHz
- 4: 44.543  $\Omega$   
8.1016  $\Omega$   
950.000 MHz
- 5: 52.930  $\Omega$   
17.682  $\Omega$   
960.000 MHz

START 335.000 000 MHz

STOP 1 335.000 000 MHz

## DASY5 H-field Result

Date: 22.01.2013

Test Laboratory: SPEAG Lab2

**DUT: HAC-Dipole 835 MHz; Type: CD835V3; Serial: CD835V3 - SN: 1171**

Communication System: CW; Frequency: 835 MHz  
Medium parameters used:  $\sigma = 0 \text{ S/m}$ ,  $\epsilon_r = 1$ ;  $\rho = 1 \text{ kg/m}^3$   
Phantom section: RF Section  
Measurement Standard: DASY5 (IEEE/IEC/ANSI C63.19-2007)

DASY52 Configuration:

- Probe: H3DV6 - SN6065; ; Calibrated: 28.12.2012
- Sensor-Surface: (Fix Surface)
- Electronics: DAE4 Sn781; Calibrated: 29.05.2012
- Phantom: HAC Test Arch with AMCC; Type: SD HAC P01 BA; Serial: 1070
- DASY52 52.8.5(1059); SEMCAD X 14.6.8(7028)

**Dipole H-Field measurement @ 835MHz/H-Scan - 835MHz d=10mm/Hearing Aid Compatibility Test (41x361x1):**

Interpolated grid: dx=0.5000 mm, dy=0.5000 mm

Device Reference Point: 0, 0, -6.3 mm

Reference Value = 0.5000 A/m; Power Drift = -0.01 dB

PMR not calibrated. PMF = 1.000 is applied.

H-field emissions = 0.4695 A/m

**Near-field category: M4 (AWF 0 dB)**

PMF scaled H-field

|                        |                        |                        |
|------------------------|------------------------|------------------------|
| Grid 1 M4<br>0.388 A/m | Grid 2 M4<br>0.414 A/m | Grid 3 M4<br>0.396 A/m |
| Grid 4 M4<br>0.434 A/m | Grid 5 M4<br>0.470 A/m | Grid 6 M4<br>0.454 A/m |
| Grid 7 M4<br>0.378 A/m | Grid 8 M4<br>0.415 A/m | Grid 9 M4<br>0.404 A/m |

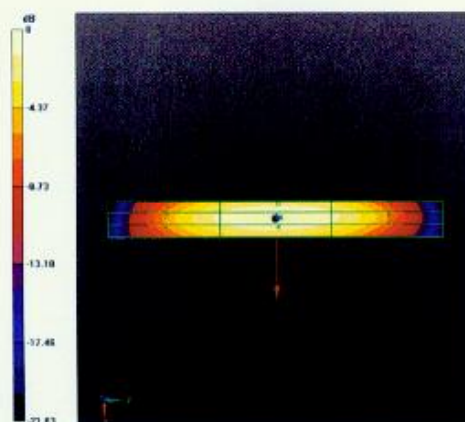

## DASY5 E-field Result

Date: 22.01.2013

Test Laboratory: SPEAG Lab2

**DUT: HAC-Dipole 835 MHz; Type: CD835V3; Serial: CD835V3 - SN: 1171**

Communication System: CW; Frequency: 835 MHz

Medium parameters used:  $\sigma = 0$  S/m,  $\epsilon_r = 1$ ;  $\rho = 1000$  kg/m<sup>3</sup>

Phantom section: RF Section

Measurement Standard: DASY5 (IEEE/IEC/ANSI C63.19-2007)

DASY52 Configuration:

- Probe: ER3DV6 - SN2336; ConvF(1, 1, 1); Calibrated: 28.12.2012;
- Sensor-Surface: (Fix Surface)
- Electronics: DAE4 Sn781; Calibrated: 29.05.2012
- Phantom: HAC Test Arch with AMCC; Type: SD HAC P01 BA; Serial: 1070
- DASY52 52.8.5(1059); SEMCAD X 14.6.8(7028)

**Dipole E-Field measurement @ 835MHz/E-Scan - 835MHz d=10mm/Hearing Aid Compatibility Test (41x361x1):**

Interpolated grid: dx=0.5000 mm, dy=0.5000 mm

Device Reference Point: 0, 0, -6.3 mm

Reference Value = 112.2 V/m; Power Drift = 0.01 dB

PMR not calibrated. PMF = 1.000 is applied.

E-field emissions = 170.7 V/m

**Near-field category: M4 (AWF 0 dB)**

PMF scaled E-field

|                        |                        |                        |
|------------------------|------------------------|------------------------|
| Grid 1 M4<br>162.4 V/m | Grid 2 M4<br>168.2 V/m | Grid 3 M4<br>163.2 V/m |
| Grid 4 M4<br>87.41 V/m | Grid 5 M4<br>89.98 V/m | Grid 6 M4<br>87.51 V/m |
| Grid 7 M4<br>161.5 V/m | Grid 8 M4<br>170.7 V/m | Grid 9 M4<br>168.5 V/m |

**Dipole E-Field measurement @ 835MHz/E-Scan - 835MHz d=15mm/Hearing Aid Compatibility Test (41x361x1):**

Interpolated grid: dx=0.5000 mm, dy=0.5000 mm

Device Reference Point: 0, 0, -6.3 mm

Reference Value = 112.2 V/m; Power Drift = 0.00 dB

PMR not calibrated. PMF = 1.000 is applied.

E-field emissions = 108.6 V/m

**Near-field category: M4 (AWF 0 dB)**

PMF scaled E-field

|                        |                        |                        |
|------------------------|------------------------|------------------------|
| Grid 1 M4<br>106.6 V/m | Grid 2 M4<br>108.6 V/m | Grid 3 M4<br>107.3 V/m |
| Grid 4 M4<br>63.23 V/m | Grid 5 M4<br>64.09 V/m | Grid 6 M4<br>63.16 V/m |
| Grid 7 M4<br>106.9 V/m | Grid 8 M4<br>109.4 V/m | Grid 9 M4<br>108.4 V/m |

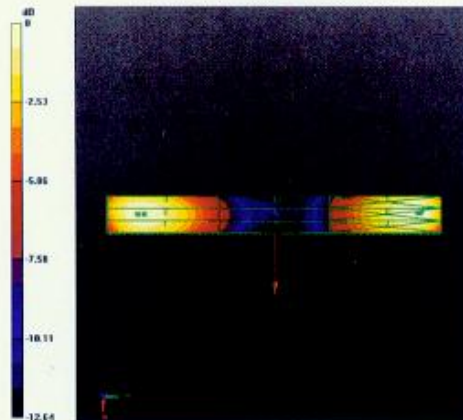

0 dB = 170.7 V/m = 44.64 dBV/m



Accredited by the Swiss Accreditation Service (SAS)  
The Swiss Accreditation Service is one of the signatories to the EA  
Multilateral Agreement for the recognition of calibration certificates

Accreditation No.: **SCS 108**

Client **Sporton-CN (Auden)**

Certificate No: **CD1880V3-1155\_Jan13**

## CALIBRATION CERTIFICATE

Object **CD1880V3 - SN: 1155**

Calibration procedure(s) **QA CAL-20.v6  
Calibration procedure for dipoles in air**

Calibration date: **January 22, 2013**

This calibration certificate documents the traceability to national standards, which realize the physical units of measurements (SI).  
The measurements and the uncertainties with confidence probability are given on the following pages and are part of the certificate.

All calibrations have been conducted in the closed laboratory facility: environment temperature ( $22 \pm 3$ )°C and humidity < 70%.

Calibration Equipment used (M&TE critical for calibration)

| Primary Standards          | ID #             | Cal Date (Certificate No.)     | Scheduled Calibration |
|----------------------------|------------------|--------------------------------|-----------------------|
| Power meter EPM-442A       | GB37480704       | 01-Nov-12 (No. 217-01640)      | Oct-13                |
| Power sensor HP 8481A      | US37292783       | 01-Nov-12 (No. 217-01640)      | Oct-13                |
| Reference 10 dB Attenuator | SN: 5047.2 (10q) | 27-Mar-12 (No. 217-01527)      | Apr-13                |
| Probe ER3DV6               | SN: 2336         | 28-Dec-12 (No. ER3-2336_Dec12) | Dec-13                |
| Probe H3DV6                | SN: 6065         | 28-Dec-12 (No. H3-6065_Dec12)  | Dec-13                |
| DAE4                       | SN: 781          | 29-May-12 (No. DAE4-781_May12) | May-13                |

| Secondary Standards       | ID #           | Check Date (in house)             | Scheduled Check        |
|---------------------------|----------------|-----------------------------------|------------------------|
| Power meter Agilent 4419B | SN: GB42420191 | 09-Oct-09 (in house check Oct-12) | In house check: Oct-13 |
| Power sensor HP E4412A    | SN: MY41495277 | 01-Apr-08 (in house check Oct-12) | In house check: Oct-13 |
| Power sensor HP 8482A     | SN: US37295597 | 09-Oct-09 (in house check Oct-12) | In house check: Oct-13 |
| Network Analyzer HP 8753E | US37390585     | 18-Oct-01 (in house check Oct-12) | In house check: Oct-13 |
| RF generator R&S SMT-06   | SN: 832283/011 | 27-Aug-12 (in house check Oct-12) | In house check: Oct-14 |

|                |                                |                                   |               |
|----------------|--------------------------------|-----------------------------------|---------------|
| Calibrated by: | Name<br><b>Claudio Leubler</b> | Function<br>Laboratory Technician | Signature<br> |
| Approved by:   | Name<br><b>Fin Bomholt</b>     | Deputy Technical Manager          |               |

Issued: January 24, 2013

This calibration certificate shall not be reproduced except in full without written approval of the laboratory.



Accredited by the Swiss Accreditation Service (SAS)

The Swiss Accreditation Service is one of the signatories to the EA  
Multilateral Agreement for the recognition of calibration certificates

Accreditation No.: **SCS 108**

#### References

- [1] ANSI-C63.19-2007  
American National Standard for Methods of Measurement of Compatibility between Wireless Communications Devices and Hearing Aids.
- [2] ANSI-C63.19-2011  
American National Standard, Methods of Measurement of Compatibility between Wireless Communications Devices and Hearing Aids.

#### Methods Applied and Interpretation of Parameters:

- **Coordinate System:** y-axis is in the direction of the dipole arms. z-axis is from the basis of the antenna (mounted on the table) towards its feed point between the two dipole arms. x-axis is normal to the other axes. In coincidence with the standards [1], the measurement planes (probe sensor center) are selected to be at a distance of 10 mm (15 mm for [2]) above the top metal edge of the dipole arms.
- **Measurement Conditions:** Further details are available from the hardcopies at the end of the certificate. All figures stated in the certificate are valid at the frequency indicated. The forward power to the dipole connector is set with a calibrated power meter connected and monitored with an auxiliary power meter connected to a directional coupler. While the dipole under test is connected, the forward power is adjusted to the same level.
- **Antenna Positioning:** The dipole is mounted on a HAC Test Arch phantom using the matching dipole positioner with the arms horizontal and the feeding cable coming from the floor. The measurements are performed in a shielded room with absorbers around the setup to reduce the reflections. It is verified before the mounting of the dipole under the Test Arch phantom, that its arms are perfectly in a line. It is installed on the HAC dipole positioner with its arms parallel below the dielectric reference wire and able to move elastically in vertical direction without changing its relative position to the top center of the Test Arch phantom. The vertical distance to the probe is adjusted after dipole mounting with a DASY5 Surface Check job. Before the measurement, the distance between phantom surface and probe tip is verified. The proper measurement distance is selected by choosing the matching section of the HAC Test Arch phantom with the proper device reference point (upper surface of the dipole) and the matching grid reference point (tip of the probe) considering the probe sensor offset. The vertical distance to the probe is essential for the accuracy.
- **Feed Point Impedance and Return Loss:** These parameters are measured using a HP 8753E Vector Network Analyzer. The impedance is specified at the SMA connector of the dipole. The influence of reflections was eliminated by applying the averaging function while moving the dipole in the air, at least 70cm away from any obstacles.
- **E-field distribution:** E field is measured in the x-y-plane with an isotropic ER3D-field probe with 100 mW forward power to the antenna feed point. In accordance with [1] and [2], the scan area is 20mm wide, its length exceeds the dipole arm length (180 or 90mm). The sensor center is 10 mm (15 mm for [2]) (in z) above the metal top of the dipole arms. Two 3D maxima are available near the end of the dipole arms. Assuming the dipole arms are perfectly in one line, the average of these two maxima (in subgrid 2 and subgrid 8) is determined to compensate for any non-parallelity to the measurement plane as well as the sensor displacement. The E-field value stated as calibration value represents the maximum of the interpolated 3D-E-field, in the plane above the dipole surface.
- **H-field distribution:** H-field is measured with an isotropic H-field probe with 100mW forward power to the antenna feed point, in the x-y-plane. The scan area and sensor distance is equivalent to the E-field scan. The maximum of the field is available at the center (subgrid 5) above the feed point. The H-field value stated as calibration value represents the maximum of the interpolated H-field, 10mm above the dipole surface at the feed point.

The reported uncertainty of measurement is stated as the standard uncertainty of measurement multiplied by the coverage factor  $k=2$ , which for a normal distribution corresponds to a coverage probability of approximately 95%.

## Measurement Conditions

DASY system configuration, as far as not given on page 1.

|   |  |         |
|---|--|---------|
| <b>DASY Version</b>                       | DASY5  | V52.8.5 |
| <b>Extrapolation</b>                      | Advanced Extrapolation                       |         |
| <b>Phantom</b>                            | HAC Test Arch                                |         |
| <b>Distance Dipole Top - Probe Center</b> | 10mm<br>15mm                                 |         |
| <b>Scan resolution</b>                    | dx, dy = 5 mm                                |         |
| <b>Frequency</b>                          | 1730 MHz $\pm$ 1 MHz<br>1880 MHz $\pm$ 1 MHz |         |
| <b>Input power drift</b>                  | < 0.05 dB                                    |         |

### Maximum Field values at 1730 MHz

| <b>H-field 10 mm above dipole surface</b> | condition          | <b>interpolated maximum</b>                     |
|---|--------------------|---|
| Maximum measured                          | 100 mW input power | <b>0.502 A / m <math>\pm</math> 8.2 % (k=2)</b> |

| <b>E-field 10 mm above dipole surface</b> | condition          | <b>Interpolated maximum</b>                      |
|---|--------------------|--|
| Maximum measured above high end           | 100 mW input power | 158.9 V / m                                      |
| Maximum measured above low end            | 100 mW input power | 149.8 V / m                                      |
| Averaged maximum above arm                | 100 mW input power | <b>154.4 V / m <math>\pm</math> 12.8 % (k=2)</b> |

| <b>E-field 15 mm above dipole surface</b> | condition          | <b>Interpolated maximum</b>                     |
|---|--------------------|---|
| Maximum measured above high end           | 100 mW input power | 99.8 V / m                                      |
| Maximum measured above low end            | 100 mW input power | 98.1 V / m                                      |
| Averaged maximum above arm                | 100 mW input power | <b>99.0 V / m <math>\pm</math> 12.8 % (k=2)</b> |

### Maximum Field values at 1880 MHz

| <b>H-field 10 mm above dipole surface</b> | condition          | <b>interpolated maximum</b>                     |
|---|--------------------|---|
| Maximum measured                          | 100 mW input power | <b>0.471 A / m <math>\pm</math> 8.2 % (k=2)</b> |

| <b>E-field 10 mm above dipole surface</b> | condition          | <b>Interpolated maximum</b>                      |
|---|--------------------|--|
| Maximum measured above high end           | 100 mW input power | 144.1 V / m                                      |
| Maximum measured above low end            | 100 mW input power | 138.3 V / m                                      |
| Averaged maximum above arm                | 100 mW input power | <b>141.2 V / m <math>\pm</math> 12.8 % (k=2)</b> |

| <b>E-field 15 mm above dipole surface</b> | condition          | <b>Interpolated maximum</b>                     |
|---|--------------------|---|
| Maximum measured above high end           | 100 mW input power | 90.8 V / m                                      |
| Maximum measured above low end            | 100 mW input power | 90.2 V / m                                      |
| Averaged maximum above arm                | 100 mW input power | <b>90.5 V / m <math>\pm</math> 12.8 % (k=2)</b> |

## Appendix

### Antenna Parameters

#### Nominal Frequencies

| Frequency | Return Loss | Impedance                       |
|-----------|-------------|---------------------------------|
| 1730 MHz  | 33.3 dB     | 52.0 $\Omega$ - 1.0 j $\Omega$  |
| 1880 MHz  | 18.3 dB     | 43.4 $\Omega$ + 9.2 j $\Omega$  |
| 1900 MHz  | 19.0 dB     | 46.2 $\Omega$ + 10.1 j $\Omega$ |
| 1950 MHz  | 23.5 dB     | 50.4 $\Omega$ + 6.7 j $\Omega$  |
| 2000 MHz  | 19.4 dB     | 42.7 $\Omega$ + 6.8 j $\Omega$  |

#### 3.2 Antenna Design and Handling

The calibration dipole has a symmetric geometry with a built-in two stub matching network, which leads to the enhanced bandwidth.

The dipole is built of standard semirigid coaxial cable. The internal matching line is open ended. The antenna is therefore open for DC signals.

Do not apply force to dipole arms, as they are liable to bend. The soldered connections near the feedpoint may be damaged. After excessive mechanical stress or overheating, check the impedance characteristics to ensure that the internal matching network is not affected.

After long term use with 40W radiated power, only a slight warming of the dipole near the feedpoint can be measured.



# Impedance Measurement Plot

22 Jan 2013 17:18:23

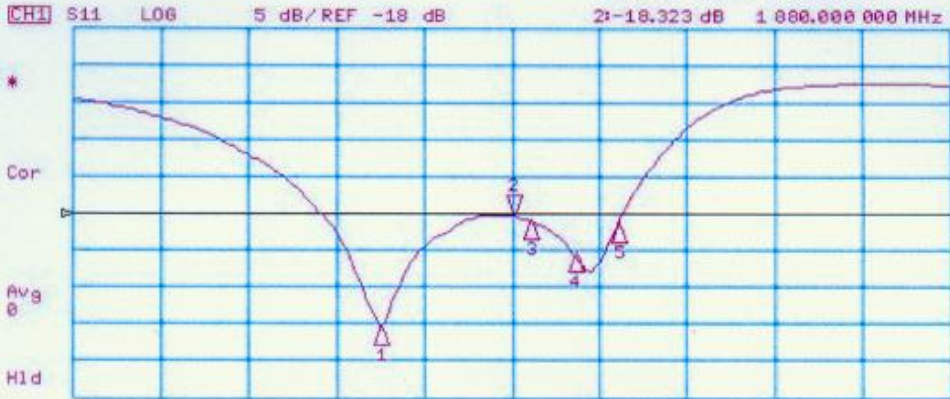

CH2 S11 1 U FS 2: 43.355  $\Omega$  9.2402  $\Omega$  782.25 pF 1 880.000 000 MHz

Del  
Cor  
Avg 0  
H1d

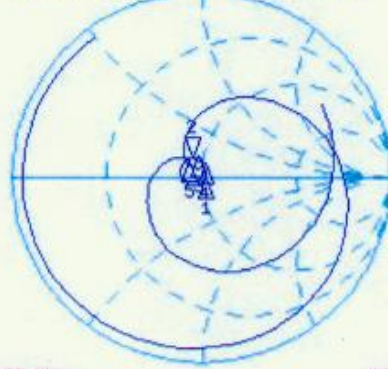

CH2 Markers

|    |                 |                     |             |
|----|-----------------|---------------------|-------------|
| 1: | 51.971 $\Omega$ | -978.70 $\mu\Omega$ | 1.73000 GHz |
| 3: | 46.188 $\Omega$ | 18.146 $\mu\Omega$  | 1.90000 GHz |
| 4: | 50.416 $\Omega$ | 6.6953 $\mu\Omega$  | 1.95000 GHz |
| 5: | 42.688 $\Omega$ | 6.7969 $\mu\Omega$  | 2.00000 GHz |

CENTER 1 880.000 000 MHz

SPAN 1 880.000 000 MHz

## DASY5 H-field Result

Date: 22.01.2013

Test Laboratory: SPEAG Lab2

**DUT: HAC Dipole 1880 MHz; Type: CD1880V3; Serial: CD1880V3 - SN: 1155**

Communication System: CW; Frequency: 1880 MHz, Frequency: 1730 MHz

Medium parameters used:  $\sigma = 0$  S/m,  $\epsilon_r = 1$ ;  $\rho = 1$  kg/m<sup>3</sup>

Phantom section: RF Section

Measurement Standard: DASY5 (IEEE/IEC/ANSI C63.19-2007)

DASY52 Configuration:

- Probe: H3DV6 - SN6065; ; Calibrated: 28.12.2012
- Sensor-Surface: (Fix Surface)
- Electronics: DAE4 Sn781; Calibrated: 29.05.2012
- Phantom: HAC Test Arch with AMCC; Type: SD HAC P01 BA; Serial: 1070
- DASY52 52.8.5(1059); SEMCAD X 14.6.8(7028)

**Dipole H-Field measurement @ 1880MHz/H-Scan - 1880MHz d=10mm/Hearing Aid Compatibility Test (41x181x1):**

Interpolated grid: dx=0.5000 mm, dy=0.5000 mm

Device Reference Point: 0, 0, -6.3 mm

Reference Value = 0.5000 A/m; Power Drift = 0.00 dB

PMR not calibrated. PMF = 1.000 is applied.

H-field emissions = 0.4711 A/m

**Near-field category: M2 (AWF 0 dB)**

PMF scaled H-field

|           |           |           |
|-----------|-----------|-----------|
| Grid 1 M2 | Grid 2 M2 | Grid 3 M2 |
| 0.407 A/m | 0.431 A/m | 0.414 A/m |
| Grid 4 M2 | Grid 5 M2 | Grid 6 M2 |
| 0.441 A/m | 0.471 A/m | 0.456 A/m |
| Grid 7 M2 | Grid 8 M2 | Grid 9 M2 |
| 0.399 A/m | 0.435 A/m | 0.422 A/m |

**Dipole H-Field measurement @ 1880MHz/H-Scan - 1730MHz d=10mm/Hearing Aid Compatibility Test (41x181x1):**

Interpolated grid: dx=0.5000 mm, dy=0.5000 mm

Device Reference Point: 0, 0, -6.3 mm

Reference Value = 0.5340 A/m; Power Drift = 0.00 dB

PMR not calibrated. PMF = 1.000 is applied.

H-field emissions = 0.5016 A/m

**Near-field category: M2 (AWF 0 dB)**

PMF scaled H-field

|                        |                        |                        |
|------------------------|------------------------|------------------------|
| Grid 1 M2<br>0.417 A/m | Grid 2 M2<br>0.442 A/m | Grid 3 M2<br>0.424 A/m |
| Grid 4 M2<br>0.466 A/m | Grid 5 M2<br>0.502 A/m | Grid 6 M2<br>0.485 A/m |
| Grid 7 M2<br>0.407 A/m | Grid 8 M2<br>0.445 A/m | Grid 9 M2<br>0.432 A/m |

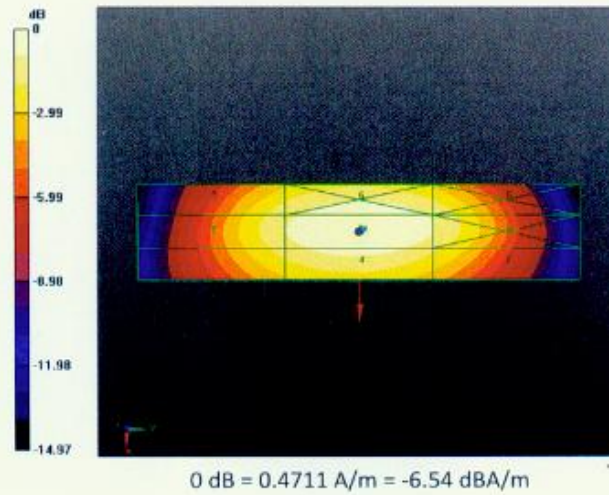

## DASY5 E-field Result

Date: 22.01.2013

Test Laboratory: SPEAG Lab2

**DUT: HAC Dipole 1880 MHz; Type: CD1880V3; Serial: CD1880V3 - SN: 1155**

Communication System: CW; Frequency: 1880 MHz, Frequency: 1730 MHz

Medium parameters used:  $\sigma = 0 \text{ S/m}$ ,  $\epsilon_r = 1$ ;  $\rho = 1000 \text{ kg/m}^3$

Phantom section: RF Section

Measurement Standard: DASY5 (IEEE/IEC/ANSI C63.19-2007)

DASY52 Configuration:

- Probe: ER3DV6 - SN2336; ConvF(1, 1, 1); Calibrated: 28.12.2012;
- Sensor-Surface: (Fix Surface)
- Electronics: DAE4 Sn781; Calibrated: 29.05.2012
- Phantom: HAC Test Arch with AMCC; Type: SD HAC P01 BA; Serial: 1070
- DASY52 52.8.5(1059); SEMCAD X 14.6.8(7028)

**Dipole E-Field measurement @ 1880MHz/E-Scan - 1880MHz d=10mm/Hearing Aid Compatibility Test (41x181x1):**

Interpolated grid: dx=0.5000 mm, dy=0.5000 mm

Device Reference Point: 0, 0, -6.3 mm

Reference Value = 158.6 V/m; Power Drift = 0.02 dB

PMR not calibrated. PMF = 1.000 is applied.

E-field emissions = 144.1 V/m

**Near-field category: M2 (AWF 0 dB)**

PMF scaled E-field

|                        |                        |                        |
|------------------------|------------------------|------------------------|
| Grid 1 M2<br>133.2 V/m | Grid 2 M2<br>138.3 V/m | Grid 3 M2<br>135.0 V/m |
| Grid 4 M3<br>87.36 V/m | Grid 5 M3<br>90.00 V/m | Grid 6 M3<br>86.70 V/m |
| Grid 7 M2<br>134.1 V/m | Grid 8 M2<br>144.1 V/m | Grid 9 M2<br>141.9 V/m |

**Dipole E-Field measurement @ 1880MHz/E-Scan - 1880MHz d=15mm/Hearing Aid Compatibility Test (41x181x1):**

Interpolated grid: dx=0.5000 mm, dy=0.5000 mm

Device Reference Point: 0, 0, -6.3 mm

Reference Value = 158.4 V/m; Power Drift = 0.03 dB

PMR not calibrated. PMF = 1.000 is applied.

E-field emissions = 90.17 V/m

**Near-field category: M3 (AWF 0 dB)**

PMF scaled E-field

|           |           |           |
|-----------|-----------|-----------|
| Grid 1 M3 | Grid 2 M3 | Grid 3 M3 |
| 88.89 V/m | 90.79 V/m | 89.91 V/m |
| Grid 4 M3 | Grid 5 M3 | Grid 6 M3 |
| 69.62 V/m | 70.44 V/m | 69.49 V/m |
| Grid 7 M3 | Grid 8 M3 | Grid 9 M3 |
| 87.24 V/m | 90.17 V/m | 89.49 V/m |

**Dipole E-Field measurement @ 1880MHz/E-Scan - 1730MHz d=10mm/Hearing Aid Compatibility Test (41x181x1):**

Interpolated grid: dx=0.5000 mm, dy=0.5000 mm

Device Reference Point: 0, 0, -6.3 mm

Reference Value = 174.7 V/m; Power Drift = 0.01 dB

PMR not calibrated. PMF = 1.000 is applied.

E-field emissions = 149.8 V/m

**Near-field category: M2 (AWF 0 dB)**

PMF scaled E-field

|           |           |           |
|-----------|-----------|-----------|
| Grid 1 M2 | Grid 2 M2 | Grid 3 M2 |
| 144.2 V/m | 149.8 V/m | 146.4 V/m |
| Grid 4 M3 | Grid 5 M3 | Grid 6 M3 |
| 99.58 V/m | 102.9 V/m | 99.22 V/m |
| Grid 7 M2 | Grid 8 M2 | Grid 9 M2 |
| 148.4 V/m | 158.9 V/m | 156.4 V/m |

**Dipole E-Field measurement @ 1880MHz/E-Scan - 1730MHz d=15mm/Hearing Aid Compatibility Test (41x181x1):**

Interpolated grid: dx=0.5000 mm, dy=0.5000 mm

Device Reference Point: 0, 0, -6.3 mm

Reference Value = 175.3 V/m; Power Drift = -0.01 dB

PMR not calibrated. PMF = 1.000 is applied.

E-field emissions = 98.12 V/m

**Near-field category: M3 (AWF 0 dB)**

PMF scaled E-field

|                               |                               |                               |
|-------------------------------|-------------------------------|-------------------------------|
| Grid 1 <b>M3</b><br>95.89 V/m | Grid 2 <b>M3</b><br>98.12 V/m | Grid 3 <b>M3</b><br>97.01 V/m |
| Grid 4 <b>M3</b><br>75.66 V/m | Grid 5 <b>M3</b><br>76.83 V/m | Grid 6 <b>M3</b><br>75.74 V/m |
| Grid 7 <b>M3</b><br>96.58 V/m | Grid 8 <b>M3</b><br>99.78 V/m | Grid 9 <b>M3</b><br>98.86 V/m |

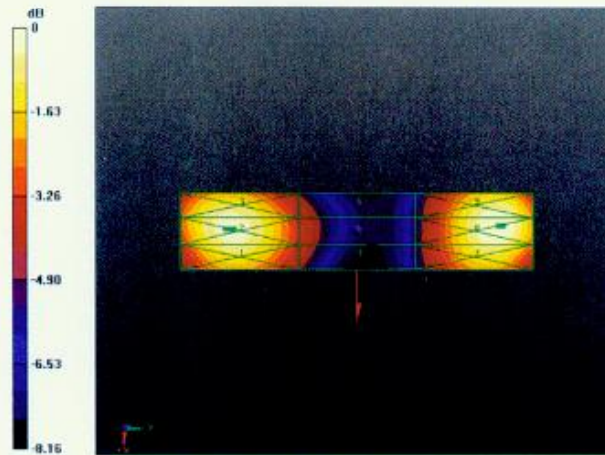

0 dB = 144.1 V/m = 43.17 dBV/m

## IMPORTANT NOTICE

### USAGE OF THE DAE 4

The DAE unit is a delicate, high precision instrument and requires careful treatment by the user. There are no serviceable parts inside the DAE. Special attention shall be given to the following points:

**Battery Exchange:** The battery cover of the DAE4 unit is closed using a screw, over tightening the screw may cause the threads inside the DAE to wear out.

**Shipping of the DAE:** Before shipping the DAE to SPEAG for calibration, remove the batteries and pack the DAE in an antistatic bag. This antistatic bag shall then be packed into a larger box or container which protects the DAE from impacts during transportation. The package shall be marked to indicate that a fragile instrument is inside.

**E-Stop Failures:** Touch detection may be malfunctioning due to broken magnets in the E-stop. Rough handling of the E-stop may lead to damage of these magnets. Touch and collision errors are often caused by dust and dirt accumulated in the E-stop. To prevent E-stop failure, the customer shall always mount the probe to the DAE carefully and keep the DAE unit in a non-dusty environment if not used for measurements.

**Repair:** Minor repairs are performed at no extra cost during the annual calibration. However, SPEAG reserves the right to charge for any repair especially if rough unprofessional handling caused the defect.

**DASY Configuration Files:** Since the exact values of the DAE input resistances, as measured during the calibration procedure of a DAE unit, are not used by the DASY software, a nominal value of 200 MOhm is given in the corresponding configuration file.

**Important Note:**

**Warranty and calibration is void if the DAE unit is disassembled partly or fully by the Customer.**

**Important Note:**

**Never attempt to grease or oil the E-stop assembly. Cleaning and readjusting of the E-stop assembly is allowed by certified SPEAG personnel only and is part of the annual calibration procedure.**

**Important Note:**

**To prevent damage of the DAE probe connector pins, use great care when installing the probe to the DAE. Carefully connect the probe with the connector notch oriented in the mating position. Avoid any rotational movement of the probe body versus the DAE while turning the locking nut of the connector. The same care shall be used when disconnecting the probe from the DAE.**



Accredited by the Swiss Accreditation Service (SAS)  
The Swiss Accreditation Service is one of the signatories to the EA  
Multilateral Agreement for the recognition of calibration certificates

Accreditation No.: **SCS 108**

Client **Sporton-SZ (Auden)**

Certificate No: **DAE4-1303\_Dec14**

**CALIBRATION CERTIFICATE**

Object **DAE4 - SD 000 D04 BM - SN: 1303**

Calibration procedure(s) **QA CAL-06.v28  
Calibration procedure for the data acquisition electronics (DAE)**

Calibration date: **December 11, 2014**

This calibration certificate documents the traceability to national standards, which realize the physical units of measurements (SI).  
The measurements and the uncertainties with confidence probability are given on the following pages and are part of the certificate.

All calibrations have been conducted in the closed laboratory facility: environment temperature (22 ± 3)°C and humidity < 70%.

Calibration Equipment used (M&TE critical for calibration)

| Primary Standards             | ID #               | Cal Date (Certificate No.) | Scheduled Calibration  |
|-------------------------------|--------------------|----------------------------|------------------------|
| Keithley Multimeter Type 2001 | SN: 0810278        | 03-Oct-14 (No:15573)       | Oct-15                 |
| Secondary Standards           | ID #               | Check Date (in house)      | Scheduled Check        |
| Auto DAE Calibration Unit     | SE UWS 053 AA 1001 | 07-Jan-14 (in house check) | In house check: Jan-15 |
| Calibrator Box V2.1           | SE UMS 006 AA 1002 | 07-Jan-14 (in house check) | In house check: Jan-15 |

|                |                   |                          |                  |
|----------------|-------------------|--------------------------|------------------|
|                | <b>Name</b>       | <b>Function</b>          | <b>Signature</b> |
| Calibrated by: | Dominique Steffen | Technician               |                  |
| Approved by:   | Fin Bornholt      | Deputy Technical Manager |                  |

Issued: December 11, 2014

This calibration certificate shall not be reproduced except in full without written approval of the laboratory.





Accredited by the Swiss Accreditation Service (SAS)  
The Swiss Accreditation Service is one of the signatories to the EA  
Multilateral Agreement for the recognition of calibration certificates

Accreditation No.: **SCS 108**

## Glossary

DAE data acquisition electronics  
Connector angle information used in DASY system to align probe sensor X to the robot coordinate system.

## Methods Applied and Interpretation of Parameters

- *DC Voltage Measurement*: Calibration Factor assessed for use in DASY system by comparison with a calibrated instrument traceable to national standards. The figure given corresponds to the full scale range of the voltmeter in the respective range.
- *Connector angle*: The angle of the connector is assessed measuring the angle mechanically by a tool inserted. Uncertainty is not required.
- The following parameters as documented in the Appendix contain technical information as a result from the performance test and require no uncertainty.
  - *DC Voltage Measurement Linearity*: Verification of the Linearity at +10% and -10% of the nominal calibration voltage. Influence of offset voltage is included in this measurement.
  - *Common mode sensitivity*: Influence of a positive or negative common mode voltage on the differential measurement.
  - *Channel separation*: Influence of a voltage on the neighbor channels not subject to an input voltage.
  - *AD Converter Values with inputs shorted*: Values on the internal AD converter corresponding to zero input voltage
  - *Input Offset Measurement*: Output voltage and statistical results over a large number of zero voltage measurements.
  - *Input Offset Current*: Typical value for information; Maximum channel input offset current, not considering the input resistance.
  - *Input resistance*: Typical value for information: DAE input resistance at the connector, during internal auto-zeroing and during measurement.
  - *Low Battery Alarm Voltage*: Typical value for information. Below this voltage, a battery alarm signal is generated.
  - *Power consumption*: Typical value for information. Supply currents in various operating modes.

## DC Voltage Measurement

A/D - Converter Resolution nominal

High Range: 1LSB = 6.1 $\mu$ V, full range = -100...+300 mV

Low Range: 1LSB = 61nV, full range = -1.....+3mV

DASY measurement parameters: Auto Zero Time: 3 sec; Measuring time: 3 sec

| Calibration Factors | X                         | Y                         | Z                         |
|---------------------|---------------------------|---------------------------|---------------------------|
| High Range          | 405.582 $\pm$ 0.02% (k=2) | 403.473 $\pm$ 0.02% (k=2) | 404.923 $\pm$ 0.02% (k=2) |
| Low Range           | 3.96551 $\pm$ 1.50% (k=2) | 3.99166 $\pm$ 1.50% (k=2) | 3.98776 $\pm$ 1.50% (k=2) |

## Connector Angle

|   |                                     |
|---|-------------------------------------|
| Connector Angle to be used in DASY system | 186.0 $^{\circ}$ $\pm$ 1 $^{\circ}$ |
|---|-------------------------------------|

## Appendix (Additional assessments outside the scope of SCS108)

### 1. DC Voltage Linearity

| High Range        | Reading ( $\mu\text{V}$ ) | Difference ( $\mu\text{V}$ ) | Error (%) |
|-------------------|---------------------------|------------------------------|-----------|
| Channel X + Input | 200032.42                 | 0.17                         | 0.00      |
| Channel X + Input | 20006.44                  | 2.48                         | 0.01      |
| Channel X - Input | -20003.75                 | 1.42                         | -0.01     |
| Channel Y + Input | 200033.90                 | 1.88                         | 0.00      |
| Channel Y + Input | 20003.42                  | -0.41                        | -0.00     |
| Channel Y - Input | -20004.48                 | 0.84                         | -0.00     |
| Channel Z + Input | 200035.95                 | 4.02                         | 0.00      |
| Channel Z + Input | 20001.57                  | -2.14                        | -0.01     |
| Channel Z - Input | -20006.48                 | -1.03                        | 0.01      |

| Low Range         | Reading ( $\mu\text{V}$ ) | Difference ( $\mu\text{V}$ ) | Error (%) |
|-------------------|---------------------------|------------------------------|-----------|
| Channel X + Input | 2000.63                   | 0.09                         | 0.00      |
| Channel X + Input | 201.55                    | 0.94                         | 0.47      |
| Channel X - Input | -199.12                   | 0.32                         | -0.16     |
| Channel Y + Input | 2000.86                   | 0.46                         | 0.02      |
| Channel Y + Input | 200.23                    | -0.19                        | -0.10     |
| Channel Y - Input | -199.83                   | -0.23                        | 0.11      |
| Channel Z + Input | 1999.80                   | -0.49                        | -0.02     |
| Channel Z + Input | 199.09                    | -1.38                        | -0.69     |
| Channel Z - Input | -200.32                   | -0.71                        | 0.35      |

### 2. Common mode sensitivity

DASY measurement parameters: Auto Zero Time: 3 sec; Measuring time: 3 sec

|           | Common mode Input Voltage (mV) | High Range Average Reading ( $\mu\text{V}$ ) | Low Range Average Reading ( $\mu\text{V}$ ) |
|-----------|--------------------------------|--|---|
| Channel X | 200                            | 8.67   | 7.40  |
|           | - 200                          | -5.53  | -7.23                                       |
| Channel Y | 200                            | 6.03   | 5.93  |
|           | - 200                          | -7.02  | -6.90                                       |
| Channel Z | 200                            | -4.66  | -4.55                                       |
|           | - 200                          | 1.56   | 1.76  |

### 3. Channel separation

DASY measurement parameters: Auto Zero Time: 3 sec; Measuring time: 3 sec

|           | Input Voltage (mV) | Channel X ( $\mu\text{V}$ ) | Channel Y ( $\mu\text{V}$ ) | Channel Z ( $\mu\text{V}$ ) |
|-----------|--------------------|-----------------------------|-----------------------------|-----------------------------|
| Channel X | 200                | -                           | 1.77                        | -4.82                       |
| Channel Y | 200                | 8.18                        | -                           | 1.73                        |
| Channel Z | 200                | 9.79                        | 5.56                        | -                           |

#### 4. AD-Converter Values with inputs shorted

DASY measurement parameters: Auto Zero Time: 3 sec; Measuring time: 3 sec

|           | High Range (LSB) | Low Range (LSB) |
|-----------|------------------|-----------------|
| Channel X | 15917            | 16559           |
| Channel Y | 15625            | 16454           |
| Channel Z | 16119            | 13095           |

#### 5. Input Offset Measurement

DASY measurement parameters: Auto Zero Time: 3 sec; Measuring time: 3 sec

Input 10M $\Omega$

|           | Average ( $\mu$ V) | min. Offset ( $\mu$ V) | max. Offset ( $\mu$ V) | Std. Deviation ( $\mu$ V) |
|-----------|--------------------|------------------------|------------------------|---------------------------|
| Channel X | -0.80              | -1.98                  | 0.43                   | 0.53                      |
| Channel Y | -0.05              | -2.62                  | 1.86                   | 0.61                      |
| Channel Z | -0.54              | -2.21                  | 1.34                   | 0.55                      |

#### 6. Input Offset Current

Nominal Input circuitry offset current on all channels: <25fA

#### 7. Input Resistance (Typical values for information)

|           | Zeroing (kOhm) | Measuring (MOhm) |
|-----------|----------------|------------------|
| Channel X | 200            | 200              |
| Channel Y | 200            | 200              |
| Channel Z | 200            | 200              |

#### 8. Low Battery Alarm Voltage (Typical values for information)

| Typical values | Alarm Level (VDC) |
|----------------|-------------------|
| Supply (+ Vcc) | +7.9              |
| Supply (- Vcc) | -7.6              |

#### 9. Power Consumption (Typical values for information)

| Typical values | Switched off (mA) | Stand by (mA) | Transmitting (mA) |
|----------------|-------------------|---------------|-------------------|
| Supply (+ Vcc) | +0.01             | +6            | +14               |
| Supply (- Vcc) | -0.01             | -8            | -9                |

**Calibration Laboratory of  
Schmid & Partner  
Engineering AG**  
Zeughausstrasse 43, 8004 Zurich, Switzerland



**S  
C  
S** Schweizerischer Kalibrierdienst  
Service suisse d'étalonnage  
Servizio svizzero di tarature  
Swiss Calibration Service

Accredited by the Swiss Accreditation Service (SAS)  
The Swiss Accreditation Service is one of the signatories to the EA  
Multilateral Agreement for the recognition of calibration certificates

Accreditation No.: **SCS 108**

Client: **Sporten-CN (Auden)**

Certificate No: **ER3-2528\_Mar14**

**CALIBRATION CERTIFICATE**

Object: **ER3DV6 - SN:2528**

Calibration procedure(s): **QA CAL-02.v8, QA CAL-25.v8**  
Calibration procedure for E-field probes optimized for close near field evaluations in air

Calibration date: **March 24, 2014**

This calibration certificate documents the traceability to national standards, which realize the physical units of measurements (SI).  
The measurements and the uncertainties with confidence probability are given on the following pages and are part of the certificate

All calibrations have been conducted in the closed laboratory facility: environment temperature (22 ± 3)°C and humidity < 70%.

Calibration Equipment used (M&TE critical for calibration)

| Primary Standards          | ID              | Cal Date (Certificate No.)        | Scheduled Calibration  |
|----------------------------|-----------------|-----------------------------------|------------------------|
| Power meter F4419B         | GB4129J874      | 04-Apr-13 (No. 217-01733)         | Apr-14                 |
| Power sensor E4412A        | MY41496087      | 04-Apr-13 (No. 217-01733)         | Apr-14                 |
| Reference 3 dB Attenuator  | SN: S5054 (3c)  | 04-Apr-13 (No. 217-01737)         | Apr-14                 |
| Reference 20 dB Attenuator | SN: S6277 (20x) | 04-Apr-13 (No. 217-01735)         | Apr-14                 |
| Reference 30 dB Attenuator | SN: S5129 (30a) | 04-Apr-13 (No. 217-01738)         | Apr-14                 |
| Reference Probe ER3DV6     | SN: 2328        | 10-Oct-13 (No. ER3-2528_Oct13)    | Oct-14                 |
| DAE4                       | SN: 789         | 15-May-13 (No. DAE4-789_May13)    | May 14                 |
| Secondary Standards        | ID              | Check Date (in house)             | Scheduled Check        |
| RF generator HP 8648C      | L53642U01700    | 4-Aug-99 (in house check Apr 13)  | In house check: Apr-13 |
| Network Analyzer HP 8753F  | L53739058b      | 18-Oct-01 (in house check Oct-13) | In house check: Oct-14 |

|                |                                |  |               |
|----------------|--------------------------------|--|---------------|
| Calibrated by: | Name<br><b>Claudio Leubler</b> | Function<br><b>Laboratory Technician</b> | Signature<br> |
| Approved by:   | Name<br><b>Katja Pokucic</b>   | Function<br><b>Technical Manager</b>     | Signature<br> |

Issued: **March 26, 2014**

This calibration certificate shall not be reproduced except in full without written approval of the laboratory.



Accredited by the Swiss Accreditation Service (SAS)

Accreditation No.: **SCS 108**

The Swiss Accreditation Service is one of the signatories to the EA  
Multilateral Agreement for the recognition of calibration certificates

### Glossary:

|   |   |
|---|---|
| <b>NORM<sub>x,y,z</sub></b>             | sensitivity in free space   |
| <b>DCP</b>                              | diode compression point   |
| <b>CF</b>                               | crest factor (1/duty_cycle) of the RF signal  |
| <b>A, B, C, D</b>                       | modulation dependent linearization parameters   |
| <b>Polarization <math>\phi</math></b>   | $\phi$ rotation around probe axis   |
| <b>Polarization <math>\theta</math></b> | $\theta$ rotation around an axis that is in the plane normal to probe axis (at measurement center),<br>i.e., $\theta = 0$ is normal to probe axis |
| <b>Connector Angle</b>                  | information used in DASY system to align probe sensor X to the robot coordinate system  |

### Calibration is Performed According to the Following Standards:

- IEEE Std 1309-2005, "IEEE Standard for calibration of electromagnetic field sensors and probes, excluding antennas, from 9 kHz to 40 GHz", December 2005
- CTIA Test Plan for Hearing Aid Compatibility, April 2010.

### Methods Applied and Interpretation of Parameters:

- NORM<sub>x,y,z</sub>**: Assessed for E-field polarization  $\theta = 0$  for XY sensors and  $\theta = 90$  for Z sensor ( $f \leq 900$  MHz in TEM-cell;  $f > 1800$  MHz: R22 waveguide).
- NORM(f)<sub>x,y,z</sub>** = **NORM<sub>x,y,z</sub>** \* *frequency\_response* (see Frequency Response Chart).
- DCP<sub>x,y,z</sub>**: DCP are numerical linearization parameters assessed based on the data of power sweep with CW signal (no uncertainty required). DCP does not depend on frequency nor media.
- PAR**: PAR is the Peak to Average Ratio that is not calibrated but determined based on the signal characteristics
- A<sub>x,y,z</sub>; B<sub>x,y,z</sub>; C<sub>x,y,z</sub>; D<sub>x,y,z</sub>; VR<sub>x,y,z</sub>; A, B, C, D** are numerical linearization parameters assessed based on the data of power sweep for specific modulation signal. The parameters do not depend on frequency nor media. VR is the maximum calibration range expressed in RMS voltage across the diode.
- Spherical isotropy (3D deviation from isotropy)**: in a locally homogeneous field realized using an open waveguide setup.
- Sensor Offset**: The sensor offset corresponds to the offset of virtual measurement center from the probe tip (on probe axis). No tolerance required.
- Connector Angle**: The angle is assessed using the information gained by determining the **NORM<sub>x</sub>** (no uncertainty required).

# Probe ER3DV6

## SN:2528

Manufactured: April 26, 2010  
Calibrated: March 24, 2014

Calibrated for DASY/EASY Systems  
(Note: non-compatible with DASY2 system!)

## DASY/EASY - Parameters of Probe: ER3DV6 - SN:2528

### Basic Calibration Parameters

|                                       | Sensor X | Sensor Y | Sensor Z | Unc (k=2)    |
|---------------------------------------|----------|----------|----------|--------------|
| Norm ( $\mu\text{V}/(\text{V/m})^2$ ) | 1.95     | 1.61     | 1.58     | $\pm 10.1\%$ |
| DCP (mV) <sup>D</sup>                 | 98.5     | 100.1    | 98.9     |              |

### Modulation Calibration Parameters

| UID           | Communication System Name             |   | A<br>dB | B<br>dB $\sqrt{\mu\text{V}}$ | C    | D<br>dB | VR<br>mV | Unc <sup>E</sup><br>(k=2) |
|---------------|---------------------------------------|---|---------|------------------------------|------|---------|----------|---------------------------|
| 0             | CW                                    | X | 0.0     | 0.0                          | 1.0  | 0.00    | 163.4    | $\pm 3.5\%$               |
|               |                                       | Y | 0.0     | 0.0                          | 1.0  |         | 217.8    |                           |
|               |                                       | Z | 0.0     | 0.0                          | 1.0  |         | 201.0    |                           |
| 10011-<br>CAB | UMTS-FDD (WCDMA)                      | X | 3.27    | 65.5                         | 18.4 | 2.91    | 132.5    | $\pm 0.9\%$               |
|               |                                       | Y | 3.32    | 67.0                         | 18.8 |         | 130.7    |                           |
|               |                                       | Z | 3.21    | 66.0                         | 18.0 |         | 122.4    |                           |
| 10021-<br>DAB | GSM-FDD (TDMA, GMSK)                  | X | 24.54   | 99.8                         | 29.1 | 9.39    | 112.5    | $\pm 2.2\%$               |
|               |                                       | Y | 24.27   | 99.3                         | 29.1 |         | 114.2    |                           |
|               |                                       | Z | 29.16   | 99.9                         | 29.7 |         | 130.0    |                           |
| 10039-<br>CAB | CDMA2000 (1xRTT, RC1)                 | X | 5.08    | 67.2                         | 19.4 | 4.57    | 137.1    | $\pm 1.4\%$               |
|               |                                       | Y | 5.07    | 67.3                         | 19.5 |         | 131.4    |                           |
|               |                                       | Z | 4.90    | 66.3                         | 18.7 |         | 122.5    |                           |
| 10081-<br>CAB | CDMA2000 (1xRTT, RC3)                 | X | 4.00    | 66.3                         | 18.8 | 3.67    | 131.4    | $\pm 0.9\%$               |
|               |                                       | Y | 4.07    | 66.4                         | 18.9 |         | 125.5    |                           |
|               |                                       | Z | 3.93    | 65.3                         | 18.1 |         | 118.2    |                           |
| 10095-<br>AAB | CDMA2000, RC1, SC3, 1/8th Rate 25 fr. | X | 18.84   | 99.2                         | 39.7 | 12.49   | 99.9     | $\pm 3.5\%$               |
|               |                                       | Y | 19.81   | 99.6                         | 39.5 |         | 148.7    |                           |
|               |                                       | Z | 22.15   | 99.6                         | 38.7 |         | 104.6    |                           |

The reported uncertainty of measurement is stated as the standard uncertainty of measurement multiplied by the coverage factor  $k=2$ , which for a normal distribution corresponds to a coverage probability of approximately 95%.

<sup>D</sup> Numerical linearization parameter. Uncertainty not required.

<sup>E</sup> Uncertainty is determined using the max. deviation from linear response applying rectangular distribution and is expressed for the square of the field value.



### Frequency Response of E-Field (TEM-Cell:ifi110 EXX, Waveguide: R22)

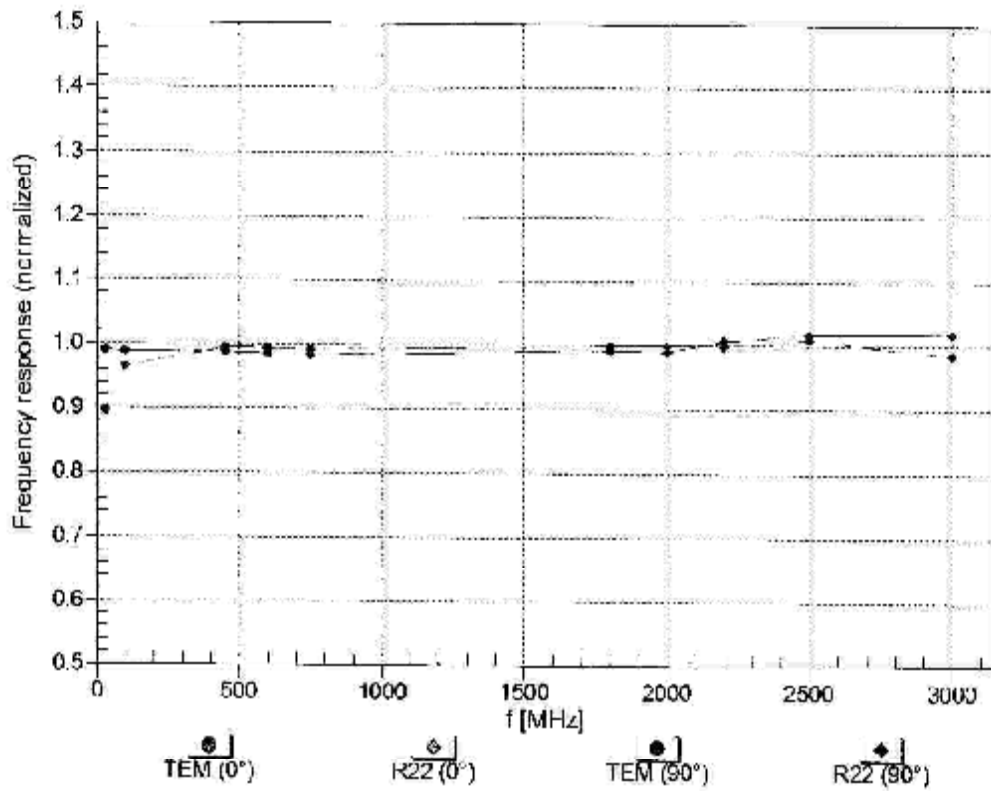

Uncertainty of Frequency Response of E-field:  $\pm 6.3\%$  (k=2)

### Receiving Pattern ( $\phi$ ), $\vartheta = 0^\circ$

f=600 MHz, TEM,  $0^\circ$

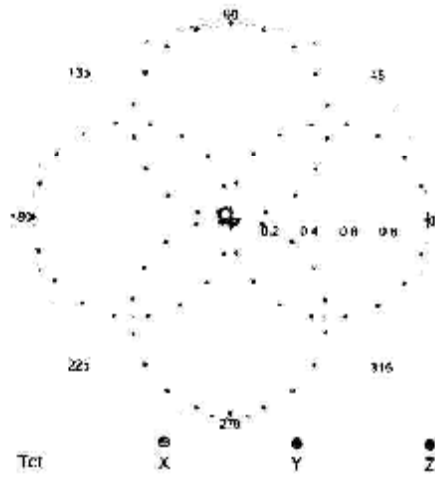

f=2500 MHz, R22,  $0^\circ$

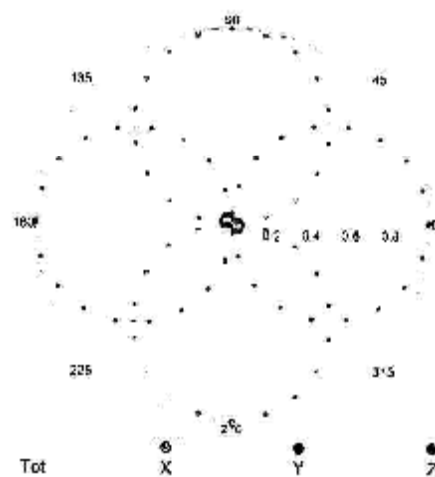

### Receiving Pattern ( $\phi$ ), $\vartheta = 90^\circ$

f=600 MHz, TEM,  $90^\circ$

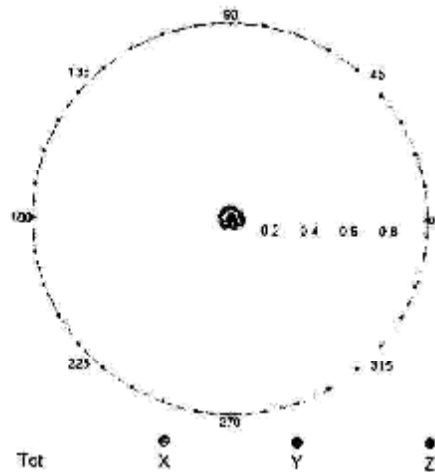

f=2500 MHz, R22,  $90^\circ$

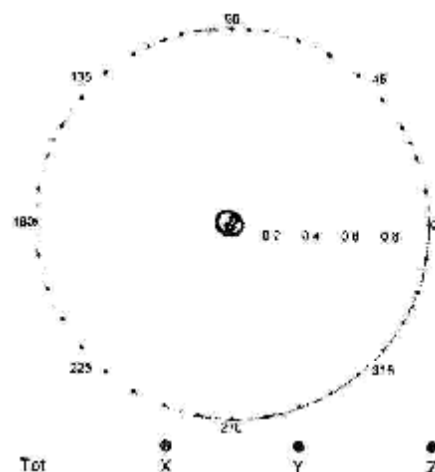

## Receiving Pattern ( $\phi$ ), $\vartheta = 0^\circ$

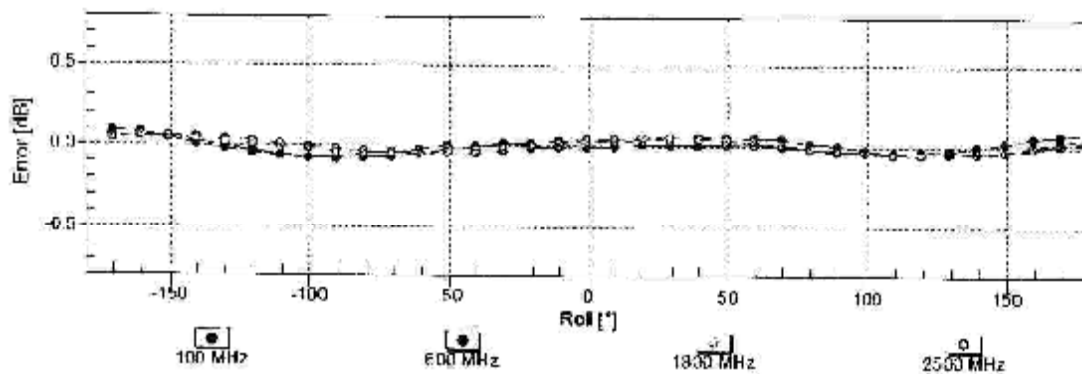

Uncertainty of Axial Isotropy Assessment:  $\pm 0.5\%$  ( $k=2$ )

## Receiving Pattern ( $\phi$ ), $\vartheta = 90^\circ$

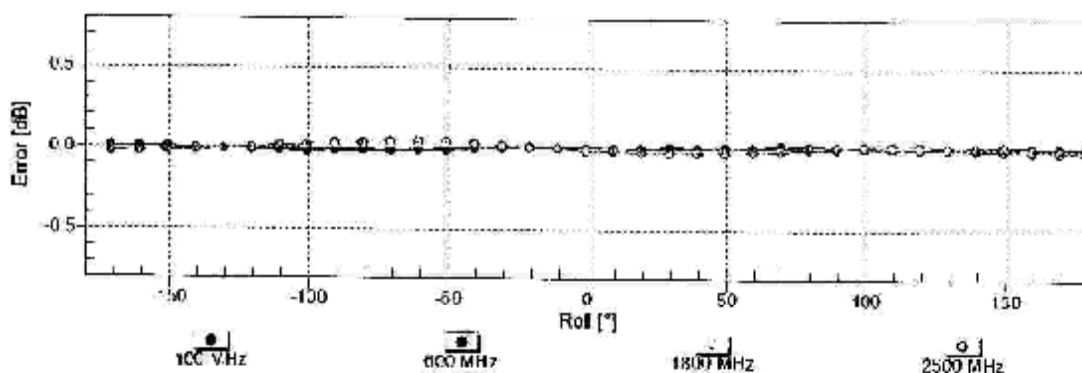

Uncertainty of Axial Isotropy Assessment:  $\pm 0.5\%$  ( $k=2$ )

### Dynamic Range f(E-field) (TEM cell , f = 900 MHz)

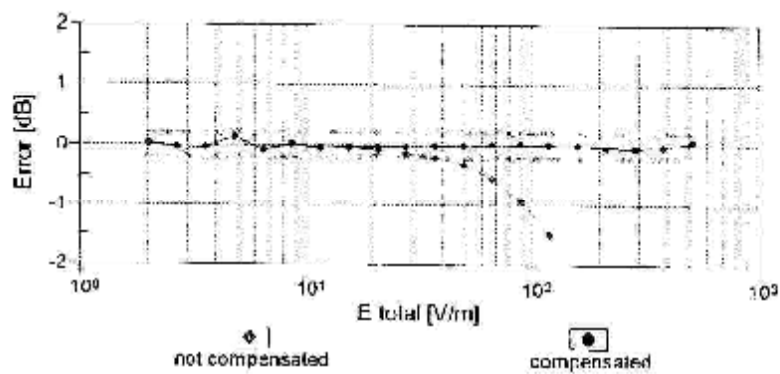
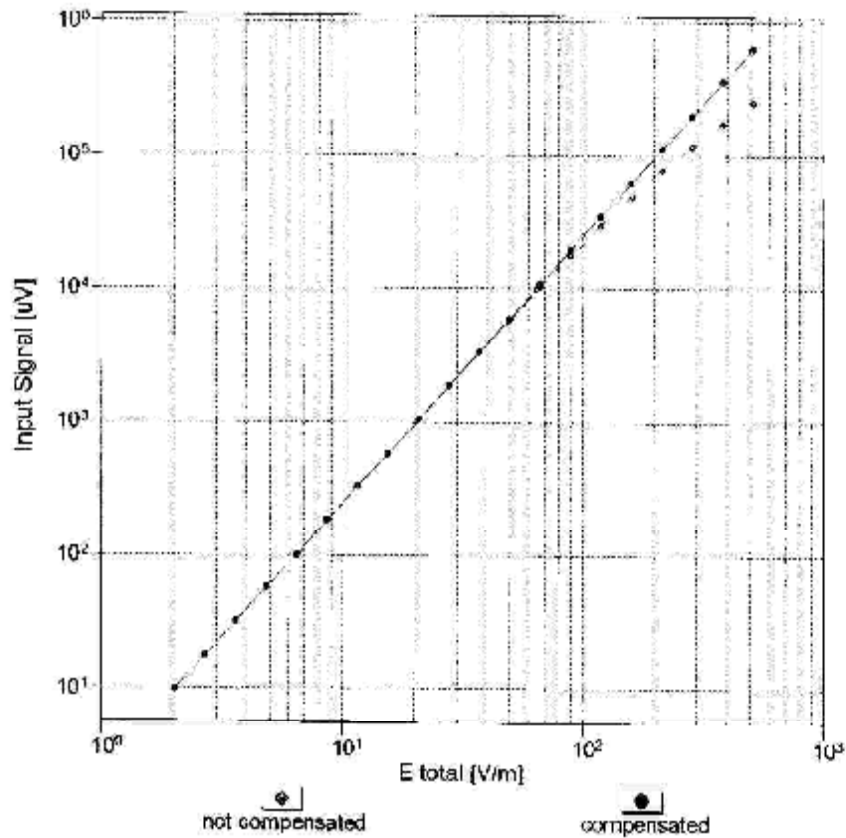

Uncertainty of Linearity Assessment:  $\pm 0.6\%$  (k=2)

### Deviation from Isotropy in Air Error ( $\sigma$ , $\theta$ ), $f = 900$ MHz

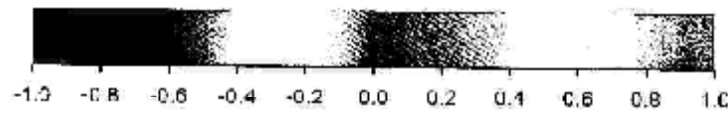
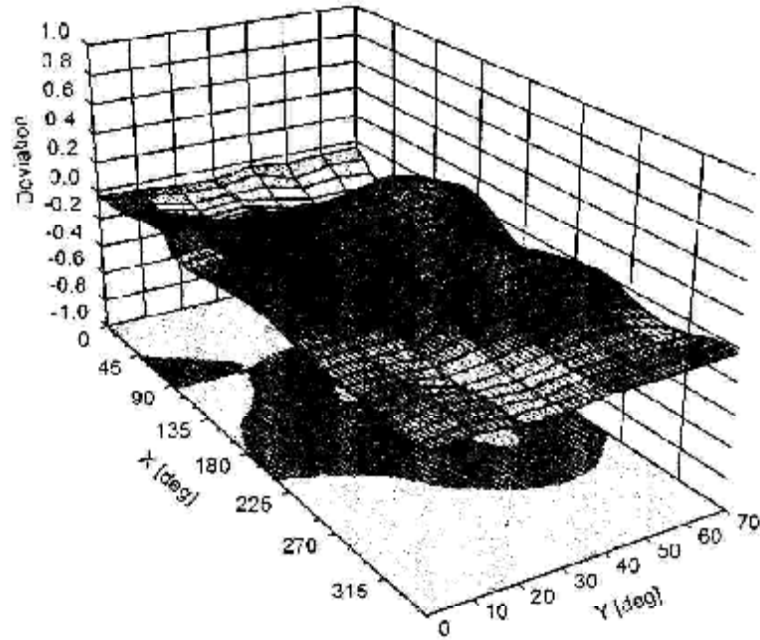

Uncertainty of Spherical Isotropy Assessment:  $\pm 2.6\%$  ( $k=2$ )

**DASY/EASY - Parameters of Probe: ER3DV6 - SN:2528****Other Probe Parameters**

|   |             |
|---|-------------|
| Sensor Arrangement                      | Rectangular |
| Connector Angle (°)                     | -20.7       |
| Mechanical Surface Detection Mode       | enabled     |
| Optical Surface Detection Mode          | disabled    |
| Probe Overall Length                    | 337 mm      |
| Probe Body Diameter                     | 10 mm       |
| Tip Length                              | 10 mm       |
| Tip Diameter                            | 8 mm        |
| Probe Tip to Sensor X Calibration Point | 2.5 mm      |
| Probe Tip to Sensor Y Calibration Point | 2.5 mm      |
| Probe Tip to Sensor Z Calibration Point | 2.5 mm      |