

FCC SAR Test Report

APPLICANT : TCT Mobile Limited
EQUIPMENT : GSM Quad-band / UMTS Quad-band / LTE six bands mobile phone
BRAND NAME : Alcatel
MODEL NAME : 6039S
FCC ID : RAD547
STANDARD : FCC 47 CFR Part 2 (2.1093)
ANSI/IEEE C95.1-1992
IEEE 1528-2003

We, SPORTON INTERNATIONAL (KUNSHAN) INC., would like to declare that the tested sample has been evaluated in accordance with the procedures and had been in compliance with the applicable technical standards.

The test results in this report apply exclusively to the tested model / sample. Without written approval of SPORTON INTERNATIONAL (KUNSHAN) INC., the test report shall not be reproduced except in full.

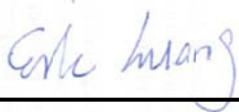

Reviewed by: Eric Huang / Deputy Manager



Approved by: Jones Tsai / Manager



SPORTON INTERNATIONAL (KUNSHAN) INC.
No. 3-2, PingXiang Road, Kunshan, Jiangsu Province, P. R. China



Table of Contents

1. Statement of Compliance4
2. Administration Data5
3. Guidance Standard5
4. Equipment Under Test (EUT)6
4.1 General Information6
4.2 Accessories and Support Equipment7
4.3 Accessories and Support Equipment for Variant Product (6039S)8
4.4 Maximum Tune-up Limit9
4.5 General LTE SAR Test and Reporting Considerations12
5. RF Exposure Limits14
5.1 Uncontrolled Environment14
5.2 Controlled Environment14
6. Specific Absorption Rate (SAR)15
6.1 Introduction15
6.2 SAR Definition15
7. System Description and Setup16
8. Measurement Procedures17
8.1 Spatial Peak SAR Evaluation17
8.2 Power Reference Measurement18
8.3 Area Scan18
8.4 Zoom Scan19
8.5 Volume Scan Procedures19
8.6 Power Drift Monitoring19
9. Test Equipment List20
10. System Verification21
10.1 Tissue Verification21
10.2 System Performance Check Results23
11. RF Exposure Positions25
11.1 Ear and handset reference point25
11.2 Definition of the cheek position26
11.3 Definition of the tilt position27
11.4 Body Worn Accessory28
11.5 Wireless Router28
12. Conducted RF Output Power (Unit: dBm)29
13. Conducted RF Output Power for Variant Product (6039S) (Unit: dBm)52
14. Bluetooth Exclusions Applied84
15. Antenna Location85
16. Antenna Location for Variant Product (6039S)87
17. SAR Test Results89
17.1 Head SAR90
17.2 Hotspot SAR95
17.3 Body Worn Accessory SAR98
17.4 Repeated SAR Measurement100
18. SAR Test Results for Variant Product (6039S)101
18.1 Head SAR102
18.2 Hotspot SAR107
18.3 Body Worn Accessory SAR110
18.4 Repeated SAR Measurement112
19. Simultaneous Transmission Analysis113
19.1 Head Exposure Conditions114
19.2 Hotspot Exposure Conditions118
19.3 Body-Worn Accessory Exposure Conditions122
19.4 SPLSR Evaluation and Analysis124
20. Uncertainty Assessment130
21. References132
Appendix A. Plots of System Performance Check
Appendix B. Plots of High SAR Measurement
Appendix C. DASY Calibration Certificate
Appendix D. Test Setup Photos
Appendix E. Product Equality Declaration



Revision History

REPORT NO.	VERSION	DESCRIPTION	ISSUED DATE
FA511303-06	Rev. 01	This is a variant product of 6039A. According to the product equality declaration as Appendix E provide by client. Based on the original test report, for GSM850/1900, WCDMA Band II/IV, LTE band 2/4/7, only the conducted power and the worst cases of SAR test items were verified for the differences, WLAN only verified he worst cases SAR test items, and the full test for the new bands WCDMA Band IV and LTE band 5/12/17, all other test cases were performed on original report which can be referred to Sporton report number FA511303 (Model name: 6039A; FCC ID: RAD544).	Jun. 15, 2015



1. Statement of Compliance

The maximum results of Specific Absorption Rate (SAR) found during testing for **TCT Mobile Limited, GSM Quad-band / UMTS Quad-band / LTE six bands mobile phone, 6039S**, are as follows.

Equipment Class	Frequency Band	Highest SAR Summary			
		Head 1g SAR (W/kg)	Wireless Router (Separation 1cm) 1g SAR (W/kg)	Body-worn (Separation 1.5cm) 1g SAR (W/kg)	Highest Simultaneous Transmission 1g SAR (W/kg)
PCE	GSM850	1.21	1.25	0.80	1.48
	GSM1900	1.06	1.24	0.51	
	WCDMA Band V	1.41	0.85	0.65	
	WCDMA Band IV	1.10	0.92	0.67	
	WCDMA Band II	1.23	1.36	0.58	
	LTE Band 12	0.85	0.38	0.26	
	LTE Band 17	0.86	0.39	0.27	
	LTE Band 5	1.17	0.68	0.57	
	LTE Band 4	1.44	1.08	0.54	
	LTE Band 2	1.41	1.23	0.54	
	LTE Band 7	1.41	1.32	1.39	
DTS	WLAN 2.4GHz Band	0.31	1.28	0.47	1.46
Date of Testing:		Feb. 16, 2015 ~ Jun. 12, 2015			

Note:

1. The SAR value list above are all rounded to two decimal digits.
2. a. According to section 19.4, the maximum simultaneous SAR for WWAN+DTS is 2.19W/kg.
 b. Per KDB 447498 D01, when the sum of SAR is larger than the limit, SAR test exclusion is determined by the SAR to peak location separation ratio. The ratio is determined by $(SAR1 + SAR2)^{1.5}/R_i$, rounded to two decimal digits, and must be ≤ 0.04 for all antenna pairs in the configuration to qualify for 1-g SAR test exclusion. For all configurations SPLSR is ≤ 0.04 and qualify for 1-g SAR test exclusion.

This device is in compliance with Specific Absorption Rate (SAR) for general population/uncontrolled exposure limits (1.6 W/kg) specified in FCC 47 CFR part 2 (2.1093) and ANSI/IEEE C95.1-1992, and had been tested in accordance with the measurement methods and procedures specified in IEEE 1528-2003.



2. Administration Data

Testing Laboratory	
Test Site	SPORTON INTERNATIONAL (KUNSHAN) INC.
Test Site Location	No. 3-2, PingXiang Road, Kunshan, Jiangsu Province, P. R. China TEL: +86-0512-5790-0158 FAX: +86-0512-5790-0958

Applicant	
Company Name	TCT Mobile Limited
Address	5F, C building, No. 232, Liang Jing Road ZhangJiang High-Tech Park, Pudong Area Shanghai, P. R. China. 201203

Manufacturer	
Company Name	TCT Mobile Limited
Address	5F, C building, No. 232, Liang Jing Road ZhangJiang High-Tech Park, Pudong Area Shanghai, P. R. China. 201203

3. Guidance Standard

The Specific Absorption Rate (SAR) testing specification, method, and procedure for this device is in accordance with the following standards:

- FCC 47 CFR Part 2 (2.1093)
- ANSI/IEEE C95.1-1992
- IEEE 1528-2003
- FCC KDB 865664 D01 SAR Measurement 100 MHz to 6 GHz v01r03
- FCC KDB 865664 D02 SAR Reporting v01r01
- FCC KDB 447498 D01 General RF Exposure Guidance v05r02
- FCC KDB 648474 D04 SAR Evaluation Considerations for Wireless Handsets v01r02
- FCC KDB 248227 D01 802.11 Wi-Fi SAR v02r01
- FCC KDB 941225 D01 3G SAR Procedures v03
- FCC KDB 941225 D05 SAR for LTE Devices v02r03
- FCC KDB 941225 D06 Hotspot Mode SAR v02



4. Equipment Under Test (EUT)

4.1 General Information

Product Feature & Specification	
Equipment Name	GSM Quad-band / UMTS Quad-band / LTE six bands mobile phone
Brand Name	Alcatel
Model Name	6039S
FCC ID	RAD547
IMEI Code	Sample for 6039A SAR testing: 014368000051070 Sample for variant product 6039S WWAN SAR testing: 014369000013006 Sample for variant product 6039S WLAN SAR testing: 014369000017007
Wireless Technology and Frequency Range	GSM850: 824.2 MHz ~ 848.8 MHz GSM1900: 1850.2 MHz ~ 1909.8 MHz WCDMA Band V: 826.4 MHz ~ 846.6 MHz WCDMA Band IV: 1712.4 MHz ~ 1752.6 MHz WCDMA Band II: 1852.4 MHz ~ 1907.6 MHz LTE Band 12: 699.7 MHz ~ 715.3 MHz LTE Band 17: 706.5 MHz ~ 713.5 MHz LTE Band 5: 824.7 MHz ~ 848.3 MHz LTE Band 4: 1710.7 MHz ~ 1754.3 MHz LTE Band 2: 1850.7 MHz ~ 1909.3 MHz LTE Band 7: 2502.5 MHz ~ 2567.5 MHz WLAN 2.4GHz Band: 2412 MHz ~ 2462 MHz Bluetooth: 2402 MHz ~ 2480 MHz NFC: 13.56 MHz
Mode	<ul style="list-style-type: none"> • GSM/GPRS/EGPRS • RMC/AMR 12.2Kbps • HSDPA • HSUPA • DC-HSDPA • HSPA+ (uplink 16QAM is not supported) • LTE • WLAN 2.4GHz 802.11b/g/n HT20 • Bluetooth v3.0+EDR, Bluetooth v4.1 LE • NFC
HW Version	SBA34D60000K
SW Version	SVN 01
GSM / (E)GPRS Dual Transfer mode	Class A – EUT can support Packet Switched and Circuit Switched Network simultaneously.
EUT Stage	Identical Prototype
Remark:	
<ol style="list-style-type: none"> 1. This device supports VoIP in GPRS, EGPRS, WCDMA and LTE (e.g. 3rd party VoIP), LTE supports VoLTE operation and 802.11n-HT40 is not supported in 2.4GHz WLAN. 2. This device supports GRPS/EGPRS mode up to multi-slot class12 and supports DTM up to multi-slot class11. 3. This device has two sets of receivers and microphone, 1 receiver is located at the top and another one is located at the bottom of the phone. For the next-to-ear voice call the product allows the end user to use the device in the typical calling positions and in the reversed calling position. When the User Interface is in reversed portrait orientation, power reduction is implemented for the scenario that the bottom receiver is placed next-to-ear during the voice call for GSM850/1900, WCDMA Band II/IV, LTE band 2/4/7/12/17, and SAR compliance was accessed for both orientations. The details of the power reduction mechanism for the reverse call are illustrated in the operational description. 4. There are two types of EUT sample 1 and sample 2, the differences between two samples is only for memory, sample 1 is 1GB capacity and sample 2 is 1.5GB capacity. We only chose the sample 1 to perform all tests for 6039A. 5. When hotspot mode is enabled, power reduction will be activated and limited to WCDMA Band IV and LTE Band 7. 	

4.2 Accessories and Support Equipment

Specification of Accessory				
AC Adapter 1	Brand Name	ACE-Tenpao	Model Name	UC11US
	Power Rating	I/P: 100-240Vac, 200mA, O/P: 5Vdc, 1000mA		
	P/N	CBA0058AG0C2		
AC Adapter 2	Brand Name	ACE-Yingju	Model Name	UC11US
	Power Rating	I/P: 100-240Vac, 200mA, O/P: 5Vdc, 1000mA		
	P/N	CBA0058AG0C3		
Battery 1	Brand Name	ALCATEL onetouch	Model Name	TLp020K2
	Power Rating	3.8Vdc, 2000mAh		
	P/N	CAC2000023C2		
Battery 2	Brand Name	ALCATEL onetouch	Model Name	TLp020KJ
	Power Rating	3.8Vdc, 2000mAh		
	P/N	CAC2000025CJ		
USB Cable 1	Brand Name	ACE-Shenhua	Model Name	CDA0000025C1
	Signal Line Type	1.10m shielded without core		
USB Cable 2	Brand Name	ACE-Juwei	Model Name	CDA0000025C2
	Signal Line Type	1.10m shielded without core		
USB Cable 3	Brand Name	ACE-Juwei	Model Name	CDA0000025C8
	Signal Line Type	1.10m shielded without core		
Earphone 1	Brand Name	ACE-Lianyun	Model Name	CCB0023A10C2
	Signal Line Type	1.16m non-shielded without core		
Earphone 2	Brand Name	ACE-JBL	Model Name	J22C
	Signal Line Type	1.38m non-shielded without core		
Earphone 3	Brand Name	ACE-Lianyun	Model Name	CCB0023A11C2
	Signal Line Type	1.26m non-shielded without core		
Earphone 4	Brand Name	ACE-JBL	Model Name	CCA0001A10C9
	Signal Line Type	1.28m non-shielded without core		

4.3 Accessories and Support Equipment for Variant Product (6039S)

Specification of Accessory				
AC Adapter	Brand Name	ACE-Tenpao	Model Name	UC11US
	Power Rating	I/P: 100-240Vac, 200mA, O/P: 5Vdc, 1000mA		
	P/N	CBA0058AG0C2		
Battery	Brand Name	ALCATEL onetouch	Model Name	TLp020K2
	Power Rating	3.8Vdc, 2000mAh		
	P/N	CAC2000023C2		
USB Cable 1	Brand Name	ACE-Shenhua	Model Name	CDA0000025C1
	Signal Line Type	1.10m shielded without core		
USB Cable 2	Brand Name	ACE-Juwei	Model Name	CDA0000025C2
	Signal Line Type	1.10m shielded without core		
USB Cable 3	Brand Name	ACE-Juwei	Model Name	CDA0000025C8
	Signal Line Type	1.10m shielded without core		
Earphone	Brand Name	ACE-JBL	Model Name	J22C
	Signal Line Type	1.38m non-shielded without core		

4.4 Maximum Tune-up Limit

Mode		Burst Average Power(dBm)			
		GSM850		GSM1900	
		Full power mode	Reduced power mode (for reverse call)	Full power mode	Reduced power mode (for reverse call)
GSM (GMSK, 1 Tx slot)		34.0	30.0	30.0	25.0
GPRS (GMSK, 1 Tx slot)		34.0	30.0	30.0	25.0
GPRS (GMSK, 2 Tx slots)		31.5	29.5	29.5	21.5
GPRS (GMSK, 3 Tx slots)		29.5	27.5	27.0	20.0
GPRS (GMSK, 4 Tx slots)		28.5	26.5	25.5	19.0
EDGE (8PSK, 1 Tx slot)		26.0	26.0	26.0	24.5
EDGE (8PSK, 2 Tx slots)		26.0	26.0	25.0	21.5
EDGE (8PSK, 3 Tx slots)		24.0	24.5	23.5	20.0
EDGE (8PSK, 4 Tx slots)		22.5	23.0	22.0	18.5
DTM 5	GSM (GMSK, 1 Tx slot)	31.5	29.5	29.5	21.5
	GPRS (GMSK, 1 Tx slot)	31.5	29.5	29.5	21.5
DTM 9	GSM (GMSK, 1 Tx slot)	31.5	29.5	29.5	21.5
	GPRS (GMSK, 1 Tx slot)	31.5	29.5	29.5	21.5
DTM11	GSM (GMSK, 1 Tx slot)	29.5	27.5	27.0	20.0
	GPRS (GMSK, 2 Tx slots)	29.5	27.5	27.0	20.0
DTM 5	GSM (GMSK, 1 Tx slot)	31.5	29.5	29.5	21.5
	EDGE (8PSK, 1 Tx slot)	26.0	26.0	25.0	21.5
DTM 9	GSM (GMSK, 1 Tx slot)	31.5	29.5	29.5	21.5
	EDGE (8PSK, 1 Tx slot)	26.0	26.0	25.0	21.5
DTM 11	GSM (GMSK, 1 Tx slot)	29.5	27.5	27.0	20.0
	EDGE (8PSK, 2 Tx slots)	24.5	24.5	23.5	20.0



Band / Mode			Average Power (dBm)	
WCDMA	Band V	Full Power Mode	RMC / AMR12.2Kbps	24.0
			HSDPA	22.0
			DC-HSDPA	22.0
			HSUPA	22.0
	Band IV	Full Power Mode	RMC / AMR12.2Kbps	24.5
			HSDPA	23.0
			DC-HSDPA	23.0
			HSUPA	23.0
		Reduced Power Mode (for reverse call)	RMC / AMR12.2Kbps	17.0
			HSDPA	15.5
			DC-HSDPA	15.5
			HSUPA	15.5
		Hotspot Mode	RMC / AMR12.2Kbps	22.0
			HSDPA	21.0
			DC-HSDPA	21.0
			HSUPA	21.0
	Band II	Full Power Mode	RMC / AMR12.2Kbps	22.5
			HSDPA	21.5
			DC-HSDPA	21.5
			HSUPA	21.5
Reduced Power Mode (for reverse call)		RMC / AMR12.2Kbps	16.5	
		HSDPA	15.5	
		DC-HSDPA	15.5	
		HSUPA	15.5	

Band / Mode		Average Power (dBm)	
LTE	Band 12	Full Power Mode	24.0
		Reduced Power Mode (for reverse call)	21.0
	Band 17	Full Power Mode	24.0
		Reduced Power Mode (for reverse call)	21.0
	Band 5	Full Power Mode	24.0
	Band 4	Full Power Mode	22.5
		Reduced Power Mode (for reverse call)	18.0
	Band 2	Full Power Mode	22.5
		Reduced Power Mode (for reverse call)	17.0
	Band 7	Full Power Mode	23.5
		Reduced Power Mode (for reverse call) for 6039A	15.5
		Reduced Power Mode (for reverse call) for Variant Product 6039S	15.0
		Hotspot Mode	17.5
2.4GHz WLAN	802.11b	18.5	
	802.11g	12.5	
	802.11n HT20	12.0	
Bluetooth v3.0 + EDR		1.5	
Bluetooth v4.1 LE		-2.0	

Remark:

This device employs a “reverse calling” feature based on the orientation of the device such that a call can be made or taken in either portrait orientation (“Normal” and “Upside Down”). When a user answer a voice call or initiate a voice call, the dialer UI orientation is locked and the power reduction mechanism will be activated if it’s locked in the reverse portrait mode. The maximum output power is reduced for a number of wireless technologies, as specified above, for the reverse calling mode, during the voice call the power reduction will never release even the hotspot mode operates simultaneously, and the power reduction will release only when the voice call ends. The details of the implementation are illustrated in the operational description for reverse call.

The device has been tested in voice mode for head SAR exposure compliance in both normal and reduced power mode according to the maximum output power specified in this document.

4.5 General LTE SAR Test and Reporting Considerations

Summarized necessary items addressed in KDB 941225 D05 v02r03																																															
FCC ID	RAD547																																														
Equipment Name	GSM Quad-band / UMTS Quad-band / LTE six bands mobile phone																																														
Operating Frequency Range of each LTE transmission band	LTE Band 12: 699.7 MHz ~ 715.3 MHz LTE Band 17: 706.5 MHz ~ 713.5 MHz LTE Band 5: 824.7 MHz ~ 848.3 MHz LTE Band 4: 1710.7 MHz ~ 1754.3 MHz LTE Band 2: 1850.7 MHz ~ 1909.3 MHz LTE Band 7: 2502.5 MHz ~ 2567.5 MHz																																														
Channel Bandwidth	LTE Band 12: 1.4MHz, 3MHz, 5MHz, 10MHz LTE Band 17: 5MHz, 10MHz LTE Band 5: 1.4MHz, 3MHz, 5MHz, 10MHz LTE Band 4: 1.4MHz, 3MHz, 5MHz, 10MHz, 15MHz, 20MHz LTE Band 2: 1.4MHz, 3MHz, 5MHz, 10MHz, 15MHz, 20MHz LTE Band 7: 5MHz, 10MHz, 15MHz, 20MHz																																														
uplink modulations used	QPSK, and 16QAM																																														
LTE Voice / Data requirements	VoLTE is supported																																														
LTE MPR permanently built-in by design	<table border="1"> <thead> <tr> <th colspan="8">Table 6.2.3-1: Maximum Power Reduction (MPR) for Power Class 3</th> </tr> <tr> <th rowspan="2">Modulation</th> <th colspan="6">Channel bandwidth / Transmission bandwidth (RB)</th> <th rowspan="2">MPR (dB)</th> </tr> <tr> <th>1.4 MHz</th> <th>3.0 MHz</th> <th>5 MHz</th> <th>10 MHz</th> <th>15 MHz</th> <th>20 MHz</th> </tr> </thead> <tbody> <tr> <td>QPSK</td> <td>> 5</td> <td>> 4</td> <td>> 8</td> <td>> 12</td> <td>> 16</td> <td>> 18</td> <td>≤ 1</td> </tr> <tr> <td>16 QAM</td> <td>≤ 5</td> <td>≤ 4</td> <td>≤ 8</td> <td>≤ 12</td> <td>≤ 16</td> <td>≤ 18</td> <td>≤ 1</td> </tr> <tr> <td>16 QAM</td> <td>> 5</td> <td>> 4</td> <td>> 8</td> <td>> 12</td> <td>> 16</td> <td>> 18</td> <td>≤ 2</td> </tr> </tbody> </table>	Table 6.2.3-1: Maximum Power Reduction (MPR) for Power Class 3								Modulation	Channel bandwidth / Transmission bandwidth (RB)						MPR (dB)	1.4 MHz	3.0 MHz	5 MHz	10 MHz	15 MHz	20 MHz	QPSK	> 5	> 4	> 8	> 12	> 16	> 18	≤ 1	16 QAM	≤ 5	≤ 4	≤ 8	≤ 12	≤ 16	≤ 18	≤ 1	16 QAM	> 5	> 4	> 8	> 12	> 16	> 18	≤ 2
Table 6.2.3-1: Maximum Power Reduction (MPR) for Power Class 3																																															
Modulation	Channel bandwidth / Transmission bandwidth (RB)						MPR (dB)																																								
	1.4 MHz	3.0 MHz	5 MHz	10 MHz	15 MHz	20 MHz																																									
QPSK	> 5	> 4	> 8	> 12	> 16	> 18	≤ 1																																								
16 QAM	≤ 5	≤ 4	≤ 8	≤ 12	≤ 16	≤ 18	≤ 1																																								
16 QAM	> 5	> 4	> 8	> 12	> 16	> 18	≤ 2																																								
LTE A-MPR	In the base station simulator configuration, Network Setting value is set to NS_01 to disable A-MPR during SAR testing and the LTE SAR tests was transmitting on all TTI frames (Maximum TTI).																																														
Spectrum plots for RB configuration	A properly configured base station simulator was used for the SAR and power measurement; therefore, spectrum plots for each RB allocation and offset configuration are not included in the SAR report.																																														
LTE Release Version	R9 Cat 4																																														
LTE Carrier Aggregation Combinations	Not Supported																																														
Power reduction applied to satisfy SAR compliance	Yes, 1. Power reduction is enabled when the User Interface is in the reversed portrait orientation for GSM850/1900, WCDMA Band II/IV, LTE band 2/4/7/12/17. 2. Hotspot mode reduced power only for WCDMA Band IV and LTE Band 7.																																														



Transmission (H, M, L) channel numbers and frequencies in each LTE band												
LTE Band 12												
	Bandwidth 1.4 MHz		Bandwidth 3 MHz		Bandwidth 5 MHz		Bandwidth 10 MHz					
	Ch. #	Freq. (MHz)	Ch. #	Freq. (MHz)	Ch. #	Freq. (MHz)	Ch. #	Freq. (MHz)	Ch. #	Freq. (MHz)		
L	23017	699.7	23025	700.5	23035	701.5	23060	704				
M	23095	707.5	23095	707.5	23095	707.5	23095	707.5				
H	23173	715.3	23165	714.5	23155	713.5	23130	711				
LTE Band 17												
	Bandwidth 5 MHz				Bandwidth 10 MHz							
	Channel #		Freq.(MHz)		Channel #		Freq. (MHz)					
L	23755		706.5		23780		709					
M	23790		710		23790		710					
H	23825		713.5		23800		711					
LTE Band 5												
	Bandwidth 1.4 MHz		Bandwidth 3 MHz		Bandwidth 5 MHz		Bandwidth 10 MHz					
	Ch. #	Freq. (MHz)	Ch. #	Freq. (MHz)	Ch. #	Freq. (MHz)	Ch. #	Freq. (MHz)	Ch. #	Freq. (MHz)		
L	20407	824.7	20415	825.5	20425	826.5	20450	829				
M	20525	836.5	20525	836.5	20525	836.5	20525	836.5				
H	20643	848.3	20635	847.5	20625	846.5	20600	844				
LTE Band 4												
	Bandwidth 1.4 MHz		Bandwidth 3 MHz		Bandwidth 5 MHz		Bandwidth 10 MHz		Bandwidth 15 MHz		Bandwidth 20 MHz	
	Ch. #	Freq. (MHz)	Ch. #	Freq. (MHz)	Ch. #	Freq. (MHz)	Ch. #	Freq. (MHz)	Ch. #	Freq. (MHz)	Ch. #	Freq. (MHz)
L	19957	1710.7	19965	1711.5	19975	1712.5	20000	1715	20025	1717.5	20050	1720
M	20175	1732.5	20175	1732.5	20175	1732.5	20175	1732.5	20175	1732.5	20175	1732.5
H	20393	1754.3	20385	1753.5	20375	1752.5	20350	1750	20325	1747.5	20300	1745
LTE Band 2												
	Bandwidth 1.4 MHz		Bandwidth 3 MHz		Bandwidth 5 MHz		Bandwidth 10 MHz		Bandwidth 15 MHz		Bandwidth 20 MHz	
	Ch. #	Freq. (MHz)	Ch. #	Freq. (MHz)	Ch. #	Freq. (MHz)	Ch. #	Freq. (MHz)	Ch. #	Freq. (MHz)	Ch. #	Freq. (MHz)
L	18607	1850.7	18615	1851.5	18625	1852.5	18650	1855	18675	1857.5	18700	1860
M	18900	1880	18900	1880	18900	1880	18900	1880	18900	1880	18900	1880
H	19193	1909.3	19185	1908.5	19175	1907.5	19150	1905	19125	1902.5	19100	1900
LTE Band 7												
	Bandwidth 5 MHz		Bandwidth 10 MHz		Bandwidth 15 MHz		Bandwidth 20 MHz					
	Ch. #	Freq. (MHz)	Ch. #	Freq. (MHz)	Ch. #	Freq. (MHz)	Ch. #	Freq. (MHz)	Ch. #	Freq. (MHz)		
L	20775	2502.5	20800	2505	20825	2507.5	20850	2510				
M	21100	2535	21100	2535	21100	2535	21100	2535				
H	21425	2567.5	21400	2565	21375	2562.5	21350	2560				



5. RF Exposure Limits

5.1 Uncontrolled Environment

Uncontrolled Environments are defined as locations where there is the exposure of individuals who have no knowledge or control of their exposure. The general population/uncontrolled exposure limits are applicable to situations in which the general public may be exposed or in which persons who are exposed as a consequence of their employment may not be made fully aware of the potential for exposure or cannot exercise control over their exposure. Members of the general public would come under this category when exposure is not employment-related; for example, in the case of a wireless transmitter that exposes persons in its vicinity.

5.2 Controlled Environment

Controlled Environments are defined as locations where there is exposure that may be incurred by persons who are aware of the potential for exposure, (i.e. as a result of employment or occupation). In general, occupational/controlled exposure limits are applicable to situations in which persons are exposed as a consequence of their employment, who have been made fully aware of the potential for exposure and can exercise control over their exposure. The exposure category is also applicable when the exposure is of a transient nature due to incidental passage through a location where the exposure levels may be higher than the general population/uncontrolled limits, but the exposed person is fully aware of the potential for exposure and can exercise control over his or her exposure by leaving the area or by some other appropriate means.

Limits for Occupational/Controlled Exposure (W/kg)

Whole-Body	Partial-Body	Hands, Wrists, Feet and Ankles
0.4	8.0	20.0

Limits for General Population/Uncontrolled Exposure (W/kg)

Whole-Body	Partial-Body	Hands, Wrists, Feet and Ankles
0.08	1.6	4.0

Whole-Body SAR is averaged over the entire body, partial-body SAR is averaged over any 1gram of tissue defined as a tissue volume in the shape of a cube. SAR for hands, wrists, feet and ankles is averaged over any 10 grams of tissue defined as a tissue volume in the shape of a cube.

6. Specific Absorption Rate (SAR)

6.1 Introduction

SAR is related to the rate at which energy is absorbed per unit mass in an object exposed to a radio field. The SAR distribution in a biological body is complicated and is usually carried out by experimental techniques or numerical modeling. The standard recommends limits for two tiers of groups, occupational/controlled and general population/uncontrolled, based on a person's awareness and ability to exercise control over his or her exposure. In general, occupational/controlled exposure limits are higher than the limits for general population/uncontrolled.

6.2 SAR Definition

The SAR definition is the time derivative (rate) of the incremental energy (dW) absorbed by (dissipated in) an incremental mass (dm) contained in a volume element (dv) of a given density (ρ). The equation description is as below:

$$SAR = \frac{d}{dt} \left(\frac{dW}{dm} \right) = \frac{d}{dt} \left(\frac{dW}{\rho dv} \right)$$

SAR is expressed in units of Watts per kilogram (W/kg)

$$SAR = \frac{\sigma |E|^2}{\rho}$$

Where: σ is the conductivity of the tissue, ρ is the mass density of the tissue and E is the RMS electrical field strength.

7. System Description and Setup

The DASY system used for performing compliance tests consists of the following items:

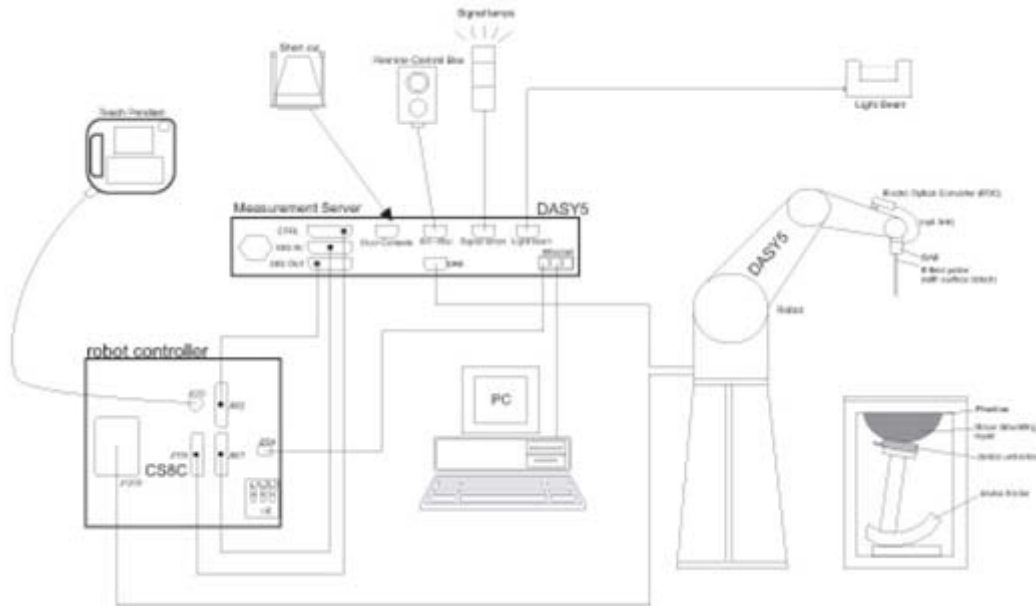

- A standard high precision 6-axis robot with controller, teach pendant and software. An arm extension for accommodating the data acquisition electronics (DAE).
- An isotropic Field probe optimized and calibrated for the targeted measurement.
- A data acquisition electronics (DAE) which performs the signal amplification, signal multiplexing, AD-conversion, offset measurements, mechanical surface detection, collision detection, etc. The unit is battery powered with standard or rechargeable batteries. The signal is optically transmitted to the EOC.
- The Electro-optical converter (EOC) performs the conversion from optical to electrical signals for the digital communication to the DAE. To use optical surface detection, a special version of the EOC is required. The EOC signal is transmitted to the measurement server.
- The function of the measurement server is to perform the time critical tasks such as signal filtering, control of the robot operation and fast movement interrupts.
- The Light Beam used is for probe alignment. This improves the (absolute) accuracy of the probe positioning.
- A computer running WinXP or Win7 and the DASY5 software.
- Remote control and teach pendant as well as additional circuitry for robot safety such as warning lamps, etc.
- The phantom, the device holder and other accessories according to the targeted measurement.

8. Measurement Procedures

The measurement procedures are as follows:

<Conducted power measurement>

- (a) For WWAN power measurement, use base station simulator to configure EUT WWAN transmission in conducted connection with RF cable, at maximum power in each supported wireless interface and frequency band.
- (b) Read the WWAN RF power level from the base station simulator.
- (c) For WLAN/BT power measurement, use engineering software to configure EUT WLAN/BT continuously transmission, at maximum RF power in each supported wireless interface and frequency band
- (d) Connect EUT RF port through RF cable to the power meter, and measure WLAN/BT output power

<SAR measurement>

- (a) Use base station simulator to configure EUT WWAN transmission in radiated connection, and engineering software to configure EUT WLAN/BT continuously transmission, at maximum RF power, in the highest power channel.
- (b) Place the EUT in the positions as Appendix D demonstrates.
- (c) Set scan area, grid size and other setting on the DASY software.
- (d) Measure SAR results for the highest power channel on each testing position.
- (e) Find out the largest SAR result on these testing positions of each band
- (f) Measure SAR results for other channels in worst SAR testing position if the reported SAR of highest power channel is larger than 0.8 W/kg

According to the test standard, the recommended procedure for assessing the peak spatial-average SAR value consists of the following steps:

- (a) Power reference measurement
- (b) Area scan
- (c) Zoom scan
- (d) Power drift measurement

8.1 Spatial Peak SAR Evaluation

The procedure for spatial peak SAR evaluation has been implemented according to the test standard. It can be conducted for 1g and 10g, as well as for user-specific masses. The DASY software includes all numerical procedures necessary to evaluate the spatial peak SAR value.

The base for the evaluation is a "cube" measurement. The measured volume must include the 1g and 10g cubes with the highest averaged SAR values. For that purpose, the center of the measured volume is aligned to the interpolated peak SAR value of a previously performed area scan.

The entire evaluation of the spatial peak values is performed within the post-processing engine (SEMCAD). The system always gives the maximum values for the 1g and 10g cubes. The algorithm to find the cube with highest averaged SAR is divided into the following stages:

- (a) Extraction of the measured data (grid and values) from the Zoom Scan
- (b) Calculation of the SAR value at every measurement point based on all stored data (A/D values and measurement parameters)
- (c) Generation of a high-resolution mesh within the measured volume
- (d) Interpolation of all measured values from the measurement grid to the high-resolution grid
- (e) Extrapolation of the entire 3-D field distribution to the phantom surface over the distance from sensor to surface
- (f) Calculation of the averaged SAR within masses of 1g and 10g

8.2 Power Reference Measurement

The Power Reference Measurement and Power Drift Measurements are for monitoring the power drift of the device under test in the batch process. The minimum distance of probe sensors to surface determines the closest measurement point to phantom surface. This distance cannot be smaller than the distance of sensor calibration points to probe tip as defined in the probe properties.

8.3 Area Scan

The area scan is used as a fast scan in two dimensions to find the area of high field values, before doing a fine measurement around the hot spot. The sophisticated interpolation routines implemented in DASY software can find the maximum found in the scanned area, within a range of the global maximum. The range (in dB) is specified in the standards for compliance testing. For example, a 2 dB range is required in IEEE standard 1528 and IEC 62209 standards, whereby 3 dB is a requirement when compliance is assessed in accordance with the ARIB standard (Japan), if only one zoom scan follows the area scan, then only the absolute maximum will be taken as reference. For cases where multiple maximums are detected, the number of zoom scans has to be increased accordingly.

Area scan parameters extracted from FCC KDB 865664 D01v01r03 SAR measurement 100 MHz to 6 GHz.

	≤ 3 GHz	> 3 GHz
Maximum distance from closest measurement point (geometric center of probe sensors) to phantom surface	5 ± 1 mm	$\frac{1}{2} \cdot \delta \cdot \ln(2) \pm 0.5$ mm
Maximum probe angle from probe axis to phantom surface normal at the measurement location	30° ± 1°	20° ± 1°
Maximum area scan spatial resolution: Δx_{Area} , Δy_{Area}	≤ 2 GHz: ≤ 15 mm 2 – 3 GHz: ≤ 12 mm	3 – 4 GHz: ≤ 12 mm 4 – 6 GHz: ≤ 10 mm
	When the x or y dimension of the test device, in the measurement plane orientation, is smaller than the above, the measurement resolution must be ≤ the corresponding x or y dimension of the test device with at least one measurement point on the test device.	

8.4 Zoom Scan

Zoom scans are used assess the peak spatial SAR values within a cubic averaging volume containing 1 gram and 10 gram of simulated tissue. The zoom scan measures points (refer to table below) within a cube shoes base faces are centered on the maxima found in a preceding area scan job within the same procedure. When the measurement is done, the zoom scan evaluates the averaged SAR for 1 gram and 10 gram and displays these values next to the job's label.

Zoom scan parameters extracted from FCC KDB 865664 D01v01r03 SAR measurement 100 MHz to 6 GHz.

		≤ 3 GHz	> 3 GHz	
Maximum zoom scan spatial resolution: $\Delta x_{Zoom}, \Delta y_{Zoom}$		≤ 2 GHz: ≤ 8 mm 2 – 3 GHz: ≤ 5 mm*	3 – 4 GHz: ≤ 5 mm* 4 – 6 GHz: ≤ 4 mm*	
Maximum zoom scan spatial resolution, normal to phantom surface	uniform grid: $\Delta z_{Zoom}(n)$	≤ 5 mm	3 – 4 GHz: ≤ 4 mm 4 – 5 GHz: ≤ 3 mm 5 – 6 GHz: ≤ 2 mm	
	graded grid	$\Delta z_{Zoom}(1)$: between 1 st two points closest to phantom surface	≤ 4 mm	3 – 4 GHz: ≤ 3 mm 4 – 5 GHz: ≤ 2.5 mm 5 – 6 GHz: ≤ 2 mm
		$\Delta z_{Zoom}(n>1)$: between subsequent points	$\leq 1.5 \cdot \Delta z_{Zoom}(n-1)$	
Minimum zoom scan volume	x, y, z	≥ 30 mm	3 – 4 GHz: ≥ 28 mm 4 – 5 GHz: ≥ 25 mm 5 – 6 GHz: ≥ 22 mm	
Note: δ is the penetration depth of a plane-wave at normal incidence to the tissue medium; see draft standard IEEE P1528-2011 for details. * When zoom scan is required and the <i>reported</i> SAR from the <i>area scan based 1-g SAR estimation</i> procedures of KDB 447498 is ≤ 1.4 W/kg, ≤ 8 mm, ≤ 7 mm and ≤ 5 mm zoom scan resolution may be applied, respectively, for 2 GHz to 3 GHz, 3 GHz to 4 GHz and 4 GHz to 6 GHz.				

8.5 Volume Scan Procedures

The volume scan is used for assess overlapping SAR distributions for antennas transmitting in different frequency bands. It is equivalent to an oversized zoom scan used in standalone measurements. The measurement volume will be used to enclose all the simultaneous transmitting antennas. For antennas transmitting simultaneously in different frequency bands, the volume scan is measured separately in each frequency band. In order to sum correctly to compute the 1g aggregate SAR, the EUT remain in the same test position for all measurements and all volume scan use the same spatial resolution and grid spacing. When all volume scan were completed, the software, SEMCAD postprocessor can combine and subsequently superpose these measurement data to calculating the multiband SAR.

8.6 Power Drift Monitoring

All SAR testing is under the EUT install full charged battery and transmit maximum output power. In DASY measurement software, the power reference measurement and power drift measurement procedures are used for monitoring the power drift of EUT during SAR test. Both these procedures measure the field at a specified reference position before and after the SAR testing. The software will calculate the field difference in dB. If the power drifts more than 5%, the SAR will be retested.



9. Test Equipment List

Manufacturer	Name of Equipment	Type/Model	Serial Number	Calibration	
				Last Cal.	Due Date
SPEAG	750MHz System Validation Kit	D750V3	1065	Nov. 19, 2014	Nov. 18, 2015
SPEAG	835MHz System Validation Kit	D835V2	4d091	Nov. 21, 2014	Nov. 20, 2015
SPEAG	1750MHz System Validation Kit	D1750V2	1069	Nov. 21, 2014	Nov. 20, 2015
SPEAG	1900MHz System Validation Kit	D1900V2	5d118	Nov. 21, 2014	Nov. 20, 2015
SPEAG	2450MHz System Validation Kit	D2450V2	840	Nov. 19, 2014	Nov. 18, 2015
SPEAG	2600MHz System Validation Kit	D2600V2	1061	Nov. 19, 2014	Nov. 18, 2015
SPEAG	Data Acquisition Electronics	DAE4	1210	May 19, 2014	May 18, 2015
SPEAG	Data Acquisition Electronics	DAE4	905	Jul. 14, 2014	Jul. 13, 2015
SPEAG	Data Acquisition Electronics	DAE4	1358	Apr. 28, 2015	Apr. 27, 2016
SPEAG	Dosimetric E-Field Probe	EX3DV4	3857	May 23, 2014	May 22, 2015
SPEAG	Dosimetric E-Field Probe	EX3DV4	3801	Jun. 18, 2014	Jun. 17, 2015
SPEAG	Dosimetric E-Field Probe	EX3DV4	3911	Oct. 02, 2014	Oct. 01, 2015
SPEAG	Dosimetric E-Field Probe	EX3DV4	7350	Jan. 08, 2015	Jan. 07, 2016
SPEAG	SAM Twin Phantom	QD 000 P40 CB	TP-1477	NCR	NCR
SPEAG	SAM Twin Phantom	QD 000 P40 CB	TP-1479	NCR	NCR
SPEAG	SAM Twin Phantom	QD 000 P40 CD	TP-1753	NCR	NCR
SPEAG	SAM Twin Phantom	QD 000 P40 CD	TP-1754	NCR	NCR
SPEAG	Phone Positioner	N/A	N/A	NCR	NCR
Anritsu	Radio communication analyzer	MT8820C	6201091028	Jul. 10, 2014	Jul. 09, 2015
Agilent	Wireless Communication Test Set	E5515C	MY52102706	May 03, 2014	May 02, 2015
Agilent	Wireless Communication Test Set	E5515C	MY52102600	Dec. 09, 2014	Dec. 08, 2015
Agilent	Wireless Communication Test Set	E5515E	MY53211040	Jun. 12, 2014	Jun. 11, 2015
Agilent	Wireless Communication Test Set	E5515E	MY53211040	Jun. 11, 2015	Jun. 10, 2016
R&S	Signal Generator	SMBV100A	258305	Jan. 23, 2015	Jan. 22, 2016
R&S	Bluetooth Tester	CBT	100783	Aug. 11, 2014	Aug. 10, 2015
Agilent	ENA Series Network Analyzer	E5071C	MY46111157	May 04, 2014	May 03, 2015
R&S	Network Analyzer	ZVB8	100106	Sep. 29, 2014	Sep. 28, 2015
Agilent	Dielectric Probe Kit	85070E	MY44300475	NCR	NCR
Agilent	Dielectric Probe Kit	85070E	MY44300751	NCR	NCR
Speag	Dielectric Assessment Kit	DAK-3.5	1032	NCR	NCR
Anritsu	Power Sensor	MA2411B	0917070	Jan. 23, 2015	Jan. 22, 2016
Anritsu	Power Meter	ML2495A	1005002	Jan. 23, 2015	Jan. 22, 2016
ARRA	Power Divider	A3200-2	N/A	NA	NA
R&S	Spectrum Analyzer	FSP40	100319	Oct. 28, 2014	Oct. 27, 2015
R&S	Spectrum Analyzer	FSP30	101362	Sep. 29, 2014	Sep. 28, 2015
R&S	Spectrum Analyzer	FSP7	101045	Dec. 09, 2014	Dec. 08, 2015
Agilent	Dual Directional Coupler	778D	50422	Note1	
Woken	Attenuator 1	WK0602-XX	N/A	Note1	
PE	Attenuator 2	PE7005-10	N/A	Note1	
PE	Attenuator 3	PE7005-3	N/A	Note1	
AR	Power Amplifier	5S1G4M2	0328767	Note1	
Mini-Circuits	Power Amplifier	ZVE-3W	162601250	Note1	
Mini-Circuits	Power Amplifier	ZHL-42W+	13440021344	Note1	

General Note:

1. Prior to system verification and validation, the path loss from the signal generator to the system check source and the power meter, which includes the amplifier, cable, attenuator and directional coupler, was measured by the network analyzer. The reading of the power meter was offset by the path loss difference between the path to the power meter and the path to the system check source to monitor the actual power level fed to the system check source.



10. System Verification

10.1 Tissue Verification

The following tissue formulations are provided for reference only as some of the parameters have not been thoroughly verified. The composition of ingredients may be modified accordingly to achieve the desired target tissue parameters required for routine SAR evaluation.

Frequency (MHz)	Water (%)	Sugar (%)	Cellulose (%)	Salt (%)	Preventol (%)	DGBE (%)	Conductivity (σ)	Permittivity (ε _r)
For Head								
750	41.1	57.0	0.2	1.4	0.2	0	0.89	41.9
835	40.3	57.9	0.2	1.4	0.2	0	0.90	41.5
1750	55.2	0	0	0.3	0	44.5	1.37	40.1
1800, 1900, 2000	55.2	0	0	0.3	0	44.5	1.40	40.0
2450	55.0	0	0	0	0	45.0	1.80	39.2
2600	54.8	0	0	0.1	0	45.1	1.96	39.0
For Body								
750	51.7	47.2	0	0.9	0.1	0	0.96	55.5
835	50.8	48.2	0	0.9	0.1	0	0.97	55.2
1750	70.2	0	0	0.4	0	29.4	1.49	53.4
1800, 1900, 2000	70.2	0	0	0.4	0	29.4	1.52	53.3
2450	68.6	0	0	0	0	31.4	1.95	52.7
2600	68.1	0	0	0.1	0	31.8	2.16	52.5

<Tissue Dielectric Parameter Check Results>

Frequency (MHz)	Tissue Type	Liquid Temp. (°C)	Conductivity (σ)	Permittivity (ε _r)	Conductivity Target (σ)	Permittivity Target (ε _r)	Delta (σ) (%)	Delta (ε _r) (%)	Limit (%)	Date
835	Head	22.6	0.884	41.053	0.90	41.50	-1.78	-1.08	±5	Feb. 16, 2015
835	Head	22.8	0.905	42.264	0.90	41.50	0.56	1.84	±5	Apr. 15, 2015
1750	Head	22.7	1.373	41.392	1.37	40.10	0.22	3.22	±5	Feb. 17, 2015
1750	Head	22.7	1.407	41.718	1.37	40.10	2.70	4.03	±5	Apr. 15, 2015
1750	Head	22.7	1.375	41.541	1.37	40.10	0.36	3.59	±5	Apr. 17, 2015
1900	Head	22.5	1.425	38.906	1.40	40.00	1.79	-2.74	±5	Feb. 16, 2015
1900	Head	22.8	1.424	38.988	1.40	40.00	1.71	-2.53	±5	Apr. 15, 2015
2450	Head	22.7	1.819	39.212	1.80	39.20	1.06	0.03	±5	Feb. 27, 2015
2450	Head	22.6	1.842	39.923	1.80	39.20	2.33	1.84	±5	Apr. 16, 2015
2600	Head	22.9	1.981	38.254	1.96	39.00	1.07	-1.91	±5	Feb. 25, 2015
2600	Head	22.9	1.974	38.204	1.96	39.00	0.71	-2.04	±5	Apr. 16, 2015
835	Body	22.8	0.982	54.848	0.97	55.20	1.24	-0.64	±5	Mar. 04, 2015
835	Body	22.8	0.980	54.480	0.97	55.20	1.03	-1.30	±5	Apr. 15, 2015
1750	Body	22.9	1.512	55.273	1.49	53.40	1.48	3.51	±5	Feb. 28, 2015
1750	Body	22.8	1.519	54.941	1.49	53.40	1.95	2.89	±5	Apr. 16, 2015
1900	Body	22.6	1.552	53.303	1.52	53.30	2.11	0.01	±5	Feb. 28, 2015
1900	Body	22.6	1.555	53.699	1.52	53.30	2.30	0.75	±5	Apr. 16, 2015
2450	Body	22.9	1.933	51.282	1.95	52.70	-0.87	-2.69	±5	Mar. 01, 2015
2450	Body	22.7	1.943	50.960	1.95	52.70	-0.36	-3.30	±5	Apr. 16, 2015
2600	Body	22.8	2.201	52.823	2.16	52.50	1.90	0.62	±5	Mar. 01, 2015
2600	Body	22.9	2.209	51.123	2.16	52.50	2.27	-2.62	±5	Mar. 26, 2015
2600	Body	22.8	2.165	53.823	2.16	52.50	0.23	2.52	±5	Apr. 16, 2015

<Tissue Dielectric Parameter Check Results for Variant Product (6039S)>

Frequency (MHz)	Tissue Type	Liquid Temp. (°C)	Conductivity (σ)	Permittivity (ϵ_r)	Conductivity Target (σ)	Permittivity Target (ϵ_r)	Delta (σ) (%)	Delta (ϵ_r) (%)	Limit (%)	Date
750	Head	22.4	0.879	40.711	0.89	41.90	-1.24	-2.84	±5	May 28, 2015
750	Head	22.6	0.887	40.957	0.89	41.90	-0.34	-2.25	±5	Jun. 09, 2015
835	Head	22.5	0.918	42.176	0.90	41.50	2.00	1.63	±5	May 28, 2015
1750	Head	22.6	1.395	41.214	1.37	40.10	1.82	2.78	±5	May 23, 2015
1900	Head	22.5	1.456	40.841	1.40	40.00	4.00	2.10	±5	May 31, 2015
2450	Head	22.7	1.817	39.204	1.80	39.20	0.94	0.01	±5	Jun. 11, 2015
2600	Head	22.3	2.053	38.335	1.96	39.00	4.74	-1.71	±5	Jun. 02, 2015
750	Body	22.5	0.963	54.228	0.96	55.50	0.31	-2.29	±5	May 29, 2015
750	Body	22.8	0.966	54.242	0.96	55.50	0.63	-2.27	±5	Jun. 10, 2015
835	Body	22.3	0.976	54.388	0.97	55.20	0.62	-1.47	±5	May 30, 2015
1750	Body	22.7	1.492	53.378	1.49	53.40	0.13	-0.04	±5	May 29, 2015
1900	Body	22.6	1.545	53.535	1.52	53.30	1.64	0.44	±5	May 31, 2015
2450	Body	22.6	1.943	51.453	1.95	52.70	-0.36	-2.37	±5	Jun. 12, 2015
2600	Body	22.5	2.155	53.811	2.16	52.50	-0.23	2.50	±5	Jun. 03, 2015



10.2 System Performance Check Results

Comparing to the original SAR value provided by SPEAG, the verification data should be within its specification of 10 %. Below table shows the target SAR and measured SAR after normalized to 1W input power. The table below indicates the system performance check can meet the variation criterion and the plots can be referred to Appendix A of this report.

Date	Frequency (MHz)	Tissue Type	Input Power (mW)	Dipole S/N	Probe S/N	DAE S/N	Measured SAR (W/kg)	Targeted SAR (W/kg)	Normalized SAR (W/kg)	Deviation (%)
Feb. 16, 2015	835	Head	250	4d091	3857	1210	2.35	9.11	9.4	3.18
Apr. 15, 2015	835	Head	250	4d091	3857	1210	2.28	9.11	9.12	0.11
Feb. 17, 2015	1750	Head	250	1069	3857	1210	9.33	37.10	37.32	0.59
Apr. 15, 2015	1750	Head	250	1069	3857	1210	9.38	37.10	37.52	1.13
Apr. 17, 2015	1750	Head	250	1069	3857	1210	9.35	37.10	37.4	0.81
Feb. 16, 2015	1900	Head	250	5d118	3857	1210	10.00	40.10	40	-0.25
Apr. 15, 2015	1900	Head	250	5d118	3857	1210	9.57	40.10	38.28	-4.54
Feb. 27, 2015	2450	Head	250	840	3857	1210	12.90	52.30	51.6	-1.34
Apr. 16, 2015	2450	Head	250	840	3857	1210	12.10	52.30	48.4	-7.46
Feb. 25, 2015	2600	Head	250	1061	3857	1210	14.00	56.90	56	-1.58
Apr. 16, 2015	2600	Head	250	1061	3857	1210	14.20	56.90	56.8	-0.18
Mar. 04, 2015	835	Body	250	4d091	3857	1210	2.32	9.60	9.28	-3.33
Apr. 15, 2015	835	Body	250	4d091	3857	1210	2.26	9.60	9.04	-5.83
Feb. 28, 2015	1750	Body	250	1069	3857	1210	9.18	38.10	36.72	-3.62
Apr. 16, 2015	1750	Body	250	1069	3857	1210	9.14	38.10	36.56	-4.04
Feb. 28, 2015	1900	Body	250	5d118	3857	1210	10.40	40.00	41.6	4.00
Apr. 16, 2015	1900	Body	250	5d118	3857	1210	10.40	40.00	41.6	4.00
Mar. 01, 2015	2450	Body	250	840	3857	1210	12.50	51.00	50	-1.96
Apr. 16, 2015	2450	Body	250	840	3857	1210	12.50	51.00	50	-1.96
Mar. 01, 2015	2600	Body	250	1061	3857	1210	13.70	54.90	54.8	-0.18
Mar. 26, 2015	2600	Body	250	1061	3857	1210	14.00	54.90	56	2.00
Apr. 16, 2015	2600	Body	250	1061	3857	1210	13.20	54.90	52.8	-3.83

<System Performance Check Results for Variant Product (6039S)>

Date	Frequency (MHz)	Tissue Type	Input Power (mW)	Dipole S/N	Probe S/N	DAE S/N	Measured SAR (W/kg)	Targeted SAR (W/kg)	Normalized SAR (W/kg)	Deviation (%)
May 28, 2015	750	Head	250	1065	3911	1358	2.01	8.14	8.04	-1.23
Jun. 09, 2015	750	Head	250	1065	3801	905	2.09	8.14	8.36	2.70
May 28, 2015	835	Head	250	4d091	3911	1358	2.23	9.11	8.92	-2.09
May 23, 2015	1750	Head	250	1069	3911	1358	9.59	37.10	38.36	3.40
May 31, 2015	1900	Head	250	5d118	3911	1358	10.30	40.10	41.2	2.74
Jun. 11, 2015	2450	Head	250	840	7350	905	12.80	52.30	51.2	-2.10
Jun. 02, 2015	2600	Head	250	1061	3911	1358	15.10	56.90	60.4	6.15
May 29, 2015	750	Body	250	1065	3911	1358	2.17	8.64	8.68	0.46
Jun. 10, 2015	750	Body	250	1065	3801	905	2.11	8.64	8.44	-2.31
May 30, 2015	835	Body	250	4d091	3911	1358	2.39	9.60	9.56	-0.42
May 29, 2015	1750	Body	250	1069	3911	1358	9.47	38.10	37.88	-0.58
May 31, 2015	1900	Body	250	5d118	3911	1358	9.90	40.00	39.6	-1.00
Jun. 12, 2015	2450	Body	250	840	7350	905	13.30	51.00	53.2	4.31
Jun. 03, 2015	2600	Body	250	1061	3911	1358	14.60	54.90	58.4	6.38

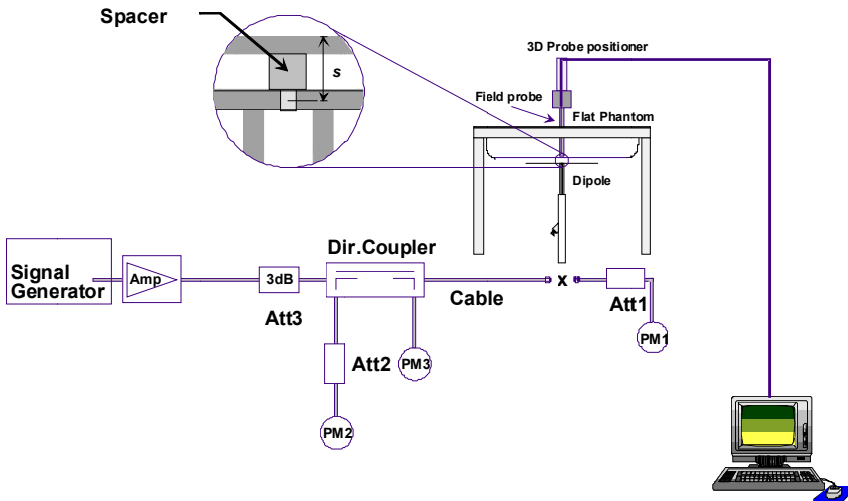

Fig 8.3.1 System Performance Check Setup



Fig 8.3.2 Setup Photo

11. RF Exposure Positions

11.1 Ear and handset reference point

Figure 9.1.1 shows the front, back, and side views of the SAM phantom. The center-of-mouth reference point is labeled "M," the left ear reference point (ERP) is marked "LE," and the right ERP is marked "RE." Each ERP is 15 mm along the B-M (back-mouth) line behind the entrance-to-ear-canal (EEC) point, as shown in Figure 9.1.2 The Reference Plane is defined as passing through the two ear reference points and point M. The line N-F (neck-front), also called the reference pivoting line, is normal to the Reference Plane and perpendicular to both a line passing through RE and LE and the B-M line (see Figure 9.1.3). Both N-F and B-M lines should be marked on the exterior of the phantom shell to facilitate handset positioning. Posterior to the N-F line the ear shape is a flat surface with 6 mm thickness at each ERP, and forward of the N-F line the ear is truncated, as illustrated in Figure 9.1.2. The ear truncation is introduced to preclude the ear lobe from interfering with handset tilt, which could lead to unstable positioning at the cheek.

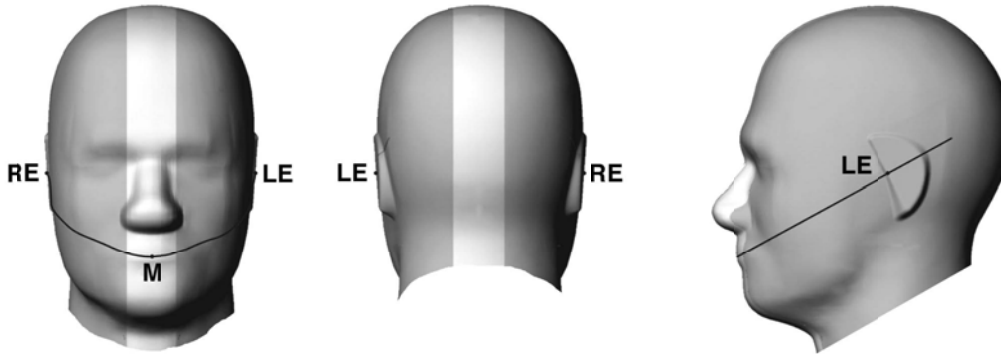

Fig 9.1.1 Front, back, and side views of SAM twin phantom

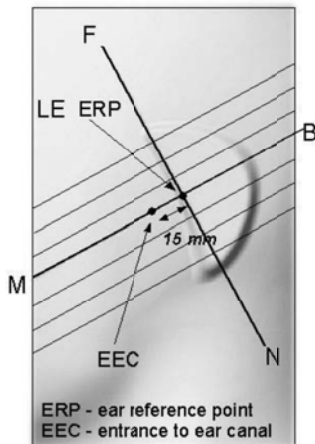

Fig 9.1.2 Close-up side view of phantom showing the ear region.

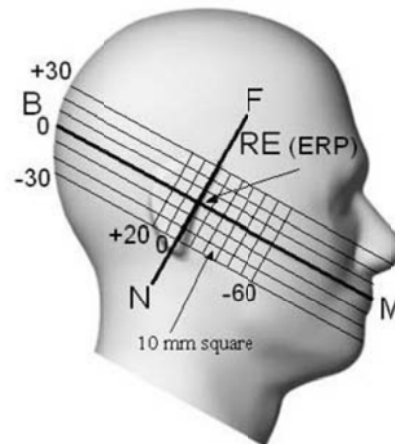

Fig 9.1.3 Side view of the phantom showing relevant markings and seven cross-sectional plane locations

11.2 Definition of the cheek position

1. Ready the handset for talk operation, if necessary. For example, for handsets with a cover piece (flip cover), open the cover. If the handset can transmit with the cover closed, both configurations must be tested.
2. Define two imaginary lines on the handset—the vertical centerline and the horizontal line. The vertical centerline passes through two points on the front side of the handset—the midpoint of the width w_t of the handset at the level of the acoustic output (point A in Figure 9.2.1 and Figure 9.2.2), and the midpoint of the width w_b of the bottom of the handset (point B). The horizontal line is perpendicular to the vertical centerline and passes through the center of the acoustic output (see Figure 9.2.1). The two lines intersect at point A. Note that for many handsets, point A coincides with the center of the acoustic output; however, the acoustic output may be located elsewhere on the horizontal line. Also note that the vertical centerline is not necessarily parallel to the front face of the handset (see Figure 9.2.2), especially for clamshell handsets, handsets with flip covers, and other irregularly-shaped handsets.
3. Position the handset close to the surface of the phantom such that point A is on the (virtual) extension of the line passing through points RE and LE on the phantom (see Figure 9.2.3), such that the plane defined by the vertical centerline and the horizontal line of the handset is approximately parallel to the sagittal plane of the phantom.
4. Translate the handset towards the phantom along the line passing through RE and LE until handset point A touches the pinna at the ERP.
5. While maintaining the handset in this plane, rotate it around the LE-RE line until the vertical centerline is in the plane normal to the plane containing B-M and N-F lines, i.e., the Reference Plane.
6. Rotate the handset around the vertical centerline until the handset (horizontal line) is parallel to the N-F line.
7. While maintaining the vertical centerline in the Reference Plane, keeping point A on the line passing through RE and LE, and maintaining the handset contact with the pinna, rotate the handset about the N-F line until any point on the handset is in contact with a phantom point below the pinna on the cheek. See Figure 9.2.3. The actual rotation angles should be documented in the test report.

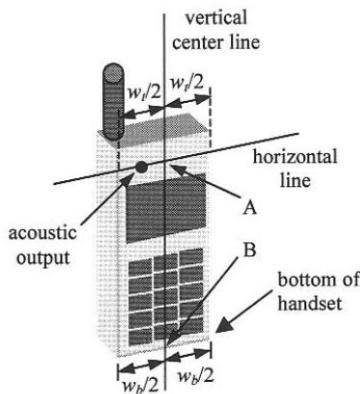

Fig 9.2.1 Handset vertical and horizontal reference lines—“fixed case”

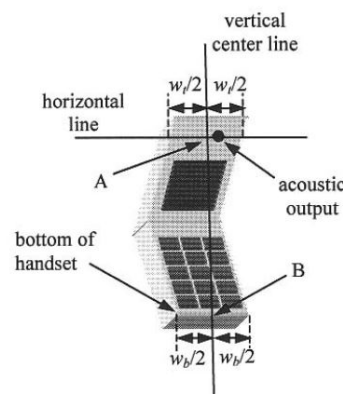

Fig 9.2.2 Handset vertical and horizontal reference lines—“clam-shell case”

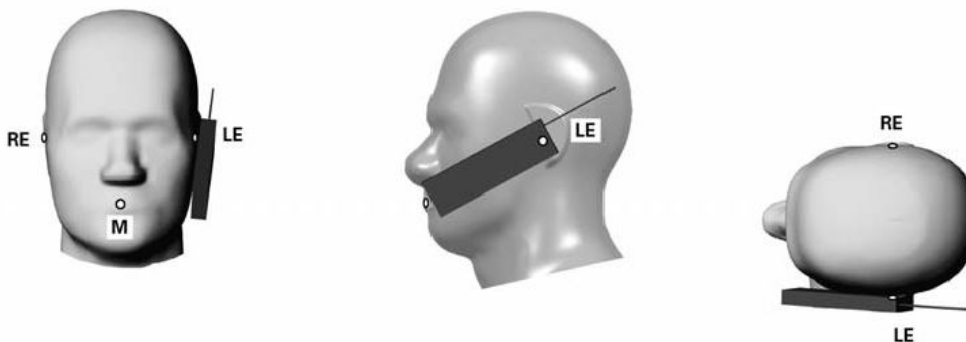

Fig 9.2.3 cheek or touch position. The reference points for the right ear (RE), left ear (LE), and mouth (M), which establish the Reference Plane for handset positioning, are indicated.

11.3 Definition of the tilt position

1. Ready the handset for talk operation, if necessary. For example, for handsets with a cover piece (flip cover), open the cover. If the handset can transmit with the cover closed, both configurations must be tested.
2. While maintaining the orientation of the handset, move the handset away from the pinna along the line passing through RE and LE far enough to allow a rotation of the handset away from the cheek by 15°.
3. Rotate the handset around the horizontal line by 15°.
4. While maintaining the orientation of the handset, move the handset towards the phantom on the line passing through RE and LE until any part of the handset touches the ear. The tilt position is obtained when the contact point is on the pinna. See Figure 9.3.1. If contact occurs at any location other than the pinna, e.g., the antenna at the back of the phantom head, the angle of the handset should be reduced. In this case, the tilt position is obtained if any point on the handset is in contact with the pinna and a second point

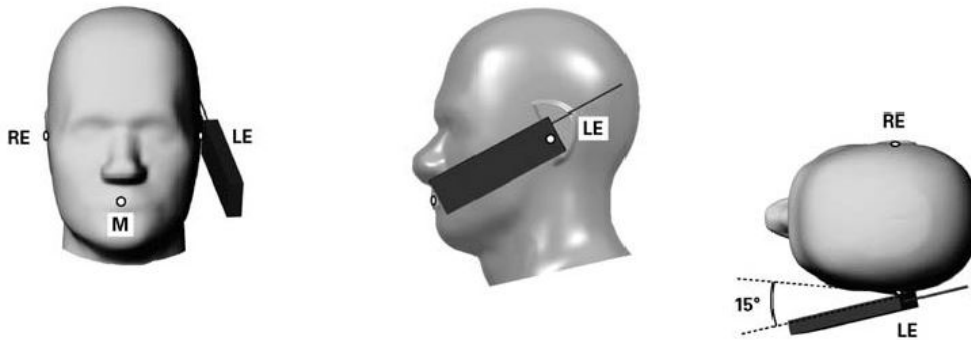

Fig 9.3.1 Tilt position. The reference points for the right ear (RE), left ear (LE), and mouth (M), which define the Reference Plane for handset positioning, are indicated.

11.4 Body Worn Accessory

Body-worn operating configurations are tested with the belt-clips and holsters attached to the device and positioned against a flat phantom in a normal use configuration (see Figure 9.4). Per KDB 648474 D04v01r02, body-worn accessory exposure is typically related to voice mode operations when handsets are carried in body-worn accessories. The body-worn accessory procedures in FCC KDB 447498 D01v05r02 should be used to test for body-worn accessory SAR compliance, without a headset connected to it. This enables the test results for such configuration to be compatible with that required for hotspot mode when the body-worn accessory test separation distance is greater than or equal to that required for hotspot mode, when applicable. When the reported SAR for body-worn accessory, measured without a headset connected to the handset is < 1.2 W/kg, the highest reported SAR configuration for that wireless mode and frequency band should be repeated for that body-worn accessory with a handset attached to the handset.

Accessories for body-worn operation configurations are divided into two categories: those that do not contain metallic components and those that do contain metallic components. When multiple accessories that do not contain metallic components are supplied with the device, the device is tested with only the accessory that dictates the closest spacing to the body. Then multiple accessories that contain metallic components are test with the device with each accessory. If multiple accessories share an identical metallic component (i.e. the same metallic belt-chip used with different holsters with no other metallic components) only the accessory that dictates the closest spacing to the body is tested.

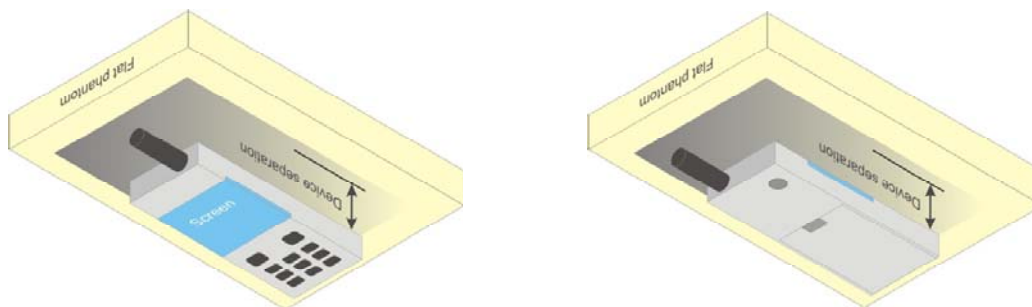

Fig 9.4 Body Worn Position

11.5 Wireless Router

Some battery-operated handsets have the capability to transmit and receive user through simultaneous transmission of WIFI simultaneously with a separate licensed transmitter. The FCC has provided guidance in FCC HDB Publication 941225 D06 v02 where SAR test considerations for handsets (L x W ≥ 9 cm x 5 cm) are based on a composite test separation distance of 10mm from the front, back and edges of the device containing transmitting antennas within 2.5cm of their edges, determined from general mixed use conditions for this type of devices. Since the hotspot SAR results may overlap with the body-worn accessory SAR requirements, the more conservative configurations can be considered, thus excluding some body-worn accessory SAR tests.

When the user enables the personal wireless router functions for the handset, actual operations include simultaneous transmission of both the WIFI transmitter and another licensed transmitter. Both transmitters often do not transmit at the same transmitting frequency and thus cannot be evaluated for SAR under actual use conditions due to the limitations of the SAR assessment probes. Therefore, SAR must be evaluated for each frequency transmission and mode separately and spatially summed with the WIFI transmitter according to FCC KDB Publication 447498 D01v05r02 publication procedures. The "Portable Hotspot" feature on the handset was NOT activated during SAR assessments, to ensure the SAR measurements were evaluated for a single transmission frequency RF signal at a time.

12. Conducted RF Output Power (Unit: dBm)

<GSM Conducted Power>

1. For DTM multi-slot class mode, the device was linked with base station simulator (Agilent E5515C) and transmit maximum power on maximum number of TX slots, i.e. one CS timeslot, and additional PS timeslots (1 for DTM class 5 and 9, 2 for DTM class 11) in one TDMA frame.
2. Agilent E5515C was used to setup the device operated under DTM mode for power measurement and SAR testing. For conducted power, the power of the burst for voice and the power of the bursts for data was reported separately in the table above, and the frame-average power is derived below to determine SAR testing.

$$DTM \text{ frame average power (dBm)} = 10 * \log [\sum(\text{power of each slot, in mW})/8]$$
3. Per KDB 447498 D01v05r02, the maximum output power channel is used for SAR testing and for further SAR test reduction.
4. Considering the possibility of e.g. 3rd party VoIP operation for Head SAR test reduction for GSM, GPRS, EDGE and DTM modes is determined by the source-based time-averaged output power including tune-up tolerance. The mode with highest specified time-averaged output power should be tested for SAR compliance in the applicable exposure conditions. For mode with the same specified maximum output power and tolerance, the higher tune-up with higher measured power configuration should be tested. Therefore, the EUT was set in GPRS (2Tx slots) for GSM850/GSM1900 at receiver 1, and GPRS (2Tx slots) for GSM850 and GSM Voice for GSM1900 at receiver 2.
5. For body-worn and hotspot SAR test reduction for GPRS, EDGE and DTM modes are determined by the source-based time-averaged output power including tune-up tolerance, for modes with the same specified maximum output power and tolerance, the higher tune-up with higher measured power configuration should be tested, therefore, the EUT was set in GPRS (2Tx slots) for GSM850/GSM1900.

<Full Power Mode>:

Band GSM850		Burst Average Power (dBm)			Tune-up Limit (dBm)	Frame-Average Power (dBm)			Tune-up Limit (dBm)
Tx Channel		128	189	251		128	189	251	
Frequency (MHz)		824.2	836.4	848.8		824.2	836.4	848.8	
GSM (GMSK, 1 Tx slot)		33.51	33.72	33.42	34.00	24.51	24.72	24.42	25.00
GPRS (GMSK, 1 Tx slot) – CS1		33.50	33.71	33.40	34.00	24.50	24.71	24.40	25.00
GPRS (GMSK, 2 Tx slots) – CS1		31.04	31.19	31.32	31.50	25.04	25.19	25.32	25.50
GPRS (GMSK, 3 Tx slots) – CS1		29.01	29.20	29.26	29.50	24.75	24.94	25.00	25.24
GPRS (GMSK, 4 Tx slots) – CS1		27.82	28.02	28.05	28.50	24.82	25.02	25.05	25.50
EDGE (8PSK, 1 Tx slot) – MCS5		25.64	25.70	25.85	26.00	16.64	16.70	16.85	17.00
EDGE (8PSK, 2 Tx slots) – MCS5		25.31	25.36	25.52	26.00	19.31	19.36	19.52	20.00
EDGE (8PSK, 3 Tx slots) – MCS5		23.77	23.75	23.91	24.00	19.51	19.49	19.65	19.74
EDGE (8PSK, 4 Tx slots) – MCS5		22.11	22.14	22.31	22.50	19.11	19.14	19.31	19.50
DTM 5 (2Tx slots)	GSM (GMSK, 1 Tx slot)	30.91	31.00	31.07	31.50	24.85	24.92	24.96	25.48
	GPRS (GMSK, 1 Tx slot) – CS1	30.83	30.88	30.89	31.50				
DTM 9 (2Tx slots)	GSM (GMSK, 1 Tx slot)	30.86	30.92	30.93	31.50	24.80	24.86	24.87	25.48
	GPRS (GMSK, 1 Tx slot) – CS1	30.78	30.84	30.85	31.50				
DTM 11 (3Tx slots)	GSM (GMSK, 1 Tx slot)	29.02	29.10	29.20	29.50	24.67	24.75	24.84	25.24
	GPRS (GMSK, 2 Tx slots) – CS1	28.89	28.97	29.05	29.50				
DTM 5 (2Tx slots)	GSM (GMSK, 1 Tx slot)	30.98	31.00	31.05	31.50	22.99	23.00	23.06	23.55
	EDGE (8PSK, 1 Tx slot) – MCS5	25.30	25.29	25.36	26.00				
DTM 9 (2Tx slots)	GSM (GMSK, 1 Tx slot)	30.93	30.01	31.03	31.50	22.92	22.21	23.02	23.55
	EDGE (8PSK, 1 Tx slot) – MCS5	25.18	25.17	25.24	26.00				
DTM 11 (3Tx slots)	GSM (GMSK, 1 Tx slot)	29.05	29.21	29.25	29.50	22.00	22.10	22.15	22.60
	EDGE (8PSK, 2 Tx slots) – MCS5	23.67	23.66	23.73	24.50				



Band GSM1900		Burst Average Power (dBm)			Tune-up Limit (dBm)	Frame-Average Power (dBm)			Tune-up Limit (dBm)
Tx Channel		512	661	810		512	661	810	
Frequency (MHz)		1850.2	1880	1909.8	1850.2	1880	1909.8		
GSM (GMSK, 1 Tx slot)		29.22	29.35	29.50	30.00	20.22	20.35	20.50	21.00
GPRS (GMSK, 1 Tx slot) – CS1		29.20	29.34	29.47	30.00	20.20	20.34	20.47	21.00
GPRS (GMSK, 2 Tx slots) – CS1		28.10	28.29	28.81	29.50	22.10	22.29	22.81	23.50
GPRS (GMSK, 3 Tx slots) – CS1		26.19	26.32	26.46	27.00	21.93	22.06	22.20	22.74
GPRS (GMSK, 4 Tx slots) – CS1		25.04	25.15	25.09	25.50	22.04	22.15	22.09	22.50
EDGE (8PSK, 1 Tx slot) – MCS5		25.61	25.65	25.67	26.00	16.61	16.65	16.67	17.00
EDGE (8PSK, 2 Tx slots) – MCS5		24.51	24.55	24.59	25.00	18.51	18.55	18.59	19.00
EDGE (8PSK, 3 Tx slots) – MCS5		22.96	22.99	22.96	23.50	18.70	18.73	18.70	19.24
EDGE (8PSK, 4 Tx slots) – MCS5		21.34	21.38	21.39	22.00	18.34	18.38	18.39	19.00
DTM 5 (2Tx slots)	GSM (GMSK, 1 Tx slot)	28.09	28.24	28.47	29.50	22.00	22.15	22.38	23.48
	GPRS (GMSK, 1 Tx slot) – CS1	27.95	28.11	28.34	29.50				
DTM 9 (2Tx slots)	GSM (GMSK, 1 Tx slot)	27.95	28.07	28.34	29.50	21.92	22.03	22.29	23.48
	GPRS (GMSK, 1 Tx slot) – CS1	27.93	28.03	28.28	29.50				
DTM 11 (3Tx slots)	GSM (GMSK, 1 Tx slot)	26.23	26.27	26.67	27.00	21.93	22.00	22.40	22.74
	GPRS (GMSK, 2 Tx slots) – CS1	26.17	26.25	26.65	27.00				
DTM 5 (2Tx slots)	GSM (GMSK, 1 Tx slot)	28.08	28.20	28.46	29.50	20.62	20.71	20.89	21.79
	EDGE (8PSK, 1 Tx slot) – MCS5	24.47	24.50	24.48	25.00				
DTM 9 (2Tx slots)	GSM (GMSK, 1 Tx slot)	27.77	28.16	28.45	29.50	20.41	20.66	20.86	21.79
	EDGE (8PSK, 1 Tx slot) – MCS5	24.49	24.41	24.41	25.00				
DTM 11 (3Tx slots)	GSM (GMSK, 1 Tx slot)	26.10	26.02	26.20	27.00	19.97	19.94	20.04	20.74
	EDGE (8PSK, 2 Tx slots) – MCS5	22.86	22.88	22.90	23.50				

<Reduced Power Mode, for reverse call>:

Band GSM850		Burst Average Power (dBm)			Tune-up Limit (dBm)	Frame-Average Power (dBm)			Tune-up Limit (dBm)
Tx Channel	128	189	251	128		189	251		
Frequency (MHz)		824.2	836.4	848.8	(dBm)	824.2	836.4	848.8	
GSM (GMSK, 1 Tx slot)		29.60	29.66	29.59	30.00	20.60	20.66	20.59	21.00
GPRS (GMSK, 1 Tx slot) – CS1		29.59	29.65	29.57	30.00	20.59	20.65	20.57	21.00
GPRS (GMSK, 2 Tx slots) – CS1		29.06	28.89	28.85	29.50	23.06	22.89	22.85	23.50
GPRS (GMSK, 3 Tx slots) – CS1		27.06	27.04	26.77	27.50	22.80	22.78	22.51	23.24
GPRS (GMSK, 4 Tx slots) – CS1		25.82	25.83	25.77	26.50	22.82	22.83	22.77	23.50
EDGE (8PSK, 1 Tx slot) – MCS5		25.93	25.85	25.89	26.00	16.93	16.85	16.89	17.00
EDGE (8PSK, 2 Tx slots) – MCS5		25.64	25.57	25.59	26.00	19.64	19.57	19.59	20.00
EDGE (8PSK, 3 Tx slots) – MCS5		24.11	24.01	24.04	24.50	19.85	19.75	19.78	20.24
EDGE (8PSK, 4 Tx slots) – MCS5		22.46	22.45	22.43	23.00	19.46	19.45	19.43	20.00
DTM 5 (2Tx slots)	GSM (GMSK, 1 Tx slot)	28.86	28.98	29.01	29.50	22.80	22.92	22.95	23.48
	GPRS (GMSK, 1 Tx slot) – CS1	28.78	28.90	28.93	29.50				
DTM 9 (2Tx slots)	GSM (GMSK, 1 Tx slot)	28.81	28.94	28.98	29.50	22.75	22.88	22.92	23.48
	GPRS (GMSK, 1 Tx slot) – CS1	28.73	28.86	28.90	29.50				
DTM 11 (3Tx slots)	GSM (GMSK, 1 Tx slot)	27.01	27.11	27.23	27.50	22.66	22.76	22.88	23.24
	GPRS (GMSK, 2 Tx slots) – CS1	26.88	26.98	27.10	27.50				
DTM 5 (2Tx slots)	GSM (GMSK, 1 Tx slot)	28.91	28.98	29.00	29.50	21.50	21.56	21.58	22.07
	EDGE (8PSK, 1 Tx slot) – MCS5	25.48	25.51	25.52	26.00				
DTM 9 (2Tx slots)	GSM (GMSK, 1 Tx slot)	28.91	28.99	29.00	29.50	21.50	21.58	21.57	22.07
	EDGE (8PSK, 1 Tx slot) – MCS5	25.46	25.53	25.49	26.00				
DTM 11 (3Tx slots)	GSM (GMSK, 1 Tx slot)	27.13	27.22	27.35	27.50	21.09	21.09	21.19	21.48
	EDGE (8PSK, 2 Tx slots) – MCS5	24.08	23.98	24.05	24.50				

Band GSM1900		Burst Average Power (dBm)			Tune-up Limit (dBm)	Frame-Average Power (dBm)			Tune-up Limit (dBm)
Tx Channel	512	661	810	512		661	810		
Frequency (MHz)		1850.2	1880	1909.8	(dBm)	1850.2	1880	1909.8	
GSM (GMSK, 1 Tx slot)		24.15	24.39	24.55	25.00	15.15	15.39	15.55	16.00
GPRS (GMSK, 1 Tx slot) – CS1		24.12	24.38	24.54	25.00	15.12	15.38	15.54	16.00
GPRS (GMSK, 2 Tx slots) – CS1		21.04	21.28	21.30	21.50	15.04	15.28	15.30	15.50
GPRS (GMSK, 3 Tx slots) – CS1		19.56	19.68	19.82	20.00	15.30	15.42	15.56	15.74
GPRS (GMSK, 4 Tx slots) – CS1		18.04	18.04	18.26	19.00	15.04	15.04	15.26	16.00
EDGE (8PSK, 1 Tx slot) – MCS5		23.96	24.00	24.04	24.50	14.96	15.00	15.04	15.50
EDGE (8PSK, 2 Tx slots) – MCS5		20.94	20.96	21.02	21.50	14.94	14.96	15.02	15.50
EDGE (8PSK, 3 Tx slots) – MCS5		19.42	19.45	19.42	20.00	15.16	15.19	15.16	15.74
EDGE (8PSK, 4 Tx slots) – MCS5		17.80	17.90	17.91	18.50	14.80	14.90	14.91	15.50
DTM 5 (2Tx slots)	GSM (GMSK, 1 Tx slot)	21.06	21.24	21.28	21.50	15.02	15.23	15.25	15.48
	GPRS (GMSK, 1 Tx slot) – CS1	21.03	21.26	21.27	21.50				
DTM 9 (2Tx slots)	GSM (GMSK, 1 Tx slot)	21.03	21.21	21.24	21.50	14.99	15.20	15.22	15.48
	GPRS (GMSK, 1 Tx slot) – CS1	21.00	21.23	21.25	21.50				
DTM 11 (3Tx slots)	GSM (GMSK, 1 Tx slot)	19.53	19.62	19.75	20.00	15.24	15.29	15.46	15.74
	GPRS (GMSK, 2 Tx slots) – CS1	19.48	19.52	19.70	20.00				
DTM 5 (2Tx slots)	GSM (GMSK, 1 Tx slot)	21.00	21.26	21.28	21.50	14.93	15.07	15.12	15.48
	EDGE (8PSK, 1 Tx slot) – MCS5	20.91	20.92	21.00	21.50				
DTM 9 (2Tx slots)	GSM (GMSK, 1 Tx slot)	21.02	21.23	21.30	21.50	14.93	15.05	15.13	15.48
	EDGE (8PSK, 1 Tx slot) – MCS5	20.89	20.91	20.99	21.50				
DTM 11 (3Tx slots)	GSM (GMSK, 1 Tx slot)	19.48	19.58	19.76	20.00	15.17	15.21	15.26	15.74
	EDGE (8PSK, 2 Tx slots) – MCS5	19.40	19.42	19.40	20.00				

<WCDMA Conducted Power>

1. The following tests were conducted according to the test requirements outlines in 3GPP TS 34.121 specification.
2. The procedures in KDB 941225 D01 are applied for 3GPP Rel. 6 HSPA to configure the device in the required sub-test mode(s) to determine SAR test exclusion.
3. For DC-HSDPA, the device was configured according to the H-Set 12, Fixed Reference Channel (FRC) configuration in Table C.8.1.12 of 3GPP TS 34.121-1, with the primary and the secondary serving HS-DSCH Cell enabled during the power measurement.

A summary of these settings are illustrated below:

HSDPA Setup Configuration:

- a. The EUT was connected to Base Station Agilent E5515C referred to the Setup Configuration.
- b. The RF path losses were compensated into the measurements.
- c. A call was established between EUT and Base Station with following setting:
 - i. Set Gain Factors (β_c and β_d) and parameters were set according to each
 - ii. Specific sub-test in the following table, C10.1.4, quoted from the TS 34.121
 - iii. Set RMC 12.2Kbps + HSDPA mode.
 - iv. Set Cell Power = -86 dBm
 - v. Set HS-DSCH Configuration Type to FRC (H-set 1, QPSK)
 - vi. Select HSDPA Uplink Parameters
 - vii. Set Delta ACK, Delta NACK and Delta CQI = 8
 - viii. Set Ack-Nack Repetition Factor to 3
 - ix. Set CQI Feedback Cycle (k) to 4 ms
 - x. Set CQI Repetition Factor to 2
 - xi. Power Ctrl Mode = All Up bits
- d. The transmitted maximum output power was recorded.

Table C.10.1.4: β values for transmitter characteristics tests with HS-DPCCH

Sub-test	β_c	β_d	β_d (SF)	β_c/β_d	β_{HS} (Note 1, Note 2)	CM (dB) (Note 3)	MPR (dB) (Note 3)
1	2/15	15/15	64	2/15	4/15	0.0	0.0
2	12/15 (Note 4)	15/15 (Note 4)	64	12/15 (Note 4)	24/15	1.0	0.0
3	15/15	8/15	64	15/8	30/15	1.5	0.5
4	15/15	4/15	64	15/4	30/15	1.5	0.5

Note 1: $\Delta_{ACK}, \Delta_{NACK}$ and $\Delta_{CQI} = 30/15$ with $\beta_{HS} = 30/15 * \beta_c$.

Note 2: For the HS-DPCCH power mask requirement test in clause 5.2C, 5.7A, and the Error Vector Magnitude (EVM) with HS-DPCCH test in clause 5.13.1A, and HSDPA EVM with phase discontinuity in clause 5.13.1AA, Δ_{ACK} and $\Delta_{NACK} = 30/15$ with $\beta_{HS} = 30/15 * \beta_c$, and $\Delta_{CQI} = 24/15$ with $\beta_{HS} = 24/15 * \beta_c$.

Note 3: CM = 1 for $\beta_c/\beta_d = 12/15$, $\beta_{HS}/\beta_c = 24/15$. For all other combinations of DPDCH, DPCCH and HS-DPCCH the MPR is based on the relative CM difference. This is applicable for only UEs that support HSDPA in release 6 and later releases.

Note 4: For subtest 2 the β_c/β_d ratio of 12/15 for the TFC during the measurement period (TF1, TF0) is achieved by setting the signalled gain factors for the reference TFC (TF1, TF1) to $\beta_c = 11/15$ and $\beta_d = 15/15$.

Setup Configuration

HSUPA Setup Configuration:

- a. The EUT was connected to Base Station Agilent E5515C referred to the Setup Configuration.
- b. The RF path losses were compensated into the measurements.
- c. A call was established between EUT and Base Station with following setting * :
 - i. Call Configs = 5.2B, 5.9B, 5.10B, and 5.13.2B with QPSK
 - ii. Set the Gain Factors (β_c and β_d) and parameters (AG Index) were set according to each specific sub-test in the following table, C11.1.3, quoted from the TS 34.121
 - iii. Set Cell Power = -86 dBm
 - iv. Set Channel Type = 12.2k + HSPA
 - v. Set UE Target Power
 - vi. Power Ctrl Mode= Alternating bits
 - vii. Set and observe the E-TFCl
 - viii. Confirm that E-TFCl is equal to the target E-TFCl of 75 for sub-test 1, and other subtest's E-TFCl
- d. The transmitted maximum output power was recorded.

Table C.11.1.3: β values for transmitter characteristics tests with HS-DPCCH and E-DCH

Sub-test	β_c	β_d	β_d (SF)	β_c/β_d	β_{HS} (Note 1)	β_{ec}	β_{ed} (Note 5) (Note 6)	β_{ed} (SF)	β_{ed} (Codes)	CM (dB) (Note 2)	MPR (dB) (Note 2)	AG Index (Note 6)	E-TFCl
1	11/15 (Note 3)	15/15 (Note 3)	64	11/15 (Note 3)	22/15	209/25	1309/225	4	1	1.0	0.0	20	75
2	6/15	15/15	64	6/15	12/15	12/15	94/75	4	1	3.0	2.0	12	67
3	15/15	9/15	64	15/9	30/15	30/15	$\beta_{ed1}: 47/15$ $\beta_{ed2}: 47/15$	4 4	2	2.0	1.0	15	92
4	2/15	15/15	64	2/15	4/15	2/15	56/75	4	1	3.0	2.0	17	71
5	15/15 (Note 4)	15/15 (Note 4)	64	15/15 (Note 4)	30/15	24/15	134/15	4	1	1.0	0.0	21	81

Note 1: $\Delta_{ACK}, \Delta_{NACK}$ and $\Delta_{CQI} = 30/15$ with $\beta_{hs} = 30/15 * \beta_c$.

Note 2: CM = 1 for $\beta_c/\beta_d = 12/15$, $\beta_{hs}/\beta_c = 24/15$. For all other combinations of DPDCH, DPCCH, HS- DPCCH, E-DPDCH and E-DPCCH the MPR is based on the relative CM difference.

Note 3: For subtest 1 the β_c/β_d ratio of 11/15 for the TFC during the measurement period (TF1, TF0) is achieved by setting the signalled gain factors for the reference TFC (TF1, TF1) to $\beta_c = 10/15$ and $\beta_d = 15/15$.

Note 4: For subtest 5 the β_c/β_d ratio of 15/15 for the TFC during the measurement period (TF1, TF0) is achieved by setting the signalled gain factors for the reference TFC (TF1, TF1) to $\beta_c = 14/15$ and $\beta_d = 15/15$.

Note 5: In case of testing by UE using E-DPDCH Physical Layer category 1, Sub-test 3 is omitted according to TS25.306 Table 5.1g.

Note 6: β_{ed} can not be set directly, it is set by Absolute Grant Value.

Setup Configuration

DC-HSDPA 3GPP release 8 Setup Configuration:

- a. The EUT was connected to Base Station Agilent E5515C referred to the Setup Configuration below
- b. The RF path losses were compensated into the measurements.
- c. A call was established between EUT and Base Station with following setting:
 - i. Set RMC 12.2Kbps + HSDPA mode.
 - ii. Set Cell Power = -25 dBm
 - iii. Set HS-DSCH Configuration Type to FRC (H-set 12, QPSK)
 - iv. Select HSDPA Uplink Parameters
 - v. Set Gain Factors (β_c and β_d) and parameters were set according to each Specific sub-test in the following table, C10.1.4, quoted from the TS 34.121
 - a). Subtest 1: $\beta_c/\beta_d=2/15$
 - b). Subtest 2: $\beta_c/\beta_d=12/15$
 - c). Subtest 3: $\beta_c/\beta_d=15/8$
 - d). Subtest 4: $\beta_c/\beta_d=15/4$
 - vi. Set Delta ACK, Delta NACK and Delta CQI = 8
 - vii. Set Ack-Nack Repetition Factor to 3
 - viii. Set CQI Feedback Cycle (k) to 4 ms
 - ix. Set CQI Repetition Factor to 2
 - x. Power Ctrl Mode = All Up bits
- d. The transmitted maximum output power was recorded.

The following tests were conducted according to the test requirements outlines in 3GPP TS 34.121 specification. A summary of these settings are illustrated below:

C.8.1.12 Fixed Reference Channel Definition H-Set 12

Table C.8.1.12: Fixed Reference Channel H-Set 12

Parameter	Unit	Value
Nominal Avg. Inf. Bit Rate	kbps	60
Inter-TTI Distance	TTI's	1
Number of HARQ Processes	Processes	6
Information Bit Payload (N_{INF})	Bits	120
Number Code Blocks	Blocks	1
Binary Channel Bits Per TTI	Bits	960
Total Available SML's in UE	SML's	19200
Number of SML's per HARQ Proc.	SML's	3200
Coding Rate		0.15
Number of Physical Channel Codes	Codes	1
Modulation		QPSK
Note 1: The RMC is intended to be used for DC-HSDPA mode and both cells shall transmit with identical parameters as listed in the table. Note 2: Maximum number of transmission is limited to 1, i.e., retransmission is not allowed. The redundancy and constellation version 0 shall be used.		

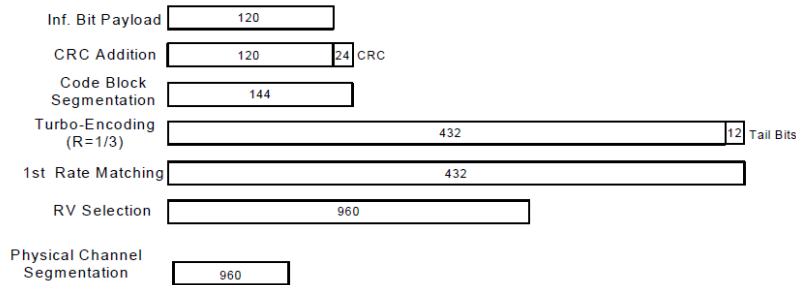

Figure C.8.19: Coding rate for Fixed reference Channel H-Set 12 (QPSK)

Setup Configuration

<WCDMA Conducted Power>

General Note:

1. Per KDB 941225 D01v03, SAR for Head / Hotspot / Body-worn exposure is measured using a 12.2 kbps RMC with TPC bits configured to all "1's".
2. Per KDB 941225 D01v03, RMC 12.2kbps setting is used to evaluate SAR. If the maximum output power and tune-up tolerance specified for production units in HSDPA / HSUPA / DC-HSDPA is $\leq \frac{1}{4}$ dB higher than RMC 12.2Kbps or when the highest reported SAR of the RMC12.2Kbps is scaled by the ratio of specified maximum output power and tune-up tolerance of HSDPA / HSUPA / DC-HSDPA to RMC12.2Kbps and the adjusted SAR is ≤ 1.2 W/kg, SAR measurement is not required for HSDPA / HSUPA / DC-HSDPA.

<Full Power Mode>:

Band			WCDMA Band V			WCDMA Band II		
Tx Channel			4132	4182	4233	9262	9400	9538
Rx Channel			4357	4407	4458	9662	9800	9938
Frequency (MHz)			826.4	836.4	846.6	1852.4	1880	1907.6
MPR (dB)	3GPP Rel 99	AMR 12.2Kbps	23.41	23.35	23.27	21.98	22.07	22.09
	3GPP Rel 99	RMC 12.2Kbps	23.42	23.37	23.28	21.99	22.10	22.11
0	3GPP Rel 6	HSDPA Subtest-1	21.84	21.68	21.69	20.70	20.83	20.80
0	3GPP Rel 6	HSDPA Subtest-2	21.82	21.67	21.40	20.69	20.92	20.60
0.5	3GPP Rel 6	HSDPA Subtest-3	21.76	21.30	21.63	20.53	20.38	20.64
0.5	3GPP Rel 6	HSDPA Subtest-4	21.39	21.60	21.62	20.17	20.78	20.63
0	3GPP Rel 8	DC-HSDPA Subtest-1	21.71	21.71	21.77	20.67	20.72	20.78
0	3GPP Rel 8	DC-HSDPA Subtest-2	21.73	21.78	21.76	20.66	20.71	20.77
0.5	3GPP Rel 8	DC-HSDPA Subtest-3	21.72	21.81	21.80	20.64	20.68	20.76
0.5	3GPP Rel 8	DC-HSDPA Subtest-4	21.77	21.82	21.78	20.64	20.69	20.77
0	3GPP Rel 6	HSUPA Subtest-1	21.80	21.68	21.84	20.45	20.49	20.87
2	3GPP Rel 6	HSUPA Subtest-2	20.92	20.82	20.44	19.78	19.95	19.52
1	3GPP Rel 6	HSUPA Subtest-3	20.72	20.42	20.10	19.60	19.62	19.58
2	3GPP Rel 6	HSUPA Subtest-4	21.31	21.07	21.40	19.96	20.20	20.56
0	3GPP Rel 6	HSUPA Subtest-5	21.57	21.50	21.43	20.34	20.51	20.43

<Reduced Power Mode, for reverse call >:

Band			WCDMA Band II		
Tx Channel			9262	9400	9538
Rx Channel			9662	9800	9938
Frequency (MHz)			1852.4	1880	1907.6
MPR (dB)	3GPP Rel 99	AMR 12.2Kbps	16.20	16.11	16.23
	3GPP Rel 99	RMC 12.2Kbps	16.21	16.13	16.24
0	3GPP Rel 6	HSDPA Subtest-1	14.76	14.67	14.78
0	3GPP Rel 6	HSDPA Subtest-2	14.74	14.68	14.76
0.5	3GPP Rel 6	HSDPA Subtest-3	14.71	14.68	14.74
0.5	3GPP Rel 6	HSDPA Subtest-4	14.52	14.79	14.72
0	3GPP Rel 8	DC-HSDPA Subtest-1	14.71	14.81	14.78
0	3GPP Rel 8	DC-HSDPA Subtest-2	14.68	14.80	14.65
0.5	3GPP Rel 8	DC-HSDPA Subtest-3	14.66	14.77	14.69
0.5	3GPP Rel 8	DC-HSDPA Subtest-4	14.63	14.78	14.68
0	3GPP Rel 6	HSUPA Subtest-1	14.82	14.91	14.98
2	3GPP Rel 6	HSUPA Subtest-2	14.20	14.38	14.08
1	3GPP Rel 6	HSUPA Subtest-3	13.82	14.02	13.71
2	3GPP Rel 6	HSUPA Subtest-4	14.41	14.60	14.65
0	3GPP Rel 6	HSUPA Subtest-5	14.69	14.96	14.80

**<LTE Conducted Power>****General Note:**

1. Anritsu MT8820C base station simulator was used to setup the connection with EUT; the frequency band, channel bandwidth, RB allocation configuration, modulation type are set in the base station simulator to configure EUT transmitting at maximum power and at different configurations which are requested to be reported to FCC, for conducted power measurement and SAR testing.
2. Per KDB 941225 D05v02r03, when a properly configured base station simulator is used for the SAR and power measurements, spectrum plots for each RB allocation and offset configuration is not required.
3. Per KDB 941225 D05v02r03, start with the largest channel bandwidth and measure SAR for QPSK with 1 RB allocation, using the RB offset and required test channel combination with the highest maximum output power for RB offsets at the upper edge, middle and lower edge of each required test channel.
4. Per KDB 941225 D05v02r03, 50% RB allocation for QPSK SAR testing follows 1RB QPSK allocation procedure.
5. Per KDB 941225 D05v02r03, For QPSK with 100% RB allocation, SAR is not required when the highest maximum output power for 100 % RB allocation is less than the highest maximum output power in 50% and 1 RB allocations and the highest reported SAR for 1 RB and 50% RB allocation are ≤ 0.8 W/kg. Otherwise, SAR is measured for the highest output power channel; and if the reported SAR is > 1.45 W/kg, the remaining required test channels must also be tested.
6. Per KDB 941225 D05v02r03, 16QAM output power for each RB allocation configuration is $>$ not $\frac{1}{2}$ dB higher than the same configuration in QPSK and the reported SAR for the QPSK configuration is ≤ 1.45 W/kg; Per KDB 941225 D05v02r03, 16QAM SAR testing is not required.
7. Per KDB 941225 D05v02r03, Smaller bandwidth output power for each RB allocation configuration is $>$ not $\frac{1}{2}$ dB higher than the same configuration in the largest supported bandwidth, and the reported SAR for the largest supported bandwidth is ≤ 1.45 W/kg; Per KDB 941225 D05v02r03, smaller bandwidth SAR testing is not required.



<Full Power Mode>

<LTE Band 4>

BW [MHz]	Modulation	RB Size	RB Offset	Power Low Ch. / Freq.	Power Middle Ch. / Freq.	Power High Ch. / Freq.	Tune up Limit (dBm)	MPR (dB)
Channel				20050	20175	20300		
Frequency (MHz)				1720	1732.5	1745		
20	QPSK	1	0	22.18	22.37	22.33	22.5	0
20	QPSK	1	49	22.14	22.35	22.06		
20	QPSK	1	99	21.93	21.91	21.77		
20	QPSK	50	0	21.11	21.20	21.17	21.5	1
20	QPSK	50	24	21.03	21.13	20.97		
20	QPSK	50	49	20.96	21.08	21.02		
20	QPSK	100	0	21.11	21.17	21.06	21.5	1
20	16QAM	1	0	21.47	21.20	20.97		
20	16QAM	1	49	21.44	21.43	21.37		
20	16QAM	1	99	21.48	20.94	20.81	20.5	2
20	16QAM	50	0	20.22	20.27	20.20		
20	16QAM	50	24	20.08	20.19	19.93		
20	16QAM	50	49	20.07	20.07	19.93	20.5	2
20	16QAM	50	99	20.07	20.07	19.93		
20	16QAM	100	0	20.10	20.20	20.04		
Channel				20025	20175	20325	Tune up Limit (dBm)	MPR (dB)
Frequency (MHz)				1717.5	1732.5	1747.5		
15	QPSK	1	0	22.28	22.26	22.32	22.5	0
15	QPSK	1	37	22.35	22.35	22.30		
15	QPSK	1	74	22.20	21.98	22.05		
15	QPSK	36	0	21.15	21.23	21.03	21.5	1
15	QPSK	36	18	21.05	21.22	21.24		
15	QPSK	36	37	20.99	21.08	20.98		
15	QPSK	75	0	21.02	21.17	21.20	21.5	1
15	16QAM	1	0	21.39	21.43	21.28		
15	16QAM	1	37	21.41	21.48	21.11		
15	16QAM	1	74	21.42	21.41	21.40	20.5	2
15	16QAM	36	0	20.18	20.24	20.02		
15	16QAM	36	18	20.15	20.22	19.97		
15	16QAM	36	37	20.20	20.09	20.04	20.5	2
15	16QAM	36	74	20.20	20.09	20.04		
15	16QAM	75	0	20.10	20.22	19.94		
Channel				20000	20175	20350	Tune up Limit (dBm)	MPR (dB)
Frequency (MHz)				1715	1732.5	1750		
10	QPSK	1	0	22.12	22.27	22.26	22.5	0
10	QPSK	1	24	22.24	22.28	22.23		
10	QPSK	1	49	22.23	22.02	21.93		
10	QPSK	25	0	21.15	21.27	21.15	21.5	1
10	QPSK	25	12	21.07	21.26	21.15		
10	QPSK	25	24	21.09	21.11	21.04		
10	QPSK	50	0	21.03	21.20	21.10	21.5	1
10	16QAM	1	0	21.45	21.45	21.44		
10	16QAM	1	24	21.36	21.48	20.97		
10	16QAM	1	49	21.20	21.46	21.22	20.5	2
10	16QAM	25	0	20.11	20.19	20.25		
10	16QAM	25	12	20.14	20.33	20.16		
10	16QAM	25	24	20.06	20.08	20.08	20.5	2
10	16QAM	25	49	20.06	20.08	20.08		
10	16QAM	50	0	20.14	20.26	20.09		



BW [MHz]	Modulation	RB Size	RB Offset	Power Low Ch. / Freq.	Power Middle Ch. / Freq.	Power High Ch. / Freq.	Tune up Limit (dBm)	MPR (dB)
Channel				19975	20175	20375		
Frequency (MHz)				1712.5	1732.5	1752.5		
5	QPSK	1	0	22.03	22.20	22.20	22.5	0
5	QPSK	1	12	22.27	22.36	22.32		
5	QPSK	1	24	21.93	22.06	21.89		
5	QPSK	12	0	21.07	21.17	21.13	21.5	1
5	QPSK	12	6	21.09	21.15	21.08		
5	QPSK	12	11	21.07	21.08	20.94		
5	QPSK	25	0	21.09	21.14	20.97		
5	16QAM	1	0	21.48	21.43	21.03	21.5	1
5	16QAM	1	12	21.42	21.48	21.39		
5	16QAM	1	24	21.32	20.89	20.85		
5	16QAM	12	0	20.25	20.24	20.25	20.5	2
5	16QAM	12	6	20.25	20.17	20.18		
5	16QAM	12	11	20.03	19.98	19.91		
5	16QAM	12	11	20.03	19.98	19.91		
5	16QAM	25	0	20.01	20.23	19.83		
Channel				19965	20175	20385	Tune up Limit (dBm)	MPR (dB)
Frequency (MHz)				1711.5	1732.5	1753.5		
3	QPSK	1	0	21.69	21.83	21.52	22.5	0
3	QPSK	1	7	22.15	21.88	21.39		
3	QPSK	1	14	21.74	21.36	21.31		
3	QPSK	8	0	20.68	20.78	20.71	21.5	1
3	QPSK	8	4	20.69	20.75	20.59		
3	QPSK	8	7	20.68	20.70	20.52		
3	QPSK	15	0	20.68	20.81	20.55		
3	16QAM	1	0	20.84	20.74	20.31	21.5	1
3	16QAM	1	7	21.04	20.59	20.12		
3	16QAM	1	14	20.75	20.96	20.75		
3	16QAM	8	0	19.73	19.94	19.56	20.5	2
3	16QAM	8	4	19.81	19.99	19.39		
3	16QAM	8	7	19.77	19.92	19.36		
3	16QAM	8	7	19.77	19.92	19.36		
3	16QAM	15	0	19.66	20.08	19.22		
Channel				19957	20175	20393	Tune up Limit (dBm)	MPR (dB)
Frequency (MHz)				1710.7	1732.5	1754.3		
1.4	QPSK	1	0	21.62	21.48	21.48	22.5	0
1.4	QPSK	1	2	21.57	21.72	21.61		
1.4	QPSK	1	5	21.56	21.73	21.38		
1.4	QPSK	3	0	21.78	21.82	21.62		
1.4	QPSK	3	1	21.81	21.87	21.71		
1.4	QPSK	3	2	21.74	21.80	21.60		
1.4	QPSK	6	0	20.57	20.73	20.55	21.5	1
1.4	16QAM	1	0	21.18	21.38	21.09	21.5	1
1.4	16QAM	1	2	20.72	21.48	21.28		
1.4	16QAM	1	5	20.85	20.69	21.14		
1.4	16QAM	3	0	20.54	20.61	20.78		
1.4	16QAM	3	1	20.61	20.82	20.83		
1.4	16QAM	3	2	20.50	20.63	20.79		
1.4	16QAM	6	0	19.42	19.22	19.49		



<LTE Band 2>

BW [MHz]	Modulation	RB Size	RB Offset	Power Low Ch. / Freq.	Power Middle Ch. / Freq.	Power High Ch. / Freq.	Tune up Limit (dBm)	MPR (dB)
Channel				18700	18900	19100		
Frequency (MHz)				1860	1880	1900		
20	QPSK	1	0	21.93	21.98	21.94	22.5	0
20	QPSK	1	49	21.95	22.30	22.28		
20	QPSK	1	99	21.71	21.89	21.86		
20	QPSK	50	0	20.62	20.93	20.90	21.5	1
20	QPSK	50	24	20.63	20.96	20.94		
20	QPSK	50	49	20.59	20.80	20.91		
20	QPSK	100	0	20.70	20.95	20.93	21.5	1
20	16QAM	1	0	21.12	21.41	21.37		
20	16QAM	1	49	21.20	21.05	21.33		
20	16QAM	1	99	21.09	21.02	21.24	20.5	2
20	16QAM	50	0	19.84	19.99	19.96		
20	16QAM	50	24	19.76	19.86	19.91		
20	16QAM	50	49	19.66	19.88	19.91	20.5	2
20	16QAM	100	0	19.75	19.85	19.93		
Channel				18675	18900	19125		
Frequency (MHz)				1857.5	1880	1902.5		
15	QPSK	1	0	21.88	22.10	22.29	22.5	0
15	QPSK	1	37	22.07	22.14	22.21		
15	QPSK	1	74	21.84	21.87	22.12		
15	QPSK	36	0	20.80	20.95	20.95	21.5	1
15	QPSK	36	18	20.65	20.85	20.90		
15	QPSK	36	37	20.62	20.90	20.90		
15	QPSK	75	0	20.69	20.91	20.91	21.5	1
15	16QAM	1	0	21.49	20.84	21.35		
15	16QAM	1	37	21.46	21.41	20.65		
15	16QAM	1	74	21.16	20.80	21.48	20.5	2
15	16QAM	36	0	19.89	19.91	20.05		
15	16QAM	36	18	19.75	19.86	19.92		
15	16QAM	36	37	19.77	19.84	19.79	20.5	2
15	16QAM	75	0	19.72	19.94	19.90		
Channel				18650	18900	19150		
Frequency (MHz)				1855	1880	1905		
10	QPSK	1	0	21.87	22.08	22.02	22.5	0
10	QPSK	1	24	21.81	22.01	22.09		
10	QPSK	1	49	21.82	21.68	21.94		
10	QPSK	25	0	20.78	20.98	20.92	21.5	1
10	QPSK	25	12	20.74	20.95	20.96		
10	QPSK	25	24	20.65	20.91	20.97		
10	QPSK	50	0	20.66	20.82	21.04	21.5	1
10	16QAM	1	0	21.25	21.45	21.47		
10	16QAM	1	24	20.90	21.44	21.45		
10	16QAM	1	49	21.11	21.40	21.37	20.5	2
10	16QAM	25	0	19.91	19.93	20.05		
10	16QAM	25	12	19.88	20.02	19.96		
10	16QAM	25	24	19.77	19.99	19.80	20.5	2
10	16QAM	25	24	19.77	19.99	19.80		
10	16QAM	50	0	19.85	19.88	19.94		



BW [MHz]	Modulation	RB Size	RB Offset	Power Low Ch. / Freq.	Power Middle Ch. / Freq.	Power High Ch. / Freq.	Tune up Limit (dBm)	MPR (dB)
Channel				18625	18900	19175		
Frequency (MHz)				1852.5	1880	1907.5		
5	QPSK	1	0	21.73	21.84	22.17	22.5	0
5	QPSK	1	12	21.88	22.11	22.23		
5	QPSK	1	24	21.67	21.83	22.06		
5	QPSK	12	0	20.67	20.92	20.95	21.5	1
5	QPSK	12	6	20.73	20.90	21.00		
5	QPSK	12	11	20.63	20.88	20.97		
5	QPSK	25	0	20.67	20.84	20.99	21.5	1
5	16QAM	1	0	21.17	21.26	21.47		
5	16QAM	1	12	21.06	20.87	21.43		
5	16QAM	1	24	20.70	21.22	20.91	20.5	2
5	16QAM	12	0	19.65	19.83	19.73		
5	16QAM	12	6	19.72	20.02	19.80		
5	16QAM	12	11	19.66	19.91	19.78		
5	16QAM	25	0	19.64	19.97	19.93		
Channel				18615	18900	19185	Tune up Limit (dBm)	MPR (dB)
Frequency (MHz)				1851.5	1880	1908.5		
3	QPSK	1	0	21.36	21.36	21.34	22.5	0
3	QPSK	1	7	21.99	21.59	21.58		
3	QPSK	1	14	21.31	21.56	21.65		
3	QPSK	8	0	20.49	20.48	20.47	21.5	1
3	QPSK	8	4	20.46	20.43	20.40		
3	QPSK	8	7	20.45	20.58	20.45		
3	QPSK	15	0	20.36	20.44	20.39	21.5	1
3	16QAM	1	0	21.05	20.98	20.30		
3	16QAM	1	7	21.44	21.42	19.85		
3	16QAM	1	14	21.29	21.08	19.90	20.5	2
3	16QAM	8	0	19.65	19.76	19.23		
3	16QAM	8	4	19.64	19.61	19.11		
3	16QAM	8	7	19.67	19.76	19.30		
3	16QAM	15	0	19.56	19.79	19.04		
Channel				18607	18900	19193	Tune up Limit (dBm)	MPR (dB)
Frequency (MHz)				1850.7	1880	1909.3		
1.4	QPSK	1	0	21.47	21.44	21.47	22.5	0
1.4	QPSK	1	2	21.44	21.60	21.40		
1.4	QPSK	1	5	21.41	21.48	21.40		
1.4	QPSK	3	0	21.54	21.63	21.56		
1.4	QPSK	3	1	21.62	21.72	21.65		
1.4	QPSK	3	2	21.59	21.56	21.54		
1.4	QPSK	6	0	20.42	20.54	20.40	21.5	1
1.4	16QAM	1	0	20.80	20.92	20.82	21.5	1
1.4	16QAM	1	2	20.75	20.47	20.92		
1.4	16QAM	1	5	20.39	21.00	20.49		
1.4	16QAM	3	0	20.23	20.17	20.33		
1.4	16QAM	3	1	20.33	20.49	20.90		
1.4	16QAM	3	2	20.57	20.38	20.82		
1.4	16QAM	6	0	19.33	19.30	19.39	20.5	2



<LTE Band 7>

BW [MHz]	Modulation	RB Size	RB Offset	Power Low Ch. / Freq.	Power Middle Ch. / Freq.	Power High Ch. / Freq.	Tune up Limit (dBm)	MPR (dB)
Channel				20850	21100	21350		
Frequency (MHz)				2510	2535	2560		
20	QPSK	1	0	22.94	22.99	22.89	23.5	0
20	QPSK	1	49	22.84	22.89	22.81		
20	QPSK	1	99	22.73	22.73	22.70		
20	QPSK	50	0	21.74	21.84	21.72	22.5	1
20	QPSK	50	24	21.69	21.73	21.62		
20	QPSK	50	49	21.70	21.64	21.60		
20	QPSK	100	0	21.74	21.85	21.62	22.5	1
20	16QAM	1	0	22.07	22.43	21.83		
20	16QAM	1	49	22.23	22.40	21.82		
20	16QAM	1	99	22.43	22.28	21.69	21.5	2
20	16QAM	50	0	20.79	20.77	20.71		
20	16QAM	50	24	20.71	20.73	20.57		
20	16QAM	50	49	20.68	20.74	20.59	21.5	2
20	16QAM	100	0	20.83	20.81	20.61		
Channel				20825	21100	21375	Tune up Limit (dBm)	MPR (dB)
Frequency (MHz)				2507.5	2535	2562.5		
15	QPSK	1	0	22.97	22.95	22.83	23.5	0
15	QPSK	1	37	22.96	22.81	22.89		
15	QPSK	1	74	22.87	22.79	22.82		
15	QPSK	36	0	21.81	21.71	21.63	22.5	1
15	QPSK	36	18	21.50	21.69	21.62		
15	QPSK	36	37	21.64	21.65	21.51		
15	QPSK	75	0	21.56	21.65	21.59	22.5	1
15	16QAM	1	0	22.03	22.01	21.81		
15	16QAM	1	37	21.97	22.18	21.89		
15	16QAM	1	74	22.15	21.96	21.69	21.5	2
15	16QAM	36	0	20.78	20.75	20.57		
15	16QAM	36	18	20.69	20.67	20.71		
15	16QAM	36	37	20.56	20.67	20.64	21.5	2
15	16QAM	75	0	20.70	20.78	20.55		



BW [MHz]	Modulation	RB Size	RB Offset	Power Low Ch. / Freq.	Power Middle Ch. / Freq.	Power High Ch. / Freq.	Tune up Limit (dBm)	MPR (dB)
Channel				20800	21100	21400		
Frequency (MHz)				2505	2535	2565		
10	QPSK	1	0	22.91	22.80	22.77	23.5	0
10	QPSK	1	24	22.89	22.82	22.71		
10	QPSK	1	49	22.69	22.85	22.61		
10	QPSK	25	0	21.82	21.70	21.67	22.5	1
10	QPSK	25	12	21.78	21.63	21.56		
10	QPSK	25	24	21.72	21.66	21.53		
10	QPSK	50	0	21.70	21.72	21.60		
10	16QAM	1	0	22.49	22.45	21.90	22.5	1
10	16QAM	1	24	22.47	21.86	21.87		
10	16QAM	1	49	22.37	22.19	21.78		
10	16QAM	25	0	20.77	20.88	20.68	21.5	2
10	16QAM	25	12	20.91	20.71	20.65		
10	16QAM	25	24	20.71	20.69	20.57		
10	16QAM	50	0	20.70	20.69	20.58		
Channel				20775	21100	21425	Tune up Limit (dBm)	MPR (dB)
Frequency (MHz)				2502.5	2535	2567.5		
5	QPSK	1	0	22.74	22.64	22.56	23.5	0
5	QPSK	1	12	22.68	22.87	22.92		
5	QPSK	1	24	22.73	22.65	22.54		
5	QPSK	12	0	21.80	21.66	21.56	22.5	1
5	QPSK	12	6	21.77	21.71	21.60		
5	QPSK	12	11	21.86	21.71	21.57		
5	QPSK	25	0	21.75	21.59	21.57		
5	16QAM	1	0	21.59	21.96	21.92	22.5	1
5	16QAM	1	12	22.33	21.97	22.42		
5	16QAM	1	24	22.09	22.07	22.03		
5	16QAM	12	0	20.50	20.85	20.70	21.5	2
5	16QAM	12	6	20.70	20.70	20.61		
5	16QAM	12	11	20.75	20.88	20.52		
5	16QAM	25	0	20.68	20.75	20.58		



< Reduced Power Mode, for reverse call >

<LTE Band 4>

BW [MHz]	Modulation	RB Size	RB Offset	Power Low Ch. / Freq.	Power Middle Ch. / Freq.	Power High Ch. / Freq.	Tune up Limit (dBm)	MPR (dB)
Channel				20050	20175	20300	18.0	0
Frequency (MHz)				1720	1732.5	1745		
20	QPSK	1	0	17.76	17.81	17.67		
20	QPSK	1	49	17.65	17.14	17.46	18.0	0
20	QPSK	1	99	17.68	17.24	17.14		
20	QPSK	50	0	17.39	17.65	17.35		
20	QPSK	50	24	17.19	17.16	17.01	18.0	0
20	QPSK	50	49	17.21	17.15	17.10		
20	QPSK	100	0	17.20	17.31	17.04		
20	16QAM	1	0	17.51	17.50	17.29	18.0	0
20	16QAM	1	49	17.58	17.54	17.26		
20	16QAM	1	99	17.33	17.53	17.02		
20	16QAM	50	0	17.34	17.13	17.11	18.0	0
20	16QAM	50	24	17.27	17.13	17.06		
20	16QAM	50	49	17.22	17.12	17.09		
20	16QAM	100	0	17.32	17.16	17.01		
Channel				20025	20175	20325	18.0	0
Frequency (MHz)				1717.5	1732.5	1747.5		
15	QPSK	1	0	17.38	17.36	17.15		
15	QPSK	1	37	17.34	17.45	17.47	18.0	0
15	QPSK	1	74	17.22	16.94	16.78		
15	QPSK	36	0	17.20	17.20	16.89		
15	QPSK	36	18	17.06	17.20	16.93	18.0	0
15	QPSK	36	37	16.95	17.04	16.97		
15	QPSK	75	0	17.04	17.17	16.88		
15	16QAM	1	0	17.58	17.79	17.11	18.0	0
15	16QAM	1	37	17.59	17.40	17.41		
15	16QAM	1	74	17.24	17.39	17.01		
15	16QAM	36	0	17.12	17.23	16.98	18.0	0
15	16QAM	36	18	17.15	17.17	17.00		
15	16QAM	36	37	17.01	17.00	16.99		
15	16QAM	75	0	17.01	17.15	16.87		
Channel				20000	20175	20350	18.0	0
Frequency (MHz)				1715	1732.5	1750		
10	QPSK	1	0	17.24	17.35	17.35		
10	QPSK	1	24	17.35	17.23	17.15	18.0	0
10	QPSK	1	49	17.21	17.12	16.90		
10	QPSK	25	0	17.05	17.19	17.01		
10	QPSK	25	12	17.04	17.23	17.08	18.0	0
10	QPSK	25	24	17.02	16.99	17.00		
10	QPSK	50	0	17.11	17.17	17.05		
10	16QAM	1	0	17.31	17.31	17.50	18.0	0
10	16QAM	1	24	17.64	17.62	17.21		
10	16QAM	1	49	17.50	17.21	16.81		
10	16QAM	25	0	17.11	17.05	17.06	18.0	0
10	16QAM	25	12	17.03	17.09	17.13		
10	16QAM	25	24	17.00	17.10	16.92		
10	16QAM	50	0	17.10	17.20	17.08		



BW [MHz]	Modulation	RB Size	RB Offset	Power Low Ch. / Freq.	Power Middle Ch. / Freq.	Power High Ch. / Freq.	Tune up Limit (dBm)	MPR (dB)
Channel				19975	20175	20375		
Frequency (MHz)				1712.5	1732.5	1752.5		
5	QPSK	1	0	17.04	17.32	17.05	18.0	0
5	QPSK	1	12	17.27	17.35	17.28		
5	QPSK	1	24	16.98	17.10	16.73		
5	QPSK	12	0	16.98	17.12	17.03	18.0	0
5	QPSK	12	6	16.98	17.15	17.00		
5	QPSK	12	11	16.92	17.11	16.92		
5	QPSK	25	0	17.02	17.09	16.90	18.0	0
5	16QAM	1	0	17.22	17.38	17.23		
5	16QAM	1	12	17.74	17.24	17.65		
5	16QAM	1	24	17.16	17.33	17.64	18.0	0
5	16QAM	12	0	17.20	17.33	17.12		
5	16QAM	12	6	16.96	17.24	17.13		
5	16QAM	12	11	17.04	17.29	16.67	18.0	0
5	16QAM	25	0	17.14	17.19	16.97		
Channel				19965	20175	20385	Tune up Limit (dBm)	MPR (dB)
Frequency (MHz)				1711.5	1732.5	1753.5		
3	QPSK	1	0	16.58	16.56	16.36	18.0	0
3	QPSK	1	7	16.54	16.53	16.41		
3	QPSK	1	14	16.51	16.44	16.24		
3	QPSK	8	0	16.61	16.69	16.56	18.0	0
3	QPSK	8	4	16.58	16.77	16.44		
3	QPSK	8	7	16.54	16.64	16.44		
3	QPSK	15	0	16.57	16.65	16.46	18.0	0
3	16QAM	1	0	16.80	16.96	16.31		
3	16QAM	1	7	16.96	17.07	16.23		
3	16QAM	1	14	17.18	16.91	16.11	18.0	0
3	16QAM	8	0	16.49	16.89	16.80		
3	16QAM	8	4	16.58	16.70	16.61		
3	16QAM	8	7	16.54	16.55	16.62	18.0	0
3	16QAM	15	0	16.66	16.53	16.54		
Channel				19957	20175	20393	Tune up Limit (dBm)	MPR (dB)
Frequency (MHz)				1710.7	1732.5	1754.3		
1.4	QPSK	1	0	16.66	16.69	16.39	18.0	0
1.4	QPSK	1	2	16.63	16.77	16.51		
1.4	QPSK	1	5	16.60	16.49	16.29		
1.4	QPSK	3	0	16.71	16.63	16.37	18.0	0
1.4	QPSK	3	1	16.82	16.68	16.51		
1.4	QPSK	3	2	16.54	16.70	16.63		
1.4	QPSK	6	0	16.67	16.75	16.46	18.0	0
1.4	16QAM	1	0	16.70	16.95	16.51	18.0	0
1.4	16QAM	1	2	16.62	16.83	16.42		
1.4	16QAM	1	5	16.78	16.90	16.69		
1.4	16QAM	3	0	16.94	16.81	16.54	18.0	0
1.4	16QAM	3	1	16.98	17.20	16.66		
1.4	16QAM	3	2	16.96	16.97	16.63		
1.4	16QAM	6	0	16.53	16.67	16.12	18.0	0



<LTE Band 2>

BW [MHz]	Modulation	RB Size	RB Offset	Power Low Ch. / Freq.	Power Middle Ch. / Freq.	Power High Ch. / Freq.	Tune up Limit (dBm)	MPR (dB)
Channel				18700	18900	19100		
Frequency (MHz)				1860	1880	1900		
20	QPSK	1	0	16.44	16.69	16.33	17.0	0
20	QPSK	1	49	16.18	16.03	15.99		
20	QPSK	1	99	15.78	16.40	16.32		
20	QPSK	50	0	15.90	16.09	15.95	17.0	0
20	QPSK	50	24	15.93	16.14	15.97		
20	QPSK	50	49	15.92	16.03	15.92		
20	QPSK	100	0	16.02	16.12	15.94	17.0	0
20	16QAM	1	0	16.39	16.16	15.95		
20	16QAM	1	49	16.02	16.19	15.99		
20	16QAM	1	99	16.17	16.13	15.92	17.0	0
20	16QAM	50	0	16.07	16.12	15.96		
20	16QAM	50	24	15.86	16.16	15.91		
20	16QAM	50	49	15.87	16.07	15.95	17.0	0
20	16QAM	100	0	16.06	16.03	15.91		
Channel				18675	18900	19125		
Frequency (MHz)				1857.5	1880	1902.5		
15	QPSK	1	0	16.00	16.32	16.16	17.0	0
15	QPSK	1	37	16.13	16.24	16.21		
15	QPSK	1	74	15.95	15.99	16.31		
15	QPSK	36	0	15.84	15.96	16.03	17.0	0
15	QPSK	36	18	15.80	15.93	15.98		
15	QPSK	36	37	15.66	15.95	15.96		
15	QPSK	75	0	15.88	15.94	15.98	17.0	0
15	16QAM	1	0	16.37	16.40	16.33		
15	16QAM	1	37	16.51	16.09	16.08		
15	16QAM	1	74	15.93	16.06	16.14	17.0	0
15	16QAM	36	0	15.82	16.05	16.02		
15	16QAM	36	18	15.87	15.99	16.01		
15	16QAM	36	37	15.82	15.94	15.85	17.0	0
15	16QAM	75	0	15.89	15.83	16.05		
Channel				18650	18900	19150		
Frequency (MHz)				1855	1880	1905		
10	QPSK	1	0	16.25	16.05	16.27	17.0	0
10	QPSK	1	24	15.93	16.22	16.21		
10	QPSK	1	49	15.83	15.87	16.18		
10	QPSK	25	0	15.82	15.99	16.03	17.0	0
10	QPSK	25	12	15.85	16.02	16.03		
10	QPSK	25	24	15.85	16.00	16.06		
10	QPSK	50	0	15.81	15.95	16.11	17.0	0
10	16QAM	1	0	16.66	15.88	16.63		
10	16QAM	1	24	16.18	16.21	16.58		
10	16QAM	1	49	16.68	16.64	16.47	17.0	0
10	16QAM	25	0	15.79	15.98	16.00		
10	16QAM	25	12	15.91	16.01	15.91		
10	16QAM	25	24	15.84	15.93	16.14	17.0	0
10	16QAM	50	0	15.87	15.95	16.06		



BW [MHz]	Modulation	RB Size	RB Offset	Power Low Ch. / Freq.	Power Middle Ch. / Freq.	Power High Ch. / Freq.	Tune up Limit (dBm)	MPR (dB)
Channel				18625	18900	19175		
Frequency (MHz)				1852.5	1880	1907.5		
5	QPSK	1	0	15.84	16.10	16.11	17.0	0
5	QPSK	1	12	16.17	16.17	16.41		
5	QPSK	1	24	15.83	15.80	16.14		
5	QPSK	12	0	15.76	15.96	15.99	17.0	0
5	QPSK	12	6	15.81	15.96	16.01		
5	QPSK	12	11	15.85	15.93	15.99		
5	QPSK	25	0	15.76	15.91	16.07	17.0	0
5	16QAM	1	0	16.20	16.13	16.57		
5	16QAM	1	12	16.57	16.52	16.62		
5	16QAM	1	24	16.03	16.32	15.83	17.0	0
5	16QAM	12	0	15.63	16.05	15.80		
5	16QAM	12	6	15.80	15.95	15.99		
5	16QAM	12	11	15.76	15.98	16.14	17.0	0
5	16QAM	12	11	15.76	15.98	16.14		
5	16QAM	25	0	15.81	15.89	16.04		
Channel				18615	18900	19185	Tune up Limit (dBm)	MPR (dB)
Frequency (MHz)				1851.5	1880	1908.5		
3	QPSK	1	0	15.26	15.34	15.20	17.0	0
3	QPSK	1	7	15.15	15.25	15.35		
3	QPSK	1	14	15.09	15.26	15.17		
3	QPSK	8	0	15.30	15.44	15.21	17.0	0
3	QPSK	8	4	15.29	15.39	15.27		
3	QPSK	8	7	15.28	15.37	15.29		
3	QPSK	15	0	15.29	15.41	15.25	17.0	0
3	16QAM	1	0	15.85	15.95	15.08		
3	16QAM	1	7	15.01	15.64	15.37		
3	16QAM	1	14	15.24	15.77	15.89	17.0	0
3	16QAM	8	0	15.50	15.29	15.47		
3	16QAM	8	4	15.42	15.46	15.54		
3	16QAM	8	7	15.50	15.69	15.20	17.0	0
3	16QAM	8	7	15.50	15.69	15.20		
3	16QAM	15	0	15.37	15.40	15.07		
Channel				18607	18900	19193	Tune up Limit (dBm)	MPR (dB)
Frequency (MHz)				1850.7	1880	1909.3		
1.4	QPSK	1	0	15.00	15.23	15.14	17.0	0
1.4	QPSK	1	2	15.05	15.37	15.47		
1.4	QPSK	1	5	15.12	15.41	15.23		
1.4	QPSK	3	0	15.34	15.43	15.42	17.0	0
1.4	QPSK	3	1	15.27	15.66	15.45		
1.4	QPSK	3	2	15.28	15.38	15.32		
1.4	QPSK	6	0	15.26	15.36	15.29	17.0	0
1.4	16QAM	1	0	15.08	15.45	15.39	17.0	0
1.4	16QAM	1	2	15.11	15.52	15.21		
1.4	16QAM	1	5	15.18	15.10	15.12		
1.4	16QAM	3	0	15.02	15.74	15.35	17.0	0
1.4	16QAM	3	1	15.11	15.80	15.44		
1.4	16QAM	3	2	15.02	15.53	15.43		
1.4	16QAM	6	0	15.13	15.13	15.02	17.0	0



<LTE Band 7>

BW [MHz]	Modulation	RB Size	RB Offset	Power Low Ch. / Freq.	Power Middle Ch. / Freq.	Power High Ch. / Freq.	Tune up Limit (dBm)	MPR (dB)
Channel				20850	21100	21350		
Frequency (MHz)				2510	2535	2560		
20	QPSK	1	0	14.89	14.96	14.92	15.5	0
20	QPSK	1	49	14.46	14.44	14.44		
20	QPSK	1	99	14.43	14.44	14.43		
20	QPSK	50	0	14.38	14.53	14.44	15.5	0
20	QPSK	50	24	14.27	14.44	14.32		
20	QPSK	50	49	14.35	14.36	14.24		
20	QPSK	100	0	14.38	14.41	14.38	15.5	0
20	16QAM	1	0	14.88	14.68	14.61		
20	16QAM	1	49	14.82	14.66	14.59		
20	16QAM	1	99	14.65	14.47	14.45	15.5	0
20	16QAM	50	0	14.41	14.43	14.52		
20	16QAM	50	24	14.20	14.43	14.26		
20	16QAM	50	49	14.29	14.45	14.29	15.5	0
20	16QAM	100	0	14.42	14.46	14.30		
Channel				20825	21100	21375		
Frequency (MHz)				2507.5	2535	2562.5		
15	QPSK	1	0	14.59	14.57	14.49	15.5	0
15	QPSK	1	37	14.71	14.65	14.54		
15	QPSK	1	74	14.39	14.47	14.26		
15	QPSK	36	0	14.35	14.53	14.37	15.5	0
15	QPSK	36	18	14.36	14.47	14.37		
15	QPSK	36	37	14.21	14.44	14.21		
15	QPSK	75	0	14.23	14.48	14.29	15.5	0
15	16QAM	1	0	14.42	14.78	14.83		
15	16QAM	1	37	14.95	14.72	14.62		
15	16QAM	1	74	14.88	14.58	14.59	15.5	0
15	16QAM	36	0	14.41	14.60	14.35		
15	16QAM	36	18	14.32	14.50	14.39		
15	16QAM	36	37	14.23	14.46	14.22	15.5	0
15	16QAM	75	0	14.27	14.52	14.25		



BW [MHz]	Modulation	RB Size	RB Offset	Power Low Ch. / Freq.	Power Middle Ch. / Freq.	Power High Ch. / Freq.	Tune up Limit (dBm)	MPR (dB)
Channel				20800	21100	21400		
Frequency (MHz)				2505	2535	2565		
10	QPSK	1	0	14.64	14.71	14.68	15.5	0
10	QPSK	1	24	14.77	14.65	14.38		
10	QPSK	1	49	14.42	14.69	14.47		
10	QPSK	25	0	14.54	14.53	14.53	15.5	0
10	QPSK	25	12	14.59	14.44	14.33		
10	QPSK	25	24	14.50	14.43	14.28		
10	QPSK	50	0	14.34	14.52	14.39	15.5	0
10	16QAM	1	0	14.81	14.60	14.69		
10	16QAM	1	24	14.58	14.65	14.68		
10	16QAM	1	49	14.41	14.66	14.61	15.5	0
10	16QAM	25	0	14.50	14.61	14.51		
10	16QAM	25	12	14.67	14.57	14.38		
10	16QAM	25	24	14.43	14.49	14.28	15.5	0
10	16QAM	50	0	14.45	14.56	14.43		
Channel				20775	21100	21425	Tune up Limit (dBm)	MPR (dB)
Frequency (MHz)				2502.5	2535	2567.5		
5	QPSK	1	0	14.43	14.55	14.43	15.5	0
5	QPSK	1	12	14.63	14.58	14.64		
5	QPSK	1	24	14.43	14.45	14.36		
5	QPSK	12	0	14.48	14.55	14.39	15.5	0
5	QPSK	12	6	14.47	14.45	14.28		
5	QPSK	12	11	14.55	14.44	14.25		
5	QPSK	25	0	14.45	14.48	14.32	15.5	0
5	16QAM	1	0	14.93	14.86	14.51		
5	16QAM	1	12	14.91	14.62	14.55		
5	16QAM	1	24	14.90	14.63	14.43	15.5	0
5	16QAM	12	0	14.81	14.54	14.29		
5	16QAM	12	6	14.49	14.48	14.32		
5	16QAM	12	11	14.56	14.30	14.11	15.5	0
5	16QAM	25	0	14.38	14.53	14.35		



<Reduced Power Mode, for hotspot>

<LTE Band 7>

BW [MHz]	Modulation	RB Size	RB Offset	Power Low Ch. / Freq.	Power Middle Ch. / Freq.	Power High Ch. / Freq.	Tune up Limit (dBm)	MPR (dB)
Channel				20850	21100	21350		
Frequency (MHz)				2510	2535	2560		
20	QPSK	1	0	17.24	17.37	17.18	17.5	0
20	QPSK	1	49	17.07	17.22	17.10		
20	QPSK	1	99	17.10	17.00	16.77		
20	QPSK	50	0	17.00	17.12	17.06	17.5	0
20	QPSK	50	24	16.99	17.06	16.86		
20	QPSK	50	49	16.92	17.04	16.83		
20	QPSK	100	0	16.86	17.03	16.90	17.5	0
20	16QAM	1	0	17.03	16.96	16.88		
20	16QAM	1	49	16.88	16.78	16.67		
20	16QAM	1	99	16.74	16.68	16.54	17.5	0
20	16QAM	50	0	16.93	16.87	16.84		
20	16QAM	50	24	16.81	16.81	16.63		
20	16QAM	50	49	16.74	16.81	16.63	17.5	0
20	16QAM	100	0	16.82	16.87	16.67		
Channel				20825	21100	21375	Tune up Limit (dBm)	MPR (dB)
Frequency (MHz)				2507.5	2535	2562.5		
15	QPSK	1	0	16.73	16.80	16.48	17.5	0
15	QPSK	1	37	16.51	16.54	16.45		
15	QPSK	1	74	16.55	16.72	16.35		
15	QPSK	36	0	16.72	16.70	16.56	17.5	0
15	QPSK	36	18	16.64	16.56	16.53		
15	QPSK	36	37	16.49	16.61	16.45		
15	QPSK	75	0	16.48	16.60	16.41	17.5	0
15	16QAM	1	0	17.00	17.06	17.05		
15	16QAM	1	37	16.63	17.07	17.16		
15	16QAM	1	74	16.67	16.99	17.15	17.5	0
15	16QAM	36	0	16.95	16.79	16.39		
15	16QAM	36	18	16.55	16.63	16.41		
15	16QAM	36	37	16.57	16.65	16.34	17.5	0
15	16QAM	75	0	16.52	16.63	16.41		
Channel				20800	21100	21400	Tune up Limit (dBm)	MPR (dB)
Frequency (MHz)				2505	2535	2565		
10	QPSK	1	0	16.69	16.80	16.63	17.5	0
10	QPSK	1	24	17.07	16.96	16.41		
10	QPSK	1	49	16.61	16.57	16.47		
10	QPSK	25	0	16.76	16.72	16.69	17.5	0
10	QPSK	25	12	16.76	16.66	16.48		
10	QPSK	25	24	16.56	16.67	16.50		
10	QPSK	50	0	16.72	16.69	16.48	17.5	0
10	16QAM	1	0	16.97	16.50	16.80		
10	16QAM	1	24	17.24	16.59	16.94		
10	16QAM	1	49	16.51	16.38	16.49	17.5	0
10	16QAM	25	0	17.04	16.85	16.39		
10	16QAM	25	12	16.99	16.78	16.39		
10	16QAM	25	24	17.13	16.54	16.29	17.5	0
10	16QAM	50	0	16.55	16.63	16.60		



Channel				20775	21100	21425	Tune up Limit (dBm)	MPR (dB)
Frequency (MHz)				2502.5	2535	2567.5		
5	QPSK	1	0	16.49	16.34	16.28	17.5	0
5	QPSK	1	12	16.97	16.57	16.94		
5	QPSK	1	24	16.78	16.56	16.36		
5	QPSK	12	0	16.71	16.66	16.52	17.5	0
5	QPSK	12	6	16.65	16.63	16.47		
5	QPSK	12	11	16.73	16.68	16.48		
5	QPSK	25	0	16.70	16.69	16.53		
5	16QAM	1	0	17.10	16.52	16.59	17.5	0
5	16QAM	1	12	16.89	16.29	17.17		
5	16QAM	1	24	16.74	16.34	16.40		
5	16QAM	12	0	16.74	16.73	16.46	17.5	0
5	16QAM	12	6	16.74	16.61	16.52		
5	16QAM	12	11	16.99	16.58	16.47		
5	16QAM	25	0	16.75	16.65	16.52		



<WLAN Conducted Power>

General Note:

For 2.4GHz WLAN SAR testing, highest average RF output power channel for the lowest data rate for 802.11b were selected for SAR evaluation. 802.11g/n HT20 were not investigated since the average output powers over all channels and data rates were not more than 0.25 dB higher than the tested channel in the lowest data rate of 802.11b mode.

WLAN 2.4GHz 802.11b Average Power (dBm)						
Power vs. Channel			Power vs. Data Rate			
Channel	Frequency (MHz)	Data Rate 1Mbps	Channel	2Mbps	5.5Mbps	11Mbps
CH 01	2412	17.21	CH 11	17.73	18.05	18.08
CH 06	2437	17.73				
CH 11	2462	18.11				

WLAN 2.4GHz 802.11g Average Power (dBm)										
Power vs. Channel			Power vs. Data Rate							
Channel	Frequency (MHz)	Data Rate 6Mbps	Channel	9Mbps	12Mbps	18Mbps	24Mbps	36Mbps	48Mbps	54Mbps
CH 01	2412	11.11	CH 11	12.33	12.32	12.38	12.30	12.35	12.39	12.37
CH 06	2437	12.09								
CH 11	2462	12.41								

WLAN 2.4GHz 802.11n HT20 Average Power (dBm)										
Power vs. Channel			Power vs. MCS Index							
Channel	Frequency (MHz)	MCS Index MCS0	Channel	MCS1	MCS2	MCS3	MCS4	MCS5	MCS6	MCS7
CH 01	2412	10.55	CH 11	11.79	11.71	11.72	11.70	11.76	11.69	11.78
CH 06	2437	11.50								
CH 11	2462	11.85								

13. Conducted RF Output Power for Variant Product (6039S) (Unit: dBm)

<GSM Conducted Power>

- For DTM multi-slot class mode, the device was linked with base station simulator (Agilent E5515C) and transmit maximum power on maximum number of TX slots, i.e. one CS timeslot, and additional PS timeslots (1 for DTM class 5 and 9, 2 for DTM class 11) in one TDMA frame.
- Agilent E5515C was used to setup the device operated under DTM mode for power measurement and SAR testing. For conducted power, the power of the burst for voice and the power of the bursts for data was reported separately in the table above, and the frame-average power is derived below to determine SAR testing.

$$DTM \text{ frame average power (dBm)} = 10 * \log [\sum(\text{power of each slot, in mW})/8]$$
- Per KDB 447498 D01v05r02, the maximum output power channel is used for SAR testing and for further SAR test reduction.
- Considering the possibility of e.g. 3rd party VoIP operation for Head SAR test reduction for GSM, GPRS, EDGE and DTM modes is determined by the source-based time-averaged output power including tune-up tolerance. The mode with highest specified time-averaged output power should be tested for SAR compliance in the applicable exposure conditions. For mode with the same specified maximum output power and tolerance, the higher tune-up with higher measured power configuration should be tested. Therefore, the EUT was set in GPRS (2Tx slots) for GSM850/GSM1900 at receiver 1, and GPRS (2Tx slots) for GSM850 and GSM Voice for GSM1900 at receiver 2.
- For body-worn and hotspot SAR test reduction for GPRS, EDGE and DTM modes are determined by the source-based time-averaged output power including tune-up tolerance, for modes with the same specified maximum output power and tolerance, the higher tune-up with higher measured power configuration should be tested, therefore, the EUT was set in GPRS (2Tx slots) for GSM850/GSM1900.

<Full Power Mode>:

Band GSM850		Burst Average Power (dBm)			Tune-up Limit (dBm)	Frame-Average Power (dBm)			Tune-up Limit (dBm)
Tx Channel		128	189	251		128	189	251	
Frequency (MHz)		824.2	836.4	848.8		824.2	836.4	848.8	
GSM (GMSK, 1 Tx slot)		33.00	33.11	33.25	34.00	24.00	24.11	24.25	25.00
GPRS (GMSK, 1 Tx slot) – CS1		32.99	33.10	33.23	34.00	23.99	24.10	24.23	25.00
GPRS (GMSK, 2 Tx slots) – CS1		31.25	30.92	31.10	31.50	25.25	24.92	25.10	25.50
GPRS (GMSK, 3 Tx slots) – CS1		29.08	29.12	29.33	29.50	24.82	24.86	25.07	25.24
GPRS (GMSK, 4 Tx slots) – CS1		28.00	28.04	28.24	28.50	25.00	25.04	25.24	25.50
EDGE (8PSK, 1 Tx slot) – MCS5		25.57	25.55	25.65	26.00	16.57	16.55	16.65	17.00
EDGE (8PSK, 2 Tx slots) – MCS5		25.53	25.45	25.59	26.00	19.53	19.45	19.59	20.00
EDGE (8PSK, 3 Tx slots) – MCS5		23.70	23.64	23.70	24.00	19.44	19.38	19.44	19.74
EDGE (8PSK, 4 Tx slots) – MCS5		21.91	21.93	22.00	22.50	18.91	18.93	19.00	19.50
DTM 5 (2Tx slots)	GSM (GMSK, 1 Tx slot)	31.13	31.09	31.15	31.50	25.07	25.03	25.08	25.48
	GPRS (GMSK, 1 Tx slot) – CS1	31.05	31.01	31.06	31.50				
DTM 9 (2Tx slots)	GSM (GMSK, 1 Tx slot)	31.12	31.06	31.05	31.50	25.05	24.99	24.98	25.48
	GPRS (GMSK, 1 Tx slot) – CS1	31.02	30.97	30.96	31.50				
DTM 11 (3Tx slots)	GSM (GMSK, 1 Tx slot)	28.95	29.06	29.17	29.50	24.63	24.75	24.86	25.24
	GPRS (GMSK, 2 Tx slots) – CS1	28.86	28.98	29.09	29.50				
DTM 5 (2Tx slots)	GSM (GMSK, 1 Tx slot)	31.15	31.12	31.15	31.50	23.15	23.14	23.18	23.55
	EDGE (8PSK, 1 Tx slot) – MCS5	25.45	25.50	25.58	26.00				
DTM 9 (2Tx slots)	GSM (GMSK, 1 Tx slot)	31.18	31.02	31.05	31.50	23.16	23.04	23.09	23.55
	EDGE (8PSK, 1 Tx slot) – MCS5	25.37	25.41	25.53	26.00				
DTM 11 (3Tx slots)	GSM (GMSK, 1 Tx slot)	28.84	29.03	29.14	29.50	21.81	21.90	21.97	22.60
	EDGE (8PSK, 2 Tx slots) – MCS5	23.49	23.41	23.41	24.50				



Band GSM1900		Burst Average Power (dBm)			Tune-up Limit (dBm)	Frame-Average Power (dBm)			Tune-up Limit (dBm)
Tx Channel		512	661	810		512	661	810	
Frequency (MHz)		1850.2	1880	1909.8	1850.2	1880	1909.8		
GSM (GMSK, 1 Tx slot)		29.44	29.35	29.60	30.00	20.44	20.35	20.60	21.00
GPRS (GMSK, 1 Tx slot) – CS1		29.42	29.34	29.59	30.00	20.42	20.34	20.59	21.00
GPRS (GMSK, 2 Tx slots) – CS1		28.33	28.00	28.27	29.50	22.33	22.00	22.27	23.50
GPRS (GMSK, 3 Tx slots) – CS1		26.00	25.96	25.95	27.00	21.74	21.70	21.69	22.74
GPRS (GMSK, 4 Tx slots) – CS1		24.99	24.92	24.83	25.50	21.99	21.92	21.83	22.50
EDGE (8PSK, 1 Tx slot) – MCS5		25.81	25.75	25.89	26.00	16.81	16.75	16.89	17.00
EDGE (8PSK, 2 Tx slots) – MCS5		24.60	24.39	24.75	25.00	18.60	18.39	18.75	19.00
EDGE (8PSK, 3 Tx slots) – MCS5		22.91	22.84	23.00	23.50	18.65	18.58	18.74	19.24
EDGE (8PSK, 4 Tx slots) – MCS5		21.41	21.35	21.45	22.00	18.41	18.35	18.45	19.00
DTM 5 (2Tx slots)	GSM (GMSK, 1 Tx slot)	28.24	28.08	28.30	29.50	22.21	22.03	22.25	23.48
	GPRS (GMSK, 1 Tx slot) – CS1	28.22	28.03	28.25	29.50				
DTM 9 (2Tx slots)	GSM (GMSK, 1 Tx slot)	28.22	28.01	28.30	29.50	22.15	21.98	22.25	23.48
	GPRS (GMSK, 1 Tx slot) – CS1	28.12	28.00	28.24	29.50				
DTM 11 (3Tx slots)	GSM (GMSK, 1 Tx slot)	25.62	25.82	25.87	27.00	21.40	21.57	21.62	22.74
	GPRS (GMSK, 2 Tx slots) – CS1	25.68	25.84	25.89	27.00				
DTM 5 (2Tx slots)	GSM (GMSK, 1 Tx slot)	28.12	28.01	28.23	29.50	20.61	20.56	20.79	21.79
	EDGE (8PSK, 1 Tx slot) – MCS5	24.36	24.43	24.69	25.00				
DTM 9 (2Tx slots)	GSM (GMSK, 1 Tx slot)	28.11	28.02	28.23	29.50	20.63	20.58	20.79	21.79
	EDGE (8PSK, 1 Tx slot) – MCS5	24.43	24.48	24.70	25.00				
DTM 11 (3Tx slots)	GSM (GMSK, 1 Tx slot)	25.68	25.89	25.93	27.00	19.64	19.81	19.90	20.74
	EDGE (8PSK, 2 Tx slots) – MCS5	22.64	22.75	22.90	23.50				



<Reduced Power Mode, for reverse call>:

Band GSM850		Burst Average Power (dBm)			Tune-up Limit (dBm)	Frame-Average Power (dBm)			Tune-up Limit (dBm)
Tx Channel	128	189	251	128		189	251		
Frequency (MHz)		824.2	836.4	848.8	824.2	836.4	848.8		
GSM (GMSK, 1 Tx slot)		29.27	29.37	29.39	30.00	20.27	20.37	20.39	21.00
GPRS (GMSK, 1 Tx slot) – CS1		29.22	29.32	29.38	30.00	20.22	20.32	20.38	21.00
GPRS (GMSK, 2 Tx slots) – CS1		28.88	28.56	28.67	29.50	22.88	22.56	22.67	23.50
GPRS (GMSK, 3 Tx slots) – CS1		26.66	26.62	26.55	27.50	22.40	22.36	22.29	23.24
GPRS (GMSK, 4 Tx slots) – CS1		25.45	25.52	25.59	26.50	22.45	22.52	22.59	23.50
EDGE (8PSK, 1 Tx slot) – MCS5		25.61	25.58	25.61	26.00	16.61	16.58	16.61	17.00
EDGE (8PSK, 2 Tx slots) – MCS5		25.53	25.51	25.52	26.00	19.53	19.51	19.52	20.00
EDGE (8PSK, 3 Tx slots) – MCS5		23.73	23.70	23.72	24.50	19.47	19.44	19.46	20.24
EDGE (8PSK, 4 Tx slots) – MCS5		22.08	22.07	22.06	23.00	19.08	19.07	19.06	20.00
DTM 5 (2Tx slots)	GSM (GMSK, 1 Tx slot)	28.80	28.63	28.76	29.50	22.75	22.58	22.71	23.48
	GPRS (GMSK, 1 Tx slot) – CS1	28.74	28.57	28.70	29.50				
DTM 9 (2Tx slots)	GSM (GMSK, 1 Tx slot)	28.72	28.60	28.74	29.50	22.67	22.54	22.69	23.48
	GPRS (GMSK, 1 Tx slot) – CS1	28.66	28.52	28.69	29.50				
DTM 11 (3Tx slots)	GSM (GMSK, 1 Tx slot)	26.69	26.64	26.57	27.50	22.42	22.38	22.28	23.24
	GPRS (GMSK, 2 Tx slots) – CS1	26.67	26.64	26.53	27.50				
DTM 5 (2Tx slots)	GSM (GMSK, 1 Tx slot)	28.76	28.48	28.70	29.50	21.40	21.20	21.40	22.07
	EDGE (8PSK, 1 Tx slot) – MCS5	25.48	25.45	25.59	26.00				
DTM 9 (2Tx slots)	GSM (GMSK, 1 Tx slot)	28.75	28.57	28.69	29.50	21.36	21.27	21.36	22.07
	EDGE (8PSK, 1 Tx slot) – MCS5	25.38	25.47	25.51	26.00				
DTM 11 (3Tx slots)	GSM (GMSK, 1 Tx slot)	26.68	26.63	26.64	27.50	20.59	20.57	20.65	21.48
	EDGE (8PSK, 2 Tx slots) – MCS5	23.53	23.54	23.69	24.50				

Band GSM1900		Burst Average Power (dBm)			Tune-up Limit (dBm)	Frame-Average Power (dBm)			Tune-up Limit (dBm)
Tx Channel	512	661	810	512		661	810		
Frequency (MHz)		1850.2	1880	1909.8	1850.2	1880	1909.8		
GSM (GMSK, 1 Tx slot)		24.25	24.16	24.33	25.00	15.25	15.16	15.33	16.00
GPRS (GMSK, 1 Tx slot) – CS1		24.24	24.15	24.27	25.00	15.24	15.15	15.27	16.00
GPRS (GMSK, 2 Tx slots) – CS1		21.13	21.27	21.15	21.50	15.13	15.27	15.15	15.50
GPRS (GMSK, 3 Tx slots) – CS1		19.60	19.77	19.69	20.00	15.34	15.51	15.43	15.74
GPRS (GMSK, 4 Tx slots) – CS1		18.00	18.22	18.21	19.00	15.00	15.22	15.21	16.00
EDGE (8PSK, 1 Tx slot) – MCS5		24.07	24.01	24.02	24.50	15.07	15.01	15.02	15.50
EDGE (8PSK, 2 Tx slots) – MCS5		21.18	21.12	21.10	21.50	15.18	15.12	15.10	15.50
EDGE (8PSK, 3 Tx slots) – MCS5		19.52	19.48	19.63	20.00	15.26	15.22	15.37	15.74
EDGE (8PSK, 4 Tx slots) – MCS5		17.97	17.96	18.00	18.50	14.97	14.96	15.00	15.50
DTM 5 (2Tx slots)	GSM (GMSK, 1 Tx slot)	21.17	21.14	21.11	21.50	15.07	15.15	15.06	15.48
	GPRS (GMSK, 1 Tx slot) – CS1	21.01	21.20	21.06	21.50				
DTM 9 (2Tx slots)	GSM (GMSK, 1 Tx slot)	21.09	21.23	21.09	21.50	14.99	15.17	15.04	15.48
	GPRS (GMSK, 1 Tx slot) – CS1	20.93	21.15	21.04	21.50				
DTM 11 (3Tx slots)	GSM (GMSK, 1 Tx slot)	19.63	19.74	19.92	20.00	15.26	15.37	15.57	15.74
	GPRS (GMSK, 2 Tx slots) – CS1	19.47	19.58	19.78	20.00				
DTM 5 (2Tx slots)	GSM (GMSK, 1 Tx slot)	20.96	21.20	21.12	21.50	14.79	14.97	14.94	15.48
	EDGE (8PSK, 1 Tx slot) – MCS5	20.65	20.77	20.80	21.50				
DTM 9 (2Tx slots)	GSM (GMSK, 1 Tx slot)	20.82	20.83	21.00	21.50	14.78	14.86	15.05	15.48
	EDGE (8PSK, 1 Tx slot) – MCS5	20.78	20.94	21.14	21.50				
DTM 11 (3Tx slots)	GSM (GMSK, 1 Tx slot)	19.37	19.48	19.65	20.00	15.11	15.23	15.30	15.74
	EDGE (8PSK, 2 Tx slots) – MCS5	19.37	19.49	19.52	20.00				

<WCDMA Conducted Power>

1. The following tests were conducted according to the test requirements outlines in 3GPP TS 34.121 specification.
2. The procedures in KDB 941225 D01 are applied for 3GPP Rel. 6 HSPA to configure the device in the required sub-test mode(s) to determine SAR test exclusion.
3. For DC-HSDPA, the device was configured according to the H-Set 12, Fixed Reference Channel (FRC) configuration in Table C.8.1.12 of 3GPP TS 34.121-1, with the primary and the secondary serving HS-DSCH Cell enabled during the power measurement.

A summary of these settings are illustrated below:

HSDPA Setup Configuration:

- a. The EUT was connected to Base Station Agilent E5515C referred to the Setup Configuration.
- b. The RF path losses were compensated into the measurements.
- c. A call was established between EUT and Base Station with following setting:
 - i. Set Gain Factors (β_c and β_d) and parameters were set according to each
 - ii. Specific sub-test in the following table, C10.1.4, quoted from the TS 34.121
 - iii. Set RMC 12.2Kbps + HSDPA mode.
 - iv. Set Cell Power = -86 dBm
 - v. Set HS-DSCH Configuration Type to FRC (H-set 1, QPSK)
 - vi. Select HSDPA Uplink Parameters
 - vii. Set Delta ACK, Delta NACK and Delta CQI = 8
 - viii. Set Ack-Nack Repetition Factor to 3
 - ix. Set CQI Feedback Cycle (k) to 4 ms
 - x. Set CQI Repetition Factor to 2
 - xi. Power Ctrl Mode = All Up bits
- d. The transmitted maximum output power was recorded.

Table C.10.1.4: β values for transmitter characteristics tests with HS-DPCCH

Sub-test	β_c	β_d	β_d (SF)	β_c/β_d	β_{HS} (Note 1, Note 2)	CM (dB) (Note 3)	MPR (dB) (Note 3)
1	2/15	15/15	64	2/15	4/15	0.0	0.0
2	12/15 (Note 4)	15/15 (Note 4)	64	12/15 (Note 4)	24/15	1.0	0.0
3	15/15	8/15	64	15/8	30/15	1.5	0.5
4	15/15	4/15	64	15/4	30/15	1.5	0.5

Note 1: $\Delta_{ACK}, \Delta_{NACK}$ and $\Delta_{CQI} = 30/15$ with $\beta_{HS} = 30/15 * \beta_c$.

Note 2: For the HS-DPCCH power mask requirement test in clause 5.2C, 5.7A, and the Error Vector Magnitude (EVM) with HS-DPCCH test in clause 5.13.1A, and HSDPA EVM with phase discontinuity in clause 5.13.1AA, Δ_{ACK} and $\Delta_{NACK} = 30/15$ with $\beta_{HS} = 30/15 * \beta_c$, and $\Delta_{CQI} = 24/15$ with $\beta_{HS} = 24/15 * \beta_c$.

Note 3: CM = 1 for $\beta_c/\beta_d = 12/15$, $\beta_{HS}/\beta_c = 24/15$. For all other combinations of DPDCCH, DPCCH and HS-DPCCH the MPR is based on the relative CM difference. This is applicable for only UEs that support HSDPA in release 6 and later releases.

Note 4: For subtest 2 the β_c/β_d ratio of 12/15 for the TFC during the measurement period (TF1, TF0) is achieved by setting the signalled gain factors for the reference TFC (TF1, TF1) to $\beta_c = 11/15$ and $\beta_d = 15/15$.

Setup Configuration

HSUPA Setup Configuration:

- a. The EUT was connected to Base Station Agilent E5515C referred to the Setup Configuration.
- b. The RF path losses were compensated into the measurements.
- c. A call was established between EUT and Base Station with following setting * :
 - i. Call Configs = 5.2B, 5.9B, 5.10B, and 5.13.2B with QPSK
 - ii. Set the Gain Factors (β_c and β_d) and parameters (AG Index) were set according to each specific sub-test in the following table, C11.1.3, quoted from the TS 34.121
 - iii. Set Cell Power = -86 dBm
 - iv. Set Channel Type = 12.2k + HSPA
 - v. Set UE Target Power
 - vi. Power Ctrl Mode= Alternating bits
 - vii. Set and observe the E-TFCI
 - viii. Confirm that E-TFCI is equal to the target E-TFCI of 75 for sub-test 1, and other subtest's E-TFCI
- d. The transmitted maximum output power was recorded.

Table C.11.1.3: β values for transmitter characteristics tests with HS-DPCCH and E-DCH

Sub-test	β_c	β_d	β_d (SF)	β_c/β_d	β_{HS} (Note 1)	β_{ec}	β_{ed} (Note 5) (Note 6)	β_{ed} (SF)	β_{ed} (Codes)	CM (dB) (Note 2)	MPR (dB) (Note 2)	AG Index (Note 6)	E-TFCI
1	11/15 (Note 3)	15/15 (Note 3)	64	11/15 (Note 3)	22/15	209/25	1309/225	4	1	1.0	0.0	20	75
2	6/15	15/15	64	6/15	12/15	12/15	94/75	4	1	3.0	2.0	12	67
3	15/15	9/15	64	15/9	30/15	30/15	$\beta_{ed1}: 47/15$ $\beta_{ed2}: 47/15$	4 4	2	2.0	1.0	15	92
4	2/15	15/15	64	2/15	4/15	2/15	56/75	4	1	3.0	2.0	17	71
5	15/15 (Note 4)	15/15 (Note 4)	64	15/15 (Note 4)	30/15	24/15	134/15	4	1	1.0	0.0	21	81

Note 1: $\Delta_{ACK}, \Delta_{NACK}$ and $\Delta_{CQI} = 30/15$ with $\beta_{hs} = 30/15 * \beta_c$.

Note 2: CM = 1 for $\beta_c/\beta_d = 12/15, \beta_{hs}/\beta_c = 24/15$. For all other combinations of DPDCH, DPCCH, HS-DPCCH, E-DPDCH and E-DPCCH the MPR is based on the relative CM difference.

Note 3: For subtest 1 the β_c/β_d ratio of 11/15 for the TFC during the measurement period (TF1, TF0) is achieved by setting the signalled gain factors for the reference TFC (TF1, TF1) to $\beta_c = 10/15$ and $\beta_d = 15/15$.

Note 4: For subtest 5 the β_c/β_d ratio of 15/15 for the TFC during the measurement period (TF1, TF0) is achieved by setting the signalled gain factors for the reference TFC (TF1, TF1) to $\beta_c = 14/15$ and $\beta_d = 15/15$.

Note 5: In case of testing by UE using E-DPDCH Physical Layer category 1, Sub-test 3 is omitted according to TS25.306 Table 5.1g.

Note 6: β_{ed} can not be set directly, it is set by Absolute Grant Value.

Setup Configuration

DC-HSDPA 3GPP release 8 Setup Configuration:

- a. The EUT was connected to Base Station Agilent E5515C referred to the Setup Configuration below
- b. The RF path losses were compensated into the measurements.
- c. A call was established between EUT and Base Station with following setting:
 - i. Set RMC 12.2Kbps + HSDPA mode.
 - ii. Set Cell Power = -25 dBm
 - iii. Set HS-DSCH Configuration Type to FRC (H-set 12, QPSK)
 - iv. Select HSDPA Uplink Parameters
 - v. Set Gain Factors (β_c and β_d) and parameters were set according to each Specific sub-test in the following table, C10.1.4, quoted from the TS 34.121
 - a). Subtest 1: $\beta_c/\beta_d=2/15$
 - b). Subtest 2: $\beta_c/\beta_d=12/15$
 - c). Subtest 3: $\beta_c/\beta_d=15/8$
 - d). Subtest 4: $\beta_c/\beta_d=15/4$
 - vi. Set Delta ACK, Delta NACK and Delta CQI = 8
 - vii. Set Ack-Nack Repetition Factor to 3
 - viii. Set CQI Feedback Cycle (k) to 4 ms
 - ix. Set CQI Repetition Factor to 2
 - x. Power Ctrl Mode = All Up bits
- d. The transmitted maximum output power was recorded.

The following tests were conducted according to the test requirements outlines in 3GPP TS 34.121 specification. A summary of these settings are illustrated below:

C.8.1.12 Fixed Reference Channel Definition H-Set 12

Table C.8.1.12: Fixed Reference Channel H-Set 12

Parameter	Unit	Value
Nominal Avg. Inf. Bit Rate	kbps	60
Inter-TTI Distance	TTI's	1
Number of HARQ Processes	Processes	6
Information Bit Payload (N_{INF})	Bits	120
Number Code Blocks	Blocks	1
Binary Channel Bits Per TTI	Bits	960
Total Available SML's in UE	SML's	19200
Number of SML's per HARQ Proc.	SML's	3200
Coding Rate		0.15
Number of Physical Channel Codes	Codes	1
Modulation		QPSK
Note 1: The RMC is intended to be used for DC-HSDPA mode and both cells shall transmit with identical parameters as listed in the table. Note 2: Maximum number of transmission is limited to 1, i.e., retransmission is not allowed. The redundancy and constellation version 0 shall be used.		

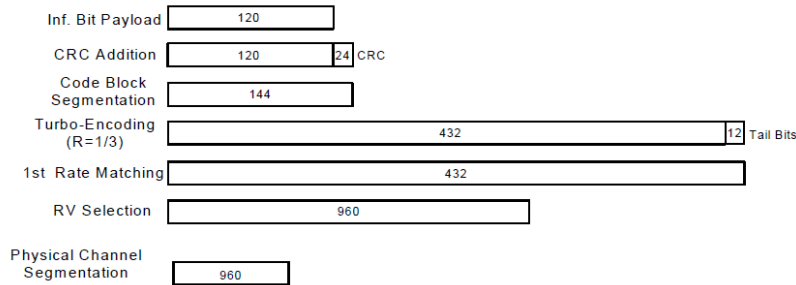

Figure C.8.19: Coding rate for Fixed reference Channel H-Set 12 (QPSK)

Setup Configuration

<WCDMA Conducted Power>

General Note:

1. Per KDB 941225 D01v03, SAR for Head / Hotspot / Body-worn exposure is measured using a 12.2 kbps RMC with TPC bits configured to all "1's".
2. Per KDB 941225 D01v03, RMC 12.2kbps setting is used to evaluate SAR. If the maximum output power and tune-up tolerance specified for production units in HSDPA / HSUPA / DC-HSDPA is $\leq \frac{1}{4}$ dB higher than RMC 12.2Kbps or when the highest reported SAR of the RMC12.2Kbps is scaled by the ratio of specified maximum output power and tune-up tolerance of HSDPA / HSUPA / DC-HSDPA to RMC12.2Kbps and the adjusted SAR is ≤ 1.2 W/kg, SAR measurement is not required for HSDPA / HSUPA / DC-HSDPA.

<Full Power Mode>:

Band			WCDMA Band V			WCDMA Band II		
Tx Channel			4132	4182	4233	9262	9400	9538
Rx Channel			4357	4407	4458	9662	9800	9938
Frequency (MHz)			826.4	836.4	846.6	1852.4	1880	1907.6
MPR (dB)	3GPP Rel 99	AMR 12.2Kbps	23.12	22.93	23.35	22.16	22.14	22.28
	3GPP Rel 99	RMC 12.2Kbps	23.14	22.95	23.36	22.18	22.15	22.29
0	3GPP Rel 6	HSDPA Subtest-1	21.75	21.54	21.90	20.39	20.40	20.38
0	3GPP Rel 6	HSDPA Subtest-2	21.76	21.57	21.86	20.38	20.42	20.47
0.5	3GPP Rel 6	HSDPA Subtest-3	21.77	21.59	21.87	20.36	20.41	20.46
0.5	3GPP Rel 6	HSDPA Subtest-4	21.73	21.53	21.89	20.44	20.42	20.45
0	3GPP Rel 8	DC-HSDPA Subtest-1	21.69	21.54	21.83	20.35	20.30	20.43
0	3GPP Rel 8	DC-HSDPA Subtest-2	21.77	21.55	21.87	20.33	20.42	20.44
0.5	3GPP Rel 8	DC-HSDPA Subtest-3	21.76	21.51	21.86	20.32	20.32	20.49
0.5	3GPP Rel 8	DC-HSDPA Subtest-4	21.75	21.58	21.89	20.34	20.31	20.47
0	3GPP Rel 6	HSUPA Subtest-1	21.33	21.14	21.47	20.55	20.32	20.52
2	3GPP Rel 6	HSUPA Subtest-2	20.86	20.69	20.77	19.68	19.66	19.55
1	3GPP Rel 6	HSUPA Subtest-3	20.41	20.22	20.40	19.74	19.71	19.79
2	3GPP Rel 6	HSUPA Subtest-4	20.99	20.72	20.96	20.11	20.01	20.14
0	3GPP Rel 6	HSUPA Subtest-5	21.22	21.01	21.32	20.56	20.53	20.54

Band			WCDMA Band IV		
Tx Channel			1312	1413	1513
Rx Channel			1537	1638	1738
Frequency (MHz)			1712.4	1732.6	1752.6
MPR (dB)	3GPP Rel 99	AMR 12.2Kbps	24.04	23.96	24.01
	3GPP Rel 99	RMC 12.2Kbps	24.05	23.99	24.03
0	3GPP Rel 6	HSDPA Subtest-1	22.40	22.35	22.31
0	3GPP Rel 6	HSDPA Subtest-2	22.38	22.28	22.32
0.5	3GPP Rel 6	HSDPA Subtest-3	22.36	22.32	22.38
0.5	3GPP Rel 6	HSDPA Subtest-4	22.34	22.34	22.39
0	3GPP Rel 8	DC-HSDPA Subtest-1	22.43	22.26	22.47
0	3GPP Rel 8	DC-HSDPA Subtest-2	22.51	22.38	22.41
0.5	3GPP Rel 8	DC-HSDPA Subtest-3	22.50	22.42	22.40
0.5	3GPP Rel 8	DC-HSDPA Subtest-4	22.49	22.28	22.44
0	3GPP Rel 6	HSUPA Subtest-1	22.47	22.41	22.48
2	3GPP Rel 6	HSUPA Subtest-2	21.55	21.56	21.57
1	3GPP Rel 6	HSUPA Subtest-3	21.57	21.58	21.55
2	3GPP Rel 6	HSUPA Subtest-4	22.11	22.08	22.09
0	3GPP Rel 6	HSUPA Subtest-5	22.48	22.46	22.41

<Reduced Power Mode, for reverse call >:

Band			WCDMA Band II			WCDMA Band IV		
Tx Channel			9262	9400	9538	1312	1413	1513
Rx Channel			9662	9800	9938	1537	1638	1738
Frequency (MHz)			1852.4	1880	1907.6	1712.4	1732.6	1752.6
MPR (dB)	3GPP Rel 99	AMR 12.2Kbps	16.34	16.36	16.30	16.53	16.43	16.49
	3GPP Rel 99	RMC 12.2Kbps	16.36	16.37	16.32	16.55	16.45	16.50
0	3GPP Rel 6	HSDPA Subtest-1	14.55	14.41	14.58	14.85	14.69	14.88
0	3GPP Rel 6	HSDPA Subtest-2	14.54	14.39	14.57	14.86	14.72	14.89
0.5	3GPP Rel 6	HSDPA Subtest-3	14.57	14.42	14.59	14.87	14.65	14.85
0.5	3GPP Rel 6	HSDPA Subtest-4	14.57	14.43	14.57	14.89	14.64	14.88
0	3GPP Rel 8	DC-HSDPA Subtest-1	14.37	14.43	14.51	14.89	14.74	14.86
0	3GPP Rel 8	DC-HSDPA Subtest-2	14.45	14.40	14.46	14.85	14.77	14.84
0.5	3GPP Rel 8	DC-HSDPA Subtest-3	14.38	14.42	14.48	14.83	14.75	14.77
0.5	3GPP Rel 8	DC-HSDPA Subtest-4	14.42	14.48	14.46	14.81	14.69	14.81
0	3GPP Rel 6	HSUPA Subtest-1	14.47	14.48	14.48	14.97	14.81	14.89
2	3GPP Rel 6	HSUPA Subtest-2	14.02	14.03	14.09	14.15	14.15	14.19
1	3GPP Rel 6	HSUPA Subtest-3	14.05	14.01	14.04	14.15	14.16	14.14
2	3GPP Rel 6	HSUPA Subtest-4	14.17	14.14	14.18	14.53	14.68	14.66
0	3GPP Rel 6	HSUPA Subtest-5	14.61	14.63	14.72	14.88	14.96	14.84

<Reduced Power Mode, for hotspot>

Band			WCDMA Band IV		
Tx Channel			1312	1413	1513
Rx Channel			1537	1638	1738
Frequency (MHz)			1712.4	1732.6	1752.6
MPR (dB)	3GPP Rel 99	AMR 12.2Kbps	21.74	21.65	21.58
	3GPP Rel 99	RMC 12.2Kbps	21.75	21.66	21.60
0	3GPP Rel 6	HSDPA Subtest-1	19.98	19.96	20.05
0	3GPP Rel 6	HSDPA Subtest-2	19.98	19.95	20.08
0.5	3GPP Rel 6	HSDPA Subtest-3	19.91	19.94	20.02
0.5	3GPP Rel 6	HSDPA Subtest-4	19.88	19.91	20.13
0	3GPP Rel 8	DC-HSDPA Subtest-1	19.96	19.95	20.06
0	3GPP Rel 8	DC-HSDPA Subtest-2	20.00	19.95	20.03
0.5	3GPP Rel 8	DC-HSDPA Subtest-3	19.91	19.97	20.03
0.5	3GPP Rel 8	DC-HSDPA Subtest-4	19.99	19.92	20.07
0	3GPP Rel 6	HSUPA Subtest-1	19.98	19.92	19.93
2	3GPP Rel 6	HSUPA Subtest-2	19.14	19.11	19.17
1	3GPP Rel 6	HSUPA Subtest-3	19.08	19.05	19.08
2	3GPP Rel 6	HSUPA Subtest-4	19.47	19.49	19.46
0	3GPP Rel 6	HSUPA Subtest-5	19.96	19.95	19.95

**<LTE Conducted Power>****General Note:**

1. Anritsu MT8820C base station simulator was used to setup the connection with EUT; the frequency band, channel bandwidth, RB allocation configuration, modulation type are set in the base station simulator to configure EUT transmitting at maximum power and at different configurations which are requested to be reported to FCC, for conducted power measurement and SAR testing.
2. Per KDB 941225 D05v02r03, when a properly configured base station simulator is used for the SAR and power measurements, spectrum plots for each RB allocation and offset configuration is not required.
3. Per KDB 941225 D05v02r03, start with the largest channel bandwidth and measure SAR for QPSK with 1 RB allocation, using the RB offset and required test channel combination with the highest maximum output power for RB offsets at the upper edge, middle and lower edge of each required test channel.
4. Per KDB 941225 D05v02r03, 50% RB allocation for QPSK SAR testing follows 1RB QPSK allocation procedure.
5. Per KDB 941225 D05v02r03, For QPSK with 100% RB allocation, SAR is not required when the highest maximum output power for 100 % RB allocation is less than the highest maximum output power in 50% and 1 RB allocations and the highest reported SAR for 1 RB and 50% RB allocation are ≤ 0.8 W/kg. Otherwise, SAR is measured for the highest output power channel; and if the reported SAR is > 1.45 W/kg, the remaining required test channels must also be tested.
6. Per KDB 941225 D05v02r03, 16QAM output power for each RB allocation configuration is $>$ not $\frac{1}{2}$ dB higher than the same configuration in QPSK and the reported SAR for the QPSK configuration is ≤ 1.45 W/kg; Per KDB 941225 D05v02r03, 16QAM SAR testing is not required.
7. Per KDB 941225 D05v02r03, Smaller bandwidth output power for each RB allocation configuration is $>$ not $\frac{1}{2}$ dB higher than the same configuration in the largest supported bandwidth, and the reported SAR for the largest supported bandwidth is ≤ 1.45 W/kg; Per KDB 941225 D05v02r03, smaller bandwidth SAR testing is not required.



<Full Power Mode>

<LTE Band 12>

BW [MHz]	Modulation	RB Size	RB Offset	Power Low Ch. / Freq.	Power Middle Ch. / Freq.	Power High Ch. / Freq.	Tune up Limit (dBm)	MPR (dB)
Channel				23060	23095	23130		
Frequency (MHz)				704	707.5	711		
10	QPSK	1	0	23.64	23.82	23.57	24.0	0
10	QPSK	1	24	23.60	23.78	23.36		
10	QPSK	1	49	23.50	23.54	23.38		
10	QPSK	25	0	22.54	22.67	22.57	23.0	1
10	QPSK	25	12	22.53	22.63	22.53		
10	QPSK	25	24	22.71	22.65	22.55		
10	QPSK	50	0	22.65	22.68	22.60	23.0	1
10	16QAM	1	0	22.33	22.93	22.73		
10	16QAM	1	24	22.52	22.85	22.71		
10	16QAM	1	49	22.47	22.73	22.72	22.0	2
10	16QAM	25	0	21.81	21.64	21.59		
10	16QAM	25	12	21.50	21.71	21.71		
10	16QAM	25	24	21.87	21.66	21.74	22.0	2
10	16QAM	50	0	21.54	21.69	21.37		
Channel				23035	23095	23155	Tune up Limit (dBm)	MPR (dB)
Frequency (MHz)				701.5	707.5	713.5		
5	QPSK	1	0	23.65	23.56	23.59	24.0	0
5	QPSK	1	12	23.64	23.71	23.72		
5	QPSK	1	24	23.73	23.26	23.57		
5	QPSK	12	0	22.74	22.64	22.64	23.0	1
5	QPSK	12	6	22.72	22.58	22.68		
5	QPSK	12	11	22.70	22.68	22.58		
5	QPSK	25	0	22.70	22.65	22.60	23.0	1
5	16QAM	1	0	22.24	22.88	22.14		
5	16QAM	1	12	22.27	22.92	22.26		
5	16QAM	1	24	22.25	22.73	22.14	22.0	2
5	16QAM	12	0	21.45	21.44	21.52		
5	16QAM	12	6	21.39	21.39	21.50		
5	16QAM	12	11	21.51	21.39	21.51	22.0	2
5	16QAM	25	0	21.70	21.57	21.61		



BW [MHz]	Modulation	RB Size	RB Offset	Power Low Ch. / Freq.	Power Middle Ch. / Freq.	Power High Ch. / Freq.	Tune up Limit (dBm)	MPR (dB)
Channel				23025	23095	23165		
Frequency (MHz)				700.5	707.5	714.5		
3	QPSK	1	0	23.59	23.56	23.44	24.0	0
3	QPSK	1	7	23.64	23.61	23.43		
3	QPSK	1	14	23.36	23.44	23.35		
3	QPSK	8	0	22.72	22.68	22.73	23.0	1
3	QPSK	8	4	22.69	22.63	22.65		
3	QPSK	8	7	22.61	22.68	22.57		
3	QPSK	15	0	22.62	22.68	22.61		
3	16QAM	1	0	22.60	22.51	22.80	23.0	1
3	16QAM	1	7	22.71	22.72	22.70		
3	16QAM	1	14	22.70	22.49	22.62		
3	16QAM	8	0	21.52	21.89	21.82	22.0	2
3	16QAM	8	4	21.56	21.77	21.94		
3	16QAM	8	7	21.55	21.92	21.93		
3	16QAM	15	0	21.32	21.41	21.67		
Channel				23017	23095	23173	Tune up Limit (dBm)	MPR (dB)
Frequency (MHz)				699.7	707.5	715.3		
1.4	QPSK	1	0	23.50	23.61	23.50	24.0	0
1.4	QPSK	1	2	23.59	23.63	23.57		
1.4	QPSK	1	5	23.58	23.64	23.54		
1.4	QPSK	3	0	23.57	23.73	23.58		
1.4	QPSK	3	1	23.76	23.77	23.56		
1.4	QPSK	3	2	23.72	23.68	23.55	23.0	1
1.4	QPSK	6	0	22.69	22.67	22.66		
1.4	16QAM	1	0	22.91	22.90	22.76	23.0	1
1.4	16QAM	1	2	22.93	22.80	22.75		
1.4	16QAM	1	5	22.60	22.78	22.83		
1.4	16QAM	3	0	22.37	22.62	22.68		
1.4	16QAM	3	1	22.69	22.64	22.74		
1.4	16QAM	3	2	22.84	22.56	22.84		
1.4	16QAM	6	0	21.07	21.14	21.62	22.0	2



<LTE Band 17>

BW [MHz]	Modulation	RB Size	RB Offset	Power Low Ch. / Freq.	Power Middle Ch. / Freq.	Power High Ch. / Freq.	Tune up Limit (dBm)	MPR (dB)
Channel				23780	23790	23800		
Frequency (MHz)				709	710	711		
10	QPSK	1	0	23.73	23.87	23.85	24.0	0
10	QPSK	1	24	23.60	23.74	23.62		
10	QPSK	1	49	23.54	23.75	23.53		
10	QPSK	25	0	22.78	22.85	22.71	23.0	1
10	QPSK	25	12	22.77	22.71	22.73		
10	QPSK	25	24	22.78	22.84	22.80		
10	QPSK	50	0	22.80	22.84	22.70	23.0	1
10	16QAM	1	0	22.97	22.78	22.91		
10	16QAM	1	24	22.95	22.56	22.90		
10	16QAM	1	49	22.85	22.59	22.80	22.0	2
10	16QAM	25	0	21.90	21.86	21.80		
10	16QAM	25	12	21.82	21.93	21.71		
10	16QAM	25	24	21.81	21.93	21.69	22.0	2
10	16QAM	25	0	21.53	21.52	21.71		
10	16QAM	50	0	21.53	21.52	21.71		
Channel				23755	23790	23825	Tune up Limit (dBm)	MPR (dB)
Frequency (MHz)				706.5	710	713.5		
5	QPSK	1	0	23.47	23.78	23.52	24.0	0
5	QPSK	1	12	23.82	23.74	23.50		
5	QPSK	1	24	23.75	23.61	23.39		
5	QPSK	12	0	22.79	22.62	22.63	23.0	1
5	QPSK	12	6	22.81	22.63	22.60		
5	QPSK	12	11	22.81	22.59	22.73		
5	QPSK	25	0	22.79	22.62	22.68	23.0	1
5	16QAM	1	0	22.29	22.68	22.57		
5	16QAM	1	12	22.38	22.62	22.88		
5	16QAM	1	24	22.26	22.59	22.31	22.0	2
5	16QAM	12	0	21.72	21.59	21.56		
5	16QAM	12	6	21.53	21.61	21.90		
5	16QAM	12	11	21.62	21.56	21.96	22.0	2
5	16QAM	12	0	21.64	21.60	21.68		



<LTE Band 5>

BW [MHz]	Modulation	RB Size	RB Offset	Power Low Ch. / Freq.	Power Middle Ch. / Freq.	Power High Ch. / Freq.	Tune up Limit (dBm)	MPR (dB)
Channel				20450	20525	20600		
Frequency (MHz)				829	836.5	844		
10	QPSK	1	0	23.61	23.69	23.40		
10	QPSK	1	24	23.48	23.60	23.31	24.0	0
10	QPSK	1	49	23.33	23.48	23.31		
10	QPSK	25	0	22.53	22.67	22.46		
10	QPSK	25	12	22.50	22.61	22.43	23.0	1
10	QPSK	25	24	22.49	22.55	22.49		
10	QPSK	50	0	22.54	22.64	22.44		
10	16QAM	1	0	22.43	22.34	22.75	23.0	1
10	16QAM	1	24	22.13	22.22	22.83		
10	16QAM	1	49	22.25	22.32	22.71		
10	16QAM	25	0	21.65	21.60	21.35	22.0	2
10	16QAM	25	12	21.65	21.54	21.26		
10	16QAM	25	24	21.62	21.43	21.33		
10	16QAM	50	0	21.26	21.25	21.35		
Channel				20425	20525	20625	Tune up Limit (dBm)	MPR (dB)
Frequency (MHz)				826.5	836.5	846.5		
5	QPSK	1	0	23.39	23.39	23.51		
5	QPSK	1	12	23.55	23.52	23.55	24.0	0
5	QPSK	1	24	23.09	23.38	23.21		
5	QPSK	12	0	22.50	22.41	22.45		
5	QPSK	12	6	22.51	22.35	22.51	23.0	1
5	QPSK	12	11	22.54	22.34	22.47		
5	QPSK	25	0	22.46	22.45	22.51		
5	16QAM	1	0	22.90	22.58	22.59	23.0	1
5	16QAM	1	12	22.89	22.67	22.71		
5	16QAM	1	24	22.87	22.57	22.61		
5	16QAM	12	0	21.41	21.16	21.34	22.0	2
5	16QAM	12	6	21.43	21.20	21.37		
5	16QAM	12	11	21.37	21.13	21.38		
5	16QAM	25	0	21.60	21.22	21.72		



BW [MHz]	Modulation	RB Size	RB Offset	Power Low Ch. / Freq.	Power Middle Ch. / Freq.	Power High Ch. / Freq.	Tune up Limit (dBm)	MPR (dB)
Channel				20415	20525	20635		
Frequency (MHz)				825.5	836.5	847.5		
3	QPSK	1	0	23.58	23.35	23.49	24.0	0
3	QPSK	1	7	23.47	23.43	23.51		
3	QPSK	1	14	23.57	23.26	23.34		
3	QPSK	8	0	22.52	22.53	22.58	23.0	1
3	QPSK	8	4	22.52	22.45	22.52		
3	QPSK	8	7	22.58	22.50	22.50		
3	QPSK	15	0	22.49	22.46	22.48		
3	16QAM	1	0	22.70	22.62	22.35	23.0	1
3	16QAM	1	7	22.68	22.67	22.38		
3	16QAM	1	14	22.46	22.48	22.32		
3	16QAM	8	0	21.70	21.64	21.63	22.0	2
3	16QAM	8	4	21.56	21.58	21.57		
3	16QAM	8	7	21.64	21.63	21.60		
3	16QAM	15	0	21.64	21.55	21.53		
Channel				20407	20525	20643	Tune up Limit (dBm)	MPR (dB)
Frequency (MHz)				824.7	836.5	848.3		
1.4	QPSK	1	0	23.63	23.34	23.36	24.0	0
1.4	QPSK	1	2	23.53	23.47	23.61		
1.4	QPSK	1	5	23.23	23.36	23.36		
1.4	QPSK	3	0	23.46	23.40	23.61		
1.4	QPSK	3	1	23.57	23.64	23.65		
1.4	QPSK	3	2	23.62	23.45	23.59	23.0	1
1.4	QPSK	6	0	22.54	22.49	22.56		
1.4	16QAM	1	0	22.95	22.63	22.47	23.0	1
1.4	16QAM	1	2	22.79	22.97	22.38		
1.4	16QAM	1	5	22.78	22.61	22.30		
1.4	16QAM	3	0	22.34	22.91	22.32		
1.4	16QAM	3	1	22.56	22.62	22.53		
1.4	16QAM	3	2	22.35	22.55	22.38		
1.4	16QAM	6	0	21.11	21.03	21.19	22.0	2



<LTE Band 4>

BW [MHz]	Modulation	RB Size	RB Offset	Power Low Ch. / Freq.	Power Middle Ch. / Freq.	Power High Ch. / Freq.	Tune up Limit (dBm)	MPR (dB)
Channel				20050	20175	20300		
Frequency (MHz)				1720	1732.5	1745		
20	QPSK	1	0	22.36	22.37	22.35	22.5	0
20	QPSK	1	49	22.31	22.35	22.33		
20	QPSK	1	99	22.32	22.18	22.14		
20	QPSK	50	0	21.39	21.45	21.28	21.5	1
20	QPSK	50	24	21.35	21.43	21.22		
20	QPSK	50	49	21.35	21.39	21.16		
20	QPSK	100	0	21.36	21.45	21.15		
20	16QAM	1	0	21.37	21.33	21.35	21.5	1
20	16QAM	1	49	21.42	21.25	21.34		
20	16QAM	1	99	21.35	21.27	21.10		
20	16QAM	50	0	20.43	20.33	20.40	20.5	2
20	16QAM	50	24	20.38	20.31	20.38		
20	16QAM	50	49	20.32	20.36	20.29		
20	16QAM	100	0	20.43	20.26	20.16		
Channel				20025	20175	20325	Tune up Limit (dBm)	MPR (dB)
Frequency (MHz)				1717.5	1732.5	1747.5		
15	QPSK	1	0	22.31	22.38	22.37	22.5	0
15	QPSK	1	37	22.30	22.29	22.33		
15	QPSK	1	74	22.27	22.24	22.26		
15	QPSK	36	0	21.44	21.32	21.37	21.5	1
15	QPSK	36	18	21.40	21.44	21.35		
15	QPSK	36	37	21.41	21.43	21.28		
15	QPSK	75	0	21.40	21.40	21.24		
15	16QAM	1	0	21.28	21.37	21.34	21.5	1
15	16QAM	1	37	21.37	21.38	21.33		
15	16QAM	1	74	21.32	21.42	21.25		
15	16QAM	36	0	20.24	20.35	20.42	20.5	2
15	16QAM	36	18	20.13	20.36	20.32		
15	16QAM	36	37	20.26	20.33	20.33		
15	16QAM	75	0	20.19	20.23	20.21		
Channel				20000	20175	20350	Tune up Limit (dBm)	MPR (dB)
Frequency (MHz)				1715	1732.5	1750		
10	QPSK	1	0	22.40	22.37	22.39	22.5	0
10	QPSK	1	24	22.35	22.18	22.33		
10	QPSK	1	49	22.31	22.12	22.26		
10	QPSK	25	0	21.44	21.46	21.44	21.5	1
10	QPSK	25	12	21.36	21.43	21.31		
10	QPSK	25	24	21.40	21.39	21.34		
10	QPSK	50	0	21.36	21.43	21.45		
10	16QAM	1	0	21.41	21.28	21.35	21.5	1
10	16QAM	1	24	21.34	21.37	21.27		
10	16QAM	1	49	21.35	21.31	21.27		
10	16QAM	25	0	20.34	20.33	20.38	20.5	2
10	16QAM	25	12	20.35	20.32	20.38		
10	16QAM	25	24	20.40	20.34	20.42		
10	16QAM	50	0	20.21	20.41	20.21		



BW [MHz]	Modulation	RB Size	RB Offset	Power Low Ch. / Freq.	Power Middle Ch. / Freq.	Power High Ch. / Freq.	Tune up Limit (dBm)	MPR (dB)
Channel				19975	20175	20375		
Frequency (MHz)				1712.5	1732.5	1752.5		
5	QPSK	1	0	22.35	22.37	22.38	22.5	0
5	QPSK	1	12	22.26	22.32	22.25		
5	QPSK	1	24	22.19	22.16	22.24		
5	QPSK	12	0	21.32	21.42	21.45	21.5	1
5	QPSK	12	6	21.39	21.37	21.40		
5	QPSK	12	11	21.42	21.35	21.42		
5	QPSK	25	0	21.31	21.42	21.41		
5	16QAM	1	0	21.30	21.31	21.14	21.5	1
5	16QAM	1	12	21.26	21.33	21.19		
5	16QAM	1	24	21.33	21.38	21.28		
5	16QAM	12	0	20.32	20.21	20.41	20.5	2
5	16QAM	12	6	20.23	20.16	20.40		
5	16QAM	12	11	20.16	20.29	20.15		
5	16QAM	12	11	20.16	20.29	20.15		
5	16QAM	25	0	20.34	20.29	20.16		
Channel				19965	20175	20385	Tune up Limit (dBm)	MPR (dB)
Frequency (MHz)				1711.5	1732.5	1753.5		
3	QPSK	1	0	22.41	22.37	22.40	22.5	0
3	QPSK	1	7	22.33	22.35	22.37		
3	QPSK	1	14	22.25	22.31	22.35		
3	QPSK	8	0	21.41	21.33	21.40	21.5	1
3	QPSK	8	4	21.37	21.34	21.38		
3	QPSK	8	7	21.36	21.40	21.42		
3	QPSK	15	0	21.34	21.41	21.43		
3	16QAM	1	0	21.38	21.25	21.13	21.5	1
3	16QAM	1	7	21.34	21.47	21.11		
3	16QAM	1	14	21.24	21.39	21.34		
3	16QAM	8	0	20.33	20.32	20.31	20.5	2
3	16QAM	8	4	20.33	20.34	20.26		
3	16QAM	8	7	20.33	20.34	20.19		
3	16QAM	8	7	20.33	20.34	20.19		
3	16QAM	15	0	20.14	20.32	20.15		
Channel				19957	20175	20393	Tune up Limit (dBm)	MPR (dB)
Frequency (MHz)				1710.7	1732.5	1754.3		
1.4	QPSK	1	0	22.40	22.27	22.28	22.5	0
1.4	QPSK	1	2	22.42	22.28	22.24		
1.4	QPSK	1	5	22.41	22.42	22.21		
1.4	QPSK	3	0	22.37	22.32	22.37		
1.4	QPSK	3	1	22.29	22.36	22.28		
1.4	QPSK	3	2	22.38	22.36	22.36		
1.4	QPSK	6	0	21.35	21.44	21.44	21.5	1
1.4	16QAM	1	0	21.30	21.31	21.38	21.5	1
1.4	16QAM	1	2	21.26	21.38	21.30		
1.4	16QAM	1	5	21.21	21.35	21.07		
1.4	16QAM	3	0	21.34	21.37	21.36		
1.4	16QAM	3	1	21.24	21.25	21.35		
1.4	16QAM	3	2	21.25	21.17	21.33		
1.4	16QAM	3	2	21.25	21.17	21.33		
1.4	16QAM	6	0	20.35	20.32	20.23		



<LTE Band 2>

BW [MHz]	Modulation	RB Size	RB Offset	Power Low Ch. / Freq.	Power Middle Ch. / Freq.	Power High Ch. / Freq.	Tune up Limit (dBm)	MPR (dB)
Channel				18700	18900	19100		
Frequency (MHz)				1860	1880	1900		
20	QPSK	1	0	21.68	21.71	21.61	22.5	0
20	QPSK	1	49	21.75	21.77	21.67		
20	QPSK	1	99	21.69	21.29	21.54		
20	QPSK	50	0	20.43	20.62	20.52	21.5	1
20	QPSK	50	24	20.47	20.68	20.64		
20	QPSK	50	49	20.21	20.56	20.16		
20	QPSK	100	0	20.28	20.58	20.25	21.5	1
20	16QAM	1	0	20.12	20.27	20.05		
20	16QAM	1	49	20.16	20.20	20.37		
20	16QAM	1	99	20.11	20.14	20.06	20.5	2
20	16QAM	50	0	19.41	19.19	19.25		
20	16QAM	50	24	19.31	19.17	19.39		
20	16QAM	50	49	19.37	19.15	19.26	20.5	2
20	16QAM	100	0	19.34	19.19	19.27		
Channel				18675	18900	19125		
Frequency (MHz)				1857.5	1880	1902.5		
15	QPSK	1	0	21.49	21.66	21.09	22.5	0
15	QPSK	1	37	21.34	21.22	21.17		
15	QPSK	1	74	21.31	21.42	20.66		
15	QPSK	36	0	20.49	20.32	20.31	21.5	1
15	QPSK	36	18	20.49	20.36	20.23		
15	QPSK	36	37	20.13	20.42	20.24		
15	QPSK	75	0	20.46	20.31	20.60	21.5	1
15	16QAM	1	0	20.55	20.69	20.02		
15	16QAM	1	37	20.48	20.59	20.21		
15	16QAM	1	74	20.42	20.82	20.09	20.5	2
15	16QAM	36	0	19.29	19.13	19.16		
15	16QAM	36	18	19.26	19.21	19.12		
15	16QAM	36	37	19.12	19.21	19.13	20.5	2
15	16QAM	75	0	19.16	19.22	19.22		
Channel				18650	18900	19150		
Frequency (MHz)				1855	1880	1905		
10	QPSK	1	0	21.45	21.27	21.33	22.5	0
10	QPSK	1	24	21.39	21.25	21.34		
10	QPSK	1	49	21.30	21.41	21.01		
10	QPSK	25	0	20.43	20.46	20.22	21.5	1
10	QPSK	25	12	20.43	20.21	20.47		
10	QPSK	25	24	20.29	20.18	20.50		
10	QPSK	50	0	20.45	20.23	20.44	21.5	1
10	16QAM	1	0	20.54	20.66	20.32		
10	16QAM	1	24	20.51	20.77	20.36		
10	16QAM	1	49	20.51	20.59	20.31	20.5	2
10	16QAM	25	0	19.09	19.15	19.39		
10	16QAM	25	12	19.18	19.15	19.31		
10	16QAM	25	24	19.09	19.49	19.37	20.5	2
10	16QAM	25	24	19.09	19.49	19.37		
10	16QAM	50	0	19.08	19.40	19.35		



BW [MHz]	Modulation	RB Size	RB Offset	Power Low Ch. / Freq.	Power Middle Ch. / Freq.	Power High Ch. / Freq.	Tune up Limit (dBm)	MPR (dB)
Channel				18625	18900	19175		
Frequency (MHz)				1852.5	1880	1907.5		
5	QPSK	1	0	21.17	21.24	21.37	22.5	0
5	QPSK	1	12	21.45	21.29	21.32		
5	QPSK	1	24	21.23	21.21	21.07		
5	QPSK	12	0	20.16	20.07	20.44	21.5	1
5	QPSK	12	6	20.16	20.18	20.52		
5	QPSK	12	11	20.36	20.27	20.43		
5	QPSK	25	0	20.18	20.33	20.43		
5	16QAM	1	0	20.44	20.09	20.44	21.5	1
5	16QAM	1	12	20.54	20.24	20.50		
5	16QAM	1	24	20.64	20.48	20.20		
5	16QAM	12	0	19.23	19.14	19.33	20.5	2
5	16QAM	12	6	19.14	19.32	19.17		
5	16QAM	12	11	19.23	19.17	19.26		
5	16QAM	12	11	19.23	19.17	19.26		
5	16QAM	25	0	19.32	19.17	19.33		
Channel				18615	18900	19185	Tune up Limit (dBm)	MPR (dB)
Frequency (MHz)				1851.5	1880	1908.5		
3	QPSK	1	0	21.05	21.04	21.15	22.5	0
3	QPSK	1	7	21.24	21.01	21.41		
3	QPSK	1	14	21.08	21.02	21.18		
3	QPSK	8	0	20.09	20.03	20.14	21.5	1
3	QPSK	8	4	20.05	20.05	20.23		
3	QPSK	8	7	20.01	20.04	20.18		
3	QPSK	15	0	20.02	20.07	20.21		
3	16QAM	1	0	20.32	20.24	20.24	21.5	1
3	16QAM	1	7	20.38	20.41	20.53		
3	16QAM	1	14	20.44	20.45	20.16		
3	16QAM	8	0	19.25	19.07	19.31	20.5	2
3	16QAM	8	4	19.22	19.06	19.35		
3	16QAM	8	7	19.21	19.03	19.23		
3	16QAM	8	7	19.21	19.03	19.23		
3	16QAM	15	0	19.24	19.06	19.34		
Channel				18607	18900	19193	Tune up Limit (dBm)	MPR (dB)
Frequency (MHz)				1850.7	1880	1909.3		
1.4	QPSK	1	0	21.03	21.04	21.19	22.5	0
1.4	QPSK	1	2	21.01	21.03	21.16		
1.4	QPSK	1	5	21.06	21.01	21.07		
1.4	QPSK	3	0	21.01	21.08	21.56		
1.4	QPSK	3	1	21.22	21.02	21.37		
1.4	QPSK	3	2	21.03	21.02	21.47		
1.4	QPSK	6	0	20.06	20.08	20.33	21.5	1
1.4	16QAM	1	0	20.09	20.38	20.33	21.5	1
1.4	16QAM	1	2	20.23	20.42	20.32		
1.4	16QAM	1	5	20.27	20.19	20.50		
1.4	16QAM	3	0	20.32	20.59	20.15		
1.4	16QAM	3	1	20.24	20.51	20.05		
1.4	16QAM	3	2	20.30	20.64	20.04		
1.4	16QAM	3	2	20.30	20.64	20.04		
1.4	16QAM	6	0	19.16	19.01	19.03		



<LTE Band 7>

BW [MHz]	Modulation	RB Size	RB Offset	Power Low Ch. / Freq.	Power Middle Ch. / Freq.	Power High Ch. / Freq.	Tune up Limit (dBm)	MPR (dB)
Channel				20850	21100	21350		
Frequency (MHz)				2510	2535	2560		
20	QPSK	1	0	22.68	22.88	22.67	23.5	0
20	QPSK	1	49	22.54	22.86	22.62		
20	QPSK	1	99	22.25	22.71	22.51		
20	QPSK	50	0	21.62	21.64	21.54	22.5	1
20	QPSK	50	24	21.31	21.58	21.52		
20	QPSK	50	49	21.25	21.57	21.44		
20	QPSK	100	0	21.35	21.49	21.44		
20	16QAM	1	0	21.60	21.33	21.48	22.5	1
20	16QAM	1	49	21.51	21.31	21.43		
20	16QAM	1	99	21.51	21.27	21.46		
20	16QAM	50	0	20.67	20.66	20.47	21.5	2
20	16QAM	50	24	20.47	20.65	20.41		
20	16QAM	50	49	20.21	20.64	20.46		
20	16QAM	100	0	20.39	20.45	20.59		
Channel				20825	21100	21375	Tune up Limit (dBm)	MPR (dB)
Frequency (MHz)				2507.5	2535	2562.5		
15	QPSK	1	0	22.67	22.56	22.53	23.5	0
15	QPSK	1	37	22.57	22.54	22.45		
15	QPSK	1	74	22.45	22.55	22.55		
15	QPSK	36	0	21.65	21.58	21.52	22.5	1
15	QPSK	36	18	21.49	21.68	21.53		
15	QPSK	36	37	21.53	21.52	21.43		
15	QPSK	75	0	21.48	21.53	21.62		
15	16QAM	1	0	21.69	21.54	21.07	22.5	1
15	16QAM	1	37	21.83	21.62	21.21		
15	16QAM	1	74	21.61	21.77	21.17		
15	16QAM	36	0	20.49	20.62	20.90	21.5	2
15	16QAM	36	18	20.42	20.52	20.61		
15	16QAM	36	37	20.32	20.55	20.65		
15	16QAM	75	0	20.55	20.46	20.50		



BW [MHz]	Modulation	RB Size	RB Offset	Power Low Ch. / Freq.	Power Middle Ch. / Freq.	Power High Ch. / Freq.	Tune up Limit (dBm)	MPR (dB)
Channel				20800	21100	21400		
Frequency (MHz)				2505	2535	2565		
10	QPSK	1	0	22.65	22.66	22.45	23.5	0
10	QPSK	1	24	22.63	22.56	22.37		
10	QPSK	1	49	22.44	22.59	22.36		
10	QPSK	25	0	21.67	21.53	21.36	22.5	1
10	QPSK	25	12	21.53	21.53	21.42		
10	QPSK	25	24	21.48	21.58	21.43		
10	QPSK	50	0	21.57	21.58	21.41	22.5	1
10	16QAM	1	0	21.67	21.48	22.06		
10	16QAM	1	24	21.68	21.37	22.02		
10	16QAM	1	49	21.49	21.38	21.77	21.5	2
10	16QAM	25	0	20.69	20.93	20.46		
10	16QAM	25	12	20.54	20.68	20.48		
10	16QAM	25	24	20.34	20.62	20.58		
10	16QAM	50	0	20.54	20.55	20.52		
Channel				20775	21100	21425	Tune up Limit (dBm)	MPR (dB)
Frequency (MHz)				2502.5	2535	2567.5		
5	QPSK	1	0	22.45	22.56	22.55	23.5	0
5	QPSK	1	12	22.34	22.53	22.65		
5	QPSK	1	24	22.39	22.55	22.43		
5	QPSK	12	0	21.54	21.52	21.52	22.5	1
5	QPSK	12	6	21.50	21.62	21.61		
5	QPSK	12	11	21.50	21.69	21.63		
5	QPSK	25	0	21.52	21.54	21.62	22.5	1
5	16QAM	1	0	21.56	21.59	21.79		
5	16QAM	1	12	21.92	21.66	21.73		
5	16QAM	1	24	21.54	21.65	21.44	21.5	2
5	16QAM	12	0	20.58	20.69	20.58		
5	16QAM	12	6	20.54	20.66	20.71		
5	16QAM	12	11	20.56	20.62	20.68		
5	16QAM	25	0	20.54	20.58	20.57		



<Reduced Power Mode, for reverse call>

<LTE Band 12>

BW [MHz]	Modulation	RB Size	RB Offset	Power Low Ch. / Freq.	Power Middle Ch. / Freq.	Power High Ch. / Freq.	Tune up Limit (dBm)	MPR (dB)
Channel				23060	23095	23130	21.0	0
Frequency (MHz)				704	707.5	711		
10	QPSK	1	0	20.49	20.77	20.73		
10	QPSK	1	24	20.82	20.62	20.54	21.0	0
10	QPSK	1	49	20.40	20.66	20.71		
10	QPSK	25	0	20.41	20.34	20.62		
10	QPSK	25	12	20.48	20.37	20.66	21.0	0
10	QPSK	25	24	20.56	20.58	20.64		
10	QPSK	50	0	20.52	20.59	20.66		
10	16QAM	1	0	20.31	20.71	20.67	21.0	0
10	16QAM	1	24	20.59	20.34	20.23		
10	16QAM	1	49	20.52	20.57	20.27		
10	16QAM	25	0	20.54	20.45	20.64	21.0	0
10	16QAM	25	12	20.31	20.48	20.59		
10	16QAM	25	24	20.43	20.53	20.48		
10	16QAM	50	0	20.33	20.55	20.61	21.0	0
Channel				23035	23095	23155		
Frequency (MHz)				701.5	707.5	713.5		
5	QPSK	1	0	20.28	20.77	20.63	21.0	0
5	QPSK	1	12	20.28	20.72	20.66		
5	QPSK	1	24	20.41	20.44	20.26		
5	QPSK	12	0	20.55	20.51	20.52	21.0	0
5	QPSK	12	6	20.54	20.59	20.52		
5	QPSK	12	11	20.56	20.63	20.45		
5	QPSK	25	0	20.62	20.59	20.41	21.0	0
5	16QAM	1	0	20.10	20.52	20.63		
5	16QAM	1	12	20.07	20.21	20.61		
5	16QAM	1	24	20.26	20.24	20.57	21.0	0
5	16QAM	12	0	20.51	20.42	20.46		
5	16QAM	12	6	20.40	20.46	20.45		
5	16QAM	12	11	20.52	20.35	20.38	21.0	0
5	16QAM	25	0	20.69	20.50	20.45		



BW [MHz]	Modulation	RB Size	RB Offset	Power Low Ch. / Freq.	Power Middle Ch. / Freq.	Power High Ch. / Freq.	Tune up Limit (dBm)	MPR (dB)
Channel				23025	23095	23165		
Frequency (MHz)				700.5	707.5	714.5		
3	QPSK	1	0	20.22	20.65	20.60	21.0	0
3	QPSK	1	7	20.23	20.40	20.34		
3	QPSK	1	14	20.35	20.28	20.23		
3	QPSK	8	0	20.67	20.51	20.58	21.0	0
3	QPSK	8	4	20.63	20.63	20.35		
3	QPSK	8	7	20.59	20.56	20.47		
3	QPSK	15	0	20.47	20.57	20.55	21.0	0
3	16QAM	1	0	20.46	20.61	20.57		
3	16QAM	1	7	20.57	20.59	20.14		
3	16QAM	1	14	20.72	20.38	20.15	21.0	0
3	16QAM	8	0	20.77	20.43	20.24		
3	16QAM	8	4	20.72	20.59	20.30		
3	16QAM	8	7	20.68	20.53	20.29	21.0	0
3	16QAM	15	0	20.83	20.59	20.42		
Channel				23017	23095	23173	Tune up Limit (dBm)	MPR (dB)
Frequency (MHz)				699.7	707.5	715.3		
1.4	QPSK	1	0	20.63	20.71	20.52	21.0	0
1.4	QPSK	1	2	20.31	20.54	20.52		
1.4	QPSK	1	5	20.59	20.51	20.42		
1.4	QPSK	3	0	20.61	20.58	20.64		
1.4	QPSK	3	1	20.60	20.63	20.71		
1.4	QPSK	3	2	20.52	20.62	20.66	21.0	0
1.4	QPSK	6	0	20.55	20.59	20.57	21.0	0
1.4	16QAM	1	0	20.54	20.66	20.15		
1.4	16QAM	1	2	20.11	20.55	20.10		
1.4	16QAM	1	5	20.20	20.65	20.50		
1.4	16QAM	3	0	20.12	20.51	20.11		
1.4	16QAM	3	1	20.34	20.55	20.09	21.0	0
1.4	16QAM	3	2	20.45	20.64	20.08		
1.4	16QAM	6	0	20.53	20.49	20.19	21.0	0



<LTE Band 17>

BW [MHz]	Modulation	RB Size	RB Offset	Power Low Ch. / Freq.	Power Middle Ch. / Freq.	Power High Ch. / Freq.	Tune up Limit (dBm)	MPR (dB)
Channel				23780	23790	23800		
Frequency (MHz)				709	710	711		
10	QPSK	1	0	20.73	20.83	20.74	21.0	0
10	QPSK	1	24	20.79	20.79	20.81		
10	QPSK	1	49	20.62	20.62	20.54		
10	QPSK	25	0	20.62	20.72	20.55	21.0	0
10	QPSK	25	12	20.59	20.55	20.56		
10	QPSK	25	24	20.58	20.57	20.67		
10	QPSK	50	0	20.55	20.62	20.59	21.0	0
10	16QAM	1	0	20.77	20.66	20.75		
10	16QAM	1	24	20.61	20.49	20.69		
10	16QAM	1	49	20.69	20.31	20.71	21.0	0
10	16QAM	25	0	20.66	20.64	20.62		
10	16QAM	25	12	20.64	20.62	20.61		
10	16QAM	25	24	20.67	20.64	20.72	21.0	0
10	16QAM	25	0	20.67	20.64	20.72		
10	16QAM	50	0	20.62	20.65	20.43		
Channel				23755	23790	23825	Tune up Limit (dBm)	MPR (dB)
Frequency (MHz)				706.5	710	713.5		
5	QPSK	1	0	20.65	20.64	20.45	21.0	0
5	QPSK	1	12	20.53	20.47	20.78		
5	QPSK	1	24	20.48	20.39	20.24		
5	QPSK	12	0	20.59	20.57	20.50	21.0	0
5	QPSK	12	6	20.58	20.58	20.57		
5	QPSK	12	11	20.55	20.54	20.61		
5	QPSK	25	0	20.57	20.60	20.45	21.0	0
5	16QAM	1	0	20.71	20.60	20.73		
5	16QAM	1	12	20.72	20.35	20.72		
5	16QAM	1	24	20.70	20.35	20.38	21.0	0
5	16QAM	12	0	20.62	20.51	20.48		
5	16QAM	12	6	20.62	20.42	20.55		
5	16QAM	12	11	20.58	20.40	20.54	21.0	0
5	16QAM	12	0	20.58	20.40	20.54		
5	16QAM	25	0	20.60	20.44	20.73		



<LTE Band 4>

BW [MHz]	Modulation	RB Size	RB Offset	Power Low Ch. / Freq.	Power Middle Ch. / Freq.	Power High Ch. / Freq.	Tune up Limit (dBm)	MPR (dB)
Channel				20050	20175	20300	18.0	0
Frequency (MHz)				1720	1732.5	1745		
20	QPSK	1	0	16.72	16.81	16.68		
20	QPSK	1	49	16.68	16.70	16.58	18.0	0
20	QPSK	1	99	16.37	16.54	16.24		
20	QPSK	50	0	16.61	16.73	16.67		
20	QPSK	50	24	16.54	16.65	16.53	18.0	0
20	QPSK	50	49	16.46	16.60	16.53		
20	QPSK	100	0	16.50	16.71	16.60		
20	16QAM	1	0	16.67	16.79	16.67	18.0	0
20	16QAM	1	49	16.58	16.76	16.54		
20	16QAM	1	99	16.52	16.73	16.50		
20	16QAM	50	0	16.56	16.74	16.66	18.0	0
20	16QAM	50	24	16.65	16.74	16.60		
20	16QAM	50	49	16.48	16.70	16.55		
20	16QAM	100	0	16.54	16.70	16.55	18.0	0
Channel				20025	20175	20325		
Frequency (MHz)				1717.5	1732.5	1747.5		
15	QPSK	1	0	16.64	16.60	16.76	18.0	0
15	QPSK	1	37	16.50	16.58	16.73		
15	QPSK	1	74	16.40	16.45	16.46		
15	QPSK	36	0	16.51	16.51	16.66	18.0	0
15	QPSK	36	18	16.50	16.44	16.59		
15	QPSK	36	37	16.56	16.44	16.60		
15	QPSK	75	0	16.61	16.46	16.59	18.0	0
15	16QAM	1	0	16.55	16.41	16.68		
15	16QAM	1	37	16.48	16.46	16.57		
15	16QAM	1	74	16.37	16.32	16.63	18.0	0
15	16QAM	36	0	16.45	16.66	16.60		
15	16QAM	36	18	16.32	16.56	16.66		
15	16QAM	36	37	16.36	16.56	16.63	18.0	0
15	16QAM	75	0	16.49	16.49	16.56		
Channel				20000	20175	20350		
Frequency (MHz)				1715	1732.5	1750		
10	QPSK	1	0	16.79	16.80	16.64	18.0	0
10	QPSK	1	24	16.73	16.39	16.63		
10	QPSK	1	49	16.63	16.39	16.63		
10	QPSK	25	0	16.64	16.52	16.68	18.0	0
10	QPSK	25	12	16.50	16.57	16.69		
10	QPSK	25	24	16.45	16.54	16.60		
10	QPSK	50	0	16.52	16.53	16.62	18.0	0
10	16QAM	1	0	16.69	16.57	16.68		
10	16QAM	1	24	16.66	16.77	16.65		
10	16QAM	1	49	16.62	16.73	16.62	18.0	0
10	16QAM	25	0	16.66	16.54	16.63		
10	16QAM	25	12	16.66	16.50	16.60		
10	16QAM	25	24	16.66	16.58	16.61	18.0	0
10	16QAM	25	0	16.66	16.54	16.63		
10	16QAM	50	0	16.41	16.57	16.64		



BW [MHz]	Modulation	RB Size	RB Offset	Power Low Ch. / Freq.	Power Middle Ch. / Freq.	Power High Ch. / Freq.	Tune up Limit (dBm)	MPR (dB)
Channel				19975	20175	20375	18.0	0
Frequency (MHz)				1712.5	1732.5	1752.5		
5	QPSK	1	0	16.75	16.37	16.42	18.0	0
5	QPSK	1	12	16.52	16.57	16.52		
5	QPSK	1	24	16.38	16.52	16.34		
5	QPSK	12	0	16.59	16.62	16.60	18.0	0
5	QPSK	12	6	16.55	16.50	16.57		
5	QPSK	12	11	16.51	16.59	16.59		
5	QPSK	25	0	16.59	16.56	16.54	18.0	0
5	16QAM	1	0	16.66	16.61	16.59		
5	16QAM	1	12	16.50	16.40	16.60		
5	16QAM	1	24	16.13	16.19	16.67	18.0	0
5	16QAM	12	0	16.62	16.54	16.61		
5	16QAM	12	6	16.65	16.54	16.58		
5	16QAM	12	11	16.46	16.53	16.59	18.0	0
5	16QAM	25	0	16.47	16.41	16.55		
Channel				19965	20175	20385	18.0	0
Frequency (MHz)				1711.5	1732.5	1753.5		
3	QPSK	1	0	16.64	16.47	16.53	18.0	0
3	QPSK	1	7	16.53	16.58	16.68		
3	QPSK	1	14	16.42	16.51	16.39		
3	QPSK	8	0	16.68	16.64	16.61	18.0	0
3	QPSK	8	4	16.55	16.59	16.54		
3	QPSK	8	7	16.50	16.63	16.49		
3	QPSK	15	0	16.55	16.49	16.46	18.0	0
3	16QAM	1	0	16.80	16.22	16.64		
3	16QAM	1	7	16.72	16.44	16.46		
3	16QAM	1	14	16.69	16.28	16.51	18.0	0
3	16QAM	8	0	16.61	16.69	16.67		
3	16QAM	8	4	16.59	16.63	16.65		
3	16QAM	8	7	16.78	16.62	16.63	18.0	0
3	16QAM	15	0	16.71	16.64	16.66		
Channel				19957	20175	20393	18.0	0
Frequency (MHz)				1710.7	1732.5	1754.3		
1.4	QPSK	1	0	16.43	16.46	16.78	18.0	0
1.4	QPSK	1	2	16.56	16.46	16.50		
1.4	QPSK	1	5	16.40	16.46	16.41		
1.4	QPSK	3	0	16.63	16.42	16.38	18.0	0
1.4	QPSK	3	1	16.73	16.46	16.50		
1.4	QPSK	3	2	16.65	16.47	16.49		
1.4	QPSK	6	0	16.62	16.43	16.59	18.0	0
1.4	16QAM	1	0	16.64	16.78	16.74	18.0	0
1.4	16QAM	1	2	16.56	16.76	16.72		
1.4	16QAM	1	5	16.33	16.75	16.70		
1.4	16QAM	3	0	16.43	16.58	16.73	18.0	0
1.4	16QAM	3	1	16.63	16.68	16.68		
1.4	16QAM	3	2	16.44	16.63	16.66		
1.4	16QAM	6	0	16.20	16.62	16.54	18.0	0



<LTE Band 2>

BW [MHz]	Modulation	RB Size	RB Offset	Power Low Ch. / Freq.	Power Middle Ch. / Freq.	Power High Ch. / Freq.	Tune up Limit (dBm)	MPR (dB)
Channel				18700	18900	19100	17.0	0
Frequency (MHz)				1860	1880	1900		
20	QPSK	1	0	15.65	15.75	15.55	17.0	0
20	QPSK	1	49	15.50	15.72	15.42		
20	QPSK	1	99	15.56	15.58	15.34		
20	QPSK	50	0	15.24	15.51	15.45	17.0	0
20	QPSK	50	24	15.26	15.52	15.47		
20	QPSK	50	49	15.24	15.44	15.37		
20	QPSK	100	0	15.38	15.45	15.44		
20	16QAM	1	0	15.57	15.55	15.43	17.0	0
20	16QAM	1	49	15.43	15.44	15.45		
20	16QAM	1	99	15.36	15.26	15.37		
20	16QAM	50	0	15.49	15.54	15.39	17.0	0
20	16QAM	50	24	15.29	15.48	15.39		
20	16QAM	50	49	15.36	15.52	15.30		
20	16QAM	100	0	15.37	15.47	15.39		
Channel				18675	18900	19125	17.0	0
Frequency (MHz)				1857.5	1880	1902.5		
15	QPSK	1	0	15.69	15.49	15.55	17.0	0
15	QPSK	1	37	15.34	15.42	15.65		
15	QPSK	1	74	15.23	15.41	15.55		
15	QPSK	36	0	15.44	15.47	15.47	17.0	0
15	QPSK	36	18	15.46	15.43	15.44		
15	QPSK	36	37	15.38	15.39	15.39		
15	QPSK	75	0	15.47	15.41	15.49		
15	16QAM	1	0	15.67	15.63	15.68	17.0	0
15	16QAM	1	37	15.54	15.58	15.67		
15	16QAM	1	74	15.47	15.57	15.69		
15	16QAM	36	0	15.46	15.43	15.47	17.0	0
15	16QAM	36	18	15.36	15.32	15.36		
15	16QAM	36	37	15.30	15.29	15.31		
15	16QAM	75	0	15.38	15.44	15.41		
Channel				18650	18900	19150	17.0	0
Frequency (MHz)				1855	1880	1905		
10	QPSK	1	0	15.73	15.63	15.57	17.0	0
10	QPSK	1	24	15.39	15.49	15.39		
10	QPSK	1	49	15.32	15.64	15.41		
10	QPSK	25	0	15.61	15.56	15.36	17.0	0
10	QPSK	25	12	15.44	15.63	15.43		
10	QPSK	25	24	15.64	15.60	15.46		
10	QPSK	50	0	15.41	15.39	15.39		
10	16QAM	1	0	15.49	15.48	15.60	17.0	0
10	16QAM	1	24	15.29	15.27	15.50		
10	16QAM	1	49	15.30	15.35	15.47		
10	16QAM	25	0	15.38	15.47	15.29	17.0	0
10	16QAM	25	12	15.42	15.33	15.11		
10	16QAM	25	24	15.36	15.38	15.13		
10	16QAM	50	0	15.34	15.34	15.26		



BW [MHz]	Modulation	RB Size	RB Offset	Power Low Ch. / Freq.	Power Middle Ch. / Freq.	Power High Ch. / Freq.	Tune up Limit (dBm)	MPR (dB)
Channel				18625	18900	19175	17.0	0
Frequency (MHz)				1852.5	1880	1907.5		
5	QPSK	1	0	15.37	15.65	15.59	17.0	0
5	QPSK	1	12	15.24	15.58	15.51		
5	QPSK	1	24	15.16	15.54	15.56		
5	QPSK	12	0	15.25	15.36	15.17	17.0	0
5	QPSK	12	6	15.30	15.33	15.12		
5	QPSK	12	11	15.33	15.29	15.17		
5	QPSK	25	0	15.35	15.36	15.26	17.0	0
5	16QAM	1	0	15.53	15.36	15.38		
5	16QAM	1	12	15.51	15.17	15.26		
5	16QAM	1	24	15.52	15.18	15.21	17.0	0
5	16QAM	12	0	15.20	15.25	15.30		
5	16QAM	12	6	15.13	15.31	15.37		
5	16QAM	12	11	15.26	15.28	15.32	17.0	0
5	16QAM	25	0	15.39	15.35	15.30		
Channel				18615	18900	19185	17.0	0
Frequency (MHz)				1851.5	1880	1908.5		
3	QPSK	1	0	15.39	15.42	15.59	17.0	0
3	QPSK	1	7	15.24	15.56	15.56		
3	QPSK	1	14	15.20	15.27	15.58		
3	QPSK	8	0	15.36	15.35	15.25	17.0	0
3	QPSK	8	4	15.38	15.31	15.25		
3	QPSK	8	7	15.38	15.36	15.51		
3	QPSK	15	0	15.29	15.41	15.13	17.0	0
3	16QAM	1	0	15.13	15.54	15.45		
3	16QAM	1	7	15.09	15.49	15.21		
3	16QAM	1	14	15.37	15.50	15.33	17.0	0
3	16QAM	8	0	15.20	15.20	15.43		
3	16QAM	8	4	15.20	15.15	15.34		
3	16QAM	8	7	15.20	15.50	15.35	17.0	0
3	16QAM	15	0	15.07	15.41	15.34		
Channel				18607	18900	19193	17.0	0
Frequency (MHz)				1850.7	1880	1909.3		
1.4	QPSK	1	0	15.29	15.17	15.27	17.0	0
1.4	QPSK	1	2	15.34	15.41	15.50		
1.4	QPSK	1	5	15.30	15.10	15.46		
1.4	QPSK	3	0	15.43	15.36	15.50	17.0	0
1.4	QPSK	3	1	15.48	15.39	15.62		
1.4	QPSK	3	2	15.28	15.40	15.46		
1.4	QPSK	6	0	15.46	15.39	15.44	17.0	0
1.4	16QAM	1	0	15.48	15.47	15.37	17.0	0
1.4	16QAM	1	2	15.54	15.44	15.57		
1.4	16QAM	1	5	15.37	15.48	15.49		
1.4	16QAM	3	0	15.23	15.21	15.50	17.0	0
1.4	16QAM	3	1	15.46	15.30	15.51		
1.4	16QAM	3	2	15.46	15.23	15.47	17.0	0
1.4	16QAM	6	0	15.12	15.07	15.19		



<LTE Band 7>

BW [MHz]	Modulation	RB Size	RB Offset	Power Low Ch. / Freq.	Power Middle Ch. / Freq.	Power High Ch. / Freq.	Tune up Limit (dBm)	MPR (dB)
Channel				20850	21100	21350		
Frequency (MHz)				2510	2535	2560		
20	QPSK	1	0	14.15	13.98	13.93	15.0	0
20	QPSK	1	49	14.12	13.92	13.88		
20	QPSK	1	99	13.95	13.88	13.79		
20	QPSK	50	0	14.09	13.89	13.80	15.0	0
20	QPSK	50	24	14.01	13.72	13.76		
20	QPSK	50	49	13.86	13.74	13.72		
20	QPSK	100	0	13.84	13.67	13.80	15.0	0
20	16QAM	1	0	14.00	13.96	13.91		
20	16QAM	1	49	13.95	13.91	13.90		
20	16QAM	1	99	13.73	13.87	13.83	15.0	0
20	16QAM	50	0	13.93	13.77	13.78		
20	16QAM	50	24	13.95	13.78	13.71		
20	16QAM	50	49	13.92	13.74	13.64	15.0	0
20	16QAM	100	0	13.86	13.68	13.84		
Channel				20825	21100	21375		
Frequency (MHz)				2507.5	2535	2562.5		
15	QPSK	1	0	14.04	14.00	13.99	15.0	0
15	QPSK	1	37	14.02	13.95	13.74		
15	QPSK	1	74	13.95	13.93	13.81		
15	QPSK	36	0	13.95	13.79	13.83	15.0	0
15	QPSK	36	18	13.92	13.71	13.69		
15	QPSK	36	37	13.83	13.78	13.71		
15	QPSK	75	0	13.77	13.78	13.78	15.0	0
15	16QAM	1	0	13.99	13.95	13.93		
15	16QAM	1	37	13.87	13.89	13.83		
15	16QAM	1	74	13.72	13.83	13.82	15.0	0
15	16QAM	36	0	13.92	13.79	13.87		
15	16QAM	36	18	13.86	13.70	13.69		
15	16QAM	36	37	13.92	13.83	13.67	15.0	0
15	16QAM	75	0	13.85	13.65	13.72		



BW [MHz]	Modulation	RB Size	RB Offset	Power Low Ch. / Freq.	Power Middle Ch. / Freq.	Power High Ch. / Freq.	Tune up Limit (dBm)	MPR (dB)
Channel				20800	21100	21400		
Frequency (MHz)				2505	2535	2565		
10	QPSK	1	0	14.03	14.02	14.01	15.0	0
10	QPSK	1	24	14.01	13.83	13.94		
10	QPSK	1	49	13.98	13.89	13.74		
10	QPSK	25	0	13.95	13.85	13.76	15.0	0
10	QPSK	25	12	13.93	13.79	13.76		
10	QPSK	25	24	13.78	13.82	13.74		
10	QPSK	50	0	13.76	13.74	13.75		
10	16QAM	1	0	14.01	13.93	13.98	15.0	0
10	16QAM	1	24	13.90	13.88	13.96		
10	16QAM	1	49	13.88	13.89	13.94		
10	16QAM	25	0	13.88	13.89	13.86	15.0	0
10	16QAM	25	12	13.89	13.88	13.76		
10	16QAM	25	24	13.78	13.79	13.77		
10	16QAM	50	0	13.78	13.79	13.79		
Channel				20775	21100	21425	Tune up Limit (dBm)	MPR (dB)
Frequency (MHz)				2502.5	2535	2567.5		
5	QPSK	1	0	14.10	13.97	13.98	15.0	0
5	QPSK	1	12	13.92	13.83	13.82		
5	QPSK	1	24	13.95	13.82	13.68		
5	QPSK	12	0	14.00	13.91	13.75	15.0	0
5	QPSK	12	6	13.97	13.79	13.72		
5	QPSK	12	11	13.90	13.74	13.80		
5	QPSK	25	0	13.83	13.74	13.79		
5	16QAM	1	0	13.97	13.93	13.93	15.0	0
5	16QAM	1	12	13.91	13.89	13.95		
5	16QAM	1	24	13.89	13.88	13.92		
5	16QAM	12	0	13.93	13.89	13.79	15.0	0
5	16QAM	12	6	13.90	13.86	13.76		
5	16QAM	12	11	13.90	13.87	13.68		
5	16QAM	25	0	13.82	13.77	13.77		



<Reduced Power Mode, for hotspot>

<LTE Band 7>

BW [MHz]	Modulation	RB Size	RB Offset	Power Low Ch. / Freq.	Power Middle Ch. / Freq.	Power High Ch. / Freq.	Tune up Limit (dBm)	MPR (dB)
Channel				20850	21100	21350		
Frequency (MHz)				2510	2535	2560		
20	QPSK	1	0	17.37	17.45	17.44	17.5	0
20	QPSK	1	49	17.28	17.32	17.37		
20	QPSK	1	99	17.33	17.37	17.42		
20	QPSK	50	0	17.25	17.29	17.28	17.5	0
20	QPSK	50	24	17.21	17.28	17.19		
20	QPSK	50	49	17.11	17.29	17.21		
20	QPSK	100	0	17.21	17.39	17.38	17.5	0
20	16QAM	1	0	17.25	17.44	17.41		
20	16QAM	1	49	17.21	17.42	17.38		
20	16QAM	1	99	17.11	17.43	17.21	17.5	0
20	16QAM	50	0	17.20	17.29	17.33		
20	16QAM	50	24	17.11	17.33	17.34		
20	16QAM	50	49	17.09	17.35	17.31	17.5	0
20	16QAM	100	0	17.13	17.34	17.30		
Channel				20825	21100	21375	Tune up Limit (dBm)	MPR (dB)
Frequency (MHz)				2507.5	2535	2562.5		
15	QPSK	1	0	17.35	17.44	17.46	17.5	0
15	QPSK	1	37	17.28	17.39	17.44		
15	QPSK	1	74	17.13	17.31	17.42		
15	QPSK	36	0	17.26	17.30	17.22	17.5	0
15	QPSK	36	18	17.22	17.24	17.29		
15	QPSK	36	37	17.04	17.24	17.21		
15	QPSK	75	0	17.11	17.29	17.20	17.5	0
15	16QAM	1	0	17.45	17.43	17.28		
15	16QAM	1	37	17.33	17.42	17.16		
15	16QAM	1	74	17.21	17.41	17.22	17.5	0
15	16QAM	36	0	17.22	17.29	17.22		
15	16QAM	36	18	17.10	17.33	17.18		
15	16QAM	36	37	17.11	17.38	17.24	17.5	0
15	16QAM	75	0	17.01	17.35	17.26		



BW [MHz]	Modulation	RB Size	RB Offset	Power Low Ch. / Freq.	Power Middle Ch. / Freq.	Power High Ch. / Freq.	Tune up Limit (dBm)	MPR (dB)
Channel				20800	21100	21400		
Frequency (MHz)				2505	2535	2565		
10	QPSK	1	0	17.39	17.46	17.43	17.5	0
10	QPSK	1	24	17.27	17.45	17.36		
10	QPSK	1	49	17.27	17.39	17.35		
10	QPSK	25	0	17.21	17.34	17.22	17.5	0
10	QPSK	25	12	17.01	17.38	17.22		
10	QPSK	25	24	17.10	17.31	17.31		
10	QPSK	50	0	17.01	17.32	17.29	17.5	0
10	16QAM	1	0	17.25	17.44	17.38		
10	16QAM	1	24	17.21	17.33	17.29		
10	16QAM	1	49	17.16	17.37	17.17	17.5	0
10	16QAM	25	0	17.19	17.21	17.18		
10	16QAM	25	12	17.15	17.32	17.28		
10	16QAM	25	24	17.12	17.38	17.31	17.5	0
10	16QAM	50	0	17.13	17.41	17.32		
Channel				20775	21100	21425	Tune up Limit (dBm)	MPR (dB)
Frequency (MHz)				2502.5	2535	2567.5		
5	QPSK	1	0	17.31	17.43	17.33	17.5	0
5	QPSK	1	12	17.27	17.39	17.32		
5	QPSK	1	24	17.22	17.41	17.28		
5	QPSK	12	0	17.21	17.36	17.27	17.5	0
5	QPSK	12	6	17.19	17.34	17.24		
5	QPSK	12	11	17.17	17.37	17.19		
5	QPSK	25	0	17.13	17.36	17.25	17.5	0
5	16QAM	1	0	17.25	17.31	17.23		
5	16QAM	1	12	17.14	17.30	17.37		
5	16QAM	1	24	17.09	17.38	17.33	17.5	0
5	16QAM	12	0	17.22	17.31	17.27		
5	16QAM	12	6	17.21	17.12	17.22		
5	16QAM	12	11	17.12	17.18	17.11	17.5	0
5	16QAM	25	0	17.12	17.22	17.27		



<WLAN Conducted Power>

General Note:

1. For WLAN SAR testing was performed on single antenna RF power in SISO mode is larger or equal to the single antenna RF power in MIMO mode, and for RF exposure assessment of MIMO mode simultaneous transmission exclusion analysis was performed with SAR test results of each antenna in SISO mode.
2. Per KDB 248227 D01v02r01, the simultaneous SAR provisions in KDB publication 447498 should be applied to determine simultaneous transmission SAR test exclusion for WiFi MIMO. If the sum of 1g single transmission chain SAR measurements is < 1.6W/kg and SAR peak to location ratio < 0.04, no additional SAR measurements for MIMO.
3. Per KDB 248227 D01v02r01, SAR test reduction is determined according to 802.11 transmission mode configurations and certain exposure conditions with multiple test positions. In the 2.4 GHz band, separate SAR procedures are applied to DSSS and OFDM configurations to simplify DSSS test requirements. For OFDM, in both 2.4 and 5 GHz bands, an initial test configuration must be determined for each standalone and aggregated frequency band, according to the transmission mode configuration with the highest maximum output power specified for production units to perform SAR measurements. If the same highest maximum output power applies to different combinations of channel bandwidths, modulations and data rates, additional procedures are applied to determine which test configurations require SAR measurement. When applicable, an initial test position may be applied to reduce the number of SAR measurements required for next to the ear, UMPC mini-tablet or hotspot mode configurations with multiple test positions.
4. For 2.4 GHz 802.11b DSSS, either the initial test position procedure for multiple exposure test positions or the DSSS procedure for fixed exposure position is applied; these are mutually exclusive. For 2.4 GHz and 5 GHz OFDM configurations, the initial test configuration is applied to measure SAR using either the initial test position procedure for multiple exposure test position configurations or the initial test configuration procedures for fixed exposure test conditions. Based on the reported SAR of the measured configurations and maximum output power of the transmission mode configurations that are not included in the initial test configuration, the subsequent test configuration and initial test position procedures are applied to determine if SAR measurements are required for the remaining OFDM transmission configurations. In general, the number of test channels that require SAR measurement is minimized based on maximum output power measured for the test sample(s).
5. For OFDM transmission configurations in the 2.4 GHz and 5 GHz bands, When the same maximum power is specified for multiple transmission modes in a frequency band, the largest channel bandwidth, lowest order modulation, lowest data rate and lowest order 802.11a/g/n/ac mode is used for SAR measurement, on the highest measured output power channel for each frequency band.
6. DSSS and OFDM configurations are considered separately according to the required SAR procedures. SAR is measured in the initial test position using the 802.11 transmission mode configuration required by the DSSS procedure or initial test configuration and subsequent test configuration(s) according to the OFDM procedures.18 The initial test position procedure is described in the following:
 - a. When the reported SAR of the initial test position is ≤ 0.4 W/kg, further SAR measurement is not required for the other test positions in that exposure configuration and 802.11 transmission mode combinations within the frequency band or aggregated band.
 - b. When the reported SAR of the test position is > 0.4 W/kg, SAR is repeated for the 802.11 transmission mode configuration tested in the initial test position to measure the subsequent next closet/smallest test separation distance and maximum coupling test position on the highest maximum output power channel, until the report SAR is ≤ 0.8 W/kg or all required test position are tested.
 - c. For all positions/configurations, when the reported SAR is > 0.8 W/kg, SAR is measured for these test positions/configurations on the subsequent next highest measured output power channel(s) until the reported SAR is ≤ 1.2 W/kg or all required channels are tested.

	Mode	Channel	Frequency (MHz)	Data Rate	Average power (dBm)
2.4GHz WLAN	802.11b	CH 01	2412	1Mbps	17.21
		CH 06	2437		17.73
		CH 11	2462		18.11
	802.11g	CH 01	2412	6Mbps	11.11
		CH 06	2437		12.09
		CH 11	2462		12.41
	802.11n HT20	CH 01	2412	MCS0	10.55
		CH 06	2437		11.50
		CH 11	2462		11.85

14. Bluetooth Exclusions Applied

Mode Band	Average power(dBm)	
	Bluetooth v3.0 + EDR	Bluetooth v4.1 LE
2.4GHz Bluetooth	1.5	-2.0

Note:

Per KDB 447498 D01v05r02, the 1-g and 10-g SAR test exclusion thresholds for 100 MHz to 6 GHz at *test separation distances* ≤ 50 mm are determined by:

$$[(\text{max. power of channel, including tune-up tolerance, mW}) / (\text{min. test separation distance, mm})] \cdot [\sqrt{f(\text{GHz})}] \leq 3.0 \text{ for}$$

1-g SAR and ≤ 7.5 for 10-g extremity SAR

- f(GHz) is the RF channel transmit frequency in GHz
- Power and distance are rounded to the nearest mW and mm before calculation
- The result is rounded to one decimal place for comparison

Bluetooth Max Power (dBm)	Separation Distance (mm)	Frequency (GHz)	Exclusion Thresholds
1.5	0	2.48	0.3

Note:

Per KDB 447498 D01v05r02, when the minimum test separation distance is < 5 mm, a distance of 5 mm is applied to determine SAR test exclusion. The test exclusion threshold is 0.3 which is ≤ 3, SAR testing is not required.

15. Antenna Location

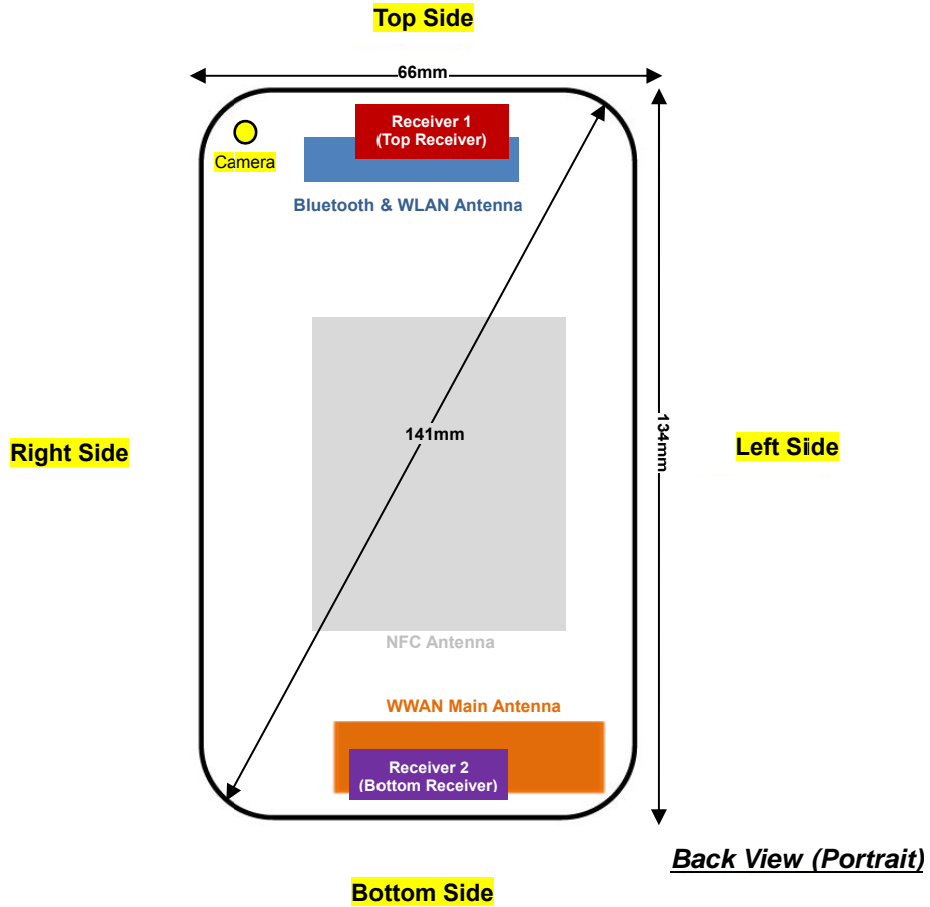

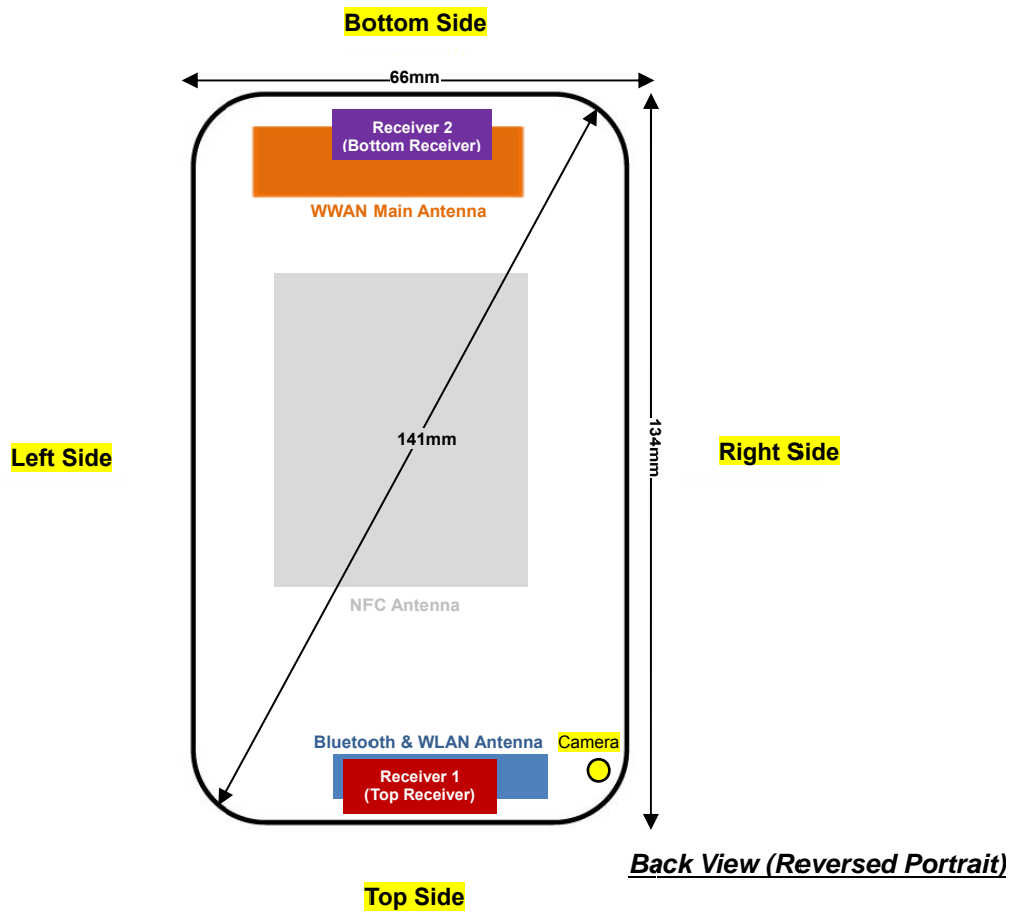

Distance of the Antenna to the EUT surface/edge						
Antennas	Back	Front	Top Side	Bottom Side	Right Side	Left Side
WWAN Main	≤ 25mm	≤ 25mm	116mm	≤ 25mm	≤ 25mm	≤ 25mm
Bluetooth & WLAN	≤ 25mm	≤ 25mm	≤ 25mm	114mm	≤ 25mm	≤ 25mm
Positions for SAR tests; Hotspot mode						
Antennas	Back	Front	Top Side	Bottom Side	Right Side	Left Side
WWAN Main	Yes	Yes	No	Yes	Yes	Yes
Bluetooth & WLAN	Yes	Yes	Yes	No	Yes	Yes

General Note:

Referring to KDB 941225 D06 v02, when the overall device length and width are ≥ 9cm*5cm, the test distance is 10 mm. SAR must be measured for all sides and surfaces with a transmitting antenna located within 25mm from that surface or edge.

16. Antenna Location for Variant Product (6039S)

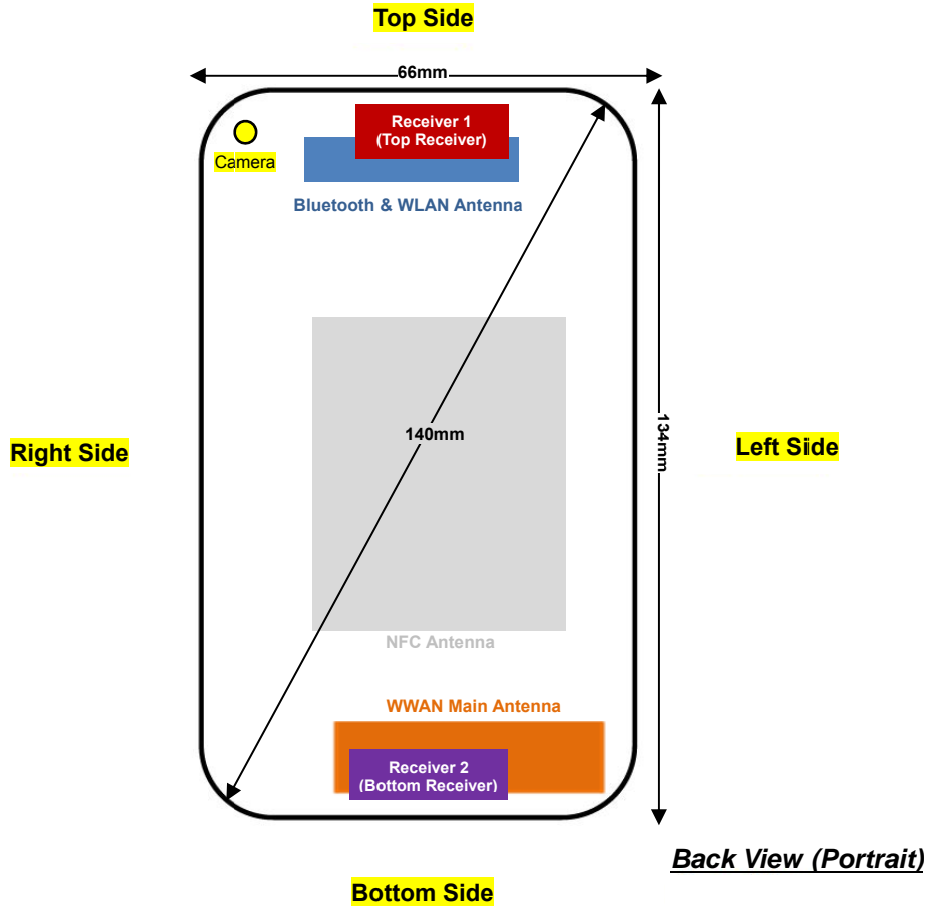

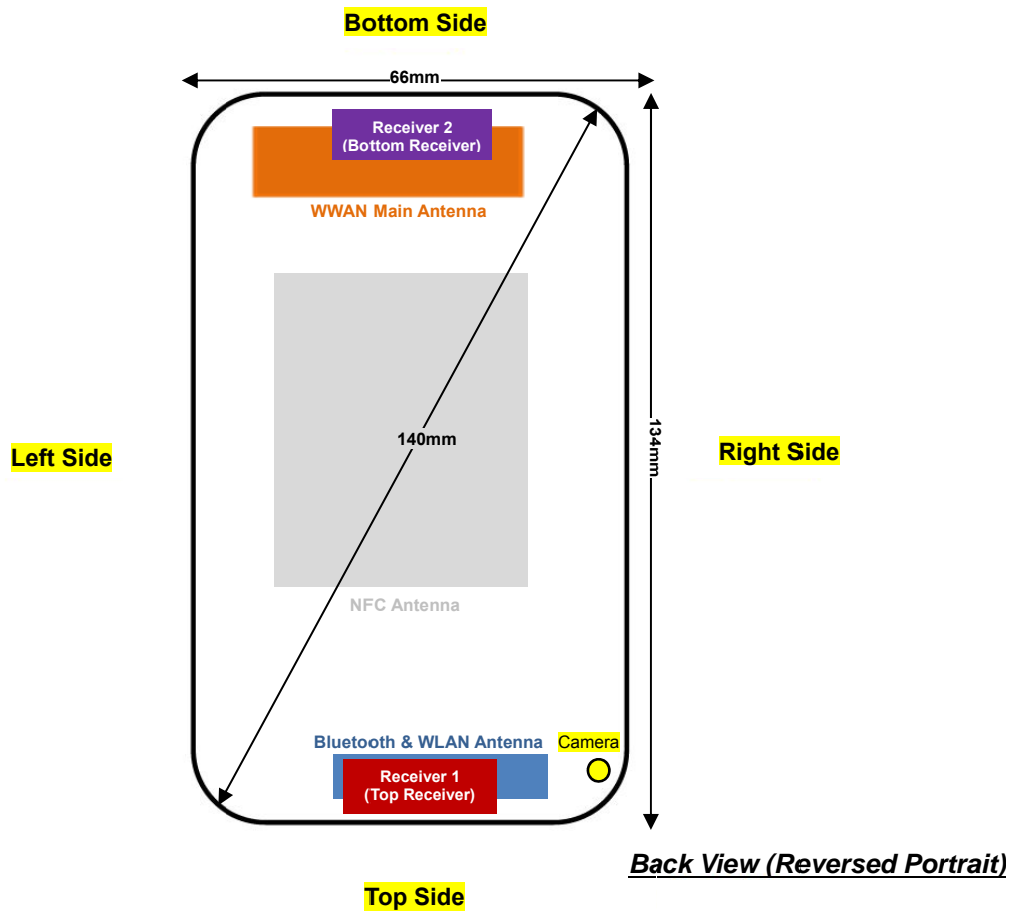

Distance of the Antenna to the EUT surface/edge						
Antennas	Back	Front	Top Side	Bottom Side	Right Side	Left Side
WWAN Main	≤ 25mm	≤ 25mm	118mm	≤ 25mm	≤ 25mm	≤ 25mm
Bluetooth & WLAN	≤ 25mm	≤ 25mm	≤ 25mm	114mm	≤ 25mm	≤ 25mm
Positions for SAR tests; Hotspot mode						
Antennas	Back	Front	Top Side	Bottom Side	Right Side	Left Side
WWAN Main	Yes	Yes	No	Yes	Yes	Yes
Bluetooth & WLAN	Yes	Yes	Yes	No	Yes	Yes

General Note:

Referring to KDB 941225 D06 v02, when the overall device length and width are ≥ 9cm*5cm, the test distance is 10 mm. SAR must be measured for all sides and surfaces with a transmitting antenna located within 25mm from that surface or edge.



17. SAR Test Results

General Note:

1. Per KDB 447498 D01v05r02, the reported SAR is the measured SAR value adjusted for maximum tune-up tolerance.
 - a. Tune-up scaling Factor = tune-up limit power (mW) / EUT RF power (mW), where tune-up limit is the maximum rated power among all production units.
 - b. For SAR testing of WLAN signal with non-100% duty cycle, the measured SAR is scaled-up by the duty cycle scaling factor which is equal to "1/(duty cycle)"
 - c. For WWAN: Reported SAR(W/kg)= Measured SAR(W/kg)*Tune-up Scaling Factor
 - d. For WLAN: Reported SAR(W/kg)= Measured SAR(W/kg)* Duty Cycle scaling factor * Tune-up scaling factor
2. Per KDB 447498 D01v05r02, for each exposure position, testing of other required channels within the operating mode of a frequency band is not required when the *reported* 1-g or 10-g SAR for the mid-band or highest output power channel is:
 - ≤ 0.8 W/kg or 2.0 W/kg, for 1-g or 10-g respectively, when the transmission band is ≤ 100 MHz
 - ≤ 0.6 W/kg or 1.5 W/kg, for 1-g or 10-g respectively, when the transmission band is between 100 MHz and 200 MHz
 - ≤ 0.4 W/kg or 1.0 W/kg, for 1-g or 10-g respectively, when the transmission band is ≥ 200 MHz
3. Per KDB 648474 D04v01r02, when the reported SAR for a body-worn accessory measured without a headset connected to the handset is ≤ 1.2 W/kg, SAR testing with a headset connected to the handset is not required.
4. This device has two sets of receivers and microphone, 1 receiver is located at the top and another one is located at the bottom of the phone. For the next-to-ear voice call the product allows the end user to use the device in the typical calling positions and in the reversed calling position. When the User Interface is in reversed portrait orientation, power reduction is implemented for the scenario that the bottom receiver is placed next-to-ear during the voice call for GSM850/1900, WCDMA Band II ,LTE band 2/4/7, and SAR compliance was accessed for both orientations. The details of the power reduction mechanism for the reverse call are illustrated in the operational description.
5. When hotspot mode is enabled, power reduction will be activated and limited to LTE Band 7.
6. Per KDB 648474 D04, for additional accessories (batteries, NFC and wireless charging battery covers or similar accessory), need repeat SAR testing at the worst position (head, and body-worn, and hotspot), for each wireless mode and each band. In addition, for test cases where the measured SAR for a handset without the accessory is greater than 1.2 W/kg, these tests should be repeated with the additional accessories.

GSM Note:

1. Considering the possibility of e.g. 3rd party VoIP operation for Head SAR test reduction for GSM, GPRS, EDGE and DTM modes is determined by the source-based time-averaged output power including tune-up tolerance. The mode with highest specified time-averaged output power should be tested for SAR compliance in the applicable exposure conditions. For mode with the same specified maximum output power and tolerance, the higher tune-up with higher measured power configuration should be tested. Therefore, the EUT was set in GPRS (2Tx slots) for GSM850/GSM1900 at receiver 1, and GPRS (2Tx slots) for GSM850 and GSM Voice for GSM1900 at receiver 2.
2. For body-worn and hotspot SAR test reduction for GPRS, EDGE and DTM modes are determined by the source-based time-averaged output power including tune-up tolerance, for modes with the same specified maximum output power and tolerance, the higher tune-up with higher measured power configuration should be tested, therefore, the EUT was set in GPRS (2Tx slots) for GSM850/GSM1900.

WCDMA Note:

1. Per KDB 941225 D01v03, SAR for next to the ear head / Hotspot / Body-worn exposure is measured using a 12.2 kbps RMC with TPC bits configured to all "1's".
2. Per KDB 941225 D01v03, RMC 12.2kbps setting is used to evaluate SAR. If the maximum output power and tune-up tolerance specified for production units in HSDPA / HSUPA / DC-HSDPA is $\leq 1/4$ dB higher than RMC 12.2Kbps or when the highest reported SAR of the RMC12.2Kbps is scaled by the ratio of specified maximum output power and tune-up tolerance of HSDPA / HSUPA / DC-HSDPA to RMC12.2Kbps and the adjusted SAR is ≤ 1.2 W/kg, SAR measurement is not required for HSDPA / HSUPA / DC-HSDPA.

WLAN Note:

1. This device 2.4 GHz WLAN supports hotspot operation.



LTE Note:

1. Per KDB 941225 D05v02r03, start with the largest channel bandwidth and measure SAR for QPSK with 1 RB allocation, using the RB offset and required test channel combination with the highest maximum output power for RB offsets at the upper edge, middle and lower edge of each required test channel.
2. Per KDB 941225 D05v02r03, 50% RB allocation for QPSK SAR testing follows 1RB QPSK allocation procedure.
3. Per KDB 941225 D05v02r03, For QPSK with 100% RB allocation, SAR is not required when the highest maximum output power for 100 % RB allocation is less than the highest maximum output power in 50% and 1 RB allocations and the highest reported SAR for 1 RB and 50% RB allocation are ≤ 0.8 W/kg. Otherwise, SAR is measured for the highest output power channel; and if the reported SAR is > 1.45 W/kg, the remaining required test channels must also be tested.
4. Per KDB 941225 D05v02r03, 16QAM output power for each RB allocation configuration is $>$ not $\frac{1}{2}$ dB higher than the same configuration in QPSK and the reported SAR for the QPSK configuration is ≤ 1.45 W/kg; Per KDB 941225 D05v02r03, 16QAM SAR testing is not required.
5. Per KDB 941225 D05v02r03, smaller bandwidth output power for each RB allocation configuration is $>$ not $\frac{1}{2}$ dB higher than the same configuration in the largest supported bandwidth, and the reported SAR for the largest supported bandwidth is ≤ 1.45 W/kg; Per KDB 941225 D05v02r03, smaller bandwidth SAR testing is not required

17.1 Head SAR

<GSM SAR>

Plot No.	Band	Mode	Test Position	Receiver Enabled	Power Reduction (reverse call)	Battery	Ch.	Freq. (MHz)	Average Power (dBm)	Tune-Up Limit (dBm)	Tune-up Scaling Factor	Power Drift (dB)	Measured 1g SAR (W/kg)	Reported 1g SAR (W/kg)
	GSM850	GPRS (2 Tx slots)	Right Cheek	Receiver 1	OFF	1	251	848.8	31.32	31.50	1.042	0.03	0.745	0.777
	GSM850	GPRS (2 Tx slots)	Right Tilted	Receiver 1	OFF	1	251	848.8	31.32	31.50	1.042	0.13	0.524	0.546
	GSM850	GPRS (2 Tx slots)	Left Cheek	Receiver 1	OFF	1	251	848.8	31.32	31.50	1.042	0.01	0.736	0.767
	GSM850	GPRS (2 Tx slots)	Left Tilted	Receiver 1	OFF	1	251	848.8	31.32	31.50	1.042	0.11	0.508	0.529
	GSM850	GPRS (2 Tx slots)	Right Cheek	Receiver 1	OFF	2	251	848.8	31.32	31.50	1.042	0.03	0.525	0.547
	GSM850	GPRS(2Tx slots)	Right Cheek	Receiver 2	ON	1	128	824.2	29.06	29.50	1.107	0.07	0.944	1.045
	GSM850	GPRS(2Tx slots)	Right Cheek	Receiver 2	ON	1	189	836.4	28.89	29.50	1.151	0.03	0.672	0.773
	GSM850	GPRS(2Tx slots)	Right Cheek	Receiver 2	ON	1	251	848.8	28.85	29.50	1.161	0.04	0.510	0.592
	GSM850	GPRS(2Tx slots)	Right Tilted	Receiver 2	ON	1	128	824.2	29.06	29.50	1.107	-0.03	0.648	0.717
#01	GSM850	GPRS(2Tx slots)	Left Cheek	Receiver 2	ON	1	128	824.2	29.06	29.50	1.107	0.02	1.090	1.206
	GSM850	GPRS(2Tx slots)	Left Cheek	Receiver 2	ON	1	189	836.4	28.89	29.50	1.151	-0.01	0.797	0.917
	GSM850	GPRS(2Tx slots)	Left Cheek	Receiver 2	ON	1	251	848.8	28.85	29.50	1.161	-0.04	0.617	0.717
	GSM850	GPRS(2Tx slots)	Left Tilted	Receiver 2	ON	1	128	824.2	29.06	29.50	1.107	-0.0072	0.714	0.790
	GSM850	GPRS(2Tx slots)	Left Cheek	Receiver 2	ON	2	128	824.2	29.06	29.50	1.107	0.0064	1.080	1.195
	GSM850	GPRS(2Tx slots)	Left Cheek	Receiver 2	ON	2	189	836.4	28.89	29.50	1.151	0.0045	0.746	0.858
	GSM850	GPRS(2Tx slots)	Left Cheek	Receiver 2	ON	2	251	848.8	28.85	29.50	1.161	-0.003	0.571	0.663
	GSM1900	GPRS (2 Tx slots)	Right Cheek	Receiver 1	OFF	1	810	1909.8	28.81	29.50	1.172	0.03	0.211	0.247
	GSM1900	GPRS (2 Tx slots)	Right Tilted	Receiver 1	OFF	1	810	1909.8	28.81	29.50	1.172	0.12	0.091	0.107
	GSM1900	GPRS (2 Tx slots)	Left Cheek	Receiver 1	OFF	1	810	1909.8	28.81	29.50	1.172	0.08	0.248	0.291
	GSM1900	GPRS (2 Tx slots)	Left Tilted	Receiver 1	OFF	1	810	1909.8	28.81	29.50	1.172	0.0042	0.092	0.108
	GSM1900	GPRS (2 Tx slots)	Left Cheek	Receiver 1	OFF	2	810	1909.8	28.81	29.50	1.172	0.13	0.241	0.282
	GSM1900	GSM Voice	Right Cheek	Receiver 2	ON	1	810	1909.8	24.55	25.00	1.109	-0.14	0.557	0.618
	GSM1900	GSM Voice	Right Tilted	Receiver 2	ON	1	810	1909.8	24.55	25.00	1.109	-0.13	0.590	0.654
#02	GSM1900	GSM Voice	Left Cheek	Receiver 2	ON	1	810	1909.8	24.55	25.00	1.109	-0.06	0.959	1.064
	GSM1900	GSM Voice	Left Cheek	Receiver 2	ON	1	512	1850.2	24.15	25.00	1.216	-0.03	0.854	1.039
	GSM1900	GSM Voice	Left Cheek	Receiver 2	ON	1	661	1880	24.39	25.00	1.151	-0.05	0.892	1.027
	GSM1900	GSM Voice	Left Tilted	Receiver 2	ON	1	810	1909.8	24.55	25.00	1.109	-0.07	0.917	1.017
	GSM1900	GSM Voice	Left Tilted	Receiver 2	ON	1	512	1850.2	24.15	25.00	1.216	-0.04	0.786	0.956
	GSM1900	GSM Voice	Left Tilted	Receiver 2	ON	1	661	1880	24.39	25.00	1.151	0.06	0.836	0.962
	GSM1900	GSM Voice	Left Cheek	Receiver 2	ON	2	810	1909.8	24.55	25.00	1.109	-0.07	0.829	0.920
	GSM1900	GSM Voice	Left Cheek	Receiver 2	ON	2	512	1850.2	24.15	25.00	1.216	-0.07	0.717	0.872
	GSM1900	GSM Voice	Left Cheek	Receiver 2	ON	2	661	1880	24.39	25.00	1.151	-0.11	0.784	0.902



<WCDMA SAR>

Plot No.	Band	Mode	Test Position	Receiver Enabled	Power Reduction (reverse call)	Battery	Ch.	Freq. (MHz)	Average Power (dBm)	Tune-Up Limit (dBm)	Tune-up Scaling Factor	Power Drift (dB)	Measured 1g SAR (W/kg)	Reported 1g SAR (W/kg)
	WCDMA Band V	RMC12.2Kbps	Right Cheek	Receiver 1	OFF	1	4132	826.4	23.42	24.00	1.143	0.054	0.646	0.738
	WCDMA Band V	RMC12.2Kbps	Right Tilted	Receiver 1	OFF	1	4132	826.4	23.42	24.00	1.143	0.022	0.445	0.509
	WCDMA Band V	RMC12.2Kbps	Left Cheek	Receiver 1	OFF	1	4132	826.4	23.42	24.00	1.143	0.025	0.672	0.768
	WCDMA Band V	RMC12.2Kbps	Left Tilted	Receiver 1	OFF	1	4132	826.4	23.42	24.00	1.143	0.15	0.465	0.531
	WCDMA Band V	RMC12.2Kbps	Left Cheek	Receiver 1	OFF	2	4132	826.4	23.42	24.00	1.143	0.0026	0.505	0.577
	WCDMA Band V	RMC12.2Kbps	Right Cheek	Receiver 2	OFF	1	4132	826.4	23.42	24.00	1.143	0.03	0.981	1.121
	WCDMA Band V	RMC12.2Kbps	Right Cheek	Receiver 2	OFF	1	4182	836.4	23.37	24.00	1.156	0.13	0.855	0.988
	WCDMA Band V	RMC12.2Kbps	Right Cheek	Receiver 2	OFF	1	4233	846.6	23.28	24.00	1.180	-0.03	0.757	0.894
	WCDMA Band V	RMC12.2Kbps	Right Tilted	Receiver 2	OFF	1	4132	826.4	23.42	24.00	1.143	-0.02	0.728	0.832
	WCDMA Band V	RMC12.2Kbps	Right Tilted	Receiver 2	OFF	1	4182	836.4	23.37	24.00	1.156	0.02	0.637	0.736
	WCDMA Band V	RMC12.2Kbps	Right Tilted	Receiver 2	OFF	1	4233	846.6	23.28	24.00	1.180	-0.0042	0.558	0.659
#03	WCDMA Band V	RMC12.2Kbps	Left Cheek	Receiver 2	OFF	1	4132	826.4	23.42	24.00	1.143	-0.03	1.230	1.406
	WCDMA Band V	RMC12.2Kbps	Left Cheek	Receiver 2	OFF	1	4182	836.4	23.37	24.00	1.156	-0.00066	0.726	0.839
	WCDMA Band V	RMC12.2Kbps	Left Cheek	Receiver 2	OFF	1	4233	846.6	23.28	24.00	1.180	0.02	1.080	1.275
	WCDMA Band V	RMC12.2Kbps	Left Tilted	Receiver 2	OFF	1	4132	826.4	23.42	24.00	1.143	0.0059	0.848	0.969
	WCDMA Band V	RMC12.2Kbps	Left Tilted	Receiver 2	OFF	1	4182	836.4	23.37	24.00	1.156	0.0066	0.759	0.877
	WCDMA Band V	RMC12.2Kbps	Left Tilted	Receiver 2	OFF	1	4233	846.6	23.28	24.00	1.180	0.03	0.685	0.809
	WCDMA Band V	RMC12.2Kbps	Left Cheek	Receiver 2	OFF	2	4132	826.4	23.42	24.00	1.143	0.08	1.220	1.394
	WCDMA Band V	RMC12.2Kbps	Left Cheek	Receiver 2	OFF	2	4182	836.4	23.37	24.00	1.156	-0.04	1.090	1.260
	WCDMA Band V	RMC12.2Kbps	Left Cheek	Receiver 2	OFF	2	4233	846.6	23.28	24.00	1.180	-0.03	0.967	1.141
	WCDMA Band II	RMC12.2Kbps	Right Cheek	Receiver 1	OFF	1	9538	1907.6	22.11	22.50	1.094	0.08	0.276	0.302
	WCDMA Band II	RMC12.2Kbps	Right Tilted	Receiver 1	OFF	1	9538	1907.6	22.11	22.50	1.094	0.021	0.130	0.142
	WCDMA Band II	RMC12.2Kbps	Left Cheek	Receiver 1	OFF	1	9538	1907.6	22.11	22.50	1.094	0.024	0.310	0.339
	WCDMA Band II	RMC12.2Kbps	Left Tilted	Receiver 1	OFF	1	9538	1907.6	22.11	22.50	1.094	0.16	0.116	0.127
	WCDMA Band II	RMC12.2Kbps	Left Cheek	Receiver 1	OFF	2	9538	1907.6	22.11	22.50	1.094	-0.02	0.296	0.324
	WCDMA Band II	RMC12.2Kbps	Right Cheek	Receiver 2	ON	1	9538	1907.6	16.24	16.50	1.062	-0.022	0.716	0.760
	WCDMA Band II	RMC12.2Kbps	Right Tilted	Receiver 2	ON	1	9538	1907.6	16.24	16.50	1.062	-0.11	0.722	0.767
	WCDMA Band II	RMC12.2Kbps	Left Cheek	Receiver 2	ON	1	9538	1907.6	16.24	16.50	1.062	-0.12	1.010	1.072
	WCDMA Band II	RMC12.2Kbps	Left Cheek	Receiver 2	ON	1	9262	1852.4	16.21	16.50	1.069	-0.04	0.969	1.036
	WCDMA Band II	RMC12.2Kbps	Left Cheek	Receiver 2	ON	1	9400	1880	16.13	16.50	1.089	0.03	0.980	1.067
	WCDMA Band II	RMC12.2Kbps	Left Tilted	Receiver 2	ON	1	9538	1907.6	16.24	16.50	1.062	-0.076	1.010	1.072
	WCDMA Band II	RMC12.2Kbps	Left Tilted	Receiver 2	ON	1	9262	1852.4	16.21	16.50	1.069	0.04	1.010	1.080
#04	WCDMA Band II	RMC12.2Kbps	Left Tilted	Receiver 2	ON	1	9400	1880	16.13	16.50	1.089	-0.08	1.040	1.132
	WCDMA Band II	RMC12.2Kbps	Left Tilted	Receiver 2	ON	2	9400	1880	16.13	16.50	1.089	-0.05	1.010	1.100
	WCDMA Band II	RMC12.2Kbps	Left Tilted	Receiver 2	ON	2	9538	1907.6	16.24	16.50	1.062	-0.04	1.040	1.104
	WCDMA Band II	RMC12.2Kbps	Left Tilted	Receiver 2	ON	2	9262	1852.4	16.21	16.50	1.069	0.00037	0.985	1.053



<LTE SAR>

Table with 18 columns: Plot No., Band, BW (MHz), Mode, RB Size, RB offset, Test Position, Receiver Enabled, Power Reduction (reverse call), Battery, Ch., Freq. (MHz), Average Power (dBm), Tune-Up Limit (dBm), Tune-up Scaling Factor, Power Drift (dB), Measured 1g SAR (W/kg), Reported 1g SAR (W/kg). Contains multiple rows of test data for LTE Band 4.



Plot No.	Band	BW (MHz)	Mode	RB Size	RB offset	Test Position	Receiver Enabled	Power Reduction (reverse call)	Battery	Ch.	Freq. (MHz)	Average Power (dBm)	Tune-Up Limit (dBm)	Tune-up Scaling Factor	Power Drift (dB)	Measured 1g SAR (W/kg)	Reported 1g SAR (W/kg)
	LTE Band 2	20M	QPSK	1	49	Right Cheek	Receiver 1	OFF	1	18900	1880	22.30	22.50	1.047	0.021	0.274	0.287
	LTE Band 2	20M	QPSK	50	24	Right Cheek	Receiver 1	OFF	1	18900	1880	20.96	21.50	1.132	0.025	0.211	0.239
	LTE Band 2	20M	QPSK	1	49	Right Tilted	Receiver 1	OFF	1	18900	1880	22.30	22.50	1.047	0.14	0.120	0.126
	LTE Band 2	20M	QPSK	50	24	Right Tilted	Receiver 1	OFF	1	18900	1860	20.96	21.50	1.132	0.033	0.092	0.104
	LTE Band 2	20M	QPSK	1	49	Left Cheek	Receiver 1	OFF	1	18900	1900	22.30	22.50	1.047	0.048	0.333	0.349
	LTE Band 2	20M	QPSK	50	24	Left Cheek	Receiver 1	OFF	1	18900	1880	20.96	21.50	1.132	0.053	0.268	0.303
	LTE Band 2	20M	QPSK	1	49	Left Tilted	Receiver 1	OFF	1	18900	1880	22.30	22.50	1.047	0.023	0.093	0.097
	LTE Band 2	20M	QPSK	50	24	Left Tilted	Receiver 1	OFF	1	18900	1880	20.96	21.50	1.132	-0.02	0.069	0.078
	LTE Band 2	20M	QPSK	1	49	Left Cheek	Receiver 1	OFF	2	18900	1900	22.30	22.50	1.047	0.14	0.329	0.345
	LTE Band 2	20M	QPSK	1	0	Right Cheek	Receiver 2	ON	1	18900	1880	16.69	17.00	1.074	-0.15	0.689	0.740
	LTE Band 2	20M	QPSK	50	24	Right Cheek	Receiver 2	ON	1	18900	1880	16.14	17.00	1.219	-0.13	0.686	0.836
	LTE Band 2	20M	QPSK	50	24	Right Cheek	Receiver 2	ON	1	18700	1860	15.93	17.00	1.279	-0.16	0.664	0.850
	LTE Band 2	20M	QPSK	50	24	Right Cheek	Receiver 2	ON	1	19100	1900	15.97	17.00	1.268	-0.17	0.685	0.868
	LTE Band 2	20M	QPSK	100	0	Right Cheek	Receiver 2	ON	1	18900	1880	16.12	17.00	1.225	-0.021	0.689	0.844
	LTE Band 2	20M	QPSK	1	0	Right Tilted	Receiver 2	ON	1	18900	1880	16.69	17.00	1.074	-0.09	0.642	0.690
	LTE Band 2	20M	QPSK	50	24	Right Tilted	Receiver 2	ON	1	18900	1880	16.14	17.00	1.219	-0.07	0.640	0.780
	LTE Band 2	20M	QPSK	1	0	Left Cheek	Receiver 2	ON	1	18900	1880	16.69	17.00	1.074	0.12	1.150	1.235
	LTE Band 2	20M	QPSK	1	0	Left Cheek	Receiver 2	ON	1	18700	1860	16.44	17.00	1.138	-0.13	1.140	1.297
#06	LTE Band 2	20M	QPSK	1	0	Left Cheek	Receiver 2	ON	1	19100	1900	16.33	17.00	1.167	-0.05	1.210	1.412
	LTE Band 2	20M	QPSK	50	24	Left Cheek	Receiver 2	ON	1	18900	1880	16.14	17.00	1.219	-0.11	1.060	1.292
	LTE Band 2	20M	QPSK	50	24	Left Cheek	Receiver 2	ON	1	18700	1860	15.93	17.00	1.279	-0.03	1.040	1.331
	LTE Band 2	20M	QPSK	50	24	Left Cheek	Receiver 2	ON	1	19100	1900	15.97	17.00	1.268	-0.05	1.080	1.369
	LTE Band 2	20M	QPSK	100	0	Left Cheek	Receiver 2	ON	1	18900	1880	16.12	17.00	1.225	-0.04	1.090	1.335
	LTE Band 2	20M	QPSK	1	0	Left Tilted	Receiver 2	ON	1	18900	1880	16.69	17.00	1.074	0.04	1.010	1.085
	LTE Band 2	20M	QPSK	1	0	Left Tilted	Receiver 2	ON	1	18700	1860	16.44	17.00	1.138	0.16	0.975	1.109
	LTE Band 2	20M	QPSK	1	0	Left Tilted	Receiver 2	ON	1	19100	1900	16.33	17.00	1.167	0.03	1.000	1.167
	LTE Band 2	20M	QPSK	50	24	Left Tilted	Receiver 2	ON	1	18900	1880	16.14	17.00	1.219	-0.1	1.100	1.341
	LTE Band 2	20M	QPSK	50	24	Left Tilted	Receiver 2	ON	1	18700	1860	15.93	17.00	1.279	-0.04	1.070	1.369
	LTE Band 2	20M	QPSK	50	24	Left Tilted	Receiver 2	ON	1	19100	1900	15.97	17.00	1.268	0.02	1.040	1.318
	LTE Band 2	20M	QPSK	100	0	Left Tilted	Receiver 2	ON	1	18900	1880	16.12	17.00	1.225	-0.05	1.130	1.384
	LTE Band 2	20M	QPSK	1	0	Left Cheek	Receiver 2	ON	2	19100	1900	16.33	17.00	1.167	-0.05	1.030	1.202
	LTE Band 2	20M	QPSK	1	0	Left Cheek	Receiver 2	ON	2	18900	1880	16.69	17.00	1.074	0.06	0.968	1.040
	LTE Band 2	20M	QPSK	1	0	Left Cheek	Receiver 2	ON	2	18700	1860	16.44	17.00	1.138	-0.04	1.000	1.138



17.2 Hotspot SAR

<GSM SAR>

Table with 14 columns: Plot No., Band, Mode, Test Position, Gap (cm), Battery, Ch., Freq. (MHz), Average Power (dBm), Tune-Up Limit (dBm), Tune-up Scaling Factor, Power Drift (dB), Measured 1g SAR (W/kg), Reported 1g SAR (W/kg). Rows include GSM850 and GSM1900 data points.

<WCDMA SAR>

Table with 14 columns: Plot No., Band, Mode, Test Position, Gap (cm), Battery, Ch., Freq. (MHz), Average Power (dBm), Tune-Up Limit (dBm), Tune-up Scaling Factor, Power Drift (dB), Measured 1g SAR (W/kg), Reported 1g SAR (W/kg). Rows include WCDMA Band V and WCDMA Band II data points.



<LTE SAR>

Table with columns: Plot No., Band, BW (MHz), Mode, RB Size, RB offset, Test Position, Gap (cm), Battery, Ch., Freq. (MHz), Average Power (dBm), Tune-Up Limit (dBm), Tune-up Scaling Factor, Power Drift (dB), Measured 1g SAR (W/kg), Reported 1g SAR (W/kg). Contains multiple rows of test data, including entries for #13 and #14.



Plot No.	Band	BW (MHz)	Mode	RB Size	RB offset	Test Position	Gap (cm)	Battery	Ch.	Freq. (MHz)	Average Power (dBm)	Tune-Up Limit (dBm)	Tune-up Scaling Factor	Power Drift (dB)	Measured 1g SAR (W/kg)	Reported 1g SAR (W/kg)
	LTE Band 7	20M	QPSK	1	0	Front	1	1	21100	2535	17.37	17.50	1.030	0.02	0.531	0.547
	LTE Band 7	20M	QPSK	50	0	Front	1	1	21100	2535	17.12	17.50	1.091	0.13	0.494	0.539
	LTE Band 7	20M	QPSK	1	0	Back	1	1	21100	2535	17.37	17.50	1.030	0.02	0.808	0.833
	LTE Band 7	20M	QPSK	1	0	Back	1	1	20850	2510	17.24	17.50	1.062	-0.09	0.812	0.862
	LTE Band 7	20M	QPSK	1	0	Back	1	1	21350	2560	17.18	17.50	1.076	-0.07	0.688	0.741
	LTE Band 7	20M	QPSK	50	0	Back	1	1	21100	2535	17.12	17.50	1.091	-0.15	0.760	0.829
	LTE Band 7	20M	QPSK	50	0	Back	1	1	20850	2510	17.00	17.50	1.122	0.03	0.811	0.910
	LTE Band 7	20M	QPSK	50	0	Back	1	1	21350	2560	17.06	17.50	1.107	0.046	0.669	0.740
	LTE Band 7	20M	QPSK	100	0	Back	1	1	21100	2535	17.03	17.50	1.114	-0.16	0.742	0.827
	LTE Band 7	20M	QPSK	1	0	Left Side	1	1	21100	2535	17.37	17.50	1.030	0.06	0.120	0.124
	LTE Band 7	20M	QPSK	50	0	Left Side	1	1	21100	2535	17.12	17.50	1.091	0.03	0.116	0.127
	LTE Band 7	20M	QPSK	1	0	Right Side	1	1	21100	2535	17.37	17.50	1.030	-0.05	0.015	0.015
	LTE Band 7	20M	QPSK	50	0	Right Side	1	1	21100	2535	17.12	17.50	1.091	0.044	0.014	0.015
	LTE Band 7	20M	QPSK	1	0	Bottom Side	1	1	21100	2535	17.37	17.50	1.030	0.15	1.140	1.175
	LTE Band 7	20M	QPSK	1	0	Bottom Side	1	1	20850	2510	17.24	17.50	1.062	0.03	1.160	1.232
	LTE Band 7	20M	QPSK	1	0	Bottom Side	1	1	21350	2560	17.18	17.50	1.076	0.15	1.040	1.120
	LTE Band 7	20M	QPSK	50	0	Bottom Side	1	1	21100	2535	17.12	17.50	1.091	0.1	1.140	1.244
#15	LTE Band 7	20M	QPSK	50	0	Bottom Side	1	1	20850	2510	17.00	17.50	1.122	0.02	1.180	1.324
	LTE Band 7	20M	QPSK	50	0	Bottom Side	1	1	21350	2560	17.06	17.50	1.107	0.027	1.060	1.173
	LTE Band 7	20M	QPSK	100	0	Bottom Side	1	1	21100	2535	17.03	17.50	1.114	0.024	1.150	1.281
	LTE Band 7	20M	QPSK	50	0	Bottom Side	1	2	20850	2510	17.00	17.50	1.122	0.01	1.100	1.234
	LTE Band 7	20M	QPSK	50	0	Bottom Side	1	2	21350	2560	17.06	17.50	1.107	0.01	0.957	1.059
	LTE Band 7	20M	QPSK	50	0	Bottom Side	1	2	21100	2535	17.12	17.50	1.091	0.023	1.070	1.168

<DTS WLAN SAR>

Plot No.	Band	Mode	Test Position	Gap (cm)	Battery	Ch.	Freq. (MHz)	Average Power (dBm)	Tune-Up Limit (dBm)	Tune-up Scaling Factor	Duty Cycle %	Duty Cycle Scaling Factor	Power Drift (dB)	Measured 1g SAR (W/kg)	Reported 1g SAR (W/kg)
	WLAN 2.4GHz	802.11b 1Mbps	Front	1	1	11	2462	18.11	18.50	1.094	97.62	1.024	-0.04	0.042	0.047
#16	WLAN 2.4GHz	802.11b 1Mbps	Back	1	1	11	2462	18.11	18.50	1.094	97.62	1.024	0.08	1.140	1.277
	WLAN 2.4GHz	802.11b 1Mbps	Back	1	1	1	2412	17.21	18.50	1.346	97.62	1.024	-0.14	0.894	1.232
	WLAN 2.4GHz	802.11b 1Mbps	Back	1	1	6	2437	17.73	18.50	1.194	97.62	1.024	-0.06	1.040	1.272
	WLAN 2.4GHz	802.11b 1Mbps	Left Side	1	1	11	2462	18.11	18.50	1.094	97.62	1.024	-0.028	0.020	0.022
	WLAN 2.4GHz	802.11b 1Mbps	Right Side	1	1	11	2462	18.11	18.50	1.094	97.62	1.024	-0.043	0.038	0.043
	WLAN 2.4GHz	802.11b 1Mbps	Top Side	1	1	11	2462	18.11	18.50	1.094	97.62	1.024	0.021	0.081	0.091
	WLAN 2.4GHz	802.11b 1Mbps	Back	1	2	11	2462	18.11	18.50	1.094	97.62	1.024	0.05	1.130	1.266
	WLAN 2.4GHz	802.11b 1Mbps	Back	1	2	1	2412	17.21	18.50	1.346	97.62	1.024	0.09	0.910	1.254
	WLAN 2.4GHz	802.11b 1Mbps	Back	1	2	6	2437	17.73	18.50	1.194	97.62	1.024	-0.08	0.989	1.209

17.3 Body Worn Accessory SAR

<GSM SAR>

Plot No.	Band	Mode	Test Position	Gap (cm)	Battery	Ch.	Freq. (MHz)	Average Power (dBm)	Tune-Up Limit (dBm)	Tune-up Scaling Factor	Power Drift (dB)	Measured 1g SAR (W/kg)	Reported 1g SAR (W/kg)
	GSM850	GPRS (2 Tx slots)	Front	1.5	1	251	848.8	31.32	31.50	1.042	-0.00026	0.597	0.622
#17	GSM850	GPRS (2 Tx slots)	Back	1.5	1	251	848.8	31.32	31.50	1.042	-0.04	0.603	0.629
	GSM850	GPRS (2 Tx slots)	Back	1.5	2	251	848.8	31.32	31.50	1.042	0.02	0.587	0.612
#18	GSM1900	GPRS (2 Tx slots)	Front	1.5	1	810	1909.8	28.81	29.50	1.172	0.09	0.429	0.503
	GSM1900	GPRS (2 Tx slots)	Back	1.5	1	810	1909.8	28.81	29.50	1.172	-0.1	0.362	0.424
	GSM1900	GPRS (2 Tx slots)	Front	1.5	2	810	1909.8	28.81	29.50	1.172	-0.11	0.384	0.450

<WCDMA SAR>

Plot No.	Band	Mode	Test Position	Gap (cm)	Battery	Ch.	Freq. (MHz)	Average Power (dBm)	Tune-Up Limit (dBm)	Tune-up Scaling Factor	Power Drift (dB)	Measured 1g SAR (W/kg)	Reported 1g SAR (W/kg)
	WCDMA Band V	RMC12.2Kbps	Front	1.5	1	4132	826.4	23.42	24.00	1.143	-0.0084	0.556	0.635
#19	WCDMA Band V	RMC12.2Kbps	Back	1.5	1	4132	826.4	23.42	24.00	1.143	-0.0099	0.572	0.654
	WCDMA Band V	RMC12.2Kbps	Back	1.5	2	4132	826.4	23.42	24.00	1.143	0.002	0.565	0.646
#20	WCDMA Band II	RMC12.2Kbps	Front	1.5	1	9538	1907.6	22.11	22.50	1.094	0.11	0.529	0.579
	WCDMA Band II	RMC12.2Kbps	Back	1.5	1	9538	1907.6	22.11	22.50	1.094	-0.07	0.428	0.468
	WCDMA Band II	RMC12.2Kbps	Front	1.5	2	9538	1907.6	22.11	22.50	1.094	-0.02	0.498	0.545



<LTE SAR>

Plot No.	Band	BW (MHz)	Mode	RB Size	RB offset	Test Position	Gap (cm)	Battery	Ch.	Freq. (MHz)	Average Power (dBm)	Tune-Up Limit (dBm)	Tune-up Scaling Factor	Power Drift (dB)	Measured 1g SAR (W/kg)	Reported 1g SAR (W/kg)	
#21	LTE Band 4	20M	QPSK	1	0	Front	1.5	1	20175	1732.5	22.37	22.50	1.030	-0.19	0.480	0.495	
	LTE Band 4	20M	QPSK	50	0	Front	1.5	1	20175	1732.5	21.20	21.50	1.072	-0.09	0.382	0.409	
	LTE Band 4	20M	QPSK	1	0	Back	1.5	1	20175	1732.5	22.37	22.50	1.030	-0.12	0.383	0.395	
	LTE Band 4	20M	QPSK	50	0	Back	1.5	1	20175	1732.5	21.20	21.50	1.072	-0.17	0.309	0.331	
	LTE Band 4	20M	QPSK	1	0	Front	1.5	2	20175	1732.5	22.37	22.50	1.030	0.11	0.475	0.489	
#22	LTE Band 2	20M	QPSK	1	49	Front	1.5	1	18900	1880	22.30	22.50	1.047	-0.12	0.452	0.473	
	LTE Band 2	20M	QPSK	50	24	Front	1.5	1	18900	1880	20.96	21.50	1.132	0.05	0.335	0.379	
	LTE Band 2	20M	QPSK	1	49	Back	1.5	1	18900	1880	22.30	22.50	1.047	0.1	0.392	0.410	
	LTE Band 2	20M	QPSK	50	24	Back	1.5	1	18900	1880	20.96	21.50	1.132	0.03	0.299	0.339	
	LTE Band 2	20M	QPSK	1	49	Front	1.5	2	18900	1880	22.30	22.50	1.047	0.11	0.432	0.452	
	LTE Band 7	20M	QPSK	1	0	Front	1.5	1	21100	2535	22.99	23.50	1.125	0.16	0.636	0.715	
	LTE Band 7	20M	QPSK	50	0	Front	1.5	1	21100	2535	21.84	22.50	1.164	0.14	0.466	0.542	
	LTE Band 7	20M	QPSK	1	0	Back	1.5	1	21100	2535	22.99	23.50	1.125	-0.15	1.030	1.158	
	#23	LTE Band 7	20M	QPSK	1	0	Back	1.5	1	20850	2510	22.94	23.50	1.138	0.11	1.050	1.195
		LTE Band 7	20M	QPSK	1	0	Back	1.5	1	21350	2560	22.89	23.50	1.151	-0.05	0.899	1.035
LTE Band 7		20M	QPSK	50	0	Back	1.5	1	21100	2535	21.84	22.50	1.164	0.12	0.809	0.942	
LTE Band 7		20M	QPSK	50	0	Back	1.5	1	20850	2510	21.74	22.50	1.191	0.06	0.816	0.972	
LTE Band 7		20M	QPSK	50	0	Back	1.5	1	21350	2560	21.72	22.50	1.197	0.15	0.695	0.832	
LTE Band 7	20M	QPSK	100	0	Back	1.5	1	21100	2535	21.85	22.50	1.161	0.17	0.774	0.899		
LTE Band 7	20M	QPSK	1	0	Back	1.5	2	20850	2510	22.94	23.50	1.138	-0.09	1.010	1.149		
LTE Band 7	20M	QPSK	1	0	Back	1.5	2	21100	2535	22.99	23.50	1.125	-0.05	1.030	1.158		
LTE Band 7	20M	QPSK	1	0	Back	1.5	2	21350	2560	22.89	23.50	1.151	-0.18	0.952	1.096		

<DTS WLAN SAR>

Plot No.	Band	Mode	Test Position	Gap (cm)	Battery	Ch.	Freq. (MHz)	Average Power (dBm)	Tune-Up Limit (dBm)	Tune-up Scaling Factor	Duty Cycle %	Duty Cycle Scaling Factor	Power Drift (dB)	Measured 1g SAR (W/kg)	Reported 1g SAR (W/kg)
	WLAN 2.4GHz	802.11b 1Mbps	Front	1.5	1	11	2462	18.11	18.50	1.094	97.62	1.024	-0.055	0.024	0.027
#24	WLAN 2.4GHz	802.11b 1Mbps	Back	1.5	1	11	2462	18.11	18.50	1.094	97.62	1.024	-0.031	0.423	0.474
	WLAN 2.4GHz	802.11b 1Mbps	Back	1.5	2	11	2462	18.11	18.50	1.094	97.62	1.024	-0.09	0.401	0.449



17.4 Repeated SAR Measurement

General Note:

1. Per KDB 865664 D01v01r03, for each frequency band, repeated SAR measurement is required only when the measured SAR is $\geq 0.8W/kg$.
2. Per KDB 865664 D01v01r03, if the ratio among the repeated measurement is ≤ 1.2 and the measured SAR $< 1.45W/kg$, only one repeated measurement is required.
3. The ratio is the difference in percentage between original and repeated *measured SAR*.
4. All measurement SAR result is scaled-up to account for tune-up tolerance and is compliant.

No.	Band	Mode	Test Position	Receiver Enabled	Gap (cm)	Battery	Ch.	Freq. (MHz)	Average Power (dBm)	Tune-Up Limit (dBm)	Tune-up Scaling Factor	Duty Cycle %	Duty Cycle Scaling Factor	Power Drift (dB)	Measured 1g SAR (W/kg)	Ratio	Reported 1g SAR (W/kg)
1st	WCDMA Band V	RMC12.2Kbps	Left Cheek	2	-	1	4132	826.4	23.42	24.00	1.143	-	-	-0.03	1.230	1	1.406
2nd	WCDMA Band V	RMC12.2Kbps	Left Cheek	2	-	1	4132	826.4	23.42	24.00	1.143	-	-	-0.01	1.220	1.008	1.394
1st	WCDMA Band II	RMC12.2Kbps	Bottom Side	-	1	1	9538	1907.6	22.11	22.50	1.094	-	-	-0.05	1.240	1	1.357
2nd	WCDMA Band II	RMC12.2Kbps	Bottom Side	-	1	1	9538	1907.6	22.11	22.50	1.094	-	-	-0.12	1.230	1.008	1.346
1st	WLAN 2.4GHz	802.11b 1Mbps	Back	-	1	1	11	2462	18.11	18.50	1.094	97.62	1.024	0.08	1.140	1	1.277
2nd	WLAN 2.4GHz	802.11b 1Mbps	Back	-	1	1	11	2462	18.11	18.50	1.094	97.62	1.024	0.08	1.130	1.009	1.266

No.	Band	BW (MHz)	Mode	RB Size	RB offset	Test Position	Receiver Enabled	Gap (cm)	Battery	Ch.	Freq. (MHz)	Average Power (dBm)	Tune-Up Limit (dBm)	Tune-up Scaling Factor	Power Drift (dB)	Measured 1g SAR (W/kg)	Ratio	Reported 1g SAR (W/kg)
1st	LTE Band 4	20M	QPSK	50	0	Left Cheek	2	-	1	20175	1732.5	17.65	18.00	1.084	-0.08	1.330	1	1.442
2nd	LTE Band 4	20M	QPSK	50	0	Left Cheek	2	-	1	20175	1732.5	17.65	18.00	1.084	-0.1	1.320	1.008	1.431
1st	LTE Band 7	20M	QPSK	50	0	Bottom Side	-	1	1	20850	2510	17.00	17.50	1.122	0.02	1.180	1	1.324
2nd	LTE Band 7	20M	QPSK	50	0	Bottom Side	-	1	1	20850	2510	17.00	17.50	1.122	0.1	1.150	1.026	1.290



18. SAR Test Results for Variant Product (6039S)

General Note:

1. Per KDB 447498 D01v05r02, the reported SAR is the measured SAR value adjusted for maximum tune-up tolerance.
 - e. Tune-up scaling Factor = tune-up limit power (mW) / EUT RF power (mW), where tune-up limit is the maximum rated power among all production units.
 - f. For SAR testing of WLAN signal with non-100% duty cycle, the measured SAR is scaled-up by the duty cycle scaling factor which is equal to "1/(duty cycle)"
 - g. For WWAN: Reported SAR(W/kg)= Measured SAR(W/kg)*Tune-up Scaling Factor
 - h. For WLAN: Reported SAR(W/kg)= Measured SAR(W/kg)* Duty Cycle scaling factor * Tune-up scaling factor
2. Per KDB 447498 D01v05r02, for each exposure position, testing of other required channels within the operating mode of a frequency band is not required when the *reported* 1-g or 10-g SAR for the mid-band or highest output power channel is:
 - ≤ 0.8 W/kg or 2.0 W/kg, for 1-g or 10-g respectively, when the transmission band is ≤ 100 MHz
 - ≤ 0.6 W/kg or 1.5 W/kg, for 1-g or 10-g respectively, when the transmission band is between 100 MHz and 200 MHz
 - ≤ 0.4 W/kg or 1.0 W/kg, for 1-g or 10-g respectively, when the transmission band is ≥ 200 MHz
3. Per KDB 648474 D04v01r02, when the reported SAR for a body-worn accessory measured without a headset connected to the handset is ≤ 1.2 W/kg, SAR testing with a headset connected to the handset is not required.
4. This device has two sets of receivers and microphone, 1 receiver is located at the top and another one is located at the bottom of the phone. For the next-to-ear voice call the product allows the end user to use the device in the typical calling positions and in the reversed calling position. When the User Interface is in reversed portrait orientation, power reduction is implemented for the scenario that the bottom receiver is placed next-to-ear during the voice call for GSM850/1900, WCDMA Band II/IV, LTE band 2/4/7/12/17, and SAR compliance was accessed for both orientations. The details of the power reduction mechanism for the reverse call are illustrated in the operational description.
5. When hotspot mode is enabled, power reduction will be activated and limited to WCDMA Band IV and LTE Band 7.

GSM Note:

1. Considering the possibility of e.g. 3rd party VoIP operation for Head SAR test reduction for GSM, GPRS, EDGE and DTM modes is determined by the source-based time-averaged output power including tune-up tolerance. The mode with highest specified time-averaged output power should be tested for SAR compliance in the applicable exposure conditions. For mode with the same specified maximum output power and tolerance, the higher tune-up with higher measured power configuration should be tested. Therefore, the EUT was set in GPRS (2Tx slots) for GSM850/GSM1900 at receiver 1, and GPRS (2Tx slots) for GSM850 and GSM Voice for GSM1900 at receiver 2.
2. For body-worn and hotspot SAR test reduction for GPRS, EDGE and DTM modes are determined by the source-based time-averaged output power including tune-up tolerance, for modes with the same specified maximum output power and tolerance, the higher tune-up with higher measured power configuration should be tested, therefore, the EUT was set in GPRS (2Tx slots) for GSM850/GSM1900.

WCDMA Note:

1. Per KDB 941225 D01v03, SAR for next to the ear head / Hotspot / Body-worn exposure is measured using a 12.2 kbps RMC with TPC bits configured to all "1's".
2. Per KDB 941225 D01v03, RMC 12.2kbps setting is used to evaluate SAR. If the maximum output power and tune-up tolerance specified for production units in HSDPA / HSUPA / DC-HSDPA is $\leq \frac{1}{4}$ dB higher than RMC 12.2Kbps or when the highest reported SAR of the RMC12.2Kbps is scaled by the ratio of specified maximum output power and tune-up tolerance of HSDPA / HSUPA / DC-HSDPA to RMC12.2Kbps and the adjusted SAR is ≤ 1.2 W/kg, SAR measurement is not required for HSDPA / HSUPA / DC-HSDPA.

WLAN Note:

1. This device 2.4 GHz WLAN supports hotspot operation.
2. Per KDB 248227 D01v02r01, for 2.4GHz 802.11g/n SAR testing is not required when the highest reported SAR for DSSS is adjusted by the ratio of OFDM to DSSS specified maximum output power and the adjusted SAR is ≤ 1.2 W/kg.



LTE Note:

1. Per KDB 941225 D05v02r03, start with the largest channel bandwidth and measure SAR for QPSK with 1 RB allocation, using the RB offset and required test channel combination with the highest maximum output power for RB offsets at the upper edge, middle and lower edge of each required test channel.
2. Per KDB 941225 D05v02r03, 50% RB allocation for QPSK SAR testing follows 1RB QPSK allocation procedure.
3. Per KDB 941225 D05v02r03, For QPSK with 100% RB allocation, SAR is not required when the highest maximum output power for 100 % RB allocation is less than the highest maximum output power in 50% and 1 RB allocations and the highest reported SAR for 1 RB and 50% RB allocation are ≤ 0.8 W/kg. Otherwise, SAR is measured for the highest output power channel; and if the reported SAR is > 1.45 W/kg, the remaining required test channels must also be tested.
4. Per KDB 941225 D05v02r03, 16QAM output power for each RB allocation configuration is $>$ not $\frac{1}{2}$ dB higher than the same configuration in QPSK and the reported SAR for the QPSK configuration is ≤ 1.45 W/kg; Per KDB 941225 D05v02r03, 16QAM SAR testing is not required.
5. Per KDB 941225 D05v02r03, smaller bandwidth output power for each RB allocation configuration is $>$ not $\frac{1}{2}$ dB higher than the same configuration in the largest supported bandwidth, and the reported SAR for the largest supported bandwidth is ≤ 1.45 W/kg; Per KDB 941225 D05v02r03, smaller bandwidth SAR testing is not required

18.1 Head SAR

<GSM SAR>

Plot No.	Band	Mode	Test Position	Receiver Enabled	Power Reduction (reverse call)	Ch.	Freq. (MHz)	Average Power (dBm)	Tune-Up Limit (dBm)	Tune-up Scaling Factor	Power Drift (dB)	Measured 1g SAR (W/kg)	Reported 1g SAR (W/kg)
	GSM850	GPRS (2 Tx slots)	Right Cheek	Receiver 1	OFF	251	848.8	31.10	31.50	1.096	0.08	0.535	0.587
	GSM850	GPRS (2 Tx slots)	Right Cheek	Receiver 1	OFF	128	824.2	31.25	31.50	1.059	0.08	0.798	0.845
	GSM850	GPRS (2 Tx slots)	Right Cheek	Receiver 1	OFF	189	836.4	30.92	31.50	1.143	0.03	0.653	0.746
#01-1	GSM850	GPRS(2Tx slots)	Left Cheek	Receiver 2	ON	128	824.2	28.88	29.50	1.153	-0.09	0.926	1.068
	GSM850	GPRS(2Tx slots)	Left Cheek	Receiver 2	ON	189	836.4	28.56	29.50	1.242	-0.04	0.651	0.808
	GSM850	GPRS(2Tx slots)	Left Cheek	Receiver 2	ON	251	848.8	28.67	29.50	1.211	-0.04	0.501	0.607
	GSM1900	GPRS (2 Tx slots)	Left Cheek	Receiver 1	OFF	810	1909.8	28.27	29.50	1.327	-0.17	0.230	0.305
	GSM1900	GPRS (2 Tx slots)	Left Cheek	Receiver 1	OFF	512	1850.2	28.33	29.50	1.309	0.05	0.223	0.292
	GSM1900	GPRS (2 Tx slots)	Left Cheek	Receiver 1	OFF	661	1880	28.00	29.50	1.413	0.13	0.224	0.316
#02-1	GSM1900	GSM Voice	Left Cheek	Receiver 2	ON	810	1909.8	24.33	25.00	1.167	0.07	0.786	0.917
	GSM1900	GSM Voice	Left Cheek	Receiver 2	ON	512	1850.2	24.25	25.00	1.189	0.13	0.707	0.840
	GSM1900	GSM Voice	Left Cheek	Receiver 2	ON	661	1880	24.16	25.00	1.213	0.07	0.704	0.854



<WCDMA SAR>

Plot No.	Band	Mode	Test Position	Receiver Enabled	Power Reduction (reverse call)	Ch.	Freq. (MHz)	Average Power (dBm)	Tune-Up Limit (dBm)	Tune-up Scaling Factor	Power Drift (dB)	Measured 1g SAR (W/kg)	Reported 1g SAR (W/kg)
	WCDMA Band V	RMC12.2Kbps	Left Cheek	Receiver 1	OFF	4132	826.4	23.14	24.00	1.219	0.02	0.516	0.629
	WCDMA Band V	RMC12.2Kbps	Left Cheek	Receiver 1	OFF	4182	836.4	22.95	24.00	1.274	0.03	0.472	0.601
	WCDMA Band V	RMC12.2Kbps	Left Cheek	Receiver 1	OFF	4233	846.6	23.36	24.00	1.159	0.19	0.431	0.499
#03-1	WCDMA Band V	RMC12.2Kbps	Left Cheek	Receiver 2	OFF	4132	826.4	23.14	24.00	1.219	-0.04	1.020	1.243
	WCDMA Band V	RMC12.2Kbps	Left Cheek	Receiver 2	OFF	4182	836.4	22.95	24.00	1.274	-0.03	0.931	1.186
	WCDMA Band V	RMC12.2Kbps	Left Cheek	Receiver 2	OFF	4233	846.6	23.36	24.00	1.159	0.01	0.892	1.034
	WCDMA Band IV	RMC12.2Kbps	Right Cheek	Receiver 1	OFF	1312	1712.4	24.05	24.50	1.109	0.16	0.518	0.575
	WCDMA Band IV	RMC12.2Kbps	Right Tilted	Receiver 1	OFF	1312	1712.4	24.05	24.50	1.109	0.08	0.132	0.146
	WCDMA Band IV	RMC12.2Kbps	Left Cheek	Receiver 1	OFF	1312	1712.4	24.05	24.50	1.109	0.06	0.550	0.610
	WCDMA Band IV	RMC12.2Kbps	Left Tilted	Receiver 1	OFF	1312	1712.4	24.05	24.50	1.109	0.14	0.223	0.247
	WCDMA Band IV	RMC12.2Kbps	Left Cheek	Receiver 1	OFF	1413	1732.6	23.99	24.50	1.125	0.02	0.571	0.642
	WCDMA Band IV	RMC12.2Kbps	Left Cheek	Receiver 1	OFF	1513	1752.6	24.03	24.50	1.114	0.02	0.565	0.630
	WCDMA Band IV	RMC12.2Kbps	Right Cheek	Receiver 2	ON	1312	1712.4	16.55	17.00	1.109	-0.05	0.559	0.620
	WCDMA Band IV	RMC12.2Kbps	Right Tilted	Receiver 2	ON	1312	1712.4	16.55	17.00	1.109	-0.05	0.528	0.586
	WCDMA Band IV	RMC12.2Kbps	Left Cheek	Receiver 2	ON	1312	1712.4	16.55	17.00	1.109	0.19	0.895	0.993
	WCDMA Band IV	RMC12.2Kbps	Left Tilted	Receiver 2	ON	1312	1712.4	16.55	17.00	1.109	0.13	0.922	1.023
	WCDMA Band IV	RMC12.2Kbps	Left Cheek	Receiver 2	ON	1413	1732.6	16.45	17.00	1.135	0.18	0.902	1.024
#04-1	WCDMA Band IV	RMC12.2Kbps	Left Cheek	Receiver 2	ON	1513	1752.6	16.50	17.00	1.122	0.12	0.983	1.103
	WCDMA Band IV	RMC12.2Kbps	Left Tilted	Receiver 2	ON	1413	1732.6	16.45	17.00	1.135	0.11	0.906	1.028
	WCDMA Band IV	RMC12.2Kbps	Left Tilted	Receiver 2	ON	1513	1752.6	16.50	17.00	1.122	0.13	0.944	1.059
	WCDMA Band II	RMC12.2Kbps	Left Cheek	Receiver 1	OFF	9538	1907.6	22.29	22.50	1.050	0.14	0.291	0.305
	WCDMA Band II	RMC12.2Kbps	Left Cheek	Receiver 1	OFF	9262	1852.4	22.18	22.50	1.076	0.14	0.278	0.299
	WCDMA Band II	RMC12.2Kbps	Left Cheek	Receiver 1	OFF	9400	1880	22.15	22.50	1.084	0.04	0.280	0.303
	WCDMA Band II	RMC12.2Kbps	Left Tilted	Receiver 2	ON	9400	1880	16.37	16.50	1.030	-0.05	1.130	1.164
	WCDMA Band II	RMC12.2Kbps	Left Tilted	Receiver 2	ON	9262	1852.4	16.36	16.50	1.033	0.04	1.100	1.136
#05-1	WCDMA Band II	RMC12.2Kbps	Left Tilted	Receiver 2	ON	9538	1907.6	16.32	16.50	1.042	-0.06	1.180	1.230



<LTE SAR>

Plot No.	Band	BW (MHz)	Mode	RB Size	RB offset	Test Position	Receiver Enabled	Power Reduction (reverse call)	Ch.	Freq. (MHz)	Average Power (dBm)	Tune-Up Limit (dBm)	Tune-up Scaling Factor	Power Drift (dB)	Measured 1g SAR (W/kg)	Reported 1g SAR (W/kg)
	LTE Band 12	10M	QPSK	1	0	Right Cheek	Receiver 1	OFF	23095	707.5	23.82	24.00	1.042	0.07	0.182	0.190
	LTE Band 12	10M	QPSK	25	24	Right Cheek	Receiver 1	OFF	23060	704	22.71	23.00	1.069	0.01	0.152	0.162
	LTE Band 12	10M	QPSK	1	0	Right Tilted	Receiver 1	OFF	23095	707.5	23.82	24.00	1.042	-0.12	0.110	0.115
	LTE Band 12	10M	QPSK	25	24	Right Tilted	Receiver 1	OFF	23060	704	22.71	23.00	1.069	0.18	0.089	0.095
	LTE Band 12	10M	QPSK	1	0	Left Cheek	Receiver 1	OFF	23095	707.5	23.82	24.00	1.042	0.07	0.213	0.222
	LTE Band 12	10M	QPSK	25	24	Left Cheek	Receiver 1	OFF	23060	704	22.71	23.00	1.069	0.07	0.176	0.188
	LTE Band 12	10M	QPSK	1	0	Left Tilted	Receiver 1	OFF	23095	707.5	23.82	24.00	1.042	0.02	0.125	0.130
	LTE Band 12	10M	QPSK	25	24	Left Tilted	Receiver 1	OFF	23060	704	22.71	23.00	1.069	0.09	0.101	0.108
	LTE Band 12	10M	QPSK	1	0	Left Cheek	Receiver 1	OFF	23060	704	23.64	24.00	1.086	0.05	0.195	0.212
	LTE Band 12	10M	QPSK	1	0	Left Cheek	Receiver 1	OFF	23130	711	23.57	24.00	1.104	0.07	0.232	0.256
	LTE Band 12	10M	QPSK	1	24	Right Cheek	Receiver 2	ON	23060	704	20.82	21.00	1.042	-0.1	0.379	0.395
	LTE Band 12	10M	QPSK	25	12	Right Cheek	Receiver 2	ON	23130	711	20.66	21.00	1.081	-0.04	0.475	0.514
	LTE Band 12	10M	QPSK	1	24	Right Tilted	Receiver 2	ON	23060	704	20.82	21.00	1.042	-0.08	0.344	0.359
	LTE Band 12	10M	QPSK	25	12	Right Tilted	Receiver 2	ON	23130	711	20.66	21.00	1.081	0.05	0.413	0.447
	LTE Band 12	10M	QPSK	1	24	Left Cheek	Receiver 2	ON	23060	704	20.82	21.00	1.042	-0.04	0.666	0.694
#06-1	LTE Band 12	10M	QPSK	25	12	Left Cheek	Receiver 2	ON	23130	711	20.66	21.00	1.081	-0.04	0.788	0.852
	LTE Band 12	10M	QPSK	50	0	Left Cheek	Receiver 2	ON	23130	711	20.66	21.00	1.081	-0.13	0.729	0.788
	LTE Band 12	10M	QPSK	1	24	Left Tilted	Receiver 2	ON	23060	704	20.82	21.00	1.042	-0.11	0.578	0.602
	LTE Band 12	10M	QPSK	25	12	Left Tilted	Receiver 2	ON	23130	711	20.66	21.00	1.081	-0.01	0.615	0.665
	LTE Band 12	10M	QPSK	25	12	Left Cheek	Receiver 2	ON	23060	704	20.48	21.00	1.127	0.02	0.573	0.646
	LTE Band 12	10M	QPSK	25	12	Left Cheek	Receiver 2	ON	23095	707.5	20.37	21.00	1.156	-0.07	0.600	0.694
	LTE Band 17	10M	QPSK	1	0	Right Cheek	Receiver 1	OFF	23790	710	23.87	24.00	1.030	0.13	0.182	0.188
	LTE Band 17	10M	QPSK	25	0	Right Cheek	Receiver 1	OFF	23790	710	22.85	23.00	1.035	-0.02	0.146	0.151
	LTE Band 17	10M	QPSK	1	0	Right Tilted	Receiver 1	OFF	23790	710	23.87	24.00	1.030	0.021	0.102	0.105
	LTE Band 17	10M	QPSK	25	0	Right Tilted	Receiver 1	OFF	23790	710	22.85	23.00	1.035	0.037	0.079	0.082
	LTE Band 17	10M	QPSK	1	0	Left Cheek	Receiver 1	OFF	23790	710	23.87	24.00	1.030	0.14	0.207	0.213
	LTE Band 17	10M	QPSK	25	0	Left Cheek	Receiver 1	OFF	23790	710	22.85	23.00	1.035	0.038	0.168	0.174
	LTE Band 17	10M	QPSK	1	0	Left Tilted	Receiver 1	OFF	23790	710	23.87	24.00	1.030	0.03	0.118	0.122
	LTE Band 17	10M	QPSK	25	0	Left Tilted	Receiver 1	OFF	23790	710	22.85	23.00	1.035	0.14	0.093	0.096
	LTE Band 17	10M	QPSK	1	0	Left Cheek	Receiver 1	OFF	23780	709	23.73	24.00	1.064	0.19	0.207	0.220
	LTE Band 17	10M	QPSK	1	0	Left Cheek	Receiver 1	OFF	23800	711	23.85	24.00	1.035	0.032	0.210	0.217
	LTE Band 17	10M	QPSK	1	0	Right Cheek	Receiver 2	ON	23790	710	20.83	21.00	1.040	-0.02	0.484	0.503
	LTE Band 17	10M	QPSK	25	0	Right Cheek	Receiver 2	ON	23790	710	20.72	21.00	1.067	-0.02	0.517	0.551
	LTE Band 17	10M	QPSK	1	0	Right Tilted	Receiver 2	ON	23790	710	20.83	21.00	1.040	-0.06	0.435	0.452
	LTE Band 17	10M	QPSK	25	0	Right Tilted	Receiver 2	ON	23790	710	20.72	21.00	1.067	0.06	0.440	0.469
	LTE Band 17	10M	QPSK	1	0	Left Cheek	Receiver 2	ON	23790	710	20.83	21.00	1.040	0.1	0.719	0.748
	LTE Band 17	10M	QPSK	25	0	Left Cheek	Receiver 2	ON	23790	710	20.72	21.00	1.067	0.02	0.772	0.823
	LTE Band 17	10M	QPSK	50	0	Left Cheek	Receiver 2	ON	23790	710	20.62	21.00	1.091	0.03	0.763	0.833
	LTE Band 17	10M	QPSK	1	0	Left Tilted	Receiver 2	ON	23790	710	20.83	21.00	1.040	0.01	0.585	0.608
	LTE Band 17	10M	QPSK	25	0	Left Tilted	Receiver 2	ON	23790	710	20.72	21.00	1.067	0.04	0.583	0.622
	LTE Band 17	10M	QPSK	25	0	Left Cheek	Receiver 2	ON	23780	709	20.62	21.00	1.091	0.02	0.742	0.810
#07-1	LTE Band 17	10M	QPSK	25	0	Left Cheek	Receiver 2	ON	23800	711	20.55	21.00	1.109	0.01	0.775	0.860



Table with 17 columns: Plot No., Band, BW (MHz), Mode, RB Size, RB offset, Test Position, Receiver Enabled, Power Reduction (reverse call), Ch., Freq. (MHz), Average Power (dBm), Tune-Up Limit (dBm), Tune-up Scaling Factor, Power Drift (dB), Measured 1g SAR (W/kg), Reported 1g SAR (W/kg). Rows include various LTE Band 5, 4, and 2 configurations with SAR values ranging from 0.249 to 1.409.



<DTS WLAN SAR>

Plot No.	Band	Mode	Test Position	Receiver Enabled	Ch.	Freq. (MHz)	Average Power (dBm)	Tune-Up Limit (dBm)	Tune-up Scaling Factor	Duty Cycle %	Duty Cycle Scaling Factor	Power Drift (dB)	Measured 1g SAR (W/kg)	Reported 1g SAR (W/kg)
	WLAN 2.4GHz	802.11b_1Mbps	Right Cheek	Receiver 1	11	2462	18.11	18.50	1.094	97.62	1.024	0.09	0.213	0.239
#12-1	WLAN 2.4GHz	802.11b_1Mbps	Right Cheek	Receiver 1	1	2412	17.21	18.50	1.346	97.62	1.024	0.09	0.222	0.306
	WLAN 2.4GHz	802.11b_1Mbps	Right Cheek	Receiver 1	6	2437	17.73	18.50	1.194	97.62	1.024	0.1	0.240	0.293
	WLAN 2.4GHz	802.11b_1Mbps	Right Cheek	Receiver 2	11	2462	18.11	18.50	1.094	97.62	1.024	0.05	0.033	0.037
	WLAN 2.4GHz	802.11b_1Mbps	Right Cheek	Receiver 2	1	2412	17.21	18.50	1.346	97.62	1.024	0.04	0.030	0.041
	WLAN 2.4GHz	802.11b_1Mbps	Right Cheek	Receiver 2	6	2437	17.73	18.50	1.194	97.62	1.024	0.03	0.038	0.046

18.2 Hotspot SAR

<GSM SAR>

Plot No.	Band	Mode	Test Position	Gap (cm)	Ch.	Freq. (MHz)	Average Power (dBm)	Tune-Up Limit (dBm)	Tune-up Scaling Factor	Power Drift (dB)	Measured 1g SAR (W/kg)	Reported 1g SAR (W/kg)
#13-1	GSM850	GPRS (2 Tx slots)	Left Side	1	128	824.2	31.25	31.50	1.059	-0.06	1.040	1.102
	GSM850	GPRS (2 Tx slots)	Left Side	1	189	836.4	30.82	31.50	1.169	-0.01	0.928	1.085
	GSM850	GPRS (2 Tx slots)	Left Side	1	251	848.8	31.10	31.50	1.096	-0.01	0.807	0.885
#14-1	GSM1900	GPRS (2 Tx slots)	Bottom Side	1	661	1880	28.00	29.50	1.413	-0.12	0.880	1.243
	GSM1900	GPRS (2 Tx slots)	Bottom Side	1	512	1850.2	28.33	29.50	1.309	-0.06	0.797	1.043
	GSM1900	GPRS (2 Tx slots)	Bottom Side	1	810	1909.8	28.27	29.50	1.327	-0.04	0.891	1.183

<WCDMA SAR>

Plot No.	Band	Mode	Test Position	Gap (cm)	Ch.	Freq. (MHz)	Average Power (dBm)	Tune-Up Limit (dBm)	Tune-up Scaling Factor	Power Drift (dB)	Measured 1g SAR (W/kg)	Reported 1g SAR (W/kg)
#15-1	WCDMA Band V	RMC12.2Kbps	Left Side	1	4132	826.4	23.14	24.00	1.219	0.10	0.596	0.727
	WCDMA Band V	RMC12.2Kbps	Left Side	1	4182	836.4	22.95	24.00	1.274	0.03	0.562	0.716
	WCDMA Band V	RMC12.2Kbps	Left Side	1	4233	846.6	23.36	24.00	1.159	-0.01	0.548	0.635
	WCDMA Band IV	RMC12.2Kbps	Front	1	1312	1712.4	21.75	22.00	1.059	0.03	0.776	0.822
	WCDMA Band IV	RMC12.2Kbps	Back	1	1312	1712.4	21.75	22.00	1.059	0.1	0.740	0.784
	WCDMA Band IV	RMC12.2Kbps	Left side	1	1312	1712.4	21.75	22.00	1.059	0.05	0.209	0.221
	WCDMA Band IV	RMC12.2Kbps	Right side	1	1312	1712.4	21.75	22.00	1.059	-0.02	0.115	0.122
	WCDMA Band IV	RMC12.2Kbps	Bottom side	1	1312	1712.4	21.75	22.00	1.059	-0.06	0.675	0.715
	WCDMA Band IV	RMC12.2Kbps	Front	1	1413	1732.6	21.66	22.00	1.081	0.13	0.803	0.868
#16-1	WCDMA Band IV	RMC12.2Kbps	Front	1	1513	1752.6	21.60	22.00	1.096	0.15	0.835	0.916
#17-1	WCDMA Band II	RMC12.2Kbps	Bottom Side	1	9538	1907.6	22.29	22.50	1.050	0.03	1.190	1.249
	WCDMA Band II	RMC12.2Kbps	Bottom Side	1	9262	1852.4	22.18	22.50	1.076	-0.01	1.070	1.152
	WCDMA Band II	RMC12.2Kbps	Bottom Side	1	9400	1880	22.15	22.50	1.084	0.03	1.090	1.181



<LTE SAR>

Plot No.	Band	BW (MHz)	Mode	RB Size	RB offset	Test Position	Gap (cm)	Ch.	Freq. (MHz)	Average Power (dBm)	Tune-Up Limit (dBm)	Tune-up Scaling Factor	Power Drift (dB)	Measured 1g SAR (W/kg)	Reported 1g SAR (W/kg)
	LTE Band 12	10M	QPSK	1	0	Front	1	23095	707.5	23.82	24.00	1.042	-0.19	0.232	0.242
	LTE Band 12	10M	QPSK	25	24	Front	1	23060	704	22.71	23.00	1.069	0.03	0.195	0.208
	LTE Band 12	10M	QPSK	1	0	Back	1	23095	707.5	23.82	24.00	1.042	-0.03	0.303	0.316
	LTE Band 12	10M	QPSK	25	24	Back	1	23060	704	22.71	23.00	1.069	0.04	0.255	0.273
	LTE Band 12	10M	QPSK	1	0	Left side	1	23095	707.5	23.82	24.00	1.042	0.02	0.202	0.211
	LTE Band 12	10M	QPSK	25	24	Left side	1	23060	704	22.71	23.00	1.069	-0.02	0.169	0.181
	LTE Band 12	10M	QPSK	1	0	Right side	1	23095	707.5	23.82	24.00	1.042	0.06	0.104	0.108
	LTE Band 12	10M	QPSK	25	24	Right side	1	23060	704	22.71	23.00	1.069	0.12	0.085	0.091
	LTE Band 12	10M	QPSK	1	0	Bottom side	1	23095	707.5	23.82	24.00	1.042	-0.14	0.064	0.067
	LTE Band 12	10M	QPSK	25	24	Bottom side	1	23060	704	22.71	23.00	1.069	-0.05	0.054	0.058
	LTE Band 12	10M	QPSK	1	0	Back	1	23060	704	23.64	24.00	1.086	-0.02	0.289	0.314
#18-1	LTE Band 12	10M	QPSK	1	0	Back	1	23130	711	23.57	24.00	1.104	-0.08	0.344	0.380
	LTE Band 17	10M	QPSK	1	0	Front	1	23790	710	23.87	24.00	1.030	0.04	0.261	0.269
	LTE Band 17	10M	QPSK	25	0	Front	1	23790	710	22.85	23.00	1.035	0.1	0.218	0.226
	LTE Band 17	10M	QPSK	1	0	Back	1	23790	710	23.87	24.00	1.030	0.04	0.363	0.374
	LTE Band 17	10M	QPSK	25	0	Back	1	23790	710	22.85	23.00	1.035	-0.02	0.286	0.296
	LTE Band 17	10M	QPSK	1	0	Left side	1	23790	710	23.87	24.00	1.030	-0.03	0.236	0.243
	LTE Band 17	10M	QPSK	25	0	Left side	1	23790	710	22.85	23.00	1.035	-0.0022	0.188	0.195
	LTE Band 17	10M	QPSK	1	0	Right side	1	23790	710	23.87	24.00	1.030	0.14	0.114	0.117
	LTE Band 17	10M	QPSK	25	0	Right side	1	23790	710	22.85	23.00	1.035	0.17	0.091	0.094
	LTE Band 17	10M	QPSK	1	0	Bottom side	1	23790	710	23.87	24.00	1.030	-0.04	0.070	0.072
	LTE Band 17	10M	QPSK	25	0	Bottom side	1	23790	710	22.85	23.00	1.035	0.05	0.055	0.057
	LTE Band 17	10M	QPSK	1	0	Back	1	23780	709	23.73	24.00	1.064	-0.15	0.362	0.385
#19-1	LTE Band 17	10M	QPSK	1	0	Back	1	23800	711	23.85	24.00	1.035	-0.03	0.373	0.386
	LTE Band 5	10M	QPSK	1	0	Front	1	20525	836.5	23.69	24.00	1.074	-0.05	0.504	0.541
	LTE Band 5	10M	QPSK	25	0	Front	1	20525	836.5	22.67	23.00	1.079	0.02	0.402	0.434
	LTE Band 5	10M	QPSK	1	0	Back	1	20525	836.5	23.69	24.00	1.074	0.01	0.528	0.567
	LTE Band 5	10M	QPSK	25	0	Back	1	20525	836.5	22.67	23.00	1.079	-0.05	0.418	0.451
	LTE Band 5	10M	QPSK	1	0	Left side	1	20525	836.5	23.69	24.00	1.074	-0.06	0.588	0.632
	LTE Band 5	10M	QPSK	25	0	Left side	1	20525	836.5	22.67	23.00	1.079	-0.02	0.461	0.497
	LTE Band 5	10M	QPSK	1	0	Right side	1	20525	836.5	23.69	24.00	1.074	0.02	0.508	0.546
	LTE Band 5	10M	QPSK	25	0	Right side	1	20525	836.5	22.67	23.00	1.079	-0.08	0.408	0.440
	LTE Band 5	10M	QPSK	1	0	Bottom side	1	20525	836.5	23.69	24.00	1.074	0.07	0.145	0.156
	LTE Band 5	10M	QPSK	25	0	Bottom side	1	20525	836.5	22.67	23.00	1.079	-0.08	0.114	0.123
#20-1	LTE Band 5	10M	QPSK	1	0	Left side	1	20450	829	23.61	24.00	1.094	-0.08	0.624	0.683
	LTE Band 5	10M	QPSK	1	0	Left side	1	20600	844	23.40	24.00	1.148	0.18	0.569	0.653
#21-1	LTE Band 4	20M	QPSK	1	0	Front	1	20300	1745	22.35	22.50	1.035	0.04	1.040	1.077
	LTE Band 4	20M	QPSK	1	0	Front	1	20050	1720	22.36	22.50	1.033	0.06	0.937	0.968
	LTE Band 4	20M	QPSK	1	0	Front	1	20175	1732.5	22.37	22.50	1.030	-0.19	0.972	1.002
#22-1	LTE Band 2	20M	QPSK	1	49	Front	1	19100	1900	21.67	22.50	1.211	0.02	0.837	1.013
	LTE Band 2	20M	QPSK	1	49	Front	1	18700	1860	21.75	22.50	1.189	0.01	0.792	0.941
	LTE Band 2	20M	QPSK	1	49	Front	1	18900	1880	21.77	22.50	1.183	-0.06	0.792	0.937
	LTE Band 7	20M	QPSK	50	0	Bottom Side	1	20850	2510	17.25	17.50	1.059	0.07	0.921	0.976
#23-1	LTE Band 7	20M	QPSK	50	0	Bottom Side	1	21100	2535	17.29	17.50	1.050	-0.02	0.940	0.987
	LTE Band 7	20M	QPSK	50	0	Bottom Side	1	21350	2560	17.28	17.50	1.052	-0.02	0.843	0.887



<DTS WLAN SAR>

Plot No.	Band	Mode	Test Position	Gap (cm)	Ch.	Freq. (MHz)	Average Power (dBm)	Tune-Up Limit (dBm)	Tune-up Scaling Factor	Duty Cycle %	Duty Cycle Scaling Factor	Power Drift (dB)	Measured 1g SAR (W/kg)	Reported 1g SAR (W/kg)
	WLAN 2.4GHz	802.11b 1Mbps	Back	1	11	2462	18.11	18.50	1.094	97.62	1.024	0.048	0.849	0.951
#24-1	WLAN 2.4GHz	802.11b 1Mbps	Back	1	1	2412	17.21	18.50	1.346	97.62	1.024	0.043	0.801	1.104
	WLAN 2.4GHz	802.11b 1Mbps	Back	1	6	2437	17.73	18.50	1.194	97.62	1.024	0.1	0.897	1.097

18.3 Body Worn Accessory SAR

<GSM SAR>

Plot No.	Band	Mode	Test Position	Gap (cm)	Ch.	Freq. (MHz)	Average Power (dBm)	Tune-Up Limit (dBm)	Tune-up Scaling Factor	Power Drift (dB)	Measured 1g SAR (W/kg)	Reported 1g SAR (W/kg)
	GSM850	GPRS (2 Tx slots)	Back	1.5	251	848.8	31.10	31.50	1.096	-0.02	0.513	0.562
#25-1	GSM850	GPRS (2 Tx slots)	Back	1.5	128	824.2	31.25	31.50	1.059	-0.03	0.753	0.798
	GSM850	GPRS (2 Tx slots)	Back	1.5	189	836.4	30.92	31.50	1.143	0.03	0.622	0.711
	GSM1900	GPRS (2 Tx slots)	Front	1.5	810	1909.8	28.27	29.50	1.327	0.13	0.365	0.484
	GSM1900	GPRS (2 Tx slots)	Front	1.5	512	1850.2	28.33	29.50	1.309	0.19	0.345	0.452
#26-1	GSM1900	GPRS (2 Tx slots)	Front	1.5	661	1880	28.00	29.50	1.413	0.15	0.363	0.513

<WCDMA SAR>

Plot No.	Band	Mode	Test Position	Gap (cm)	Ch.	Freq. (MHz)	Average Power (dBm)	Tune-Up Limit (dBm)	Tune-up Scaling Factor	Power Drift (dB)	Measured 1g SAR (W/kg)	Reported 1g SAR (W/kg)
	WCDMA Band V	RMC12.2Kbps	Back	1.5	4132	826.4	23.14	24.00	1.219	0.05	0.490	0.597
	WCDMA Band V	RMC12.2Kbps	Back	1.5	4182	836.4	22.95	24.00	1.274	0.01	0.456	0.581
#27-1	WCDMA Band V	RMC12.2Kbps	Back	1.5	4233	846.6	23.36	24.00	1.159	0.02	0.535	0.620
#28-1	WCDMA Band IV	RMC12.2Kbps	Front	1.5	1312	1712.4	24.05	24.50	1.109	0.08	0.600	0.666
	WCDMA Band IV	RMC12.2Kbps	Back	1.5	1312	1712.4	24.05	24.50	1.109	0.12	0.588	0.652
	WCDMA Band IV	RMC12.2Kbps	Front	1.5	1413	1732.6	23.99	24.50	1.125	0.05	0.421	0.473
	WCDMA Band IV	RMC12.2Kbps	Front	1.5	1513	1752.6	24.03	24.50	1.114	0.08	0.452	0.504
#29-1	WCDMA Band II	RMC12.2Kbps	Front	1.5	9538	1907.6	22.29	22.50	1.050	0.14	0.490	0.514
	WCDMA Band II	RMC12.2Kbps	Front	1.5	9262	1852.4	22.18	22.50	1.076	0.03	0.429	0.462
	WCDMA Band II	RMC12.2Kbps	Front	1.5	9400	1880	22.15	22.50	1.084	0.14	0.471	0.511



<LTE SAR>

Plot No.	Band	BW (MHz)	Mode	RB Size	RB offset	Test Position	Gap (cm)	Ch.	Freq. (MHz)	Average Power (dBm)	Tune-Up Limit (dBm)	Tune-up Scaling Factor	Power Drift (dB)	Measured 1g SAR (W/kg)	Reported 1g SAR (W/kg)
	LTE Band 12	10M	QPSK	1	0	Front	1.5	23095	707.5	23.82	24.00	1.042	-0.01	0.167	0.174
	LTE Band 12	10M	QPSK	25	24	Front	1.5	23060	704	22.71	23.00	1.069	0.04	0.150	0.160
	LTE Band 12	10M	QPSK	1	0	Back	1.5	23095	707.5	23.82	24.00	1.042	0.07	0.216	0.225
	LTE Band 12	10M	QPSK	25	24	Back	1.5	23060	704	22.71	23.00	1.069	0.07	0.186	0.199
	LTE Band 12	10M	QPSK	1	0	Back	1.5	23060	704	23.64	24.00	1.086	0.11	0.198	0.215
#30-1	LTE Band 12	10M	QPSK	1	0	Back	1.5	23130	711	23.57	24.00	1.104	0.14	0.236	0.261
	LTE Band 17	10M	QPSK	1	0	Front	1.5	23790	710	23.87	24.00	1.030	0.09	0.184	0.190
	LTE Band 17	10M	QPSK	25	0	Front	1.5	23790	710	22.85	23.00	1.035	0.0036	0.155	0.160
	LTE Band 17	10M	QPSK	1	0	Back	1.5	23790	710	23.87	24.00	1.030	-0.06	0.242	0.249
	LTE Band 17	10M	QPSK	25	0	Back	1.5	23790	710	22.85	23.00	1.035	-0.04	0.195	0.202
	LTE Band 17	10M	QPSK	1	0	Back	1.5	23780	709	23.73	24.00	1.064	0.02	0.246	0.262
#31-1	LTE Band 17	10M	QPSK	1	0	Back	1.5	23800	711	23.85	24.00	1.035	-0.04	0.257	0.266
	LTE Band 5	10M	QPSK	1	0	Front	1.5	20525	836.5	23.69	24.00	1.074	-0.06	0.474	0.509
	LTE Band 5	10M	QPSK	25	0	Front	1.5	20525	836.5	22.67	23.00	1.079	0.02	0.379	0.409
	LTE Band 5	10M	QPSK	1	0	Back	1.5	20525	836.5	23.69	24.00	1.074	-0.01	0.483	0.519
	LTE Band 5	10M	QPSK	25	0	Back	1.5	20525	836.5	22.67	23.00	1.079	0.02	0.381	0.411
#32-1	LTE Band 5	10M	QPSK	1	0	Back	1.5	20450	829	23.61	24.00	1.094	0.07	0.517	0.566
	LTE Band 5	10M	QPSK	1	0	Back	1.5	20600	844	23.40	24.00	1.148	-0.11	0.458	0.526
#33-1	LTE Band 4	20M	QPSK	1	0	Front	1.5	20175	1732.5	22.37	22.50	1.030	-0.01	0.524	0.540
	LTE Band 4	20M	QPSK	1	0	Front	1.5	20050	1720	22.36	22.50	1.033	0.04	0.512	0.529
	LTE Band 4	20M	QPSK	1	0	Front	1.5	20300	1745	22.35	22.50	1.035	0.07	0.509	0.527
	LTE Band 2	20M	QPSK	1	49	Front	1.5	18900	1880	21.77	22.50	1.183	-0.04	0.380	0.450
	LTE Band 2	20M	QPSK	1	49	Front	1.5	18700	1860	21.75	22.50	1.189	-0.02	0.392	0.466
#34-1	LTE Band 2	20M	QPSK	1	49	Front	1.5	19100	1900	21.67	22.50	1.211	0.04	0.443	0.536
	LTE Band 7	20M	QPSK	1	0	Back	1.5	20850	2510	22.68	23.50	1.208	0.07	1.100	1.329
	LTE Band 7	20M	QPSK	1	0	Back	1.5	21100	2535	22.88	23.50	1.153	0.17	1.100	1.269
	LTE Band 7	20M	QPSK	1	0	Back	1.5	21350	2560	22.67	23.50	1.211	0.14	1.020	1.235
#35-1	LTE Band 7	20M	QPSK	1	0	Back with/headset	1.5	20850	2510	22.68	23.50	1.208	0.13	1.150	1.389
	LTE Band 7	20M	QPSK	1	0	Back with/headset	1.5	21100	2535	22.88	23.50	1.153	0.01	1.170	1.350
	LTE Band 7	20M	QPSK	1	0	Back with/headset	1.5	21350	2560	22.67	23.50	1.211	0.02	1.060	1.283

<DTS WLAN SAR>

Plot No.	Band	Mode	Test Position	Gap (cm)	Ch.	Freq. (MHz)	Average Power (dBm)	Tune-Up Limit (dBm)	Tune-up Scaling Factor	Duty Cycle %	Duty Cycle Scaling Factor	Power Drift (dB)	Measured 1g SAR (W/kg)	Reported 1g SAR (W/kg)
	WLAN 2.4GHz	802.11b 1Mbps	Back	1.5	11	2462	18.11	18.50	1.094	97.62	1.024	0.031	0.308	0.345
	WLAN 2.4GHz	802.11b 1Mbps	Back	1.5	1	2412	17.21	18.50	1.346	97.62	1.024	0.081	0.281	0.387
#36-1	WLAN 2.4GHz	802.11b 1Mbps	Back	1.5	6	2437	17.73	18.50	1.194	97.62	1.024	0.072	0.318	0.389

18.4 Repeated SAR Measurement

General Note:

1. Per KDB 865664 D01v01r03, for each frequency band, repeated SAR measurement is required only when the measured SAR is $\geq 0.8W/kg$.
2. Per KDB 865664 D01v01r03, if the ratio among the repeated measurement is ≤ 1.2 and the measured SAR $< 1.45W/kg$, only one repeated measurement is required.
3. The ratio is the difference in percentage between original and repeated *measured SAR*.
4. All measurement SAR result is scaled-up to account for tune-up tolerance and is compliant.

No.	Band	Mode	Test Position	Receiver Enabled	Gap (cm)	Ch.	Freq. (MHz)	Average Power (dBm)	Tune-Up Limit (dBm)	Tune-up Scaling Factor	Duty Cycle %	Duty Cycle Scaling Factor	Power Drift (dB)	Measured 1g SAR (W/kg)	Ratio	Reported 1g SAR (W/kg)
1st	WCDMA Band II	RMC12.2Kbps	Bottom Side	-	1	9538	1907.6	22.29	22.50	1.050	-	-	0.03	1.190	1	1.249
2nd	WCDMA Band II	RMC12.2Kbps	Bottom Side	-	1	9538	1907.6	22.29	22.50	1.050	-	-	-0.02	1.130	1.053	1.186
1st	WLAN 2.4GHz	802.11b 1Mbps	Back	-	1	6	2437	17.73	18.50	1.194	97.62	1.024	0.1	0.897	1	1.097
2nd	WLAN 2.4GHz	802.11b 1Mbps	Back	-	1	6	2437	17.73	18.50	1.194	97.62	1.024	0.03	0.894	1.003	1.093

No.	Band	BW (MHz)	Mode	RB Size	RB offset	Test Position	Receiver Enabled	Gap (cm)	Ch.	Freq. (MHz)	Average Power (dBm)	Tune-Up Limit (dBm)	Tune-up Scaling Factor	Power Drift (dB)	Measured 1g SAR (W/kg)	Ratio	Reported 1g SAR (W/kg)
1st	LTE Band 5	10M	QPSK	1	0	Left Cheek	Receiver 2	OFF	20450	829	23.61	24.00	1.094	0.05	1.070	1	1.171
2nd	LTE Band 5	10M	QPSK	1	0	Left Cheek	Receiver 2	OFF	20450	829	23.61	24.00	1.094	-0.01	1.060	1.009	1.160
1st	LTE Band 4	20M	QPSK	1	0	Front	-	1	20300	1745	22.35	22.50	1.035	0.04	1.040	1	1.077
2nd	LTE Band 4	20M	QPSK	1	0	Front	-	1	20300	1745	22.35	22.50	1.035	0.08	1.030	1.010	1.066
1st	LTE Band 7	20M	QPSK	1	0	Back with/headset	-	1.5	21100	2535	22.88	23.50	1.153	0.01	1.170	1	1.350
2nd	LTE Band 7	20M	QPSK	1	0	Back with/headset	-	1.5	21100	2535	22.88	23.50	1.153	0.01	1.150	1.017	1.326

19. Simultaneous Transmission Analysis

NO.	Simultaneous Transmission Configurations	Head	Body-worn	Hotspot	Note
1.	GSM(voice) + WLAN 2.4GHz(data)	Yes	Yes		
2.	WCDMA(voice) + WLAN 2.4GHz(data)	Yes	Yes		
3.	LTE(voice) + WLAN 2.4GHz(data)	Yes	Yes		
4.	GSM(voice) + Bluetooth(data)	Yes	Yes		
5.	WCDMA((voice) + Bluetooth(data)	Yes	Yes		
6.	LTE(voice) + Bluetooth(data)	Yes	Yes		
7.	GPRS/EDGE(data) + WLAN 2.4GHz(data)	Yes	Yes	Yes	2.4GHz Hotspot
8.	WCDMA(data) + WLAN 2.4GHz(data)	Yes	Yes	Yes	2.4GHz Hotspot
9.	LTE(data) + WLAN 2.4GHz(data)	Yes	Yes	Yes	2.4GHz Hotspot
10.	GPRS/EDGE(data) + Bluetooth(data)	Yes	Yes	Yes	Bluetooth Tethering
11.	WCDMA(data) + Bluetooth(data)	Yes	Yes	Yes	Bluetooth Tethering
12.	LTE(Data) + Bluetooth(data)	Yes	Yes	Yes	Bluetooth Tethering

General Note:

- This device supported VoIP in GPRS, EGPRS, WCDMA and LTE (e.g. 3rd party VoIP) and LTE Supports VoLTE operation.
- This device 2.4 GHz WLAN supports hotspot operation.
- WLAN and Bluetooth share the same antenna, and cannot transmit simultaneously.
- EUT will choose each GSM, WCDMA and LTE according to the network signal condition; therefore, they will not operate simultaneously at any moment.
- The reported SAR summation is calculated based on the same configuration and test position.
- Per KDB 447498 D01v05r02, simultaneous transmission SAR is compliant if,
 - Scalar SAR summation < 1.6W/kg.
 - $SPLSR = (SAR_1 + SAR_2)^{1.5} / (min. separation distance, mm)$, and the peak separation distance is determined from the square root of $[(x_1-x_2)^2 + (y_1-y_2)^2 + (z_1-z_2)^2]$, where (x_1, y_1, z_1) and (x_2, y_2, z_2) are the coordinates of the extrapolated peak SAR locations in the zoom scan.
 - If $SPLSR \leq 0.04$, simultaneously transmission SAR measurement is not necessary.
 - Simultaneously transmission SAR measurement, and the reported multi-band SAR < 1.6W/kg.
- For simultaneous transmission analysis, Bluetooth SAR is estimated per KDB 447498 D01v05r02 based on the formula below.
 - $(max. power of channel, including tune-up tolerance, mW)/(min. test separation distance, mm) \cdot [\sqrt{f(GHz)} \cdot x] W/kg$ for test separation distances ≤ 50 mm; where $x = 7.5$ for 1-g SAR, and $x = 18.75$ for 10-g SAR.
 - When the minimum separation distance is < 5mm, the distance is used 5mm to determine SAR test exclusion.
 - 0.4 W/kg for 1-g SAR and 1.0 W/kg for 10-g SAR, when the test separation distances is > 50 mm.

Bluetooth Max Power	Exposure Position	Head	Hotspot	Body worn
	Test separation (mm)	0	10	15
1.5 dBm	Estimated SAR (W/kg)	0.042	0.021	0.014



19.1 Head Exposure Conditions

<Receiver1 configuration>

WWAN Band		Exposure Position	WWAN PCE	WLAN DTS	Summed SAR (W/kg)	SPLSR	Case No
			Max. WWAN SAR (W/kg)	Max. WLAN SAR (W/kg)			
GSM	GSM850	Right Cheek	0.845	0.306	1.15		
		Right Tilted	0.546	0.139	0.69		
		Left Cheek	0.767	0.233	1.00		
		Left Tilted	0.529	0.149	0.68		
	GSM1900	Right Cheek	0.247	0.306	0.55		
		Right Tilted	0.107	0.139	0.25		
		Left Cheek	0.316	0.233	0.55		
		Left Tilted	0.108	0.149	0.26		
WCDMA	Band V	Right Cheek	0.738	0.306	1.04		
		Right Tilted	0.509	0.139	0.65		
		Left Cheek	0.768	0.233	1.00		
		Left Tilted	0.531	0.149	0.68		
	Band IV	Right Cheek	0.575	0.306	0.88		
		Right Tilted	0.146	0.139	0.29		
		Left Cheek	0.642	0.233	0.88		
		Left Tilted	0.247	0.149	0.40		
	Band II	Right Cheek	0.302	0.306	0.61		
		Right Tilted	0.142	0.139	0.28		
		Left Cheek	0.339	0.233	0.57		
		Left Tilted	0.127	0.149	0.28		
LTE	Band 12	Right Cheek	0.190	0.306	0.50		
		Right Tilted	0.115	0.139	0.25		
		Left Cheek	0.256	0.233	0.49		
		Left Tilted	0.130	0.149	0.28		
	Band 17	Right Cheek	0.188	0.306	0.49		
		Right Tilted	0.105	0.139	0.24		
		Left Cheek	0.220	0.233	0.45		
		Left Tilted	0.122	0.149	0.27		
	Band 5	Right Cheek	0.440	0.306	0.75		
		Right Tilted	0.293	0.139	0.43		
		Left Cheek	0.520	0.233	0.75		
		Left Tilted	0.332	0.149	0.48		
LTE	Band 4	Right Cheek	0.355	0.306	0.66		
		Right Tilted	0.088	0.139	0.23		
		Left Cheek	0.402	0.233	0.64		
		Left Tilted	0.134	0.149	0.28		
	Band 2	Right Cheek	0.287	0.306	0.59		
		Right Tilted	0.126	0.139	0.27		
		Left Cheek	0.349	0.233	0.58		
		Left Tilted	0.097	0.149	0.25		
	Band 7	Right Cheek	0.213	0.306	0.52		
		Right Tilted	0.141	0.139	0.28		
		Left Cheek	0.483	0.233	0.72		
		Left Tilted	0.106	0.149	0.26		



WWAN Band		Exposure Position	WWAN PCE	Bluetooth DSS	Summed SAR (W/kg)	SPLSR	Case No
			Max. WWAN SAR (W/kg)	Estimated Bluetooth SAR (W/kg)			
GSM	GSM850	Right Cheek	0.845	0.042	0.89		
		Right Tilted	0.546	0.042	0.59		
		Left Cheek	0.767	0.042	0.81		
		Left Tilted	0.529	0.042	0.57		
	GSM1900	Right Cheek	0.247	0.042	0.29		
		Right Tilted	0.107	0.042	0.15		
		Left Cheek	0.316	0.042	0.36		
		Left Tilted	0.108	0.042	0.15		
WCDMA	Band V	Right Cheek	0.738	0.042	0.78		
		Right Tilted	0.509	0.042	0.55		
		Left Cheek	0.768	0.042	0.81		
		Left Tilted	0.531	0.042	0.57		
	Band IV	Right Cheek	0.575	0.042	0.62		
		Right Tilted	0.146	0.042	0.19		
		Left Cheek	0.642	0.042	0.68		
		Left Tilted	0.247	0.042	0.29		
	Band II	Right Cheek	0.302	0.042	0.34		
		Right Tilted	0.142	0.042	0.18		
		Left Cheek	0.339	0.042	0.38		
		Left Tilted	0.127	0.042	0.17		
LTE	Band 12	Right Cheek	0.190	0.042	0.23		
		Right Tilted	0.115	0.042	0.16		
		Left Cheek	0.256	0.042	0.30		
		Left Tilted	0.130	0.042	0.17		
	Band 17	Right Cheek	0.188	0.042	0.23		
		Right Tilted	0.105	0.042	0.15		
		Left Cheek	0.220	0.042	0.26		
		Left Tilted	0.122	0.042	0.16		
	Band 5	Right Cheek	0.440	0.042	0.48		
		Right Tilted	0.293	0.042	0.34		
		Left Cheek	0.520	0.042	0.56		
		Left Tilted	0.332	0.042	0.37		
LTE	Band 4	Right Cheek	0.355	0.042	0.40		
		Right Tilted	0.088	0.042	0.13		
		Left Cheek	0.402	0.042	0.44		
		Left Tilted	0.134	0.042	0.18		
	Band 2	Right Cheek	0.287	0.042	0.33		
		Right Tilted	0.126	0.042	0.17		
		Left Cheek	0.349	0.042	0.39		
		Left Tilted	0.097	0.042	0.14		
	Band 7	Right Cheek	0.213	0.042	0.26		
		Right Tilted	0.141	0.042	0.18		
		Left Cheek	0.483	0.042	0.53		
		Left Tilted	0.106	0.042	0.15		



<Receiver2 configuration>:

WWAN Band		Exposure Position	WWAN PCE	WLAN DTS	Summed SAR (W/kg)	SPLSR	Case No
			Max. WWAN SAR (W/kg)	Max. WLAN SAR (W/kg)			
GSM	GSM850	Right Cheek	1.045	0.046	1.09		
		Right Tilted	0.717	0.009	0.73		
		Left Cheek	1.206	0.022	1.23		
		Left Tilted	0.790	0.015	0.81		
	GSM1900	Right Cheek	0.618	0.046	0.66		
		Right Tilted	0.654	0.009	0.66		
		Left Cheek	1.064	0.022	1.09		
		Left Tilted	1.017	0.015	1.03		
WCDMA	Band V	Right Cheek	1.121	0.046	1.17		
		Right Tilted	0.832	0.009	0.84		
		Left Cheek	1.406	0.022	1.43		
		Left Tilted	0.969	0.015	0.98		
	Band IV	Right Cheek	0.620	0.046	0.67		
		Right Tilted	0.586	0.009	0.60		
		Left Cheek	1.103	0.022	1.13		
		Left Tilted	1.059	0.015	1.07		
	Band II	Right Cheek	0.760	0.046	0.81		
		Right Tilted	0.767	0.009	0.78		
		Left Cheek	1.072	0.022	1.09		
		Left Tilted	1.230	0.015	1.25		
LTE	Band 12	Right Cheek	0.514	0.046	0.56		
		Right Tilted	0.447	0.009	0.46		
		Left Cheek	0.852	0.022	0.87		
		Left Tilted	0.665	0.015	0.68		
	Band 17	Right Cheek	0.551	0.046	0.60		
		Right Tilted	0.469	0.009	0.48		
		Left Cheek	0.860	0.022	0.88		
		Left Tilted	0.622	0.015	0.64		
	Band 5	Right Cheek	0.951	0.046	1.00		
		Right Tilted	0.661	0.009	0.67		
		Left Cheek	1.171	0.022	1.19		
		Left Tilted	0.742	0.015	0.76		
	Band 4	Right Cheek	0.967	0.046	1.01		
		Right Tilted	0.918	0.009	0.93		
		Left Cheek	1.442	0.022	1.46		
		Left Tilted	1.306	0.015	1.32		
	Band 2	Right Cheek	0.868	0.046	0.91		
		Right Tilted	0.780	0.009	0.79		
		Left Cheek	1.412	0.022	1.43		
		Left Tilted	1.384	0.015	1.40		
Band 7	Right Cheek	0.600	0.046	0.65			
	Right Tilted	0.746	0.009	0.76			
	Left Cheek	1.220	0.022	1.24			
	Left Tilted	1.411	0.015	1.43			



WWAN Band		Exposure Position	WWAN PCE	Bluetooth DSS	Summed SAR (W/kg)	SPLSR	Case No
			Max. WWAN SAR (W/kg)	Estimated Bluetooth SAR (W/kg)			
GSM	GSM850	Right Cheek	1.045	0.042	1.09		
		Right Tilted	0.717	0.042	0.76		
		Left Cheek	1.206	0.042	1.25		
		Left Tilted	0.790	0.042	0.83		
	GSM1900	Right Cheek	0.618	0.042	0.66		
		Right Tilted	0.654	0.042	0.70		
		Left Cheek	1.064	0.042	1.11		
		Left Tilted	1.017	0.042	1.06		
WCDMA	Band V	Right Cheek	1.121	0.042	1.16		
		Right Tilted	0.832	0.042	0.87		
		Left Cheek	1.406	0.042	1.45		
		Left Tilted	0.969	0.042	1.01		
	Band IV	Right Cheek	0.620	0.042	0.66		
		Right Tilted	0.586	0.042	0.63		
		Left Cheek	1.103	0.042	1.15		
		Left Tilted	1.059	0.042	1.10		
	Band II	Right Cheek	0.760	0.042	0.80		
		Right Tilted	0.767	0.042	0.81		
		Left Cheek	1.072	0.042	1.11		
		Left Tilted	1.230	0.042	1.27		
LTE	Band 12	Right Cheek	0.514	0.042	0.56		
		Right Tilted	0.447	0.042	0.49		
		Left Cheek	0.852	0.042	0.89		
		Left Tilted	0.665	0.042	0.71		
	Band 17	Right Cheek	0.551	0.042	0.59		
		Right Tilted	0.469	0.042	0.51		
		Left Cheek	0.860	0.042	0.90		
		Left Tilted	0.622	0.042	0.66		
	Band 5	Right Cheek	0.951	0.042	0.99		
		Right Tilted	0.661	0.042	0.70		
		Left Cheek	1.171	0.042	1.21		
		Left Tilted	0.742	0.042	0.78		
	Band 4	Right Cheek	0.967	0.042	1.01		
		Right Tilted	0.918	0.042	0.96		
		Left Cheek	1.442	0.042	1.48		
		Left Tilted	1.306	0.042	1.35		
	Band 2	Right Cheek	0.868	0.042	0.91		
		Right Tilted	0.780	0.042	0.82		
		Left Cheek	1.412	0.042	1.45		
		Left Tilted	1.384	0.042	1.43		
Band 7	Right Cheek	0.600	0.042	0.64			
	Right Tilted	0.746	0.042	0.79			
	Left Cheek	1.220	0.042	1.26			
	Left Tilted	1.411	0.042	1.45			

19.2 Hotspot Exposure Conditions

WWAN Band		Exposure Position	WWAN PCE	WLAN DTS	Summed SAR (W/kg)	SPLSR	Case No
			Max. WWAN SAR (W/kg)	Max. WLAN SAR (W/kg)			
GSM	GSM850	Front	0.660	0.047	0.71		
		Back	0.676	1.277	1.95	0.04	#1
		Left side	1.245	0.022	1.27		
		Right side	0.761	0.043	0.80		
		Top side		0.091	0.09		
		Bottom side	0.197		0.20		
	GSM1900	Front	1.046	0.047	1.09		
		Back	0.762	1.277	2.04	0.02	#2
		Left side	0.191	0.022	0.21		
		Right side	0.107	0.043	0.15		
		Top side		0.091	0.09		
		Bottom side	1.243		1.24		
WCDMA	Band V	Front	0.690	0.047	0.74		
		Back	0.605	1.277	1.88	0.04	#3
		Left side	0.849	0.022	0.87		
		Right side	0.727	0.043	0.77		
		Top side		0.091	0.09		
		Bottom side	0.177		0.18		
	Band IV	Front	0.916	0.047	0.96		
		Back	0.784	1.277	2.06	0.03	#4
		Left side	0.221	0.022	0.24		
		Right side	0.122	0.043	0.17		
		Top side		0.091	0.09		
		Bottom side	0.715		0.72		
	Band II	Front	1.116	0.047	1.16		
		Back	0.849	1.277	2.13	0.03	#5
		Left side	0.226	0.022	0.25		
		Right side	0.123	0.043	0.17		
		Top side		0.091	0.09		
		Bottom side	1.357		1.36		



LTE	Band 12	Front	0.242	0.047	0.29		
		Back	0.380	1.277	1.66	0.03	#6
		Left side	0.211	0.022	0.23		
		Right side	0.108	0.043	0.15		
		Top side		0.091	0.09		
		Bottom side	0.067		0.07		
	Band 17	Front	0.269	0.047	0.32		
		Back	0.386	1.277	1.66	0.02	#7
		Left side	0.243	0.022	0.27		
		Right side	0.117	0.043	0.16		
		Top side		0.091	0.09		
		Bottom side	0.072		0.07		
	Band 5	Front	0.541	0.047	0.59		
		Back	0.567	1.277	1.84	0.04	#8
		Left side	0.683	0.022	0.71		
		Right side	0.546	0.043	0.59		
		Top side		0.091	0.09		
		Bottom side	0.156		0.16		
	Band 4	Front	1.077	0.047	1.12		
		Back	0.809	1.277	2.09	0.03	#9
		Left side	0.251	0.022	0.27		
		Right side	0.160	0.043	0.20		
		Top side		0.091	0.09		
		Bottom side	1.005		1.01		
	Band 2	Front	1.231	0.047	1.28		
		Back	0.787	1.277	2.06	0.03	#10
		Left side	0.304	0.022	0.33		
		Right side	0.157	0.043	0.20		
		Top side		0.091	0.09		
		Bottom side	1.210		1.21		
Band 7	Front	0.547	0.047	0.59			
	Back	0.910	1.277	2.19	0.03	#11	
	Left side	0.127	0.022	0.15			
	Right side	0.015	0.043	0.06			
	Top side		0.091	0.09			
	Bottom side	1.324		1.32			

WWAN Band		Exposure Position	WWAN PCE	Bluetooth DSS	Summed SAR (W/kg)	SPLSR	Case No
			Max. WWAN SAR (W/kg)	Estimated Bluetooth SAR (W/kg)			
GSM	GSM850	Front	0.660	0.021	0.68		
		Back	0.676	0.021	0.70		
		Left side	1.245	0.021	1.27		
		Right side	0.761	0.021	0.78		
		Top side		0.021	0.02		
		Bottom side	0.197		0.20		
	GSM1900	Front	1.046	0.021	1.07		
		Back	0.762	0.021	0.78		
		Left side	0.191	0.021	0.21		
		Right side	0.107	0.021	0.13		
		Top side		0.021	0.02		
		Bottom side	1.243		1.24		
WCDMA	Band V	Front	0.690	0.021	0.71		
		Back	0.605	0.021	0.63		
		Left side	0.849	0.021	0.87		
		Right side	0.727	0.021	0.75		
		Top side		0.021	0.02		
		Bottom side	0.177		0.18		
	Band IV	Front	0.916	0.021	0.94		
		Back	0.784	0.021	0.81		
		Left side	0.221	0.021	0.24		
		Right side	0.122	0.021	0.14		
		Top side		0.021	0.02		
		Bottom side	0.715		0.72		
	Band II	Front	1.116	0.021	1.14		
		Back	0.849	0.021	0.87		
		Left side	0.226	0.021	0.25		
		Right side	0.123	0.021	0.14		
		Top side		0.021	0.02		
		Bottom side	1.357		1.36		



LTE	Band 12	Front	0.242	0.021	0.26		
		Back	0.380	0.021	0.40		
		Left side	0.211	0.021	0.23		
		Right side	0.108	0.021	0.13		
		Top side		0.021	0.02		
		Bottom side	0.067		0.07		
	Band 17	Front	0.269	0.021	0.29		
		Back	0.386	0.021	0.41		
		Left side	0.243	0.021	0.26		
		Right side	0.117	0.021	0.14		
		Top side		0.021	0.02		
		Bottom side	0.072		0.07		
	Band 5	Front	0.541	0.021	0.56		
		Back	0.567	0.021	0.59		
		Left side	0.683	0.021	0.70		
		Right side	0.546	0.021	0.57		
		Top side		0.021	0.02		
		Bottom side	0.156		0.16		
	Band 4	Front	1.077	0.021	1.10		
		Back	0.809	0.021	0.83		
		Left side	0.251	0.021	0.27		
		Right side	0.160	0.021	0.18		
		Top side		0.021	0.02		
		Bottom side	1.005		1.01		
	Band 2	Front	1.231	0.021	1.25		
		Back	0.787	0.021	0.81		
		Left side	0.304	0.021	0.33		
		Right side	0.157	0.021	0.18		
		Top side		0.021	0.02		
		Bottom side	1.210		1.21		
Band 7	Front	0.547	0.021	0.57			
	Back	0.910	0.021	0.93			
	Left side	0.127	0.021	0.15			
	Right side	0.015	0.021	0.04			
	Top side		0.021	0.02			
	Bottom side	1.324		1.32			



19.3 Body-Worn Accessory Exposure Conditions

WWAN Band		Exposure Position	WWAN PCE	WLAN DTS	Summed SAR (W/kg)	SPLSR	Case No
			Max. WWAN SAR (W/kg)	Max. WLAN SAR (W/kg)			
GSM	GSM850	Front	0.622	0.027	0.65		
		Back	0.798	0.474	1.27		
	GSM1900	Front	0.513	0.027	0.54		
		Back	0.424	0.474	0.90		
WCDMA	Band V	Front	0.635	0.027	0.66		
		Back	0.654	0.474	1.13		
	Band IV	Front	0.666	0.027	0.69		
		Back	0.652	0.474	1.13		
	Band II	Front	0.579	0.027	0.61		
		Back	0.468	0.474	0.94		
LTE	Band 12	Front	0.174	0.027	0.20		
		Back	0.261	0.474	0.74		
	Band 17	Front	0.190	0.027	0.22		
		Back	0.266	0.474	0.74		
	Band 5	Front	0.509	0.027	0.54		
		Back	0.566	0.474	1.04		
	Band 4	Front	0.540	0.027	0.57		
		Back	0.395	0.474	0.87		
	Band 2	Front	0.536	0.027	0.56		
		Back	0.410	0.474	0.88		
	Band 7	Front	0.715	0.027	0.74		
		Back	1.329	0.474	1.80	0.02	#12
Back (with/headset)		1.389		1.39			

WWAN Band		Exposure Position	WWAN PCE	Bluetooth DSS	Summed SAR (W/kg)	SPLSR	Case No
			Max. WWAN SAR (W/kg)	Estimated Bluetooth SAR (W/kg)			
GSM	GSM850	Front	0.622	0.014	0.64		
		Back	0.798	0.014	0.81		
	GSM1900	Front	0.513	0.014	0.53		
		Back	0.424	0.014	0.44		
WCDMA	Band V	Front	0.635	0.014	0.65		
		Back	0.654	0.014	0.67		
	Band IV	Front	0.666	0.014	0.68		
		Back	0.652	0.014	0.67		
	Band II	Front	0.579	0.014	0.59		
		Back	0.468	0.014	0.48		
LTE	Band 12	Front	0.174	0.014	0.19		
		Back	0.261	0.014	0.28		
	Band 17	Front	0.190	0.014	0.20		
		Back	0.266	0.014	0.28		
	Band 5	Front	0.509	0.014	0.52		
		Back	0.566	0.014	0.58		
	Band 4	Front	0.540	0.014	0.55		
		Back	0.395	0.014	0.41		
	Band 2	Front	0.536	0.014	0.55		
		Back	0.410	0.014	0.42		
	Band 7	Front	0.715	0.014	0.73		
		Back	1.329	0.014	1.34		
Back (with/headset)		1.389		1.39			

19.4 SPLSR Evaluation and Analysis

General Note: $SPLSR = (SAR_1 + SAR_2)^{1.5} / (min. \text{ separation distance, mm})$. If $SPLSR \leq 0.04$, simultaneously transmission SAR measurement is not necessary.

Case No #1 Position	Band	SAR (W/kg)	Gap (cm)	SAR peak location (m)			3D distance (mm)	Pair SAR sum (W/kg)	SPLSR	Simultaneous SAR
				X	Y	Z				
Back	GSM850	0.676	1	-0.0185	-0.0105	-0.207	62.7	1.95	0.04	Not required
	WLAN 2.4GHz	1.277	1	-0.024	0.052	-0.206				

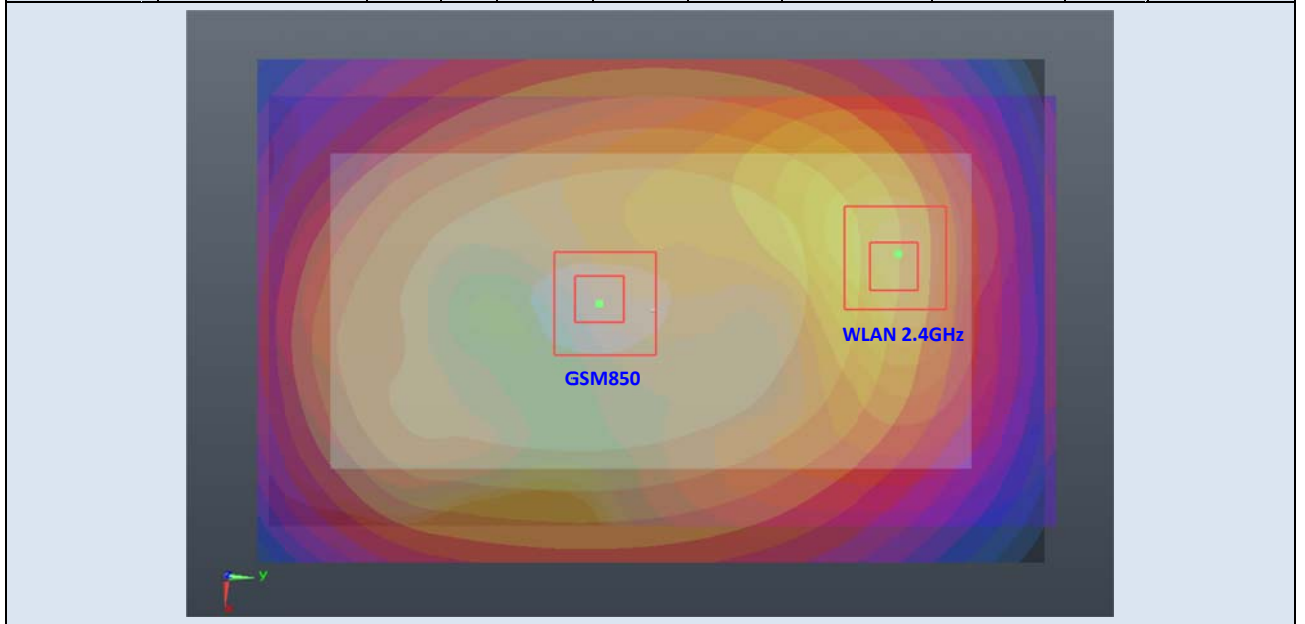

Case No #2 Position	Band	SAR (W/kg)	Gap (cm)	SAR peak location (m)			3D distance (mm)	Pair SAR sum (W/kg)	SPLSR	Simultaneous SAR
				X	Y	Z				
Back	GSM1900	0.762	1	-0.0005	-0.0645	-0.206	118.8	2.04	0.02	Not required
	WLAN 2.4GHz	1.277	1	-0.024	0.052	-0.206				

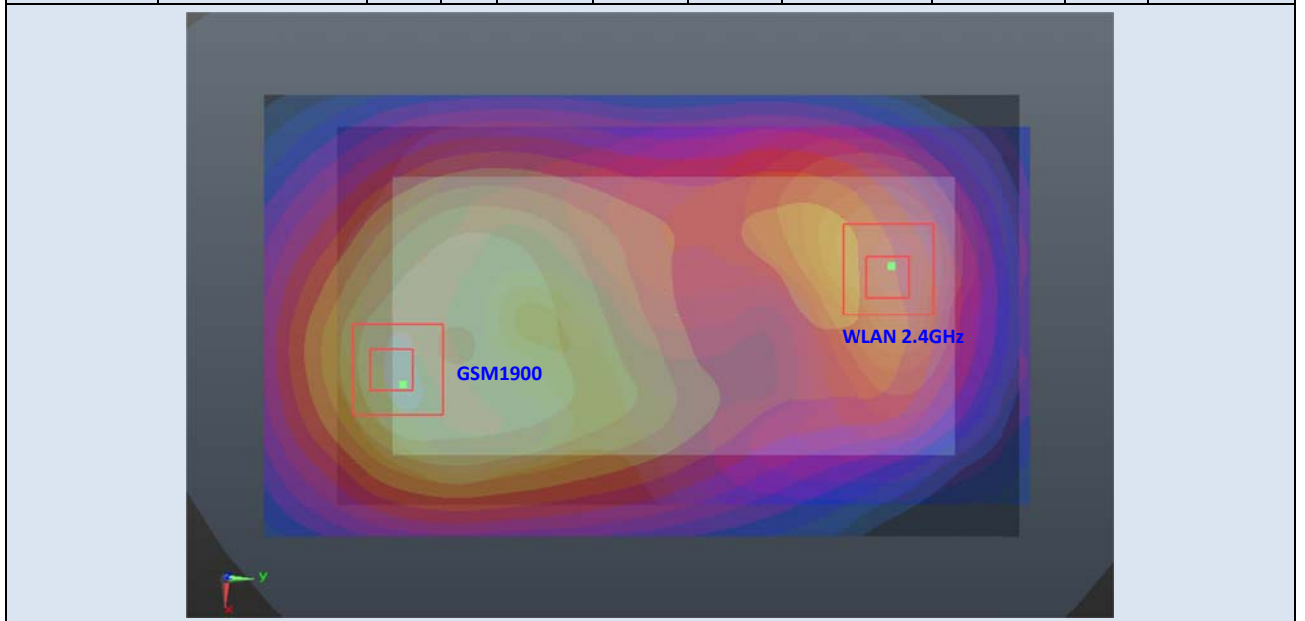

Case No #3	Band	SAR (W/kg)	Gap (cm)	SAR peak location (m)			3D distance (mm)	Pair SAR sum (W/kg)	SPLSR	Simultaneous SAR
				X	Y	Z				
Back	WCDMA Band V	0.605	1	-0.017	-0.0135	-0.207	65.9	1.88	0.04	Not required
	WLAN 2.4GHz	1.277	1	-0.024	0.052	-0.206				

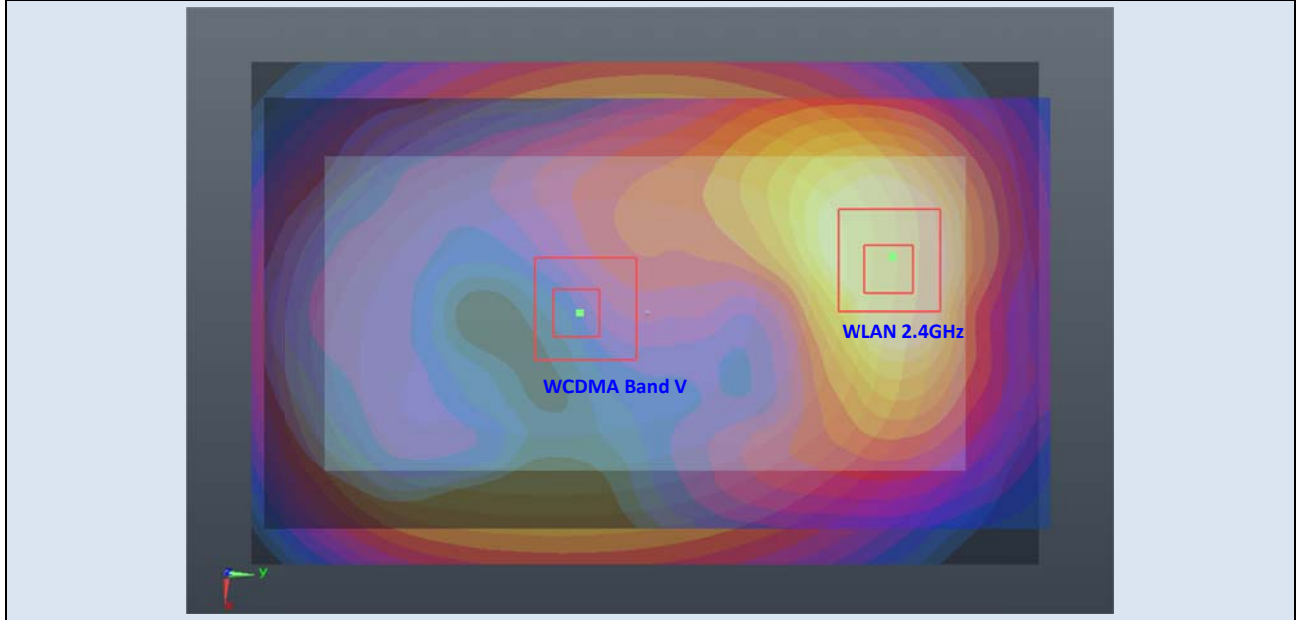

Case No #4	Band	SAR (W/kg)	Gap (cm)	SAR peak location (m)			3D distance (mm)	Pair SAR sum (W/kg)	SPLSR	Simultaneous SAR
				X	Y	Z				
Back	WCDMA Band IV	0.784	1	-0.0045	-0.0375	-0.205	91.6	2.06	0.03	Not required
	WLAN 2.4GHz	1.277	1	-0.024	0.052	-0.206				

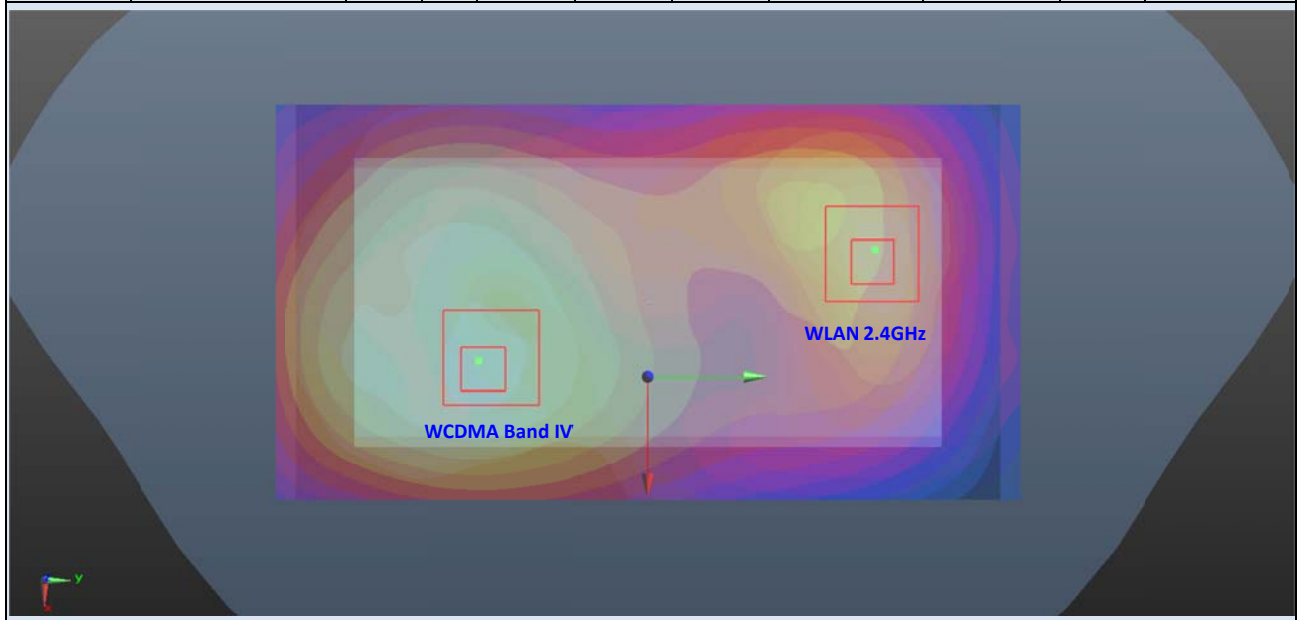

Case No #5	Band	SAR (W/kg)	Gap (cm)	SAR peak location (m)			3D distance (mm)	Pair SAR sum (W/kg)	SPLSR	Simultaneous SAR
				X	Y	Z				
Back	WCDMA Band II	0.849	1	0.001	-0.0645	-0.206	119.2	2.13	0.03	Not required
	WLAN 2.4GHz	1.277	1	-0.024	0.052	-0.206				

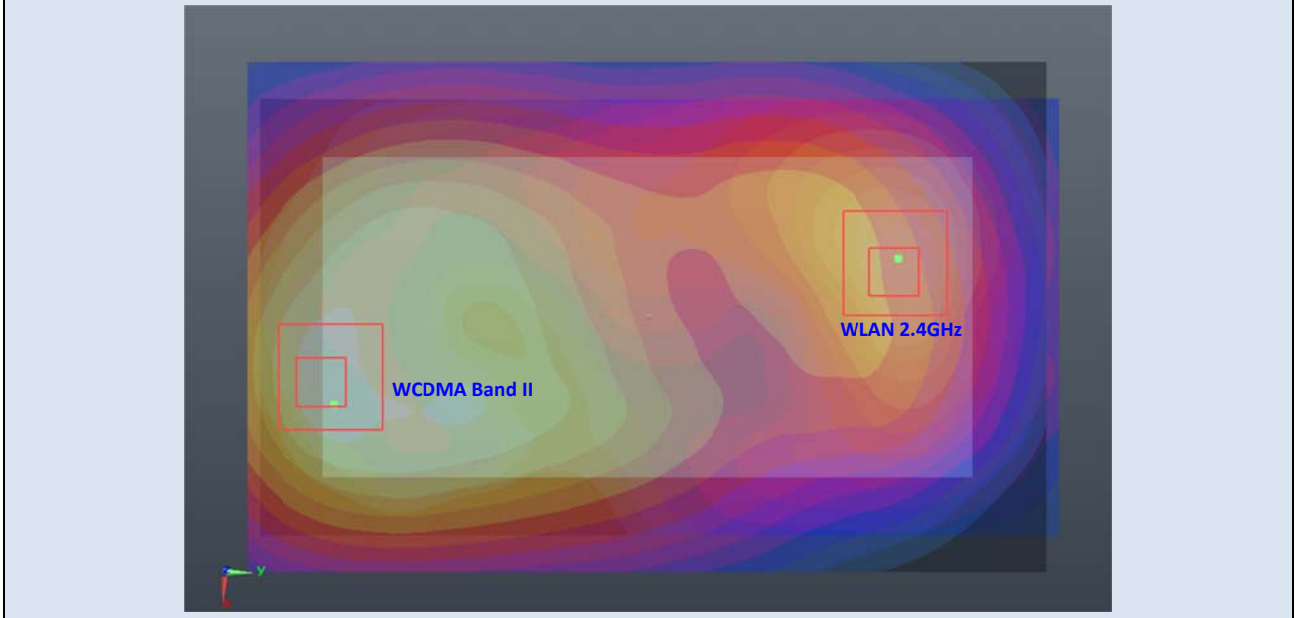

Case No #6	Band	SAR (W/kg)	Gap (cm)	SAR peak location (m)			3D distance (mm)	Pair SAR sum (W/kg)	SPLSR	Simultaneous SAR
				X	Y	Z				
Back	LTE Band 12	0.380	1	-0.0155	-0.029	-0.205	81.5	1.66	0.03	Not required
	WLAN 2.4GHz	1.277	1	-0.024	0.052	-0.206				

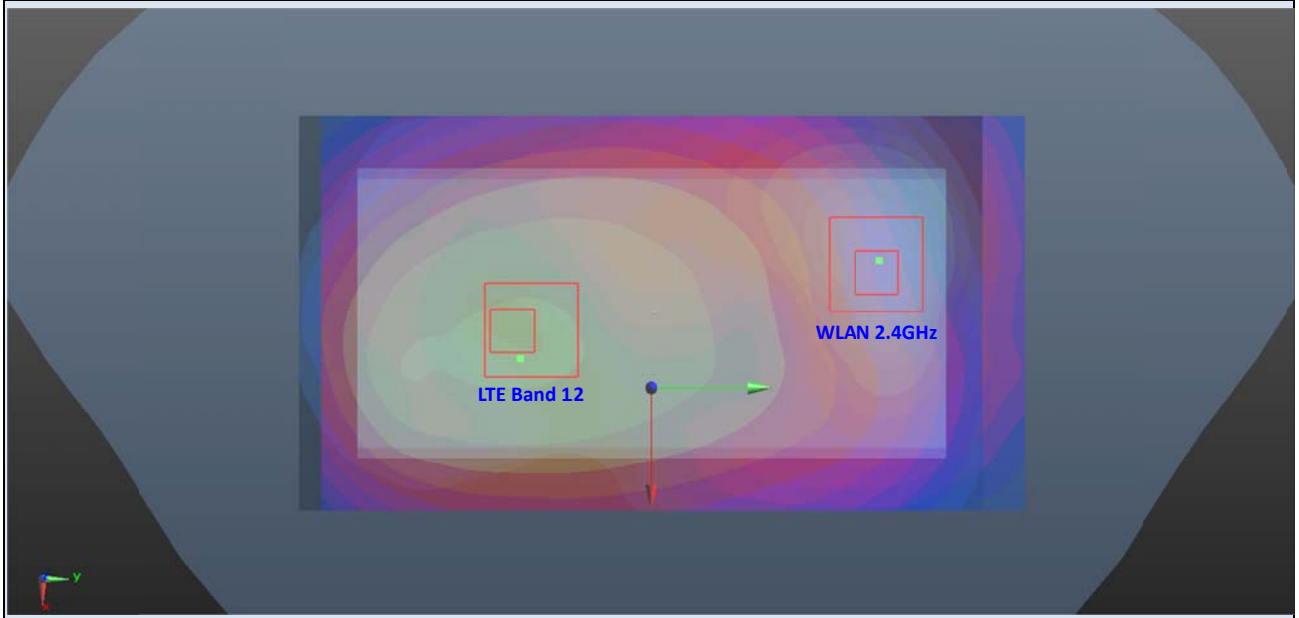

Case No #7	Band	SAR (W/kg)	Gap (cm)	SAR peak location (m)			3D distance (mm)	Pair SAR sum (W/kg)	SPLSR	Simultaneous SAR
				X	Y	Z				
Back	LTE Band 17	0.386	1	-0.0105	-0.035	-0.205	88.0	1.66	0.02	Not required
	WLAN 2.4GHz	1.277	1	-0.024	0.052	-0.206				

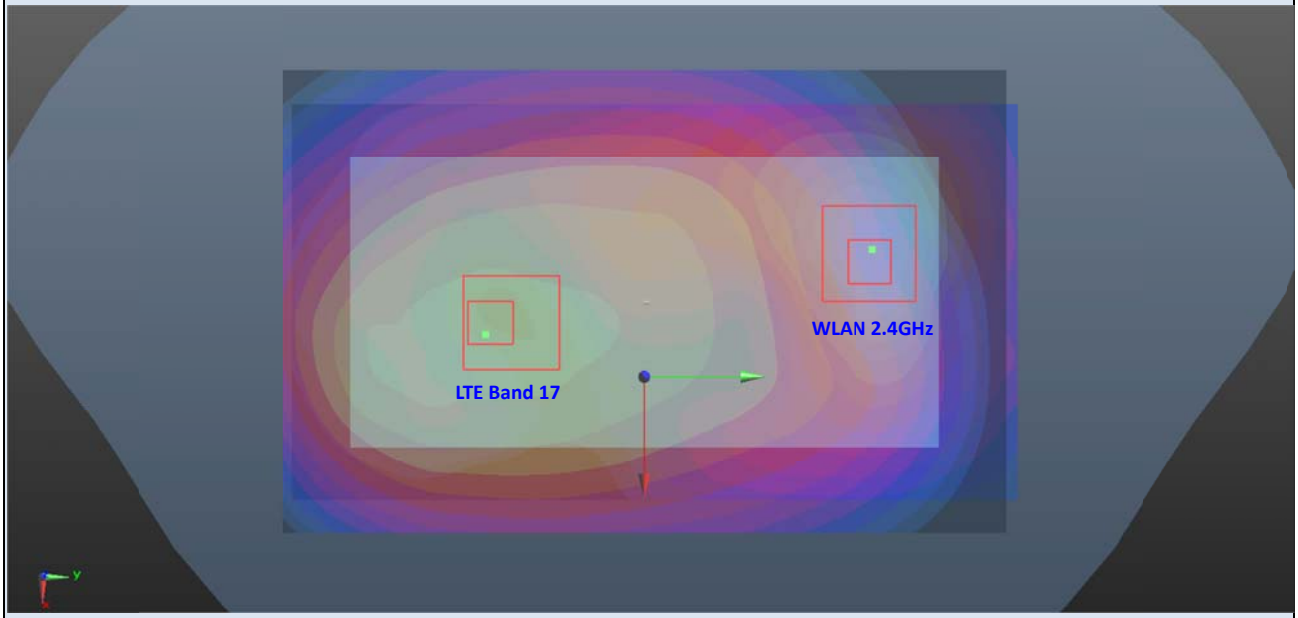

Case No #8	Band	SAR (W/kg)	Gap (cm)	SAR peak location (m)			3D distance (mm)	Pair SAR sum (W/kg)	SPLSR	Simultaneous SAR
				X	Y	Z				
Back	LTE Band 5	0.567	1	-0.018	-0.014	-0.206	66.3	1.84	0.04	Not required
	WLAN 2.4GHz	1.277	1	-0.024	0.052	-0.206				

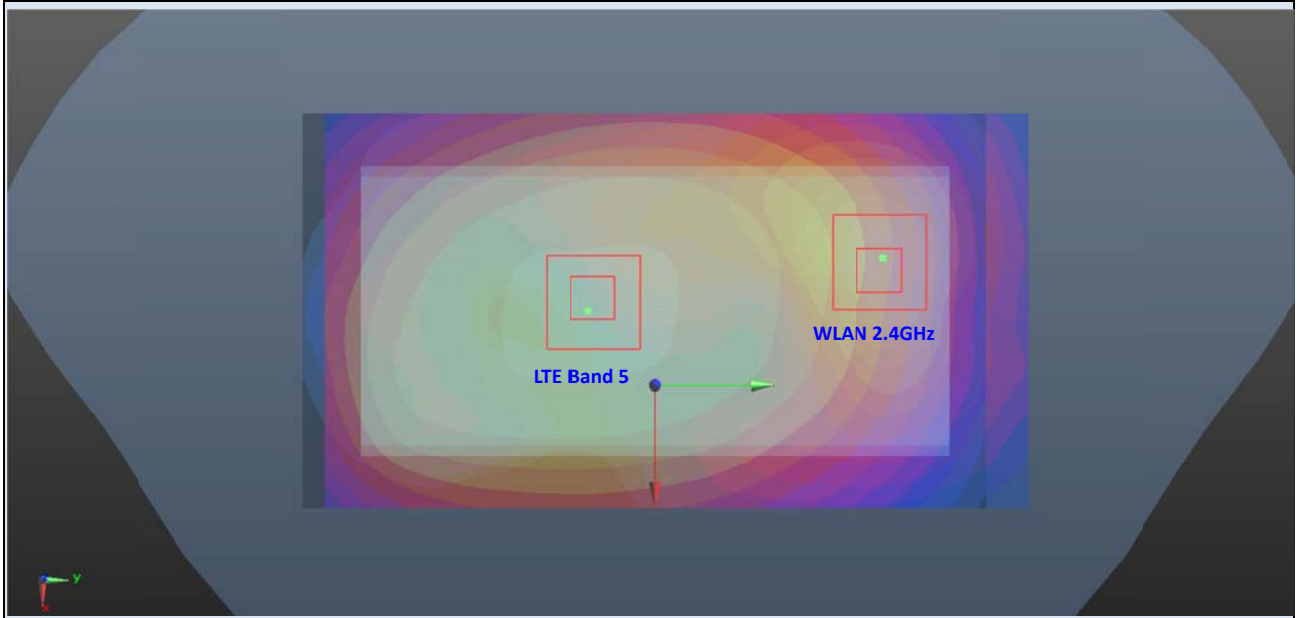

Case No #9	Band	SAR (W/kg)	Gap (cm)	SAR peak location (m)			3D distance (mm)	Pair SAR sum (W/kg)	SPLSR	Simultaneous SAR
				X	Y	Z				
Back	LTE Band 4	0.809	1	-0.0005	-0.042	-0.206	96.9	2.09	0.03	Not required
	WLAN 2.4GHz	1.277	1	-0.024	0.052	-0.206				

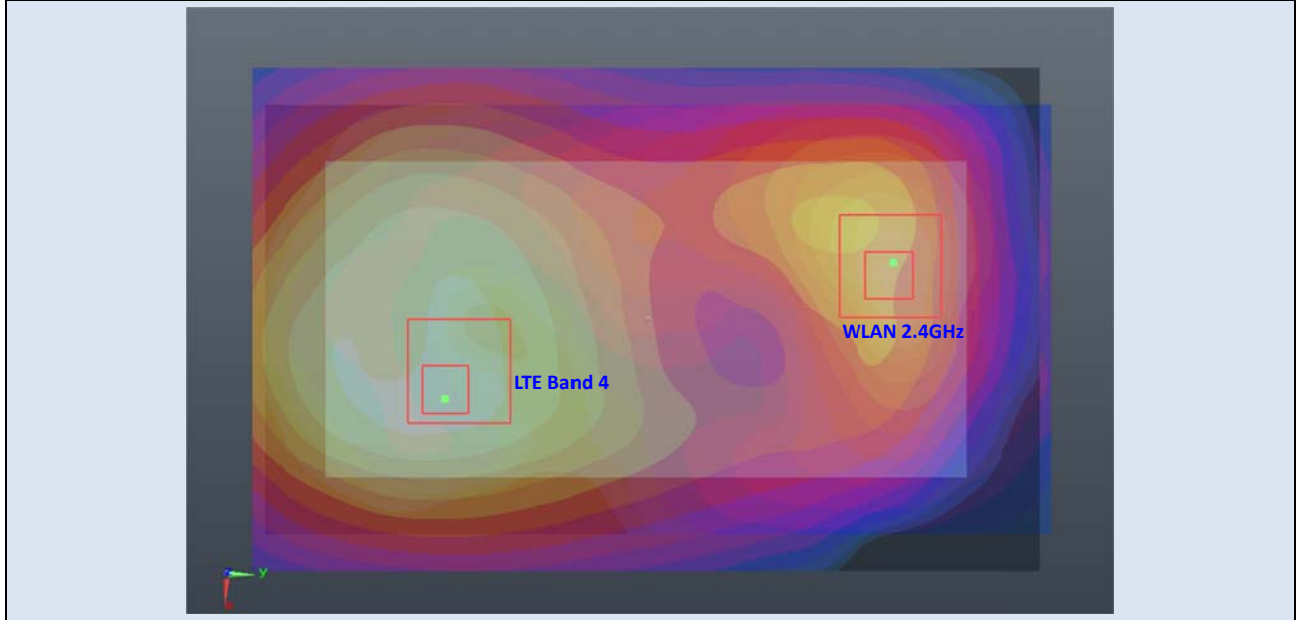

Case No #10	Band	SAR (W/kg)	Gap (cm)	SAR peak location (m)			3D distance (mm)	Pair SAR sum (W/kg)	SPLSR	Simultaneous SAR
				X	Y	Z				
Back	LTE Band 2	0.787	1	-0.002	-0.0645	-0.205	118.6	2.06	0.03	Not required
	WLAN 2.4GHz	1.277	1	-0.024	0.052	-0.206				

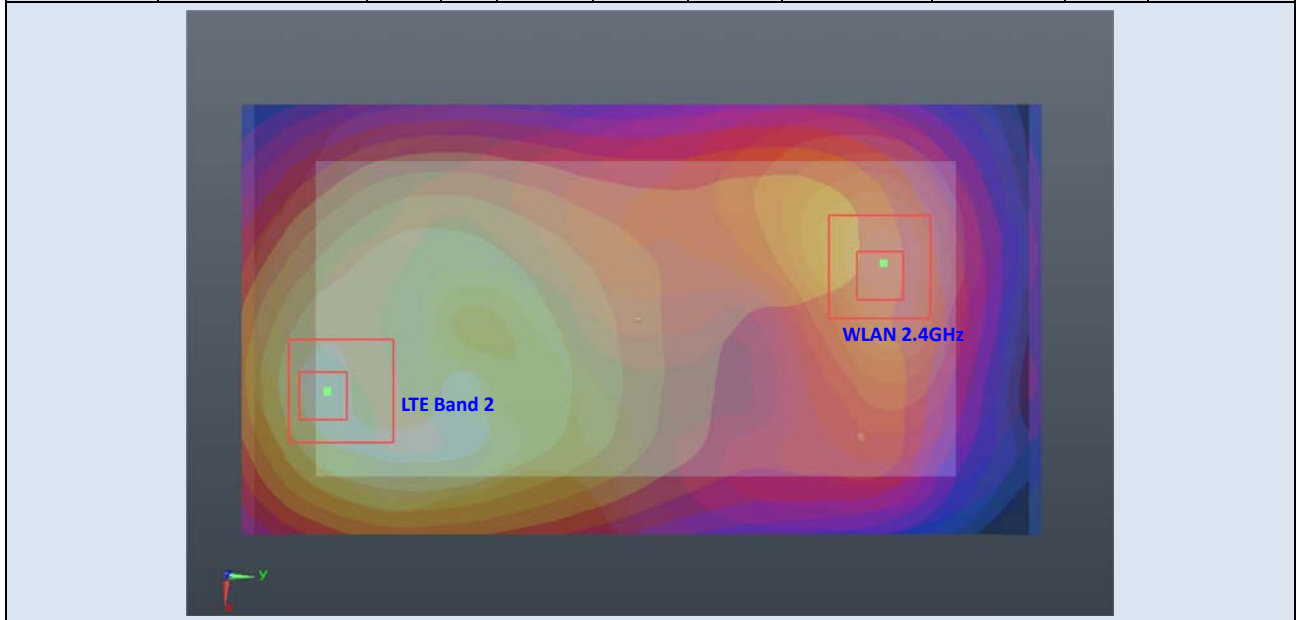

Case No #11	Band	SAR (W/kg)	Gap (cm)	SAR peak location (m)			3D distance (mm)	Pair SAR sum (W/kg)	SPLSR	Simultaneous SAR
				X	Y	Z				
Back	LTE Band 7	0.910	1	-0.0062	-0.0672	-0.205	120.5	2.19	0.03	Not required
	WLAN 2.4GHz	1.277	1	-0.024	0.052	-0.206				

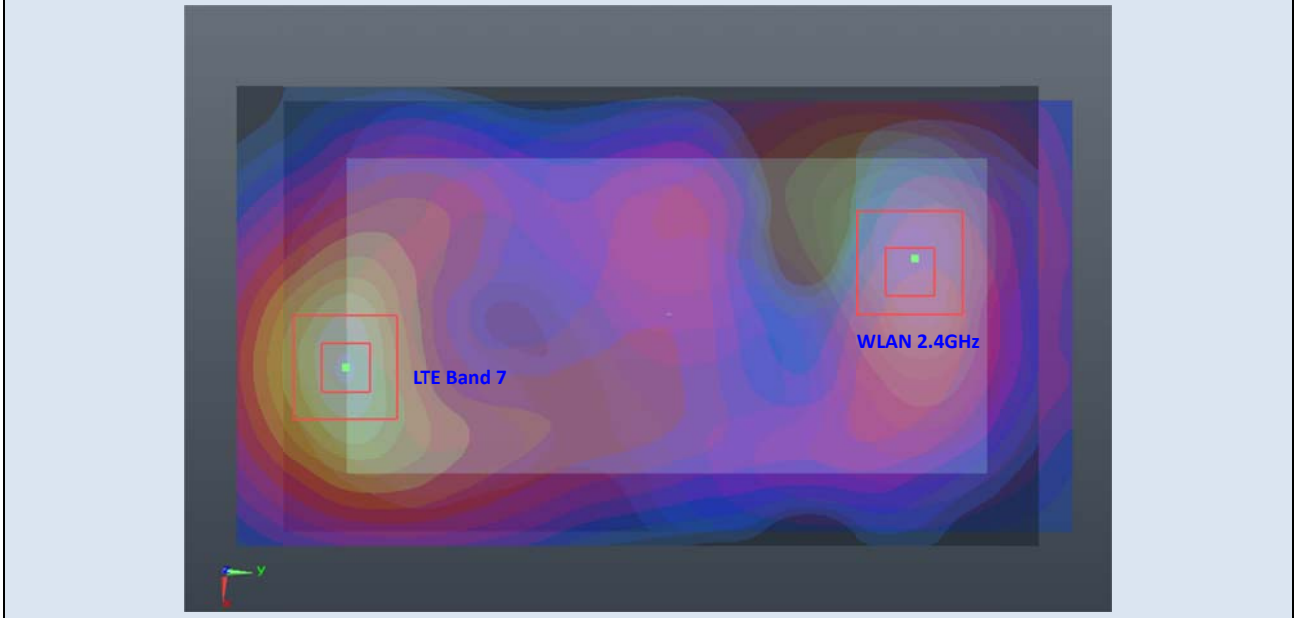

Case No #12	Band	SAR (W/kg)	Gap (cm)	SAR peak location (m)			3D distance (mm)	Pair SAR sum (W/kg)	SPLSR	Simultaneous SAR
				X	Y	Z				
Back	LTE Band 7	1.329	1.5	-0.0062	-0.0636	-0.205	117.2	1.80	0.02	Not required
	WLAN 2.4GHz	0.474	1.5	-0.0255	0.052	-0.206				

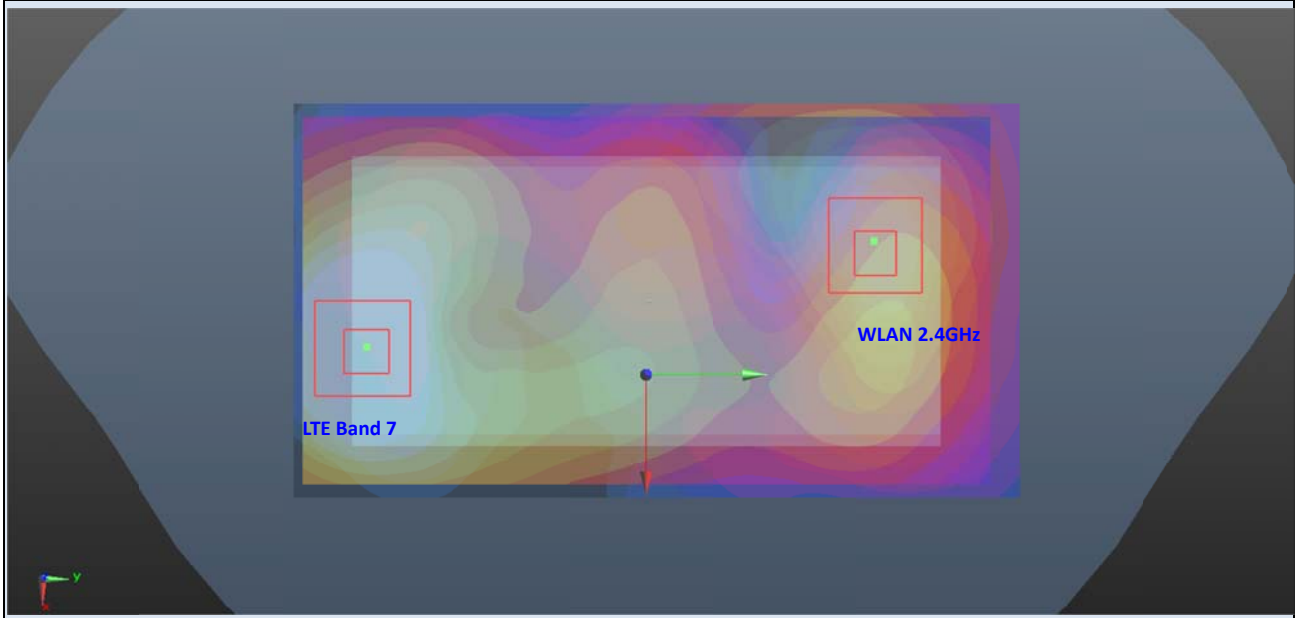

Test Engineer : Frank Qiao

20. Uncertainty Assessment

The component of uncertainty may generally be categorized according to the methods used to evaluate them. The evaluation of uncertainty by the statistical analysis of a series of observations is termed a Type A evaluation of uncertainty. The evaluation of uncertainty by means other than the statistical analysis of a series of observation is termed a Type B evaluation of uncertainty. Each component of uncertainty, however evaluated, is represented by an estimated standard deviation, termed standard uncertainty, which is determined by the positive square root of the estimated variance.

A Type A evaluation of standard uncertainty may be based on any valid statistical method for treating data. This includes calculating the standard deviation of the mean of a series of independent observations; using the method of least squares to fit a curve to the data in order to estimate the parameter of the curve and their standard deviations; or carrying out an analysis of variance in order to identify and quantify random effects in certain kinds of measurement.

A type B evaluation of standard uncertainty is typically based on scientific judgment using all of the relevant information available. These may include previous measurement data, experience, and knowledge of the behavior and properties of relevant materials and instruments, manufacture’s specification, data provided in calibration reports and uncertainties assigned to reference data taken from handbooks. Broadly speaking, the uncertainty is either obtained from an outdoor source or obtained from an assumed distribution, such as the normal distribution, rectangular or triangular distributions indicated in table below.

Uncertainty Distributions	Normal	Rectangular	Triangular	U-Shape
Multi-plying Factor ^(a)	1/k ^(b)	1/√3	1/√6	1/√2

(a) standard uncertainty is determined as the product of the multiplying factor and the estimated range of variations in the measured quantity

(b) κ is the coverage factor

Table 20.1. Standard Uncertainty for Assumed Distribution

The combined standard uncertainty of the measurement result represents the estimated standard deviation of the result. It is obtained by combining the individual standard uncertainties of both Type A and Type B evaluation using the usual “root-sum-squares” (RSS) methods of combining standard deviations by taking the positive square root of the estimated variances.

Expanded uncertainty is a measure of uncertainty that defines an interval about the measurement result within which the measured value is confidently believed to lie. It is obtained by multiplying the combined standard uncertainty by a coverage factor. Typically, the coverage factor ranges from 2 to 3. Using a coverage factor allows the true value of a measured quantity to be specified with a defined probability within the specified uncertainty range. For purpose of this document, a coverage factor two is used, which corresponds to confidence interval of about 95 %. The DASY uncertainty Budget is shown in the following tables.

Error Description	Uncertainty Value (±%)	Probability Distribution	Divisor	Ci (1g)	Ci (10g)	Standard Uncertainty (1g)	Standard Uncertainty (10g)
Measurement System							
Probe Calibration	6.0	Normal	1	1	1	± 6.0 %	± 6.0 %
Axial Isotropy	4.7	Rectangular	√3	0.7	0.7	± 1.9 %	± 1.9 %
Hemispherical Isotropy	9.6	Rectangular	√3	0.7	0.7	± 3.9 %	± 3.9 %
Boundary Effects	1.0	Rectangular	√3	1	1	± 0.6 %	± 0.6 %
Linearity	4.7	Rectangular	√3	1	1	± 2.7 %	± 2.7 %
System Detection Limits	1.0	Rectangular	√3	1	1	± 0.6 %	± 0.6 %
Readout Electronics	0.3	Normal	1	1	1	± 0.3 %	± 0.3 %
Response Time	0.8	Rectangular	√3	1	1	± 0.5 %	± 0.5 %
Integration Time	2.6	Rectangular	√3	1	1	± 1.5 %	± 1.5 %
RF Ambient Noise	3.0	Rectangular	√3	1	1	± 1.7 %	± 1.7 %
RF Ambient Reflections	3.0	Rectangular	√3	1	1	± 1.7 %	± 1.7 %
Probe Positioner	0.4	Rectangular	√3	1	1	± 0.2 %	± 0.2 %
Probe Positioning	2.9	Rectangular	√3	1	1	± 1.7 %	± 1.7 %
Max. SAR Eval.	1.0	Rectangular	√3	1	1	± 0.6 %	± 0.6 %
Test Sample Related							
Device Positioning	2.9	Normal	1	1	1	± 2.9 %	± 2.9 %
Device Holder	3.6	Normal	1	1	1	± 3.6 %	± 3.6 %
Power Drift	5.0	Rectangular	√3	1	1	± 2.9 %	± 2.9 %
Phantom and Setup							
Phantom Uncertainty	4.0	Rectangular	√3	1	1	± 2.3 %	± 2.3 %
Liquid Conductivity (Target)	5.0	Rectangular	√3	0.64	0.43	± 1.8 %	± 1.2 %
Liquid Conductivity (Meas.)	2.5	Normal	1	0.64	0.43	± 1.6 %	± 1.1 %
Liquid Permittivity (Target)	5.0	Rectangular	√3	0.6	0.49	± 1.7 %	± 1.4 %
Liquid Permittivity (Meas.)	2.5	Normal	1	0.6	0.49	± 1.5 %	± 1.2 %
Combined Standard Uncertainty						± 11.0 %	± 10.8 %
Coverage Factor for 95 %						K=2	
Expanded Uncertainty						± 22.0 %	± 21.5 %

Table 20.2. Uncertainty Budget for frequency range 300 MHz to 3 GHz

21. References

- [1] FCC 47 CFR Part 2 "Frequency Allocations and Radio Treaty Matters; General Rules and Regulations"
- [2] ANSI/IEEE Std. C95.1-1992, "IEEE Standard for Safety Levels with Respect to Human Exposure to Radio Frequency Electromagnetic Fields, 3 kHz to 300 GHz", September 1992.
- [3] ANSI/IEEE C95.3-2002, IEEE Recommended Practice for the Measurement of Potentially Hazardous Electromagnetic Fields - RF and Microwave, New York: IEEE, December 2002.
- [4] IEEE Std. 1528-2003, "Recommended Practice for Determining the Peak Spatial-Average Specific Absorption Rate (SAR) in the Human Head from Wireless Communications Devices: Measurement Techniques", December 2003.
- [5] SPEAG DASY System Handbook.
- [6] FCC KDB 865664 D01 v01r03, "SAR Measurement Requirements for 100 MHz to 6 GHz", Feb 2014.
- [7] FCC KDB 865664 D02 v01r01, "RF Exposure Compliance Reporting and Documentation Considerations" May 2013.
- [8] FCC KDB 447498 D01 v05r02, "Mobile and Portable Device RF Exposure Procedures and Equipment Authorization Policies", Feb 2014.
- [9] FCC KDB 648474 D04 v01r02, "SAR Evaluation Considerations for Wireless Handsets", Dec 2013.
- [10] FCC KDB 248227 D01 v02r01, "SAR Guidance for IEEE 802.11 (WiFi) Transmitters", June 2015.
- [11] FCC KDB 941225 D01 v03, "3G SAR MEAUREMENT PROCEDURES", Oct 2014.
- [12] FCC KDB 941225 D05 v02r03, "SAR Evaluation Considerations for LTE Devices", Dec 2013.
- [13] FCC KDB 941225 D06 v02, "SAR Evaluation Procedures for Portable Devices with Wireless Router Capabilities", Oct 2014.



Appendix A. Plots of System Performance Check

The plots are shown as follows.



Appendix B. Plots of High SAR Measurement

The plots are shown as follows.



Appendix C. DASYS Calibration Certificate

The DASYS calibration certificates are shown as follows.



Appendix E. Product Equality Declaration