



FCC Test Report

APPLICANT : TCT Mobile Limited
EQUIPMENT : GSM Quad-band / UMTS Quad-band / LTE
Penta-band mobile phone
BRAND NAME : Alcatel
MODEL NAME : 6039Y
FCC ID : RAD546
STANDARD : FCC 47 CFR FCC Part 15 Subpart B
CLASSIFICATION : Certification

The product was received on Jan. 14, 2015 and testing was completed on Mar. 24, 2015. We, SPORTON INTERNATIONAL (KUNSHAN) INC., would like to declare that the tested sample has been evaluated in accordance with the test procedures given in ANSI C63.4-2009 and has been in compliance with the applicable technical standards.

The test results in this report apply exclusively to the tested model / sample. Without written approval of SPORTON INTERNATIONAL (KUNSHAN) INC., the test report shall not be reproduced except in full.

Reviewed by: Louis Wu / Manager

Approved by: Jones Tsai / Manager



SPORTON INTERNATIONAL (KUNSHAN) INC.
No. 3-2, PingXiang Road, Kunshan, Jiangsu Province, P. R. China



TABLE OF CONTENTS

REVISION HISTORY.....	3
SUMMARY OF TEST RESULT	4
1. GENERAL DESCRIPTION	5
1.1. Applicant.....	5
1.2. Manufacturer	5
1.3. Product Feature of Equipment Under Test	5
1.4. Product Specification subjective to this standard.....	6
1.5. Modification of EUT.....	7
1.6. Test Location.....	7
1.7. Applicable Standards	7
2. TEST CONFIGURATION OF EQUIPMENT UNDER TEST.....	8
2.1. Test Mode	8
2.2. Connection Diagram of Test System	11
2.3. Support Unit used in test configuration and system.....	13
2.4. EUT Operation Test Setup.....	14
3. TEST RESULT.....	15
3.1. Test of AC Conducted Emission Measurement	15
3.2. Test of Radiated Emission Measurement	21
4. LIST OF MEASURING EQUIPMENT	27
5. UNCERTAINTY OF EVALUATION	28
APPENDIX A. SETUP PHOTOGRAPHS	



REVISION HISTORY

REPORT NO.	VERSION	DESCRIPTION	ISSUED DATE
FC511303-01	Rev. 01	Initial issue of report	Apr. 10, 2015



SUMMARY OF TEST RESULT

Report Section	FCC Rule	Description	Limit	Result	Remark
3.1	15.107	AC Conducted Emission	< 15.107 limits	PASS	Under limit 4.66 dB at 0.330 MHz
3.2	15.109	Radiated Emission	< 15.109 limits	PASS	Under limit 0.92 dB at 889.420 MHz for quasi-peak



1. General Description

1.1. Applicant

TCT Mobile Limited

5F, C building, No. 232, Liang Jing Road ZhangJiang High-Tech Park, Pudong Area Shanghai, P. R. China. 201203

1.2. Manufacturer

TCT Mobile Limited

5F, C building, No. 232, Liang Jing Road ZhangJiang High-Tech Park, Pudong Area Shanghai, P. R. China. 201203

1.3. Product Feature of Equipment Under Test

Product Feature	
Equipment	GSM Quad-band / UMTS Quad-band / LTE Penta-band mobile phone
Brand Name	Alcatel
Model Name	6039Y
FCC ID	RAD546
EUT supports Radios application	GSM/GPRS/EGPRS/WCDMA/HSPA/HSPA+(Downlink Only)/DC-HSDPA/LTE/NFC/WLAN 2.4GHz 802.11b/g/n HT20/Bluetooth v3.0+ EDR/Bluetooth v4.1 LE
HW Version	BAB34D000GCX
SW Version	vA5M
EUT Stage	Identical Prototype

Remark: The above EUT's information was declared by manufacturer. Please refer to the specifications or user's manual for more detailed description.



1.4. Product Specification subjective to this standard

Product Specification subjective to this standard	
Tx Frequency	GSM850 : 824.2 MHz ~ 848.8 MHz GSM1900 : 1850.2 MHz ~ 1909.8MHz WCDMA Band V : 826.4 MHz ~ 846.6 MHz WCDMA Band II : 1852.4 MHz ~ 1907.6 MHz LTE Band 7 : 2502.5 MHz ~ 2567.5 MHz 802.11b/g/n: 2412 MHz ~ 2472 MHz Bluetooth: 2402 MHz ~ 2480 MHz NFC : 13.56 MHz
Rx Frequency	GSM850 : 869.2 MHz ~ 893.8 MHz GSM1900 : 1930.2 MHz ~ 1989.8 MHz WCDMA Band V : 871.4 MHz ~ 891.6 MHz WCDMA Band II : 1932.4 MHz ~ 1987.6 MHz LTE Band 7 : 2622.5MHz ~ 2687.5 MHz 802.11b/g/n: 2412 MHz ~ 2472 MHz Bluetooth: 2402 MHz ~ 2480 MHz NFC : 13.56 MHz GPS : 1.57542 GHz Glonass : 1602 MHz + $n \times 0.5625\text{MHz}$ ($n=-7, -6, -5, \dots, 0, \dots, 6$)
Antenna Type	WWAN : PIFA Antenna WLAN : PIFA Antenna Bluetooth : PIFA Antenna GPS/ Glonass : PIFA Antenna
Type of Modulation	GSM: GMSK GPRS: GMSK EDGE(MCS 0-4): GMSK / (MCS 5-9): 8PSK WCDMA: QPSK (Uplink) HSDPA/DC-HSDPA: QPSK (Uplink) HSUPA: QPSK (Uplink) HSPA+: 16QAM (Downlink Only) DC-HSDPA: 64QAM LTE: QPSK / 16QAM 802.11b : DSSS (DBPSK / DQPSK / CCK) 802.11g/n : OFDM (BPSK / QPSK / 16QAM / 64QAM) Bluetooth v4.0 LE : GFSK Bluetooth (1Mbps) : GFSK Bluetooth (2Mbps) : $\pi/4$ -DQPSK Bluetooth (3Mbps) : 8-DPSK NFC: ASK GPS : BPSK Glonass : BPSK



1.5. Modification of EUT

No modifications are made to the EUT during all test items.

1.6. Test Location

Test Site	SPORTON INTERNATIONAL (KUNSHAN) INC.		
Test Site Location	No. 3-2, PingXiang Road, Kunshan, Jiangsu Province, P. R. China TEL: +86-0512-5790-0158 FAX: +86-0512-5790-0958		
Test Site No.	Sporton Site No.		FCC Registration No.
	CO01-KS	03CH01-KS	149928

Note: The test site complies with ANSI C63.4 2009 requirement.

1.7. Applicable Standards

According to the specifications of the manufacturer, the EUT must comply with the requirements of the following standards:

- ♦ FCC 47 CFR FCC Part 15 Subpart B
- ♦ ANSI C63.4-2009

Remark: All test items were verified and recorded according to the standards and without any deviation during the test.



2. Test Configuration of Equipment Under Test

2.1. Test Mode

The EUT has been associated with peripherals pursuant to ANSI C63.4-2009 and configuration operated in a manner tended to maximize its emission characteristics in a typical application.

Frequency range investigated: conduction (150 kHz to 30 MHz), radiation (30MHz to the 5th harmonic of the highest fundamental frequency or to 40 GHz, whichever is lower).

The following tables are showing the test modes as the worst cases and recorded in this report.

Item	EUT Configuration	Test Condition		
		EMI AC	EMI RE<1G	EMI RE≥1G
1.	Charging Mode (EUT with adapter)	☒	☒	☒
2.	Data application transferred mode (EUT connected with notebook)	☒	☒	☒

Abbreviations:

- EMI AC: AC conducted emissions
- EMI RE ≥ 1G: EUT radiated emissions ≥ 1GHz
- EMI RE < 1G: EUT radiated emissions < 1GHz



Test Items	EUT Configure Mode	Function Type
AC Conducted Emission	1/2	<p>Mode 1 : GSM850 Idle + Bluetooth Idle + WLAN Idle + USB Cable 1 (Charging from Adapter 1) + Battery 1 + Earphone 1 + Camera <Fig.1></p> <p>Mode 2 : GSM1900 Idle + Bluetooth Idle + WLAN Idle + USB Cable 2 (Charging from Adapter 2) + Battery 2 + Earphone 1 + MPEG4 <Fig.1></p> <p>Mode 3 : WCDMA Band V Idle + Bluetooth Idle + WLAN Idle + USB Cable 1 (Charging from Adapter 1) + Battery 1 + Earphone 1 + NFC On <Fig.1></p> <p>Mode 4 : WCDMA Band II Idle + Bluetooth Idle + WLAN Idle + USB Cable 1 (Charging from Adapter 1) + Battery 1 + Earphone 1 + Glonass Rx <Fig.2></p> <p>Mode 5 : LTE Band 7 Idle + Bluetooth Idle + WLAN Idle + USB Cable 1 (Data Link with Notebook) + Battery 1 + Earphone 1 + GPS Rx <Fig.3></p> <p>Mode 6 : GSM850 Idle + Bluetooth Idle + WLAN Idle + USB Cable 2 (Data Link with Notebook) + Battery 1 + Earphone 1 + GPS Rx <Fig.3></p> <p>Mode 7 : GSM850 Idle + Bluetooth Idle + WLAN Idle + USB Cable 3 (Charging from Adapter 1) + Battery 1 + Earphone 1 + Camera <Fig.1></p> <p>Mode 8 : GSM850 Idle + Bluetooth Idle + WLAN Idle + USB Cable 1 (Charging from Adapter 1) + Battery 1 + Earphone 2 + Camera <Fig.1></p> <p>Mode 9 : GSM850 Idle + Bluetooth Idle + WLAN Idle + USB Cable 3 (Charging from Adapter 1) + Battery 1 + Earphone 3 + Camera <Fig.1></p> <p>Mode 10 : GSM850 Idle + Bluetooth Idle + WLAN Idle + USB Cable 3 (Charging from Adapter 1) + Battery 1 + Earphone 4 + Camera <Fig.1></p>

<p>Radiated Emissions < 1GHz</p>	<p>1/2</p>	<p>Mode 1: GSM850 Idle + Bluetooth Idle + WLAN Idle + USB Cable 1 (Charging from Adapter 1) + Battery 1 + Earphone 1 + Camera <Fig.1></p> <p>Mode 2: GSM1900 Idle + Bluetooth Idle + WLAN Idle + USB Cable 2 (Charging from Adapter 2) + Battery 2 + Earphone 1 + MPEG4 <Fig.1></p> <p>Mode 3: WCDMA Band V Idle + Bluetooth Idle + WLAN Idle + USB Cable 1 (Charging from Adapter 1) + Battery 1 + Earphone 1 + NFC On <Fig.1></p> <p>Mode 4: WCDMA Band II Idle + Bluetooth Idle + WLAN Idle + USB Cable 1 (Charging from Adapter 1) + Battery 1 + Earphone 1 + Glonass Rx <Fig.2></p> <p>Mode 5: LTE Band 7 Idle + Bluetooth Idle + WLAN Idle + USB Cable 1 (Data Link with Notebook) + Battery 1 + Earphone 1 + GPS Rx <Fig.3></p> <p>Mode 6: GSM850 Idle + Bluetooth Idle + WLAN Idle + USB Cable 2 (Data Link with Notebook) + Battery 1 + Earphone 1 + GPS Rx <Fig.3></p> <p>Mode 7: GSM850 Idle + Bluetooth Idle + WLAN Idle + USB Cable 3 (Charging from Adapter 1) + Battery 1 + Earphone 1 + Camera <Fig.1></p> <p>Mode 8: GSM850 Idle + Bluetooth Idle + WLAN Idle + USB Cable 1 (Charging from Adapter 1) + Battery 1 + Earphone 2 + Camera <Fig.1></p> <p>Mode 9: GSM850 Idle + Bluetooth Idle + WLAN Idle + USB Cable 3 (Charging from Adapter 1) + Battery 1 + Earphone 3 + Camera <Fig.1></p> <p>Mode 10 : GSM850 Idle + Bluetooth Idle + WLAN Idle + USB Cable 3 (Charging from Adapter 1) + Battery 1 + Earphone 4 + Camera <Fig.1></p>
<p>Radiated Emissions ≥ 1GHz</p>	<p>1/2</p>	<p>Mode 1: GSM850 Idle + Bluetooth Idle + WLAN Idle + USB Cable 3 (Charging from Adapter 1) + Battery 1 + Earphone 1 + Camera <Fig.1></p> <p>Mode 2: LTE Band 7 Idle + Bluetooth Idle + WLAN Idle + USB Cable 1 (Data Link with Notebook) + Battery 1 + Earphone 1 + GPS Rx <Fig.3></p>
<p>Remark:</p> <ol style="list-style-type: none"> 1. The worst case of AC is mode 1, and the worst USB Link mode of AC is mode 6, the test data of these modes are reported. 2. The worst case of RE < 1G is mode 7, and the worst USB Link mode of RE is mode 6, the test data of these modes are reported. 3. Link with notebook means data application transferred mode between EUT and notebook. 		

2.2. Connection Diagram of Test System

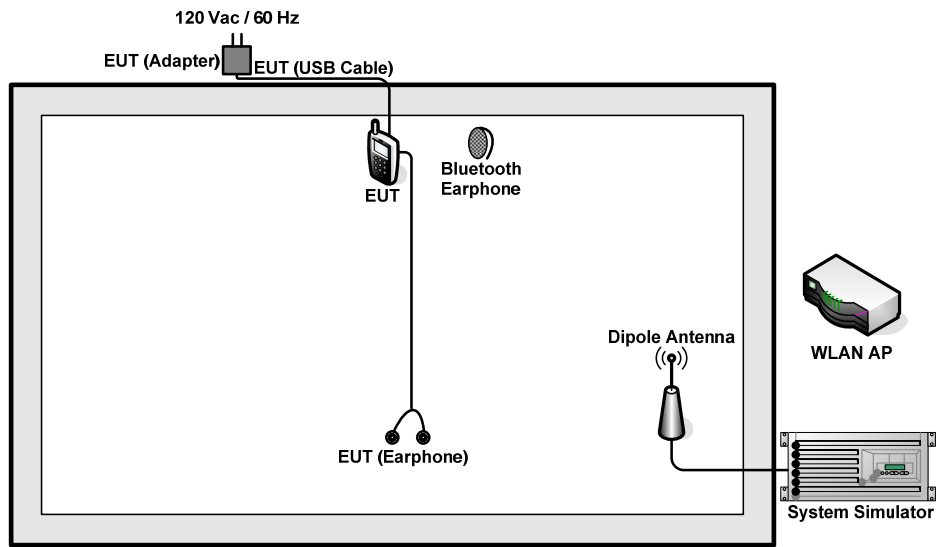

<Fig.1>

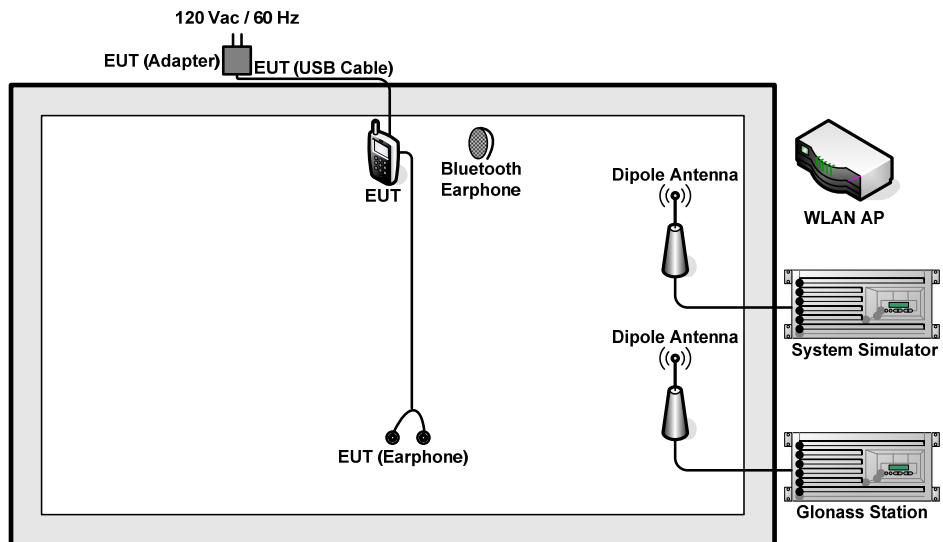

<Fig.2>

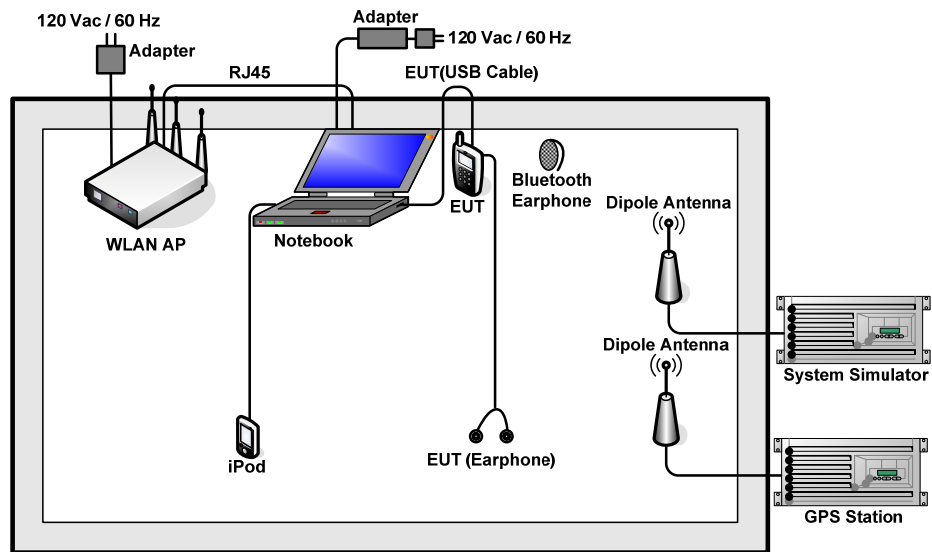

<Fig.3>



2.3. Support Unit used in test configuration and system

Item	Equipment	Trade Name	Model Name	FCC ID	Data Cable	Power Cord
1.	System Simulator	R&S	CMU 200	N/A	N/A	Unshielded, 1.8m
2.	GPS Station	ADIVIC	MP9000	N/A	N/A	Unshielded, 1.8 m
3.	Glomass Station	RACELOGIC	RLLS03-2RP	N/A	N/A	Unshielded, 1.8 m
4.	LTE Base Station	Anitsu	MT8820C	N/A	N/A	Unshielded, 1.8 m
5.	Bluetooth Earphone	lenovo	LBH 301	FCC DoC	N/A	N/A
6.	Bluetooth Earphone	Nokia	BH-102	PYAHS-107W	N/A	N/A
7.	Notebook	Lenovo	G480	FCC DoC	N/A	AC I/P: Unshielded, 1.2m DC O/P: Shielded, 1.8 m
8.	WLAN AP	D-link	DIR-855	KA2IR855A2	N/A	Unshielded, 1.8 m
9.	iPod	Apple	A1199	FCC DoC	Shielded, 1.0 m	N/A



2.4. EUT Operation Test Setup

The EUT was in GSM or WCDMA or LTE idle mode during the testing. The EUT was synchronized to the BCCH, and was in continuous receiving mode by setting system simulator's paging reorganization.

At the same time, the EUT was attached to the Bluetooth earphone or WLAN AP, and the following programs installed in the EUT were programmed during the test.

1. Execute the program, "Winthrax" under WIN7 installed in notebook for files transfer with EUT via USB cable.
2. Execute "GPS/Glonass Test" to make the EUT receive continuous signals from GPS/Glonass station.
3. Execute "Video Player" to play MPEG4 files.
4. Turn on camera to capture images.
5. Turn on NFC function.



3. Test Result

3.1. Test of AC Conducted Emission Measurement

3.1.1 Limits of AC Conducted Emission

For equipment that is designed to be connected to the public utility (AC) power line, the radio frequency voltage that is conducted back onto the AC power line on any frequency or frequencies within the band 150 kHz to 30 MHz shall not exceed the limits in the following table.

Frequency of emission (MHz)	Conducted limit (dBuV)	
	Quasi-peak	Average
0.15-0.5	66 to 56*	56 to 46*
0.5-5	56	46
5-30	60	50

*Decreases with the logarithm of the frequency.

3.1.2 Measuring Instruments

The measuring equipment is listed in the section 4 of this test report.

3.1.3 Test Procedure

1. The EUT was placed 0.4 meter from the conducting wall of the shielding room was kept at least 80 centimeters from any other grounded conducting surface.
2. Connect EUT to the power mains through a line impedance stabilization network (LISN).
3. All the support units are connecting to the other LISN.
4. The LISN provides 50 ohm coupling impedance for the measuring instrument.
5. The FCC states that a 50 ohm, 50 microhenry LISN should be used.
6. Both sides of AC line were checked for maximum conducted interference.
7. The frequency range from 150 kHz to 30 MHz was searched.
8. Set the test-receiver system to Peak Detect Function and specified bandwidth (IF Bandwidth = 9kHz) with Maximum Hold Mode. Then measurement is also conducted by Average Detector and Quasi-Peak Detector Function respectively.

3.1.4 Test Setup

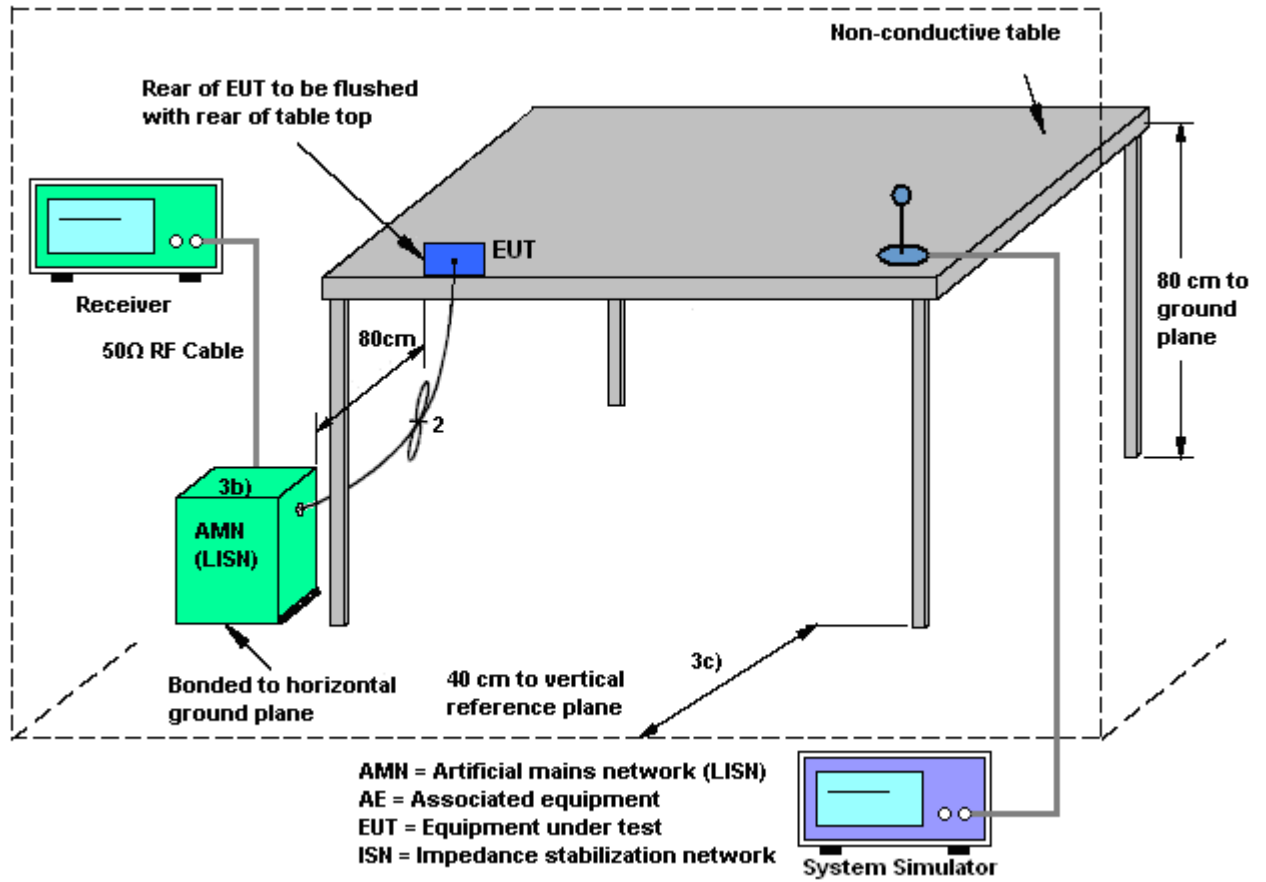



3.1.5 Test Result of AC Conducted Emission

Test Mode :	Mode 1	Temperature :	22~24°C
Test Engineer :	Eko Guan	Relative Humidity :	33~35%
Test Voltage :	120Vac / 60Hz	Phase :	Line
Function Type :	GSM850 Idle + Bluetooth Idle + WLAN Idle + USB Cable 1 (Charging from Adapter 1) + Battery 1 + Earphone 1 + Camera		

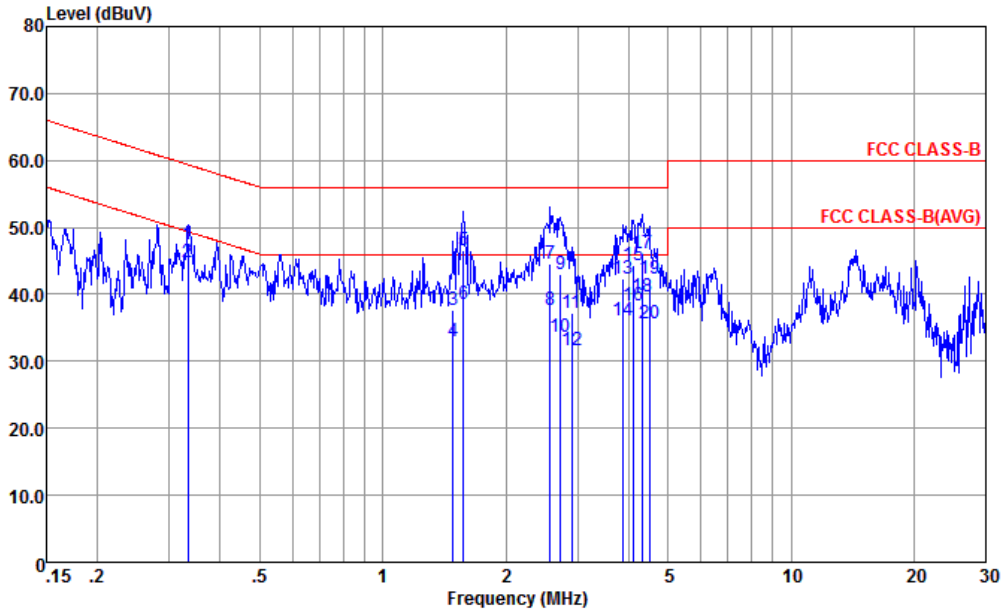

Site : CO01-KS
 Condition : FCC CLASS-B LISN-L20140306 LINE
 Project : (FC) 511303-01
 mode : Mode 1

	Freq	Level	Over Limit	Limit Line	Read Level	LISN Factor	Cable Loss	Remark
	MHz	dBuV	dB	dBuV	dBuV	dB	dB	
1	0.33	47.39	-11.96	59.35	36.29	0.50	10.60	QP
2 *	0.33	44.69	-4.66	49.35	33.59	0.50	10.60	Average
3	1.49	37.58	-18.42	56.00	26.80	0.10	10.68	QP
4	1.49	33.08	-12.92	46.00	22.30	0.10	10.68	Average
5	1.58	46.59	-9.41	56.00	35.80	0.10	10.69	QP
6	1.58	38.59	-7.41	46.00	27.80	0.10	10.69	Average
7	2.57	44.55	-11.45	56.00	33.69	0.12	10.74	QP
8	2.57	37.55	-8.45	46.00	26.69	0.12	10.74	Average
9	2.72	42.97	-13.03	56.00	32.10	0.12	10.75	QP
10	2.72	33.67	-12.33	46.00	22.80	0.12	10.75	Average
11	2.90	37.21	-18.79	56.00	26.31	0.13	10.77	QP
12	2.90	31.71	-14.29	46.00	20.81	0.13	10.77	Average
13	3.88	42.31	-13.69	56.00	31.30	0.18	10.83	QP
14	3.88	36.11	-9.89	46.00	25.10	0.18	10.83	Average
15	4.11	44.32	-11.68	56.00	33.30	0.19	10.83	QP
16	4.11	38.32	-7.68	46.00	27.30	0.19	10.83	Average
17	4.34	46.13	-9.87	56.00	35.10	0.19	10.84	QP
18	4.34	39.63	-6.37	46.00	28.60	0.19	10.84	Average
19	4.50	42.23	-13.77	56.00	31.20	0.19	10.84	QP
20	4.50	35.73	-10.27	46.00	24.70	0.19	10.84	Average



Test Mode :	Mode 1	Temperature :	22~24°C
Test Engineer :	Eko Guan	Relative Humidity :	33~35%
Test Voltage :	120Vac / 60Hz	Phase :	Neutral
Function Type :	GSM850 Idle + Bluetooth Idle + WLAN Idle + USB Cable 1 (Charging from Adapter 1) + Battery 1 + Earphone 1 + Camera		

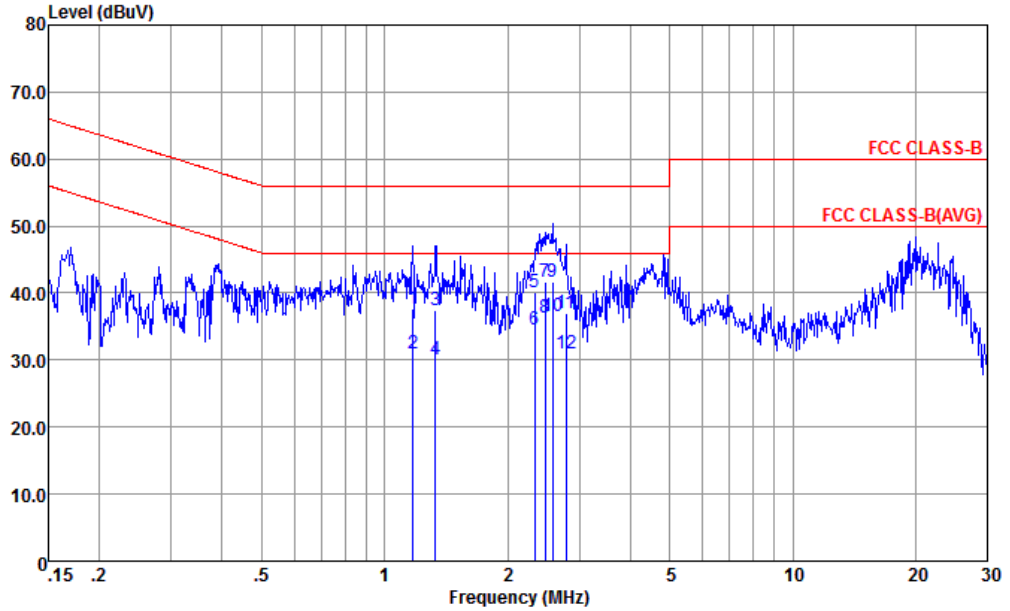

Site : CO01-KS
 Condition : FCC CLASS-B LISN-N20140306 NEUTRAL
 Project : (FC) 511303-01
 mode : Mode 1

	Freq	Level	Over	Limit	Read	LISN	Cable	Remark
	MHz	dBuV	Limit	Line	Level	Factor	Loss	
		dBuV	dB	dBuV	dBuV	dB	dB	
1	1.17	37.66	-18.34	56.00	26.90	0.10	10.66	QP
2	1.17	31.06	-14.94	46.00	20.30	0.10	10.66	Average
3	1.33	37.37	-18.63	56.00	26.60	0.10	10.67	QP
4	1.33	30.17	-15.83	46.00	19.40	0.10	10.67	Average
5	2.33	40.13	-15.87	56.00	29.30	0.11	10.72	QP
6	2.33	34.63	-11.37	46.00	23.80	0.11	10.72	Average
7	2.47	41.74	-14.26	56.00	30.90	0.11	10.73	QP
8	2.47	36.24	-9.76	46.00	25.40	0.11	10.73	Average
9	2.58	41.66	-14.34	56.00	30.80	0.12	10.74	QP
10 *	2.58	36.46	-9.54	46.00	25.60	0.12	10.74	Average
11	2.78	37.08	-18.92	56.00	26.19	0.13	10.76	QP
12	2.78	31.08	-14.92	46.00	20.19	0.13	10.76	Average



Test Mode :	Mode 6	Temperature :	22~24°C
Test Engineer :	Eko Guan	Relative Humidity :	33~35%
Test Voltage :	120Vac / 60Hz	Phase :	Line
Function Type :	GSM850 Idle + Bluetooth Idle + WLAN Idle + USB Cable 2 (Data Link with Notebook) + Battery 1 + Earphone 1 + GPS Rx		

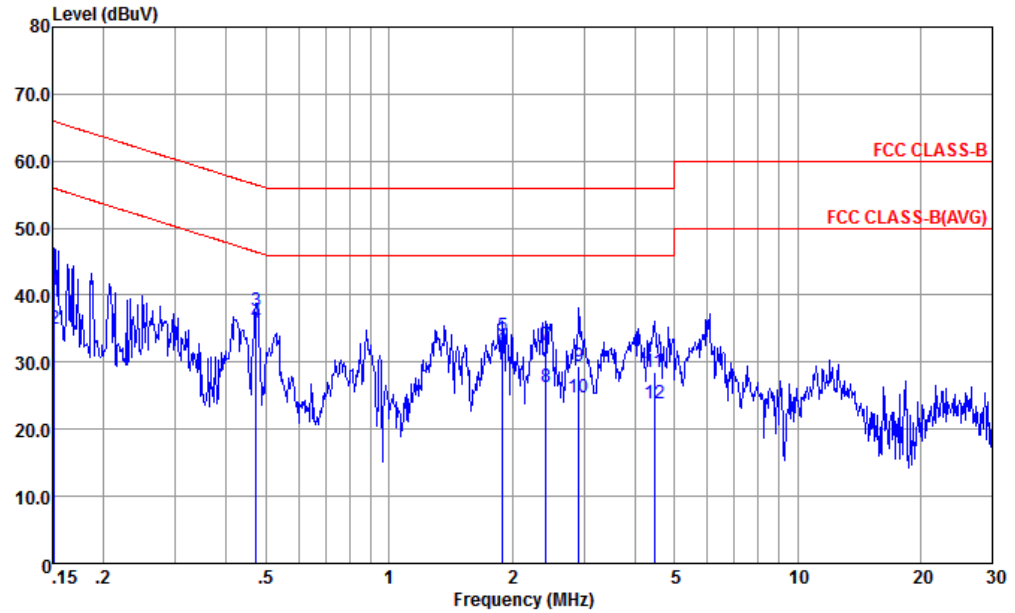

Site : CO01-KS
 Condition : FCC CLASS-B LISN-L20140306 LINE
 Project : (FC) 511303-01
 mode : Mode 6

	Freq	Level	Over	Limit	Read	LISN	Cable	Remark
	MHz	dBuV	Limit	Line	Level	Factor	Loss	
			dB	dBuV	dBuV	dB	dB	
1	0.15	40.70	-25.21	65.91	28.40	1.93	10.37	QP
2	0.15	34.90	-21.01	55.91	22.60	1.93	10.37	Average
3	0.47	37.75	-18.70	56.45	26.91	0.22	10.62	QP
4 *	0.47	35.95	-10.50	46.45	25.11	0.22	10.62	Average
5	1.90	33.90	-22.10	56.00	23.10	0.10	10.70	QP
6	1.90	31.70	-14.30	46.00	20.90	0.10	10.70	Average
7	2.42	32.64	-23.36	56.00	21.81	0.11	10.72	QP
8	2.42	26.34	-19.66	46.00	15.51	0.11	10.72	Average
9	2.92	29.51	-26.49	56.00	18.60	0.13	10.78	QP
10	2.92	24.81	-21.19	46.00	13.90	0.13	10.78	Average
11	4.45	28.53	-27.47	56.00	17.50	0.19	10.84	QP
12	4.45	23.83	-22.17	46.00	12.80	0.19	10.84	Average



Test Mode :	Mode 6	Temperature :	22~24°C
Test Engineer :	Eko Guan	Relative Humidity :	33~35%
Test Voltage :	120Vac / 60Hz	Phase :	Neutral
Function Type :	GSM850 Idle + Bluetooth Idle + WLAN Idle + USB Cable 2 (Data Link with Notebook) + Battery 1 + Earphone 1 + GPS Rx		

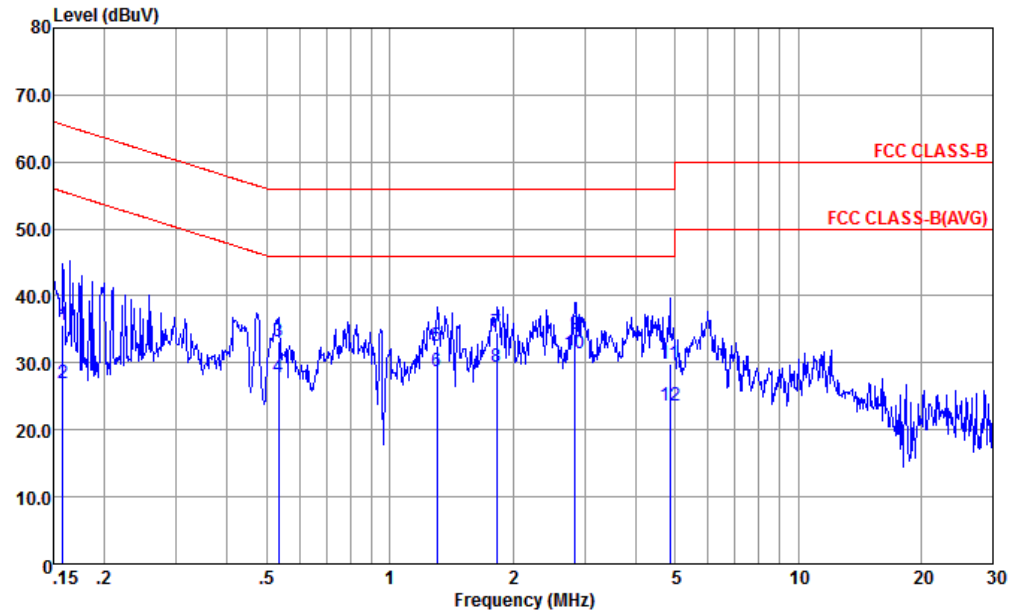

Site : CO01-KS
 Condition : FCC CLASS-B LISN-N20140306 NEUTRAL
 Project : (FC) 511303-01
 mode : Mode 6

	Freq	Level	Over	Limit	Read	LISN	Cable	Remark
	MHz	dBuV	dB	dBuV	dBuV	dB	dB	
1	0.16	35.76	-29.80	65.56	23.60	1.77	10.39	QP
2	0.16	26.96	-28.60	55.56	14.80	1.77	10.39	Average
3	0.53	33.31	-22.69	56.00	22.40	0.28	10.63	QP
4	0.53	27.81	-18.19	46.00	16.90	0.28	10.63	Average
5	1.30	32.46	-23.54	56.00	21.70	0.10	10.66	QP
6	1.30	28.66	-17.34	46.00	17.90	0.10	10.66	Average
7	1.83	34.60	-21.40	56.00	23.80	0.10	10.70	QP
8	1.83	29.40	-16.60	46.00	18.60	0.10	10.70	Average
9	2.84	34.30	-21.70	56.00	23.40	0.13	10.77	QP
10 *	2.84	31.40	-14.60	46.00	20.50	0.13	10.77	Average
11	4.85	29.94	-26.06	56.00	18.89	0.20	10.85	QP
12	4.85	23.54	-22.46	46.00	12.49	0.20	10.85	Average



3.2. Test of Radiated Emission Measurement

3.2.1. Limit of Radiated Emission

The emissions from an unintentional radiator shall not exceed the field strength levels specified in the following table:

Frequency (MHz)	Field Strength (microvolts/meter)	Measurement Distance (meters)
30 – 88	100	3
88 – 216	150	3
216 - 960	200	3
Above 960	500	3

3.2.2. Measuring Instruments

The measuring equipment is listed in the section 4 of this test report.

3.2.3. Test Procedures

1. The EUT was placed on a turntable with 0.8 meter above ground.
2. The EUT was set 3 meters from the interference receiving antenna, which was mounted on the top of a variable height antenna tower.
3. The table was rotated 360 degrees to determine the position of the highest radiation.
4. The antenna height is adjusted between one to four meters above ground to find the maximum value of the field strength for both horizontal polarization and vertical polarization of the antenna.
5. For each suspected emission, the EUT was arranged to its worst case and then tune the antenna tower (from 1 m to 4 m) and turntable (from 0 degree to 360 degrees) to find the maximum reading.
6. Set the test-receiver system to Peak Detect Function and specified bandwidth with Maximum Hold Mode (RBW=120kHz/VBW=300kHz for frequency below 1GHz; RBW=1MHz VBW=3MHz (Peak), RBW=1MHz/VBW=10Hz (Average) for frequency above 1GHz).
7. If the emission level of the EUT in peak mode was 3 dB lower than the limit specified, peak values of EUT will be reported. Otherwise, the emission will be repeated by using the quasi-peak method and reported.
8. Emission level (dBµV/m) = 20 log Emission level (µV/m)
9. Corrected Reading: Antenna Factor + Cable Loss + Read Level - Preamp Factor = Level

3.2.4. Test Setup of Radiated Emission

For radiated emissions from 30MHz to 1GHz

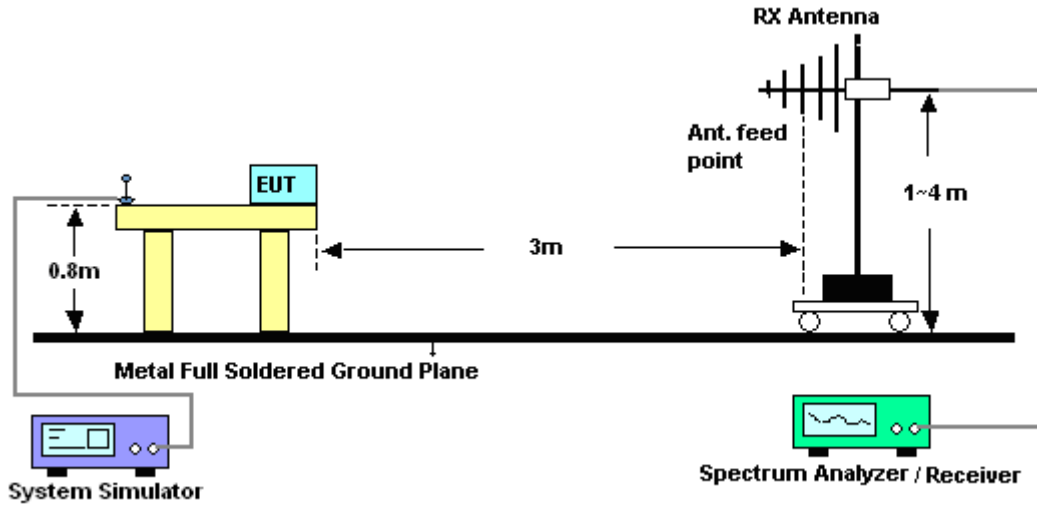

For radiated emissions above 1GHz

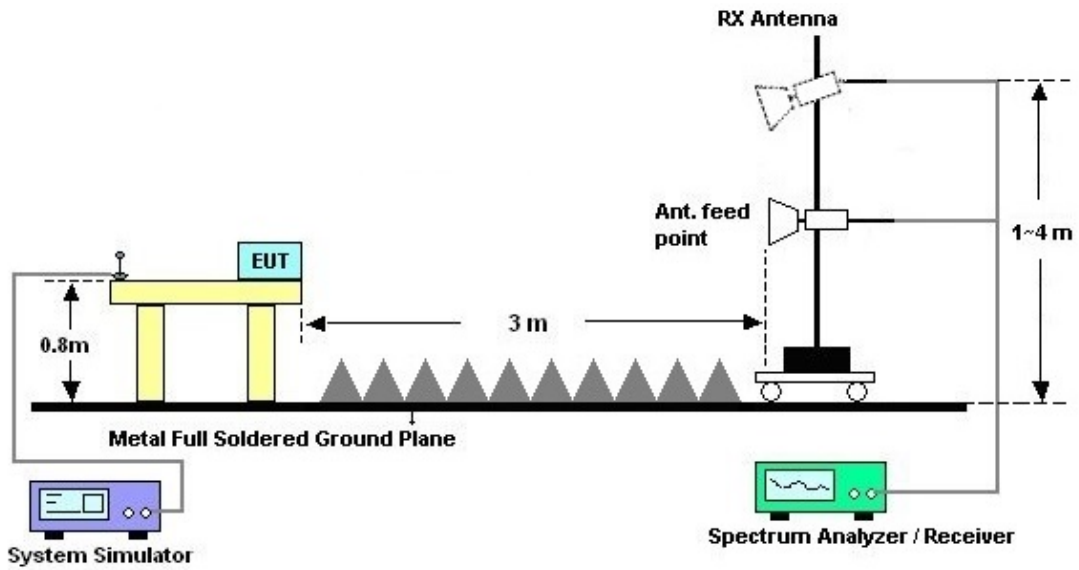



3.2.5. Test Result of Radiated Emission

Test Mode :	Mode 7	Temperature :	22~23°C
Test Engineer :	Nick Su	Relative Humidity :	40~41%
Test Distance :	3m	Polarization :	Horizontal
Function Type :	GSM850 Idle + Bluetooth Idle + WLAN Idle + USB Cable 3 (Charging from Adapter 1) + Battery 1 + Earphone 1 + Camera		
Remark :	#6 is system simulator signal which can be ignored.		

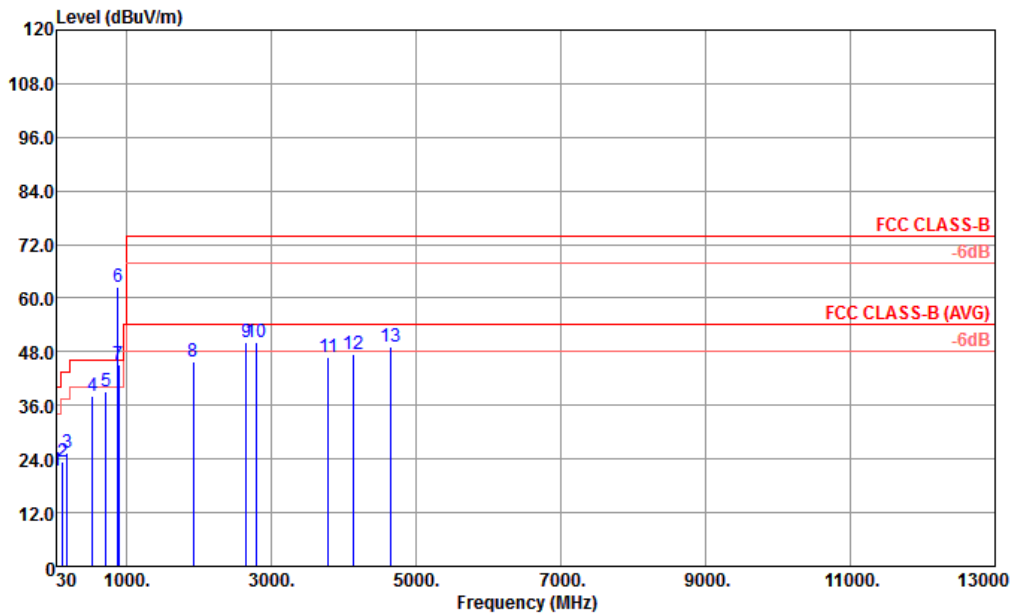

Site : 03CH01-KS
 Condition : FCC CLASS-B 3m LF ANT_37879 HORIZONTAL
 Mode : 7

	Freq	Level	Limit	Limit	ReadAntenna	Cable	Preamp	A/Pos	T/Pos	Remark	
	MHz	dBuV/m	dB	dBuV/m	dBuV	dB/m	dB	dB	cm	deg	
1	34.85	21.24	-18.76	40.00	36.33	16.75	0.79	32.63	---	---	Peak
2	113.42	23.49	-20.01	43.50	43.49	11.41	1.23	32.64	---	---	Peak
3	177.44	25.48	-18.02	43.50	45.86	10.66	1.44	32.48	---	---	Peak
4	533.43	38.14	-7.86	46.00	49.36	18.30	2.64	32.16	---	---	Peak
5	710.94	39.25	-6.75	46.00	48.06	20.04	3.12	31.97	---	---	Peak
6 *	881.66	62.47			68.69	22.08	3.50	31.80	---	---	Peak
7 !	889.42	45.08	-0.92	46.00	51.00	22.34	3.50	31.76	100	324	QP
8	1920.00	45.68	-28.32	74.00	44.83	30.01	5.51	34.67	---	---	Peak
9	2658.00	50.20	-23.80	74.00	45.94	31.93	6.52	34.19	---	---	Peak
10	2790.00	50.12	-23.88	74.00	45.24	32.34	6.67	34.13	---	---	Peak
11	3786.00	46.89	-27.11	74.00	38.08	34.25	8.14	33.58	---	---	Peak
12	4132.00	47.39	-26.61	74.00	37.49	34.73	8.52	33.35	---	---	Peak
13	4642.00	49.20	-24.80	74.00	39.10	34.78	8.60	33.28	---	---	Peak



Test Mode :	Mode 7	Temperature :	22~23°C
Test Engineer :	Nick Su	Relative Humidity :	40~41%
Test Distance :	3m	Polarization :	Vertical
Function Type :	GSM850 Idle + Bluetooth Idle + WLAN Idle + USB Cable 3 (Charging from Adapter 1) + Battery 1 + Earphone 1 + Camera		
Remark :	#6 is system simulator signal which can be ignored.		

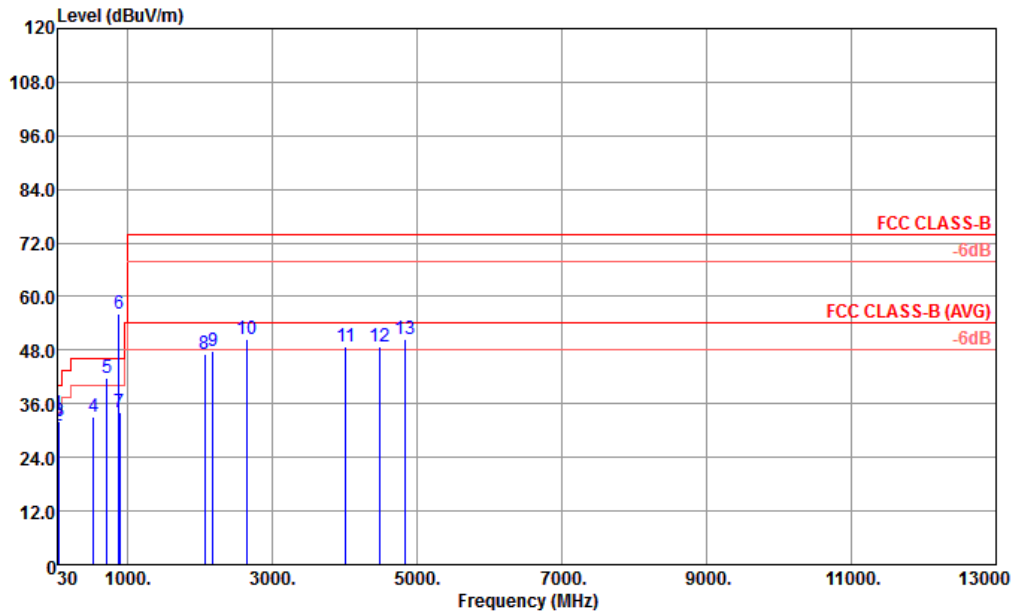

Site : 03CH01-KS
 Condition : FCC CLASS-B 3m LF_ANT_37879 VERTICAL
 Mode : 7

	Freq	Level	Limit	Limit	ReadAntenna	Cable	Preamp	A/Pos	T/Pos	Remark	
	MHz	dBuV/m	dB	dBuV/m	dBuV	dB/m	dB	dB	cm	deg	
1	35.82	33.62	-6.38	40.00	49.19	16.26	0.79	32.62	---	---	Peak
2	46.49	31.23	-8.77	40.00	52.35	10.74	0.79	32.65	---	---	Peak
3	52.31	32.12	-7.88	40.00	55.76	8.18	0.79	32.61	---	---	Peak
4	533.43	32.98	-13.02	46.00	44.20	18.30	2.64	32.16	---	---	Peak
5 !	710.94	41.77	-4.23	46.00	50.58	20.04	3.12	31.97	100	211	Peak
6 *	881.66	56.25			62.47	22.08	3.50	31.80	---	---	Peak
7	889.42	34.21	-11.79	46.00	40.13	22.34	3.50	31.76	---	---	Peak
8	2062.00	47.00	-27.00	74.00	44.92	30.88	5.75	34.55	---	---	Peak
9	2182.00	47.95	-26.05	74.00	45.43	31.08	5.91	34.47	---	---	Peak
10	2644.00	50.43	-23.57	74.00	46.24	31.87	6.52	34.20	---	---	Peak
11	4014.00	48.73	-25.27	74.00	39.13	34.56	8.52	33.48	---	---	Peak
12	4484.00	48.72	-25.28	74.00	38.80	34.71	8.52	33.31	---	---	Peak
13	4838.00	50.39	-23.61	74.00	39.90	34.90	8.73	33.14	---	---	Peak



Test Mode :	Mode 6	Temperature :	22~23°C
Test Engineer :	Nick Su	Relative Humidity :	40~41%
Test Distance :	3m	Polarization :	Vertical
Function Type :	GSM850 Idle + Bluetooth Idle + WLAN Idle + USB Cable 2 (Data Link with Notebook) + Battery 1 + Earphone 1 + GPS Rx		
Remark :	#7 is system simulator signal which can be ignored.		

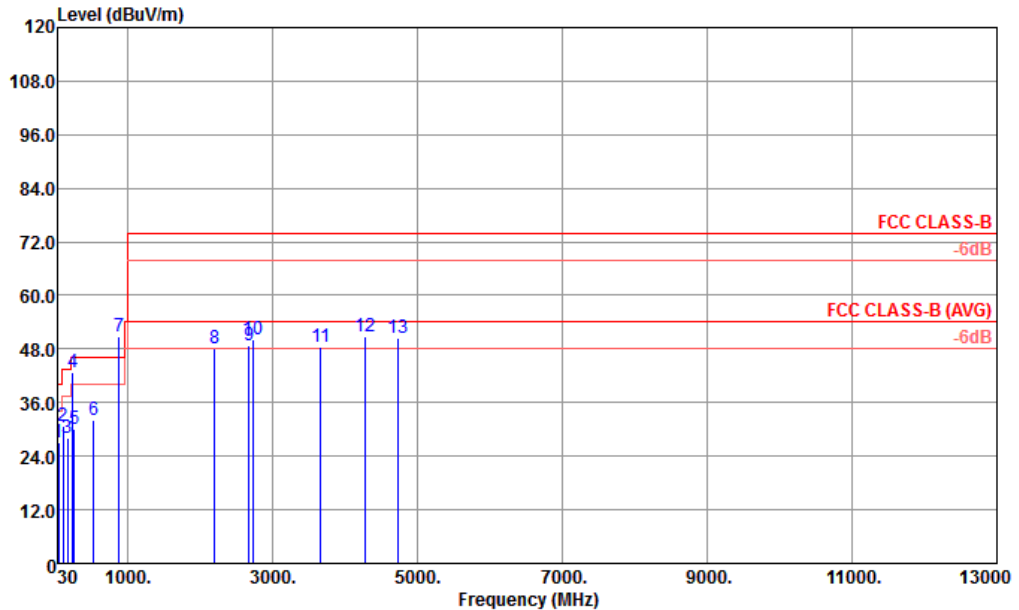

Site : 03CH01-KS
 Condition : FCC CLASS-B 3m LF_ANT_37879 HORIZONTAL
 Mode : 6

	Freq	Level	Over Limit	Limit Line	ReadAntenna Level	Antenna Factor	Cable Loss	Preamp Factor	A/Pos	T/Pos	Remark	Pol/Phas
	MHz	dBuV/m	dB	dBuV/m	dBuV	dB/m	dB	dB	cm	deg		
1	48.43	27.21	-12.79	40.00	49.33	9.72	0.79	32.63	---	---	Peak	HORIZONT
2	103.72	30.83	-12.67	43.50	51.10	11.33	1.04	32.64	---	---	Peak	HORIZONT
3	165.80	27.96	-15.54	43.50	47.95	11.10	1.44	32.53	---	---	Peak	HORIZONT
4 !	242.43	42.62	-3.38	46.00	61.59	11.75	1.75	32.47	129	47	QP	HORIZONT
5	263.77	30.03	-15.97	46.00	48.36	12.35	1.75	32.43	---	---	Peak	HORIZONT
6	533.43	31.98	-14.02	46.00	43.20	18.30	2.64	32.16	---	---	Peak	HORIZONT
7 *	881.66	50.82			57.04	22.08	3.50	31.80	---	---	Peak	HORIZONT
8	2200.00	48.03	-25.97	74.00	45.48	31.10	5.91	34.46	---	---	Peak	HORIZONT
9	2672.00	48.96	-25.04	74.00	44.70	31.93	6.52	34.19	---	---	Peak	HORIZONT
10	2736.00	49.99	-24.01	74.00	45.37	32.16	6.62	34.16	---	---	Peak	HORIZONT
11	3664.00	48.35	-25.65	74.00	40.18	33.92	7.91	33.66	---	---	Peak	HORIZONT
12	4282.00	50.68	-23.32	74.00	40.68	34.77	8.52	33.29	---	---	Peak	HORIZONT
13	4738.00	50.53	-23.47	74.00	40.21	34.84	8.68	33.20	---	---	Peak	HORIZONT



Test Mode :	Mode 6	Temperature :	22~23°C
Test Engineer :	Nick Su	Relative Humidity :	40~41%
Test Distance :	3m	Polarization :	Vertical
Function Type :	GSM850 Idle + Bluetooth Idle + WLAN Idle + USB Cable 2 (Data Link with Notebook) + Battery 1 + Earphone 1 + GPS Rx		
Remark :	#7 is system simulator signal which can be ignored.		

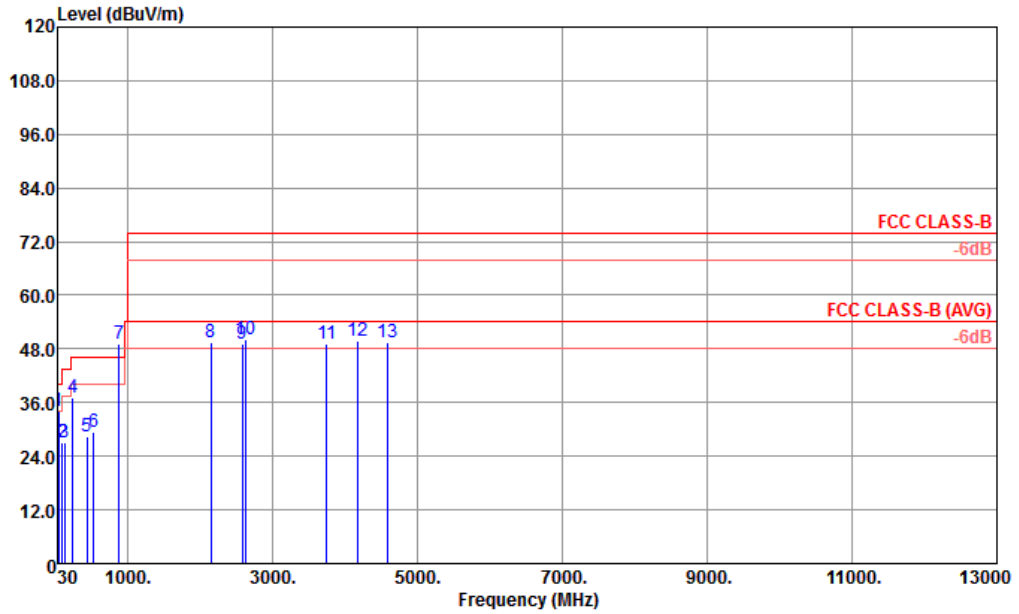

Site : 03CH01-KS
 Condition : FCC CLASS-B 3m LF_ANT_37879 VERTICAL
 Mode : 6

	Freq	Level	Over Limit	Limit Line	ReadAntenna Level	Cable Factor	Preamp Loss	A/Pos	T/Pos	Remark	Pol/Phas
	MHz	dBuV/m	dB	dBuV/m	dBuV	dB/m	dB	dB	cm	deg	
1 !	46.49	34.10	-5.90	40.00	55.22	10.74	0.79	32.65	120	168	Peak VERTICAL
2	101.78	26.91	-16.59	43.50	47.18	11.32	1.04	32.63	---	---	Peak VERTICAL
3	131.85	26.91	-16.59	43.50	46.72	11.55	1.23	32.59	---	---	Peak VERTICAL
4	240.49	37.11	-8.89	46.00	56.18	11.66	1.75	32.48	---	---	Peak VERTICAL
5	439.34	28.38	-17.62	46.00	40.99	17.13	2.40	32.14	---	---	Peak VERTICAL
6	533.43	29.47	-16.53	46.00	40.69	18.30	2.64	32.16	---	---	Peak VERTICAL
7 *	881.66	49.25			55.47	22.08	3.50	31.80	---	---	Peak VERTICAL
8	2150.00	49.63	-24.37	74.00	47.25	31.02	5.85	34.49	---	---	Peak VERTICAL
9	2582.00	49.14	-24.86	74.00	45.31	31.64	6.43	34.24	---	---	Peak VERTICAL
10	2624.00	50.14	-23.86	74.00	46.06	31.81	6.48	34.21	---	---	Peak VERTICAL
11	3746.00	48.98	-25.02	74.00	40.32	34.20	8.06	33.60	---	---	Peak VERTICAL
12	4180.00	49.75	-24.25	74.00	39.72	34.80	8.52	33.29	---	---	Peak VERTICAL
13	4586.00	49.50	-24.50	74.00	39.49	34.75	8.57	33.31	---	---	Peak VERTICAL



4. List of Measuring Equipment

Instrument	Manufacturer	Model No.	Serial No.	Characteristics	Calibration Date	Test Date	Due Date	Remark
EMI Receiver	R&S	ESCI7	100768	9kHz~7GHz;	May 04, 2014	Mar. 24, 2015	May 03, 2015	Conduction (CO01-KS)
AC LISN	MessTec	AN3016	060103	9kHz~30MHz	Oct. 25, 2014	Mar. 24, 2015	Oct. 24, 2015	Conduction (CO01-KS)
AC LISN (for auxiliary equipment)	MessTec	AN3016	060105	9kHz~30MHz	Oct. 25, 2014	Mar. 24, 2015	Oct. 24, 2015	Conduction (CO01-KS)
AC Power Source	Chroma	61602	ABP0000008 11	AC 0V~300V, 45Hz~1000Hz	Oct. 25, 2014	Mar. 24, 2015	Oct. 24, 2015	Conduction (CO01-KS)
EMI Test Receiver	R&S	ESCI	100534	9kHz~3GHz	Oct. 25, 2014	Mar. 22, 2015	Oct. 24, 2015	Radiation (03CH01-KS)
Spectrum Analyzer	R&S	FSP30	101399	9kHz~30GHz	May 04, 2014	Mar. 22, 2015	May 03, 2015	Radiation (03CH01-KS)
Bilog Antenna	TeseQ	CBL6112D	37879	30Mhz-2Ghz	Sep. 13, 2014	Mar. 22, 2015	Sep. 12, 2015	Radiation (03CH01-KS)
Double Ridge Horn Antenna	ETS-Lindgren	3117	75957	1GHz~18GHz	Nov. 08, 2014	Mar. 22, 2015	Nov. 07, 2015	Radiation (03CH01-KS)
Amplifier	com-power	PA-103A	161073	1MHz~1GHz	May 04, 2014	Mar. 22, 2015	May 03, 2015	Radiation (03CH01-KS)
Amplifier	Agilent	8449B	3008A02371	1GHz~26.5GHz	Oct. 28, 2014	Mar. 22, 2015	Oct. 27, 2015	Radiation (03CH01-KS)
AC Power Source	Chroma	61601	F104090004	N/A	NCR	Mar. 22, 2015	NCR	Radiation (03CH01-KS)
Turn Table	MF	MF7802	N/A	0~360 degree	NCR	Mar. 22, 2015	NCR	Radiation (03CH01-KS)
Antenna Mast	MF	MF7802	N/A	1 m~4 m	NCR	Mar. 22, 2015	NCR	Radiation (03CH01-KS)



5. Uncertainty of Evaluation

Uncertainty of Conducted Emission Measurement (150 kHz ~ 30 MHz)

Measuring Uncertainty for a Level of Confidence of 95% ($U = 2Uc(y)$)	2.3 dB
---	--------

Uncertainty of Radiated Emission Measurement (30 MHz ~ 1000 MHz)

Measuring Uncertainty for a Level of Confidence of 95% ($U = 2Uc(y)$)	2.5 dB
---	--------