



# FCC RF Test Report

**APPLICANT** : TCT Mobile Limited  
**EQUIPMENT** : GSM Quad-band / UMTS Quad-band / LTE  
Penta-band mobile phone  
**BRAND NAME** : Alcatel  
**MODEL NAME** : 6039J  
**FCC ID** : RAD545  
**STANDARD** : FCC 47 CFR Part 2, 22(H), 24(E)  
**CLASSIFICATION** : PCS Licensed Transmitter Held to Ear (PCE)

The product was testing completed on Feb. 20, 2015. We, SPORTON INTERNATIONAL (KUNSHAN) INC., would like to declare that the tested sample has been evaluated in accordance with the test procedures given in ANSI / TIA / EIA-603-C-2004 and has been in compliance with the applicable technical standards.

The test results in this report apply exclusively to the tested model / sample. Without written approval of SPORTON INTERNATIONAL (KUNSHAN) INC., the test report shall not be reproduced except in full.

Reviewed by: Joseph Lin / Supervisor

Approved by: Jones Tsai / Manager



Testing Laboratory  
2627

**SPORTON INTERNATIONAL (KUNSHAN) INC.**  
No. 3-2, PingXiang Road, Kunshan, Jiangsu Province, P. R. China



# TABLE OF CONTENTS

**REVISION HISTORY..... 3**

**SUMMARY OF TEST RESULT ..... 4**

**1 GENERAL DESCRIPTION ..... 5**

    1.1 Applicant..... 5

    1.2 Manufacturer ..... 5

    1.3 Product Feature of Equipment Under Test ..... 5

    1.4 Product Specification subjective to this standard..... 6

    1.5 Accessories and Support Equipment ..... 7

    1.6 Modification of EUT ..... 8

    1.7 Maximum ERP/EIRP Power, Frequency Tolerance, and Emission Designator ..... 8

    1.8 Testing Location ..... 9

    1.9 Applicable Standards ..... 9

**2 TEST CONFIGURATION OF EQUIPMENT UNDER TEST ..... 10**

    2.1 Test Mode..... 10

    2.2 Connection Diagram of Test System ..... 13

    2.3 Support Unit used in test configuration ..... 14

    2.4 Measurement Results Explanation Example ..... 14

**3 TEST RESULT ..... 15**

    3.1 Conducted Output Power Measurement..... 15

    3.2 Peak-to-Average Ratio ..... 17

    3.3 Effective Radiated Power and Effective Isotropic Radiated Power Measurement ..... 25

    3.4 99% Occupied Bandwidth and 26dB Bandwidth Measurement..... 31

    3.5 Band Edge Measurement..... 51

    3.6 Conducted Spurious Emission Measurement..... 64

    3.7 Field Strength of Spurious Radiation Measurement ..... 80

    3.8 Frequency Stability Measurement..... 88

**4 LIST OF MEASURING EQUIPMENT ..... 93**

**5 UNCERTAINTY OF EVALUATION ..... 95**

**APPENDIX A. SETUP PHOTOGRAPHS**

**APPENDIX B. PRODUCT EQUALITY DECLARATION**





## SUMMARY OF TEST RESULT

Report Section	FCC Rule	Description	Limit	Result	Remark
3.1	§2.1046	Conducted Output Power	N/A	PASS	-
3.2	§24.232(d)	Peak-to-Average Ratio	<13 dB	PASS	-
3.3	§22.913(a)(2)	Effective Radiated Power	< 7 Watts	PASS	-
	§24.232(c)	Equivalent Isotropic Radiated Power	< 2 Watts	PASS	-
3.4	§2.1049 §22.917(b) §24.238(b)	Occupied Bandwidth	N/A	PASS	-
3.5	§2.1051 §22.917(a) §24.238(a)	Band Edge Measurement	< 43+10log <sub>10</sub> (P[Watts])	PASS	-
3.6	§2.1051 §22.917(a) §24.238(a)	Conducted Spurious Emission	< 43+10log <sub>10</sub> (P[Watts])	PASS	-
3.7	§2.1053 §22.917(a) §24.238(a)	Field Strength of Spurious Radiation	< 43+10log <sub>10</sub> (P[Watts])	PASS	Under limit 37.45 dB at 7521.000 MHz
3.8	§2.1055 §22.355	Frequency Stability for Temperature & Voltage	< 2.5 ppm for Part 22 Within Authorized Band	PASS	-
	§2.1055 §24.235				



# 1 General Description

## 1.1 Applicant

**TCT Mobile Limited**

5F, C building, No. 232, Liang Jing Road ZhangJiang High-Tech Park, Pudong Area Shanghai, P. R. China. 201203

## 1.2 Manufacturer

**TCT Mobile Limited**

5F, C building, No. 232, Liang Jing Road ZhangJiang High-Tech Park, Pudong Area Shanghai, P. R. China. 201203

## 1.3 Product Feature of Equipment Under Test

Product Feature	
<b>Equipment</b>	GSM Quad-band / UMTS Quad-band / LTE Penta-band mobile phone
<b>Brand Name</b>	Alcatel
<b>Model Name</b>	6039J
<b>FCC ID</b>	RAD545
<b>EUT supports Radios application</b>	GSM/GPRS/EGPRS/WCDMA/HSPA/HSPA+ (Downlink Only)/DC-HSDPA/LTE/NFC/WLAN 2.4GHz 802.11b/g/n HT20/Bluetooth v3.0 + EDR / Bluetooth v4.1 LE
<b>IMEI Code for 6039A</b>	Conducted: 014322000050866 Radiated: 014368000006976 ERP/EIRP: 014368000051146
<b>HW Version</b>	BAB34D000GCX
<b>SW Version</b>	vA7M
<b>EUT Stage</b>	Identical Prototype

**Remark:**

1. The above EUT's information was declared by manufacturer. Please refer to the specifications or user's manual for more detailed description.
2. There are two types of EUT sample 1 and sample 2, the differences between two samples is only for memory, sample 1 is 1GB capacity and sample 2 is 1.5GB capacity. We only chose the sample 1 to perform all tests.
3. The device has two acoustic receives function, when a voice call is coming, user can choose any one receiver to response. And only when receiver on the bottom of the EUT is enabled, the power reduction will be activated to limit the maximum power of any cellular band except WCDMA Band V.



### 1.4 Product Specification subjective to this standard

Product Specification subjective to this standard	
<b>Tx Frequency</b>	GSM850: 824.2 MHz ~ 848.8 MHz GSM1900: 1850.2 MHz ~ 1909.8MHz WCDMA Band V: 826.4 MHz ~ 846.6 MHz WCDMA Band II: 1852.4 MHz ~ 1907.6 MHz
<b>Rx Frequency</b>	GSM850: 869.2 MHz ~ 893.8 MHz GSM1900: 1930.2 MHz ~ 1989.8 MHz WCDMA Band V: 871.4 MHz ~ 891.6 MHz WCDMA Band II: 1932.4 MHz ~ 1987.6 MHz
<b>Maximum Output Power to Antenna</b>	GSM850 : 33.72 dBm GSM1900 : 29.50 dBm WCDMA Band V : 23.42 dBm WCDMA Band II : 22.11 dBm
<b>Antenna Type</b>	PIFA Antenna
<b>Type of Modulation</b>	GSM: GMSK GPRS: GMSK EDGE: GMSK / 8PSK WCDMA : QPSK (Uplink) HSDPA/DC-HSDPA : QPSK (Uplink) HSUPA : QPSK (Uplink) HSPA+ : 16QAM (Downlink Only) DC-HSDPA : 64QAM

### 1.5 Accessories and Support Equipment

Specification of Accessory			
AC Adapter 1	Brand Name	ACE-Tenpao	Model Name UC11US
	Power Rating	I/P: 100-240Vac, 200mA, O/P: 5Vdc, 1000mA	
	P/N	CBA0058AG0C2	
AC Adapter 2	Brand Name	ACE-Yingju	Model Name UC11US
	Power Rating	I/P: 100-240Vac, 200mA, O/P: 5Vdc, 1000mA	
	P/N	CBA0058AG0C3	
Battery 1	Brand Name	ALCATEL onetouch	Model Name TLp020K2
	Power Rating	3.8Vdc, 2000mAh	
	P/N	CAC2000023C2	
Battery 2	Brand Name	ALCATEL onetouch	Model Name TLp020KJ
	Power Rating	3.8Vdc, 2000mAh	
	P/N	CAC2000025CJ	
USB Cable 1	Brand Name	ACE-Shenhua	Model Name CDA0000025C1
	Signal Line Type	1.10m shielded without core	
USB Cable 2	Brand Name	ACE-Juwei	Model Name CDA0000025C2
	Signal Line Type	1.10m shielded without core	
USB Cable 3	Brand Name	ACE-Juwei	Model Name CDA0000025C8
	Signal Line Type	1.10m shielded without core	
Earphone 1	Brand Name	ACE-Lianyun	Model Name CCB0023A10C2
	Signal Line Type	1.16m non-shielded without core	
Earphone 2	Brand Name	ACE-JBL	Model Name J22C
	Signal Line Type	1.38m non-shielded without core	
Earphone 3	Brand Name	ACE-Lianyun	Model Name CCB0023A11C2
	Signal Line Type	1.26m non-shielded without core	
Earphone 4	Brand Name	ACE-JBL	Model Name CCA0001A10C9
	Signal Line Type	1.28m non-shielded without core	



### 1.6 Modification of EUT

No modifications are made to the EUT during all test items.

### 1.7 Maximum ERP/EIRP Power, Frequency Tolerance, and Emission Designator

FCC Rule	System	Type of Modulation	Maximum ERP/EIRP (W)	Frequency Tolerance (ppm)	Emission Designator
Part 22	GSM850 GSM	GMSK	0.86	0.0287 ppm	246KGXW
Part 22	GSM850 EDGE class 8	8PSK	0.21	0.0203 ppm	244KG7W
Part 22	WCDMA Band V RMC 12.2Kbps	QPSK	0.10	0.0251 ppm	4M18F9W
Part 24	GSM1900 GSM	GMSK	1.97	0.0106 ppm	246KGXW
Part 24	GSM1900 EDGE class 8	8PSK	0.85	0.0133 ppm	250KG7W
Part 24	WCDMA Band II RMC 12.2Kbps	QPSK	0.49	0.0122 ppm	4M18F9W





### 1.8 Testing Location

<b>Test Site</b>	SPORTON INTERNATIONAL (KUNSHAN) INC.			
<b>Test Site Location</b>	No. 3-2, PingXiang Road, Kunshan, Jiangsu Province, P. R. China TEL: +86-0512-5790-0158 FAX: +86-0512-5790-0958			
<b>Test Site No.</b>	<b>Sporton Site No.</b>			<b>FCC Registration No.</b>
	TH01-KS	03CH01-KS	OTA01-KS	149928

### 1.9 Applicable Standards

According to the specifications of the manufacturer, the EUT must comply with the requirements of the following standards:

- FCC 47 CFR Part 2, 22(H), 24(E)
- ANSI / TIA / EIA-603-C-2004
- FCC KDB 971168 D01 Power Meas. License Digital Systems v02r02

**Remark:**

1. All test items were verified and recorded according to the standards and without any deviation during the test.
2. This EUT has also been tested and complied with the requirements of FCC Part 15, Subpart B, recorded in a separate test report.



## 2 Test Configuration of Equipment Under Test

### 2.1 Test Mode

Antenna port conducted and radiated test items were performed according to KDB 971168 D01 Power Meas. License Digital Systems v02r02 with maximum output power.

Radiated measurements were performed with rotating EUT in different three orthogonal test planes to find the maximum emission.

Radiated emissions were investigated as following frequency range:

1. 30 MHz to 10th harmonic for GSM850 and WCDMA Band V.
2. 30 MHz to 10th harmonic for GSM1900 and WCDMA Band II.

All modes and data rates and positions were investigated.

Test modes are chosen to be reported as the worst case configuration below:

Test Modes		
Band	Radiated TCs	Conducted TCs
GSM 850	<ul style="list-style-type: none"> <li>■ GSM Link</li> <li>■ EDGE class 8 Link</li> </ul>	<ul style="list-style-type: none"> <li>■ GSM Link</li> <li>■ EDGE class 8 Link</li> </ul>
GSM 1900	<ul style="list-style-type: none"> <li>■ GSM Link</li> <li>■ EDGE class 8 Link</li> </ul>	<ul style="list-style-type: none"> <li>■ GSM Link</li> <li>■ EDGE class 8 Link</li> </ul>
WCDMA Band V	<ul style="list-style-type: none"> <li>■ RMC 12.2Kbps Link</li> </ul>	<ul style="list-style-type: none"> <li>■ RMC 12.2Kbps Link</li> </ul>
WCDMA Band II	<ul style="list-style-type: none"> <li>■ RMC 12.2Kbps Link</li> </ul>	<ul style="list-style-type: none"> <li>■ RMC 12.2Kbps Link</li> </ul>

**Note:** According the functionality of the EUT, the maximum power levels are chosen to test all test cases listed in this report as the worst case configuration is when top acoustic receiver works.



Conducted Power Measurement Results:

<Full Power Mode>:

Conducted Power (*Unit: dBm)						
Band	GSM850			GSM1900		
Channel	128	189	251	512	661	810
Frequency	824.2	836.4	848.8	1850.2	1880.0	1909.8
GSM	33.51	33.72	33.42	29.22	29.35	29.50
GPRS class 8	33.50	33.71	33.40	29.20	29.34	29.47
GPRS class 10	31.04	31.19	31.32	28.10	28.29	28.81
GPRS class 11	29.01	29.20	29.26	26.19	26.32	26.46
GPRS class 12	27.82	28.02	28.05	25.04	25.15	25.09
EGPRS class 8	25.64	25.70	25.85	25.61	25.65	25.67
EGPRS class 10	25.31	25.36	25.52	24.51	24.55	24.59
EGPRS class 11	23.77	23.75	23.91	22.96	22.99	22.96
EGPRS class 12	22.11	22.14	22.31	21.34	21.38	21.39

Conducted Power (*Unit: dBm)						
Band	WCDMA Band V			WCDMA Band II		
Channel	4132	4182	4233	9262	9400	9538
Frequency	826.4	836.4	846.6	1852.4	1880.0	1907.6
AMR 12.2Kbps	23.41	23.35	23.27	21.98	22.07	22.09
RMC 12.2Kbps	23.42	23.37	23.28	21.99	22.10	22.11
HSDPA Subtest-1	22.34	22.18	22.19	20.70	20.83	20.80
HSDPA Subtest-2	22.32	22.17	21.90	20.69	20.92	20.60
HSDPA Subtest-3	21.76	21.30	21.63	20.53	20.38	20.64
HSDPA Subtest-4	21.39	21.60	21.62	20.17	20.78	20.63
DC-HSDPA Subtest-1	21.71	21.71	21.77	20.67	20.72	20.78
DC-HSDPA Subtest-2	21.73	21.78	21.76	20.66	20.71	20.77
DC-HSDPA Subtest-3	21.72	21.81	21.80	20.64	20.68	20.76
DC-HSDPA Subtest-4	21.77	21.82	21.78	20.64	20.69	20.77
HSUPA Subtest-1	21.80	21.68	21.84	20.45	20.49	20.87
HSUPA Subtest-2	20.92	20.82	20.44	19.78	19.95	19.52
HSUPA Subtest-3	20.72	20.42	20.10	19.60	19.62	19.58
HSUPA Subtest-4	21.31	21.07	21.40	19.96	20.20	20.56
HSUPA Subtest-5	21.57	21.50	21.43	20.34	20.51	20.43



<Reduced Power Mode>:

Conducted Power (*Unit: dBm)						
Band	GSM850			GSM1900		
Channel	128	189	251	512	661	810
Frequency	824.2	836.4	848.8	1850.2	1880.0	1909.8
GSM	29.60	29.66	29.59	24.15	24.39	24.55
GPRS class 8	29.59	29.65	29.57	24.12	24.38	24.54
GPRS class 10	29.06	28.89	28.85	21.04	21.28	21.30
GPRS class 11	27.06	27.04	26.77	19.56	19.68	19.82
GPRS class 12	25.82	25.83	25.77	18.04	18.04	18.26
EGPRS class 8	25.93	25.85	25.89	23.96	24.00	24.04
EGPRS class 10	25.64	25.57	25.59	20.94	20.96	21.02
EGPRS class 11	24.11	24.01	24.04	19.42	19.45	19.42
EGPRS class 12	22.46	22.45	22.43	17.80	17.90	17.91

Conducted Power (*Unit: dBm)			
Band	WCDMA Band II		
Channel	9262	9400	9538
Frequency	1852.4	1880	1907.6
AMR 12.2Kbps	16.20	16.11	16.23
RMC 12.2Kbps	16.21	16.13	16.24
HSDPA Subtest-1	14.76	14.67	14.78
HSDPA Subtest-2	14.74	14.68	14.76
HSDPA Subtest-3	14.71	14.68	14.74
HSDPA Subtest-4	14.52	14.79	14.72
DC-HSDPA Subtest-1	14.71	14.81	14.78
DC-HSDPA Subtest-2	14.68	14.80	14.65
DC-HSDPA Subtest-3	14.66	14.77	14.69
DC-HSDPA Subtest-4	14.63	14.78	14.68
HSUPA Subtest-1	14.82	14.91	14.98
HSUPA Subtest-2	14.20	14.38	14.08
HSUPA Subtest-3	13.82	14.02	13.71
HSUPA Subtest-4	14.41	14.60	14.65
HSUPA Subtest-5	14.69	14.96	14.80

## 2.2 Connection Diagram of Test System

<22H Tx Mode>

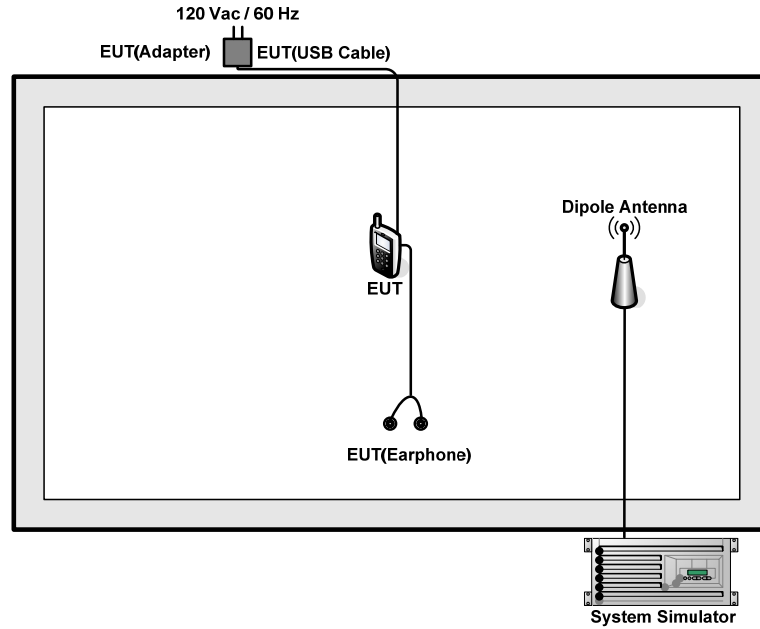

<24E Tx Mode>

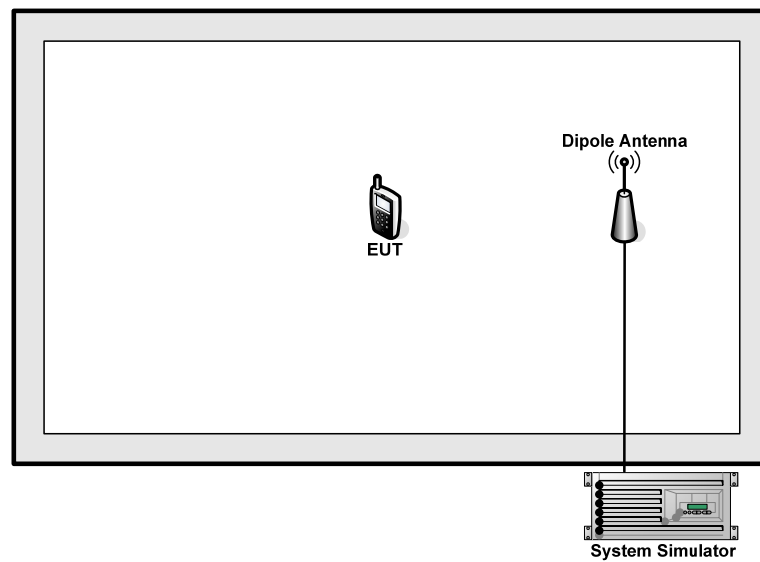



### 2.3 Support Unit used in test configuration

Item	Equipment	Trade Name	Model No.	FCC ID	Data Cable	Power Cord
1.	System Simulator	R&S	CMU 200	N/A	N/A	Unshielded, 1.8 m
2.	DC Power Supply	GW INSTEK	GPS-3030D	N/A	N/A	Unshielded, 1.8 m

### 2.4 Measurement Results Explanation Example

For all conducted test items:

The offset level is set in the spectrum analyzer to compensate the RF cable loss and attenuator factor between RF conducted output port and spectrum analyzer. With the offset compensation, the spectrum analyzer reading level will be exactly the RF output level.

The spectrum analyzer offset is derived from RF cable loss and attenuator factor.

*Offset = RF cable loss + attenuator factor.*

The following shows an offset computation example with RF cable loss 6.0 dB and a 10dB attenuator.

Example :

$$\begin{aligned} \text{Offset(dB)} &= \text{RF cable loss(dB)} + \text{attenuator factor(dB)}. \\ &= 6.0 + 10 = 16.0 \text{ (dB)} \end{aligned}$$

### 3 Test Result

#### 3.1 Conducted Output Power Measurement

##### 3.1.1 Description of the Conducted Output Power Measurement

A system simulator was used to establish communication with the EUT. Its parameters were set to enforce EUT transmitting at the maximum power. The measured power in the radio frequency on the transmitter output terminals shall be reported.

##### 3.1.2 Measuring Instruments

The measuring equipment is listed in the section 4 of this test report.

##### 3.1.3 Test Procedures

1. The transmitter output port was connected to the system simulator.
2. Set EUT at maximum power through system simulator.
3. Select lowest, middle, and highest channels for each band and different modulation.
4. Measure the maximum burst average power for GSM and maximum average power for other modulation signal.

##### 3.1.4 Test Setup

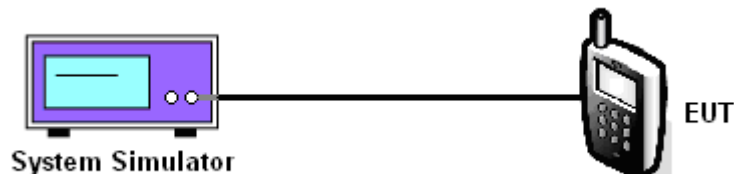

### 3.1.5 Test Result of Conducted Output Power

Cellular Band									
Modes	GSM850 (GSM)			GSM850 (EDGE class 8)			WCDMA Band V (RMC 12.2Kbps)		
Channel	128 (Low)	189 (Mid)	251 (High)	128 (Low)	189 (Mid)	251 (High)	4132 (Low)	4182 (Mid)	4233 (High)
Frequency (MHz)	824.2	836.4	848.8	824.2	836.4	848.8	826.4	836.4	846.6
Conducted Power (dBm)	33.51	33.72	33.42	25.64	25.70	25.85	23.42	23.37	23.28

PCS Band									
Modes	GSM1900 (GSM)			GSM1900 (EDGE class 8)			WCDMA Band II (RMC 12.2Kbps)		
Channel	512 (Low)	661 (Mid)	810 (High)	512 (Low)	661 (Mid)	810 (High)	9262 (Low)	9400 (Mid)	9538 (High)
Frequency (MHz)	1850.2	1880	1909.8	1850.2	1880	1909.8	1852.4	1880	1907.6
Conducted Power (dBm)	29.22	29.35	29.50	25.61	25.65	25.67	21.99	22.10	22.11

**Note:** Maximum burst average power for GSM, and maximum average power for WCDMA.



## 3.2 Peak-to-Average Ratio

### 3.2.1 Description of the PAR Measurement

The peak-to-average ratio (PAR) of the transmission may not exceed 13 dB.

### 3.2.2 Measuring Instruments

The measuring equipment is listed in the section 4 of this test report.

### 3.2.3 Test Procedures

1. The testing follows FCC KDB 971168 v02r02 Section 5.7.1.
2. The EUT was connected to the spectrum analyzer and system simulator via a power divider.
3. For GSM/EGPRS operating modes:
  - a. Set EUT in maximum power output.
  - b. Set the RBW = 1MHz, VBW = 3MHz, Peak detector on spectrum analyzer for first trace.
  - c. Set the RBW = 1MHz, VBW = 3MHz, RMS detector on spectrum analyzer for second trace.
  - d. The wanted burst signal is triggered by spectrum analyzer, and measured respectively the peak level and Mean level without burst-off time, after system simulator has synchronized with the spectrum analyzer.
4. For UMTS operating modes:
  - a. Set the CCDF (Complementary Cumulative Distribution Function) option on the spectrum analyzer.
  - b. The highest RF powers were measured and recorded the maximum PAPR level associated with a probability of 0.1 %.
5. Record the deviation as Peak to Average Ratio.

### 3.2.4 Test Setup

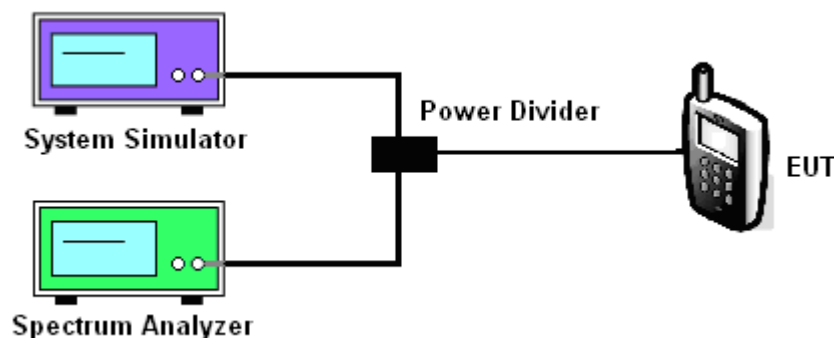



### 3.2.5 Test Result of Peak-to-Average Ratio

PCS Band									
Modes	GSM1900 (GSM)			GSM1900 (EDGE class 8)			WCDMA Band II (RMC 12.2Kbps)		
Channel	512 (Low)	661 (Mid)	810 (High)	512 (Low)	661 (Mid)	810 (High)	9262 (Low)	9400 (Mid)	9538 (High)
Frequency (MHz)	1850.2	1880	1909.8	1850.2	1880	1909.8	1852.4	1880	1907.6
Peak-to-Average Ratio (dB)	0.37	0.37	0.37	2.86	2.78	2.95	2.80	2.44	2.68



### 3.2.6 Test Result (Plots) of Peak-to-Average Ratio

Band :	GSM 1900	Test Mode :	GSM Link (GMSK)
--------	----------	-------------	-----------------

Peak-to-Average Ratio on Channel 512 (1850.2 MHz)

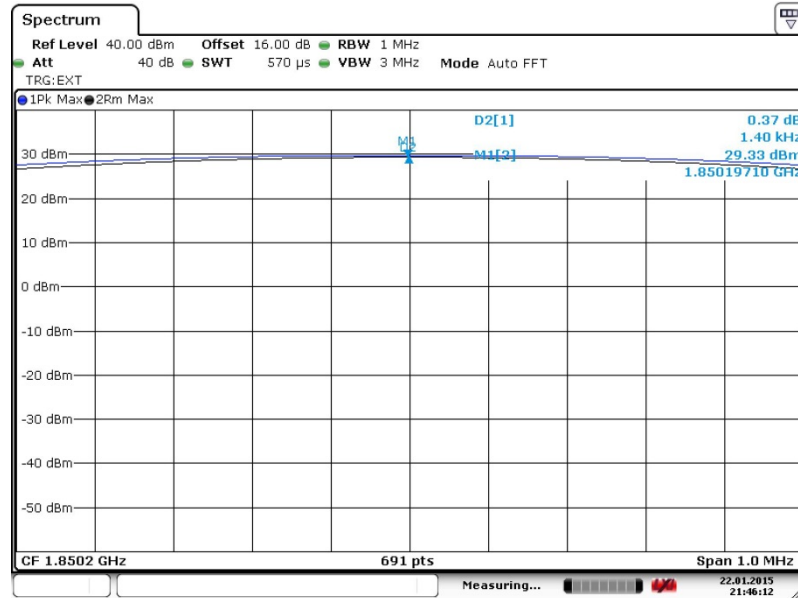

Date: 22.JAN.2015 21:46:13

Peak-to-Average Ratio on Channel 661 (1880.0 MHz)

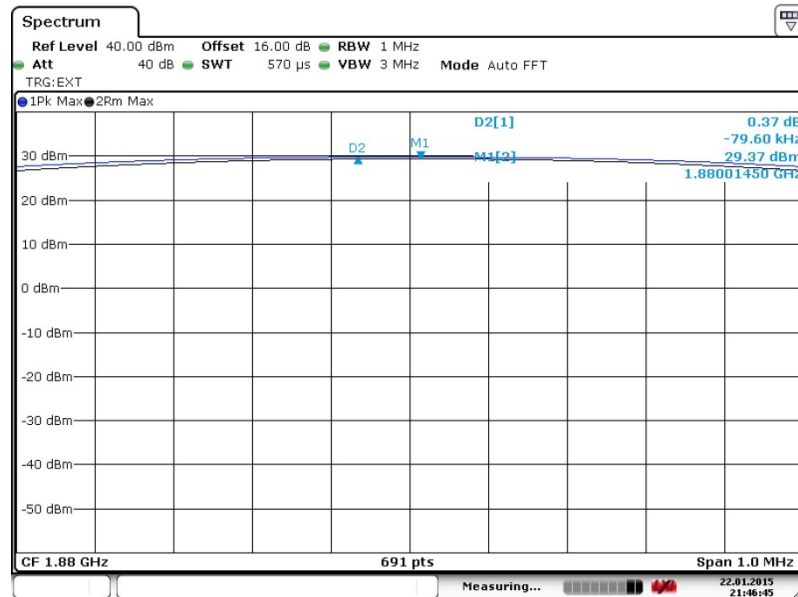

Date: 22.JAN.2015 21:46:44



Peak-to-Average Ratio on Channel 810 (1909.8 MHz)

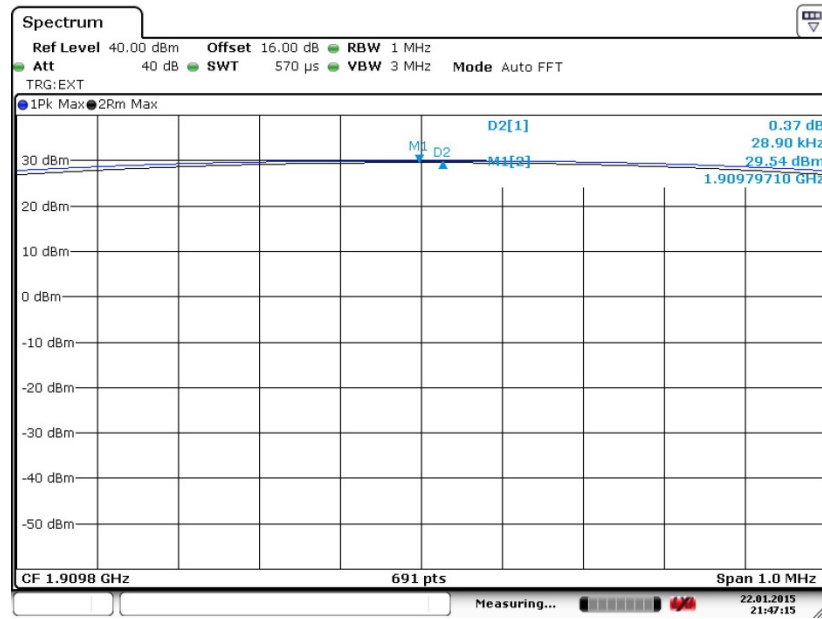

Date: 22.JAN.2015 21:47:15



<b>Band :</b>	GSM 1900	<b>Test Mode :</b>	EDGE class 8 Link (8PSK)
---------------	----------	--------------------	--------------------------

Peak-to-Average Ratio on Channel 512 (1850.2 MHz)

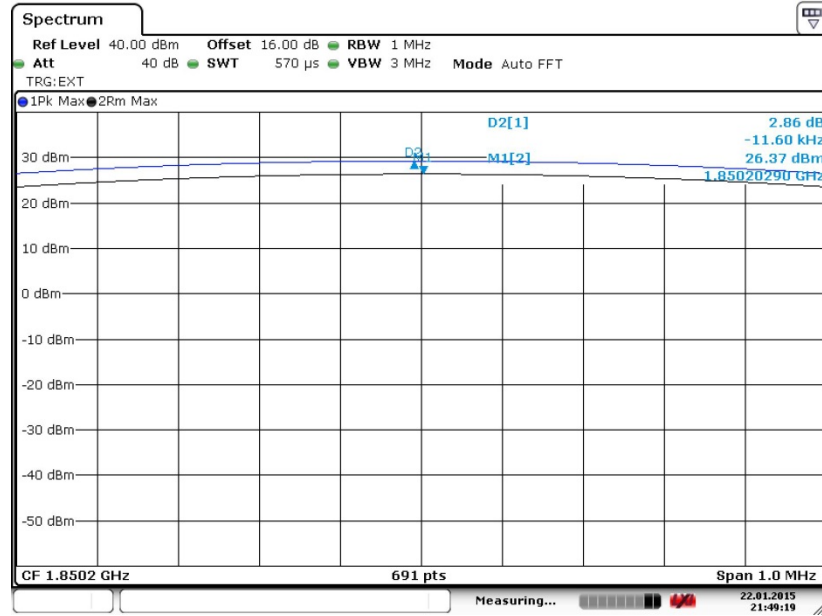

Date: 22.JAN.2015 21:49:18

Peak-to-Average Ratio on Channel 661 (1880.0 MHz)

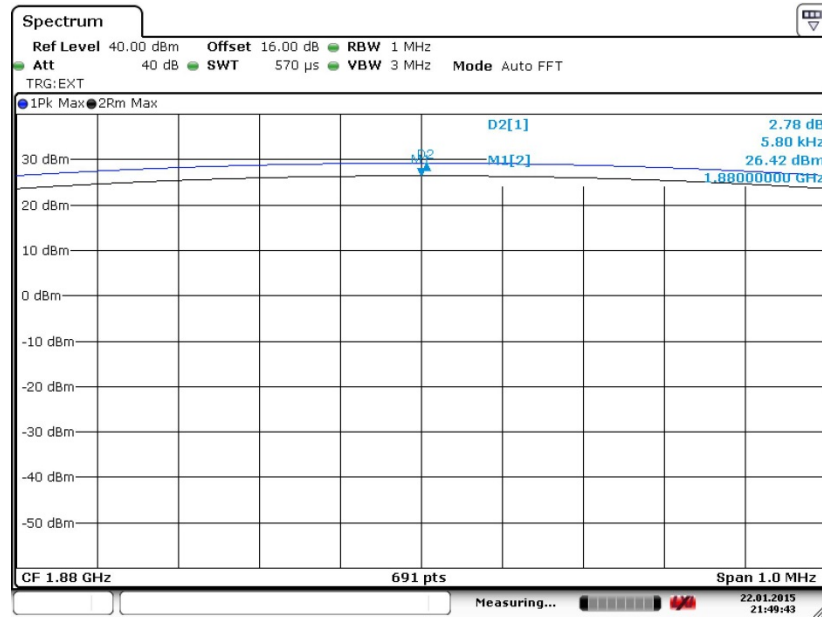

Date: 22.JAN.2015 21:49:43



Peak-to-Average Ratio on Channel 810 (1909.8 MHz)

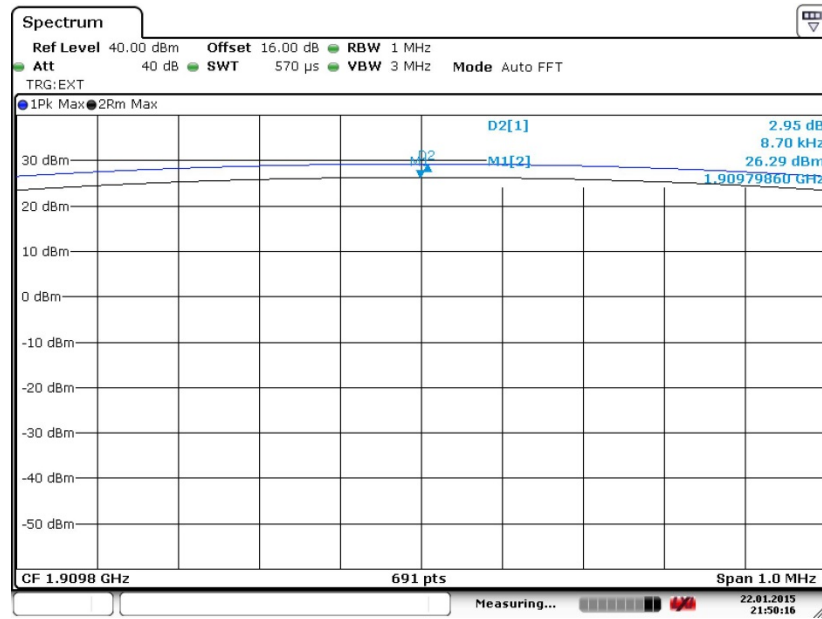

Date: 22.JAN.2015 21:50:15



<b>Band :</b>	WCDMA Band II	<b>Test Mode :</b>	RMC 12.2Kbps Link (QPSK)
---------------	---------------	--------------------	--------------------------

**Peak-to-Average Ratio on Channel 9262 (1852.4 MHz)**

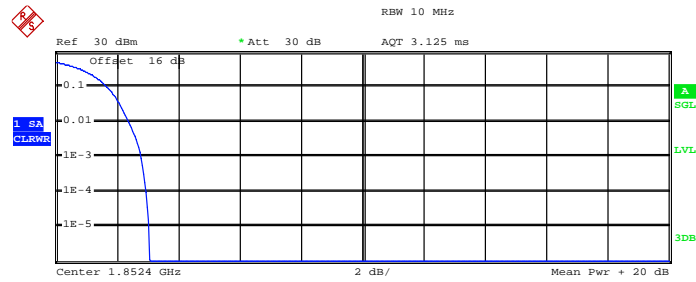

Complementary Cumulative Distribution Function (100000 samples)

Trace 1  
 Mean 23.31 dBm  
 Peak 26.38 dBm  
 Crest 3.07 dB

10 % 1.68 dB  
 1 % 2.40 dB  
 .1 % 2.80 dB  
 .01 % 2.96 dB

Date: 22.JAN.2015 22:31:39

**Peak-to-Average Ratio on Channel 9400 (1880.0 MHz)**

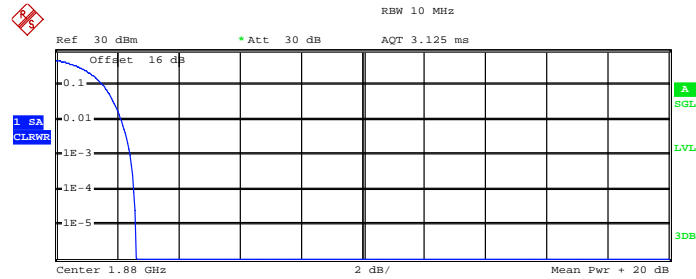

Complementary Cumulative Distribution Function (100000 samples)

Trace 1  
 Mean 23.49 dBm  
 Peak 26.10 dBm  
 Crest 2.61 dB

10 % 1.56 dB  
 1 % 2.16 dB  
 .1 % 2.44 dB  
 .01 % 2.56 dB

Date: 22.JAN.2015 22:31:55



Peak-to-Average Ratio on Channel 9538 (1907.6 MHz)

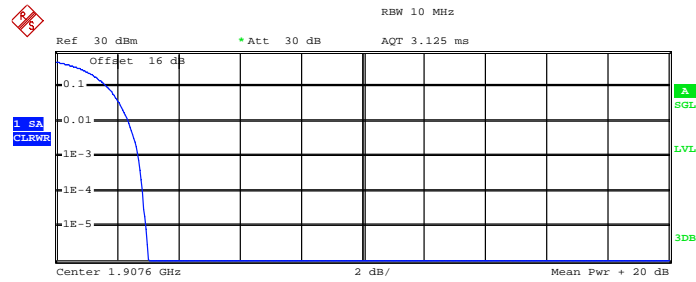

Complementary Cumulative Distribution Function (100000 samples)

Trace 1

Mean	23.51 dBm
Peak	26.52 dBm
Crest	3.01 dB
10 %	1.68 dB
1 %	2.36 dB
.1 %	2.68 dB
.01 %	2.84 dB

Date: 22.JAN.2015 22:32:12





### 3.3 Effective Radiated Power and Effective Isotropic Radiated Power Measurement

#### 3.3.1 Description of the ERP/EIRP Measurement

The substitution method, in ANSI / TIA / EIA-603-C-2004, was used for ERP/EIRP measurement, and the spectrum analyzer configuration follows KDB 971168 D01 Power Meas. License Digital Systems v02r02. The ERP of mobile transmitters must not exceed 7 Watts and the EIRP of mobile transmitters are limited to 2 Watts.

#### 3.3.2 Measuring Instruments

The measuring equipment is listed in the section 4 of this test report.

#### 3.3.3 Test Procedures

1. The testing follows FCC KDB 971168 v02r02 Section 5.2.1. (for WCDMA), Section 5.2.2.2 (for GSM/GPRS/EDGE) and ANSI / TIA-603-C-2004 Section 2.2.17.
2. The EUT was placed on a turntable 1.5 meters high in a fully anechoic chamber.
3. The EUT was placed 3 meters from the receiving antenna, which was mounted on the antenna tower.
4. GSM operating modes: Set RBW= 1MHz, VBW= 3MHz, RMS detector over burst;  
UMTS operating modes: Set RBW= 100 kHz, VBW= 300 kHz, RMS detector over frame, and use channel power option with bandwidth=5MHz, per KDB 971168 D01.
5. The table was rotated 360 degrees to determine the position of the highest radiated power.
6. The height of the receiving antenna is adjusted to look for the maximum ERP/EIRP.
7. Taking the record of maximum ERP/EIRP.
8. A dipole antenna was substituted in place of the EUT and was driven by a signal generator.
9. The conducted power at the terminal of the dipole antenna is measured.
10. Repeat step 3 to step 5 to get the maximum ERP/EIRP of the substitution antenna.
11.  $ERP/EIRP = P_s + E_t - E_s + G_s = P_s + R_t - R_s + G_s$

$P_s$  (dBm) : Input power to substitution antenna.

$G_s$  (dBi or dBd) : Substitution antenna Gain.

$E_t = R_t + AF$

$E_s = R_s + AF$

AF (dB/m) : Receive antenna factor

$R_t$  : The highest received signal in spectrum analyzer for EUT.

$R_s$  : The highest received signal in spectrum analyzer for substitution antenna.

### 3.3.4 Test Setup

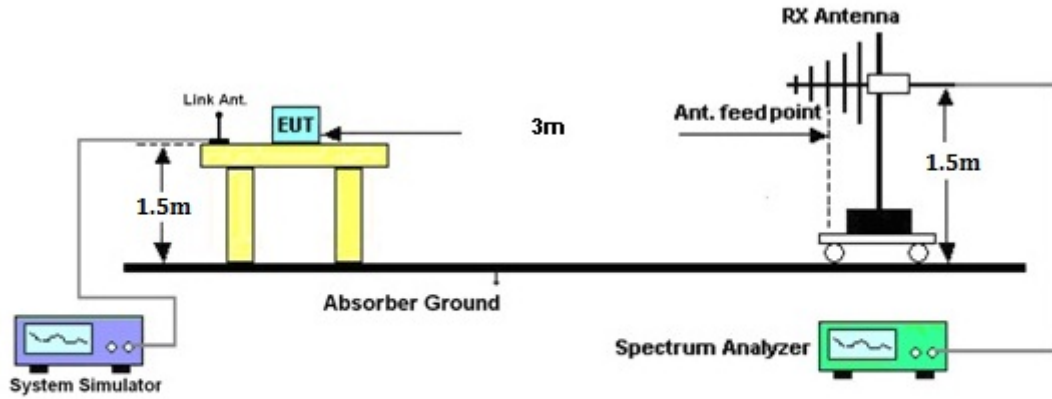



3.3.5 Test Result of ERP

GSM850 (GSM) Radiated Power ERP						
Horizontal Polarization						
Frequency (MHz)	Rt (dBm)	Rs (dBm)	Ps (dBm)	Gs (dBd)	ERP (dBm)	ERP (W)
824.20	-17.68	-48.12	0.00	-1.08	29.36	0.8635
836.40	-19.12	-48.28	0.00	-0.93	28.23	0.6647
848.80	-20.39	-48.35	0.00	-0.76	27.20	0.5250
Vertical Polarization						
Frequency (MHz)	Rt (dBm)	Rs (dBm)	Ps (dBm)	Gs (dBd)	ERP (dBm)	ERP (W)
824.20	-30.17	-47.97	0.00	-1.08	16.72	0.0470
836.40	-31.05	-48.01	0.00	-0.93	16.03	0.0401
848.80	-31.89	-48.05	0.00	-0.76	15.40	0.0347

GSM850 (EDGE class 8) Radiated Power ERP						
Horizontal Polarization						
Frequency (MHz)	Rt (dBm)	Rs (dBm)	Ps (dBm)	Gs (dBd)	ERP (dBm)	ERP (W)
824.20	-23.90	-48.12	0.00	-1.08	23.14	0.2061
836.40	-25.27	-48.28	0.00	-0.93	22.08	0.1616
848.80	-26.87	-48.35	0.00	-0.76	20.72	0.1181
Vertical Polarization						
Frequency (MHz)	Rt (dBm)	Rs (dBm)	Ps (dBm)	Gs (dBd)	ERP (dBm)	ERP (W)
824.20	-36.28	-47.97	0.00	-1.08	10.61	0.0115
836.40	-37.22	-48.01	0.00	-0.93	9.86	0.0097
848.80	-38.54	-48.05	0.00	-0.76	8.75	0.0075



WCDMA Band V (RMC 12.2Kbps) Radiated Power ERP						
Horizontal Polarization						
Frequency (MHz)	Rt (dBm)	Rs (dBm)	Ps (dBm)	Gs (dBd)	ERP (dBm)	ERP (W)
826.40	-27.04	-48.12	0.00	-1.08	20.00	0.1000
836.40	-27.96	-48.28	0.00	-0.93	19.39	0.0870
846.60	-28.80	-48.35	0.00	-0.76	18.79	0.0757
Vertical Polarization						
Frequency (MHz)	Rt (dBm)	Rs (dBm)	Ps (dBm)	Gs (dBd)	ERP (dBm)	ERP (W)
826.40	-39.65	-47.97	0.00	-1.08	7.24	0.0053
836.40	-40.03	-48.01	0.00	-0.93	7.05	0.0051
846.60	-40.31	-48.05	0.00	-0.76	6.98	0.0050



3.3.6 Test Result of EIRP

GSM1900 (GSM) Radiated Power EIRP						
Horizontal Polarization						
Frequency (MHz)	Rt (dBm)	Rs (dBm)	Ps (dBm)	Gs (dBi)	EIRP (dBm)	EIRP (W)
1850.20	-22.14	-51.88	0.00	1.96	31.70	1.4780
1880.00	-22.63	-52.99	0.00	2.00	32.36	1.7238
1909.80	-23.52	-54.28	0.00	1.98	32.74	1.8781
Vertical Polarization						
Frequency (MHz)	Rt (dBm)	Rs (dBm)	Ps (dBm)	Gs (dBi)	EIRP (dBm)	EIRP (W)
1850.20	-21.83	-52.13	0.00	1.96	32.26	1.6843
1880.00	-22.38	-53.17	0.00	2.00	32.79	1.9004
1909.80	-23.17	-54.13	0.00	1.98	32.94	1.9678

GSM1900 (EDGE class 8) Radiated Power EIRP						
Horizontal Polarization						
Frequency (MHz)	Rt (dBm)	Rs (dBm)	Ps (dBm)	Gs (dBi)	EIRP (dBm)	EIRP (W)
1850.20	-26.08	-51.88	0.00	1.96	27.76	0.5974
1880.00	-26.47	-52.99	0.00	2.00	28.52	0.7119
1909.80	-27.35	-54.28	0.00	1.98	28.91	0.7775
Vertical Polarization						
Frequency (MHz)	Rt (dBm)	Rs (dBm)	Ps (dBm)	Gs (dBi)	EIRP (dBm)	EIRP (W)
1850.20	-25.70	-52.13	0.00	1.96	28.39	0.6902
1880.00	-26.23	-53.17	0.00	2.00	28.94	0.7828
1909.80	-26.84	-54.13	0.00	1.98	29.27	0.8456



WCDMA Band II (RMC 12.2Kbps) Radiated Power EIRP						
Horizontal Polarization						
Frequency (MHz)	Rt (dBm)	Rs (dBm)	Ps (dBm)	Gs (dBi)	EIRP (dBm)	EIRP (W)
1852.40	-28.00	-51.88	0.00	1.96	25.84	0.3839
1880.00	-28.52	-52.99	0.00	2.00	26.47	0.4441
1907.60	-29.69	-54.28	0.00	1.98	26.57	0.4539
Vertical Polarization						
Frequency (MHz)	Rt (dBm)	Rs (dBm)	Ps (dBm)	Gs (dBi)	EIRP (dBm)	EIRP (W)
1852.40	-27.52	-52.13	0.00	1.96	26.57	0.4535
1880.00	-28.31	-53.17	0.00	2.00	26.86	0.4855
1907.60	-29.31	-54.13	0.00	1.98	26.80	0.4789

### 3.4 99% Occupied Bandwidth and 26dB Bandwidth Measurement

#### 3.4.1 Description of 99% Occupied Bandwidth and 26dB Bandwidth Measurement

The 99% occupied bandwidth is the width of a frequency band such that, below the lower and above the upper frequency limits, the mean powers emitted are each equal to a specified percentage 0.5% of the total mean transmitted power.

The emission bandwidth is defined as the width of the signal between two points, located at the 2 sides of the carrier frequency, outside of which all emissions are attenuated at least 26 dB below the transmitter power.

#### 3.4.2 Measuring Instruments

The measuring equipment is listed in the section 4 of this test report.

#### 3.4.3 Test Procedures

1. The testing follows FCC KDB 971168 v02r02 Section 4.2.
2. The EUT was connected to the spectrum analyzer and system simulator via a power divider.
3. The RF output of the EUT was connected to the spectrum analyzer by RF cable and attenuator. The path loss was compensated to the results for each measurement.
4. The 99% occupied bandwidth were measured, set RBW= 1% of span, VBW= 3\*RBW, peak detector, trace maximum hold.
5. The 26dB bandwidth were measured, set RBW= 1% of EBW, VBW= 3\*RBW, peak detector, trace maximum hold.

#### 3.4.4 Test Setup

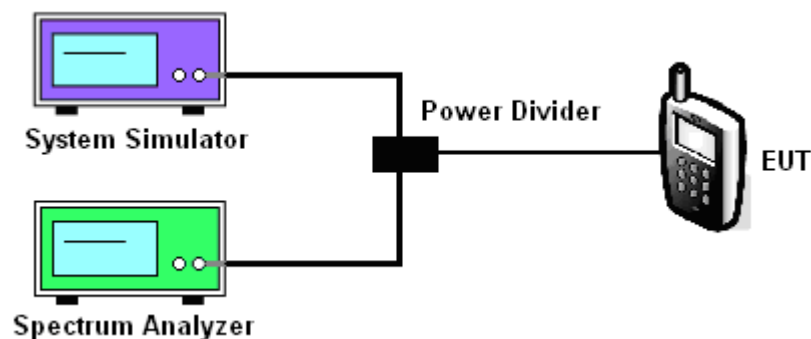



3.4.5 Test Result of Occupied Bandwidth and 26dB Bandwidth

Cellular Band						
Modes	GSM850 (GSM)			GSM850 (EDGE class 8)		
Channel	128 (Low)	189 (Mid)	251 (High)	128 (Low)	189 (Mid)	251 (High)
Frequency (MHz)	824.2	836.4	848.8	824.2	836.4	848.8
99% OBW (kHz)	246.00	244.00	244.00	244.00	244.00	242.00
26dB BW (kHz)	312.00	316.00	312.00	304.00	306.00	312.00

PCS Band						
Modes	GSM1900 (GSM)			GSM1900 (EDGE class 8)		
Channel	512 (Low)	661 (Mid)	810 (High)	512 (Low)	661 (Mid)	810 (High)
Frequency (MHz)	1850.2	1880	1909.8	1850.2	1880	1909.8
99% OBW (kHz)	244.00	246.00	246.00	250.00	246.00	248.00
26dB BW (kHz)	314.00	310.00	310.00	312.00	308.00	314.00

Cellular Band			
Modes	WCDMA Band V (RMC 12.2Kbps)		
Channel	4132 (Low)	4182 (Mid)	4233 (High)
Frequency (MHz)	826.4	836.4	846.6
99% OBW (MHz)	4.16	4.16	4.18
26dB BW (MHz)	4.68	4.68	4.68

PCS Band			
Modes	WCDMA Band II (RMC 12.2Kbps)		
Channel	9262 (Low)	9400 (Mid)	9538 (High)
Frequency (MHz)	1852.4	1880	1907.6
99% OBW (MHz)	4.18	4.18	4.18
26dB BW (MHz)	4.68	4.70	4.68





### 3.4.6 Test Result (Plots) of Occupied Bandwidth and 26dB Bandwidth

Band :	GSM 850	Test Mode :	GSM Link (GMSK)
--------	---------	-------------	-----------------

#### 99% Occupied Bandwidth Plot on Channel 128 (824.2 MHz)

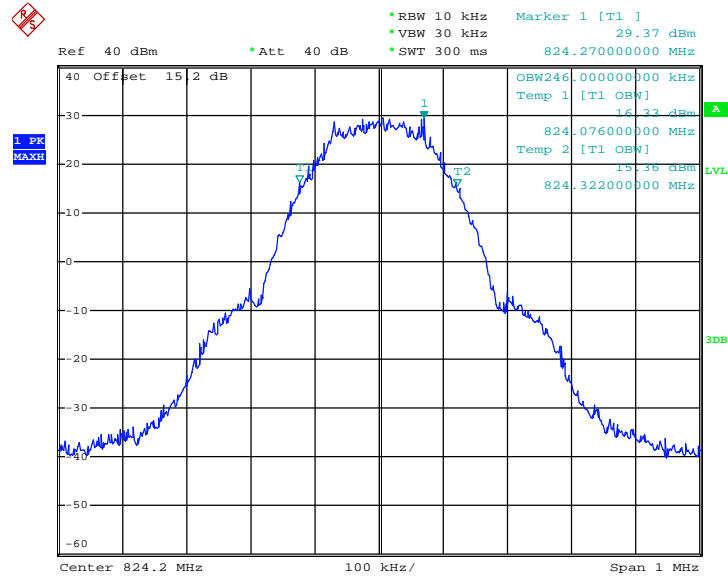

Date: 22.JAN.2015 21:24:23

#### 26dB Bandwidth Plot on Channel 128 (824.2 MHz)

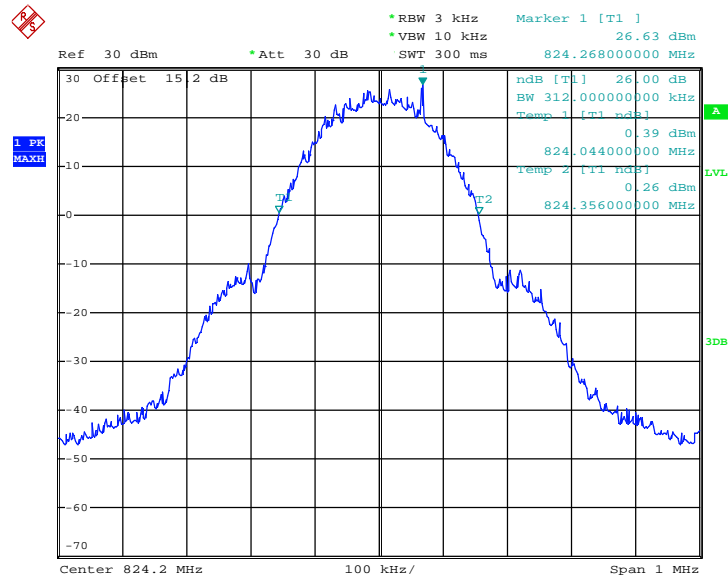

Date: 22.JAN.2015 20:51:29



99% Occupied Bandwidth Plot on Channel 189 (836.4 MHz)

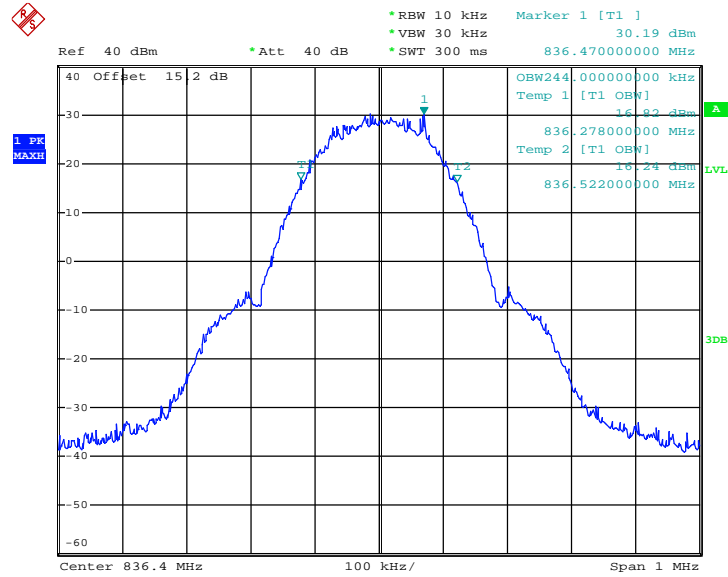

Date: 22.JAN.2015 21:21:36

26dB Bandwidth Plot on Channel 189 (836.4 MHz)

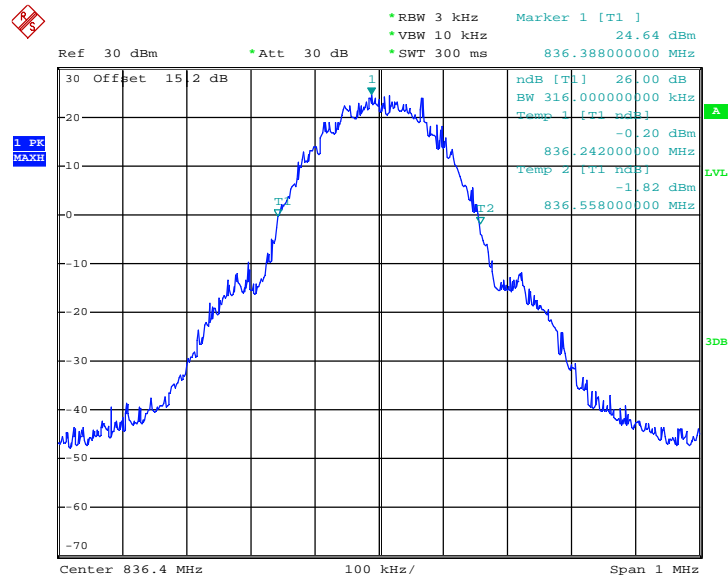

Date: 22.JAN.2015 20:52:29



99% Occupied Bandwidth Plot on Channel 251 (848.8 MHz)

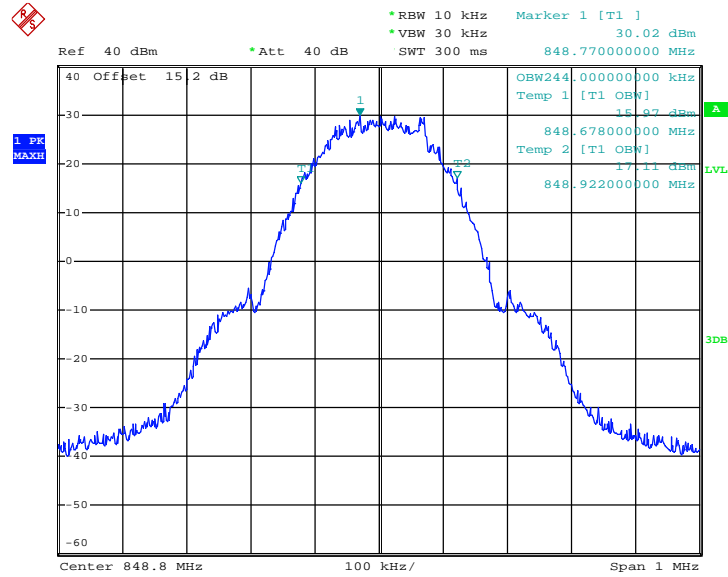

Date: 22.JAN.2015 20:57:02

26dB Bandwidth Plot on Channel 251 (848.8 MHz)

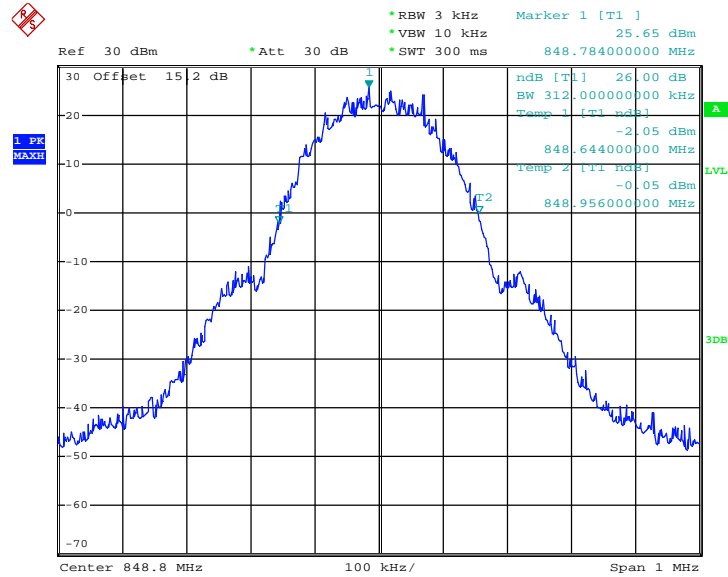

Date: 22.JAN.2015 20:53:20



Band :	GSM 850	Test Mode :	EDGE class 8 Link (8PSK)
--------	---------	-------------	--------------------------

99% Occupied Bandwidth Plot on Channel 128 (824.2 MHz)

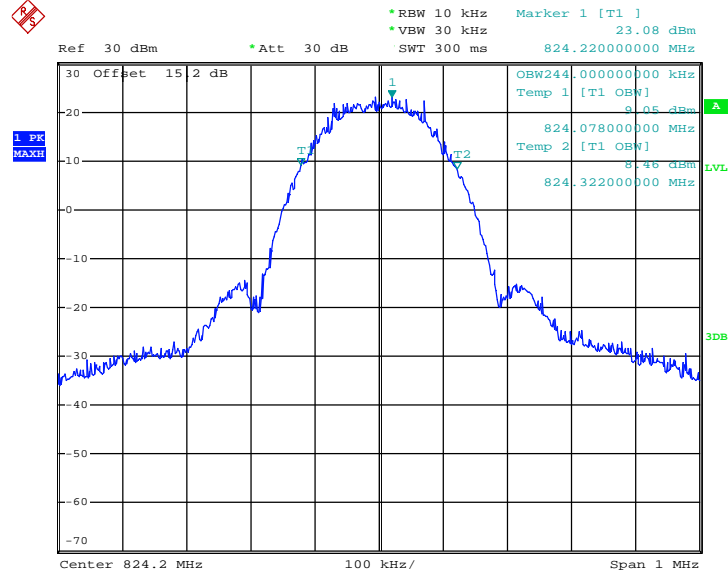

Date: 22.JAN.2015 21:28:46

26dB Bandwidth Plot on Channel 128 (824.2 MHz)

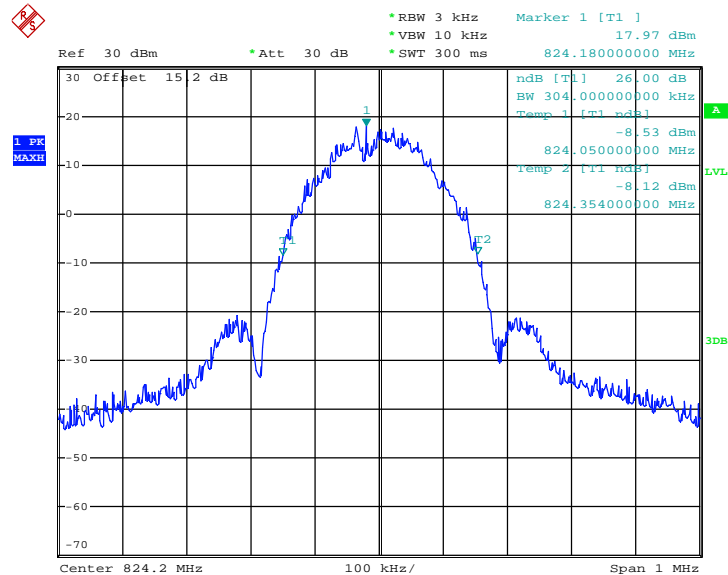

Date: 22.JAN.2015 21:38:05



99% Occupied Bandwidth Plot on Channel 189 (836.4 MHz)

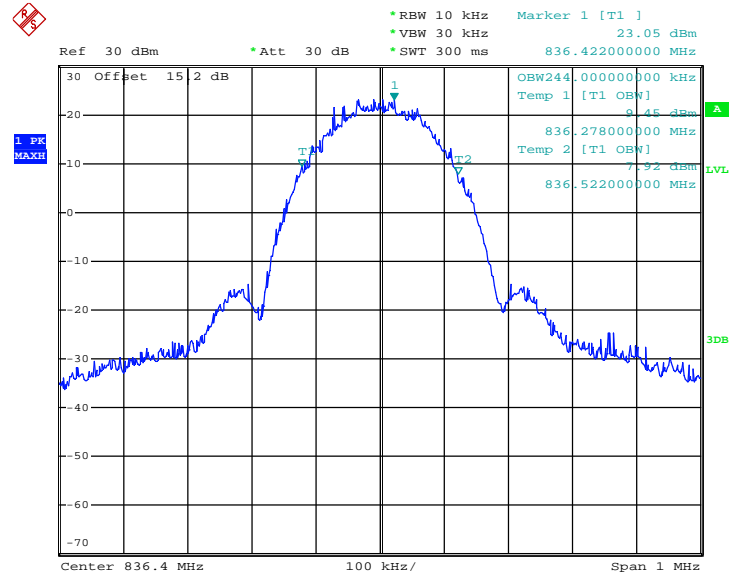

Date: 22.JAN.2015 21:31:56

26dB Bandwidth Plot on Channel 189 (836.4 MHz)

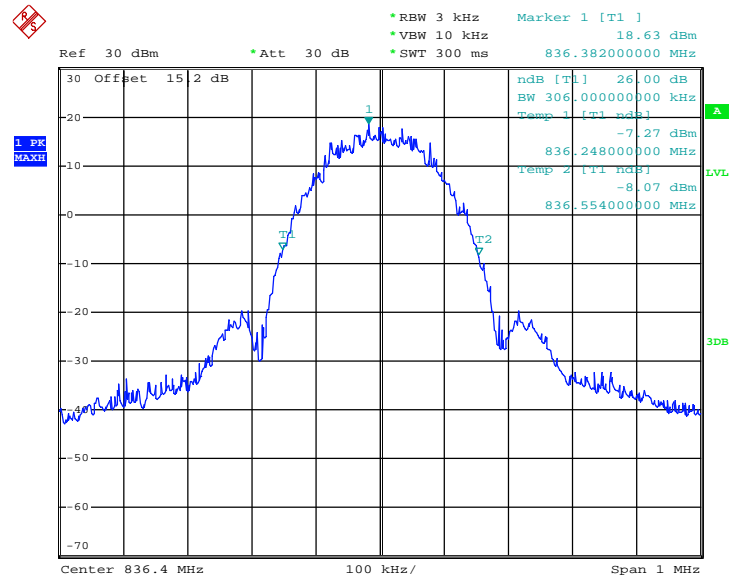

Date: 22.JAN.2015 21:37:20



### 99% Occupied Bandwidth Plot on Channel 251 (848.8 MHz)

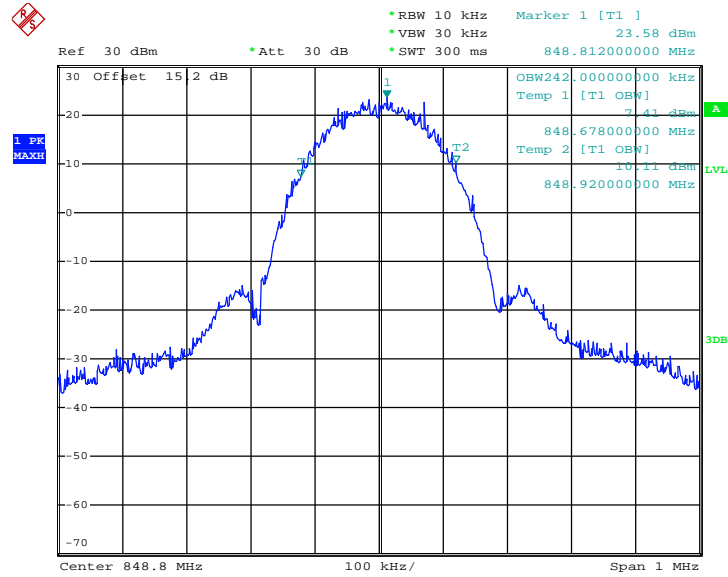

Date: 22.JAN.2015 21:32:43

### 26dB Bandwidth Plot on Channel 251 (848.8 MHz)

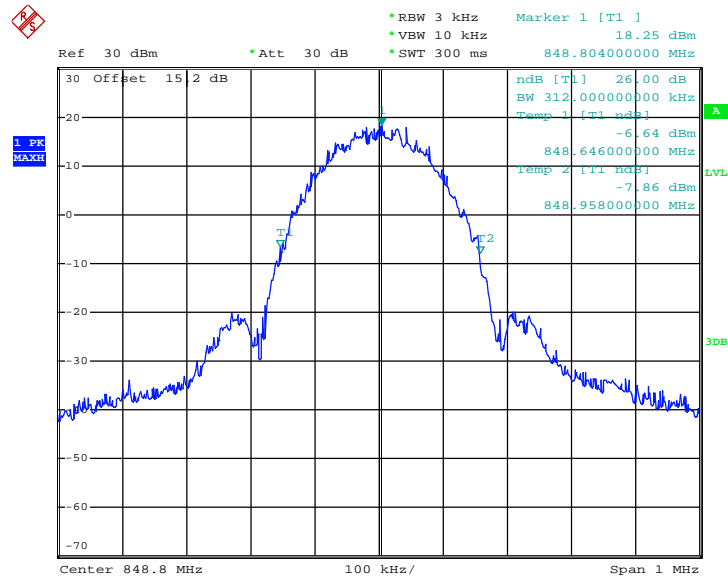

Date: 22.JAN.2015 21:35:39



Band :	GSM 1900	Test Mode :	GSM Link (GMSK)
--------	----------	-------------	-----------------

99% Occupied Bandwidth Plot on Channel 512 (1850.2 MHz)

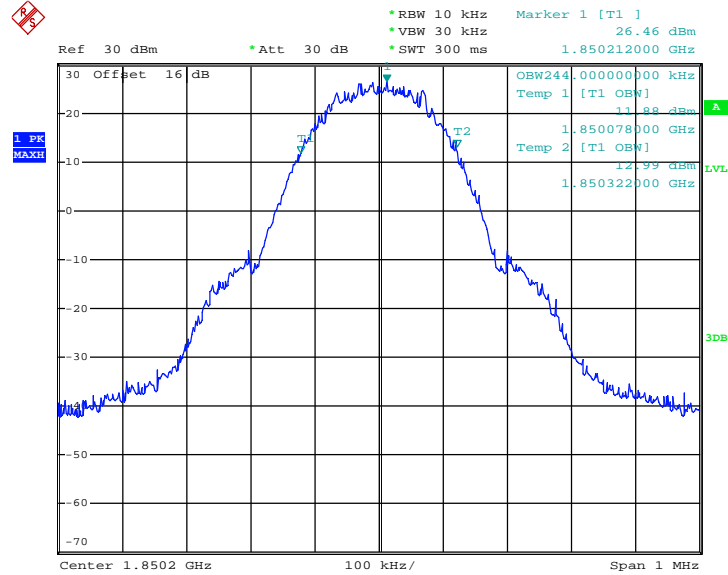

Date: 22.JAN.2015 22:53:37

26dB Bandwidth Plot on Channel 512 (1850.2 MHz)

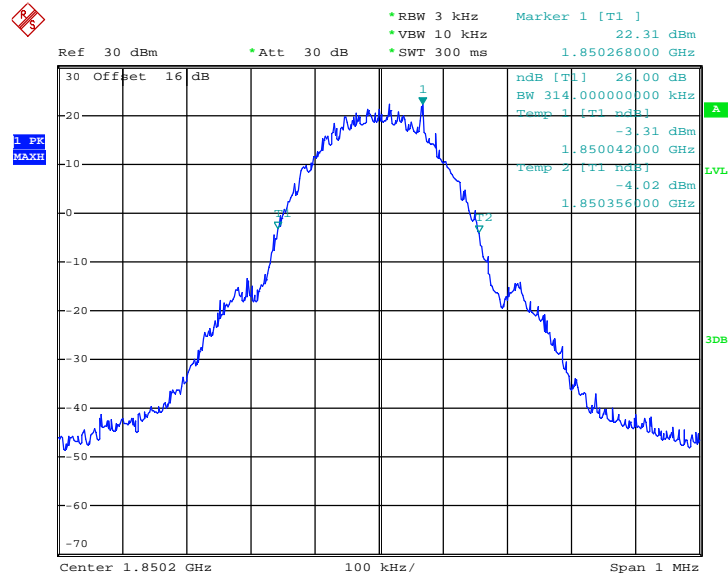

Date: 22.JAN.2015 22:43:17



99% Occupied Bandwidth Plot on Channel 661 (1880.0 MHz)

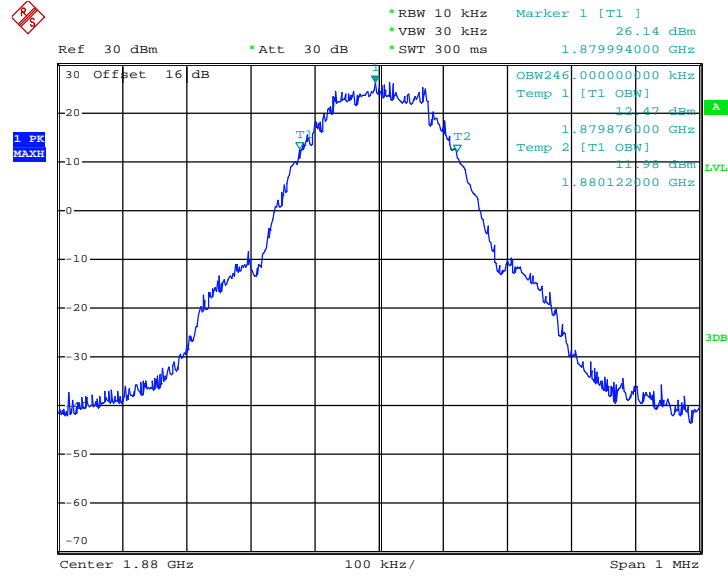

Date: 22.JAN.2015 22:48:52

26dB Bandwidth Plot on Channel 661 (1880.0 MHz)

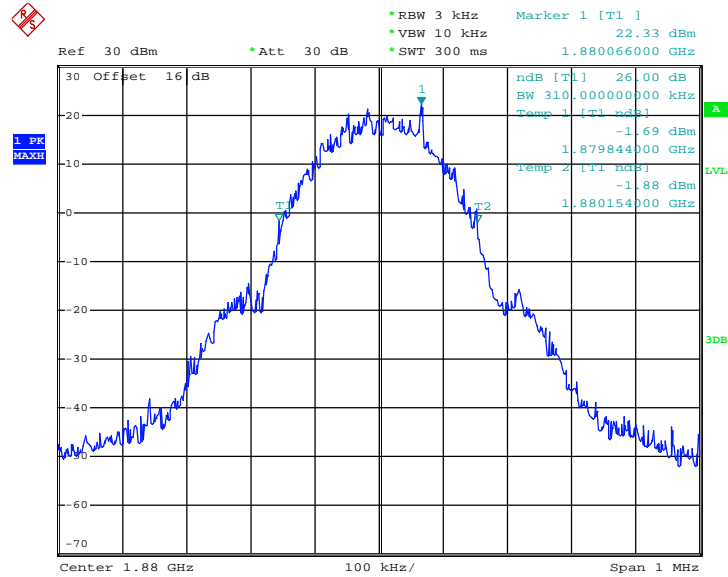

Date: 21.JAN.2015 20:47:22





99% Occupied Bandwidth Plot on Channel 810 (1909.8 MHz)

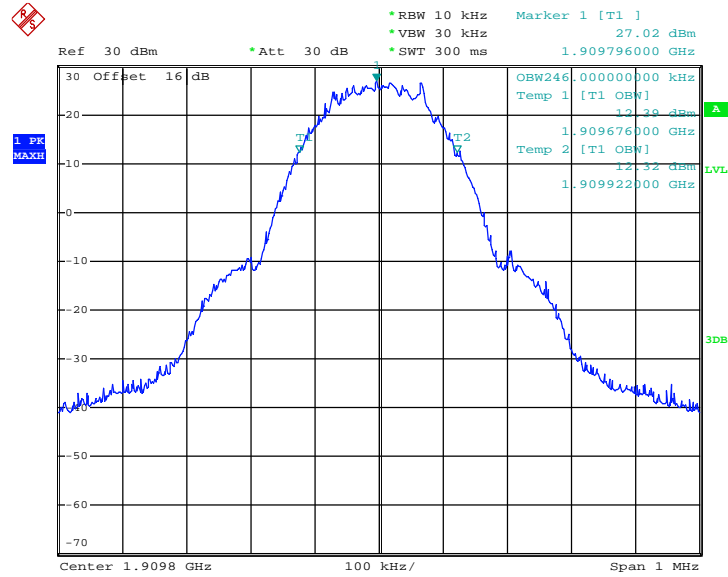

Date: 22.JAN.2015 22:46:09

26dB Bandwidth Plot on Channel 810 (1909.8 MHz)

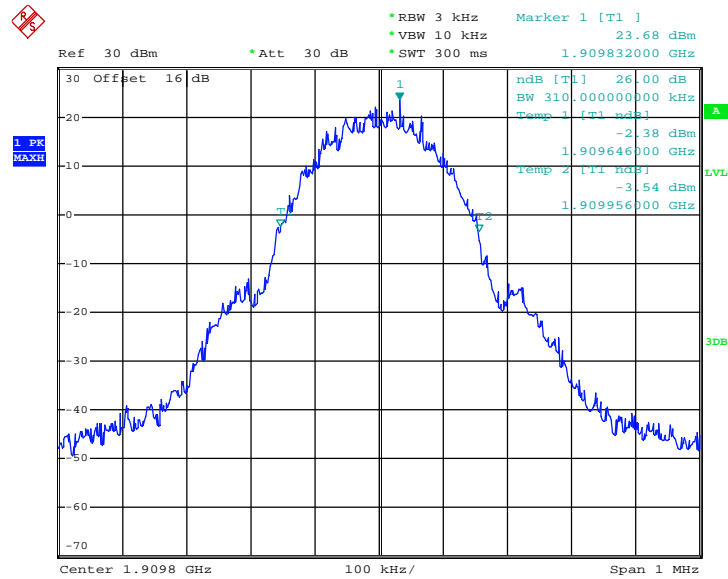

Date: 22.JAN.2015 22:44:40



<b>Band :</b>	GSM 1900	<b>Test Mode :</b>	EDGE class 8 Link (8PSK)
---------------	----------	--------------------	--------------------------

99% Occupied Bandwidth Plot on Channel 512 (1850.2 MHz)

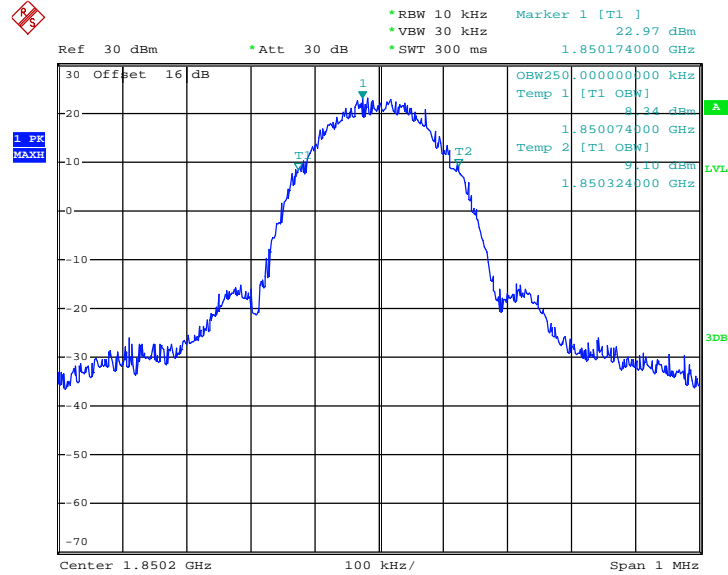

Date: 22.JAN.2015 23:51:56

26dB Bandwidth Plot on Channel 512 (1850.2 MHz)

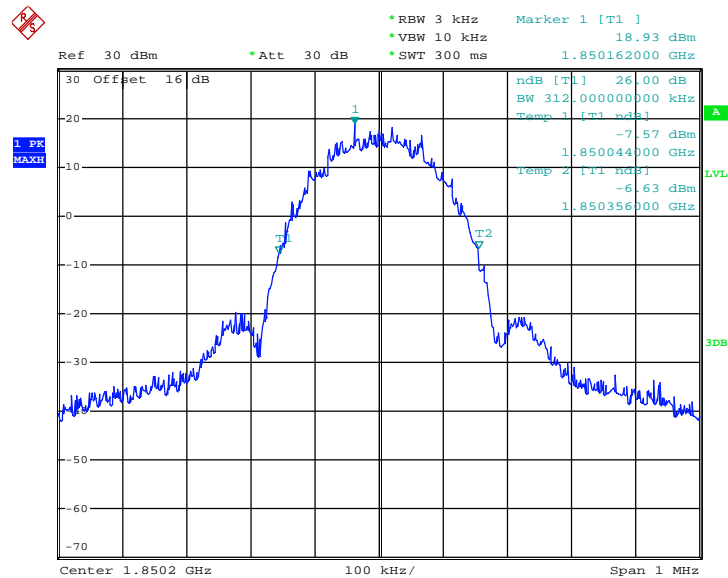

Date: 22.JAN.2015 23:23:06



99% Occupied Bandwidth Plot on Channel 661 (1880.0 MHz)

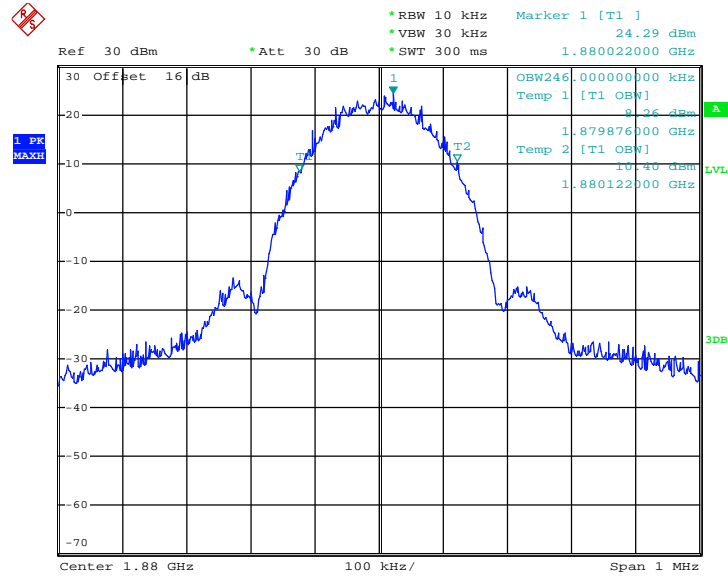

Date: 22.JAN.2015 23:50:40

26dB Bandwidth Plot on Channel 661 (1880.0 MHz)

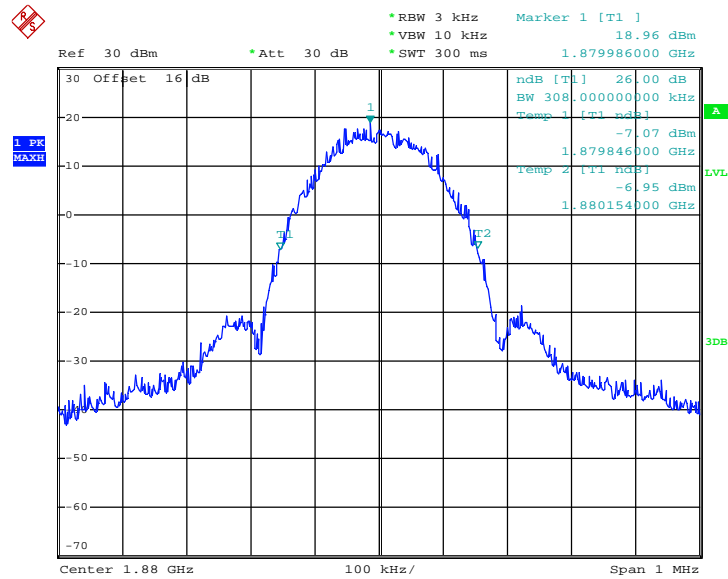

Date: 22.JAN.2015 23:24:41



99% Occupied Bandwidth Plot on Channel 810 (1909.8 MHz)

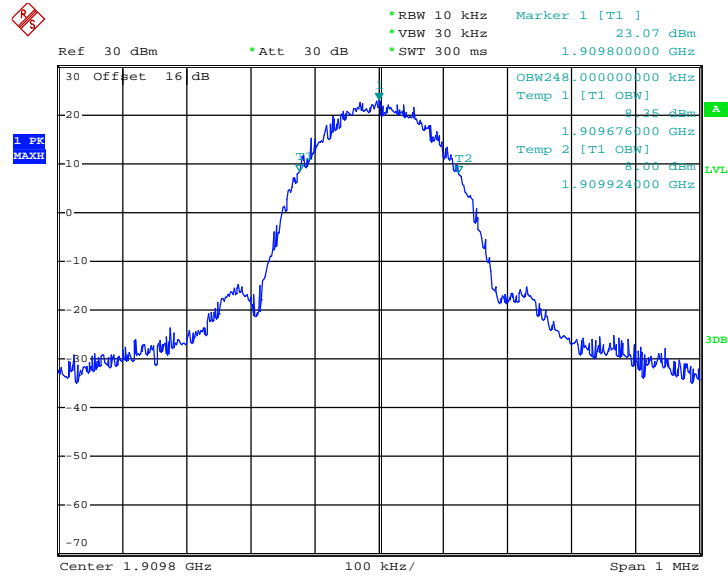

Date: 22.JAN.2015 23:47:12

26dB Bandwidth Plot on Channel 810 (1909.8 MHz)

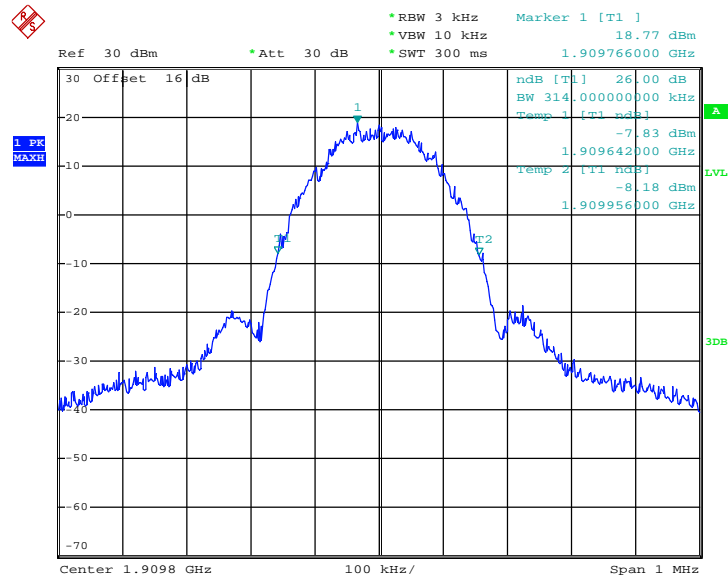

Date: 22.JAN.2015 23:46:15



Band :	WCDMA Band V	Test Mode :	RMC 12.2Kbps Link (QPSK)
--------	--------------	-------------	--------------------------

99% Occupied Bandwidth Plot on Channel 4132 (826.4 MHz)

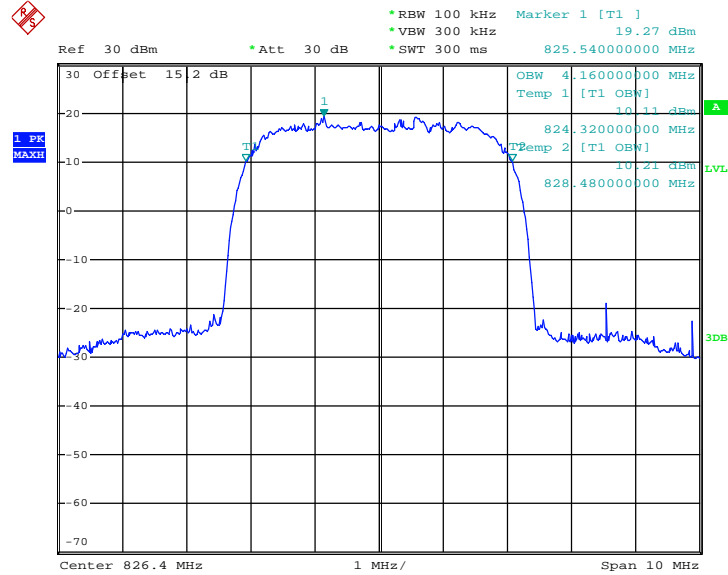

Date: 22.JAN.2015 22:09:00

26dB Bandwidth Plot on Channel 4132 (826.4 MHz)

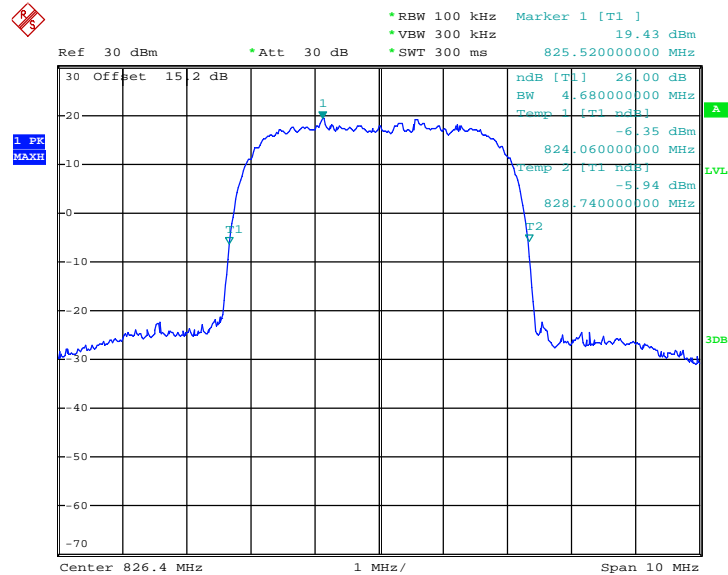

Date: 22.JAN.2015 22:04:53



99% Occupied Bandwidth Plot on Channel 4182 (836.4 MHz)

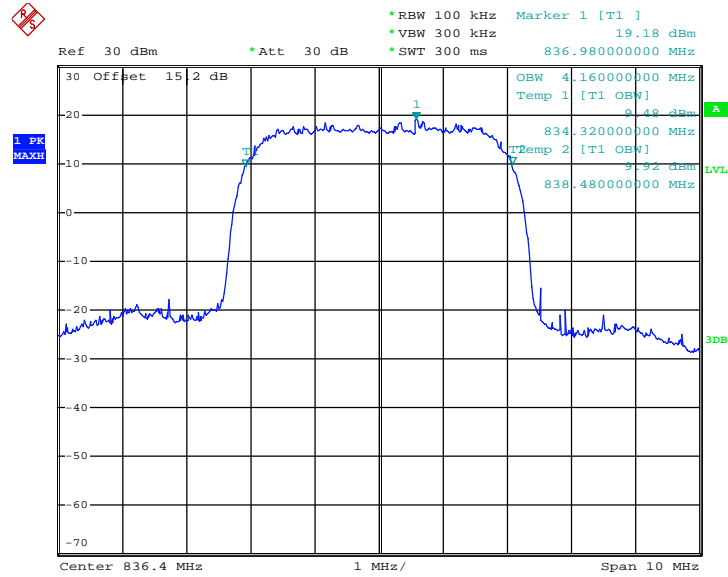

Date: 22.JAN.2015 22:08:38

26dB Bandwidth Plot on Channel 4182 (836.4 MHz)

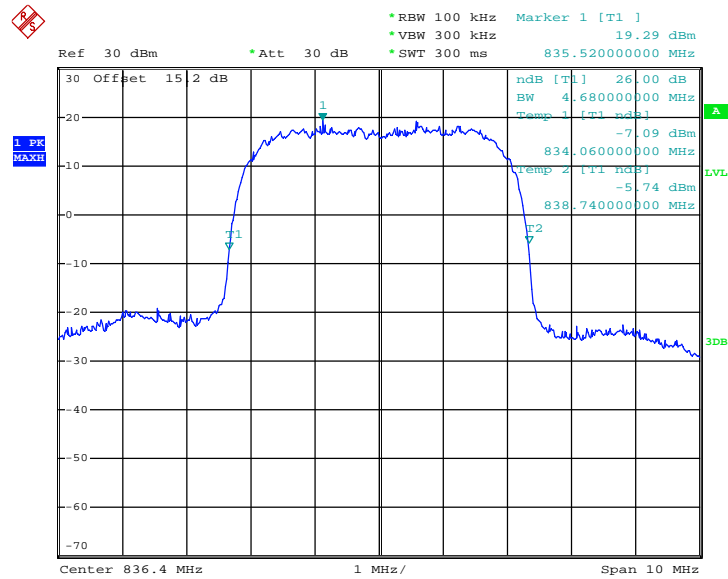

Date: 22.JAN.2015 22:05:19



99% Occupied Bandwidth Plot on Channel 4233 (846.6 MHz)

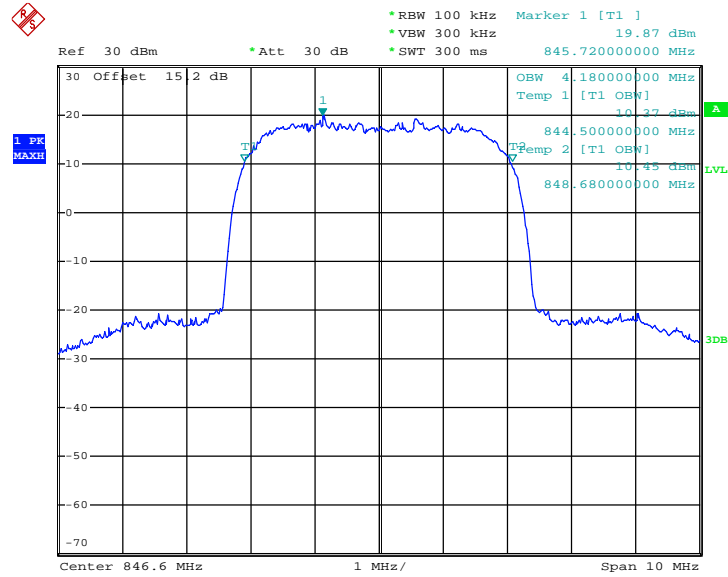

Date: 22.JAN.2015 22:07:18

26dB Bandwidth Plot on Channel 4233 (846.6 MHz)

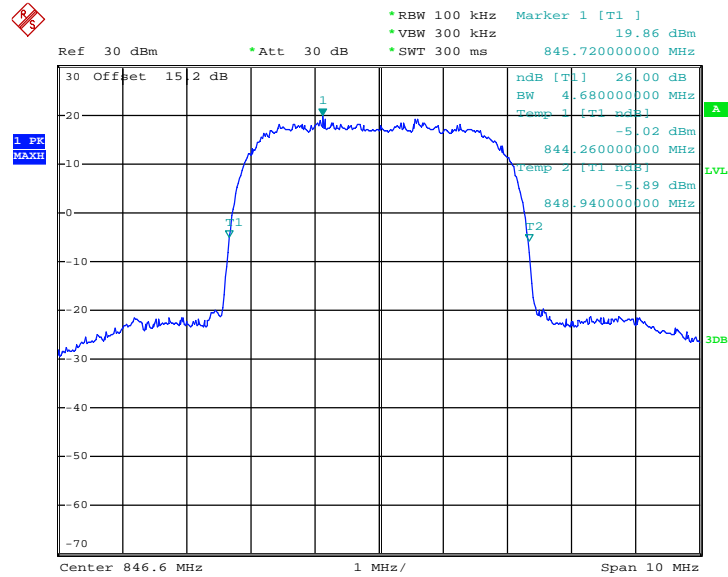

Date: 22.JAN.2015 22:05:52



Band :	WCDMA Band II	Test Mode :	RMC 12.2Kbps Link (QPSK)
--------	---------------	-------------	--------------------------

99% Occupied Bandwidth Plot on Channel 9262 (1852.4 MHz)

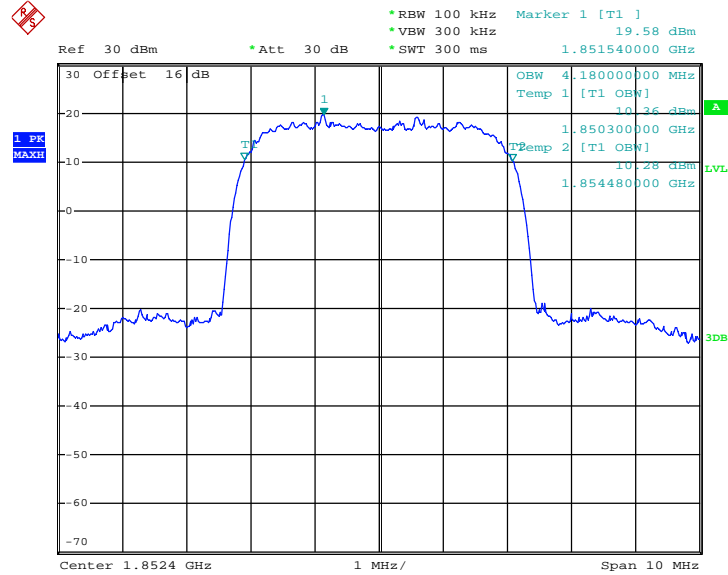

Date: 22.JAN.2015 22:29:14

26dB Bandwidth Plot on Channel 9262 (1852.4 MHz)

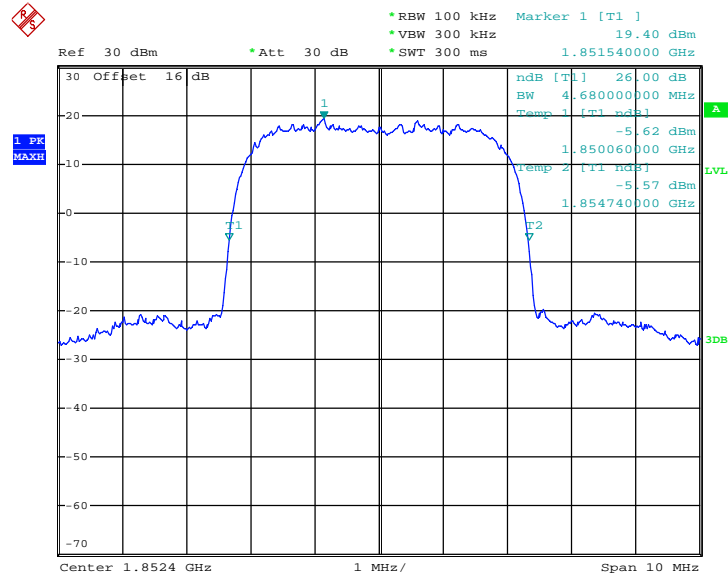

Date: 22.JAN.2015 22:23:02





99% Occupied Bandwidth Plot on Channel 9400 (1880.0 MHz)

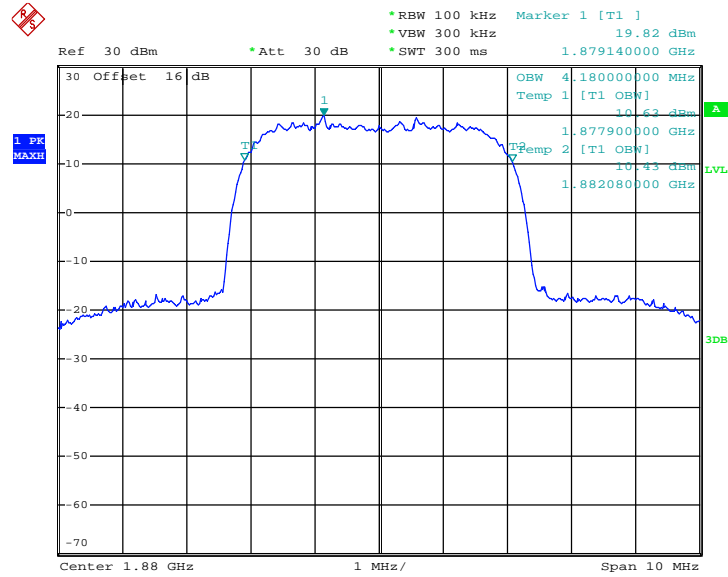

Date: 22.JAN.2015 22:28:12

26dB Bandwidth Plot on Channel 9400 (1880.0 MHz)

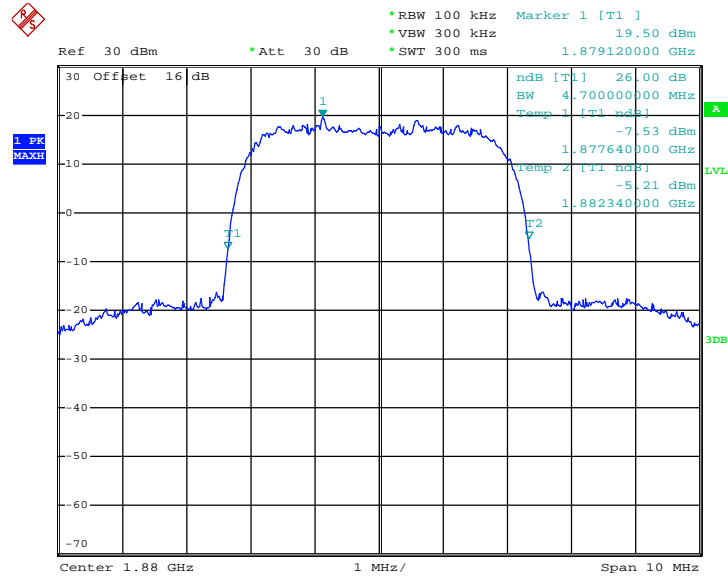

Date: 22.JAN.2015 22:23:23



### 99% Occupied Bandwidth Plot on Channel 9538 (1907.6 MHz)

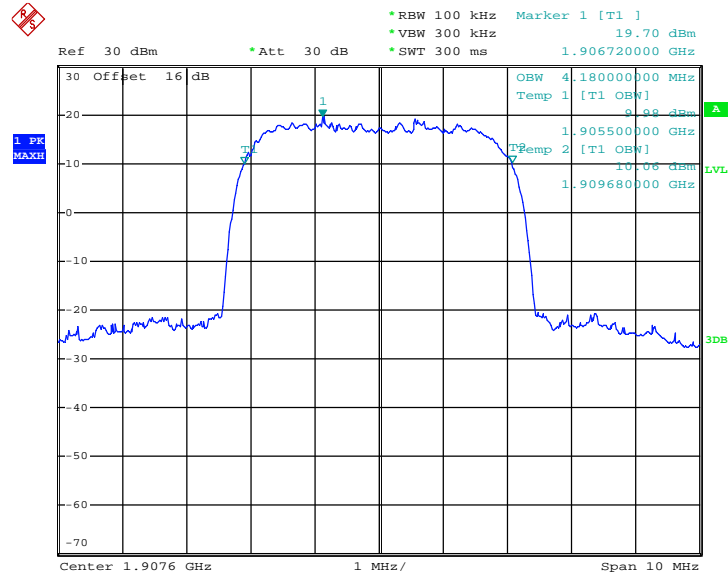

Date: 22.JAN.2015 22:24:21

### 26dB Bandwidth Plot on Channel 9538 (1907.6 MHz)

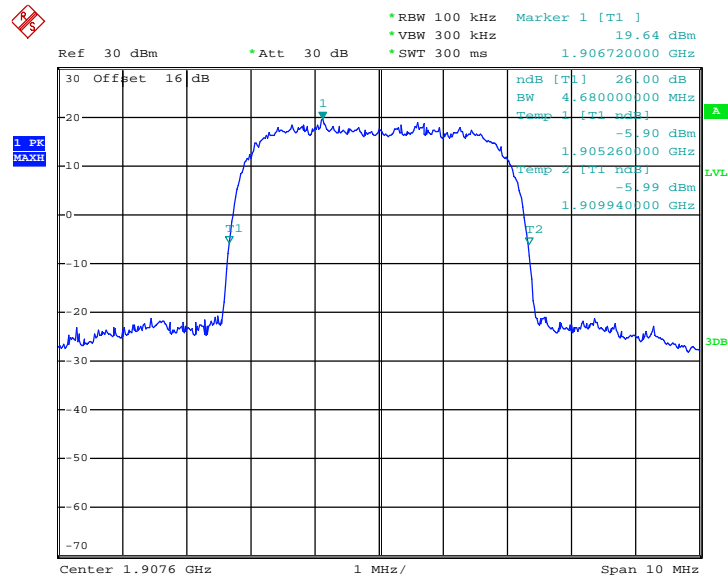

Date: 22.JAN.2015 22:23:51

## 3.5 Band Edge Measurement

### 3.5.1 Description of Band Edge Measurement

The power of any emission outside of the authorized operating frequency ranges must be lower than the transmitter power (P) by a factor of at least  $43 + 10 \log (P)$  dB.

### 3.5.2 Measuring Instruments

The measuring equipment is listed in the section 4 of this test report.

### 3.5.3 Test Procedures

1. The testing follows FCC KDB 971168 v02r02 Section 6.0.
2. The EUT was connected to the spectrum analyzer and system simulator via a power divider.
3. The RF output of EUT was connected to the spectrum analyzer by an RF cable and attenuator. The path loss was compensated to the results for each measurement.
4. The band edges of low and high channels for the highest RF powers were measured.
5. The RF fundamental frequency should be excluded against the limit line in the operating frequency band.
6. The limit line is derived from  $43 + 10\log(P)$  dB below the transmitter power P(Watts)  
 $= P(W) - [43 + 10\log(P)] \text{ (dB)}$   
 $= [30 + 10\log(P)] \text{ (dBm)} - [43 + 10\log(P)] \text{ (dB)}$   
 $= -13\text{dBm}.$

### 3.5.4 Test Setup

<Conducted Band Edge >

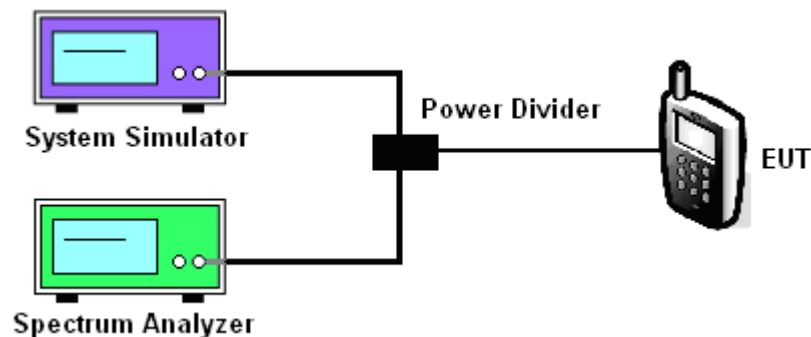



### 3.5.5 Test Result (Plots) of Conducted Band Edge

Band :	GSM850	Test Mode :	GSM Link (GMSK)
--------	--------	-------------	--------------------

Lower Band Edge Plot on Channel 128 (824.2 MHz)

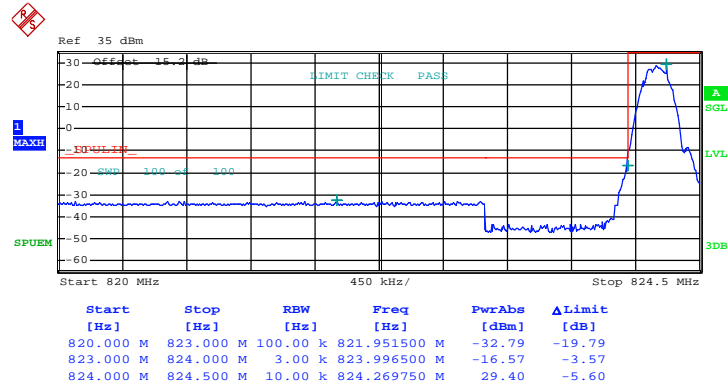

Date: 22.JAN.2015 21:09:54



Band :	GSM850	Test Mode :	GSM Link (GMSK)
--------	--------	-------------	--------------------

Higher Band Edge Plot on Channel 251 (848.8 MHz)

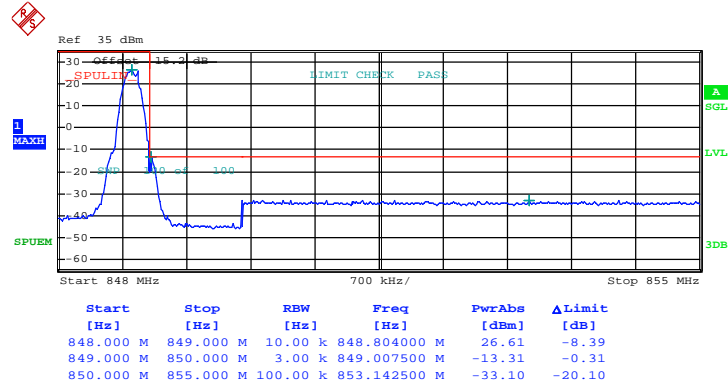

Date: 22.JAN.2015 21:07:48



Band :	GSM850	Test Mode :	EDGE class 8 Link (8PSK)
--------	--------	-------------	-----------------------------

Lower Band Edge Plot on Channel 128 (824.2 MHz)

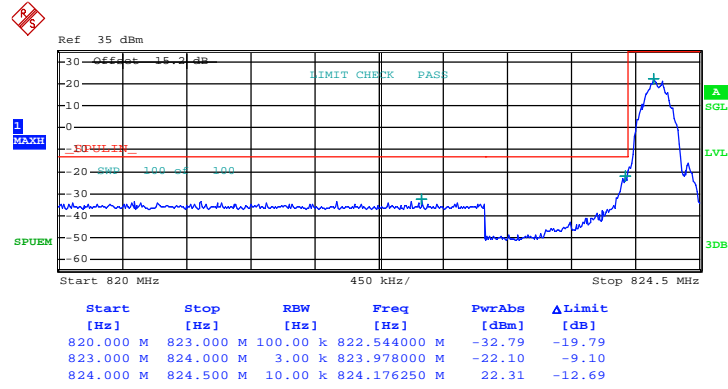

Date: 23.JAN.2015 01:11:43



Band :	GSM850	Test Mode :	EDGE class 8 Link (8PSK)
--------	--------	-------------	-----------------------------

Higher Band Edge Plot on Channel 251 (848.8 MHz)

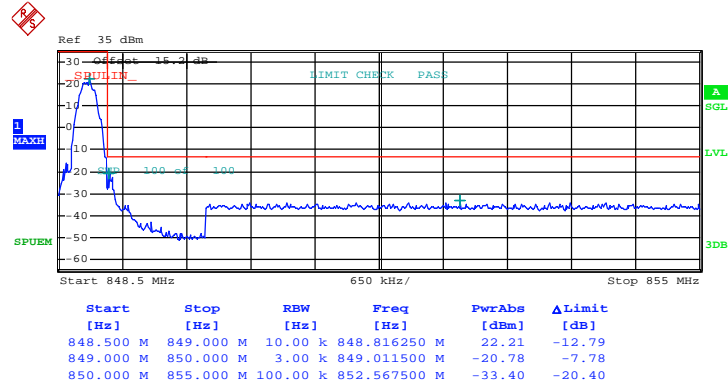

Date: 23.JAN.2015 01:13:32



Band :	GSM1900	Test Mode :	GSM Link (GMSK)
--------	---------	-------------	--------------------

Lower Band Edge Plot on Channel 512 (1850.2 MHz)

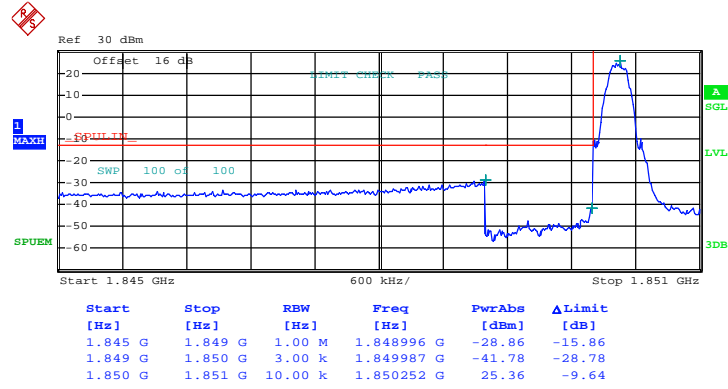

Date: 22.JAN.2015 23:04:30





Band :	GSM1900	Test Mode :	GSM Link (GMSK)
--------	---------	-------------	--------------------

Higher Band Edge Plot on Channel 810 (1909.8 MHz)

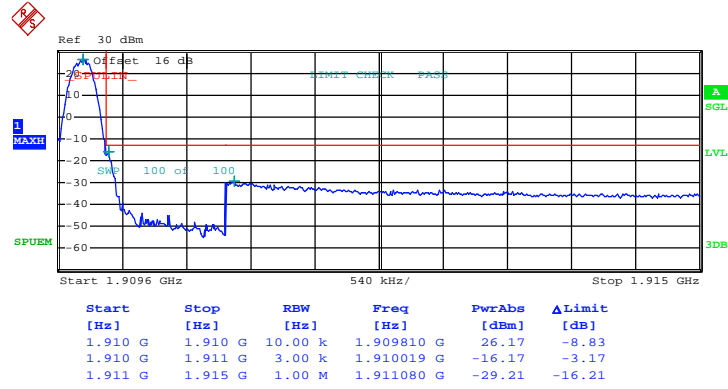

Date: 22.JAN.2015 23:07:26



Band :	GSM1900	Test Mode :	EDGE class 8 Link (8PSK)
--------	---------	-------------	--------------------------

Lower Band Edge Plot on Channel 512 (1850.2 MHz)

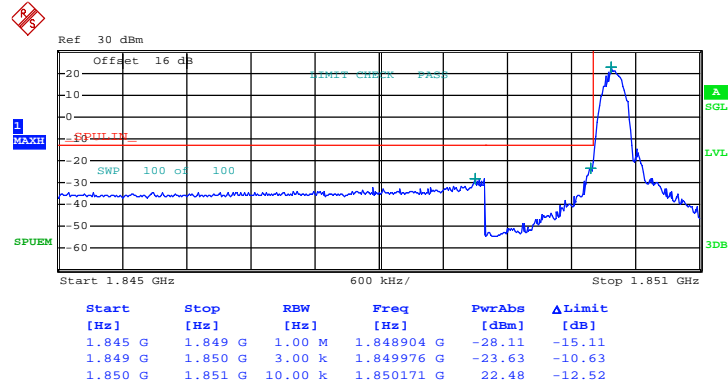

Date: 22.JAN.2015 23:18:56



Band :	GSM1900	Test Mode :	EDGE class 8 Link (8PSK)
--------	---------	-------------	-----------------------------

Higher Band Edge Plot on Channel 810 (1909.8 MHz)

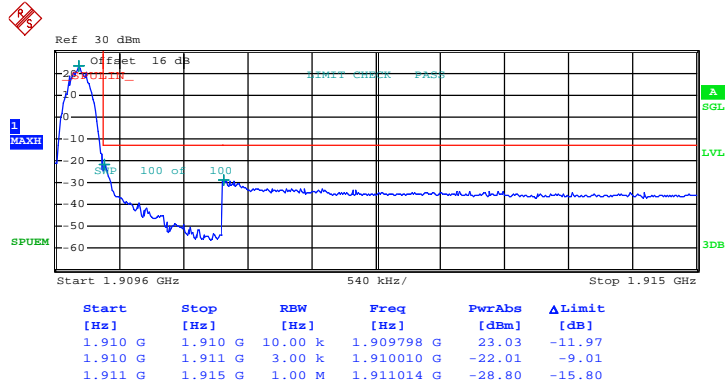

Date: 22.JAN.2015 23:14:23



Band :	WCDMA Band V	Test Mode :	RMC 12.2Kbps Link (QPSK)
--------	--------------	-------------	--------------------------

Lower Band Edge Plot on Channel 4132 (826.4 MHz)

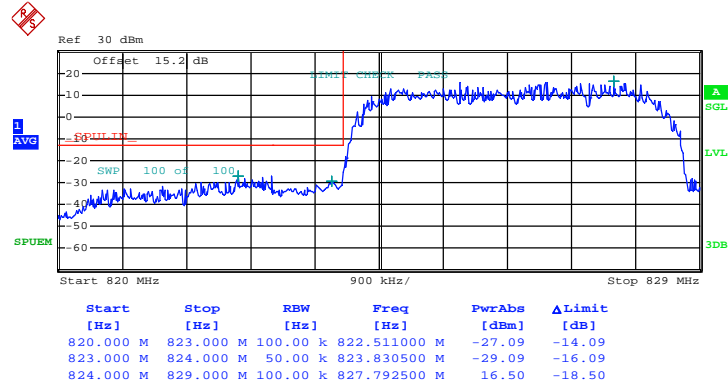

Date: 22.JAN.2015 22:15:32



Band :	WCDMA Band V	Test Mode :	RMC 12.2Kbps Link (QPSK)
--------	--------------	-------------	--------------------------

Higher Band Edge Plot on Channel 4233 (846.6 MHz)

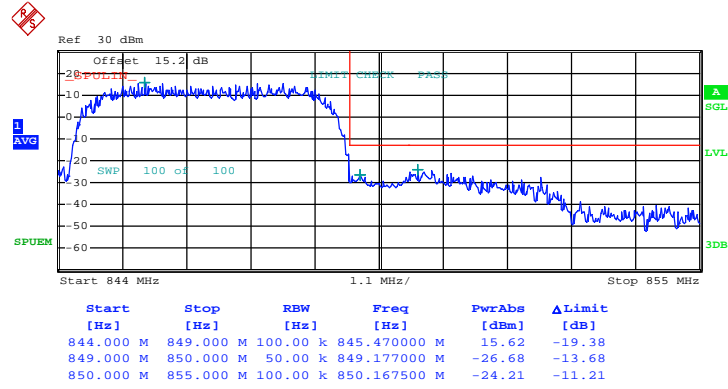

Date: 22.JAN.2015 22:13:36



Band :	WCDMA Band II	Test Mode :	RMC 12.2Kbps Link (QPSK)
--------	---------------	-------------	--------------------------

Lower Band Edge Plot on Channel 9262 (1852.4 MHz)

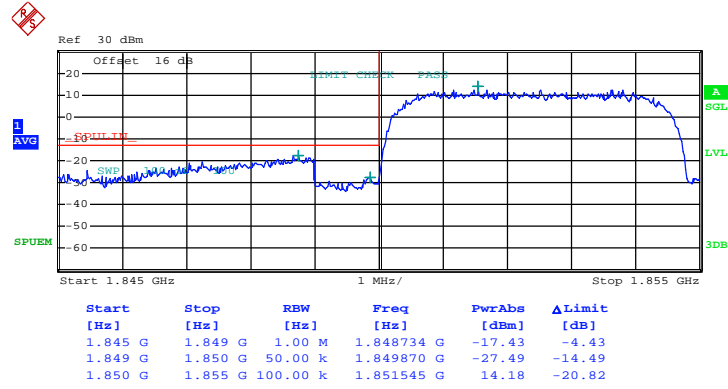

Date: 23.JAN.2015 00:10:32



Band :	WCDMA Band II	Test Mode :	RMC 12.2Kbps Link (QPSK)
--------	---------------	-------------	--------------------------

Higher Band Edge Plot on Channel 9538 (1907.6 MHz)

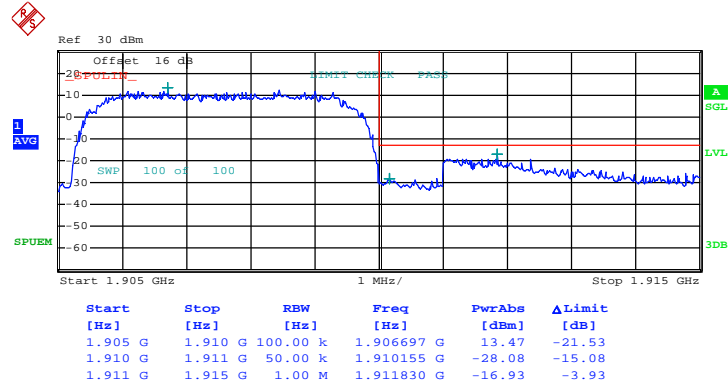

Date: 23.JAN.2015 00:12:31

## 3.6 Conducted Spurious Emission Measurement

### 3.6.1 Description of Conducted Spurious Emission Measurement

The power of any emission outside of the authorized operating frequency ranges must be lower than the transmitter power (P) by a factor of at least  $43 + 10 \log (P)$  dB.

It is measured by means of a calibrated spectrum analyzer and scanned from 30 MHz up to a frequency including its 10<sup>th</sup> harmonic.

### 3.6.2 Measuring Instruments

The measuring equipment is listed in the section 4 of this test report.

### 3.6.3 Test Procedures

1. The testing follows FCC KDB 971168 v02r02 Section 6.0.
2. The EUT was connected to the spectrum analyzer and system simulator via a power divider.
3. The RF output of EUT was connected to the spectrum analyzer by an RF cable and attenuator. The path loss was compensated to the results for each measurement.
4. The middle channel for the highest RF power within the transmitting frequency was measured.
5. The conducted spurious emission for the whole frequency range was taken.
6. The RF fundamental frequency should be excluded against the limit line in the operating frequency band.
7. The limit line is derived from  $43 + 10\log(P)$  dB below the transmitter power P(Watts)  
 $= P(W) - [43 + 10\log(P)]$  (dB)  
 $= [30 + 10\log(P)]$  (dBm) -  $[43 + 10\log(P)]$  (dB)  
 $= -13\text{dBm}$ .

### 3.6.4 Test Setup

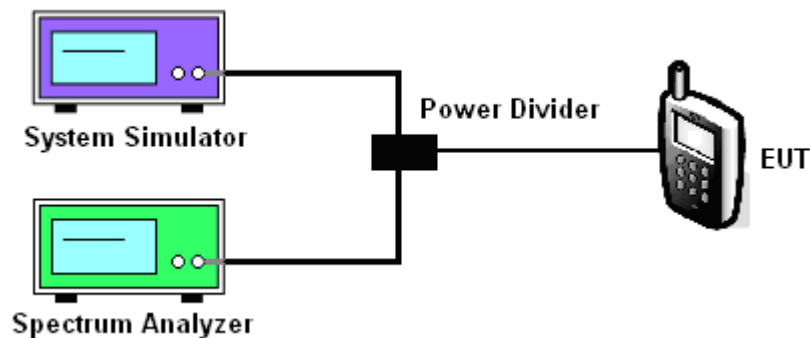





### 3.6.5 Test Result (Plots) of Conducted Spurious Emission

Band :	GSM850	Channel :	CH189
Test Mode :	GSM Link (GMSK)	Frequency :	836.4 MHz

Conducted Spurious Emission Plot between 30MHz ~ 1GHz

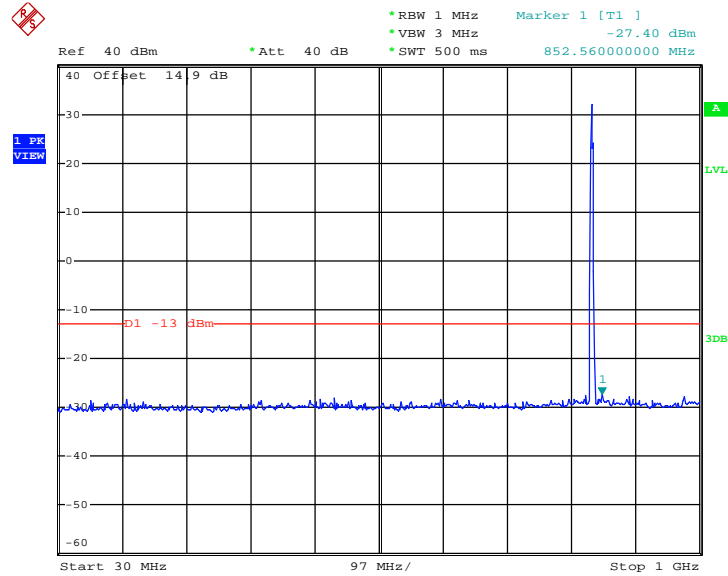

Date: 22.JAN.2015 21:13:15

Conducted Spurious Emission Plot between 1GHz ~ 3GHz

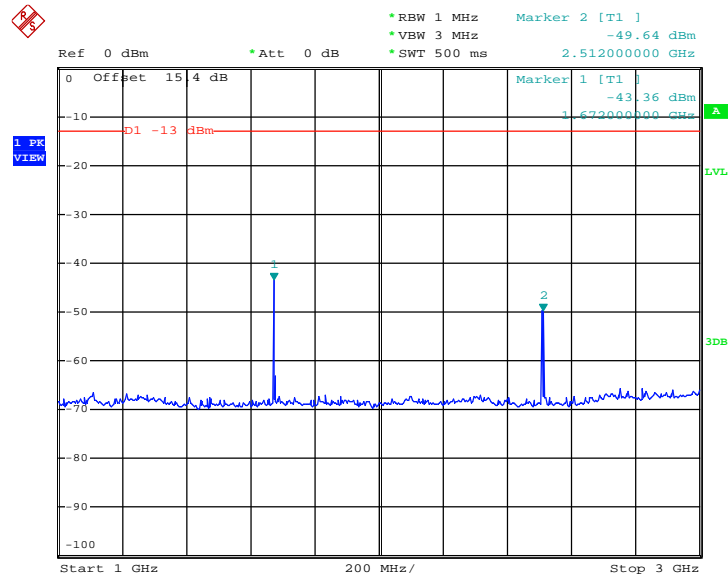

Date: 22.JAN.2015 21:15:00



### Conducted Spurious Emission Plot between 3GHz ~ 7GHz

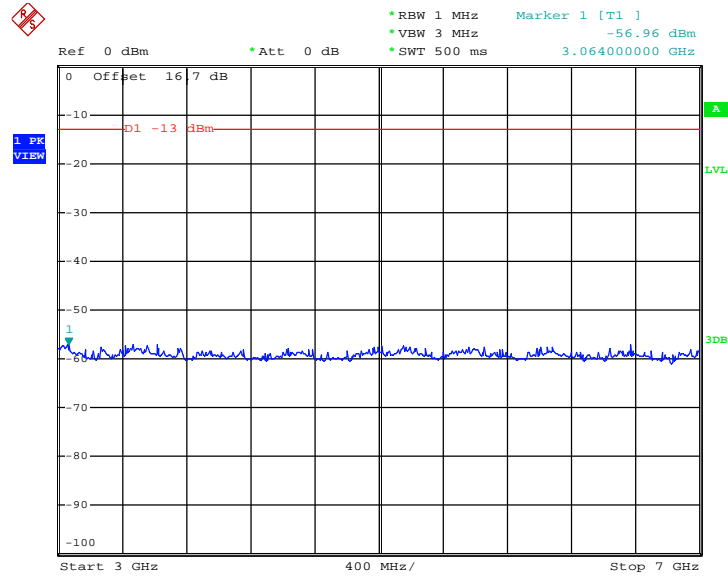

Date: 22.JAN.2015 21:15:56

### Conducted Spurious Emission Plot between 7GHz ~ 9GHz

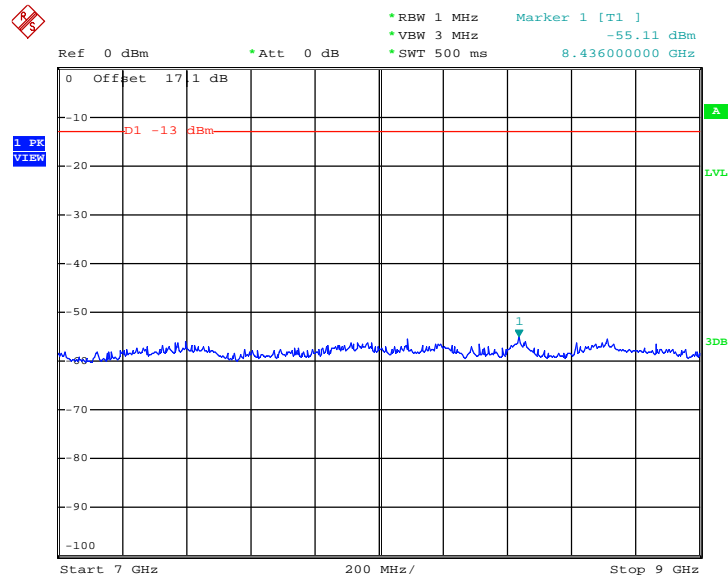

Date: 22.JAN.2015 21:16:29



<b>Band :</b>	GSM850	<b>Channel :</b>	CH189
<b>Test Mode :</b>	EDGE class 8 Link (8PSK)	<b>Frequency :</b>	836.4 MHz

Conducted Spurious Emission Plot between 30MHz ~ 1GHz

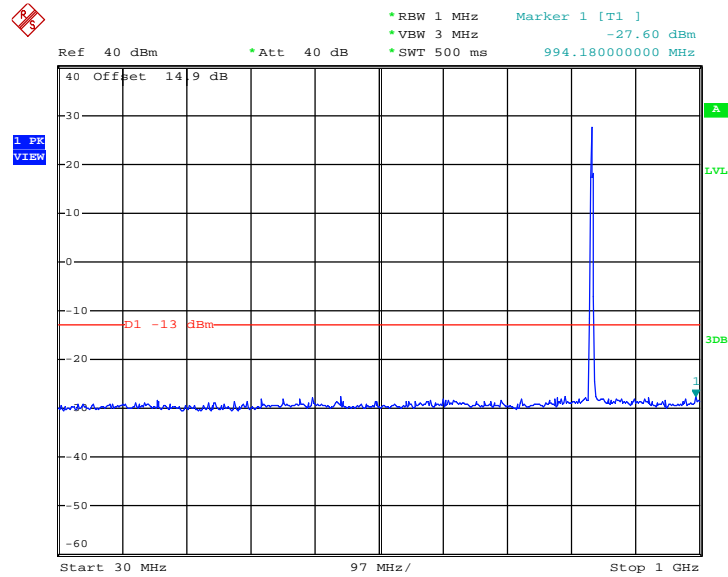

Date: 22.JAN.2015 21:40:33

Conducted Spurious Emission Plot between 1GHz ~ 3GHz

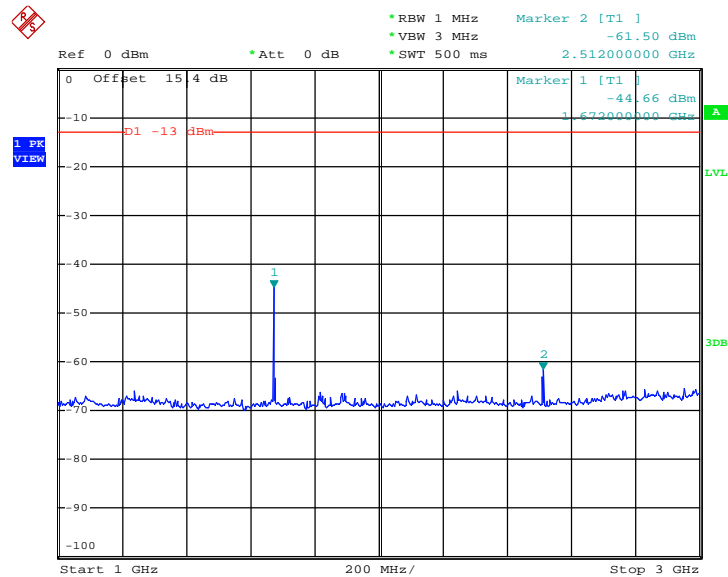

Date: 22.JAN.2015 21:43:13



### Conducted Spurious Emission Plot between 3GHz ~ 7GHz

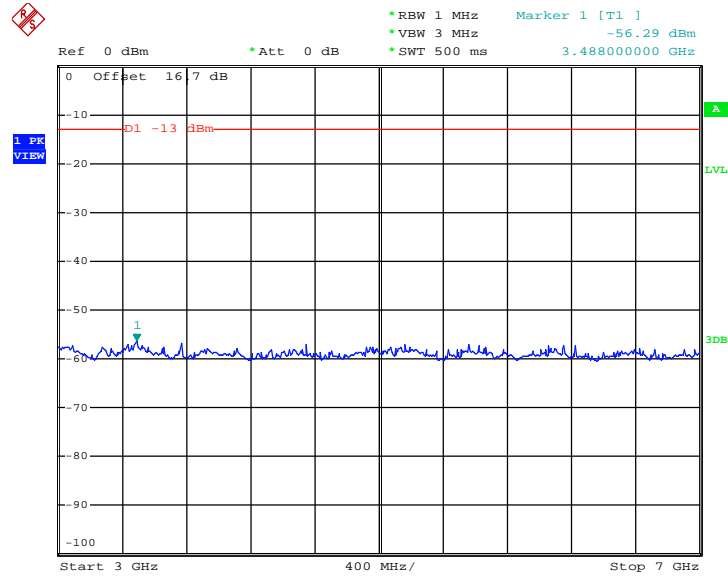

Date: 22.JAN.2015 21:44:34

### Conducted Spurious Emission Plot between 7GHz ~ 9GHz

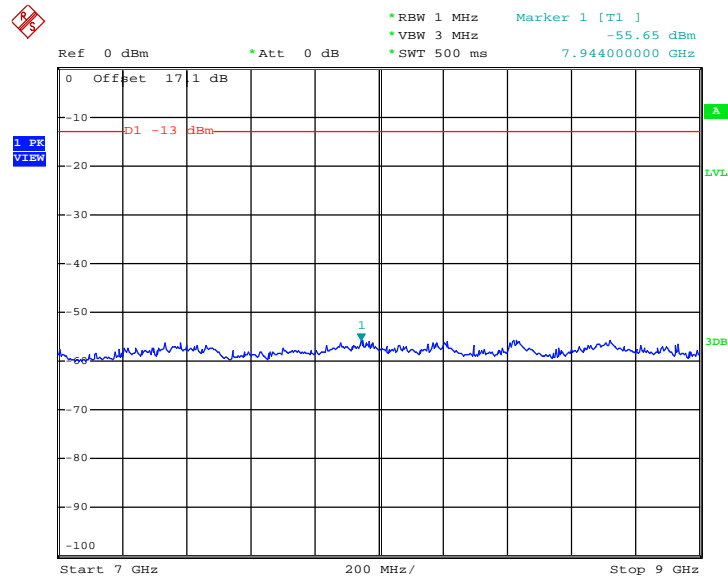

Date: 22.JAN.2015 21:45:39



Band :	GSM1900	Channel :	CH661
Test Mode :	GSM Link (GMSK)	Frequency :	1880.0 MHz

Conducted Spurious Emission Plot between 30MHz ~ 1GHz

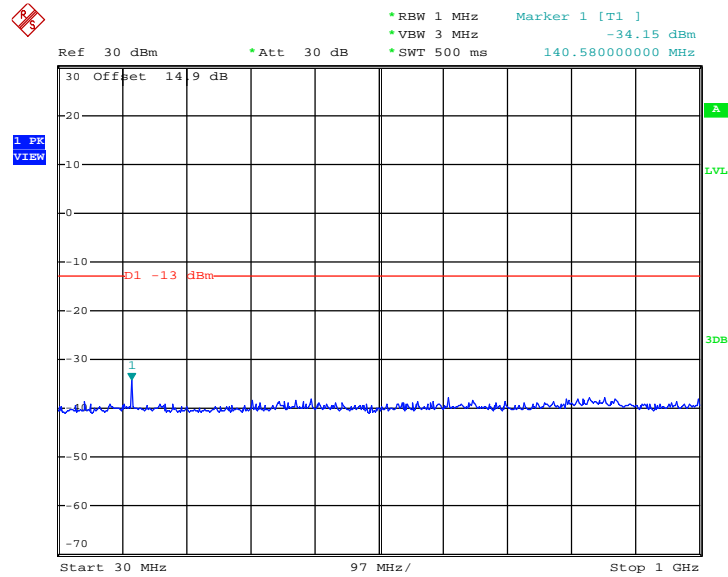

Date: 22.JAN.2015 22:57:18

Conducted Spurious Emission Plot between 1GHz ~ 3GHz

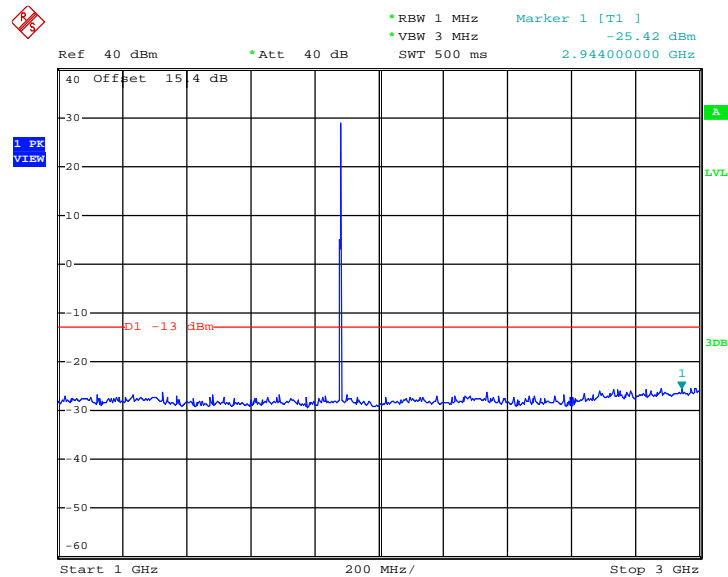

Date: 22.JAN.2015 22:59:16



### Conducted Spurious Emission Plot between 3GHz ~ 7GHz

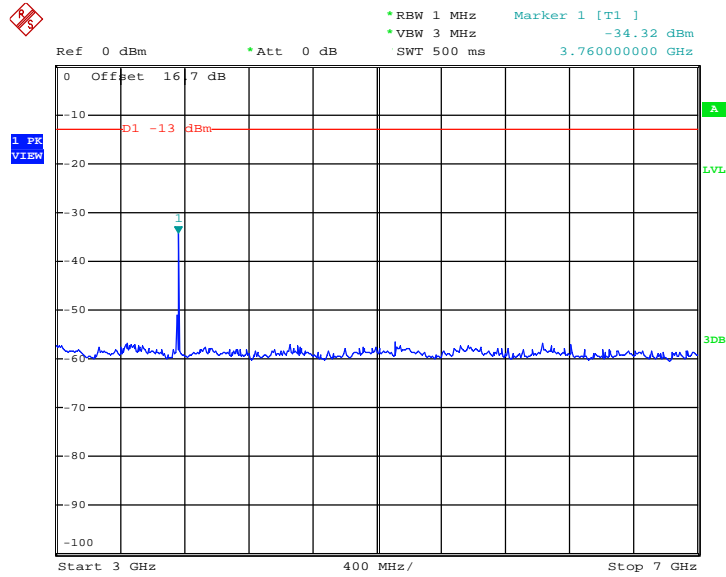

Date: 22.JAN.2015 23:00:12

### Conducted Spurious Emission Plot between 7GHz ~ 13.6GHz

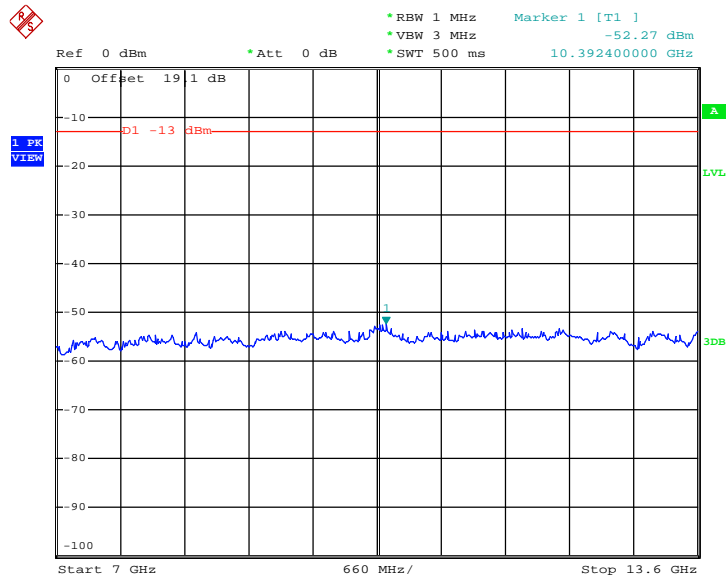

Date: 22.JAN.2015 23:00:41



Conducted Spurious Emission Plot between 13.6GHz ~ 19.1GHz

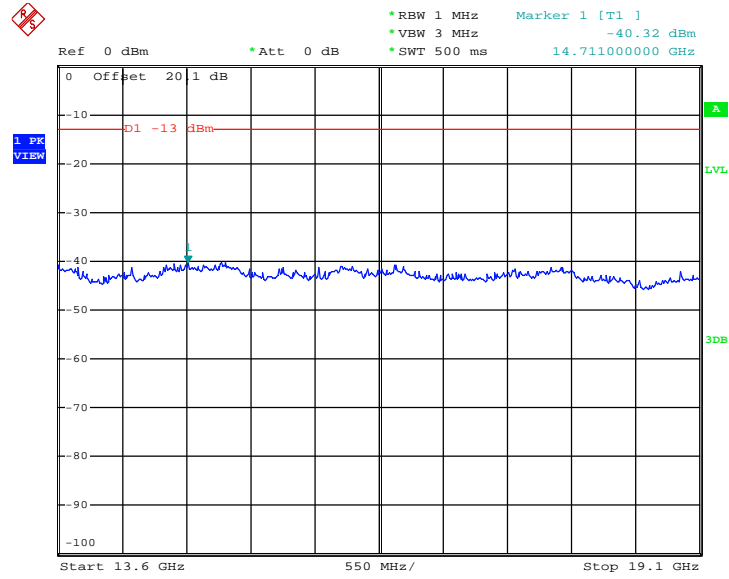

Date: 22.JAN.2015 23:01:22



<b>Band :</b>	GSM1900	<b>Channel :</b>	CH661
<b>Test Mode :</b>	EDGE class 8 Link (8PSK)	<b>Frequency :</b>	1880.0 MHz

Conducted Spurious Emission Plot between 30MHz ~ 1GHz

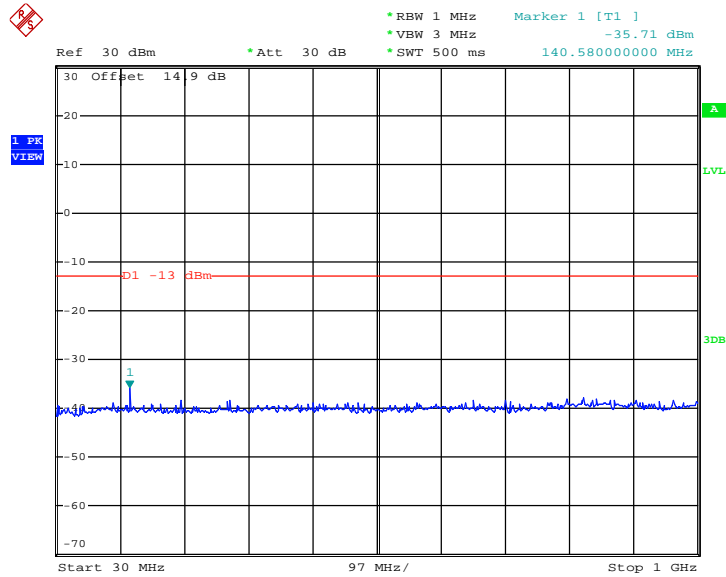

Date: 22.JAN.2015 23:39:15

Conducted Spurious Emission Plot between 1GHz ~ 3GHz

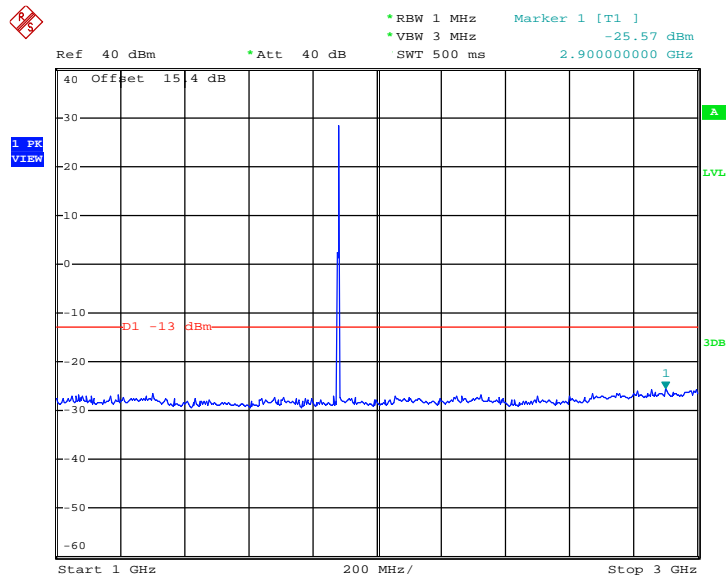

Date: 22.JAN.2015 23:40:11





### Conducted Spurious Emission Plot between 3GHz ~ 7GHz

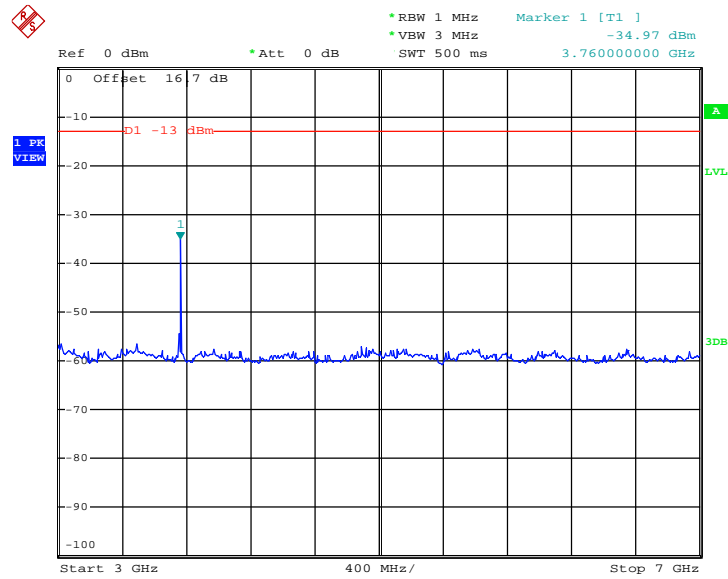

Date: 22.JAN.2015 23:40:52

### Conducted Spurious Emission Plot between 7GHz ~ 13.6GHz

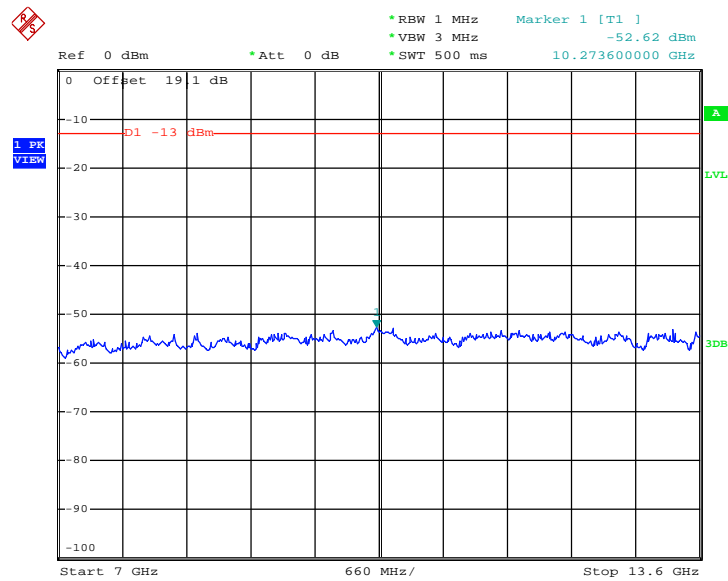

Date: 22.JAN.2015 23:41:31



Conducted Spurious Emission Plot between 13.6GHz ~ 19.1GHz

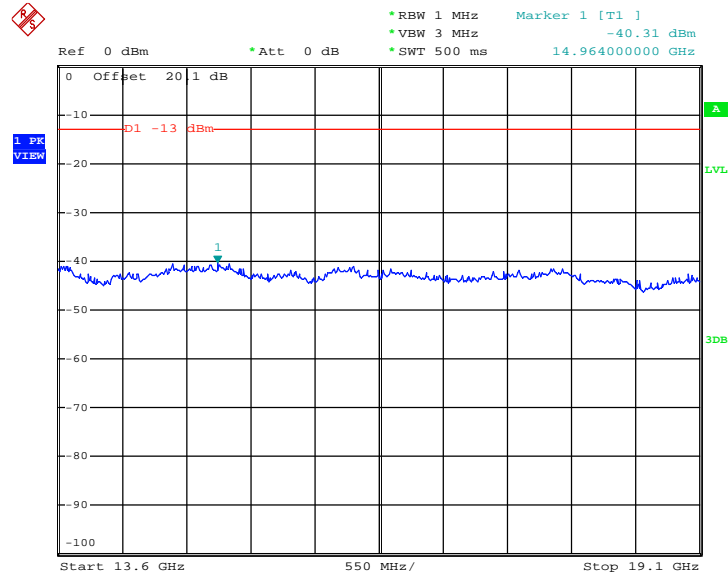

Date: 22.JAN.2015 23:42:16



<b>Band :</b>	WCDMA Band V	<b>Channel :</b>	CH4182
<b>Test Mode :</b>	RMC 12.2Kbps Link (QPSK)	<b>Frequency :</b>	836.4 MHz

Conducted Spurious Emission Plot between 30MHz ~ 1GHz

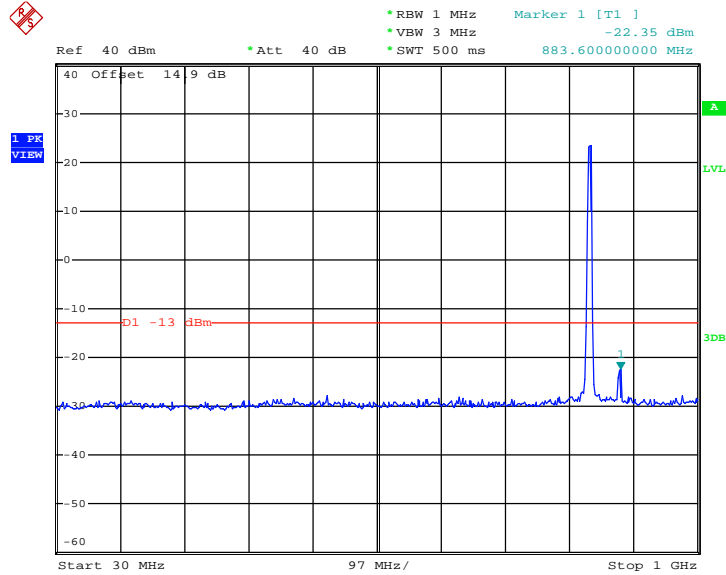

Date: 22.JAN.2015 22:17:25

Conducted Spurious Emission Plot between 1GHz ~ 3GHz

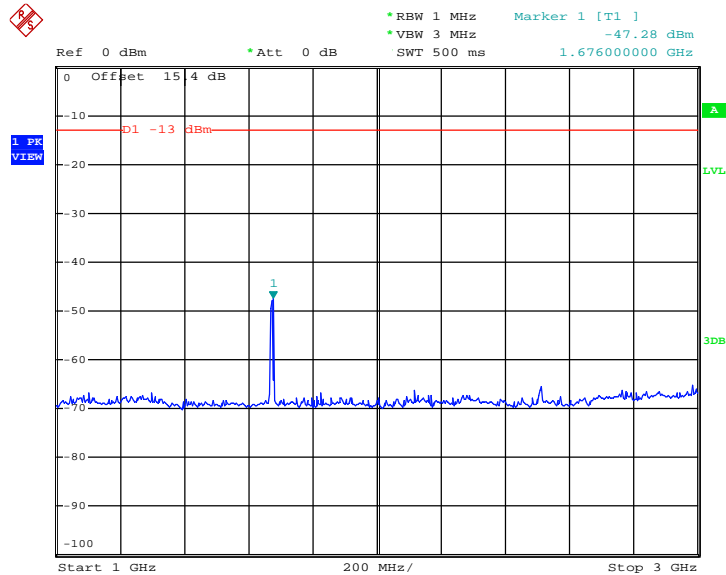

Date: 22.JAN.2015 22:18:29



### Conducted Spurious Emission Plot between 3GHz ~ 7GHz

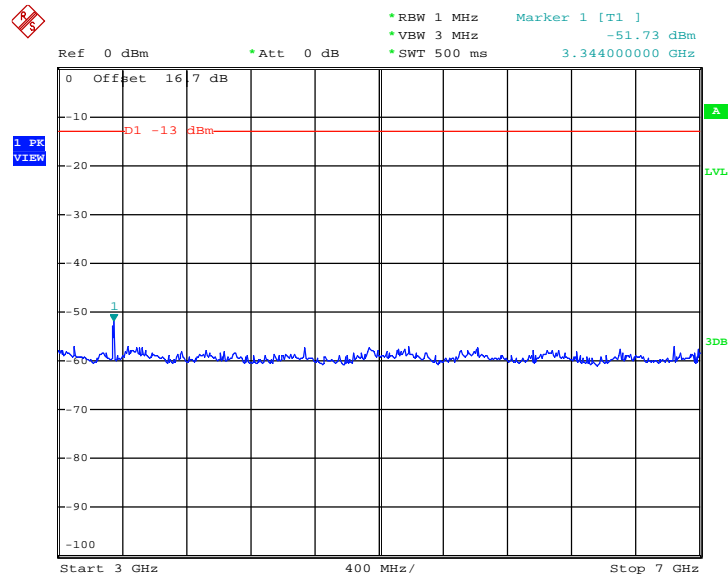

Date: 22.JAN.2015 22:19:05

### Conducted Spurious Emission Plot between 7GHz ~ 9GHz

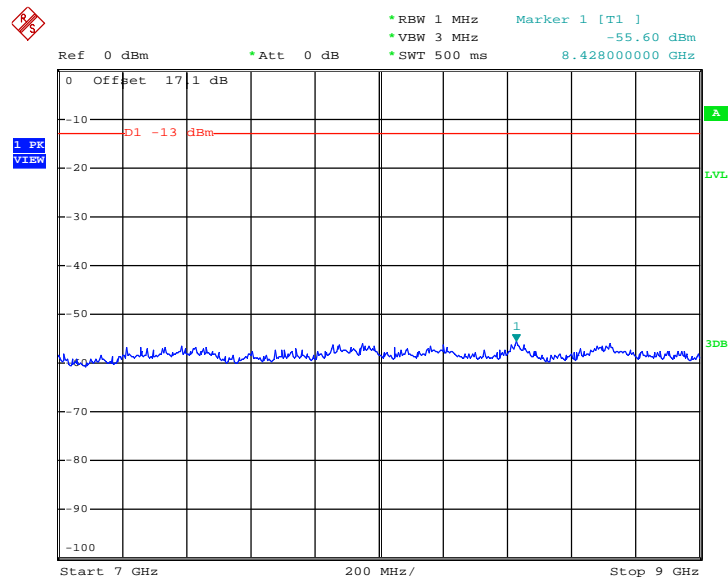

Date: 22.JAN.2015 22:19:31



<b>Band :</b>	WCDMA Band II	<b>Channel :</b>	CH9400
<b>Test Mode :</b>	RMC 12.2Kbps Link (QPSK)	<b>Frequency :</b>	1880.0 MHz

Conducted Spurious Emission Plot between 30MHz ~ 1GHz

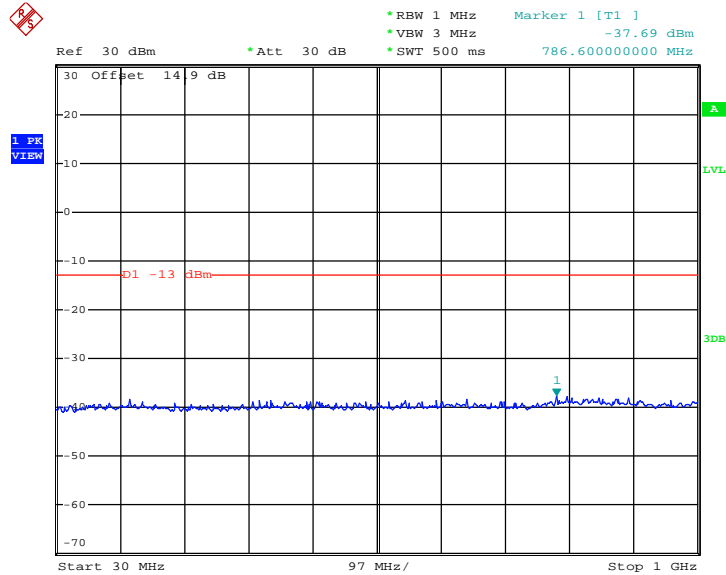

Date: 22.JAN.2015 22:33:51

Conducted Spurious Emission Plot between 1GHz ~ 3GHz

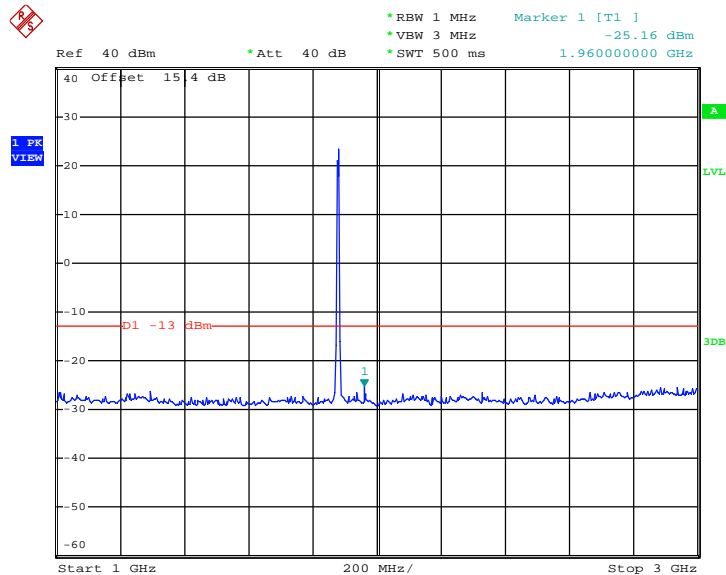

Date: 22.JAN.2015 22:35:08



### Conducted Spurious Emission Plot between 3GHz ~ 7GHz

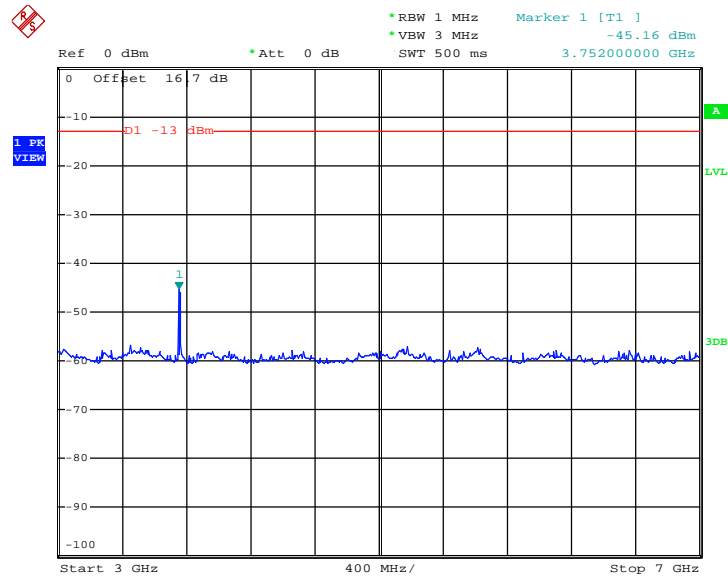

Date: 22.JAN.2015 22:36:15

### Conducted Spurious Emission Plot between 7GHz ~ 13.6GHz

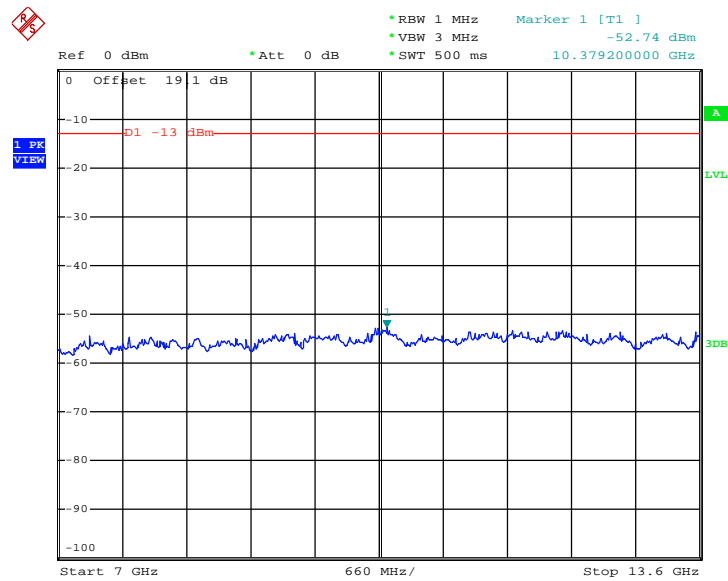

Date: 22.JAN.2015 22:36:58



Conducted Spurious Emission Plot between 13.6GHz ~ 19.1GHz

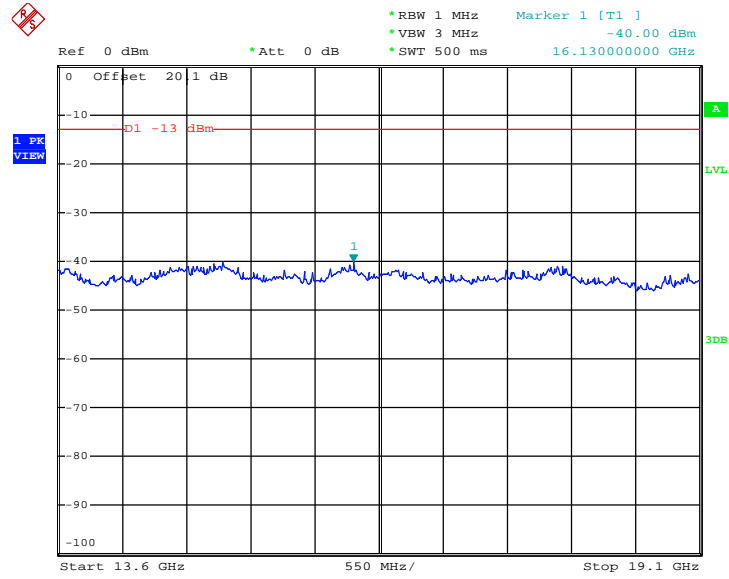

Date: 22.JAN.2015 22:37:40



### 3.7 Field Strength of Spurious Radiation Measurement

#### 3.7.1 Description of Field Strength of Spurious Radiated Measurement

The power of any emission outside of the authorized operating frequency ranges must be attenuated below the transmitter power (P) by a factor of at least  $43 + 10 \log (P)$  dB. The spectrum is scanned from 30 MHz up to a frequency including its 10th harmonic.

#### 3.7.2 Measuring Instruments

The measuring equipment is listed in the section 4 of this test report.

#### 3.7.3 Test Procedures

1. The testing follows FCC KDB 971168 v02r02 Section 5.8 and ANSI / TIA-603-C-2004 Section 2.2.12.
2. The EUT was placed on a rotatable wooden table 0.8 meters above the ground.
3. The EUT was set 3 meters from the receiving antenna, which was mounted on the antenna tower.
4. The table was rotated 360 degrees to determine the position of the highest spurious emission.
5. The height of the receiving antenna is varied between one meter and four meters to search for the maximum spurious emission for both horizontal and vertical polarizations.
6. Make the measurement with the spectrum analyzer's RBW = 1MHz, VBW = 3MHz, taking record of maximum spurious emission.
7. A horn antenna was substituted in place of the EUT and was driven by a signal generator.
8. Tune the output power of signal generator to the same emission level with EUT maximum spurious emission.
9. Taking the record of output power at antenna port.
10. Repeat step 7 to step 8 for another polarization.
11.  $EIRP (dBm) = S.G. Power - Tx Cable Loss + Tx Antenna Gain$
12.  $ERP (dBm) = EIRP - 2.15$
13. The RF fundamental frequency should be excluded against the limit line in the operating frequency band.
14. The limit line is derived from  $43 + 10\log(P)$  dB below the transmitter power P(Watts)  
=  $P(W) - [43 + 10\log(P)] (dB)$   
=  $[30 + 10\log(P)] (dBm) - [43 + 10\log(P)] (dB)$   
= -13dBm.



### 3.7.4 Test Setup

For radiated emissions from 30MHz to 1GHz

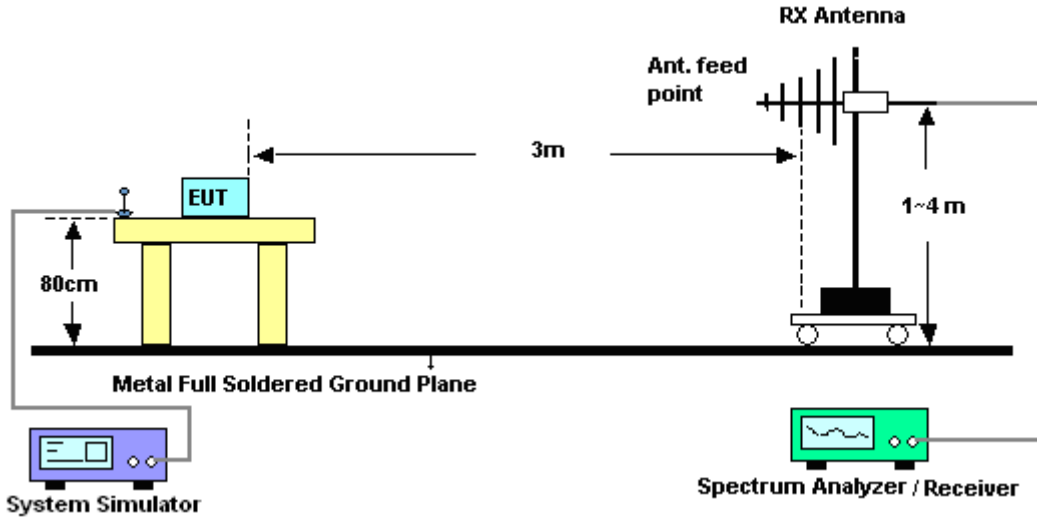

For radiated emissions above 1GHz

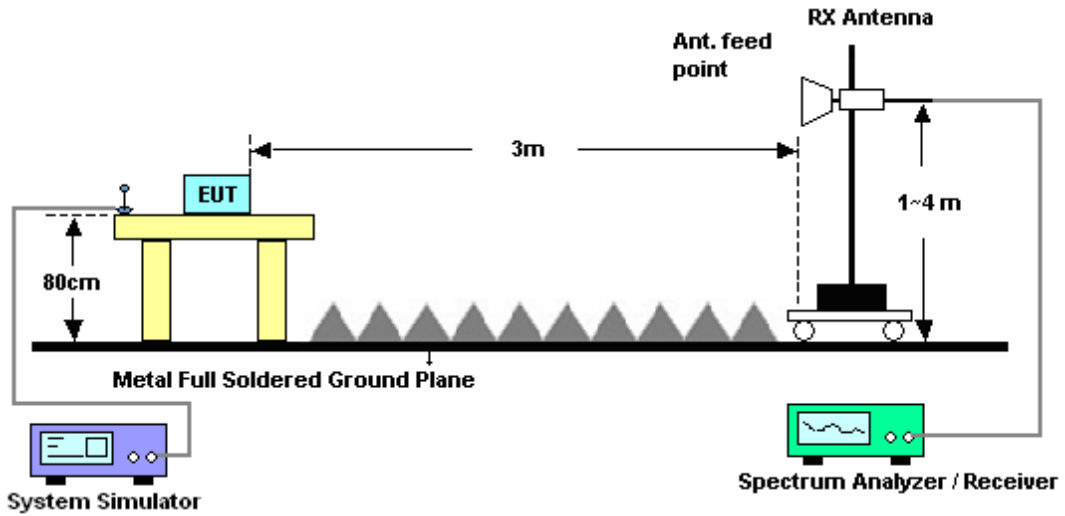



3.7.5 Test Result of Field Strength of Spurious Radiated

<b>Band :</b>	GSM850				<b>Temperature :</b>	22~23°C			
<b>Test Mode :</b>	GSM Link (GMSK)				<b>Relative Humidity :</b>	40~41%			
<b>Test Engineer :</b>	Leve Zhao				<b>Polarization :</b>	Horizontal			
<b>Remark :</b>	Spurious emissions within 30-1000MHz were found more than 20dB below limit line.								
Frequency ( MHz )	ERP ( dBm )	Limit ( dBm )	Over Limit ( dB )	SPA Reading ( dBm )	S.G. Power ( dBm )	TX Cable loss ( dB )	TX Antenna Gain ( dBi )	Polarization ( H/V )	Result
1674	-59.65	-13	-46.65	-52.92	-58.67	1.86	3.03	H	Pass
2508	-62.34	-13	-49.34	-62.47	-62.89	2.31	5.02	H	Pass
3344	-61.96	-13	-48.96	-64.87	-63.41	2.85	6.45	H	Pass

<b>Band :</b>	GSM850				<b>Temperature :</b>	22~23°C			
<b>Test Mode :</b>	GSM Link (GMSK)				<b>Relative Humidity :</b>	40~41%			
<b>Test Engineer :</b>	Leve Zhao				<b>Polarization :</b>	Vertical			
<b>Remark :</b>	Spurious emissions within 30-1000MHz were found more than 20dB below limit line.								
Frequency ( MHz )	ERP ( dBm )	Limit ( dBm )	Over Limit ( dB )	SPA Reading ( dBm )	S.G. Power ( dBm )	TX Cable loss ( dB )	TX Antenna Gain ( dBi )	Polarization ( H/V )	Result
1674	-50.93	-13	-37.93	-49.59	-49.96	1.86	3.03	V	Pass
2508	-59.31	-13	-46.31	-62.25	-59.87	2.31	5.02	V	Pass
3348	-55.53	-13	-42.53	-63.37	-56.98	2.85	6.45	V	Pass



<b>Band :</b>	GSM850		<b>Temperature :</b>	22~23°C					
<b>Test Mode :</b>	EDGE class 8 Link (8PSK)		<b>Relative Humidity :</b>	40~41%					
<b>Test Engineer :</b>	Leve Zhao		<b>Polarization :</b>	Horizontal					
<b>Remark :</b>	Spurious emissions within 30-1000MHz were found more than 20dB below limit line.								
Frequency ( MHz )	ERP ( dBm )	Limit ( dBm )	Over Limit ( dB )	SPA Reading ( dBm )	S.G. Power ( dBm )	TX Cable loss ( dB )	TX Antenna Gain ( dBi )	Polarization ( H/V )	Result
1672	-68.20	-13	-55.20	-56.84	-67.22	1.86	3.03	H	Pass
2508	-61.80	-13	-48.80	-61.99	-62.35	2.31	5.02	H	Pass
3344	-62.06	-13	-49.06	-64.97	-63.51	2.85	6.45	H	Pass

<b>Band :</b>	GSM850		<b>Temperature :</b>	22~23°C					
<b>Test Mode :</b>	EDGE class 8 Link (8PSK)		<b>Relative Humidity :</b>	40~41%					
<b>Test Engineer :</b>	Leve Zhao		<b>Polarization :</b>	Vertical					
<b>Remark :</b>	Spurious emissions within 30-1000MHz were found more than 20dB below limit line.								
Frequency ( MHz )	ERP ( dBm )	Limit ( dBm )	Over Limit ( dB )	SPA Reading ( dBm )	S.G. Power ( dBm )	TX Cable loss ( dB )	TX Antenna Gain ( dBi )	Polarization ( H/V )	Result
1672	-68.00	-13	-55.00	-57.40	-67.02	1.86	3.03	V	Pass
2509	-59.95	-13	-46.95	-62.89	-60.51	2.31	5.02	V	Pass
3348	-56.20	-13	-43.20	-64.04	-57.65	2.85	6.45	V	Pass



<b>Band :</b>	GSM1900				<b>Temperature :</b>	22~23°C			
<b>Test Mode :</b>	GSM Link (GMSK)				<b>Relative Humidity :</b>	40~41%			
<b>Test Engineer :</b>	Leve Zhao				<b>Polarization :</b>	Horizontal			
<b>Remark :</b>	Spurious emissions within 30-1000MHz were found more than 20dB below limit line.								
Frequency ( MHz )	EIRP ( dBm )	Limit ( dBm )	Over Limit ( dB )	SPA Reading ( dBm )	S.G. Power ( dBm )	TX Cable loss ( dB )	TX Antenna Gain ( dBi )	Polarization ( H/V )	Result
3759	-57.41	-13	-44.41	-64.40	-60.98	3	6.58	H	Pass
5646	-52.75	-13	-39.75	-59.19	-58.12	3.84	9.21	H	Pass
7521	-51.27	-13	-38.27	-60.47	-57.95	4.43	11.10	H	Pass

<b>Band :</b>	GSM1900				<b>Temperature :</b>	22~23°C			
<b>Test Mode :</b>	GSM Link (GMSK)				<b>Relative Humidity :</b>	40~41%			
<b>Test Engineer :</b>	Leve Zhao				<b>Polarization :</b>	Vertical			
<b>Remark :</b>	Spurious emissions within 30-1000MHz were found more than 20dB below limit line.								
Frequency ( MHz )	EIRP ( dBm )	Limit ( dBm )	Over Limit ( dB )	SPA Reading ( dBm )	S.G. Power ( dBm )	TX Cable loss ( dB )	TX Antenna Gain ( dBi )	Polarization ( H/V )	Result
3759	-61.21	-13	-48.21	-65.29	-64.78	3	6.58	V	Pass
5631	-51.53	-13	-38.53	-59.18	-56.90	3.84	9.21	V	Pass
7521	-53.55	-13	-40.55	-61.03	-60.22	4.43	11.10	V	Pass



<b>Band :</b>	GSM1900		<b>Temperature :</b>	22~23°C					
<b>Test Mode :</b>	EDGE class 8 Link (8PSK)		<b>Relative Humidity :</b>	40~41%					
<b>Test Engineer :</b>	Leve Zhao		<b>Polarization :</b>	Horizontal					
<b>Remark :</b>	Spurious emissions within 30-1000MHz were found more than 20dB below limit line.								
Frequency ( MHz )	EIRP ( dBm )	Limit ( dBm )	Over Limit ( dB )	SPA Reading ( dBm )	S.G. Power ( dBm )	TX Cable loss ( dB )	TX Antenna Gain ( dBi )	Polarization ( H/V )	Result
3762	-57.32	-13	-44.32	-64.31	-60.89	3	6.58	H	Pass
5646	-55.78	-13	-42.78	-60.16	-61.15	3.84	9.21	H	Pass
7521	-53.04	-13	-40.04	-61.42	-59.71	4.43	11.10	H	Pass

<b>Band :</b>	GSM1900		<b>Temperature :</b>	22~23°C					
<b>Test Mode :</b>	EDGE class 8 Link (8PSK)		<b>Relative Humidity :</b>	40~41%					
<b>Test Engineer :</b>	Leve Zhao		<b>Polarization :</b>	Vertical					
<b>Remark :</b>	Spurious emissions within 30-1000MHz were found more than 20dB below limit line.								
Frequency ( MHz )	EIRP ( dBm )	Limit ( dBm )	Over Limit ( dB )	SPA Reading ( dBm )	S.G. Power ( dBm )	TX Cable loss ( dB )	TX Antenna Gain ( dBi )	Polarization ( H/V )	Result
3759	-61.23	-13	-48.23	-65.31	-64.80	3	6.58	V	Pass
5640	-55.14	-13	-42.14	-61.37	-60.50	3.84	9.21	V	Pass
7521	-52.75	-13	-39.75	-60.81	-59.42	4.43	11.10	V	Pass



<b>Band :</b>	WCDMA Band V	<b>Temperature :</b>	22~23°C						
<b>Test Mode :</b>	RMC 12.2Kbps Link (QPSK)	<b>Relative Humidity :</b>	40~41%						
<b>Test Engineer :</b>	Leve Zhao	<b>Polarization :</b>	Horizontal						
<b>Remark :</b>	Spurious emissions within 30-1000MHz were found more than 20dB below limit line.								
Frequency ( MHz )	ERP ( dBm )	Limit ( dBm )	Over Limit ( dB )	SPA Reading ( dBm )	S.G. Power ( dBm )	TX Cable loss ( dB )	TX Antenna Gain ( dBi )	Polarization ( H/V )	Result
1672	-69.11	-13	-56.11	-57.43	-68.13	1.86	3.03	H	Pass
2510	-61.54	-13	-48.54	-61.74	-62.10	2.31	5.02	H	Pass
3344	-61.09	-13	-48.09	-64.00	-62.54	2.85	6.45	H	Pass

<b>Band :</b>	WCDMA Band V	<b>Temperature :</b>	22~23°C						
<b>Test Mode :</b>	RMC 12.2Kbps Link (QPSK)	<b>Relative Humidity :</b>	40~41%						
<b>Test Engineer :</b>	Leve Zhao	<b>Polarization :</b>	Vertical						
<b>Remark :</b>	Spurious emissions within 30-1000MHz were found more than 20dB below limit line.								
Frequency ( MHz )	ERP ( dBm )	Limit ( dBm )	Over Limit ( dB )	SPA Reading ( dBm )	S.G. Power ( dBm )	TX Cable loss ( dB )	TX Antenna Gain ( dBi )	Polarization ( H/V )	Result
1672	-65.15	-13	-52.15	-56.41	-64.17	1.86	3.03	V	Pass
2510	-59.39	-13	-46.39	-62.33	-59.95	2.31	5.02	V	Pass
3344	-57.03	-13	-44.03	-64.87	-58.48	2.85	6.45	V	Pass



<b>Band :</b>	WCDMA Band II	<b>Temperature :</b>	22~23°C						
<b>Test Mode :</b>	RMC 12.2Kbps Link (QPSK)	<b>Relative Humidity :</b>	40~41%						
<b>Test Engineer :</b>	Leve Zhao	<b>Polarization :</b>	Horizontal						
<b>Remark :</b>	Spurious emissions within 30-1000MHz were found more than 20dB below limit line.								
Frequency ( MHz )	EIRP ( dBm )	Limit ( dBm )	Over Limit ( dB )	SPA Reading ( dBm )	S.G. Power ( dBm )	TX Cable loss ( dB )	TX Antenna Gain ( dBi )	Polarization ( H/V )	Result
3759	-54.28	-13	-41.28	-62.92	-57.86	3	6.58	H	Pass
5640	-52.58	-13	-39.58	-59.09	-57.95	3.84	9.21	H	Pass
7521	-50.45	-13	-37.45	-60.02	-57.12	4.43	11.10	H	Pass

<b>Band :</b>	WCDMA Band II	<b>Temperature :</b>	22~23°C						
<b>Test Mode :</b>	RMC 12.2Kbps Link (QPSK)	<b>Relative Humidity :</b>	40~41%						
<b>Test Engineer :</b>	Leve Zhao	<b>Polarization :</b>	Vertical						
<b>Remark :</b>	Spurious emissions within 30-1000MHz were found more than 20dB below limit line.								
Frequency ( MHz )	EIRP ( dBm )	Limit ( dBm )	Over Limit ( dB )	SPA Reading ( dBm )	S.G. Power ( dBm )	TX Cable loss ( dB )	TX Antenna Gain ( dBi )	Polarization ( H/V )	Result
3759	-60.96	-13	-47.96	-65.04	-64.53	3	6.58	V	Pass
5640	-54.33	-13	-41.33	-60.56	-59.70	3.84	9.21	V	Pass
7521	-51.46	-13	-38.46	-60.33	-58.13	4.43	11.10	V	Pass

## 3.8 Frequency Stability Measurement

### 3.8.1 Description of Frequency Stability Measurement

The frequency stability shall be measured by variation of ambient temperature and variation of primary supply voltage to ensure that the fundamental emission stays within the authorized frequency block. The frequency stability of the transmitter shall be maintained within  $\pm 0.00025\%$  ( $\pm 2.5\text{ppm}$ ) of the center frequency.

### 3.8.2 Measuring Instruments

The measuring equipment is listed in the section 4 of this test report.

### 3.8.3 Test Procedures for Temperature Variation

1. The testing follows FCC KDB 971168 v02r02 Section 9.0.
2. The EUT was set up in the thermal chamber and connected with the system simulator.
3. With power OFF, the temperature was decreased to  $-30^{\circ}\text{C}$  and the EUT was stabilized before testing. Power was applied and the maximum change in frequency was recorded within one minute.
4. With power OFF, the temperature was raised in  $10^{\circ}\text{C}$  steps up to  $50^{\circ}\text{C}$ . The EUT was stabilized at each step for at least half an hour. Power was applied and the maximum frequency change was recorded within one minute.

### 3.8.4 Test Procedures for Voltage Variation

1. The testing follows FCC KDB 971168 v02r02 Section 9.0.
2. The EUT was placed in a temperature chamber at  $25\pm 5^{\circ}\text{C}$  and connected with the system simulator.
3. The power supply voltage to the EUT was varied from BEP to 115% of the nominal value measured at the input to the EUT.
4. The variation in frequency was measured for the worst case.



### 3.8.5 Test Setup

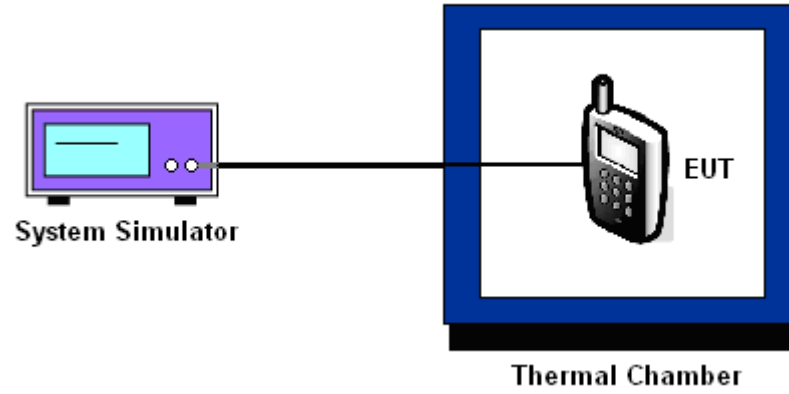



3.8.6 Test Result of Temperature Variation

Band :	GSM 850	Channel :	189
Limit (ppm) :	2.5	Frequency :	836.4 MHz

Temperature (°C)	GSM		EDGE class 8		Result
	Freq. Dev. (Hz)	Deviation (ppm)	Freq. Dev. (Hz)	Deviation (ppm)	
50	-36	0.0251	-33	0.0179	PASS
40	-24	0.0108	-28	0.0120	
30	-18	0.0036	-23	0.0060	
20(Ref.)	-15	0.0000	-18	0.0000	
10	-19	0.0048	-20	0.0024	
0	-23	0.0096	-23	0.0060	
-10	-28	0.0155	-28	0.0120	
-20	-33	0.0215	-31	0.0155	
-30	-39	0.0287	-35	0.0203	

Band :	GSM 1900	Channel :	661
Limit (ppm) :	within authorized band	Frequency :	1880.0 MHz

Temperature (°C)	GSM		EDGE class 8		Result
	Freq. Dev. (Hz)	Deviation (ppm)	Freq. Dev. (Hz)	Deviation (ppm)	
50	-33	0.0096	-35	0.0133	PASS
40	-28	0.0069	-24	0.0074	
30	-17	0.0011	-18	0.0043	
20(Ref.)	-15	0.0000	-10	0.0000	
10	-19	0.0021	-15	0.0027	
0	-22	0.0037	-19	0.0048	
-10	-29	0.0074	-25	0.0080	
-20	-31	0.0085	-30	0.0106	
-30	-35	0.0106	-33	0.0122	

Note: The frequency fundamental emissions stay within the authorized frequency block based on the frequency deviation measured is small.



<b>Band :</b>	WCDMA Band V	<b>Channel :</b>	4182
<b>Limit (ppm) :</b>	2.5	<b>Frequency :</b>	836.4 MHz

Temperature (°C)	RMC 12.2Kbps		Result
	Freq. Dev. (Hz)	Deviation (ppm)	
50	-36	0.0251	PASS
40	-31	0.0191	
30	-20	0.0060	
20(Ref.)	-15	0.0000	
10	-18	0.0036	
0	-21	0.0072	
-10	-26	0.0132	
-20	-30	0.0179	
-30	-34	0.0227	

<b>Band :</b>	WCDMA Band II	<b>Channel :</b>	9400
<b>Limit (ppm) :</b>	within authorized band	<b>Frequency :</b>	1880.0 MHz

Temperature (°C)	RMC 12.2Kbps		Result
	Freq. Dev. (Hz)	Deviation (ppm)	
50	-33	0.0096	PASS
40	-28	0.0069	
30	-21	0.0032	
20(Ref.)	-15	0.0000	
10	-18	0.0016	
0	-26	0.0059	
-10	-31	0.0085	
-20	-35	0.0106	
-30	-38	0.0122	

Note: The frequency fundamental emissions stay within the authorized frequency block based on the frequency deviation measured is small.



3.8.7 Test Result of Voltage Variation

Band & Channel	Mode	Voltage (Volt)	Freq. Dev. (Hz)	Deviation (ppm)	Limit (ppm)	Result
GSM 850 CH189	GSM	4.35	-13	0.0024	2.5	PASS
		3.80	-12	0.0036		
		BEP	-14	0.0012		
	EDGE class 8	4.35	-14	0.0048		
		3.80	-13	0.0060		
		BEP	-12	0.0072		
GSM 1900 CH661	GSM	4.35	-14	0.0005	(Note 3.)	
		3.80	-12	0.0016		
		BEP	-11	0.0021		
	EDGE class 8	4.35	-14	0.0021		
		3.80	-15	0.0027		
		BEP	-12	0.0011		
WCDMA Band V CH4182	RMC 12.2Kbps	4.35	-14	0.0012	2.5	
		3.80	-10	0.0060		
		BEP	-13	0.0024		
WCDMA Band II CH9400	RMC 12.2Kbps	4.35	-18	0.0016	(Note 3.)	
		3.80	-15	0.0000		
		BEP	-16	0.0005		

Note:

1. Normal Voltage = 3.80V.
2. Battery End Point (BEP) = 3.40 V.
3. The frequency fundamental emissions stay within the authorized frequency block based on the frequency deviation measured is small.



## 4 List of Measuring Equipment

Instrument	Manufacturer	Model No.	Serial No.	Characteristics	Calibration Date	Test Date	Due Date	Remark
Spectrum Analyzer	R&S	FSP40	100319	9kHz~40GHz	Oct. 28, 2014	Jan. 21, 2015~ Jan. 23, 2015	Oct. 27, 2015	Conducted (TH01-KS)
Spectrum Analyzer	R&S	FSV30	101338	9kHz~30GHz	May 04, 2014	Jan. 21, 2015~ Jan. 23, 2015	May 03, 2015	Conducted (TH01-KS)
Thermal Chamber	Ten Billion	TTC-B3S	TBN-960502	-40~+150°C	Oct. 25, 2014	Jan. 21, 2015~ Jan. 23, 2015	Oct. 24, 2015	Conducted (TH01-KS)
EMI Test Receiver	R&S	ESCI	100534	9kHz~3GHz	Oct. 25, 2014	Feb. 20, 2015	Oct. 24, 2015	Radiation (03CH01-KS)
Spectrum Analyzer	R&S	FSP30	101399	9kHz~30GHz	May 04, 2014	Feb. 20, 2015	May 03, 2015	Radiation (03CH01-KS)
Bilog Antenna	TeseQ	CBL6112D	37879	30Mhz-2Ghz	Sep. 13, 2014	Feb. 20, 2015	Sep. 12, 2015	Radiation (03CH01-KS)
Double Ridge Horn	ETS-Lindgren	3117	75957	1GHz~18GHz	Nov. 08, 2014	Feb. 20, 2015	Nov. 07, 2015	Radiation (03CH01-KS)
Active Horn	com-power	AHA-118	701030	1GHz~18GHz	Nov. 08, 2014	Feb. 20, 2015	Nov. 07, 2015	Radiation (03CH01-KS)
SHF-EHF Horn	Schwarzbeck	BBHA 9170	BBHA170249	15GHz~40GHz	Mar. 10, 2014	Feb. 20, 2015	Mar. 09, 2015	Radiation (03CH01-KS)
Amplifier	com-power	PA-103A	161073	1MHz~1GHz	May 04, 2014	Feb. 20, 2015	May 03, 2015	Radiation (03CH01-KS)
Amplifier	Agilent	8449B	3008A02371	1GHz~26.5GHz	Oct. 28, 2014	Feb. 20, 2015	Oct. 27, 2015	Radiation (03CH01-KS)
AC Power Source	Chroma	61601	F104090004	N/A	NCR	Feb. 20, 2015	NCR	Radiation (03CH01-KS)
Turn Table	MF	MF7802	N/A	0~360 degree	NCR	Feb. 20, 2015	NCR	Radiation (03CH01-KS)
Antenna Mast	MF	MF7802	N/A	1 m~4 m	NCR	Feb. 20, 2015	NCR	Radiation (03CH01-KS)



Spectrum Analyzer	R&S	FSP 7	100819	9kHz~7GHz	May 04, 2014	Feb. 20, 2015	May 03, 2015	ERP/EIRP (OTA01-KS)
Switch Control Manframe	Agilent	3499A	MY42005452	N/A	N/A	Feb. 20, 2015	N/A	ERP/EIRP (OTA01-KS)
Dual 1-to-6(4) MW MUX	Agilent	N2276A	MY42000841	N/A	N/A	Feb. 20, 2015	N/A	ERP/EIRP (OTA01-KS)
Microwave Switch	Agilent	44476A	MY42002573	N/A	N/A	Feb. 20, 2015	N/A	ERP/EIRP (OTA01-KS)
Microwave Switch	Agilent	44476A	MY42002586	N/A	N/A	Feb. 20, 2015	N/A	ERP/EIRP (OTA01-KS)
Diagonal Dual Polarized Horn	ETS-Lindgren	3164-04	00066993	700MHz~6GHz	N/A	Feb. 20, 2015	N/A	ERP/EIRP (OTA01-KS)
Multi-Devices Controller	ETS-Lindgren	2090-OPT1	00066604	N/A	N/A	Feb. 20, 2015	N/A	ERP/EIRP (OTA01-KS)
Conical Log Spiral (Small)	ETS-Lindgren	3102	00066951	1~10GHz	N/A	Feb. 20, 2015	N/A	ERP/EIRP (OTA01-KS)
Turn Table	ETS-Lindgren	2088	N/A	Resolution : 0.1degree	N/A	Feb. 20, 2015	N/A	ERP/EIRP (OTA01-KS)
Limiting Amplifier	ETS-lindgren	109643	920326	10MHz~2.5GHz	N/A	Feb. 20, 2015	N/A	ERP/EIRP (OTA01-KS)
EMQuest	ETS-Lindgren	EMQ-100	1125	N/A	N/A	Feb. 20, 2015	N/A	ERP/EIRP (OTA01-KS)
Medium Duty Holder	ETS-Lindgren	2015	N/A	N/A	N/A	Feb. 20, 2015	N/A	ERP/EIRP (OTA01-KS)



## 5 Uncertainty of Evaluation

### Uncertainty of Radiated Emission Measurement (30 MHz ~ 1000 MHz)

Measuring Uncertainty for a Level of Confidence of 95% ( $U = 2Uc(y)$ )	2.5 dB
---	--------



## **Appendix B. Product Equality Declaration**





	Antenna	AP	Modem	Transceiver	Power Amplifier	Balun	Band pass filter	Diplexer
<b>Bluetooth</b>	No	No	No	No	No	No	No	No
<b>Wi-Fi</b>	No	No	No	No	No	No	No	No

- FM changes: No
- LCD/ Speaker/ Camera/ Vibrator changes: No (indicated the changed items if yes)
- Other changes detailed:

● **MECHANICAL MODIFICATIONS:**

- Use new metal front/back cover or keypad: No
- Mechanical shell changes:
  - Whole size of EUT: No
  - Distance of Ear reference point to bottom of handset: No
  - Other trinkets to change the surface of handset: No
- Other changes detailed: replace SD card slot by the second SIM card slot on enclosure

**APPROVED BY:**

Project Manager:

Signature:

Date:

*Danielji*

*2015.3.19.*