



Hearing Aid Compatibility (HAC) RF Emissions Test Report

APPLICANT : TCT Mobile Limited
EQUIPMENT : GSM Quad-band / UMTS Quad-band / LTE
Penta-band mobile phone
BRAND NAME : Alcatel
MODEL NAME : 6039J
FCC ID : RAD545
STANDARD : FCC 47 CFR §20.19
ANSI C63.19-2011
HAC RATING : M3

The product was completely tested on Apr. 17, 2015. We, SPORTON INTERNATIONAL (KUNSHAN) INC., would like to declare that the tested sample has been evaluated in accordance with the procedures and shown the compliance with the applicable technical standards.

The test results in this report apply exclusively to the tested model / sample. Without written approval of SPORTON INTERNATIONAL (KUNSHAN) INC., the test report shall not be reproduced except in full.

Reviewed by: Eric Huang / Deputy Manager

Approved by: Jones Tsai / Manager



SPORTON INTERNATIONAL (KUNSHAN) INC.
No. 3-2, PingXiang Road, Kunshan, Jiangsu Province, P. R. China



Table of Contents

Revision History...3
1. Statement of Compliance...4
2. Administration Data...5
3. General Information...6
3.1 Description of Equipment Under Test (EUT)...6
3.2 Accessories and Support Equipment...7
3.3 Air Interface and Operating Mode...8
3.4 Applied Standards...8
4. HAC RF Emission...9
5. Measurement System Specification...10
5.1 Test Arch Phantom...10
5.2 E-Field Probe System...11
E-Field Probe Specification...11
Probe Tip Description...11
5.3 System Hardware...11
5.4 Data Storage and Evaluation...12
5.5 Test Equipment List...13
6. Measurement System Validation...14
6.1 Purpose of System Performance Check...14
6.2 System Setup...14
6.3 Verification Results...15
7. Modulation Interference Factor...16
8. RF Emissions Test Procedure...18
9. Receiver Location...21
10. Maximum Tune-up Limit...22
11. Low-power Exemption...25
12. Conducted RF Output Power (Unit: dBm)...28
13. HAC RF Emission Test Results...29
13.1 E-Field Emission...29
14. Uncertainty Assessment...30
15. References...32
Appendix A. Plots of System Performance Check
Appendix B. Plots of RF Emission Measurement
Appendix C. DASY Calibration Certificate
Appendix D. Test Setup Photos
Appendix E. Product Equality Declaration



1. Statement of Compliance

The HAC Rating of each air interface found during testing for the **Alcatel, 6039J** are follows:

Band	M Rating
GSM850	M3
GSM1900	M3
WCDMA Band V	M4
WCDMA Band II	M4
LTE Band 2	M4
LTE Band 4	M4
LTE Band 7	M4

They are in compliance with HAC limits specified in guidelines FCC 47 CFR §20.19 and ANSI Standard ANSI C63.19.

HAC Rating = M3 (ANSI C63.19-2011)



2. Administration Data

Testing Laboratory	
Test Site	SPORTON INTERNATIONAL (KUNSHAN) INC.
Test Site Location	No. 3-2, PingXiang Road, Kunshan, Jiangsu Province, P. R. China TEL: +86-0512-5790-0158 FAX: +86-0512-5790-0958
Test Site No.	Sporton Site No. :
	SAR01-KS
Applicant	
Company Name	TCT Mobile Limited
Address	5F, C building, No. 232, Liang Jing Road ZhangJiang High-Tech Park, Pudong Area Shanghai, P.R. China. 201203
Manufacturer	
Company Name	TCT Mobile Limited
Address	5F, C building, No. 232, Liang Jing Road ZhangJiang High-Tech Park, Pudong Area Shanghai, P.R. China. 201203
Application Details	
Date of Start during the Test	Mar. 04, 2015
Date of End during the Test	Apr. 17, 2015

3. General Information

3.1 Description of Equipment Under Test (EUT)

Product Feature & Specification	
EUT Type	GSM Quad-band / UMTS Quad-band / LTE Penta-band mobile phone
Brand Name	Alcatel
Model Name	6039J
FCC ID	RAD545
IMEI Code for 6039A	014368000051070
Tx Frequency	GSM850: 824.2 MHz ~ 848.8 MHz GSM1900: 1850.2 MHz ~ 1909.8 MHz WCDMA Band V: 826.4 MHz ~ 846.6 MHz WCDMA Band II: 1852.4 MHz ~ 1907.6 MHz LTE Band 4: 1710.7 MHz ~ 1754.3 MHz LTE Band 2: 1850.7 MHz ~ 1909.3 MHz LTE Band 7: 2502.5 MHz ~ 2567.5 MHz WLAN 2.4GHz Band: 2412 MHz ~ 2472 MHz Bluetooth: 2402 MHz ~ 2480 MHz NFC : 13.56 MHz
Antenna Type	WWAN PIFA Antenna WLAN PIFA Antenna Bluetooth: PIFA Antenna NFC: Loop Antenna
HW Version	BAB34D000GCX
SW Version	vA7M
Mode	<ul style="list-style-type: none"> •GSM/GPRS/EGPRS •WCDMA •HSDPA •HSUPA •DC-HSDPA •HSPA+ (Downlink Only) •LTE: QPSK, 16QAM •802.11b/g/n HT20 •Bluetooth v3.0+EDR, Bluetooth v4.1 LE •NFC:ASK
EUT Stage	Identical Prototype
Note: <ol style="list-style-type: none"> 1. This device supports VoLTE function. 2. When hotspot mode is enabled, power reduction will be activated and limited to LTE Band 7. 3. EUT reduced power is not available at WCDMA Band V. 4. This mobile phone allows the end user to talk in two positions, that is, it has two sets of speaker and microphone, which are located on the top and on the bottom of the phone. The location of the two sets of speaker / microphone allows the end user to use the device in the typical calling positions and in the upside-down calling position. Therefore, two orientations be tested in HAC report. 5. There are two types of EUT sample 1 and sample 2, the differences between two samples is only for memory, sample 1 is 1GB capacity and sample 2 is 1.5GB capacity. We only chose the sample 1 to perform all tests. 	

3.2 Accessories and Support Equipment

Specification of Accessory				
AC Adapter 1	Brand Name	ACE-Tenpao	Model Name	UC11US
	Power Rating	I/P: 100-240Vac, 200mA, O/P: 5Vdc, 1000mA		
	P/N	CBA0058AG0C2		
AC Adapter 2	Brand Name	ACE-Yingju	Model Name	UC11US
	Power Rating	I/P: 100-240Vac, 200mA, O/P: 5Vdc, 1000mA		
	P/N	CBA0058AG0C3		
Battery 1	Brand Name	ALCATEL onetouch	Model Name	TLp020K2
	Power Rating	3.8Vdc, 2000mAh		
	P/N	CAC2000023C2		
Battery 2	Brand Name	ALCATEL onetouch	Model Name	TLp020KJ
	Power Rating	3.8Vdc, 2000mAh		
	P/N	CAC2000025CJ		
USB Cable 1	Brand Name	ACE-Shenhua	Model Name	CDA0000025C1
	Signal Line Type	1.10m shielded without core		
USB Cable 2	Brand Name	ACE-Juwei	Model Name	CDA0000025C2
	Signal Line Type	1.10m shielded without core		
USB Cable 3	Brand Name	ACE-Juwei	Model Name	CDA0000025C8
	Signal Line Type	1.10m shielded without core		
Earphone 1	Brand Name	ACE-Lianyun	Model Name	CCB0023A10C2
	Signal Line Type	1.16m non-shielded without core		
Earphone 2	Brand Name	ACE-JBL	Model Name	J22C
	Signal Line Type	1.38m non-shielded without core		
Earphone 3	Brand Name	ACE-Lianyun	Model Name	CCB0023A11C2
	Signal Line Type	1.26m non-shielded without core		
Earphone 4	Brand Name	ACE-JBL	Model Name	CCA0001A10C9
	Signal Line Type	1.28m non-shielded without core		



3.3 Air Interface and Operating Mode

Air Interface	Band MHz	Type	C63.19 Tested	Simultaneous Transmitter	OTT	Power Reduction
GSM	850	VO	Yes	WLAN, BT	NA	Yes
	1900			WLAN, BT	NA	Yes
	GPRS/EDGE	DT	No	WLAN, BT	Yes	Yes
WCDMA	Band V	VO	No ⁽¹⁾	WLAN, BT	NA	Yes
	Band II			WLAN, BT	NA	Yes
	HSPA	DT	No	WLAN, BT	Yes	Yes
LTE	Band 2	VD	No ⁽¹⁾	WLAN, BT	Yes	Yes
	Band 4			WLAN, BT		Yes
	Band 7			WLAN, BT		Yes
WLAN	2450	DT	No	GSM, WCDMA,LTE	Yes	No
BT	2450	DT	No	GSM, WCDMA,LTE	NA	No

VO=CMRS Voice Service
DT=Digital Transport
VD=CMRS IP Voice Service and Digital Transport
(*)No Associated T-Coil measurement has been made in accordance with 285076 D02 T-Coil testing for CMRS IP

Remark:
1. WCDMA/LTE Band 2/4/7 are exempted from testing by low power exemption that their average antenna input power plus its MIF is ≤ 17 dBm, and are rated as M4

3.4 Applied Standards

- FCC CFR47 Part 20.19
- ANSI C63.19 2011-version
- FCC KDB 285076 D01 HAC Guidance v04
- FCC KDB 285076 D02 T Coil testing for CMRS IP v01r01

4. HAC RF Emission

FCC wireless hearing aid compatibility rules ensure that consumers with hearing loss are able to access wireless communications services through a wide selection of handsets without experiencing disabling radio frequency (RF) interference or other technical obstacles.

To define and measure the hearing aid compatibility of handsets, in CFR47 part 20.19 ANSI C63.19 is referenced. A handset is considered hearing aid-compatible for acoustic coupling if it meets a rating of at least M3 under ANSI C63.19, and A handset is considered hearing aid compatible for inductive coupling if it meets a rating of at least T3.

According to ANSI C63.19 2011 version, for acoustic coupling, the RF electric field emissions of wireless communication devices should be measured and rated according to the emission level as below.

Emission Categories	E-field emissions	
	<960Mhz	>960Mhz
M1	50 to 55 dB (V/m)	40 to 45 dB (V/m)
M2	45 to 50 dB (V/m)	35 to 40 dB (V/m)
M3	40 to 45 dB (V/m)	30 to 35 dB (V/m)
M4	<40 dB (V/m)	<30 dB (V/m)

Table 4.1 Telephone near-field categories in linear units

5. Measurement System Specification

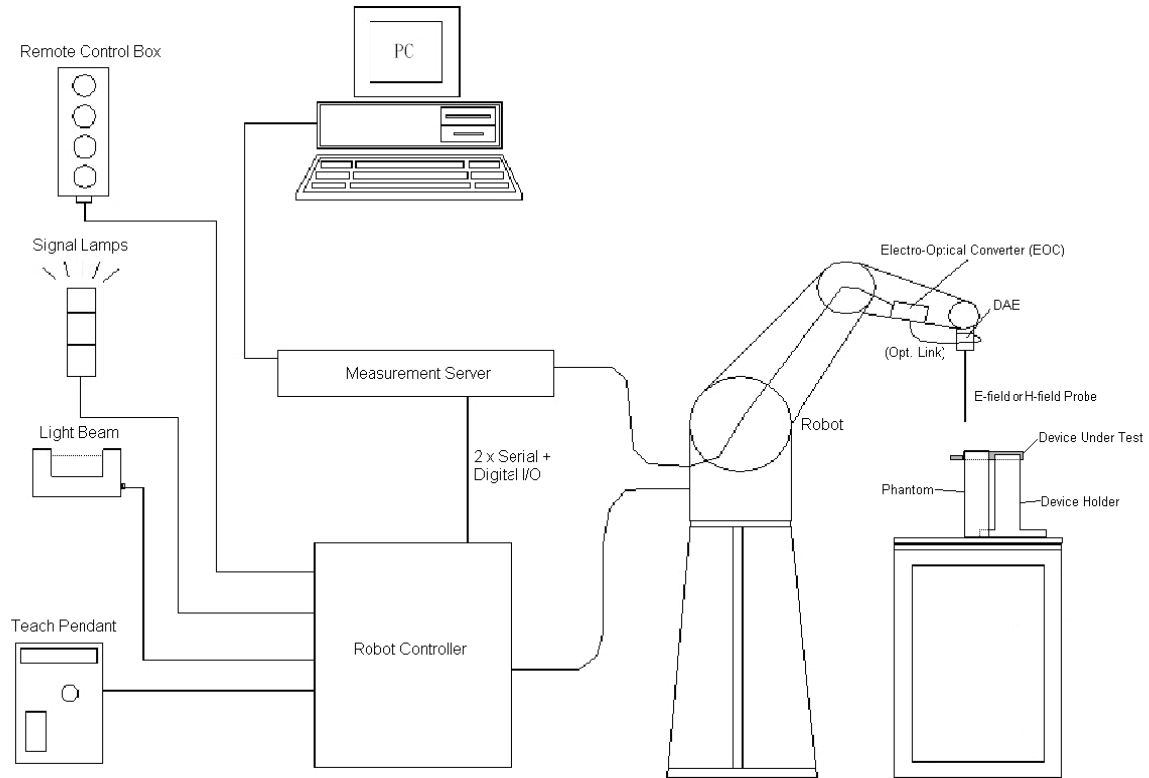

Fig 5.1 SPEAG DASY5 System Configurations

5.1 Test Arch Phantom

Construction :	Enables easy and well defined positioning of the phone and validation dipoles as well as simple teaching of the robot.	
Dimensions :	370x 370 x 370 mm	

Fig 5.8 Photo of Arch Phantom

5.2 E-Field Probe System

E-Field Probe Specification

<ER3DV6>

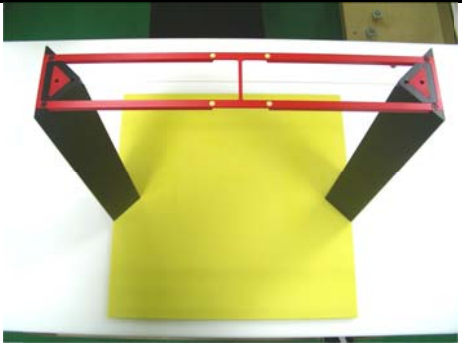
Construction	One dipole parallel, two dipoles normal to probe axis Built-in shielding against static charges
Calibration	In air from 100 MHz to 3.0 GHz (absolute accuracy $\pm 6.0\%$, $k=2$)
Frequency	100 MHz to 6 GHz; Linearity: ± 2.0 dB (100 MHz to 3 GHz)
Directivity	± 0.2 dB in air (rotation around probe axis) ± 0.4 dB in air (rotation normal to probe axis)
Dynamic Range	2 V/m to 1000 V/m (M3 or better device readings fall well below diode compression point)
Linearity	± 0.2 dB
Dimensions	Overall length: 330 mm (Tip: 16 mm) Tip diameter: 8 mm (Body: 12 mm) Distance from probe tip to dipole centers: 2.5 mm



Fig 5.2 Photo of E-field Probe

Probe Tip Description:

HAC field measurements take place in the close near field with high gradients. Increasing the measuring distance from the source will generally decrease the measured field values (in case of the validation dipole approx. 10% per mm).

5.3 System Hardware

DAE
The data acquisition electronics (DAE) consists of a highly sensitive electrometer-grade preamplifier with auto-zeroing, a channel and gain-switching multiplexer, a fast 16 bit AD-converter and a command decoder and control logic unit.
Robot
The SPEAG DASY system uses the high precision robots (DASY5: TX90XL) type from Stäubli SA (France). For the 6-axis controller system, the robot controller version (DASY5: CS8c) from Stäubli is used.

5.4 Data Storage and Evaluation

The DASY software stores the assessed data from the data acquisition electronics as raw data (in microvolt readings from the probe sensors), together with all the necessary software parameters for the data evaluation (probe calibration data, and device frequency and modulation data) in measurement files.

Probe parameters :	- Sensitivity	Norm _i , a _{i0} , a _{i1} , a _{i2}
	- Conversion factor	ConvF _i
	- Diode compression point	dcp _i
Device parameters :	- Frequency	f
	- Crest factor	cf
Media parameters :	- Conductivity	σ
	- Density	ρ

The formula for each channel can be given as :

$$V_i = U_i + U_i^2 \cdot \frac{cf}{dcp_i}$$

- with V_i = compensated signal of channel i, (i = x, y, z)
 U_i = input signal of channel i, (i = x, y, z)
 cf = crest factor of exciting field (DASY parameter)
 dcp_i = diode compression point (DASY parameter)

From the compensated input signals, the primary field data for each channel can be evaluated :

$$\text{E-field Probes : } E_i = \sqrt{\frac{V_i}{\text{Norm}_i \cdot \text{ConvF}}}$$

- with V_i = compensated signal of channel i, (i = x, y, z)
 Norm_i = sensor sensitivity of channel i, (i = x, y, z), μV/(V/m)² for E-field Probes
 ConvF = sensitivity enhancement in solution
 f = carrier frequency [GHz]
 E_i = electric field strength of channel i in V/m

The RSS value of the field components gives the total field strength (Hermitian magnitude) :

$$E_{\text{tot}} = \sqrt{E_x^2 + E_y^2 + E_z^2}$$

The primary field data are used to calculate the derived field units.



5.5 Test Equipment List

Manufacturer	Name of Equipment	Type/Model	Serial Number	Calibration	
				Last Cal.	Due Date
SPEAG*	Dipole	CD835V3	1171	Jan. 22, 2013	Jan. 21, 2016
SPEAG*	Dipole	CD1880V3	1155	Jan. 22, 2013	Jan. 21, 2016
SPEAG	Data Acquisition Electronics	DAE4	1210	May 19, 2014	May 18, 2015
SPEAG	Probe	ER3DV6	2476	Nov. 19, 2014	Nov. 18, 2015
SPEAG	Test Arch Phantom	Par phantom	1105	NCR	NCR
SPEAG	Phone Positioner	N/A	N/A	NCR	NCR
Agilent	Wireless Communication Test Set	E5515C	MY52102706	May 03, 2014	May 02, 2015
Agilent	Wireless Communication Test Set	E5515E	MY53211040	Jun. 12, 2014	Jun. 11, 2015
R&S	Signal Generator	SMBV100A	258305	Jan. 23, 2015	Jan. 22, 2016
AR	Amplifier	551G4	333096	NCR	NCR
Anritsu	Power Sensor	MA2411B	0917070	Jan. 23, 2015	Jan. 22, 2016
Anritsu	Power Meter	ML2495A	1005002	Jan. 23, 2015	Jan. 22, 2016
ARRA	Power Divider	A3200-2	N/A	NA	NA
MCL	Attenuation	BW-S10W5	N/A	NA	NA

Table 5.1 Test Equipment List

Note: "*" Means calibration interval of instruments listed above is three years.

6. Measurement System Validation

Each DASY system is equipped with one or more system validation kits. These units, together with the predefined measurement procedures within the DASY software, enable the user to conduct the system performance check and system validation. System validation kit includes a dipole, tripod holder to fix it underneath the test Arch and a corresponding distance holder.

6.1 Purpose of System Performance Check

The system performance check verifies that the system operates within its specifications. System and operator errors can be detected and corrected. It is recommended that the system performance check be performed prior to any usage of the system in order to guarantee reproducible results. The system performance check uses normal HAC measurements in a simplified setup with a well characterized source. This setup was selected to give a high sensitivity to all parameters that might fail or vary over time. The system check does not intend to replace the calibration of the components, but indicates situations where the system uncertainty is exceeded due to drift or failure.

6.2 System Setup

1. In the simplified setup for system evaluation, the EUT is replaced by a calibrated dipole and the power source is replaced by a continuous wave which comes from a signal generator.
2. The center point of the probe element(s) is 15mm from the closest surface of the dipole elements.
3. The calibrated dipole must be placed beneath the arch phantom. The equipment setup is shown below:

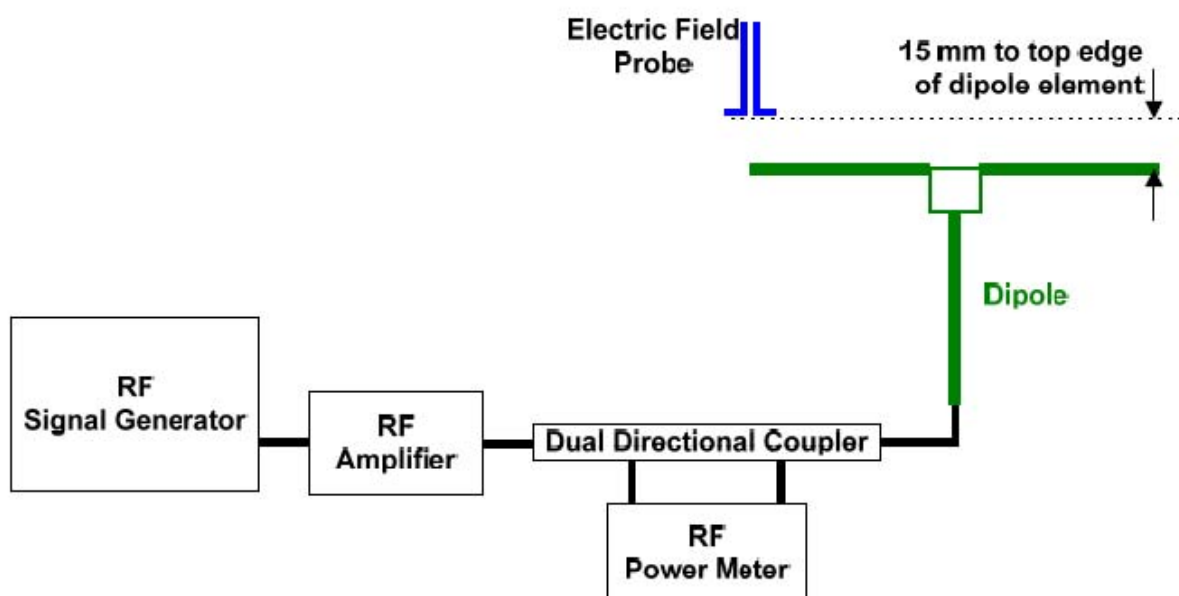

Fig. 6.1 System Validation Setup

The output power on dipole port must be calibrated to 20dBm (100mW) before dipole is connected.

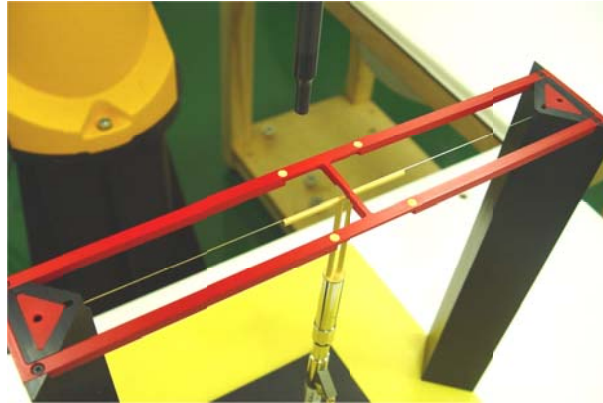

Fig 7.2 Dipole Setup

6.3 Verification Results

Comparing to the original E-field value provided by SPEAG, the verification data should be within its specification of 25 %. Table 6.1 shows the target value and measured value. The table below indicates the system performance check can meet the variation criterion and the plots can be referred to appendix A of this report.

Frequency (MHz)	Input Power (dBm)	Target Value (V/m)	E-Field above high end (V/m)	E-Field above low end (V/m)	Average Value (V/m)	Deviation (%)	Date
835	20	109	107.1	106.5	106.8	-2.02	Mar. 04, 2015
835	20	109	103.2	114.7	108.95	-0.05	Apr. 17, 2015
1880	20	90.5	88.58	83.64	86.11	-4.85	Mar. 04, 2015
1880	20	90.5	88.24	83.38	85.81	-5.18	Apr. 17, 2015

Table 6.1 Test Results of System Validation

Note: Deviation = ((Average E-field Value) - (Target value)) / (Target value) * 100%



7. Modulation Interference Factor

The HAC Standard ANSI C63.19-2011 defines a new scaling using the Modulation Interference Factor (MIF).

For any specific fixed and repeatable modulated signal, a modulation interference factor (MIF, expressed in dB) may be developed that relates its interference potential to its steady-state rms signal level or average power level. This factor is a function only of the audio-frequency amplitude modulation characteristics of the signal and is the same for field-strength and conducted power measurements. It is important to emphasize that the MIF is valid only for a specific repeatable audio-frequency amplitude modulation characteristic. Any change in modulation characteristic requires determination and application of a new MIF

The Modulation Interference factor (MIF, in dB) is added to the measured average E-field (in dBV/m) and converts it to the RF Audio Interference level (in dBV/m). This level considers the audible amplitude modulation components in the RF E-field. CW fields without amplitude modulation are assumed to not interfere with the hearing aid electronics. Modulations without time slots and low fluctuations at low frequencies have low MIF values, TDMA modulations with narrow transmission and repetition rates of few 100 Hz have high MIF values and give similar classifications as ANSI C63.19-2007.

ER3D, EF3D and EU2D E-field probes have a bandwidth <10 kHz and can therefore not evaluate the RF envelope in the full audio band. DASY52 is therefore using the indirect measurement method according to ANSI C63.19-2011 which is the primary method. These near field probes read the averaged E-field measurement. Especially for the new high peak-to-average (PAR) signal types, the probes shall be linearized by PMR calibration in order to not overestimate the field reading. Probe Modulation Response (PMR) calibration linearizes the probe response over its dynamic range for specific modulations which are characterized by their UID and result in an uncertainty specified in the probe calibration certificate. The MIF is characteristic for a given waveform envelope and can be used as a constant conversion factor if the probe has been PMR calibrated.

The evaluation method for the MIF is defined in ANSI C63.19-2011 section D.7. An RMS demodulated RF signal is fed to a spectral filter (similar to an A weighting filter) and forwarded to a temporal filter acting as a quasi-peak detector. The averaged output of these filtering is scaled to a 1 kHz 80% AM signal as reference. MIF measurement requires additional instrumentation and is not well suited for evaluation by the end user with reasonable uncertainty. It may alternatively be determined through analysis and simulation, because it is constant and characteristic for a communication signal. DASY52 uses well-defined signals for PMR calibration. The MIF of these signals has been determined by simulation and it is automatically applied.



MIF values applied in this test report were provided by the HAC equipment provider, SPEAG, and the values are listed below

UID	Communication System Name	MIF(dB)
10021	GSM-FDD(TDMA,GMSK)	3.63
10011	UMTS-FDD(WCDMA)	-27.23
10100	LTE-FDD(SC-FDMA,100%RB,20MHz,QPSK)	-23.48
10101	LTE-FDD(SC-FDMA,100%RB,20MHz,16-QAM)	-17.86
10108	LTE-FDD(SC-FDMA,100%RB,10MHz,QPSK)	-21.57
10109	LTE-FDD(SC-FDMA,100%RB,10MHz,16-QAM)	-16.87
10110	LTE-FDD(SC-FDMA,100%RB,5MHz,QPSK)	-23.39
10111	LTE-FDD(SC-FDMA,100%RB,5MHz,16-QAM)	-16.35
10139	LTE-FDD(SC-FDMA,100%RB,15MHz,QPSK)	-18.25
10140	LTE-FDD(SC-FDMA,100%RB,15MHz,16-QAM)	-19.37
10142	LTE-FDD(SC-FDMA,100%RB,3MHz,QPSK)	-22.36
10143	LTE-FDD(SC-FDMA,100%RB,3MHz,16-QAM)	-14.75
10145	LTE-FDD(SC-FDMA,100%RB,1.4MHz,QPSK)	-17.39
10146	LTE-FDD(SC-FDMA,100%RB,1.4MHz,16-QAM)	-13.6
10148	LTE-FDD(SC-FDMA,50%RB,20MHz,QPSK)	-18.28
10149	LTE-FDD(SC-FDMA,50%RB,20MHz,16-QAM)	-16.87
10154	LTE-FDD(SC-FDMA,50%RB,10MHz,QPSK)	-23.42
10155	LTE-FDD(SC-FDMA,50%RB,10MHz,16-QAM)	-16.36
10156	LTE-FDD(SC-FDMA,50%RB,5MHz,QPSK)	-21.71
10157	LTE-FDD(SC-FDMA,50%RB,5MHz,16-QAM)	-15.78
10160	LTE-FDD(SC-FDMA,50%RB,15MHz,QPSK)	-17.95
10161	LTE-FDD(SC-FDMA,50%RB,15MHz,16-QAM)	-17.54
10163	LTE-FDD(SC-FDMA,50%RB,3MHz,QPSK)	-19.99
10164	LTE-FDD(SC-FDMA,50%RB,3MHz,16-QAM)	-14.41
10166	LTE-FDD(SC-FDMA,50%RB,1.4MHz,QPSK)	-18.1
10167	LTE-FDD(SC-FDMA,50%RB,1.4MHz,16-QAM)	-12.15
10169	LTE-FDD(SC-FDMA,1RB,20MHz,QPSK)	-15.63
10170	LTE-FDD(SC-FDMA,1RB,20MHz,16-QAM)	-9.76
10175	LTE-FDD(SC-FDMA,1RB,10MHz,QPSK)	-15.63
10176	LTE-FDD(SC-FDMA,1RB,10MHz,16-QAM)	-9.76
10177	LTE-FDD(SC-FDMA,1RB,5MHz,QPSK)	-15.63
10178	LTE-FDD(SC-FDMA,1RB,5MHz,16-QAM)	-9.76
10181	LTE-FDD(SC-FDMA,1RB,15MHz,QPSK)	-15.63
10182	LTE-FDD(SC-FDMA,1RB,15MHz,16-QAM)	-9.76
10184	LTE-FDD(SC-FDMA,1RB,3MHz,QPSK)	-15.62
10185	LTE-FDD(SC-FDMA,1RB,3MHz,16-QAM)	-9.76
10187	LTE-FDD(SC-FDMA,1RB,1.4MHz,QPSK)	-15.62
10188	LTE-FDD(SC-FDMA,1RB,1.4MHz,16-QAM)	-9.76

The MIF measurement uncertainty is estimated as follows, declared by HAC equipment provider SPEAG, for modulation frequencies from slotted waveforms with fundamental frequency and at least 2 harmonics within 10 kHz:

- i) 0.2 dB for MIF: -7 to +5 dB,
- ii) 0.5 dB for MIF: -13 to +11 dB
- iii) 1 dB for MIF: > -20 dB



8. RF Emissions Test Procedure

Referenced from ANSI C63.19 -2011 section 5.5.1

- a) Confirm the proper operation of the field probe, probe measurement system, and other instrumentation and the positioning system.
- b) Position the WD in its intended test position.
- c) Set the WD to transmit a fixed and repeatable combination of signal power and modulation characteristic that is representative of the worst case (highest interference potential) encountered in normal use. Transiently occurring start-up, changeover, or termination conditions, or other operations likely to occur less than 1% of the time during normal operation, may be excluded from consideration.
- d) The center sub-grid shall be centered on the T-Coil mode perpendicular measurement point or the acoustic output, as appropriate. Locate the field probe at the initial test position in the 50 mm by 50 mm grid, which is contained in the measurement plane, refer to illustrated in Figure 8.2. If the field alignment method is used, align the probe for maximum field reception.
- e) Record the reading at the output of the measurement system.
- f) Scan the entire 50 mm by 50 mm region in equality spaced increments and record the reading at each measurement point, The distance between measurement points shall be sufficient to assure the identification of the maximum reading.
- g) Identify the five contiguous sub-grids around the center sub-grid whose maximum reading is the lowest of all available choices. This eliminates the three sub-grids with the maximum readings. Thus, the six areas to be used to determine the WD's highest emissions are identified.
- h) Identify the maximum reading within the non-excluded sub-grids identified in step g).
- i) *Indirect measurement method*
The RF audio interference level in dB (V/m) is obtained by adding the MIF (in dB) to the maximum steady-state rms field-strength reading, in dB (V/m)
- j) Compare this RF audio interference level with the categories in ANSI C63.19-2011 clause 8 and record the resulting WD category rating.
- k) For the T-Coil mode M-rating assessment, determine whether the chosen perpendicular measurement point is contained in an included sub-grid of the first scan. If so, then a second scan is not necessary. The first scan and resultant category rating may be used for the T-Coil mode M rating.

Otherwise, repeat step a) through step i), with the grid shifted so that it is centered on the perpendicular measurement point. Record the WD category rating.

Test Instructions

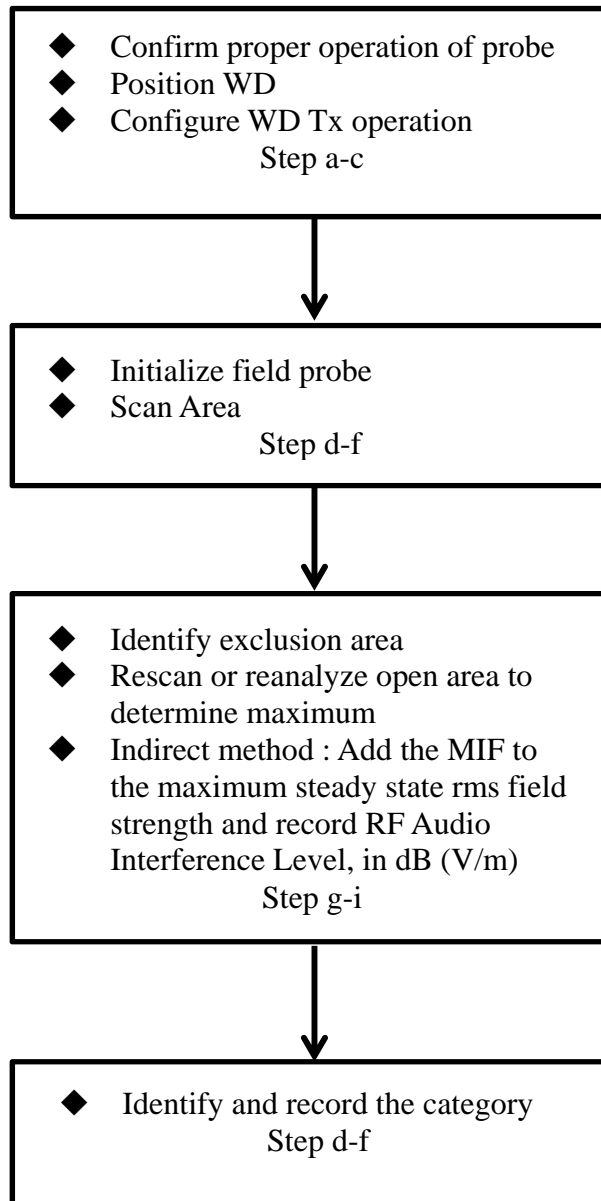

Fig 8.1 Flow Chart of HAC RF Emission



Fig 8.2 EUT reference and plane for HAC RF emission measurements

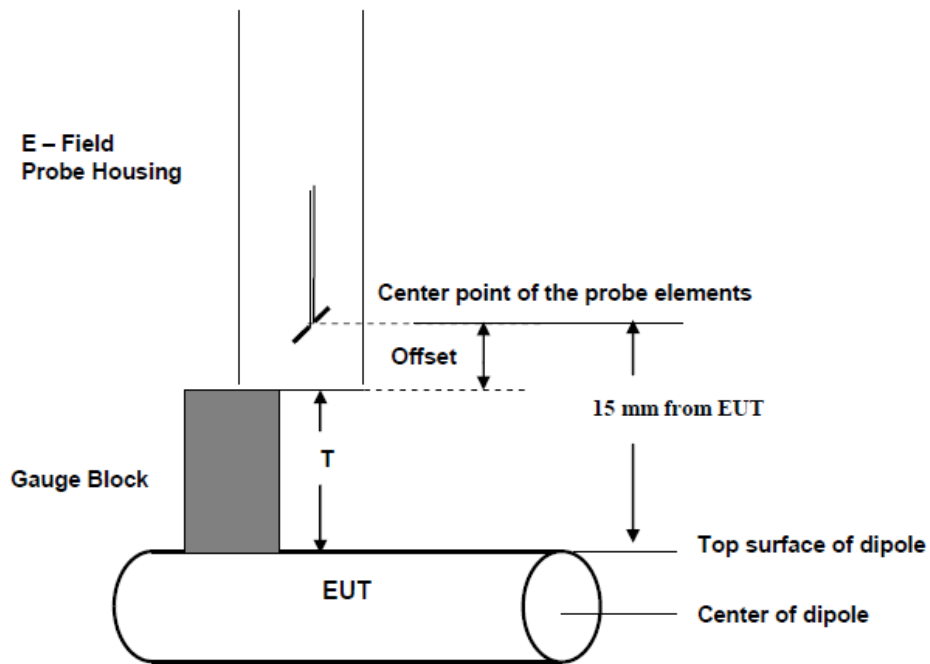
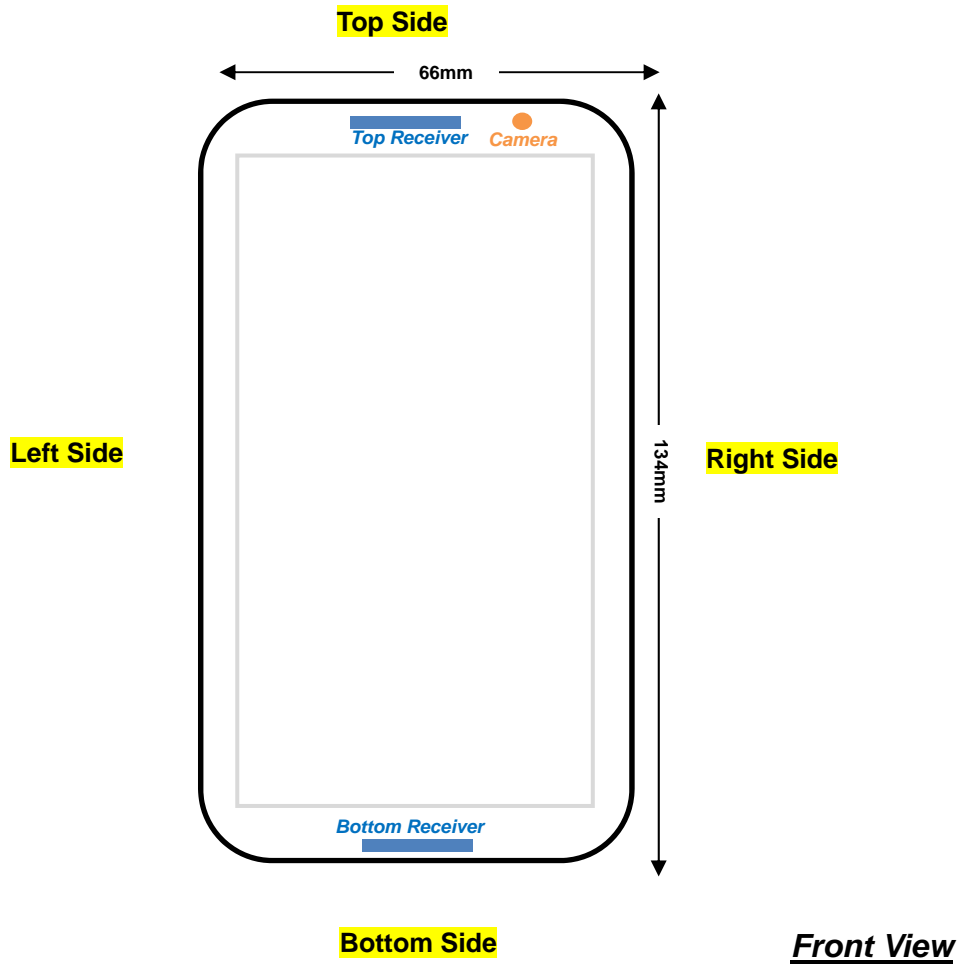

Fig. 8.3 Gauge block with E-field probe

9. Receiver Location





10. Maximum Tune-up Limit

Top Receiver Worked
Full Power:

Band	Maximum Average Antenna Input Power (dBm)	
	GSM850	GSM1900
GSM (GMSK, 1 Tx slot)	34.0	30.0

Band	Maximum Average Antenna Input Power (dBm)	
	WCDMA Band V	WCDMA Band II
WCDMA	24.0	22.5

LTE Band 2				
Maximum Average Antenna Input Power (dBm)				
Modulation	BW (MHz)	RB size	MPR	Target Power
QPSK	1.4, 3, 5, 10, 15, 20	1 – 49%	0	22.5
QPSK	1.4, 3, 5, 10, 15, 20	49 – 99%	1	21.5
QPSK	1.4, 3, 5, 10, 15, 20	100%	1	21.5
16QAM	1.4, 3, 5, 10, 15, 20	1 – 49%	1	21.5
16QAM	1.4, 3, 5, 10, 15, 20	49 – 99%	2	20.5
16QAM	1.4, 3, 5, 10, 15, 20	100%	2	20.5

LTE Band 4				
Maximum Average Antenna Input Power (dBm)				
Modulation	BW (MHz)	RB size	MPR	Target Power
QPSK	1.4, 3, 5, 10, 15, 20	1 – 49%	0	22.5
QPSK	1.4, 3, 5, 10, 15, 20	49 – 99%	1	21.5
QPSK	1.4, 3, 5, 10, 15, 20	100%	1	21.5
16QAM	1.4, 3, 5, 10, 15, 20	1 – 49%	1	21.5
16QAM	1.4, 3, 5, 10, 15, 20	49 – 99%	2	20.5
16QAM	1.4, 3, 5, 10, 15, 20	100%	2	20.5

LTE Band 7				
Maximum Average Antenna Input Power (dBm)				
Modulation	BW (MHz)	RB size	MPR	Target Power
QPSK	5, 10, 15, 20	1 – 49%	0	23.5
QPSK	5, 10, 15, 20	49 – 99%	1	22.5
QPSK	5, 10, 15, 20	100%	1	22.5
16QAM	5, 10, 15, 20	1 – 49%	1	22.5
16QAM	5, 10, 15, 20	49 – 99%	2	21.5
16QAM	5, 10, 15, 20	100%	2	21.5



**Bottom Receiver Worked
Reduced Power:**

Band	Maximum Average Antenna Input Power (dBm)	
	GSM850	GSM1900
GSM (GMSK, 1 Tx slot)	30.0	25.0

Band	Maximum Average Antenna Input Power (dBm)	
	WCDMA Band II	
WCDMA	16.5	

LTE Band 2				
Maximum Average Antenna Input Power (dBm)				
Modulation	BW (MHz)	RB size	MPR	Target Power
QPSK	1.4, 3, 5, 10, 15, 20	1 – 49%	0	17.0
QPSK	1.4, 3, 5, 10, 15, 20	49 – 99%	0	17.0
QPSK	1.4, 3, 5, 10, 15, 20	100%	0	17.0
16QAM	1.4, 3, 5, 10, 15, 20	1 – 49%	0	17.0
16QAM	1.4, 3, 5, 10, 15, 20	49 – 99%	0	17.0
16QAM	1.4, 3, 5, 10, 15, 20	100%	0	17.0

LTE Band 4				
Maximum Average Antenna Input Power (dBm)				
Modulation	BW (MHz)	RB size	MPR	Target Power
QPSK	1.4, 3, 5, 10, 15, 20	1 – 49%	0	18.0
QPSK	1.4, 3, 5, 10, 15, 20	49 – 99%	0	18.0
QPSK	1.4, 3, 5, 10, 15, 20	100%	0	18.0
16QAM	1.4, 3, 5, 10, 15, 20	1 – 49%	0	18.0
16QAM	1.4, 3, 5, 10, 15, 20	49 – 99%	0	18.0
16QAM	1.4, 3, 5, 10, 15, 20	100%	0	18.0

LTE Band 7				
Maximum Average Antenna Input Power (dBm)				
Modulation	BW (MHz)	RB size	MPR	Target Power
QPSK	5, 10, 15, 20	1 – 49%	0	15.5
QPSK	5, 10, 15, 20	49 – 99%	0	15.5
QPSK	5, 10, 15, 20	100%	0	15.5
16QAM	5, 10, 15, 20	1 – 49%	0	15.5
16QAM	5, 10, 15, 20	49 – 99%	0	15.5
16QAM	5, 10, 15, 20	100%	0	15.5



Hotspot Mode
Reduced Power:

LTE Band 7				
Maximum Average Antenna Input Power (dBm)				
Modulation	BW (MHz)	RB size	MPR	Target Power
QPSK	5, 10, 15, 20	1 – 49%	0	17.5
QPSK	5, 10, 15, 20	49 – 99%	0	17.5
QPSK	5, 10, 15, 20	100%	0	17.5
16QAM	5, 10, 15, 20	1 – 49%	0	17.5
16QAM	5, 10, 15, 20	49 – 99%	0	17.5
16QAM	5, 10, 15, 20	100%	0	17.5



11. Low-power Exemption

According to ANSI C63.19 2011-version, an RF air interface technology of a device is exempt from testing when its average antenna input power plus its MIF is ≤ 17 dBm for any of its operating modes.

Top Receiver Worked Full Power:

Air Interface	BW (MHz)	RB Size	Operating Mode	Average Antenna Input Power (dBm)	MIF (dB)	Power + MIF(dB)	C63.19 test required
GSM850	-	-	GSM	34.0	3.63	37.63	Yes
GSM1900	-	-	GSM	30.0	3.63	33.63	Yes
WCDMA Band V	-	-	RMC 12.2Kbps	24.0	-27.23	-3.23	No
WCDMA Band II	-	-	RMC 12.2Kbps	22.5	-27.23	-4.73	No
LTE Band 2	20	1RB	QPSK	22.5	-15.63	6.87	No
	20	1RB	16QAM	21.5	-9.76	11.74	No
	15	1RB	QPSK	22.5	-15.63	6.87	No
	15	1RB	16QAM	21.5	-9.76	11.74	No
	10	1RB	QPSK	22.5	-15.63	6.87	No
	10	1RB	16QAM	21.5	-9.76	11.74	No
	5	1RB	QPSK	22.5	-15.63	6.87	No
	5	1RB	16QAM	21.5	-9.76	11.74	No
	3	1RB	QPSK	22.5	-15.62	6.88	No
	3	1RB	16QAM	21.5	-9.76	11.74	No
	1.4	1RB	QPSK	22.5	-15.62	6.88	No
1.4	1RB	16QAM	21.5	-9.76	11.74	No	
LTE Band 4	20	1RB	QPSK	22.5	-15.63	6.87	No
	20	1RB	16QAM	21.5	-9.76	11.74	No
	15	1RB	QPSK	22.5	-15.63	6.87	No
	15	1RB	16QAM	21.5	-9.76	11.74	No
	10	1RB	QPSK	22.5	-15.63	6.87	No
	10	1RB	16QAM	21.5	-9.76	11.74	No
	5	1RB	QPSK	22.5	-15.63	6.87	No
	5	1RB	16QAM	21.5	-9.76	11.74	No
	3	1RB	QPSK	22.5	-15.62	6.88	No
	3	1RB	16QAM	21.5	-9.76	11.74	No
	1.4	1RB	QPSK	22.5	-15.62	6.88	No
1.4	1RB	16QAM	21.5	-9.76	11.74	No	
LTE Band 7	20	1RB	QPSK	23.5	-15.63	7.87	No
	20	1RB	16QAM	22.5	-9.76	12.74	No
	15	1RB	QPSK	23.5	-15.63	7.87	No
	15	1RB	16QAM	22.5	-9.76	12.74	No
	10	1RB	QPSK	23.5	-15.63	7.87	No
	10	1RB	16QAM	22.5	-9.76	12.74	No
	5	1RB	QPSK	23.5	-15.63	7.87	No
	5	1RB	16QAM	22.5	-9.76	12.74	No



**Bottom Receiver Worked
Reduced Power:**

Air Interface	BW (MHz)	RB Size	Operating Mode	Average Antenna Input Power (dBm)	MIF (dB)	Power + MIF(dB)	C63.19 test required
GSM850	-	-	GSM	30.0	3.63	33.63	Yes
GSM1900	-	-	GSM	25.0	3.63	28.63	Yes
WCDMA Band II	-	-	RMC 12.2Kbps	16.5	-27.23	-10.73	No
LTE Band 2	20	1RB	QPSK	17	-15.63	1.37	No
	20	1RB	16QAM	17	-9.76	7.24	No
	15	1RB	QPSK	17	-15.63	1.37	No
	15	1RB	16QAM	17	-9.76	7.24	No
	10	1RB	QPSK	17	-15.63	1.37	No
	10	1RB	16QAM	17	-9.76	7.24	No
	5	1RB	QPSK	17	-15.63	1.37	No
	5	1RB	16QAM	17	-9.76	7.24	No
	3	1RB	QPSK	17	-15.62	1.38	No
	3	1RB	16QAM	17	-9.76	7.24	No
	1.4	1RB	QPSK	17	-15.62	1.38	No
1.4	1RB	16QAM	17	-9.76	7.24	No	
LTE Band 4	20	1RB	QPSK	18	-15.63	2.37	No
	20	1RB	16QAM	18	-9.76	8.24	No
	15	1RB	QPSK	18	-15.63	2.37	No
	15	1RB	16QAM	18	-9.76	8.24	No
	10	1RB	QPSK	18	-15.63	2.37	No
	10	1RB	16QAM	18	-9.76	8.24	No
	5	1RB	QPSK	18	-15.63	2.37	No
	5	1RB	16QAM	18	-9.76	8.24	No
	3	1RB	QPSK	18	-15.62	2.38	No
	3	1RB	16QAM	18	-9.76	8.24	No
	1.4	1RB	QPSK	18	-15.62	2.38	No
1.4	1RB	16QAM	18	-9.76	8.24	No	
LTE Band 7	20	1RB	QPSK	15.5	-15.63	-0.13	No
	20	1RB	16QAM	15.5	-9.76	5.74	No
	15	1RB	QPSK	15.5	-15.63	-0.13	No
	15	1RB	16QAM	15.5	-9.76	5.74	No
	10	1RB	QPSK	15.5	-15.63	-0.13	No
	10	1RB	16QAM	15.5	-9.76	5.74	No
	5	1RB	QPSK	15.5	-15.63	-0.13	No
	5	1RB	16QAM	15.5	-9.76	5.74	No



Hotspot mode
Reduced Power:

Air Interface	BW (MHz)	RB Size	Operating Mode	Average Antenna Input Power (dBm)	MIF (dB)	Power + MIF(dB)	C63.19 test required
LTE Band 7	20	1RB	QPSK	17.5	-15.63	1.87	No
	20	1RB	16QAM	17.5	-9.76	7.74	No
	15	1RB	QPSK	17.5	-15.63	1.87	No
	15	1RB	16QAM	17.5	-9.76	7.74	No
	10	1RB	QPSK	17.5	-15.63	1.87	No
	10	1RB	16QAM	17.5	-9.76	7.74	No
	5	1RB	QPSK	17.5	-15.63	1.87	No
	5	1RB	16QAM	17.5	-9.76	7.74	No

Conclusion:

1. HAC RF rating is M4 for the air interface which meets the low power exemption.
2. Low power exemption is applicable to WCDMA and LTE, and HAC rating is M4 for both air interfaces.



12. Conducted RF Output Power (Unit: dBm)

Top Receiver Worked
Full Power:

Air Interface	GSM850			GSM1900		
Channel	128	189	251	512	661	810
Frequency (MHz)	824.2	836.4	848.8	1850.2	1880.0	1909.8
Average Antenna Input Power(dBm)	33.51	33.72	33.42	29.22	29.35	29.50

Bottom Receiver Worked
Reduced Power:

Air Interface	GSM850			GSM1900		
Channel	128	189	251	512	661	810
Frequency (MHz)	824.2	836.4	848.8	1850.2	1880.0	1909.8
Average Antenna Input Power(dBm)	29.60	29.66	29.59	24.15	24.39	24.55



13. HAC RF Emission Test Results

13.1 E-Field Emission

Emission Categories	E-field emissions	
	<960Mhz	>960Mhz
M1	50 to 55 dB (V/m)	40 to 45 dB (V/m)
M2	45 to 50 dB (V/m)	35 to 40 dB (V/m)
M3	40 to 45 dB (V/m)	30 to 35 dB (V/m)
M4	<40 dB (V/m)	<30 dB (V/m)

Plot No.	Air Interface	Operating Mode	Channel	Receiver Worked status	Power reduction	Battery	Average Antenna Input Power (dBm)	MIF	RF audio interference level dB(V/m)	Margin to FCC M3 limit (dB)	M -Rating
1	GSM850	GSM Voice	128	Top	Off	1	33.51	3.63	39.88	5.12	M4
2	GSM850	GSM Voice	189	Top	Off	1	33.72	3.63	39.87	5.13	M4
3	GSM850	GSM Voice	251	Top	Off	1	33.42	3.63	38.66	6.34	M4
13	GSM850	GSM Voice	128	Top	Off	2	33.51	3.63	40.60	4.40	M3
4	GSM1900	GSM Voice	512	Top	Off	1	29.22	3.63	26.46	8.54	M4
5	GSM1900	GSM Voice	661	Top	Off	1	29.35	3.63	27.41	7.59	M4
6	GSM1900	GSM Voice	810	Top	Off	1	29.50	3.63	26.94	8.06	M4
14	GSM1900	GSM Voice	661	Top	Off	2	29.35	3.63	26.44	8.56	M4
7	GSM850	GSM Voice	128	Bottom	On	1	29.60	3.63	43.62	1.38	M3
8	GSM850	GSM Voice	189	Bottom	On	1	29.66	3.63	43.05	1.95	M3
9	GSM850	GSM Voice	251	Bottom	On	1	29.59	3.63	41.72	3.28	M3
15	GSM850	GSM Voice	128	Bottom	On	2	29.60	3.63	43.77	1.23	M3
10	GSM1900	GSM Voice	512	Bottom	On	1	24.15	3.63	33.16	1.84	M3
11	GSM1900	GSM Voice	661	Bottom	On	1	24.39	3.63	33.42	1.58	M3
12	GSM1900	GSM Voice	810	Bottom	On	1	24.55	3.63	33.48	1.52	M3
16	GSM1900	GSM Voice	810	Bottom	On	2	24.55	3.63	33.24	1.76	M3

Remark:

1. The HAC measurement system applies MIF value onto the measured RMS E-field, which is indirect method in ANSI C63.19 2011 version, and reports the RF audio interference level.
2. The uncertainty is 0.2dB of MIF ranges from -7dB to +5dB. GSM850 band with rating M3, GSM1900 band with rating M3 would not be affected considering the MIF uncertainty.
3. There is no special HAC mode software on this EUT.

Test Engineer : Fulu Hu.



14. Uncertainty Assessment

The component of uncertainty may generally be categorized according to the methods used to evaluate them. The evaluation of uncertainty by the statistical analysis of a series of observations is termed a Type A evaluation of uncertainty. The evaluation of uncertainty by means other than the statistical analysis of a series of observation is termed a Type B evaluation of uncertainty. Each component of uncertainty, however evaluated, is represented by an estimated standard deviation, termed standard uncertainty, which is determined by the positive square root of the estimated variance.

The combined standard uncertainty of the measurement result represents the estimated standard deviation of the result. It is obtained by combining the individual standard uncertainties of both Type A and Type B evaluation using the usual "root-sum-squares" (RSS) methods of combining standard deviations by taking the positive square root of the estimated variances. Expanded uncertainty is a measure of uncertainty that defines an interval about the measurement result within which the measured value is confidently believed to lie. It is obtained by multiplying the combined standard uncertainty by a coverage factor. For purpose of this document, a coverage factor two is used, which corresponds to confidence interval of about 95 %. The DASY uncertainty Budget is showed in Table 12.1.

Error Description	Uncertainty Value (±%)	Probability Distribution	Divisor	Ci (E)	Standard Uncertainty (E)
Measurement System					
Probe Calibration	5.1	Normal	1	1	± 5.1 %
Axial Isotropy	4.7	Rectangular	$\sqrt{3}$	1	± 2.7 %
Sensor Displacement	16.5	Rectangular	$\sqrt{3}$	1	± 9.5 %
Boundary Effects	2.4	Rectangular	$\sqrt{3}$	1	± 1.4 %
Phantom Boundary Effects	7.2	Rectangular	$\sqrt{3}$	1	± 4.1 %
Linearity	4.7	Rectangular	$\sqrt{3}$	1	± 2.7 %
Scaling with PMF Calibration	10.0	Rectangular	$\sqrt{3}$	1	± 5.77 %
System Detection Limit	1.0	Rectangular	$\sqrt{3}$	1	± 0.6 %
Readout Electronics	0.3	Normal	1	1	± 0.3 %
Response Time	0.8	Rectangular	$\sqrt{3}$	1	± 0.5 %
Integration Time	2.6	Rectangular	$\sqrt{3}$	1	± 1.5 %
RF Ambient Conditions	3.0	Rectangular	$\sqrt{3}$	1	± 1.7 %
RF Reflections	12.0	Rectangular	$\sqrt{3}$	1	± 6.9 %
Probe Positioner	1.2	Rectangular	$\sqrt{3}$	1	± 0.7 %
Probe Positioning	4.7	Rectangular	$\sqrt{3}$	1	± 2.7 %
Extrap. and Interpolation	1.0	Rectangular	$\sqrt{3}$	1	± 0.6 %
Test Sample Related					
Device Positioning Vertical	4.7	Rectangular	$\sqrt{3}$	1	± 2.7 %
Device Positioning Lateral	1.0	Rectangular	$\sqrt{3}$	1	± 0.6 %
Device Holder and Phantom	2.4	Rectangular	$\sqrt{3}$	1	± 1.4 %
Power Drift	5.0	Rectangular	$\sqrt{3}$	1	± 2.9 %
Phantom and Setup Related					
Phantom Thickness	2.4	Rectangular	$\sqrt{3}$	1	± 1.4 %
Combined Standard Uncertainty					± 16.30 %
Coverage Factor for 95 %					K = 2
Expanded Std. Uncertainty on Power					± 32.6 %
Expanded Std. Uncertainty on Field					± 16.3 %

Table 14.1 Uncertainty Budget of HAC free field assessment
Remark:

Worst-Case uncertainty budget for HAC free field assessment according to ANSIC63.19 [1], [2]. The budget is valid for the frequency range 700 MHz - 3 GHz and represents a worst case analysis.



15. References

- [1] ANSI C63.19-2011, "American National Standard for Methods of Measurement of Compatibility between Wireless Communications Devices and Hearing Aids", 27 May 2011
- [2] SPEAG DASY System Handbook



Appendix A. Plots of System Performance Check

The plots are shown as follows.



Appendix B. Plots of RF Emission Measurement

The plots are shown as follows.



Appendix C. DASY Calibration Certificate

The DASY calibration certificates are shown as follows.



Appendix E. Appendix E Product Equality Declaration

	Antenna	AP	Modem	Transceiver	Power Amplifier	Balun	Band pass filter	Diplexer
Bluetooth	No	No	No	No	No	No	No	No
Wi-Fi	No	No	No	No	No	No	No	No

- FM changes: No
- LCD/ Speaker/ Camera/ Vibrator changes: No (indicated the changed items if yes)
- Other changes detailed:

● **MECHANICAL MODIFICATIONS:**

- Use new metal front/back cover or keypad: No
- Mechanical shell changes:
 - Whole size of EUT: No
 - Distance of Ear reference point to bottom of handset: No
 - Other trinkets to change the surface of handset: No
- Other changes detailed: replace SD card slot by the second SIM card slot on enclosure

APPROVED BY:

Project Manager:

Signature:

Date:

Danielji

2015.3.19.