



FCC RF Test Report

APPLICANT : TCT Mobile Limited
EQUIPMENT : GSM Quad-band / UMTS Quad-band / LTE Penta-band mobile phone
BRAND NAME : Alcatel
MODEL NAME : 6039J
FCC ID : RAD545
STANDARD : FCC Part 15 Subpart C §15.247
CLASSIFICATION : (DTS) Digital Transmission System

The product was testing completed on Apr. 17, 2015. We, SPORTON INTERNATIONAL (KUNSHAN) INC., would like to declare that the tested sample has been evaluated in accordance with the test procedures and has been in compliance with the applicable technical standards.

The test results in this report apply exclusively to the tested model / sample. Without written approval of SPORTON INTERNATIONAL (KUNSHAN) INC., the test report shall not be reproduced except in full.

Reviewed by: Joseph Lin / Supervisor

Approved by: Jones Tsai / Manager



SPORTON INTERNATIONAL (KUNSHAN) INC.
No. 3-2, PingXiang Road, Kunshan, Jiangsu Province, P. R. China



TABLE OF CONTENTS

SUMMARY OF TEST RESULT 4

1 GENERAL DESCRIPTION 5

1.1 Applicant 5

1.2 Manufacturer 5

1.3 Product Feature of Equipment Under Test 5

1.4 Product Specification subjective to this standard 6

1.5 Modification of EUT 7

1.6 Testing Location 7

1.7 Applicable Standards 7

2 TEST CONFIGURATION OF EQUIPMENT UNDER TEST 8

2.1 Carrier Frequency Channel 8

2.2 Pre-Scanned RF Power 9

2.3 Test Mode 10

2.4 Connection Diagram of Test System 11

2.5 Support Unit used in test configuration and system 13

2.6 EUT Operation Test Setup 13

2.7 Measurement Results Explanation Example 13

3 TEST RESULT 14

3.1 6dB Bandwidth Measurement 14

3.2 Output Power Measurement 16

3.3 Power Spectral Density Measurement 19

3.4 Conducted Band Edges and Spurious Emission Measurement 21

3.5 Radiated Band Edges and Spurious Emission Measurement 31

3.6 AC Conducted Emission Measurement 35

3.7 Antenna Requirements 39

4 LIST OF MEASURING EQUIPMENT 40

5 UNCERTAINTY OF EVALUATION 41

APPENDIX A. RADIATED TEST RESULTS

APPENDIX B. SETUP PHOTOGRAPHS

APPENDIX C. PRODUCT EQUALITY DECLARATION



REVISION HISTORY

REPORT NO.	VERSION	DESCRIPTION	ISSUED DATE
FR511303-03C	Rev. 01	This is a variant product of 6039A. According to the product equality declaration as Appendix C which is provided by client, the test result is not affected, all test cases were performed on original report which can be referred to sporton report number FR511303C (Model name: 6039A; FCC ID: RAD544).	Apr. 28, 2015



SUMMARY OF TEST RESULT

Report Section	FCC Rule	Description	Limit	Result	Remark
3.1	15.247(a)(2)	6dB Bandwidth	$\geq 0.5\text{MHz}$	Pass	-
3.2	15.247(b)	Power Output Measurement	$\leq 30\text{dBm}$	Pass	-
3.3	15.247(e)	Power Spectral Density	$\leq 8\text{dBm}/3\text{kHz}$	Pass	-
3.4	15.247(d)	Conducted Band Edges	$\leq 20\text{dBc}$	Pass	-
		Conducted Spurious Emission		Pass	-
3.5	15.247(d)	Radiated Band Edges and Radiated Spurious Emission	15.209(a) & 15.247(d)	Pass	Under limit 7.47 dB at 2483.800 MHz
3.6	15.207	AC Conducted Emission	15.207(a)	Pass	Under limit 6.58 dB at 0.510 MHz
3.7	15.203 & 15.247(b)	Antenna Requirement	N/A	Pass	-



1 General Description

1.1 Applicant

TCT Mobile Limited

5F, C building, No. 232, Liang Jing Road ZhangJiang High-Tech Park, Pudong Area Shanghai, P. R. China. 201203

1.2 Manufacturer

TCT Mobile Limited

5F, C building, No. 232, Liang Jing Road ZhangJiang High-Tech Park, Pudong Area Shanghai, P. R. China. 201203

1.3 Product Feature of Equipment Under Test

Product Feature	
Equipment	GSM Quad-band / UMTS Quad-band / LTE Penta-band mobile phone
Brand Name	Alcatel
Model Name	6039J
FCC ID	RAD545
EUT supports Radios application	GSM/GPRS/EGPRS/WCDMA/HSPA/ HSPA+ (Downlink Only)/DC-HSDPA/LTE/NFC/ WLAN 2.4GHz 802.11b/g/n HT20/ Bluetooth v3.0 + EDR / Bluetooth v4.1 LE
IMEI Code for 6039A	Conducted: 01436800002652 Radiated: 01436800003239 Conduction: 01436800002652
HW Version	BAB34D000GCX
SW Version	vA7M
EUT Stage	Identical Prototype

Remark:

1. The above EUT's information was declared by manufacturer. Please refer to the specifications or user's manual for more detailed description.
2. There are two types of EUT sample 1 and sample 2, the differences between two samples is only for memory, sample 1 is 1GB capacity and sample 2 is 1.5GB capacity. We only chose the sample 1 to perform all tests.

1.4 Product Specification subjective to this standard

Product Specification subjective to this standard	
Tx/Rx Channel Frequency Range	802.11b/g/n : 2412 MHz ~ 2462 MHz
Maximum (Peak) Output Power to Antenna	802.11b : 20.24 dBm (0.1057 W) 802.11g : 20.63 dBm (0.1156 W) 802.11n HT20 : 19.99 dBm (0.0998 W)
Antenna Type / Gain	PIFA Antenna with gain 1.0 dBi
Type of Modulation	802.11b : DSSS (DBPSK / DQPSK / CCK) 802.11g/n : OFDM (BPSK / QPSK / 16QAM / 64QAM)

1.5 Accessories and Support Equipment

Specification of Accessory				
AC Adapter 1	Brand Name	ACE-Tenpao	Model Name	UC11US
	Power Rating	I/P: 100-240Vac, 200mA, O/P: 5Vdc, 1000mA		
	P/N	CBA0058AG0C2		
AC Adapter 2	Brand Name	ACE-Yingju	Model Name	UC11US
	Power Rating	I/P: 100-240Vac, 200mA, O/P: 5Vdc, 1000mA		
	P/N	CBA0058AG0C3		
Battery 1	Brand Name	ALCATEL onetouch	Model Name	TLp020K2
	Power Rating	3.8Vdc, 2000mAh		
	P/N	CAC2000023C2		
Battery 2	Brand Name	ALCATEL onetouch	Model Name	TLp020KJ
	Power Rating	3.8Vdc, 2000mAh		
	P/N	CAC2000025CJ		
USB Cable 1	Brand Name	ACE-Shenhua	Model Name	CDA0000025C1
	Signal Line Type	1.10m shielded without core		
USB Cable 2	Brand Name	ACE-Juwei	Model Name	CDA0000025C2
	Signal Line Type	1.10m shielded without core		
USB Cable 3	Brand Name	ACE-Juwei	Model Name	CDA0000025C8
	Signal Line Type	1.10m shielded without core		
Earphone 1	Brand Name	ACE-Lianyun	Model Name	CCB0023A10C2
	Signal Line Type	1.16m non-shielded without core		
Earphone 2	Brand Name	ACE-JBL	Model Name	J22C
	Signal Line Type	1.38m non-shielded without core		
Earphone 3	Brand Name	ACE-Lianyun	Model Name	CCB0023A11C2
	Signal Line Type	1.26m non-shielded without core		
Earphone 4	Brand Name	ACE-JBL	Model Name	CCA0001A10C9
	Signal Line Type	1.28m non-shielded without core		



1.6 Modification of EUT

No modifications are made to the EUT during all test items.

1.7 Testing Location

Test Site	SPORTON INTERNATIONAL (KUNSHAN) INC.			
Test Site Location	No. 3-2, PingXiang Road, Kunshan, Jiangsu Province, P. R. China TEL: +86-0512-5790-0158 FAX: +86-0512-5790-0958			
Test Site No.	Sporton Site No.			FCC Registration No.
	TH01-KS	03CH01-KS	CO01-KS	149928

Note: The test site complies with ANSI C63.4 2009 requirement.

1.8 Applicable Standards

According to the specifications of the manufacturer, the EUT must comply with the requirements of the following standards:

- ♦ FCC Part 15 Subpart C §15.247
- ♦ FCC KDB Publication No. 558074 D01 DTS Meas. Guidance v03r02
- ♦ ANSI C63.10-2013

Remark:

1. All test items were verified and recorded according to the standards and without any deviation during the test.
2. FCC permits the use of the 1.5 meter table as an alternative in C63.10-2013 through inquiry tracking number 961829.
3. This EUT has also been tested and complied with the requirements of FCC Part 15, Subpart B, recorded in a separate test report.



2 Test Configuration of Equipment Under Test

The EUT has been associated with peripherals and configuration operated in a manner tended to maximize its emission characteristics in a typical application. Frequency range investigated: conducted emission (150 kHz to 30 MHz) and radiated emission (9 kHz to the 10th harmonic of the highest fundamental frequency or to 40 GHz, whichever is lower). For radiated measurement, pre-scanned in three orthogonal panels, X, Y, Z. The worst cases were recorded in this report.

The final configuration from all the combinations and the worst-case data rates were investigated by measuring the maximum power across all the data rates and modulation modes under section 2.2.

Based on the worst configuration found above, the RF power setting is set individually to meet FCC compliance limit for the final conducted and radiated tests shown in section 2.3.

2.1 Carrier Frequency Channel

Frequency Band	Channel	Freq. (MHz)	Channel	Freq. (MHz)
2400-2483.5 MHz	1	2412	7	2442
	2	2417	8	2447
	3	2422	9	2452
	4	2427	10	2457
	5	2432	11	2462
	6	2437	-	-



2.2 Pre-Scanned RF Power

Preliminary tests were performed in different data rate and data rate associated with the highest power were chosen for full test shown in the following tables.

2.4GHz 802.11b RF Output Power (dBm)						
Power vs. Channel			Power vs. Data Rate			
Channel	Frequency (MHz)	Data Rate	Channel	2Mbps	5.5Mbps	11Mbps
		1Mbps				
CH 01	2412 MHz	19.71	CH 11	20.15	20.18	20.22
CH 06	2437 MHz	19.99				
CH 11	2462 MHz	20.24				

2.4GHz 802.11g RF Output Power (dBm)										
Power vs. Channel			Power vs. Data Rate							
Channel	Frequency (MHz)	Data Rate	Channel	9Mbps	12Mbps	18Mbps	24Mbps	36Mbps	48Mbps	54Mbps
		6Mbps								
CH 01	2412 MHz	19.65	CH 11	20.49	20.53	20.45	20.51	20.58	20.61	20.55
CH 06	2437 MHz	20.47								
CH 11	2462 MHz	20.63								

2.4GHz 802.11n HT20 RF Output Power (dBm)										
Power vs. Channel			Power vs. MCS Index							
Channel	Frequency (MHz)	MCS Index	Channel	MCS1	MCS2	MCS3	MCS4	MCS5	MCS6	MCS7
		MCS0								
CH 01	2412 MHz	19.45	CH 11	19.85	19.92	19.83	19.95	19.97	19.94	19.89
CH 06	2437 MHz	19.89								
CH 11	2462 MHz	19.99								



2.3 Test Mode

Final results of test modes, data rates and test channels are shown as following table.

Test Cases				
	Test Items	Mode	Data Rate	Test Channel
Conducted TCs	6dB BW Power Spectral Density	802.11b	1 Mbps	1/6/11
		802.11g	6 Mbps	1/6/11
		802.11n HT20	MCS0	1/6/11
	Output Power	802.11b	1 Mbps	1/6/11
		802.11g	6 Mbps	1/6/11
		802.11n HT20	MCS0	1/6/11
	Conducted Band Edge	802.11b	1 Mbps	1/11
		802.11g	6 Mbps	1/11
		802.11n HT20	MCS0	1/11
	Conducted Spurious Emission	802.11b	1 Mbps	1/6/11
		802.11g	6 Mbps	1/6/11
		802.11n HT20	MCS0	1/6/11
Radiated TCs	Radiated Band Edge	802.11b	1 Mbps	1/11
		802.11g	6 Mbps	1/11
		802.11n HT20	MCS0	1/11
	Radiated Spurious Emission	802.11b	1 Mbps	1/6/11
		802.11g	6 Mbps	1/6/11
		802.11n HT20	MCS0	1/6/11
AC Conducted Emission	Mode 1 : GSM850 Idle + Bluetooth Link + WLAN Link + USB Cable 1 (Charging from Adapter 1) + Battery 1 + Earphone 1			
Remark: For Radiated Test Cases, the tests were performance with adapter 1, earphone 1, battery 1 and USB cable 1.				

2.4 Connection Diagram of Test System

<WLAN 11b Tx Mode>

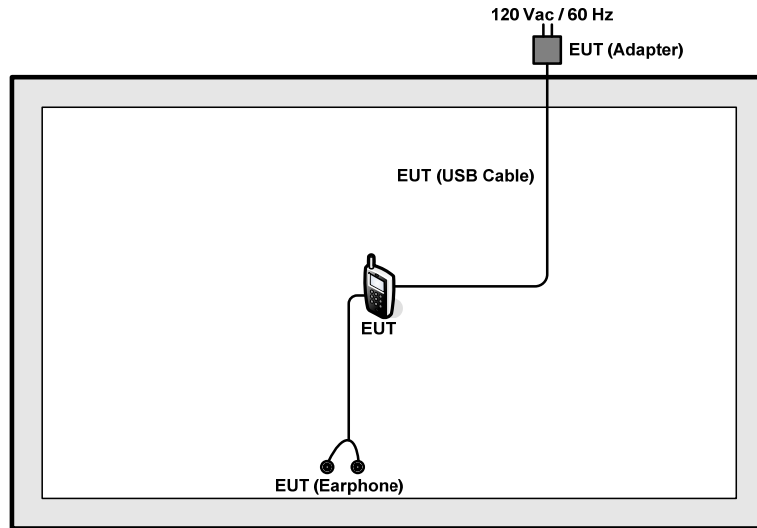

<WLAN 11g/n Tx Mode>

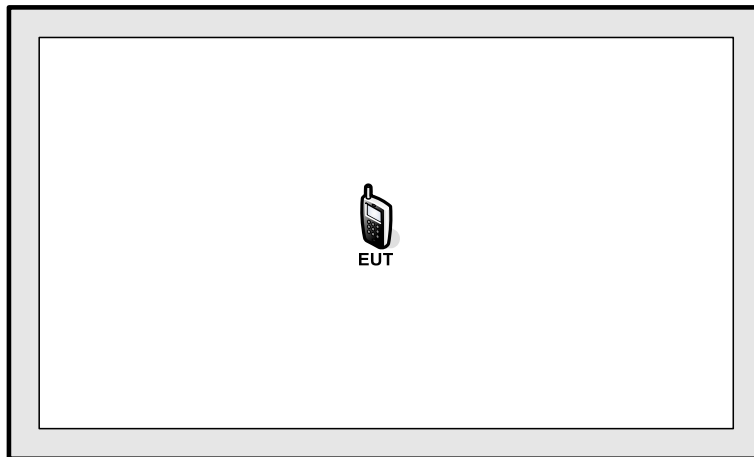

<AC Conducted Emission Mode>

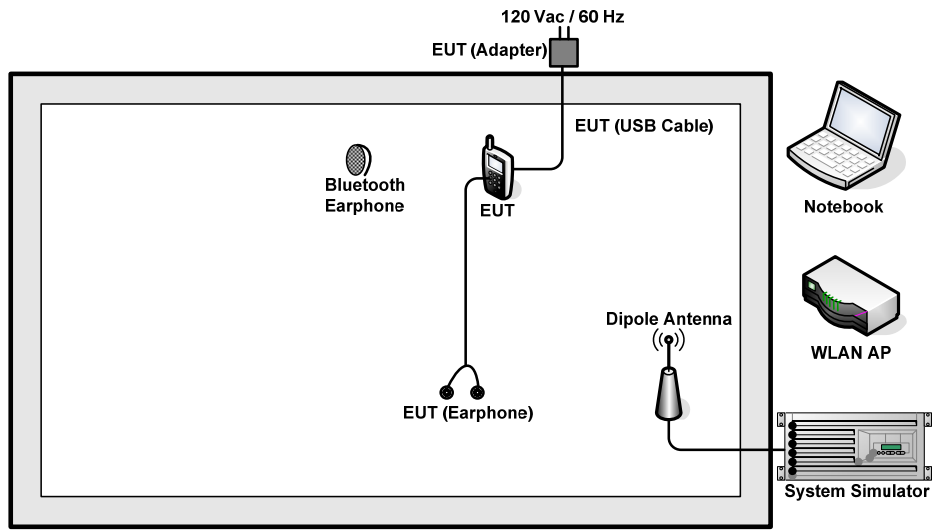

2.5 Support Unit used in test configuration and system

Item	Equipment	Trade Name	Model Name	FCC ID	Data Cable	Power Cord
1.	System Simulator	R&S	CMU 200	N/A	N/A	Unshielded, 1.8 m
2.	WLAN AP	D-Link	DIR-855	KA2DIR855A2	N/A	Unshielded, 1.8 m
3.	Notebook	Lenovo	G480	PRC4	N/A	AC I/P: Unshielded, 1.2 m DC O/P: Shielded, 1.8 m
4.	Bluetooth Earphone	Nokia	BH-102	PYAHS-107W	N/A	N/A

2.6 EUT Operation Test Setup

For WLAN RF test items, an engineering test program was provided and enabled to make EUT continuously transmit/receive.

For AC power line conducted emissions, the EUT was set to connect with the WLAN AP under large package sizes transmission.

2.7 Measurement Results Explanation Example

For all conducted test items:

The offset level is set in the spectrum analyzer to compensate the RF cable loss between EUT conducted output port and spectrum analyzer. With the offset compensation, the spectrum analyzer reading level is exactly the EUT RF output level.

Example :

The spectrum analyzer offset is derived from RF cable loss

Offset = RF cable loss

Following shows an offset computation example with cable loss 5.5 dB.

$$\begin{aligned} \text{Offset(dB)} &= \text{RF cable loss(dB)} \\ &= 5.5 \text{ (dB)} \end{aligned}$$

3 Test Result

3.1 6dB Bandwidth Measurement

3.1.1 Limit of 6dB Bandwidth

The minimum 6 dB bandwidth shall be at least 500 kHz.

3.1.2 Measuring Instruments

The measuring equipment is listed in the section 4 of this test report.

3.1.3 Test Procedures

1. The testing follows FCC KDB Publication No. 558074 DTS D01 Meas. Guidance v03r02.
2. The RF output of EUT was connected to the spectrum analyzer by RF cable and attenuator. The path loss was compensated to the results for each measurement.
3. Set to the maximum power setting and enable the EUT transmit continuously.
4. Make the measurement with the spectrum analyzer's resolution bandwidth (RBW) = 100 kHz. Set the Video bandwidth (VBW) = 300 kHz. In order to make an accurate measurement. The 6 dB bandwidth must be greater than 500 kHz.
5. Measure and record the results in the test report.

3.1.4 Test Setup

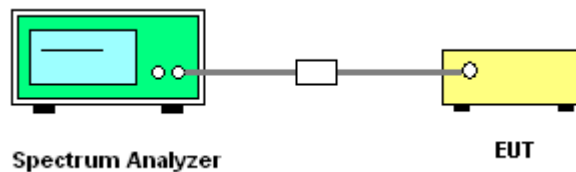



3.1.5 Test Result of 6dB Bandwidth

Test Band :	2.4GHz	Temperature :	21~25°C
Test Engineer :	Smile Wang	Relative Humidity :	51~54%

Mod.	Data Rate	N _{TX}	Channel	Freq. (MHz)	6dB Bandwidth (MHz)	6dB Bandwidth Min. Limit (MHz)	Pass/Fail
11b	1Mbps	1	1	2412	7.56	0.5	Pass
11b	1Mbps	1	6	2437	8.04	0.5	Pass
11b	1Mbps	1	11	2462	7.56	0.5	Pass
11g	6Mbps	1	1	2412	16.32	0.5	Pass
11g	6Mbps	1	6	2437	16.32	0.5	Pass
11g	6Mbps	1	11	2462	16.32	0.5	Pass
HT20	MCS0	1	1	2412	17.56	0.5	Pass
HT20	MCS0	1	6	2437	17.60	0.5	Pass
HT20	MCS0	1	11	2462	17.56	0.5	Pass

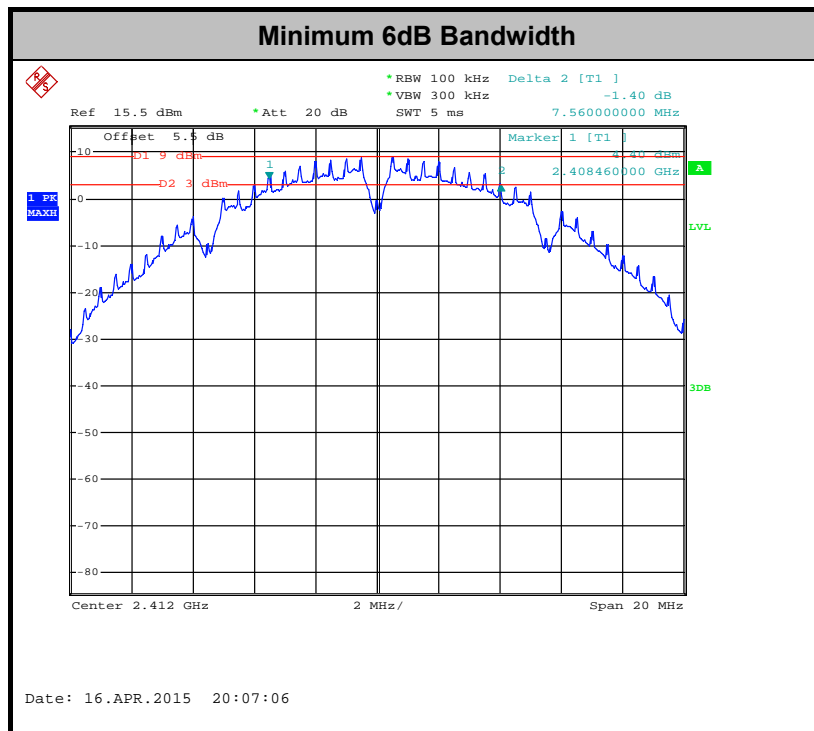

Note : The occupied channel bandwidth is maintained within the band of operation for all of the modulations.

3.2 Output Power Measurement

3.2.1 Limit of Output Power

For systems using digital modulation in the 2400-2483.5MHz, the limit for peak output power is 30dBm. If transmitting Antenna of directional gain greater than 6dBi are used the peak output power from the intentional radiator shall be reduced below the above stated value by the amount in dB that the directional gain of the Antenna exceeds 6 dBi. In case of point-to-point operation, the limit has to be reduced by 1dB for every 3dB that the directional gain of the Antenna exceeds 6dBi.

3.2.2 Measuring Instruments

The measuring equipment is listed in the section 4 of this test report.

3.2.3 Test Procedures

1. The testing follows the Measurement Procedure of FCC KDB No. 558074 DTS D01 Meas. Guidance v03r02.
2. The RF output of EUT was connected to the power meter by RF cable and attenuator. The path loss was compensated to the results for each measurement.
3. Set to the maximum power setting and enable the EUT transmit continuously.
4. Measure the conducted output power and record the results in the test report.

3.2.4 Test Setup

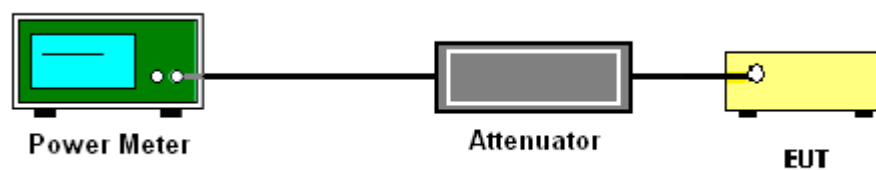



3.2.5 Test Result of Peak Output Power

Test Mode :	2.4GHz	Temperature :	21~25°C
Test Engineer :	Smile Wang	Relative Humidity :	51~54%

Mod.	Data Rate	N _{TX}	Channel	Freq. (MHz)	RF Output Power (dBm)	Power Limit (dBm)	DG (dBi)	Pass/Fail
11b	1Mbps	1	1	2412	19.71	30	1.00	Pass
11b	1Mbps	1	6	2437	19.99	30	1.00	Pass
11b	1Mbps	1	11	2462	20.24	30	1.00	Pass
11g	6Mbps	1	1	2412	19.65	30	1.00	Pass
11g	6Mbps	1	6	2437	20.47	30	1.00	Pass
11g	6Mbps	1	11	2462	20.63	30	1.00	Pass
HT20	MCS0	1	1	2412	19.45	30	1.00	Pass
HT20	MCS0	1	6	2437	19.89	30	1.00	Pass
HT20	MCS0	1	11	2462	19.99	30	1.00	Pass

Note: Measured power (dBm) has offset with cable loss.

**3.2.6 Test Result of Average output Power (Reporting Only)**

Test Mode :	2.4GHz	Temperature :	21~25°C
Test Engineer :	Smile Wang	Relative Humidity :	51~54%

Mod.	Data Rate	N _{TX}	Channel	Freq. (MHz)	Duty Factor (dB)	Average Output Power (dBm)	Power Limit (dBm)	DG (dBi)	Pass/Fail
11b	1Mbps	1	1	2412	0.10	17.21	30	1.00	Pass
11b	1Mbps	1	6	2437	0.10	17.73	30	1.00	Pass
11b	1Mbps	1	11	2462	0.10	18.11	30	1.00	Pass
11g	6Mbps	1	1	2412	0.60	11.11	30	1.00	Pass
11g	6Mbps	1	6	2437	0.60	12.09	30	1.00	Pass
11g	6Mbps	1	11	2462	0.60	12.41	30	1.00	Pass
HT20	MCS0	1	1	2412	0.63	10.55	30	1.00	Pass
HT20	MCS0	1	6	2437	0.63	11.50	30	1.00	Pass
HT20	MCS0	1	11	2462	0.63	11.85	30	1.00	Pass

Note: Measured power (dBm) has offset with cable loss and duty factor.

3.3 Power Spectral Density Measurement

3.3.1 Limit of Power Spectral Density

The peak power spectral density shall not be greater than 8dBm in any 3kHz band at any time interval of continuous transmission.

3.3.2 Measuring Instruments

The measuring equipment is listed in the section 4 of this test report.

3.3.3 Test Procedures

1. The testing follows Measurement Procedure 10.2 Method PKPSD of FCC KDB Publication No. 558074 D01 DTS Meas. Guidance v03r02
2. The RF output of EUT was connected to the spectrum analyzer by RF cable and attenuator. The path loss was compensated to the results for each measurement.
3. Set to the maximum power setting and enable the EUT transmit continuously.
4. Make the measurement with the spectrum analyzer's resolution bandwidth (RBW) = 3 kHz. Video bandwidth VBW = 10 kHz In order to make an accurate measurement, set the span to 1.5 times DTS Channel Bandwidth. (6dB BW)
5. Detector = peak, Sweep time = auto couple, Trace mode = max hold, Allow trace to fully stabilize. Use the peak marker function to determine the maximum power level.
6. Measure and record the results in the test report.

3.3.4 Test Setup

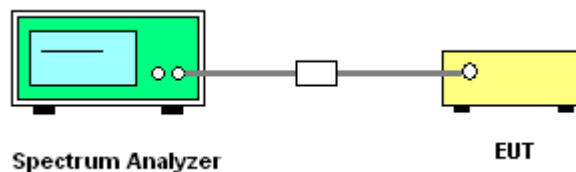



3.3.5 Test Result of Power Spectral Density

Test Mode :	2.4GHz	Temperature :	21~25°C
Test Engineer :	Smile Wang	Relative Humidity :	51~54%

Mod.	Data Rate	N _{TX}	Channel	Freq. (MHz)	Peak Power Density (dBm/3kHz)	Max. Limits (dBm/3kHz)	DG (dBi)	Pass/Fail
11b	1Mbps	1	1	2412	-5.25	8	1.00	Pass
11b	1Mbps	1	6	2437	-4.39	8	1.00	Pass
11b	1Mbps	1	11	2462	-4.45	8	1.00	Pass
11g	6Mbps	1	1	2412	-13.42	8	1.00	Pass
11g	6Mbps	1	6	2437	-12.72	8	1.00	Pass
11g	6Mbps	1	11	2462	-12.52	8	1.00	Pass
HT20	MCS0	1	1	2412	-14.55	8	1.00	Pass
HT20	MCS0	1	6	2437	-12.95	8	1.00	Pass
HT20	MCS0	1	11	2462	-13.27	8	1.00	Pass

Note: Measured power density (dBm) has offset with cable loss.

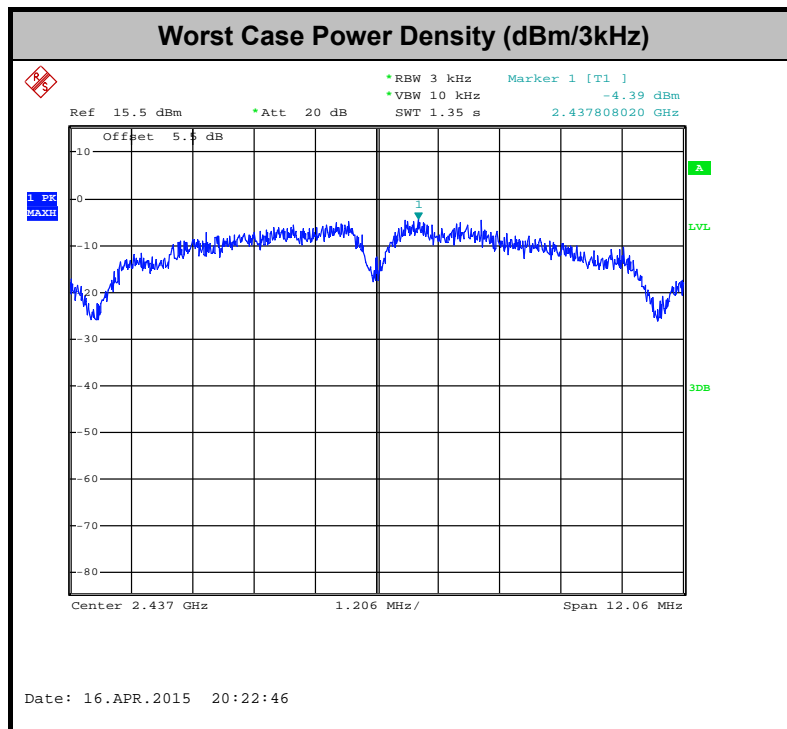

3.4 Conducted Band Edges and Spurious Emission Measurement

3.4.1 Limit of Conducted Band Edges and Spurious Emission Measurement

In any 100 kHz bandwidth outside of the authorized frequency band, the emissions which fall in the non-restricted bands shall be attenuated at least 20 dB / 30dB relative to the maximum PSD level in 100 kHz by RF conducted measurement and radiated emissions which fall in the restricted bands, as defined in Section 15.205(a), must also comply with the radiated emission limits specified in Section 15.209(a).

3.4.2 Measuring Instruments

The measuring equipment is listed in the section 4 of this test report.

3.4.3 Test Procedures

1. The testing follows FCC KDB Publication No. 558074 D01 DTS Meas. Guidance v03r02.
2. The RF output of EUT was connected to the spectrum analyzer by RF cable and attenuator. The path loss was compensated to the results for each measurement.
3. Set to the maximum power setting and enable the EUT transmit continuously.
4. Set RBW = 100 kHz, VBW=300 kHz, Peak Detector. Unwanted Emissions measured in any 100 kHz bandwidth outside of the authorized frequency band shall be attenuated by at least 20 dB relative to the maximum in-band peak PSD level in 100 kHz when maximum peak conducted output power procedure is used. If the transmitter complies with the conducted power limits based on the use of RMS averaging over a time interval, the attenuation required under this paragraph shall be 30 dB instead of 20 dB per 15.247(d).
5. Measure and record the results in the test report.
6. The RF fundamental frequency should be excluded against the limit line in the operating frequency band.

3.4.4 Test Setup

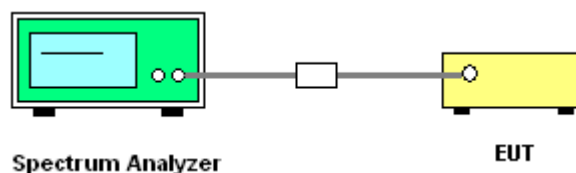



3.4.5 Test Result of Conducted Band Edges and Spurious Emission

Test Mode :	802.11b	Temperature :	21~25°C
Test Band :	2.4GHz Low	Relative Humidity :	51~54%
Test Channel :	01	Test Engineer :	Smile Wang

WLAN 802.11b Channel 01

100kHz PSD reference Level

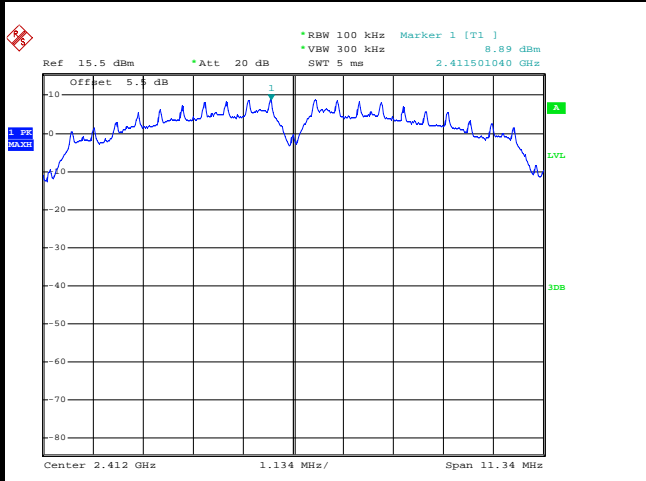

Date: 16.APR.2015 20:08:27

Low Channel Plot

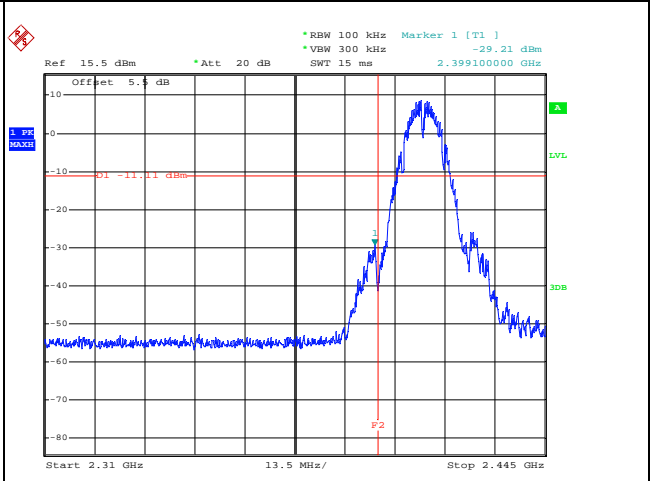

Date: 16.APR.2015 20:08:49

Spurious Emission 30MHz~3GHz

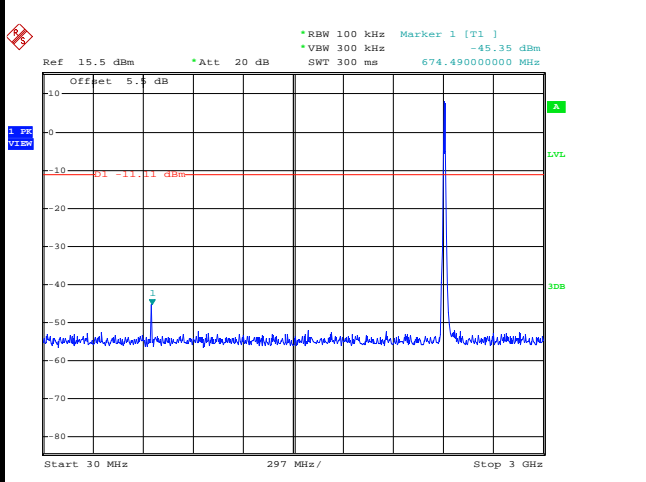

Date: 16.APR.2015 20:09:13

Spurious Emission 2GHz~25GHz

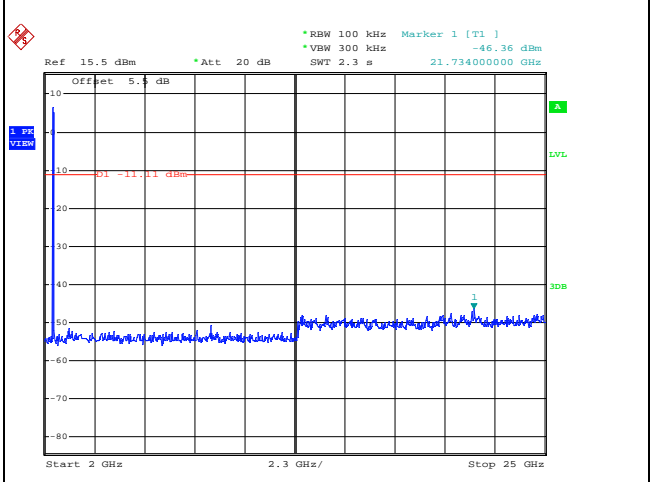

Date: 16.APR.2015 20:09:31



Test Mode :	802.11b	Temperature :	21~25°C
Test Band :	2.4GHz Mid	Relative Humidity :	51~54%
Test Channel :	06	Test Engineer :	Smile Wang

WLAN 802.11b Channel 06

100kHz PSD reference Level

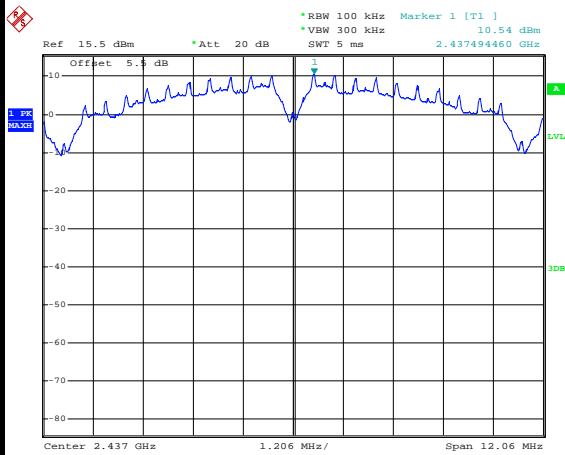

Date: 16.APR.2015 20:23:08

Spurious Emission 30MHz~3GHz

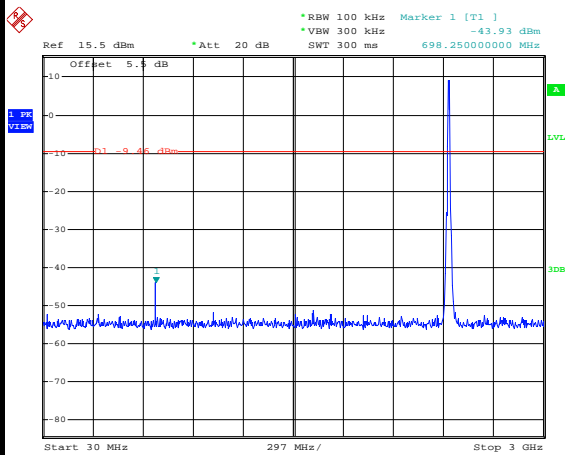

Date: 16.APR.2015 20:23:37

Spurious Emission 2GHz~25GHz

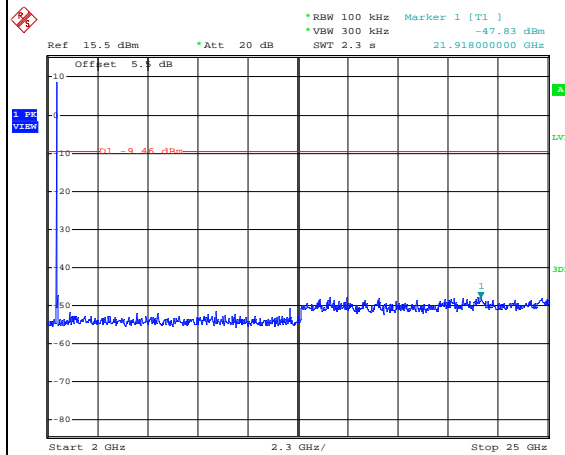

Date: 16.APR.2015 20:23:54



Test Mode :	802.11b	Temperature :	21~25°C
Test Band :	2.4GHz High	Relative Humidity :	51~54%
Test Channel :	11	Test Engineer :	Smile Wang

WLAN 802.11b Channel 11

100kHz PSD reference Level

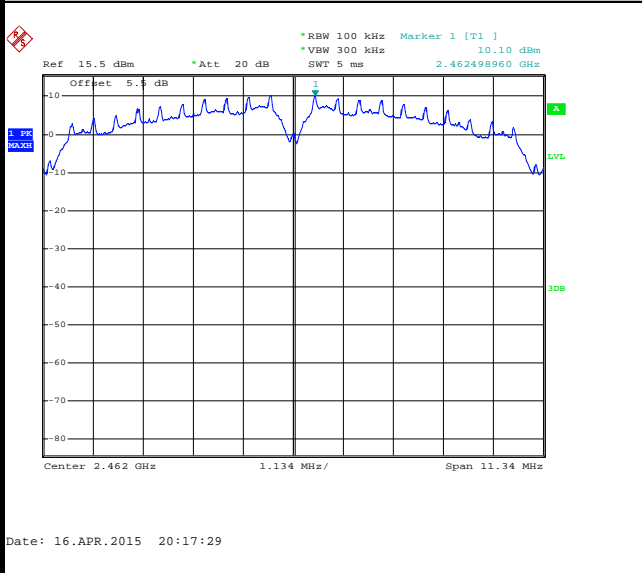

High Channel Plot

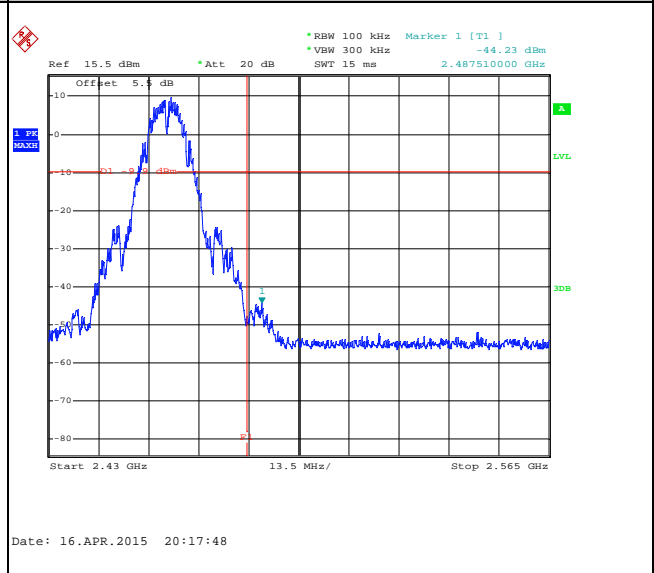

Spurious Emission 30MHz~3GHz

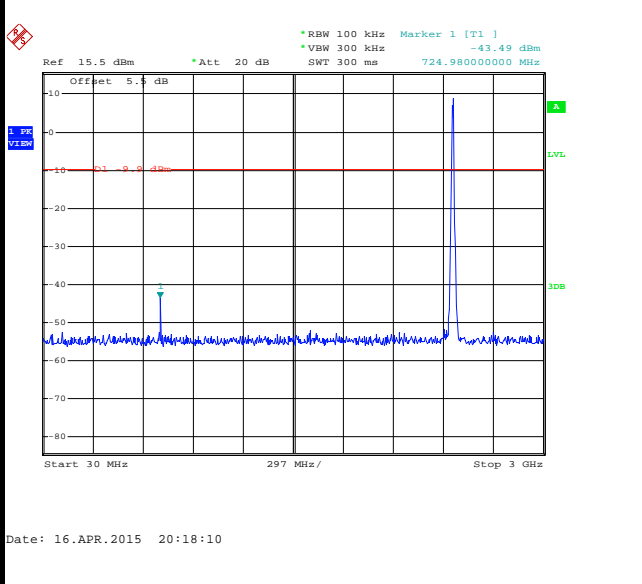

Spurious Emission 2GHz~25GHz

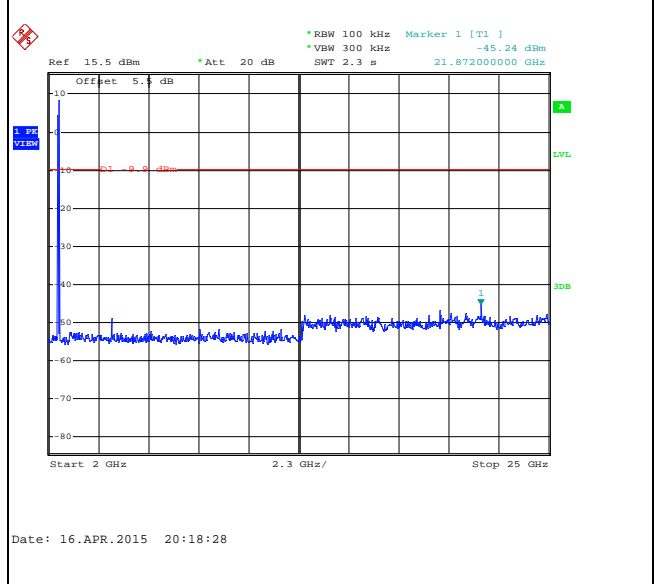



Test Mode :	802.11g	Temperature :	21~25°C
Test Band :	2.4GHz Low	Relative Humidity :	51~54%
Test Channel :	01	Test Engineer :	Smile Wang

WLAN 802.11g Channel 01

100kHz PSD reference Level

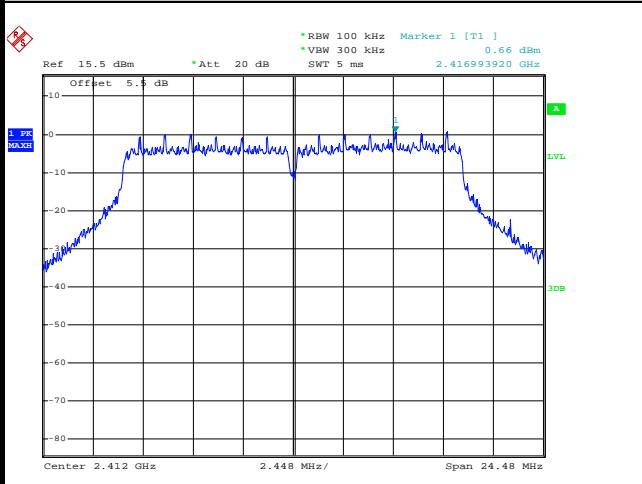

Date: 16.APR.2015 20:28:00

Low Channel Plot

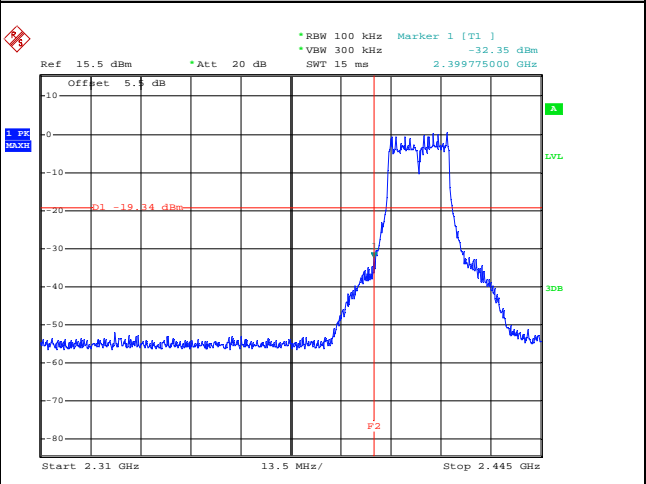

Date: 16.APR.2015 20:28:28

Spurious Emission 30MHz~3GHz

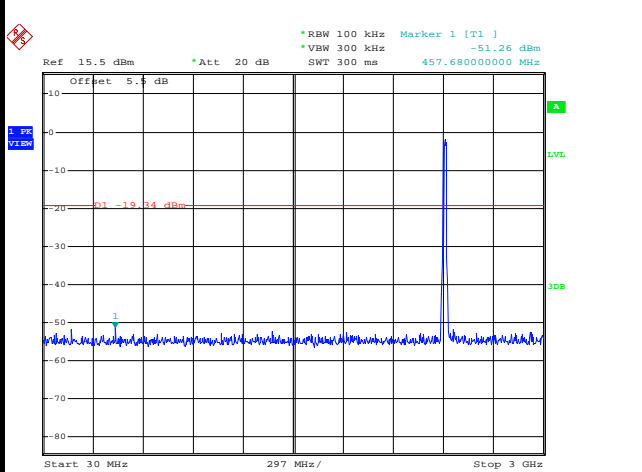

Date: 16.APR.2015 20:33:45

Spurious Emission 2GHz~25GHz

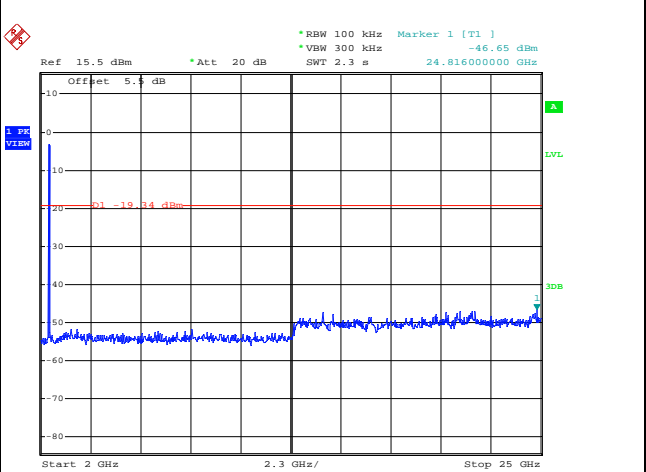

Date: 16.APR.2015 20:34:03



Test Mode :	802.11g	Temperature :	21~25°C
Test Band :	2.4GHz Mid	Relative Humidity :	51~54%
Test Channel :	06	Test Engineer :	Smile Wang

WLAN 802.11g Channel 06

100kHz PSD reference Level

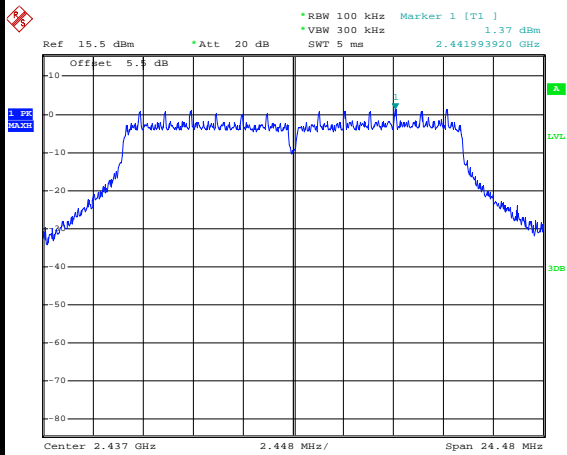

Date: 16.APR.2015 20:36:35

Spurious Emission 30MHz~3GHz

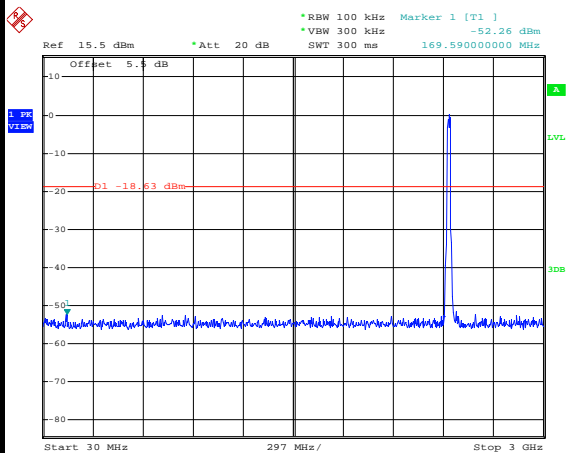

Date: 16.APR.2015 20:38:08

Spurious Emission 2GHz~25GHz

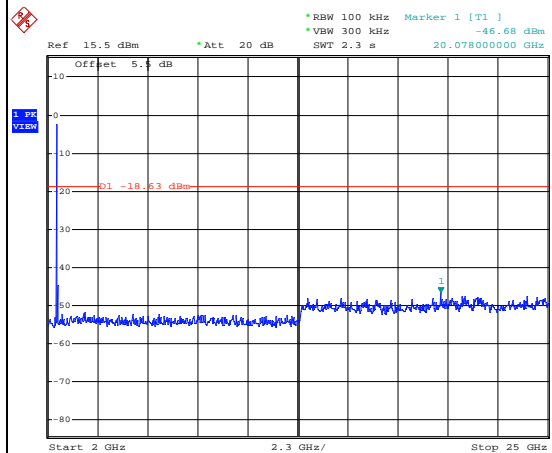

Date: 16.APR.2015 20:38:26



Test Mode :	802.11g	Temperature :	21~25°C
Test Band :	2.4GHz High	Relative Humidity :	51~54%
Test Channel :	11	Test Engineer :	Smile Wang

WLAN 802.11g Channel 11

100kHz PSD reference Level

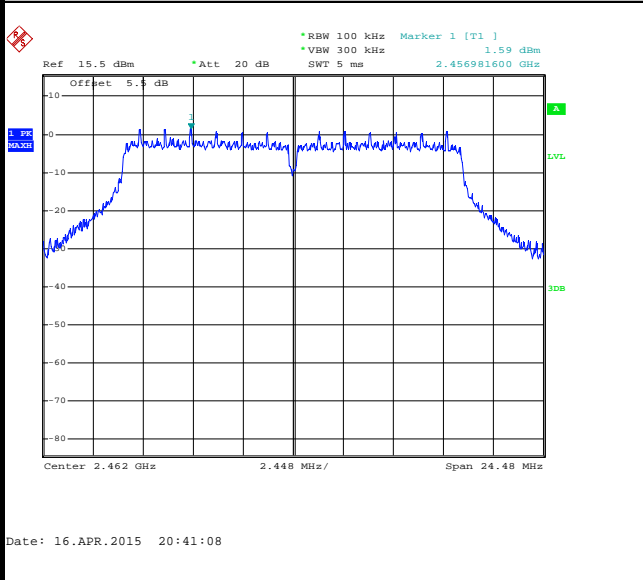

High Channel Plot

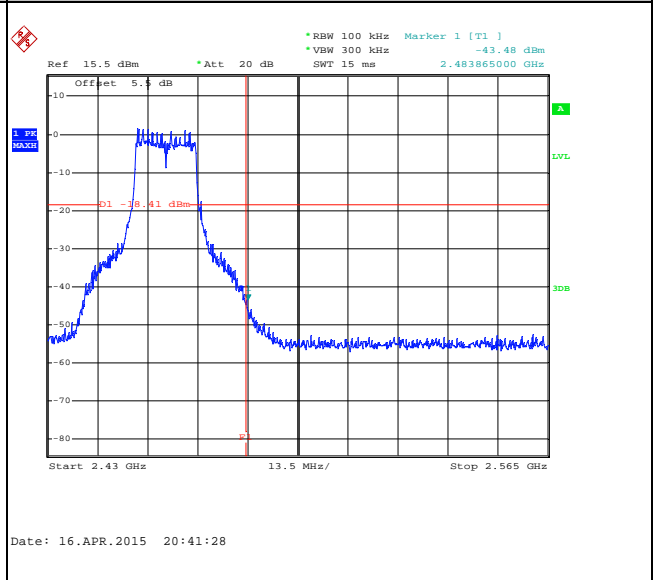

Spurious Emission 30MHz~3GHz

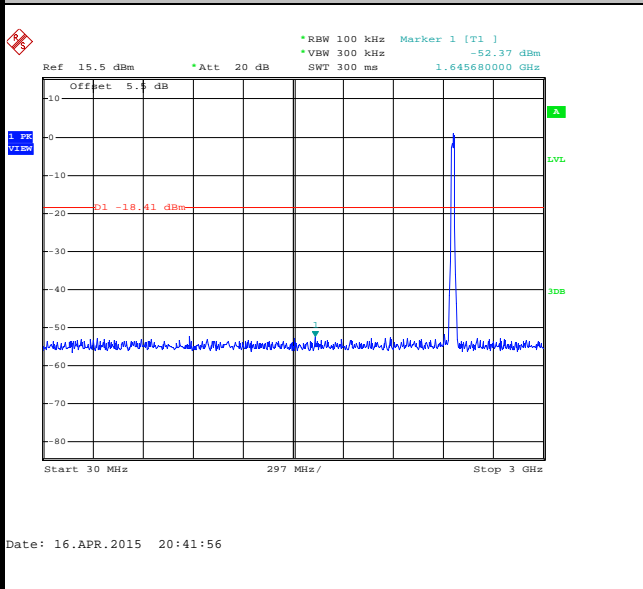

Spurious Emission 2GHz~25GHz

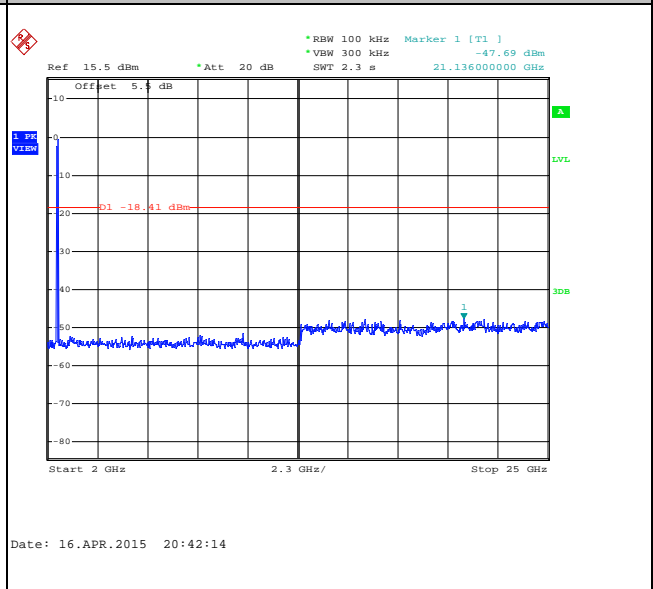



Test Mode :	802.11n HT20	Temperature :	21~25°C
Test Band :	2.4GHz Low	Relative Humidity :	51~54%
Test Channel :	01	Test Engineer :	Smile Wang

WLAN 802.11n HT20 Channel 01

100kHz PSD reference Level

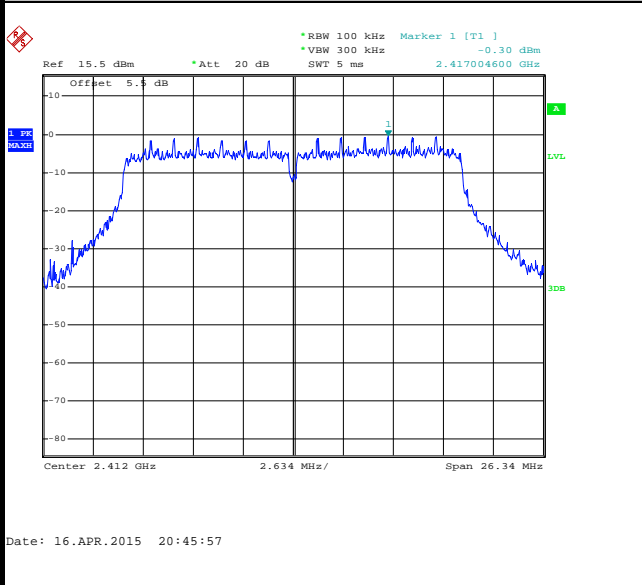

Low Channel Plot

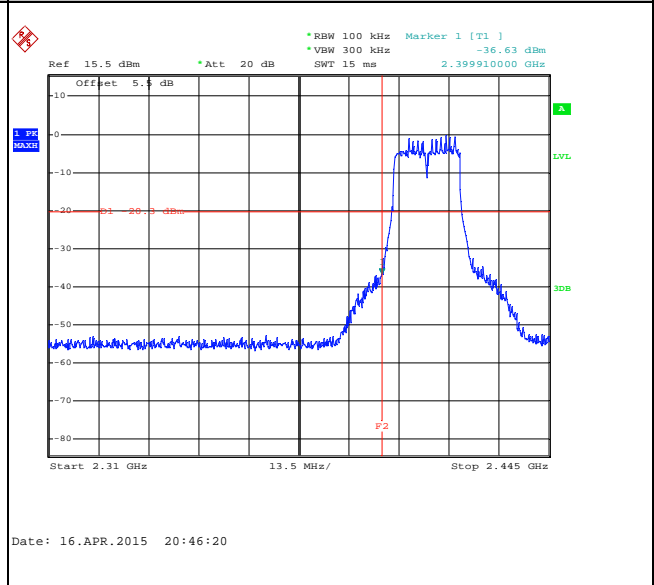

Spurious Emission 30MHz~3GHz

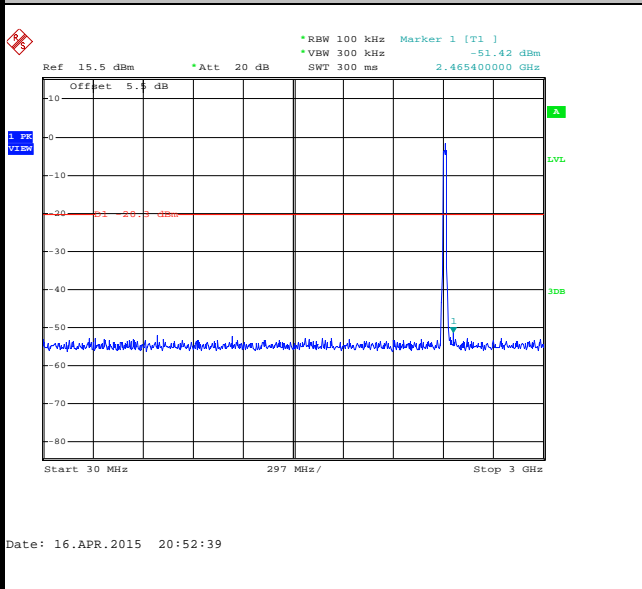

Spurious Emission 2GHz~25GHz

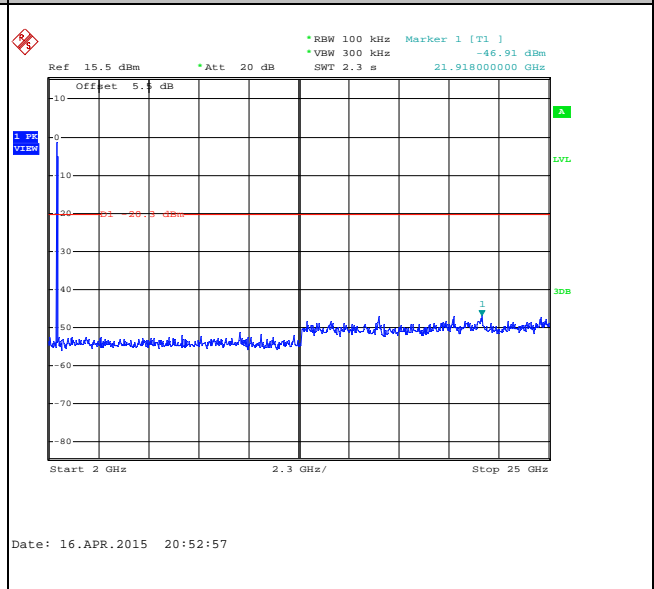



Test Mode :	802.11n HT20	Temperature :	21~25°C
Test Band :	2.4GHz Mid	Relative Humidity :	51~54%
Test Channel :	06	Test Engineer :	Smile Wang

WLAN 802.11n HT20 Channel 06

100kHz PSD reference Level

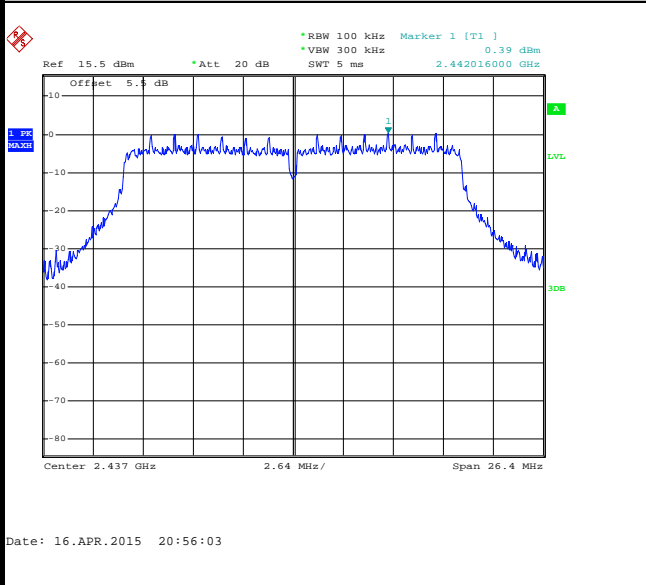

Spurious Emission 30MHz~3GHz

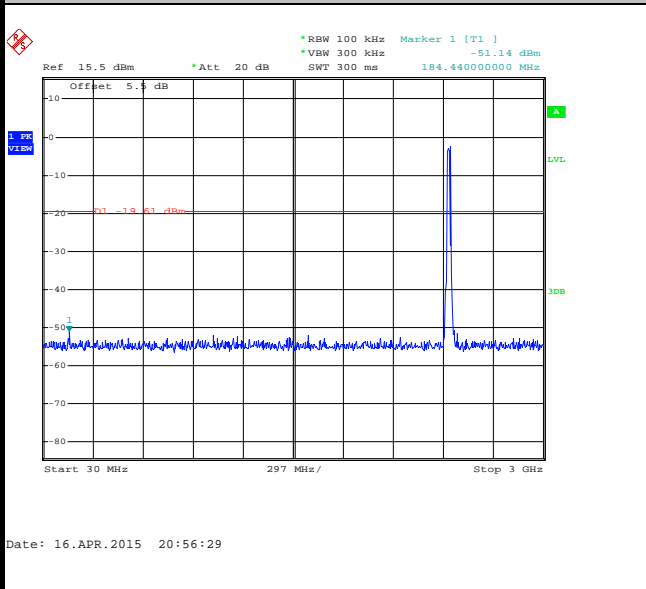

Spurious Emission 2GHz~25GHz

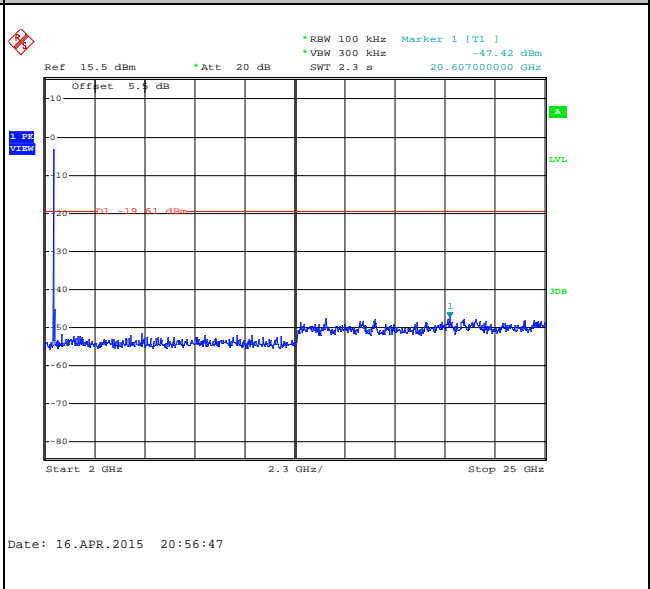



Test Mode :	802.11n HT20	Temperature :	21~25°C
Test Band :	2.4GHz High	Relative Humidity :	51~54%
Test Channel :	11	Test Engineer :	Smile Wang

WLAN 802.11n HT20 Channel 11

100kHz PSD reference Level

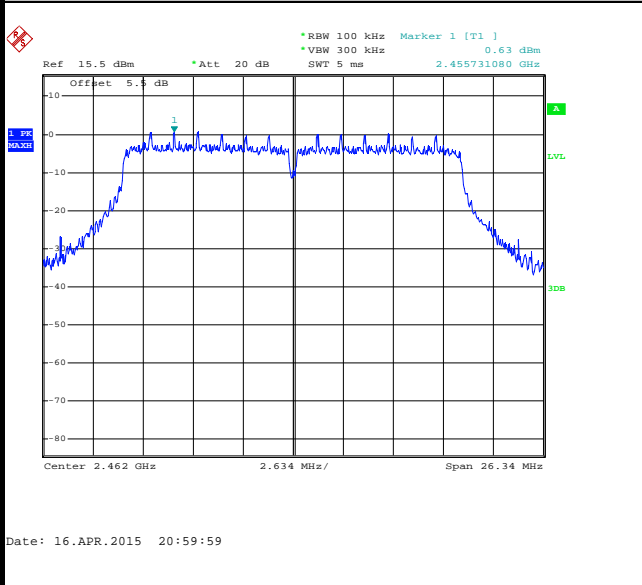

High Channel Plot

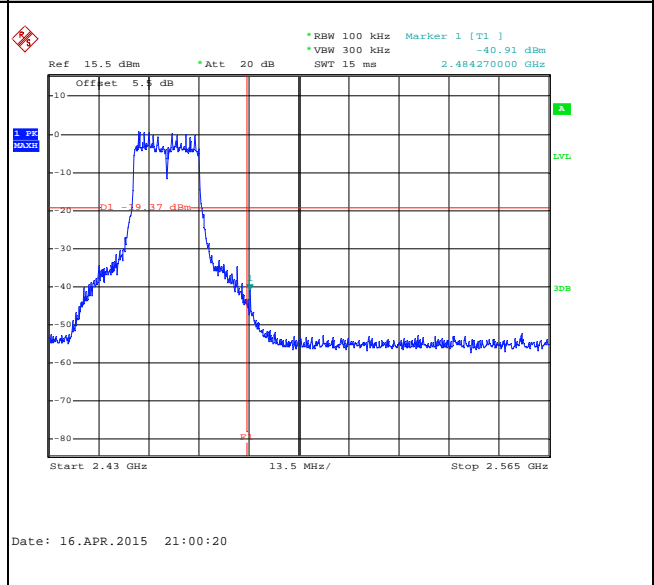

Spurious Emission 30MHz~3GHz

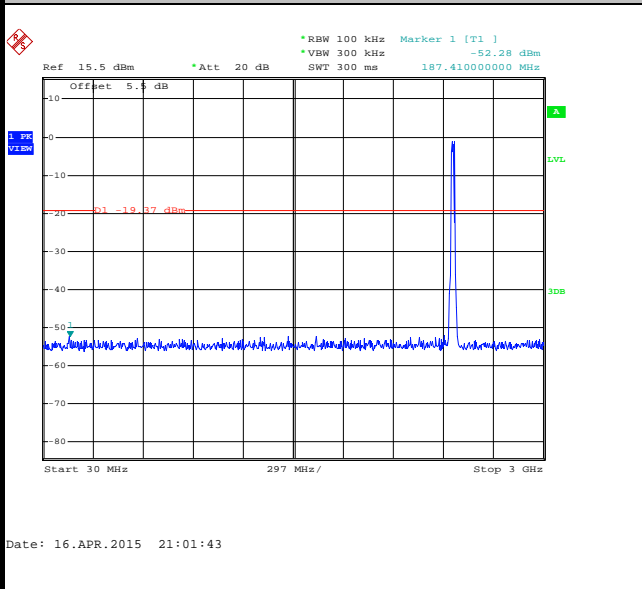

Spurious Emission 2GHz~25GHz

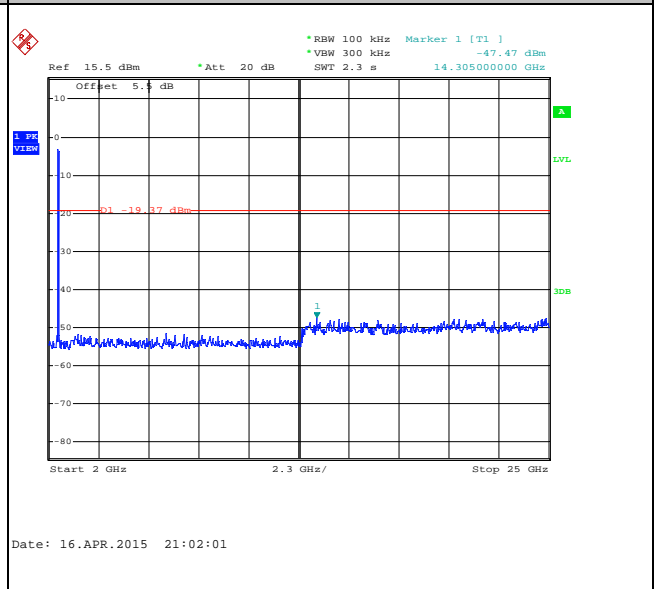



3.5 Radiated Band Edges and Spurious Emission Measurement

3.5.1 Limit of Radiated band edge and Spurious Emission Measurement

In any 100 kHz bandwidth outside the intentional radiator frequency band, all harmonics/spurious must be at least 20 dB below the highest emission level within the authorized band. If the output power of this device was measured by spectrum analyzer, the attenuation under this paragraph shall be 30 dB instead of 20 dB. In addition, radiated emissions which fall in the restricted bands must also comply with the FCC section 15.209 limits as below.

Frequency (MHz)	Field Strength (microvolts/meter)	Measurement Distance (meters)
0.009 – 0.490	2400/F(kHz)	300
0.490 – 1.705	24000/F(kHz)	30
1.705 – 30.0	30	30
30 – 88	100	3
88 – 216	150	3
216 - 960	200	3
Above 960	500	3

3.5.2 Measuring Instruments

The measuring equipment is listed in the section 4 of this test report.



3.5.3 Test Procedures

1. The testing follows FCC KDB Publication No. 558074 D01 DTS Meas. Guidance v03r02.
2. The EUT was arranged to its worst case and then tune the antenna tower (from 1 m to 4 m) and turntable (from 0 degree to 360 degrees) to find the maximum reading. A pre-amp and a high pass filter are used for the test in order to get better signal level.
3. The EUT was placed on a turntable with 0.8 meter for frequency below 1GHz and 1.5 meter for frequency above 1GHz respectively above ground.
4. The EUT was set 3 meters from the interference receiving antenna, which was mounted on the top of a variable height antenna tower.
5. Corrected Reading: Antenna Factor + Cable Loss + Read Level - Preamp Factor = Level
6. For measurement below 1GHz, If the emission level of the EUT measured by the peak detector is 3 dB lower than the applicable limit, the peak emission level will be reported. Otherwise, the emission measurement will be repeated using the quasi-peak detector and reported.
7. Use the following spectrum analyzer settings:
 - (1) Span shall wide enough to fully capture the emission being measured;
 - (2) Set RBW=100 kHz for $f < 1$ GHz; $VBW \geq RBW$; Sweep = auto; Detector function = peak; Trace = max hold;
 - (3) Set RBW = 1 MHz, VBW= 3MHz for $f \geq 1$ GHz for peak measurement.

For average measurement:

 - $VBW = 10$ Hz, when duty cycle is no less than 98 percent.
 - $VBW \geq 1/T$, when duty cycle is less than 98 percent where T is the minimum transmission duration over which the transmitter is on and is transmitting at its maximum power control level for the tested mode of operation.

Band	Duty Cycle(%)	Tms)	1/T(kHz)	VBW Setting
802.11b	97.62	8.20	0.12	300Hz
802.11g	87.18	1.36	0.74	1kHz
2.4GHz 802.11n HT20	86.41	1.27	0.79	1kHz

3.5.4 Test Setup

For radiated emissions below 30MHz

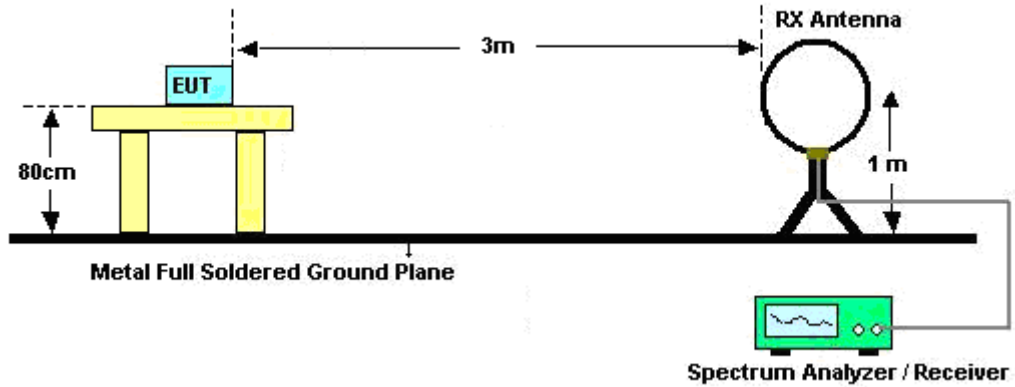

For radiated emissions from 30MHz to 1GHz

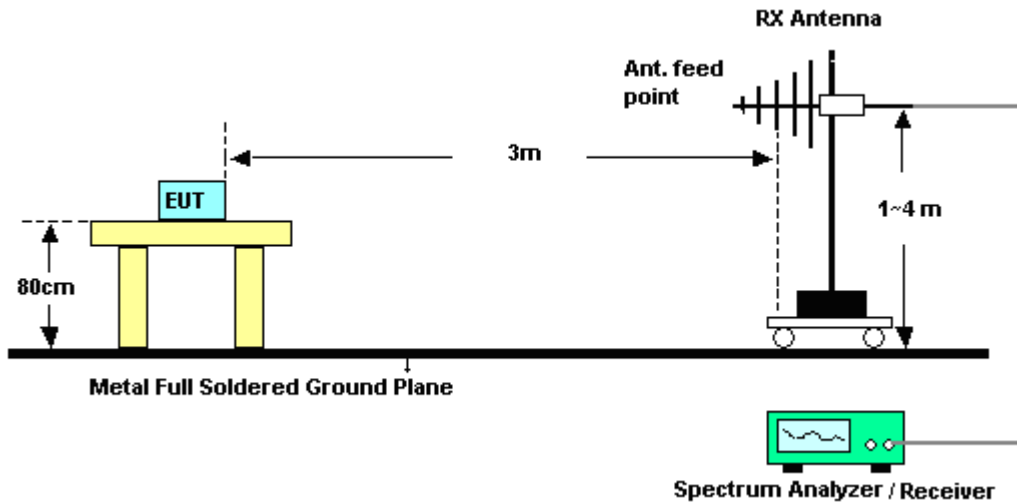

For radiated emissions above 1GHz

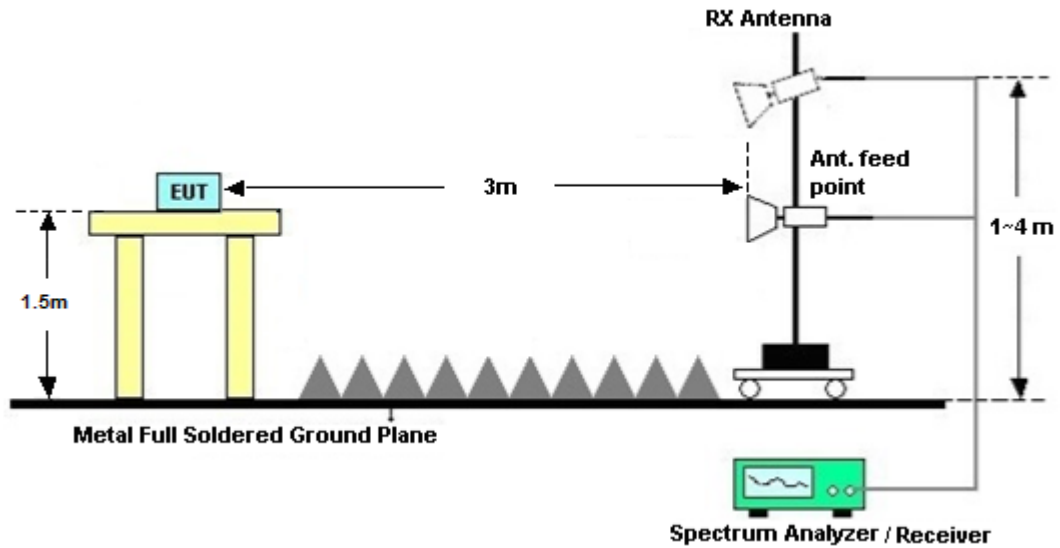

3.5.5 Test Results of Radiated Spurious Emissions (9kHz ~ 30MHz)

The low frequency, which started from 9 kHz to 30MHz, was pre-scanned and the result which was 20dB lower than the limit line per 15.31(o) was not reported.

3.5.6 Test Result of Radiated Spurious at Band Edges

Please refer to Appendix A.

3.5.7 Test Result of Radiated Spurious Emission (30MHz ~ 10th Harmonic)

Please refer to Appendix A.



3.6 AC Conducted Emission Measurement

3.6.1 Limit of AC Conducted Emission

For equipment that is designed to be connected to the public utility (AC) power line, the radio frequency voltage that is conducted back onto the AC power line on any frequency or frequencies within the band 150 kHz to 30 MHz shall not exceed the limits in the following table.

Frequency of Emission (MHz)	Conducted Limit (dB μ V)	
	Quasi-Peak	Average
0.15-0.5	66 to 56*	56 to 46*
0.5-5	56	46
5-30	60	50

*Decreases with the logarithm of the frequency.

3.6.2 Measuring Instruments

The measuring equipment is listed in the section 4 of this test report.

3.6.3 Test Procedures

1. The EUT was placed 0.4 meter from the conducting wall of the shielding room, and it was kept at least 80 centimeters from any other grounded conducting surface.
2. Connect EUT to the power mains through a line impedance stabilization network (LISN).
3. All the support units are connecting to the other LISN.
4. The LISN provides 50 ohm coupling impedance for the measuring instrument.
5. The FCC states that a 50 ohm, 50 microhenry LISN should be used.
6. Both sides of AC line were checked for maximum conducted interference.
7. The frequency range from 150 kHz to 30 MHz was searched.
8. Set the test-receiver system to Peak Detect Function and specified bandwidth (IF bandwidth = 9kHz) with Maximum Hold Mode.

3.6.4 Test Setup

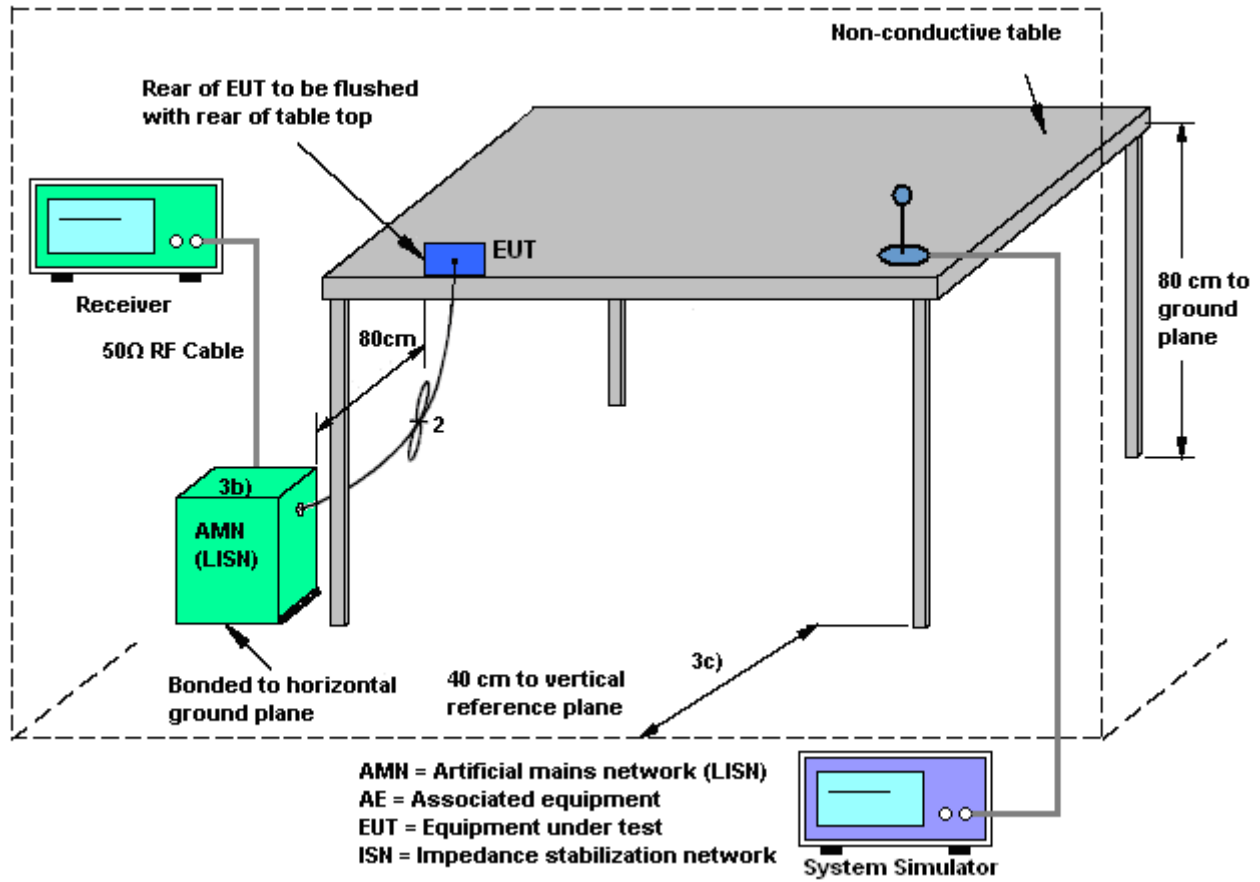



3.6.5 Test Result of AC Conducted Emission

Test Mode :	Mode 1	Temperature :	22~24°C
Test Engineer :	Eko Guan	Relative Humidity :	30~32%
Test Voltage :	120Vac / 60Hz	Phase :	Line
Function Type :	GSM850 Idle + Bluetooth Link + WLAN Link + USB Cable 1 (Charging from Adapter 1) + Battery 1 + Earphone 1		

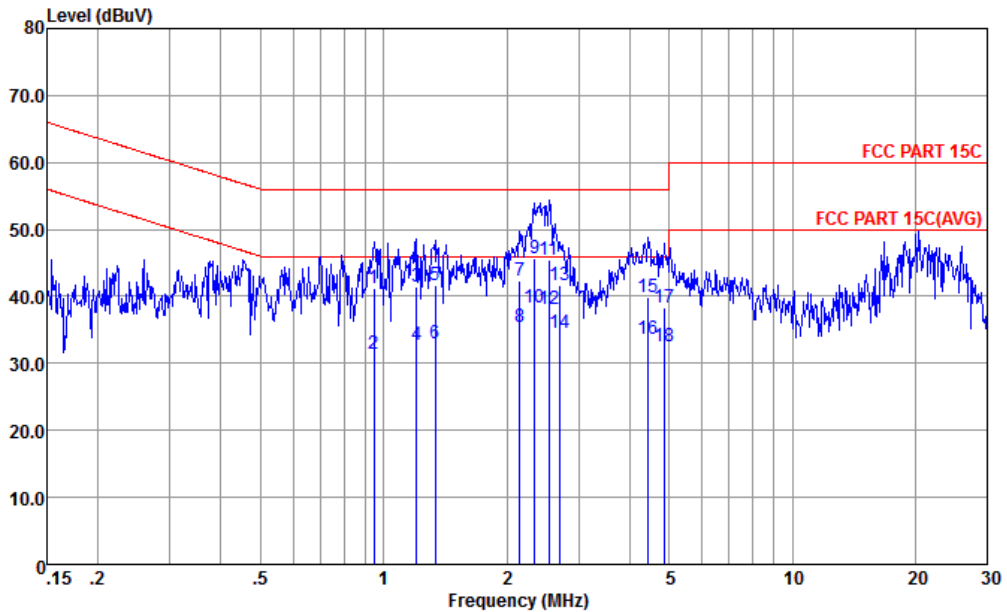

Site : CO01-KS
 Condition : FCC PART 15C LISN-L20140306 LINE

	Freq	Level	Over	Limit	Read	LISN	Cable	Remark
	MHz	dBuV	Limit	Line	Level	Factor	Loss	
			dB	dBuV	dBuV	dB	dB	
1	0.95	41.16	-14.84	56.00	30.40	0.11	10.65	QP
2	0.95	31.46	-14.54	46.00	20.70	0.11	10.65	Average
3	1.20	41.36	-14.64	56.00	30.60	0.10	10.66	QP
4	1.20	32.86	-13.14	46.00	22.10	0.10	10.66	Average
5	1.34	41.67	-14.33	56.00	30.90	0.10	10.67	QP
6	1.34	33.07	-12.93	46.00	22.30	0.10	10.67	Average
7	2.16	42.31	-13.69	56.00	31.50	0.10	10.71	QP
8	2.16	35.41	-10.59	46.00	24.60	0.10	10.71	Average
9	2.35	45.63	-10.37	56.00	34.80	0.11	10.72	QP
10 *	2.35	38.43	-7.57	46.00	27.60	0.11	10.72	Average
11	2.54	45.45	-10.55	56.00	34.60	0.12	10.73	QP
12	2.54	38.15	-7.85	46.00	27.30	0.12	10.73	Average
13	2.71	41.77	-14.23	56.00	30.90	0.12	10.75	QP
14	2.71	34.47	-11.53	46.00	23.60	0.12	10.75	Average
15	4.43	39.93	-16.07	56.00	28.90	0.19	10.84	QP
16	4.43	33.63	-12.37	46.00	22.60	0.19	10.84	Average
17	4.85	38.34	-17.66	56.00	27.29	0.20	10.85	QP
18	4.85	32.64	-13.36	46.00	21.59	0.20	10.85	Average



Test Mode :	Mode 1	Temperature :	22~24°C
Test Engineer :	Eko Guan	Relative Humidity :	30~32%
Test Voltage :	120Vac / 60Hz	Phase :	Neutral
Function Type :	GSM850 Idle + Bluetooth Link + WLAN Link + USB Cable 1 (Charging from Adapter 1) + Battery 1 + Earphone 1		

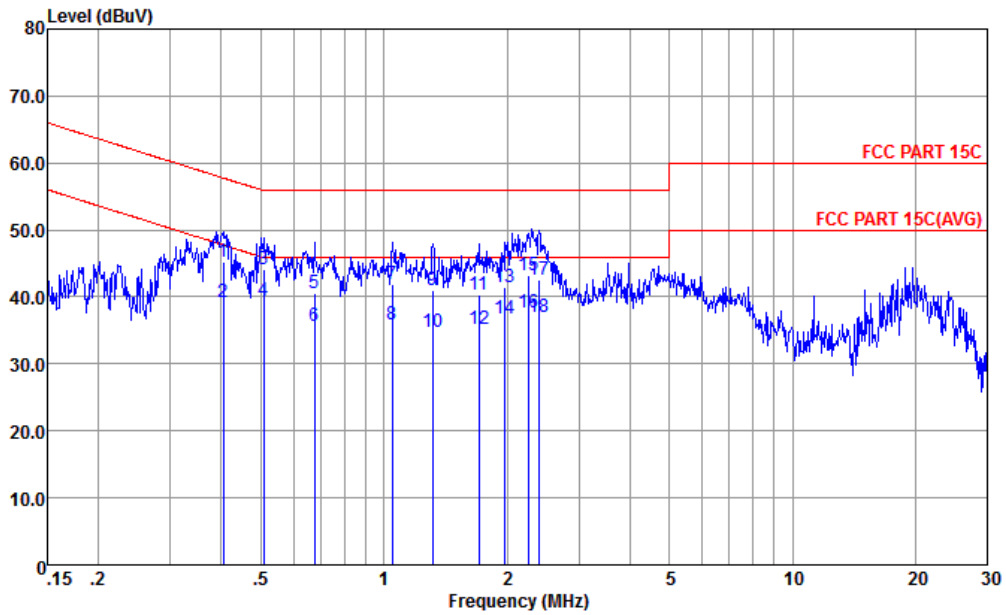

Site : CO01-KS
 Condition : FCC PART 15C LISN-N20140306 NEUTRAL

	Freq	Level	Over	Limit	Read	LISN	Cable	Remark
	MHz	dBuV	Limit	Line	Level	Factor	Loss	
			dB	dBuV	dBuV	dB	dB	
1	0.40	45.32	-12.45	57.77	34.30	0.40	10.62	QP
2	0.40	39.22	-8.55	47.77	28.20	0.40	10.62	Average
3	0.51	44.22	-11.78	56.00	33.30	0.30	10.62	QP
4 *	0.51	39.42	-6.58	46.00	28.50	0.30	10.62	Average
5	0.68	40.55	-15.45	56.00	29.70	0.21	10.64	QP
6	0.68	35.55	-10.45	46.00	24.70	0.21	10.64	Average
7	1.05	41.95	-14.05	56.00	31.20	0.10	10.65	QP
8	1.05	35.85	-10.15	46.00	25.10	0.10	10.65	Average
9	1.32	40.97	-15.03	56.00	30.20	0.10	10.67	QP
10	1.32	34.67	-11.33	46.00	23.90	0.10	10.67	Average
11	1.71	40.29	-15.71	56.00	29.50	0.10	10.69	QP
12	1.71	35.19	-10.81	46.00	24.40	0.10	10.69	Average
13	1.98	41.50	-14.50	56.00	30.70	0.10	10.70	QP
14	1.98	36.70	-9.30	46.00	25.90	0.10	10.70	Average
15	2.26	43.12	-12.88	56.00	32.30	0.11	10.71	QP
16	2.26	37.72	-8.28	46.00	26.90	0.11	10.71	Average
17	2.40	42.63	-13.37	56.00	31.80	0.11	10.72	QP
18	2.40	37.03	-8.97	46.00	26.20	0.11	10.72	Average



3.7 Antenna Requirements

3.7.1 Standard Applicable

If directional gain of transmitting antennas is greater than 6dBi, the power shall be reduced by the same level in dB comparing to gain minus 6dBi. For the fixed point-to-point operation, the power shall be reduced by one dB for every 3 dB that the directional gain of the antenna exceeds 6 dBi. The use of a permanently attached antenna or of an antenna that uses a unique coupling to the intentional radiator shall be considered sufficient to comply with the FCC rule.

3.7.2 Antenna Anti-Replacement Construction

An embedded-in antenna design is used.

3.7.3 Antenna Gain

The antenna peak gain of EUT is less than 6 dBi. Therefore, it is not necessary to reduce maximum peak output power limit.



4 List of Measuring Equipment

Instrument	Manufacturer	Model No.	Serial No.	Characteristics	Calibration Date	Test Date	Due Date	Remark
Spectrum Analyzer	R&S	FSV30	101338	9kHz~30GHz	May 04, 2014	Apr. 16, 2015	May 03, 2015	Conducted (TH01-KS)
Pulse Power Senor	Anritsu	MA2411B	0917070	30MHz~40GHz	Jan. 23, 2015	Apr. 16, 2015	Jan. 22, 2016	Conducted (TH01-KS)
Power Meter	Anritsu	ML2495A	1005002	50MHz Bandwidth	Jan. 23, 2015	Apr. 16, 2015	Jan. 22, 2016	Conducted (TH01-KS)
EMI Test Receiver	R&S	ESCI	100534	9kHz~3GHz	Oct. 25, 2014	Apr. 17, 2015	Oct. 24, 2015	Radiation (03CH01-KS)
Spectrum Analyzer	R&S	FSP30	101399	9kHz~30GHz	May 04, 2014	Apr. 17, 2015	May 03, 2015	Radiation (03CH01-KS)
Loop Antenna	R&S	HFH2-Z2	100321	9kHz~30MHz	Nov. 13, 2014	Apr. 17, 2015	Nov. 12, 2015	Radiation (03CH01-KS)
Bilog Antenna	TeseQ	CBL6112D	23182	25Mhz-2Ghz	Jan. 17, 2015	Apr. 17, 2015	Jan. 16, 2016	Radiation (03CH01-KS)
Double Ridge Horn Antenna	ETS-Lindgren	3117	75959	1GHz~18GHz	Jan. 17, 2015	Apr. 17, 2015	Jan. 16, 2016	Radiation (03CH01-KS)
Active Horn Antenna	com-power	AHA-118	701030	1GHz~18GHz	Nov. 08, 2014	Apr. 17, 2015	Nov. 07, 2015	Radiation (03CH01-KS)
SHF-EHF Horn	Schwarzbeck	BBHA 9170	BBHA170249	15GHz ~40GHz	Mar. 03, 2015	Apr. 17, 2015	Mar. 02, 2016	Radiation (03CH01-KS)
Amplifier	com-power	PA-103A	161069	1MHz~1GHz /32dB	May 04, 2014	Apr. 17, 2015	May 03, 2015	Radiation (03CH01-KS)
Amplifier	Agilent	8449B	3008A02371	1GHz~26.5GHz	Oct. 28, 2014	Apr. 17, 2015	Oct. 27, 2015	Radiation (03CH01-KS)
AC Power Source	Chroma	61601	F104090004	N/A	NCR	Apr. 17, 2015	NCR	Radiation (03CH01-KS)
Turn Table	MF	MF7802	N/A	0~360 degree	NCR	Apr. 17, 2015	NCR	Radiation (03CH01-KS)
Antenna Mast	MF	MF7802	N/A	1 m~4 m	NCR	Apr. 17, 2015	NCR	Radiation (03CH01-KS)
EMI Receiver	R&S	ESCI7	100768	9kHz~7GHz;	May 04, 2014	Feb. 09, 2015	May 03, 2015	Conduction (CO01-KS)
AC LISN	MessTec	AN3016	060103	9kHz~30MHz	Oct. 25, 2014	Feb. 09, 2015	Oct. 24, 2015	Conduction (CO01-KS)
AC LISN (for auxiliary equipment)	MessTec	AN3016	060105	9kHz~30MHz	Oct. 25, 2014	Feb. 09, 2015	Oct. 24, 2015	Conduction (CO01-KS)
AC Power Source	Chroma	61602	ABP000000811	AC 0V~300V, 45Hz~1000Hz	Oct. 25, 2014	Feb. 09, 2015	Oct. 24, 2015	Conduction (CO01-KS)



5 Uncertainty of Evaluation

Uncertainty of Conducted Emission Measurement (150kHz ~ 30MHz)

Measuring Uncertainty for a Level of Confidence of 95% ($U = 2Uc(y)$)	2.3 dB
---	--------

Uncertainty of Radiated Emission Measurement (30 MHz ~ 1000 MHz)

Measuring Uncertainty for a Level of Confidence of 95% ($U = 2Uc(y)$)	2.5 dB
---	--------



Appendix A. Radiated Spurious Emission

2.4GHz 2400~2483.5MHz

WIFI 802.11b (Band Edge @ 3m)

WIFI	Note	Frequency	Level	Over	Limit	Read	Antenna	Cable	Preamp	Ant	Table	Peak	Pol.
Ant.				Limit	Line	Level	Factor	Loss	Factor	Pos	Pos	Avg.	
1		(MHz)	(dBμV/m)	(dB)	(dBμV/m)	(dBμV)	(dB/m)	(dB)	(dB)	(cm)	(deg)	(P/A)	(H/V)
802.11b CH 01 2412MHz		2371.56	53	-21.00	74	47.04	31.28	7.06	32.38	179	342	P	H
		2389.83	39.18	-14.82	54	33.17	31.3	7.07	32.36	179	342	A	H
	*	2410.855	104.51	-	-	98.4	31.31	7.09	32.29	179	342	P	H
	*	2412.107	99.52	-	-	93.39	31.31	7.11	32.29	179	342	A	H
		2353.83	53.22	-20.78	74	47.33	31.26	7.04	32.41	256	271	P	V
		2318.19	38.22	-15.78	54	32.43	31.23	7.01	32.45	256	271	A	V
	*	2410.855	101.19	-	-	95.08	31.31	7.09	32.29	256	271	P	V
	*	2412.107	95.59	-	-	89.46	31.31	7.11	32.29	256	271	A	V
802.11b CH 06 2437MHz	*	2435.822	105.82	-	-	99.58	31.33	7.13	32.22	207	129	P	H
	*	2437.157	100.69	-	-	94.37	31.34	7.13	32.15	207	129	A	H
	*	2438.326	101.31	-	-	94.99	31.34	7.13	32.15	133	105	P	V
	*	2437.825	96.15	-	-	89.83	31.34	7.13	32.15	133	105	A	V
802.11b CH 11 2462MHz	*	2462.041	108.05	-	-	101.63	31.36	7.15	32.09	246	0	P	H
	*	2462.208	101.73	-	-	95.31	31.36	7.15	32.09	246	0	A	H
		2484.32	55.45	-18.55	74	48.91	31.37	7.19	32.02	246	0	P	H
		2483.6	45.59	-8.41	54	39.07	31.37	7.17	32.02	246	0	A	H
	*	2462.041	99.15	-	-	92.73	31.36	7.15	32.09	146	332	P	V
	*	2462.208	93.27	-	-	86.85	31.36	7.15	32.09	146	332	A	V
		2484.6	53.86	-20.14	74	47.32	31.37	7.19	32.02	146	332	P	V
		2483.56	39.17	-14.83	54	32.65	31.37	7.17	32.02	146	332	A	V
Remark	1. No other spurious found. 2. All results are PASS against Peak and Average limit line.												



**2.4GHz 2400~2483.5MHz
WIFI 802.11b (Harmonic @ 3m)**

WIFI Ant. 1	Note	Frequency (MHz)	Level (dBμV/m)	Over Limit (dB)	Limit Line (dBμV/m)	Read Level (dBμV)	Antenna Factor (dB/m)	Cable Loss (dB)	Preamp Factor (dB)	Ant Pos (cm)	Table Pos (deg)	Peak Avg. (P/A)	Pol. (H/V)
802.11b CH 01 2412MHz		4824	48.51	-25.49	74	38.55	34.89	9.8	34.73	187	305	P	H
		4824	45.48	-28.52	74	35.52	34.89	9.8	34.73	155	138	P	V
802.11b CH 06 2437MHz		4875	47.22	-26.78	74	37.09	34.92	9.84	34.63	189	163	P	H
		7311	47.82	-26.18	74	36.05	35.56	12.26	36.05	218	94	P	H
		4875	46.09	-27.91	74	35.96	34.92	9.84	34.63	166	305	P	V
		7311	47.17	-26.83	74	35.4	35.56	12.26	36.05	177	0	P	V
802.11b CH 11 2462MHz		4923	45.83	-28.17	74	35.52	34.95	9.88	34.52	132	246	P	H
		7386	50.34	-23.66	74	38.72	35.58	12.43	36.39	157	210	P	H
		4923	48.91	-25.09	74	38.6	34.95	9.88	34.52	201	68	P	V
		7386	48.24	-25.76	74	36.62	35.58	12.43	36.39	167	114	P	V
Remark	1. No other spurious found. 2. All results are PASS against Peak and Average limit line.												



2.4GHz 2400~2483.5MHz
WIFI 802.11g (Band Edge @ 3m)

WIFI Ant. 1	Note	Frequency (MHz)	Level (dBμV/m)	Over Limit (dB)	Limit Line (dBμV/m)	Read Level (dBμV)	Antenna Factor (dB/m)	Cable Loss (dB)	Preamp Factor (dB)	Ant Pos (cm)	Table Pos (deg)	Peak Avg. (P/A)	Pol. (H/V)
802.11g CH 01 2412MHz		2390	55.9	-18.10	74	49.89	31.3	7.07	32.36	100	186	P	H
		2389.83	38.91	-15.09	54	32.9	31.3	7.07	32.36	100	186	A	H
	*	2418.704	98.89	-	-	92.76	31.31	7.11	32.29	100	186	P	H
	*	2415.364	86.37	-	-	80.24	31.31	7.11	32.29	100	186	A	H
		2389.92	57.96	-16.04	74	51.95	31.3	7.07	32.36	112	0	P	V
		2390	40.31	-13.69	54	34.3	31.3	7.07	32.36	112	0	A	V
	*	2417.451	100.02	-	-	93.89	31.31	7.11	32.29	112	0	P	V
	*	2418.119	88.8	-	-	82.67	31.31	7.11	32.29	112	0	P	V
802.11g CH 06 2437MHz	*	2441.75	99.88	-	-	93.56	31.34	7.13	32.15	100	57	P	H
	*	2442.167	87.41	-	-	81.09	31.34	7.13	32.15	100	57	A	H
	*	2442.167	102.14	-	-	95.82	31.34	7.13	32.15	143	335	P	V
	*	2442.334	90.28	-	-	83.96	31.34	7.13	32.15	143	335	A	V
802.11g CH 11 2462MHz	*	2455.945	98.74	-	-	92.32	31.36	7.15	32.09	150	90	P	H
	*	2458.116	86.9	-	-	80.48	31.36	7.15	32.09	150	90	A	H
		2483.56	62	-12.00	74	55.48	31.37	7.17	32.02	150	90	P	H
		2483.52	40.33	-13.67	54	33.81	31.37	7.17	32.02	150	90	A	H
	*	2458.533	101.34	-	-	94.92	31.36	7.15	32.09	166	0	P	V
	*	2465.798	89.4	-	-	82.96	31.36	7.17	32.09	166	0	A	V
		2483.6	65.58	-8.42	74	59.06	31.37	7.17	32.02	166	0	P	V
		2483.6	42.08	-11.92	54	35.56	31.37	7.17	32.02	166	0	A	V
Remark	1. No other spurious found. 2. All results are PASS against Peak and Average limit line.												



**2.4GHz 2400~2483.5MHz
WIFI 802.11g (Harmonic @ 3m)**

WIFI Ant. 1	Note	Frequency (MHz)	Level (dBμV/m)	Over Limit (dB)	Limit Line (dBμV/m)	Read Level (dBμV)	Antenna Factor (dB/m)	Cable Loss (dB)	Preamp Factor (dB)	Ant Pos (cm)	Table Pos (deg)	Peak Avg. (P/A)	Pol. (H/V)
802.11g CH 01 2412MHz		4824	47.72	-26.28	74	37.76	34.89	9.8	34.73	130	169	P	H
		4824	46.95	-27.05	74	36.99	34.89	9.8	34.73	173	263	P	V
802.11g CH 06 2437MHz		4875	48.43	-25.57	74	38.3	34.92	9.84	34.63	166	302	P	H
		7311	47.7	-26.30	74	35.93	35.56	12.26	36.05	169	230	P	H
		4875	46.58	-27.42	74	36.45	34.92	9.84	34.63	199	165	P	V
		7311	46.89	-27.11	74	35.12	35.56	12.26	36.05	145	206	P	V
802.11g CH 11 2462MHz		4923	47.58	-26.42	74	37.27	34.95	9.88	34.52	143	261	P	H
		7386	47.6	-26.40	74	35.98	35.58	12.43	36.39	193	268	P	H
		4923	47.45	-26.55	74	37.14	34.95	9.88	34.52	236	114	P	V
		7386	46.45	-27.55	74	34.83	35.58	12.43	36.39	188	93	P	V
Remark	1. No other spurious found. 2. All results are PASS against Peak and Average limit line.												



**2.4GHz 2400~2483.5MHz
WIFI 802.11n HT20 (Band Edge @ 3m)**

WIFI Ant. 1	Note	Frequency (MHz)	Level (dBμV/m)	Over Limit (dB)	Limit Line (dBμV/m)	Read Level (dBμV)	Antenna Factor (dB/m)	Cable Loss (dB)	Preamp Factor (dB)	Ant Pos (cm)	Table Pos (deg)	Peak Avg. (P/A)	Pol. (H/V)
802.11n HT20 CH 01 2412MHz		2389.92	56.86	-17.14	74	50.85	31.3	7.07	32.36	224	63	P	H
		2390	39.13	-14.87	54	33.12	31.3	7.07	32.36	224	63	A	H
	*	2404.843	95.83	-	-	89.72	31.31	7.09	32.29	224	63	P	H
	*	2418.287	83.75	-	-	77.62	31.31	7.11	32.29	224	63	A	H
		2389.83	62.19	-11.81	74	56.18	31.3	7.07	32.36	167	360	P	V
		2390	40.64	-13.36	54	34.63	31.3	7.07	32.36	167	360	A	V
	*	2418.537	101.02	-	-	94.89	31.31	7.11	32.29	167	360	P	V
	*	2418.871	89.11	-	-	82.98	31.31	7.11	32.29	167	360	A	V
802.11n HT20 CH 06 2437MHz	*	2443.169	97.63	-	-	91.31	31.34	7.13	32.15	193	66	P	H
	*	2443.169	85.27	-	-	78.95	31.34	7.13	32.15	193	66	A	H
	*	2441.333	101.84	-	-	95.52	31.34	7.13	32.15	150	360	P	V
	*	2440.581	89.62	-	-	83.3	31.34	7.13	32.15	150	360	A	V
802.11n HT20 CH 11 2462MHz	*	2458.116	96.44	-	-	90.02	31.36	7.15	32.09	150	86	P	H
	*	2458.199	84.16	-	-	77.74	31.36	7.15	32.09	150	86	A	H
		2484.16	61.1	-12.90	74	54.56	31.37	7.19	32.02	150	86	P	H
		2483.56	39.22	-14.78	54	32.7	31.37	7.17	32.02	150	86	A	H
	*	2458.784	101.08	-	-	94.66	31.36	7.15	32.09	196	1	P	V
	*	2457.281	88.87	-	-	82.45	31.36	7.15	32.09	196	1	A	V
		2483.8	66.53	-7.47	74	59.99	31.37	7.19	32.02	196	1	P	V
	2483.52	42.09	-11.91	54	35.57	31.37	7.17	32.02	196	1	A	V	
Remark	1. No other spurious found. 2. All results are PASS against Peak and Average limit line.												



**2.4GHz 2400~2483.5MHz
WIFI 802.11n HT20 (Harmonic @ 3m)**

WIFI Ant. 1	Note	Frequency (MHz)	Level (dBμV/m)	Over Limit (dB)	Limit Line (dBμV/m)	Read Level (dBμV)	Antenna Factor (dB/m)	Cable Loss (dB)	Preamp Factor (dB)	Ant Pos (cm)	Table Pos (deg)	Peak Avg. (P/A)	Pol. (H/V)
802.11n HT20 CH 01 2412MHz		4824	47.11	-26.89	74	37.15	34.89	9.8	34.73	163	25	P	H
		4824	46.04	-27.96	74	36.08	34.89	9.8	34.73	196	87	P	V
802.11n HT20 CH 06 2437MHz		4875	47.21	-26.79	74	37.08	34.92	9.84	34.63	169	24	P	H
		7311	50.01	-23.99	74	38.24	35.56	12.26	36.05	163	54	P	H
		4875	45.75	-28.25	74	35.62	34.92	9.84	34.63	206	32	P	V
		7311	47.52	-26.48	74	35.75	35.56	12.26	36.05	163	24	P	V
802.11n HT20 CH 11 2462MHz		4923	47.43	-26.57	74	37.12	34.95	9.88	34.52	189	203	P	H
		7386	47.92	-26.08	74	36.3	35.58	12.43	36.39	158	221	P	H
		4923	46.69	-27.31	74	36.38	34.95	9.88	34.52	197	226	P	V
		7386	48.51	-25.49	74	36.89	35.58	12.43	36.39	164	59	P	V
Remark	1. No other spurious found. 2. All results are PASS against Peak and Average limit line.												



Emission below 1GHz

2.4GHz WIFI 802.11n HT20 (LF)

WIFI	Note	Frequency	Level	Over	Limit	Read	Antenna	Cable	Preamp	Ant	Table	Peak	Pol.
Ant.				Limit	Line	Level	Factor	Loss	Factor	Pos	Pos	Avg.	
1		(MHz)	(dBμV/m)	(dB)	(dBμV/m)	(dBμV)	(dB/m)	(dB)	(dB)	(cm)	(deg)	(P/A)	(H/V)
2.4GHz 802.11n HT20 LF		31.94	18.36	-21.64	40	32	18.22	0.79	32.65			P	H
		57.16	22.18	-17.82	40	47.11	6.88	0.79	32.6	154	45	P	H
		141.55	17.53	-25.97	43.5	37.23	11.63	1.23	32.56			P	H
		172.59	21.51	-21.99	43.5	41.73	10.84	1.44	32.5			P	H
		191.99	22.92	-20.58	43.5	43.68	10.1	1.61	32.47			P	H
		691.54	31.53	-14.47	46	40.5	19.9	3.05	31.92			P	H
		30.97	22.73	-17.27	40	35.89	18.71	0.79	32.66	100	21	P	V
		52.31	21.36	-18.64	40	45	8.18	0.79	32.61			P	V
		156.1	17.47	-26.03	43.5	37.11	11.48	1.44	32.56			P	V
		191.99	19.77	-23.73	43.5	40.53	10.1	1.61	32.47			P	V
		208.48	14.86	-28.64	43.5	35.53	10.2	1.61	32.48			P	V
	422.85	22.07	-23.93	46	35.17	16.87	2.28	32.25			P	V	
Remark	1. No other spurious found. 2. All results are PASS against limit line.												



Note symbol

*	Fundamental Frequency which can be ignored. However, the level of any unwanted emissions shall not exceed the level of the fundamental frequency.
!	Test result is over limit line.
P/A	Peak or Average
H/V	Horizontal or Vertical



A calculation example for radiated spurious emission is shown as below:

WIFI	Note	Frequency	Level	Over	Limit	Read	Antenna	Cable	Preamp	Ant	Table	Peak	Pol.
Ant.				Limit	Line	Level	Factor	Loss	Factor	Pos	Pos	Avg.	
1		(MHz)	(dBμV/m)	(dB)	(dBμV/m)	(dBμV)	(dB/m)	(dB)	(dB)	(cm)	(deg)	(P/A)	(H/V)
802.11b		2390	55.45	-18.55	74	54.51	32.22	4.58	35.86	103	308	P	H
CH 01													
2412MHz		2390	43.54	-10.46	54	42.6	32.22	4.58	35.86	103	308	A	H

- Level(dBμV/m) =
Antenna Factor(dB/m) + Cable Loss(dB) + Read Level(dBμV) - Preamp Factor(dB)
- Over Limit(dB) = Level(dBμV/m) – Limit Line(dBμV/m)

For Peak Limit @ 2390MHz:

- Level(dBμV/m)
= Antenna Factor(dB/m) + Cable Loss(dB) + Read Level(dBμV) - Preamp Factor(dB)
= 32.22(dB/m) + 4.58(dB) + 54.51(dBμV) – 35.86 (dB)
= 55.45 (dBμV/m)
- Over Limit(dB)
= Level(dBμV/m) – Limit Line(dBμV/m)
= 55.45(dBμV/m) – 74(dBμV/m)
= -18.55(dB)

For Average Limit @ 2390MHz:

- Level(dBμV/m)
= Antenna Factor(dB/m) + Cable Loss(dB) + Read Level(dBμV) - Preamp Factor(dB)
= 32.22(dB/m) + 4.58(dB) + 42.6(dBμV) – 35.86 (dB)
= 43.54 (dBμV/m)
- Over Limit(dB)
= Level(dBμV/m) – Limit Line(dBμV/m)
= 43.54(dBμV/m) – 54(dBμV/m)
= -10.46(dB)

Both peak and average measured complies with the limit line, so test result is “PASS”.



Appendix C. Product Equality Declaration

	Antenna	AP	Modem	Transceiver	Power Amplifier	Balun	Band pass filter	Diplexer
Bluetooth	No	No	No	No	No	No	No	No
Wi-Fi	No	No	No	No	No	No	No	No

- FM changes: No
- LCD/ Speaker/ Camera/ Vibrator changes: No (indicated the changed items if yes)
- Other changes detailed:

● **MECHANICAL MODIFICATIONS:**

- Use new metal front/back cover or keypad: No
- Mechanical shell changes:
 - Whole size of EUT: No
 - Distance of Ear reference point to bottom of handset: No
 - Other trinkets to change the surface of handset: No
- Other changes detailed: replace SD card slot by the second SIM card slot on enclosure

APPROVED BY:

Project Manager:

Signature:

Date:

Danielji

2015.3.19.