



FCC RF Test Report

APPLICANT : TCT Mobile Limited
EQUIPMENT : GSM Quad-band / UMTS Quad-band /
LTE Penta-band mobile phone
BRAND NAME : Alcatel
MODEL NAME : 6039A
FCC ID : RAD544
STANDARD : FCC Part 15 Subpart C §15.247
CLASSIFICATION : (DTS) Digital Transmission System

The product was received on Jan. 13, 2015 and testing was completed on Feb. 17, 2015. We, SPORTON INTERNATIONAL (KUNSHAN) INC., would like to declare that the tested sample has been evaluated in accordance with the test procedures and has been in compliance with the applicable technical standards.

The test results in this report apply exclusively to the tested model / sample. Without written approval of SPORTON INTERNATIONAL (KUNSHAN) INC., the test report shall not be reproduced except in full.

Reviewed by: Joseph Lin / Supervisor

Approved by: Jones Tsai / Manager



SPORTON INTERNATIONAL (KUNSHAN) INC.
No. 3-2, PingXiang Road, Kunshan, Jiangsu Province, P. R. China



TABLE OF CONTENTS

REVISION HISTORY..... 3

SUMMARY OF TEST RESULT 4

1 GENERAL DESCRIPTION..... 5

 1.1 Applicant..... 5

 1.2 Manufacturer..... 5

 1.3 Product Feature of Equipment Under Test..... 5

 1.4 Product Specification subjective to this standard 6

 1.5 Accessories and Support Equipment 7

 1.6 Modification of EUT 8

 1.7 Testing Location 8

 1.8 Applicable Standards..... 8

2 TEST CONFIGURATION OF EQUIPMENT UNDER TEST..... 9

 2.1 Descriptions of Test Mode..... 9

 2.2 Test Mode..... 10

 2.3 Connection Diagram of Test System..... 11

 2.4 Support Unit used in test configuration and system 12

 2.5 EUT Operation Test Setup 12

 2.6 Measurement Results Explanation Example..... 12

3 TEST RESULT 13

 3.1 6dB Bandwidth Measurement 13

 3.2 Peak Output Power Measurement 16

 3.3 Power Spectral Density Measurement 18

 3.4 Conducted Band Edges and Spurious Emission Measurement 24

 3.5 Radiated Band Edges and Spurious Emission Measurement 32

 3.6 AC Conducted Emission Measurement..... 37

 3.7 Antenna Requirements..... 41

4 LIST OF MEASURING EQUIPMENT..... 42

5 UNCERTAINTY OF EVALUATION..... 43

APPENDIX A. RADIATED SPURIOUS EMISSION

APPENDIX B. SETUP PHOTOGRAPHS



REVISION HISTORY

REPORT NO.	VERSION	DESCRIPTION	ISSUED DATE
FR511303B	Rev. 01	Initial issue of report	Apr. 20, 2015



SUMMARY OF TEST RESULT

Report Section	FCC Rule	Description	Limit	Result	Remark
3.1	15.247(a)(2)	6dB Bandwidth	$\geq 0.5\text{MHz}$	Pass	-
3.2	15.247(b)(1)	Peak Output Power	$\leq 30\text{dBm}$	Pass	-
3.3	15.247(e)	Power Spectral Density	$\leq 8\text{dBm}/3\text{kHz}$	Pass	-
3.4	15.247(d)	Conducted Band Edges and Spurious Emission	$\leq 20\text{dBc}$	Pass	-
3.5	15.247(d)	Radiated Band Edges and Spurious Emission	15.209(a) & 15.247(d)	Pass	Under limit 12.75 dB at 2483.520 MHz
3.6	15.207	AC Conducted Emission	15.207(a)	Pass	Under limit 6.58 dB at 0.510 MHz
3.7	15.203 & 15.247(b)	Antenna Requirement	N/A	Pass	-



1 General Description

1.1 Applicant

TCT Mobile Limited

5F, C building, No. 232, Liang Jing Road ZhangJiang High-Tech Park, Pudong Area Shanghai, P.R. China. 201203

1.2 Manufacturer

TCT Mobile Limited

5F, C building, No. 232, Liang Jing Road ZhangJiang High-Tech Park, Pudong Area Shanghai, P.R. China. 201203

1.3 Product Feature of Equipment Under Test

Product Feature	
Equipment	GSM Quad-band / UMTS Quad-band / LTE Penta-band mobile phone
Brand Name	Alcatel
Model Name	6039A
FCC ID	RAD544
EUT supports Radios application	GSM/GPRS/EGPRS/WCDMA/HSPA/ HSPA+ (Downlink Only)/DC-HSDPA/LTE/NFC/ WLAN 2.4GHz 802.11b/g/n HT20/ Bluetooth v3.0 + EDR / Bluetooth v4.1 LE
IMEI Code	Conducted: 014368000002652 Radiated: 014368000003239 Conduction: 014368000002652
HW Version	BAB34D000GCX
SW Version	vA7M
EUT Stage	Identical Prototype

Remark:

1. The above EUT's information was declared by manufacturer. Please refer to the specifications or user's manual for more detailed description.
2. There are two types of EUT sample 1 and sample 2, the differences between two samples is only for memory, sample 1 is 1GB capacity and sample 2 is 1.5GB capacity. We only chose the sample 1 to perform all tests.



1.4 Product Specification subjective to this standard

Product Specification subjective to this standard	
Tx/Rx Frequency Range	2402 MHz ~ 2480 MHz
Number of Channels	40
Carrier Frequency of Each Channel	40 Channel(37 hopping + 3 advertising channel)
Maximum Output Power to Antenna	-2.10 dBm (0.0006 W)
Antenna Type / Gain	PIFA Antenna with gain 1.0 dBi
Type of Modulation	Bluetooth v4.1 LE : GFSK



1.5 Accessories and Support Equipment

Specification of Accessory			
AC Adapter 1	Brand Name	ACE-Tenpao	Model Name UC11US
	Power Rating	I/P: 100-240Vac, 200mA, O/P: 5Vdc, 1000mA	
	P/N	CBA0058AG0C2	
AC Adapter 2	Brand Name	ACE-Yingju	Model Name UC11US
	Power Rating	I/P: 100-240Vac, 200mA, O/P: 5Vdc, 1000mA	
	P/N	CBA0058AG0C3	
Battery 1	Brand Name	ALCATEL onetouch	Model Name TLp020K2
	Power Rating	3.8Vdc, 2000mAh	
	P/N	CAC2000023C2	
Battery 2	Brand Name	ALCATEL onetouch	Model Name TLp020KJ
	Power Rating	3.8Vdc, 2000mAh	
	P/N	CAC2000025CJ	
USB Cable 1	Brand Name	ACE-Shenhua	Model Name CDA0000025C1
	Signal Line Type	1.10m shielded without core	
USB Cable 2	Brand Name	ACE-Juwei	Model Name CDA0000025C2
	Signal Line Type	1.10m shielded without core	
USB Cable 3	Brand Name	ACE-Juwei	Model Name CDA0000025C8
	Signal Line Type	1.10m shielded without core	
Earphone 1	Brand Name	ACE-Lianyun	Model Name CCB0023A10C2
	Signal Line Type	1.16m non-shielded without core	
Earphone 2	Brand Name	ACE-JBL	Model Name J22C
	Signal Line Type	1.38m non-shielded without core	
Earphone 3	Brand Name	ACE-Lianyun	Model Name CCB0023A11C2
	Signal Line Type	1.26m non-shielded without core	
Earphone 4	Brand Name	ACE-JBL	Model Name CCA0001A10C9
	Signal Line Type	1.28m non-shielded without core	



1.6 Modification of EUT

No modifications are made to the EUT during all test items.

1.7 Testing Location

Test Site	SPORTON INTERNATIONAL (KUNSHAN) INC.			
Test Site Location	No. 3-2, PingXiang Road, Kunshan, Jiangsu Province, P. R. China TEL: +86-0512-5790-0158 FAX: +86-0512-5790-0958			
Test Site No.	Sporton Site No.			FCC Registration No.
	TH01-KS	03CH01-KS	CO01-KS	149928

Note: The test site complies with ANSI C63.4 2009 requirement.

1.8 Applicable Standards

According to the specifications of the manufacturer, the EUT must comply with the requirements of the following standards:

- ♦ FCC Part 15 Subpart C §15.247
- ♦ FCC KDB Publication No. 558074 D01 DTS Meas. Guidance v03r02
- ♦ ANSI C63.10-2013

Remark:

1. All test items were verified and recorded according to the standards and without any deviation during the test.
2. FCC permits the use of the 1.5 meter table as an alternative in C63.10-2013 through inquiry tracking number 961829.
3. This EUT has also been tested and complied with the requirements of FCC Part 15, Subpart B, recorded in a separate test report.



2 Test Configuration of Equipment Under Test

2.1 Descriptions of Test Mode

The RF output power was recorded in the following table:

Channel	Frequency	Bluetooth v4.1 LE RF Output Power	
		Data Rate / Modulation	
		GFSK	
		1Mbps	
Ch00	2402MHz	-2.98 dBm	
Ch19	2440MHz	-2.10 dBm	
Ch39	2480MHz	-2.73 dBm	

- a. The EUT has been associated with peripherals and configuration operated in a manner tended to maximize its emission characteristics in a typical application. Frequency range investigated: conduction (150 kHz to 30 MHz), radiation (9 kHz to the 10th harmonic of the highest fundamental frequency or to 40 GHz, whichever is lower). Pre-scanned tests, X, Y, Z in three orthogonal panels to determine the final configuration (Y plane as worst plane) from all possible combinations.

- b. AC power line Conducted Emission was tested under maximum output power.



2.2 Test Mode

The following summary table is showing all test modes to demonstrate in compliance with the standard.

Summary table of Test Cases	
Test Item	Data Rate / Modulation
	Bluetooth v4.1 LE / GFSK
Conducted TCs	Mode 1: Bluetooth Tx CH00_2402 MHz_1Mbps Mode 2: Bluetooth Tx CH19_2440 MHz_1Mbps Mode 3: Bluetooth Tx CH39_2480 MHz_1Mbps
Radiated TCs	Mode 1: Bluetooth Tx CH00_2402 MHz_1Mbps Mode 2: Bluetooth Tx CH19_2440 MHz_1Mbps Mode 3: Bluetooth Tx CH39_2480 MHz_1Mbps
AC Conducted Emission	Mode 1: GSM850 Idle + Bluetooth Link + WLAN Link + Earphone 1 + USB Cable 1 (Charging from Adapter 1) + Battery 1
Remark: For radiated test cases, the tests were performed with adapter 1, earphone 1, battery 1 and USB cable 1.	

2.3 Connection Diagram of Test System

<Bluetooth v4.1 LE Tx Mode>

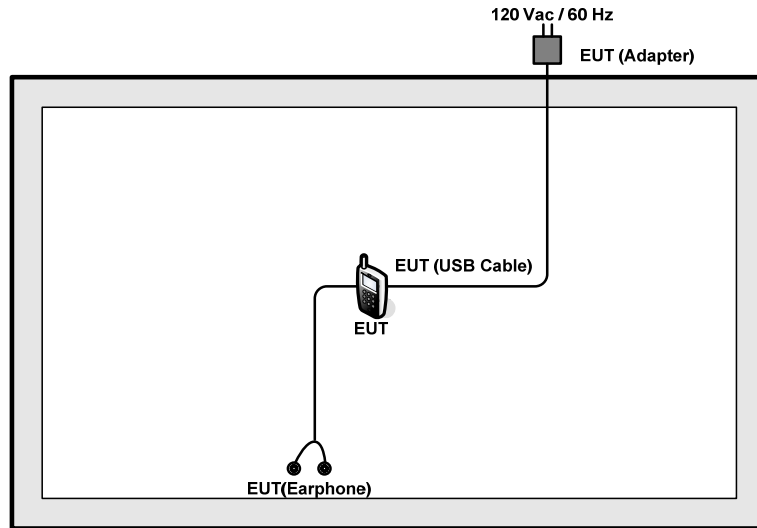

<AC Conducted Emission Mode>

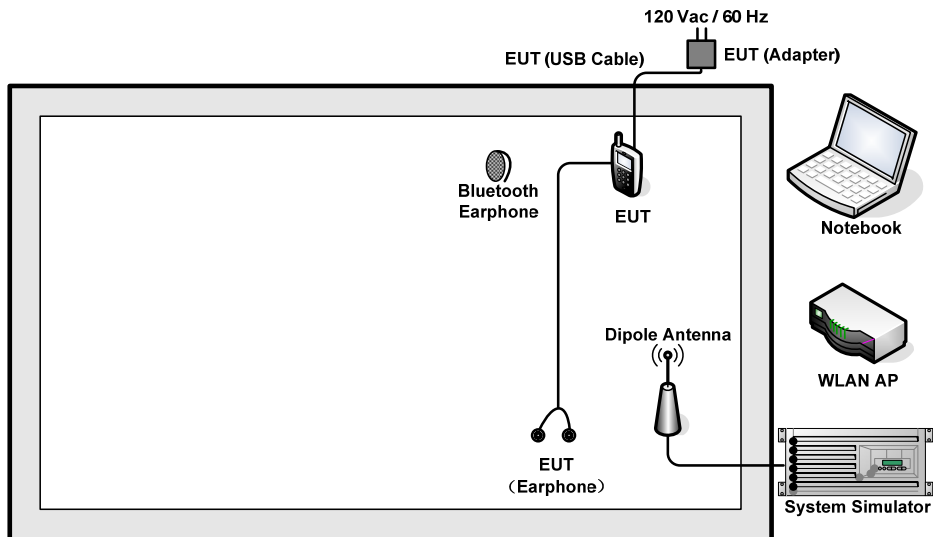

2.4 Support Unit used in test configuration and system

Item	Equipment	Trade Name	Model Name	FCC ID	Data Cable	Power Cord
1.	System Simulator	R&S	CMU 200	N/A	N/A	Unshielded, 1.8 m
2.	WLAN AP	D-Link	DIR-855	KA2DIR855A2	N/A	Unshielded, 1.8 m
3.	Notebook	Lenovo	G480	FCC DoC	N/A	AC I/P: Unshielded, 1.2 m DC O/P: Shielded, 1.8 m
4.	Bluetooth Earphone	Nokia	BH-102	PYAHS-107W	N/A	N/A

2.5 EUT Operation Test Setup

For Bluetooth v4.1 LE function, the engineering test program was provided and enabled to make EUT continuous transmit/receive.

For AC power line conducted emissions, the EUT was set to connect with the WLAN AP under large package sizes transmission.

2.6 Measurement Results Explanation Example

For all conducted test items:

The offset level is set in the spectrum analyzer to compensate the RF cable loss and attenuator factor between EUT conducted output port and spectrum analyzer. With the offset compensation, the spectrum analyzer reading level is exactly the EUT RF output level.

Example :

The spectrum analyzer offset is derived from RF cable loss.

Offset = RF cable loss.

Following shows an offset computation example with cable loss 5.5 dB.

$$\begin{aligned} \text{Offset(dB)} &= \text{RF cable loss(dB)}. \\ &= 5.5 \text{ (dB)} \end{aligned}$$

3 Test Result

3.1 6dB Bandwidth Measurement

3.1.1 Limit of 6dB Bandwidth

The minimum 6 dB bandwidth shall be at least 500 kHz.

3.1.2 Measuring Instruments

The section 4.0 of List of Measuring Equipment of this test report is used for test.

3.1.3 Test Procedures

1. The testing follows FCC KDB Publication No. 558074 D01 DTS Meas. Guidance v03r02.
2. The RF output of EUT was connected to the spectrum analyzer by RF cable and attenuator. The path loss was compensated to the results for each measurement.
3. Set to the maximum power setting and enable the EUT transmit continuously.
4. Make the measurement with the spectrum analyzer's resolution bandwidth (RBW) = 100 kHz. Set the Video bandwidth (VBW) = 300 kHz. In order to make an accurate measurement. The 6 dB bandwidth must be greater than 500 kHz.
5. Measure and record the results in the test report.

3.1.4 Test Setup

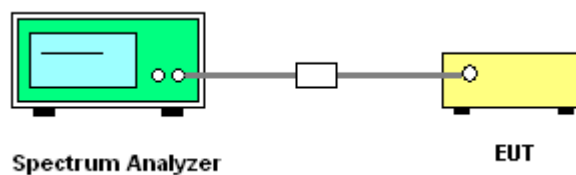



3.1.5 Test Result of 6dB Bandwidth

Test Mode :	Bluetooth v4.1 LE	Temperature :	24~25°C
Test Engineer :	Issac Song	Relative Humidity :	49~51%

Channel	Frequency (MHz)	6dB Bandwidth (MHz)	6dB Bandwidth Min. Limit (MHz)	Pass/Fail
00	2402	0.672	0.5	Pass
19	2440	0.672	0.5	Pass
39	2480	0.666	0.5	Pass

6 dB Bandwidth Plot on Channel 00

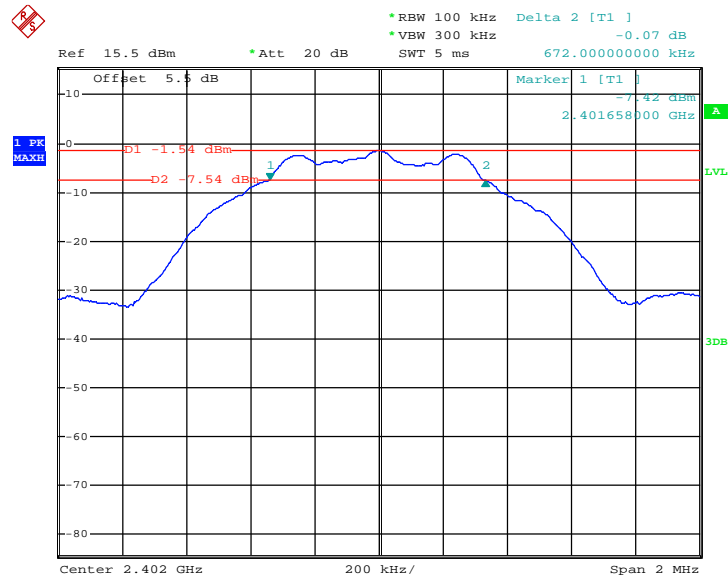

Date: 22.JAN.2015 18:33:25



6 dB Bandwidth Plot on Channel 19

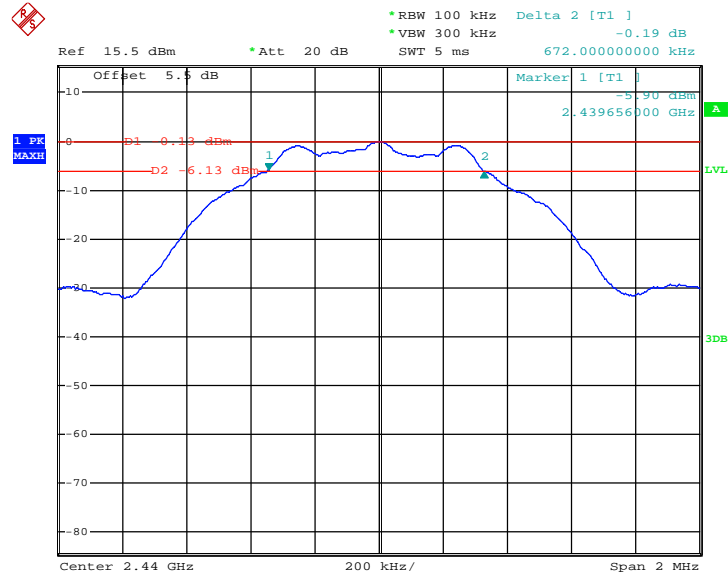

Date: 22.JAN.2015 18:38:01

6 dB Bandwidth Plot on Channel 39

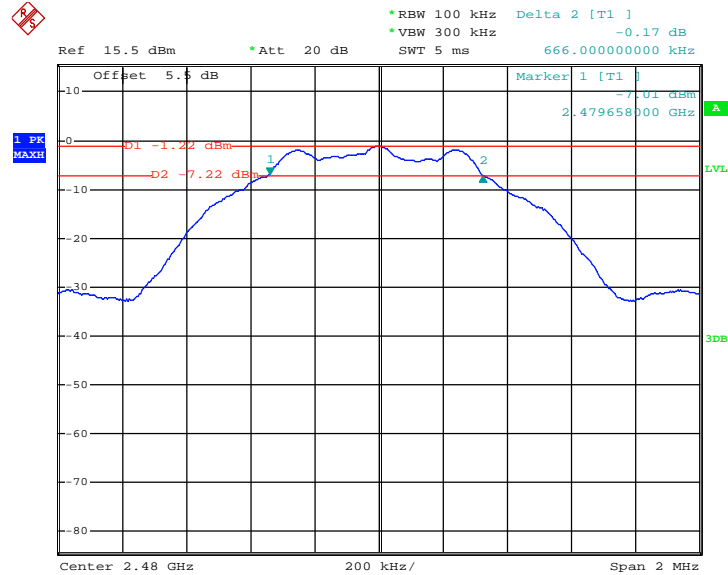

Date: 22.JAN.2015 18:41:11

3.2 Peak Output Power Measurement

3.2.1 Limit of Peak Output Power

For systems using digital modulation in the 2400-2483.5MHz, the limit for peak output power is 30dBm. If transmitting antenna of directional gain greater than 6dBi is used, the peak output power from the intentional radiator shall be reduced below the above stated value by the amount in dB that the directional gain of the antenna exceeds 6 dBi. In case of point-to-point operation, the limit has to be reduced by 1dB for every 3dB that the directional gain of the antenna exceeds 6dBi.

3.2.2 Measuring Instruments

The section 4.0 of List of Measuring Equipment of this test report is used for test.

3.2.3 Test Procedures

1. The testing follows the Measurement Procedure of FCC KDB No. 558074 DTS D01 Meas. Guidance v03r02.
2. The RF output of EUT was connected to the power meter by RF cable and attenuator. The path loss was compensated to the results for each measurement.
3. Set to the maximum power setting and enable the EUT transmit continuously.
4. Measure the conducted output power and record the results in the test report.

3.2.4 Test Setup

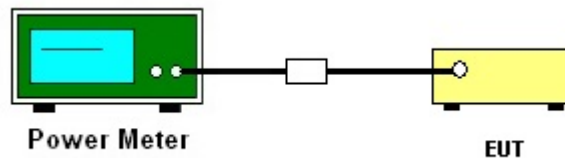



3.2.5 Test Result of Peak Output Power

Test Mode :	Bluetooth v4.1 LE	Temperature :	24~25°C
Test Engineer :	Issac Song	Relative Humidity :	49~51%

Channel	Frequency (MHz)	RF Power (dBm)		
		GFSK	Max. Limits (dBm)	Pass/Fail
		1 Mbps		
00	2402	-2.98	30.00	Pass
19	2440	-2.10	30.00	Pass
39	2480	-2.73	30.00	Pass

3.3 Power Spectral Density Measurement

3.3.1 Limit of Power Spectral Density

The peak power spectral density shall not be greater than 8dBm in any 3kHz band at any time interval of continuous transmission.

3.3.2 Measuring Instruments

The section 4.0 of List of Measuring Equipment of this test report is used for test.

3.3.3 Test Procedures

1. The testing follows Measurement Procedure 10.2 Method PKPSD of FCC KDB Publication No. 558074 D01 DTS Meas. Guidance v03r02
2. The RF output of EUT was connected to the spectrum analyzer by RF cable and attenuator. The path loss was compensated to the results for each measurement.
3. Set to the maximum power setting and enable the EUT transmit continuously.
4. Make the measurement with the spectrum analyzer's resolution bandwidth (RBW) = 3 kHz. Video bandwidth VBW = 10 kHz In order to make an accurate measurement, set the span to 1.5 times DTS Channel Bandwidth. (6dB BW)
5. Detector = peak, Sweep time = auto couple, Trace mode = max hold, Allow trace to fully stabilize. Use the peak marker function to determine the maximum power level.
6. Measure and record the results in the test report.
7. The Measured power density (dBm)/ 100kHz is a reference level and used as 20dBc down limit line for Conducted Band Edges and Conducted Spurious Emission.

3.3.4 Test Setup

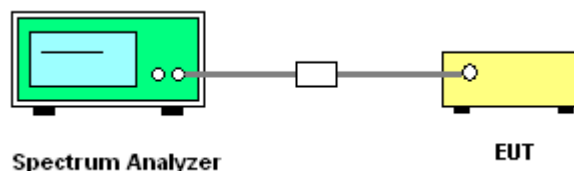



3.3.5 Test Result of Power Spectral Density

Test Mode :	Bluetooth v4.1 LE	Temperature :	24~25°C
Test Engineer :	Issac Song	Relative Humidity :	49~51%

Channel	Frequency (MHz)	Power Density		Max. Limits (dBm/3kHz)	Pass/Fail
		PSD/100kHz (dBm)	PSD/3kHz (dBm)		
00	2402	-1.50	-16.86	8	Pass
19	2440	-0.11	-15.43	8	Pass
39	2480	-1.17	-16.51	8	Pass

Note:

1. Measured power density (dBm) has offset with cable loss.
2. The Measured power density (dBm)/ 100kHz is reference level and used as 20dBc down for Conducted Band Edges and Conducted Spurious Emission limit line.



3.3.6 Test Result of Power Spectral Density Plots (100kHz)

PSD 100kHz Plot on Channel 00

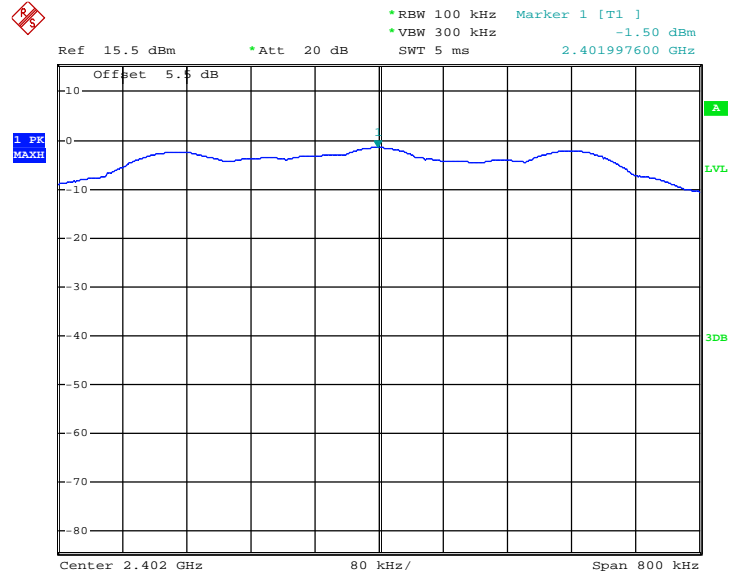

Date: 22.JAN.2015 18:34:33



PSD 100kHz Plot on Channel 19

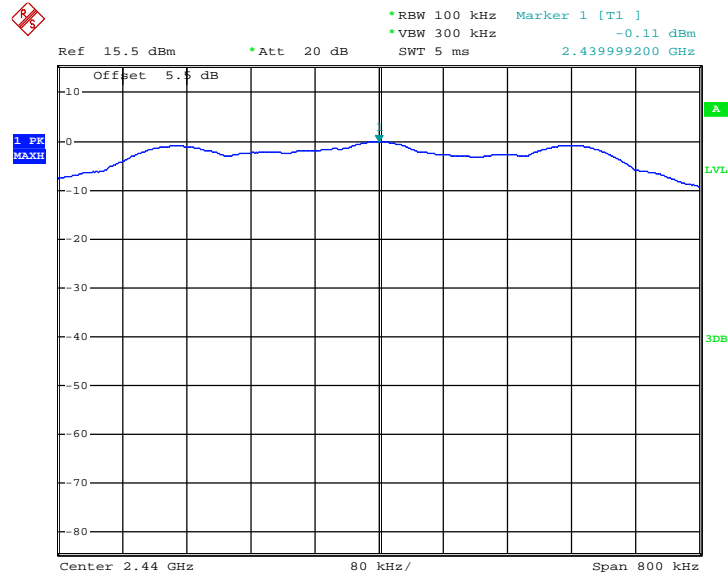

Date: 22.JAN.2015 18:39:11

PSD 100kHz Plot on Channel 39

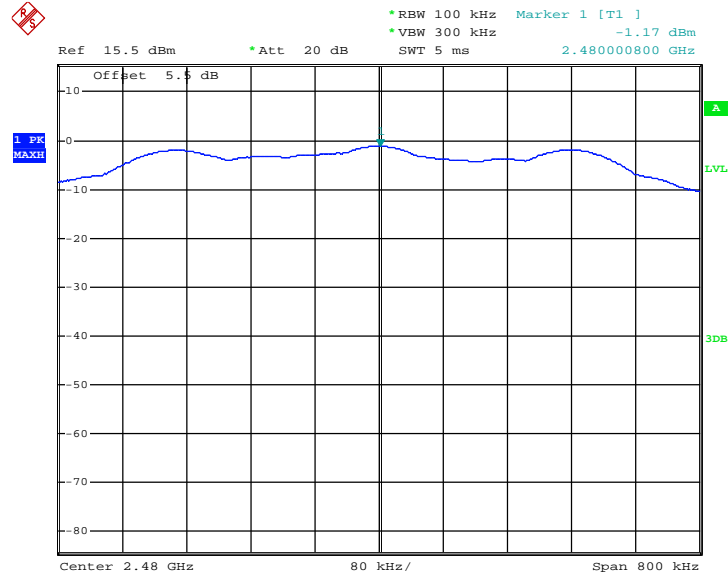

Date: 22.JAN.2015 18:42:46



3.3.7 Test Result of Power Spectral Density Plots (3kHz)

PSD 3kHz Plot on Channel 00

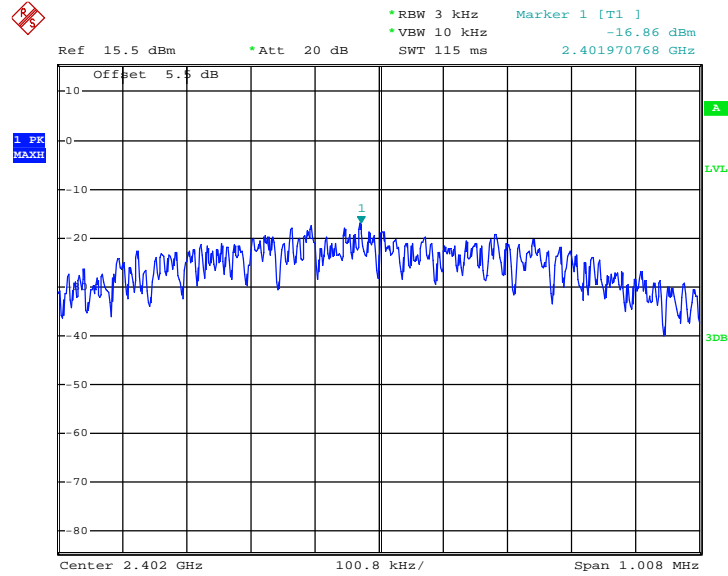

Date: 22.JAN.2015 18:34:07



PSD 3kHz Plot on Channel 19

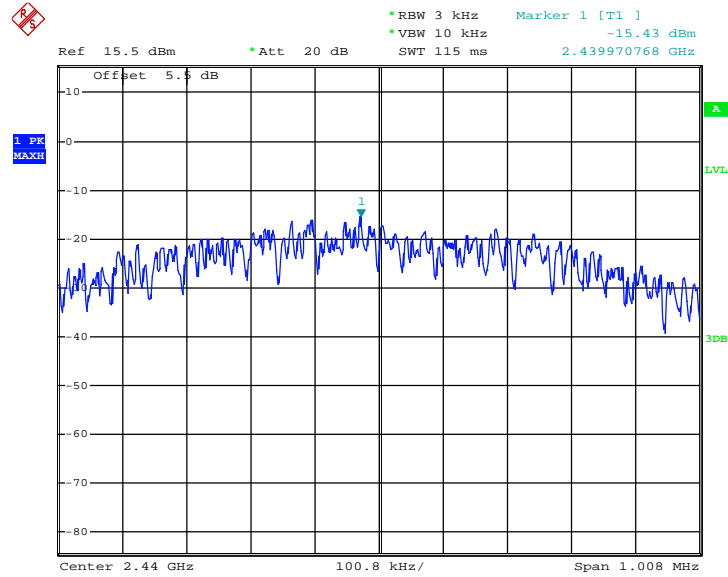

Date: 22.JAN.2015 18:38:42

PSD 3kHz Plot on Channel 39

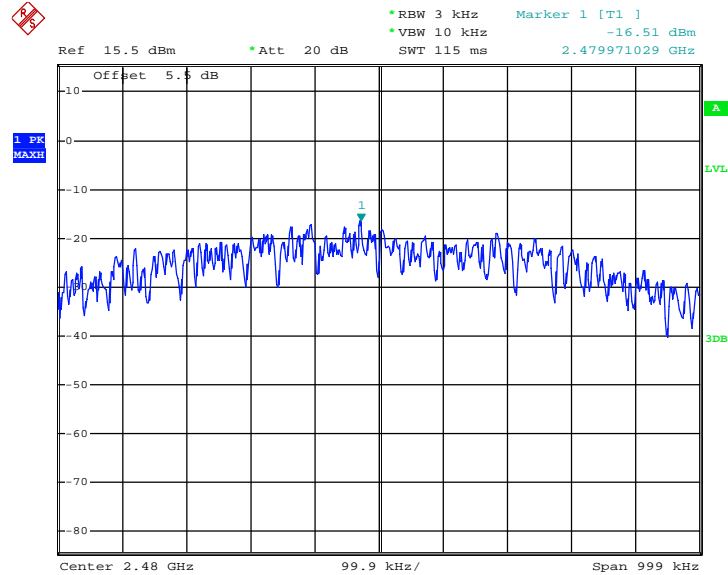

Date: 22.JAN.2015 18:42:07

3.4 Conducted Band Edges and Spurious Emission Measurement

3.4.1 Limit of Conducted Band Edges and Spurious Emission

All harmonics/spurious must be at least 20 dB down from the highest emission level within the authorized band.

3.4.2 Measuring Instruments

The section 4.0 of List of Measuring Equipment of this test report is used for test.

3.4.3 Test Procedure

1. The testing follows FCC KDB Publication No. 558074 D01 DTS Meas. Guidance v03r02.
2. The RF output of EUT was connected to the spectrum analyzer by RF cable and attenuator. The path loss was compensated to the results for each measurement.
3. Set to the maximum power setting and enable the EUT transmit continuously.
4. Set RBW = 100 kHz, VBW=300 kHz, Peak Detector. Unwanted Emissions measured in any 100 kHz bandwidth outside of the authorized frequency band shall be attenuated by at least 20 dB relative to the maximum in-band peak PSD level in 100 kHz when maximum peak conducted output power procedure is used. If the transmitter complies with the conducted power limits based on the use of RMS averaging over a time interval, the attenuation required under this paragraph shall be 30 dB instead of 20 dB per 15.247(d).
5. Measure and record the results in the test report.
6. The RF fundamental frequency should be excluded against the limit line in the operating frequency band.

3.4.4 Test Setup

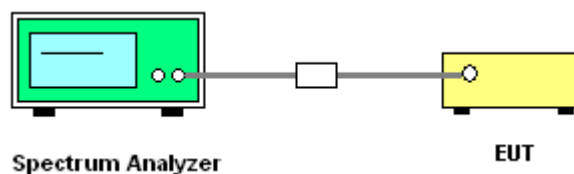



3.4.5 Test Result of Conducted Band Edges

Test Mode :	Bluetooth v4.1 LE	Temperature :	24~25°C
Test Channel :	00 and 39	Relative Humidity :	49~51%
		Test Engineer :	Issac Song

Low Band Edge Plot on Channel 00

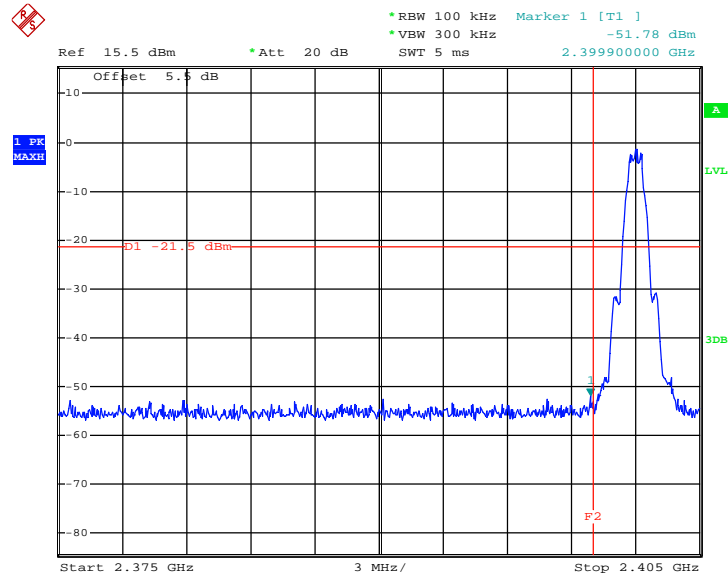

Date: 22.JAN.2015 18:34:53

High Band Edge Plot on Channel 39

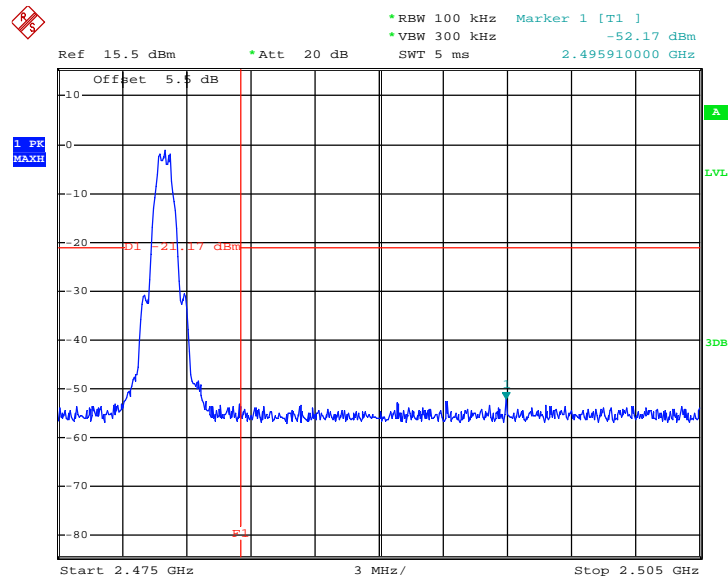

Date: 22.JAN.2015 18:43:02



3.4.6 Test Result of Conducted Spurious Emission

Test Mode :	Bluetooth v4.1 LE	Temperature :	24~25°C
Test Channel :	00	Relative Humidity :	49~51%
		Test Engineer :	Issac Song

Conducted Spurious Emission Plot on Bluetooth LE 1Mbps GFSK Channel 00

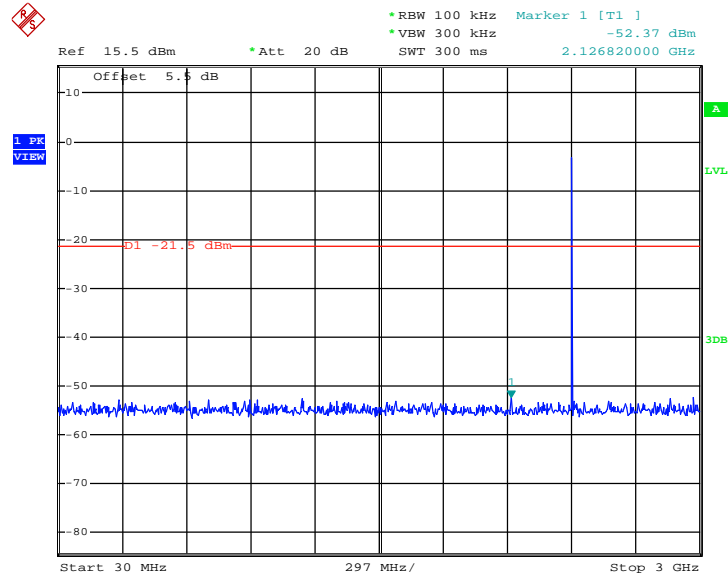

Date: 22.JAN.2015 18:35:16



Conducted Spurious Emission Plot on Bluetooth LE 1Mbps GFSK Channel 00

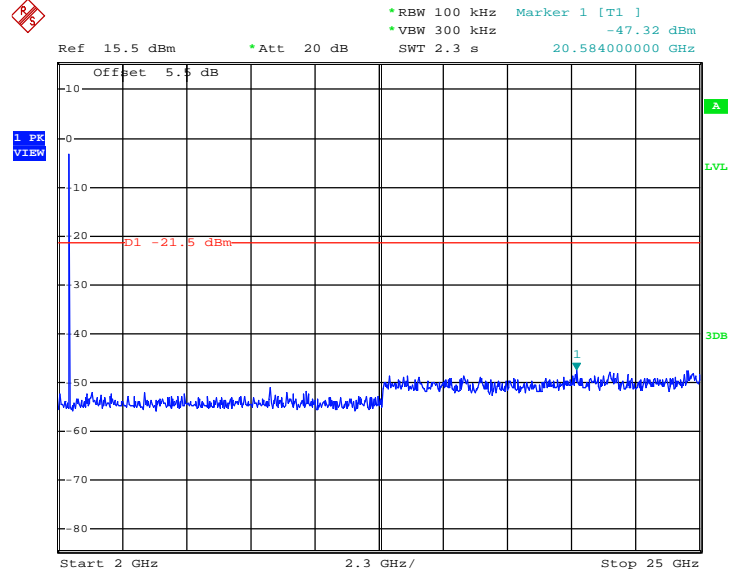

Date: 22.JAN.2015 18:35:34



Test Mode :	Bluetooth v4.1 LE	Temperature :	24~25°C
Test Channel :	19	Relative Humidity :	49~51%
		Test Engineer :	Issac Song

Conducted Spurious Emission Plot on Bluetooth LE 1Mbps
GFSK Channel 19

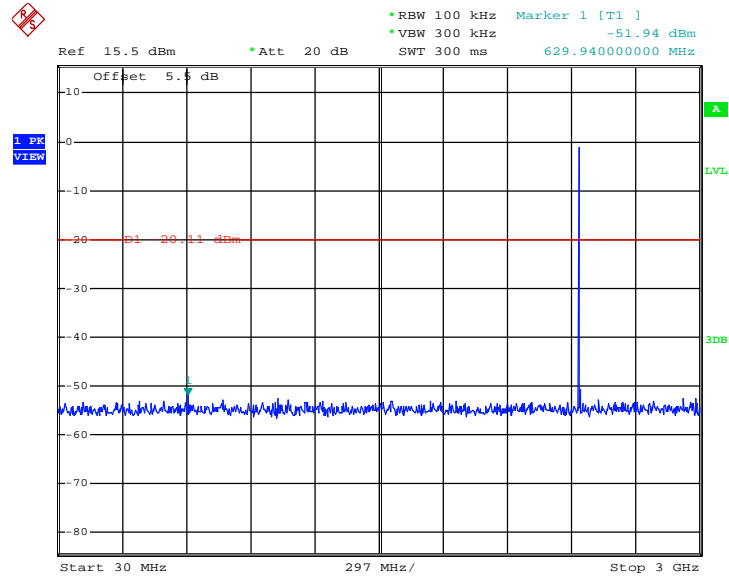

Date: 22.JAN.2015 18:39:34



Conducted Spurious Emission Plot on Bluetooth LE 1Mbps GFSK Channel 19

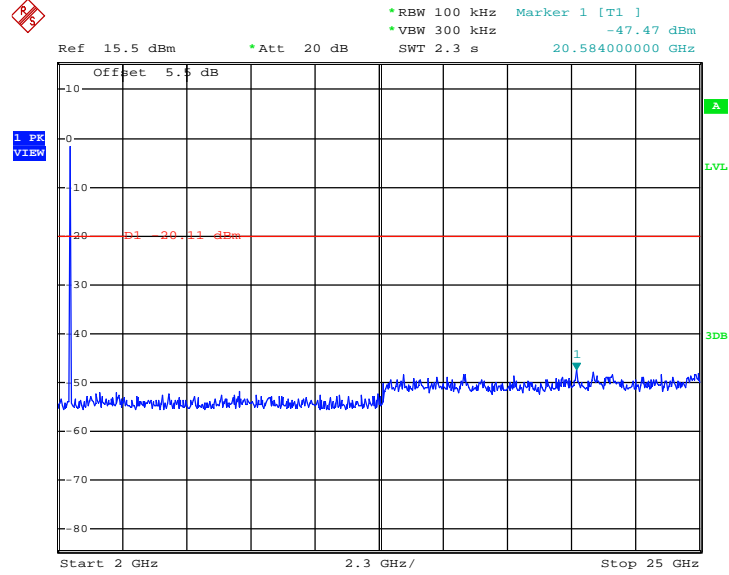

Date: 22.JAN.2015 18:39:52



Test Mode :	Bluetooth v4.1 LE	Temperature :	24~25°C
Test Channel :	39	Relative Humidity :	49~51%
		Test Engineer :	Issac Song

**Conducted Spurious Emission Plot on Bluetooth LE 1Mbps
GFSK Channel 39**

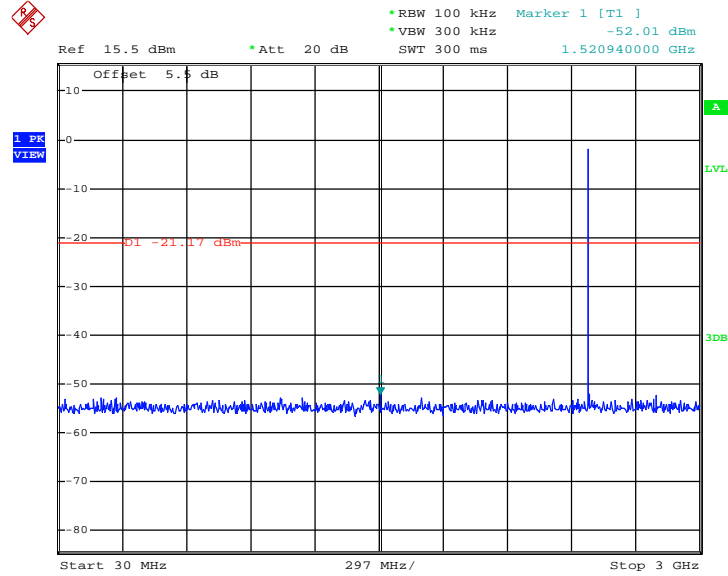

Date: 22.JAN.2015 18:43:24



Conducted Spurious Emission Plot on Bluetooth LE 1Mbps GFSK Channel 39

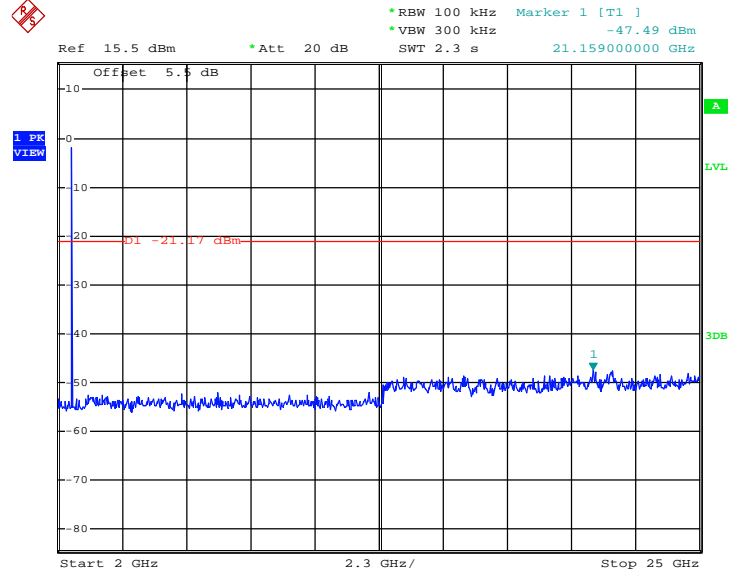

Date: 22.JAN.2015 18:43:42



3.5 Radiated Band Edges and Spurious Emission Measurement

3.5.1 Limit of Radiated Band Edges and Spurious Emission

In any 100 kHz bandwidth outside the intentional radiator frequency band, all harmonics/spurious must be at least 20 dB below the highest emission level within the authorized band. If the output power of this device was measured by spectrum analyzer, the attenuation under this paragraph shall be 30 dB instead of 20 dB. In addition, radiated emissions which fall in the restricted bands must also comply with the FCC section 15.209 limits as below.

Frequency (MHz)	Field Strength (microvolts/meter)	Measurement Distance (meters)
0.009 – 0.490	2400/F(kHz)	300
0.490 – 1.705	24000/F(kHz)	30
1.705 – 30.0	30	30
30 – 88	100	3
88 – 216	150	3
216 - 960	200	3
Above 960	500	3

3.5.2 Measuring Instruments

The section 4.0 of List of Measuring Equipment of this test report is used for test.



3.5.3 Test Procedures

1. The testing follows FCC KDB Publication No. 558074 D01 DTS Meas. Guidance v03r02.
2. The EUT was arranged to its worst case and then tune the antenna tower (from 1 m to 4 m) and turntable (from 0 degree to 360 degrees) to find the maximum reading. A pre-amp and a high pass filter are used for the test in order to get better signal level.
3. The EUT was placed on a turntable with 0.8 meter for frequency below 1GHz and 1.5 meter for frequency above 1GHz respectively above ground.
4. The EUT was set 3 meters from the interference receiving antenna, which was mounted on the top of a variable height antenna tower.
5. Corrected Reading: Antenna Factor + Cable Loss + Read Level - Preamp Factor = Level
6. For measurement below 1GHz, If the emission level of the EUT measured by the peak detector is 3 dB lower than the applicable limit, the peak emission level will be reported. Otherwise, the emission measurement will be repeated using the quasi-peak detector and reported.
7. Use the following spectrum analyzer settings:
 - (1) Span shall wide enough to fully capture the emission being measured;
 - (2) Set RBW=100 kHz for $f < 1$ GHz; $VBW \geq RBW$; Sweep = auto; Detector function = peak; Trace = max hold;
 - (3) Set RBW = 1 MHz, VBW= 3MHz for $f \geq 1$ GHz for peak measurement.
For average measurement:
 - $VBW = 10$ Hz, when duty cycle is no less than 98 percent.
 - $VBW \geq 1/T$, when duty cycle is less than 98 percent where T is the minimum transmission duration over which the transmitter is on and is transmitting at its maximum power control level for the tested mode of operation.

Band	Duty Cycle(%)	T(ms)	1/T(kHz)	VBW Setting
Bluetooth v4.1 LE	62.42	0.39	2.55	3kHz

3.5.4 Test Setup

For radiated emissions below 30MHz

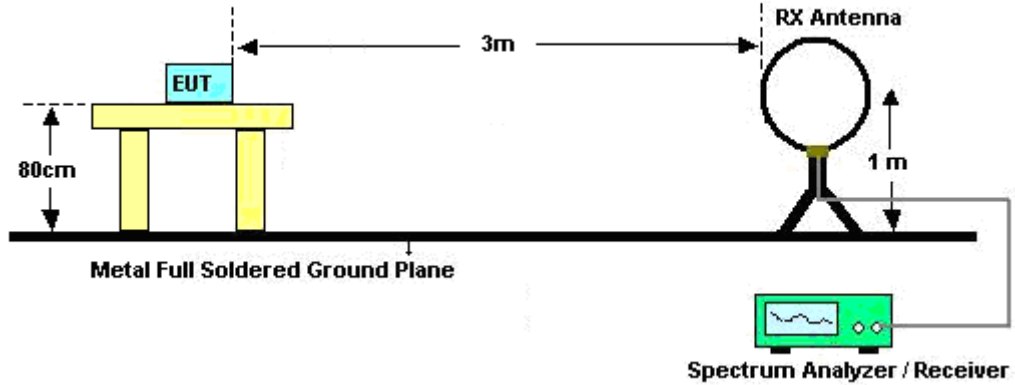

For radiated emissions from 30MHz to 1GHz

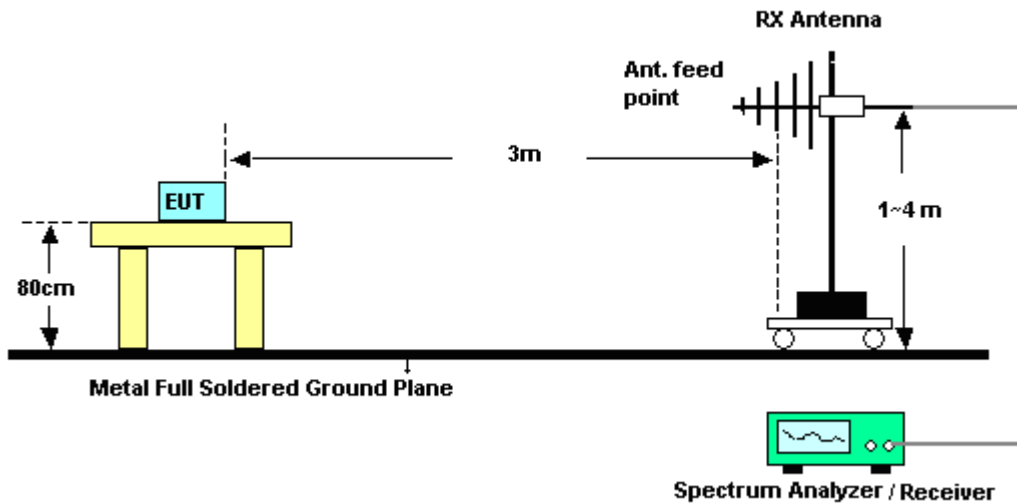

For radiated emissions above 1GHz

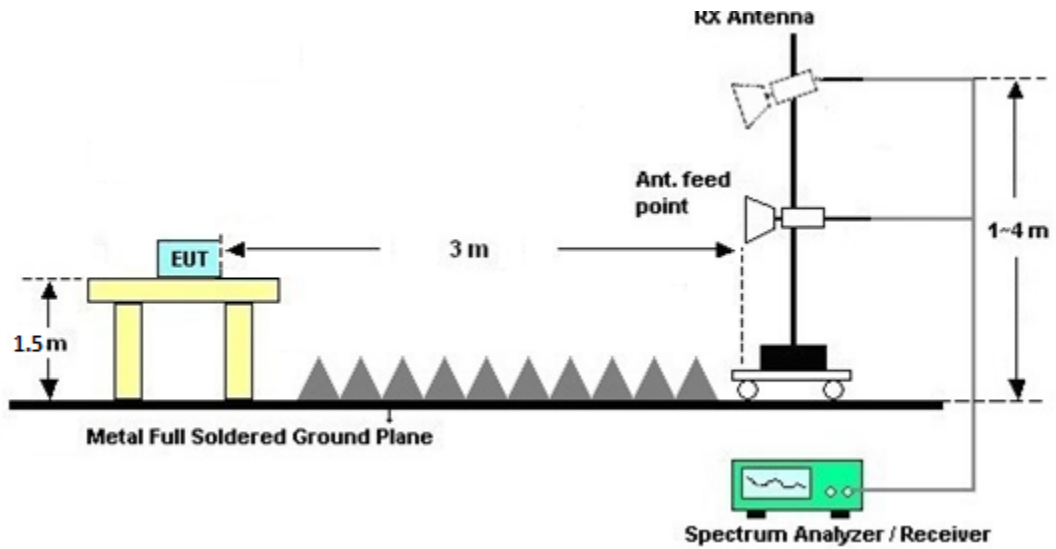

3.5.5 Test Results of Radiated Spurious Emissions (9 kHz ~ 30 MHz)

The low frequency, which started from 9 kHz to 30MHz, was pre-scanned and the result which was 20dB lower than the limit line per 15.31(o) was not reported.



3.5.6 Test Result of Radiated Spurious at Band Edges

Please refer to Appendix A.

3.5.7 Test Result of Radiated Spurious Emission (30MHz ~ 10th Harmonic)

Please refer to Appendix A.



3.6 AC Conducted Emission Measurement

3.6.1 Limit of AC Conducted Emission

For equipment that is designed to be connected to the public utility (AC) power line, the radio frequency voltage that is conducted back onto the AC power line on any frequency or frequencies within the band 150 kHz to 30 MHz shall not exceed the limits in the following table.

Frequency of emission (MHz)	Conducted limit (dBµV)	
	Quasi-peak	Average
0.15-0.5	66 to 56*	56 to 46*
0.5-5	56	46
5-30	60	50

*Decreases with the logarithm of the frequency.

3.6.2 Measuring Instruments

The section 4.0 of List of Measuring Equipment of this test report is used for test.

3.6.3 Test Procedures

1. The EUT was placed 0.4 meter from the conducting wall of the shielding room was kept at least 80 centimeters from any other grounded conducting surface.
2. Connect EUT to the power mains through a line impedance stabilization network (LISN).
3. All the support units are connecting to the other LISN.
4. The LISN provides 50 ohm coupling impedance for the measuring instrument.
5. The FCC states that a 50 ohm, 50 microhenry LISN should be used.
6. Both sides of AC line were checked for maximum conducted interference.
7. The frequency range from 150 kHz to 30 MHz was searched.
8. Set the test-receiver system to Peak Detect Function and specified bandwidth (IF Bandwidth = 9kHz) with Maximum Hold Mode. Then measurement is also conducted by Average Detector and Quasi-Peak Detector Function respectively.

3.6.4 Test Setup





3.6.5 Test Result of AC Conducted Emission

Test Mode :	Mode 1	Temperature :	22~24°C
Test Engineer :	Eko Guan	Relative Humidity :	30~32%
Test Voltage :	120Vac / 60Hz	Phase :	Line
Function Type :	GSM850 Idle + Bluetooth Link + WLAN Link + Earphone 1 + USB Cable 1 (Charging from Adapter 1) + Battery 1		

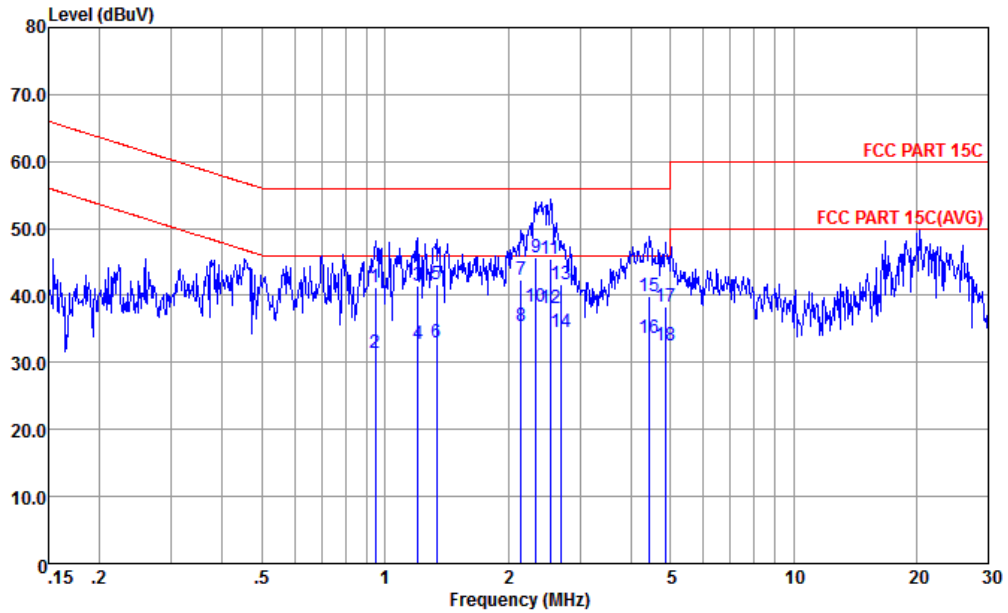

Site : CO01-KS
 Condition : FCC PART 15C LISN-L20140306 LINE

	Freq	Level	Over	Limit	Read	LISN	Cable	Remark
	MHz	dBuV	Limit	Line	Level	Factor	Loss	
			dB	dBuV	dBuV	dB	dB	
1	0.95	41.16	-14.84	56.00	30.40	0.11	10.65	QP
2	0.95	31.46	-14.54	46.00	20.70	0.11	10.65	Average
3	1.20	41.36	-14.64	56.00	30.60	0.10	10.66	QP
4	1.20	32.86	-13.14	46.00	22.10	0.10	10.66	Average
5	1.34	41.67	-14.33	56.00	30.90	0.10	10.67	QP
6	1.34	33.07	-12.93	46.00	22.30	0.10	10.67	Average
7	2.16	42.31	-13.69	56.00	31.50	0.10	10.71	QP
8	2.16	35.41	-10.59	46.00	24.60	0.10	10.71	Average
9	2.35	45.63	-10.37	56.00	34.80	0.11	10.72	QP
10 *	2.35	38.43	-7.57	46.00	27.60	0.11	10.72	Average
11	2.54	45.45	-10.55	56.00	34.60	0.12	10.73	QP
12	2.54	38.15	-7.85	46.00	27.30	0.12	10.73	Average
13	2.71	41.77	-14.23	56.00	30.90	0.12	10.75	QP
14	2.71	34.47	-11.53	46.00	23.60	0.12	10.75	Average
15	4.43	39.93	-16.07	56.00	28.90	0.19	10.84	QP
16	4.43	33.63	-12.37	46.00	22.60	0.19	10.84	Average
17	4.85	38.34	-17.66	56.00	27.29	0.20	10.85	QP
18	4.85	32.64	-13.36	46.00	21.59	0.20	10.85	Average



Test Mode :	Mode 1	Temperature :	22~24°C
Test Engineer :	Eko Guan	Relative Humidity :	30~32%
Test Voltage :	120Vac / 60Hz	Phase :	Neutral
Function Type :	GSM850 Idle + Bluetooth Link + WLAN Link + Earphone 1 + USB Cable 1 (Charging from Adapter 1) + Battery 1		

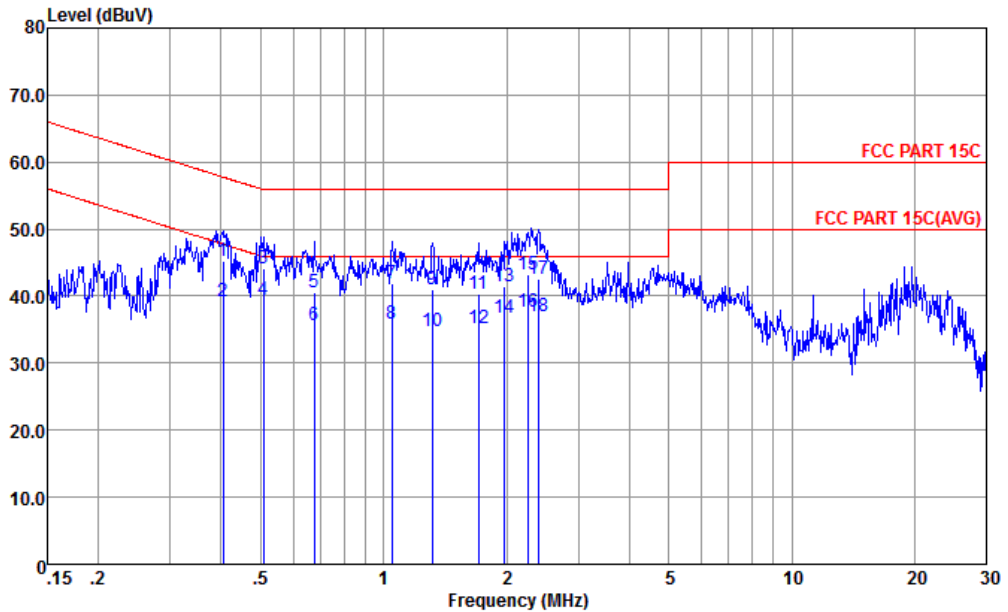

Site : CO01-KS
 Condition : FCC PART 15C LISN-N20140306 NEUTRAL

	Freq	Level	Over	Limit	Read	LISN	Cable	Remark
	MHz	dBuV	Limit	Line	Level	Factor	Loss	
			dB	dBuV	dBuV	dB	dB	
1	0.40	45.32	-12.45	57.77	34.30	0.40	10.62	QP
2	0.40	39.22	-8.55	47.77	28.20	0.40	10.62	Average
3	0.51	44.22	-11.78	56.00	33.30	0.30	10.62	QP
4 *	0.51	39.42	-6.58	46.00	28.50	0.30	10.62	Average
5	0.68	40.55	-15.45	56.00	29.70	0.21	10.64	QP
6	0.68	35.55	-10.45	46.00	24.70	0.21	10.64	Average
7	1.05	41.95	-14.05	56.00	31.20	0.10	10.65	QP
8	1.05	35.85	-10.15	46.00	25.10	0.10	10.65	Average
9	1.32	40.97	-15.03	56.00	30.20	0.10	10.67	QP
10	1.32	34.67	-11.33	46.00	23.90	0.10	10.67	Average
11	1.71	40.29	-15.71	56.00	29.50	0.10	10.69	QP
12	1.71	35.19	-10.81	46.00	24.40	0.10	10.69	Average
13	1.98	41.50	-14.50	56.00	30.70	0.10	10.70	QP
14	1.98	36.70	-9.30	46.00	25.90	0.10	10.70	Average
15	2.26	43.12	-12.88	56.00	32.30	0.11	10.71	QP
16	2.26	37.72	-8.28	46.00	26.90	0.11	10.71	Average
17	2.40	42.63	-13.37	56.00	31.80	0.11	10.72	QP
18	2.40	37.03	-8.97	46.00	26.20	0.11	10.72	Average



3.7 Antenna Requirements

3.7.1 Standard Applicable

If directional gain of transmitting antennas is greater than 6dBi, the power shall be reduced by the same level in dB comparing to gain minus 6dBi. The use of a permanently attached antenna or of an antenna that uses a unique coupling to the intentional radiator shall be considered sufficient to comply with the FCC rule.

3.7.2 Antenna Anti-Replacement Construction

An embedded-in antenna design is used.

3.7.3 Antenna Gain

The antenna peak gain of EUT is less than 6 dBi. Therefore, it is not necessary to reduce maximum peak output power limit.



4 List of Measuring Equipment

Instrument	Manufacturer	Model No.	Serial No.	Characteristics	Calibration Date	Test Date	Due Date	Remark
Spectrum Analyzer	R&S	FSP40	100319	9kHz~40GHz	Oct. 28, 2014	Jan. 22, 2015	Oct. 27, 2015	Conducted (TH01-KS)
Pulse Power Sensor	Anritsu	MA2411B	0917070	30MHz~40GHz	Feb. 27, 2014	Jan. 22, 2015	Feb. 26, 2015	Conducted (TH01-KS)
Power Meter	Anritsu	ML2495A	1005002	50MHz Bandwidth	Feb. 27, 2014	Jan. 22, 2015	Feb. 26, 2015	Conducted (TH01-KS)
EMI Test Receiver	R&S	ESCI	100534	9kHz~3GHz	Oct. 25, 2014	Feb. 17, 2015	Oct. 24, 2015	Radiation (03CH01-KS)
Spectrum Analyzer	R&S	FSP30	101399	9kHz~30GHz	May 04, 2014	Feb. 17, 2015	May 03, 2015	Radiation (03CH01-KS)
Loop Antenna	R&S	HFH2-Z2	100321	9kHz~30MHz	Nov. 13, 2014	Feb. 17, 2015	Nov. 12, 2015	Radiation (03CH01-KS)
Bilog Antenna	TeseQ	CBL6112D	23182	25Mhz-2Ghz	Jan. 17, 2015	Feb. 17, 2015	Jan. 16, 2016	Radiation (03CH01-KS)
Double Ridge Horn Antenna	ETS-Lindgren	3117	75959	1GHz~18GHz	Jan. 17, 2015	Feb. 17, 2015	Jan. 16, 2016	Radiation (03CH01-KS)
Active Horn Antenna	com-power	AHA-118	701030	1GHz~18GHz	Nov. 08, 2014	Feb. 17, 2015	Nov. 07, 2015	Radiation (03CH01-KS)
SHF-EHF Horn	Schwarzbeck	BBHA 9170	BBHA170249	15GHz~40GHz	Mar. 10, 2014	Feb. 17, 2015	Mar. 09, 2015	Radiation (03CH01-KS)
Amplifier	com-power	PA-103A	161069	1MHz~1GHz /32dB	May 04, 2014	Feb. 17, 2015	May 03, 2015	Radiation (03CH01-KS)
Amplifier	Agilent	8449B	3008A02371	1GHz~26.5GHz	Oct. 28, 2014	Feb. 17, 2015	Oct. 27, 2015	Radiation (03CH01-KS)
AC Power Source	Chroma	61601	F104090004	N/A	NCR	Feb. 17, 2015	NCR	Radiation (03CH01-KS)
Turn Table	MF	MF7802	N/A	0~360 degree	NCR	Feb. 17, 2015	NCR	Radiation (03CH01-KS)
Antenna Mast	MF	MF7802	N/A	1 m~4 m	NCR	Feb. 17, 2015	NCR	Radiation (03CH01-KS)
EMI Receiver	R&S	ESCI7	100768	9kHz~7GHz;	May 04, 2014	Feb. 09, 2015	May 03, 2015	Conduction (CO01-KS)
AC LISN	MessTec	AN3016	060103	9kHz~30MHz	Oct. 25, 2014	Feb. 09, 2015	Oct. 24, 2015	Conduction (CO01-KS)
AC LISN (for auxiliary equipment)	MessTec	AN3016	060105	9kHz~30MHz	Oct. 25, 2014	Feb. 09, 2015	Oct. 24, 2015	Conduction (CO01-KS)
AC Power Source	Chroma	61602	ABP00000811	AC 0V~300V, 45Hz~1000Hz	Oct. 25, 2014	Feb. 09, 2015	Oct. 24, 2015	Conduction (CO01-KS)



5 Uncertainty of Evaluation

Uncertainty of Conducted Emission Measurement (150 kHz ~ 30 MHz)

Measuring Uncertainty for a Level of Confidence of 95% ($U = 2Uc(y)$)	2.3dB
---	-------

Uncertainty of Radiated Emission Measurement (30 MHz ~ 1000 MHz)

Measuring Uncertainty for a Level of Confidence of 95% ($U = 2Uc(y)$)	2.5dB
---	-------



Appendix A. Radiated Spurious Emission

15C 2.4GHz 2400~2483.5MHz

BLE (Band Edge @ 3m)

BLE	Note	Frequency	Level	Over	Limit	Read	Antenna	Cable	Preamp	Ant	Table	Peak	Pol.
				Limit	Line	Level	Factor	Loss	Factor	Pos	Pos	Avg.	
		(MHz)	(dB μ V/m)	(dB)	(dB μ V/m)	(dB μ V)	(dB/m)	(dB)	(dB)	(cm)	(deg)	(P/A)	(H/V)
BLE CH 00 2402MHz	*	2402.087	83.12	-	-	81.68	31.3	6.22	36.08	269	0	P	H
	*	2402.004	82.4	-	-	80.96	31.3	6.22	36.08	269	0	A	H
		2357.52	49.37	-24.63	74	48.24	31.26	6.12	36.25	269	0	P	H
		2385.33	36.96	-17.04	54	35.67	31.28	6.17	36.16	269	0	A	H
	*	2401.92	79.63	-	-	78.19	31.3	6.22	36.08	276	125	P	V
	*	2401.92	76.78	-	-	75.34	31.3	6.22	36.08	276	125	A	V
		2320.71	48.79	-25.21	74	47.87	31.23	6.12	36.43	276	125	P	V
		2387.4	36.95	-17.05	54	35.56	31.3	6.17	36.08	276	125	A	V
BLE CH 19 2440MHz	*	2439.997	85.74	-	-	81.03	31.34	9.28	35.91	233	349	P	H
	*	2439.997	84.8	-	-	80.09	31.34	9.28	35.91	233	349	A	H
	*	2439.997	79.92	-	-	75.21	31.34	9.28	35.91	150	277	P	V
	*	2439.913	80.5	-	-	75.79	31.34	9.28	35.91	150	277	A	V



BLE CH 39 2480MHz	*	2479.993	84.46	-	-	79.55	31.37	9.33	35.79	249	0	P	H
	*	2480.076	83.57	-	-	78.66	31.37	9.33	35.79	249	0	A	H
		2489.76	52.37	-21.63	74	47.39	31.39	9.33	35.74	249	0	P	H
		2483.52	41.25	-12.75	54	36.34	31.37	9.33	35.79	249	0	A	H
	*	2480.076	77.42	-	-	72.51	31.37	9.33	35.79	261	248	P	V
	*	2480.076	76.44	-	-	71.53	31.37	9.33	35.79	261	248	A	V
		2483.72	52.36	-21.64	74	47.45	31.37	9.33	35.79	261	248	P	V
		2483.6	39.87	-14.13	54	34.96	31.37	9.33	35.79	261	248	A	V
Remark	1. No other spurious found. 2. All results are PASS against Peak and Average limit line.												



15C 2.4GHz 2400~2483.5MHz
BLE (Harmonic @ 3m)

BLE	Note	Frequency	Level	Over	Limit	Read	Antenna	Cable	Preamp	Ant	Table	Peak	Pol.
		(MHz)	(dBμV/m)	(dB)	(dBμV/m)	(dBμV)	(dB/m)	(dB)	(dB)	(cm)	(deg)	(P/A)	(H/V)
BLE CH 00 2402MHz		4803	50.51	-23.49	74	43.51	34.88	8.71	36.59	168	260	P	H
		4803	51.15	-22.85	74	44.15	34.88	8.71	36.59	239	216	P	V
BLE CH 19 2440MHz		4881	46.51	-27.49	74	39.67	34.92	8.76	36.84	168	261	P	H
		7320	46.45	-27.55	74	38.96	35.57	10.84	38.92	198	26	P	H
		4881	47.9	-26.1	74	41.06	34.92	8.76	36.84	169	147	P	V
		7320	47.07	-26.93	74	39.58	35.57	10.84	38.92	150	0	P	V
BLE CH 39 2480MHz		4959	46.35	-27.65	74	39.72	34.97	8.81	37.15	188	230	P	H
		7440	46.52	-27.48	74	38.92	35.59	10.92	38.91	200	0	P	H
		4959	47.97	-26.03	74	41.34	34.97	8.81	37.15	265	103	P	V
		7440	49.36	-24.64	74	41.76	35.59	10.92	38.91	197	230	P	V
Remark	1. No other spurious found. 2. All results are PASS against Peak and Average limit line.												



15C Emission below 1GHz

2.4GHz BLE (LF)

BLE	Note	Frequency	Level	Over	Limit	Read	Antenna	Cable	Preamp	Ant	Table	Peak	Pol.
				Limit	Line	Level	Factor	Loss	Factor	Pos	Pos	Avg.	
		(MHz)	(dBμV/m)	(dB)	(dBμV/m)	(dBμV)	(dB/m)	(dB)	(dB)	(cm)	(deg)	(P/A)	(H/V)
2.4GHz BLE LF		57.16	27	-13	40	51.93	6.88	0.79	32.6	120	14	P	H
		95.96	20.49	-23.01	43.5	41.19	10.86	1.04	32.6	-	-	P	H
		156.1	21.66	-21.84	43.5	41.3	11.48	1.44	32.56	-	-	P	H
		191.99	23.03	-20.47	43.5	43.79	10.1	1.61	32.47	-	-	P	H
		422.85	23.25	-22.75	46	36.35	16.87	2.28	32.25	-	-	P	H
		691.54	30.08	-15.92	46	39.05	19.9	3.05	31.92	-	-	P	H
		31.94	19.69	-20.31	40	33.33	18.22	0.79	32.65	-	-	P	V
		53.28	20.87	-19.13	40	44.77	7.92	0.79	32.61	124	78	P	V
		156.1	17.68	-25.82	43.5	37.32	11.48	1.44	32.56	-	-	P	V
		191.99	19.63	-23.87	43.5	40.39	10.1	1.61	32.47	-	-	P	V
		422.85	22.85	-23.15	46	35.95	16.87	2.28	32.25	-	-	P	V
		691.54	25.66	-20.34	46	34.63	19.9	3.05	31.92	-	-	P	V
Remark	1. No other spurious found. 2. All results are PASS against limit line.												



Note symbol

*	Fundamental Frequency which can be ignored. However, the level of any unwanted emissions shall not exceed the level of the fundamental frequency per 15.209(c).
!	Test result is over limit line.
P/A	Peak or Average
H/V	Horizontal or Vertical



A calculation example for radiated spurious emission is shown as below:

WIFI	Note	Frequency	Level	Over	Limit	Read	Antenna	Cable	Preamp	Ant	Table	Peak	Pol.
		(MHz)	(dBμV/m)	(dB)	Limit Line	Level	Factor	Loss	Factor	Pos	Pos	Avg.	
					(dBμV/m)	(dBμV)	(dB/m)	(dB)	(dB)	(cm)	(deg)	(P/A)	(H/V)
802.11b		2390	55.45	-18.55	74	54.51	32.22	4.58	35.86	103	308	P	H
CH 01		2390	43.54	-10.46	54	42.6	32.22	4.58	35.86	103	308	A	H
2412MHz													

- Level(dBμV/m) =
Antenna Factor(dB/m) + Cable Loss(dB) + Read Level(dBμV) - Preamp Factor(dB)
- Over Limit(dB) = Level(dBμV/m) – Limit Line(dBμV/m)

For Peak Limit @ 2390MHz:

- Level(dBμV/m)
= Antenna Factor(dB/m) + Cable Loss(dB) + Read Level(dBμV) - Preamp Factor(dB)
= 32.22(dB/m) + 4.58(dB) + 54.51(dBμV) – 35.86 (dB)
= 55.45 (dBμV/m)
- Over Limit(dB)
= Level(dBμV/m) – Limit Line(dBμV/m)
= 55.45(dBμV/m) – 74(dBμV/m)
= -18.55(dB)

For Average Limit @ 2390MHz:

- Level(dBμV/m)
= Antenna Factor(dB/m) + Cable Loss(dB) + Read Level(dBμV) - Preamp Factor(dB)
= 32.22(dB/m) + 4.58(dB) + 42.6(dBμV) – 35.86 (dB)
= 43.54 (dBμV/m)
- Over Limit(dB)
= Level(dBμV/m) – Limit Line(dBμV/m)
= 43.54(dBμV/m) – 54(dBμV/m)
= -10.46(dB)

Both peak and average measured complies with the limit line, so test result is “PASS”.