

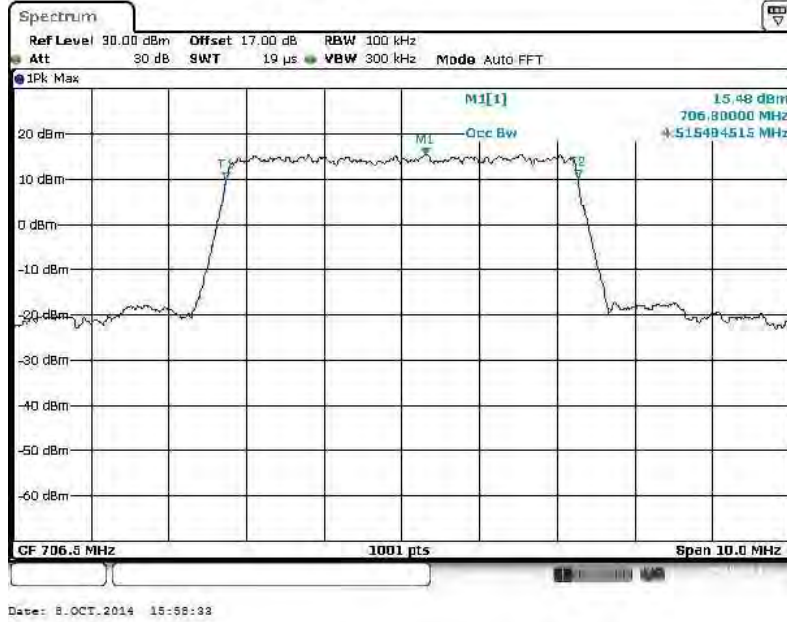

<b>Band :</b>	LTE Band 17	<b>BW / Mod. :</b>	5MHz / QPSK
---------------	-------------	--------------------	-------------

99% Occupied Bandwidth Plot on Channel 23755



26dB Bandwidth Plot on Channel 23755

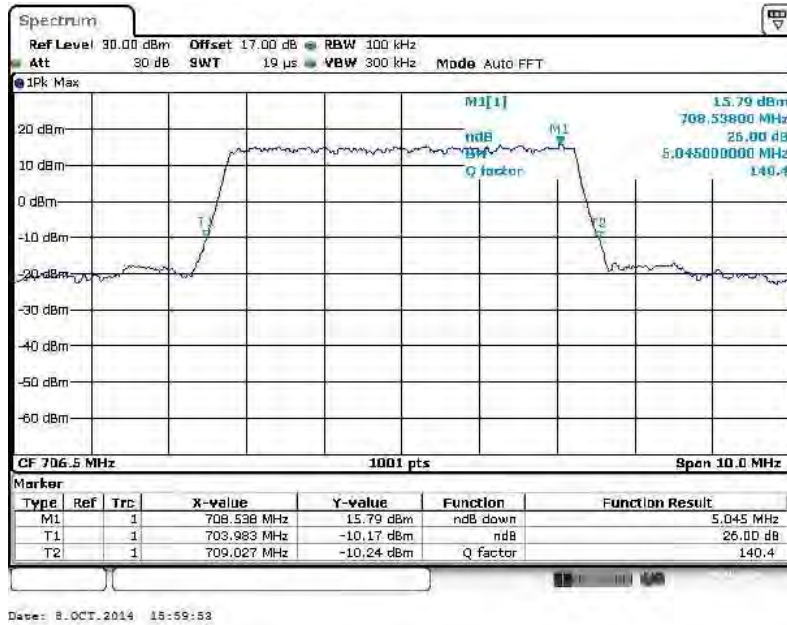



99% Occupied Bandwidth Plot on Channel 23790

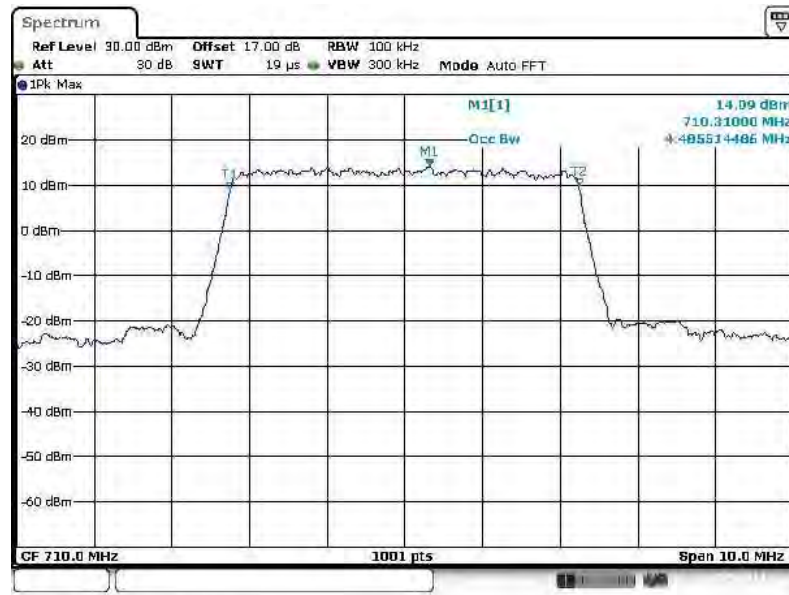

Date: 29.AUG.2014 19:04:02

26dB Bandwidth Plot on Channel 23790

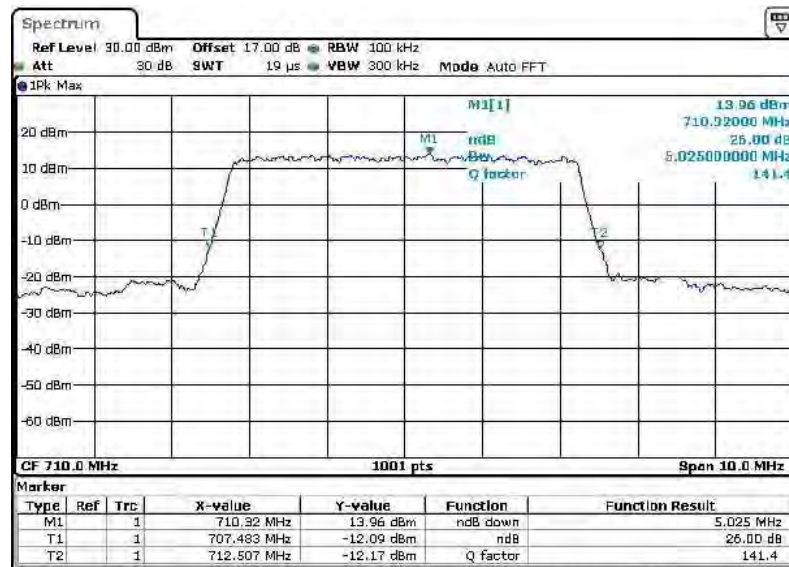

Date: 29.AUG.2014 19:15:42



99% Occupied Bandwidth Plot on Channel 23825

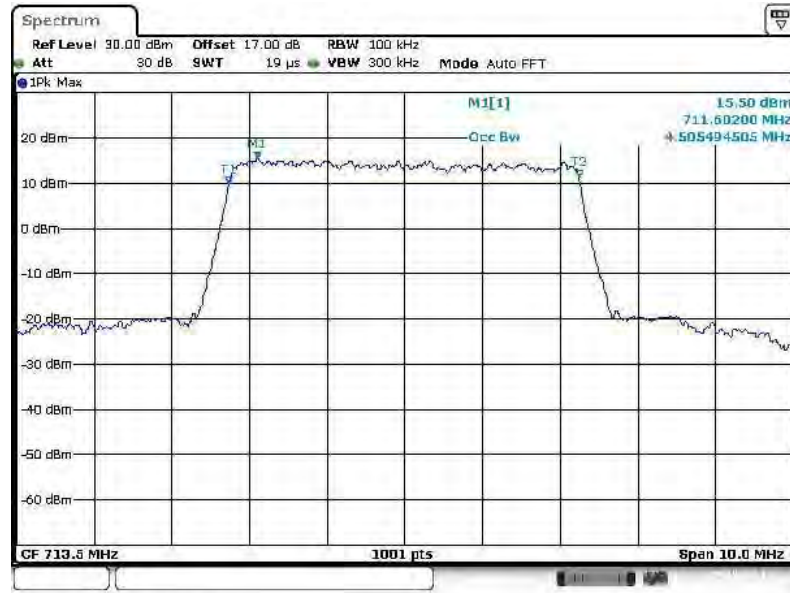

Date: 8.OCT.2014 15:52:26

26dB Bandwidth Plot on Channel 23825

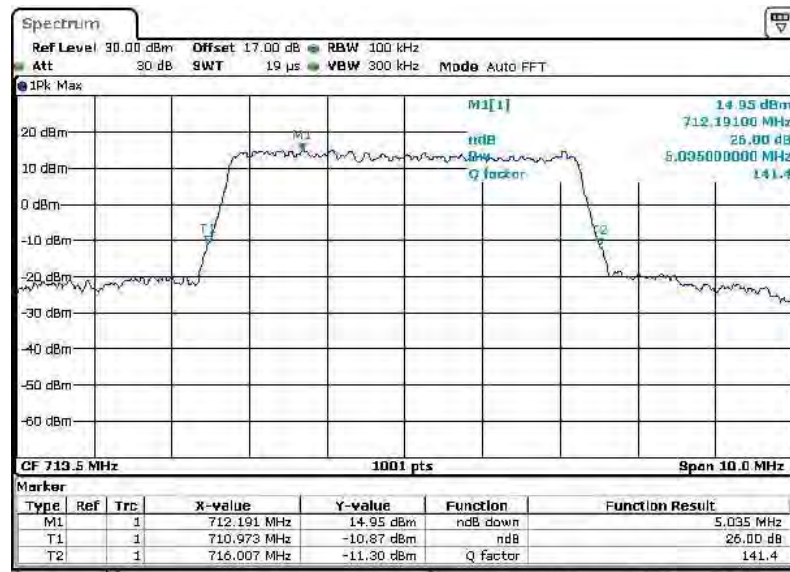

Date: 8.OCT.2014 15:54:21



<b>Band :</b>	LTE Band 17	<b>BW / Mod. :</b>	5MHz / 16QAM
---------------	-------------	--------------------	--------------

99% Occupied Bandwidth Plot on Channel 23755

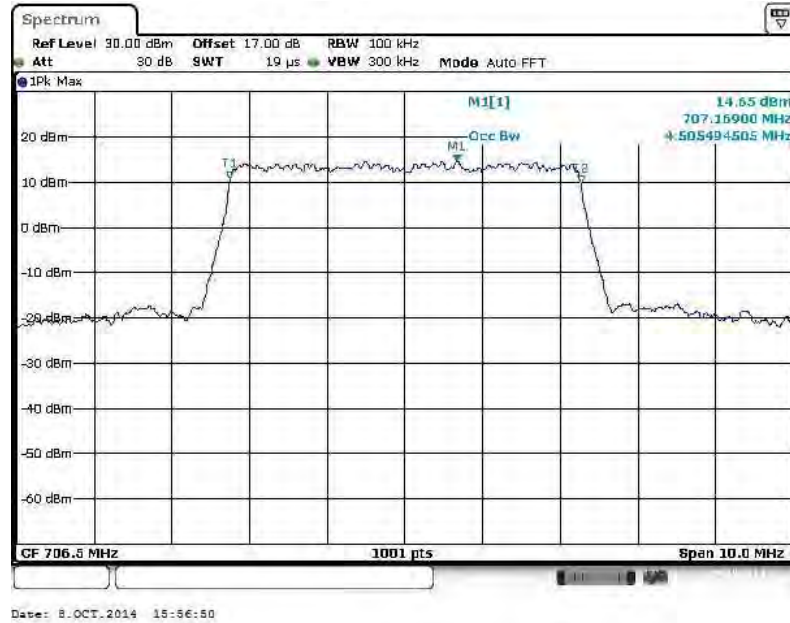

26dB Bandwidth Plot on Channel 23755

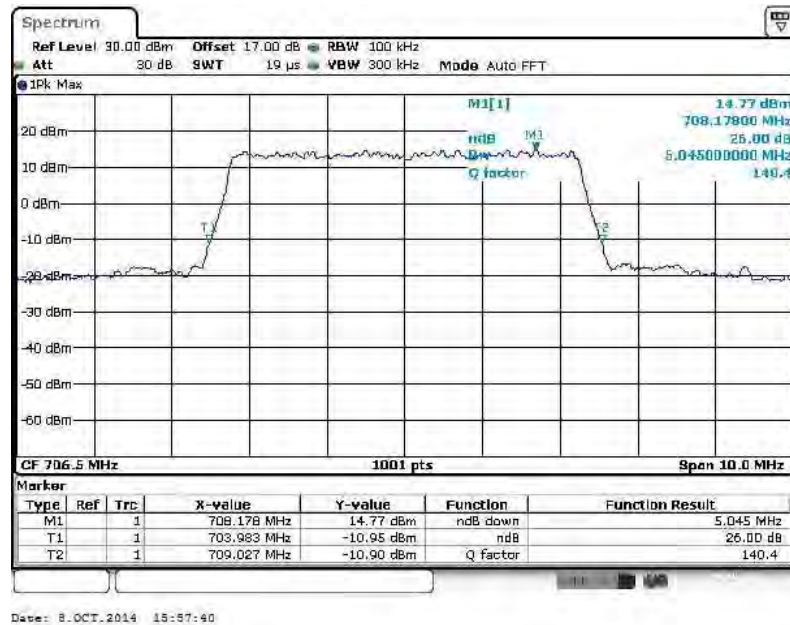



99% Occupied Bandwidth Plot on Channel 23790

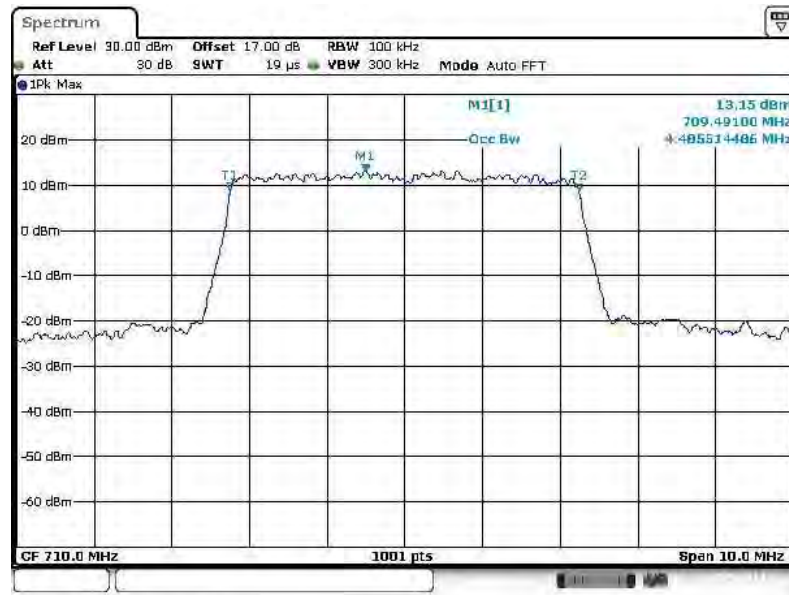

Date: 29.AUG.2014 19:07:59

26dB Bandwidth Plot on Channel 23790

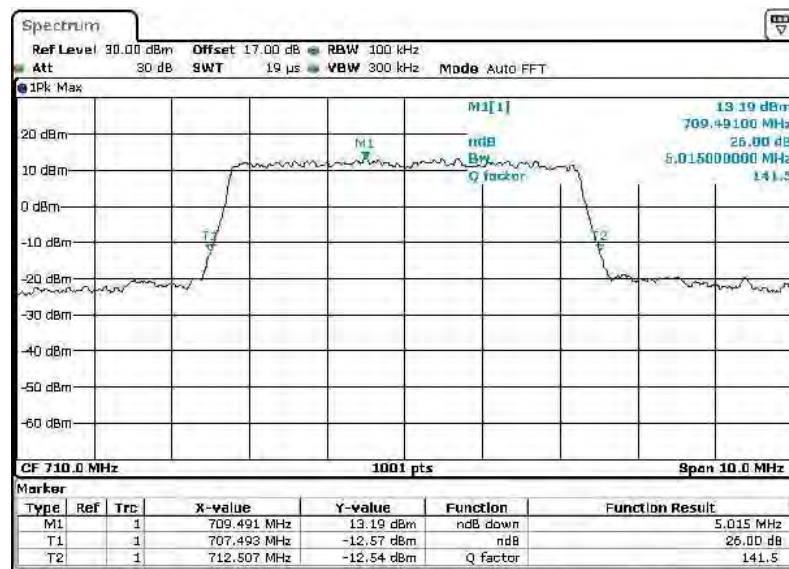

Date: 29.AUG.2014 19:18:27





99% Occupied Bandwidth Plot on Channel 23825

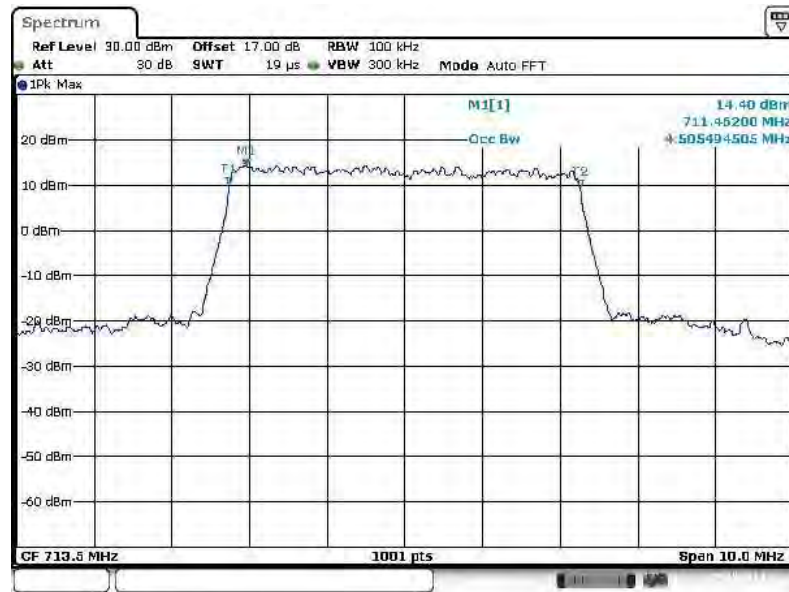

Date: 8.OCT.2014 15:56:05

26dB Bandwidth Plot on Channel 23825

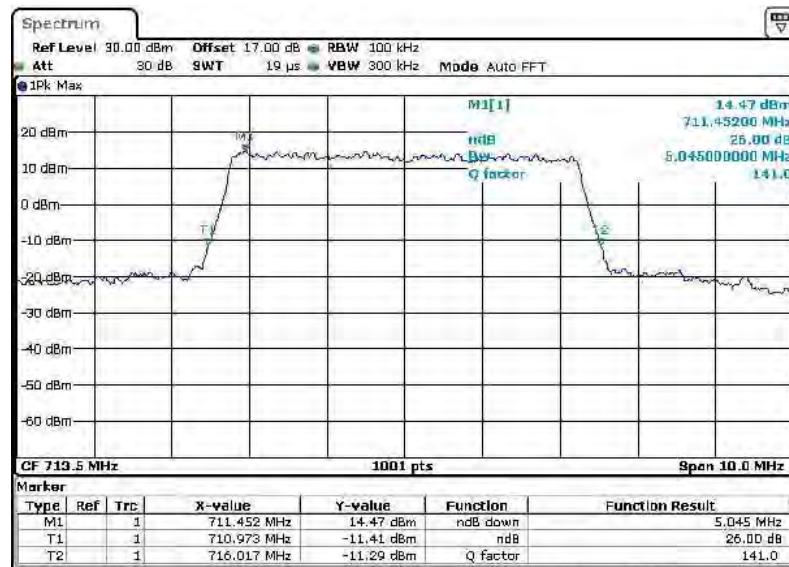

Date: 8.OCT.2014 15:55:16



<b>Band :</b>	LTE Band 17	<b>BW / Mod. :</b>	10MHz / QPSK
---------------	-------------	--------------------	--------------

99% Occupied Bandwidth Plot on Channel 23780

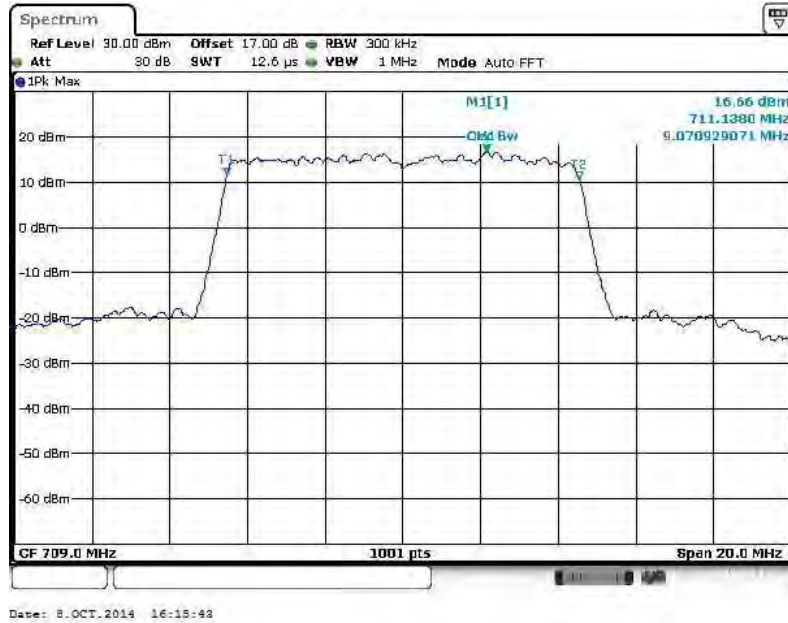

26dB Bandwidth Plot on Channel 23780

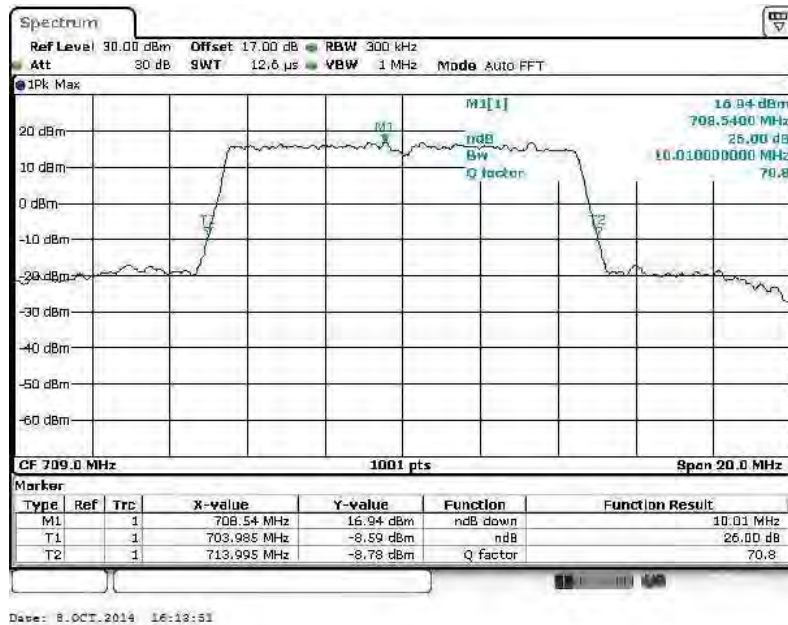



99% Occupied Bandwidth Plot on Channel 23790

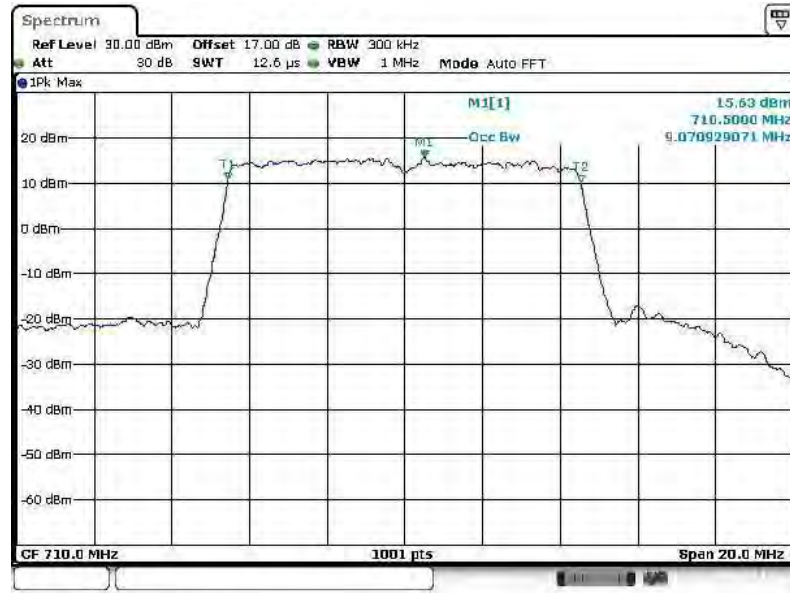

Date: 29.AUG.2014 19:06:40

26dB Bandwidth Plot on Channel 23790

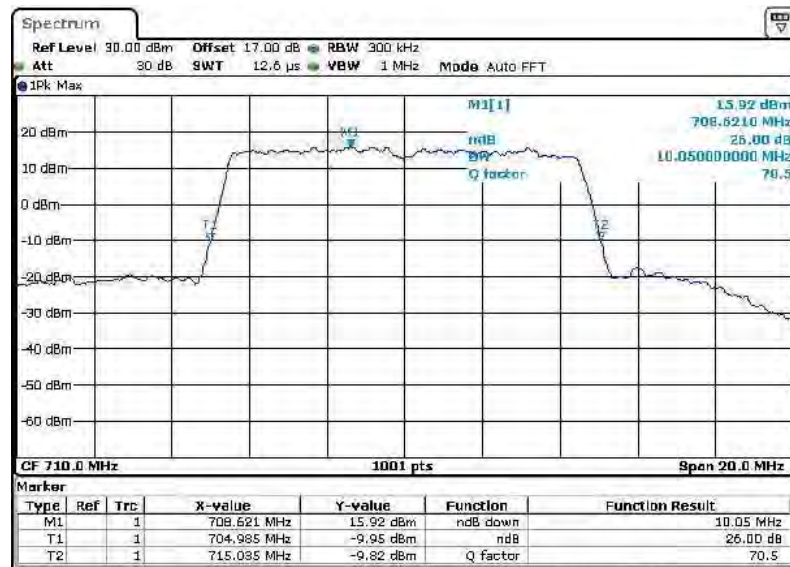

Date: 29.AUG.2014 19:17:32





99% Occupied Bandwidth Plot on Channel 23800

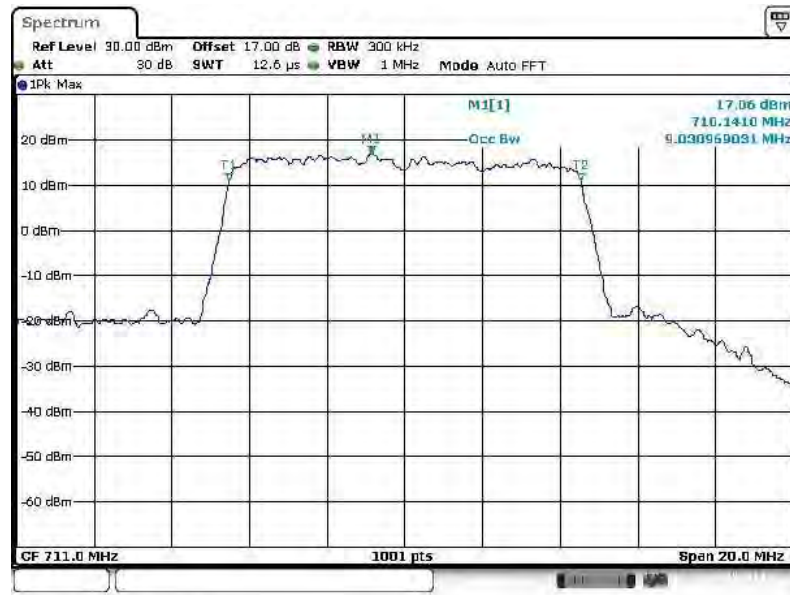

Date: 8.OCT.2014 16:05:43

26dB Bandwidth Plot on Channel 23800

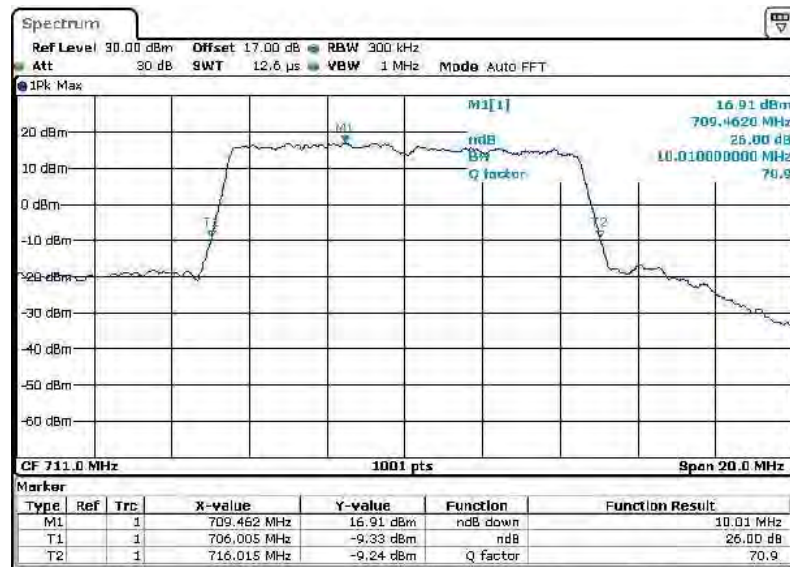

Date: 8.OCT.2014 16:05:29



<b>Band :</b>	LTE Band 17	<b>BW / Mod. :</b>	10MHz / 16QAM
---------------	-------------	--------------------	---------------

99% Occupied Bandwidth Plot on Channel 23780

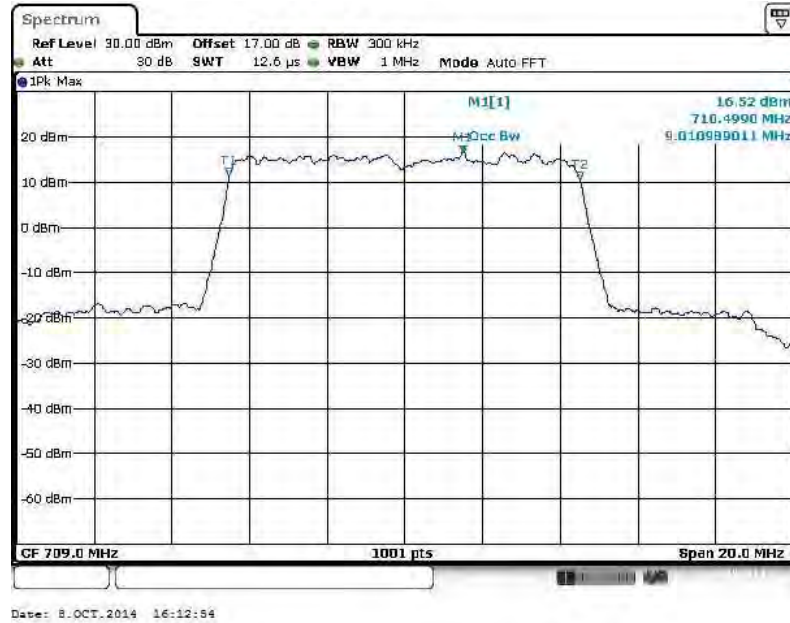

26dB Bandwidth Plot on Channel 23780

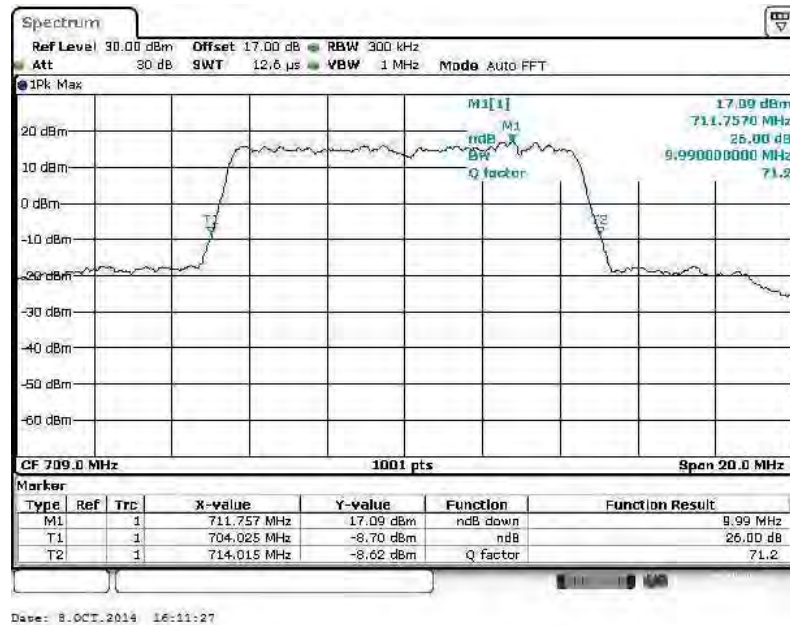



99% Occupied Bandwidth Plot on Channel 23790

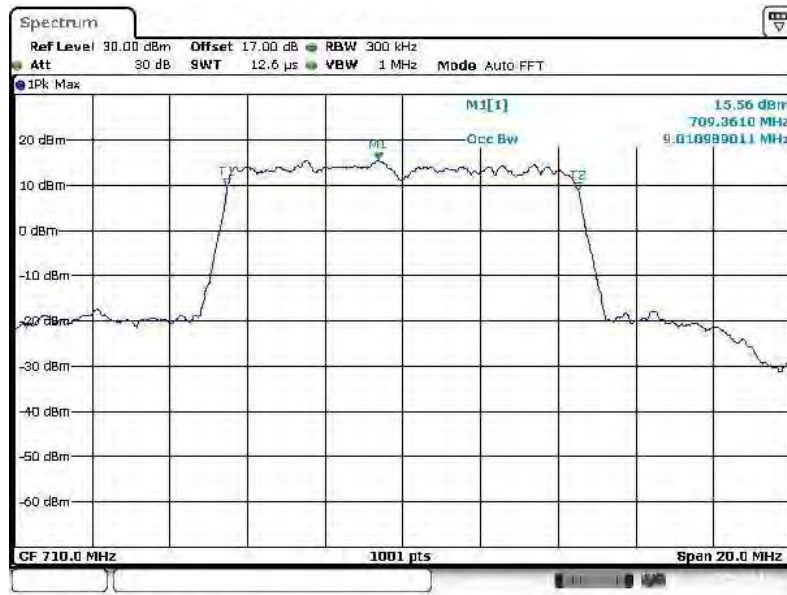

Date: 29.AUG.2014 19:11:08

26dB Bandwidth Plot on Channel 23790

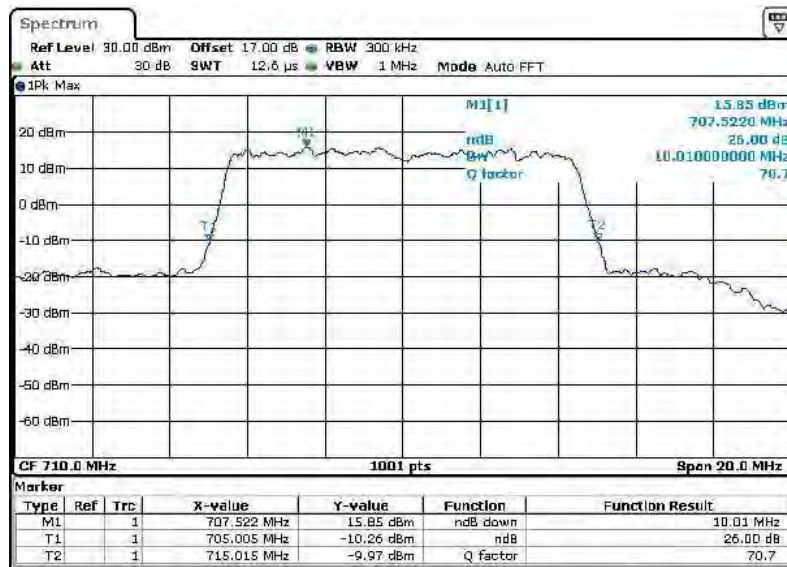

Date: 29.AUG.2014 19:20:36



99% Occupied Bandwidth Plot on Channel 23800

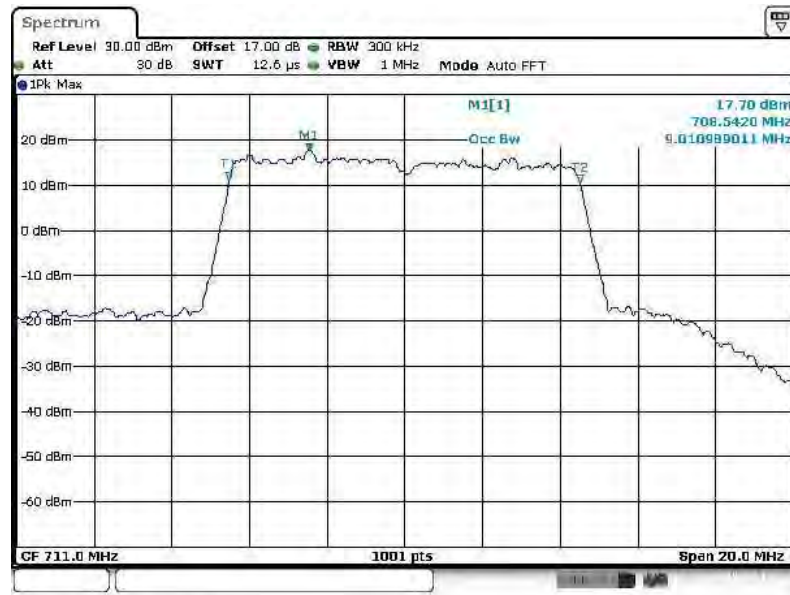

Date: 8.OCT.2014 16:09:37

26dB Bandwidth Plot on Channel 23800

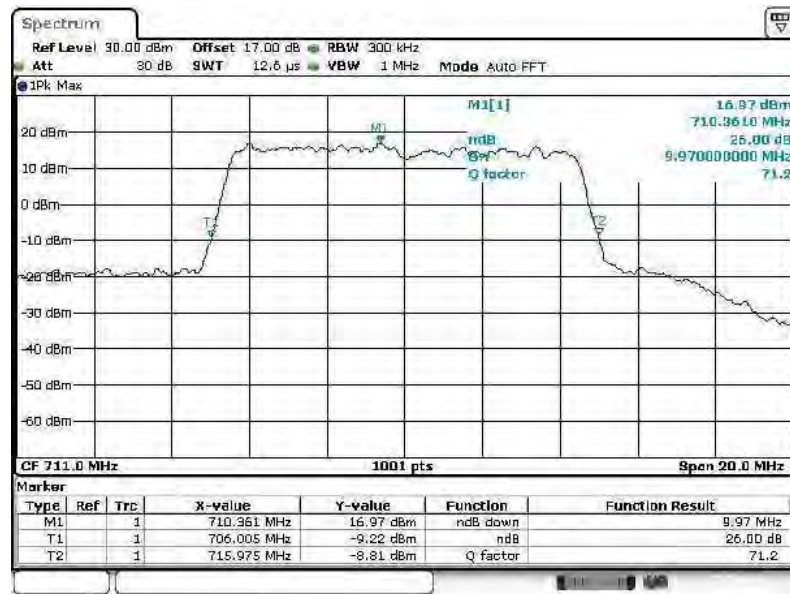

Date: 8.OCT.2014 16:10:33



Band :	LTE Band 7	BW / Mod. :	5MHz / QPSK
--------	------------	-------------	-------------

99% Occupied Bandwidth Plot on Channel 20775

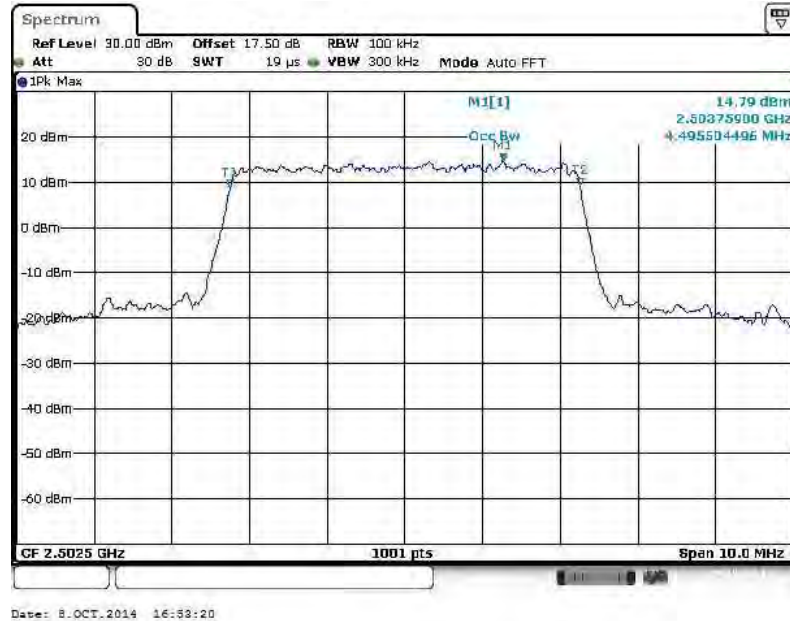

26dB Bandwidth Plot on Channel 20775

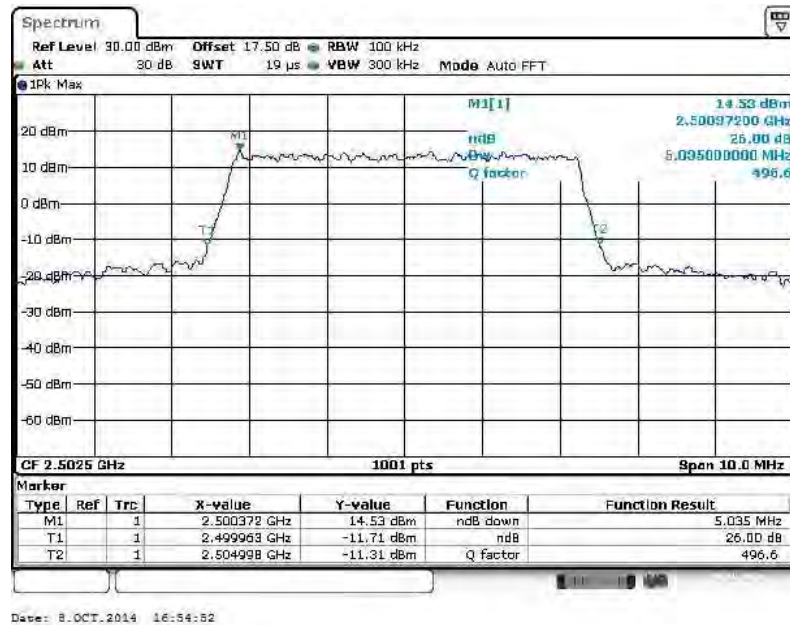





99% Occupied Bandwidth Plot on Channel 21100

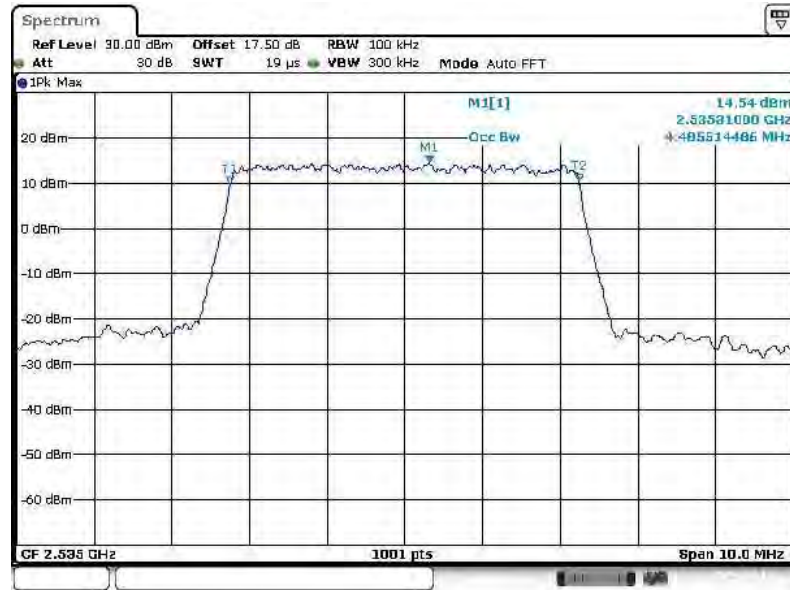

Date: 29.AUG.2014 16:49:18

26dB Bandwidth Plot on Channel 21100

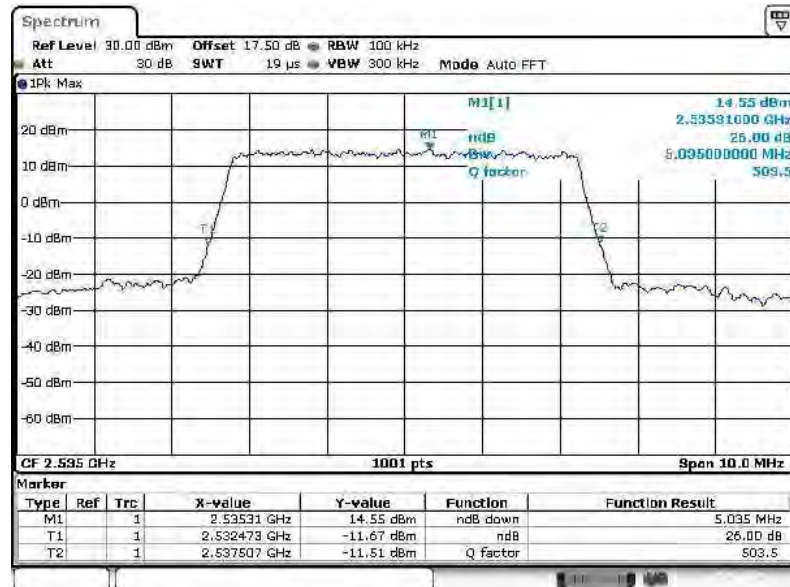

Date: 29.AUG.2014 16:50:02



99% Occupied Bandwidth Plot on Channel 21425

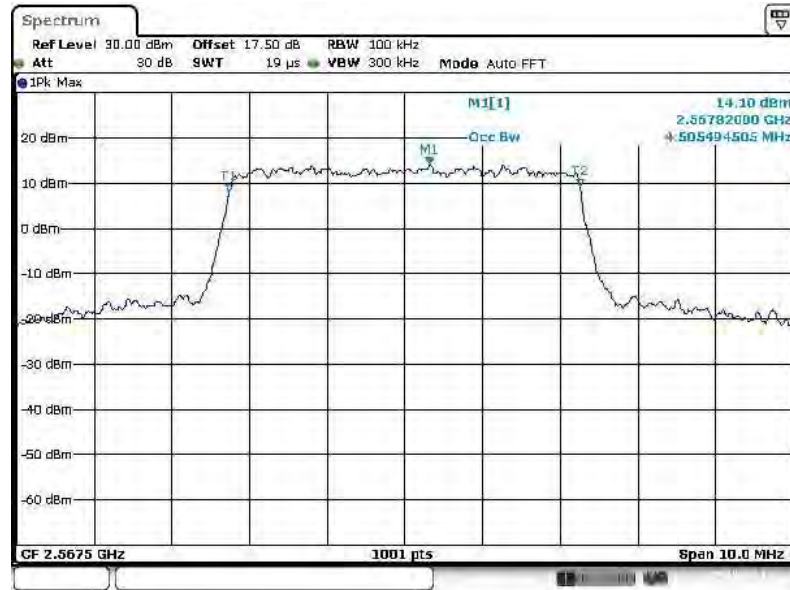

Date: 8.OCT.2014 16:38:16

26dB Bandwidth Plot on Channel 21425

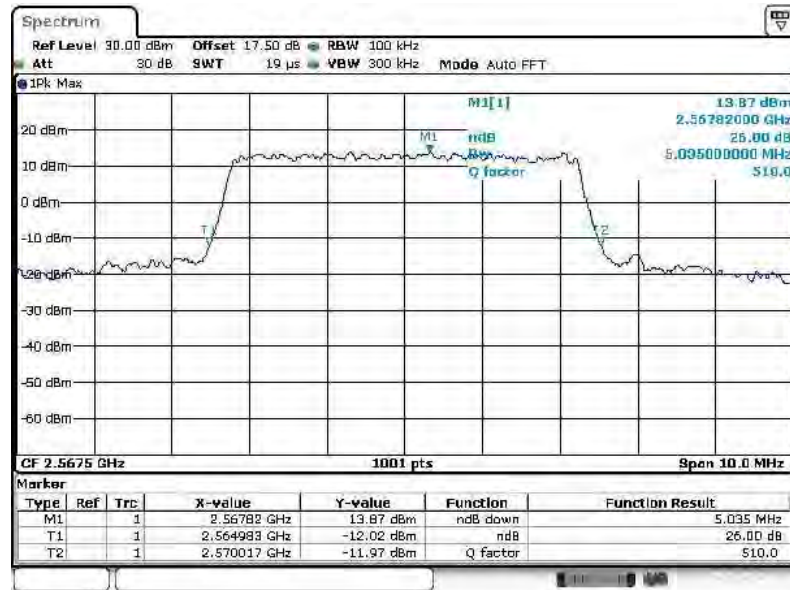

Date: 8.OCT.2014 16:38:00



<b>Band :</b>	LTE Band 7	<b>BW / Mod. :</b>	5MHz / 16QAM
---------------	------------	--------------------	--------------

99% Occupied Bandwidth Plot on Channel 20775

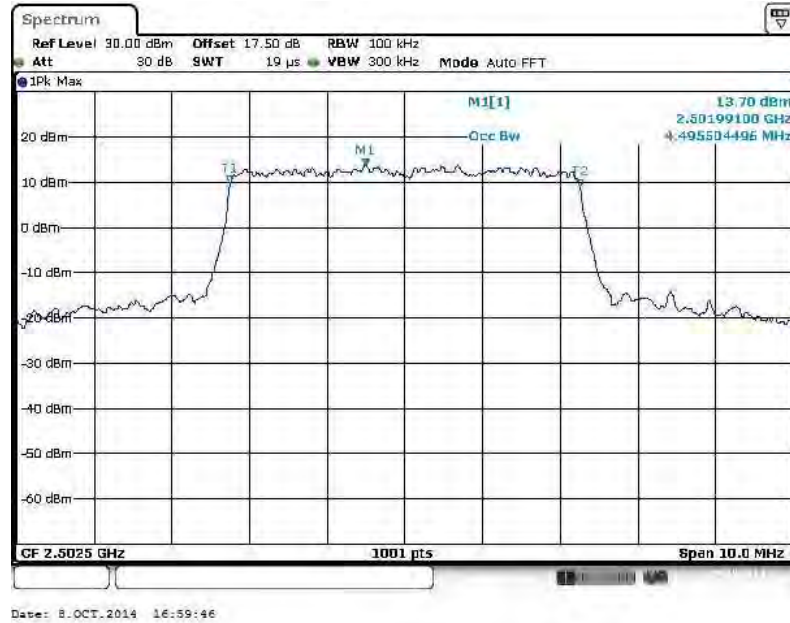

26dB Bandwidth Plot on Channel 20775

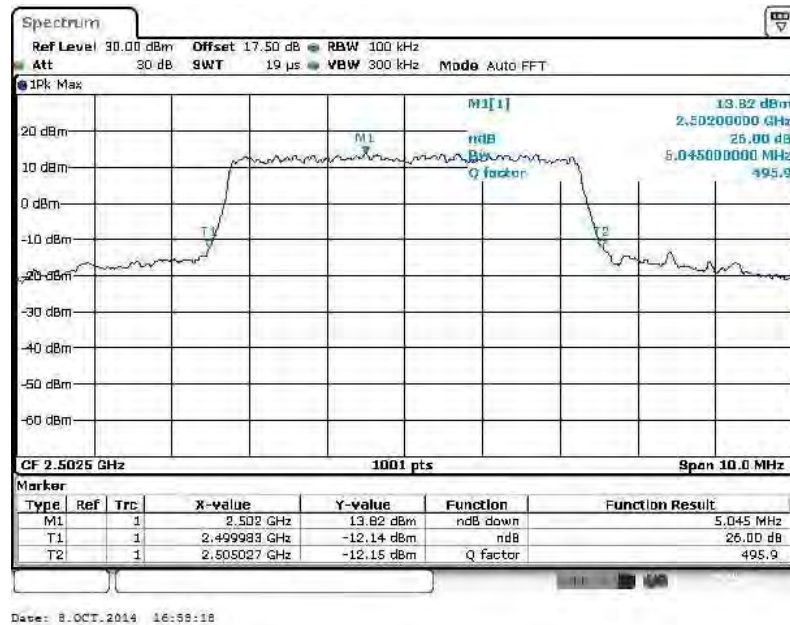



99% Occupied Bandwidth Plot on Channel 21100

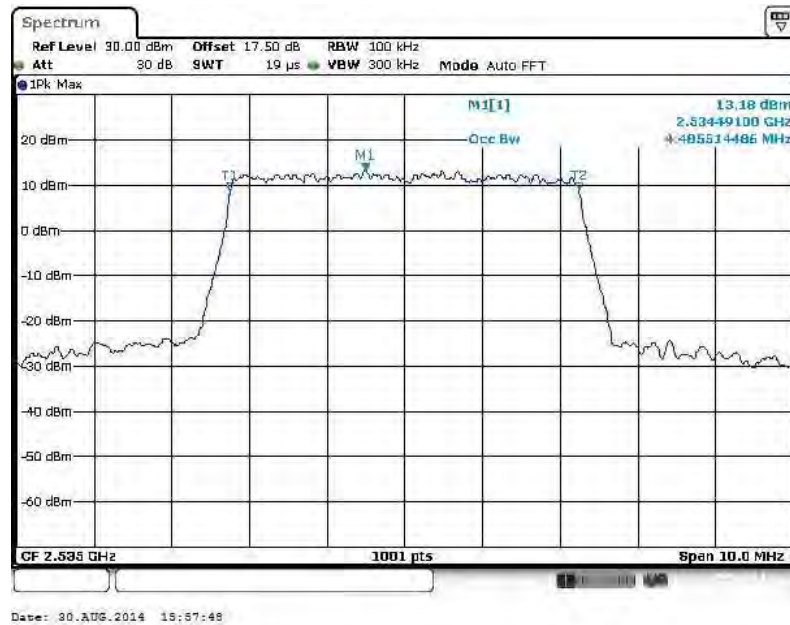

26dB Bandwidth Plot on Channel 21100

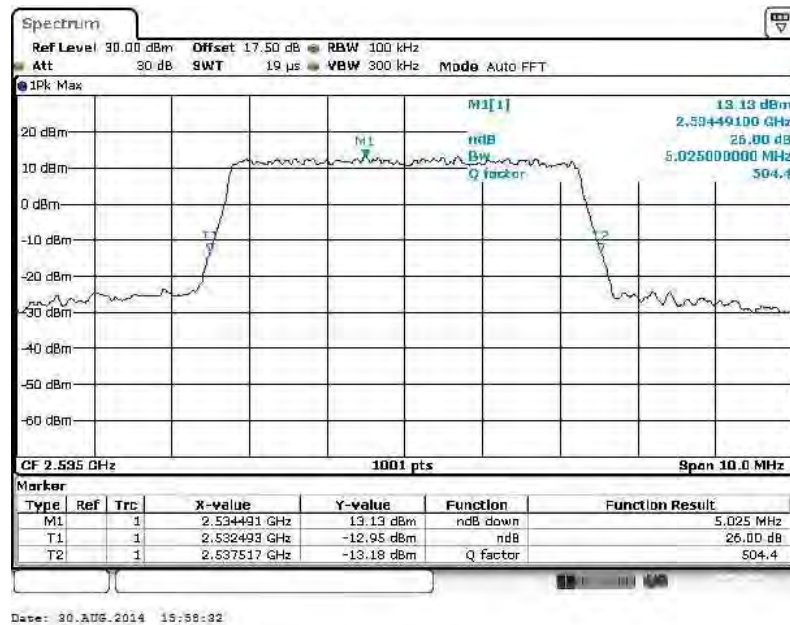



99% Occupied Bandwidth Plot on Channel 21425

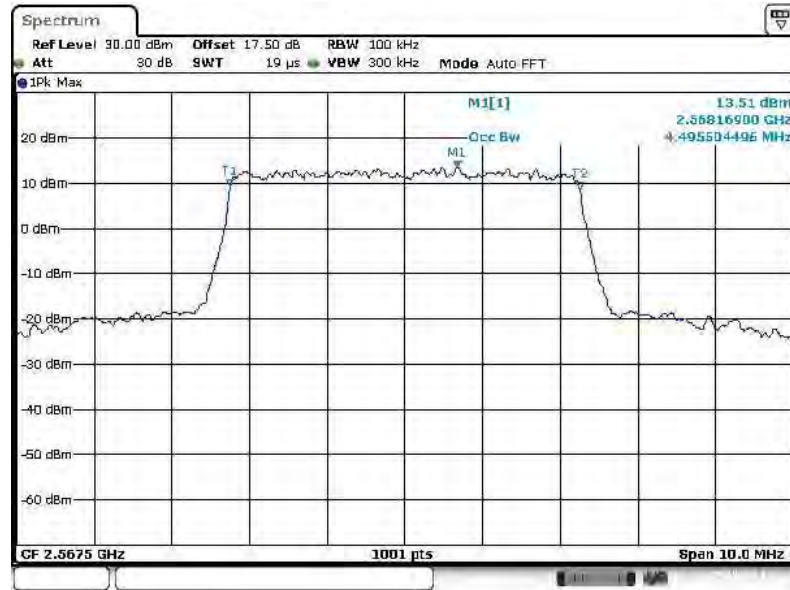

Date: 8.OCT.2014 16:27:28

26dB Bandwidth Plot on Channel 21425

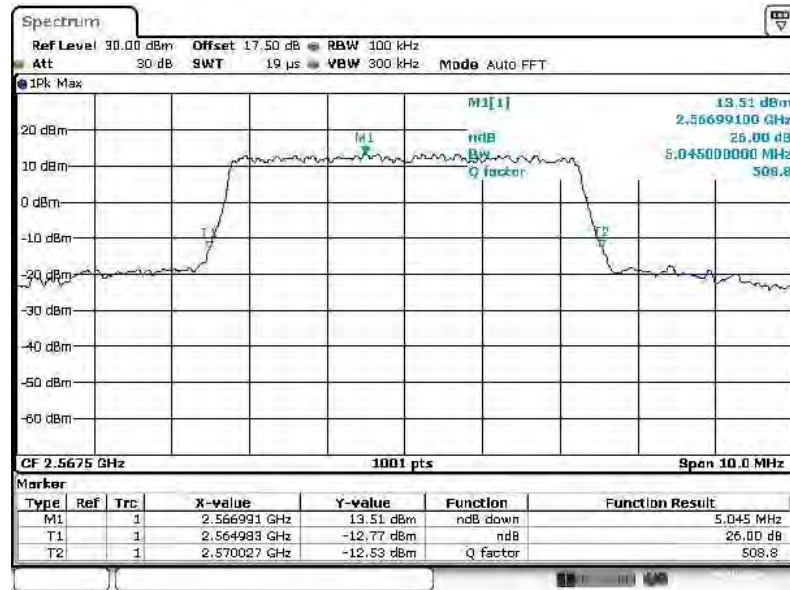

Date: 8.OCT.2014 16:31:52





Band :	LTE Band 7	BW / Mod. :	10MHz / QPSK
--------	------------	-------------	--------------

99% Occupied Bandwidth Plot on Channel 20800

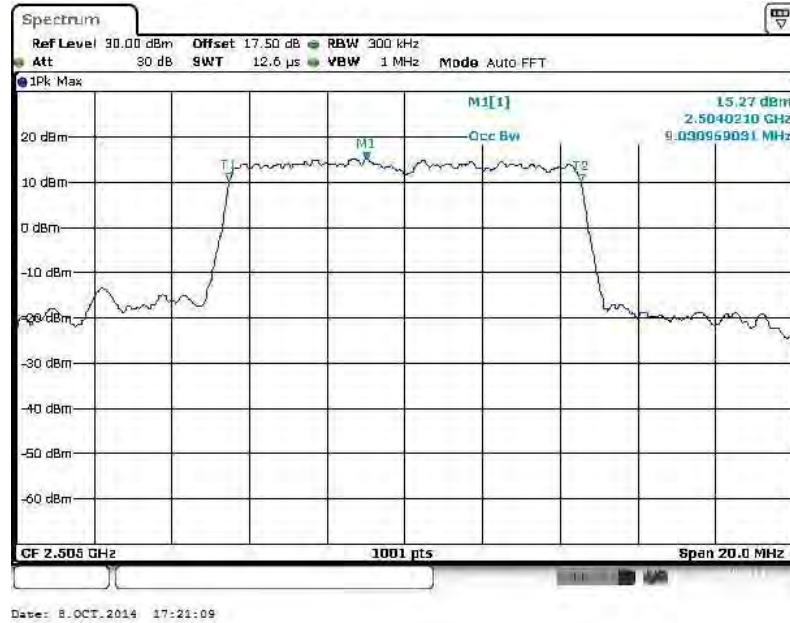

26dB Bandwidth Plot on Channel 20800

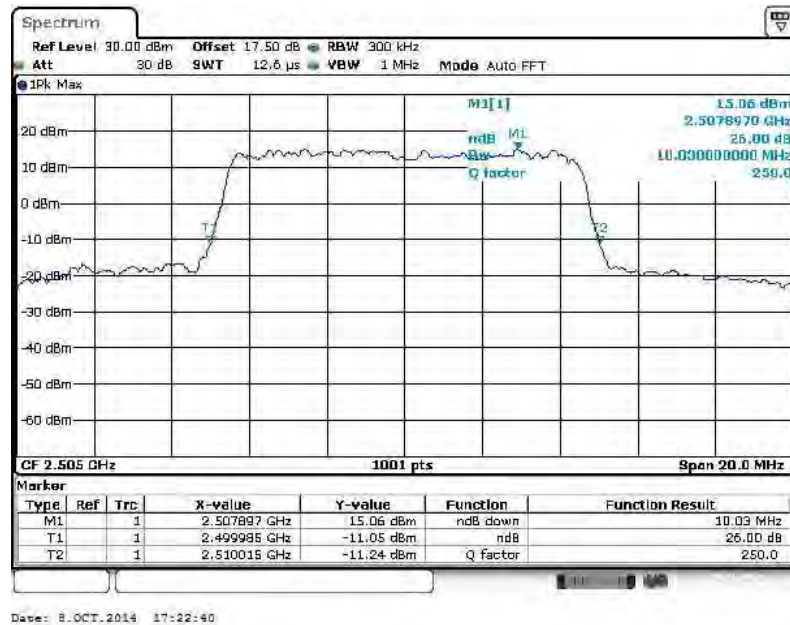



99% Occupied Bandwidth Plot on Channel 21100

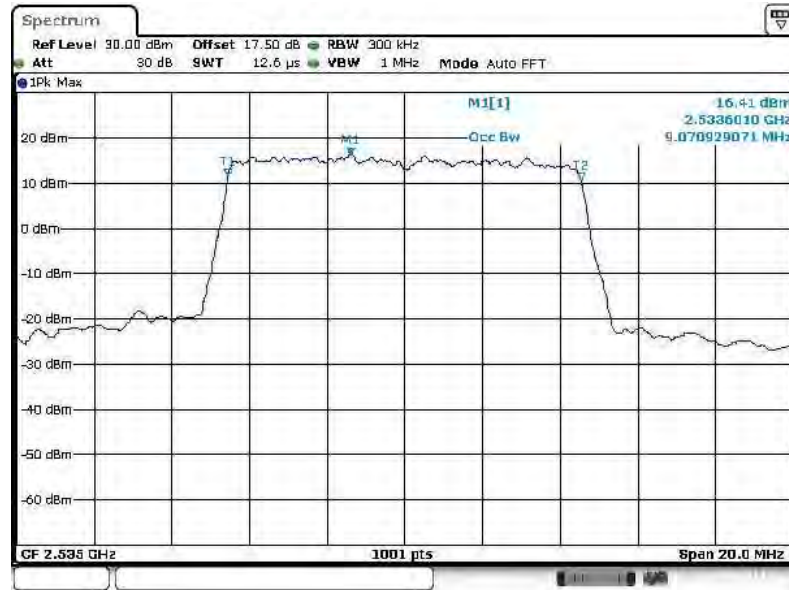

Date: 29.AUG.2014 16:50:56

26dB Bandwidth Plot on Channel 21100

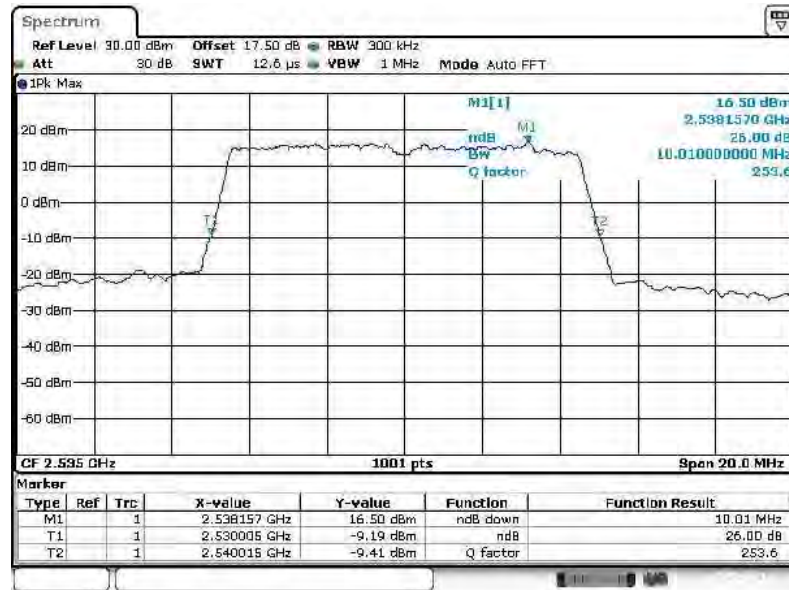

Date: 29.AUG.2014 16:51:49



99% Occupied Bandwidth Plot on Channel 21400

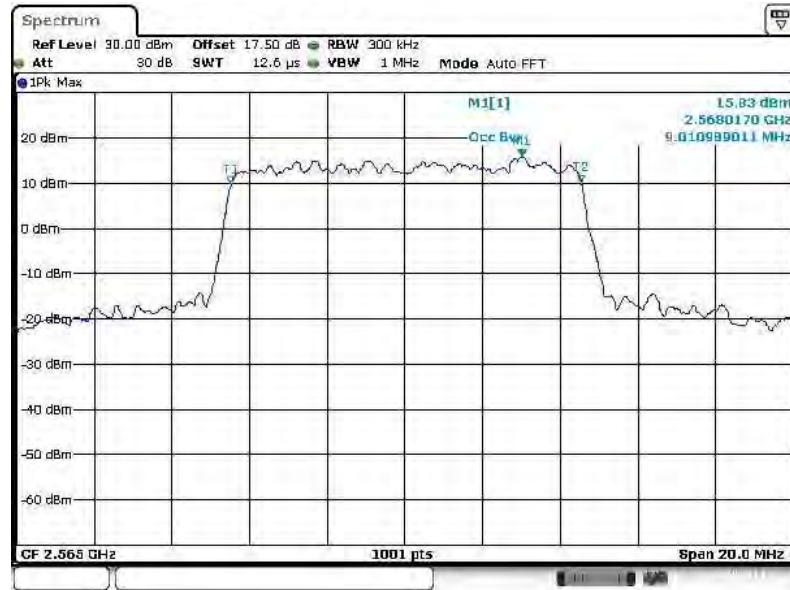

Date: 8.OCT.2014 17:20:00

26dB Bandwidth Plot on Channel 21400

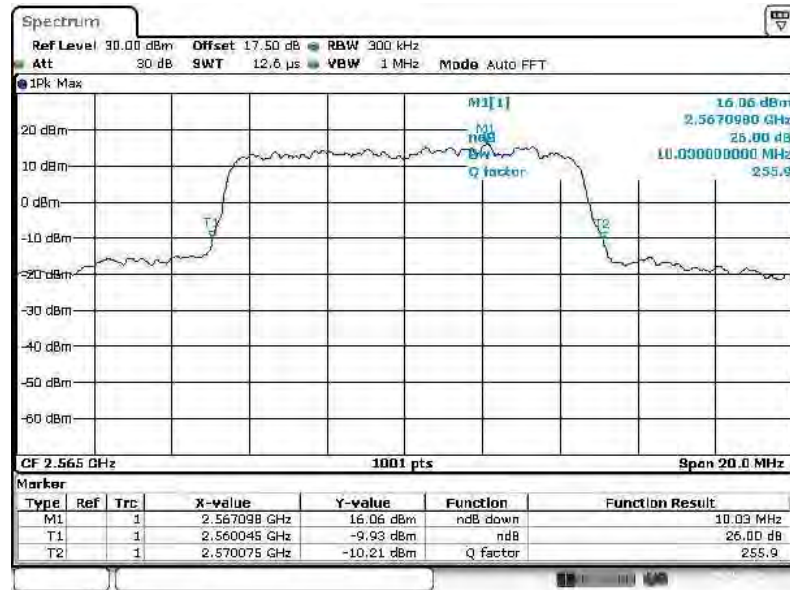

Date: 8.OCT.2014 17:08:57



<b>Band :</b>	LTE Band 7	<b>BW / Mod. :</b>	10MHz / 16QAM
---------------	------------	--------------------	---------------

99% Occupied Bandwidth Plot on Channel 20800

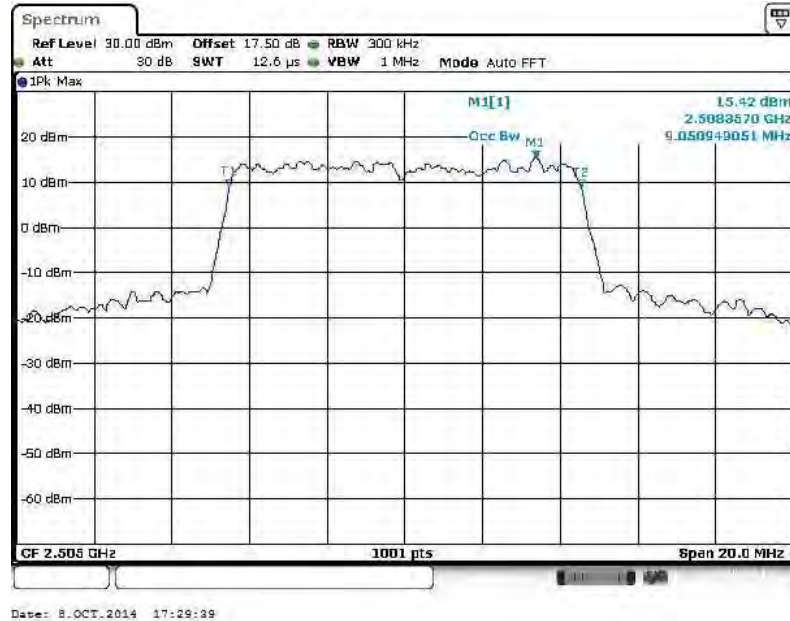

26dB Bandwidth Plot on Channel 20800

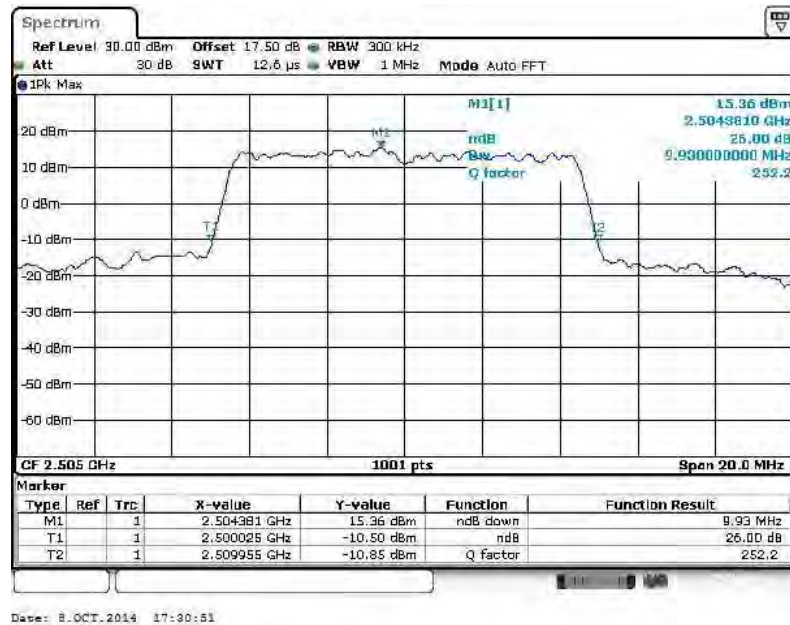



99% Occupied Bandwidth Plot on Channel 21100

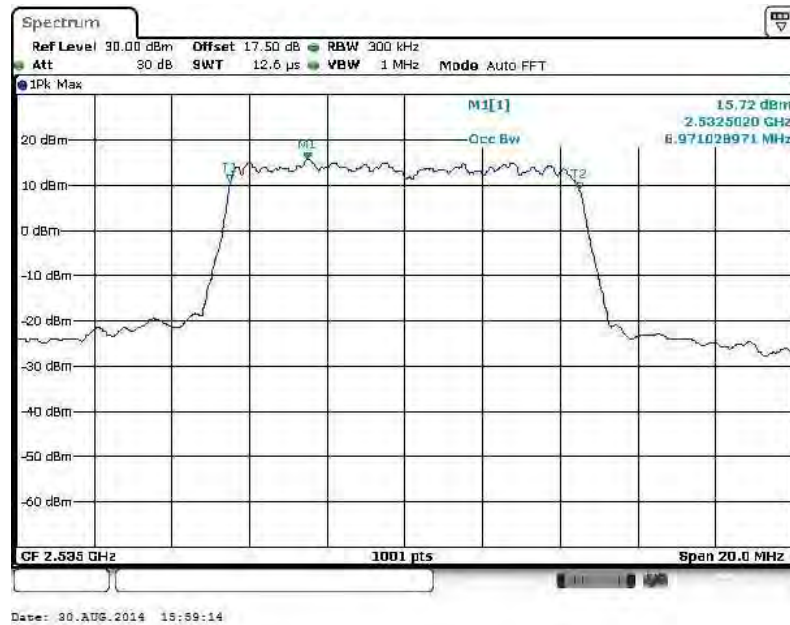

26dB Bandwidth Plot on Channel 21100

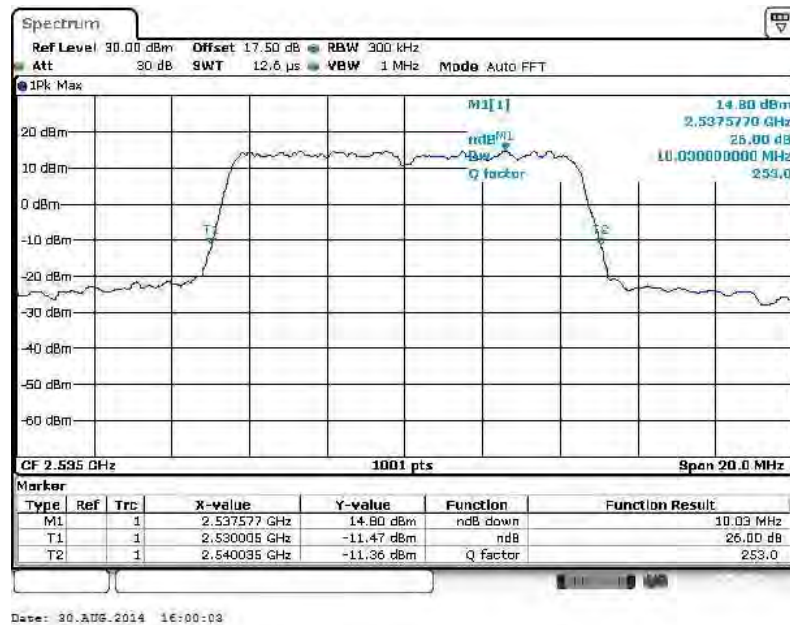





99% Occupied Bandwidth Plot on Channel 21400

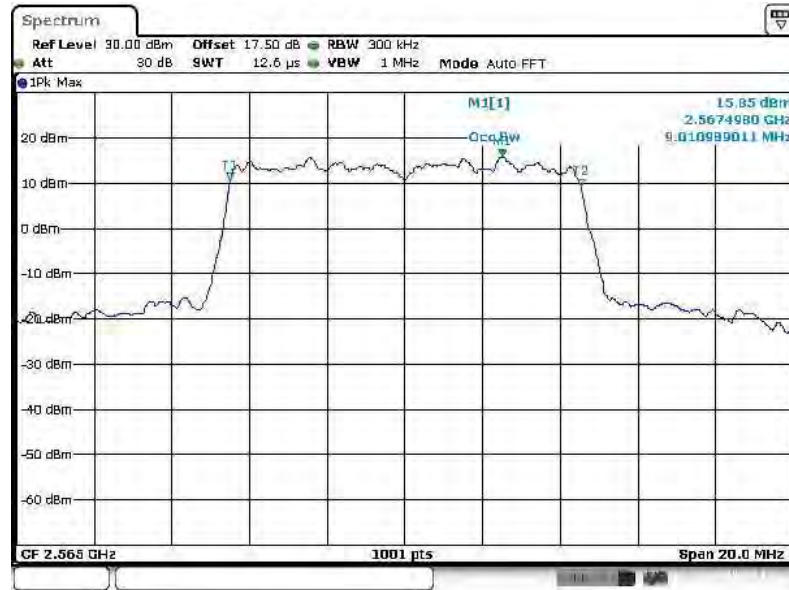

Date: 8.OCT.2014 17:08:32

26dB Bandwidth Plot on Channel 21400

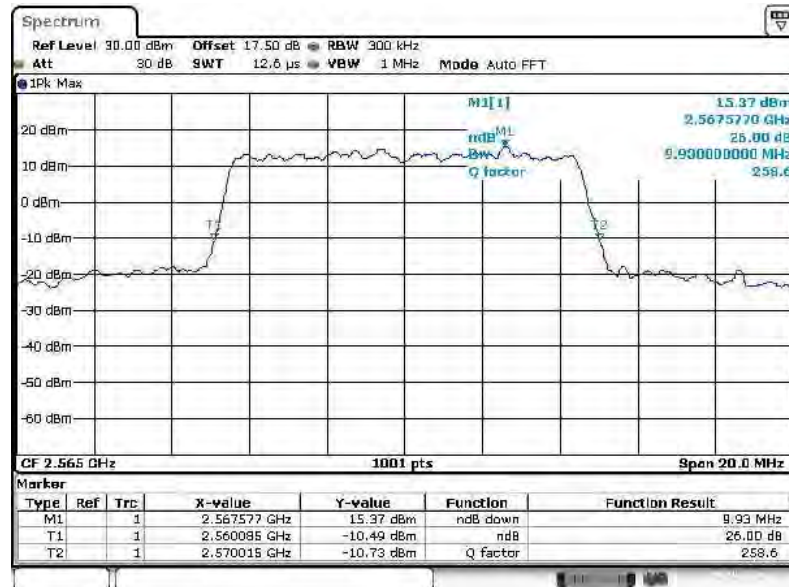

Date: 8.OCT.2014 17:06:50



<b>Band :</b>	LTE Band 7	<b>BW / Mod. :</b>	15MHz / QPSK
---------------	------------	--------------------	--------------

99% Occupied Bandwidth Plot on Channel 20825

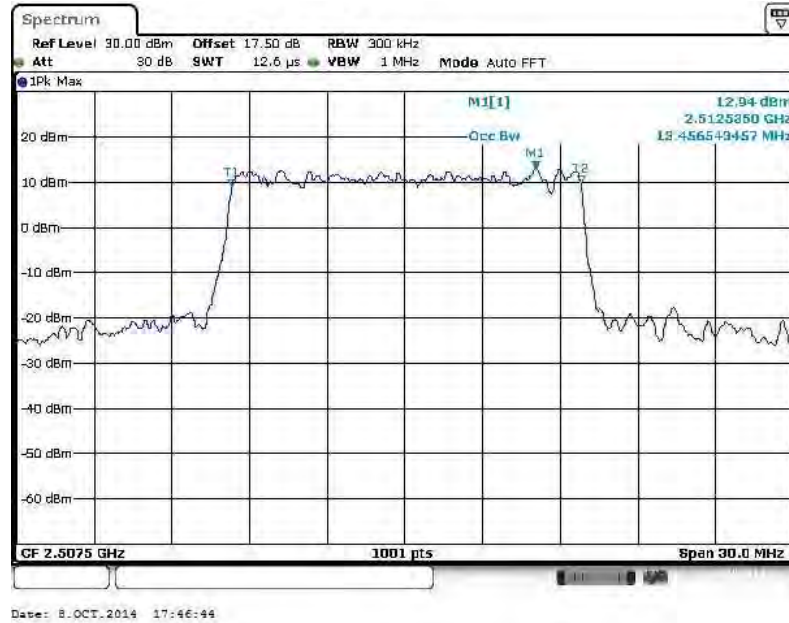

26dB Bandwidth Plot on Channel 20825

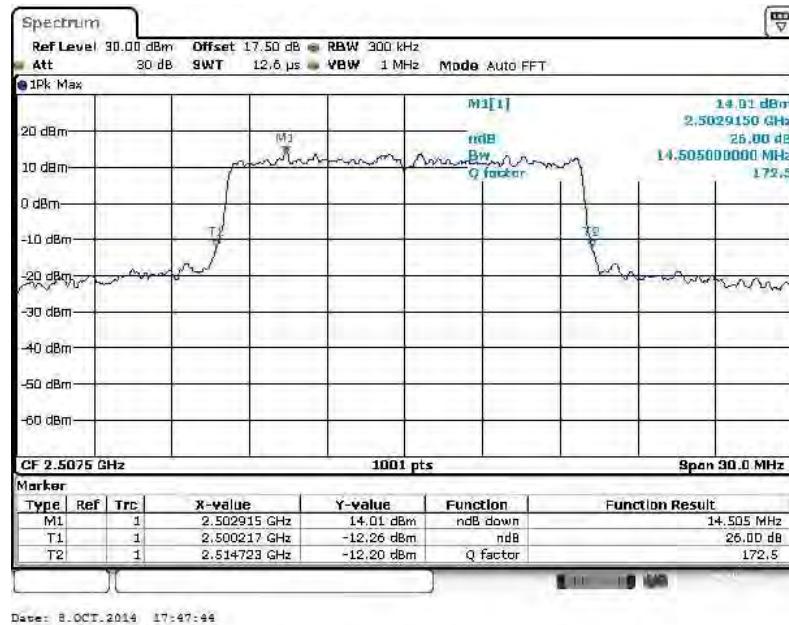



99% Occupied Bandwidth Plot on Channel 21100

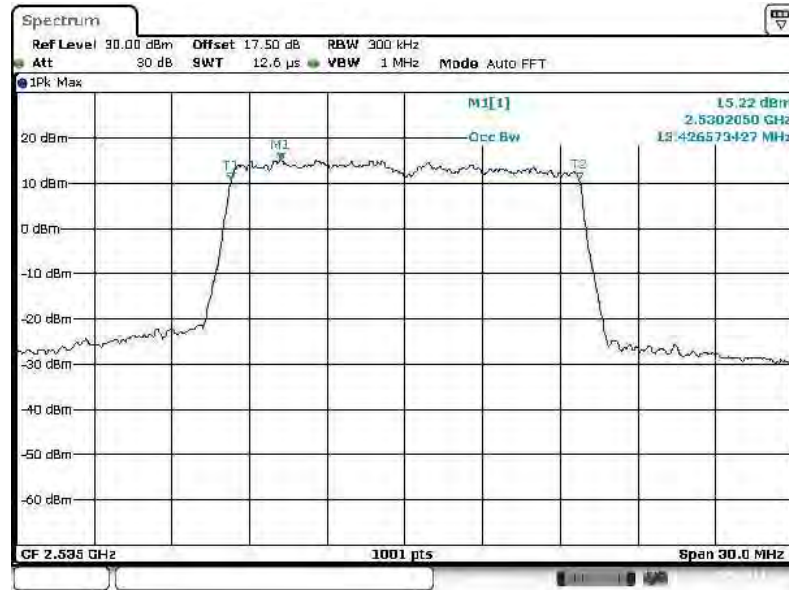

Date: 29.AUG.2014 16:53:08

26dB Bandwidth Plot on Channel 21100

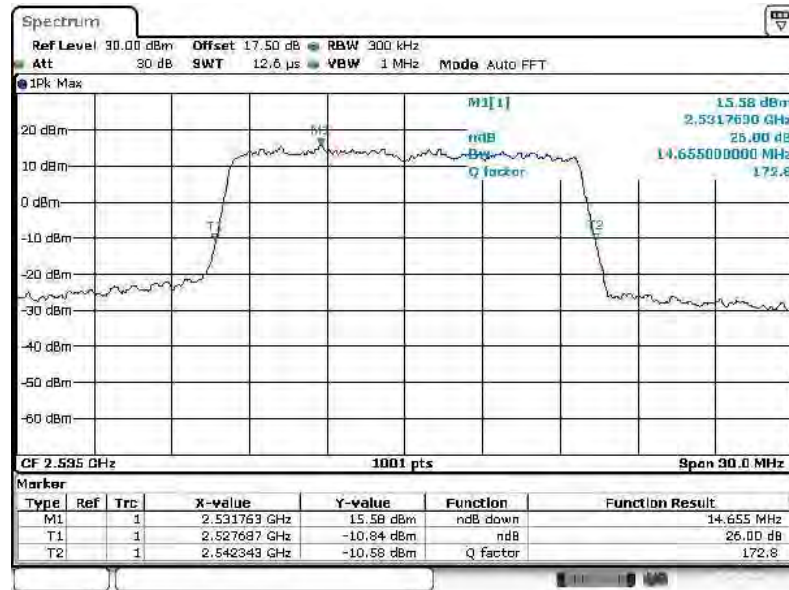

Date: 29.AUG.2014 16:54:33



99% Occupied Bandwidth Plot on Channel 21375

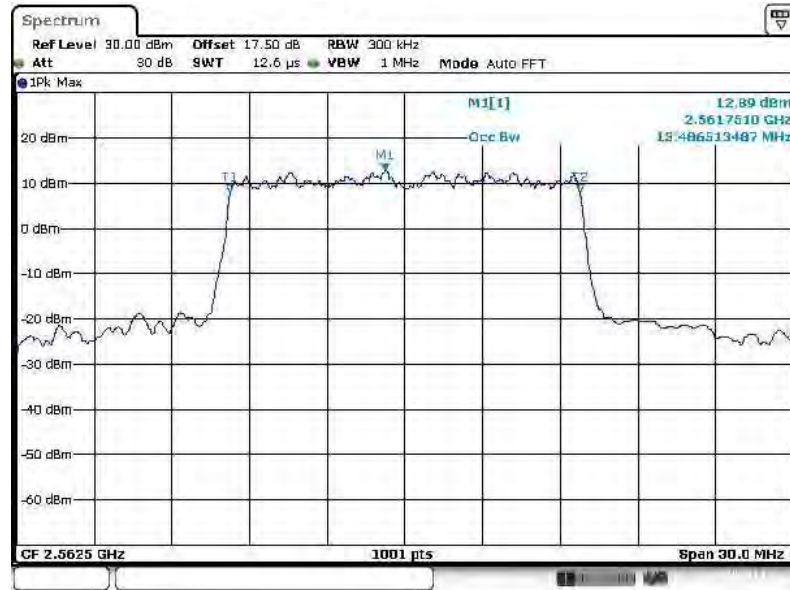

Date: 8.OCT.2014 17:42:00

26dB Bandwidth Plot on Channel 21375

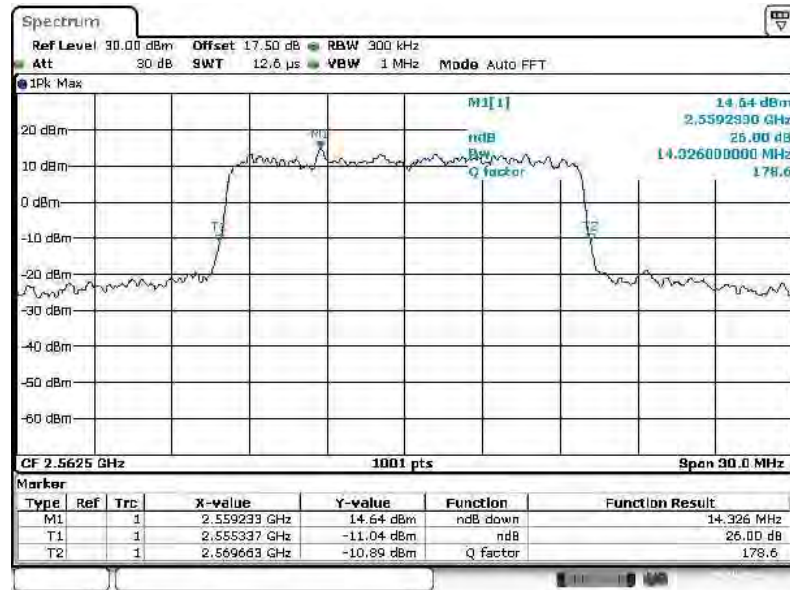

Date: 8.OCT.2014 17:44:34



<b>Band :</b>	LTE Band 7	<b>BW / Mod. :</b>	15MHz / 16QAM
---------------	------------	--------------------	---------------

99% Occupied Bandwidth Plot on Channel 20825

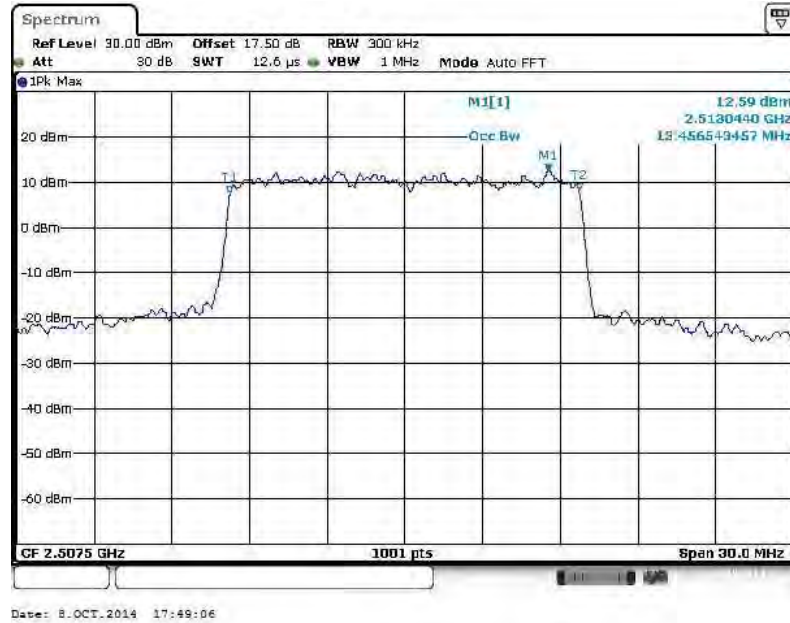

26dB Bandwidth Plot on Channel 20825

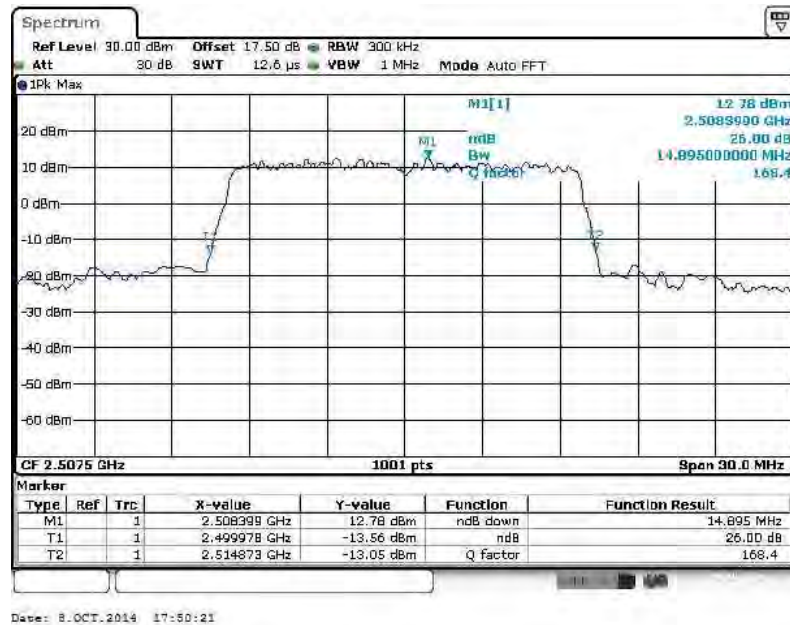





99% Occupied Bandwidth Plot on Channel 21100

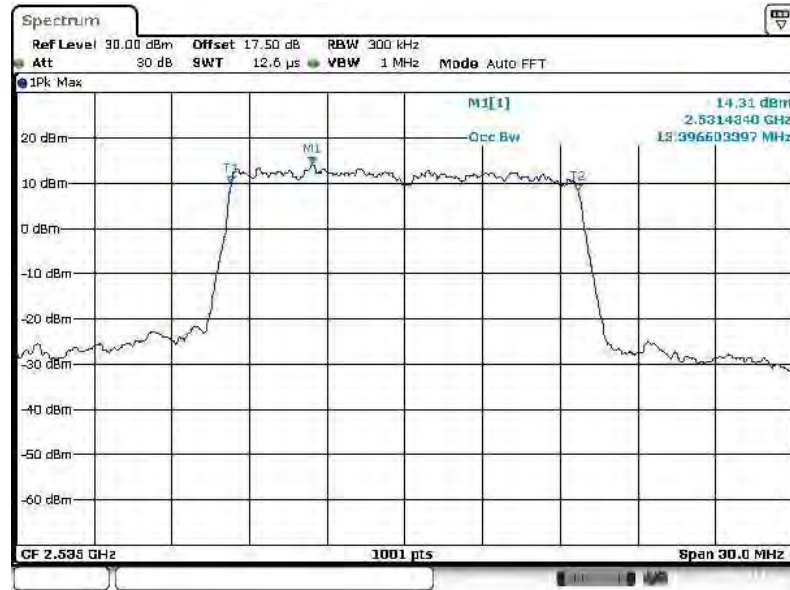

Date: 30.AUG.2014 16:01:09

26dB Bandwidth Plot on Channel 21100

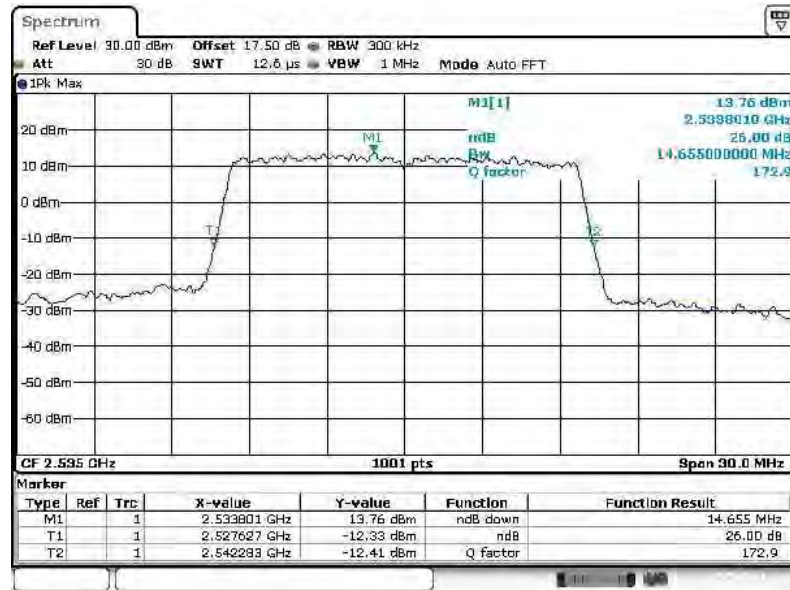

Date: 30.AUG.2014 16:02:16



99% Occupied Bandwidth Plot on Channel 21375

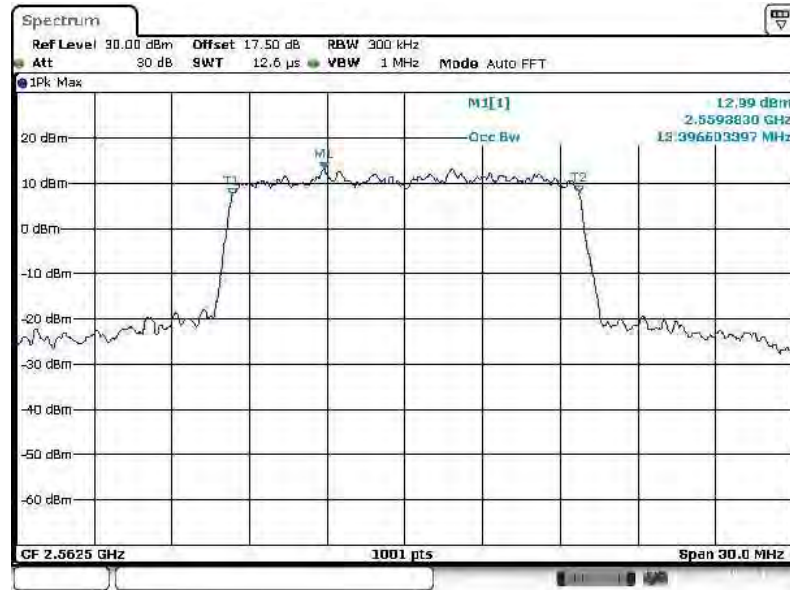

Date: 8.OCT.2014 17:38:36

26dB Bandwidth Plot on Channel 21375

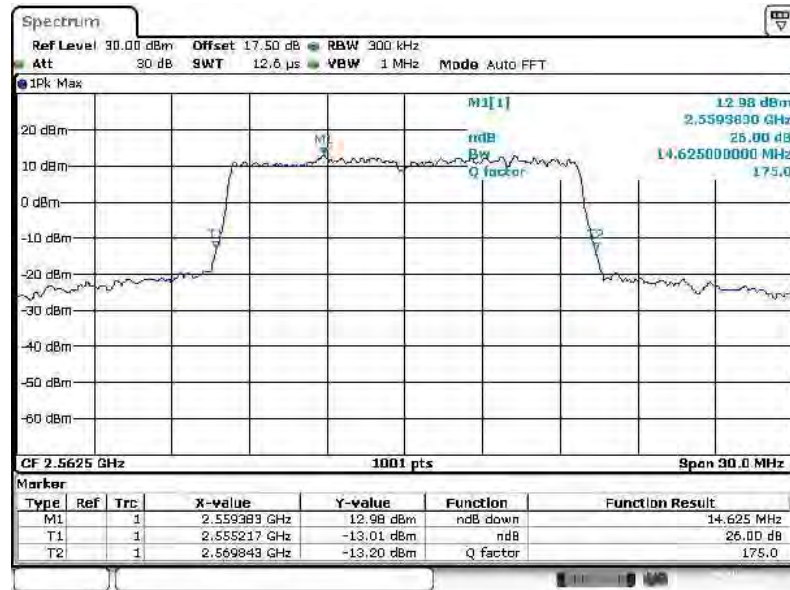

Date: 8.OCT.2014 17:37:32



<b>Band :</b>	LTE Band 7	<b>BW / Mod. :</b>	20MHz / QPSK
---------------	------------	--------------------	--------------

99% Occupied Bandwidth Plot on Channel 20850

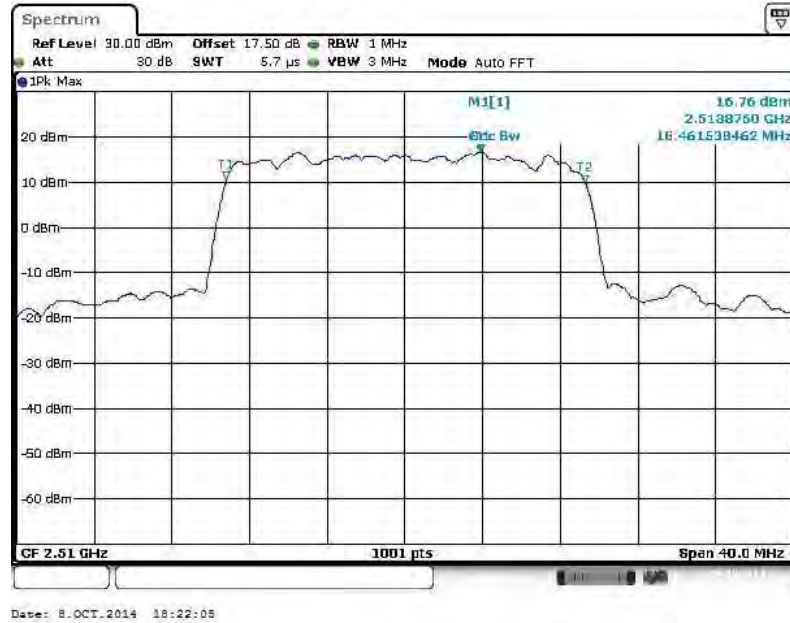

26dB Bandwidth Plot on Channel 20850

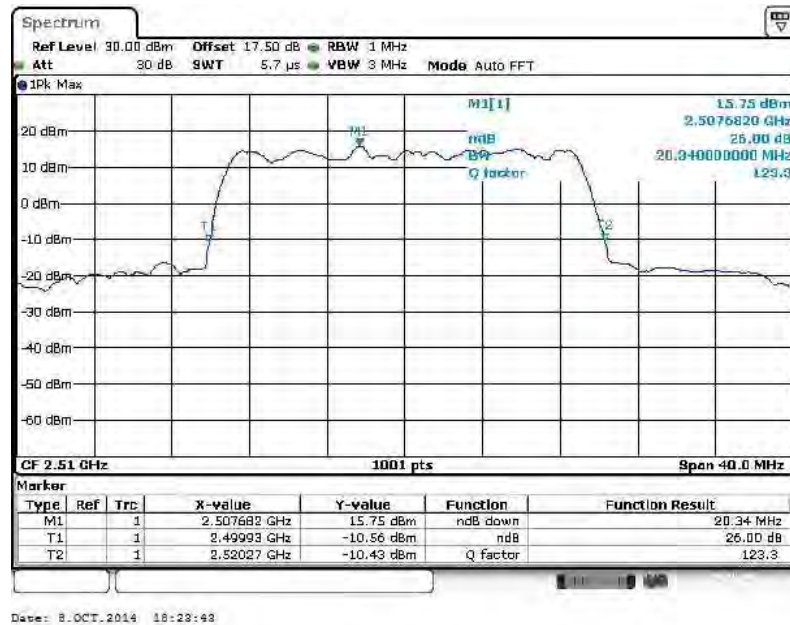



99% Occupied Bandwidth Plot on Channel 21100

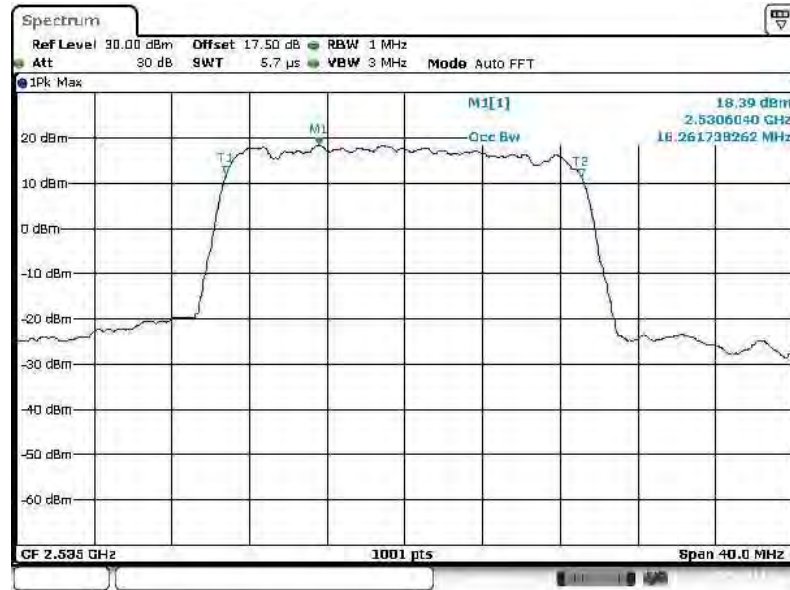

Date: 29.AUG.2014 16:55:57

26dB Bandwidth Plot on Channel 21100

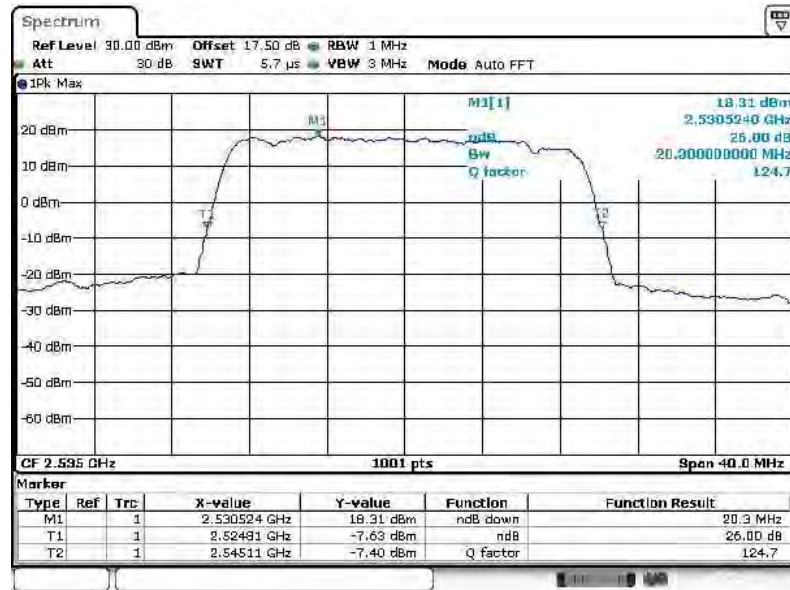

Date: 29.AUG.2014 16:57:13



99% Occupied Bandwidth Plot on Channel 21350

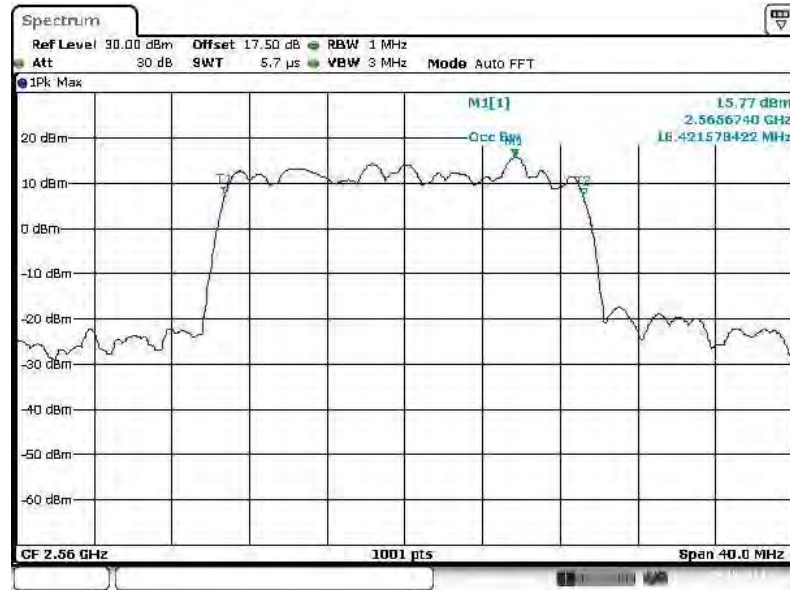

Date: 8.OCT.2014 17:59:08

26dB Bandwidth Plot on Channel 21350

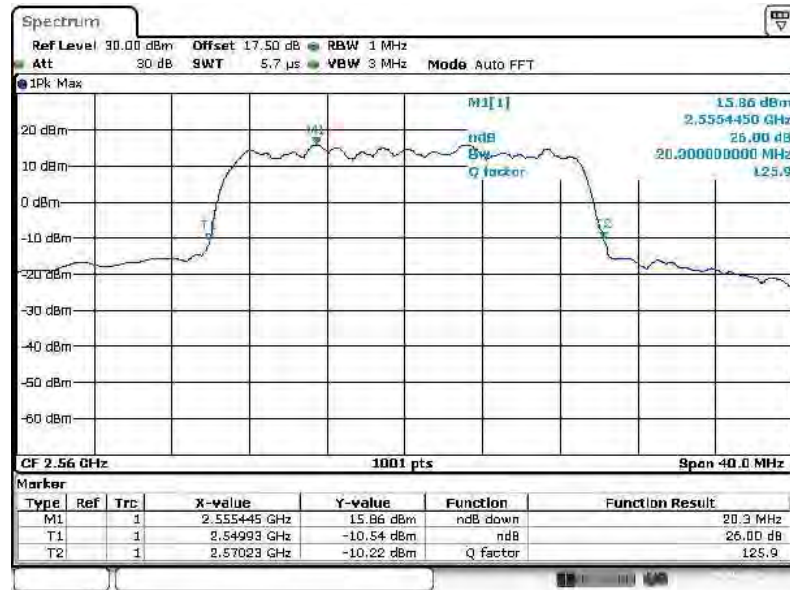

Date: 8.OCT.2014 17:59:50





<b>Band :</b>	LTE Band 7	<b>BW / Mod. :</b>	20MHz / 16QAM
---------------	------------	--------------------	---------------

99% Occupied Bandwidth Plot on Channel 20850

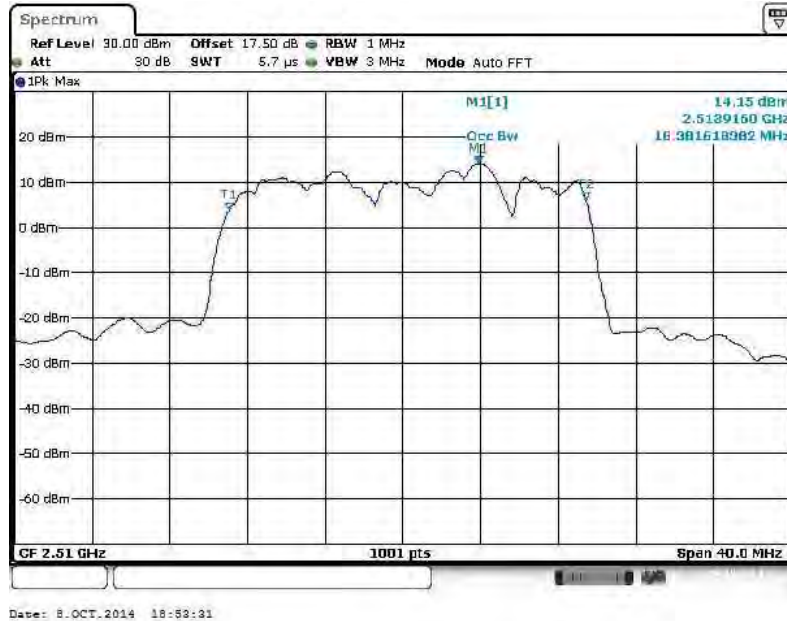

26dB Bandwidth Plot on Channel 20850

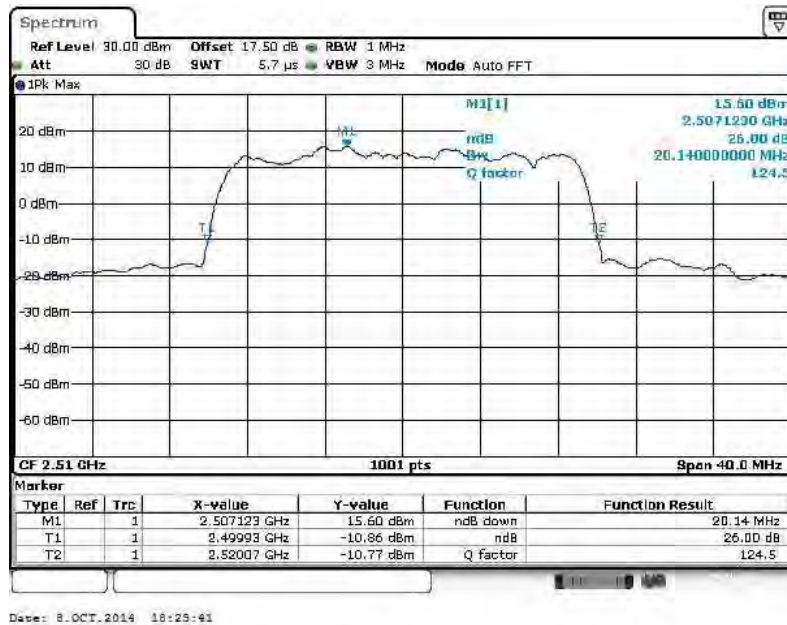



99% Occupied Bandwidth Plot on Channel 21100

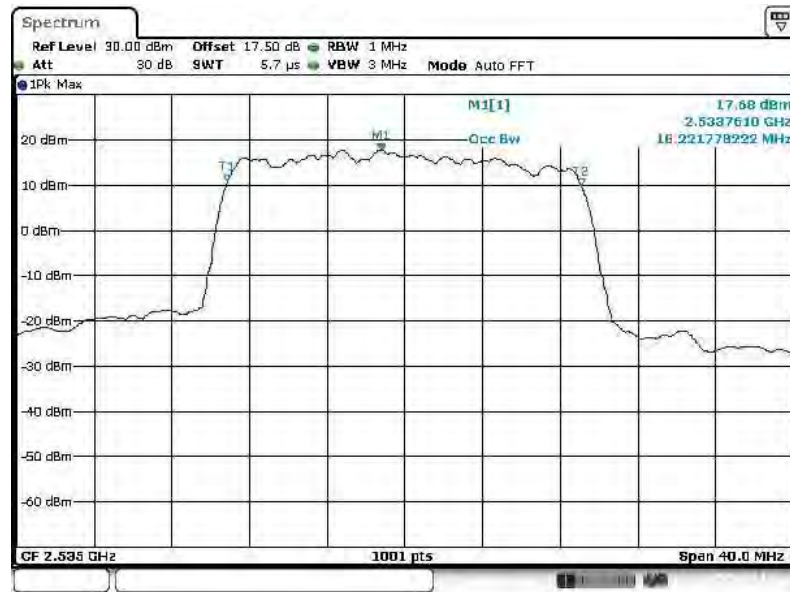

Date: 30.AUG.2014 16:03:28

26dB Bandwidth Plot on Channel 21100

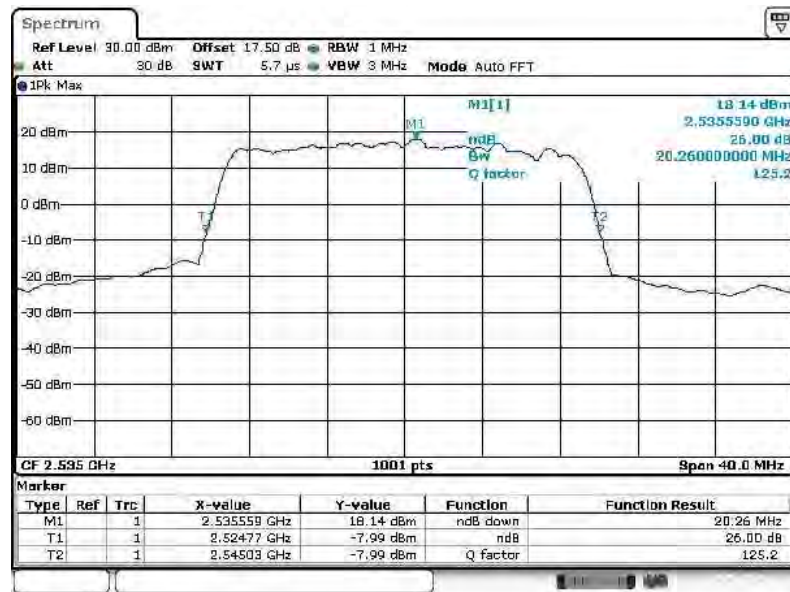

Date: 30.AUG.2014 16:04:28



99% Occupied Bandwidth Plot on Channel 21350

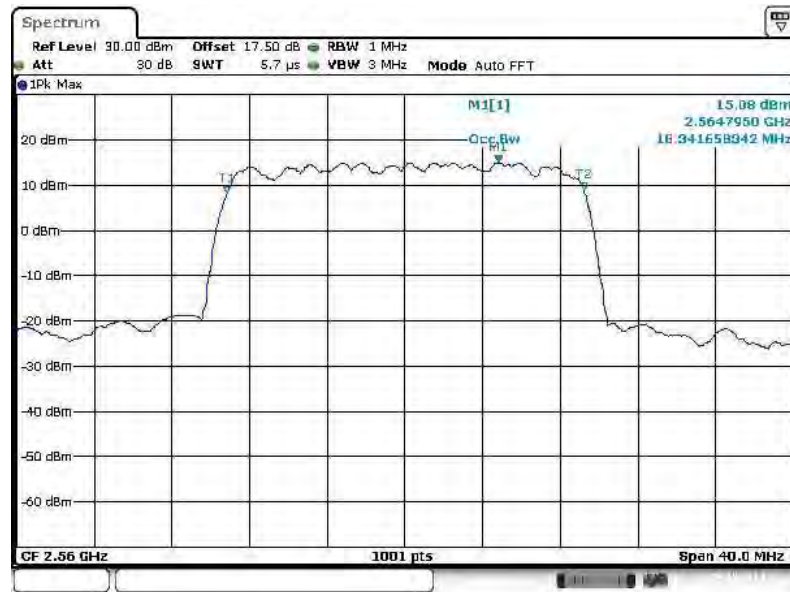

Date: 8.OCT.2014 17:53:08

26dB Bandwidth Plot on Channel 21350

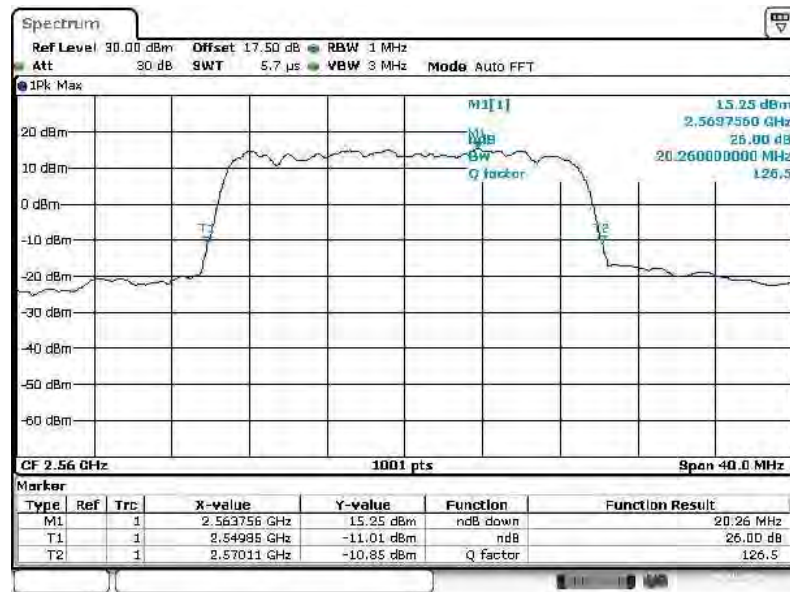

Date: 8.OCT.2014 17:54:48



### 3.5 Conducted Band Edge Measurement

#### 3.5.1 Description of Conducted Band Edge Measurement

22.917(a)

For operations in the 824 – 849 MHz band, the FCC limit is  $43 + 10\log_{10}(P[\text{Watts}])$  dB below the transmitter power  $P(\text{Watts})$  in a 100kHz bandwidth. However, in the 1MHz bands immediately outside and adjacent to the licensee's frequency block, a resolution bandwidth of at least one percent of the emission bandwidth of the fundamental emission of the transmitter may be employed.

24.238 (a)

For operations in the 1850-1910 and 1930-1990 MHz band, the FCC limit is  $43 + 10\log_{10}(P[\text{Watts}])$  dB below the transmitter power  $P(\text{Watts})$  in a 1MHz bandwidth. However, in the 1 MHz bands immediately outside and adjacent to the frequency block a resolution bandwidth of at least one percent of the emission bandwidth of the fundamental emission of the transmitter may be employed.

27.53 (g)

For operations in the 698 -746 MHz band, the FCC limit is  $43 + 10\log_{10}(P[\text{Watts}])$  dB below the transmitter power  $P(\text{Watts})$  in a 100 kHz bandwidth. However, in the 100 kilohertz bands immediately outside and adjacent to a licensee's frequency block, a resolution bandwidth of at least 30 kHz may be employed.

27.53 (h)

For operations in the 1710 – 1755 MHz band, the FCC limit is  $43 + 10\log_{10}(P[\text{Watts}])$  dB below the transmitter power  $P(\text{Watts})$  in a 1 MHz bandwidth. However, in the 1MHz bands immediately outside and adjacent to the licensee's frequency block, a resolution bandwidth of at least one percent of the emission bandwidth of the fundamental emission of the transmitter may be employed.



27.53(m)(4):

For mobile digital stations, the attenuation factor shall be not less than  $40 + 10 \log (P)$  dB on all frequencies between the channel edge and 5 megahertz from the channel edge,  $43 + 10 \log (P)$  dB on all frequencies between 5 megahertz and X megahertz from the channel edge, and  $55 + 10 \log (P)$  dB on all frequencies more than X megahertz from the channel edge, where X is the greater of 6 megahertz or the actual emission bandwidth as defined in paragraph (m)(6) of this section. In addition, the attenuation factor shall not be less that  $43 + 10 \log (P)$  dB on all frequencies between 2490.5 MHz and 2496 MHz and  $55 + 10 \log (P)$  dB at or below 2490.5 MHz. Mobile Satellite Service licensees operating on frequencies below 2495 MHz may also submit a documented interference complaint against BRS licensees operating on channel BRS Channel 1 on the same terms and conditions as adjacent channel BRS or EBS licensees.

RSS-199:

### **3.5.2 Measuring Instruments**

The measuring equipment is listed in the section 4 of this test report.

### **3.5.3 Test Procedures**

1. The EUT was connected to spectrum analyzer and system simulator via a power divider.
2. The band edges of low and high channels for the highest RF powers were measured. Set RBW  $\geq 1\%$  EBW in the 1MHz band immediately outside and adjacent to the band edge.
3. Set spectrum analyzer with RMS detector.
4. The RF fundamental frequency should be excluded against the limit line in the operating frequency band.
5. The limit line is derived from  $43 + 10\log(P)$ dB below the transmitter power P(Watts)  
=  $P(W) - [43 + 10\log(P)]$  (dB)  
=  $[30 + 10\log(P)]$  (dBm) -  $[43 + 10\log(P)]$  (dB)  
= -13dBm.



### 3.5.4 Test Setup

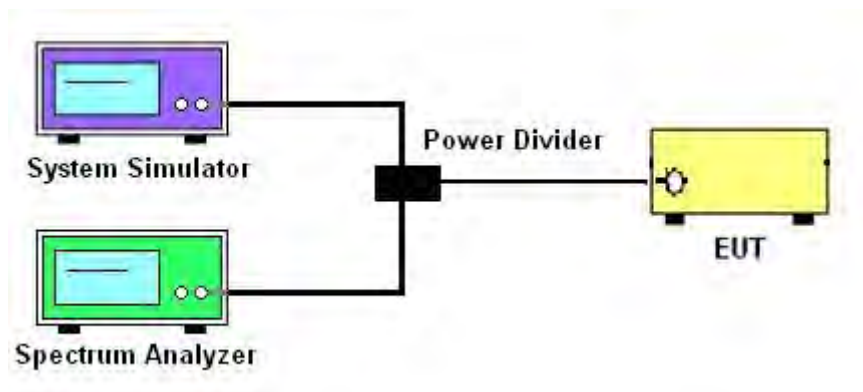



### 3.5.5 Test Result (Plots) of Conducted Band Edge

Band :	LTE Band 5	Band Width :	1.4MHz / QPSK
--------	------------	--------------	---------------

Lower Band Edge Plot for QPSK-RB Size 1, RB Offset 0

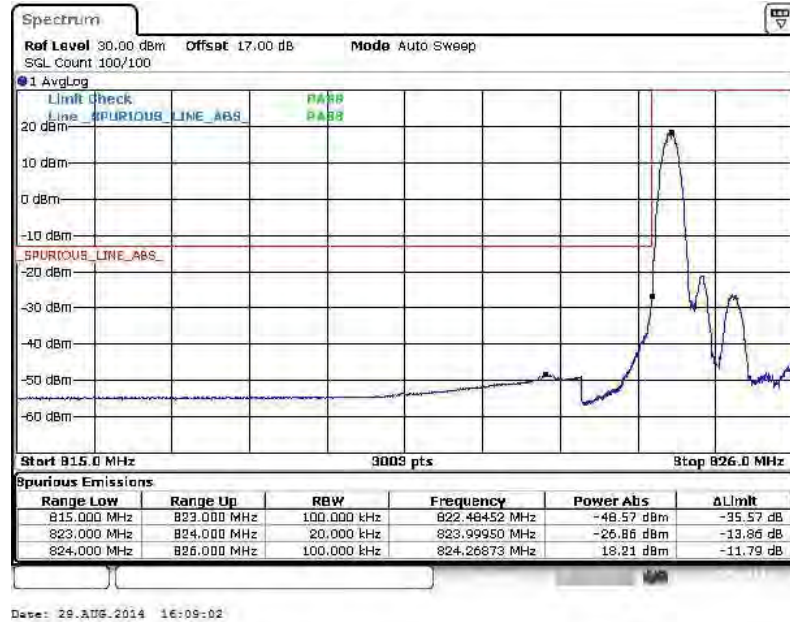

Lower Band Edge Plot for QPSK-RB Size 6, RB Offset 0

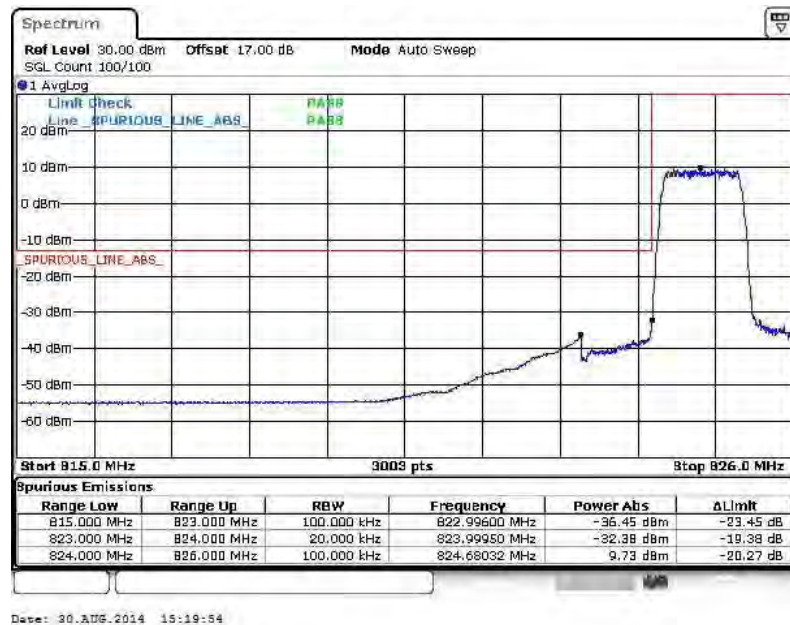



Higher Band Edge Plot for QPSK-RB Size 1, RB Offset 5

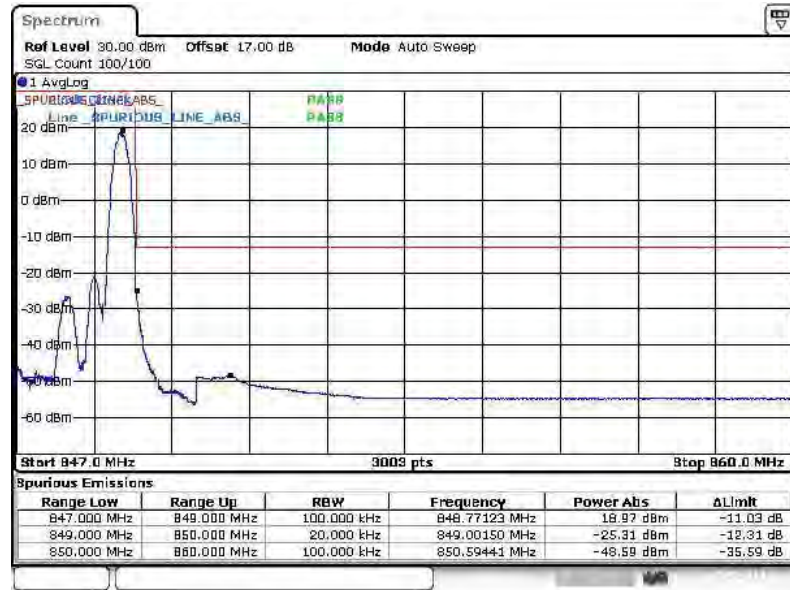

Date: 29.AUG.2014 16:20:46

Higher Band Edge Plot for QPSK-RB Size 6, RB Offset 0

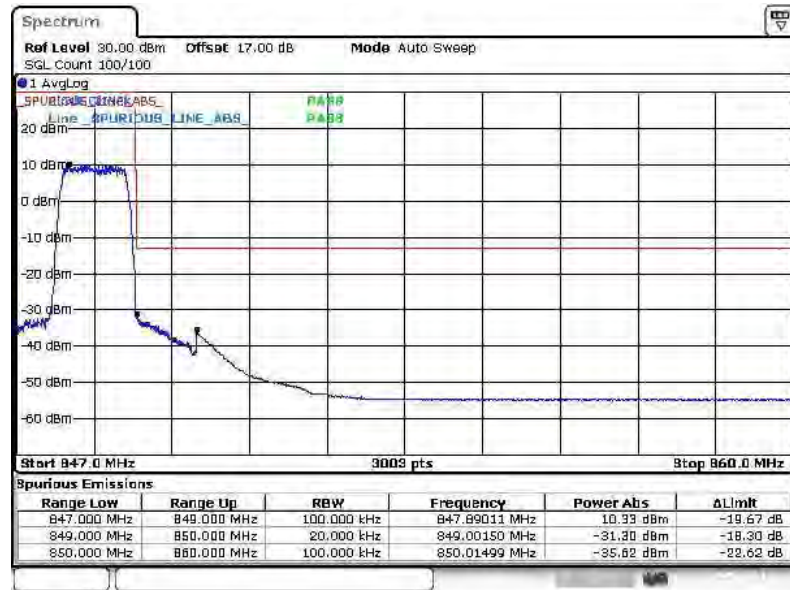

Date: 30.AUG.2014 15:27:15



<b>Band :</b>	LTE Band 5	<b>Band Width :</b>	1.4MHz / 16QAM
---------------	------------	---------------------	----------------

Lower Band Edge Plot for 16QAM -RB Size 1, RB Offset 0

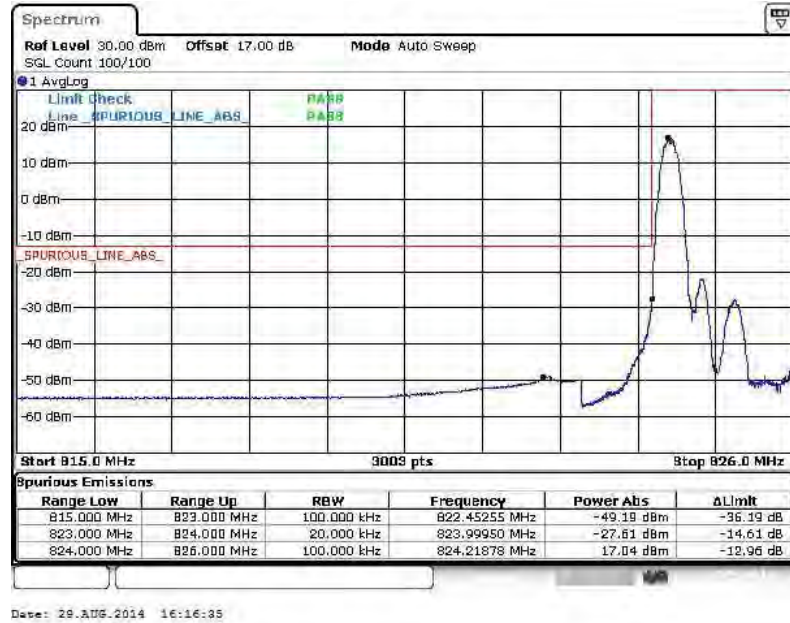

Lower Band Edge Plot for 16QAM -RB Size 6, RB Offset 0

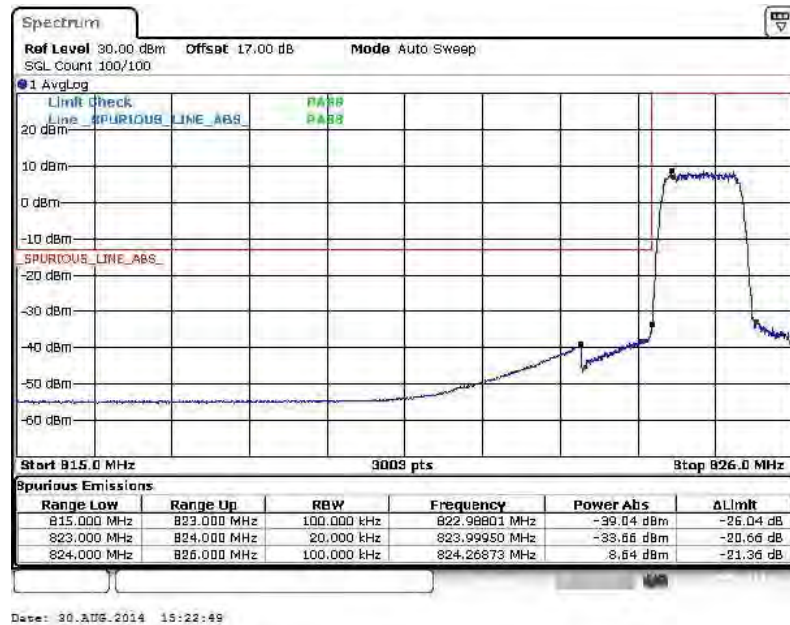





Higher Band Edge Plot for 16QAM -RB Size 1, RB Offset 5

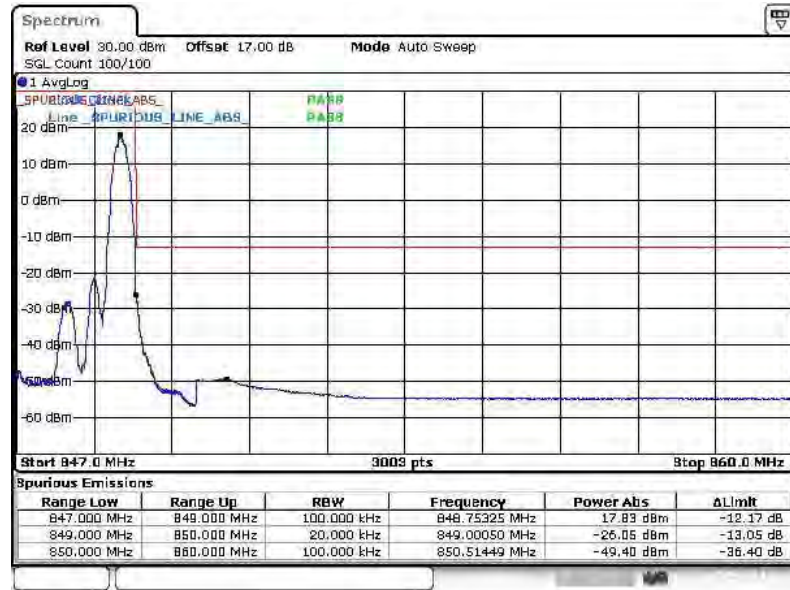

Date: 29.AUG.2014 16:18:43

Higher Band Edge Plot for 16QAM -RB Size 6, RB Offset 0



Date: 30.AUG.2014 15:24:50





Band :	LTE Band 5	Band Width :	3MHz / QPSK
--------	------------	--------------	-------------

Lower Band Edge Plot for QPSK-RB Size 1, RB Offset 0

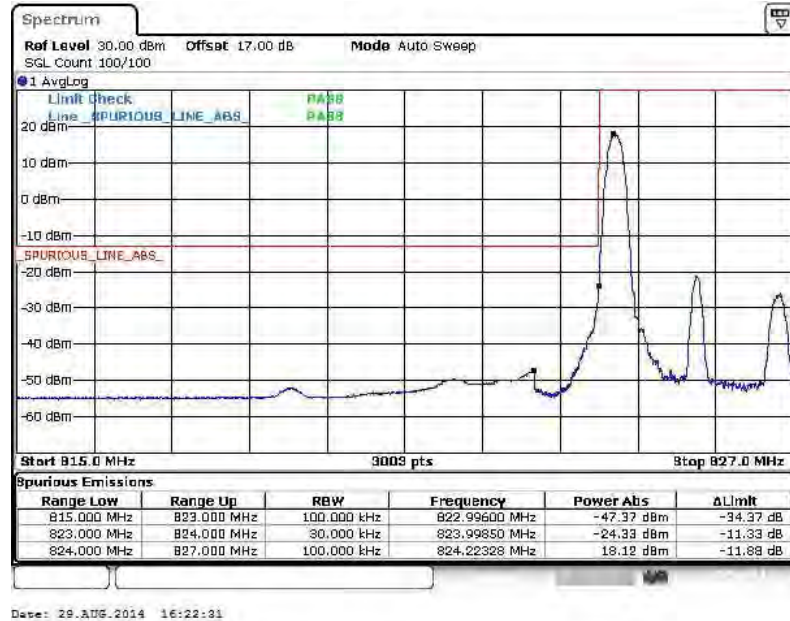

Lower Band Edge Plot for QPSK-RB Size 15, RB Offset 0

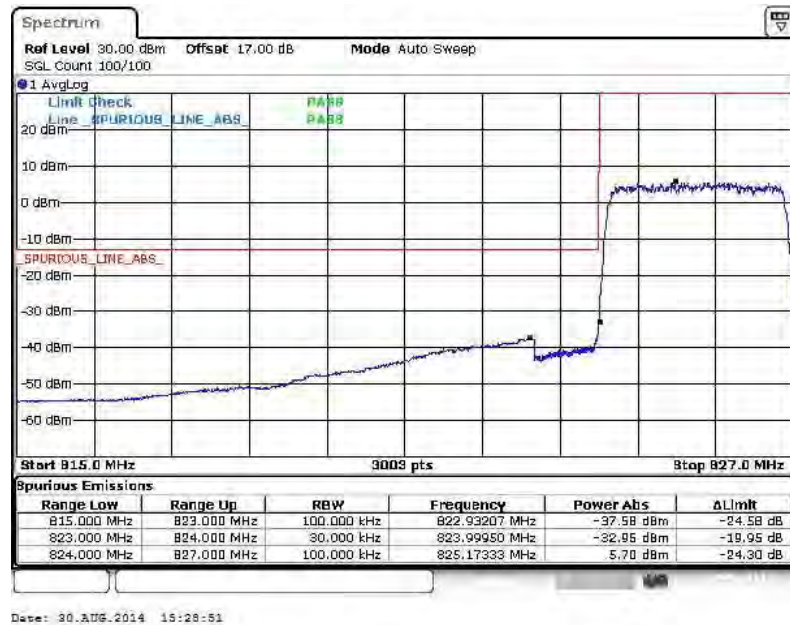



Higher Band Edge Plot for QPSK-RB Size 1, RB Offset 14

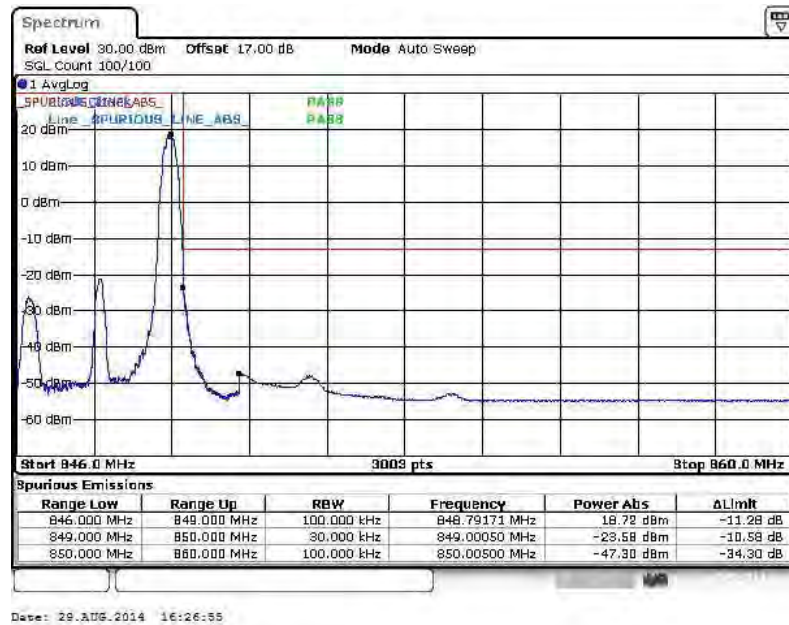

Higher Band Edge Plot for QPSK-RB Size 15, RB Offset 0

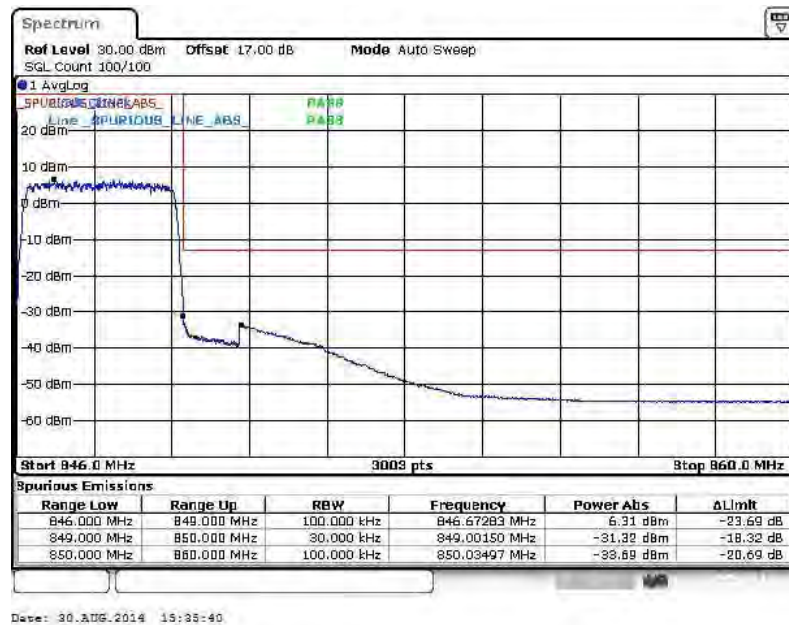



<b>Band :</b>	LTE Band 5	<b>Band Width :</b>	3MHz / 16QAM
---------------	------------	---------------------	--------------

Lower Band Edge Plot for 16QAM -RB Size 1, RB Offset 0

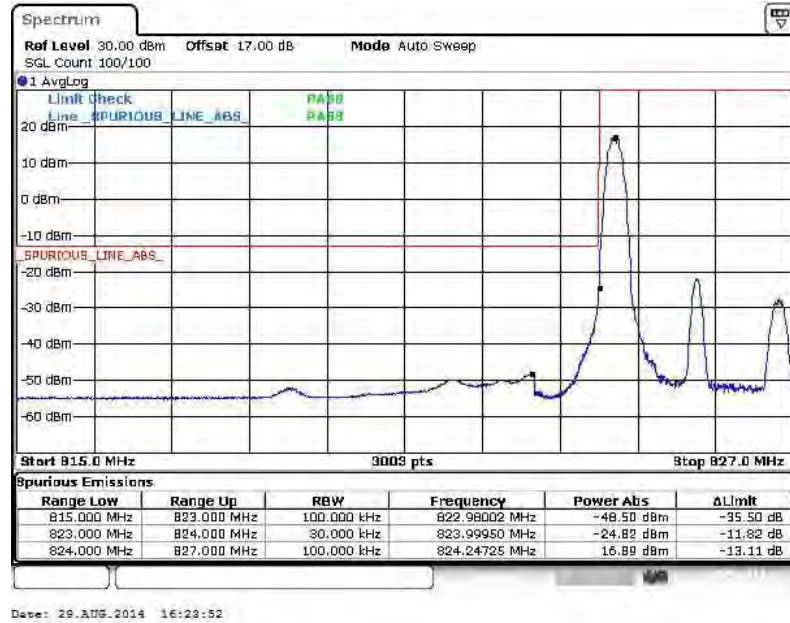

Lower Band Edge Plot for 16QAM -RB Size 15, RB Offset 0

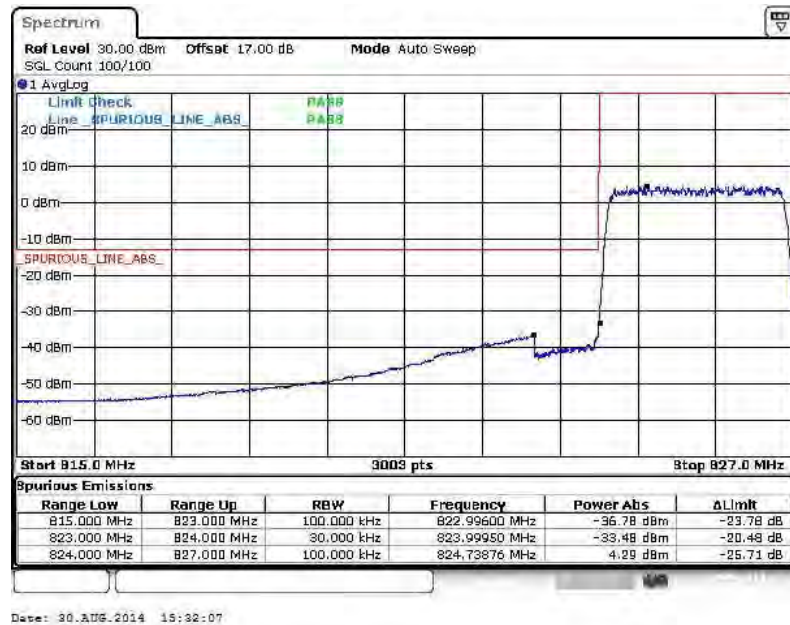



Higher Band Edge Plot for 16QAM -RB Size 1, RB Offset 14

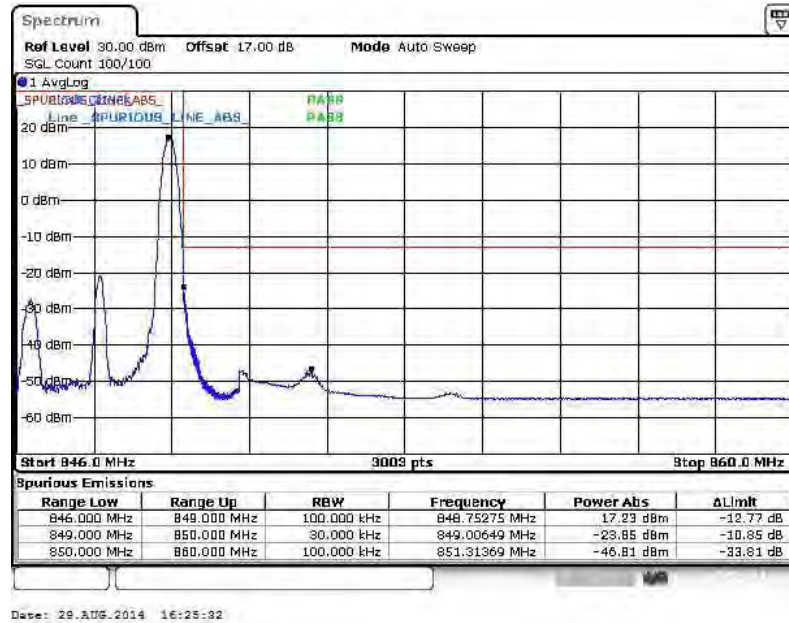

Higher Band Edge Plot for 16QAM -RB Size 15, RB Offset 0







Band :	LTE Band 5	Band Width :	5MHz / QPSK
--------	------------	--------------	-------------

Lower Band Edge Plot for QPSK-RB Size 1, RB Offset 0

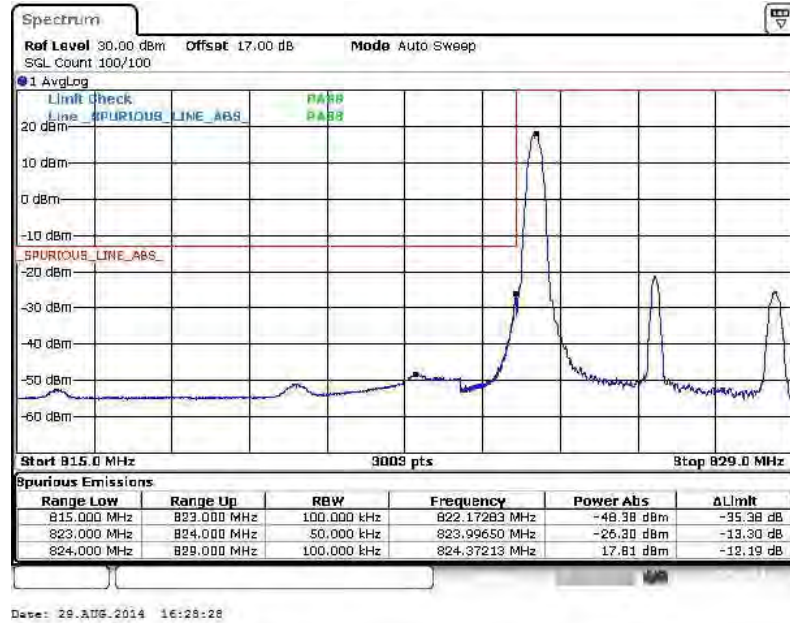

Lower Band Edge Plot for QPSK-RB Size 25, RB Offset 0

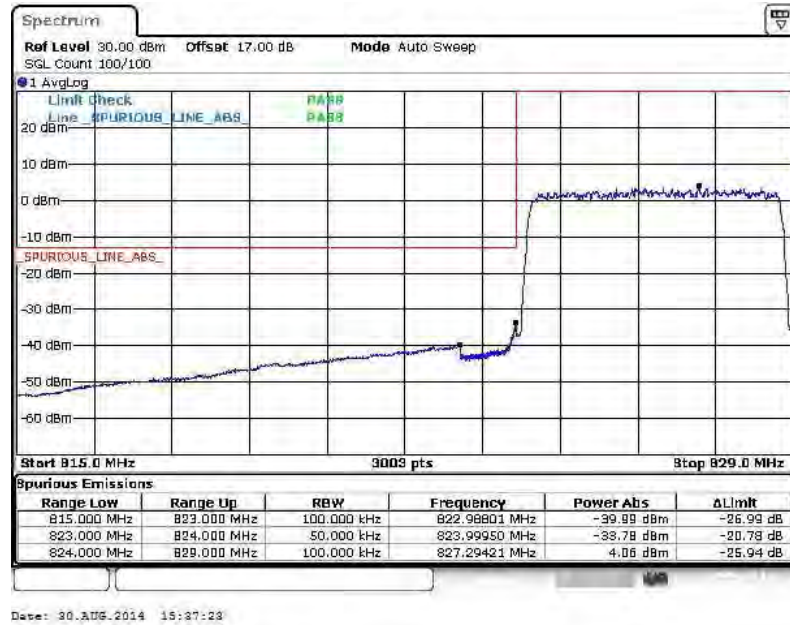





Higher Band Edge Plot for QPSK-RB Size 1, RB Offset 24

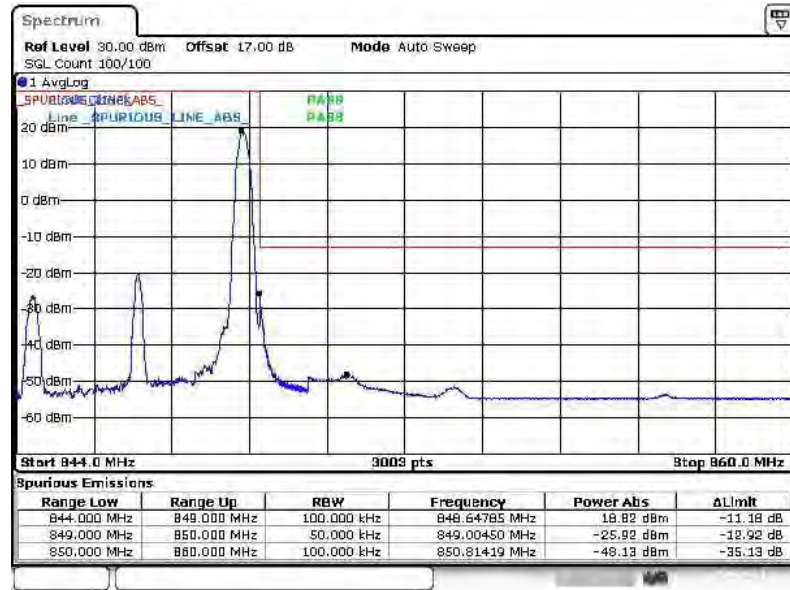

Date: 29.AUG.2014 16:32:12

Higher Band Edge Plot for QPSK-RB Size 25, RB Offset 0

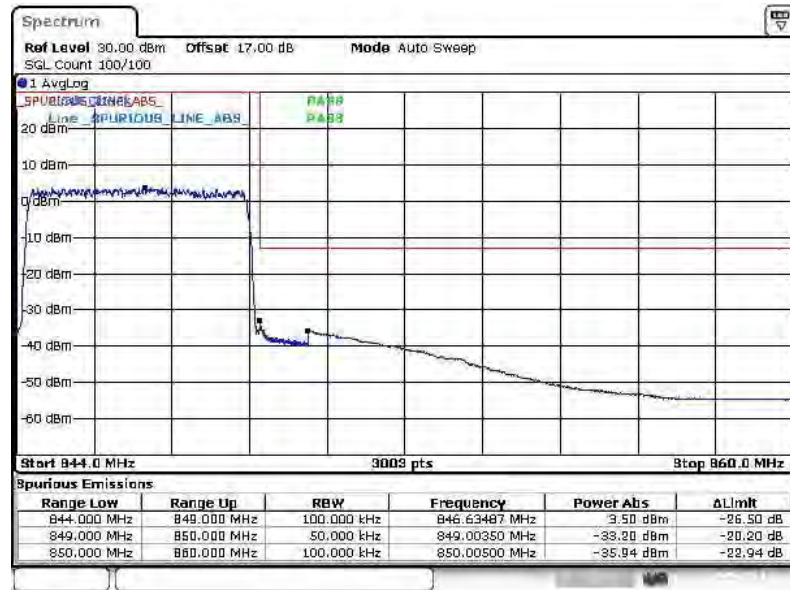

Date: 30.AUG.2014 15:44:30



<b>Band :</b>	LTE Band 5	<b>Band Width :</b>	5MHz / 16QAM
---------------	------------	---------------------	--------------

Lower Band Edge Plot for 16QAM -RB Size 1, RB Offset 0

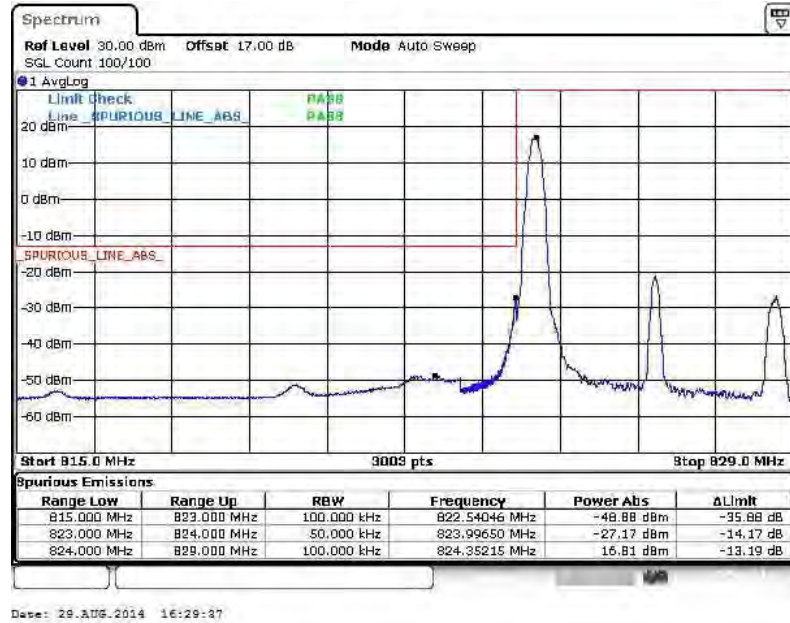

Lower Band Edge Plot for 16QAM -RB Size 25, RB Offset 0

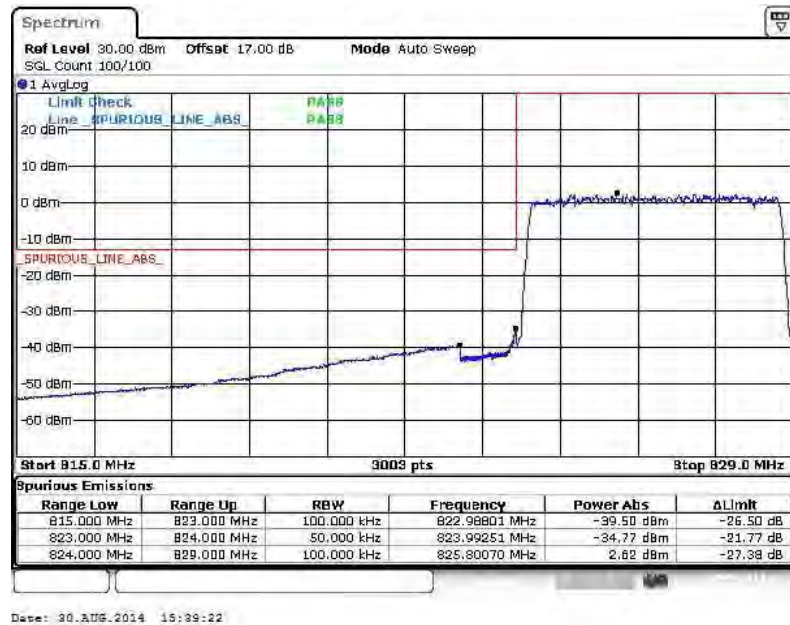



Higher Band Edge Plot for 16QAM -RB Size 1, RB Offset 24

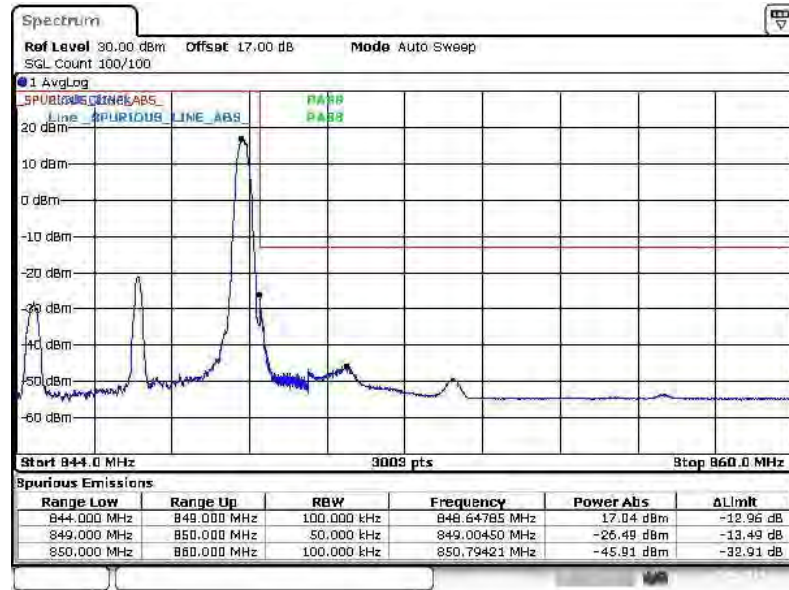

Date: 29.AUG.2014 16:30:53

Higher Band Edge Plot for 16QAM -RB Size 25, RB Offset 0

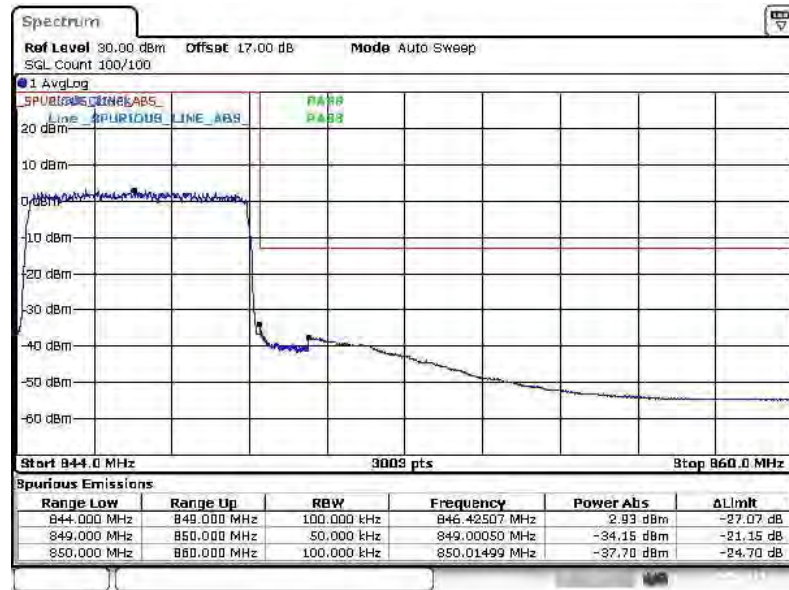

Date: 30.AUG.2014 15:41:52



<b>Band :</b>	LTE Band 5	<b>Band Width :</b>	10MHz / QPSK
---------------	------------	---------------------	--------------

Lower Band Edge Plot for QPSK-RB Size 1, RB Offset 0

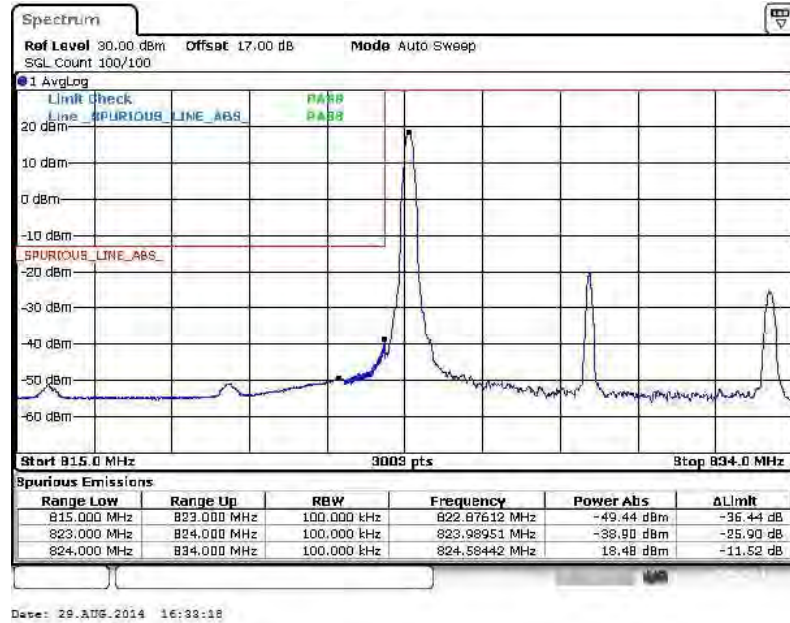

Lower Band Edge Plot for QPSK-RB Size 50, RB Offset 0

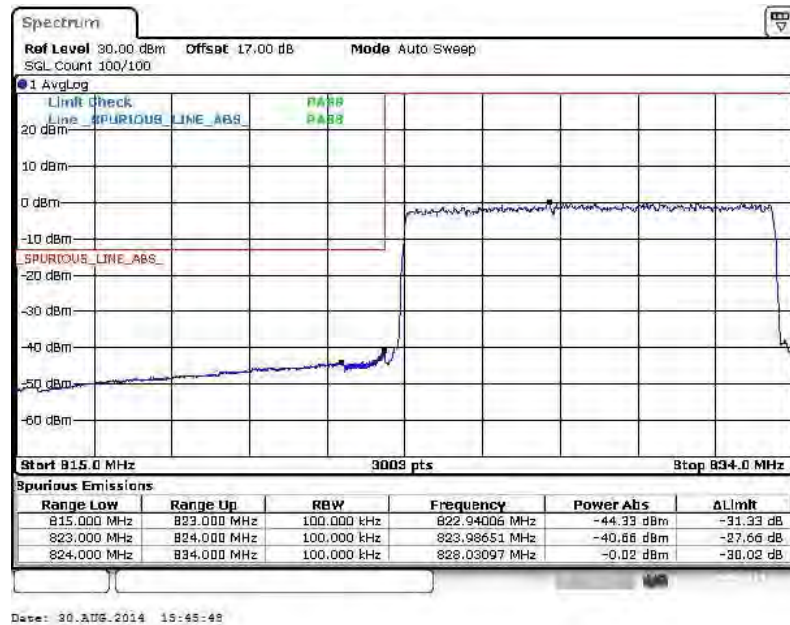





Higher Band Edge Plot for QPSK-RB Size 1, RB Offset 49

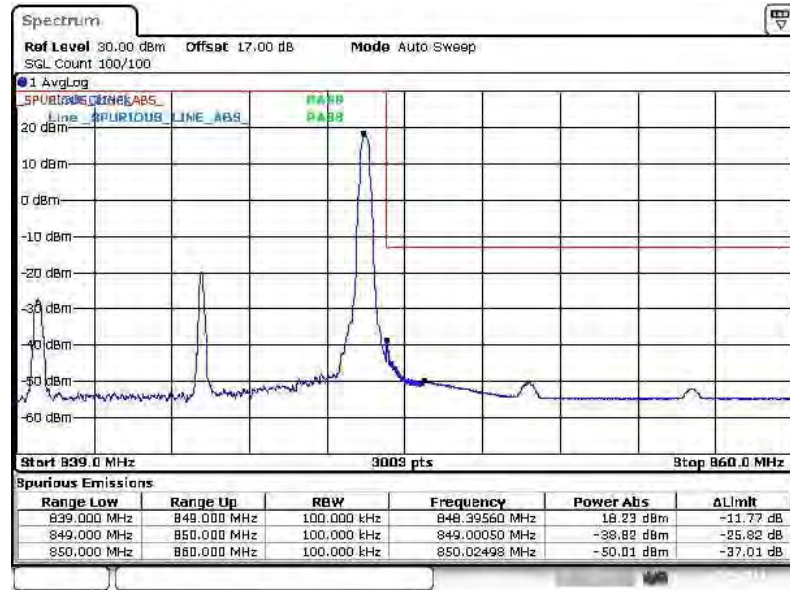

Date: 29.AUG.2014 16:36:47

Higher Band Edge Plot for QPSK-RB Size 50, RB Offset 0

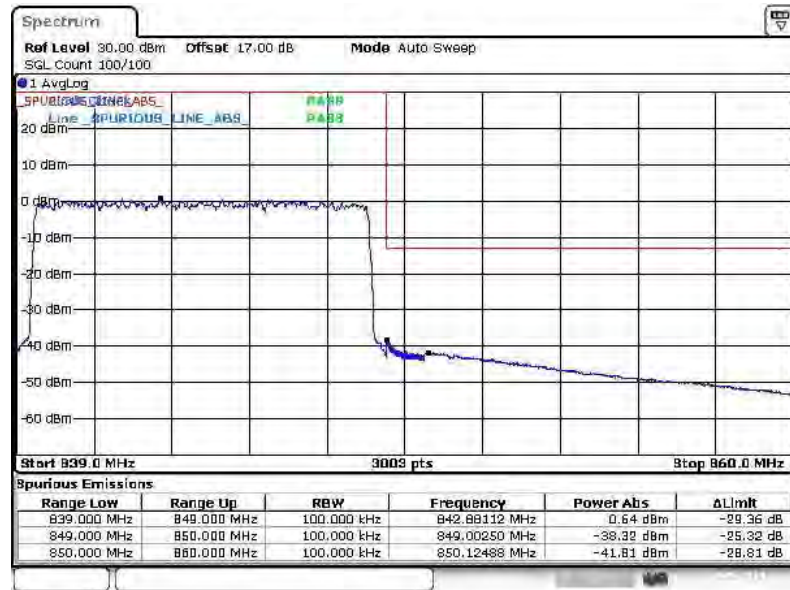

Date: 30.AUG.2014 15:49:46





Band :	LTE Band 5	Band Width :	10MHz / 16QAM
--------	------------	--------------	---------------

Lower Band Edge Plot for 16QAM -RB Size 1, RB Offset 0

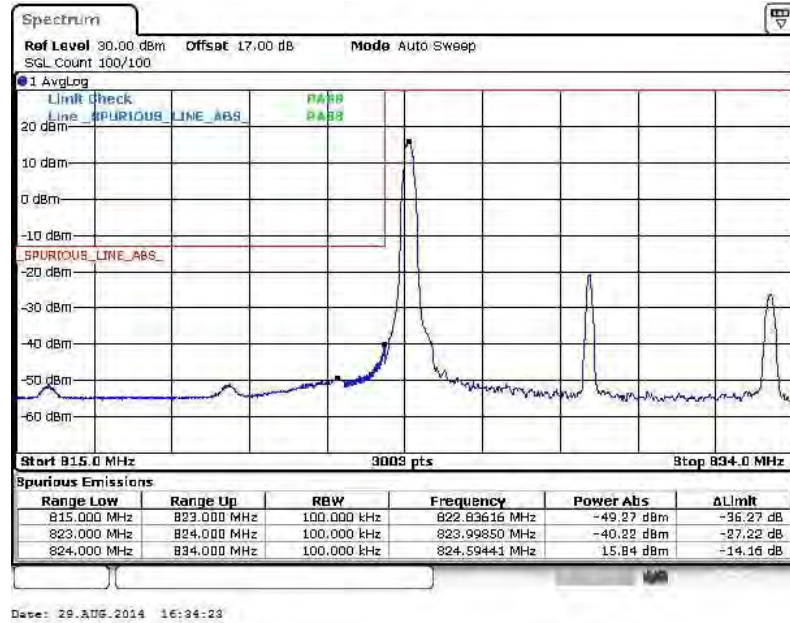

Lower Band Edge Plot for 16QAM -RB Size 50, RB Offset 0

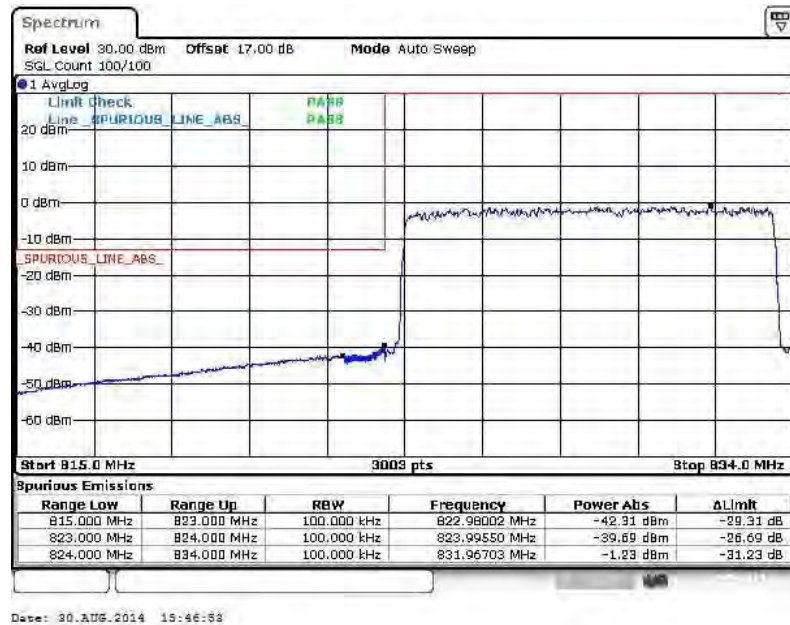



Higher Band Edge Plot for 16QAM -RB Size 1, RB Offset 49

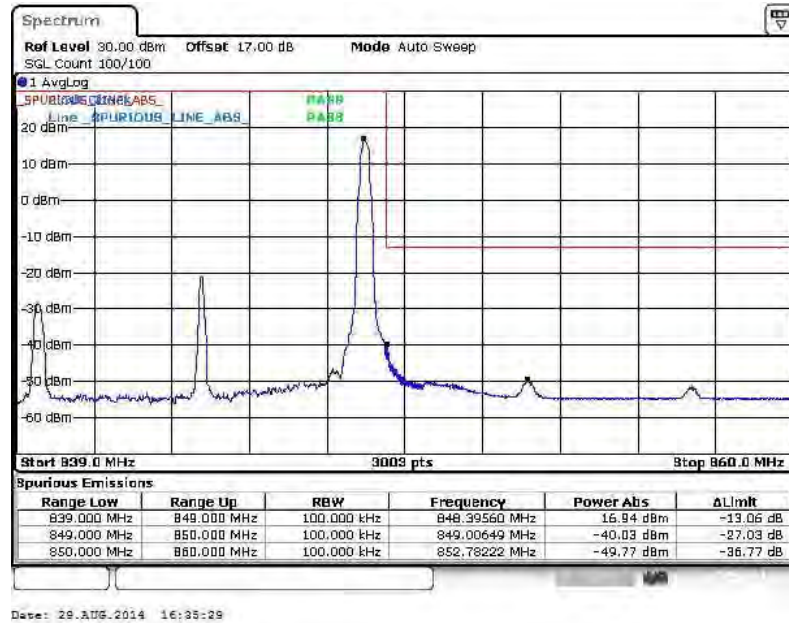

Higher Band Edge Plot for 16QAM -RB Size 50, RB Offset 0

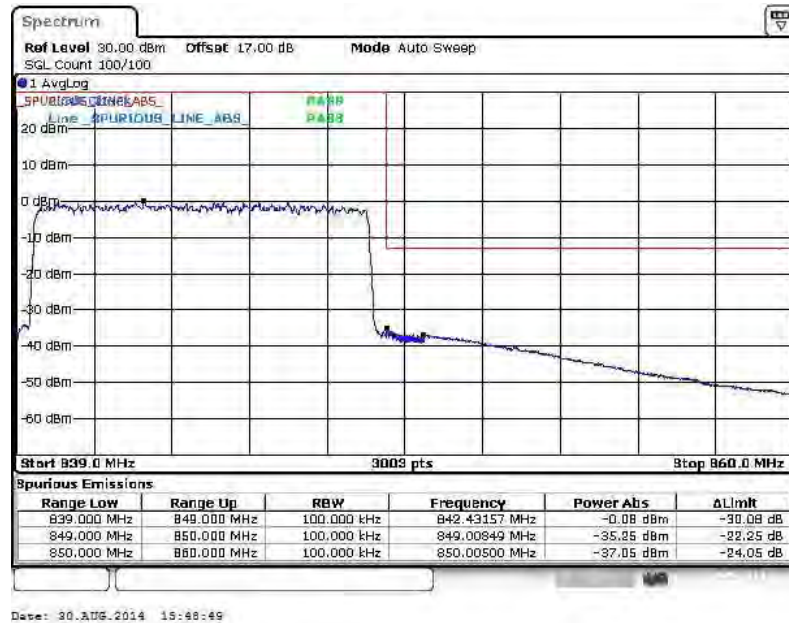



<b>Band :</b>	LTE Band 2	<b>Band Width :</b>	1.4MHz / QPSK
---------------	------------	---------------------	---------------

Lower Band Edge Plot for QPSK-RB Size 1, RB Offset 0

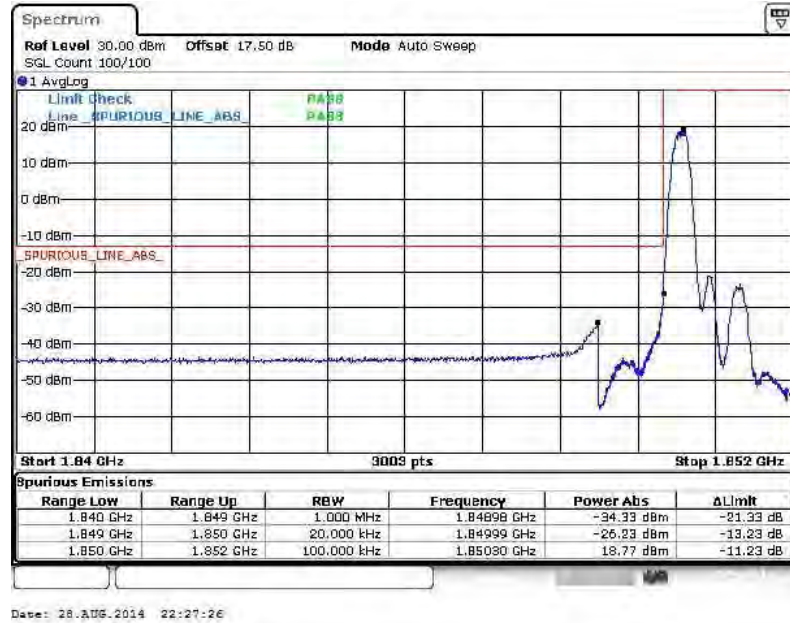

Lower Band Edge Plot for QPSK-RB Size 6, RB Offset 0

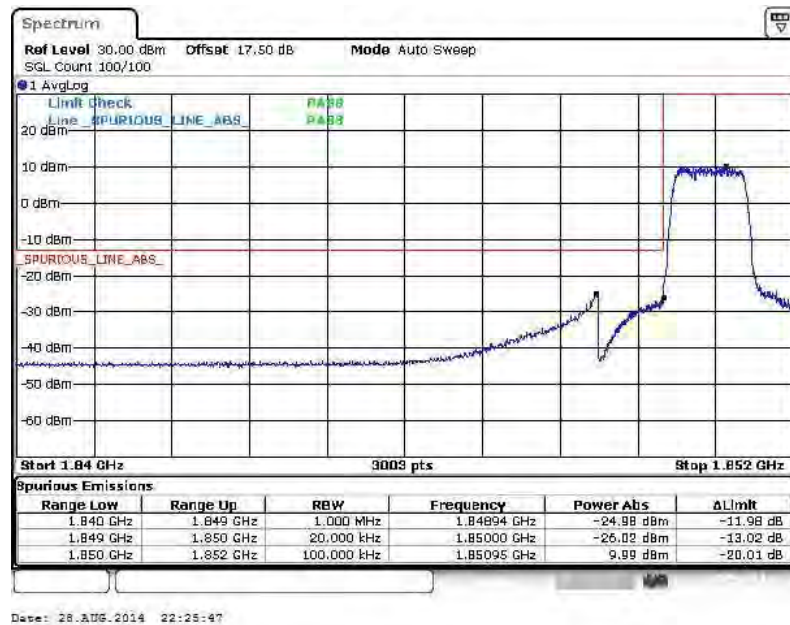



Higher Band Edge Plot for QPSK-RB Size 1, RB Offset 5

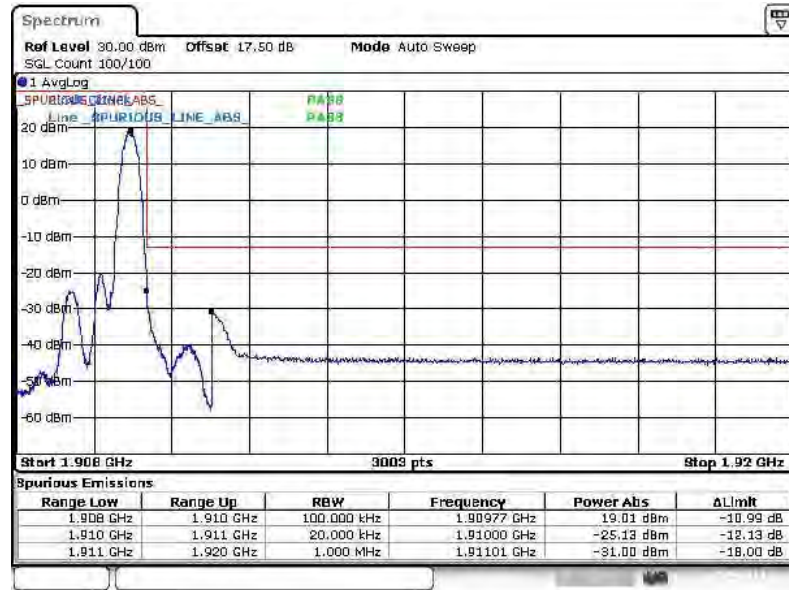

Date: 28.AUG.2014 22:45:03

Higher Band Edge Plot for QPSK-RB Size 6, RB Offset 0

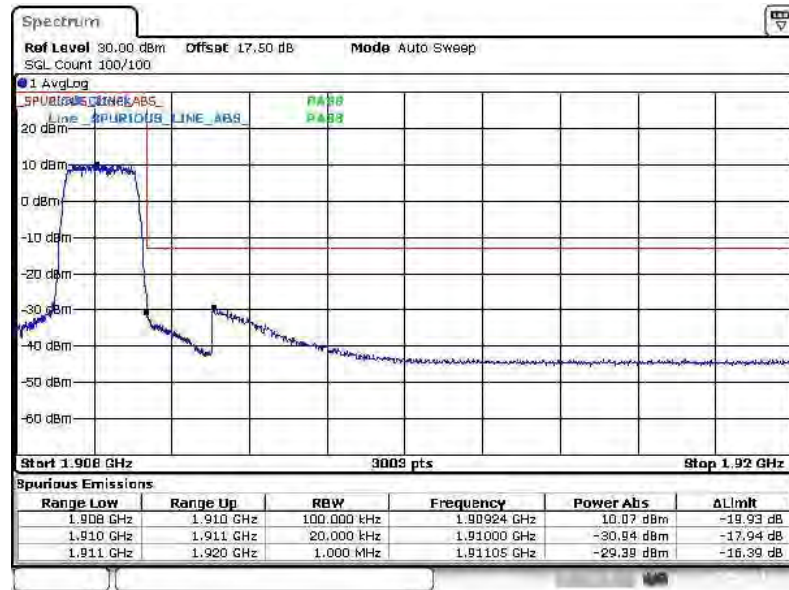

Date: 28.AUG.2014 22:42:13





Band :	LTE Band 2	Band Width :	1.4MHz / 16QAM
--------	------------	--------------	----------------

Lower Band Edge Plot for 16QAM -RB Size 1, RB Offset 0

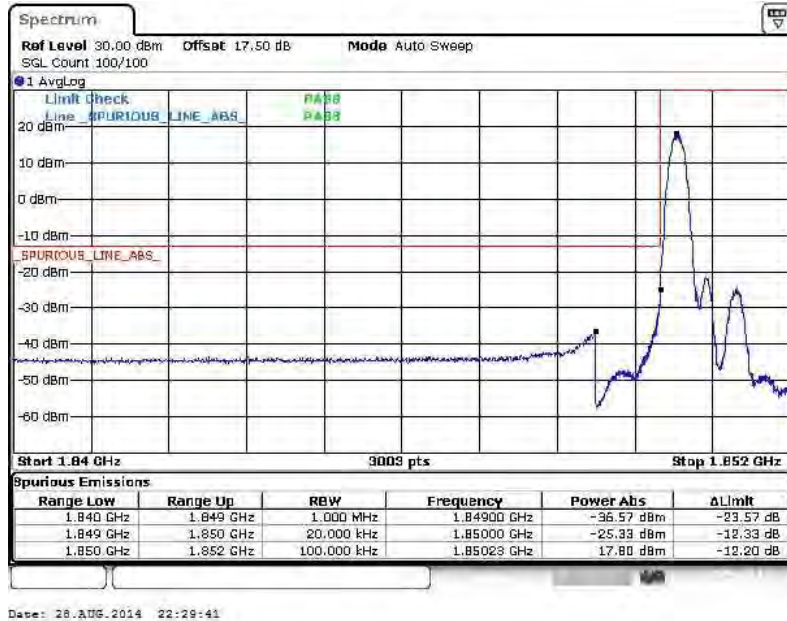

Lower Band Edge Plot for 16QAM -RB Size 6, RB Offset 0

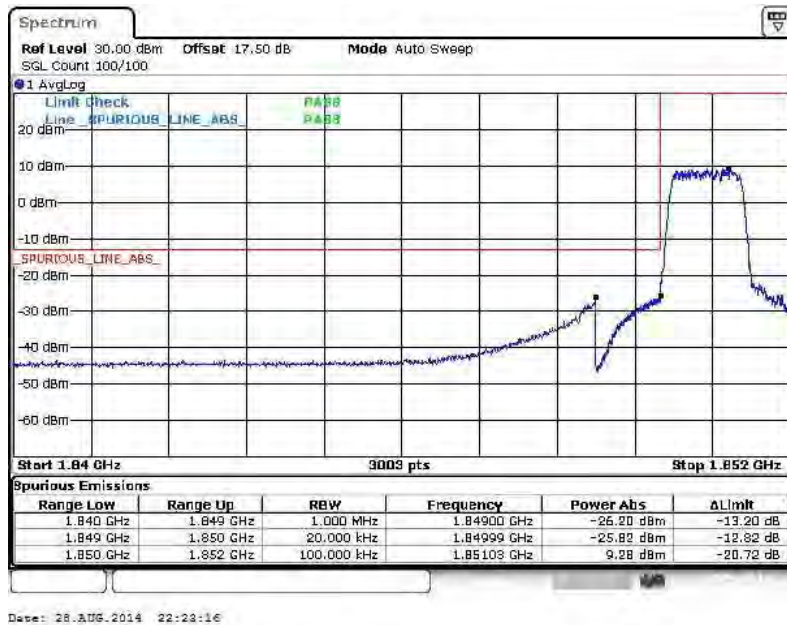





Higher Band Edge Plot for 16QAM -RB Size 1, RB Offset 5

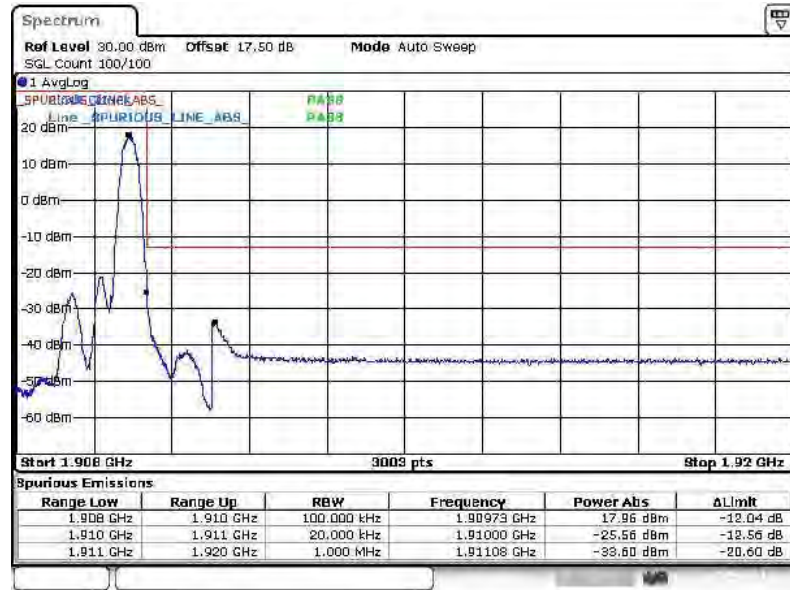

Date: 28.AUG.2014 22:28:26

Higher Band Edge Plot for 16QAM -RB Size 6, RB Offset 0

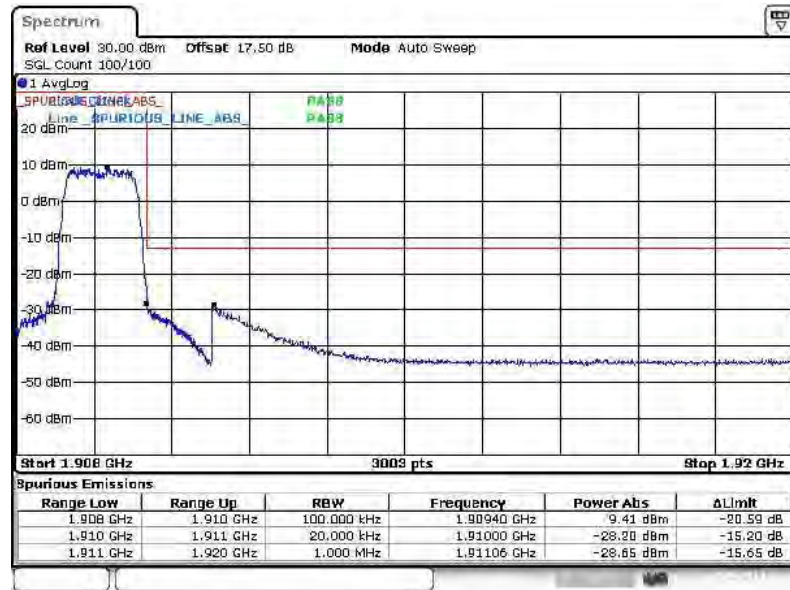

Date: 28.AUG.2014 22:32:08



<b>Band :</b>	LTE Band 2	<b>Band Width :</b>	3MHz / QPSK
---------------	------------	---------------------	-------------

Lower Band Edge Plot for QPSK-RB Size 1, RB Offset 0

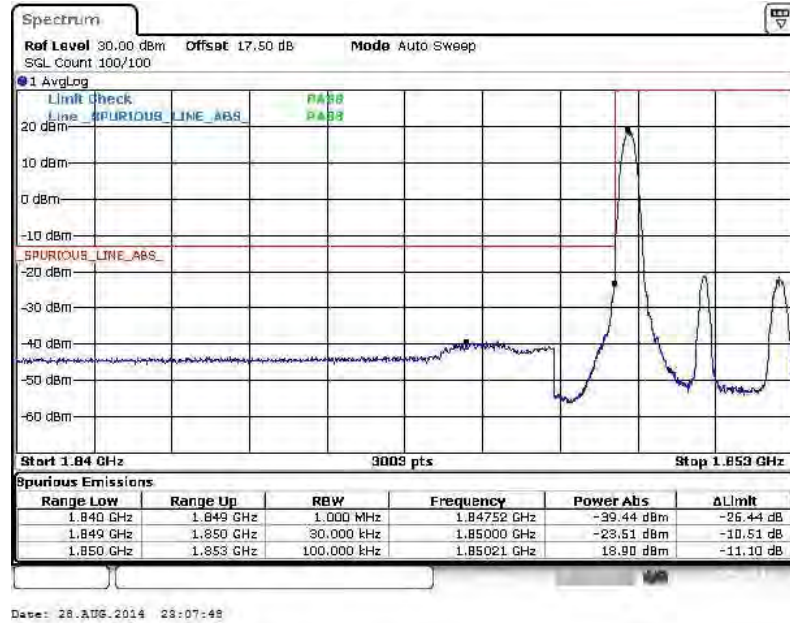

Lower Band Edge Plot for QPSK-RB Size 15, RB Offset 0

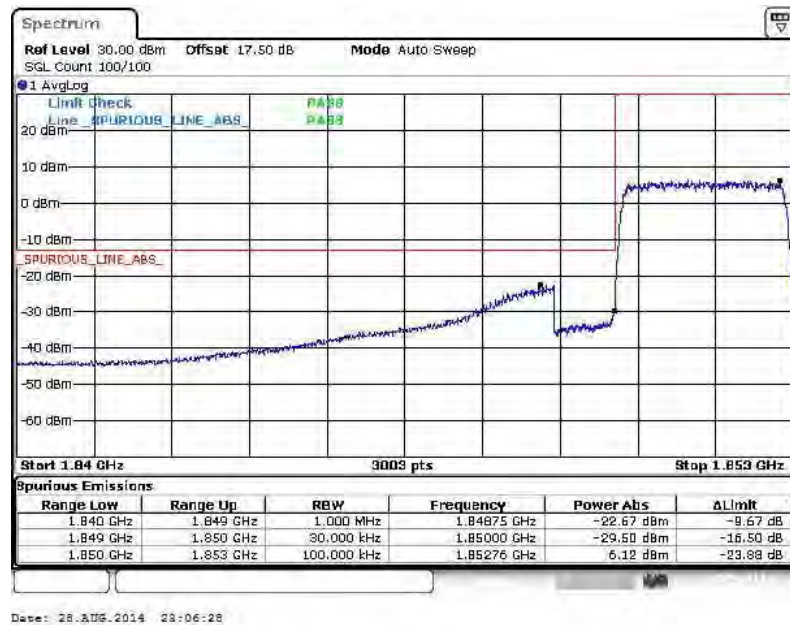



Higher Band Edge Plot for QPSK-RB Size 1, RB Offset 14

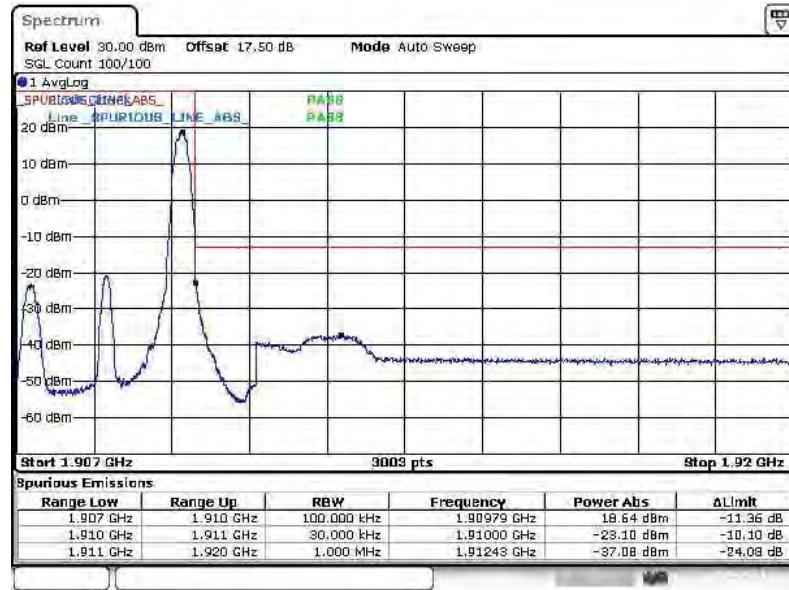

Date: 28.AUG.2014 23:14:18

Higher Band Edge Plot for QPSK-RB Size 15, RB Offset 0

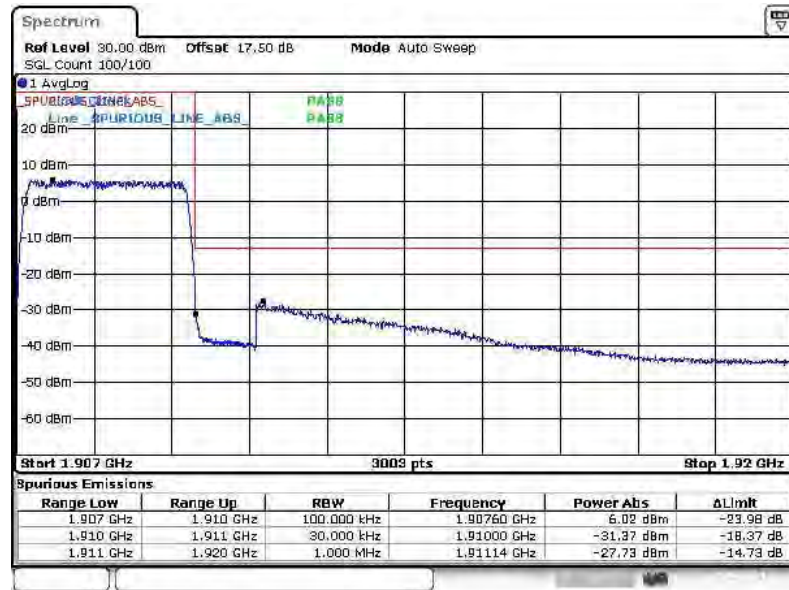

Date: 28.AUG.2014 23:12:26



<b>Band :</b>	LTE Band 2	<b>Band Width :</b>	3MHz / 16QAM
---------------	------------	---------------------	--------------

**Lower Band Edge Plot for 16QAM -RB Size 1, RB Offset 0**

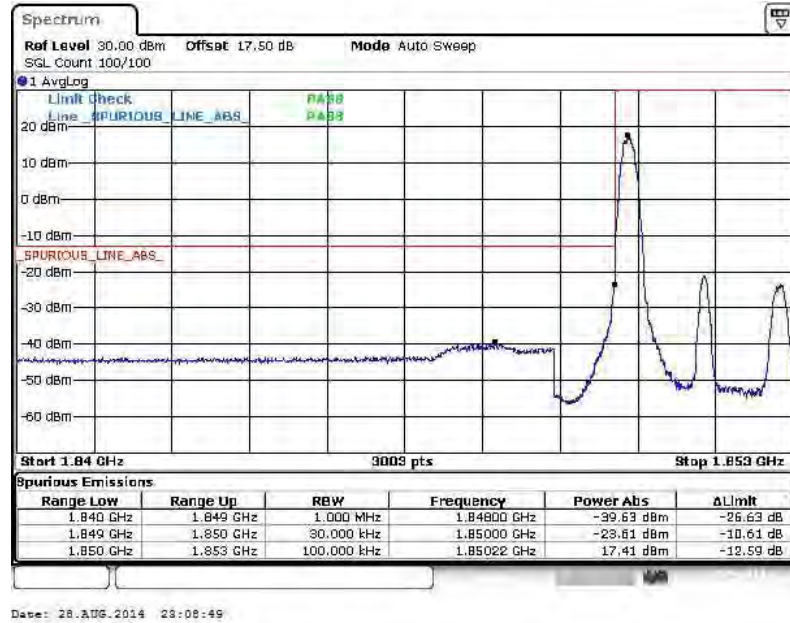

**Lower Band Edge Plot for 16QAM -RB Size 15, RB Offset 0**







Higher Band Edge Plot for 16QAM -RB Size 1, RB Offset 14

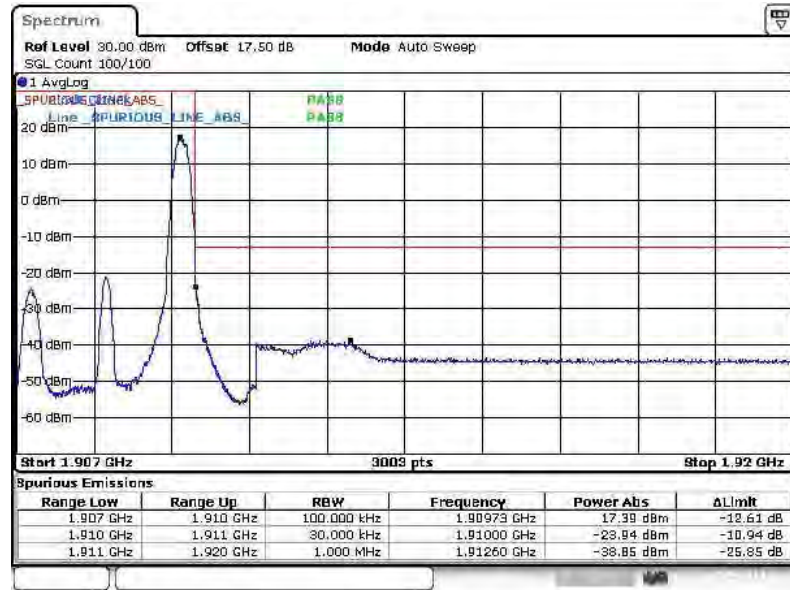

Date: 28.AUG.2014 23:16:02

Higher Band Edge Plot for 16QAM -RB Size 15, RB Offset 0

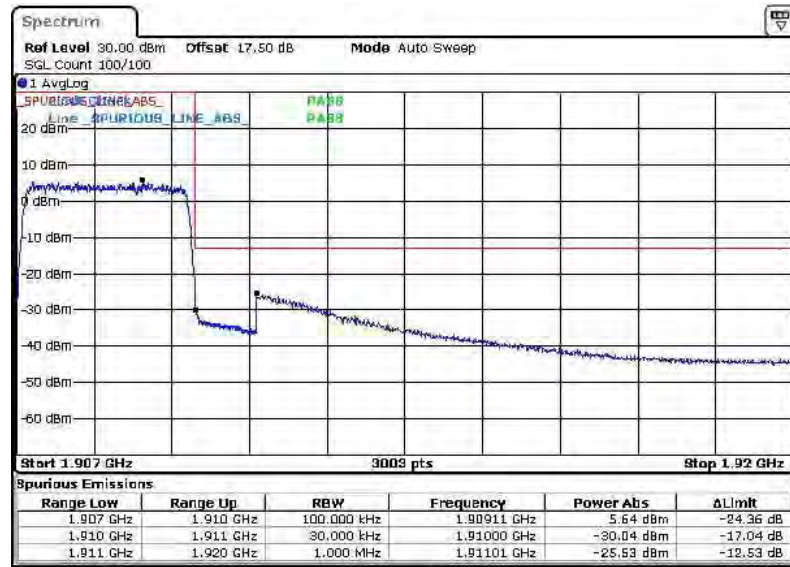

Date: 28.AUG.2014 23:10:33





Band :	LTE Band 2	Band Width :	5MHz / QPSK
--------	------------	--------------	-------------

Lower Band Edge Plot for QPSK-RB Size 1, RB Offset 0

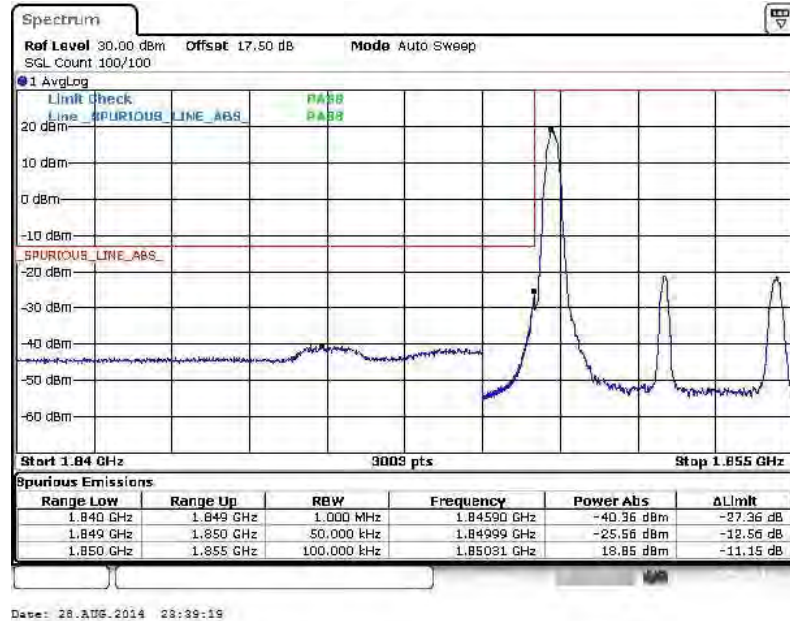

Lower Band Edge Plot for QPSK-RB Size 25, RB Offset 0

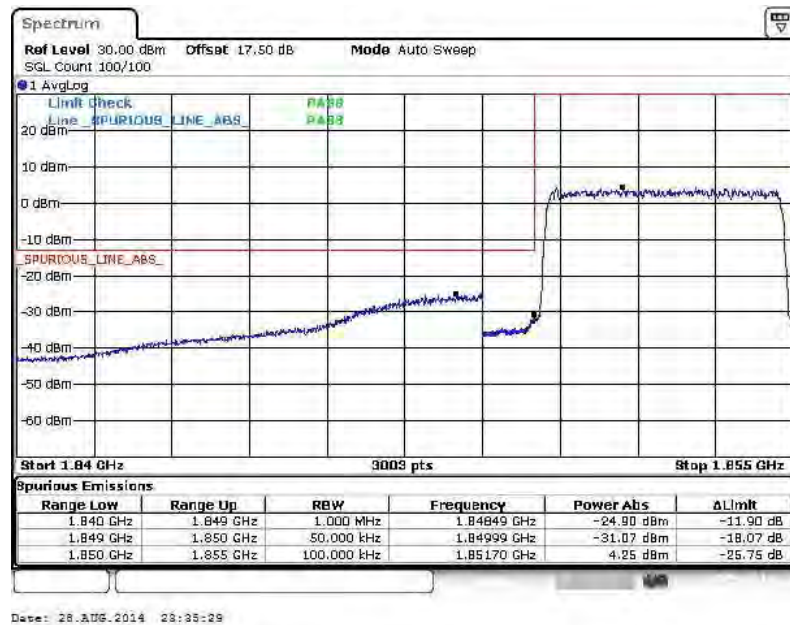



Higher Band Edge Plot for QPSK-RB Size 1, RB Offset 24

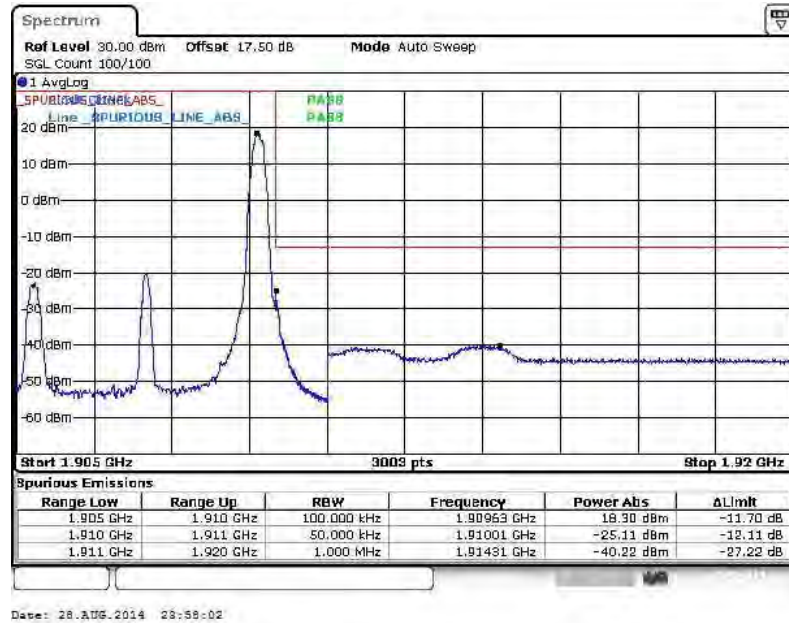

Higher Band Edge Plot for QPSK-RB Size 25, RB Offset 0

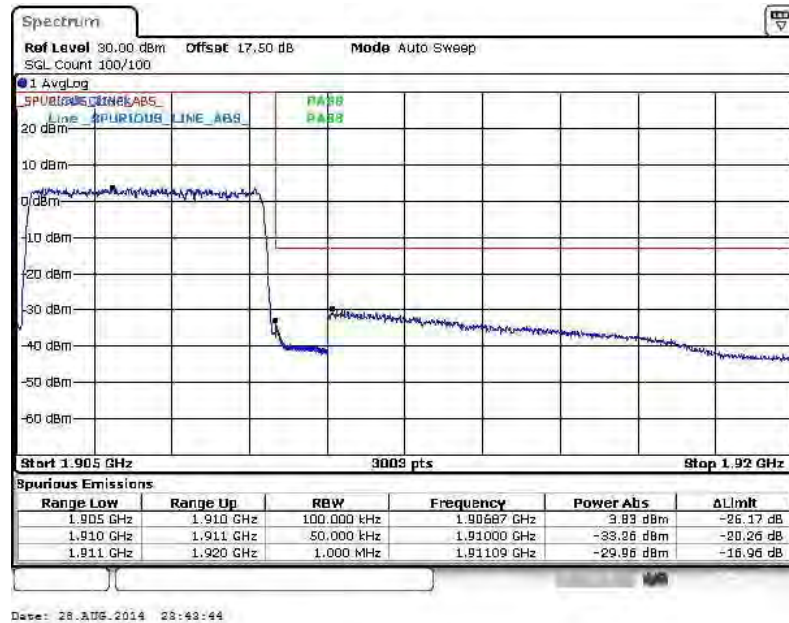



Band :	LTE Band 2	Band Width :	5MHz / 16QAM
--------	------------	--------------	--------------

Lower Band Edge Plot for 16QAM-RB Size 1, RB Offset 0

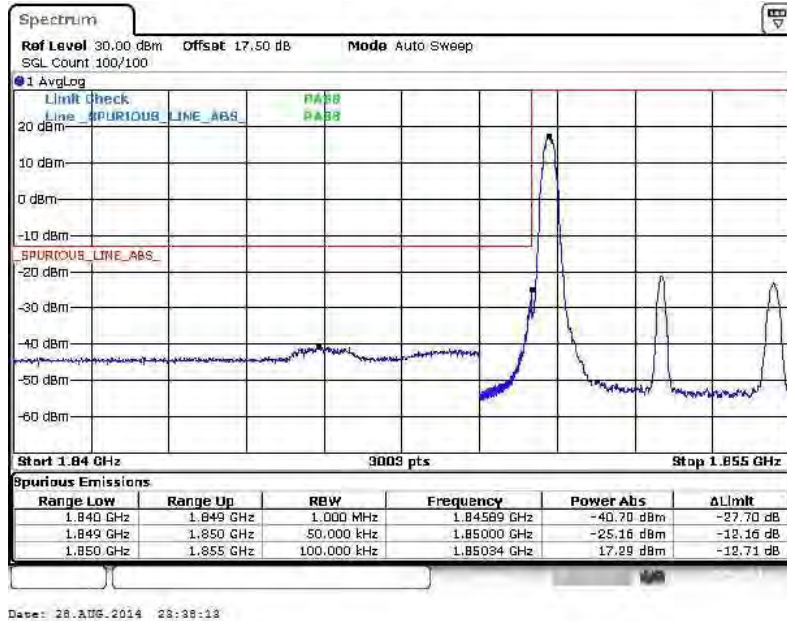

Lower Band Edge Plot for 16QAM-RB Size 25, RB Offset 0

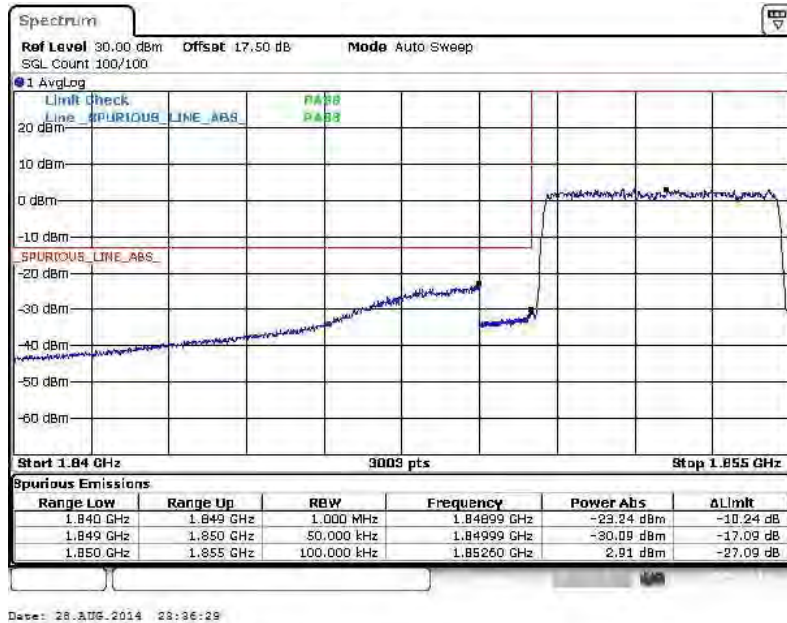



Higher Band Edge Plot for 16QAM-RB Size 1, RB Offset 24

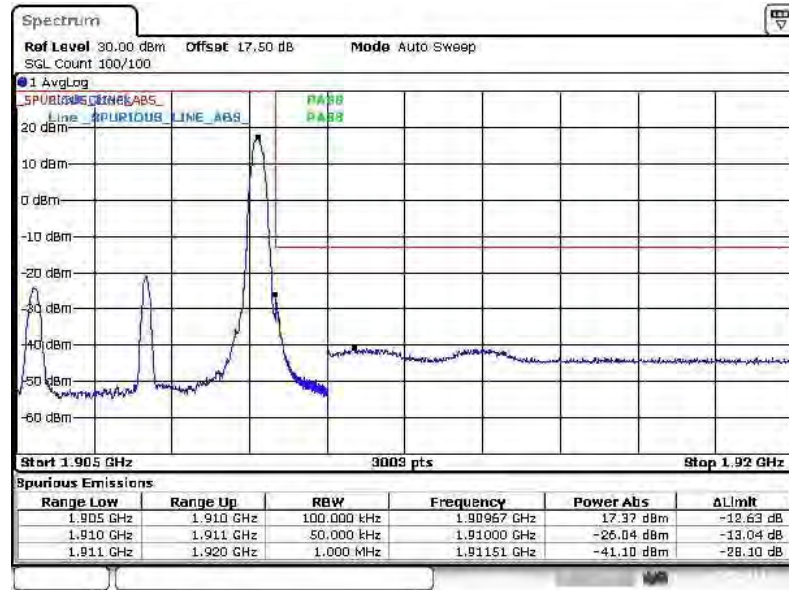

Date: 28.AUG.2014 23:37:00

Higher Band Edge Plot for 16QAM-RB Size 25, RB Offset 0

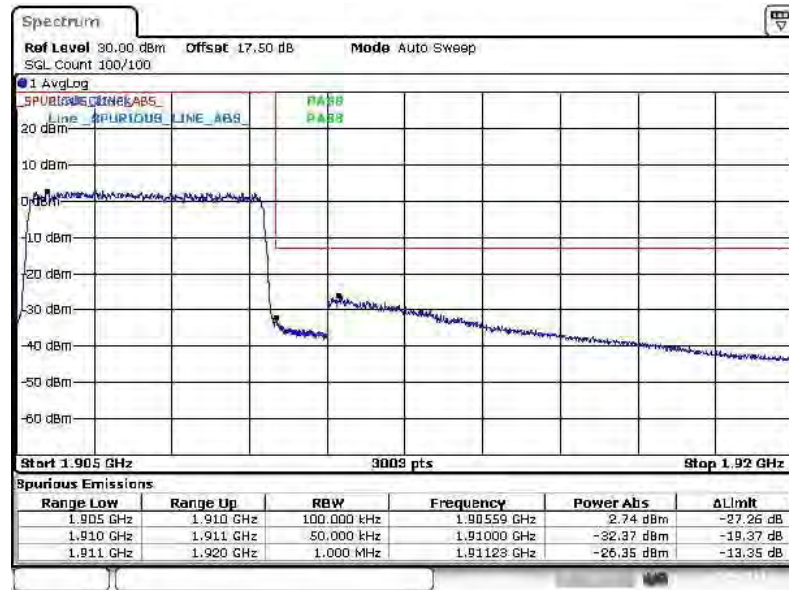

Date: 28.AUG.2014 23:44:51





Band :	LTE Band 2	Band Width :	10MHz / QPSK
--------	------------	--------------	--------------

Lower Band Edge Plot for QPSK-RB Size 1, RB Offset 0

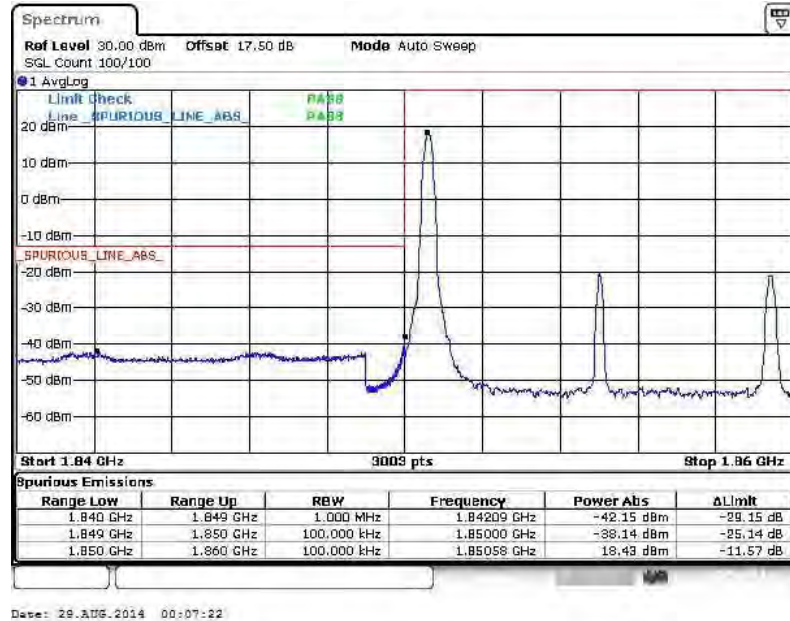

Lower Band Edge Plot for QPSK-RB Size 50, RB Offset 0

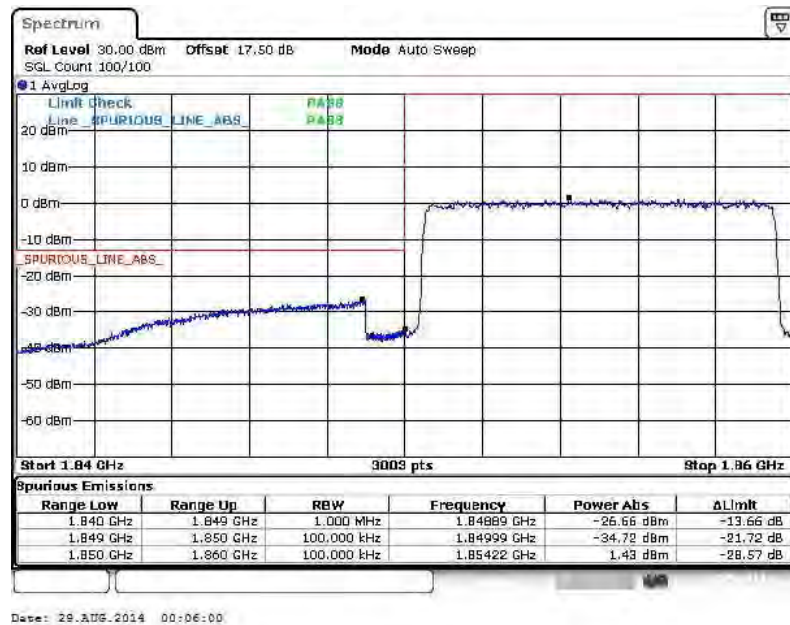





Higher Band Edge Plot for QPSK-RB Size 1, RB Offset 49

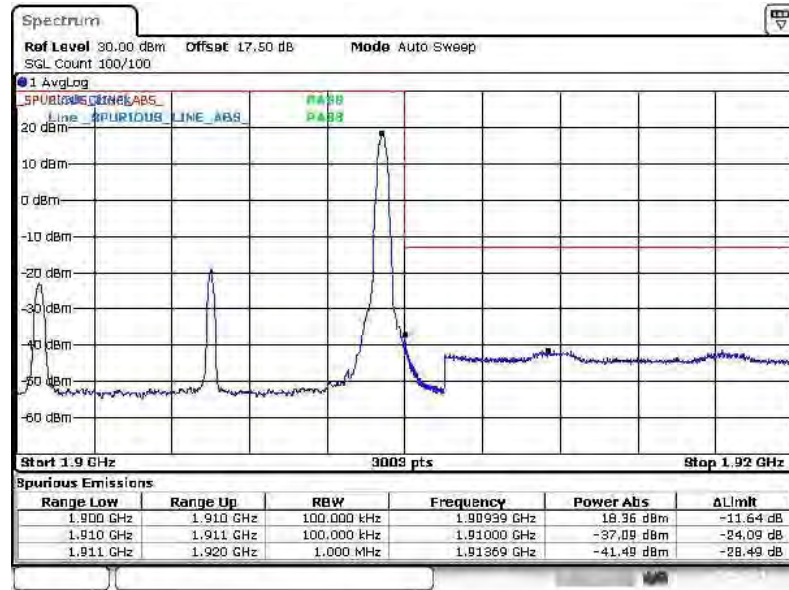

Date: 29.AUG.2014 00:15:13

Higher Band Edge Plot for QPSK-RB Size 50, RB Offset 0

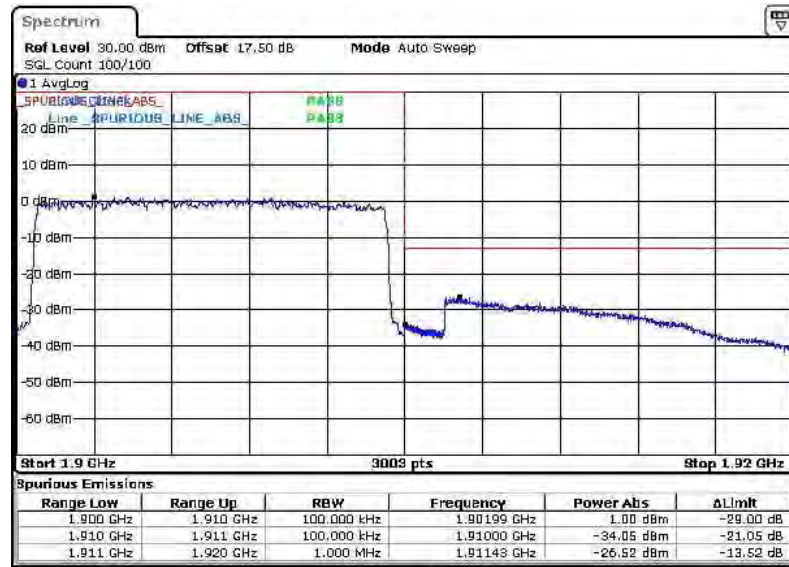

Date: 29.AUG.2014 00:11:22



Band :	LTE Band 2	Band Width :	10MHz / 16QAM
--------	------------	--------------	---------------

Lower Band Edge Plot for 16QAM-RB Size 1, RB Offset 0

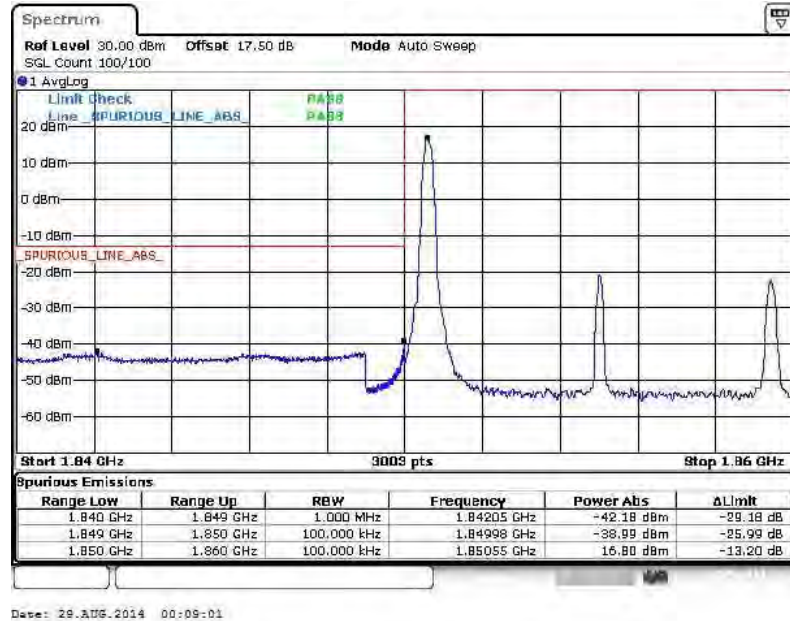

Lower Band Edge Plot for 16QAM-RB Size 50, RB Offset 0

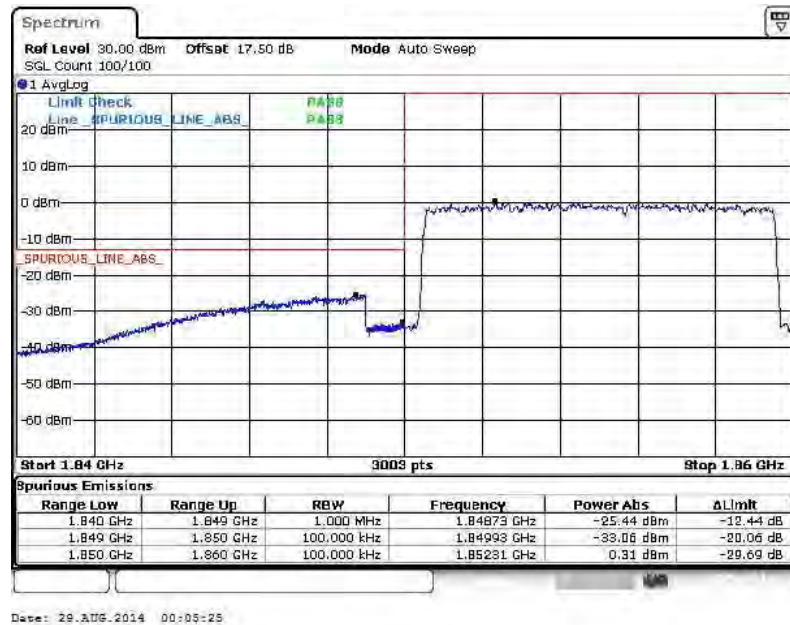



Higher Band Edge Plot for 16QAM-RB Size 1, RB Offset 49

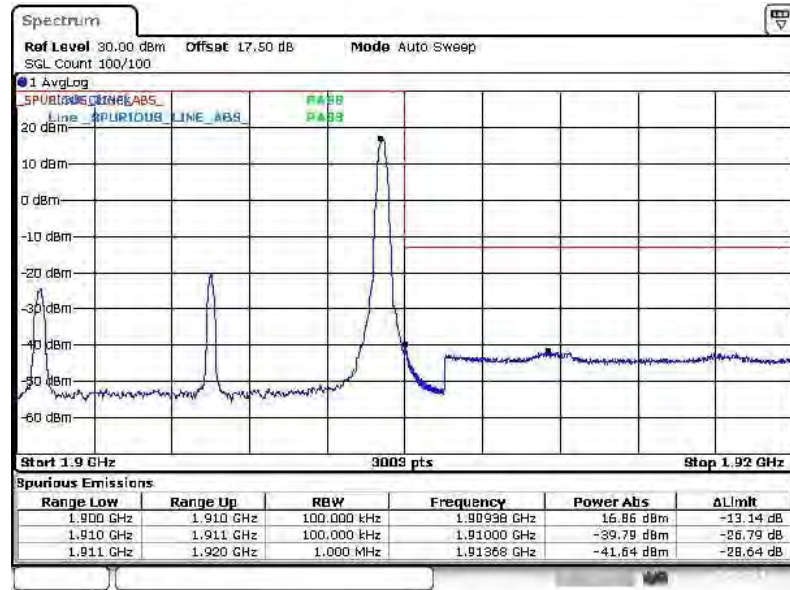

Date: 29.AUG.2014 00:22:41

Higher Band Edge Plot for 16QAM-RB Size 50, RB Offset 0

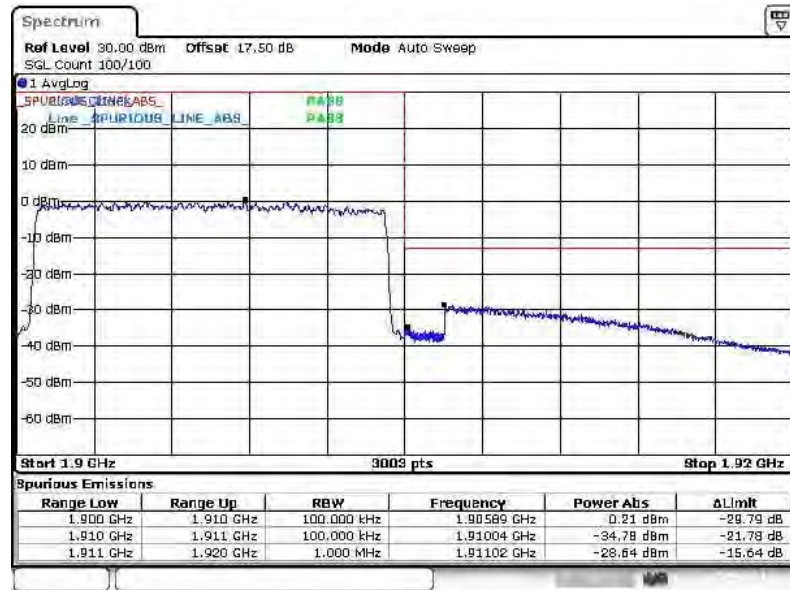

Date: 29.AUG.2014 00:10:26



<b>Band :</b>	LTE Band 2	<b>Band Width :</b>	15MHz / QPSK
---------------	------------	---------------------	--------------

Lower Band Edge Plot for QPSK-RB Size 1, RB Offset 0

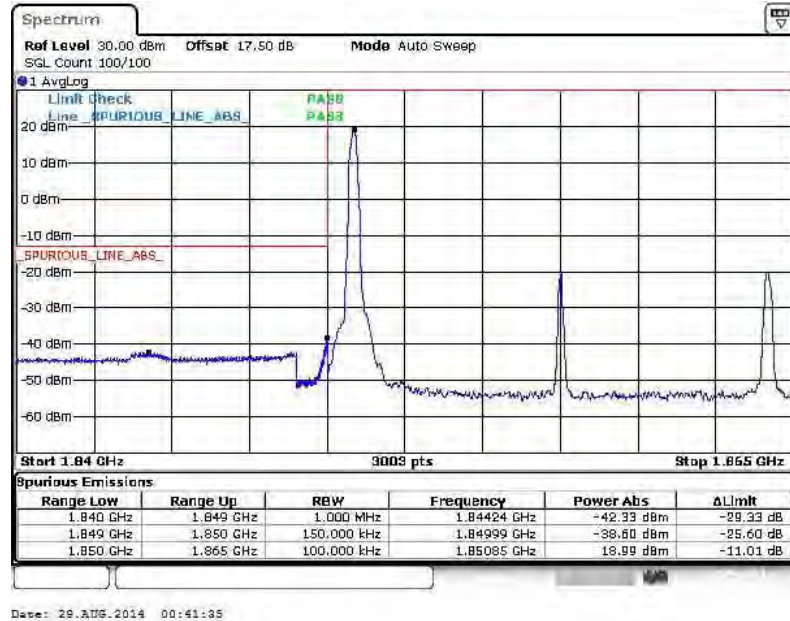

Lower Band Edge Plot for QPSK-RB Size 75, RB Offset 0

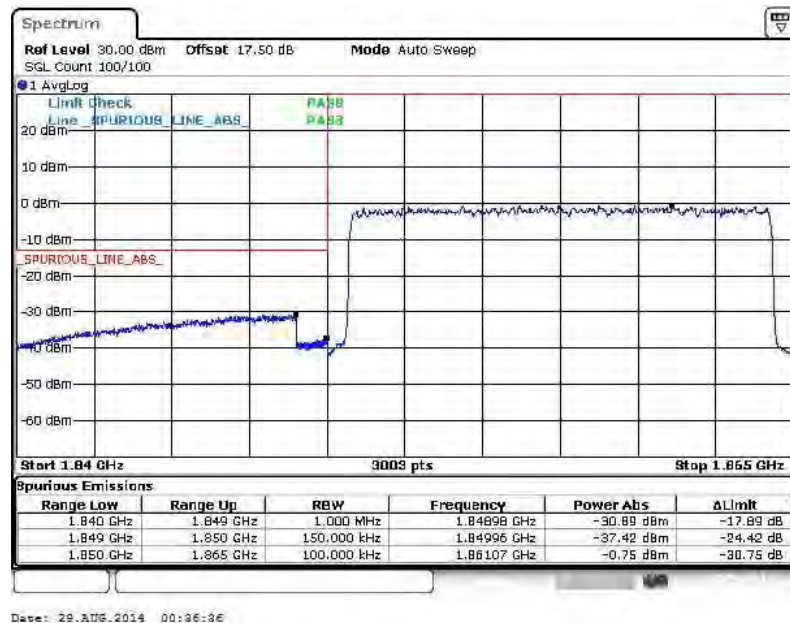





Higher Band Edge Plot for QPSK-RB Size 1, RB Offset 74

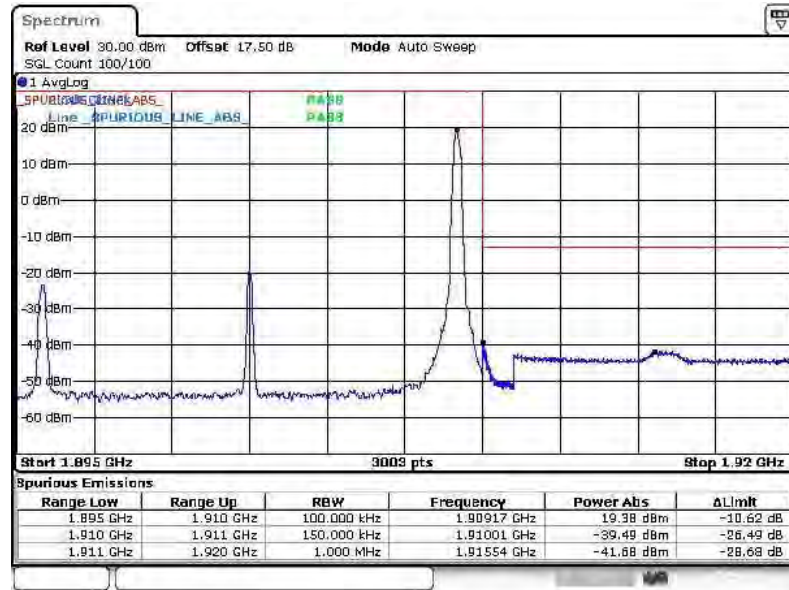

Date: 29.AUG.2014 00:46:14

Higher Band Edge Plot for QPSK-RB Size 75, RB Offset 0

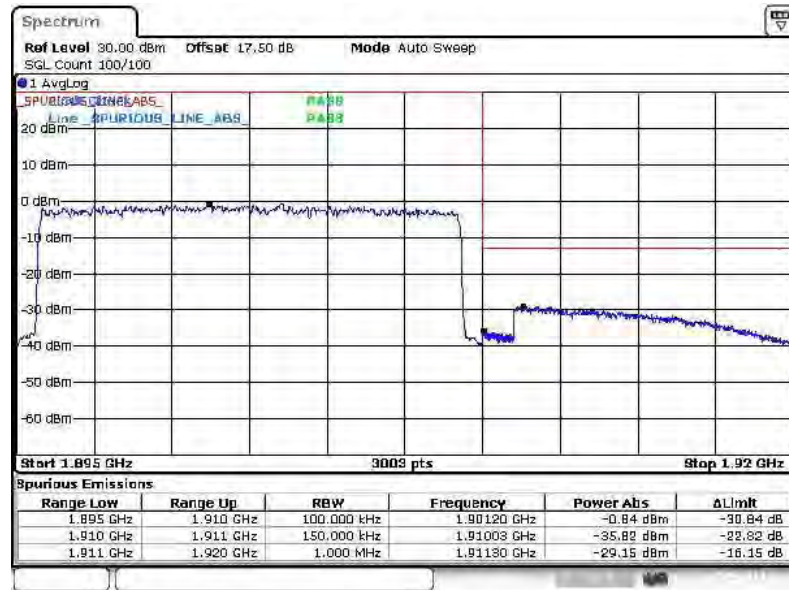

Date: 29.AUG.2014 00:42:52



Band :	LTE Band 2	Band Width :	15MHz / 16QAM
--------	------------	--------------	---------------

Lower Band Edge Plot for 16QAM-RB Size 1, RB Offset 0

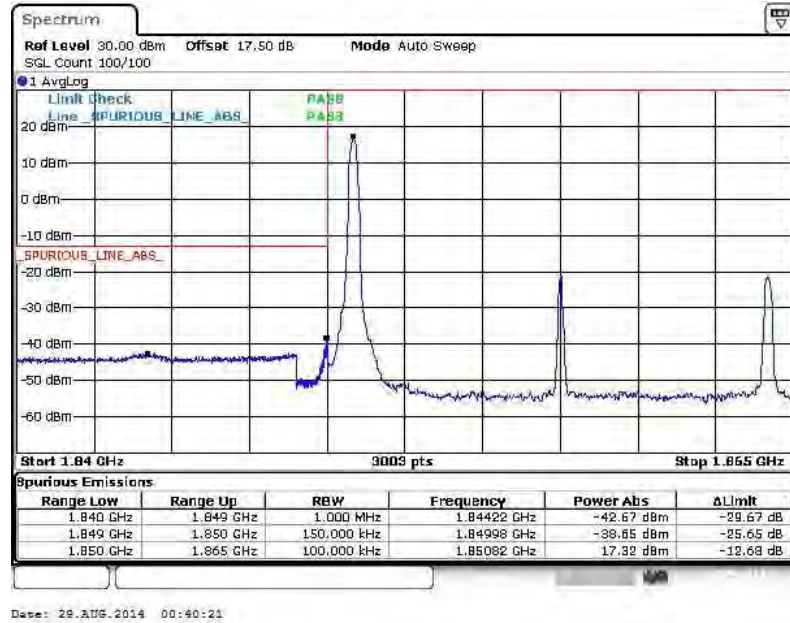

Lower Band Edge Plot for 16QAM-RB Size 75, RB Offset 0

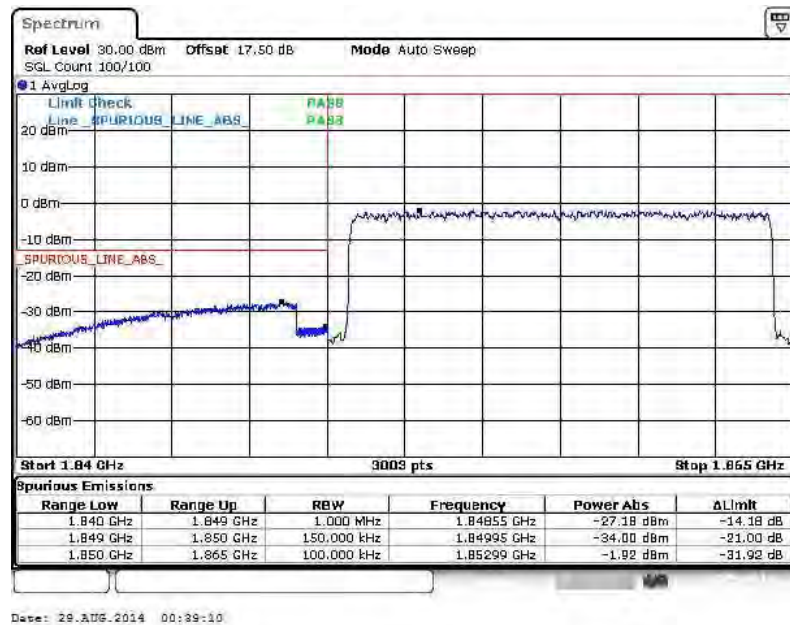



Higher Band Edge Plot for 16QAM-RB Size 1, RB Offset 74

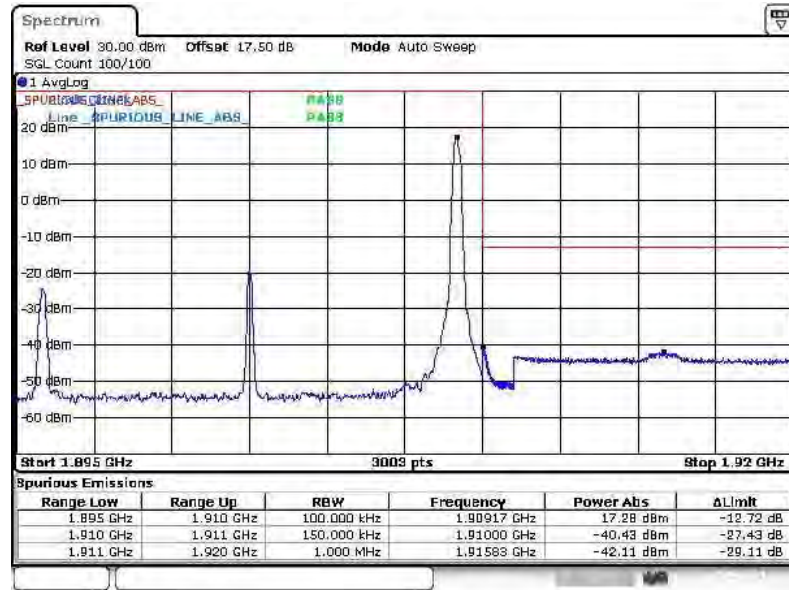

Date: 29.AUG.2014 00:45:11

Higher Band Edge Plot for 16QAM-RB Size 75, RB Offset 0

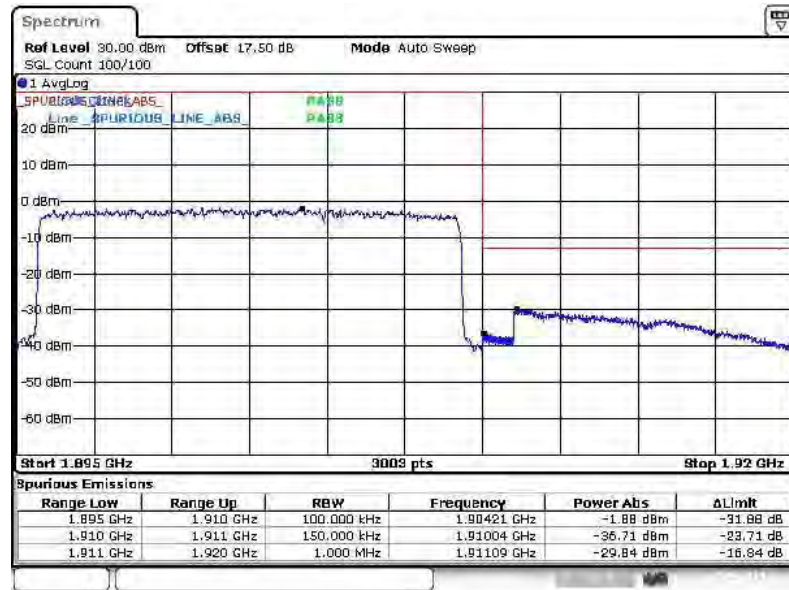

Date: 29.AUG.2014 00:43:53



<b>Band :</b>	LTE Band 2	<b>Band Width :</b>	20MHz / QPSK
---------------	------------	---------------------	--------------

Lower Band Edge Plot for QPSK-RB Size 1, RB Offset 0

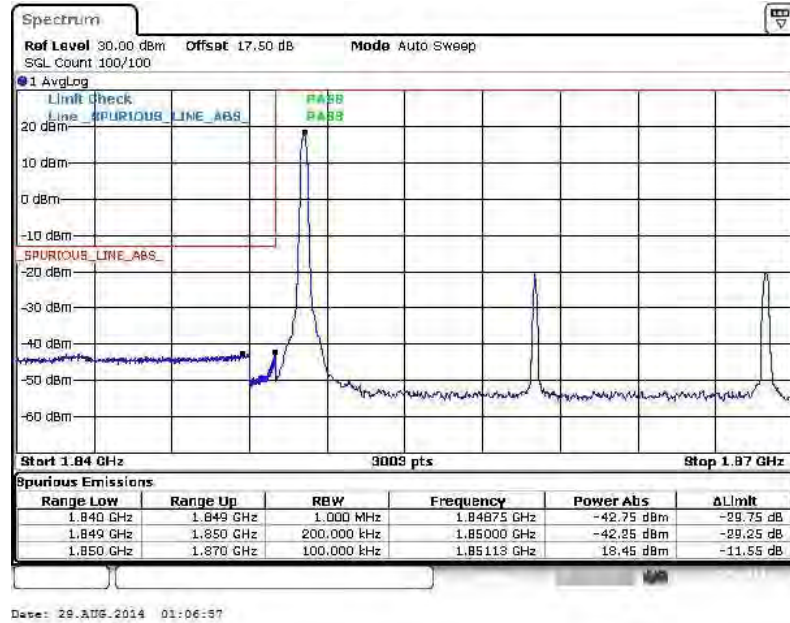

Lower Band Edge Plot for QPSK-RB Size 100, RB Offset 0

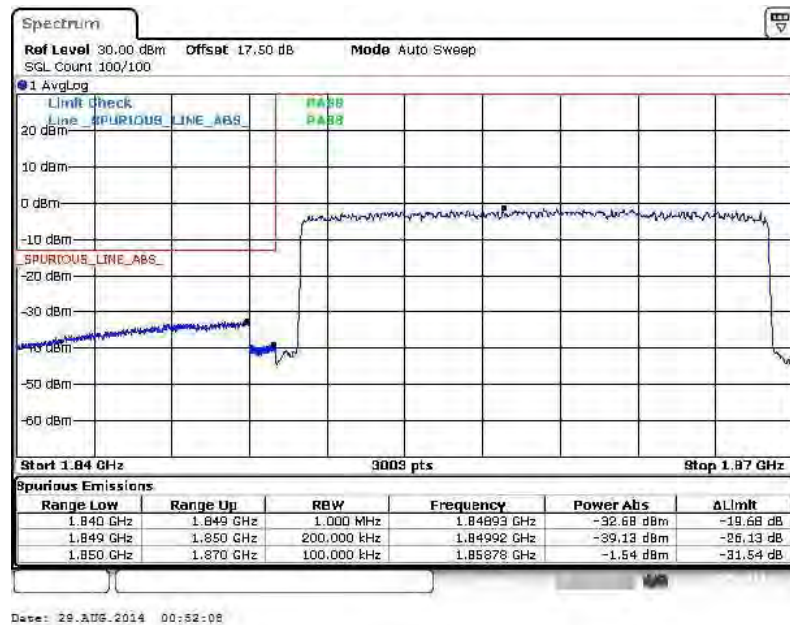





Higher Band Edge Plot for QPSK-RB Size 1, RB Offset 99

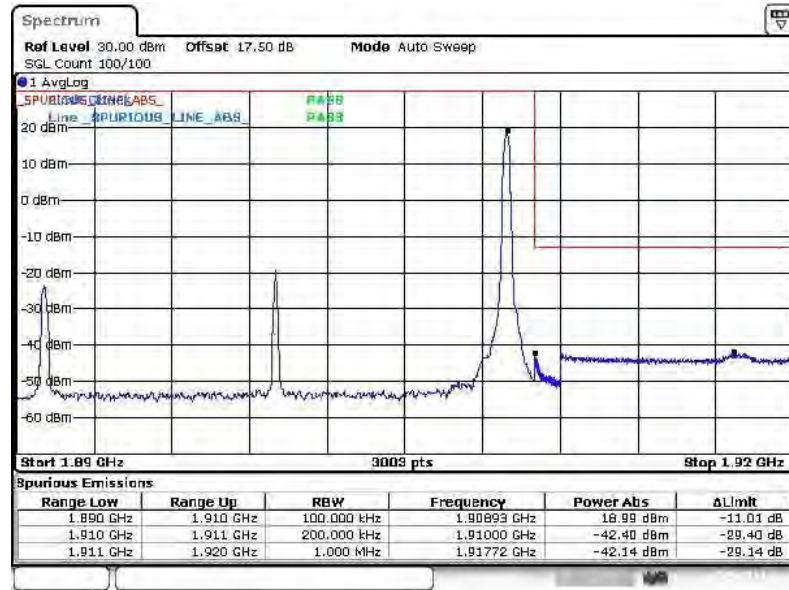

Date: 29.AUG.2014 01:34:52

Higher Band Edge Plot for QPSK-RB Size 100, RB Offset 0

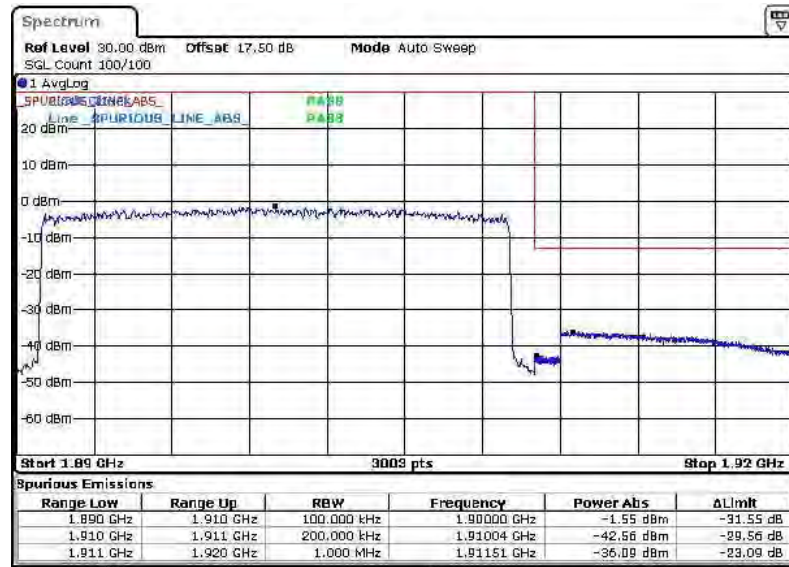

Date: 29.AUG.2014 01:36:38



<b>Band :</b>	LTE Band 2	<b>Band Width :</b>	20MHz / 16QAM
---------------	------------	---------------------	---------------

Lower Band Edge Plot for 16QAM-RB Size 1, RB Offset 0

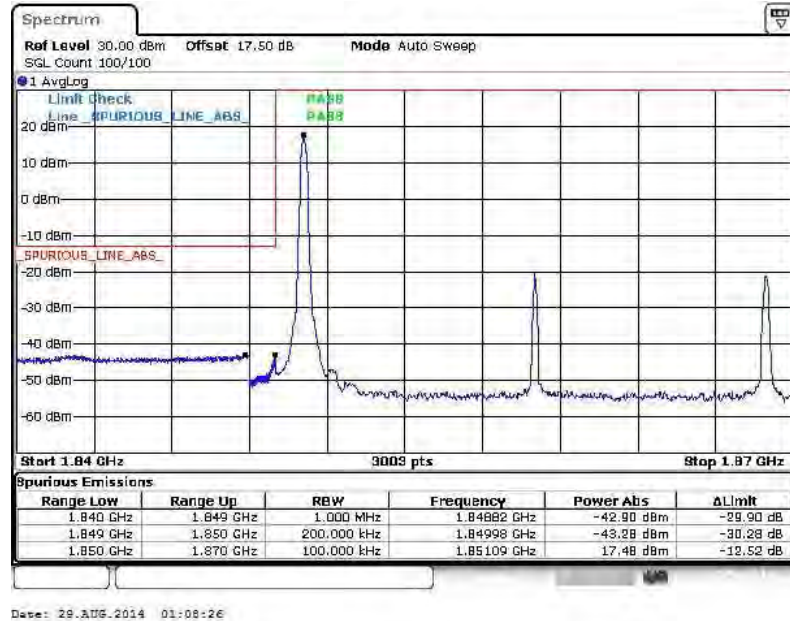

Lower Band Edge Plot for 16QAM-RB Size 100, RB Offset 0

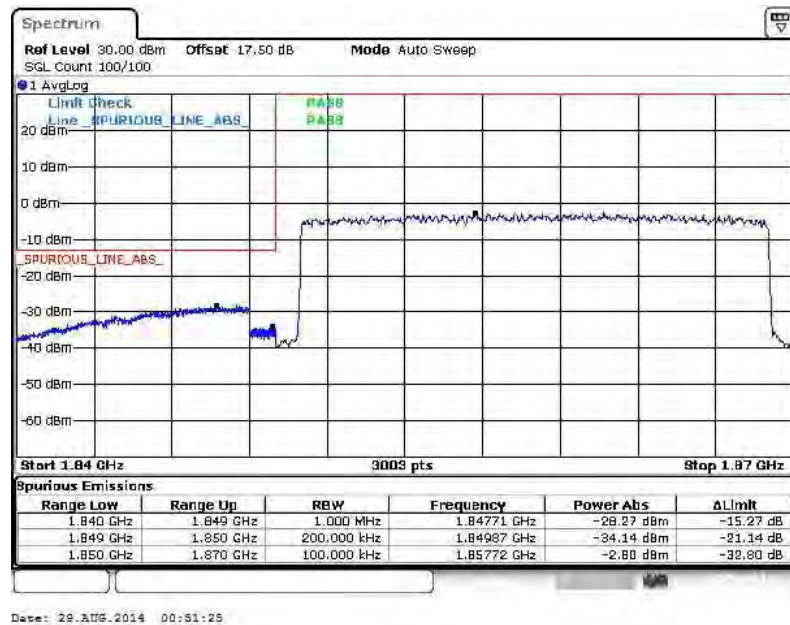



Higher Band Edge Plot for 16QAM-RB Size 1, RB Offset 99

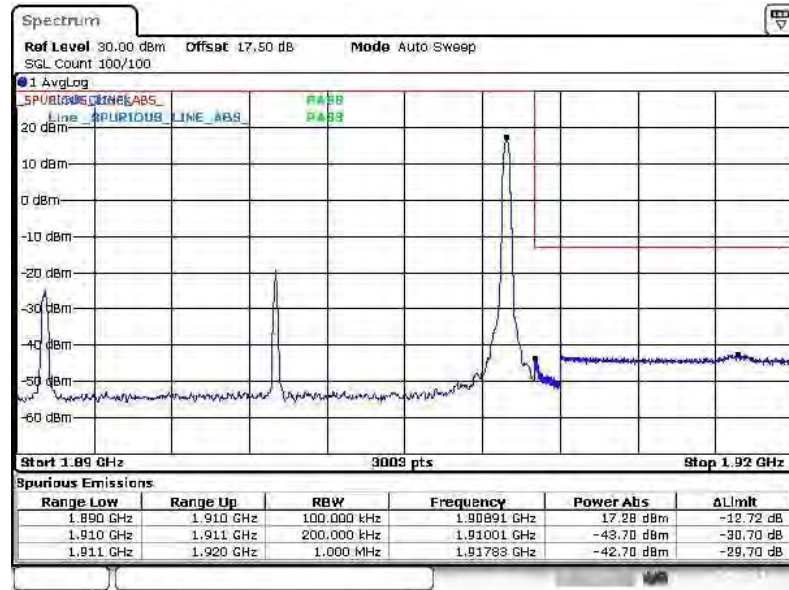

Date: 29.AUG.2014 01:12:57

Higher Band Edge Plot for 16QAM-RB Size 100, RB Offset 0

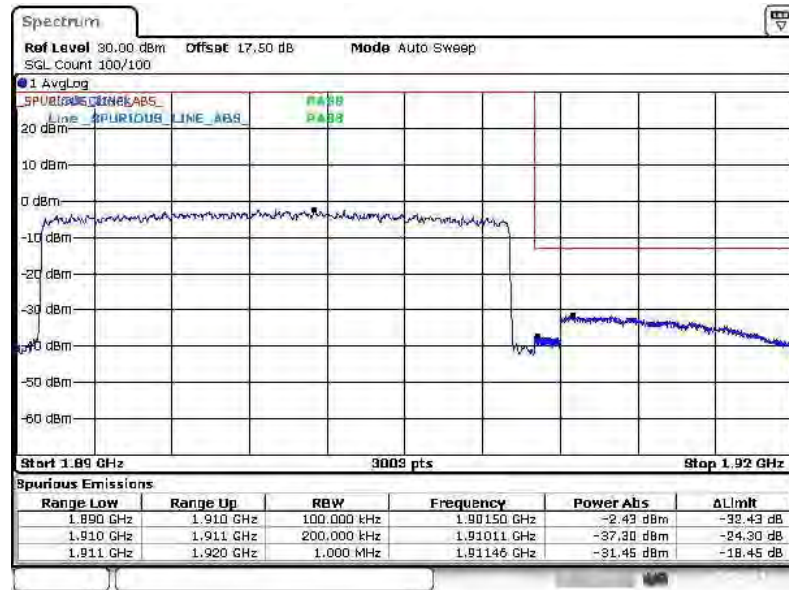

Date: 29.AUG.2014 01:37:23



Band :	LTE Band 4	Band Width :	1.4MHz / QPSK
--------	------------	--------------	---------------

Lower Band Edge Plot for QPSK-RB Size 1, RB Offset 0



Lower Band Edge Plot for QPSK-RB Size 6, RB Offset 0







Higher Band Edge Plot for QPSK-RB Size 1, RB Offset 5

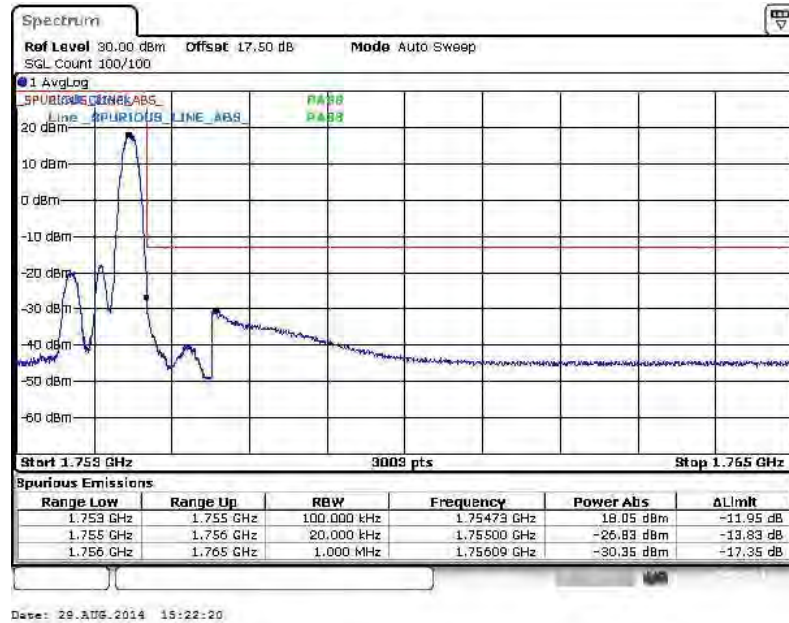

Higher Band Edge Plot for QPSK-RB Size 6, RB Offset 0

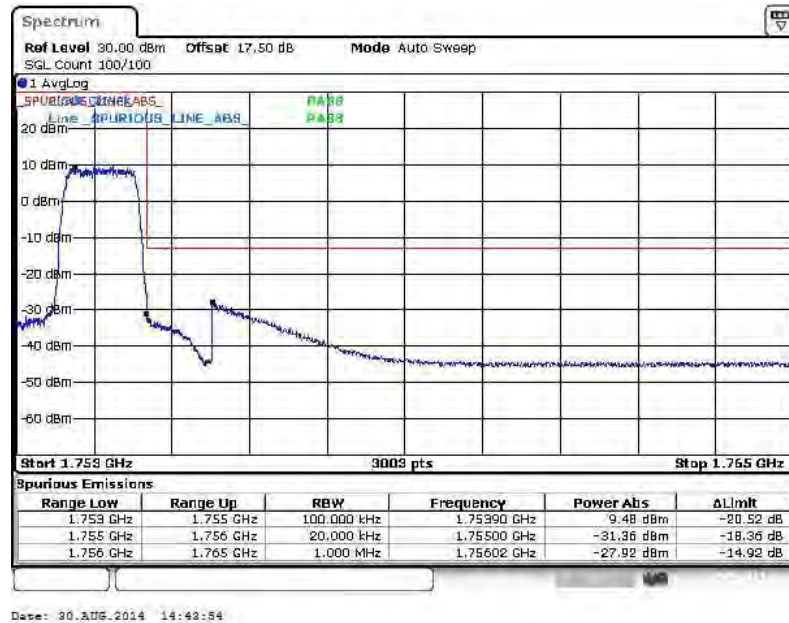



<b>Band :</b>	LTE Band 4	<b>Band Width :</b>	1.4MHz / 16QAM
---------------	------------	---------------------	----------------

Lower Band Edge Plot for 16QAM -RB Size 1, RB Offset 0

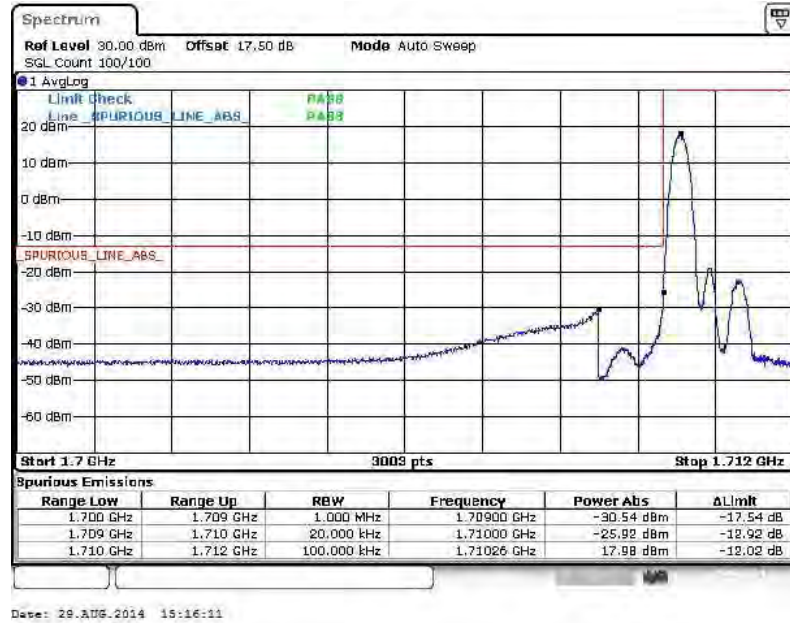

Lower Band Edge Plot for 16QAM-RB Size 6, RB Offset 0





Higher Band Edge Plot for 16QAM-RB Size 1, RB Offset 5

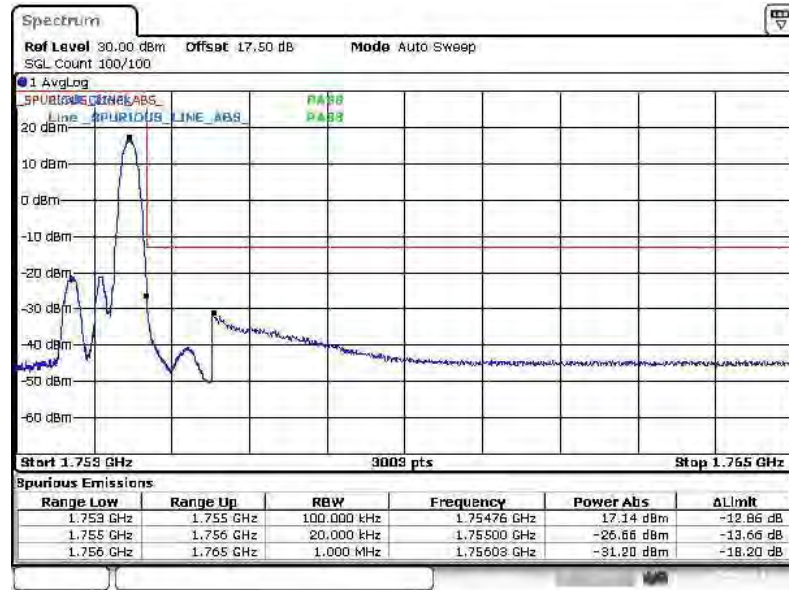

Date: 29.AUG.2014 15:17:41

Higher Band Edge Plot for 16QAM-RB Size 6, RB Offset 0



Date: 30.AUG.2014 14:41:24



<b>Band :</b>	LTE Band 4	<b>Band Width :</b>	3MHz / QPSK
---------------	------------	---------------------	-------------

**Lower Band Edge Plot for QPSK-RB Size 1, RB Offset 0**

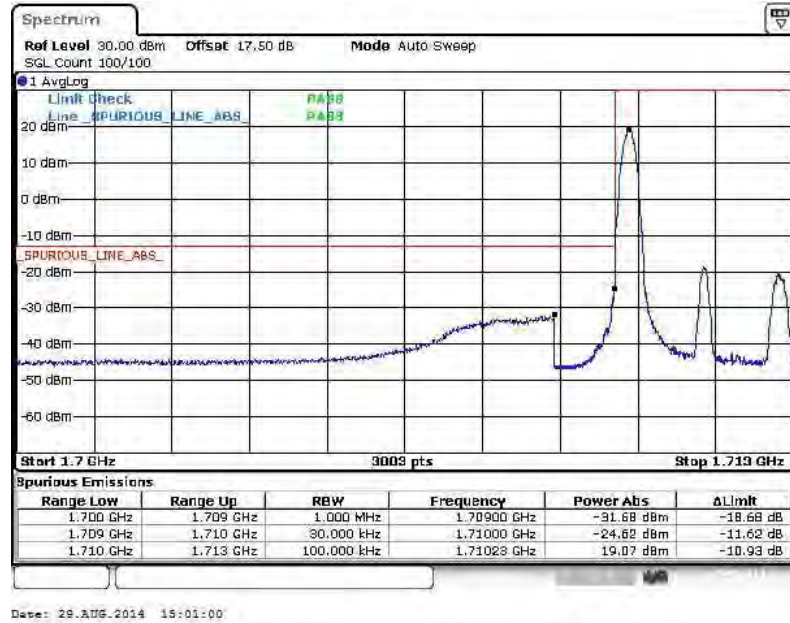

**Lower Band Edge Plot for QPSK-RB Size 15, RB Offset 0**







Higher Band Edge Plot for QPSK-RB Size 1, RB Offset 14

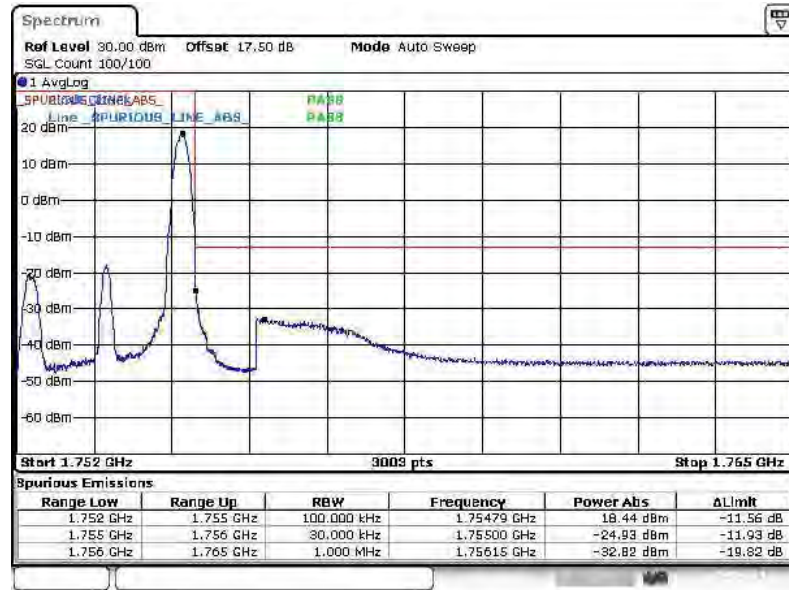

Date: 29.AUG.2014 15:06:23

Higher Band Edge Plot for QPSK-RB Size 15, RB Offset 0

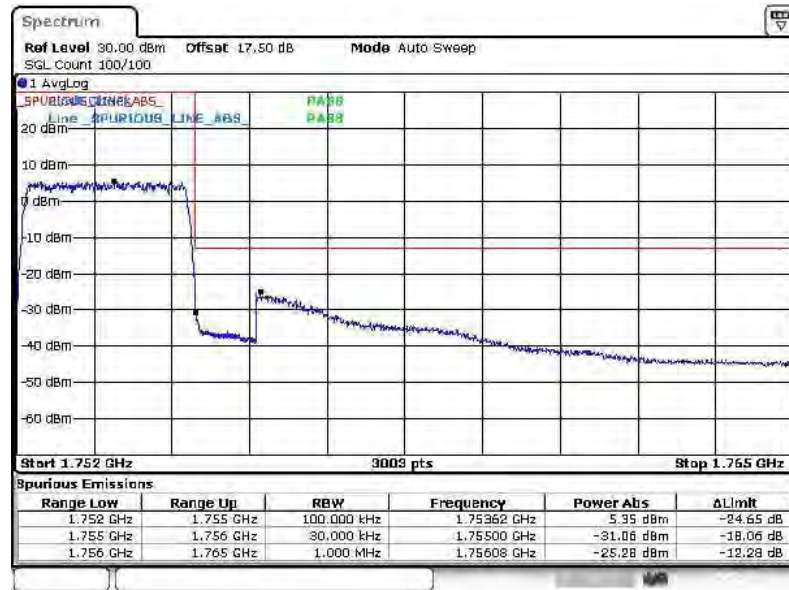

Date: 30.AUG.2014 14:51:24



<b>Band :</b>	LTE Band 4	<b>Band Width :</b>	3MHz / 16QAM
---------------	------------	---------------------	--------------

**Lower Band Edge Plot for 16QAM-RB Size 1, RB Offset 0**

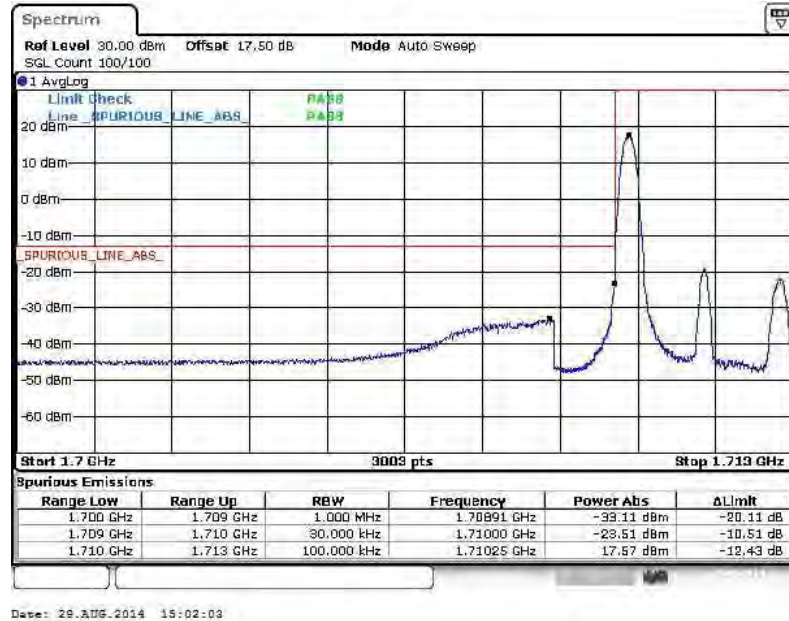

**Lower Band Edge Plot for 16QAM-RB Size 15, RB Offset 0**





Higher Band Edge Plot for 16QAM-RB Size 1, RB Offset 14

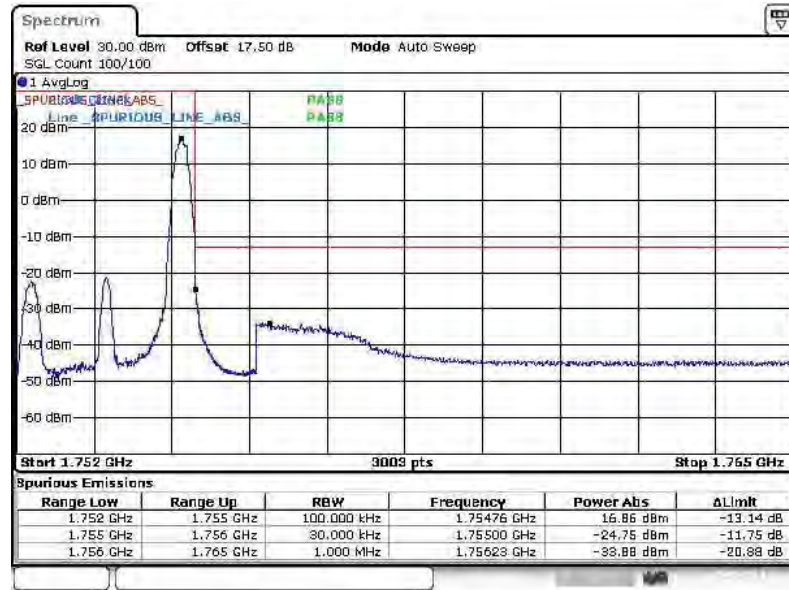

Date: 29.AUG.2014 15:03:45

Higher Band Edge Plot for 16QAM-RB Size 15, RB Offset 0

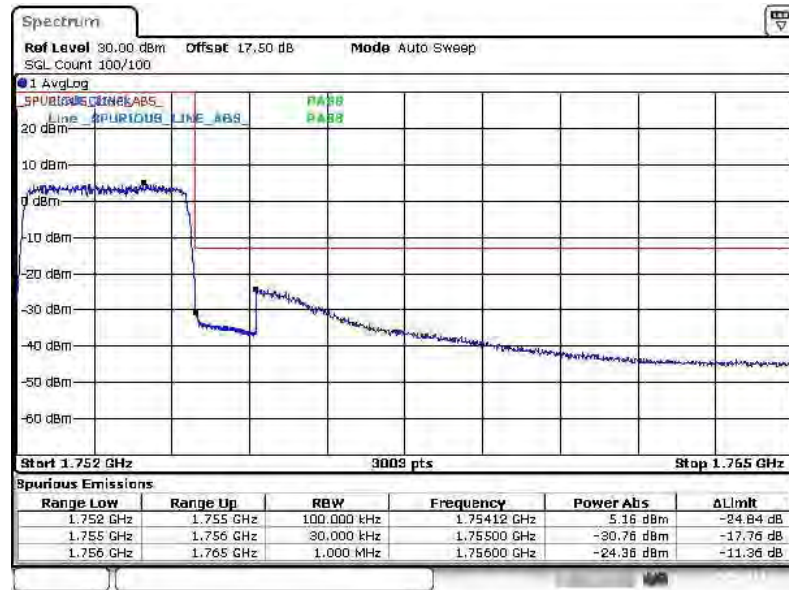

Date: 30.AUG.2014 14:49:42



<b>Band :</b>	LTE Band 4	<b>Band Width :</b>	5MHz / QPSK
---------------	------------	---------------------	-------------

Lower Band Edge Plot for QPSK-RB Size 1, RB Offset 0

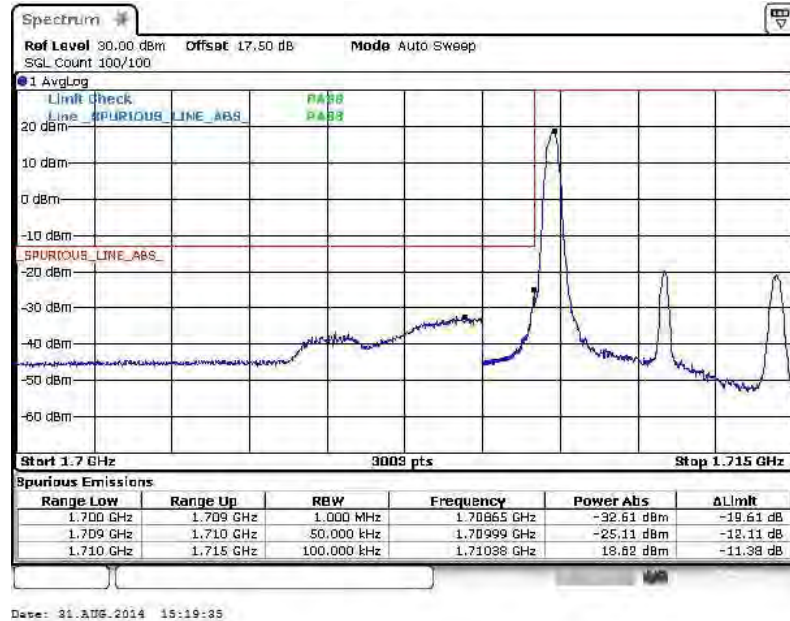

Lower Band Edge Plot for QPSK-RB Size 25, RB Offset 0

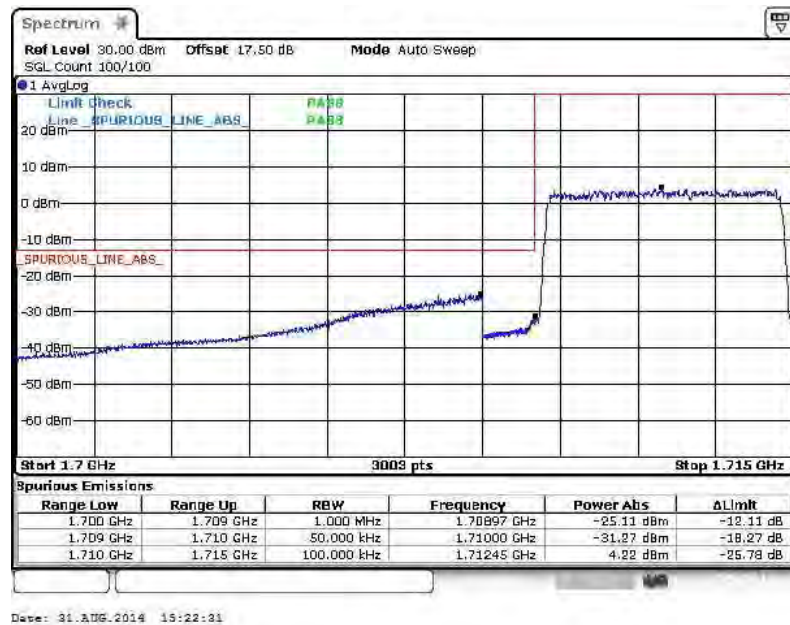





Higher Band Edge Plot for QPSK-RB Size 1, RB Offset 24

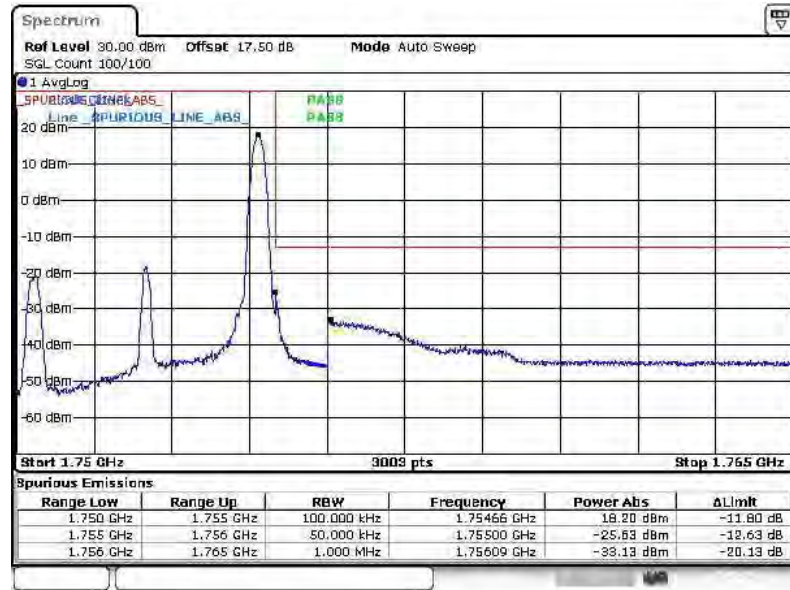

Date: 29.AUG.2014 14:54:43

Higher Band Edge Plot for QPSK-RB Size 25, RB Offset 0

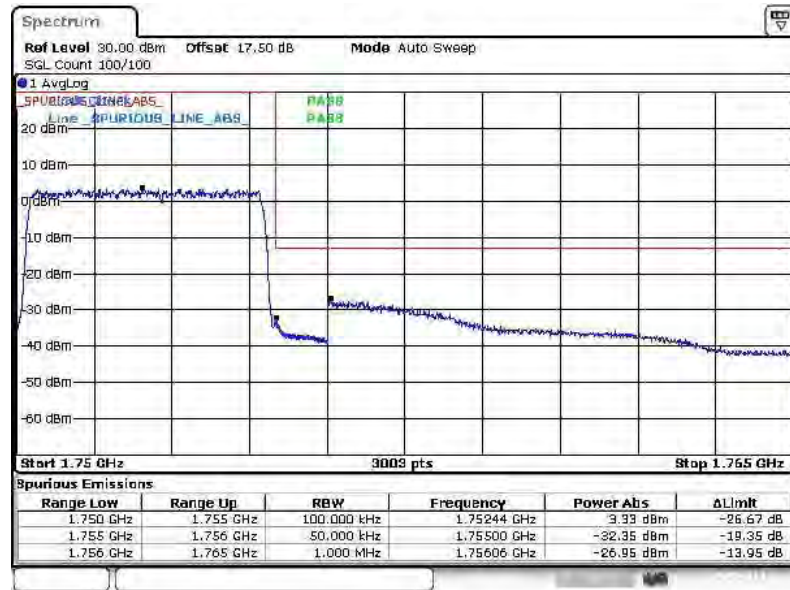

Date: 30.AUG.2014 14:56:21



<b>Band :</b>	LTE Band 4	<b>Band Width :</b>	5MHz / 16QAM
---------------	------------	---------------------	--------------

Lower Band Edge Plot for 16QAM-RB Size 1, RB Offset 0

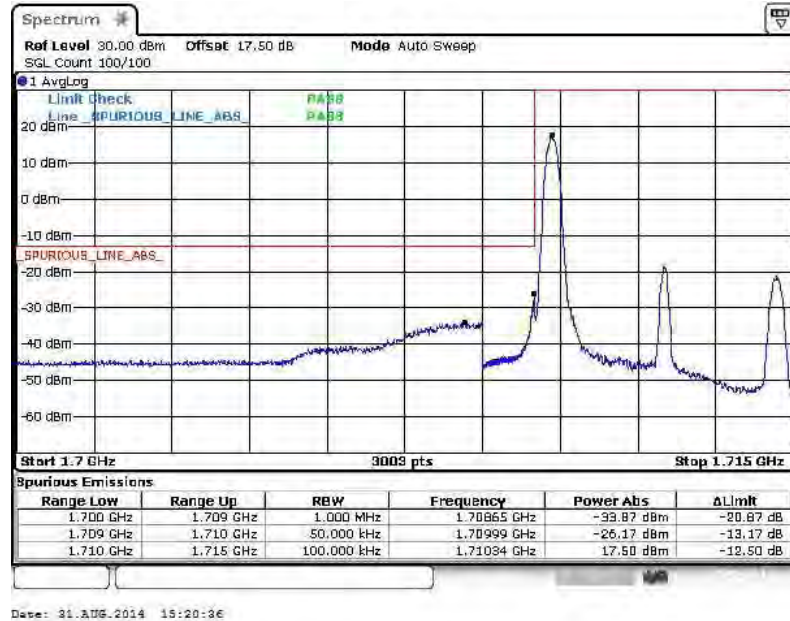

Lower Band Edge Plot for 16QAM-RB Size 25, RB Offset 0

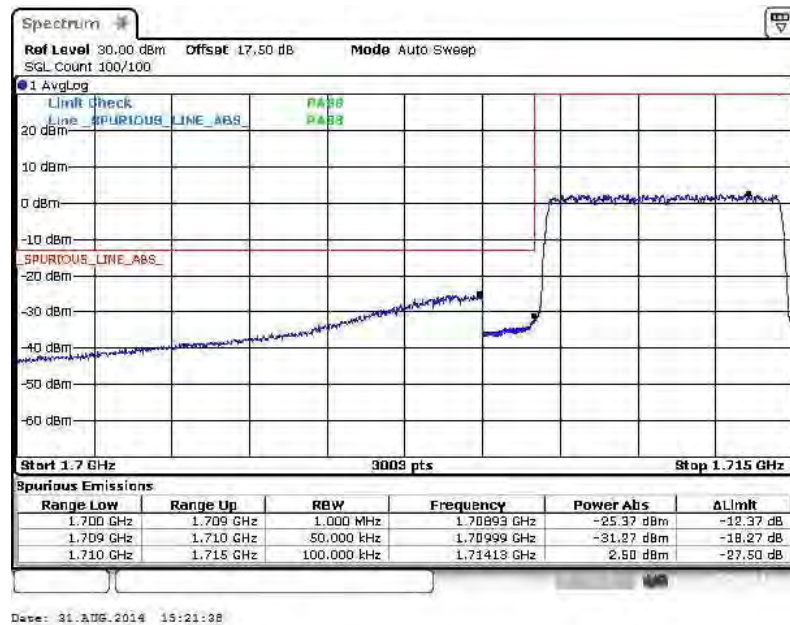



Higher Band Edge Plot for 16QAM-RB Size 1, RB Offset 24

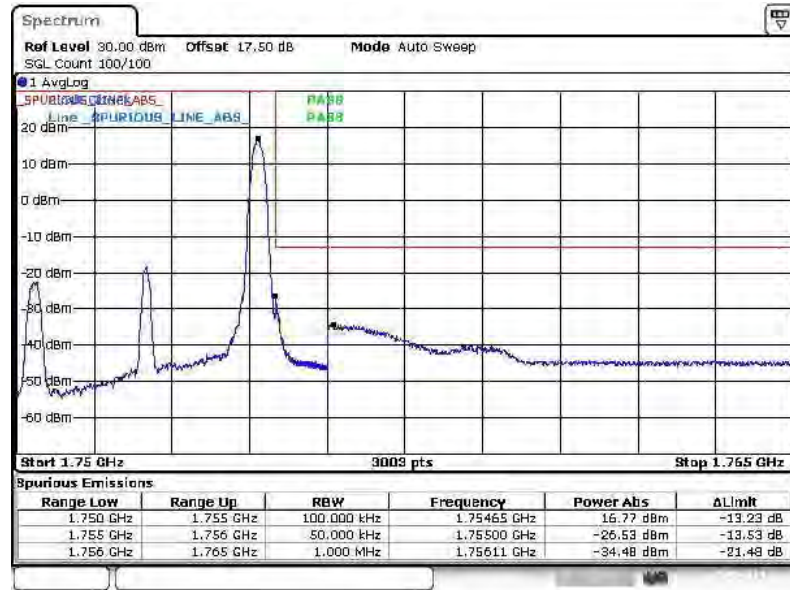

Date: 29.AUG.2014 14:56:01

Higher Band Edge Plot for 16QAM-RB Size 25, RB Offset 0

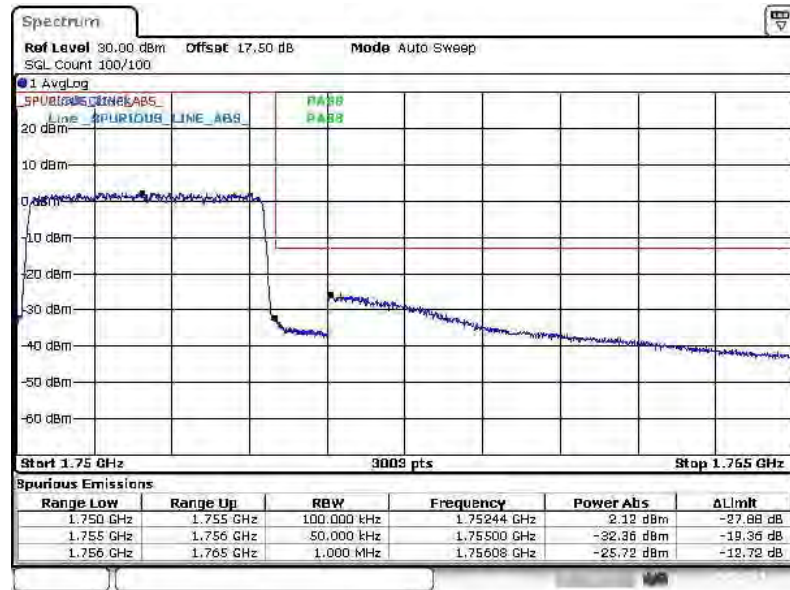

Date: 30.AUG.2014 14:54:22



<b>Band :</b>	LTE Band 4	<b>Band Width :</b>	10MHz / QPSK
---------------	------------	---------------------	--------------

Lower Band Edge Plot for QPSK-RB Size 1, RB Offset 0

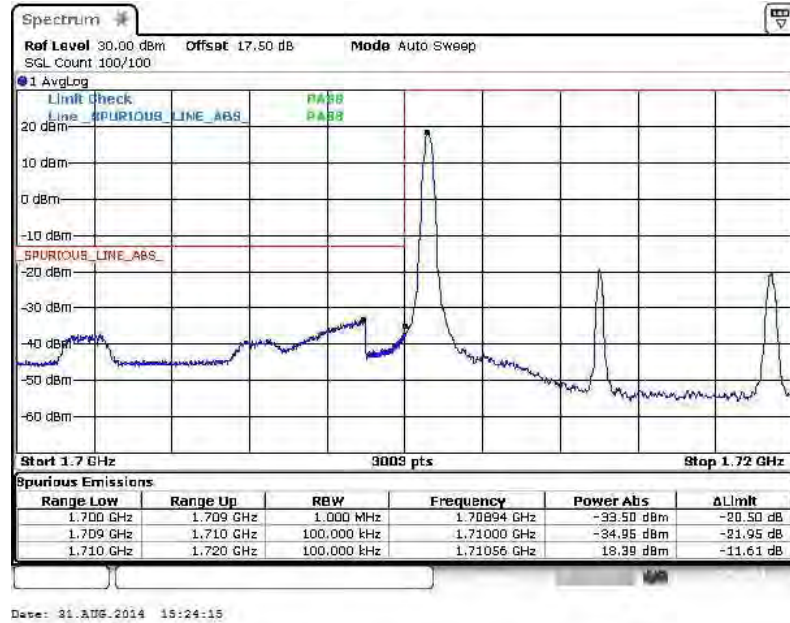

Lower Band Edge Plot for QPSK-RB Size 50, RB Offset 0

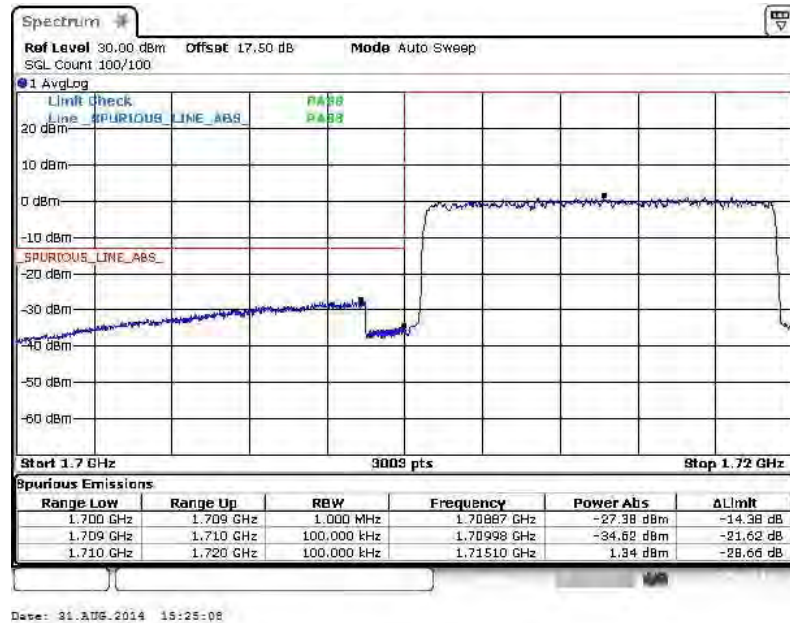





Higher Band Edge Plot for QPSK-RB Size 1, RB Offset 49

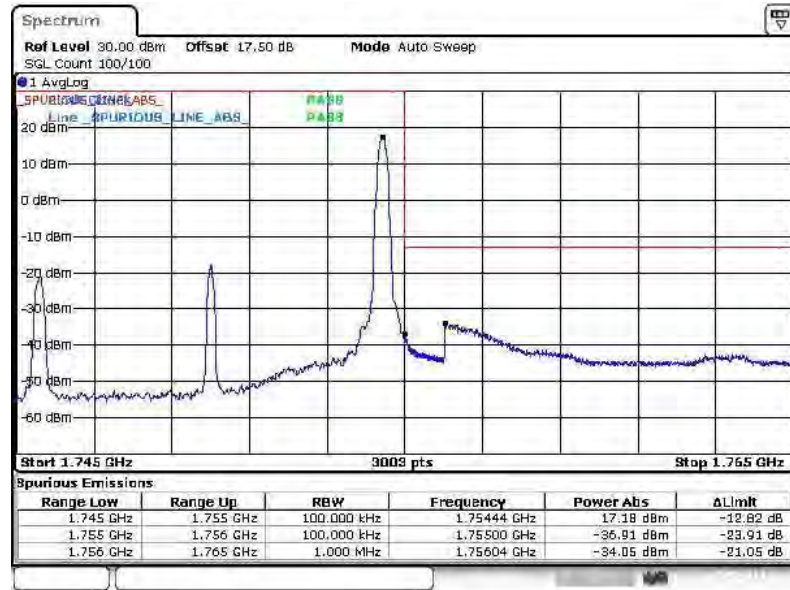

Date: 29.AUG.2014 14:53:41

Higher Band Edge Plot for QPSK-RB Size 50, RB Offset 0

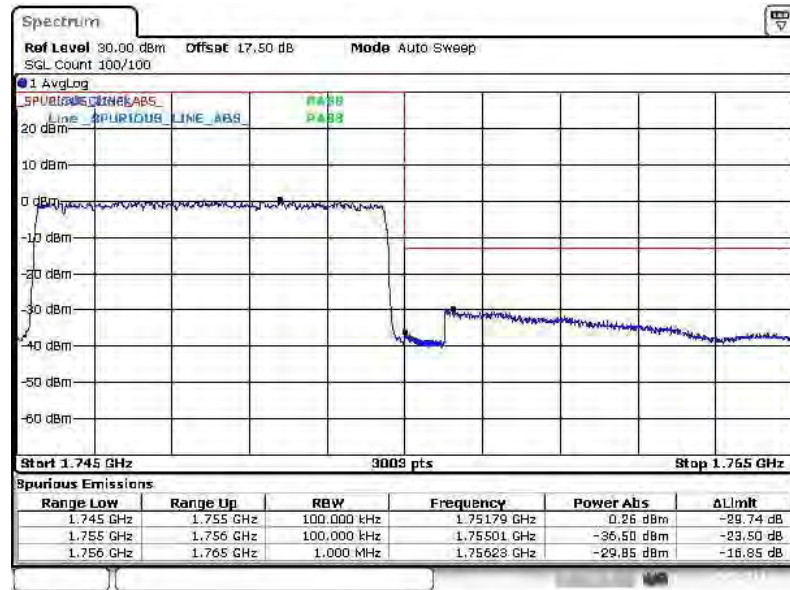

Date: 30.AUG.2014 14:59:09



<b>Band :</b>	LTE Band 4	<b>Band Width :</b>	10MHz / 16QAM
---------------	------------	---------------------	---------------

Lower Band Edge Plot for 16QAM-RB Size 1, RB Offset 0

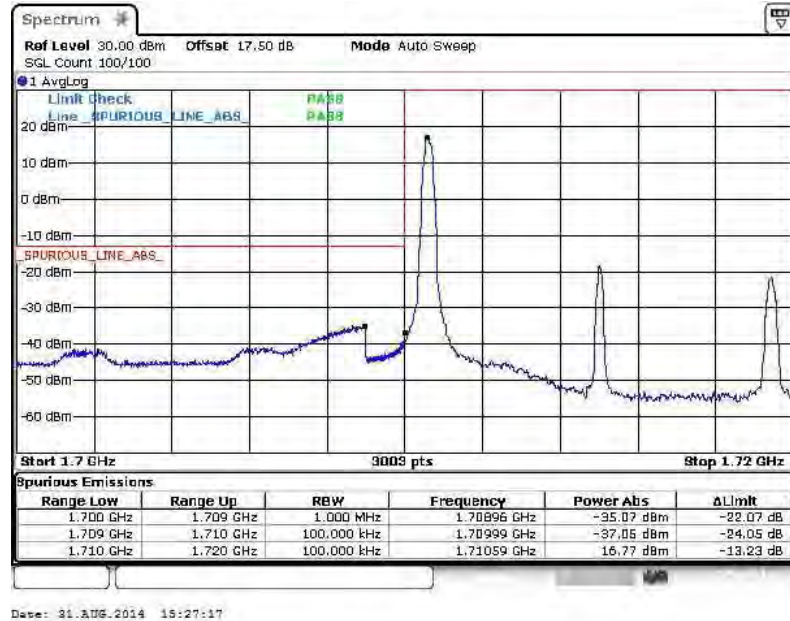

Lower Band Edge Plot for 16QAM-RB Size 50, RB Offset 0

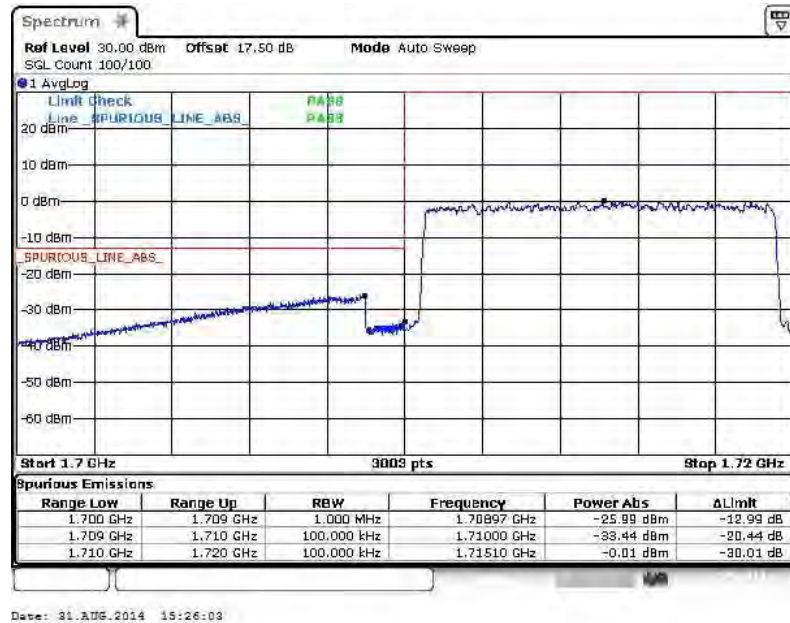



Higher Band Edge Plot for 16QAM-RB Size 1, RB Offset 49

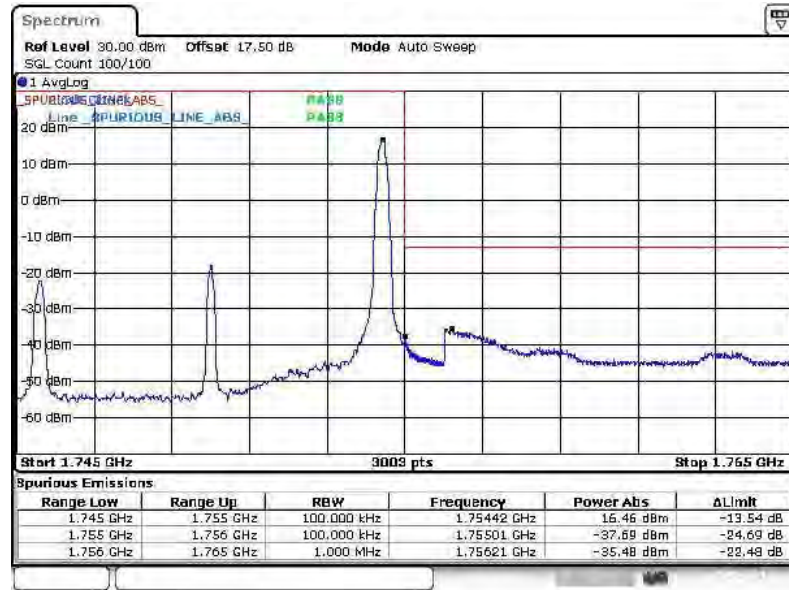

Date: 29.AUG.2014 14:52:35

Higher Band Edge Plot for 16QAM-RB Size 50, RB Offset 0

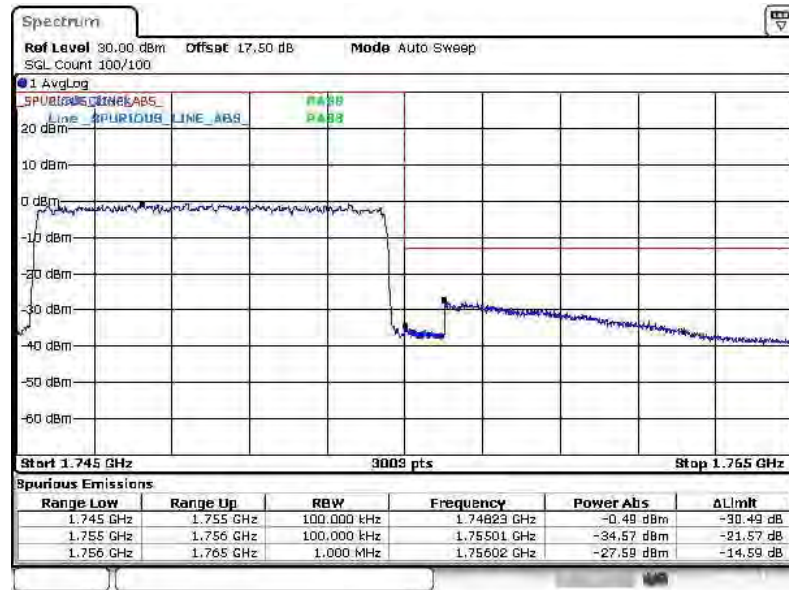

Date: 30.AUG.2014 14:58:35



<b>Band :</b>	LTE Band 4	<b>Band Width :</b>	15MHz / QPSK
---------------	------------	---------------------	--------------

Lower Band Edge Plot for QPSK-RB Size 1, RB Offset 0

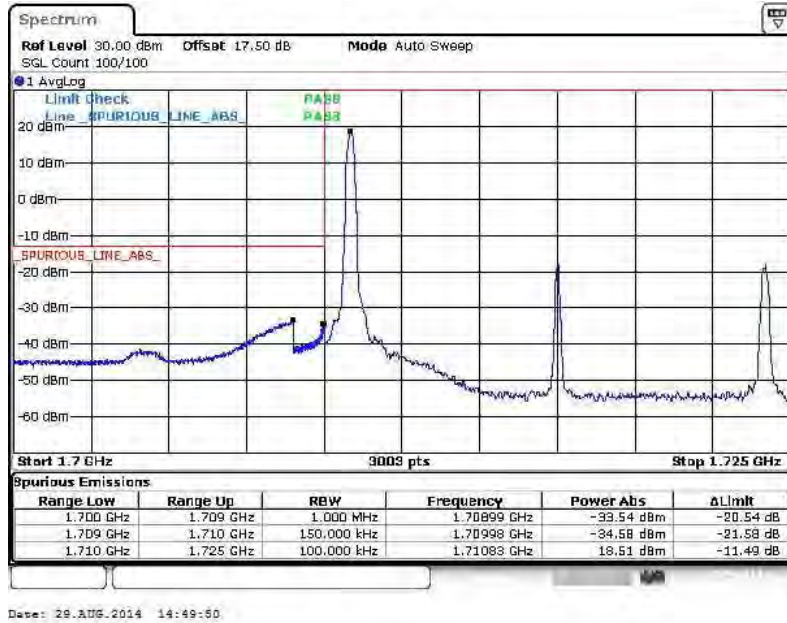

Lower Band Edge Plot for QPSK-RB Size 75, RB Offset 0

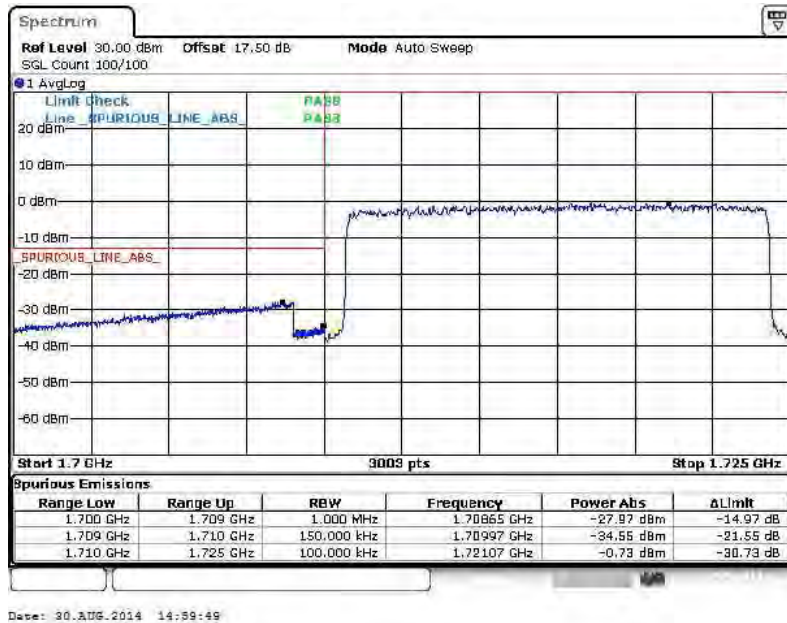





Higher Band Edge Plot for QPSK-RB Size 1, RB Offset 74

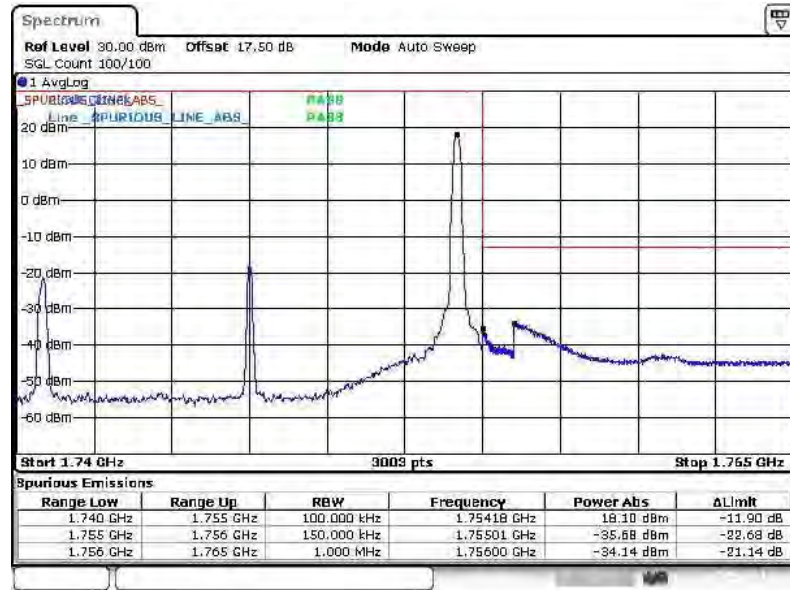

Date: 29.AUG.2014 14:47:11

Higher Band Edge Plot for QPSK-RB Size 75, RB Offset 0

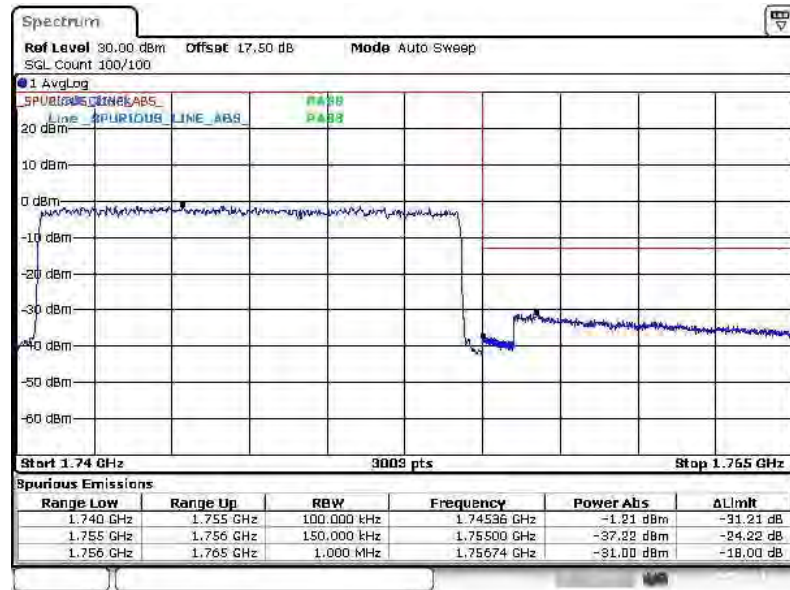

Date: 30.AUG.2014 15:01:29



Band :	LTE Band 4	Band Width :	15MHz / 16QAM
--------	------------	--------------	---------------

Lower Band Edge Plot for 16QAM-RB Size 1, RB Offset 0

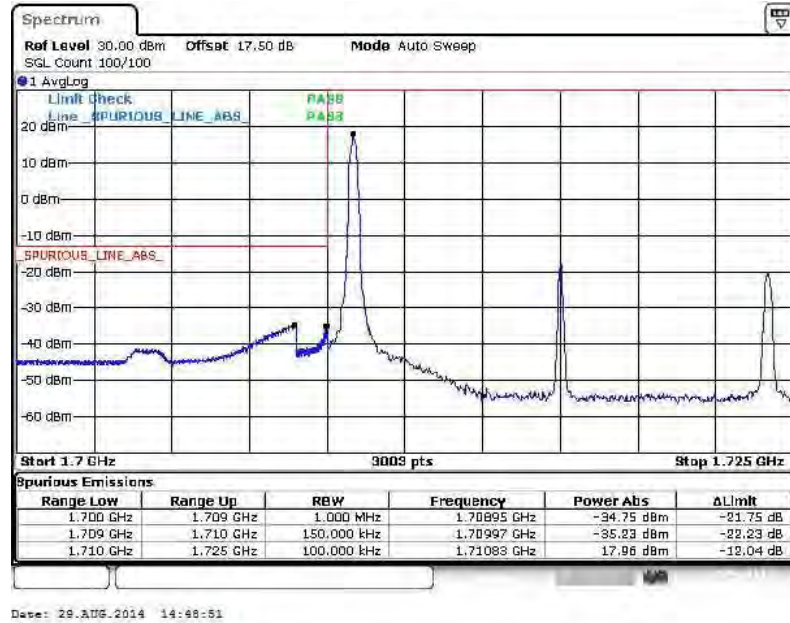

Lower Band Edge Plot for 16QAM-RB Size 75, RB Offset 0

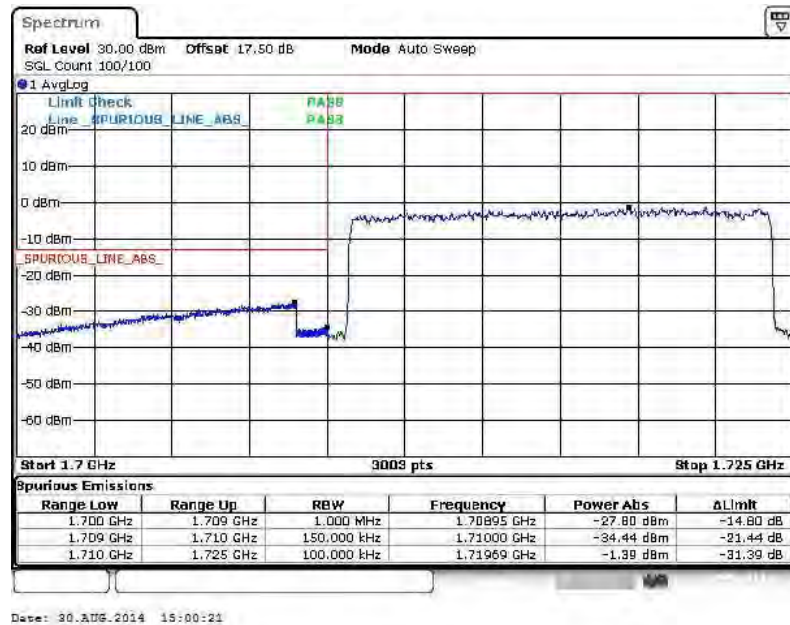



Higher Band Edge Plot for 16QAM-RB Size 1, RB Offset 74

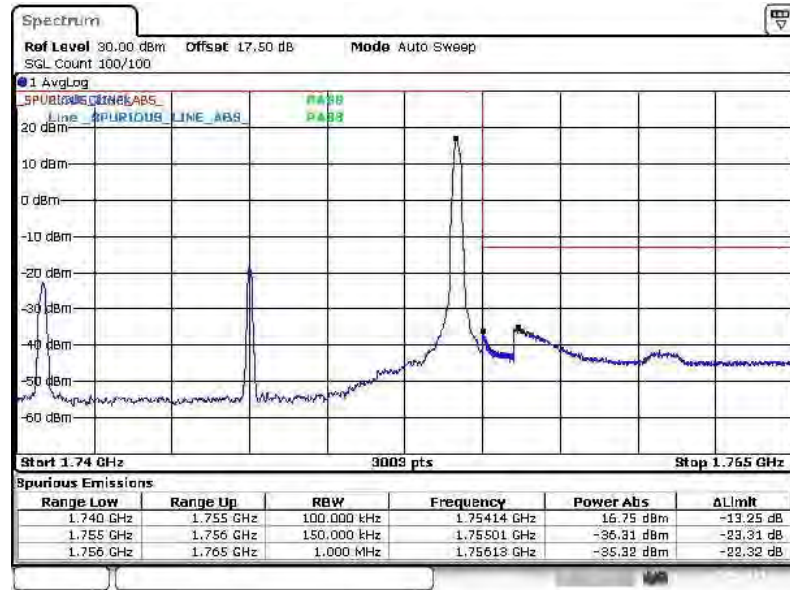

Date: 29.AUG.2014 14:47:51

Higher Band Edge Plot for 16QAM-RB Size 75, RB Offset 0

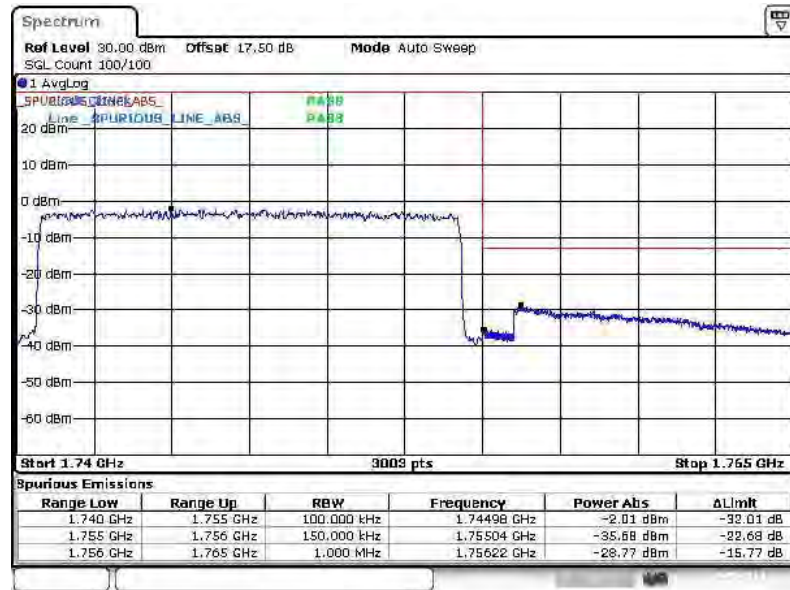

Date: 30.AUG.2014 15:00:56



<b>Band :</b>	LTE Band 4	<b>Band Width :</b>	20MHz / QPSK
---------------	------------	---------------------	--------------

Lower Band Edge Plot for QPSK-RB Size 1, RB Offset 0

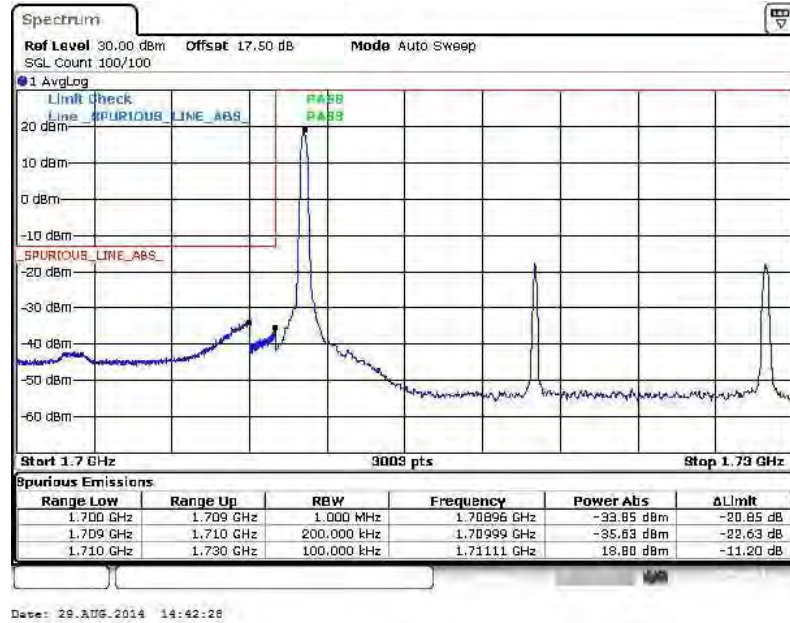

Lower Band Edge Plot for QPSK-RB Size 100, RB Offset 0

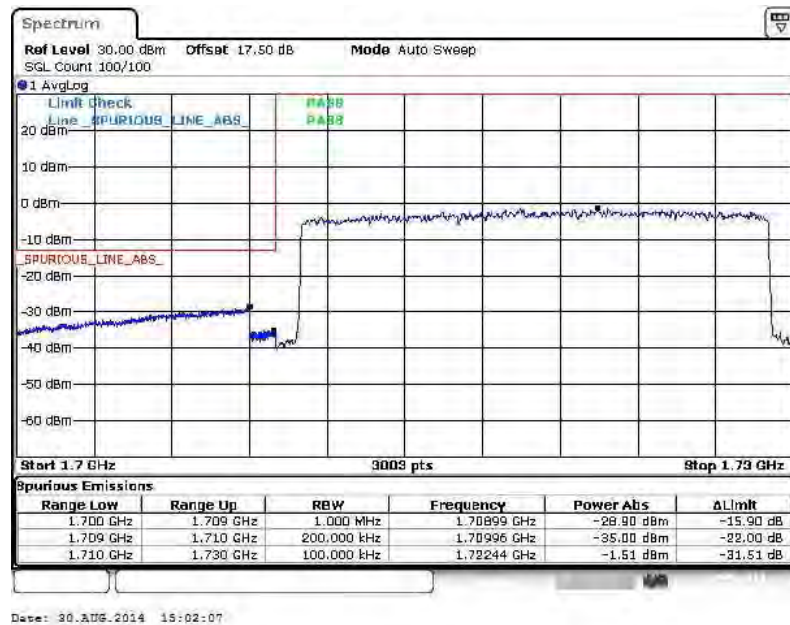





Higher Band Edge Plot for QPSK-RB Size 1, RB Offset 99

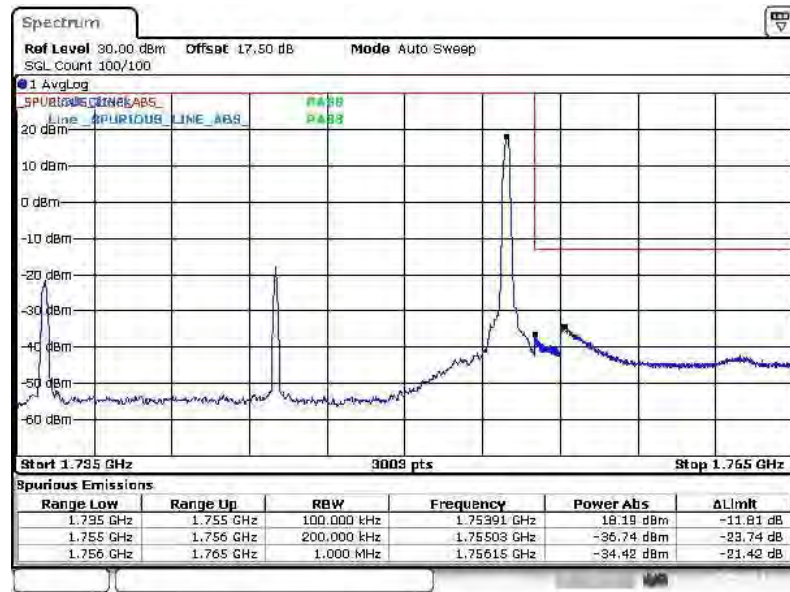

Date: 29.AUG.2014 14:45:57

Higher Band Edge Plot for QPSK-RB Size 100, RB Offset 0

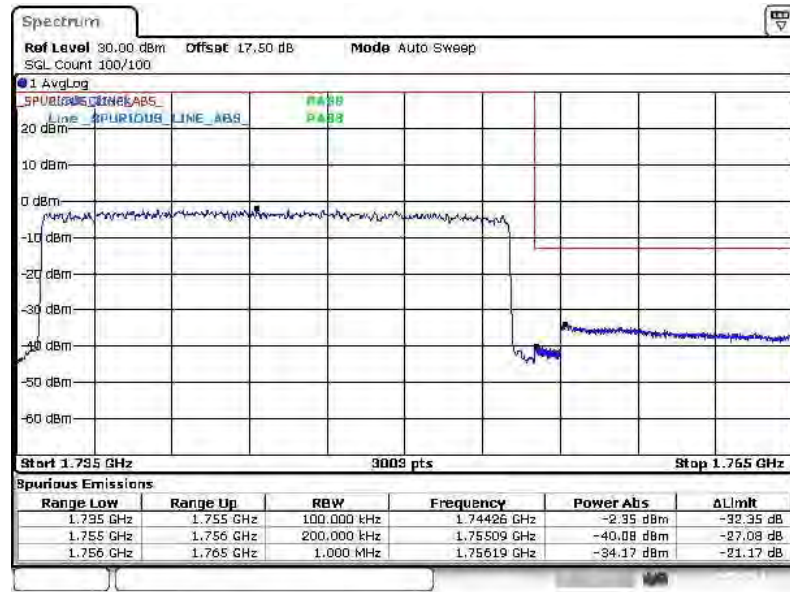

Date: 30.AUG.2014 15:04:58



<b>Band :</b>	LTE Band 4	<b>Band Width :</b>	20MHz / 16QAM
---------------	------------	---------------------	---------------

Lower Band Edge Plot for 16QAM-RB Size 1, RB Offset 0

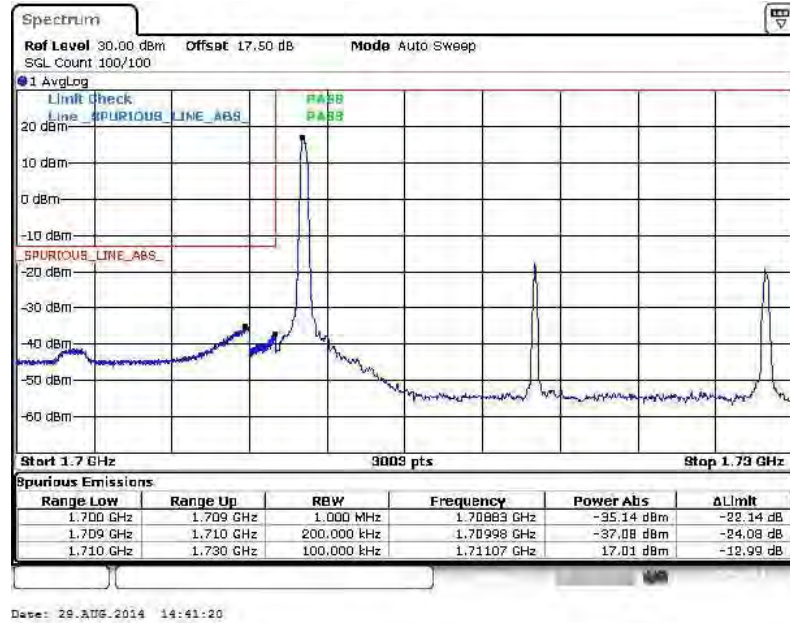

Lower Band Edge Plot for 16QAM-RB Size 100, RB Offset 0

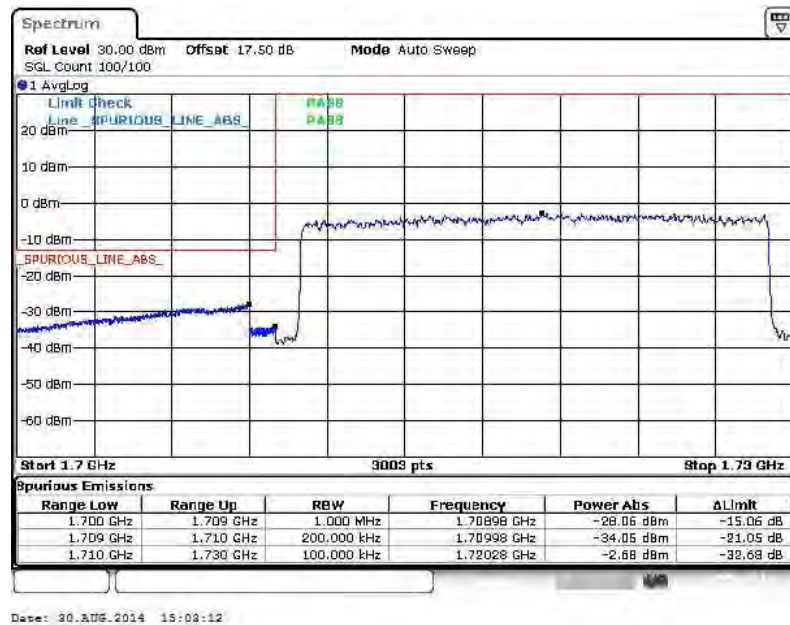



Higher Band Edge Plot for 16QAM-RB Size 1, RB Offset 99

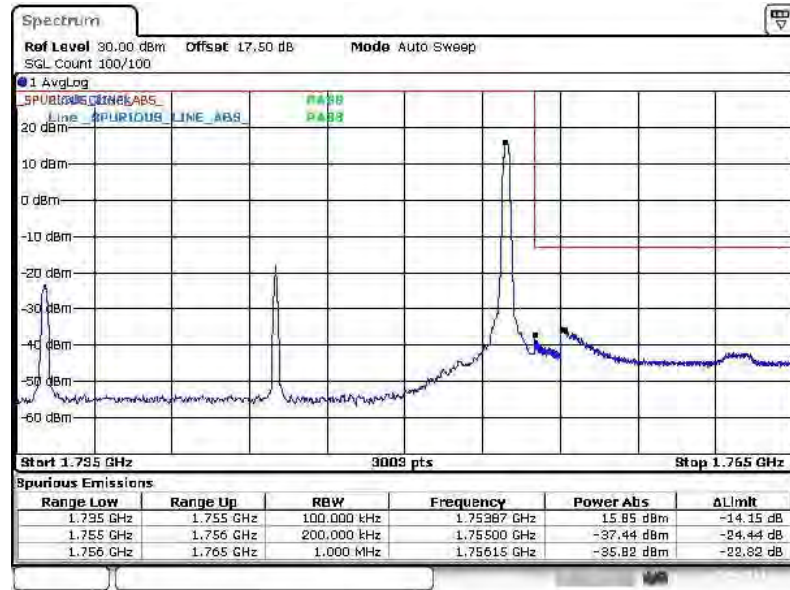

Date: 29.AUG.2014 14:44:42

Higher Band Edge Plot for 16QAM-RB Size 100, RB Offset 0

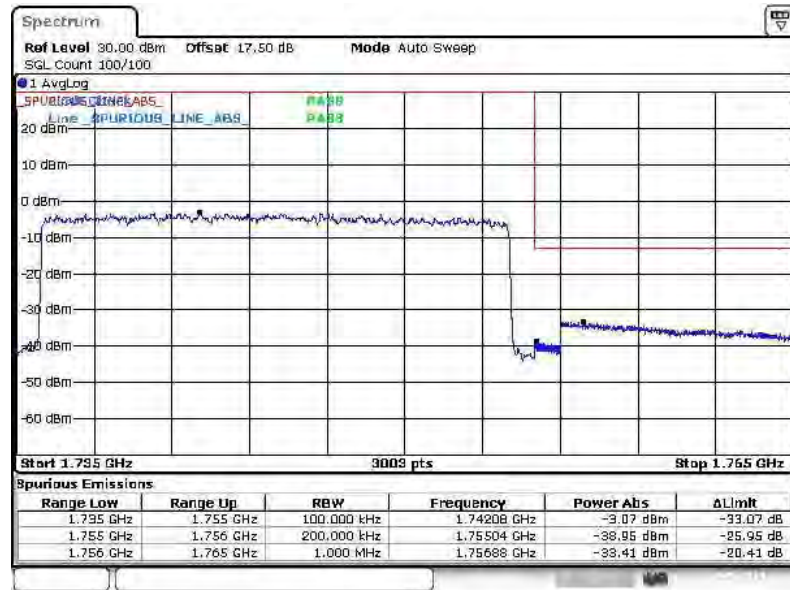

Date: 30.AUG.2014 15:08:59



Band :	LTE Band 17	Band Width :	5MHz / QPSK
--------	-------------	--------------	-------------

Lower Band Edge Plot for QPSK-RB Size 1, RB Offset 0

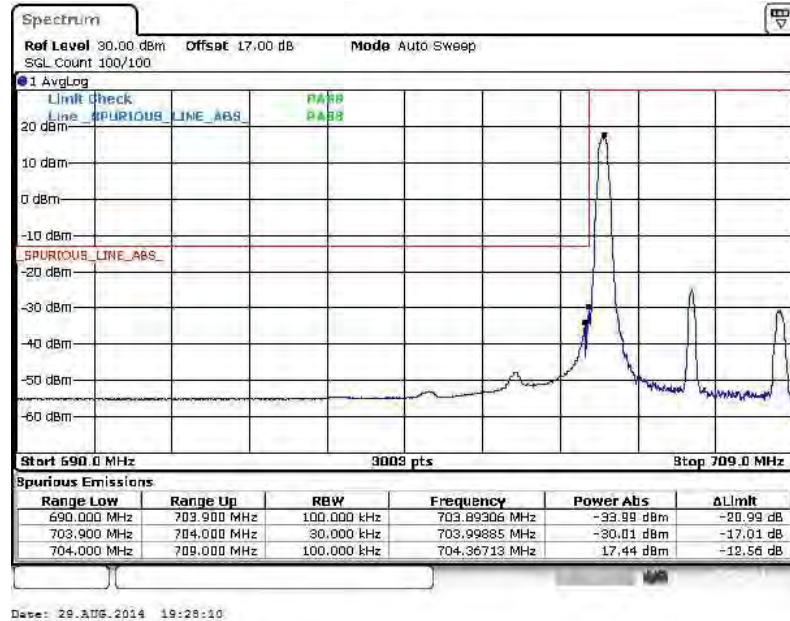

Lower Band Edge Plot for QPSK-RB Size 25, RB Offset 0

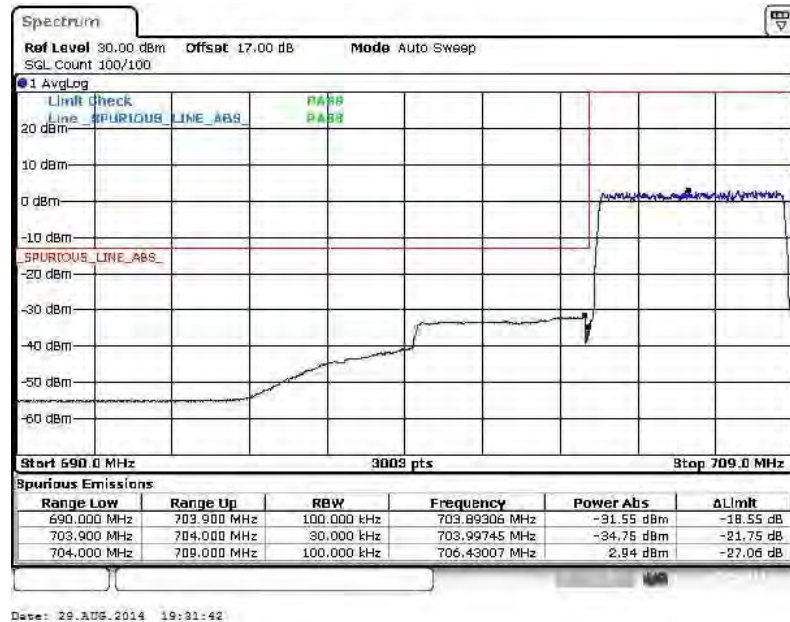





Higher Band Edge Plot for QPSK-RB Size 1, RB Offset 24

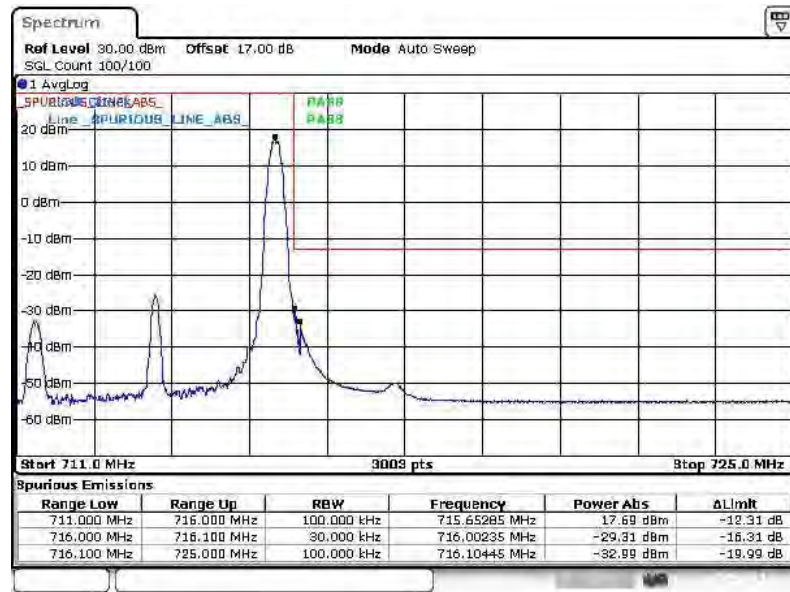

Date: 29.AUG.2014 19:33:40

Higher Band Edge Plot for QPSK-RB Size 25, RB Offset 0

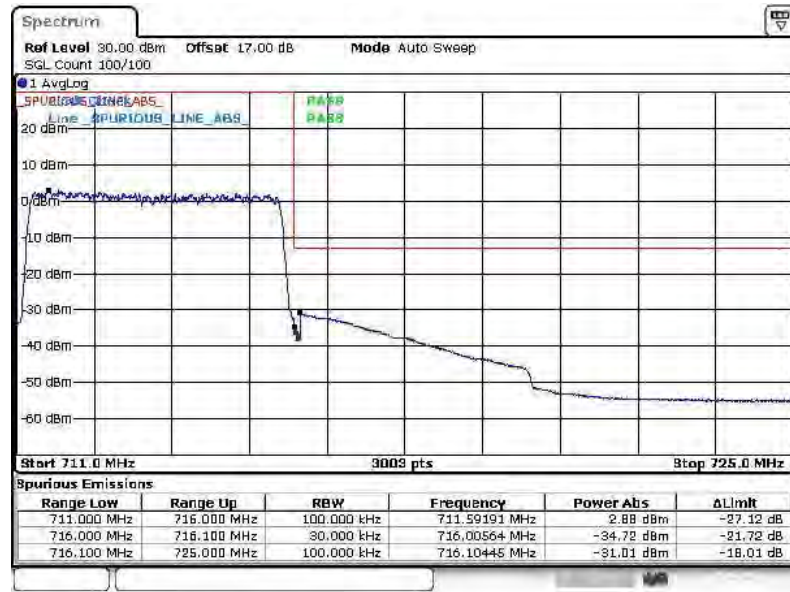

Date: 29.AUG.2014 19:33:44



<b>Band :</b>	LTE Band 17	<b>Band Width :</b>	5MHz / 16QAM
---------------	-------------	---------------------	--------------

Lower Band Edge Plot for 16QAM-RB Size 1, RB Offset 0

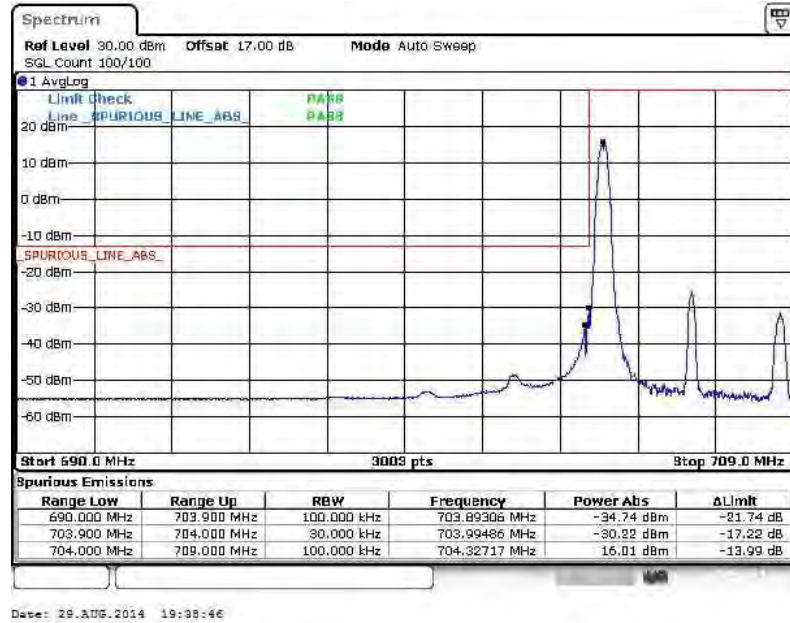

Lower Band Edge Plot for 16QAM-RB Size 25, RB Offset 0

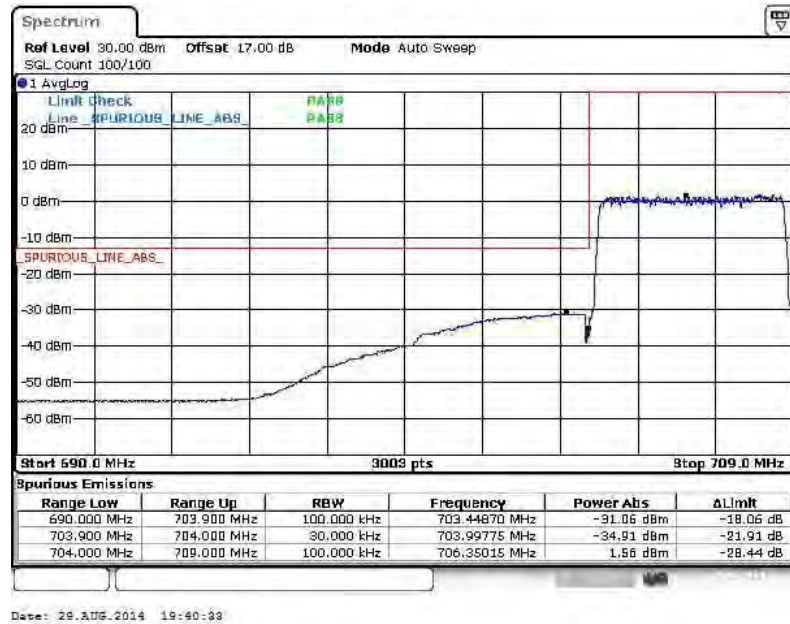



Higher Band Edge Plot for 16QAM-RB Size 1, RB Offset 24

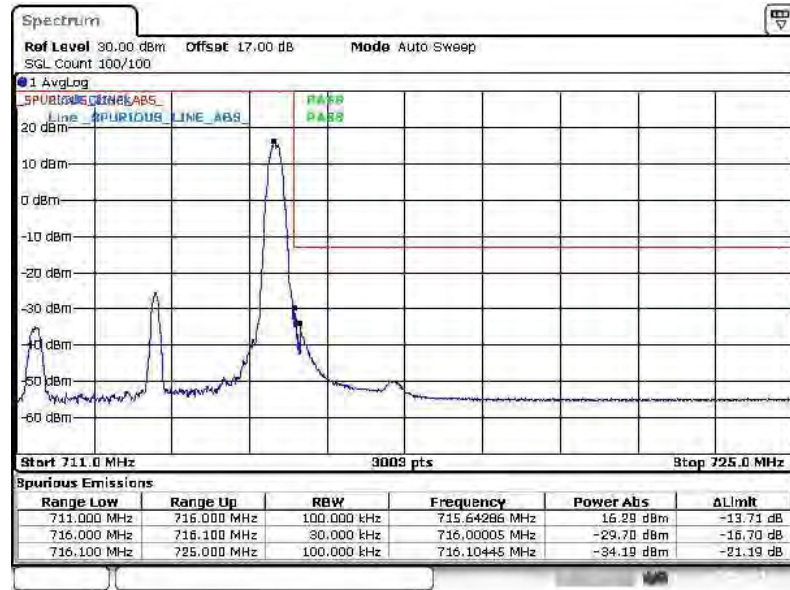

Date: 29.AUG.2014 19:42:25

Higher Band Edge Plot for 16QAM-RB Size 25, RB Offset 0

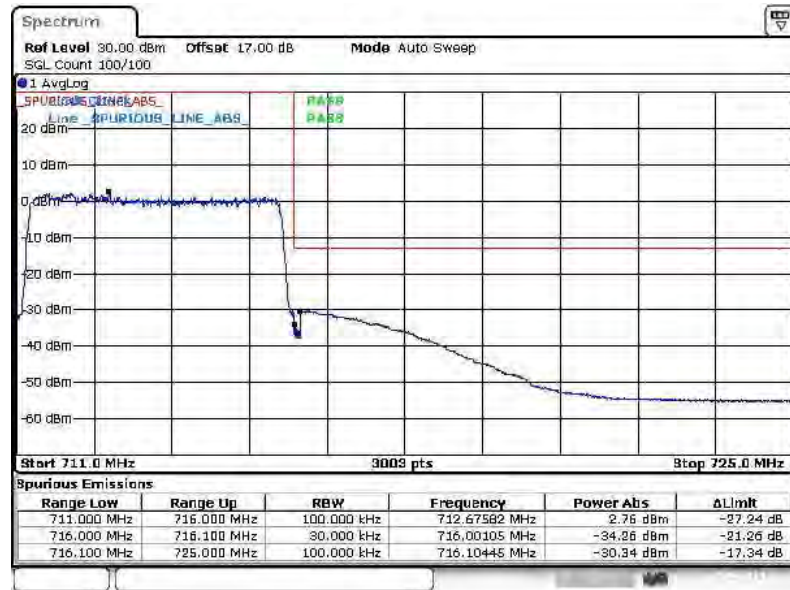

Date: 29.AUG.2014 19:44:55



Band :	LTE Band 17	Band Width :	10MHz / QPSK
--------	-------------	--------------	--------------

Lower Band Edge Plot for QPSK-RB Size 1, RB Offset 0

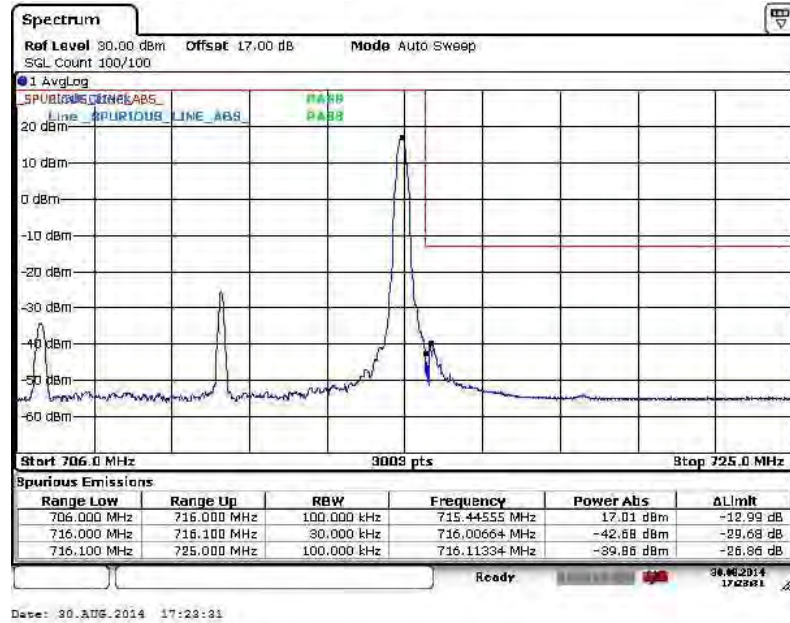

Lower Band Edge Plot for QPSK-RB Size 50, RB Offset 0

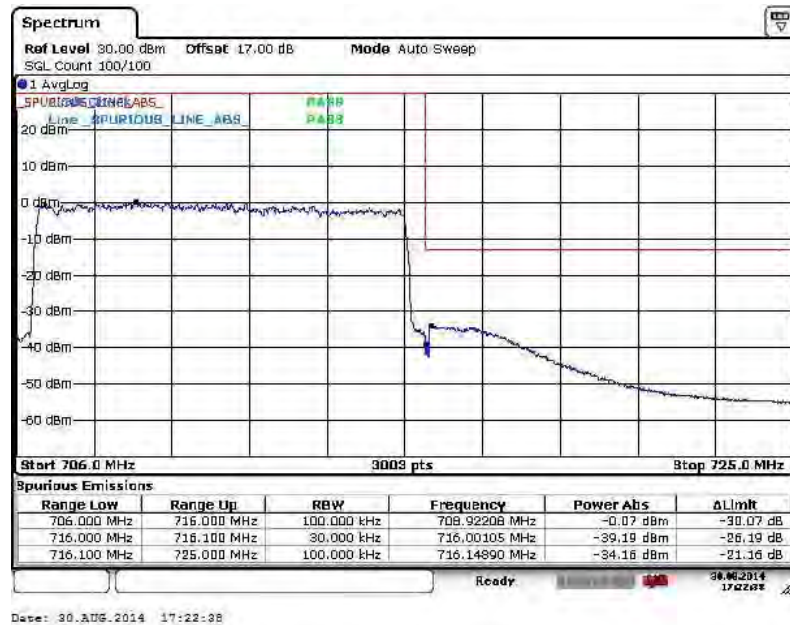





Higher Band Edge Plot for QPSK-RB Size 1, RB Offset 49

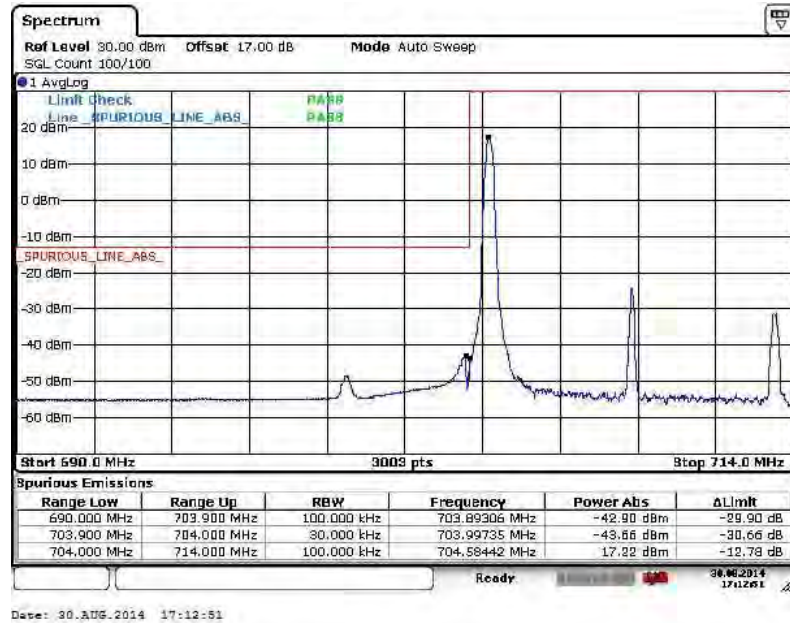

Higher Band Edge Plot for QPSK-RB Size 50, RB Offset 0

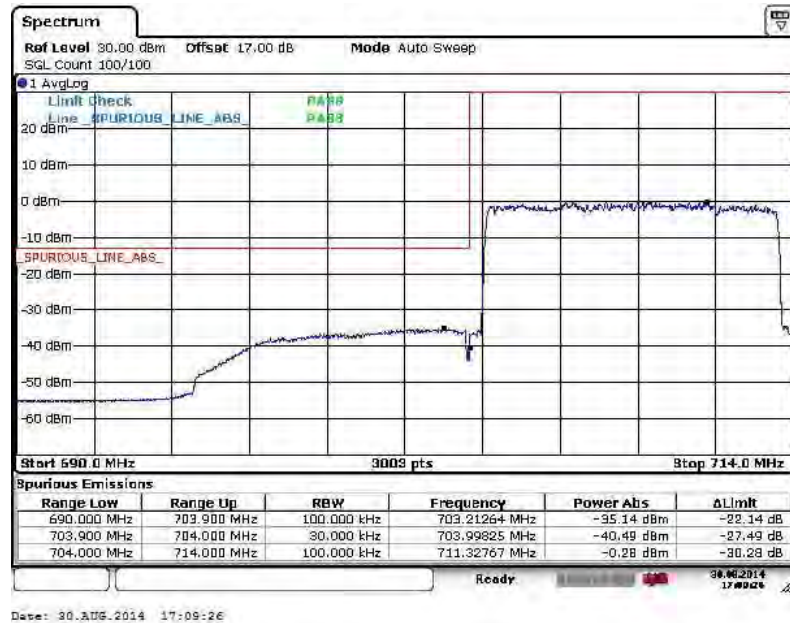



<b>Band :</b>	LTE Band 17	<b>Band Width :</b>	10MHz / 16QAM
---------------	-------------	---------------------	---------------

Lower Band Edge Plot for 16QAM-RB Size 1, RB Offset 0

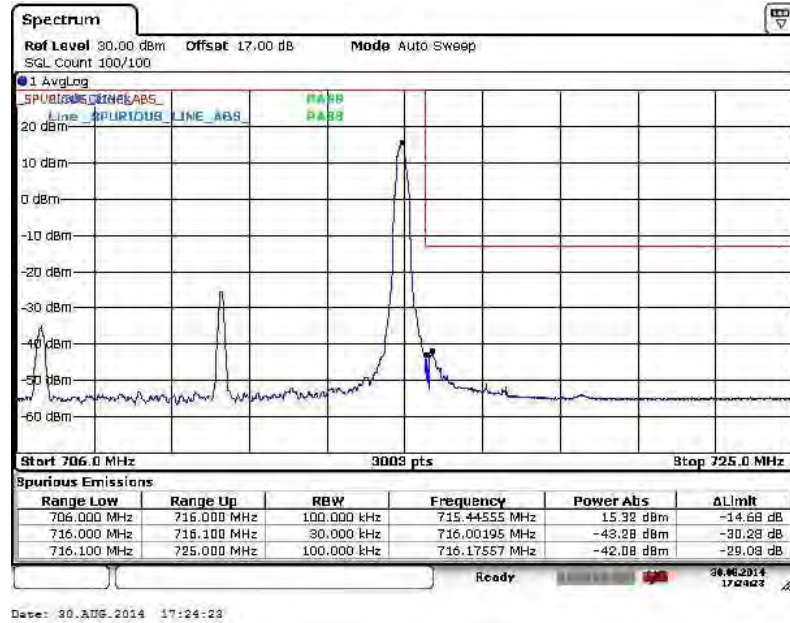

Lower Band Edge Plot for 16QAM-RB Size 50, RB Offset 0

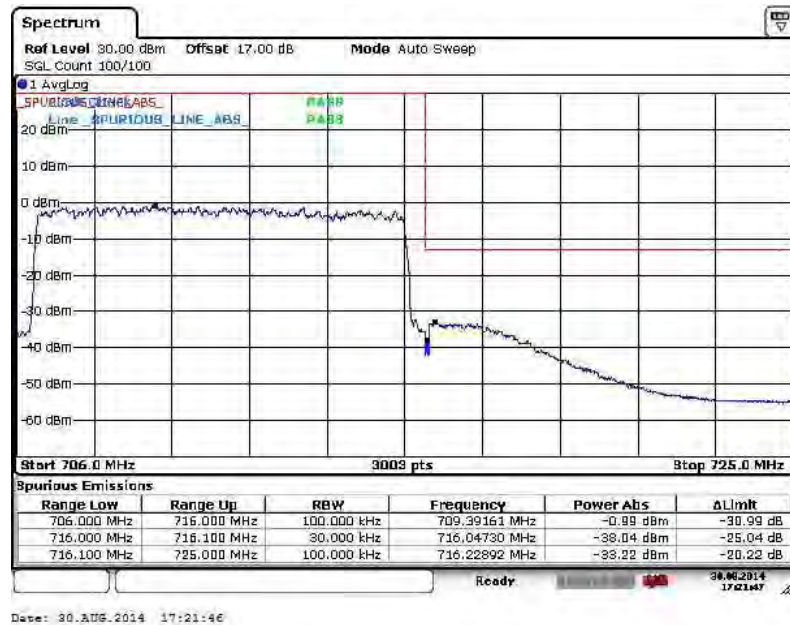



Higher Band Edge Plot for 16QAM-RB Size 1, RB Offset 49

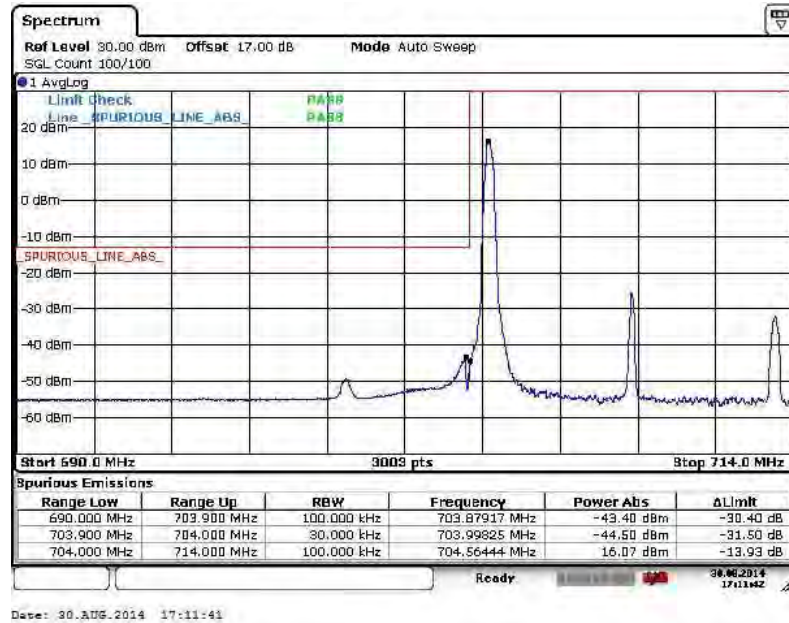

Higher Band Edge Plot for 16QAM-RB Size 50, RB Offset 0

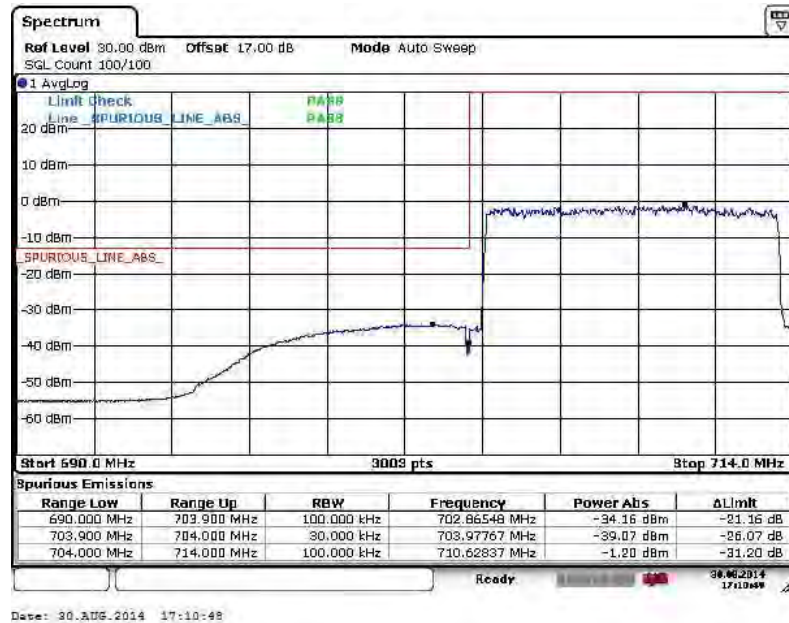



Band :	LTE Band 7	Band Width :	5MHz / QPSK
--------	------------	--------------	-------------

Lower Band Edge Plot for QPSK-RB Size 1, RB Offset 0

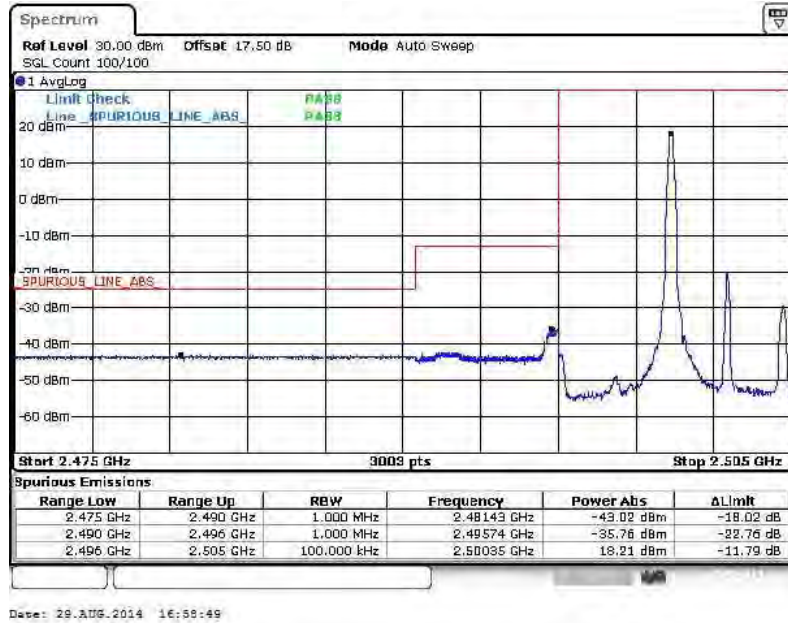

Lower Band Edge Plot for QPSK-RB Size 25, RB Offset 0

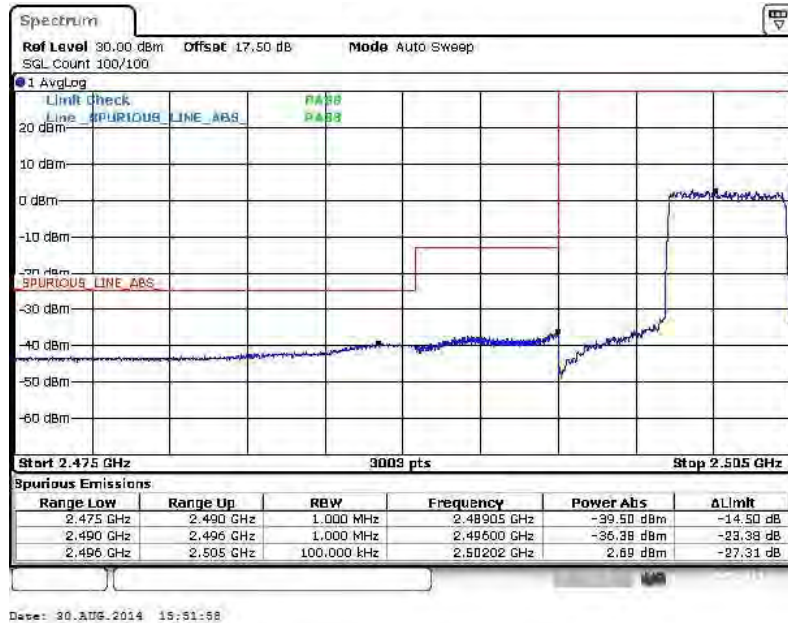





Higher Band Edge Plot for QPSK-RB Size 1, RB Offset 24

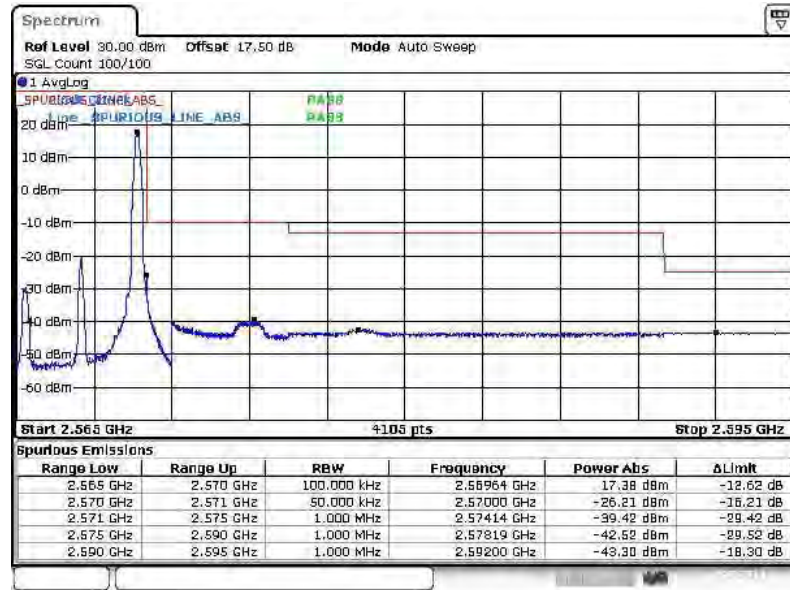

Date: 29.AUG.2014 17:03:01

Higher Band Edge Plot for QPSK-RB Size 25, RB Offset 0

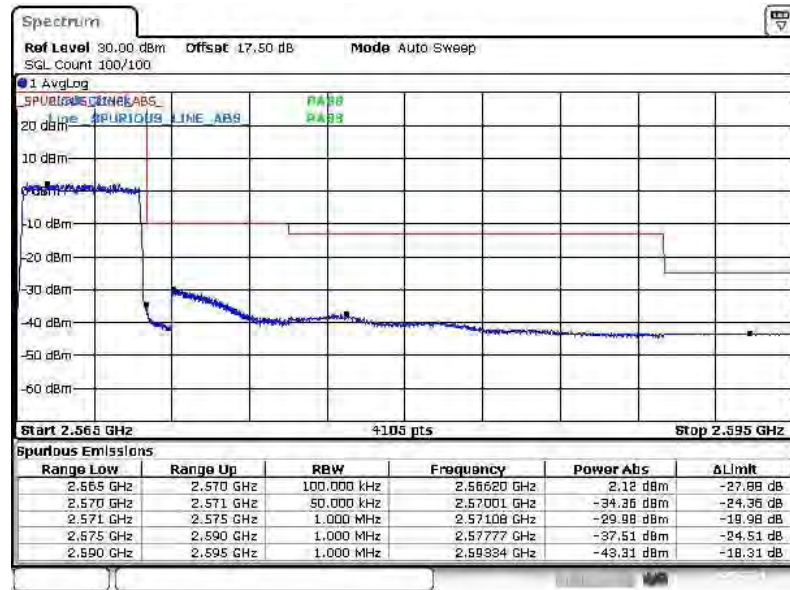

Date: 30.AUG.2014 15:55:11



<b>Band :</b>	LTE Band 7	<b>Band Width :</b>	5MHz / 16QAM
---------------	------------	---------------------	--------------

Lower Band Edge Plot for 16QAM-RB Size 1, RB Offset 0

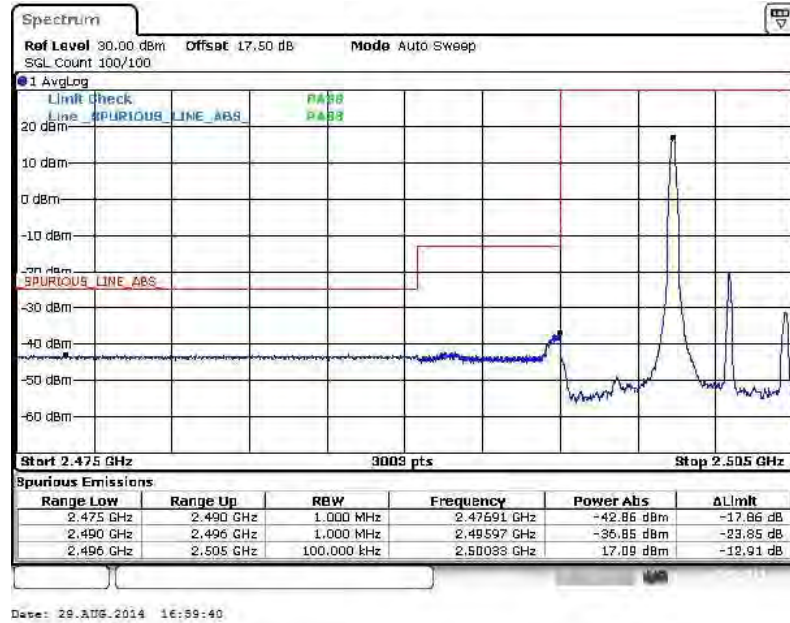

Lower Band Edge Plot for 16QAM-RB Size 25, RB Offset 0

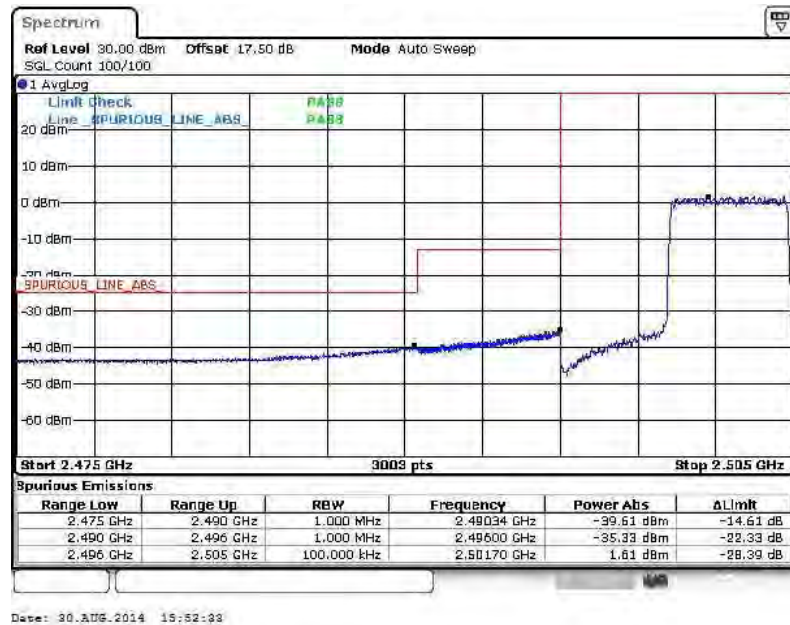



Higher Band Edge Plot for 16QAM-RB Size 1, RB Offset 24

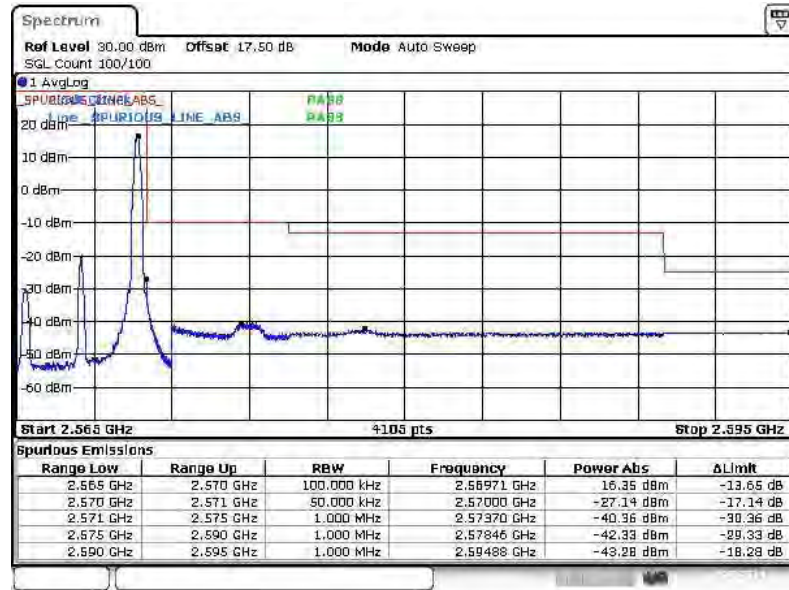

Date: 29.AUG.2014 17:00:30

Higher Band Edge Plot for 16QAM-RB Size 25, RB Offset 0

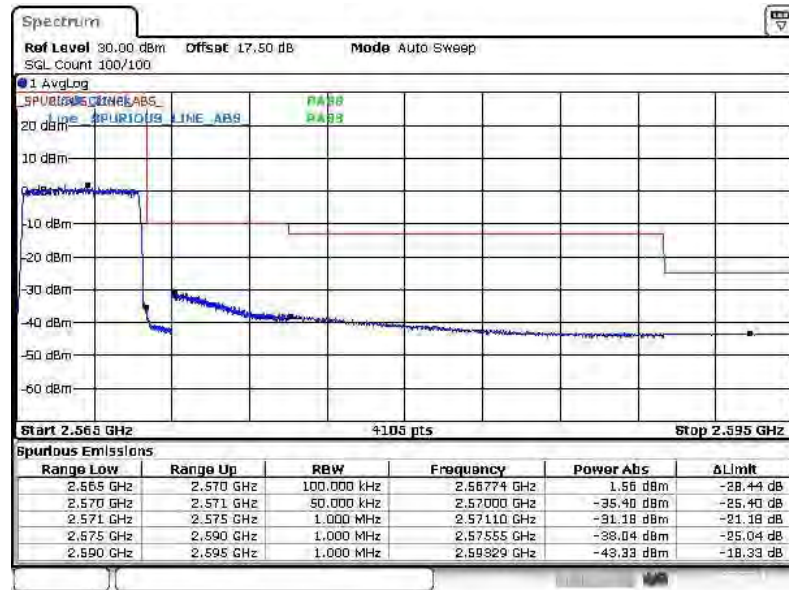

Date: 30.AUG.2014 15:53:17



Band :	LTE Band 7	Band Width :	10MHz / QPSK
--------	------------	--------------	--------------

Lower Band Edge Plot for QPSK-RB Size 1, RB Offset 0

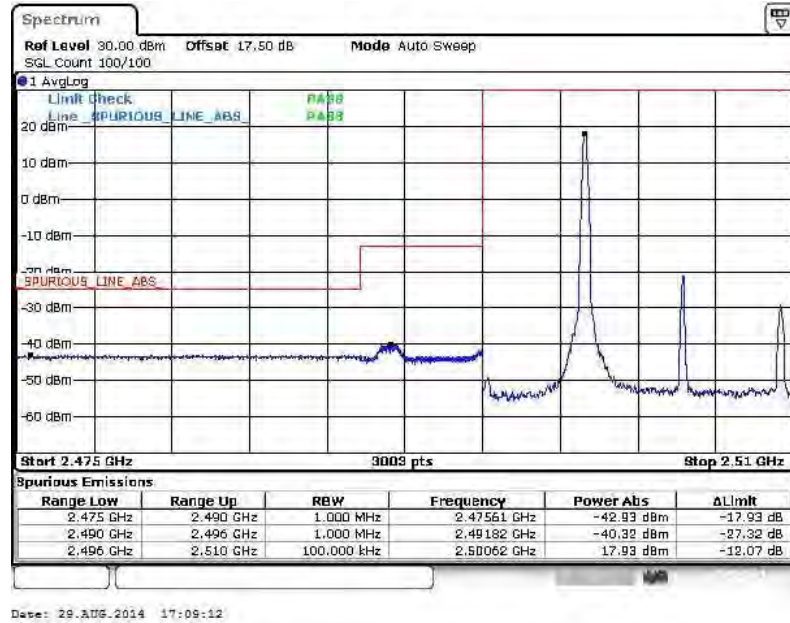

Lower Band Edge Plot for QPSK-RB Size 50, RB Offset 0

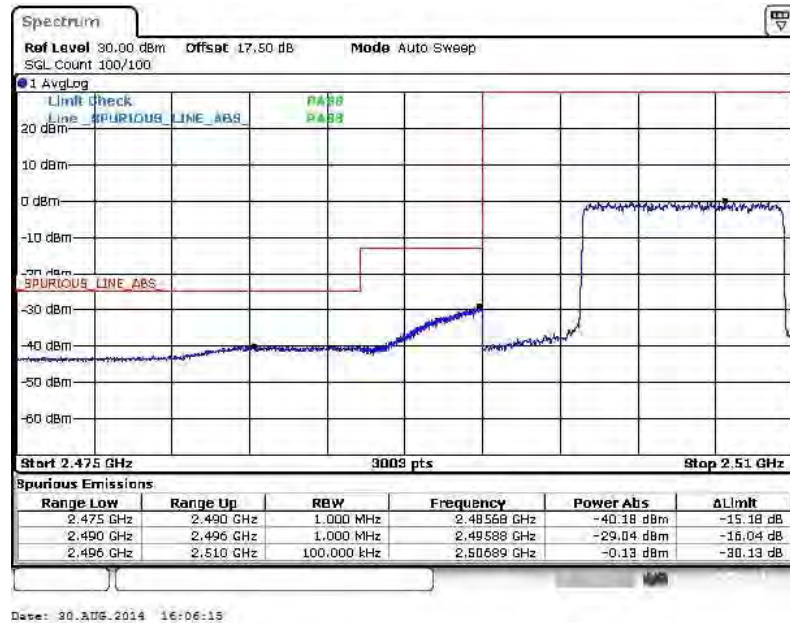





Higher Band Edge Plot for QPSK-RB Size 1, RB Offset 49

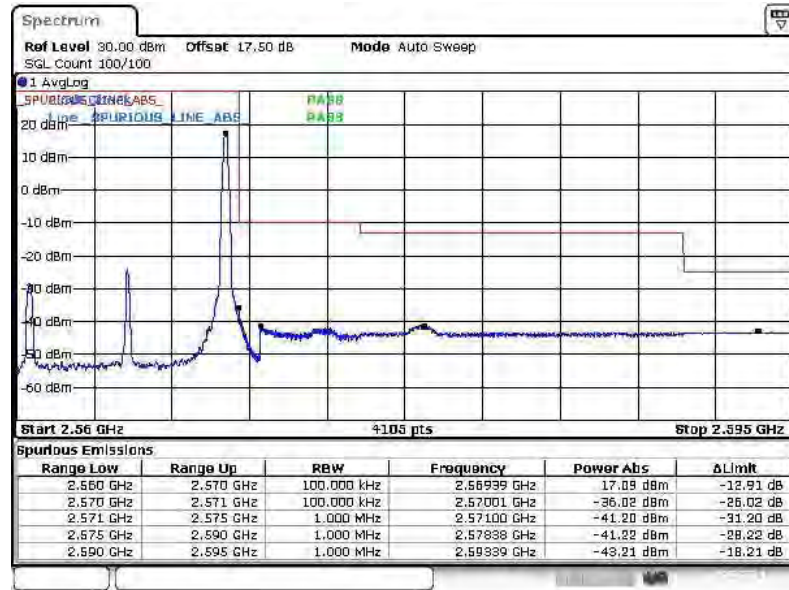

Date: 29.AUG.2014 17:13:09

Higher Band Edge Plot for QPSK-RB Size 50, RB Offset 0

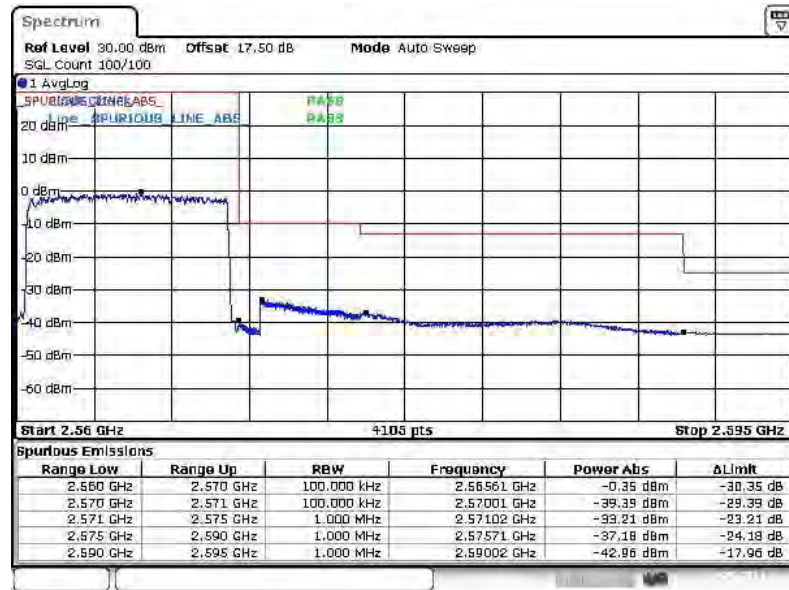

Date: 30.AUG.2014 16:09:55



<b>Band :</b>	LTE Band 7	<b>Band Width :</b>	10MHz / 16QAM
---------------	------------	---------------------	---------------

**Lower Band Edge Plot for 16QAM-RB Size 1, RB Offset 0**

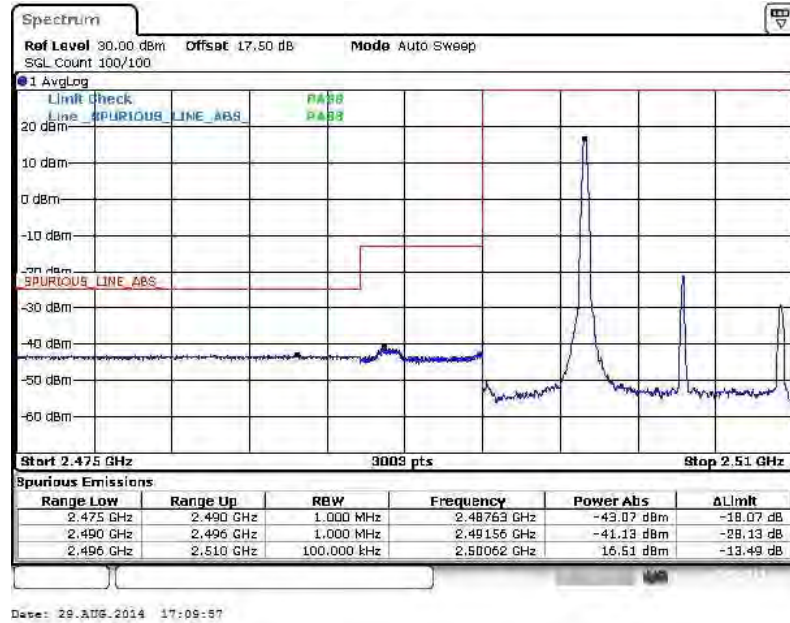

**Lower Band Edge Plot for 16QAM-RB Size 50, RB Offset 0**

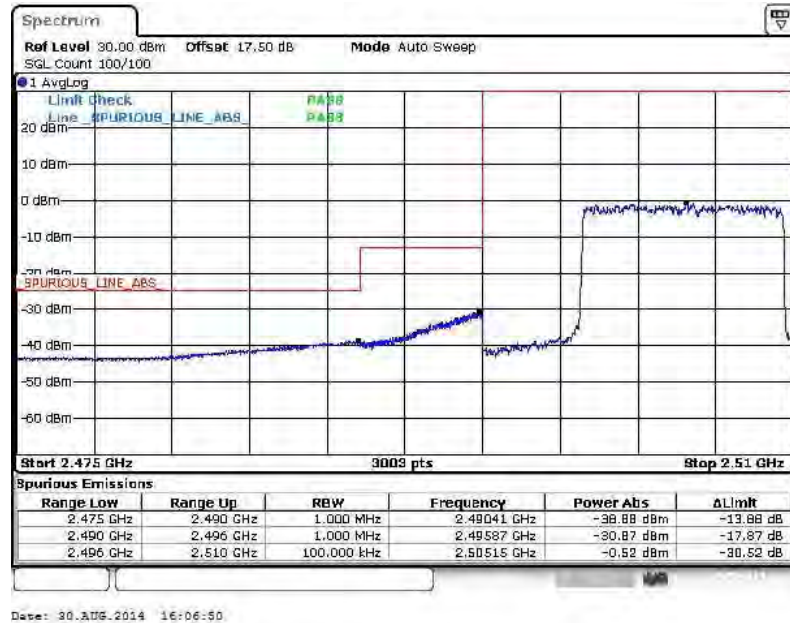



Higher Band Edge Plot for 16QAM-RB Size 1, RB Offset 49

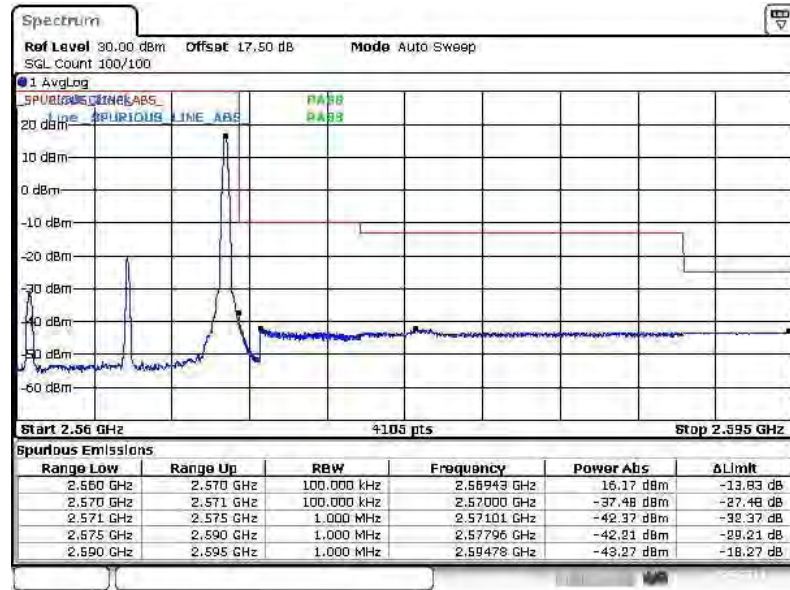

Date: 29.AUG.2014 17:10:52

Higher Band Edge Plot for 16QAM-RB Size 50, RB Offset 0

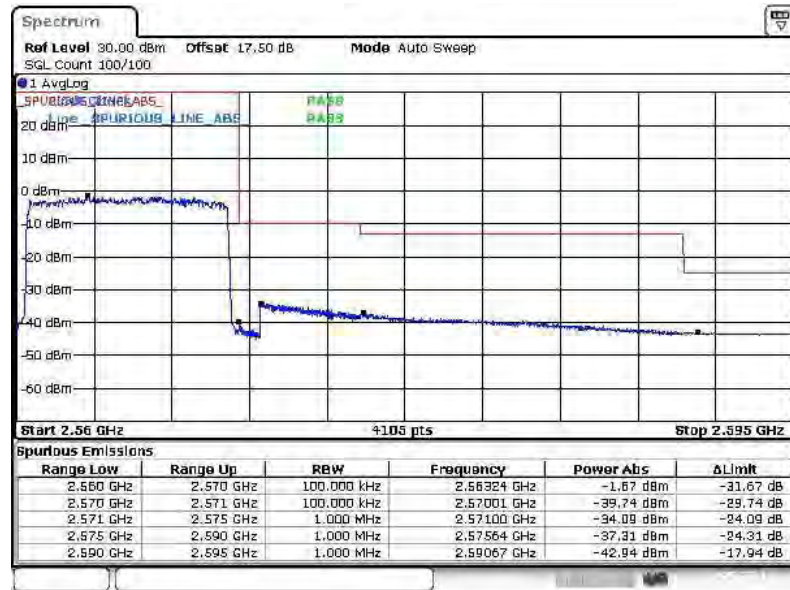

Date: 30.AUG.2014 16:07:35



<b>Band :</b>	LTE Band 7	<b>Band Width :</b>	15MHz / QPSK
---------------	------------	---------------------	--------------

Lower Band Edge Plot for QPSK-RB Size 1, RB Offset 0

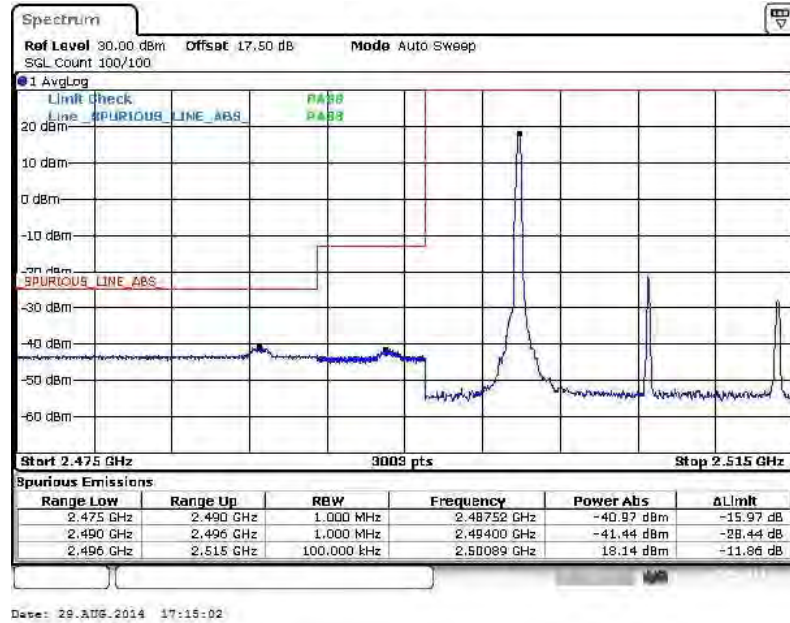

Lower Band Edge Plot for QPSK-RB Size 75, RB Offset 0

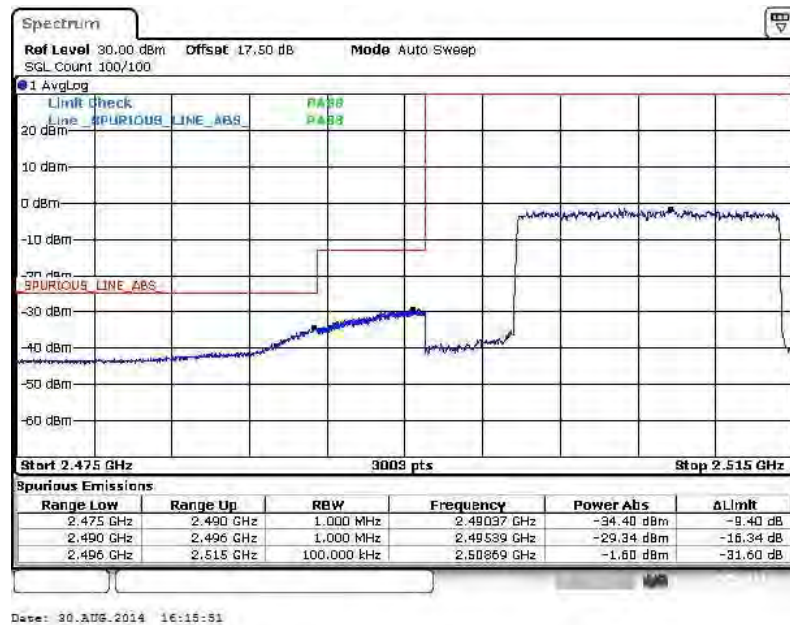





Higher Band Edge Plot for QPSK-RB Size 1, RB Offset 74

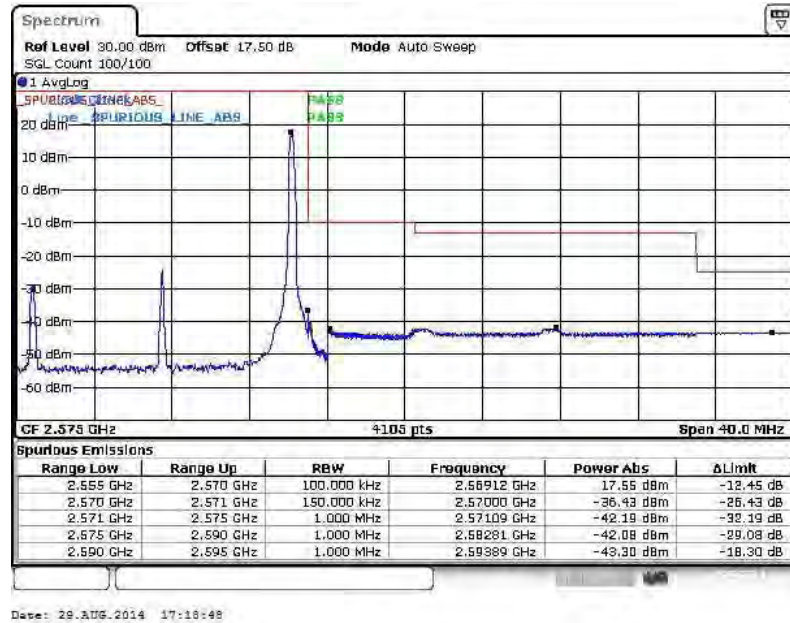

Higher Band Edge Plot for QPSK-RB Size 75, RB Offset 0

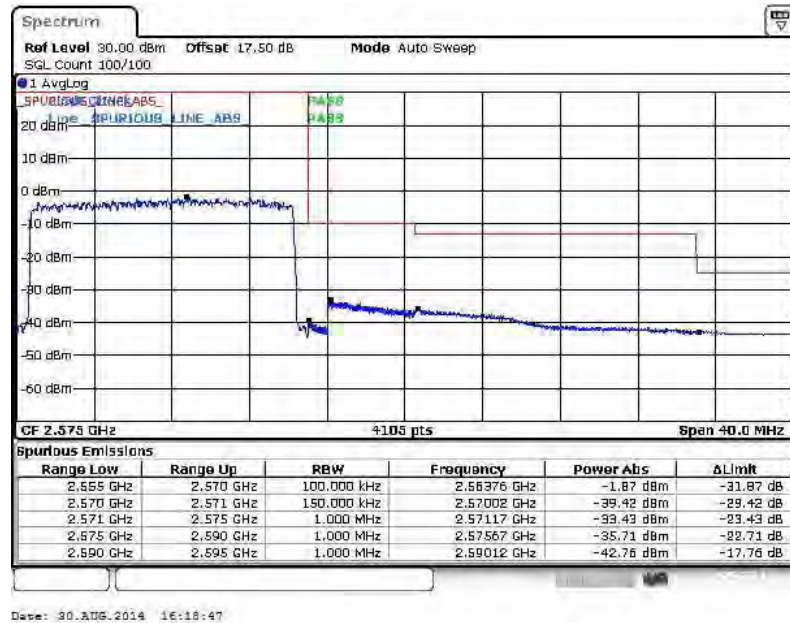



<b>Band :</b>	LTE Band 7	<b>Band Width :</b>	15MHz / 16QAM
---------------	------------	---------------------	---------------

Lower Band Edge Plot for 16QAM-RB Size 1, RB Offset 0

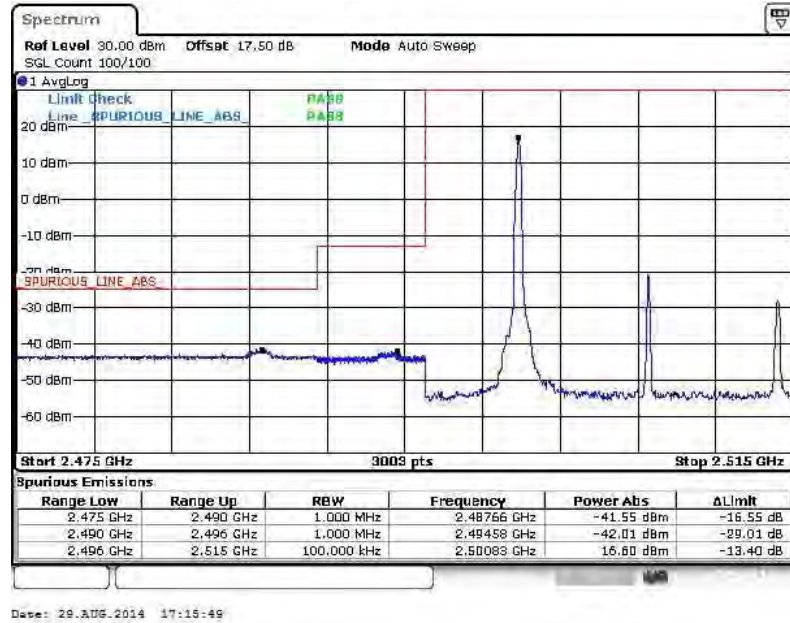

Lower Band Edge Plot for 16QAM-RB Size 75, RB Offset 0

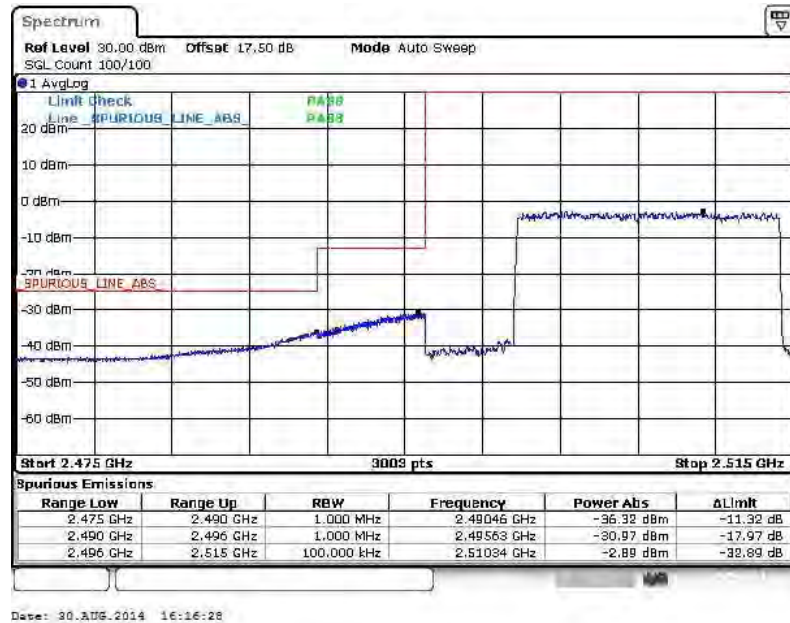



Higher Band Edge Plot for 16QAM-RB Size 1, RB Offset 74

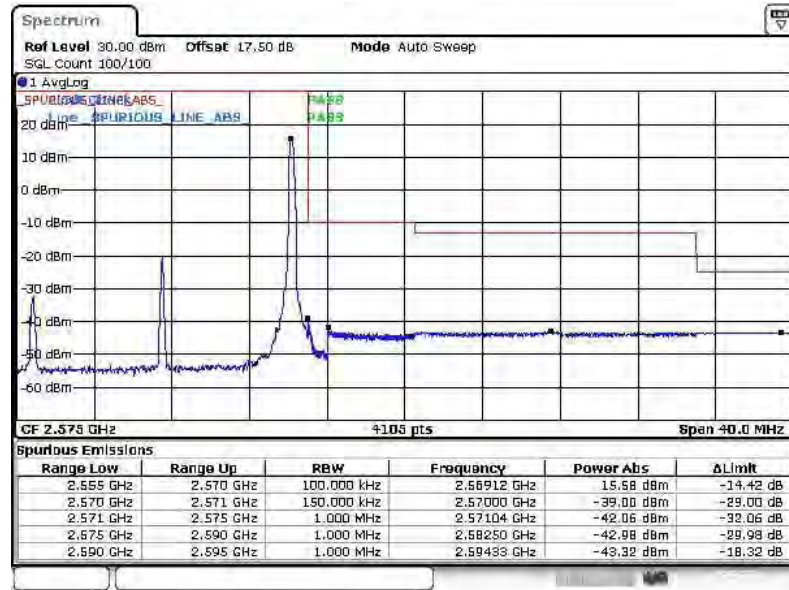

Date: 29.AUG.2014 17:16:33

Higher Band Edge Plot for 16QAM-RB Size 75, RB Offset 0

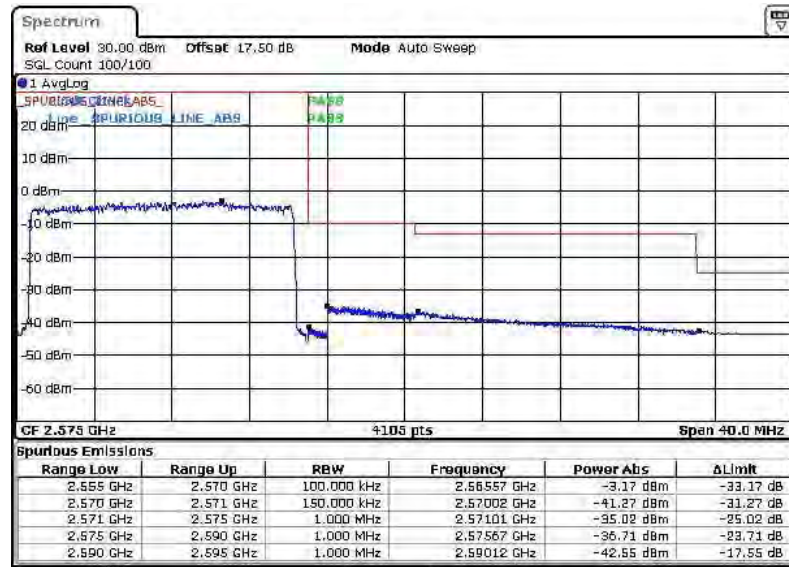

Date: 30.AUG.2014 16:17:12



Band :	LTE Band 7	Band Width :	20MHz / QPSK
--------	------------	--------------	--------------

Lower Band Edge Plot for QPSK-RB Size 1, RB Offset 0

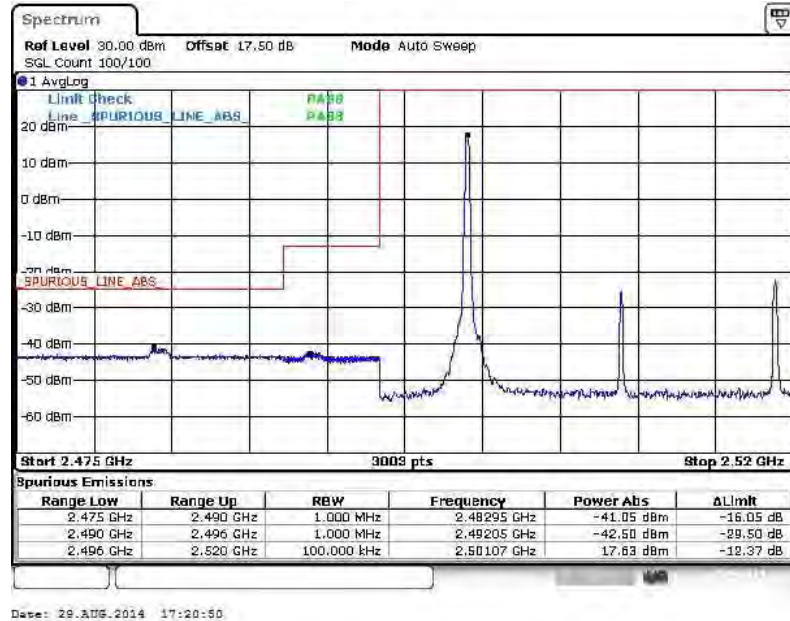

Lower Band Edge Plot for QPSK-RB Size 100, RB Offset 0

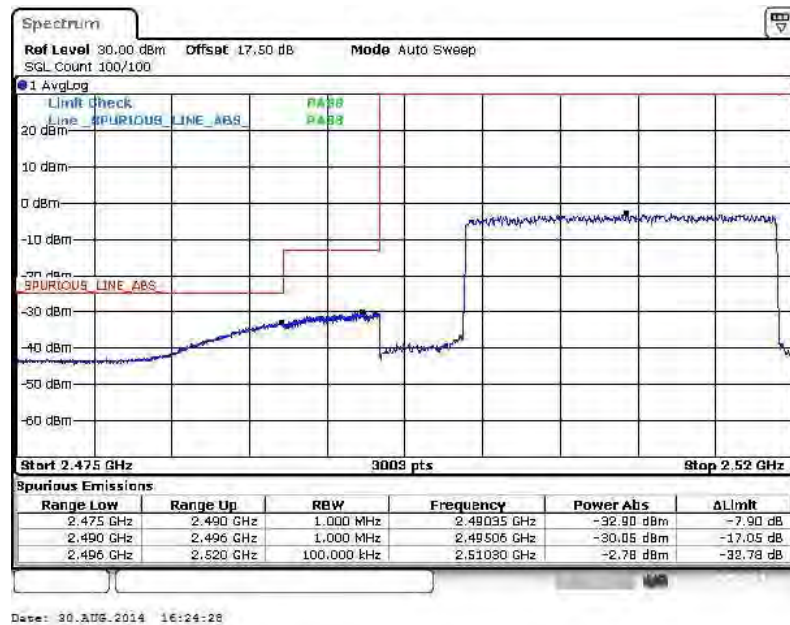





Higher Band Edge Plot for QPSK-RB Size 1, RB Offset 99

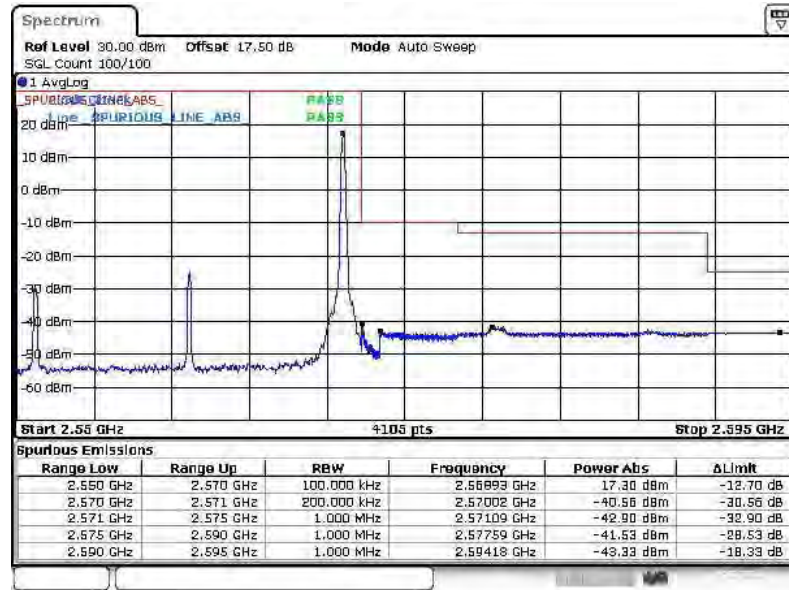

Date: 29.AUG.2014 17:23:24

Higher Band Edge Plot for QPSK-RB Size 100, RB Offset 0

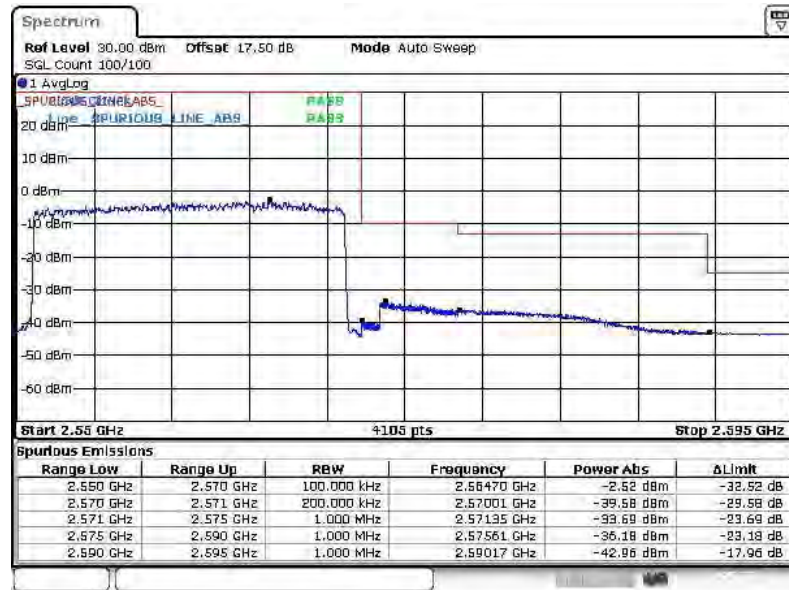

Date: 30.AUG.2014 16:27:43



<b>Band :</b>	LTE Band 7	<b>Band Width :</b>	20MHz / 16QAM
---------------	------------	---------------------	---------------

Lower Band Edge Plot for 16QAM-RB Size 1, RB Offset 0

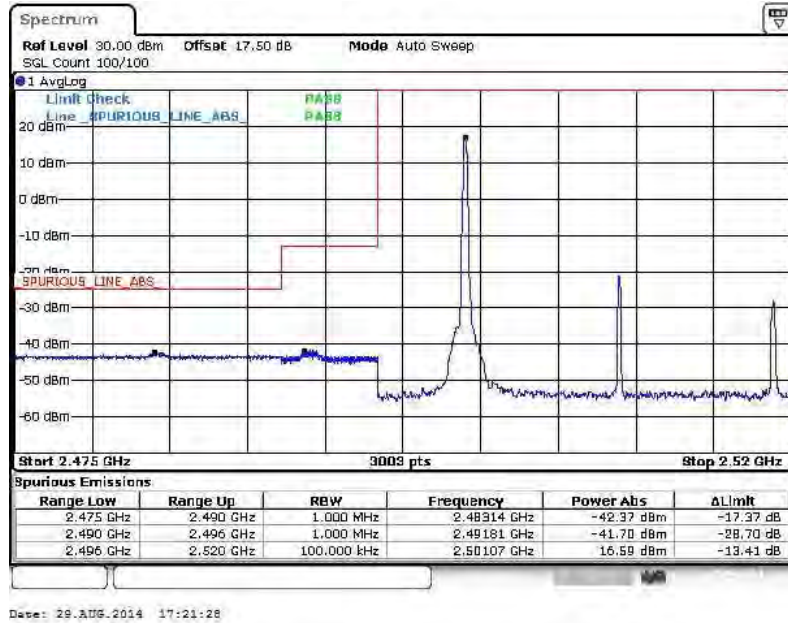

Lower Band Edge Plot for 16QAM-RB Size 100, RB Offset 0

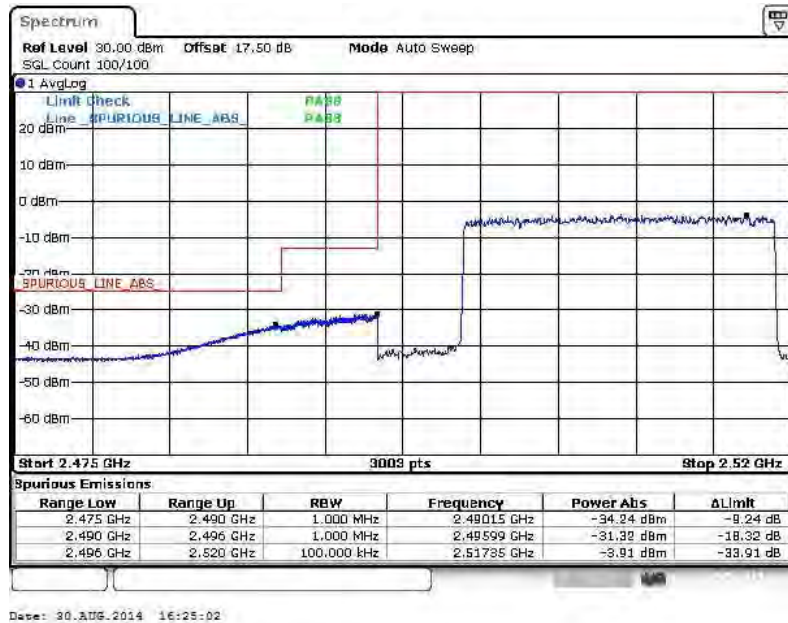



Higher Band Edge Plot for 16QAM-RB Size 1, RB Offset 99

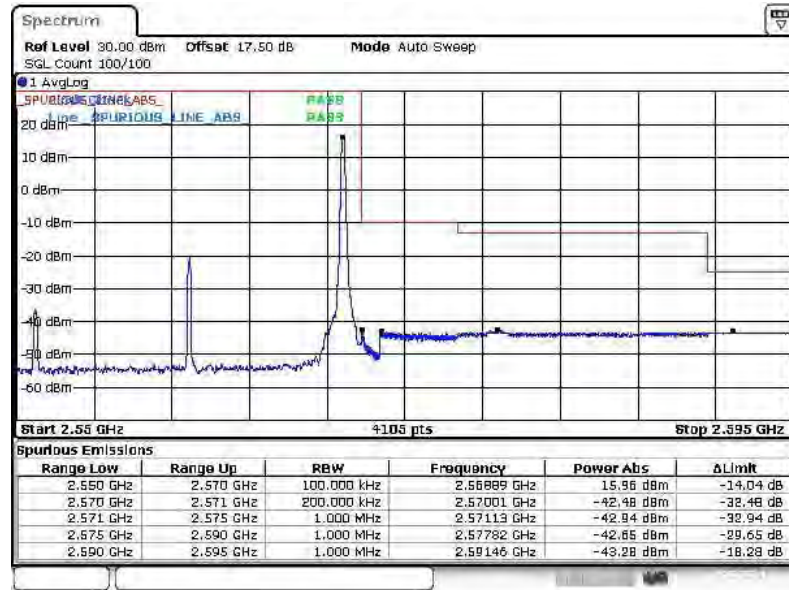

Date: 29.AUG.2014 17:22:12

Higher Band Edge Plot for 16QAM-RB Size 100, RB Offset 0

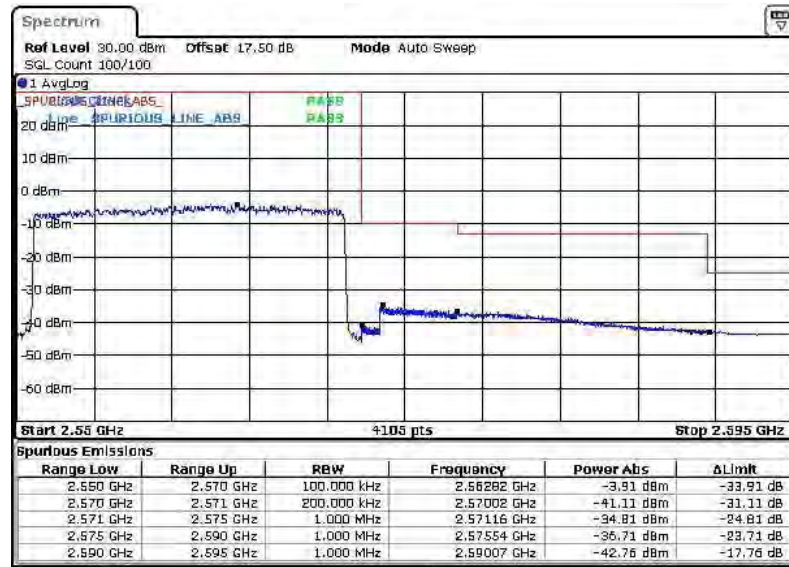

Date: 30.AUG.2014 16:25:38