



HAC RF TEST REPORT

No. I14Z45140-SEM02

For

TCT Mobile Limited

UMTS triband/GSM quadband mobile phone

Mode Name: Miata 3G

Marketing Name: 6016E

With

Hardware Version: Proto

Software Version: v1AC2_US+Z3

FCC ID: RAD464

Results Summary: M Category = M4

Issued Date: 2014-04-14



Note:

The test results in this test report relate only to the devices specified in this report. This report shall not be reproduced except in full without the written approval of TMC Beijing.

Test Laboratory:

TMC Beijing, Telecommunication Metrology Center of MIIT

No. 52, Huayuan Bei Road, Haidian District, Beijing, P. R. China 100191.

Tel:+86(0)10-62304633-2079, Fax:+86(0)10-62304793 Email:welcome@emcite.com. www.emcite.com

Revision Version

Report Number	Revision	Date	Memo
I14Z45140-SEM02	0	2014-04-14	Initial creation of test report

TABLE OF CONTENT

1 TEST LABORATORY	4
1.1 TESTING LOCATION	4
1.2 TESTING ENVIRONMENT.....	4
1.3 PROJECT DATA	4
1.4 SIGNATURE.....	4
2 CLIENT INFORMATION	5
2.1 APPLICANT INFORMATION	5
2.2 MANUFACTURER INFORMATION	5
3 EQUIPMENT UNDER TEST (EUT) AND ANCILLARY EQUIPMENT (AE)	6
3.1 ABOUT EUT	6
3.2 INTERNAL IDENTIFICATION OF EUT USED DURING THE TEST	6
3.3 INTERNAL IDENTIFICATION OF AE USED DURING THE TEST	6
3.4 AIR INTERFACES / BANDS INDICATING OPERATING MODES	6
4 CONDUCTED OUTPUT POWER MEASUREMENT	7
4.1 SUMMARY	7
4.2 CONDUCTED POWER	7
5. REFERENCE DOCUMENTS.....	7
5.1 REFERENCE DOCUMENTS FOR TESTING	7
6 OPERATIONAL CONDITIONS DURING TEST	8
6.1 HAC MEASUREMENT SET-UP.....	8
6.2 PROBE SPECIFICATION	9
6.3 TEST ARCH PHANTOM & PHONE POSITIONER.....	10
6.4 ROBOTIC SYSTEM SPECIFICATIONS	10
7 EUT ARRANGEMENT	11
7.1 WD RF EMISSION MEASUREMENTS REFERENCE AND PLANE	11
8 SYSTEM VALIDATION	12
8.1 VALIDATION PROCEDURE	12
8.2 VALIDATION RESULT	12
9 EVALUATION OF MIF	13
9.1 INTRODUCTION.....	13
9.2 MIF MEASUREMENT WITH THE AIA	14
9.3 TEST EQUIPMENT FOR THE MIF MEASUREMENT	14
9.4 TEST SIGNAL VALIDATION.....	14
9.5 DUT MIF RESULTS.....	15
10 EVALUATION FOR LOW-POWER EXEMPTION	16
10.1 PRODUCT TESTING THRESHOLD	16
10.2 CONDUCTED POWER.....	16
10.3 CONCLUSION	16
11 RF TEST PROCEDURES.....	17
12 MEASUREMENT RESULTS (E-FIELD).....	18
13 ANSI C 63.19-2011 LIMITS	18
14 MEASUREMENT UNCERTAINTY	19
15 MAIN TEST INSTRUMENTS.....	20
16 CONCLUSION	20
ANNEX A TEST LAYOUT	21
ANNEX B TEST PLOTS	22
ANNEX C SYSTEM VALIDATION RESULT	28
ANNEX D PROBE CALIBRATION CERTIFICATE.....	30
ANNEX E DIPOLE CALIBRATION CERTIFICATE	40

1 Test Laboratory

1.1 Testing Location

Company Name: TMC Beijing, Telecommunication Metrology Center of MIIT
Address: No 52, Huayuan beilu, Haidian District, Beijing,P.R.China
Postal Code: 100191
Telephone: +86-10-62304633
Fax: +86-10-62304793

1.2 Testing Environment

Temperature: 18°C~25 °C,
Relative humidity: 30%~ 70%
Ground system resistance: < 0.5 Ω

Ambient noise is checked and found very low and in compliance with requirement of standards.
Reflection of surrounding objects is minimized and in compliance with requirement of standards.

1.3 Project Data

Project Leader: Qi Dianyuan
Test Engineer: Lin Hao
Testing Start Date: February 21, 2014
Testing End Date: February 21, 2014

1.4 Signature



Lin Hao

(Prepared this test report)

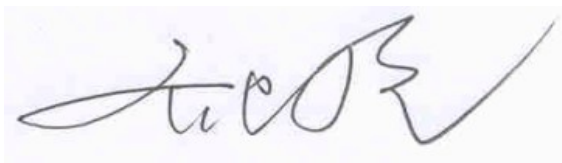

Qi Dianyuan

(Reviewed this test report)



Xiao Li

Deputy Director of the laboratory
(Approved this test report)

2 Client Information

2.1 Applicant Information

Company Name:	TCT Mobile Limited
Address /Post:	12F/B, TCL Tower, Gaoxin Nanyi Road, Nanshan District, Shenzhen, Guangdong, P.R. China. 518057
City:	Guangdong
Postal Code:	518057
Country:	P.R.China
Contact:	Lv Meixian
Email:	meixian.lv@tcl.com
Telephone:	0086-755-33956929
Fax:	0086-755-36645072

2.2 Manufacturer Information

Company Name:	TCT Mobile Limited
Address /Post:	12F/B, TCL Tower, Gaoxin Nanyi Road, Nanshan District, Shenzhen, Guangdong, P.R. China. 518057
City:	Guangdong
Postal Code:	518057
Country:	P.R.China
Contact:	Lv Meixian
Email:	meixian.lv@tcl.com
Telephone:	0086-755-33956929
Fax:	0086-755-36645072

3 Equipment Under Test (EUT) and Ancillary Equipment (AE)

3.1 About EUT

Description:	UMTS triband/GSM quadband mobile phone
Mode Name:	Miata 3G
Marketing Name:	6016E
Operating mode(s):	GSM 850/900/1800/1900, WCDMA 850/1900/2100, BT, Wi-Fi

3.2 Internal Identification of EUT used during the test

EUT ID*	IMEI	HW Version	SW Version
EUT1	863829020000772	Proto	v1AC2_US+Z3

*EUT ID: is used to identify the test sample in the lab internally.

3.3 Internal Identification of AE used during the test

AE ID*	Description	Model	SN	Manufacturer
AE1	Battery	CAC1700001C1	/	BYD
AE2	Battery	CAC1700003C2	/	SCUD

*AE ID: is used to identify the test sample in the lab internally.

Note: It is performed to test with battery CAC1700001C1.

3.4 Air Interfaces / Bands Indicating Operating Modes

Air-interface	Band(MHz)	Type	C63.19/tested	Simultaneous Transmissions	OTT	Power Reduction
GSM	850	VO	Yes	WIFI and BT	NA	NA
	1900					
GPRS/EDGE	850	DT	NA			Yes
	1900					
WCDMA (UMTS)	850	VO	Yes	WIFI and BT	NA	NA
	1900					
	HSPA	DT	NA			
WIFI	2450	DT	NA	GSM and WCDMA	Yes	NA
BT	2450	DT	NA	GSM and WCDMA	NA	NA

VO: Voice CMRS/PSTN Service Only

V/D: Voice CMRS/PSTN and Data Service

DT: Digital Transport

* HAC Rating was not based on concurrent voice and data modes, Non current mode was found to represent worst case rating for both M and T rating

According to the KDB 285076 D01 v04, the antenna must be tested in a position of maximum antenna efficiency for voice operation, when the handset is held to the ear.

The EUT is a bar phone and there is only one position for held to the ear voice calls.

4 CONDUCTED OUTPUT POWER MEASUREMENT

4.1 Summary

During the process of testing, the EUT was controlled via Agilent Digital Radio Communication tester (E5515C) to ensure the maximum power transmission and proper modulation. This result contains conducted output power for the EUT. In all cases, the measured output power should be greater and within 5% than EMI measurement.

4.2 Conducted Power

GSM 850MHz	Conducted Power (dBm)		
	Channel 251(848.8MHz)	Channel 190(836.6MHz)	Channel 128(824.2MHz)
	32.25	32.39	32.37
GSM 1900MHz	Conducted Power (dBm)		
	Channel 810(1909.8MHz)	Channel 661(1880MHz)	Channel 512(1850.2MHz)
	29.20	29.06	29.10
WCDMA 850MHz	Conducted Power (dBm)		
	Channel 4233(846.6MHz)	Channel 4182(836.4MHz)	Channel 4132(826.4MHz)
	23.04	23.06	23.04
WCDMA 1900MHz	Conducted Power (dBm)		
	Channel 9538(1907.6MHz)	Channel 9400(1880MHz)	Channel 9262(1852.4MHz)
	22.53	22.25	22.38

5. Reference Documents

5.1 Reference Documents for testing

The following document listed in this section is referred for testing.

Reference	Title	Version
ANSI C63.19-2011	American National Standard for Methods of Measurement of Compatibility between Wireless Communication Devices and Hearing Aids	2011 Edition
FCC 47 CFR §20.19	Hearing Aid Compatible Mobile Headsets	/
KDB 285076 D01	Equipment Authorization Guidance for Hearing Aid Compatibility	v04

6 OPERATIONAL CONDITIONS DURING TEST

6.1 HAC MEASUREMENT SET-UP

These measurements are performed using the DASY5 NEO automated dosimetric assessment system. It is made by Schmid & Partner Engineering AG (SPEAG) in Zurich, Switzerland. It consists of high precision robotics system (Stäubli), robot controller, Intel Core2 computer, near-field probe, probe alignment sensor. The robot is a six-axis industrial robot performing precise movements. A cell controller system contains the power supply, robot controller, teach pendant (Joystick), and remote control, is used to drive the robot motors. The PC consists of the HP Intel Core2 1.86 GHz computer with Windows XP system and HAC Measurement Software DASY5 NEO, A/D interface card, monitor, mouse, and keyboard. The Stäubli Robot is connected to the cell controller to allow software manipulation of the robot. A data acquisition electronic (DAE) circuit performs the signal amplification, signal multiplexing, AD-conversion, offset measurements, mechanical surface detection, collision detection, etc. is connected to the Electro-optical coupler (EOC). The EOC performs the conversion from the optical into digital electric signal of the DAE and transfers data to the PC plug-in card.

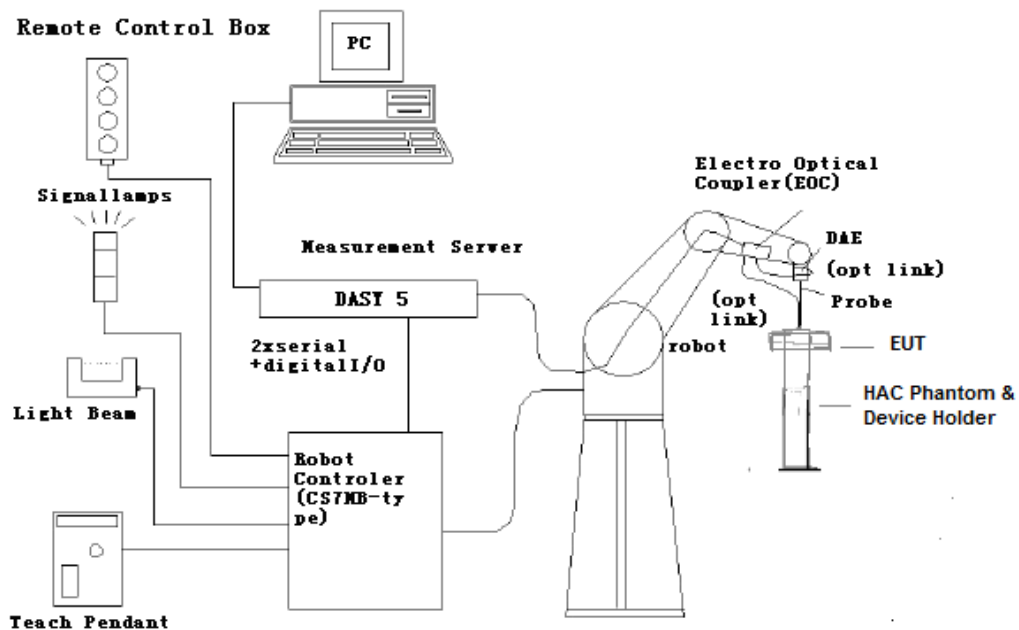

Fig. 1 HAC Test Measurement Set-up

The DAE4 consists of a highly sensitive electrometer-grade preamplifier with auto-zeroing, a channel and gain-switching multiplexer, a fast 16 bit AD-converter and a command decoder and control logic unit. Transmission to the PC-card is accomplished through an optical downlink for data and status information and an optical uplink for commands and clock lines. The mechanical probe mounting device includes two different sensor systems for frontal and sidewise probe contacts. They are also used for mechanical surface detection and probe collision detection. The robot uses its own controller with a built in VME-bus computer.

6.2 Probe Specification

E-Field Probe Description

Construction	<p>One dipole parallel, two dipoles normal to probe axis</p> <p>Built-in shielding against static charges</p> <p>PEEK enclosure material</p>
Calibration	<p>In air from 100 MHz to 3.0 GHz (absolute accuracy $\pm 6.0\%$, $k=2$)</p>
Frequency	<p>40 MHz to > 6 GHz (can be extended to < 20 MHz)</p> <p>Linearity: ± 0.2 dB (100 MHz to 3 GHz)</p>
Directivity	<p>± 0.2 dB in air (rotation around probe axis)</p> <p>± 0.4 dB in air (rotation normal to probe axis)</p>
Dynamic Range	<p>2 V/m to > 1000 V/m; Linearity: ± 0.2 dB</p>
Dimensions	<p>Overall length: 330 mm (Tip: 16 mm)</p> <p>Tip diameter: 8 mm (Body: 12 mm)</p> <p>Distance from probe tip to dipole centers: 2.5 mm</p>
Application	<p>General near-field measurements up to 6 GHz</p> <p>Field component measurements</p> <p>Fast automatic scanning in phantoms</p>

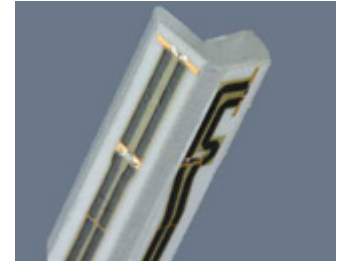

[ER3DV6]

6.3 Test Arch Phantom & Phone Positioner

The Test Arch phantom should be positioned horizontally on a stable surface. Reference markings on the Phantom allow the complete setup of all predefined phantom positions and measurement grids by manually teaching three points in the robot. It enables easy and well defined positioning of the phone and validation dipoles as well as simple teaching of the robot (Dimensions: 370 x 370 x 370 mm).

The Phone Positioner supports accurate and reliable positioning of any phone with effect on near field $< \pm 0.5$ dB.

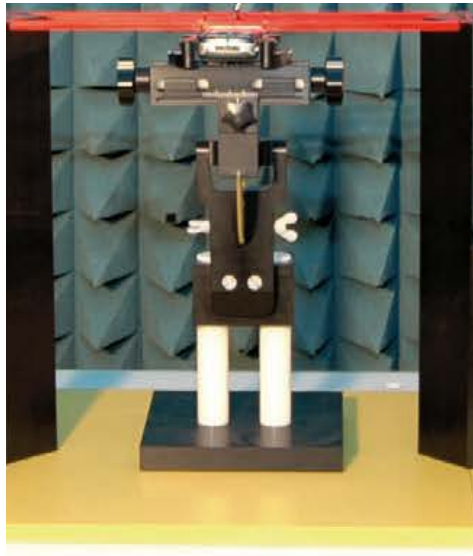

Fig. 2 HAC Phantom & Device Holder

6.4 Robotic System Specifications

Specifications

Positioner: Stäubli Unimation Corp. Robot Model: RX160L

Repeatability: ± 0.02 mm

No. of Axis: 6

Data Acquisition Electronic (DAE) System

Cell Controller

Processor: Intel Core2

Clock Speed: 1.86 GHz

Operating System: Windows XP

Data Converter

Features: Signal Amplifier, multiplexer, A/D converter, and control logic

Software: DASY5 software

Connecting Lines: Optical downlink for data and status info.

Optical uplink for commands and clock

7 EUT ARRANGEMENT

7.1 WD RF Emission Measurements Reference and Plane

Figure 4 illustrates the references and reference plane that shall be used in the WD emissions measurement.

- The grid is 5 cm by 5 cm area that is divided into 9 evenly sized blocks or sub-grids.
- The grid is centered on the audio frequency output transducer of the WD (speaker or T-coil).
- The grid is located by reference to a reference plane. This reference plane is the planar area that contains the highest point in the area of the WD that normally rests against the user's ear
- The measurement plane is located parallel to the reference plane and 15 mm from it, out from the phone. The grid is located in the measurement plane.

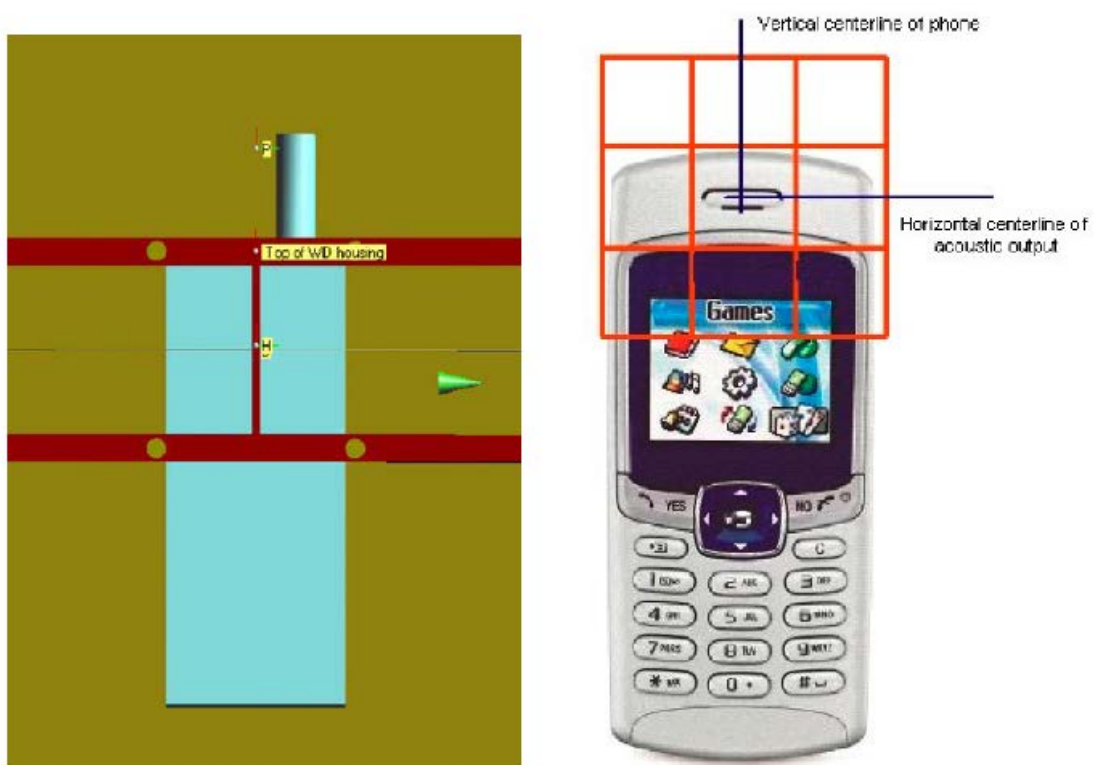

Fig. 3 WD reference and plane for RF emission measurements

8 SYSTEM VALIDATION

8.1 Validation Procedure

Place a dipole antenna meeting the requirements given in ANSI C63.19 in the position normally occupied by the WD. The dipole antenna serves as a known source for an electrical output. Position the E-field probes so that:

- The probes and their cables are parallel to the coaxial feed of the dipole antenna
- The probe cables and the coaxial feed of the dipole antenna approach the measurement area from opposite directions
- The center point of the probe element(s) are 15 mm from the closest surface of the dipole elements.

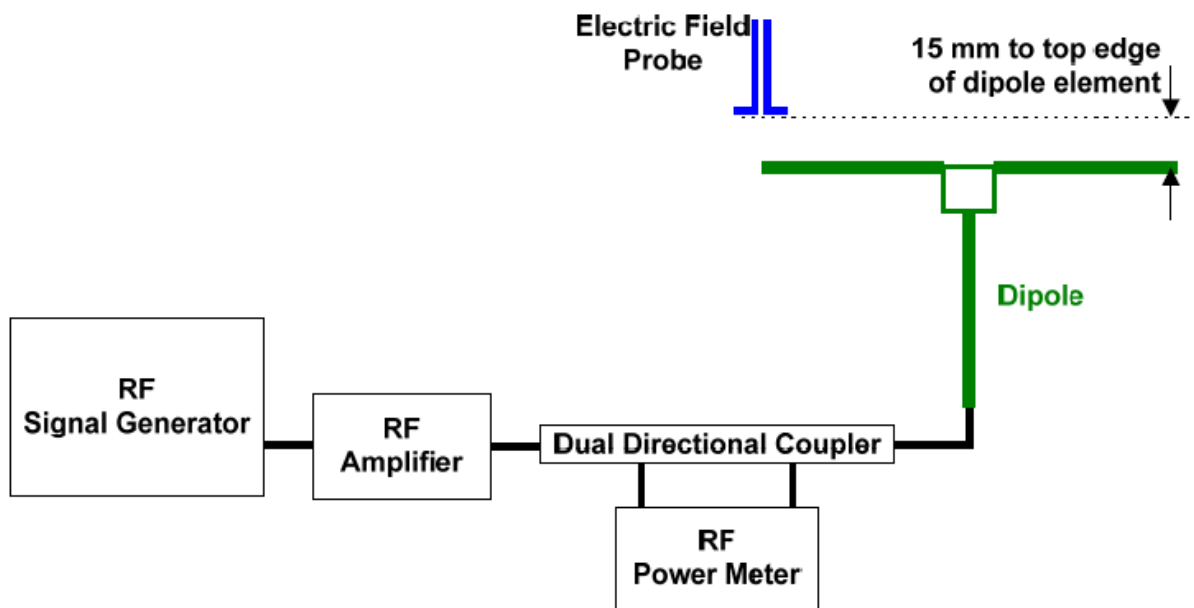

Fig. 4 Dipole Validation Setup

8.2 Validation Result

E-Field Scan							
Mode	Frequency (MHz)	Input Power (mW)	Measured ¹ Value(V/m)	Target ² Value(V/m)	Deviation ³ (%)	Limit ⁴ (%)	
CW	835	100	108.7	105.4	3.13	±25	
CW	1880	100	96.05	94.20	1.96	±25	

Notes:

1. Please refer to the attachment for detailed measurement data and plot.
2. Target value is provided by SPEAD in the calibration certificate of specific dipoles.
3. Deviation (%) = $100 * (\text{Measured value minus Target value}) / \text{Target value}$.
4. ANSI C63.19 requires values within $\pm 25\%$ are acceptable, of which 12% is deviation and 13% is measurement uncertainty. Values independently validated for the dipole actually used in the measurements should be used, when available.

9 Evaluation of MIF

9.1 Introduction

The MIF (Modulation Interference Factor) is used to classify E-field emission to determine Hearing Aid Compatibility (HAC). It scales the power-averaged signal to the RF audio interference level and is characteristic to a modulation scheme. The HAC standard preferred "indirect" measurement method is based on average field measurement with separate scaling by the MIF. With an Audio Interference Analyzer (AIA) designed by SPEAG specifically for the MIF measurement, these values have been verified by practical measurements on an RF signal modulated with each of the waveforms. The resulting deviations from the simulated values are within the requirements of the HAC standard.

The AIA (Audio Interference Analyzer) is a USB powered electronic sensor to evaluate signals in the frequency range 698 MHz - 6 GHz. It contains RMS detector and audio frequency circuits for sampling of the RF envelope.

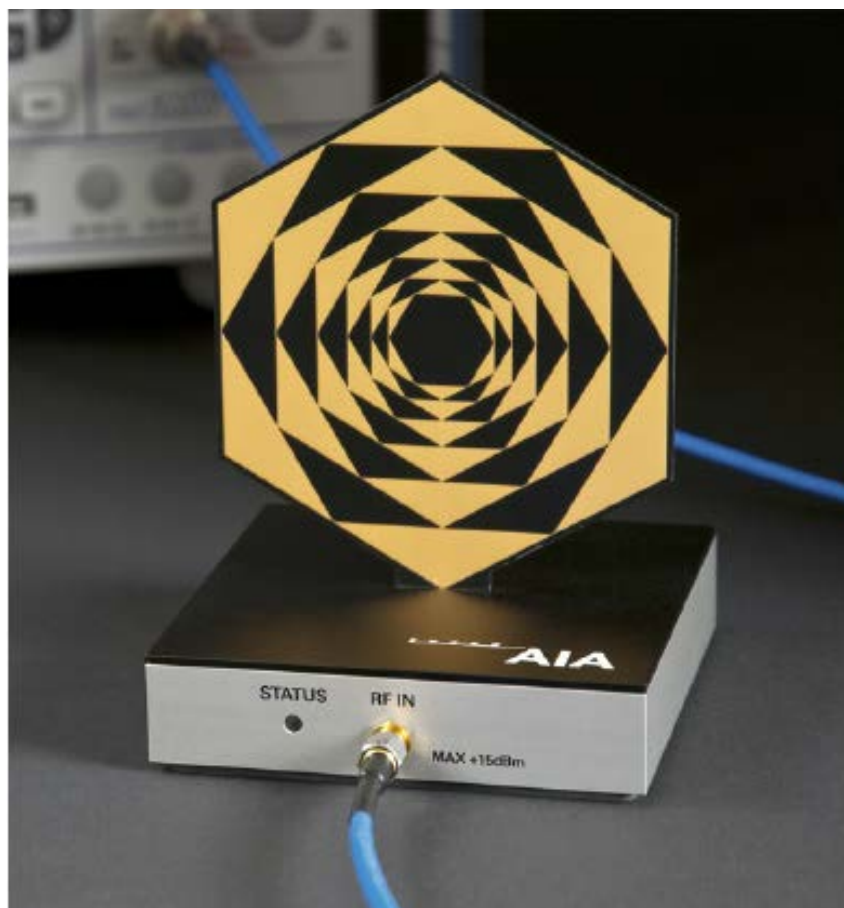

Fig. 5 AIA Front View

9.2 MIF measurement with the AIA

The MIF is measured with the AIA as follows:

1. Connect the AIA via USB to the DASY5 PC and verify the configuration settings.
2. Couple the RF signal to be evaluated to an AIA via cable or antenna.
3. Generate a MIF measurement job for the unknown signal and select the measurement port and timing settings.
4. Document the results via the post processor in a report.

9.3 Test equipment for the MIF measurement

No.	Name	Type	Serial Number	Manufacturer
01	Signal Generator	E4438C	MY49071430	Agilent
02	AIA	SE UMS 170 CB	1029	SPEAG
03	BTS	E5515C	MY50263375	Agilent

9.4 Test signal validation

The signal generator (E4438C) is used to generate a 1GHz signal with different modulation in the below table based on the ANSI C63.19-2011. The measured MIF with AIA are compared with the target values given in ANSI C63.19-2011 table D.3, D.4 and D5.

Pulse modulation	Target MIF	Measured MIF	Deviation
0.5ms pulse, 1000Hz repetition rate	-0.9 dB	-0.9 dB	0 dB
1ms pulse, 100Hz repetition rate	+3.9 dB	+3.7 dB	0.2 dB
0.1ms pulse, 100Hz repetition rate	+10.1 dB	+10.0 dB	0.1 dB
10ms pulse, 10Hz repetition rate	+1.6 dB	+1.7 dB	0.1 dB
Sine-wave modulation	Target MIF	Measured MIF	Deviation
1 kHz, 80% AM	-1.2 dB	-1.3 dB	0.1 dB
1 kHz, 10% AM	-9.1 dB	-9.0 dB	0.1 dB
1 kHz, 1% AM	-19.1 dB	-18.9 dB	0.2 dB
100 Hz, 10% AM	-16.1 dB	-16.0 dB	0.1 dB
10 kHz, 10% AM	-21.5 dB	-21.6 dB	0.1 dB
Transmission protocol	Target MIF	Measured MIF	Deviation
GSM; full-rate version 2; speech codec/handset low	+3.5 dB	+3.47 dB	0.03 dB
WCDMA; speech; speech codec low; AMR 12.2 kb/s	-20.0 dB	-19.8 dB	0.2 dB
CDMA; speech; SO3; RC3; full frame rate; 8kEVRC	-19.0 dB	-19.1 dB	0.1 dB
CDMA; speech; SO3; RC1; 1/8 th frame rate; 8kEVRC	+3.3 dB	+3.44 dB	0.14 dB

9.5 DUT MIF results

Typical MIF levels in ANSI C63.19-2011	
Transmission protocol	Modulation interference factor
GSM; full-rate version 2; speech codec/handset low	+3.5 dB
WCDMA; speech; speech codec low; AMR 12.2 kb/s	-20.0 dB

Measured MIF levels		
Band	Channel	Modulation interference factor
GSM 850	251	+3.48 dB
	190	+3.43 dB
	128	+3.47 dB
GSM 1900	810	+3.46 dB
	661	+3.38 dB
	512	+3.48 dB
WCDMA 850	4233	-18.76 dB
	4182	-18.91 dB
	4132	-18.88 dB
WCDMA 1900	9538	-18.90 dB
	9400	-18.79 dB
	9262	-18.78 dB

10 Evaluation for low-power exemption

10.1 Product testing threshold

There are two methods for exempting an RF air interface technology from testing. The first method requires evaluation of the MIF for the worst-case operating mode. An RF air interface technology of a device is exempt from testing when its average antenna input power plus its MIF is ≤ 17 dBm for any of its operating modes. The second method does not require determination of the MIF. The RF emissions testing exemption shall be applied to an RF air interface technology in a device whose peak antenna input power, averaged over intervals $\leq 50 \mu s$, is ≤ 23 dBm. An RF air interface technology that is exempted from testing by either method shall be rated as M4.

The first method is used to be exempt from testing for the RF air interface technology in this report.

10.2 Conducted power

Band	Average power (dBm)	MIF (dB)	Sum (dBm)
GSM 850	32.29	+3.48	35.77
GSM 1900	29.20	+3.48	32.68
WCDMA 850	23.06	-18.76	4.30
WCDMA 1900	22.53	-18.78	3.75

10.3 Conclusion

According to the above table, the sums of average power and MIF for UMTS are less than 17dBm. So it is only measured for GSM bands. The UMTS bands are exempt from testing and rated as M4.

11 RF TEST PROCEDURES

The evaluation was performed with the following procedure:

- 1) Confirm proper operation of the field probe, probe measurement system and other instrumentation and the positioning system.
- 2) Position the WD in its intended test position. The gauge block can simplify this positioning.
- 3) Configure the WD normal operation for maximum rated RF output power, at the desired channel and other operating parameters (e.g., test mode), as intended for the test.
- 4) The center sub-grid shall be centered on the center of the T-Coil mode axial measurement point or the acoustic output, as appropriate. Locate the field probe at the initial test position in the 50 mm by 50 mm grid, which is contained in the measurement plane. If the field alignment method is used, align the probe for maximum field reception.
- 5) Record the reading.
- 6) Scan the entire 50 mm by 50 mm region in equally spaced increments and record the reading at each measurement point. The distance between measurement points shall be sufficient to assure the identification of the maximum reading.
- 7) Identify the five contiguous sub-grids around the center sub-grid whose maximum reading is the lowest of all available choices. This eliminates the three sub-grids with the maximum readings. Thus, the six areas to be used to determine the WD's highest emissions are identified.
- 8) Identify the maximum field reading within the non-excluded sub-grids identified in Step 7)
- 9) Evaluate the MIF and add to the maximum steady-state rms field-strength reading to obtain the RF audio interference level..
- 10) Compare this RF audio interference level with the categories and record the resulting WD category rating.

12 Measurement Results (E-Field)

Frequency		Measured Value dB (V/m)	Power Drift (dB)	Category
MHz	Channel			
GSM 850				
848.8	251	37.82	-0.01	M4 (see Fig B.1)
836.6	190	37.99	-0.04	M4 (see Fig B.2)
824.2	128	38.54	-0.03	M4 (see Fig B.3)
GSM 1900				
1909.8	810	27.42	-0.12	M4 (see Fig B.4)
1880	661	27.74	0.04	M4 (see Fig B.5)
1850.2	512	27.22	-0.03	M4 (see Fig B.6)

13 ANSI C 63.19-2011 LIMITS

WD RF audio interference level categories in logarithmic units

Emission categories	< 960 MHz	
	E-field emissions	
Category M1	50 to 55	dB (V/m)
Category M2	45 to 50	dB (V/m)
Category M3	40 to 45	dB (V/m)
Category M4	< 40	dB (V/m)
Emission categories	> 960 MHz	
	E-field emissions	
Category M1	40 to 45	dB (V/m)
Category M2	35 to 40	dB (V/m)
Category M3	30 to 35	dB (V/m)
Category M4	< 30	dB (V/m)

14 MEASUREMENT UNCERTAINTY

No.	Error source	Type	Uncertainty Value (%)	Prob. Dist.	k	c _i E	Standard Uncertainty (%) u_i (%) E	Degree of freedom V_{eff} or ν_i
Measurement System								
1	Probe Calibration	B	5.	N	1	1	5.1	∞
2	Axial Isotropy	B	4.7	R	$\sqrt{3}$	1	2.7	∞
3	Sensor Displacement	B	16.5	R	$\sqrt{3}$	1	9.5	∞
4	Boundary Effects	B	2.4	R	$\sqrt{3}$	1	1.4	∞
5	Linearity	B	4.7	R	$\sqrt{3}$	1	2.7	∞
6	Scaling to Peak Envelope Power	B	2.0	R	$\sqrt{3}$	1	1.2	∞
7	System Detection Limit	B	1.0	R	$\sqrt{3}$	1	0.6	∞
8	Readout Electronics	B	0.3	N	1	1	0.3	∞
9	Response Time	B	0.8	R	$\sqrt{3}$	1	0.5	∞
10	Integration Time	B	2.6	R	$\sqrt{3}$	1	1.5	∞
11	RF Ambient Conditions	B	3.0	R	$\sqrt{3}$	1	1.7	∞
12	RF Reflections	B	12.0	R	$\sqrt{3}$	1	6.9	∞
13	Probe Positioner	B	1.2	R	$\sqrt{3}$	1	0.7	∞
14	Probe Positioning	A	4.7	R	$\sqrt{3}$	1	2.7	∞
15	Extra. And Interpolation	B	1.0	R	$\sqrt{3}$	1	0.6	∞
Test Sample Related								
16	Device Positioning Vertical	B	4.7	R	$\sqrt{3}$	1	2.7	∞
17	Device Positioning Lateral	B	1.0	R	$\sqrt{3}$	1	0.6	∞
18	Device Holder and Phantom	B	2.4	R	$\sqrt{3}$	1	1.4	∞
19	Power Drift	B	5.0	R	$\sqrt{3}$	1	2.9	∞

20	AIA measurement	B	12	R	$\sqrt{3}$	1	6.9	∞
Phantom and Setup related								
21	Phantom Thickness	B	2.4	R	$\sqrt{3}$	1	1.4	∞
Combined standard uncertainty(%)							16.2	
Expanded uncertainty (confidence interval of 95 %)		$u_e = 2u_c$		N	k=2		32.4	

15 MAIN TEST INSTRUMENTS

Table 1: List of Main Instruments

No.	Name	Type	Serial Number	Calibration Date	Valid Period
01	Signal Generator	E4438C	MY49071430	February 10, 2014	One Year
02	Power meter	NRVD	102196	March 15, 2013	One year
03	Power sensor	NRV-Z5	100596		
04	Amplifier	60S1G4	0331848	No Calibration Requested	
05	E-Field Probe	ER3DV6	2428	January 27, 2014	One year
06	HAC Dipole	CD835V3	1023	September 25, 2013	One year
07	HAC Dipole	CD1880V3	1018	September 25, 2013	One year
08	BTS	E5515C	MY50263375	January 30, 2014	One year
09	DAE	SPEAG DAE4	777	February 22, 2013	One year
10	AIA	SE UMS 170 CB	1029	No Calibration Requested	

16 CONCLUSION

The HAC measurement indicates that the EUT complies with the HAC limits of the ANSI C63.19-2011. The total M-rating is **M4**.

END OF REPORT BODY

ANNEX A TEST LAYOUT**Picture A1: HAC RF System Layout**

ANNEX B TEST PLOTS

HAC RF E-Field GSM 850 High

Date: 2014-2-21

Electronics: DAE4 Sn777

Medium: Air

Medium parameters used: $\sigma = 0$ mho/m, $\epsilon_r = 1$; $\rho = 1000$ kg/m³

Ambient Temperature: 22.2°C

Communication System: GSM 850; Frequency: 848.8 MHz; Duty Cycle: 1:8.3

Probe: ER3DV6 - SN2428; ConvF(1, 1, 1)

E Scan - ER3DV6 - 2011: 15 mm from Probe Center to the Device/Hearing Aid Compatibility Test (101x101x1): Interpolated grid: dx=0.5000 mm, dy=0.5000 mm

Device Reference Point: 0, 0, -6.3 mm

Reference Value = 63.71 V/m; Power Drift = -0.01 dB

Applied MIF = 3.48 dB

RF audio interference level = 37.82 dBV/m

Emission category: M4

MIF scaled E-field

Grid 1 M4 36.04 dBV/m	Grid 2 M4 37.6 dBV/m	Grid 3 M4 37.57 dBV/m
Grid 4 M4 36.28 dBV/m	Grid 5 M4 37.82 dBV/m	Grid 6 M4 37.78 dBV/m
Grid 7 M4 36.44 dBV/m	Grid 8 M4 37.79 dBV/m	Grid 9 M4 37.77 dBV/m

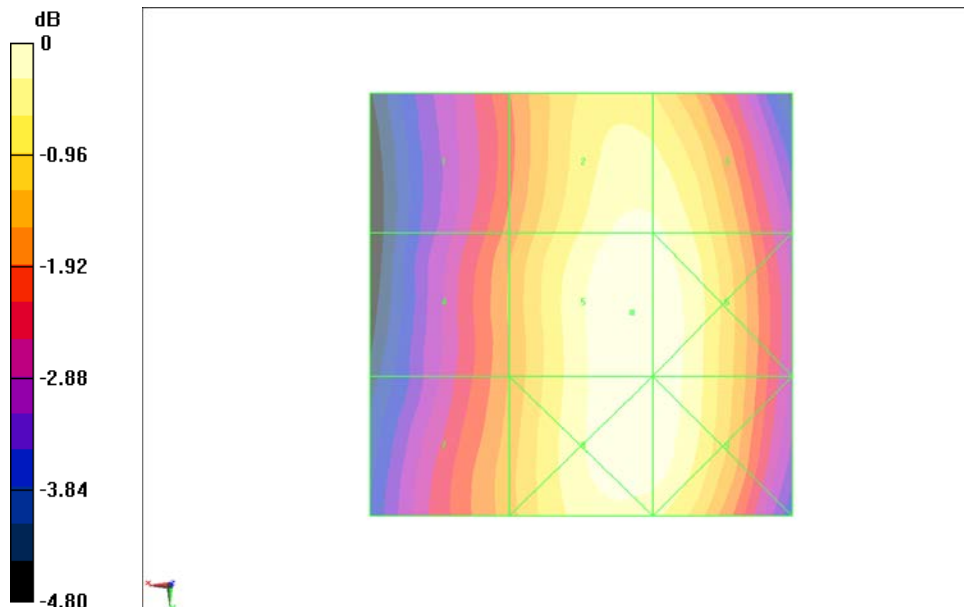

0 dB = 77.81 V/m = 37.82 dBV/m

Fig B.1 HAC RF E-Field GSM 850 High

HAC RF E-Field GSM 850 Middle

Date: 2014-2-21

Electronics: DAE4 Sn777

Medium: Air

Medium parameters used: $\sigma = 0$ mho/m, $\epsilon_r = 1$; $\rho = 1000$ kg/m³

Ambient Temperature: 22.2°C

Communication System: GSM 850; Frequency: 836.6 MHz; Duty Cycle: 1:8.3

Probe: ER3DV6 - SN2428; ConvF(1, 1, 1)

E Scan - ER3DV6 - 2011: 15 mm from Probe Center to the Device 2/Hearing Aid Compatibility Test (101x101x1): Interpolated grid: dx=0.5000 mm, dy=0.5000 mm

Device Reference Point: 0, 0, -6.3 mm

Reference Value = 65.69 V/m; Power Drift = -0.04 dB

Applied MIF = 3.43 dB

RF audio interference level = 37.99 dBV/m

Emission category: M4

MIF scaled E-field

Grid 1 M4 36.24 dBV/m	Grid 2 M4 37.75 dBV/m	Grid 3 M4 37.73 dBV/m
Grid 4 M4 36.48 dBV/m	Grid 5 M4 37.99 dBV/m	Grid 6 M4 37.93 dBV/m
Grid 7 M4 36.68 dBV/m	Grid 8 M4 37.95 dBV/m	Grid 9 M4 37.91 dBV/m

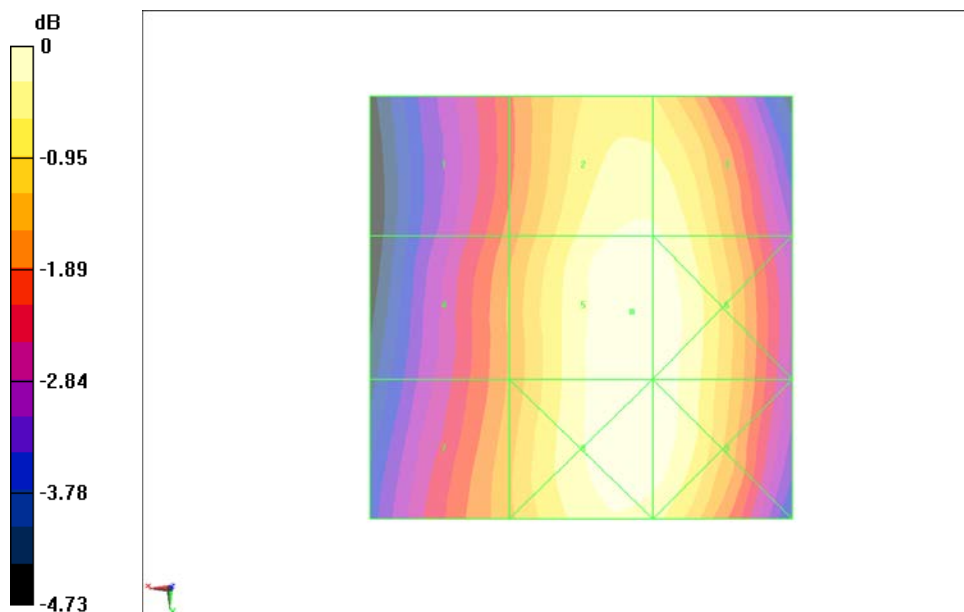

0 dB = 79.32 V/m = 37.99 dBV/m

Fig B.2 HAC RF E-Field GSM 850 Middle

HAC RF E-Field GSM 850 Low

Date: 2014-2-21

Electronics: DAE4 Sn777

Medium: Air

Medium parameters used: $\sigma = 0$ mho/m, $\epsilon_r = 1$; $\rho = 1000$ kg/m³

Ambient Temperature: 22.2°C

Communication System: GSM 850; Frequency: 824.2 MHz; Duty Cycle: 1:8.3

Probe: ER3DV6 - SN2428; ConvF(1, 1, 1)

E Scan - ER3DV6 - 2011: 15 mm from Probe Center to the Device 3/Hearing Aid Compatibility Test (101x101x1): Interpolated grid: dx=0.5000 mm, dy=0.5000 mm

Device Reference Point: 0, 0, -6.3 mm

Reference Value = 69.43 V/m; Power Drift = -0.03 dB

Applied MIF = 3.47 dB

RF audio interference level = 38.54 dBV/m

Emission category: M4

MIF scaled E-field

Grid 1 M4 36.82 dBV/m	Grid 2 M4 38.32 dBV/m	Grid 3 M4 38.27 dBV/m
Grid 4 M4 37.05 dBV/m	Grid 5 M4 38.54 dBV/m	Grid 6 M4 38.49 dBV/m
Grid 7 M4 37.21 dBV/m	Grid 8 M4 38.48 dBV/m	Grid 9 M4 38.44 dBV/m

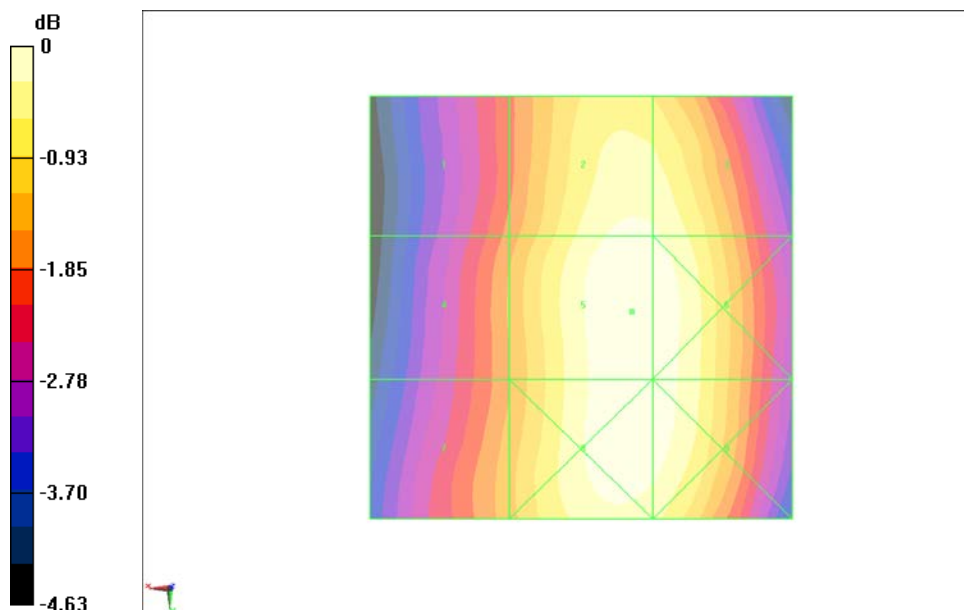

0 dB = 84.49 V/m = 38.54 dBV/m

Fig B.3 HAC RF E-Field GSM 850 Low

HAC RF E-Field GSM 1900 High

Date: 2014-2-21

Electronics: DAE4 Sn777

Medium: Air

Medium parameters used: $\sigma = 0$ mho/m, $\epsilon_r = 1$; $\rho = 1000$ kg/m³

Ambient Temperature: 22.2°C

Communication System: DCS 1900; Frequency: 1909.8 MHz; Duty Cycle: 1:8.3

Probe: ER3DV6 - SN2428; ConvF(1, 1, 1)

E Scan - ER3DV6 - 2011: 15 mm from Probe Center to the Device/Hearing Aid Compatibility Test (101x101x1): Interpolated grid: dx=0.5000 mm, dy=0.5000 mm

Device Reference Point: 0, 0, -6.3 mm

Reference Value = 6.888 V/m; Power Drift = -0.12 dB

Applied MIF = 3.46 dB

RF audio interference level = 27.42 dBV/m

Emission category: M4

MIF scaled E-field

Grid 1 M4 26.54 dBV/m	Grid 2 M4 27.42 dBV/m	Grid 3 M4 27.09 dBV/m
Grid 4 M4 20.34 dBV/m	Grid 5 M4 25.54 dBV/m	Grid 6 M4 25.64 dBV/m
Grid 7 M4 27.26 dBV/m	Grid 8 M3 30.02 dBV/m	Grid 9 M3 30.01 dBV/m

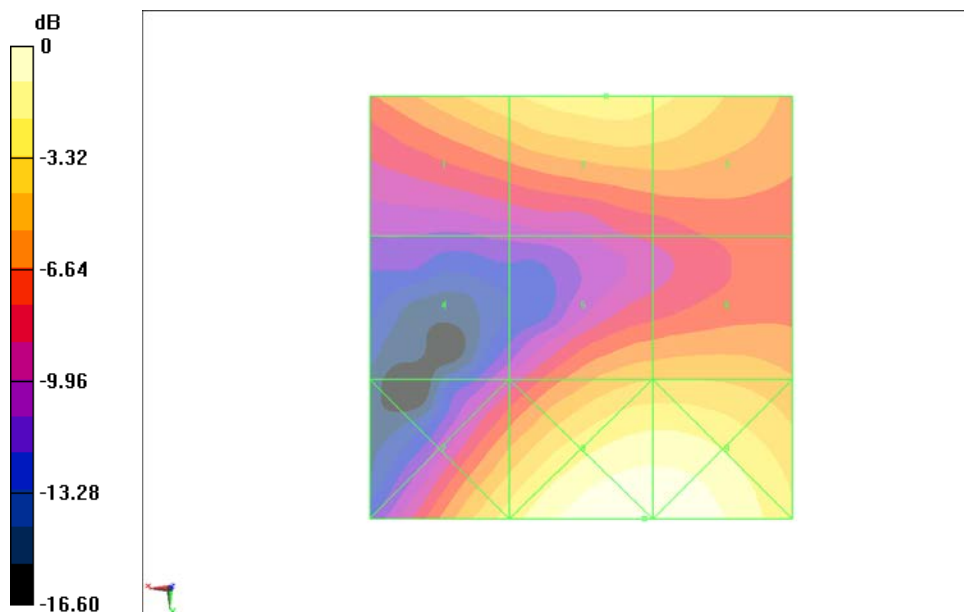

0 dB = 31.70 V/m = 30.02 dBV/m

Fig B.4 HAC RF E-Field GSM 1900 High

HAC RF E-Field GSM 1900 Middle

Date: 2014-2-21

Electronics: DAE4 Sn777

Medium: Air

Medium parameters used: $\sigma = 0$ mho/m, $\epsilon_r = 1$; $\rho = 1000$ kg/m³

Ambient Temperature: 22.2°C

Communication System: DCS 1900; Frequency: 1880 MHz; Duty Cycle: 1:8.3

Probe: ER3DV6 - SN2428; ConvF(1, 1, 1)

E Scan - ER3DV6 - 2011: 15 mm from Probe Center to the Device 2/Hearing Aid Compatibility Test (101x101x1): Interpolated grid: dx=0.5000 mm, dy=0.5000 mm

Device Reference Point: 0, 0, -6.3 mm

Reference Value = 7.591 V/m; Power Drift = 0.04 dB

Applied MIF = 3.38 dB

RF audio interference level = 27.74 dBV/m

Emission category: M4

MIF scaled E-field

Grid 1 M4 27 dBV/m	Grid 2 M4 27.74 dBV/m	Grid 3 M4 27.36 dBV/m
Grid 4 M4 21.55 dBV/m	Grid 5 M4 25.99 dBV/m	Grid 6 M4 26.12 dBV/m
Grid 7 M4 27.82 dBV/m	Grid 8 M3 30.13 dBV/m	Grid 9 M3 30.11 dBV/m

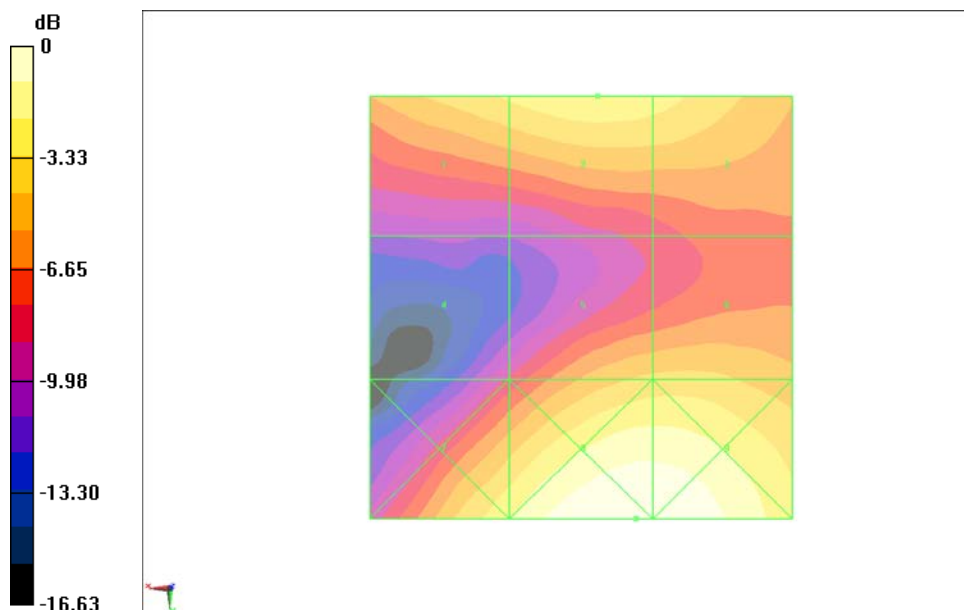

0 dB = 32.11 V/m = 30.13 dBV/m

Fig B.5 HAC RF E-Field GSM 1900 Middle

HAC RF E-Field GSM 1900 Low

Date: 2014-2-21

Electronics: DAE4 Sn777

Medium: Air

Medium parameters used: $\sigma = 0$ mho/m, $\epsilon_r = 1$; $\rho = 1000$ kg/m³

Ambient Temperature: 22.2°C

Communication System: DCS 1900; Frequency: 1850.2 MHz; Duty Cycle: 1:8.3

Probe: ER3DV6 - SN2428; ConvF(1, 1, 1)

E Scan - ER3DV6 - 2011: 15 mm from Probe Center to the Device 3/Hearing Aid Compatibility Test (101x101x1): Interpolated grid: dx=0.5000 mm, dy=0.5000 mm

Device Reference Point: 0, 0, -6.3 mm

Reference Value = 7.382 V/m; Power Drift = -0.03 dB

Applied MIF = 3.48 dB

RF audio interference level = 27.22 dBV/m

Emission category: M4

MIF scaled E-field

Grid 1 M4 26.74 dBV/m	Grid 2 M4 27.22 dBV/m	Grid 3 M4 26.52 dBV/m
Grid 4 M4 21.82 dBV/m	Grid 5 M4 25.7 dBV/m	Grid 6 M4 25.72 dBV/m
Grid 7 M4 28.05 dBV/m	Grid 8 M3 30 dBV/m	Grid 9 M4 29.82 dBV/m

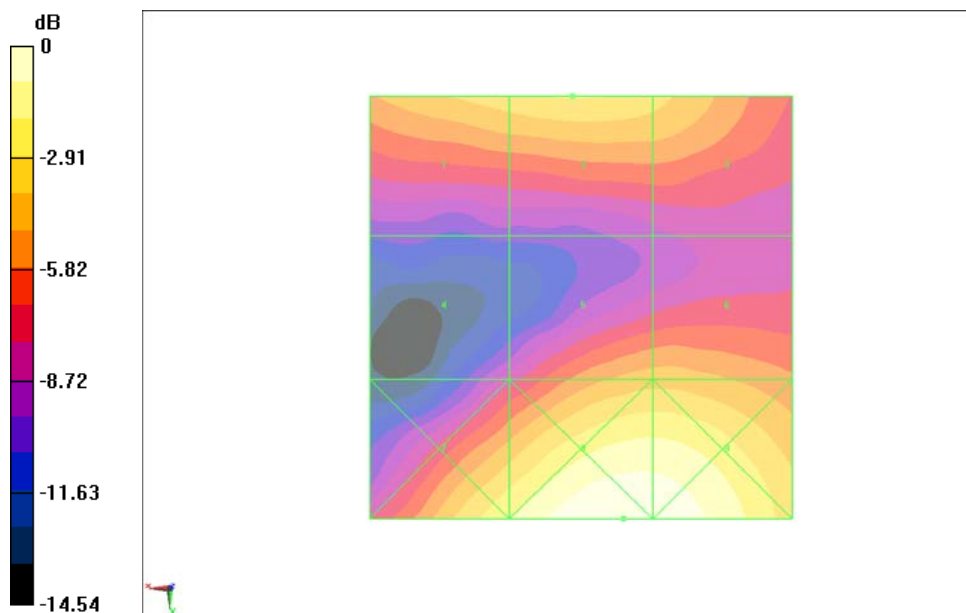

0 dB = 31.63 V/m = 30.00 dBV/m

Fig B.6 HAC RF E-Field GSM 1900 Low

ANNEX C SYSTEM VALIDATION RESULT

E SCAN of Dipole 835 MHz

Date: 2014-2-21

Electronics: DAE4 Sn777

Medium: Air

Medium parameters used: $\sigma = 0$ mho/m, $\epsilon_r = 1$; $\rho = 1000$ kg/m³

Communication System: CW; Frequency: 835 MHz; Duty Cycle: 1:1

Probe: ER3DV6 - SN2428; ConvF(1, 1, 1)

E Scan - measurement distance from the probe sensor center to CD835 Dipole = 15mm/Hearing Aid Compatibility Test (41x361x1): Interpolated grid: dx=0.5000 mm, dy=0.5000 mm

Maximum value of peak Total field = 110.9 V/m

Probe Modulation Factor = 1

Device Reference Point: 0, 0, -6.3 mm

Reference Value = 108.7 V/m; Power Drift = 0.13 dB

Hearing Aid Near-Field Category: M4 (AWF 0 dB)

PMF scaled E-field

Grid 1 M4 105.1 V/m	Grid 2 M4 107.0 V/m	Grid 3 M4 105.6 V/m
Grid 4 M4 65.86 V/m	Grid 5 M4 66.58 V/m	Grid 6 M4 65.66 V/m
Grid 7 M4 106.3 V/m	Grid 8 M4 108.7 V/m	Grid 9 M4 107.5 V/m

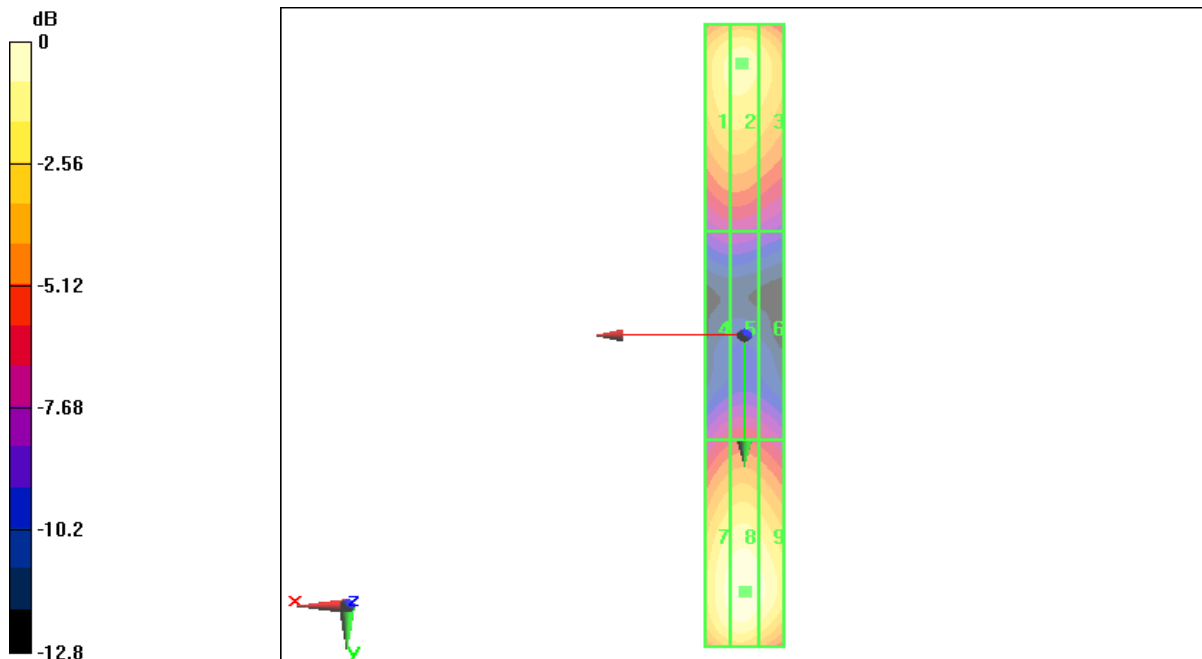

0 dB = 108.7 V/m

E SCAN of Dipole 1880 MHz

Date: 2014-2-21

Electronics: DAE4 Sn777

Medium: Air

Medium parameters used: $\sigma = 0$ mho/m, $\epsilon_r = 1$; $\rho = 1000$ kg/m³

Communication System: CW; Frequency: 1880 MHz; Duty Cycle: 1:1

Probe: ER3DV6 - SN2428;ConvF(1, 1, 1)

E Scan - measurement distance from the probe sensor center to CD1880 Dipole = 15mm/Hearing Aid Compatibility Test (41x181x1): Interpolated grid: dx=0.5000 mm, dy=0.5000 mm

Maximum value of peak Total field = 159.2 V/m

Probe Modulation Factor = 1

Device Reference Point: 0, 0, -6.3 mm

Reference Value = 96.05 V/m; Power Drift = -0.10 dB

Hearing Aid Near-Field Category: M3 (AWF 0 dB)

PMF scaled E-field

Grid 1 M3 93.60 V/m	Grid 2 M3 96.05 V/m	Grid 3 M3 95.15 V/m
Grid 4 M3 73.44 V/m	Grid 5 M3 74.54 V/m	Grid 6 M3 73.57 V/m
Grid 7 M3 88.82 V/m	Grid 8 M3 91.15 V/m	Grid 9 M3 90.17 V/m

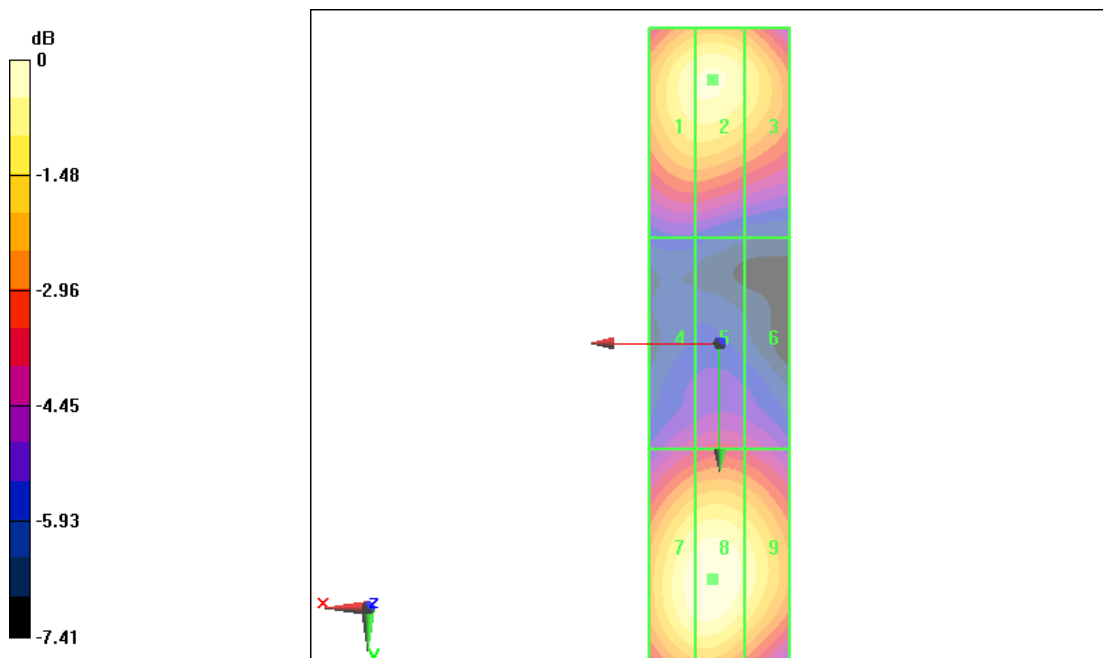

0 dB = 96.05 V/m

ANNEX D PROBE CALIBRATION CERTIFICATE

E_Probe ER3DV6

Calibration Laboratory of
Schmid & Partner
Engineering AG
Zeughausstrasse 43, 8004 Zurich, Switzerland



S Schweizerischer Kalibrierdienst
C Service suisse d'étalonnage
S Servizio svizzero di taratura
S Swiss Calibration Service

Accredited by the Swiss Accreditation Service (SAS)
The Swiss Accreditation Service is one of the signatories to the EA
Multilateral Agreement for the recognition of calibration certificates

Accreditation No.: **SCS 108**

Client **TMC Beijing (Auden)**

Certificate No: **ER3-2428_Jan14**

CALIBRATION CERTIFICATE

Object **ER3DV6 - SN:2428**

Calibration procedure(s) **QA CAL-02.v8, QA CAL-25.v6
Calibration procedure for E-field probes optimized for close near field
evaluations in air**



Calibration date: **January 27, 2014**

This calibration certificate documents the traceability to national standards, which realize the physical units of measurements (SI).
The measurements and the uncertainties with confidence probability are given on the following pages and are part of the certificate.

All calibrations have been conducted in the closed laboratory facility: environment temperature (22 ± 3)°C and humidity < 70%.

Calibration Equipment used (M&TE critical for calibration)

Primary Standards	ID	Cal Date (Certificate No.)	Scheduled Calibration
Power meter E4419B	GB41293874	04-Apr-13 (No. 217-01733)	Apr-14
Power sensor E4412A	MY41498087	04-Apr-13 (No. 217-01733)	Apr-14
Reference 3 dB Attenuator	SN: S5054 (3c)	04-Apr-13 (No. 217-01737)	Apr-14
Reference 20 dB Attenuator	SN: S5277 (20x)	04-Apr-13 (No. 217-01735)	Apr-14
Reference 30 dB Attenuator	SN: S5129 (30b)	04-Apr-13 (No. 217-01738)	Apr-14
Reference Probe ER3DV6	SN: 2328	10-Oct-13 (No. ER3-2328_Oct13)	Oct-14
DAE4	SN: 789	15-May-13 (No. DAE4-789_May13)	May-14
Secondary Standards	ID	Check Date (in house)	Scheduled Check
RF generator HP 8648C	US3642U01700	4-Aug-99 (in house check Apr-13)	In house check: Apr-16
Network Analyzer HP 8753E	US37390585	18-Oct-01 (in house check Oct-13)	In house check: Oct-14

	Name	Function	Signature
Calibrated by:	Leif Klynsner	Laboratory Technician	
Approved by:	Katja Pokovic	Technical Manager	

Issued: January 28, 2014

This calibration certificate shall not be reproduced except in full without written approval of the laboratory.

Calibration Laboratory of
Schmid & Partner
Engineering AG
Zeughausstrasse 43, 8004 Zurich, Switzerland



S Schweizerischer Kalibrierdienst
C Service suisse d'étalonnage
S Servizio svizzero di taratura
S Swiss Calibration Service

Accredited by the Swiss Accreditation Service (SAS)

Accreditation No.: **SCS 108**

The Swiss Accreditation Service is one of the signatories to the EA
Multilateral Agreement for the recognition of calibration certificates

Glossary:

NORM _{x,y,z}	sensitivity in free space
DCP	diode compression point
CF	crest factor (1/duty_cycle) of the RF signal
A, B, C, D	modulation dependent linearization parameters
Polarization φ	φ rotation around probe axis
Polarization ϑ	ϑ rotation around an axis that is in the plane normal to probe axis (at measurement center), i.e., $\vartheta = 0$ is normal to probe axis
Connector Angle	information used in DASY system to align probe sensor X to the robot coordinate system

Calibration is Performed According to the Following Standards:

- a) IEEE Std 1309-2005, "IEEE Standard for calibration of electromagnetic field sensors and probes, excluding antennas, from 9 kHz to 40 GHz", December 2005
- b) CTIA Test Plan for Hearing Aid Compatibility, April 2010.

Methods Applied and Interpretation of Parameters:

- *NORM_{x,y,z}*: Assessed for E-field polarization $\vartheta = 0$ for XY sensors and $\vartheta = 90$ for Z sensor ($f \leq 900$ MHz in TEM-cell; $f > 1800$ MHz: R22 waveguide).
- *NORM(f)_{x,y,z}* = *NORM_{x,y,z}* * *frequency_response* (see Frequency Response Chart).
- *DCP_{x,y,z}*: DCP are numerical linearization parameters assessed based on the data of power sweep with CW signal (no uncertainty required). DCP does not depend on frequency nor media.
- *PAR*: PAR is the Peak to Average Ratio that is not calibrated but determined based on the signal characteristics
- *A_{x,y,z}; B_{x,y,z}; C_{x,y,z}; D_{x,y,z}; VR_{x,y,z}*: A, B, C, D are numerical linearization parameters assessed based on the data of power sweep for specific modulation signal. The parameters do not depend on frequency nor media. VR is the maximum calibration range expressed in RMS voltage across the diode.
- *Spherical isotropy (3D deviation from isotropy)*: in a locally homogeneous field realized using an open waveguide setup.
- *Sensor Offset*: The sensor offset corresponds to the offset of virtual measurement center from the probe tip (on probe axis). No tolerance required.
- *Connector Angle*: The angle is assessed using the information gained by determining the *NORM_x* (no uncertainty required).

ER3DV6 – SN:2428

January 27, 2014

Probe ER3DV6

SN:2428

Manufactured: September 11, 2007
Calibrated: January 27, 2014

Calibrated for DASY/EASY Systems
(Note: non-compatible with DASY2 system!)

ER3DV6- SN:2428

January 27, 2014

DASY/EASY - Parameters of Probe: ER3DV6 - SN:2428

Basic Calibration Parameters

	Sensor X	Sensor Y	Sensor Z	Unc (k=2)
Norm ($\mu\text{V}/(\text{V}/\text{m})^2$)	1.51	1.59	1.83	$\pm 10.1 \%$
DCP (mV) ^B	98.9	97.0	101.1	

Modulation Calibration Parameters

UID	Communication System Name		A dB	B dB $\sqrt{\mu\text{V}}$	C	D dB	VR mV	Unc ^E (k=2)
0	CW	X	0.0	0.0	1.0	0.00	190.5	$\pm 3.3 \%$
		Y	0.0	0.0	1.0		152.5	
		Z	0.0	0.0	1.0		198.6	
10021-DAA	GSM-FDD (TDMA, GMSK)	X	20.75	99.9	29.1	9.39	119.1	$\pm 1.2 \%$
		Y	19.27	99.6	28.9		125.1	
		Z	24.43	99.4	28.5		139.5	
10039-CAA	CDMA2000 (1xRTT, RC1)	X	4.62	65.6	18.5	4.57	109.6	$\pm 0.9 \%$
		Y	4.78	66.3	18.9		121.2	
		Z	4.58	66.0	18.7		114.4	

The reported uncertainty of measurement is stated as the standard uncertainty of measurement multiplied by the coverage factor k=2, which for a normal distribution corresponds to a coverage probability of approximately 95%.

^B Numerical linearization parameter: uncertainty not required.

^E Uncertainty is determined using the max. deviation from linear response applying rectangular distribution and is expressed for the square of the field value.

ER3DV6- SN:2428

January 27, 2014

Frequency Response of E-Field (TEM-Cell: ifi110 EXX, Waveguide: R22)

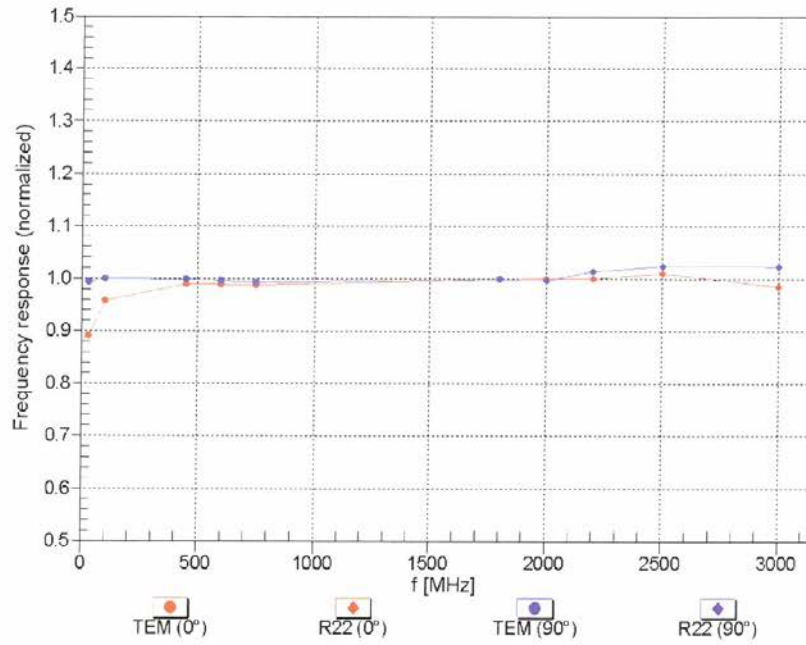

Uncertainty of Frequency Response of E-field: $\pm 6.3\%$ (k=2)

ER3DV6- SN:2428

January 27, 2014

Receiving Pattern (ϕ), $\vartheta = 0^\circ$

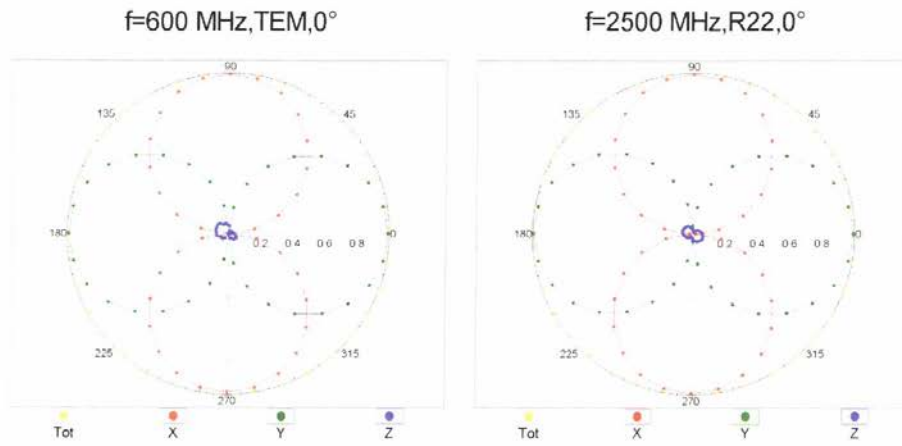

Receiving Pattern (ϕ), $\vartheta = 90^\circ$

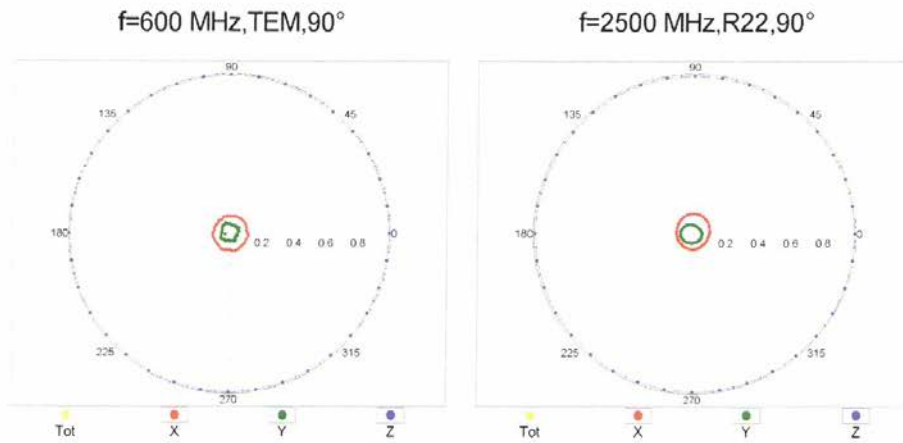

ER3DV6-SN:2428

January 27, 2014

Receiving Pattern (ϕ), $\vartheta = 0^\circ$

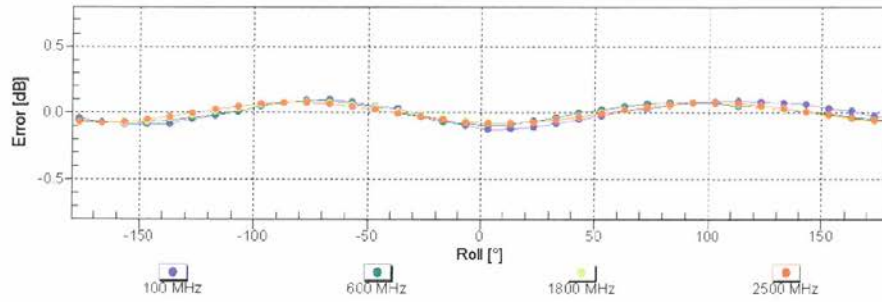

Uncertainty of Axial Isotropy Assessment: $\pm 0.5\%$ ($k=2$)

Receiving Pattern (ϕ), $\vartheta = 90^\circ$

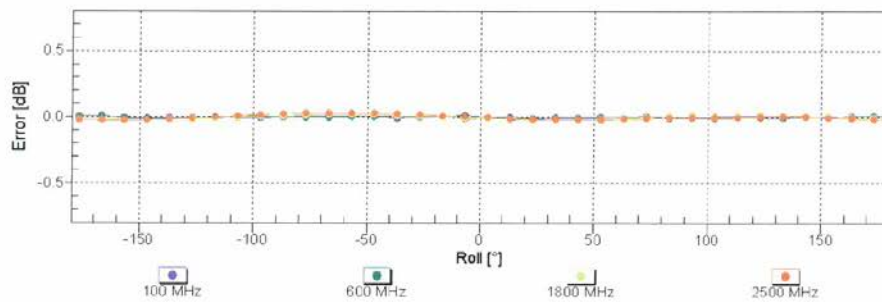

Uncertainty of Axial Isotropy Assessment: $\pm 0.5\%$ ($k=2$)

ER3DV6- SN:2428

January 27, 2014

Dynamic Range f(E-field) (TEM cell , f = 900 MHz)

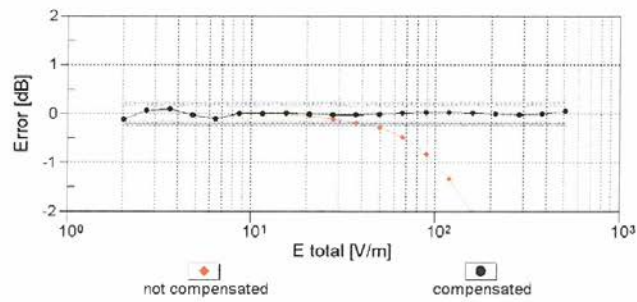
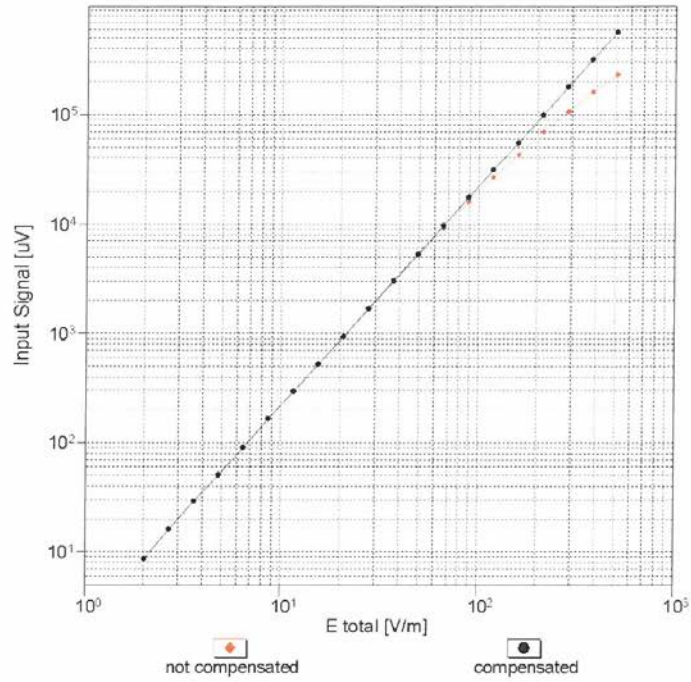

Uncertainty of Linearity Assessment: $\pm 0.6\%$ (k=2)

ER3DV6- SN:2428

January 27, 2014

Deviation from Isotropy in Air Error (ϕ , θ), $f = 900$ MHz

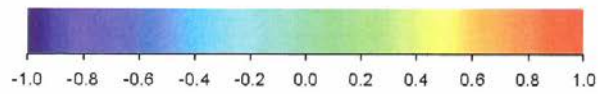
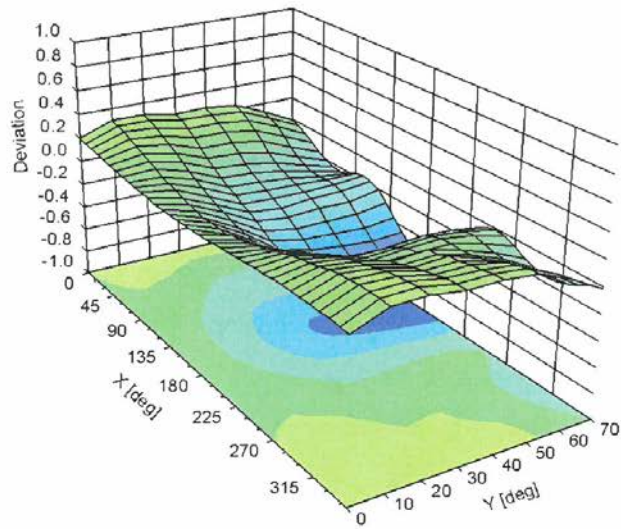

Uncertainty of Spherical Isotropy Assessment: $\pm 2.6\%$ ($k=2$)

ER3DV6- SN:2428

January 27, 2014

DASY/EASY - Parameters of Probe: ER3DV6 - SN:2428

Other Probe Parameters

Sensor Arrangement	Rectangular
Connector Angle (°)	-36.9
Mechanical Surface Detection Mode	enabled
Optical Surface Detection Mode	disabled
Probe Overall Length	337 mm
Probe Body Diameter	10 mm
Tip Length	10 mm
Tip Diameter	8 mm
Probe Tip to Sensor X Calibration Point	2.5 mm
Probe Tip to Sensor Y Calibration Point	2.5 mm
Probe Tip to Sensor Z Calibration Point	2.5 mm

ANNEX E DIPOLE CALIBRATION CERTIFICATE

Dipole 835 MHz

**Calibration Laboratory of
Schmid & Partner
Engineering AG**
Zeughausstrasse 43, 8004 Zurich, Switzerland



S Schweizerischer Kalibrierdienst
S Service suisse d'étalonnage
S Servizio svizzero di taratura
S Swiss Calibration Service

Accredited by the Swiss Accreditation Service (SAS)
The Swiss Accreditation Service is one of the signatories to the EA
Multilateral Agreement for the recognition of calibration certificates

Accreditation No.: **SCS 108**

Client **TMC-BJ (Auden)**

Certificate No: **CD835V3-1023_Sep13**

CALIBRATION CERTIFICATE

Object **CD835V3 - SN: 1023**

Calibration procedure(s) **QA CAL-20.v6
Calibration procedure for dipoles in air**

Calibration date: **September 25, 2013**

This calibration certificate documents the traceability to national standards, which realize the physical units of measurements (SI).
The measurements and the uncertainties with confidence probability are given on the following pages and are part of the certificate.

All calibrations have been conducted in the closed laboratory facility: environment temperature $(22 \pm 3)^\circ\text{C}$ and humidity $< 70\%$.

Calibration Equipment used (M&TE critical for calibration)

Primary Standards	ID #	Cal Date (Certificate No.)	Scheduled Calibration
Power meter EPM-442A	GB37480704	01-Nov-12 (No. 217-01640)	Oct-13
Power sensor HP 8481A	US37292783	01-Nov-12 (No. 217-01640)	Oct-13
Reference 10 dB Attenuator	SN: 5047.2 (10q)	04-Apr-13 (No. 217-01731)	Apr-14
Probe ER3DV6	SN: 2336	28-Dec-12 (No. ER3-2336_Dec12)	Dec-13
Probe H3DV6	SN: 6065	28-Dec-12 (No. H3-6065_Dec12)	Dec-13
DAE4	SN: 781	13-Sep-13 (No. DAE4-781_Sep13)	Sep-14

Secondary Standards	ID #	Check Date (in house)	Scheduled Check
Power meter Agilent 4419B	SN: GB42420191	09-Oct-09 (in house check Oct-12)	In house check: Oct-13
Power sensor HP E4412A	SN: MY41495277	01-Apr-08 (in house check Oct-12)	In house check: Oct-13
Power sensor HP 8482A	SN: US37295597	09-Oct-09 (in house check Oct-12)	In house check: Oct-13
Network Analyzer HP 8753E	US37390585	18-Oct-01 (in house check Oct-12)	In house check: Oct-13
RF generator R&S SMT-06	SN: 832283/011	27-Aug-12 (in house check Oct-12)	In house check: Oct-14

Calibrated by: **Claudio Leubler** (Name), **Laboratory Technician** (Function),  (Signature)

Approved by: **Fin Bomholt** (Name), **Deputy Technical Manager** (Function),  (Signature)

Issued: September 26, 2013

This calibration certificate shall not be reproduced except in full without written approval of the laboratory.

**Calibration Laboratory of
Schmid & Partner
Engineering AG**
Zeughausstrasse 43, 8004 Zurich, Switzerland



S Schweizerischer Kalibrierdienst
S Service suisse d'étalonnage
S Servizio svizzero di taratura
S Swiss Calibration Service

Accredited by the Swiss Accreditation Service (SAS)
The Swiss Accreditation Service is one of the signatories to the EA
Multilateral Agreement for the recognition of calibration certificates

Accreditation No.: **SCS 108**

References

- [1] ANSI-C63.19-2011
American National Standard, Methods of Measurement of Compatibility between Wireless Communications Devices and Hearing Aids.

Methods Applied and Interpretation of Parameters:

- *Coordinate System:* y-axis is in the direction of the dipole arms. z-axis is from the basis of the antenna (mounted on the table) towards its feed point between the two dipole arms. x-axis is normal to the other axes. In coincidence with the standards [1], the measurement planes (probe sensor center) are selected to be at a distance of 15 mm above the top metal edge of the dipole arms.
- *Measurement Conditions:* Further details are available from the hardcopies at the end of the certificate. All figures stated in the certificate are valid at the frequency indicated. The forward power to the dipole connector is set with a calibrated power meter connected and monitored with an auxiliary power meter connected to a directional coupler. While the dipole under test is connected, the forward power is adjusted to the same level.
- *Antenna Positioning:* The dipole is mounted on a HAC Test Arch phantom using the matching dipole positioner with the arms horizontal and the feeding cable coming from the floor. The measurements are performed in a shielded room with absorbers around the setup to reduce the reflections. It is verified before the mounting of the dipole under the Test Arch phantom, that its arms are perfectly in a line. It is installed on the HAC dipole positioner with its arms parallel below the dielectric reference wire and able to move elastically in vertical direction without changing its relative position to the top center of the Test Arch phantom. The vertical distance to the probe is adjusted after dipole mounting with a DASY5 Surface Check job. Before the measurement, the distance between phantom surface and probe tip is verified. The proper measurement distance is selected by choosing the matching section of the HAC Test Arch phantom with the proper device reference point (upper surface of the dipole) and the matching grid reference point (tip of the probe) considering the probe sensor offset. The vertical distance to the probe is essential for the accuracy.
- *Feed Point Impedance and Return Loss:* These parameters are measured using a HP 8753E Vector Network Analyzer. The impedance is specified at the SMA connector of the dipole. The influence of reflections was eliminated by applying the averaging function while moving the dipole in the air, at least 70cm away from any obstacles.
- *E-field distribution:* E field is measured in the x-y-plane with an isotropic ER3D-field probe with 100 mW forward power to the antenna feed point. In accordance with [1], the scan area is 20mm wide, its length exceeds the dipole arm length (180 or 90mm). The sensor center is 15 mm (in z) above the metal top of the dipole arms. Two 3D maxima are available near the end of the dipole arms. Assuming the dipole arms are perfectly in one line, the average of these two maxima (in subgrid 2 and subgrid 8) is determined to compensate for any non-parallelity to the measurement plane as well as the sensor displacement. The E-field value stated as calibration value represents the maximum of the interpolated 3D-E-field, in the plane above the dipole surface.

The reported uncertainty of measurement is stated as the standard uncertainty of measurement multiplied by the coverage factor $k=2$, which for a normal distribution corresponds to a coverage probability of approximately 95%.

Measurement Conditions

DASY system configuration, as far as not given on page 1.

DASY Version	DASY5	V52.8.7
Phantom	HAC Test Arch	
Distance Dipole Top - Probe Center	15mm	
Scan resolution	dx, dy = 5 mm	
Frequency	835 MHz ± 1 MHz	
Input power drift	< 0.05 dB	

Maximum Field values at 835 MHz

E-field 15 mm above dipole surface	condition	Interpolated maximum
Maximum measured above high end	100 mW input power	105.4 V / m
Maximum measured above low end	100 mW input power	103.7 V / m
Averaged maximum above arm	100 mW input power	104.5 V / m ± 12.8 % (k=2)

Appendix

Antenna Parameters

Frequency	Return Loss	Impedance
800 MHz	17.1 dB	44.0 Ω - 11.8 jΩ
835 MHz	24.8 dB	50.9 Ω + 5.7 jΩ
900 MHz	15.3 dB	61.4 Ω - 15.7 jΩ
950 MHz	23.1 dB	46.7 Ω + 5.9 jΩ
960 MHz	16.9 dB	53.8 Ω + 14.5 jΩ

3.2 Antenna Design and Handling

The calibration dipole has a symmetric geometry with a built-in two stub matching network, which leads to the enhanced bandwidth.

The dipole is built of standard semirigid coaxial cable. The internal matching line is open ended. The antenna is therefore open for DC signals.

Do not apply force to dipole arms, as they are liable to bend. The soldered connections near the feedpoint may be damaged. After excessive mechanical stress or overheating, check the impedance characteristics to ensure that the internal matching network is not affected.

After long term use with 40W radiated power, only a slight warming of the dipole near the feedpoint can be measured.

Impedance Measurement Plot

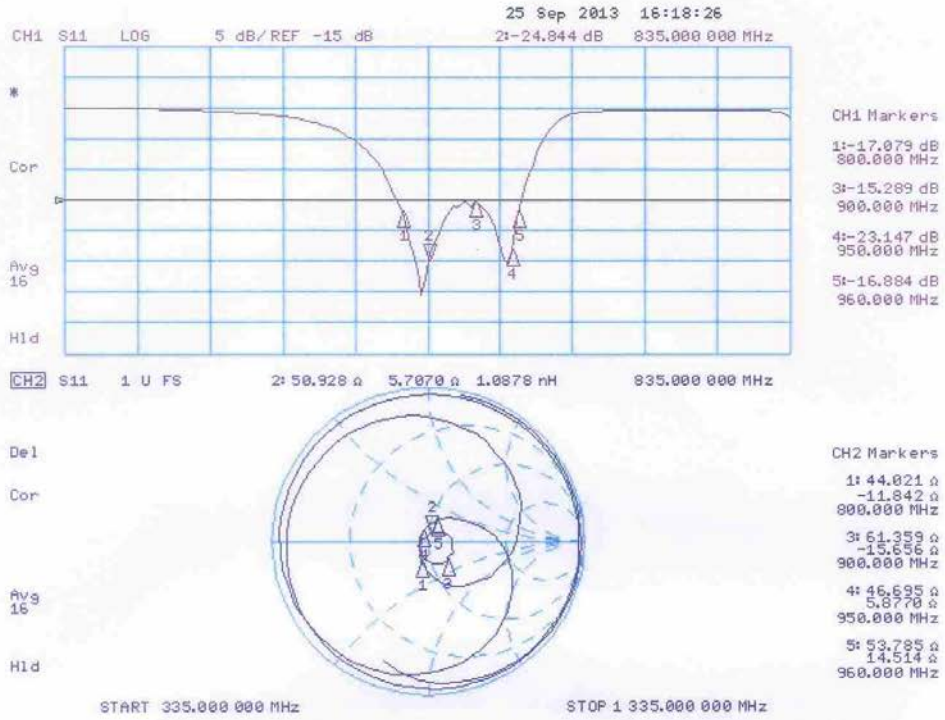

DASY5 E-field Result

Date: 25.09.2013

Test Laboratory: SPEAG Lab2

DUT: HAC-Dipole 835 MHz; Type: CD835V3; Serial: CD835V3 - SN: 1023

Communication System: UID 0 - CW ; Frequency: 835 MHz
 Medium parameters used: $\sigma = 0$ S/m, $\epsilon_r = 1$; $\rho = 1000$ kg/m³
 Phantom section: RF Section
 Measurement Standard: DASY5 (IEEE/IEC/ANSI C63.19-2007)

DASY52 Configuration:

- Probe: ER3DV6 - SN2336; ConvF(1, 1, 1); Calibrated: 28.12.2012;
- Sensor-Surface: (Fix Surface)
- Electronics: DAE4 Sn781; Calibrated: 13.09.2013
- Phantom: HAC Test Arch with AMCC; Type: SD HAC P01 BA; Serial: 1070
- DASY52 52.8.7(1137); SEMCAD X 14.6.10(7164)

Dipole E-Field measurement @ 835MHz/E-Scan - 835MHz d=15mm/Hearing Aid Compatibility Test (41x361x1):

Interpolated grid: dx=0.5000 mm, dy=0.5000 mm
 Device Reference Point: 0, 0, -6.3 mm
 Reference Value = 107.7 V/m; Power Drift = 0.03 dB
 PMR not calibrated. PMF = 1.000 is applied.
 E-field emissions = 105.4 V/m
 Near-field category: M4 (AWF 0 dB)

PMF scaled E-field

Grid 1 M4 101.9 V/m	Grid 2 M4 103.7 V/m	Grid 3 M4 102.4 V/m
Grid 4 M4 62.57 V/m	Grid 5 M4 63.29 V/m	Grid 6 M4 62.37 V/m
Grid 7 M4 103.1 V/m	Grid 8 M4 105.4 V/m	Grid 9 M4 104.3 V/m

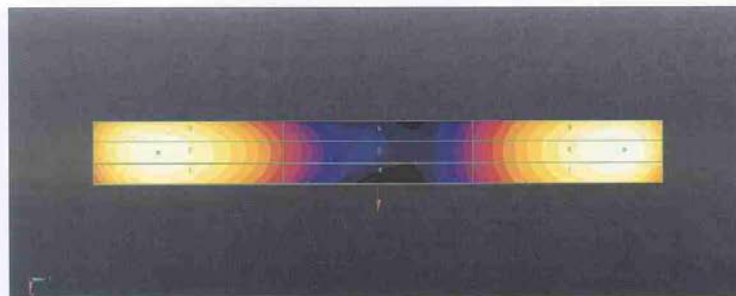

0 dB = 105.4 V/m = 40.46 dBV/m

Dipole 1880 MHz

**Calibration Laboratory of
Schmid & Partner
Engineering AG**
Zeughausstrasse 43, 8004 Zurich, Switzerland



S Schweizerischer Kalibrierdienst
S Service suisse d'étalonnage
S Servizio svizzero di taratura
S Swiss Calibration Service

Accredited by the Swiss Accreditation Service (SAS)
The Swiss Accreditation Service is one of the signatories to the EA
Multilateral Agreement for the recognition of calibration certificates

Accreditation No.: **SCS 108**

Client **TMC-BJ (Auden)**

Certificate No: **CD1880V3-1018_Sep13**

CALIBRATION CERTIFICATE

Object: **CD1880V3 - SN: 1018**

Calibration procedure(s): **QA CAL-20.v6
Calibration procedure for dipoles in air**

Calibration date: **September 25, 2013**



This calibration certificate documents the traceability to national standards, which realize the physical units of measurements (SI).
The measurements and the uncertainties with confidence probability are given on the following pages and are part of the certificate.

All calibrations have been conducted in the closed laboratory facility: environment temperature (22 ± 3)°C and humidity < 70%.

Calibration Equipment used (M&TE critical for calibration)

Primary Standards	ID #	Cal Date (Certificate No.)	Scheduled Calibration
Power meter EPM-442A	GB37480704	01-Nov-12 (No. 217-01640)	Oct-13
Power sensor HP 8481A	US37292783	01-Nov-12 (No. 217-01640)	Oct-13
Reference 10 dB Attenuator	SN: 5047.2 (10q)	04-Apr-13 (No. 217-01731)	Apr-14
Probe ER3DV6	SN: 2336	28-Dec-12 (No. ER3-2336_Dec12)	Dec-13
Probe H3DV6	SN: 6065	28-Dec-12 (No. H3-6065_Dec12)	Dec-13
DAE4	SN: 781	13-Sep-13 (No. DAE4-781_Sep13)	Sep-14

Secondary Standards	ID #	Check Date (in house)	Scheduled Check
Power meter Agilent 4419B	SN: GB42420191	09-Oct-09 (in house check Oct-12)	In house check: Oct-13
Power sensor HP E4412A	SN: MY41495277	01-Apr-08 (in house check Oct-12)	In house check: Oct-13
Power sensor HP 8482A	SN: US37295597	09-Oct-09 (in house check Oct-12)	In house check: Oct-13
Network Analyzer HP 8753E	US37390585	18-Oct-01 (in house check Oct-12)	In house check: Oct-13
RF generator R&S SMT-06	SN: 832283/011	27-Aug-12 (in house check Oct-12)	In house check: Oct-14

Calibrated by:	Name Claudio Leubler	Function Laboratory Technician	Signature 
Approved by:	Name Fin Bomholt	Function Deputy Technical Manager	Signature 

Issued: September 26, 2013

This calibration certificate shall not be reproduced except in full without written approval of the laboratory.

**Calibration Laboratory of
Schmid & Partner
Engineering AG**
Zeughausstrasse 43, 8004 Zurich, Switzerland



S Schweizerischer Kalibrierdienst
S Service suisse d'étalonnage
S Servizio svizzero di taratura
S Swiss Calibration Service

Accredited by the Swiss Accreditation Service (SAS)
The Swiss Accreditation Service is one of the signatories to the EA
Multilateral Agreement for the recognition of calibration certificates

Accreditation No.: **SCS 108**

References

- [1] ANSI-C63.19-2011
American National Standard, Methods of Measurement of Compatibility between Wireless Communications Devices and Hearing Aids.

Methods Applied and Interpretation of Parameters:

- **Coordinate System:** y-axis is in the direction of the dipole arms. z-axis is from the basis of the antenna (mounted on the table) towards its feed point between the two dipole arms. x-axis is normal to the other axes. In coincidence with the standards [1], the measurement planes (probe sensor center) are selected to be at a distance of 15 mm above the top metal edge of the dipole arms.
- **Measurement Conditions:** Further details are available from the hardcopies at the end of the certificate. All figures stated in the certificate are valid at the frequency indicated. The forward power to the dipole connector is set with a calibrated power meter connected and monitored with an auxiliary power meter connected to a directional coupler. While the dipole under test is connected, the forward power is adjusted to the same level.
- **Antenna Positioning:** The dipole is mounted on a HAC Test Arch phantom using the matching dipole positioner with the arms horizontal and the feeding cable coming from the floor. The measurements are performed in a shielded room with absorbers around the setup to reduce the reflections. It is verified before the mounting of the dipole under the Test Arch phantom, that its arms are perfectly in a line. It is installed on the HAC dipole positioner with its arms parallel below the dielectric reference wire and able to move elastically in vertical direction without changing its relative position to the top center of the Test Arch phantom. The vertical distance to the probe is adjusted after dipole mounting with a DASY5 Surface Check job. Before the measurement, the distance between phantom surface and probe tip is verified. The proper measurement distance is selected by choosing the matching section of the HAC Test Arch phantom with the proper device reference point (upper surface of the dipole) and the matching grid reference point (tip of the probe) considering the probe sensor offset. The vertical distance to the probe is essential for the accuracy.
- **Feed Point Impedance and Return Loss:** These parameters are measured using a HP 8753E Vector Network Analyzer. The impedance is specified at the SMA connector of the dipole. The influence of reflections was eliminated by applying the averaging function while moving the dipole in the air, at least 70cm away from any obstacles.
- **E-field distribution:** E field is measured in the x-y-plane with an isotropic ER3D-field probe with 100 mW forward power to the antenna feed point. In accordance with [1], the scan area is 20mm wide, its length exceeds the dipole arm length (180 or 90mm). The sensor center is 15 mm (in z) above the metal top of the dipole arms. Two 3D maxima are available near the end of the dipole arms. Assuming the dipole arms are perfectly in one line, the average of these two maxima (in subgrid 2 and subgrid 8) is determined to compensate for any non-parallelity to the measurement plane as well as the sensor displacement. The E-field value stated as calibration value represents the maximum of the interpolated 3D-E-field, in the plane above the dipole surface.

The reported uncertainty of measurement is stated as the standard uncertainty of measurement multiplied by the coverage factor $k=2$, which for a normal distribution corresponds to a coverage probability of approximately 95%.

Measurement Conditions

DASY system configuration, as far as not given on page 1.

DASY Version	DASY5	V52.8.7
Phantom	HAC Test Arch	
Distance Dipole Top - Probe Center	15mm	
Scan resolution	dx, dy = 5 mm	
Frequency	1880 MHz ± 1 MHz	
Input power drift	< 0.05 dB	

Maximum Field values at 1880 MHz

E-field 15 mm above dipole surface	condition	Interpolated maximum
Maximum measured above high end	100 mW input power	94.2 V / m
Maximum measured above low end	100 mW input power	89.3 V / m
Averaged maximum above arm	100 mW input power	91.8 V / m ± 12.8 % (k=2)

Appendix

Antenna Parameters

Frequency	Return Loss	Impedance
1730 MHz	27.8 dB	53.0 Ω + 2.9 jΩ
1880 MHz	21.6 dB	49.5 Ω + 8.3 jΩ
1900 MHz	21.9 dB	51.3 Ω + 8.0 jΩ
1950 MHz	30.5 dB	52.3 Ω + 2.0 jΩ
2000 MHz	19.3 dB	41.7 Ω + 5.6 jΩ

3.2 Antenna Design and Handling

The calibration dipole has a symmetric geometry with a built-in two stub matching network, which leads to the enhanced bandwidth.

The dipole is built of standard semirigid coaxial cable. The internal matching line is open ended. The antenna is therefore open for DC signals.

Do not apply force to dipole arms, as they are liable to bend. The soldered connections near the feedpoint may be damaged. After excessive mechanical stress or overheating, check the impedance characteristics to ensure that the internal matching network is not affected.

After long term use with 40W radiated power, only a slight warming of the dipole near the feedpoint can be measured.

Impedance Measurement Plot

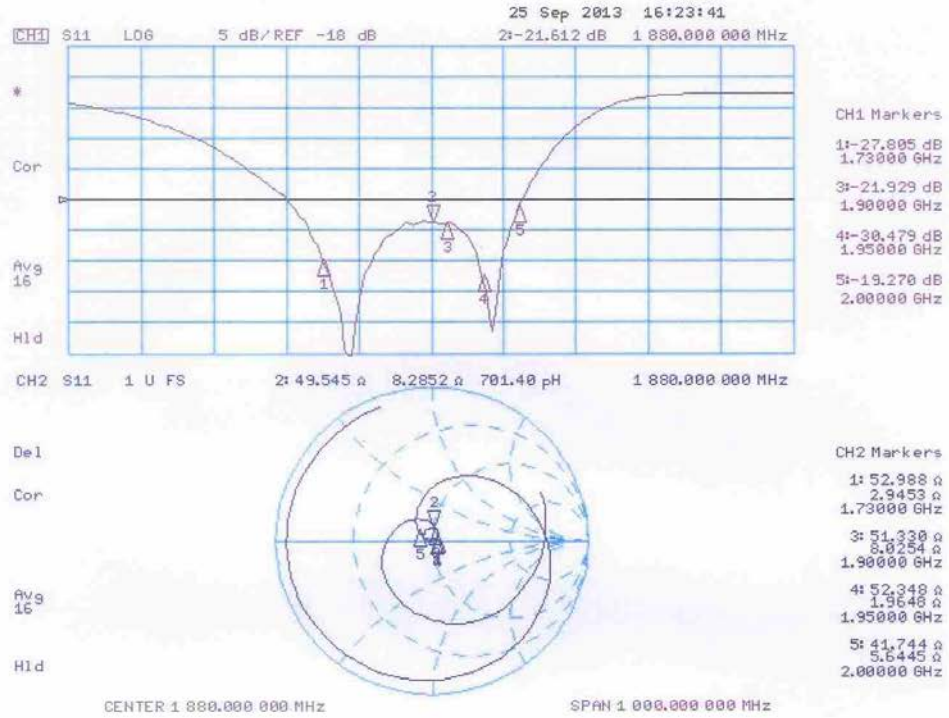

DASY5 E-field Result

Date: 25.09.2013

Test Laboratory: SPEAG Lab2

DUT: HAC Dipole 1880 MHz; Type: CD1880V3; Serial: CD1880V3 - SN: 1018

Communication System: UID 0 - CW ; Frequency: 1880 MHz
 Medium parameters used: $\sigma = 0$ S/m, $\epsilon_r = 1$; $\rho = 1000$ kg/m³
 Phantom section: RF Section
 Measurement Standard: DASY5 (IEEE/IEC/ANSI C63.19-2007)

DASY52 Configuration:

- Probe: ER3DV6 - SN2336; ConvF(1, 1, 1); Calibrated: 28.12.2012;
- Sensor-Surface: (Fix Surface)
- Electronics: DAE4 Sn781; Calibrated: 13.09.2013
- Phantom: HAC Test Arch with AMCC; Type: SD HAC P01 BA; Serial: 1070
- DASY52 52.8.7(1137); SEMCAD X 14.6.10(7164)

Dipole E-Field measurement @ 1880MHz/E-Scan - 1880MHz d=15mm/Hearing Aid Compatibility Test (41x181x1):

Interpolated grid: dx=0.5000 mm, dy=0.5000 mm
 Device Reference Point: 0, 0, -6.3 mm
 Reference Value = 157.6 V/m; Power Drift = -0.02 dB
 PMR not calibrated. PMF = 1.000 is applied.
 E-field emissions = 94.20 V/m
 Near-field category: M3 (AWF 0 dB)

PMF scaled E-field

Grid 1 M3	Grid 2 M3	Grid 3 M3
91.75 V/m	94.20 V/m	93.34 V/m
Grid 4 M3	Grid 5 M3	Grid 6 M3
71.58 V/m	72.68 V/m	71.73 V/m
Grid 7 M3	Grid 8 M3	Grid 9 M3
87.01 V/m	89.29 V/m	88.31 V/m

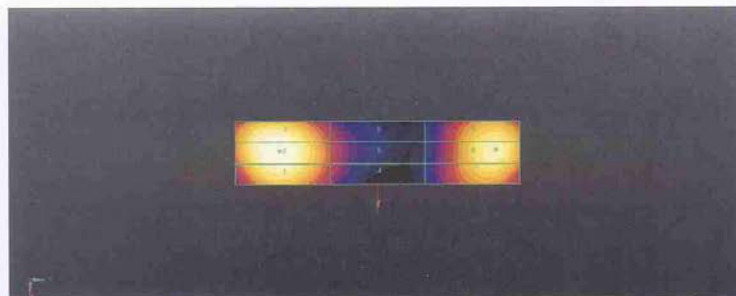
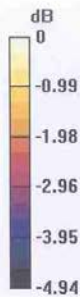

0 dB = 94.20 V/m = 39.48 dBV/m

The photos of HAC test are presented in the additional document:

Appendix to test report No. I14Z45140-SEM02

The photos of HAC test