



Variant Hearing Aid Compatibility (HAC) RF Emissions Test Report

APPLICANT : TCT Mobile Limited
EQUIPMENT : Mobile Phone
BRAND NAME : TCT Mobile Limited
MODEL NAME : 6037I
FCC ID : RAD458
STANDARD : FCC 47 CFR §20.19
ANSI C63.19-2007
M CATEGORY : M3

This is a variant report which is only valid together with the original test report. The product was completely tested on Apr. 04, 2014. We, SPORTON INTERNATIONAL (SHENZHEN) INC., would like to declare that the tested sample has been evaluated in accordance with the procedures and shown the compliance with the applicable technical standards.

The test results in this report apply exclusively to the tested model / sample. Without written approval of SPORTON INTERNATIONAL (SHENZHEN) INC., the test report shall not be reproduced except in full.

Reviewed by: Eric Huang / Deputy Manager

Approved by: Jones Tsai / Manager



SPORTON INTERNATIONAL (SHENZHEN) INC.

No. 101, Complex Building C, Guanlong Village, Xili Town, Nanshan District, Shenzhen, Guangdong, P.R.C.



Table of Contents

Revision History	3
1. Statement of Compliance	4
2. Administration Data	5
2.1 Testing Laboratory.....	5
2.2 Applicant.....	5
2.3 Manufacturer.....	5
2.4 Application Details.....	5
3. General Information	6
3.1 Description of Equipment Under Test (EUT).....	6
3.2 Air Interface and Operating Mode.....	7
3.3 Applied Standards.....	8
3.4 Test Conditions.....	9
3.4.1 Ambient Condition.....	9
3.4.2 Test Configuration.....	9
4. Hearing Aid Compliance (HAC)	10
4.1 Introduction.....	10
5. HAC RF Emission Measurement Setup	11
5.1 E-Field and H-Field Probe System.....	12
5.1.1 E-Field Probe Specification.....	12
5.1.2 H-Field Probe Description.....	12
5.1.3 Probe Tip Description.....	13
5.2 DATA Acquisition Electronics (DAE).....	14
5.3 Robot.....	15
5.4 Measurement Server.....	15
5.5 Phone Positioner.....	16
5.6 Test Arch Phantom.....	16
5.7 Data Storage and Evaluation.....	17
5.7.1 Data Storage.....	17
5.7.2 Data Evaluation.....	17
5.8 Test Equipment List.....	19
6. Uncertainty Assessment	20
7. HAC RF Emission Measurement Evaluation	22
7.1 Purpose of System Performance Check.....	22
7.2 System Setup.....	22
7.3 Validation Results.....	23
8. RF Field Probe Modulation Factor	24
9. Description for DUT Testing Position	28
10. RF Emissions Test Procedure	30
11. HAC RF Emission Test Results	31
11.1 Conducted Power (Unit: dBm).....	31
11.2 E-Field Emission.....	31
11.3 H-Field Emission.....	32
12. References	33
Appendix A. Plots of System Performance Check	
Appendix B. Plots of RF Emission Measurement	
Appendix C. DASy Calibration Certificate	
Appendix D. Test Setup Photos	
Appendix E. Product Equality Declaration	



1. Statement of Compliance

The maximum results of RF Emission of Hearing Aid Compliance (HAC) found during testing for the **TCT Mobile Limited Mobile Phone TCT Mobile Limited 6037I** are follows:

Band	HAC RF Emission Test Result		M Rating
GSM850	E-Field (V/m)	189.3	M3
	H-Field (A/m)	0.2531	M4
GSM1900	E-Field (V/m)	73.04	M3
	H-Field (A/m)	0.1851	M3
WCDMA Band V	E-Field (V/m)	62.5	M4
	H-Field (A/m)	0.08845	M4
WCDMA Band II	E-Field (V/m)	33.14	M4
	H-Field (A/m)	0.08474	M4

They are in compliance with HAC limits specified in guidelines FCC 47 CFR §20.19 and ANSI Standard ANSI C63.19.

Results Summary : M Category = M3 (ANSI C63.19-2007)



2. Administration Data

2.1 Testing Laboratory

Test Site	SPORTON INTERNATIONAL (SHENZHEN) INC.
Test Site Location	No. 101, Complex Building C, Guanlong Village, Xili Town, Nanshan District, Shenzhen, Guangdong, P.R.C. TEL: +86-755-8637-9589 FAX: +86-755-8637-9595
Test Site No.	Sporton Site No. : SAR01-SZ

2.2 Applicant

Company Name	TCT Mobile Limited
Address	TCT Mobile Limited/5F, C building, No. 232, Liang Jing Road ZhangJiang High-Tech Park, Pudong Area Shanghai, P.R. China. 201203

2.3 Manufacturer

Company Name	TCT Mobile Limited
Address	TCT Mobile Limited/5F, C building, No. 232, Liang Jing Road ZhangJiang High-Tech Park, Pudong Area Shanghai, P.R. China. 201203

2.4 Application Details

Date of Start during the Test	Apr. 10, 2014
Date of End during the Test	Apr. 10, 2014



3. General Information

3.1 Description of Equipment Under Test (EUT)

Product Feature & Specification	
EUT Type	Mobile Phone
Brand Name	TCT Mobile Limited
Model Name	60371
FCC ID	RAD458
IMEI Code	SIM 1: 864191020900355 SIM 2: 864191020900363
Tx Frequency	GSM850 : 824.2 MHz ~ 848.8 MHz GSM1900 : 1850.2 MHz ~ 1909.8 MHz WCDMA Band V : 826.4 MHz ~ 846.6 MHz WCDMA Band II : 1852.4 MHz ~ 1907.6 MHz WLAN 2.4GHz Band: 2412 MHz ~ 2462 MHz Bluetooth: 2402 MHz ~ 2480 MHz NFC : 13.56 MHz
Antenna Type	WWAN: Fixed Internal Antenna WLAN: PIFA Antenna Bluetooth: PIFA Antenna NFC : Loop Antenna
HW Version	PIO
SW Version	v3EHG-US
Type of Modulation	GSM: GMSK GPRS: GMSK EDGE: GMSK / 8PSK WCDMA (Rel 99): QPSK HSDPA (Rel 7): QPSK HSUPA (Rel 6): QPSK HSPA+ (Rel 7): 16QAM (Downlink Only) 802.11b: DSSS (DBPSK / DQPSK / CCK) 802.11g/n: OFDM (BPSK / QPSK / 16QAM / 64QAM) Bluetooth : GFSK Bluetooth EDR : $\pi/4$ -DQPSK, 8-DPSK
EUT Stage	Production Unit



3.2 Air Interface and Operating Mode

Air Interface	Band MHz	Type	C63.19 Tested	Simultaneous Transmitter	OTT	Power Reduction
GSM	850	VO	Yes	WLAN, Bluetooth	NA	No
	1900			WLAN, Bluetooth	NA	No
	GPRS	DT	No	WLAN, Bluetooth	Yes	No
WCDMA	850	VO	Yes	WLAN, Bluetooth	NA	No
	1900			WLAN, Bluetooth	NA	No
	HSPA	DT	No	WLAN, Bluetooth	Yes	No
WLAN	2450	VO	No	GSM, WCDMA	Yes	No
Bluetooth	2450	DT	No	GSM, WCDMA	NA	No

VO=CMRS Voice Service
DT=Digital Transport
VD=CMRS IP Voice Service and Digital Transport



3.3 Applied Standards

The ANSI Standard ANSI C63.19-2007 represents performance requirements for acceptable interoperability of hearing aids with wireless communications devices. When these parameters are met, a hearing aid operates acceptably in close proximity to a wireless communications device.

The following AWF factors shall be used for the standard transmission protocols:

Standard	Technology	AWF (dB)
TIA/EIA/IS-2000	CDMA	0
TIA/EIA-136	TDMA (50 Hz)	0
J-STD-007	GSM (217)	-5
T1/T1P1/3GPP	UMTS (WCDMA)	0
iDENTM	TDMA (22 and 11 Hz)	0

Table 3.1 Articulation Weighting Factor (AWF)

Category	Telephone RF Parameters		
	Near Field	AWF	H-Field Emissions
< 960 MHz			
Category M1	0	631.0 – 1122.0 V/m	1.91 – 3.39 A/m
	-5	473.2 – 841.4 V/m	1.43 – 2.54 A/m
Category M2	0	354.8 – 631.0 V/m	1.07 – 1.91 A/m
	-5	266.1 – 473.2 V/m	0.80 – 1.43 A/m
Category M3	0	199.5 – 354.8 V/m	0.6 – 1.07 A/m
	-5	149.6 – 266.1 V/m	0.45 – 0.80 A/m
Category M4	0	< 199.5 V/m	< 0.60 A/m
	-5	< 149.6 V/m	< 0.45 A/m
> 960 MHz			
Category M1	0	199.5 – 354.8 V/m	0.60 – 1.07 A/m
	-5	149.6 – 266.1 V/m	0.45 – 0.80 A/m
Category M2	0	112.2 – 199.5 V/m	0.34 – 0.60 A/m
	-5	84.1 – 149.6 V/m	0.25 – 0.45 A/m
Category M3	0	63.1 – 112.2 V/m	0.19 – 0.34 A/m
	-5	47.3 – 84.1 V/m	0.14 – 0.25 A/m
Category M4	0	< 63.1 V/m	< 0.19 A/m
	-5	< 47.3 V/m	< 0.14 A/m

Table 3.2 Telephone near-field categories in linear units



3.4 Test Conditions

3.4.1 Ambient Condition

Ambient Temperature	20 to 24 °C
Humidity	< 60 %

3.4.2 Test Configuration

The device was controlled by using a base station emulator R&S CMU200. Communication between the device and the emulator was established by air link. Measurements were performed on the low, middle and high channels of both bands. The DUT was set from the emulator to radiate maximum output power during all tests.



4. Hearing Aid Compliance (HAC)

4.1 Introduction

The federal communication commission (FCC) adopted ANSI C63.19 as HAC test standard.



5.1 E-Field and H-Field Probe System

The HAC measurement is conducted with the dosimetric probe ER3DV6 and H3DV6 (manufactured by SPEAG). The probe is specially designed and calibrated. This probe has a built in optical surface detection system to prevent from collision with EUT.

5.1.1 E-Field Probe Specification

<ER3DV6>

Construction	One dipole parallel, two dipoles normal to probe axis Built-in shielding against static charges
Calibration	In air from 100 MHz to 3.0 GHz (absolute accuracy $\pm 6.0\%$, $k=2$)
Frequency	100 MHz to 6 GHz; Linearity: ± 2.0 dB (100 MHz to 3 GHz)
Directivity	± 0.2 dB in air (rotation around probe axis) ± 0.4 dB in air (rotation normal to probe axis)
Dynamic Range	2 V/m to 1000 V/m (M3 or better device readings fall well below diode compression point)
Linearity	± 0.2 dB
Dimensions	Overall length: 330 mm (Tip: 16 mm) Tip diameter: 8 mm (Body: 12 mm) Distance from probe tip to dipole centers: 2.5 mm



Fig 5.2 Photo of E-field Probe

5.1.2 H-Field Probe Description

<H3DV6>

Construction	Three concentric loop sensors with 3.8 mm loop diameters Resistively loaded detector diodes for linear response Built-in shielding against static charges
Frequency	200 MHz to 3 GHz (absolute accuracy $\pm 6.0\%$, $k=2$); Output linearized
Directivity	± 0.25 dB (spherical isotropy error)
Dynamic Range	10 m A/m to 2 A/m at 1 GHz (M3 or better device readings fall well below diode compression point)
Dimensions	Overall length: 330 mm (Tip: 40 mm) Tip diameter: 6 mm (Body: 12 mm) Distance from probe tip to dipole centers: 3 mm
E-Field Interference	$< 10\%$ at 3 GHz (for plane wave)



Fig 5.3 Photo of H-field Probe



5.1.3 Probe Tip Description

HAC field measurements take place in the close near field with high gradients. Increasing the measuring distance from the source will generally decrease the measured field values (in case of the validation dipole approx. 10%/per mm).

Magnetic field sensors are measuring the integral of the H-field across their sensor area surrounded by the loop. They are calibrated in a precise, homogeneous field. When measuring a gradient field, the result will be very close to the field in the center of the loop which is equivalent to the value of a homogeneous field equivalent to the center value. But it will be different from the field at the field at the border of the loop.

Consequently, two sensors with different loop diameters – both calibrated ideally – would give different results when measuring from the edge of the probe sensor elements. The behavior for electrically small E-field sensors is equivalent. See below for distance plots from a WD which show the conservative nature of field readings at the probe element center vs. measurements at the sensor end:

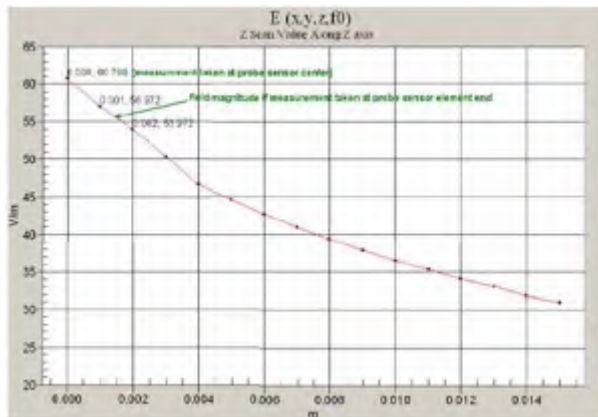

Fig 5.4 Z-Axis Scan at maximum point above a typical wireless device for E-field

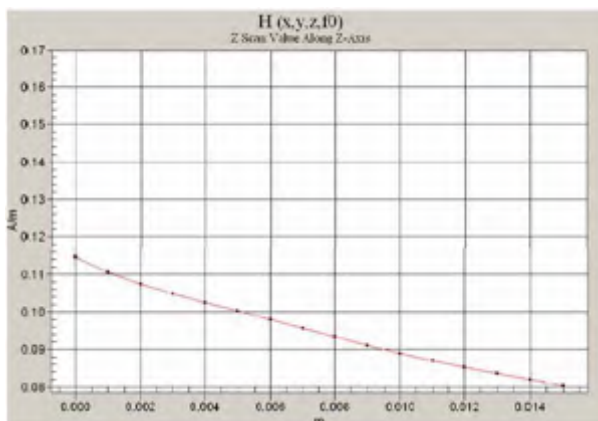

Fig 5.5 Z-Axis Scan at maximum point above a typical wireless device for H-field



The magnetic field loops of the H3D probes are concentric, with the center 3mm from the tip for H3DV6. Their radius is 1.9 mm.

The electric field probes have a more irregular internal geometry because it is physically not possible to have the 3 orthogonal sensors situated with the same center. The effect of the different sensor centers is accounted for in the HAC uncertainty budget (“sensor displacement”). Their geometric center is at 2.5 mm from the tip, and the element ends are 1.1 mm closer to the tip.

Where:

Peak Field = Peak field (in dB V/m or dB A/m)

Raw = Raw field measurement from the measurement system (in V/m or A/m).

PMF = Probe Modulation Factor (in Linear units). See Chapter 8 of test report.

5.2 DATA Acquisition Electronics (DAE)

The data acquisition electronics (DAE) consists of a highly sensitive electrometer-grade preamplifier with auto-zeroing, a channel and gain-switching multiplexer, a fast 16 bit AD-converter and a command decoder and control logic unit. Transmission to the measurement server is accomplished through an optical downlink for data and status information as well as an optical uplink for commands and the clock.

The input impedance of the DAE is 200 MOhm; the inputs are symmetrical and floating. Common mode rejection is above 80 dB.



Fig 5.6 Photo of DAE



5.3 Robot

The SPEAG DASY system uses the high precision robots (DASY5: TX90XL) type from Stäubli SA (France). For the 6-axis controller system, the robot controller version (DASY5: CS8c) from Stäubli is used. The Stäubli robot series have many features that are important for our application:

- High precision (repeatability ± 0.035 mm)
- High reliability (industrial design)
- Jerk-free straight movements
- Low ELF interference (the closed metallic construction shields against motor control fields)
- 6-axis controller



Fig 5.7 Photo of DASY5

5.4 Measurement Server

The measurement server is based on a PC/104 CPU board with CPU (DASY5: 400 MHz, Intel Celeron), chipdisk (DASY5: 128 MB), RAM (DASY5: 128 MB). The necessary circuits for communication with the DAE electronic box, as well as the 16 bit AD converter system for optical detection and digital I/O interface are contained on the DASY I/O board, which is directly connected to the PC/104 bus of the CPU board.

The measurement server performs all the real-time data evaluation for field measurements and surface detection, controls robot movements and handles safety operations.



Fig 5.8 Photo of Server for DASY5



5.5 Phone Positioner

The phone positioner shown in Fig. 5.11 is used to adjust DUT to the suitable position.



Fig 5.9 Phone Positioner

5.6 Test Arch Phantom

Construction :	Enables easy and well defined positioning of the phone and validation dipoles as well as simple teaching of the robot.
Dimensions :	370 x 370 x 370 mm



Fig 5.10 Photo of Arch Phantom



5.7 Data Storage and Evaluation

5.7.1 Data Storage

The DASY software stores the assessed data from the data acquisition electronics as raw data (in microvolt readings from the probe sensors), together with all the necessary software parameters for the data evaluation (probe calibration data, and device frequency and modulation data) in measurement files. The post-processing software evaluates the desired unit and format for output each time the data is visualized or exported. This allows verification of the complete software setup even after the measurement and allows correction of erroneous parameter settings.

5.7.2 Data Evaluation

The DASY post-processing software (SEMCAD) automatically executes the following procedures to calculate the field units from the microvolt readings at the probe connector. The parameters used in the evaluation are stored in the configuration modules of the software :

- Probe parameters :**
 - Sensitivity Norm_i, a_{i0}, a_{i1}, a_{i2}
 - Conversion factor ConvF_i
 - Diode compression point dcp_i
- Device parameters :**
 - Frequency f
 - Crest factor cf
- Media parameters :**
 - Conductivity σ
 - Density ρ

These parameters must be set correctly in the software. They can be found in the component documents or they can be imported into the software from the configuration files issued for the DASY components. In the direct measuring mode of the multi-meter option, the parameters of the actual system setup are used. In the scan visualization and export modes, the parameters stored in the corresponding document files are used.

The first step of the evaluation is a linearization of the filtered input signal to account for the compression characteristics of the detector diode. The compensation depends on the input signal, the diode type and the DC-transmission factor from the diode to the evaluation electronics. If the exciting field is pulsed, the crest factor of the signal must be known to correctly compensate for peak power. The formula for each channel can be given as :

V_i = U_i + U_i^2 * (cf / dcp_i)

- with V_i = compensated signal of channel i, (i = x, y, z)
- U_i = input signal of channel i, (i = x, y, z)
- cf = crest factor of exciting field (DASY parameter)
- dcp_i = diode compression point (DASY parameter)



From the compensated input signals, the primary field data for each channel can be evaluated :

$$\text{E-field Probes : } \mathbf{E}_i = \sqrt{\frac{V_i}{\text{Norm}_i \cdot \text{ConvF}}}$$

$$\text{H-field Probes : } \mathbf{H}_i = \sqrt{V_i} \cdot \frac{a_{i0} + a_{i1}f + a_{i2}f^2}{f}$$

with V_i = compensated signal of channel i , ($i = x, y, z$)

Norm_i = sensor sensitivity of channel i , ($i = x, y, z$), $\mu\text{V}/(\text{V}/\text{m})^2$ for E-field Probes

ConvF = sensitivity enhancement in solution

a_{ij} = sensor sensitivity factors for H-field probes

f = carrier frequency [GHz]

E_i = electric field strength of channel i in V/m

H_i = magnetic field strength of channel i in A/m

The RSS value of the field components gives the total field strength (Hermitian magnitude) :

$$\mathbf{E}_{\text{tot}} = \sqrt{\mathbf{E}_x^2 + \mathbf{E}_y^2 + \mathbf{E}_z^2}$$

The primary field data are used to calculate the derived field units.

The measurement/integration time per point, as specified by the system manufacturer is > 500 ms. The signal response time is evaluated as the time required by the system to reach 90% of the expected final value after an on/off switch of the power source with an integration time of 500 ms and a probe response time of < 5 ms. In the current implementation, DASYS waits longer than 100 ms after having reached the grid point before starting a measurement, i.e., the response time uncertainty is negligible.

If the device under test does not emit a CW signal, the integration time applied to measure the electric field at a specific point may introduce additional uncertainties due to the discretization. The tolerances for the different systems had the worst-case of 2.6%.



5.8 Test Equipment List

Manufacturer	Name of Equipment	Type/Model	Serial Number	Calibration	
				Last Cal.	Due Date
SPEAG*	Dipole	CD835V3	1171	Jan. 22, 2013	Jan. 21, 2016
SPEAG*	Dipole	CD1880V3	1155	Jan. 22, 2013	Jan. 21, 2016
SPEAG	Data Acquisition Electronics	DAE4	910	Dec. 17, 2013	Dec. 16, 2014
SPEAG	Probe	ER3DV6	2480	Feb. 28, 2014	Feb. 27, 2015
SPEAG	Probe	H3DV6	6305	Feb. 28, 2014	Feb. 27, 2015
SPEAG	Test Arch Phantom	Par phantom	1105	NCR	NCR
SPEAG	Phone Positioner	N/A	N/A	NCR	NCR
Agilent	Base Station	E5515C	MY50267224	Oct. 10, 2013	Oct. 09, 2014
AR	Amplifier	551G4	333096	NCR	NCR
Anritsu	Power Meter	ML2495A	1218010	Mar. 27, 2014	Mar. 26, 2015
Anritsu	Power Sensor	MA2411B	1207253	Mar. 27, 2014	Mar. 26, 2015
ARRA	Power Divider	A3200-2	N/A	NA	NA
MCL	Attenuation	BW-S10W5	N/A	NA	NA
R&S	Spectrum Analyzer	FSP7	101230	Jun. 13, 2013	Jun. 12, 2014

Note: "*" Means calibration interval of instruments listed above is three years.

Table 5.1 Test Equipment List



6. Uncertainty Assessment

The component of uncertainty may generally be categorized according to the methods used to evaluate them. The evaluation of uncertainty by the statistical analysis of a series of observations is termed a Type A evaluation of uncertainty. The evaluation of uncertainty by means other than the statistical analysis of a series of observation is termed a Type B evaluation of uncertainty. Each component of uncertainty, however evaluated, is represented by an estimated standard deviation, termed standard uncertainty, which is determined by the positive square root of the estimated variance.

A Type A evaluation of standard uncertainty may be based on any valid statistical method for treating data. This includes calculating the standard deviation of the mean of a series of independent observations; using the method of least squares to fit a curve to the data in order to estimate the parameter of the curve and their standard deviations; or carrying out an analysis of variance in order to identify and quantify random effects in certain kinds of measurement.

A type B evaluation of standard uncertainty is typically based on scientific judgment using all of the relevant information available. These may include previous measurement data, experience and knowledge of the behavior and properties of relevant materials and instruments, manufacture’s specification, data provided in calibration reports and uncertainties assigned to reference data taken from handbooks. Broadly speaking, the uncertainty is either obtained from an outdoor source or obtained from an assumed distribution, such as the normal distribution, rectangular or triangular distributions indicated in Table 6.1.

Uncertainty Distributions	Normal	Rectangular	Triangular	U-Shape
Multi-plying Factor ^(a)	1/k ^(b)	1/√3	1/√6	1/√2

(a) standard uncertainty is determined as the product of the multiplying factor and the estimated range of variations in the measured quantity

(b) κ is the coverage factor

Table 6.1 Multiplying Factions for Various Distributions

The combined standard uncertainty of the measurement result represents the estimated standard deviation of the result. It is obtained by combining the individual standard uncertainties of both Type A and Type B evaluation using the usual “root-sum-squares” (RSS) methods of combining standard deviations by taking the positive square root of the estimated variances.

Expanded uncertainty is a measure of uncertainty that defines an interval about the measurement result within which the measured value is confidently believed to lie. It is obtained by multiplying the combined standard uncertainty by a coverage factor. Typically, the coverage factor ranges from 2 to 3. Using a coverage factor allows the true value of a measured quantity to be specified with a defined probability within the specified uncertainty range. For purpose of this document, a coverage factor two is used, which corresponds to confidence interval of about 95 %. The DASY uncertainty Budget is showed in Table 6.2.



Error Description	Uncertainty Value (±%)	Probability Distribution	Divisor	Ci (E)	Ci (H)	Standard Uncertainty (E)	Standard Uncertainty (H)
Measurement System							
Probe Calibration	5.1	Normal	1	1	1	± 5.1 %	± 5.1 %
Axial Isotropy	4.7	Rectangular	√3	1	1	± 2.7 %	± 2.7 %
Sensor Displacement	16.5	Rectangular	√3	1	0.145	± 9.5 %	± 1.4 %
Test Arch	7.2	Rectangular	√3	1	0	± 4.1 %	± 0.0 %
Linearity	4.7	Rectangular	√3	1	1	± 2.7 %	± 2.7 %
Scaling to Peak Envelope Power	2.0	Rectangular	√3	1	1	± 1.2 %	± 1.2 %
System Detection Limit	1.0	Rectangular	√3	1	1	± 0.6 %	± 0.6 %
Readout Electronics	0.3	Normal	1	1	1	± 0.3 %	± 0.3 %
Response Time	0.8	Rectangular	√3	1	1	± 0.5 %	± 0.5 %
Integration Time	2.6	Rectangular	√3	1	1	± 1.5 %	± 1.5 %
RF Ambient Conditions	3.0	Rectangular	√3	1	1	± 1.7 %	± 1.7 %
RF Reflections	12.0	Rectangular	√3	1	1	± 6.9 %	± 6.9 %
Probe Positioner	1.2	Rectangular	√3	1	0.67	± 0.7 %	± 0.5 %
Probe Positioning	4.7	Rectangular	√3	1	0.67	± 2.7 %	± 1.8 %
Extrap. and Interpolation	1.0	Rectangular	√3	1	1	± 0.6 %	± 0.6 %
Test Sample Related							
Device Positioning Vertical	4.7	Rectangular	√3	1	0.67	± 2.7 %	± 1.8 %
Device Positioning Lateral	1.0	Rectangular	√3	1	1	± 0.6 %	± 0.6 %
Device Holder and Phantom	2.4	Rectangular	√3	1	1	± 1.4 %	± 1.4 %
Power Drift	5.0	Rectangular	√3	1	1	± 2.9 %	± 2.9 %
Phantom and Setup Related							
Phantom Thickness	2.4	Rectangular	√3	1	0.67	± 1.4 %	± 0.9 %
Combined Standard Uncertainty						± 15.2 %	± 10.8 %
Coverage Factor for 95 %						K = 2	
Expanded Uncertainty						± 30.5 %	± 21.7 %

Table 6.2 Uncertainty Budget of DASYS



7. HAC RF Emission Measurement Evaluation

Each DASy system is equipped with one or more system validation kits. These units, together with the predefined measurement procedures within the DASy software, enable the user to conduct the system performance check and system validation. System validation kit includes a dipole, tripod holder to fix it underneath the test Arch and a corresponding distance holder.

7.1 Purpose of System Performance Check

The system performance check verifies that the system operates within its specifications. System and operator errors can be detected and corrected. It is recommended that the system performance check be performed prior to any usage of the system in order to guarantee reproducible results. The system performance check uses normal HAC measurements in a simplified setup with a well characterized source. This setup was selected to give a high sensitivity to all parameters that might fail or vary over time. The system check does not intend to replace the calibration of the components, but indicates situations where the system uncertainty is exceeded due to drift or failure.

7.2 System Setup

In the simplified setup for system evaluation, the DUT is replaced by a calibrated dipole and the power source is replaced by a continuous wave which comes from a signal generator. The calibrated dipole must be placed beneath the arch phantom. The equipment setup is shown below:

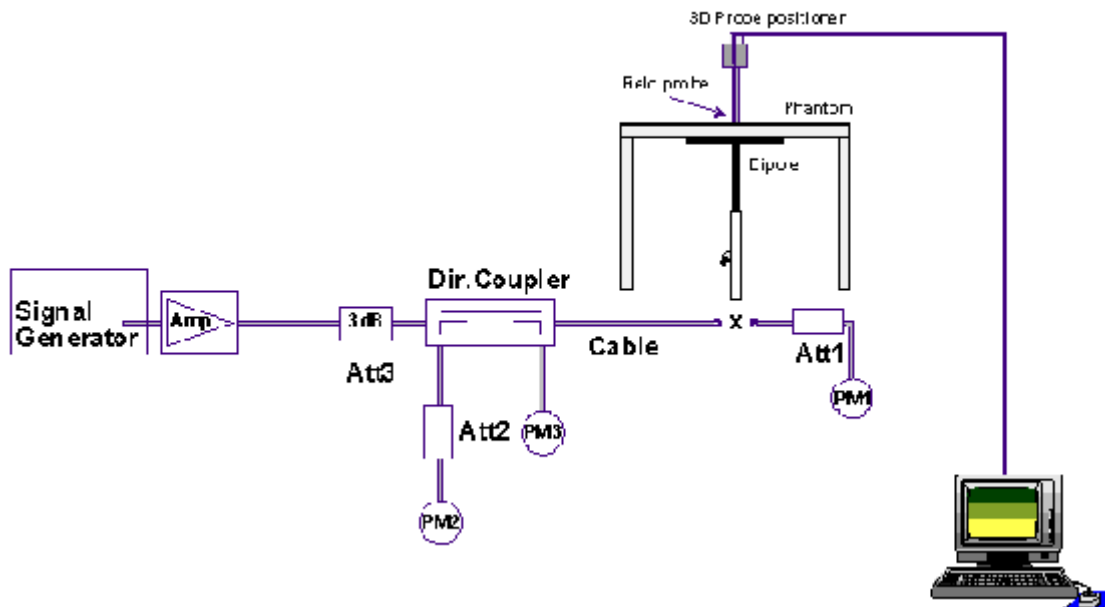

Fig. 7.1 System Setup of System Evaluation



1. Signal Generator
2. Amplifier
3. Directional Coupler
4. Power Meter
5. Calibrated Dipole

The output power on dipole port must be calibrated to 20dBm (100mW) before dipole is connected.



Fig 7.2 Dipole Setup

7.3 Validation Results

Comparing to the original E-field or H-field value provided by SPEAG, the validation data should be within its specification of 25 %. Table 7.1 shows the target value and measured value. The table below indicates the system performance check can meet the variation criterion and the plots can be referred to appendix A of this report.

Frequency (MHz)	Input Power (dBm)	Target Value (V/m)	E-Field 1 (V/m)	E-Field 2 (V/m)	Average Value (V/m)	Deviation (%)	Date
835	20	169.5	156.3	173	164.65	-2.86	Apr. 10, 2014
1880	20	141.2	130.8	139.4	135.1	-4.32	Apr. 10, 2014
Frequency (MHz)	Input Power (dBm)	Target Value (A/m)	H-Field (A/m)		Deviation (%)	Date	
835	20	0.470	0.4641		-1.26	Apr. 10, 2014	
1880	20	0.471	0.4407		-6.43	Apr. 10, 2014	

Table 7.1 Test Results of System Validation

Note: Deviation = ((E or H-field Result) - (Target field)) / (Target field) * 100%

8. RF Field Probe Modulation Factor

A calibration shall be made of the modulation response of the probe and its instrumentation chain. This calibration shall be performed with the field probe, attached to the instrumentation that is to be used with it during the measurement. The response of the probe system to a CW field at the frequency(s) of interest is compared to its response to a modulated signal with equal peak amplitude. The field level of the test signals shall be more than 10 dB above the ambient level and the noise floor of the instrumentation being used. The ratio of the CW reading to that taken with a modulated field shall be applied to the readings taken of modulated fields of the specified type.

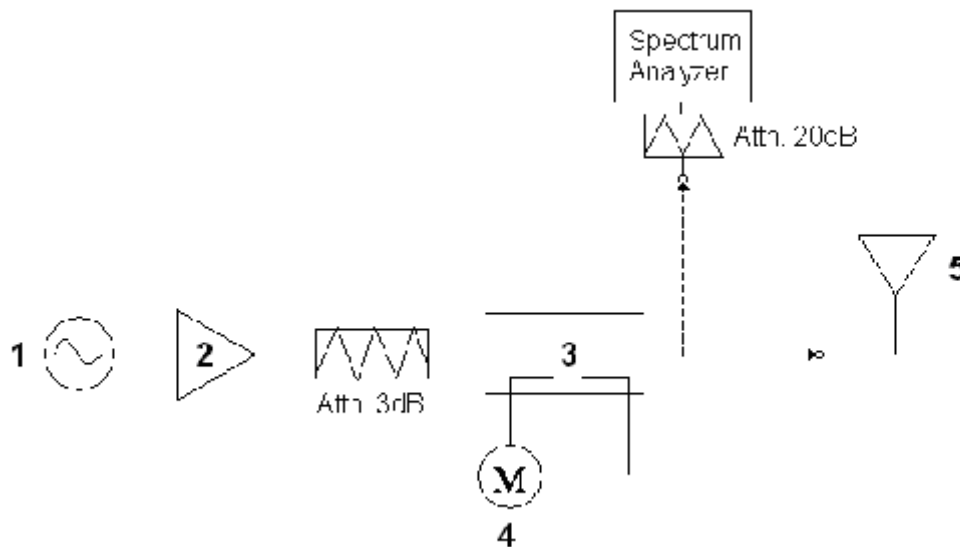

Fig. 8.1 System Calibration

This was done using the following procedure:

1. Fixing the probe in a set location relative to a field generating device.
2. Illuminate the probe with a CW signal at the intended measurement frequency.
3. Record the reading of the probe measurement system of the CW signal.
4. Determine the level of the CW signal being used to drive the field generating device.
5. Substitute a signal using the same modulation as that used by the intended WD for the CW signal.
6. Set the peak amplitude during transmission of the modulated signal to equal the amplitude of the CW signal.
7. Record the reading of the probe measurement system of the modulated signal.
8. The ratio of the CW to modulated signal reading is the modulation factor.
9. Repeat 2~8 steps at intended measurement frequency for both E and H field probe.



PMF Measurement Summary:

<GSM>

Frequency (MHz)	Functions	E-field	H-field	PMF	
		V/m	A/m	E-field	H-field
835	CW	711.0	3.382	-	-
835	AM 80%	436.0	1.530	1.90	2.49
835	GSM	268.0	1.316	2.65	2.57
1880	CW	442.1	2.721	-	-
1880	AM 80%	271.6	1.166	1.63	2.33
1880	GSM	163.2	1.063	2.71	2.56

<WCDMA>

Frequency (MHz)	Functions	E-field	H-field	PMF	
		V/m	A/m	E-field	H-field
835	CW	296.7	0.613	-	-
835	AM 80%	194.7	0.432	1.52	1.42
835	WCDMA	296.9	0.736	1.00	0.83
1880	CW	215.4	1.119	-	-
1880	AM 80%	150.5	0.603	1.43	1.86
1880	WCDMA	220.4	1.348	0.98	0.83



Zero span Spectrum Plots for RF Field Probe Modulation Factor

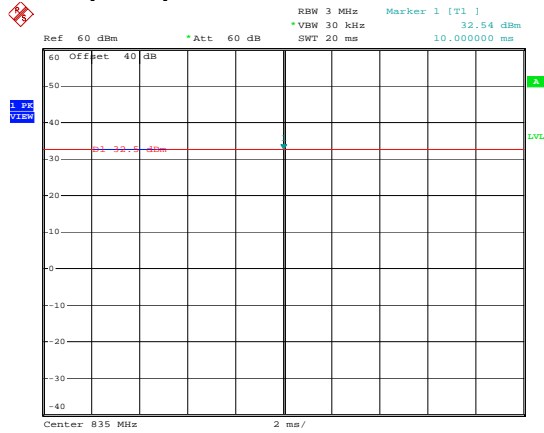

835MHz - CW

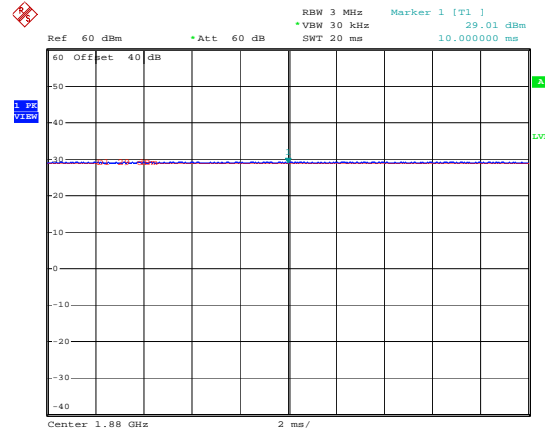

1880MHz - CW

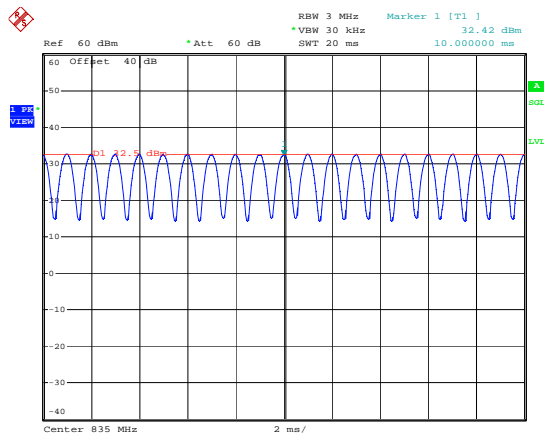

835MHz - 80% AM

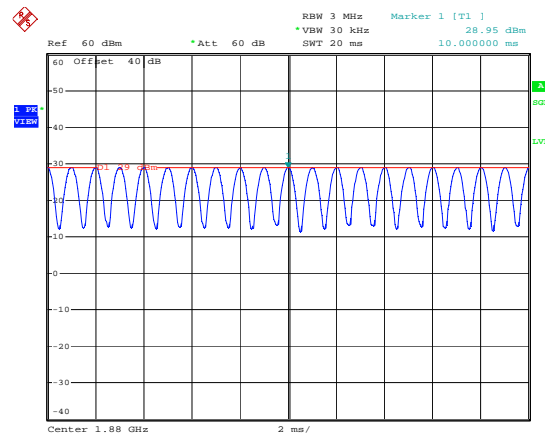

1880MHz - 80% AM

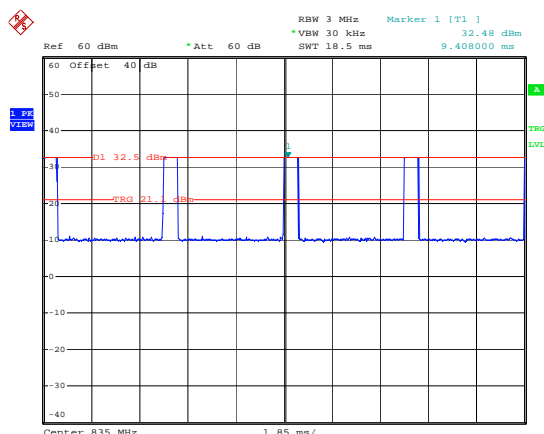

835MHz - GSM

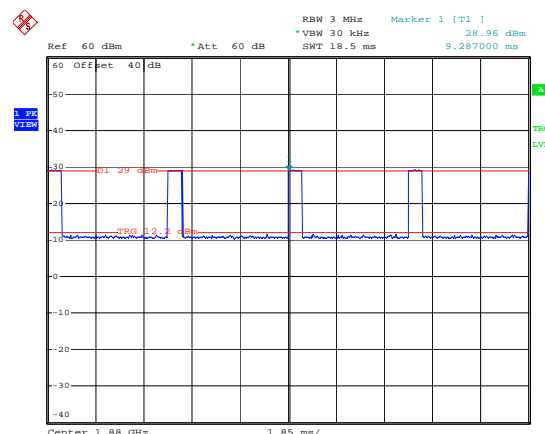

1880MHz - GSM

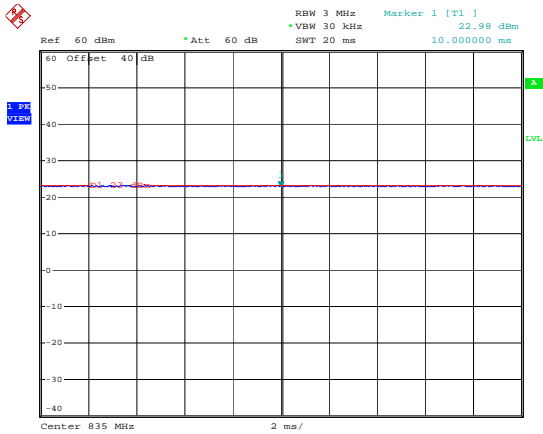

835MHz - CW

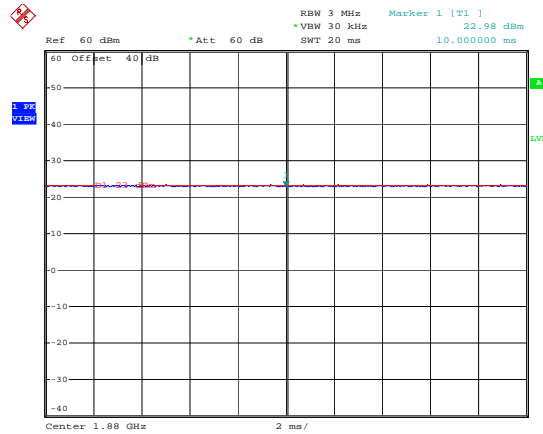

1880MHz - CW

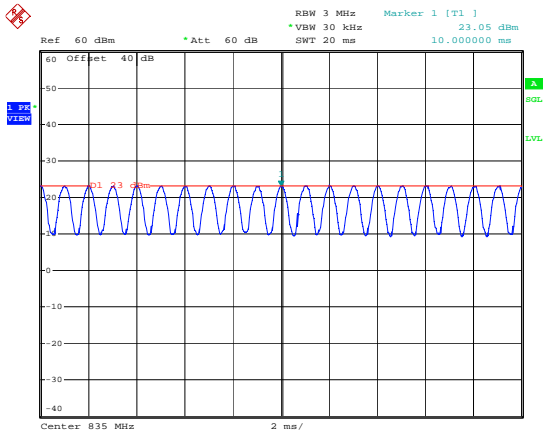

835MHz - 80% AM

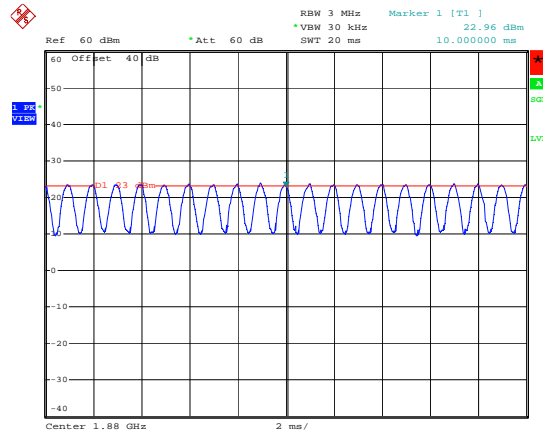

1880MHz - 80% AM

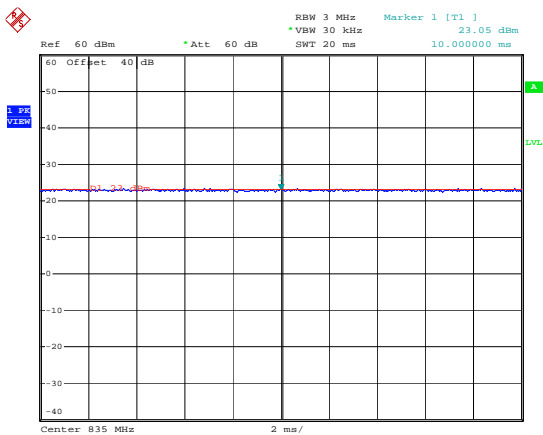

835MHz - WCDMA

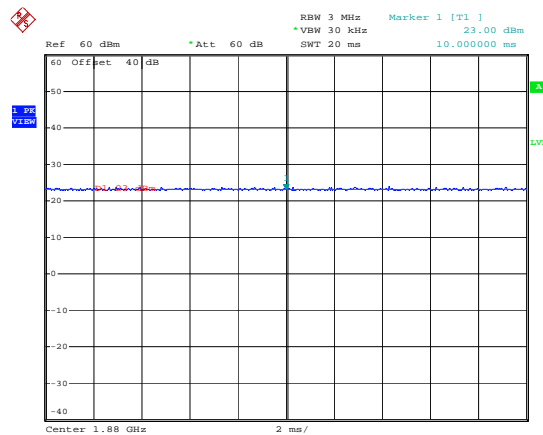

1880MHz - WCDMA



9. Description for DUT Testing Position

The DUT was put on device holder and adjusted to the accurate and reliable position. Please refer to Appendix D for the Setup photographs.

Fig. 9.1 illustrate the references and reference plane that shall be used in a typical DUT emissions measurement. The principle of this section is applied to DUT with similar geometry.

- The grid is 5 cm by 5 cm area that is divided into 9 evenly sized blocks or sub-grids.
- The grid is centered on the audio frequency output transducer of the DUT.
- The grid is in a reference plane, which is defined as the planar area that contains the highest point in the area of the phone that normally rests against the user's ear. It is parallel to the centerline of the receiver area of the phone and is defined by the points of the receiver-end of the DUT handset, which, in normal handset use, rest against the ear.
- The measurement plane is parallel to, and 15 mm in front of, the reference plane.



Fig 9.1 A typical DUT reference and plane for HAC measurements

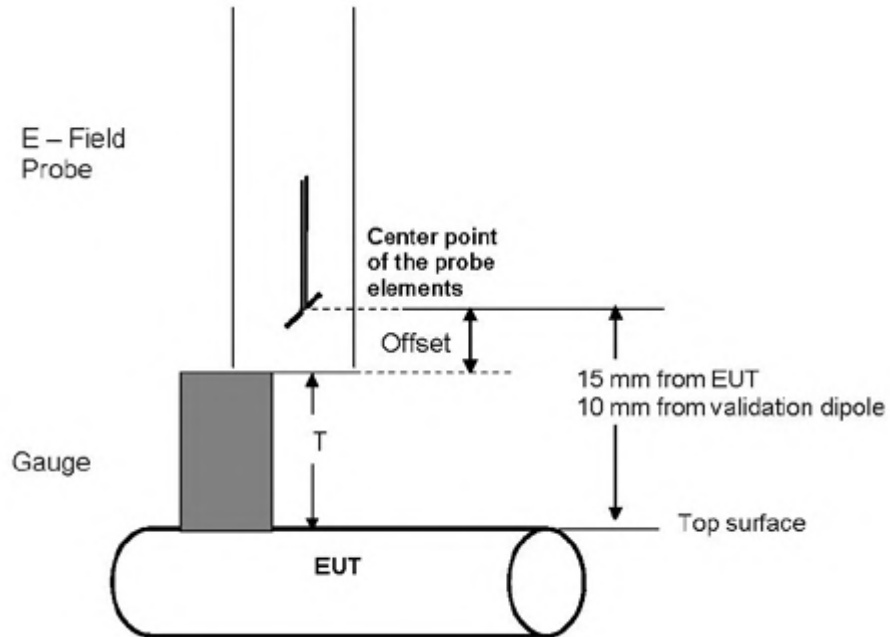

Fig. 9.2 Gauge block with E-field probe

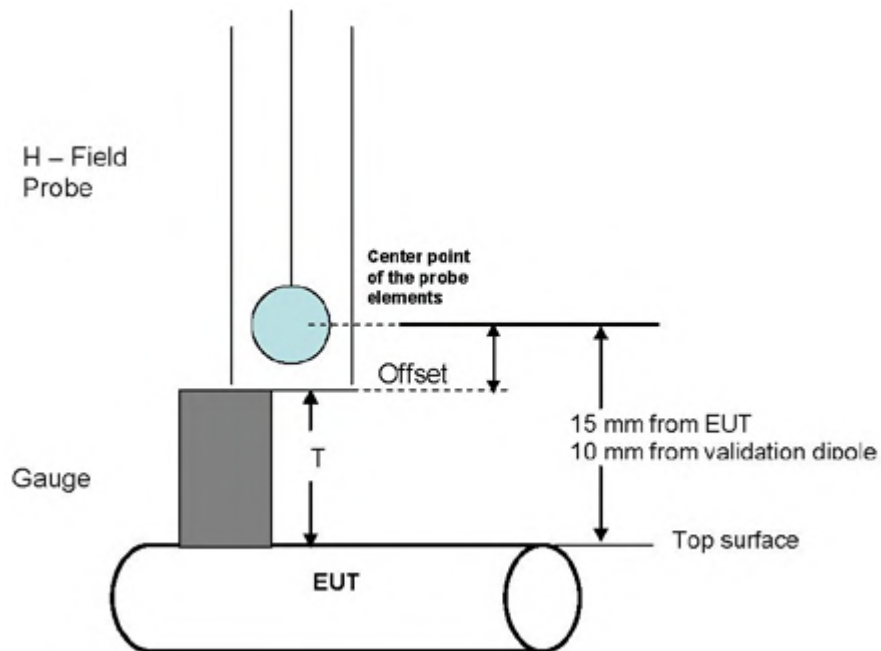

Fig. 9.3 Gauge block with H-field probe



10. RF Emissions Test Procedure

The following illustrate a typical RF emissions test scan over a wireless communications device:

1. Proper operation of the field probe, probe measurement system, other instrumentation, and the positioning system was confirmed.
2. DUT is positioned in its intended test position, acoustic output point of the device perpendicular to the field probe.
3. The DUT operation for maximum rated RF output power was configured and confirmed with the base station simulator, at the test channel and other normal operating parameters as intended for the test. The battery was ensured to be fully charged before each test.
4. The center sub-grid was centered over the center of the acoustic output (also audio band magnetic output, if applicable). The DUT audio output was positioned tangent (as physically possible) to the measurement plane.
5. A surface calibration was performed before each setup change to ensure repeatable spacing and proper maintenance of the measurement plane using the test Arch.
6. The measurement system measured the field strength at the reference location.
7. Measurements at 5 mm increments in the 5 x 5 cm region in equally spaced increments and record the reading at each measurement point. The distance between measurement points shall be sufficient to assure the identification of the peak reading.
8. The system performed a drift evaluation by measuring the field at the reference location.
9. Steps 1 ~ 8 were done for both the E and H-Field measurements.



11. HAC RF Emission Test Results

11.1 Conducted Power (Unit: dBm)

For SIM1 Card

Conducted Power (*Unit: dBm)						
Band	GSM850			GSM1900		
Channel	128	189	251	512	661	810
Frequency	824.2	836.4	848.8	1850.2	1880	1909.8
GSM (GMSK, 1 Tx slot)	32.46	32.47	32.33	28.70	28.94	29.17

Band	WCDMA Band V			WCDMA Band II		
Channel	4132	4182	4233	9262	9400	9538
Frequency	826.4	836.4	846.6	1852.4	1880.0	1907.6
AMR 12.2Kbps	22.76	22.57	22.72	22.38	22.72	22.58
RMC 12.2Kbps	22.78	22.61	22.74	22.42	22.76	22.63

For SIM2 Card

Conducted Power (*Unit: dBm)						
Band	GSM850			GSM1900		
Channel	128	189	251	512	661	810
Frequency	824.2	836.4	848.8	1850.2	1880	1909.8
GSM (GMSK, 1 Tx slot)	32.45	32.46	32.32	28.69	28.93	29.16

Band	WCDMA Band V			WCDMA Band II		
Channel	4132	4182	4233	9262	9400	9538
Frequency	826.4	836.4	846.6	1852.4	1880.0	1907.6
AMR 12.2Kbps	22.76	22.58	22.73	22.40	22.74	22.60
RMC 12.2Kbps	22.77	22.60	22.73	22.41	22.75	22.61

11.2 E-Field Emission

Plot No.	Band	Mode	Channel	PMF	Peak E-Field (V/m)	M-Rating
01	GSM850	GSM Voice	128	2.65	189.3	M3
02	GSM1900	GSM Voice	512	2.71	73.04	M3
03	WCDMA Band V	RMC12.2K	4233	1.00	62.5	M4
04	WCDMA Band II	RMC12.2K	9538	0.98	33.14	M4



11.3 H-Field Emission

Plot No.	Band	Mode	Channel	PMF	Peak H-Field (A/m)	M-Rating
01	GSM850	GSM Voice	189	2.57	0.2531	M4
02	GSM1900	GSM Voice	810	2.56	0.1851	M3
03	WCDMA Band V	RMC12.2K	4233	0.83	0.08845	M4
04	WCDMA Band II	RMC12.2K	9538	0.83	0.08474	M4

Remark:

1. The volume was adjusted to maximum level and the backlight turned off during RF Emission testing.
2. There is no special HAC mode software on this DUT.
3. Test Engineer : Luke Lu



12. References

- [1] ANSI C63.19-2007, "American National Standard for Methods of Measurement of Compatibility between Wireless Communications Devices and Hearing Aids", 8 June 2007
- [2] SPEAG DASY System Handbook



Appendix A. Plots of System Performance Check

The plots are shown as follows.

HAC-E_Dipole_835_140410

DUT: HAC-Dipole 835 MHz

Communication System: UID 0, CW; Frequency: 835 MHz; Duty Cycle: 1:1

Medium: Air Medium parameters used: $\sigma = 0$ S/m, $\epsilon_r = 1$; $\rho = 0$ kg/m³

Ambient Temperature : 23.5 °C

DASY5 Configuration:

- Probe: ER3DV6 - SN2480; ConvF(1, 1, 1); Calibrated: 2014.02.28;
- Sensor-Surface: (Fix Surface)
- Electronics: DAE4 Sn910; Calibrated: 2013.12.17
- Phantom: HAC Test Arch with AMCC; Type: SD HAC P01 BA;
- Measurement SW: DASY52, Version 52.8 (7); SEMCAD X Version 14.6.10 (7164)

E Scan - measurement distance from the probe sensor center to CD835 = 10mm/Hearing Aid Compatibility Test at 10mm distance (41x361x1): Interpolated

grid: dx=0.5000 mm, dy=0.5000 mm

Device Reference Point: 0, 0, -6.3 mm

Reference Value = 118.1 V/m; Power Drift = -0.03 dB

E-field emissions = 173.0 V/m

Average value of Total=(156.3 + 173.0) / 2=164.65 V/m

PMF scaled E-field

Grid 1 M4 165.6 V/m	Grid 2 M4 173.0 V/m	Grid 3 M4 165.9 V/m
Grid 4 M4 81.00 V/m	Grid 5 M4 85.33 V/m	Grid 6 M4 84.12 V/m
Grid 7 M4 148.4 V/m	Grid 8 M4 156.3 V/m	Grid 9 M4 153.8 V/m

Cursor:

Total = 173.0 V/m

E Category: M4

Location: 0, -79, 4.7 mm

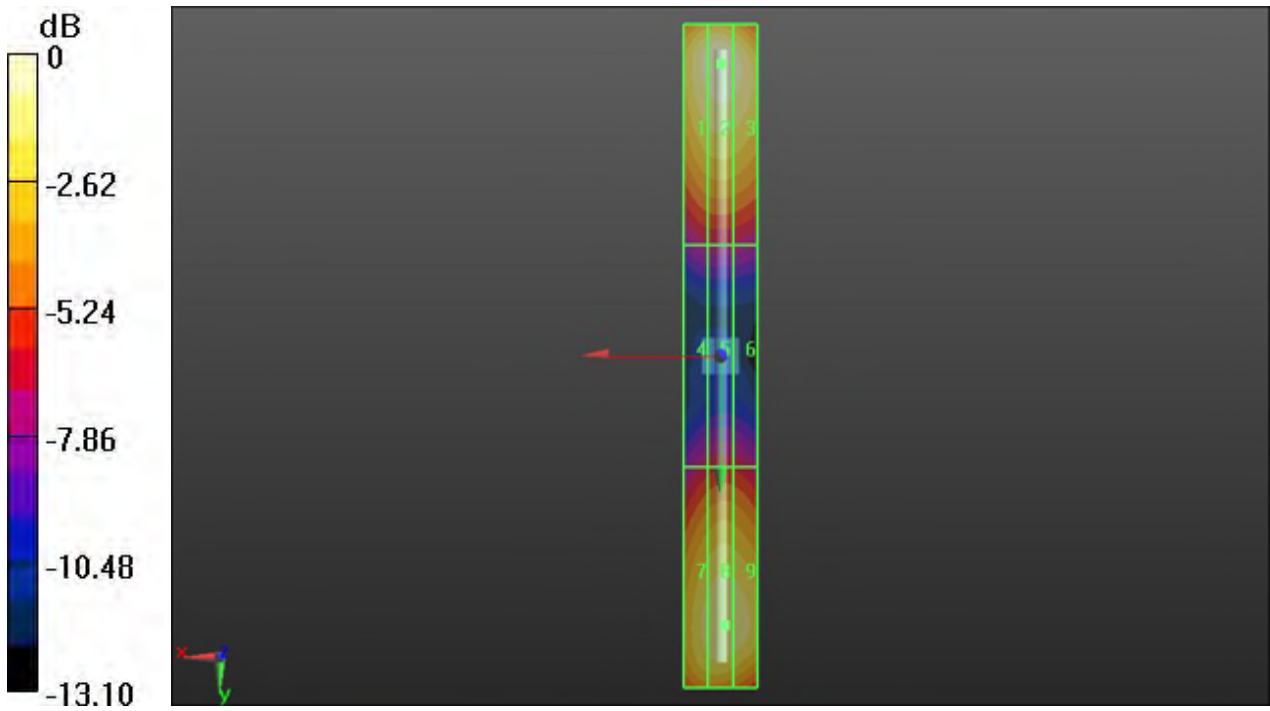

0 dB = 173.0 V/m

HAC-E_Dipole_1880_140410

DUT: HAC Dipole 1880 MHz

Communication System: UID 0, CW; Frequency: 1880 MHz; Duty Cycle: 1:1

Medium: Air Medium parameters used: $\sigma = 0$ S/m, $\epsilon_r = 1$; $\rho = 0$ kg/m³

Ambient Temperature : 23.5 °C;

DASY5 Configuration:

- Probe: ER3DV6 - SN2480; ConvF(1, 1, 1); Calibrated: 2014.02.28;
- Sensor-Surface: (Fix Surface)
- Electronics: DAE4 Sn910; Calibrated: 2013.12.17
- Phantom: HAC Test Arch with AMCC; Type: SD HAC P01 BA;
- Measurement SW: DASY52, Version 52.8 (7); SEMCAD X Version 14.6.10 (7164)

E Scan - measurement distance from the probe sensor center to CD1880 = 10mm/Hearing Aid Compatibility Test at 10mm distance (41x361x1): Interpolated

grid: dx=0.5000 mm, dy=0.5000 mm

Device Reference Point: 0, 0, -6.3 mm

Reference Value = 133.2 V/m; Power Drift = 0.01 dB

E-field emissions = 139.5 V/m

Average value of Total=(130.8 + 139.4) / 2=135.1 V/m

PMF scaled E-field

Grid 1 M2 134.4 V/m	Grid 2 M2 139.4 V/m	Grid 3 M2 132.0 V/m
Grid 4 M2 124.0 V/m	Grid 5 M2 129.5 V/m	Grid 6 M2 126.7 V/m
Grid 7 M2 126.0 V/m	Grid 8 M2 130.8 V/m	Grid 9 M2 127.6 V/m

Cursor:

Total = 139.5 V/m

E Category: M2

Location: 0.5, -38.5, 4.7 mm

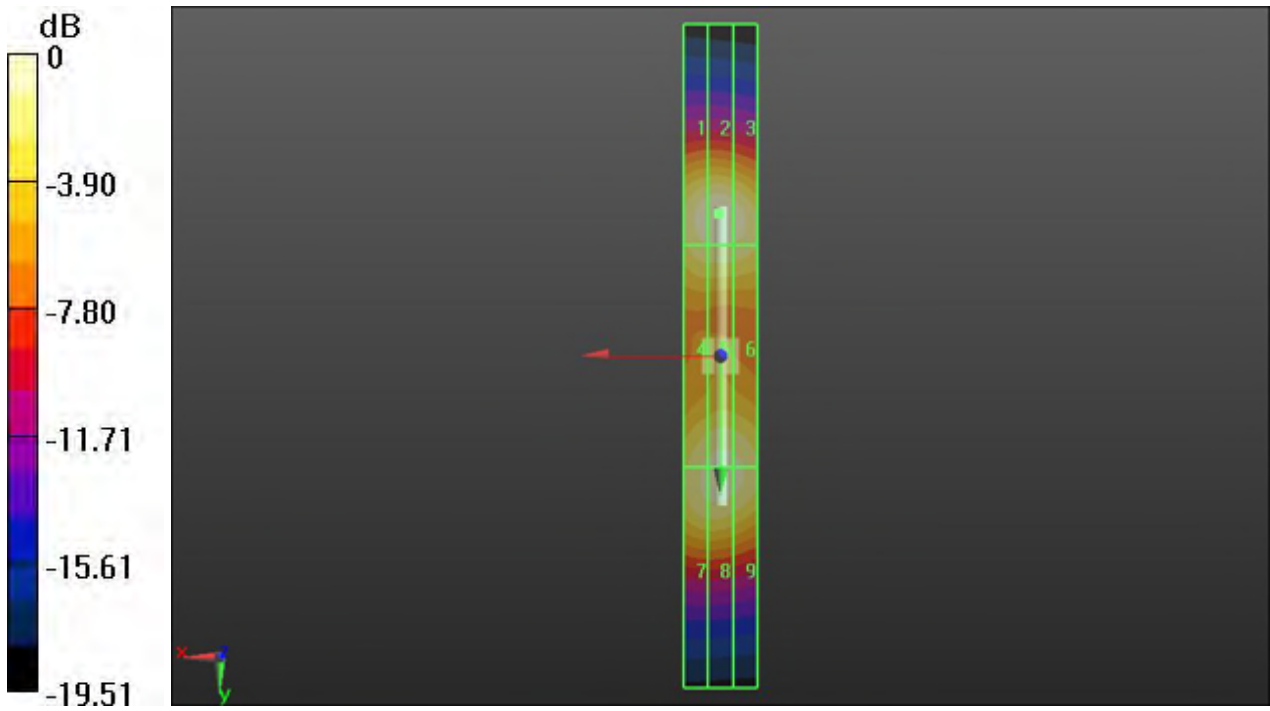

0 dB = 139.5 V/m = 42.89 dBV/m

HAC-H_Dipole_835_140410

DUT: HAC-Dipole 835 MHz

Communication System: UID 0, CW; Frequency: 835 MHz; Duty Cycle: 1:1

Medium: Air Medium parameters used: $\sigma = 0$ S/m, $\epsilon_r = 1$; $\rho = 0$ kg/m³

Ambient Temperature : 23.5 °C

DASY5 Configuration:

- Probe: H3DV6 - SN6305; ; Calibrated: 2014.02.28
- Sensor-Surface: (Fix Surface)
- Electronics: DAE4 Sn910; Calibrated: 2013.12.17
- Phantom: HAC Test Arch with AMCC; Type: SD HAC P01 BA;
- Measurement SW: DASY52, Version 52.8 (7); SEMCAD X Version 14.6.10 (7164)

H Scan - measurement distance from the probe sensor center to CD835 Dipole = 10mm/Hearing Aid Compatibility Test (41x361x1): Interpolated grid: dx=0.5000 mm, dy=0.5000 mm

Device Reference Point: 0, 0, -6.3 mm

Reference Value = 0.5180 A/m; Power Drift = -0.02 dB

H-field emissions = 0.4641 A/m

PMF scaled H-field

Grid 1 M4 0.398 A/m	Grid 2 M4 0.417 A/m	Grid 3 M4 0.399 A/m
Grid 4 M4 0.444 A/m	Grid 5 M4 0.464 A/m	Grid 6 M4 0.446 A/m
Grid 7 M4 0.390 A/m	Grid 8 M4 0.409 A/m	Grid 9 M4 0.394 A/m

Cursor:

Total = 0.4641 A/m

H Category: M4

Location: 0, -3.5, 5.3 mm

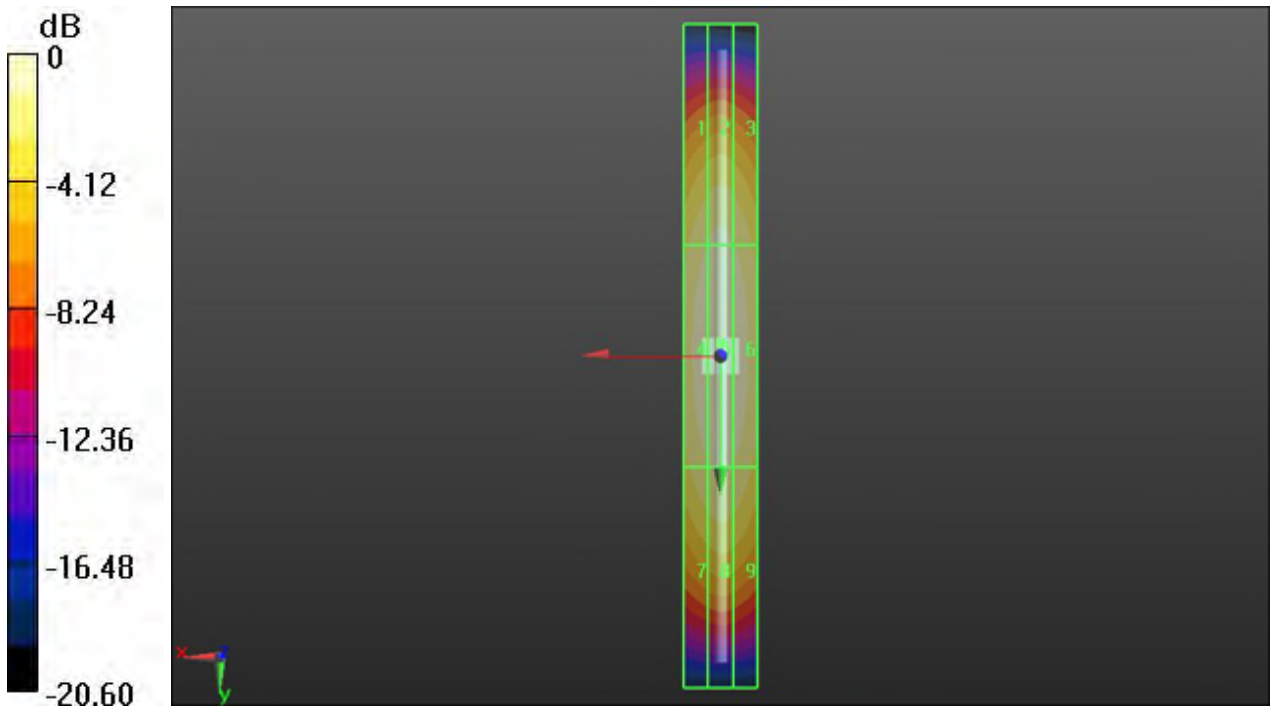

HAC-H_Dipole_1880_140410

DUT: HAC Dipole 1880 MHz

Communication System: UID 0, CW; Frequency: 1880 MHz; Duty Cycle: 1:1

Medium: Air Medium parameters used: $\sigma = 0$ S/m, $\epsilon_r = 1$; $\rho = 0$ kg/m³

Ambient Temperature : 23.5 °C;

DASY5 Configuration:

- Probe: H3DV6 - SN6305; ; Calibrated: 2014.02.28
- Sensor-Surface: (Fix Surface)
- Electronics: DAE4 Sn910; Calibrated: 2013.12.17
- Phantom: HAC Test Arch with AMCC; Type: SD HAC P01 BA;
- Measurement SW: DASY52, Version 52.8 (7); SEMCAD X Version 14.6.10 (7164)

H Scan - measurement distance from the probe sensor center to CD1880 Dipole = 10mm/Hearing Aid Compatibility Test (41x181x1): Interpolated grid: dx=0.5000 mm, dy=0.5000 mm

Device Reference Point: 0, 0, -6.3 mm

Reference Value = 0.4870 A/m; Power Drift = -0.02 dB

H-field emissions = 0.4407 A/m

PMF scaled H-field

Grid 1 M2 0.388 A/m	Grid 2 M2 0.400 A/m	Grid 3 M2 0.382 A/m
Grid 4 M2 0.427 A/m	Grid 5 M2 0.441 A/m	Grid 6 M2 0.423 A/m
Grid 7 M2 0.393 A/m	Grid 8 M2 0.407 A/m	Grid 9 M2 0.391 A/m

Cursor:

Total = 0.4407 A/m

H Category: M2

Location: 0.5, 0.5, 5.3 mm

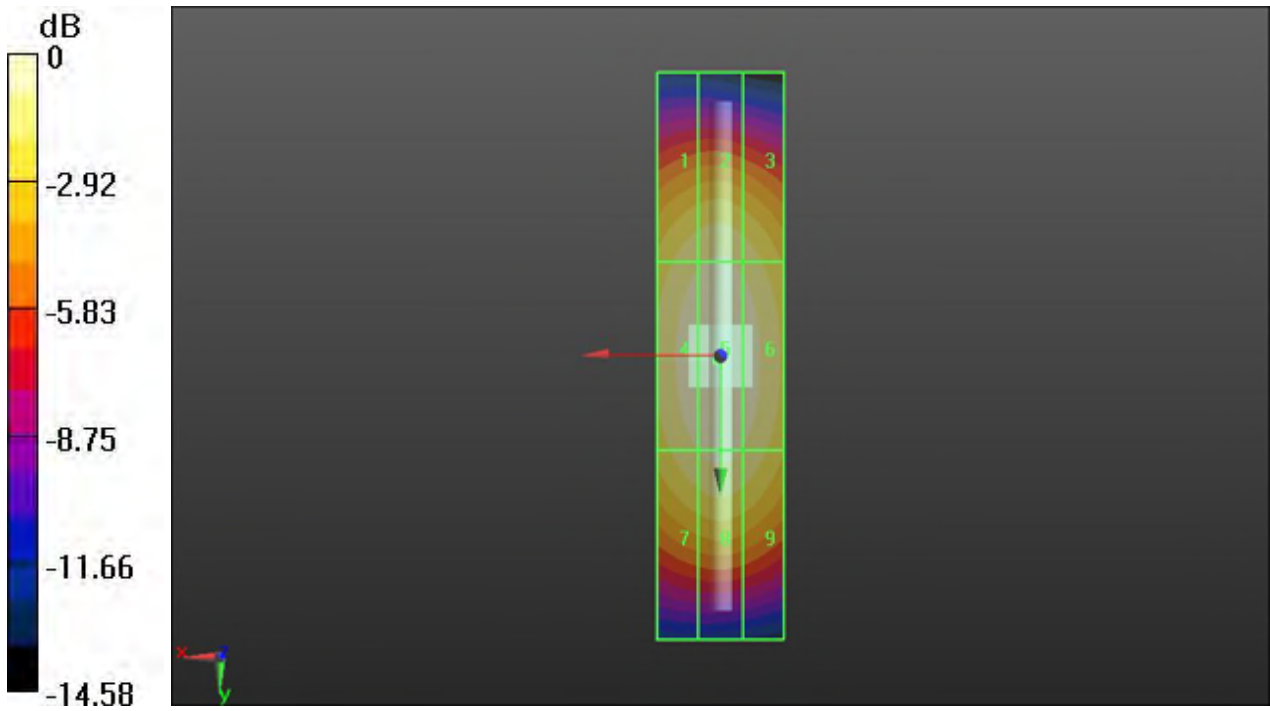

0 dB = 0.4407 A/m



Appendix B. Plots of RF Emission Measurement

The plots are shown as follows.

01 HAC RF_GSM850_GSM Voice_Ch128_E

Communication System: UID 0, Generic GSM (0); Frequency: 824.2 MHz; Duty Cycle: 1:8.3

Medium: Air Medium parameters used: $\sigma = 0$ S/m, $\epsilon_r = 1$; $\rho = 0$ kg/m³

Ambient Temperature : 23.5 °C

DASY5 Configuration:

- Probe: ER3DV6 - SN2480; ConvF(1, 1, 1); Calibrated: 2014.02.28;
- Sensor-Surface: (Fix Surface)
- Electronics: DAE4 Sn910; Calibrated: 2013.12.17
- Phantom: HAC Test Arch with AMCC; Type: SD HAC P01 BA;
- Measurement SW: DASY52, Version 52.8 (7); SEMCAD X Version 14.6.10 (7164)

Ch128/Hearing Aid Compatibility Test (101x101x1): Interpolated grid: dx=0.5000 mm, dy=0.5000 mm

Device Reference Point: 0, 0, -6.3 mm

Reference Value = 80.46 V/m; Power Drift = -0.01 dB

E-field emissions = 189.3 V/m

Near-field category: M3 (AWF -5 dB)

PMF scaled E-field

Grid 1 M3 166.5 V/m	Grid 2 M3 187.1 V/m	Grid 3 M3 186.3 V/m
Grid 4 M3 161.5 V/m	Grid 5 M3 189.3 V/m	Grid 6 M3 188.0 V/m
Grid 7 M3 154.2 V/m	Grid 8 M3 182.9 V/m	Grid 9 M3 181.8 V/m

Cursor:

Total = 189.3 V/m

E Category: M3

Location: -5.5, -4.5, 8.7 mm

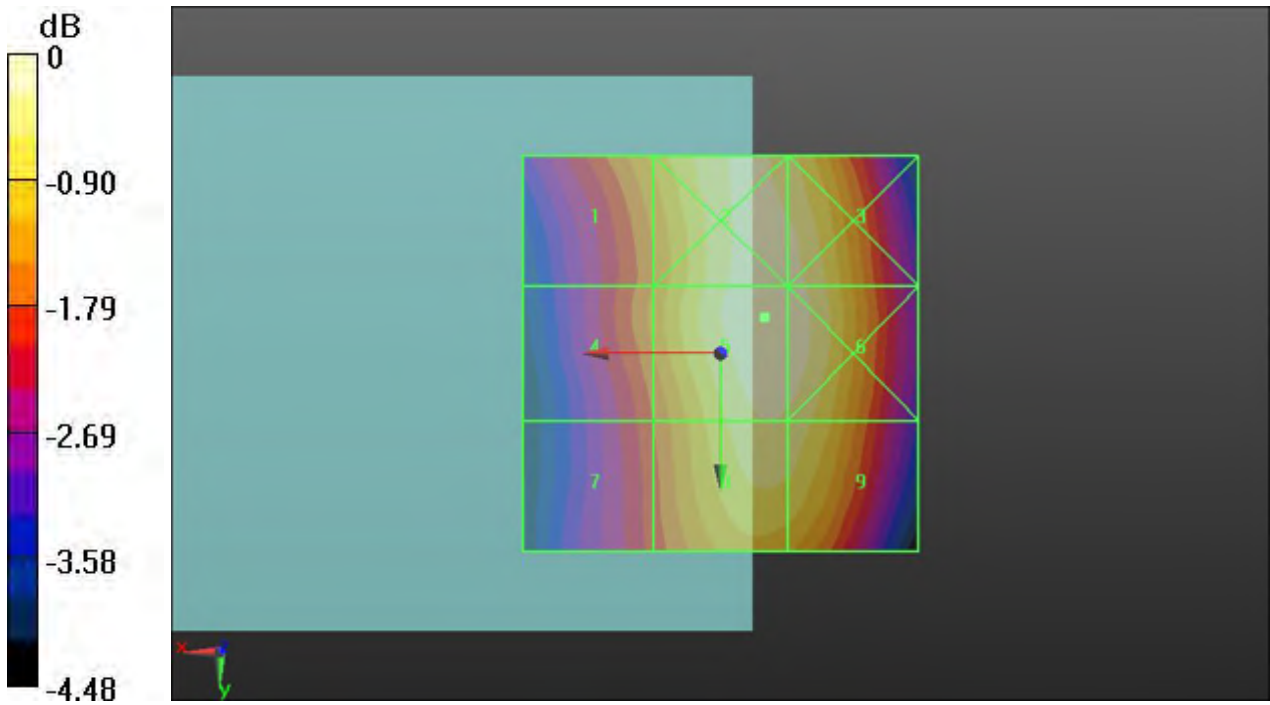

0 dB = 189.3 V/m

02 HAC RF_GSM1900_GSM Voice_Ch512_E

Communication System: UID 0, Generic GSM (0); Frequency: 1850.2 MHz; Duty Cycle: 1:8.3

Medium: Air Medium parameters used: $\sigma = 0$ S/m, $\epsilon_r = 1$; $\rho = 0$ kg/m³

Ambient Temperature : 23.5 °C

DASY5 Configuration:

- Probe: ER3DV6 - SN2480; ConvF(1, 1, 1); Calibrated: 2014.02.28;
- Sensor-Surface: (Fix Surface)
- Electronics: DAE4 Sn910; Calibrated: 2013.12.17
- Phantom: HAC Test Arch with AMCC; Type: SD HAC P01 BA;
- Measurement SW: DASY52, Version 52.8 (7); SEMCAD X Version 14.6.10 (7164)

Ch512/Hearing Aid Compatibility Test (101x101x1): Interpolated grid: dx=0.5000 mm, dy=0.5000 mm

Device Reference Point: 0, 0, -6.3 mm

Reference Value = 22.13 V/m; Power Drift = -0.04 dB

E-field emissions = 73.04 V/m

Near-field category: M3 (AWF -5 dB)

PMF scaled E-field

Grid 1 M3 60.46 V/m	Grid 2 M2 84.61 V/m	Grid 3 M2 84.53 V/m
Grid 4 M4 45.39 V/m	Grid 5 M3 73.04 V/m	Grid 6 M3 73.58 V/m
Grid 7 M3 52.44 V/m	Grid 8 M3 51.24 V/m	Grid 9 M3 52.54 V/m

Cursor:

Total = 84.61 V/m

E Category: M2

Location: -7.5, -25, 8.7 mm

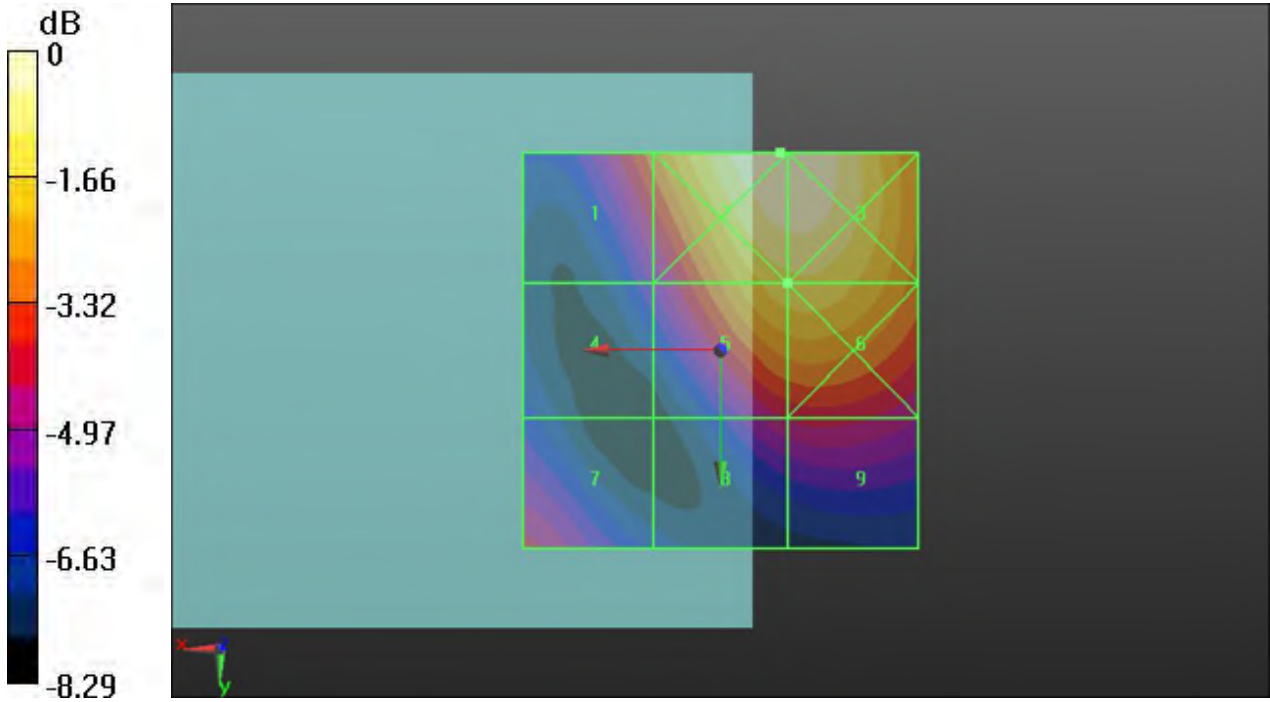

0 dB = 84.61 V/m

03 HAC RF_WCDMA Band V_RMC 12.2K_Ch4233_E

Communication System: UID 0, UMTS (0); Frequency: 846.6 MHz; Duty Cycle: 1:1

Medium: Air Medium parameters used: $\sigma = 0$ S/m, $\epsilon_r = 1$; $\rho = 0$ kg/m³

Ambient Temperature : 23.5 °C

DASY5 Configuration:

- Probe: ER3DV6 - SN2480; ConvF(1, 1, 1); Calibrated: 2014.02.28;
- Sensor-Surface: (Fix Surface)
- Electronics: DAE4 Sn910; Calibrated: 2013.12.17
- Phantom: HAC Test Arch with AMCC; Type: SD HAC P01 BA;
- Measurement SW: DASY52, Version 52.8 (7); SEMCAD X Version 14.6.10 (7164)

Ch4233/Hearing Aid Compatibility Test (101x101x1): Interpolated grid: dx=0.5000 mm, dy=0.5000 mm

Device Reference Point: 0, 0, -6.3 mm

Reference Value = 75.79 V/m; Power Drift = -0.01 dB

E-field emissions = 62.50 V/m

Near-field category: M4 (AWF 0 dB)

PMF scaled E-field

Grid 1 M4 54.46 V/m	Grid 2 M4 62.08 V/m	Grid 3 M4 61.78 V/m
Grid 4 M4 52.78 V/m	Grid 5 M4 62.50 V/m	Grid 6 M4 62.20 V/m
Grid 7 M4 50.35 V/m	Grid 8 M4 60.16 V/m	Grid 9 M4 59.99 V/m

Cursor:

Total = 62.50 V/m

E Category: M4

Location: -6, -4.5, 8.7 mm

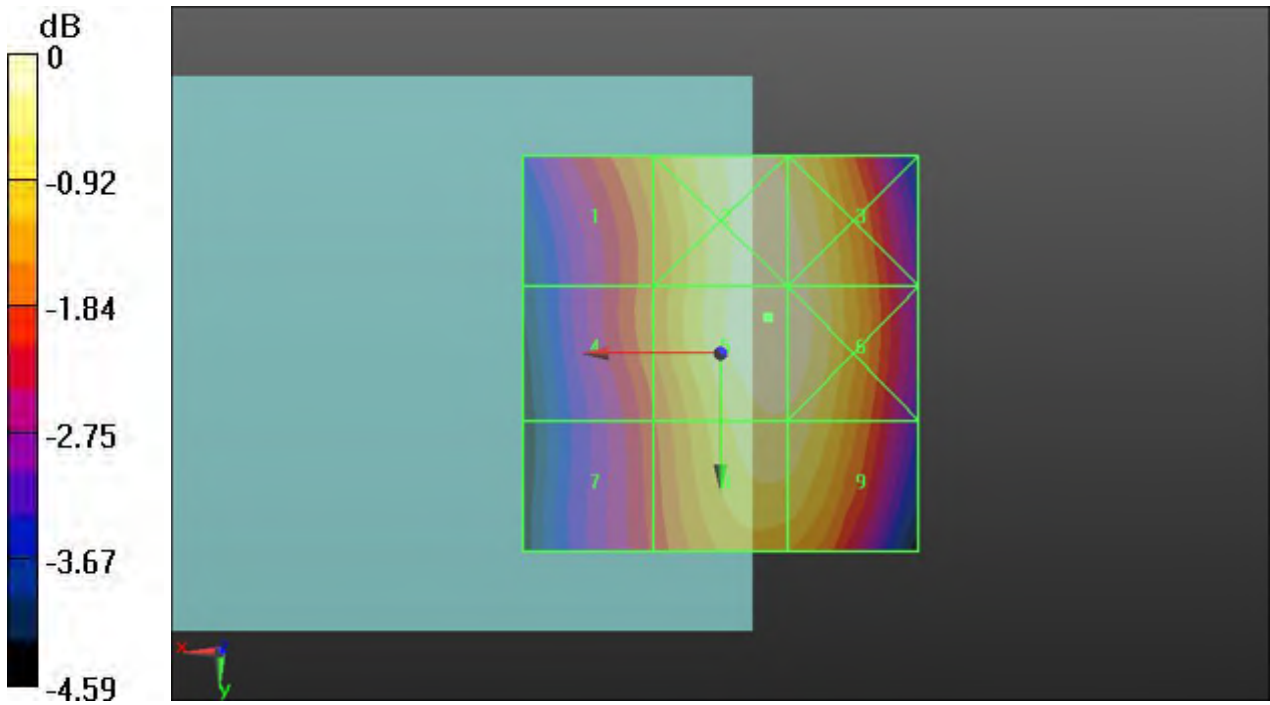

0 dB = 62.50 V/m

04 HAC RF_WCDMA Band II_RMC 12.2K_Ch9538_E

Communication System: UID 0, UMTS (0); Frequency: 1907.6 MHz; Duty Cycle: 1:1

Medium: Air Medium parameters used: $\sigma = 0$ S/m, $\epsilon_r = 1$; $\rho = 0$ kg/m³

Ambient Temperature : 23.5 °C

DASY5 Configuration:

- Probe: ER3DV6 - SN2480; ConvF(1, 1, 1); Calibrated: 2014.02.28;
- Sensor-Surface: (Fix Surface)
- Electronics: DAE4 Sn910; Calibrated: 2013.12.17
- Phantom: HAC Test Arch with AMCC; Type: SD HAC P01 BA;
- Measurement SW: DASY52, Version 52.8 (7); SEMCAD X Version 14.6.10 (7164)

Ch9538/Hearing Aid Compatibility Test (101x101x1): Interpolated grid: dx=0.5000 mm, dy=0.5000 mm

Device Reference Point: 0, 0, -6.3 mm

Reference Value = 30.26 V/m; Power Drift = -0.07 dB

E-field emissions = 33.14 V/m

Near-field category: M4 (AWF 0 dB)

PMF scaled E-field

Grid 1 M4 25.38 V/m	Grid 2 M4 37.07 V/m	Grid 3 M4 37.06 V/m
Grid 4 M4 19.80 V/m	Grid 5 M4 33.14 V/m	Grid 6 M4 33.37 V/m
Grid 7 M4 23.88 V/m	Grid 8 M4 24.27 V/m	Grid 9 M4 24.68 V/m

Cursor:

Total = 37.07 V/m

E Category: M4

Location: -8, -25, 8.7 mm

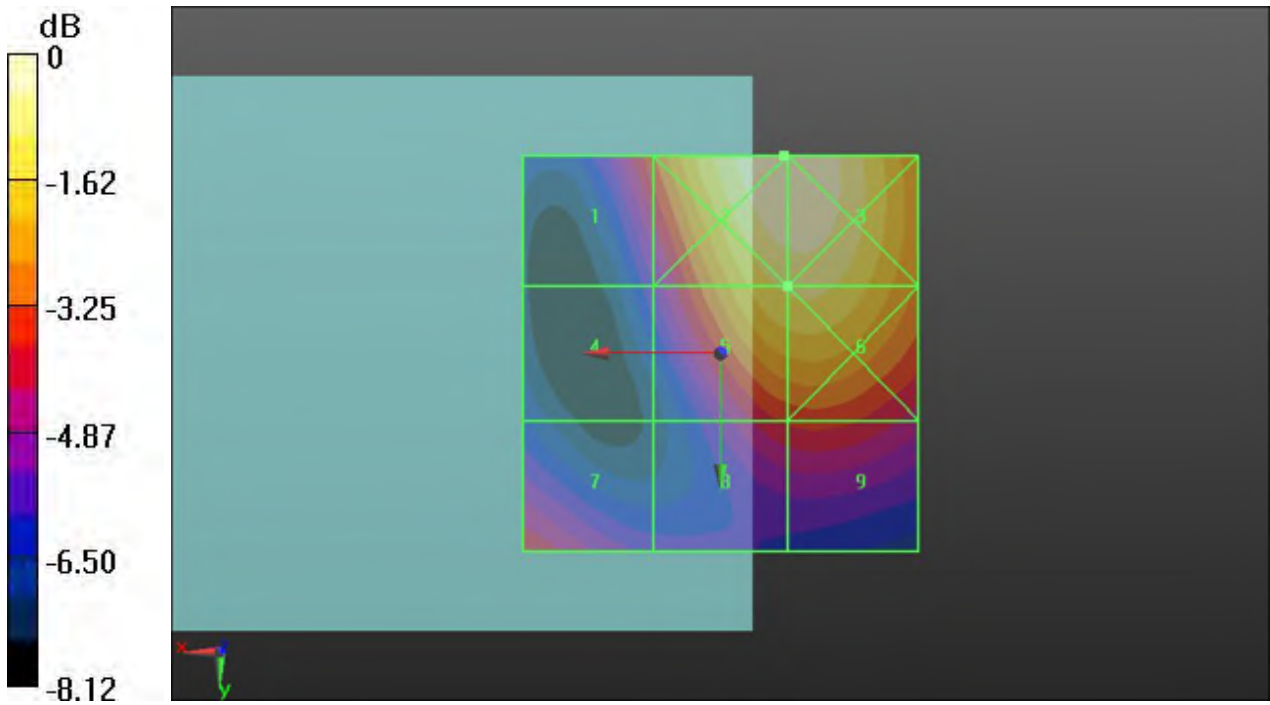

0 dB = 37.07 V/m

01 HAC_RF_GSM850_GSM Voice_Ch189_H

Communication System: UID 0, Generic GSM (0); Frequency: 836.4 MHz; Duty Cycle: 1:8.3

Medium: Air Medium parameters used: $\sigma = 0$ S/m, $\epsilon_r = 1$; $\rho = 0$ kg/m³

Ambient Temperature : 23.5 °C

DASY5 Configuration:

- Probe: H3DV6 - SN6305; ; Calibrated: 2014.02.28
- Sensor-Surface: (Fix Surface)
- Electronics: DAE4 Sn910; Calibrated: 2013.12.17
- Phantom: HAC Test Arch with AMCC; Type: SD HAC P01 BA;
- Measurement SW: DASY52, Version 52.8 (7); SEMCAD X Version 14.6.10 (7164)

Ch189/Hearing Aid Compatibility Test (101x101x1): Interpolated grid: dx=0.5000 mm, dy=0.5000 mm

Device Reference Point: 0, 0, -6.3 mm

Reference Value = 0.06100 A/m; Power Drift = 0.06 dB

H-field emissions = 0.2531 A/m

Near-field category: M4 (AWF -5 dB)

PMF scaled H-field

Grid 1 M4 0.371 A/m	Grid 2 M4 0.253 A/m	Grid 3 M4 0.153 A/m
Grid 4 M4 0.331 A/m	Grid 5 M4 0.230 A/m	Grid 6 M4 0.133 A/m
Grid 7 M4 0.347 A/m	Grid 8 M4 0.239 A/m	Grid 9 M4 0.138 A/m

Cursor:

Total = 0.3707 A/m

H Category: M4

Location: 25, -25, 8.7 mm

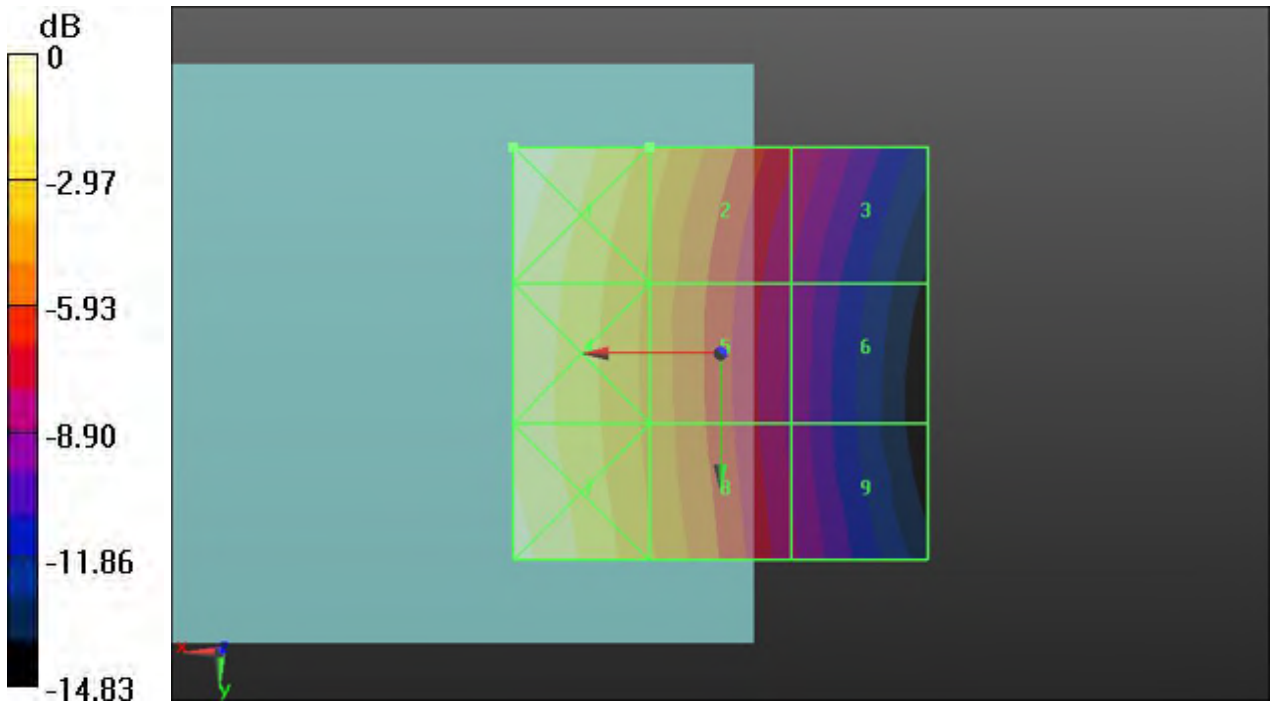

0 dB = 0.3707 A/m

02 HAC_RF_GSM1900_GSM Voice_Ch810_H

Communication System: UID 0, Generic GSM (0); Frequency: 1909.8 MHz; Duty Cycle: 1:8.3

Medium: Air Medium parameters used: $\sigma = 0$ S/m, $\epsilon_r = 1$; $\rho = 0$ kg/m³

Ambient Temperature : 23.5 °C

DASY5 Configuration:

- Probe: H3DV6 - SN6305; ; Calibrated: 2014.02.28
- Sensor-Surface: (Fix Surface)
- Electronics: DAE4 Sn910; Calibrated: 2013.12.17
- Phantom: HAC Test Arch with AMCC; Type: SD HAC P01 BA;
- Measurement SW: DASY52, Version 52.8 (7); SEMCAD X Version 14.6.10 (7164)

Ch810/Hearing Aid Compatibility Test (101x101x1): Interpolated grid: dx=0.5000 mm, dy=0.5000 mm

Device Reference Point: 0, 0, -6.3 mm

Reference Value = 0.06100 A/m; Power Drift = -0.03 dB

H-field emissions = 0.1851 A/m

Near-field category: M3 (AWF -5 dB)

PMF scaled H-field

Grid 1 M3 0.244 A/m	Grid 2 M3 0.207 A/m	Grid 3 M4 0.131 A/m
Grid 4 M3 0.199 A/m	Grid 5 M3 0.185 A/m	Grid 6 M3 0.155 A/m
Grid 7 M3 0.171 A/m	Grid 8 M3 0.171 A/m	Grid 9 M3 0.159 A/m

Cursor:

Total = 0.2440 A/m

H Category: M3

Location: 25, -25, 8.7 mm

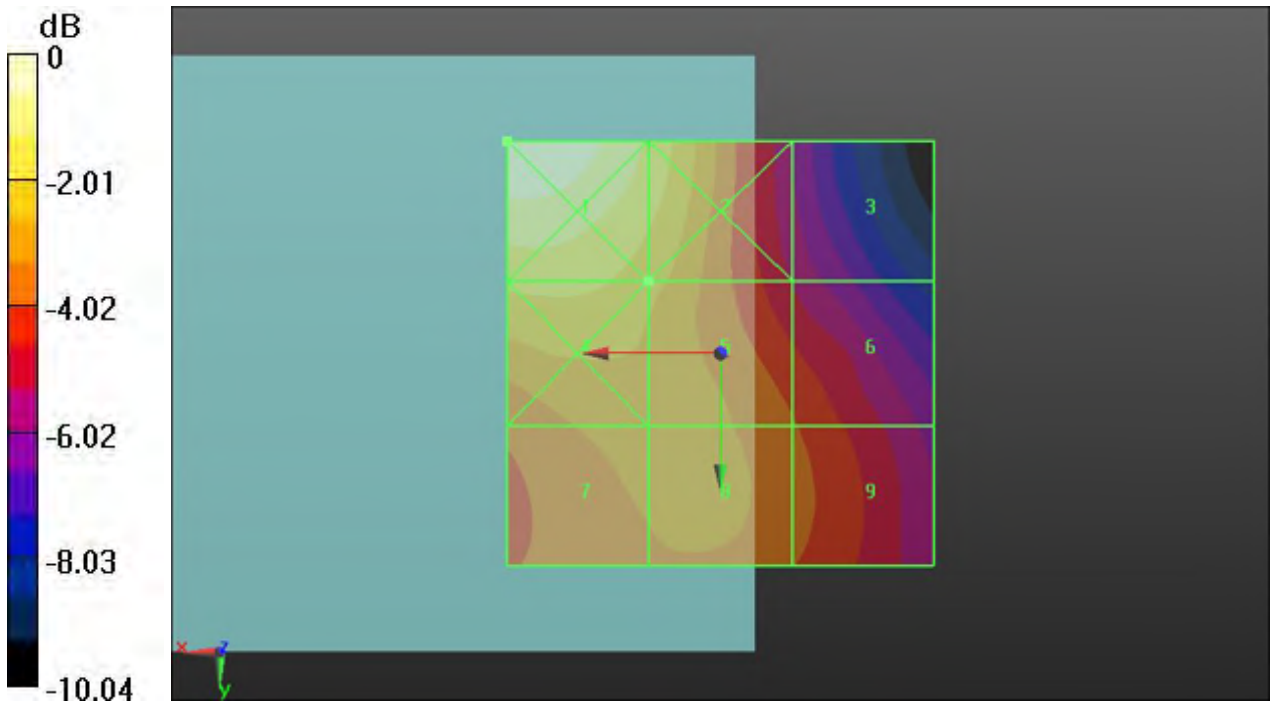

0 dB = 0.2440 A/m

03 HAC_RF_WCDMA Band V_RMC 12.2K_Ch4233_H

Communication System: UID 0, UMTS (0); Frequency: 846.6 MHz; Duty Cycle: 1:1

Medium: Air Medium parameters used: $\sigma = 0 \text{ S/m}$, $\epsilon_r = 1$; $\rho = 0 \text{ kg/m}^3$

Ambient Temperature : 23.5 °C

DASY5 Configuration:

- Probe: H3DV6 - SN6305; ; Calibrated: 2014.02.28
- Sensor-Surface: (Fix Surface)
- Electronics: DAE4 Sn910; Calibrated: 2013.12.17
- Phantom: HAC Test Arch with AMCC; Type: SD HAC P01 BA;
- Measurement SW: DASY52, Version 52.8 (7); SEMCAD X Version 14.6.10 (7164)

Ch4233/Hearing Aid Compatibility Test (101x101x1): Interpolated grid: dx=0.5000 mm, dy=0.5000 mm

Device Reference Point: 0, 0, -6.3 mm

Reference Value = 0.06200 A/m; Power Drift = 0.08 dB

H-field emissions = 0.08845 A/m

Near-field category: M4 (AWF 0 dB)

PMF scaled H-field

Grid 1 M4 0.126 A/m	Grid 2 M4 0.088 A/m	Grid 3 M4 0.054 A/m
Grid 4 M4 0.113 A/m	Grid 5 M4 0.081 A/m	Grid 6 M4 0.048 A/m
Grid 7 M4 0.119 A/m	Grid 8 M4 0.084 A/m	Grid 9 M4 0.049 A/m

Cursor:

Total = 0.1260 A/m

H Category: M4

Location: 25, -25, 8.7 mm

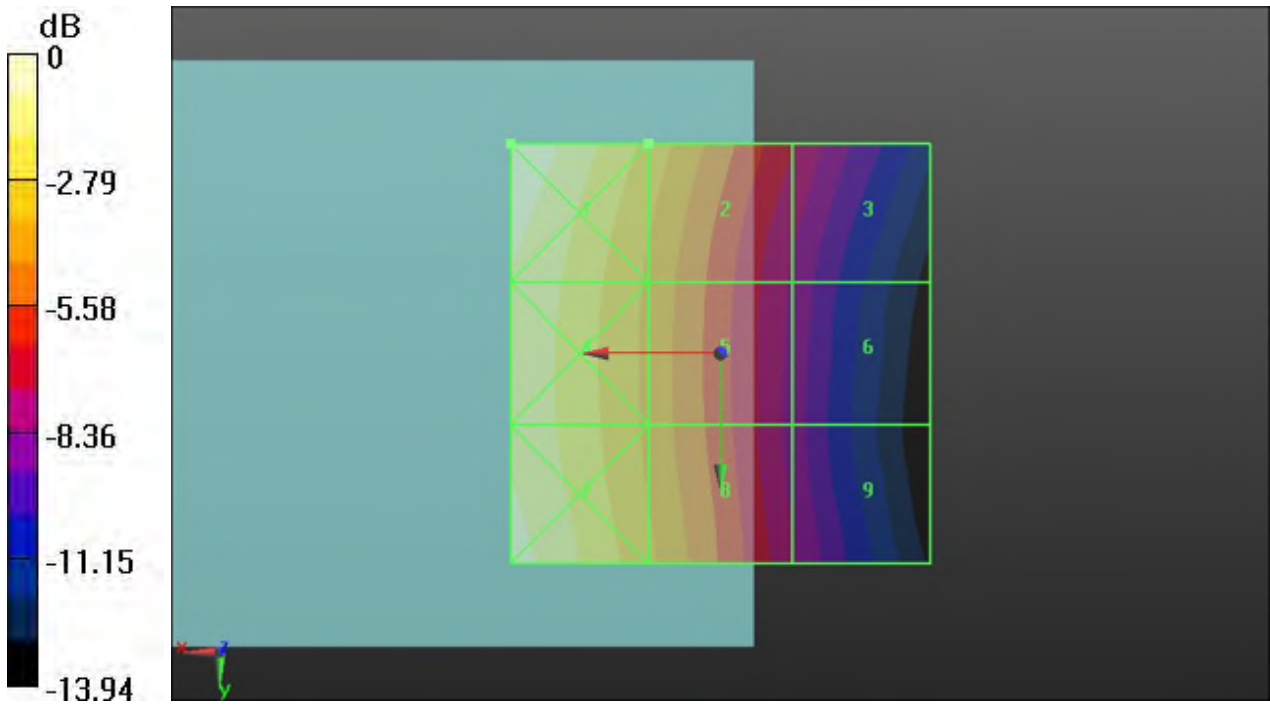

0 dB = 0.1260 A/m

04 HAC_RF_WCDMA Band II_RMC 12.2K_Ch9538_H

Communication System: UID 0, UMTS (0); Frequency: 1907.6 MHz; Duty Cycle: 1:1

Medium: Air Medium parameters used: $\sigma = 0$ S/m, $\epsilon_r = 1$; $\rho = 0$ kg/m³

Ambient Temperature : 23.5 °C

DASY5 Configuration:

- Probe: H3DV6 - SN6305; ; Calibrated: 2014.02.28
- Sensor-Surface: (Fix Surface)
- Electronics: DAE4 Sn910; Calibrated: 2013.12.17
- Phantom: HAC Test Arch with AMCC; Type: SD HAC P01 BA;
- Measurement SW: DASY52, Version 52.8 (7); SEMCAD X Version 14.6.10 (7164)

Ch9538/Hearing Aid Compatibility Test (101x101x1): Interpolated grid: dx=0.5000 mm, dy=0.5000 mm

Device Reference Point: 0, 0, -6.3 mm

Reference Value = 0.08200 A/m; Power Drift = 0.01 dB

H-field emissions = 0.08474 A/m

Near-field category: M4 (AWF 0 dB)

PMF scaled H-field

Grid 1 M4 0.109 A/m	Grid 2 M4 0.094 A/m	Grid 3 M4 0.062 A/m
Grid 4 M4 0.090 A/m	Grid 5 M4 0.085 A/m	Grid 6 M4 0.073 A/m
Grid 7 M4 0.080 A/m	Grid 8 M4 0.080 A/m	Grid 9 M4 0.075 A/m

Cursor:

Total = 0.1089 A/m

H Category: M4

Location: 25, -25, 8.7 mm

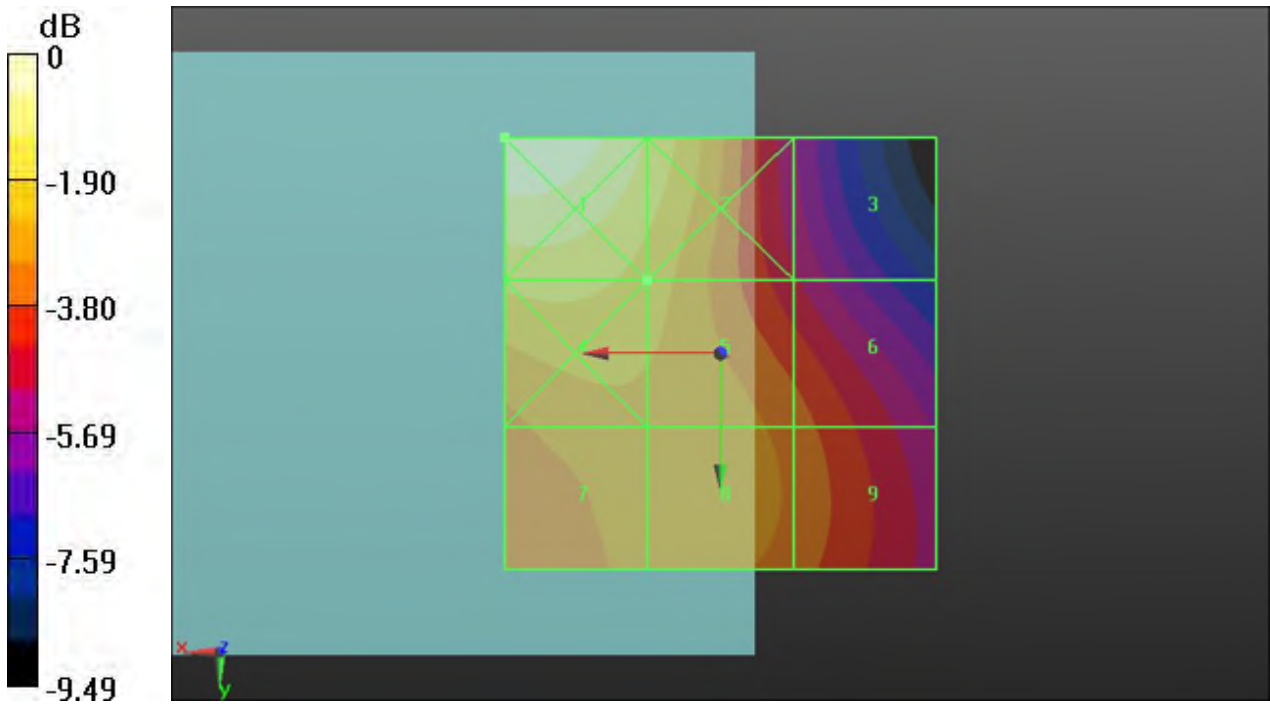

0 dB = 0.1089 A/m



Appendix C. DASY Calibration Certificate

The DASY calibration certificates are shown as follows.



Accredited by the Swiss Accreditation Service (SAS)
 The Swiss Accreditation Service is one of the signatories to the EA
 Multilateral Agreement for the recognition of calibration certificates

Accreditation No.: **SCS 108**

Client **Sporton-CN (Auden)**

Certificate No: **CD835V3-1171_Jan13**

CALIBRATION CERTIFICATE

Object: **CD835V3 - SN: 1171**

Calibration procedure(s): **QA CAL-20.v6
 Calibration procedure for dipoles in air**

Calibration date: **January 22, 2013**

This calibration certificate documents the traceability to national standards, which realize the physical units of measurements (SI).
 The measurements and the uncertainties with confidence probability are given on the following pages and are part of the certificate.

All calibrations have been conducted in the closed laboratory facility: environment temperature (22 ± 3)°C and humidity < 70%.

Calibration Equipment used (M&TE critical for calibration)

Primary Standards	ID #	Cal Date (Certificate No.)	Scheduled Calibration
Power meter EPM-442A	GB37480704	01-Nov-12 (No. 217-01640)	Oct-13
Power sensor HP 8481A	US37292783	01-Nov-12 (No. 217-01640)	Oct-13
Reference 10 dB Attenuator	SN: 5047.2 (10q)	27-Mar-12 (No. 217-01527)	Apr-13
Probe ER3DV6	SN: 2336	28-Dec-12 (No. ER3-2336_Dec12)	Dec-13
Probe H3DV6	SN: 6065	28-Dec-12 (No. H3-6065_Dec12)	Dec-13
DAE4	SN: 781	29-May-12 (No. DAE4-781_May12)	May-13
Secondary Standards	ID #	Check Date (in house)	Scheduled Check
Power meter Agilent 4419B	SN: GB42420191	09-Oct-09 (in house check Oct-12)	In house check: Oct-13
Power sensor HP E4412A	SN: MY41495277	01-Apr-08 (in house check Oct-12)	In house check: Oct-13
Power sensor HP 8482A	SN: US37295597	09-Oct-09 (in house check Oct-12)	In house check: Oct-13
Network Analyzer HP 8753E	US37390585	18-Oct-01 (in house check Oct-12)	In house check: Oct-13
RF generator R&S SMT-06	SN: 832283/011	27-Aug-12 (in house check Oct-12)	In house check: Oct-14

Calibrated by: **Claudio Leubler** Name: Claudio Leubler Function: Laboratory Technician Signature:

Approved by: **Fin Bomholt** Name: Fin Bomholt Function: Deputy Technical Manager Signature:

Issued: January 24, 2013

This calibration certificate shall not be reproduced except in full without written approval of the laboratory.



Accredited by the Swiss Accreditation Service (SAS)

The Swiss Accreditation Service is one of the signatories to the EA
Multilateral Agreement for the recognition of calibration certificates

Accreditation No.: **SCS 108**

References

- [1] ANSI-C63.19-2007
American National Standard for Methods of Measurement of Compatibility between Wireless Communications Devices and Hearing Aids.
- [2] ANSI-C63.19-2011
American National Standard, Methods of Measurement of Compatibility between Wireless Communications Devices and Hearing Aids.

Methods Applied and Interpretation of Parameters:

- *Coordinate System:* y-axis is in the direction of the dipole arms. z-axis is from the basis of the antenna (mounted on the table) towards its feed point between the two dipole arms. x-axis is normal to the other axes. In coincidence with the standards [1], the measurement planes (probe sensor center) are selected to be at a distance of 10 mm (15 mm for [2]) above the top metal edge of the dipole arms.
- *Measurement Conditions:* Further details are available from the hardcopies at the end of the certificate. All figures stated in the certificate are valid at the frequency indicated. The forward power to the dipole connector is set with a calibrated power meter connected and monitored with an auxiliary power meter connected to a directional coupler. While the dipole under test is connected, the forward power is adjusted to the same level.
- *Antenna Positioning:* The dipole is mounted on a HAC Test Arch phantom using the matching dipole positioner with the arms horizontal and the feeding cable coming from the floor. The measurements are performed in a shielded room with absorbers around the setup to reduce the reflections. It is verified before the mounting of the dipole under the Test Arch phantom, that its arms are perfectly in a line. It is installed on the HAC dipole positioner with its arms parallel below the dielectric reference wire and able to move elastically in vertical direction without changing its relative position to the top center of the Test Arch phantom. The vertical distance to the probe is adjusted after dipole mounting with a DASY5 Surface Check job. Before the measurement, the distance between phantom surface and probe tip is verified. The proper measurement distance is selected by choosing the matching section of the HAC Test Arch phantom with the proper device reference point (upper surface of the dipole) and the matching grid reference point (tip of the probe) considering the probe sensor offset. The vertical distance to the probe is essential for the accuracy.
- *Feed Point Impedance and Return Loss:* These parameters are measured using a HP 8753E Vector Network Analyzer. The impedance is specified at the SMA connector of the dipole. The influence of reflections was eliminated by applying the averaging function while moving the dipole in the air, at least 70cm away from any obstacles.
- *E-field distribution:* E field is measured in the x-y-plane with an isotropic ER3D-field probe with 100 mW forward power to the antenna feed point. In accordance with [1] and [2], the scan area is 20mm wide, its length exceeds the dipole arm length (180 or 90mm). The sensor center is 10 mm (15 mm for [2]) (in z) above the metal top of the dipole arms. Two 3D maxima are available near the end of the dipole arms. Assuming the dipole arms are perfectly in one line, the average of these two maxima (in subgrid 2 and subgrid 8) is determined to compensate for any non-parallelity to the measurement plane as well as the sensor displacement. The E-field value stated as calibration value represents the maximum of the interpolated 3D-E-field, in the plane above the dipole surface.
- *H-field distribution:* H-field is measured with an isotropic H-field probe with 100mW forward power to the antenna feed point, in the x-y-plane. The scan area and sensor distance is equivalent to the E-field scan. The maximum of the field is available at the center (subgrid 5) above the feed point. The H-field value stated as calibration value represents the maximum of the interpolated H-field, 10mm above the dipole surface at the feed point.

The reported uncertainty of measurement is stated as the standard uncertainty of measurement multiplied by the coverage factor $k=2$, which for a normal distribution corresponds to a coverage probability of approximately 95%.

Measurement Conditions

DASY system configuration, as far as not given on page 1.

DASY Version	DASY5	V52.8.5
Extrapolation	Advanced Extrapolation	
Phantom	HAC Test Arch	
Distance Dipole Top - Probe Center	10mm 15mm	
Scan resolution	dx, dy = 5 mm	
Frequency	835 MHz \pm 1 MHz	
Input power drift	< 0.05 dB	

Maximum Field values at 835 MHz

H-field 10 mm above dipole surface	condition	interpolated maximum
Maximum measured	100 mW input power	0.470 A / m \pm 8.2 % (k=2)

E-field 10 mm above dipole surface	condition	Interpolated maximum
Maximum measured above high end	100 mW input power	170.7 V / m
Maximum measured above low end	100 mW input power	168.2 V / m
Averaged maximum above arm	100 mW input power	169.5 V / m \pm 12.8 % (k=2)

E-field 15 mm above dipole surface	condition	Interpolated maximum
Maximum measured above high end	100 mW input power	109.4 V / m
Maximum measured above low end	100 mW input power	108.6 V / m
Averaged maximum above arm	100 mW input power	109.0 V / m \pm 12.8 % (k=2)

Appendix

Antenna Parameters

Frequency	Return Loss	Impedance
800 MHz	16.1 dB	41.8 Ω - 12.0 j Ω
835 MHz	24.7 dB	50.6 Ω + 5.9 j Ω
900 MHz	16.2 dB	57.1 Ω - 15.2 j Ω
950 MHz	19.8 dB	44.5 Ω + 8.1 j Ω
960 MHz	15.3 dB	52.9 Ω + 17.7 j Ω

3.2 Antenna Design and Handling

The calibration dipole has a symmetric geometry with a built-in two stub matching network, which leads to the enhanced bandwidth.

The dipole is built of standard semirigid coaxial cable. The internal matching line is open ended. The antenna is therefore open for DC signals.

Do not apply force to dipole arms, as they are liable to bend. The soldered connections near the feedpoint may be damaged. After excessive mechanical stress or overheating, check the impedance characteristics to ensure that the internal matching network is not affected.

After long term use with 40W radiated power, only a slight warming of the dipole near the feedpoint can be measured.

Impedance Measurement Plot

22 Jan 2013 17:10:47



CH2 S11 1 U FS 2: 50.623 Ω 5.8594 Ω 1.1168 nH 835.000 000 MHz

Del
Cor
Avg 16
H1d



START 335.000 000 MHz

STOP 1 335.000 000 MHz

DASY5 H-field Result

Date: 22.01.2013

Test Laboratory: SPEAG Lab2

DUT: HAC-Dipole 835 MHz; Type: CD835V3; Serial: CD835V3 - SN: 1171

Communication System: CW; Frequency: 835 MHz
Medium parameters used: $\sigma = 0 \text{ S/m}$, $\epsilon_r = 1$; $\rho = 1 \text{ kg/m}^3$
Phantom section: RF Section
Measurement Standard: DASY5 (IEEE/IEC/ANSI C63.19-2007)

DASY52 Configuration:

- Probe: H3DV6 - SN6065; ; Calibrated: 28.12.2012
- Sensor-Surface: (Fix Surface)
- Electronics: DAE4 Sn781; Calibrated: 29.05.2012
- Phantom: HAC Test Arch with AMCC; Type: SD HAC P01 BA; Serial: 1070
- DASY52 52.8.5(1059); SEMCAD X 14.6.8(7028)

Dipole H-Field measurement @ 835MHz/H-Scan - 835MHz d=10mm/Hearing Aid Compatibility Test (41x361x1):

Interpolated grid: dx=0.5000 mm, dy=0.5000 mm

Device Reference Point: 0, 0, -6.3 mm

Reference Value = 0.5000 A/m; Power Drift = -0.01 dB

PMR not calibrated. PMF = 1.000 is applied.

H-field emissions = 0.4695 A/m

Near-field category: M4 (AWF 0 dB)

PMF scaled H-field

Grid 1 M4 0.388 A/m	Grid 2 M4 0.414 A/m	Grid 3 M4 0.396 A/m
Grid 4 M4 0.434 A/m	Grid 5 M4 0.470 A/m	Grid 6 M4 0.454 A/m
Grid 7 M4 0.378 A/m	Grid 8 M4 0.415 A/m	Grid 9 M4 0.404 A/m

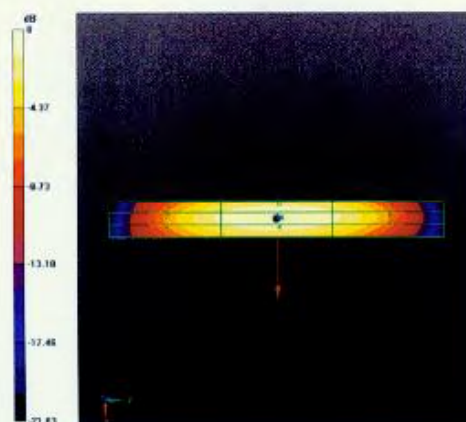

0 dB = 0.4695 A/m = -6.57 dBA/m

DASY5 E-field Result

Date: 22.01.2013

Test Laboratory: SPEAG Lab2

DUT: HAC-Dipole 835 MHz; Type: CD835V3; Serial: CD835V3 - SN: 1171

Communication System: CW; Frequency: 835 MHz

Medium parameters used: $\sigma = 0$ S/m, $\epsilon_r = 1$; $\rho = 1000$ kg/m³

Phantom section: RF Section

Measurement Standard: DASY5 (IEEE/IEC/ANSI C63.19-2007)

DASY52 Configuration:

- Probe: ER3DV6 - SN2336; ConvF(1, 1, 1); Calibrated: 28.12.2012;
- Sensor-Surface: (Fix Surface)
- Electronics: DAE4 Sn781; Calibrated: 29.05.2012
- Phantom: HAC Test Arch with AMCC; Type: SD HAC P01 BA; Serial: 1070
- DASY52 52.8.5(1059); SEMCAD X 14.6.8(7028)

Dipole E-Field measurement @ 835MHz/E-Scan - 835MHz d=10mm/Hearing Aid Compatibility Test (41x361x1):

Interpolated grid: dx=0.5000 mm, dy=0.5000 mm

Device Reference Point: 0, 0, -6.3 mm

Reference Value = 112.2 V/m; Power Drift = 0.01 dB

PMR not calibrated. PMF = 1.000 is applied.

E-field emissions = 170.7 V/m

Near-field category: M4 (AWF 0 dB)

PMF scaled E-field

Grid 1 M4 162.4 V/m	Grid 2 M4 168.2 V/m	Grid 3 M4 163.2 V/m
Grid 4 M4 87.41 V/m	Grid 5 M4 89.98 V/m	Grid 6 M4 87.51 V/m
Grid 7 M4 161.5 V/m	Grid 8 M4 170.7 V/m	Grid 9 M4 168.5 V/m

Dipole E-Field measurement @ 835MHz/E-Scan - 835MHz d=15mm/Hearing Aid Compatibility Test (41x361x1):

Interpolated grid: dx=0.5000 mm, dy=0.5000 mm

Device Reference Point: 0, 0, -6.3 mm

Reference Value = 112.2 V/m; Power Drift = 0.00 dB

PMR not calibrated. PMF = 1.000 is applied.

E-field emissions = 108.6 V/m

Near-field category: M4 (AWF 0 dB)

PMF scaled E-field

Grid 1 M4 106.6 V/m	Grid 2 M4 108.6 V/m	Grid 3 M4 107.3 V/m
Grid 4 M4 63.23 V/m	Grid 5 M4 64.09 V/m	Grid 6 M4 63.16 V/m
Grid 7 M4 106.9 V/m	Grid 8 M4 109.4 V/m	Grid 9 M4 108.4 V/m

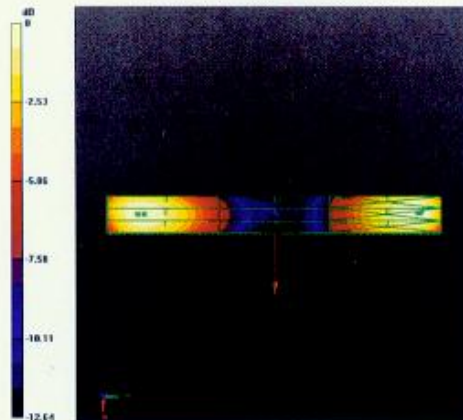

0 dB = 170.7 V/m = 44.64 dBV/m



Accredited by the Swiss Accreditation Service (SAS)
The Swiss Accreditation Service is one of the signatories to the EA
Multilateral Agreement for the recognition of calibration certificates

Accreditation No.: **SCS 108**

Client **Sporton-CN (Auden)**

Certificate No: **CD1880V3-1155_Jan13**

CALIBRATION CERTIFICATE

Object **CD1880V3 - SN: 1155**

Calibration procedure(s) **QA CAL-20.v6
Calibration procedure for dipoles in air**

Calibration date: **January 22, 2013**

This calibration certificate documents the traceability to national standards, which realize the physical units of measurements (SI).
The measurements and the uncertainties with confidence probability are given on the following pages and are part of the certificate.

All calibrations have been conducted in the closed laboratory facility: environment temperature (22 ± 3)°C and humidity < 70%.

Calibration Equipment used (M&TE critical for calibration)

Primary Standards	ID #	Cal Date (Certificate No.)	Scheduled Calibration
Power meter EPM-442A	GB37480704	01-Nov-12 (No. 217-01640)	Oct-13
Power sensor HP 8481A	US37292783	01-Nov-12 (No. 217-01640)	Oct-13
Reference 10 dB Attenuator	SN: 5047.2 (10q)	27-Mar-12 (No. 217-01527)	Apr-13
Probe ER3DV6	SN: 2336	28-Dec-12 (No. ER3-2336_Dec12)	Dec-13
Probe H3DV6	SN: 6065	28-Dec-12 (No. H3-6065_Dec12)	Dec-13
DAE4	SN: 781	29-May-12 (No. DAE4-781_May12)	May-13
Secondary Standards	ID #	Check Date (in house)	Scheduled Check
Power meter Agilent 4419B	SN: GB42420191	09-Oct-09 (in house check Oct-12)	In house check: Oct-13
Power sensor HP E4412A	SN: MY41495277	01-Apr-08 (in house check Oct-12)	In house check: Oct-13
Power sensor HP 8482A	SN: US37295597	09-Oct-09 (in house check Oct-12)	In house check: Oct-13
Network Analyzer HP 8753E	US37390585	18-Oct-01 (in house check Oct-12)	In house check: Oct-13
RF generator R&S SMT-06	SN: 832283/011	27-Aug-12 (in house check Oct-12)	In house check: Oct-14

Calibrated by: **Claudio Leubler** Name: Claudio Leubler Function: Laboratory Technician Signature:

Approved by: **Fin Bomholt** Name: Fin Bomholt Function: Deputy Technical Manager Signature:

Issued: January 24, 2013

This calibration certificate shall not be reproduced except in full without written approval of the laboratory.



Accredited by the Swiss Accreditation Service (SAS)

The Swiss Accreditation Service is one of the signatories to the EA
Multilateral Agreement for the recognition of calibration certificates

Accreditation No.: **SCS 108**

References

- [1] ANSI-C63.19-2007
American National Standard for Methods of Measurement of Compatibility between Wireless Communications Devices and Hearing Aids.
- [2] ANSI-C63.19-2011
American National Standard, Methods of Measurement of Compatibility between Wireless Communications Devices and Hearing Aids.

Methods Applied and Interpretation of Parameters:

- **Coordinate System:** y-axis is in the direction of the dipole arms. z-axis is from the basis of the antenna (mounted on the table) towards its feed point between the two dipole arms. x-axis is normal to the other axes. In coincidence with the standards [1], the measurement planes (probe sensor center) are selected to be at a distance of 10 mm (15 mm for [2]) above the top metal edge of the dipole arms.
- **Measurement Conditions:** Further details are available from the hardcopies at the end of the certificate. All figures stated in the certificate are valid at the frequency indicated. The forward power to the dipole connector is set with a calibrated power meter connected and monitored with an auxiliary power meter connected to a directional coupler. While the dipole under test is connected, the forward power is adjusted to the same level.
- **Antenna Positioning:** The dipole is mounted on a HAC Test Arch phantom using the matching dipole positioner with the arms horizontal and the feeding cable coming from the floor. The measurements are performed in a shielded room with absorbers around the setup to reduce the reflections. It is verified before the mounting of the dipole under the Test Arch phantom, that its arms are perfectly in a line. It is installed on the HAC dipole positioner with its arms parallel below the dielectric reference wire and able to move elastically in vertical direction without changing its relative position to the top center of the Test Arch phantom. The vertical distance to the probe is adjusted after dipole mounting with a DASY5 Surface Check job. Before the measurement, the distance between phantom surface and probe tip is verified. The proper measurement distance is selected by choosing the matching section of the HAC Test Arch phantom with the proper device reference point (upper surface of the dipole) and the matching grid reference point (tip of the probe) considering the probe sensor offset. The vertical distance to the probe is essential for the accuracy.
- **Feed Point Impedance and Return Loss:** These parameters are measured using a HP 8753E Vector Network Analyzer. The impedance is specified at the SMA connector of the dipole. The influence of reflections was eliminated by applying the averaging function while moving the dipole in the air, at least 70cm away from any obstacles.
- **E-field distribution:** E field is measured in the x-y-plane with an isotropic ER3D-field probe with 100 mW forward power to the antenna feed point. In accordance with [1] and [2], the scan area is 20mm wide, its length exceeds the dipole arm length (180 or 90mm). The sensor center is 10 mm (15 mm for [2]) (in z) above the metal top of the dipole arms. Two 3D maxima are available near the end of the dipole arms. Assuming the dipole arms are perfectly in one line, the average of these two maxima (in subgrid 2 and subgrid 8) is determined to compensate for any non-parallelity to the measurement plane as well as the sensor displacement. The E-field value stated as calibration value represents the maximum of the interpolated 3D-E-field, in the plane above the dipole surface.
- **H-field distribution:** H-field is measured with an isotropic H-field probe with 100mW forward power to the antenna feed point, in the x-y-plane. The scan area and sensor distance is equivalent to the E-field scan. The maximum of the field is available at the center (subgrid 5) above the feed point. The H-field value stated as calibration value represents the maximum of the interpolated H-field, 10mm above the dipole surface at the feed point.

The reported uncertainty of measurement is stated as the standard uncertainty of measurement multiplied by the coverage factor $k=2$, which for a normal distribution corresponds to a coverage probability of approximately 95%.

Measurement Conditions

DASY system configuration, as far as not given on page 1.

DASY Version	DASY5	V52.8.5
Extrapolation	Advanced Extrapolation	
Phantom	HAC Test Arch	
Distance Dipole Top - Probe Center	10mm 15mm	
Scan resolution	dx, dy = 5 mm	
Frequency	1730 MHz \pm 1 MHz 1880 MHz \pm 1 MHz	
Input power drift	< 0.05 dB	

Maximum Field values at 1730 MHz

H-field 10 mm above dipole surface	condition	interpolated maximum
Maximum measured	100 mW input power	0.502 A / m \pm 8.2 % (k=2)

E-field 10 mm above dipole surface	condition	Interpolated maximum
Maximum measured above high end	100 mW input power	158.9 V / m
Maximum measured above low end	100 mW input power	149.8 V / m
Averaged maximum above arm	100 mW input power	154.4 V / m \pm 12.8 % (k=2)

E-field 15 mm above dipole surface	condition	Interpolated maximum
Maximum measured above high end	100 mW input power	99.8 V / m
Maximum measured above low end	100 mW input power	98.1 V / m
Averaged maximum above arm	100 mW input power	99.0 V / m \pm 12.8 % (k=2)

Maximum Field values at 1880 MHz

H-field 10 mm above dipole surface	condition	interpolated maximum
Maximum measured	100 mW input power	0.471 A / m \pm 8.2 % (k=2)

E-field 10 mm above dipole surface	condition	Interpolated maximum
Maximum measured above high end	100 mW input power	144.1 V / m
Maximum measured above low end	100 mW input power	138.3 V / m
Averaged maximum above arm	100 mW input power	141.2 V / m \pm 12.8 % (k=2)

E-field 15 mm above dipole surface	condition	Interpolated maximum
Maximum measured above high end	100 mW input power	90.8 V / m
Maximum measured above low end	100 mW input power	90.2 V / m
Averaged maximum above arm	100 mW input power	90.5 V / m \pm 12.8 % (k=2)

Appendix

Antenna Parameters

Nominal Frequencies

Frequency	Return Loss	Impedance
1730 MHz	33.3 dB	$52.0 \Omega - 1.0 j\Omega$
1880 MHz	18.3 dB	$43.4 \Omega + 9.2 j\Omega$
1900 MHz	19.0 dB	$46.2 \Omega + 10.1 j\Omega$
1950 MHz	23.5 dB	$50.4 \Omega + 6.7 j\Omega$
2000 MHz	19.4 dB	$42.7 \Omega + 6.8 j\Omega$

3.2 Antenna Design and Handling

The calibration dipole has a symmetric geometry with a built-in two stub matching network, which leads to the enhanced bandwidth.

The dipole is built of standard semirigid coaxial cable. The internal matching line is open ended. The antenna is therefore open for DC signals.

Do not apply force to dipole arms, as they are liable to bend. The soldered connections near the feedpoint may be damaged. After excessive mechanical stress or overheating, check the impedance characteristics to ensure that the internal matching network is not affected.

After long term use with 40W radiated power, only a slight warming of the dipole near the feedpoint can be measured.

Impedance Measurement Plot

22 Jan 2013 17:18:23

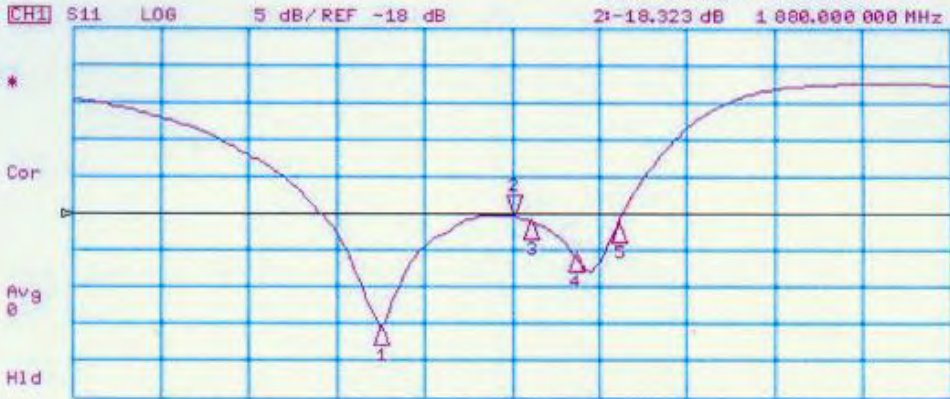

CH2 S11 1 U FS 2f: 43.355 Ω 9.2402 Ω 782.25 pF 1.880,000,000 MHz

Del
Cor
Avg
Hid

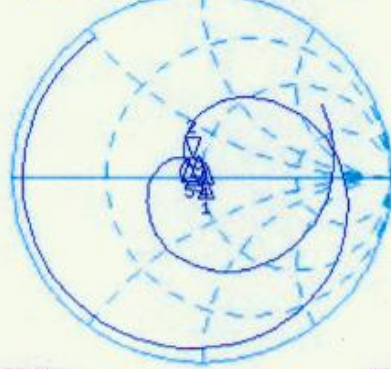

CENTER 1 880.000 000 MHz

SPAN 1 000.000 000 MHz

DASY5 H-field Result

Date: 22.01.2013

Test Laboratory: SPEAG Lab2

DUT: HAC Dipole 1880 MHz; Type: CD1880V3; Serial: CD1880V3 - SN: 1155

Communication System: CW; Frequency: 1880 MHz, Frequency: 1730 MHz

Medium parameters used: $\sigma = 0$ S/m, $\epsilon_r = 1$; $\rho = 1$ kg/m³

Phantom section: RF Section

Measurement Standard: DASY5 (IEEE/IEC/ANSI C63.19-2007)

DASY52 Configuration:

- Probe: H3DV6 - SN6065; ; Calibrated: 28.12.2012
- Sensor-Surface: (Fix Surface)
- Electronics: DAE4 Sn781; Calibrated: 29.05.2012
- Phantom: HAC Test Arch with AMCC; Type: SD HAC P01 BA; Serial: 1070
- DASY52 52.8.5(1059); SEMCAD X 14.6.8(7028)

Dipole H-Field measurement @ 1880MHz/H-Scan - 1880MHz d=10mm/Hearing Aid Compatibility Test (41x181x1):

Interpolated grid: dx=0.5000 mm, dy=0.5000 mm

Device Reference Point: 0, 0, -6.3 mm

Reference Value = 0.5000 A/m; Power Drift = 0.00 dB

PMR not calibrated. PMF = 1.000 is applied.

H-field emissions = 0.4711 A/m

Near-field category: M2 (AWF 0 dB)

PMF scaled H-field

Grid 1 M2 0.407 A/m	Grid 2 M2 0.431 A/m	Grid 3 M2 0.414 A/m
Grid 4 M2 0.441 A/m	Grid 5 M2 0.471 A/m	Grid 6 M2 0.456 A/m
Grid 7 M2 0.399 A/m	Grid 8 M2 0.435 A/m	Grid 9 M2 0.422 A/m

Dipole H-Field measurement @ 1880MHz/H-Scan - 1730MHz d=10mm/Hearing Aid Compatibility Test (41x181x1):

Interpolated grid: dx=0.5000 mm, dy=0.5000 mm

Device Reference Point: 0, 0, -6.3 mm

Reference Value = 0.5340 A/m; Power Drift = 0.00 dB

PMR not calibrated. PMF = 1.000 is applied.

H-field emissions = 0.5016 A/m

Near-field category: M2 (AWF 0 dB)

PMF scaled H-field

Grid 1 M2 0.417 A/m	Grid 2 M2 0.442 A/m	Grid 3 M2 0.424 A/m
Grid 4 M2 0.466 A/m	Grid 5 M2 0.502 A/m	Grid 6 M2 0.485 A/m
Grid 7 M2 0.407 A/m	Grid 8 M2 0.445 A/m	Grid 9 M2 0.432 A/m

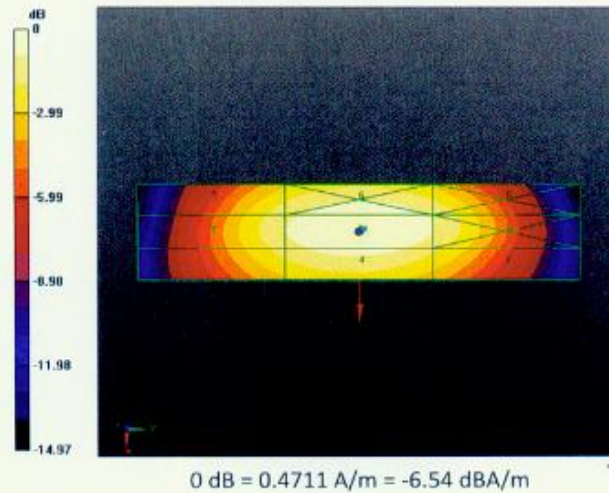

DASY5 E-field Result

Date: 22.01.2013

Test Laboratory: SPEAG Lab2

DUT: HAC Dipole 1880 MHz; Type: CD1880V3; Serial: CD1880V3 - SN: 1155

Communication System: CW; Frequency: 1880 MHz, Frequency: 1730 MHz

Medium parameters used: $\sigma = 0$ S/m, $\epsilon_r = 1$; $\rho = 1000$ kg/m³

Phantom section: RF Section

Measurement Standard: DASY5 (IEEE/IEC/ANSI C63.19-2007)

DASY52 Configuration:

- Probe: ER3DV6 - SN2336; ConvF(1, 1, 1); Calibrated: 28.12.2012;
- Sensor-Surface: (Fix Surface)
- Electronics: DAE4 Sn781; Calibrated: 29.05.2012
- Phantom: HAC Test Arch with AMCC; Type: SD HAC P01 BA; Serial: 1070
- DASY52 52.8.5(1059); SEMCAD X 14.6.8(7028)

Dipole E-Field measurement @ 1880MHz/E-Scan - 1880MHz d=10mm/Hearing Aid Compatibility Test (41x181x1):

Interpolated grid: dx=0.5000 mm, dy=0.5000 mm

Device Reference Point: 0, 0, -6.3 mm

Reference Value = 158.6 V/m; Power Drift = 0.02 dB

PMR not calibrated. PMF = 1.000 is applied.

E-field emissions = 144.1 V/m

Near-field category: M2 (AWF 0 dB)

PMF scaled E-field

Grid 1 M2 133.2 V/m	Grid 2 M2 138.3 V/m	Grid 3 M2 135.0 V/m
Grid 4 M3 87.36 V/m	Grid 5 M3 90.00 V/m	Grid 6 M3 86.70 V/m
Grid 7 M2 134.1 V/m	Grid 8 M2 144.1 V/m	Grid 9 M2 141.9 V/m

Dipole E-Field measurement @ 1880MHz/E-Scan - 1880MHz d=15mm/Hearing Aid Compatibility Test (41x181x1):

Interpolated grid: dx=0.5000 mm, dy=0.5000 mm

Device Reference Point: 0, 0, -6.3 mm

Reference Value = 158.4 V/m; Power Drift = 0.03 dB

PMR not calibrated. PMF = 1.000 is applied.

E-field emissions = 90.17 V/m

Near-field category: M3 (AWF 0 dB)

PMF scaled E-field

Grid 1 M3	Grid 2 M3	Grid 3 M3
88.89 V/m	90.79 V/m	89.91 V/m
Grid 4 M3	Grid 5 M3	Grid 6 M3
69.62 V/m	70.44 V/m	69.49 V/m
Grid 7 M3	Grid 8 M3	Grid 9 M3
87.24 V/m	90.17 V/m	89.49 V/m

Dipole E-Field measurement @ 1880MHz/E-Scan - 1730MHz d=10mm/Hearing Aid Compatibility Test (41x181x1):

Interpolated grid: dx=0.5000 mm, dy=0.5000 mm

Device Reference Point: 0, 0, -6.3 mm

Reference Value = 174.7 V/m; Power Drift = 0.01 dB

PMR not calibrated. PMF = 1.000 is applied.

E-field emissions = 149.8 V/m

Near-field category: M2 (AWF 0 dB)

PMF scaled E-field

Grid 1 M2	Grid 2 M2	Grid 3 M2
144.2 V/m	149.8 V/m	146.4 V/m
Grid 4 M3	Grid 5 M3	Grid 6 M3
99.58 V/m	102.9 V/m	99.22 V/m
Grid 7 M2	Grid 8 M2	Grid 9 M2
148.4 V/m	158.9 V/m	156.4 V/m

Dipole E-Field measurement @ 1880MHz/E-Scan - 1730MHz d=15mm/Hearing Aid Compatibility Test (41x181x1):

Interpolated grid: dx=0.5000 mm, dy=0.5000 mm

Device Reference Point: 0, 0, -6.3 mm

Reference Value = 175.3 V/m; Power Drift = -0.01 dB

PMR not calibrated. PMF = 1.000 is applied.

E-field emissions = 98.12 V/m

Near-field category: M3 (AWF 0 dB)

PMF scaled E-field

Grid 1 M3 95.89 V/m	Grid 2 M3 98.12 V/m	Grid 3 M3 97.01 V/m
Grid 4 M3 75.66 V/m	Grid 5 M3 76.83 V/m	Grid 6 M3 75.74 V/m
Grid 7 M3 96.58 V/m	Grid 8 M3 99.78 V/m	Grid 9 M3 98.86 V/m

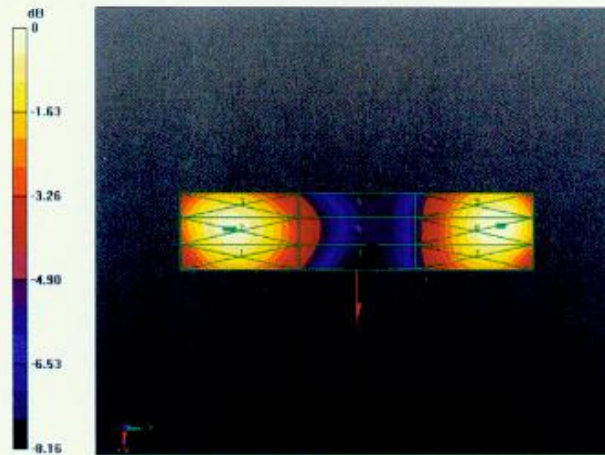

0 dB = 144.1 V/m = 43.17 dBV/m

IMPORTANT NOTICE

USAGE OF THE DAE 4

The DAE unit is a delicate, high precision instrument and requires careful treatment by the user. There are no serviceable parts inside the DAE. Special attention shall be given to the following points:

Battery Exchange: The battery cover of the DAE4 unit is closed using a screw, over tightening the screw may cause the threads inside the DAE to wear out.

Shipping of the DAE: Before shipping the DAE to SPEAG for calibration, remove the batteries and pack the DAE in an antistatic bag. This antistatic bag shall then be packed into a larger box or container which protects the DAE from impacts during transportation. The package shall be marked to indicate that a fragile instrument is inside.

E-Stop Failures: Touch detection may be malfunctioning due to broken magnets in the E-stop. Rough handling of the E-stop may lead to damage of these magnets. Touch and collision errors are often caused by dust and dirt accumulated in the E-stop. To prevent E-stop failure, the customer shall always mount the probe to the DAE carefully and keep the DAE unit in a non-dusty environment if not used for measurements.

Repair: Minor repairs are performed at no extra cost during the annual calibration. However, SPEAG reserves the right to charge for any repair especially if rough unprofessional handling caused the defect.

DASY Configuration Files: Since the exact values of the DAE input resistances, as measured during the calibration procedure of a DAE unit, are not used by the DASY software, a nominal value of 200 MOhm is given in the corresponding configuration file.

Important Note:

Warranty and calibration is void if the DAE unit is disassembled partly or fully by the Customer.

Important Note:

Never attempt to grease or oil the E-stop assembly. Cleaning and readjusting of the E-stop assembly is allowed by certified SPEAG personnel only and is part of the annual calibration procedure.

Important Note:

To prevent damage of the DAE probe connector pins, use great care when installing the probe to the DAE. Carefully connect the probe with the connector notch oriented in the mating position. Avoid any rotational movement of the probe body versus the DAE while turning the locking nut of the connector. The same care shall be used when disconnecting the probe from the DAE.



Accredited by the Swiss Accreditation Service (SAS)
The Swiss Accreditation Service is one of the signatories to the EA
Multilateral Agreement for the recognition of calibration certificates

Accreditation No.: **SCS 108**

Client **Auden**

Certificate No: **DAE4-910_Dec13**

CALIBRATION CERTIFICATE

Object **DAE4 - SD 000 D04 BK - SN: 910**

Calibration procedure(s) **QA CAL-06.v26
Calibration procedure for the data acquisition electronics (DAE)**

Calibration date: **December 17, 2013**

This calibration certificate documents the traceability to national standards, which realize the physical units of measurements (SI).
The measurements and the uncertainties with confidence probability are given on the following pages and are part of the certificate.

All calibrations have been conducted in the closed laboratory facility: environment temperature (22 ± 3)°C and humidity < 70%.

Calibration Equipment used (M&TE critical for calibration)

Primary Standards	ID #	Cal Date (Certificate No.)	Scheduled Calibration
Keithley Multimeter Type 2001	SN: 0810278	01-Oct-13 (No:13976)	Oct-14
Secondary Standards	ID #	Check Date (in house)	Scheduled Check
Auto DAE Calibration Unit	SE UWS 053 AA 1001	07-Jan-13 (in house check)	In house check: Jan-14
Calibrator Box V2.1	SE UMS 006 AA 1002	07-Jan-13 (in house check)	In house check: Jan-14

	Name	Function	Signature
Calibrated by:	R.Mayoraz	Technician	
Approved by:	Fin Bomholt	Deputy Technical Manager	

Issued: December 17, 2013

This calibration certificate shall not be reproduced except in full without written approval of the laboratory.



Accredited by the Swiss Accreditation Service (SAS)

The Swiss Accreditation Service is one of the signatories to the EA
Multilateral Agreement for the recognition of calibration certificates

Accreditation No.: **SCS 108**

Glossary

DAE	data acquisition electronics
Connector angle	information used in DASY system to align probe sensor X to the robot coordinate system.

Methods Applied and Interpretation of Parameters

- *DC Voltage Measurement:* Calibration Factor assessed for use in DASY system by comparison with a calibrated instrument traceable to national standards. The figure given corresponds to the full scale range of the voltmeter in the respective range.
- *Connector angle:* The angle of the connector is assessed measuring the angle mechanically by a tool inserted. Uncertainty is not required.
- The following parameters as documented in the Appendix contain technical information as a result from the performance test and require no uncertainty.
 - *DC Voltage Measurement Linearity:* Verification of the Linearity at +10% and -10% of the nominal calibration voltage. Influence of offset voltage is included in this measurement.
 - *Common mode sensitivity:* Influence of a positive or negative common mode voltage on the differential measurement.
 - *Channel separation:* Influence of a voltage on the neighbor channels not subject to an input voltage.
 - *AD Converter Values with inputs shorted:* Values on the internal AD converter corresponding to zero input voltage
 - *Input Offset Measurement:* Output voltage and statistical results over a large number of zero voltage measurements.
 - *Input Offset Current:* Typical value for information; Maximum channel input offset current, not considering the input resistance.
 - *Input resistance:* Typical value for information; DAE input resistance at the connector, during internal auto-zeroing and during measurement.
 - *Low Battery Alarm Voltage:* Typical value for information. Below this voltage, a battery alarm signal is generated.
 - *Power consumption:* Typical value for information. Supply currents in various operating modes.

DC Voltage Measurement

A/D - Converter Resolution nominal

High Range: 1LSB = 6.1 μ V , full range = -100...+300 mV

Low Range: 1LSB = 61nV , full range = -1.....+3mV

DASY measurement parameters: Auto Zero Time: 3 sec; Measuring time: 3 sec

Calibration Factors	X	Y	Z
High Range	403.322 \pm 0.02% (k=2)	402.723 \pm 0.02% (k=2)	403.207 \pm 0.02% (k=2)
Low Range	3.98182 \pm 1.50% (k=2)	3.94224 \pm 1.50% (k=2)	3.94936 \pm 1.50% (k=2)

Connector Angle

Connector Angle to be used in DASY system	233.0 $^{\circ}$ \pm 1 $^{\circ}$
---	-------------------------------------

Appendix

1. DC Voltage Linearity

High Range	Reading (μV)	Difference (μV)	Error (%)
Channel X + Input	200032.32	-0.83	-0.00
Channel X + Input	20004.60	1.54	0.01
Channel X - Input	-20002.78	3.07	-0.02
Channel Y + Input	200035.16	1.90	0.00
Channel Y + Input	20001.98	-1.07	-0.01
Channel Y - Input	-20006.13	-0.17	0.00
Channel Z + Input	200035.21	2.05	0.00
Channel Z + Input	20002.94	-0.06	-0.00
Channel Z - Input	-20006.08	-0.02	0.00

Low Range	Reading (μV)	Difference (μV)	Error (%)
Channel X + Input	2000.35	0.48	0.02
Channel X + Input	200.15	0.15	0.08
Channel X - Input	-200.04	0.14	-0.07
Channel Y + Input	2000.33	0.65	0.03
Channel Y + Input	199.54	-0.32	-0.16
Channel Y - Input	-201.29	-1.11	0.55
Channel Z + Input	2001.04	1.27	0.06
Channel Z + Input	198.05	-1.62	-0.81
Channel Z - Input	-201.41	-1.23	0.61

2. Common mode sensitivity

DASY measurement parameters: Auto Zero Time: 3 sec; Measuring time: 3 sec

	Common mode Input Voltage (mV)	High Range Average Reading (μV)	Low Range Average Reading (μV)
Channel X	200	-14.07	-15.91
	- 200	17.64	15.36
Channel Y	200	5.92	6.01
	- 200	-6.42	-6.96
Channel Z	200	-11.90	-12.13
	- 200	9.23	9.49

3. Channel separation

DASY measurement parameters: Auto Zero Time: 3 sec; Measuring time: 3 sec

	Input Voltage (mV)	Channel X (μV)	Channel Y (μV)	Channel Z (μV)
Channel X	200	-	5.20	-3.06
Channel Y	200	10.28	-	5.40
Channel Z	200	11.13	8.33	-

4. AD-Converter Values with inputs shorted

DASY measurement parameters: Auto Zero Time: 3 sec; Measuring time: 3 sec

	High Range (LSB)	Low Range (LSB)
Channel X	16187	15921
Channel Y	15383	16628
Channel Z	16716	16362

5. Input Offset Measurement

DASY measurement parameters: Auto Zero Time: 3 sec; Measuring time: 3 sec

Input 10M Ω

	Average (μ V)	min. Offset (μ V)	max. Offset (μ V)	Std. Deviation (μ V)
Channel X	-0.00	-1.68	1.68	0.70
Channel Y	0.62	-0.76	1.86	0.60
Channel Z	-1.19	-2.62	0.29	0.69

6. Input Offset Current

Nominal Input circuitry offset current on all channels: <25fA

7. Input Resistance (Typical values for information)

	Zeroing (kOhm)	Measuring (MOhm)
Channel X	200	200
Channel Y	200	200
Channel Z	200	200

8. Low Battery Alarm Voltage (Typical values for information)

Typical values	Alarm Level (VDC)
Supply (+ Vcc)	+7.9
Supply (- Vcc)	-7.6

9. Power Consumption (Typical values for information)

Typical values	Switched off (mA)	Stand by (mA)	Transmitting (mA)
Supply (+ Vcc)	+0.01	+6	+14
Supply (- Vcc)	-0.01	-8	-9

**Calibration Laboratory of
Schmid & Partner
Engineering AG**
Zeughausstrasse 43, 8004 Zurich, Switzerland



S Schweizerischer Kalibrierdienst
C Service suisse d'étalonnage
S Servizio svizzero di taratura
S Swiss Calibration Service

Accredited by the Swiss Accreditation Service (SAS)
The Swiss Accreditation Service is one of the signatories to the EA
Multilateral Agreement for the recognition of calibration certificates

Accreditation No.: **SCS 108**

Client **Auden**

Certificate No: **ER3-2480_Feb14**

CALIBRATION CERTIFICATE

Object **ER3DV6 - SN:2480**

Calibration procedure(s) **QA CAL-02.v8, QA CAL-25.v6
Calibration procedure for E-field probes optimized for close near field
evaluations in air**

Calibration date: **February 28, 2014**

This calibration certificate documents the traceability to national standards, which realize the physical units of measurements (SI).
The measurements and the uncertainties with confidence probability are given on the following pages and are part of the certificate.

All calibrations have been conducted in the closed laboratory facility: environment temperature (22 ± 3)°C and humidity < 70%.

Calibration Equipment used (M&TE critical for calibration)

Primary Standards	ID	Cal Date (Certificate No.)	Scheduled Calibration
Power meter E4419B	GB41293874	04-Apr-13 (No. 217-01733)	Apr-14
Power sensor E4412A	MY41498087	04-Apr-13 (No. 217-01733)	Apr-14
Reference 3 dB Attenuator	SN: S5054 (3c)	04-Apr-13 (No. 217-01737)	Apr-14
Reference 20 dB Attenuator	SN: S5277 (20x)	04-Apr-13 (No. 217-01735)	Apr-14
Reference 30 dB Attenuator	SN: S5129 (30b)	04-Apr-13 (No. 217-01738)	Apr-14
Reference Probe ER3DV6	SN: 2328	10-Oct-13 (No. ER3-2328_Oct13)	Oct-14
DAE4	SN: 789	15-May-13 (No. DAE4-789_May13)	May-14
Secondary Standards	ID	Check Date (in house)	Scheduled Check
RF generator HP 8648C	US3642U01700	4-Aug-99 (in house check Apr-13)	In house check: Apr-16
Network Analyzer HP 8753E	US37390585	18-Oct-01 (in house check Oct-13)	In house check: Oct-14

Calibrated by:	Name Israe El-Naouq	Function Laboratory Technician	Signature
Approved by:	Name Katja Pokovic	Function Technical Manager	
This calibration certificate shall not be reproduced except in full without written approval of the laboratory.			Issued: March 3, 2014



Accredited by the Swiss Accreditation Service (SAS)
The Swiss Accreditation Service is one of the signatories to the EA
Multilateral Agreement for the recognition of calibration certificates

Accreditation No.: **SCS 108**

Glossary:

NORM _{x,y,z}	sensitivity in free space
DCP	diode compression point
CF	crest factor (1/duty_cycle) of the RF signal
A, B, C, D	modulation dependent linearization parameters
Polarization ϕ	ϕ rotation around probe axis
Polarization ϑ	ϑ rotation around an axis that is in the plane normal to probe axis (at measurement center), i.e., $\vartheta = 0$ is normal to probe axis
Connector Angle	information used in DASY system to align probe sensor X to the robot coordinate system

Calibration is Performed According to the Following Standards:

- a) IEEE Std 1309-2005, "IEEE Standard for calibration of electromagnetic field sensors and probes, excluding antennas, from 9 kHz to 40 GHz", December 2005
- b) CTIA Test Plan for Hearing Aid Compatibility, April 2010.

Methods Applied and Interpretation of Parameters:

- *NORM_{x,y,z}*: Assessed for E-field polarization $\vartheta = 0$ for XY sensors and $\vartheta = 90$ for Z sensor ($f \leq 900$ MHz in TEM-cell; $f > 1800$ MHz: R22 waveguide).
- *NORM(f)_{x,y,z}* = *NORM_{x,y,z}* * *frequency_response* (see Frequency Response Chart).
- *DCP_{x,y,z}*: DCP are numerical linearization parameters assessed based on the data of power sweep with CW signal (no uncertainty required). DCP does not depend on frequency nor media.
- *PAR*: PAR is the Peak to Average Ratio that is not calibrated but determined based on the signal characteristics
- *A_{x,y,z}; B_{x,y,z}; C_{x,y,z}; D_{x,y,z}; VR_{x,y,z}; A, B, C, D* are numerical linearization parameters assessed based on the data of power sweep for specific modulation signal. The parameters do not depend on frequency nor media. *VR* is the maximum calibration range expressed in RMS voltage across the diode.
- *Spherical isotropy (3D deviation from isotropy)*: in a locally homogeneous field realized using an open waveguide setup.
- *Sensor Offset*: The sensor offset corresponds to the offset of virtual measurement center from the probe tip (on probe axis). No tolerance required.
- *Connector Angle*: The angle is assessed using the information gained by determining the *NORM_x* (no uncertainty required).

Probe ER3DV6

SN:2480

Manufactured: March 31, 2009
Calibrated: February 28, 2014

Calibrated for DASYS/EASY Systems
(Note: non-compatible with DASYS2 system!)

DASY/EASY - Parameters of Probe: ER3DV6 - SN:2480

Basic Calibration Parameters

	Sensor X	Sensor Y	Sensor Z	Unc (k=2)
Norm ($\mu\text{V}/(\text{V}/\text{m})^2$)	2.05	1.48	1.83	$\pm 10.1\%$
DCP (mV) ^B	98.6	100.1	100.7	

Modulation Calibration Parameters

UID	Communication System Name		A dB	B dB $\sqrt{\mu\text{V}}$	C	D dB	VR mV	Unc ^E (k=2)
0	CW	X	0.0	0.0	1.0	0.00	189.9	$\pm 2.7\%$
		Y	0.0	0.0	1.0		194.3	
		Z	0.0	0.0	1.0		152.9	
10011- CAB	UMTS-FDD (WCDMA)	X	3.19	66.3	18.6	2.91	113.2	$\pm 0.7\%$
		Y	3.16	66.1	18.2		113.9	
		Z	3.28	66.9	18.6		122.0	
10012- CAA	IEEE 802.11b WiFi 2.4 GHz (DSSS, 1 Mbps)	X	3.24	70.6	20.1	1.87	118.8	$\pm 0.7\%$
		Y	2.44	65.2	17.1		115.4	
		Z	3.26	70.4	19.7		124.7	
10021- DAB	GSM-FDD (TDMA, GMSK)	X	21.47	99.2	28.8	9.39	130.8	$\pm 1.9\%$
		Y	11.84	91.8	25.6		108.7	
		Z	19.62	95.3	27.4		100.1	
10039- CAB	CDMA2000 (1xRTT, RC1)	X	4.85	66.8	19.4	4.57	115.3	$\pm 0.9\%$
		Y	4.63	66.0	18.7		114.4	
		Z	4.73	66.6	19.0		122.4	
10081- CAB	CDMA2000 (1xRTT, RC3)	X	3.89	65.6	18.6	3.97	111.7	$\pm 0.7\%$
		Y	3.78	65.2	18.2		111.6	
		Z	3.84	65.6	18.4		118.9	
10082- CAB	IS-54 / IS-136 FDD (TDMA/FDM, PI/4-DQPSK, Fullrate)	X	52.11	99.8	23.0	4.77	113.1	$\pm 3.0\%$
		Y	4.25	73.2	14.2		149.2	
		Z	51.55	99.8	23.1		127.1	
10295- AAB	CDMA2000, RC1, SO3, 1/8th Rate 25 fr.	X	17.11	98.5	39.7	12.49	109.9	$\pm 3.8\%$
		Y	13.96	96.8	39.9		95.0	
		Z	19.00	99.3	38.8		129.3	

The reported uncertainty of measurement is stated as the standard uncertainty of measurement multiplied by the coverage factor $k=2$, which for a normal distribution corresponds to a coverage probability of approximately 95%.

^B Numerical linearization parameter: uncertainty not required.

^E Uncertainty is determined using the max. deviation from linear response applying rectangular distribution and is expressed for the square of the field value.

Frequency Response of E-Field (TEM-Cell:ifi110 EXX, Waveguide: R22)

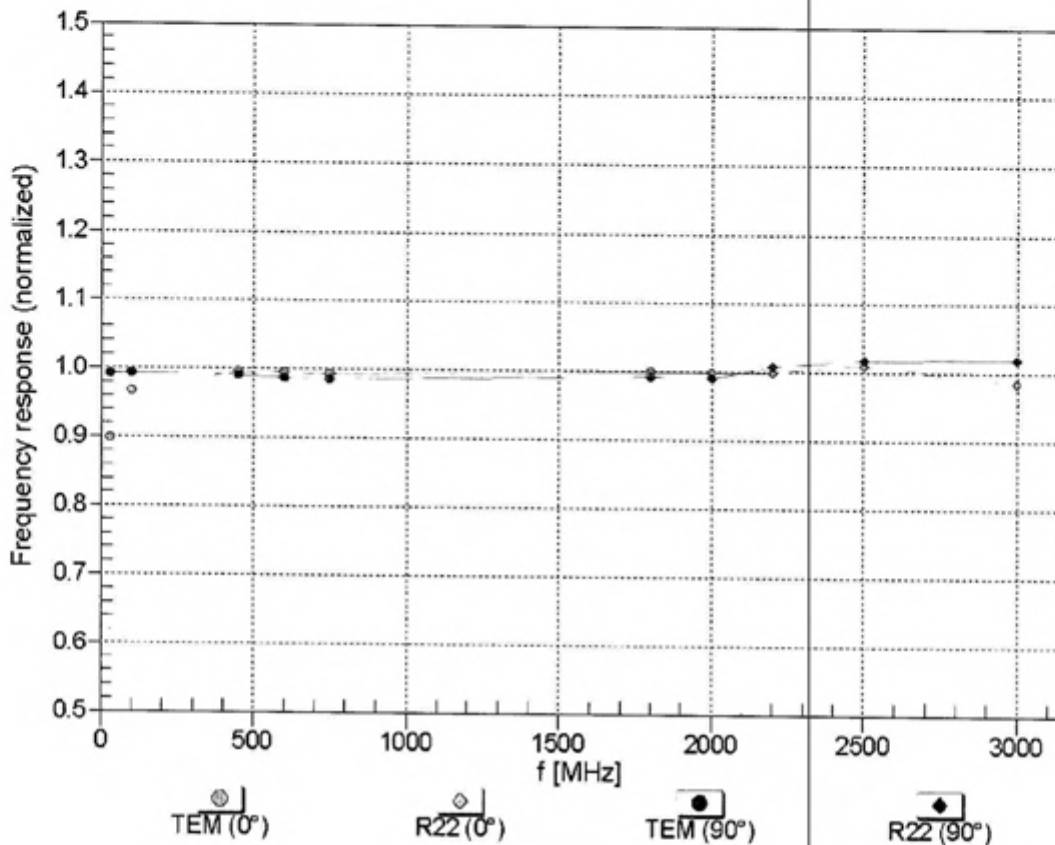

Uncertainty of Frequency Response of E-field: $\pm 6.3\%$ (k=2)

Receiving Pattern (ϕ), $\vartheta = 0^\circ$

f=600 MHz, TEM, 0°

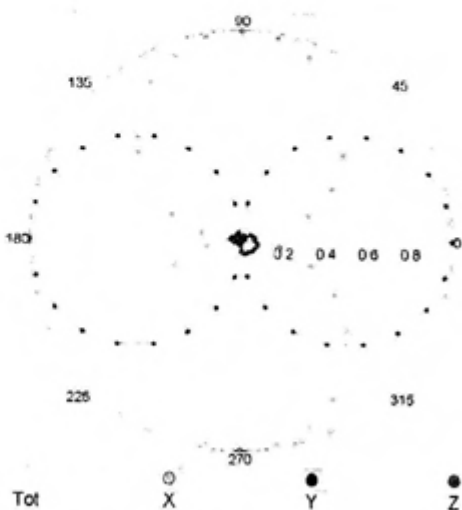

f=2500 MHz, R22, 0°

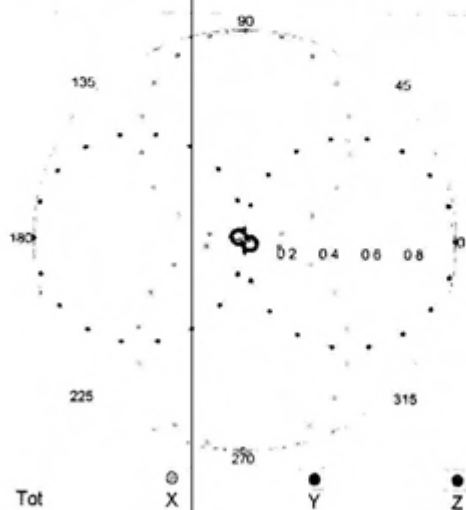

Receiving Pattern (ϕ), $\vartheta = 90^\circ$

f=600 MHz, TEM, 90°

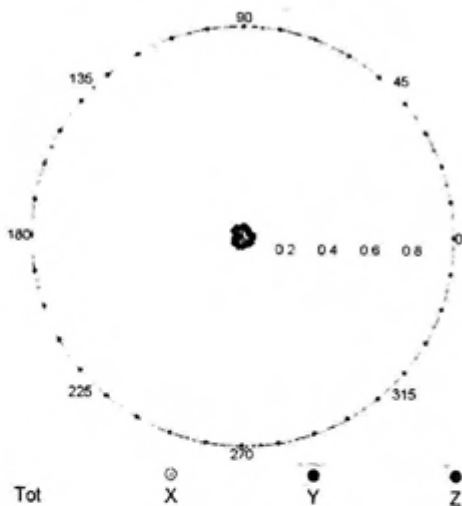

f=2500 MHz, R22, 90°

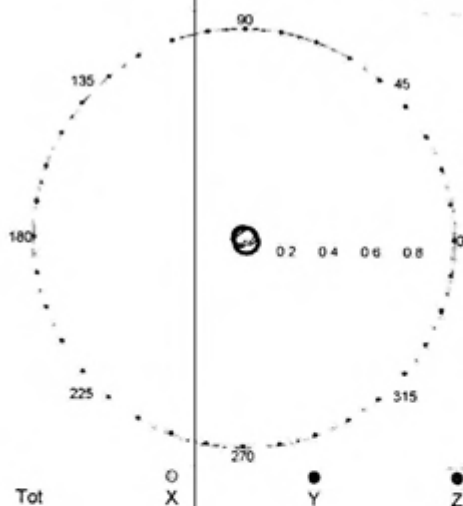

Receiving Pattern (ϕ), $\vartheta = 0^\circ$

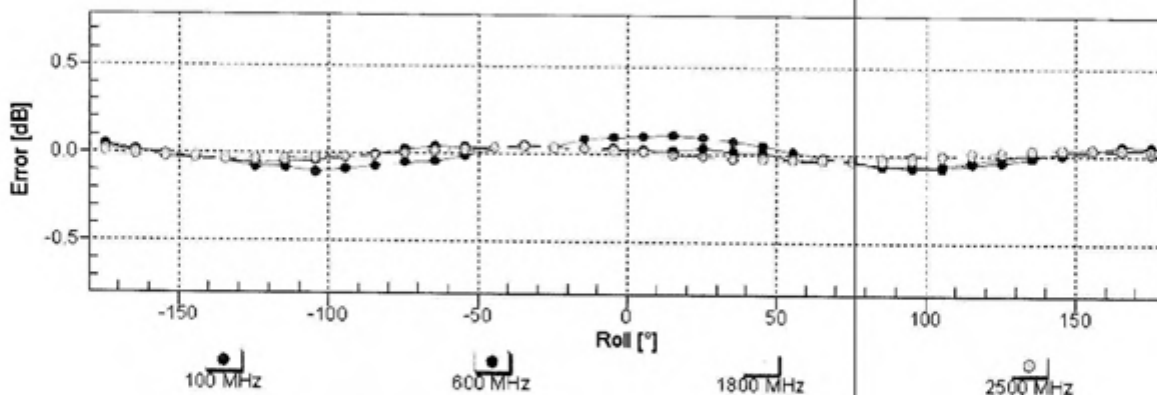

Uncertainty of Axial Isotropy Assessment: $\pm 0.5\%$ ($k=2$)

Receiving Pattern (ϕ), $\vartheta = 90^\circ$

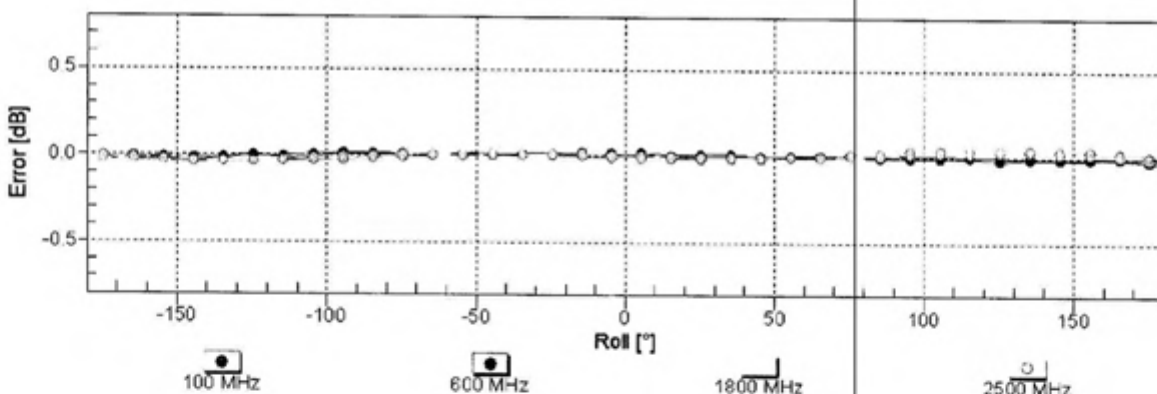

Uncertainty of Axial Isotropy Assessment: $\pm 0.5\%$ ($k=2$)

Dynamic Range f(E-field) (TEM cell , f = 900 MHz)

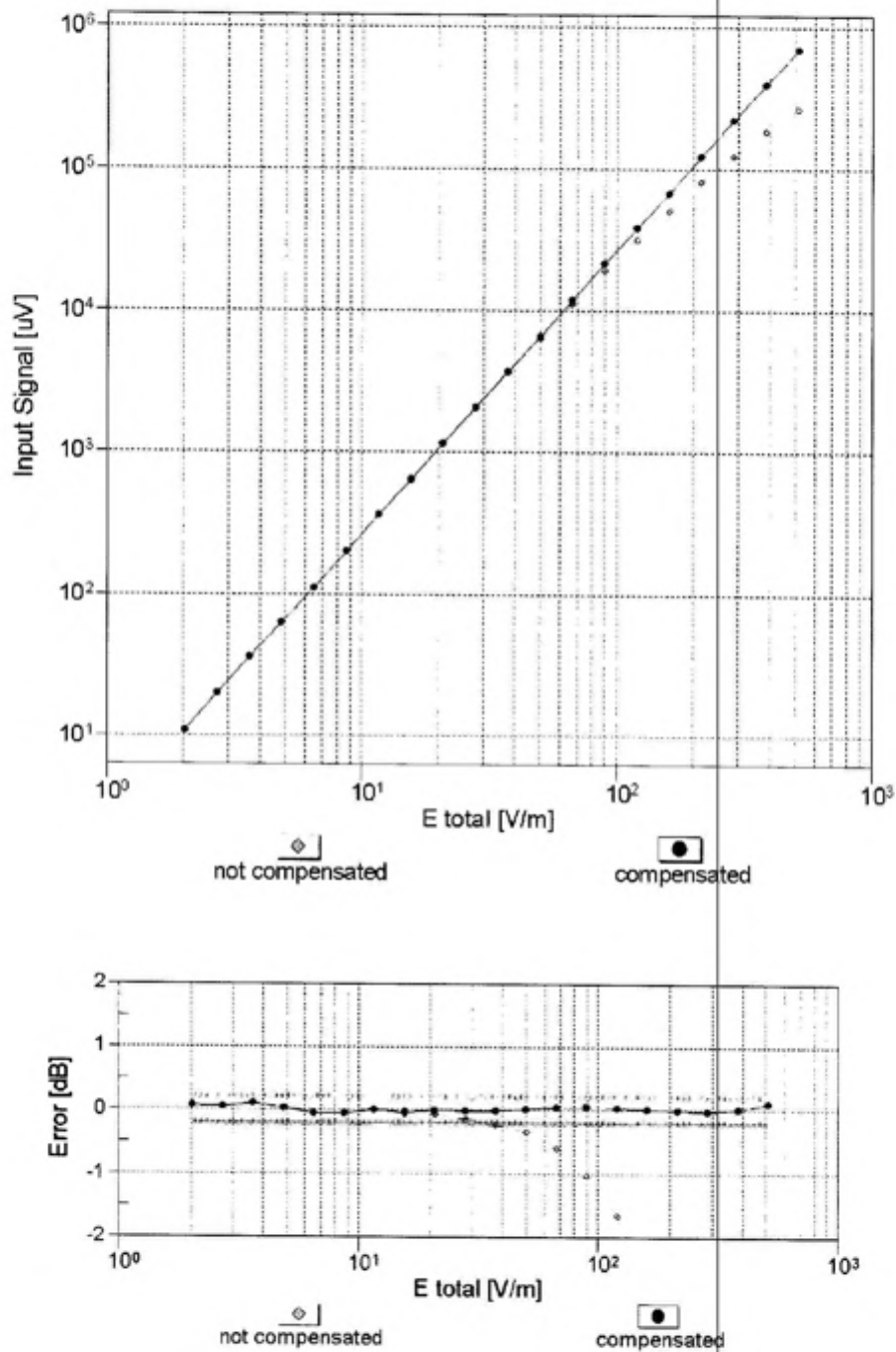

Uncertainty of Linearity Assessment: $\pm 0.6\%$ ($k=2$)

Deviation from Isotropy in Air

Error (ϕ , θ), $f = 900$ MHz

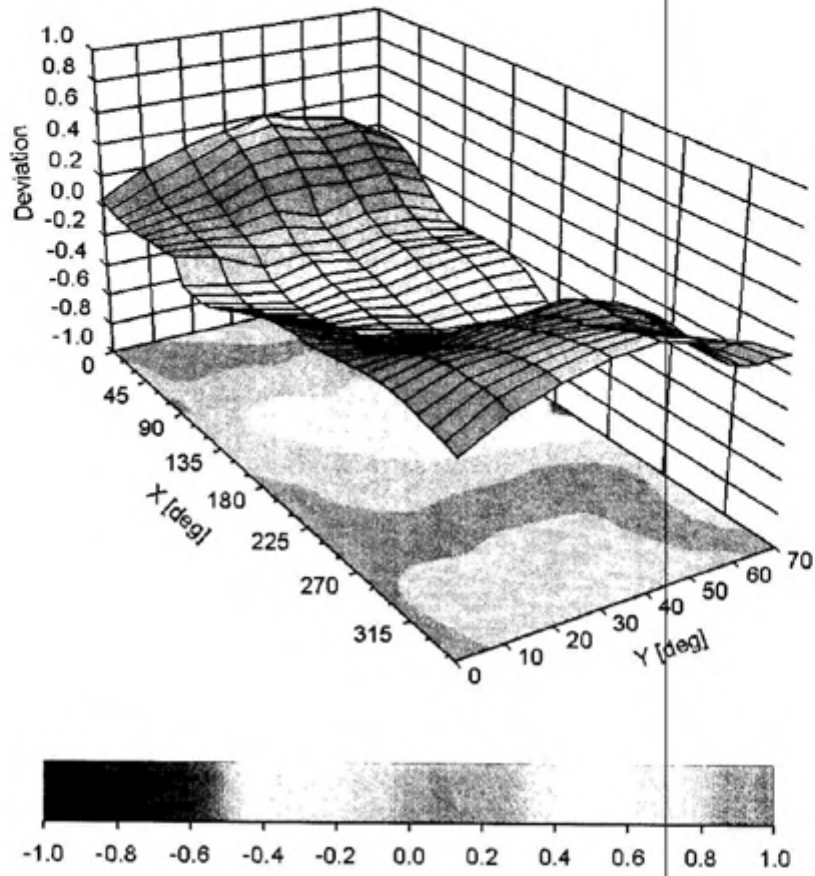

Uncertainty of Spherical Isotropy Assessment: $\pm 2.6\%$ ($k=2$)

DASY/EASY - Parameters of Probe: ER3DV6 - SN:2480**Other Probe Parameters**

Sensor Arrangement		Rectangular
Connector Angle (°)		15.5
Mechanical Surface Detection Mode		enabled
Optical Surface Detection Mode		disabled
Probe Overall Length		337 mm
Probe Body Diameter		10 mm
Tip Length		10 mm
Tip Diameter		8 mm
Probe Tip to Sensor X Calibration Point		2.5 mm
Probe Tip to Sensor Y Calibration Point		2.5 mm
Probe Tip to Sensor Z Calibration Point		2.5 mm



Accredited by the Swiss Accreditation Service (SAS)
The Swiss Accreditation Service is one of the signatories to the EA
Multilateral Agreement for the recognition of calibration certificates

Accreditation No.: **SCS 108**

Client **Auden**

Certificate No: **H3-6305_Feb14**

CALIBRATION CERTIFICATE

Object **H3DV6 - SN:6305**

Calibration procedure(s) **QA CAL-03.v8, QA CAL-25.v6**
Calibration procedure for H-field probes optimized for close near field evaluations in air

Calibration date: **February 28, 2014**

This calibration certificate documents the traceability to national standards, which realize the physical units of measurements (SI).
The measurements and the uncertainties with confidence probability are given on the following pages and are part of the certificate.

All calibrations have been conducted in the closed laboratory facility: environment temperature (22 ± 3)°C and humidity < 70%.

Calibration Equipment used (M&TE critical for calibration)

Primary Standards	ID	Cal Date (Certificate No.)	Scheduled Calibration
Power meter E4419B	GB41293874	04-Apr-13 (No. 217-01733)	Apr-14
Power sensor E4412A	MY41498087	04-Apr-13 (No. 217-01733)	Apr-14
Reference 3 dB Attenuator	SN: S5054 (3c)	04-Apr-13 (No. 217-01737)	Apr-14
Reference 20 dB Attenuator	SN: S5277 (20x)	04-Apr-13 (No. 217-01735)	Apr-14
Reference 30 dB Attenuator	SN: S5129 (30b)	04-Apr-13 (No. 217-01738)	Apr-14
Reference Probe H3DV6	SN: 6182	10-Oct-13 (No. H3-6182_Oct13)	Oct-14
DAE4	SN: 789	15-May-13 (No. DAE4-789_May13)	May-14
Secondary Standards	ID	Check Date (in house)	Scheduled Check
RF generator HP 8648C	US3642U01700	4-Aug-99 (in house check Apr-13)	In house check: Apr-16
Network Analyzer HP 8753E	US37390585	18-Oct-01 (in house check Oct-13)	In house check: Oct-14

	Name	Function	Signature
Calibrated by:	Israe El-Naouq	Laboratory Technician	
Approved by:	Katja Pokovic	Technical Manager	

Issued: March 3, 2014

This calibration certificate shall not be reproduced except in full without written approval of the laboratory.



Accredited by the Swiss Accreditation Service (SAS)

The Swiss Accreditation Service is one of the signatories to the EA
Multilateral Agreement for the recognition of calibration certificates

Accreditation No.: **SCS 108**

Glossary:

NORM _{x,y,z}	sensitivity in free space
DCP	diode compression point
CF	crest factor (1/duty_cycle) of the RF signal
A, B, C, D	modulation dependent linearization parameters
Polarization φ	φ rotation around probe axis
Polarization ϑ	ϑ rotation around an axis that is in the plane normal to probe axis (at measurement center), i.e., $\vartheta = 0$ is normal to probe axis
Connector Angle	information used in DASY system to align probe sensor X to the robot coordinate system

Calibration is Performed According to the Following Standards:

- a) IEEE Std 1309-2005, " IEEE Standard for calibration of electromagnetic field sensors and probes, excluding antennas, from 9 kHz to 40 GHz", December 2005.
- b) CTIA Test Plan for Hearing Aid Compatibility, April 2010.

Methods Applied and Interpretation of Parameters:

- *NORM_{x,y,z}*: Assessed for E-field polarization $\vartheta = 0$ for XY sensors and $\vartheta = 90$ for Z sensor ($f \leq 900$ MHz in TEM-cell; $f > 1800$ MHz: R22 waveguide).
- *X,Y,Z(f)_a0a1a2*= *X,Y,Z_a0a1a2** *frequency_response* (see Frequency Response Chart).
- *DCP_{x,y,z}*: DCP are numerical linearization parameters assessed based on the data of power sweep with CW signal (no uncertainty required). DCP does not depend on frequency nor media.
- *PAR*: PAR is the Peak to Average Ratio that is not calibrated but determined based on the signal characteristics
- *A_{x,y,z}; B_{x,y,z}; C_{x,y,z}; D_{x,y,z}; VR_{x,y,z}; A, B, C, D* are numerical linearization parameters assessed based on the data of power sweep for specific modulation signal. The parameters do not depend on frequency nor media. *VR* is the maximum calibration range expressed in RMS voltage across the diode.
- *Spherical isotropy (3D deviation from isotropy)*: in a locally homogeneous field realized using an open waveguide setup.
- *Sensor Offset*: The sensor offset corresponds to the offset of virtual measurement center from the probe tip (on probe axis). No tolerance required.
- *Connector Angle*: The angle is assessed using the information gained by determining the *X_a0a1a2* (no uncertainty required).

Probe H3DV6

SN:6305

Manufactured: December 16, 2008
Calibrated: February 28, 2014

Calibrated for DASY/EASY Systems
(Note: non-compatible with DASY2 system!)

DASY/EASY - Parameters of Probe: H3DV6 - SN:6305

Basic Calibration Parameters

		Sensor X	Sensor Y	Sensor Z	Unc (k=2)
Norm (A/m / $\sqrt{\text{mV}}$)	a0	2.54E-003	2.59E-003	3.01E-003	$\pm 5.1 \%$
Norm (A/m / $\sqrt{\text{mV}}$)	a1	-6.25E-005	-8.57E-005	-4.29E-005	$\pm 5.1 \%$
Norm (A/m / $\sqrt{\text{mV}}$)	a2	4.36E-005	7.49E-006	1.93E-005	$\pm 5.1 \%$
DCP (mV) ^B		94.1	94.7	93.0	

Modulation Calibration Parameters

UID	Communication System Name		A dB	B dB $\sqrt{\mu\text{V}}$	C	D dB	VR mV	Unc ^E (k=2)
0	CW	X	0.0	0.0	1.0	0.00	139.9	$\pm 3.5 \%$
		Y	0.0	0.0	1.0		138.5	
		Z	0.0	0.0	1.0		135.0	

The reported uncertainty of measurement is stated as the standard uncertainty of measurement multiplied by the coverage factor $k=2$, which for a normal distribution corresponds to a coverage probability of approximately 95%.

^B Numerical linearization parameter: uncertainty not required.

^E Uncertainty is determined using the max. deviation from linear response applying rectangular distribution and is expressed for the square of the field value.

Frequency Response of H-Field (TEM-Cell:ifi110 EXX, Waveguide: R22)

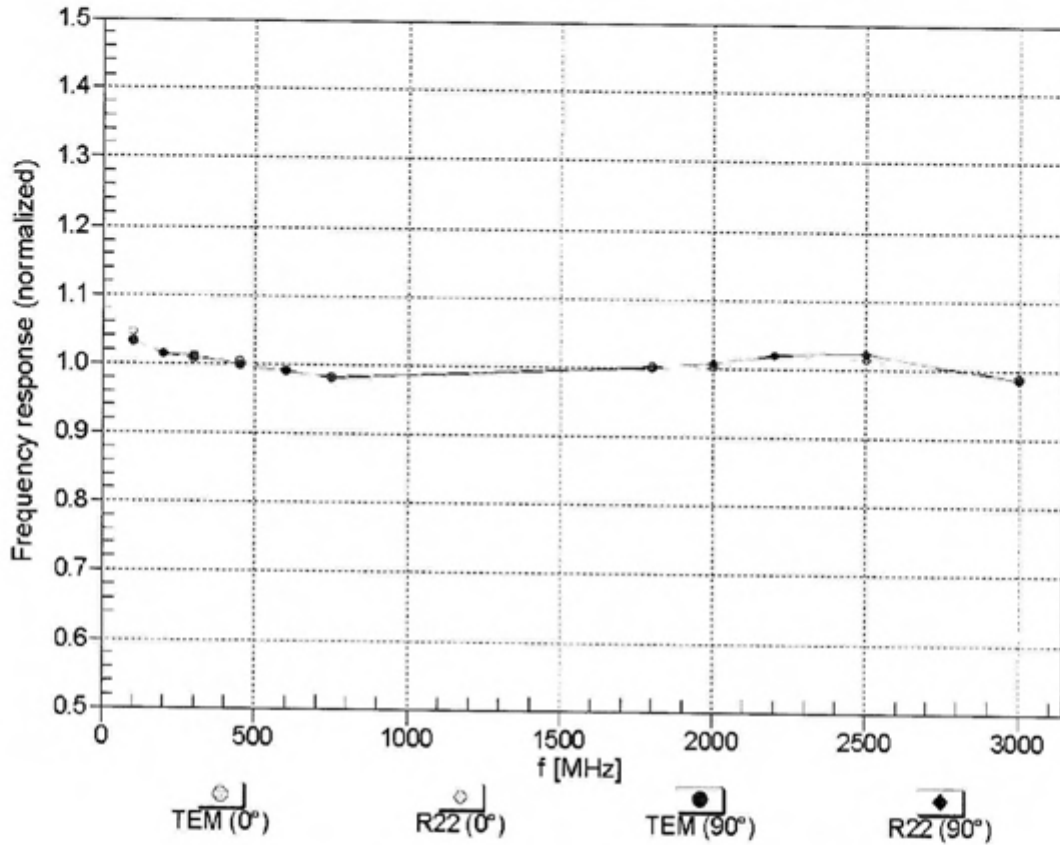

Uncertainty of Frequency Response of H-field: $\pm 6.3\%$ (k=2)

Receiving Pattern (ϕ), $\vartheta = 0^\circ$

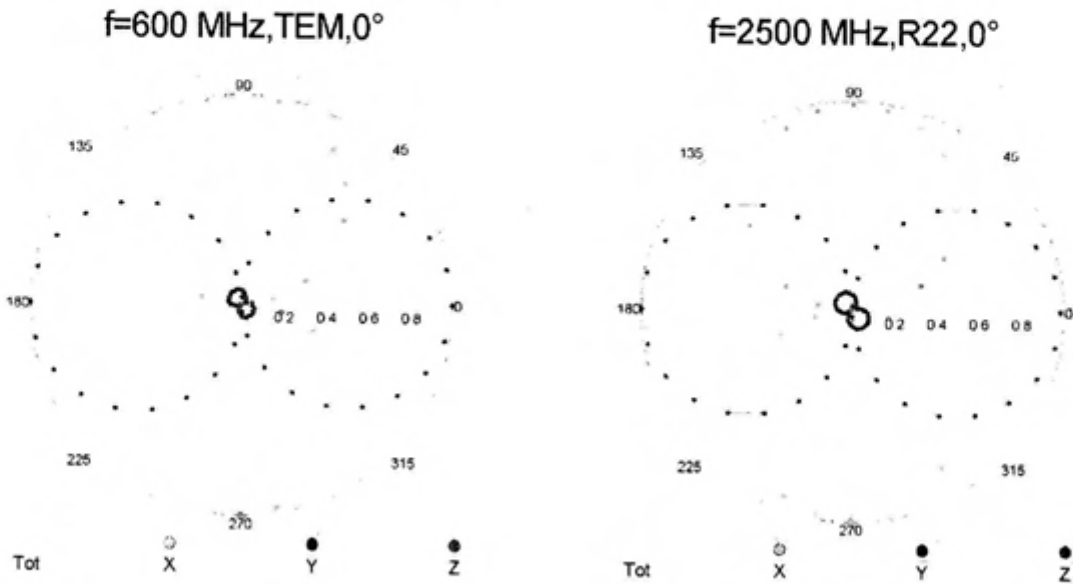

Receiving Pattern (ϕ), $\vartheta = 90^\circ$

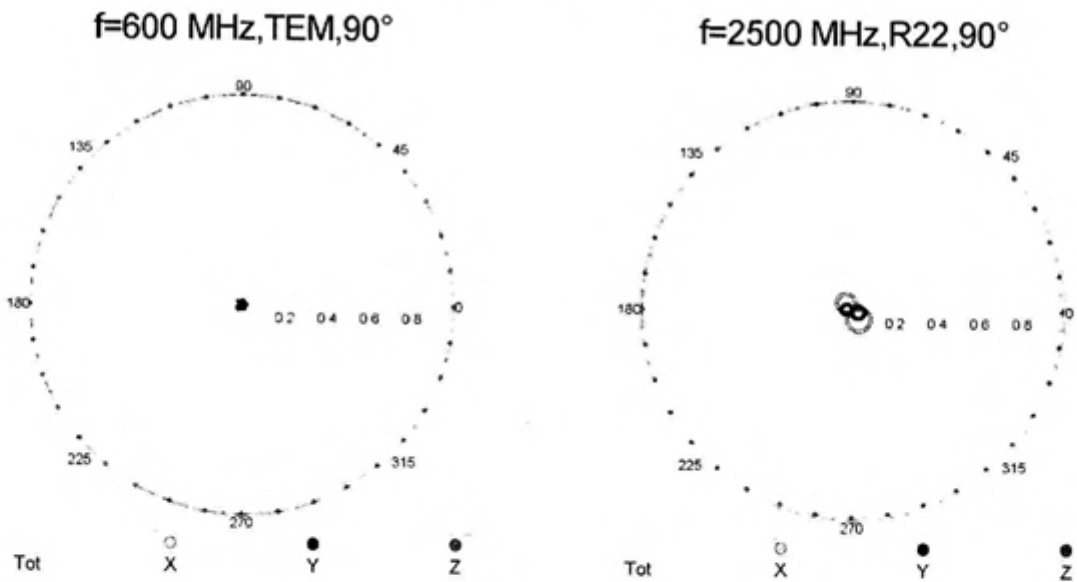

Receiving Pattern (ϕ), $\vartheta = 0^\circ$

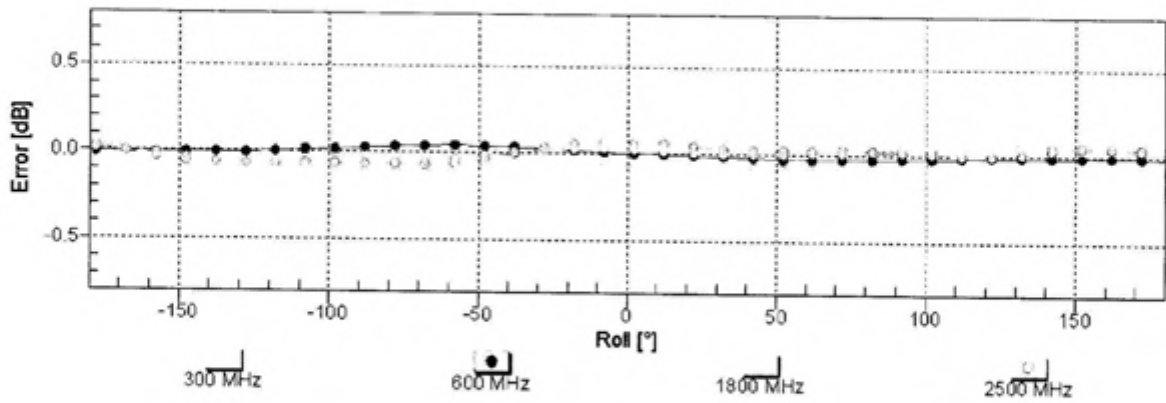

Uncertainty of Axial Isotropy Assessment: $\pm 0.5\%$ ($k=2$)

Receiving Pattern (ϕ), $\vartheta = 90^\circ$

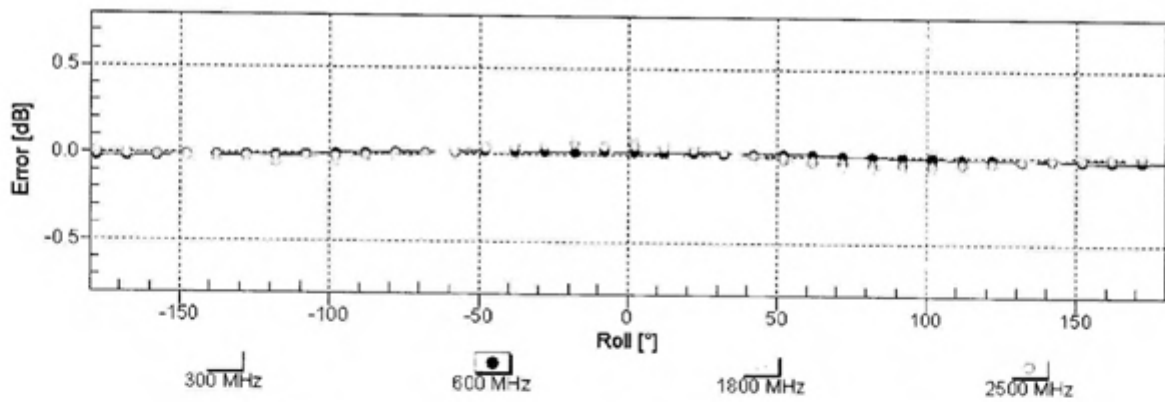

Uncertainty of Axial Isotropy Assessment: $\pm 0.5\%$ ($k=2$)

Dynamic Range f(H-field) (TEM cell, f = 900 MHz)

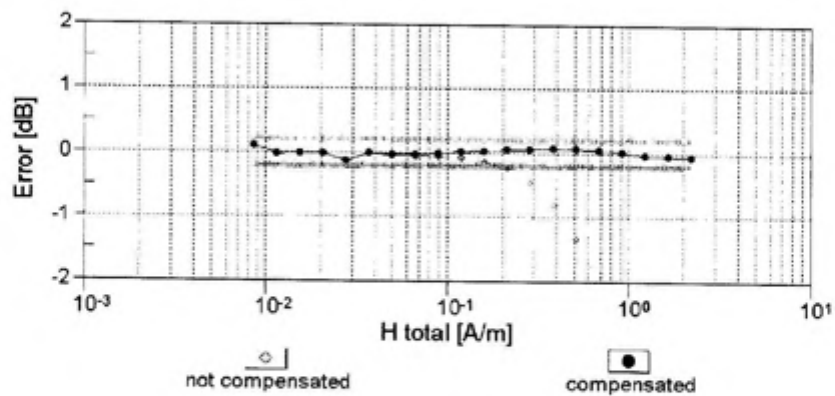
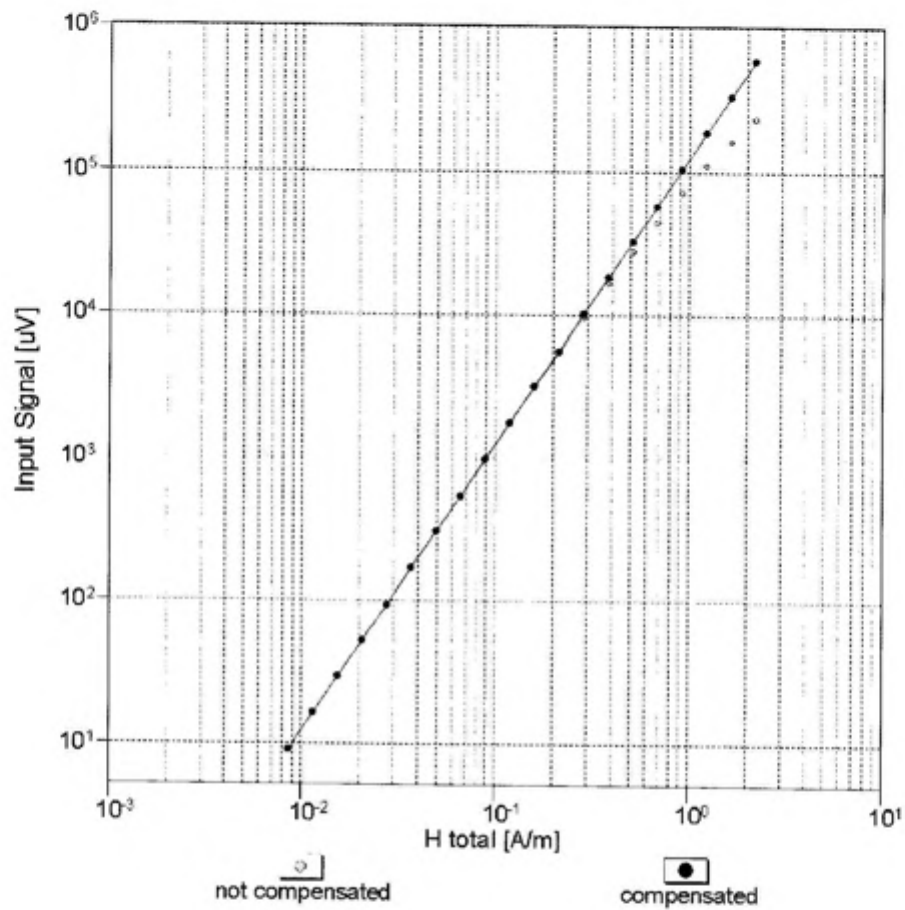

Uncertainty of Linearity Assessment: ± 0.6% (k=2)

Deviation from Isotropy in Air

Error (ϕ , θ), $f = 900$ MHz

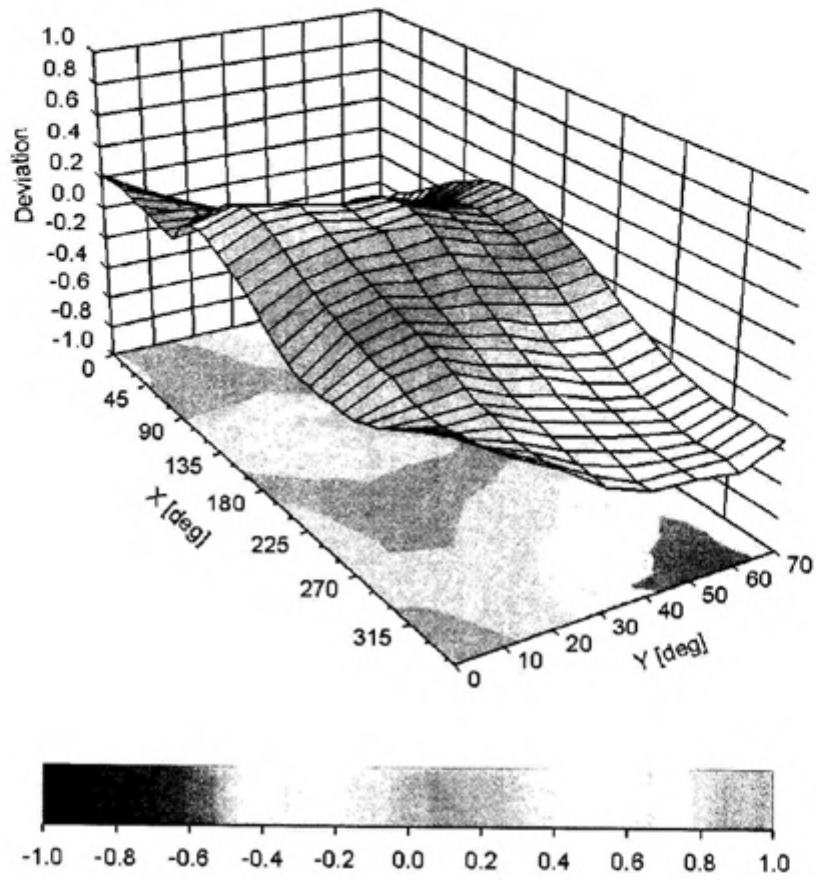

Uncertainty of Spherical Isotropy Assessment: $\pm 2.6\%$ ($k=2$)

DASY/EASY - Parameters of Probe: H3DV6 - SN:6305

Other Probe Parameters

Sensor Arrangement	Rectangular
Connector Angle (°)	-147.9
Mechanical Surface Detection Mode	enabled
Optical Surface Detection Mode	disabled
Probe Overall Length	337 mm
Probe Body Diameter	10 mm
Tip Length	20 mm
Tip Diameter	6 mm
Probe Tip to Sensor X Calibration Point	3 mm
Probe Tip to Sensor Y Calibration Point	3 mm
Probe Tip to Sensor Z Calibration Point	3 mm



Appendix D. Test Setup Photos



Front View



Left Side View



Right Side View



Appendix E. Product Equality Declaration



5F, C building, No. 232, Liang Jing Road
 ZhangJiang High-Tech Park, Pudong Area
 Shanghai, P.R. China. 201203
 TEL: +86(0)21 61460666
 FAX: +86(0)21 61460602

Declaration of changes from 6037B to 6037I

General: 6037I is a variant product of 6037B

● SOFTWARE MODIFICATIONS:

- Protocol Stack changes: No
- MMS/STK/USAT/USIM changes: No
- DM/SUPL/VT/FUMO/SWP/HCI: No (indicated the changed items if yes)
- Other changes detailed:

● HARDWARE MODIFICATIONS:

- Band changes: No
- PCB Layout changes: No
- Main RF components changes:

	Antenna	AP	Modem	Transceiver	Power Amplifier	Rx SAW Filter	ASM
GSM850	No	No	No	No	No	No	No
GSM900	No	No	No	No	No	No	No
GSM1800	No	No	No	No	No	No	No
GSM1900	No	No	No	No	No	No	No

	Antenna	AP	Modem	Transceiver	Power Amplifier	Tx SAW Filter	Duplexer	ASM
UMTS2100	No	No	No	No	No	No	No	No
UMTS1900	No	No	No	No	No	No	No	No
UMTS850	No	No	No	No	No	No	No	No

	Antenna	AP	Modem	Transceiver	Power Amplifier	Balun	Band pass filter	Diplexer
Bluetooth	No	No	No	No	No	No	No	No
Wi-Fi	No	No	No	No	No	No	No	No

- FM changes: No
- LCD/ Speaker/ Camera/ Vibrator changes: No (indicated the changed items if yes)

➤ Other changes detailed:

● **MECHANICAL MODIFICATIONS:**

- Use new metal front/back cover or keypad: No
- Mechanical shell changes:
 - Whole size of EUT: No
 - Distance of Ear reference point to bottom of handset: No
 - Other trinkets to change the surface of handset: No
- Other changes detailed: replace SD card slot by the second SIM card slot on enclosure

APPROVED BY:

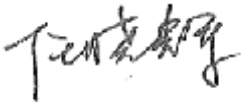
2013.12.30

Project Manager:

Signature:

Date: