



# HAC RF TEST REPORT

No. I14Z46098-SEM03

For

**TCT Mobile Limited**

**HSUPA/HSDPA/UMTS triband/GSM quadband mobile phone**

**Model Name: 4036E/4136E**

With

**Hardware Version: PIO**

**Software Version: v9H26**

**FCC ID: RAD455**

**Results Summary: M Category = M3**

**Issued Date: 2014-06-03**



**Note:**

The test results in this test report relate only to the devices specified in this report. This report shall not be reproduced except in full without the written approval of TMC Beijing.

**Test Laboratory:**

TMC Beijing, Telecommunication Metrology Center of MIIT

No. 52, Huayuan Bei Road, Haidian District, Beijing, P. R. China 100191.

Tel:+86(0)10-62304633-2079, Fax:+86(0)10-62304793 Email:welcme@emcite.com. [www.emcite.com](http://www.emcite.com)

## Revision Version

<b>Report Number</b>	<b>Revision</b>	<b>Date</b>	<b>Memo</b>
I14Z46098-SEM03	0	2014-06-03	Initial creation of test report

## TABLE OF CONTENT

<b>1 TEST LABORATORY .....</b>	<b>4</b>
1.1 TESTING LOCATION .....	4
1.2 TESTING ENVIRONMENT.....	4
1.3 PROJECT DATA .....	4
1.4 SIGNATURE.....	4
<b>2 CLIENT INFORMATION .....</b>	<b>5</b>
2.1 APPLICANT INFORMATION .....	5
2.2 MANUFACTURER INFORMATION .....	5
<b>3 EQUIPMENT UNDER TEST (EUT) AND ANCILLARY EQUIPMENT (AE) .....</b>	<b>6</b>
3.1 ABOUT EUT .....	6
3.2 INTERNAL IDENTIFICATION OF EUT USED DURING THE TEST .....	6
3.3 INTERNAL IDENTIFICATION OF AE USED DURING THE TEST .....	6
3.4 AIR INTERFACES / BANDS INDICATING OPERATING MODES .....	6
<b>4 CONDUCTED OUTPUT POWER MEASUREMENT .....</b>	<b>7</b>
4.1 SUMMARY .....	7
4.2 CONDUCTED POWER .....	7
<b>5. REFERENCE DOCUMENTS.....</b>	<b>7</b>
5.1 REFERENCE DOCUMENTS FOR TESTING .....	7
<b>6 OPERATIONAL CONDITIONS DURING TEST .....</b>	<b>8</b>
6.1 HAC MEASUREMENT SET-UP.....	8
6.2 PROBE SPECIFICATION .....	9
6.3 TEST ARCH PHANTOM & PHONE POSITIONER.....	10
6.4 ROBOTIC SYSTEM SPECIFICATIONS .....	10
<b>7 EUT ARRANGEMENT .....</b>	<b>11</b>
7.1 WD RF EMISSION MEASUREMENTS REFERENCE AND PLANE .....	11
<b>8 SYSTEM VALIDATION .....</b>	<b>12</b>
8.1 VALIDATION PROCEDURE .....	12
8.2 VALIDATION RESULT .....	12
<b>9 PROBE MODULATION FACTOR.....</b>	<b>13</b>
9.1 MODULATION FACTOR TEST PROCEDURE.....	13
9.2 MODULATION FACTOR.....	14
<b>10 RF TEST PROCEDURES .....</b>	<b>15</b>
<b>11 HAC RF TEST DATA SUMMARY .....</b>	<b>16</b>
11.1 MEASUREMENT RESULTS (E-FIELD).....	16
11.2 MEASUREMENT RESULTS (H-FIELD) .....	16
11.3 TOTAL M-RATING .....	17
<b>12 ANSI C 63.19-2007 LIMITS .....</b>	<b>17</b>
<b>13 MEASUREMENT UNCERTAINTY .....</b>	<b>18</b>
<b>14 MAIN TEST INSTRUMENTS.....</b>	<b>19</b>
<b>15 CONCLUSION .....</b>	<b>19</b>
<b>ANNEX A TEST LAYOUT .....</b>	<b>20</b>
<b>ANNEX B TEST PLOTS .....</b>	<b>21</b>
<b>ANNEX C SYSTEM VALIDATION RESULT .....</b>	<b>53</b>
<b>ANNEX D PROBE CALIBRATION CERTIFICATE.....</b>	<b>57</b>
<b>ANNEX E DIPOLE CALIBRATION CERTIFICATE .....</b>	<b>77</b>

## 1 Test Laboratory

### 1.1 Testing Location

Company Name: TMC Beijing, Telecommunication Metrology Center of MIIT  
Address: No 52, Huayuan beilu, Haidian District, Beijing,P.R.China  
Postal Code: 100191  
Telephone: +86-10-62304633  
Fax: +86-10-62304793

### 1.2 Testing Environment

Temperature: 18°C~25 °C,  
Relative humidity: 30%~ 70%  
Ground system resistance: < 0.5 Ω

Ambient noise is checked and found very low and in compliance with requirement of standards.  
Reflection of surrounding objects is minimized and in compliance with requirement of standards.

### 1.3 Project Data

Project Leader: Qi Dianyuan  
Test Engineer: Lin Hao  
Testing Start Date: May 21, 2014  
Testing End Date: May 21, 2014

### 1.4 Signature



---

Lin Hao

(Prepared this test report)

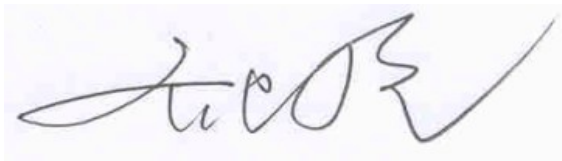

---

Qi Dianyuan

(Reviewed this test report)



---

Xiao Li

Deputy Director of the laboratory  
(Approved this test report)

## 2 Client Information

### 2.1 Applicant Information

Company Name:	TCT Mobile Limited
Address /Post:	5F, C building, No. 232, Liang Jing Road ZhangJiang High-Tech Park, Pudong Area Shanghai, P.R. China. 201203
City:	Shanghai
Postal Code:	201203
Country:	P.R.China
Contact:	Gong Zhizhou
Email:	zhizhou.gong@tcl.com
Telephone:	0086-21-61460890
Fax:	0086-21-61460602

### 2.2 Manufacturer Information

Company Name:	TCT Mobile Limited
Address /Post:	5F, C building, No. 232, Liang Jing Road ZhangJiang High-Tech Park, Pudong Area Shanghai, P.R. China. 201203
City:	Shanghai
Postal Code:	201203
Country:	P.R.China
Contact:	Gong Zhizhou
Email:	zhizhou.gong@tcl.com
Telephone:	0086-21-61460890
Fax:	0086-21-61460602

### 3 Equipment Under Test (EUT) and Ancillary Equipment (AE)

This EUT is a variant product and the report of original sample is No.I14Z45782-SEM04.  
According to the client request, we quote the test results of original sample.

#### 3.1 About EUT

Description:	HSUPA/HSDPA/UMTS triband/GSM quadband mobile phone
Model Name:	4036E/4136E
Operating mode(s):	GSM 850/900/1800/1900, WCDMA850/1900/ 2100, BT, Wi-Fi

#### 3.2 Internal Identification of EUT used during the test

EUT ID*	IMEI	HW Version	SW Version
EUT1	863665020100117	PIO	v9H26

\*EUT ID: is used to identify the test sample in the lab internally.

#### 3.3 Internal Identification of AE used during the test

AE ID*	Description	Model	SN	Manufacturer
AE1	Battery	CAB60B0000C1	/	BYD
AE2	Battery	CAB60BA000C1	/	SCUD
AE3	Battery	CAB60B0000CB	/	OS
AE4	Battery	CAB1400002C1	/	BYD
AE5	Battery	CAB31P0000C1	/	BYD

\*AE ID: is used to identify the test sample in the lab internally.

Note: It is tested with battery CAB60B0000C1

#### 3.4 Air Interfaces / Bands Indicating Operating Modes

Air-interface	Band(MHz)	Type	C63.19/ tested	Simultaneous Transmissions Note: Not to be tested	OTT	Reduced power
GSM	850	VO	Yes	WIFI and BT	NA	NA
	1900					
	GPRS/EDGE	DT	NA			No
WCDMA	850	VO	Yes	WIFI and BT	NA	No
	1900					
WIFI	2450	DT	NA	GSM, WCDMA	Yes	NA
BT	2450	DT	NA	GSM, WCDMA	NA	NA

VO: Voice CMRS/PSTN Service Only

V/D: Voice CMRS/PSTN and Data Service

DT: Digital Transport

\* HAC Rating was not based on concurrent voice and data modes, Non current mode was found to represent worst case rating for both M and T rating

## 4 CONDUCTED OUTPUT POWER MEASUREMENT

### 4.1 Summary

During the process of testing, the EUT was controlled via Agilent Digital Radio Communication tester (E5515C) to ensure the maximum power transmission and proper modulation. This result contains conducted output power for the EUT. In all cases, the measured output power should be greater and within 5% than EMI measurement.

### 4.2 Conducted Power

GSM 850MHz	Conducted Power (dBm)		
	Channel 251(848.8MHz)	Channel 190(836.6MHz)	Channel 128(824.2MHz)
	32.58	32.47	32.40
GSM 1900MHz	Conducted Power (dBm)		
	Channel 810(1909.8MHz)	Channel 661(1880MHz)	Channel 512(1850.2MHz)
	28.80	28.79	28.78
WCDMA 850MHz	Conducted Power (dBm)		
	Channel 4233(846.6MHz)	Channel 4182(836.4MHz)	Channel 4132(826.4MHz)
	22.55	22.62	22.71
WCDMA 1900MHz	Conducted Power (dBm)		
	Channel 9538(1907.6MHz)	Channel 9400(1880MHz)	Channel 9262(1852.4MHz)
	22.22	22.05	22.03

## 5. Reference Documents

### 5.1 Reference Documents for testing

The following document listed in this section is referred for testing.

Reference	Title	Version
ANSI C63.19-2007	American National Standard for Methods of Measurement of Compatibility between Wireless Communication Devices and Hearing Aids	2007 Edition
FCC 47 CFR §20.19	Hearing Aid Compatible Mobile Headsets	/
KDB 285076 D01	Equipment Authorization Guidance for Hearing Aid Compatibility	v03





## 6.2 Probe Specification

### 6.2.1 E-Field Probe Description

Construction	One dipole parallel, two dipoles normal to probe axis Built-in shielding against static charges PEEK enclosure material
Calibration	In air from 100 MHz to 3.0 GHz (absolute accuracy $\pm 6.0\%$ , $k=2$ )
Frequency	40 MHz to > 6 GHz (can be extended to < 20 MHz) Linearity: $\pm 0.2$ dB (100 MHz to 3 GHz)
Directivity	$\pm 0.2$ dB in air (rotation around probe axis) $\pm 0.4$ dB in air (rotation normal to probe axis)
Dynamic Range	2 V/m to > 1000 V/m; Linearity: $\pm 0.2$ dB
Dimensions	Overall length: 330 mm (Tip: 16 mm) Tip diameter: 8 mm (Body: 12 mm) Distance from probe tip to dipole centers: 2.5 mm
Application	General near-field measurements up to 6 GHz Field component measurements Fast automatic scanning in phantoms



[ER3DV6]

### 6.2.2 H-Field Probe Description

Construction	Three concentric loop sensors with 3.8 mm loop diameters Resistively loaded detector diodes for linear response Built-in shielding against static charges PEEK enclosure material (resistant to organic solvents, e.g., glycoether)
Frequency	200 MHz to 3 GHz (absolute accuracy $\pm 6.0\%$ , $k=2$ ); Output linearized
Directivity	$\pm 0.2$ dB (spherical isotropy error)
Dynamic Range	10 mA/m to 2 A/m at 1 GHz
E-Field Interference	< 10% at 3 GHz (for plane wave)
Dimensions	Overall length: 330 mm (Tip: 40 mm) Tip diameter: 6 mm (Body: 12 mm) Distance from probe tip to dipole centers: 3 mm
Application	General magnetic near-field measurements up to 3 GHz (in air or liquids) Field component measurements Surface current measurements Low interaction with the measured field

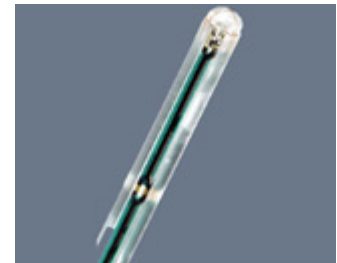

[H3DV6]

### 6.3 Test Arch Phantom & Phone Positioner

The Test Arch phantom should be positioned horizontally on a stable surface. Reference markings on the Phantom allow the complete setup of all predefined phantom positions and measurement grids by manually teaching three points in the robot. It enables easy and well defined positioning of the phone and validation dipoles as well as simple teaching of the robot (Dimensions: 370 x 370 x 370 mm).

The Phone Positioner supports accurate and reliable positioning of any phone with effect on near field  $< \pm 0.5$  dB.

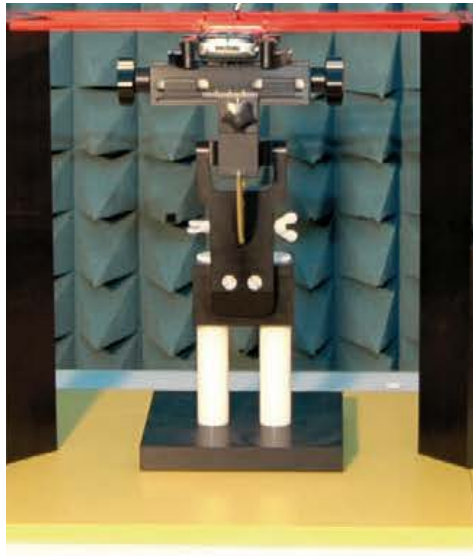

Fig. 2 HAC Phantom & Device Holder

### 6.4 Robotic System Specifications

#### Specifications

**Positioner:** Stäubli Unimation Corp. Robot Model: RX160L

**Repeatability:**  $\pm 0.02$  mm

**No. of Axis:** 6

#### Data Acquisition Electronic (DAE) System

##### Cell Controller

**Processor:** Intel Core2

**Clock Speed:** 1.86 GHz

**Operating System:** Windows XP

##### Data Converter

**Features:** Signal Amplifier, multiplexer, A/D converter, and control logic

**Software:** DASY5 software

**Connecting Lines:** Optical downlink for data and status info.

Optical uplink for commands and clock

## 7 EUT ARRANGEMENT

### 7.1 WD RF Emission Measurements Reference and Plane

Figure 4 illustrates the references and reference plane that shall be used in the WD emissions measurement.

- The grid is 5 cm by 5 cm area that is divided into 9 evenly sized blocks or sub-grids.
- The grid is centered on the audio frequency output transducer of the WD (speaker or T-coil).
- The grid is located by reference to a reference plane. This reference plane is the planar area that contains the highest point in the area of the WD that normally rests against the user's ear
- The measurement plane is located parallel to the reference plane and 15 mm from it, out from the phone. The grid is located in the measurement plane.

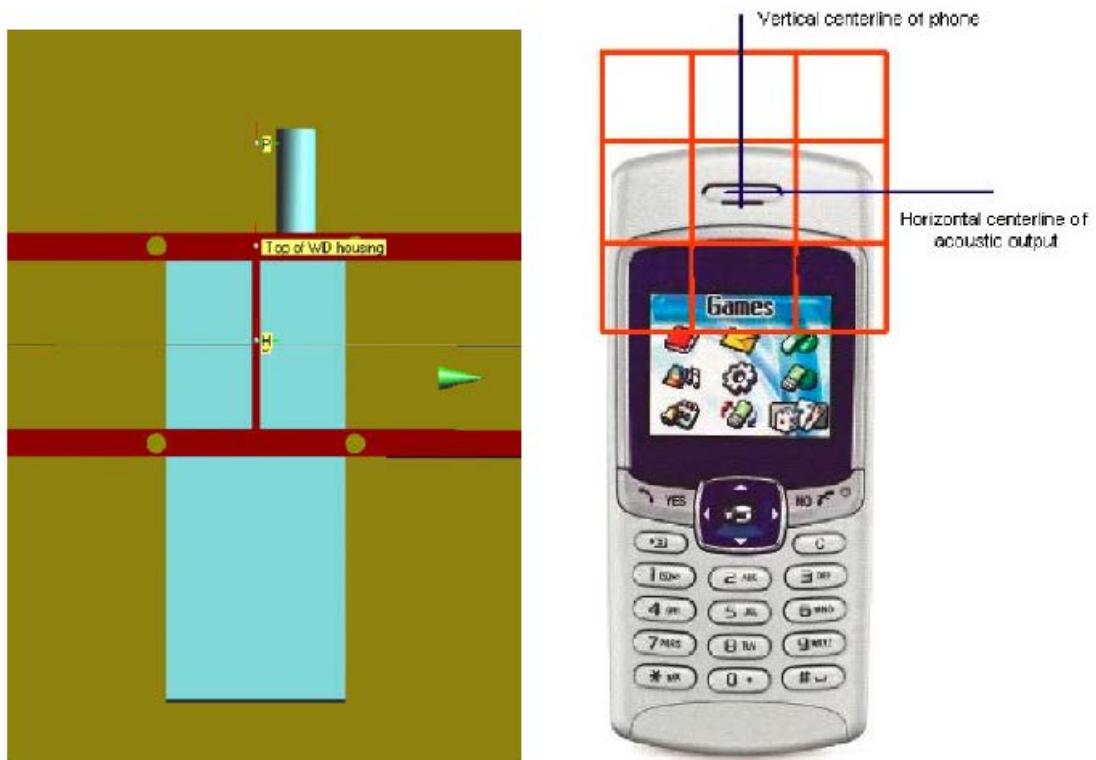

**Fig. 3 WD reference and plane for RF emission measurements**

## 8 SYSTEM VALIDATION

### 8.1 Validation Procedure

Place a dipole antenna meeting the requirements given in ANSI C63.19 D.5 in the position normally occupied by the WD. The dipole antenna serves as a known source for an electrical and magnetic output. Position the E-field and H-field probes so that:

- The probes and their cables are parallel to the coaxial feed of the dipole antenna
- The probe cables and the coaxial feed of the dipole antenna approach the measurement area from opposite directions
- The center point of the probe element(s) are 10 mm from the closest surface of the dipole elements.

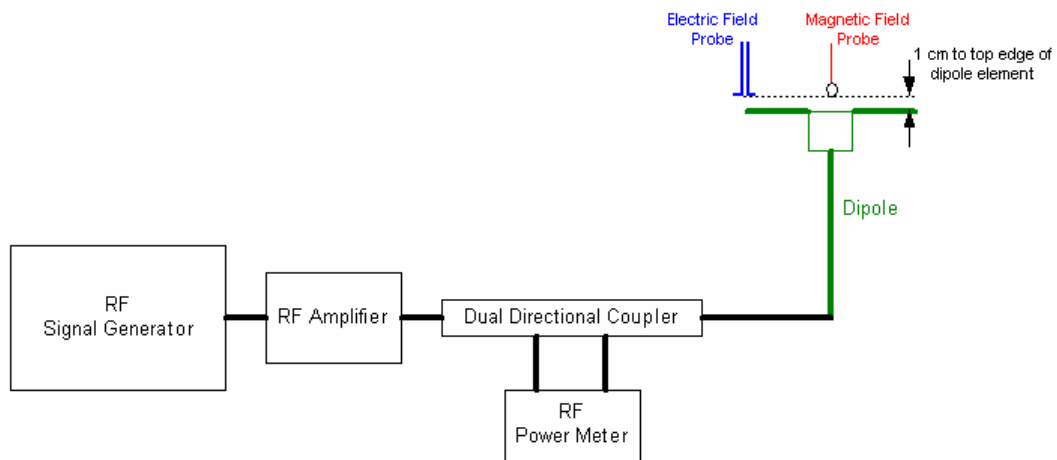

Fig. 4 Dipole Validation Setup

### 8.2 Validation Result

E-Field Scan							
Mode	Frequency (MHz)	Input Power (mW)	Power	Measured <sup>1</sup> Value(V/m)	Target <sup>2</sup> Value(V/m)	Deviation <sup>3</sup> (%)	Limit <sup>4</sup> (%)
CW	835	100		164.8	169.8	-2.94	±25
CW	1880	100		142.5	142.9	-0.28	±25
H-Field Scan							
Mode	Frequency (MHz)	Input Power (mW)	Power	Measured Value(A/m)	Target Value(A/m)	Deviation (%)	Limit (%)
CW	835	100		0.472	0.461	2.39	±25
CW	1880	100		0.456	0.470	-2.98	±25

Notes:

1. Please refer to the attachment for detailed measurement data and plot.
2. Target value is provided by SPEAD in the calibration certificate of specific dipoles.
3. Deviation (%) = 100 \* (Measured value minus Target value) divided by Target value.
4. ANSI C63.19 requires values within ± 25% are acceptable, of which 12% is deviation and 13% is measurement uncertainty. Values independently validated for the dipole actually used in the measurements should be used, when available.

## 9 Probe Modulation Factor

The Probe Modulation Factor (PMF) is defined as the ratio of the field readings for a CW and a modulated signal with the equivalent Field Envelope Peak as defined in ANSI C63.19 (Chapter C.3.1). Calibration shall be made of the modulation response of the probe and its instrumentation chain. This Calibration shall be performed with the field probe, attached to the instrumentation that is to be used with it during the measurement. The response of the probe system to a CW field at the frequency(s) of interest is compared to its response to a modulated signal with equal peak amplitude. The field level of the test signals shall be more than 10dB above the ambient level and the noise floor of the instrumentation being used. The ratio of the CW reading to that taken with a modulated field shall be applied to the readings taken of modulated fields of the specified type.

### 9.1 Modulation Factor Test Procedure

This may be done using the following procedure:

1. Fix the field probe in a set location relative to a field generating device, such as the reference dipole antenna, as illustrated in Figure 6.
2. Illuminate the probe using the wireless device connected to the reference dipole with a test signal at the intended measurement frequency, Ensure there is sufficient field coupling between the probe and the antenna so the resulting reading is greater than 10 dB above the probe system noise floor but within the systems operating range.
3. Record the amplitude applied to the antenna during transmission and the field strength measured by the E-field probe located near the tip of the dipole antenna
4. Replace the wireless device with an RF signal generator producing an unmodulated CW signal and set to the wireless device operating frequency.
5. Set the amplitude of the unmodulated signal to equal that recorded from the wireless device.
6. Record the reading of the probe measurement system of the unmodulated signal.
7. The ratio, in linear units, of the probe reading in Step 6) to the reading in Step 3) is the E-field modulation factor.  $PMF_E = E_{CW} / E_{mod}$  ( $PMF_H = H_{CW} / H_{mod}$ )
8. Repeat the previous steps using the H-field probe, except locate the probe at the center of the dipole.

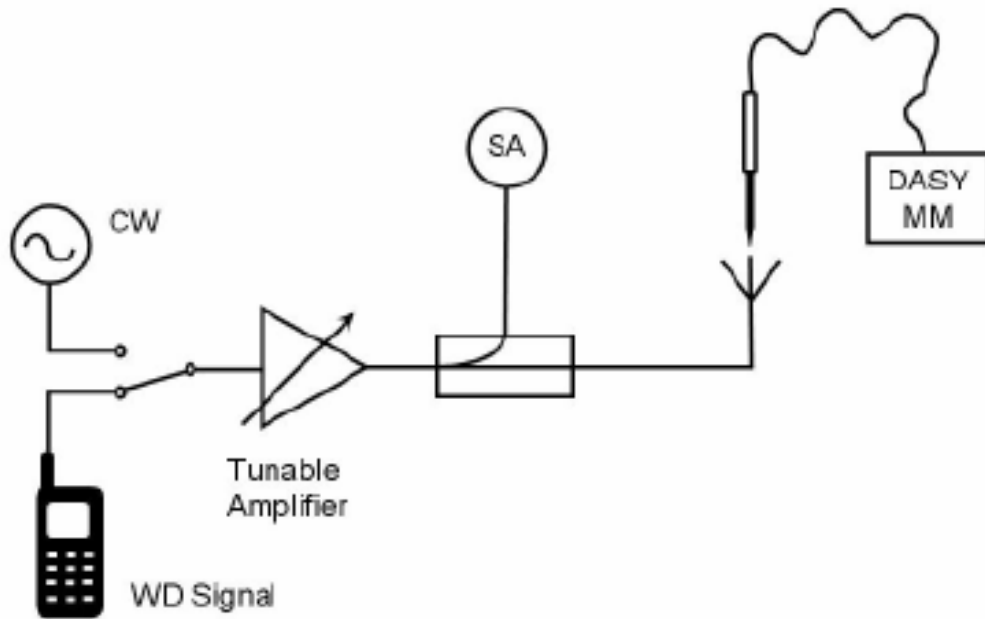

Fig. 5 Probe Modulation Factor Test Setup

## 9.2 Modulation Factor

### 9.2.1 E-Field

Frequency (MHz)	Mode	Input Power (mW)	E-Field Measured Value (V/m)	Probe Modulation Factor
835	<b>CW</b>	<b>100</b>	<b>164.8</b>	\
	WCDMA	100	164.3	<b>1.003</b>
	GSM	100	57.3	<b>2.876</b>
1880	<b>CW</b>	<b>100</b>	<b>142.5</b>	\
	WCDMA	100	142.1	<b>1.003</b>
	GSM	100	49.4	<b>2.884</b>

### 9.2.2 H-Field

Frequency (MHz)	Mode	Input Power (mW)	H-Field Measured Value (A/m)	Probe Modulation Factor
835	<b>CW</b>	<b>100</b>	<b>0.472</b>	\
	WCDMA	100	0.469	<b>1.006</b>
	GSM	100	0.164	<b>2.876</b>
1880	<b>CW</b>	<b>100</b>	<b>0.456</b>	\
	WCDMA	100	0.454	<b>1.004</b>
	GSM	100	0.159	<b>2.865</b>

## 10 RF TEST PROCEDURES

**The evaluation was performed with the following procedure:**

- 1) Confirm proper operation of the field probe, probe measurement system and other instrumentation and the positioning system.
- 2) Position the WD in its intended test position. The gauge block can simplify this positioning. Note that a separate E-field and H-field gauge block will be needed if the center of the probe sensor elements are at different distances from the tip of the probe.
- 3) Configure the WD normal operation for maximum rated RF output power, at the desired channel and other operating parameters (e.g., test mode), as intended for the test.
- 4) The center sub-grid shall be centered on the center of the T-Coil mode axial measurement point or the acoustic output, as appropriate. Locate the field probe at the initial test position in the 50 mm by 50 mm grid, which is contained in the measurement plane. If the field alignment method is used, align the probe for maximum field reception.
- 5) Record the reading.
- 6) Scan the entire 50 mm by 50 mm region in equally spaced increments and record the reading at each measurement point. The distance between measurement points shall be sufficient to assure the identification of the maximum reading.
- 7) Identify the five contiguous sub-grids around the center sub-grid with the lowest maximum field strength readings. Thus the six areas to be used to determine the WD's highest emissions are identified and outlined for the final manual scan. Please note that a maximum of five blocks can be excluded for both E-field and H-field measurements for the WD output being measured. Stated another way, the center sub-grid and three others must be common to both the E-field and H-field measurements.
- 8) Identify the maximum field reading within the non-excluded sub-grids identified in Step 7)
- 9) Convert the maximum field strength reading identified in Step 8) to V/m or A/m, as appropriate. For probes which require a probe modulation factor, this conversion shall be done using the appropriate probe modulation factor and the calibration.
- 10) Repeat Step 1) through Step 10) for both the E-field and H-field measurements.
- 11) Compare this reading to the categories in ANSI C63.19 Clause 7 and record the resulting category. The lowest category number listed in 7.2, Table 7.4, or Table 7.5 obtained in Step 10) for either E- or H-field determines the M category for the audio coupling mode assessment. Record the WD category rating.

## 11 HAC RF TEST DATA SUMMARY

### 11.1 Measurement Results (E-Field)

Frequency		AWF	Measured Value (V/m)	Power Drift (dB)	Category
MHz	Channel				
<b>GSM 850</b>					
848.8	251	-5	182.9	0.02	<b>M3</b> (see Fig B.1)
836.6	190	-5	173.0	-0.02	<b>M3</b> (see Fig B.2)
824.2	128	-5	146.1	-0.04	<b>M4</b> (see Fig B.3)
<b>GSM 1900</b>					
1909.8	810	-5	72.61	-0.19	<b>M3</b> (see Fig B.4)
1880	661	-5	57.18	0.01	<b>M3</b> (see Fig B.5)
1850.2	512	-5	55.85	-0.01	<b>M3</b> (see Fig B.6)
<b>WCDMA 850</b>					
846.6	4233	0	59.26	0.01	<b>M4</b> (see Fig B.7)
836.4	4182	0	58.73	-0.03	<b>M4</b> (see Fig B.8)
826.4	4132	0	57.11	0.05	<b>M4</b> (see Fig B.9)
<b>WCDMA 1900</b>					
1907.6	9538	0	30.20	-0.04	<b>M4</b> (see Fig B.10)
1880	9400	0	28.61	-0.01	<b>M4</b> (see Fig B.11)
1852.4	9262	0	31.53	0.03	<b>M4</b> (see Fig B.12)

### 11.2 Measurement Results (H-Field)

Frequency		AWF	Measured Value (A/m)	Power Drift (dB)	Category
MHz	Channel				
<b>GSM 850</b>					
848.8	251	-5	0.3571	0.03	<b>M4</b> (see Fig B.13)
836.6	190	-5	0.3260	0.02	<b>M4</b> (see Fig B.14)
824.2	128	-5	0.2811	-0.01	<b>M4</b> (see Fig B.15)
<b>GSM 1900</b>					
1909.8	810	-5	0.1604	0.04	<b>M3</b> (see Fig B.16)
1880	661	-5	0.1563	-0.02	<b>M3</b> (see Fig B.17)
1850.2	512	-5	0.1586	0.06	<b>M3</b> (see Fig B.18)
<b>WCDMA 850</b>					
846.6	4233	0	0.1152	0.01	<b>M4</b> (see Fig B.19)
836.4	4182	0	0.1100	0.00	<b>M4</b> (see Fig B.20)
826.4	4132	0	0.1003	0.03	<b>M4</b> (see Fig B.21)
<b>WCDMA 1900</b>					
1907.6	9538	0	0.08167	0.01	<b>M4</b> (see Fig B.22)
1880	9400	0	0.07721	-0.03	<b>M4</b> (see Fig B.23)
1852.4	9262	0	0.08719	-0.03	<b>M4</b> (see Fig B.24)



### 11.3 Total M-rating

Mode	Maximum value of peak Total E-Field (V/m)	Maximum value of peak Total H-Field (A/m)	E-Field M Rating	H-Field M Rating	Total M Rating
<b>GSM 850</b>	183.8	0.3571	M3 (AWF -5 dB)	M4 (AWF -5 dB)	<b>M3</b> (see Fig B.25)
<b>GSM 1900</b>	72.61	0.1604	M3 (AWF -5 dB)	M3 (AWF -5 dB)	<b>M3</b> (see Fig B.26)
<b>WCDMA 850</b>	59.37	0.1152	M4 (AWF 0 dB)	M4 (AWF 0 dB)	<b>M4</b> (see Fig B.27)
<b>WCDMA 1900</b>	31.53	0.08719	M4 (AWF 0 dB)	M4 (AWF 0 dB)	<b>M4</b> (see Fig B.28)

## 12 ANSI C 63.19-2007 LIMITS

AWF: Articulation Weighting Factor

Standard	Technology	AWF
TIA/EIA/IS-2000	CDMA	0
TIA/EIA-136	TDMA (50 Hz)	0
J-STD-007	GSM (217 Hz)	-5
T1/T1P1/3GPP	UMTS (WCDMA)	0
iDEN	TDMA (22 Hz and 11 Hz)	0

Table 1: Telephone near-field categories in linear units

Category		Telephone RF parameters < 960 MHz			
Near field	AWF	E-field emissions		H-field emissions	
Category M1	0	631.0 to 1122.0	V/m	1.91 to 3.39	A/m
	-5	473.2 to 841.4	V/m	1.43 to 2.54	A/m
Category M2	0	354.8 to 631.0	V/m	1.07 to 1.91	A/m
	-5	266.1 to 473.2	V/m	0.80 to 1.43	A/m
Category M3	0	199.5 to 354.8	V/m	0.60 to 1.07	A/m
	-5	149.6 to 266.1	V/m	0.45 to 0.80	A/m
Category M4	0	< 199.5	V/m	< 0.60	A/m
	-5	< 149.6	V/m	< 0.45	A/m
Category		Telephone RF parameters > 960 MHz			
Near field	AWF	E-field emissions		H-field emissions	
Category M1	0	199.5 to 354.8	V/m	0.60 to 1.07	A/m
	-5	149.6 to 266.1	V/m	0.45 to 0.80	A/m
Category M2	0	112.2 to 199.5	V/m	0.34 to 0.60	A/m
	-5	84.1 to 149.6	V/m	0.25 to 0.45	A/m

Category M3	0	63.1 to 112.2	V/m	0.19 to 0.34	A/m
	-5	47.3 to 84.1	V/m	0.14 to 0.25	A/m
Category M4	0	< 63.1	V/m	< 0.19	A/m
	-5	< 47.3	V/m	< 0.14	A/m

### 13 MEASUREMENT UNCERTAINTY

No.	Error source	Type	Uncertainty Value (%)	Prob. Dist.	k	$c_i$ E	$c_i$ H	Standard Uncertainty (%) $u_i$ (%) E	Standard Uncertainty (%) $u_i$ (%) H	Degree of freedom $V_{eff}$ or $\nu_i$
<b>Measurement System</b>										
1	Probe Calibration	B	5.	N	1	1	1	5.1	5.1	$\infty$
2	Axial Isotropy	B	4.7	R	$\sqrt{3}$	1	1	2.7	2.7	$\infty$
3	Sensor Displacement	B	16.5	R	$\sqrt{3}$	1	0.145	9.5	1.4	$\infty$
4	Boundary Effects	B	2.4	R	$\sqrt{3}$	1	1	1.4	1.4	$\infty$
5	Linearity	B	4.7	R	$\sqrt{3}$	1	1	2.7	2.7	$\infty$
6	Scaling to Peak Envelope Power	B	2.0	R	$\sqrt{3}$	1	1	1.2	1.2	$\infty$
7	System Detection Limit	B	1.0	R	$\sqrt{3}$	1	1	0.6	0.6	$\infty$
8	Readout Electronics	B	0.3	N	1	1	1	0.3	0.3	$\infty$
9	Response Time	B	0.8	R	$\sqrt{3}$	1	1	0.5	0.5	$\infty$
10	Integration Time	B	2.6	R	$\sqrt{3}$	1	1	1.5	1.5	$\infty$
11	RF Ambient Conditions	B	3.0	R	$\sqrt{3}$	1	1	1.7	1.7	$\infty$
12	RF Reflections	B	12.0	R	$\sqrt{3}$	1	1	6.9	6.9	$\infty$
13	Probe Positioner	B	1.2	R	$\sqrt{3}$	1	0.67	0.7	0.5	$\infty$
14	Probe Positioning	A	4.7	R	$\sqrt{3}$	1	0.67	2.7	1.8	$\infty$
15	Extra. And Interpolation	B	1.0	R	$\sqrt{3}$	1	1	0.6	0.6	$\infty$
<b>Test Sample Related</b>										
16	Device Positioning Vertical	B	4.7	R	$\sqrt{3}$	1	0.67	2.7	1.8	$\infty$

17	Device Positioning Lateral	B	1.0	R	$\sqrt{3}$	1	1	0.6	0.6	$\infty$
18	Device Holder and Phantom	B	2.4	R	$\sqrt{3}$	1	1	1.4	1.4	$\infty$
19	Power Drift	B	5.0	R	$\sqrt{3}$	1	1	2.9	2.9	$\infty$
<b>Phantom and Setup related</b>										
20s	Phantom Thickness	B	2.4	R	$\sqrt{3}$	1	0.67	1.4	0.9	$\infty$
Combined standard uncertainty(%)								14.7	10.9	
Expanded uncertainty (confidence interval of 95 %)		$u_e = 2u_c$		N	k=2			29.4	21.8	

## 14 MAIN TEST INSTRUMENTS

Table 2: List of Main Instruments

No.	Name	Type	Serial Number	Calibration Date	Valid Period
01	Signal Generator	E4438C	MY49071430	February 10, 2014	One Year
02	Power meter	NRVD	102083	September 11, 2013	One year
03	Power sensor	NRV-Z5	100542		
04	Amplifier	60S1G4	0331848	No Calibration Requested	
05	E-Field Probe	ER3DV6	2428	January 27, 2014	One year
06	H-Field Probe	H3DV6	6260	January 27, 2014	One year
07	HAC Dipole	CD835V3	1156	September 02, 2013	Two years
08	HAC Dipole	CD1880V3	1140	September 02, 2013	Two years
09	BTS	E5515C	MY50263375	January 30, 2014	One year
10	DAE	SPEAG DAE4	1331	January 23, 2014	One year

## 15 CONCLUSION

The HAC measurement indicates that the EUT complies with the HAC limits of the ANSI C63.19-2007. The total M-ratings are **M3**.

\*\*\*END OF REPORT BODY\*\*\*

## ANNEX A TEST LAYOUT



Picture A1: HAC RF System Layout

## ANNEX B TEST PLOTS

### HAC RF E-Field GSM 850 High

Date: 2014-5-21

Electronics: DAE4 Sn1331

Medium: Air

Medium parameters used:  $\sigma = 0$  mho/m,  $\epsilon_r = 1$ ;  $\rho = 1000$  kg/m<sup>3</sup>

Ambient Temperature: 22.1°C

Communication System: GSM 850; Frequency: 848.8 MHz; Duty Cycle: 1:8.3

Probe: ER3DV6 - SN2428; ConvF(1, 1, 1)

**E Scan - ER3DV6 - 2007: 15 mm from Probe Center to the Device/Hearing Aid Compatibility Test (101x101x1):** Interpolated grid: dx=0.5000 mm, dy=0.5000 mm

Device Reference Point: 0, 0, -6.3 mm

Reference Value = 67.21 V/m; Power Drift = 0.02 dB

PMR not calibrated. PMF = 2.876 is applied.

E-field emissions = 182.9 V/m

**Near-field category: M3 (AWF -5 dB)**

PMF scaled E-field

Grid 1 M4 134.3 V/m	Grid 2 M3 181.9 V/m	Grid 3 M3 182.5 V/m
Grid 4 M4 116.2 V/m	Grid 5 M3 182.9 V/m	Grid 6 M3 183.8 V/m
Grid 7 M4 121.3 V/m	Grid 8 M3 179.0 V/m	Grid 9 M3 179.9 V/m

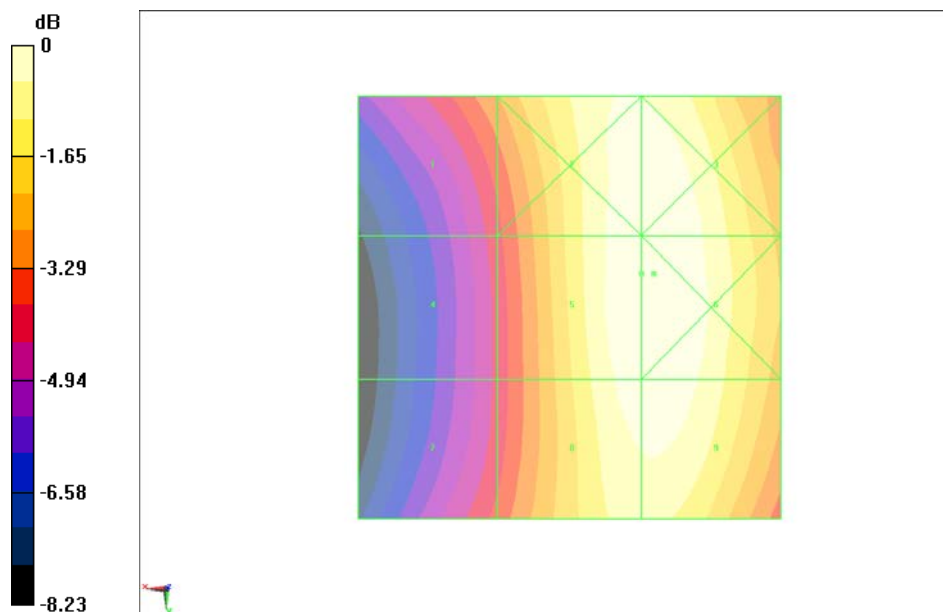

0 dB = 183.8 V/m = 45.29 dBV/m

**Fig B.1 HAC RF E-Field GSM 850 High**

### HAC RF E-Field GSM 850 Middle

Date: 2014-5-21

Electronics: DAE4 Sn1331

Medium: Air

Medium parameters used:  $\sigma = 0$  mho/m,  $\epsilon_r = 1$ ;  $\rho = 1000$  kg/m<sup>3</sup>

Ambient Temperature: 22.1°C

Communication System: GSM 850; Frequency: 836.6 MHz; Duty Cycle: 1:8.3

Probe: ER3DV6 - SN2428; ConvF(1, 1, 1)

### E Scan - ER3DV6 - 2007: 15 mm from Probe Center to the Device 2/Hearing Aid Compatibility Test (101x101x1): Interpolated grid: dx=0.5000 mm, dy=0.5000 mm

Device Reference Point: 0, 0, -6.3 mm

Reference Value = 63.95 V/m; Power Drift = -0.02 dB

PMR not calibrated. PMF = 2.876 is applied.

E-field emissions = 173.0 V/m

Near-field category: M3 (AWF -5 dB)

PMF scaled E-field

Grid 1 M4 127.1 V/m	Grid 2 M3 171.9 V/m	Grid 3 M3 172.3 V/m
Grid 4 M4 110.7 V/m	Grid 5 M3 173.0 V/m	Grid 6 M3 173.5 V/m
Grid 7 M4 115.3 V/m	Grid 8 M3 168.9 V/m	Grid 9 M3 169.3 V/m

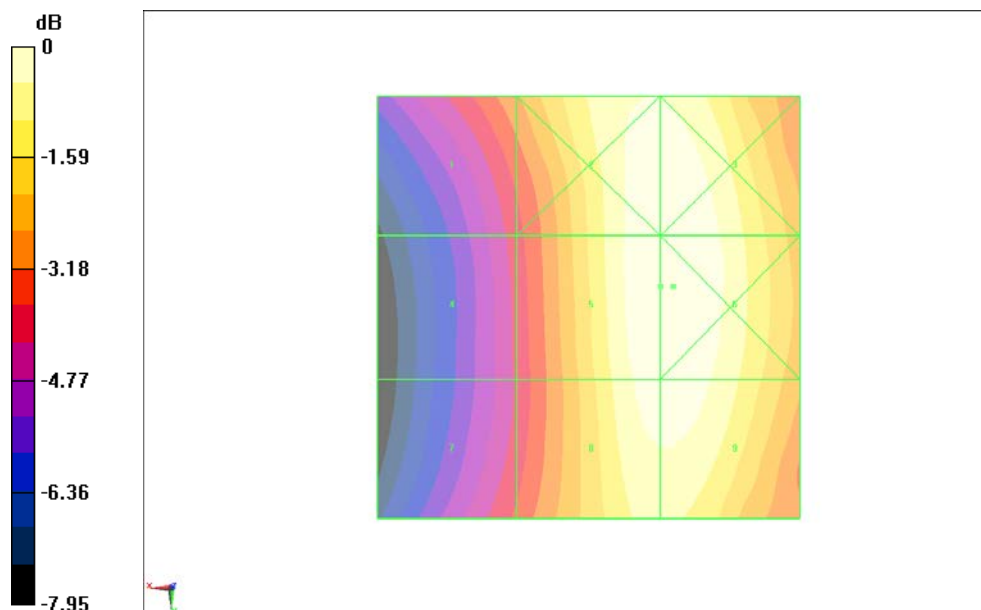

0 dB = 173.5 V/m = 44.79 dBV/m

Fig B.2 HAC RF E-Field GSM 850 Middle

**HAC RF E-Field GSM 850 Low**

Date: 2014-5-21

Electronics: DAE4 Sn1331

Medium: Air

Medium parameters used:  $\sigma = 0$  mho/m,  $\epsilon_r = 1$ ;  $\rho = 1000$  kg/m<sup>3</sup>

Ambient Temperature: 22.1°C

Communication System: GSM 850; Frequency: 824.2 MHz; Duty Cycle: 1:8.3

Probe: ER3DV6 - SN2428; ConvF(1, 1, 1)

**E Scan - ER3DV6 - 2007: 15 mm from Probe Center to the Device 3/Hearing Aid Compatibility Test (101x101x1):** Interpolated grid: dx=0.5000 mm, dy=0.5000 mm

Device Reference Point: 0, 0, -6.3 mm

Reference Value = 54.62 V/m; Power Drift = -0.04 dB

PMR not calibrated. PMF = 2.876 is applied.

E-field emissions = 146.1 V/m

**Near-field category: M4 (AWF -5 dB)**

PMF scaled E-field

Grid 1 M4 108.3 V/m	Grid 2 M4 145.0 V/m	Grid 3 M4 145.1 V/m
Grid 4 M4 95.19 V/m	Grid 5 M4 146.1 V/m	Grid 6 M4 146.3 V/m
Grid 7 M4 99.21 V/m	Grid 8 M4 142.2 V/m	Grid 9 M4 142.5 V/m

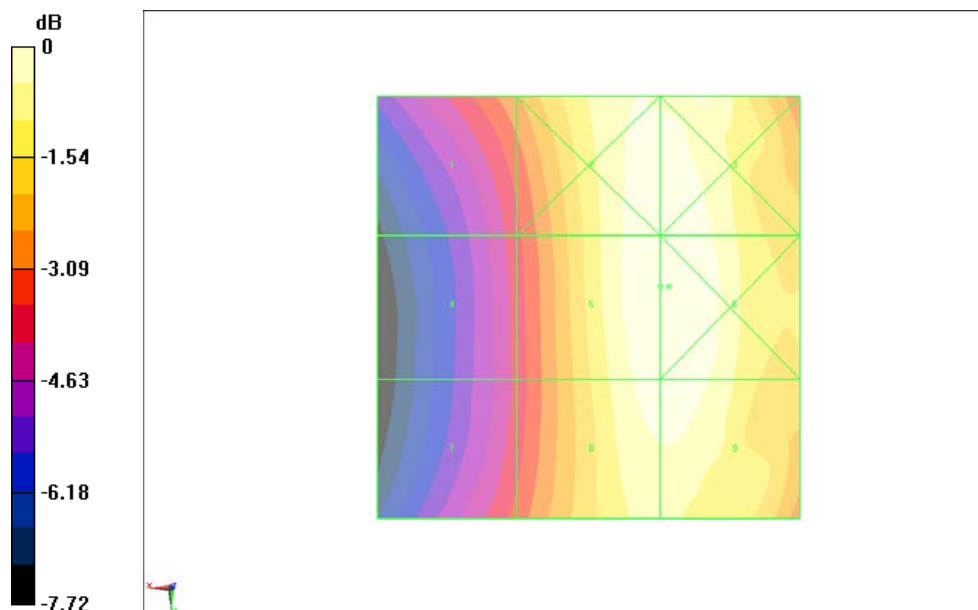

0 dB = 146.3 V/m = 43.30 dBV/m

**Fig B.3 HAC RF E-Field GSM 850 Low**

### HAC RF E-Field GSM 1900 High

Date: 2014-5-21

Electronics: DAE4 Sn1331

Medium: Air

Medium parameters used:  $\sigma = 0$  mho/m,  $\epsilon_r = 1$ ;  $\rho = 1000$  kg/m<sup>3</sup>

Ambient Temperature: 22.1°C

Communication System: DCS 1900; Frequency: 1909.8 MHz; Duty Cycle: 1:8.3

Probe: ER3DV6 - SN2428; ConvF(1, 1, 1)

### E Scan - ER3DV6 - 2007: 15 mm from Probe Center to the Device/Hearing Aid Compatibility Test (101x101x1): Interpolated grid: dx=0.5000 mm, dy=0.5000 mm

Device Reference Point: 0, 0, -6.3 mm

Reference Value = 25.61 V/m; Power Drift = -0.19 dB

PMR not calibrated. PMF = 2.884 is applied.

E-field emissions = 72.61 V/m

Near-field category: M3 (AWF -5 dB)

PMF scaled E-field

<b>Grid 1 M3</b> <b>69.21 V/m</b>	<b>Grid 2 M3</b> <b>72.61 V/m</b>	<b>Grid 3 M3</b> <b>71.94 V/m</b>
<b>Grid 4 M3</b> <b>52.67 V/m</b>	<b>Grid 5 M3</b> <b>58.38 V/m</b>	<b>Grid 6 M3</b> <b>58.36 V/m</b>
<b>Grid 7 M3</b> <b>74.95 V/m</b>	<b>Grid 8 M4</b> <b>39.25 V/m</b>	<b>Grid 9 M4</b> <b>37.80 V/m</b>

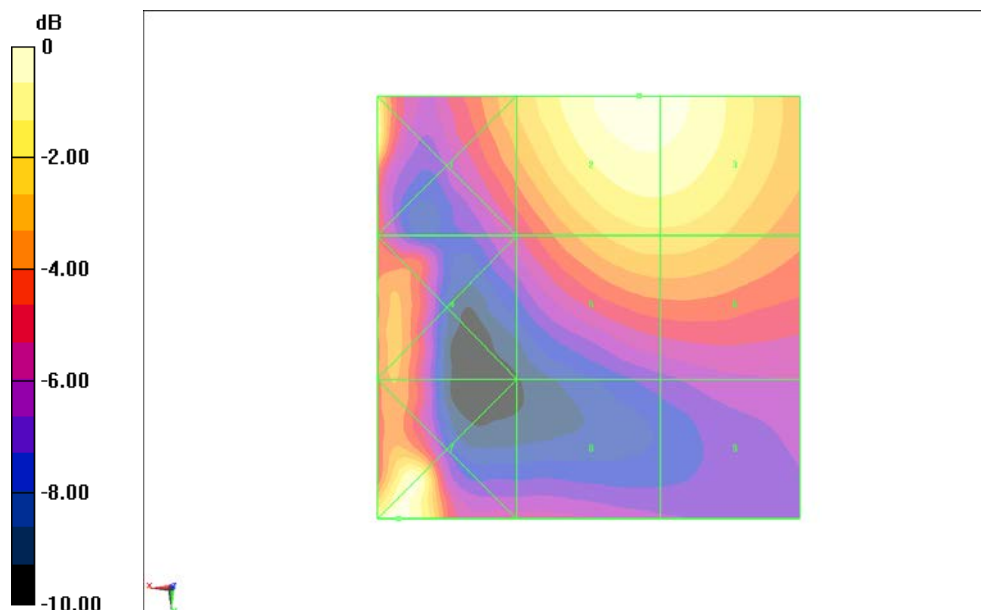

0 dB = 74.95 V/m = 37.50 dBV/m

**Fig B.4 HAC RF E-Field GSM 1900 High**



### HAC RF E-Field GSM 1900 Middle

Date: 2014-5-21

Electronics: DAE4 Sn1331

Medium: Air

Medium parameters used:  $\sigma = 0$  mho/m,  $\epsilon_r = 1$ ;  $\rho = 1000$  kg/m<sup>3</sup>

Ambient Temperature: 22.1°C

Communication System: DCS 1900; Frequency: 1880 MHz; Duty Cycle: 1:8.3

Probe: ER3DV6 - SN2428; ConvF(1, 1, 1)

### E Scan - ER3DV6 - 2007: 15 mm from Probe Center to the Device 2/Hearing Aid Compatibility Test (101x101x1): Interpolated grid: dx=0.5000 mm, dy=0.5000 mm

Device Reference Point: 0, 0, -6.3 mm

Reference Value = 15.88 V/m; Power Drift = 0.01 dB

PMR not calibrated. PMF = 2.884 is applied.

E-field emissions = 57.18 V/m

Near-field category: M3 (AWF -5 dB)

PMF scaled E-field

Grid 1 M3 57.81 V/m	Grid 2 M3 72.95 V/m	Grid 3 M3 71.82 V/m
Grid 4 M4 40.78 V/m	Grid 5 M3 57.18 V/m	Grid 6 M3 57.16 V/m
Grid 7 M4 42.33 V/m	Grid 8 M4 40.62 V/m	Grid 9 M4 38.36 V/m

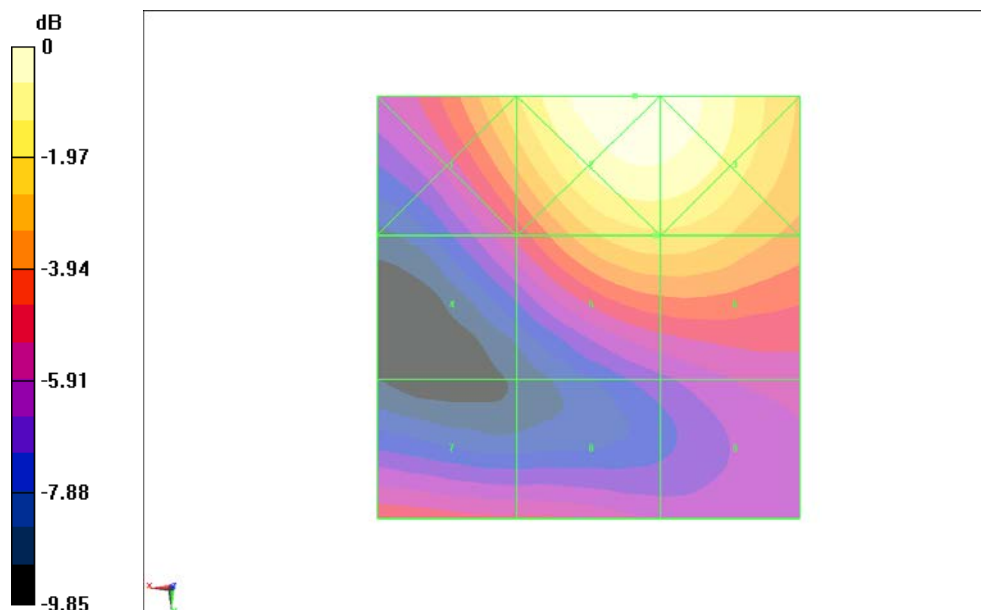

$$0 \text{ dB} = 72.95 \text{ V/m} = 37.26 \text{ dBV/m}$$

Fig B.5 HAC RF E-Field GSM 1900 Middle

**HAC RF E-Field GSM 1900 Low**

Date: 2014-5-21

Electronics: DAE4 Sn1331

Medium: Air

Medium parameters used:  $\sigma = 0$  mho/m,  $\epsilon_r = 1$ ;  $\rho = 1000$  kg/m<sup>3</sup>

Ambient Temperature: 22.1°C

Communication System: DCS 1900; Frequency: 1850.2 MHz; Duty Cycle: 1:8.3

Probe: ER3DV6 - SN2428; ConvF(1, 1, 1)

**E Scan - ER3DV6 - 2007: 15 mm from Probe Center to the Device 3/Hearing Aid Compatibility Test (101x101x1):** Interpolated grid: dx=0.5000 mm, dy=0.5000 mm

Device Reference Point: 0, 0, -6.3 mm

Reference Value = 15.42 V/m; Power Drift = -0.01 dB

PMR not calibrated. PMF = 2.884 is applied.

E-field emissions = 55.85 V/m

**Near-field category: M3 (AWF -5 dB)**

PMF scaled E-field

<b>Grid 1 M3</b> <b>60.22 V/m</b>	<b>Grid 2 M3</b> <b>73.47 V/m</b>	<b>Grid 3 M3</b> <b>71.81 V/m</b>
<b>Grid 4 M4</b> <b>41.87 V/m</b>	<b>Grid 5 M3</b> <b>55.85 V/m</b>	<b>Grid 6 M3</b> <b>55.73 V/m</b>
<b>Grid 7 M4</b> <b>42.68 V/m</b>	<b>Grid 8 M4</b> <b>40.92 V/m</b>	<b>Grid 9 M4</b> <b>36.68 V/m</b>

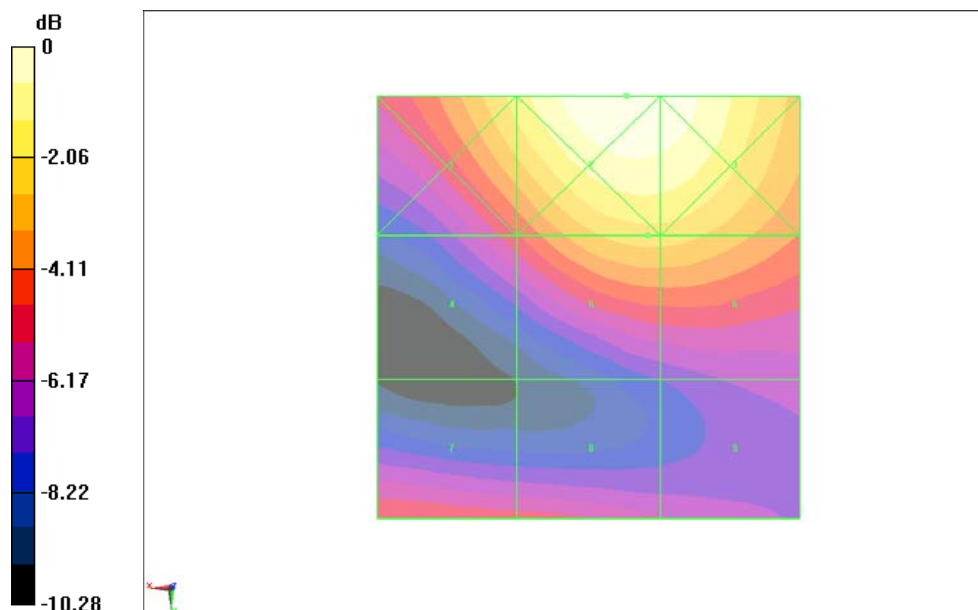

0 dB = 73.47 V/m = 37.32 dBV/m

**Fig B.6 HAC RF E-Field GSM 1900 Low**

### HAC RF E-Field WCDMA 850 High

Date: 2014-5-21

Electronics: DAE4 Sn1331

Medium: Air

Medium parameters used:  $\sigma = 0$  mho/m,  $\epsilon_r = 1$ ;  $\rho = 1000$  kg/m<sup>3</sup>

Ambient Temperature: 22.1°C

Communication System: WCDMA 850; Frequency: 846.6 MHz; Duty Cycle: 1:1

Probe: ER3DV6 - SN2428; ConvF(1, 1, 1)

### E Scan - ER3DV6 - 2007: 15 mm from Probe Center to the Device/Hearing Aid

Compatibility Test (101x101x1): Interpolated grid: dx=0.5000 mm, dy=0.5000 mm

Device Reference Point: 0, 0, -6.3 mm

Reference Value = 65.22 V/m; Power Drift = 0.01 dB

PMR not calibrated. PMF = 1.003 is applied.

E-field emissions = 59.26 V/m

Near-field category: M4 (AWF 0 dB)

PMF scaled E-field

Grid 1 M4 44.96 V/m	Grid 2 M4 59.00 V/m	Grid 3 M4 59.04 V/m
Grid 4 M4 40.07 V/m	Grid 5 M4 59.26 V/m	Grid 6 M4 59.37 V/m
Grid 7 M4 40.92 V/m	Grid 8 M4 57.97 V/m	Grid 9 M4 58.08 V/m

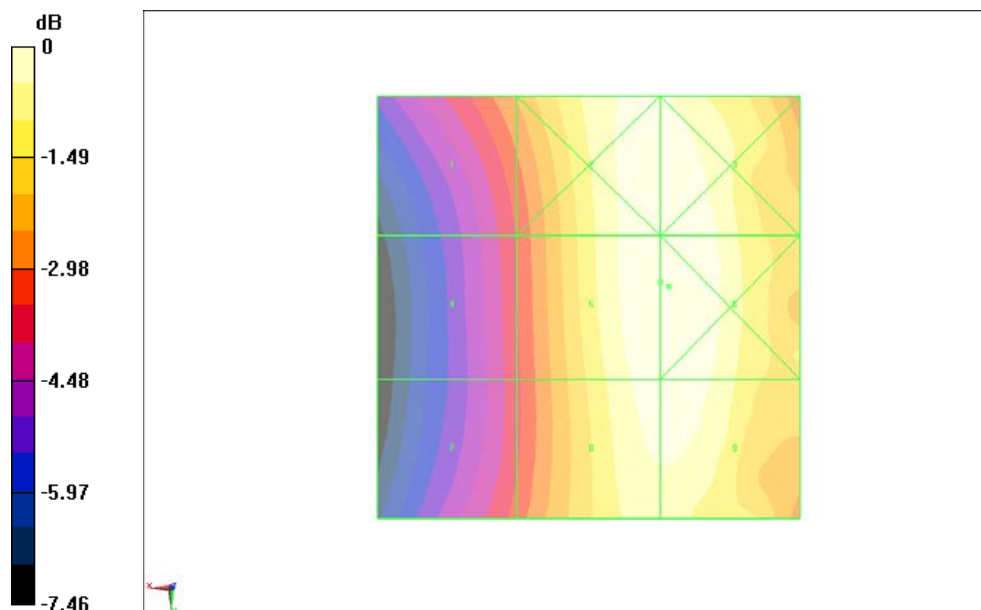

0 dB = 59.37 V/m = 35.47 dBV/m

Fig B.7 HAC RF E-Field WCDMA 850 High

### HAC RF E-Field WCDMA 850 Middle

Date: 2014-5-21

Electronics: DAE4 Sn1331

Medium: Air

Medium parameters used:  $\sigma = 0$  mho/m,  $\epsilon_r = 1$ ;  $\rho = 1000$  kg/m<sup>3</sup>

Ambient Temperature: 22.1°C

Communication System: WCDMA 850; Frequency: 836.4 MHz; Duty Cycle: 1:1

Probe: ER3DV6 - SN2428; ConvF(1, 1, 1)

### E Scan - ER3DV6 - 2007: 15 mm from Probe Center to the Device 2/Hearing Aid Compatibility Test (101x101x1): Interpolated grid: dx=0.5000 mm, dy=0.5000 mm

Device Reference Point: 0, 0, -6.3 mm

Reference Value = 65.10 V/m; Power Drift = -0.03 dB

PMR not calibrated. PMF = 1.003 is applied.

E-field emissions = 58.73 V/m

Near-field category: M4 (AWF 0 dB)

PMF scaled E-field

Grid 1 M4 44.76 V/m	Grid 2 M4 58.51 V/m	Grid 3 M4 58.54 V/m
Grid 4 M4 40.22 V/m	Grid 5 M4 58.73 V/m	Grid 6 M4 58.80 V/m
Grid 7 M4 40.88 V/m	Grid 8 M4 57.36 V/m	Grid 9 M4 57.45 V/m

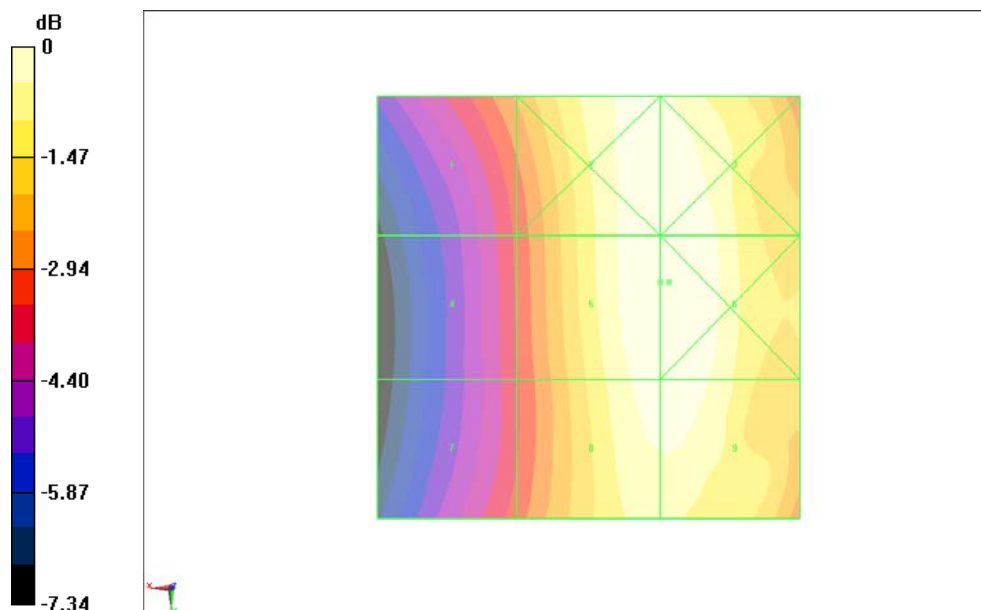

0 dB = 58.80 V/m = 35.39 dBV/m

Fig B.8 HAC RF E-Field WCDMA 850 Middle

### HAC RF E-Field WCDMA 850 Low

Date: 2014-5-21

Electronics: DAE4 Sn1331

Medium: Air

Medium parameters used:  $\sigma = 0$  mho/m,  $\epsilon_r = 1$ ;  $\rho = 1000$  kg/m<sup>3</sup>

Ambient Temperature: 22.1°C

Communication System: WCDMA 850; Frequency: 826.4 MHz; Duty Cycle: 1:1

Probe: ER3DV6 - SN2428; ConvF(1, 1, 1)

### E Scan - ER3DV6 - 2007: 15 mm from Probe Center to the Device 3/Hearing Aid Compatibility Test (101x101x1): Interpolated grid: dx=0.5000 mm, dy=0.5000 mm

Device Reference Point: 0, 0, -6.3 mm

Reference Value = 58.71 V/m; Power Drift = 0.05 dB

PMR not calibrated. PMF = 1.003 is applied.

E-field emissions = 57.11 V/m

Near-field category: M4 (AWF 0 dB)

PMF scaled E-field

Grid 1 M4 44.31 V/m	Grid 2 M4 60.15 V/m	Grid 3 M4 57.49 V/m
Grid 4 M4 36.70 V/m	Grid 5 M4 52.95 V/m	Grid 6 M4 53.02 V/m
Grid 7 M4 37.27 V/m	Grid 8 M4 55.18 V/m	Grid 9 M4 57.11 V/m

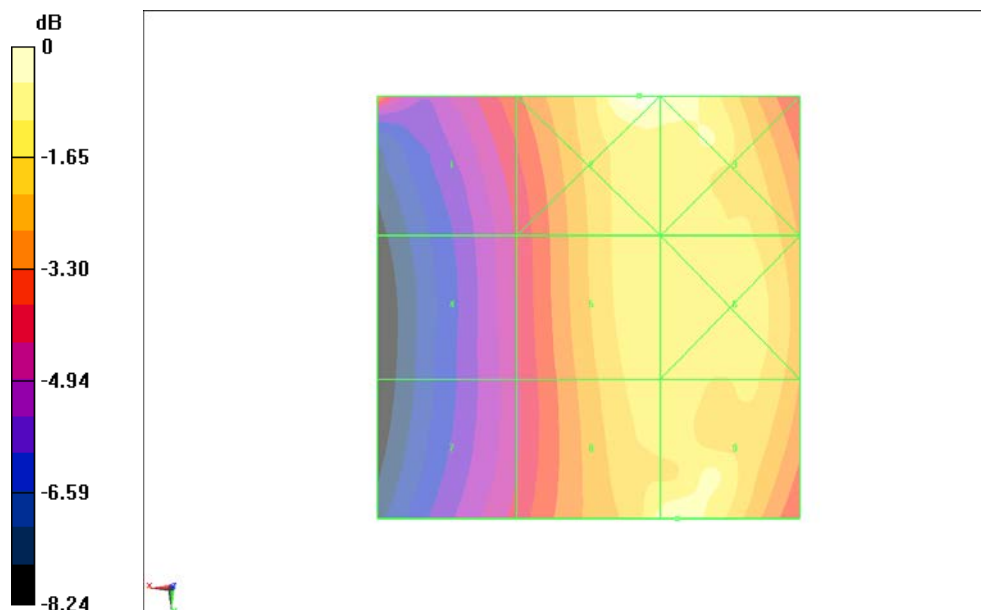

0 dB = 60.15 V/m = 35.58 dBV/m

Fig B.9 HAC RF E-Field WCDMA 850 Low

### HAC RF E-Field WCDMA 1900 High

Date: 2014-5-21

Electronics: DAE4 Sn1331

Medium: Air

Medium parameters used:  $\sigma = 0$  mho/m,  $\epsilon_r = 1$ ;  $\rho = 1000$  kg/m<sup>3</sup>

Ambient Temperature: 22.1°C

Communication System: WCDMA 1900; Frequency: 1907.6 MHz; Duty Cycle: 1:1

Probe: ER3DV6 - SN2428; ConvF(1, 1, 1)

### E Scan - ER3DV6 - 2007: 15 mm from Probe Center to the Device/Hearing Aid

Compatibility Test (101x101x1): Interpolated grid: dx=0.5000 mm, dy=0.5000 mm

Device Reference Point: 0, 0, -6.3 mm

Reference Value = 25.27 V/m; Power Drift = -0.04 dB

PMR not calibrated. PMF = 1.003 is applied.

E-field emissions = 30.20 V/m

Near-field category: M4 (AWF 0 dB)

PMF scaled E-field

Grid 1 M4 28.55 V/m	Grid 2 M4 37.43 V/m	Grid 3 M4 36.93 V/m
Grid 4 M4 20.90 V/m	Grid 5 M4 30.20 V/m	Grid 6 M4 30.18 V/m
Grid 7 M4 20.64 V/m	Grid 8 M4 19.88 V/m	Grid 9 M4 19.36 V/m

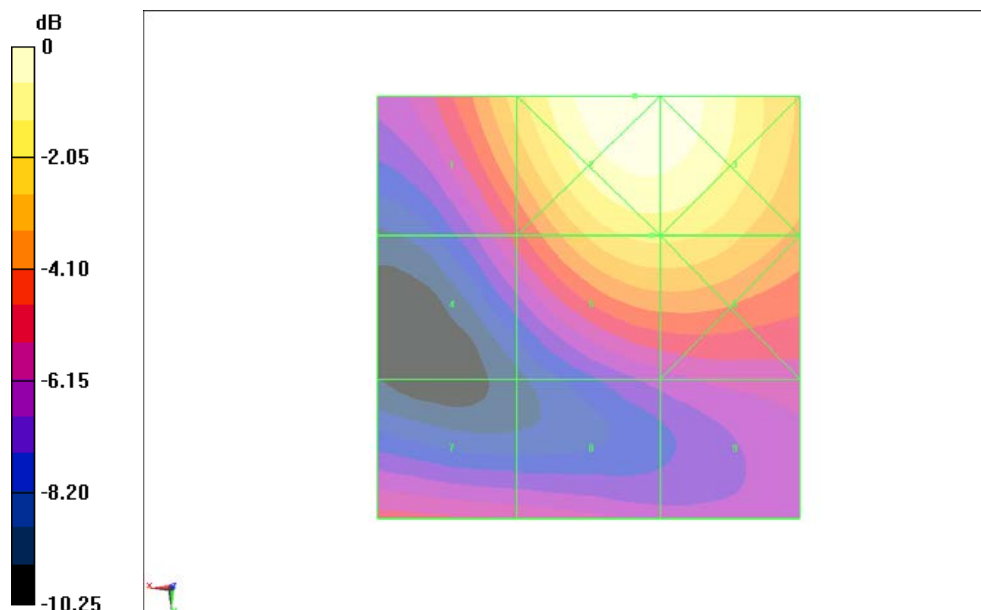

0 dB = 37.43 V/m = 31.46 dBV/m

Fig B.10 HAC RF E-Field WCDMA 1900 High

### HAC RF E-Field WCDMA 1900 Middle

Date: 2014-5-21

Electronics: DAE4 Sn1331

Medium: Air

Medium parameters used:  $\sigma = 0$  mho/m,  $\epsilon_r = 1$ ;  $\rho = 1000$  kg/m<sup>3</sup>

Ambient Temperature: 22.1°C

Communication System: WCDMA 1900; Frequency: 1880 MHz; Duty Cycle: 1:1

Probe: ER3DV6 - SN2428; ConvF(1, 1, 1)

### E Scan - ER3DV6 - 2007: 15 mm from Probe Center to the Device 2/Hearing Aid Compatibility Test (101x101x1): Interpolated grid: dx=0.5000 mm, dy=0.5000 mm

Device Reference Point: 0, 0, -6.3 mm

Reference Value = 23.27 V/m; Power Drift = -0.01 dB

PMR not calibrated. PMF = 1.003 is applied.

E-field emissions = 28.61 V/m

Near-field category: M4 (AWF 0 dB)

PMF scaled E-field

<b>Grid 1 M4</b> <b>29.02 V/m</b>	<b>Grid 2 M4</b> <b>36.44 V/m</b>	<b>Grid 3 M4</b> <b>35.94 V/m</b>
<b>Grid 4 M4</b> <b>20.68 V/m</b>	<b>Grid 5 M4</b> <b>28.61 V/m</b>	<b>Grid 6 M4</b> <b>28.59 V/m</b>
<b>Grid 7 M4</b> <b>21.08 V/m</b>	<b>Grid 8 M4</b> <b>20.06 V/m</b>	<b>Grid 9 M4</b> <b>18.90 V/m</b>

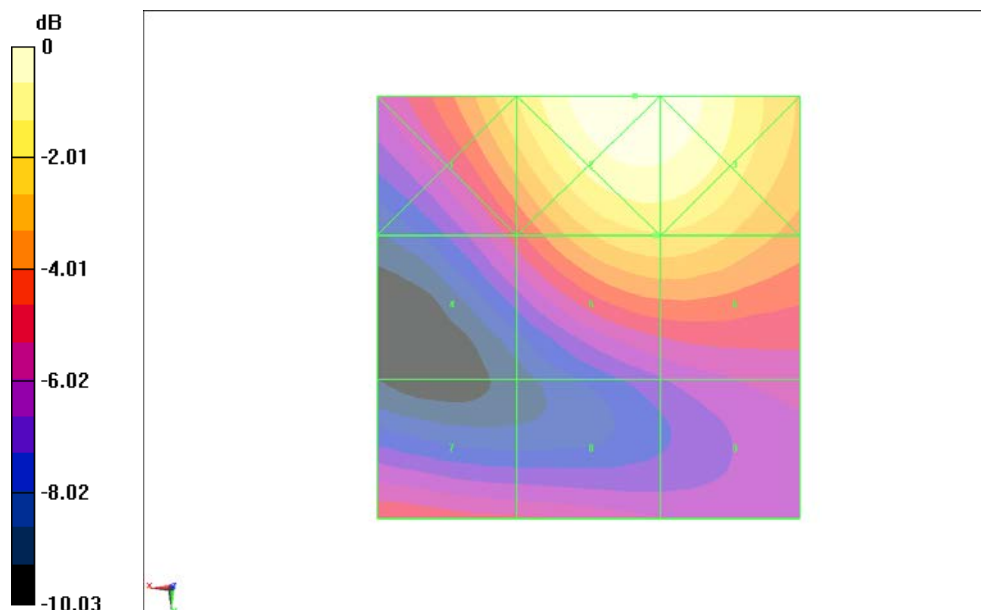

0 dB = 36.44 V/m = 31.23 dBV/m

Fig B.11 HAC RF E-Field WCDMA 1900 Middle

**HAC RF E-Field WCDMA 1900 Low**

Date: 2014-5-21

Electronics: DAE4 Sn1331

Medium: Air

Medium parameters used:  $\sigma = 0$  mho/m,  $\epsilon_r = 1$ ;  $\rho = 1000$  kg/m<sup>3</sup>

Ambient Temperature: 22.1°C

Communication System: WCDMA 1900; Frequency: 1852.4 MHz; Duty Cycle: 1:1

Probe: ER3DV6 - SN2428; ConvF(1, 1, 1)

**E Scan - ER3DV6 - 2007: 15 mm from Probe Center to the Device 3/Hearing Aid Compatibility Test (101x101x1):** Interpolated grid: dx=0.5000 mm, dy=0.5000 mm

Device Reference Point: 0, 0, -6.3 mm

Reference Value = 25.19 V/m; Power Drift = 0.03 dB

PMR not calibrated. PMF = 1.003 is applied.

E-field emissions = 31.53 V/m

**Near-field category: M4 (AWF 0 dB)**

PMF scaled E-field

<b>Grid 1 M4</b> <b>33.33 V/m</b>	<b>Grid 2 M4</b> <b>40.94 V/m</b>	<b>Grid 3 M4</b> <b>40.32 V/m</b>
<b>Grid 4 M4</b> <b>23.35 V/m</b>	<b>Grid 5 M4</b> <b>31.53 V/m</b>	<b>Grid 6 M4</b> <b>31.50 V/m</b>
<b>Grid 7 M4</b> <b>23.25 V/m</b>	<b>Grid 8 M4</b> <b>22.34 V/m</b>	<b>Grid 9 M4</b> <b>20.07 V/m</b>

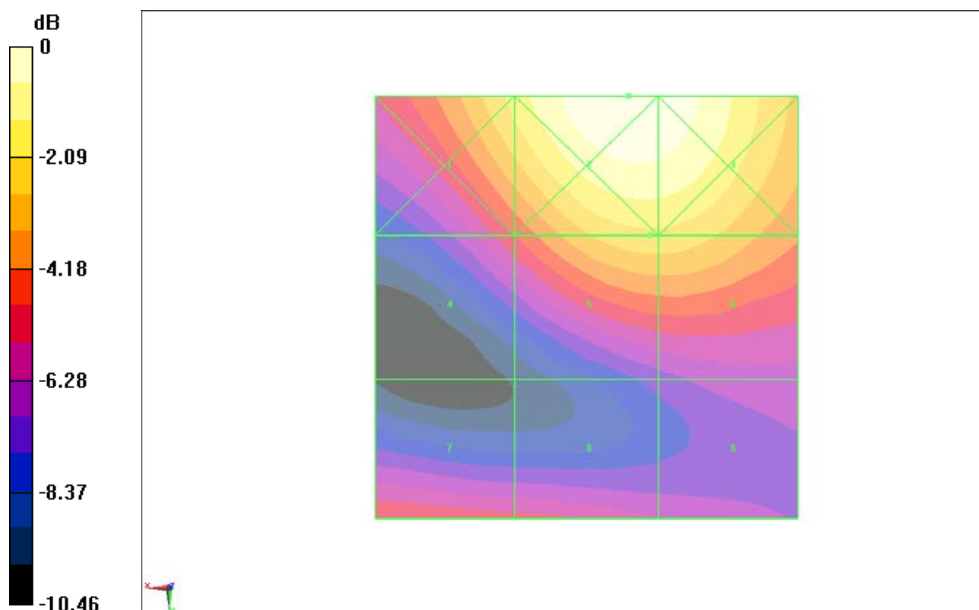

0 dB = 40.94 V/m = 32.24 dBV/m

**Fig B.12 HAC RF E-Field WCDMA 1900 Low**



### HAC RF H-Field GSM 850 High

Date: 2014-5-21

Electronics: DAE4 Sn1331

Medium: Air

Medium parameters used:  $\sigma = 0$  mho/m,  $\epsilon_r = 1$ ;  $\rho = 1$  kg/m<sup>3</sup>

Ambient Temperature: 22.1°C

Communication System: GSM 850; Frequency: 848.8 MHz; Duty Cycle: 1:8.3

Probe: H3DV6 - SN6260;

### H Scan - H3DV6 - 2007: 15 mm from Probe Center to the Device/Hearing Aid Compatibility Test (101x101x1): Interpolated grid: dx=0.5000 mm, dy=0.5000 mm

Device Reference Point: 0, 0, -6.3 mm

Reference Value = 0.1020 A/m; Power Drift = 0.03 dB

PMR not calibrated. PMF = 2.876 is applied.

H-field emissions = 0.3571 A/m

Near-field category: M4 (AWF -5 dB)

PMF scaled H-field

Grid 1 M3 0.469 A/m	Grid 2 M4 0.356 A/m	Grid 3 M4 0.213 A/m
Grid 4 M3 0.470 A/m	Grid 5 M4 0.352 A/m	Grid 6 M4 0.206 A/m
Grid 7 M3 0.475 A/m	Grid 8 M4 0.357 A/m	Grid 9 M4 0.212 A/m

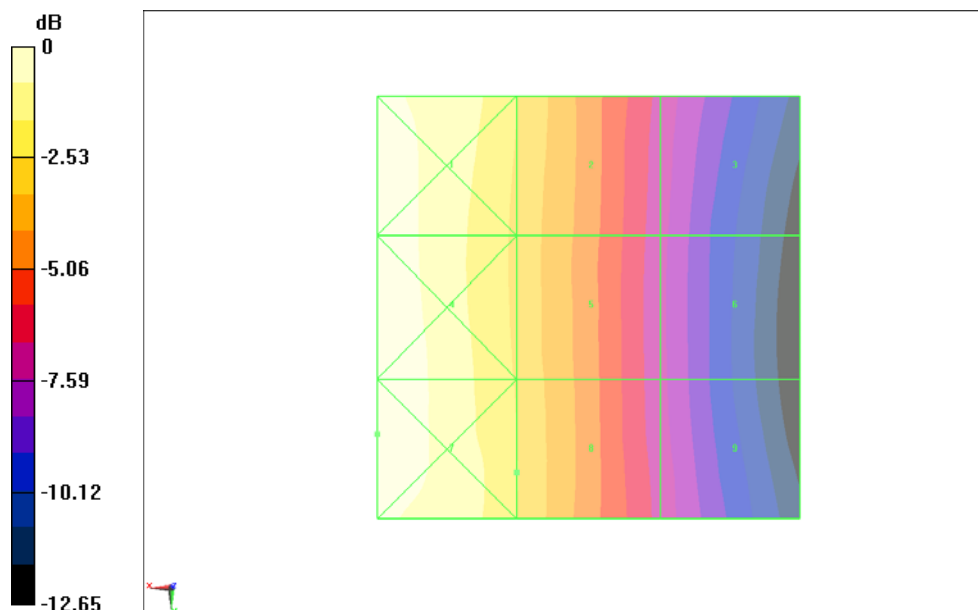

0 dB = 0.4753 A/m = -6.46 dBA/m

Fig B.13 HAC RF H-Field GSM 850 High

### HAC RF H-Field GSM 850 Middle

Date: 2014-5-21

Electronics: DAE4 Sn1331

Medium: Air

Medium parameters used:  $\sigma = 0$  mho/m,  $\epsilon_r = 1$ ;  $\rho = 1$  kg/m<sup>3</sup>

Ambient Temperature: 22.1°C

Communication System: GSM 850; Frequency: 836.6 MHz; Duty Cycle: 1:8.3

Probe: H3DV6 - SN6260;

### H Scan - H3DV6 - 2007: 15 mm from Probe Center to the Device 2/Hearing Aid Compatibility Test (101x101x1): Interpolated grid: dx=0.5000 mm, dy=0.5000 mm

Device Reference Point: 0, 0, -6.3 mm

Reference Value = 0.09300 A/m; Power Drift = 0.02 dB

PMR not calibrated. PMF = 2.876 is applied.

H-field emissions = 0.3260 A/m

Near-field category: M4 (AWF -5 dB)

PMF scaled H-field

Grid 1 M4 0.429 A/m	Grid 2 M4 0.319 A/m	Grid 3 M4 0.188 A/m
Grid 4 M4 0.436 A/m	Grid 5 M4 0.319 A/m	Grid 6 M4 0.184 A/m
Grid 7 M4 0.440 A/m	Grid 8 M4 0.326 A/m	Grid 9 M4 0.194 A/m

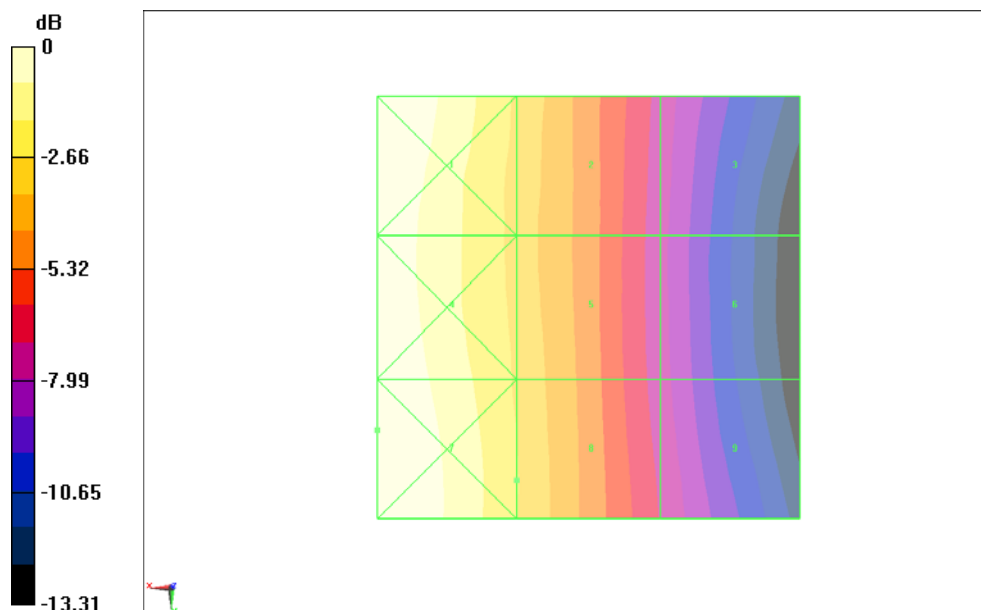

0 dB = 0.4397 A/m = -7.14 dBA/m

Fig B.14 HAC RF H-Field GSM 850 Middle

### HAC RF H-Field GSM 850 Low

Date: 2014-5-21

Electronics: DAE4 Sn1331

Medium: Air

Medium parameters used:  $\sigma = 0$  mho/m,  $\epsilon_r = 1$ ;  $\rho = 1$  kg/m<sup>3</sup>

Ambient Temperature: 22.1°C

Communication System: GSM 850; Frequency: 824.2 MHz; Duty Cycle: 1:8.3

Probe: H3DV6 - SN6260;

### H Scan - H3DV6 - 2007: 15 mm from Probe Center to the Device 3/Hearing Aid Compatibility Test (101x101x1): Interpolated grid: dx=0.5000 mm, dy=0.5000 mm

Device Reference Point: 0, 0, -6.3 mm

Reference Value = 0.08200 A/m; Power Drift = -0.01 dB

PMR not calibrated. PMF = 2.876 is applied.

H-field emissions = 0.2811 A/m

Near-field category: M4 (AWF -5 dB)

PMF scaled H-field

Grid 1 M4 0.390 A/m	Grid 2 M4 0.278 A/m	Grid 3 M4 0.167 A/m
Grid 4 M4 0.377 A/m	Grid 5 M4 0.278 A/m	Grid 6 M4 0.164 A/m
Grid 7 M4 0.391 A/m	Grid 8 M4 0.281 A/m	Grid 9 M4 0.165 A/m

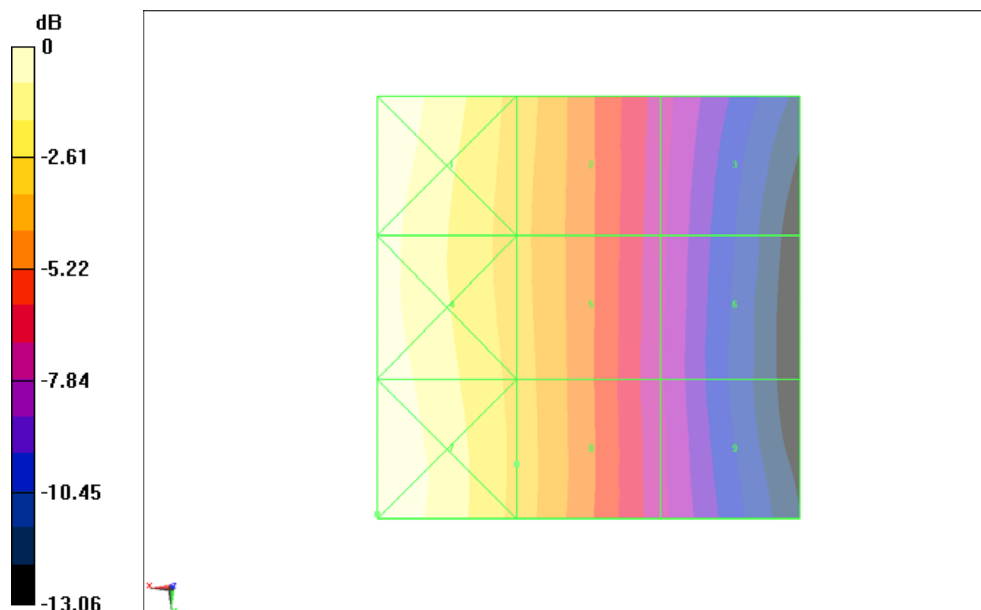

0 dB = 0.3910 A/m = -8.16 dBA/m

Fig B.15 HAC RF H-Field GSM 850 Low

### HAC RF H-Field GSM 1900 High

Date: 2014-5-21

Electronics: DAE4 Sn1331

Medium: Air

Medium parameters used:  $\sigma = 0$  mho/m,  $\epsilon_r = 1$ ;  $\rho = 1$  kg/m<sup>3</sup>

Ambient Temperature: 22.1°C

Communication System: DCS 1900; Frequency: 1909.8 MHz; Duty Cycle: 1:8.3

Probe: H3DV6 - SN6260;

### H Scan - H3DV6 - 2007: 15 mm from Probe Center to the Device/Hearing Aid Compatibility Test (101x101x1): Interpolated grid: dx=0.5000 mm, dy=0.5000 mm

Device Reference Point: 0, 0, -6.3 mm

Reference Value = 0.06000 A/m; Power Drift = 0.04 dB

PMR not calibrated. PMF = 2.865 is applied.

H-field emissions = 0.1604 A/m

Near-field category: M3 (AWF -5 dB)

PMF scaled H-field

Grid 1 M3 0.203 A/m	Grid 2 M3 0.173 A/m	Grid 3 M3 0.150 A/m
Grid 4 M3 0.150 A/m	Grid 5 M3 0.160 A/m	Grid 6 M3 0.160 A/m
Grid 7 M4 0.132 A/m	Grid 8 M3 0.159 A/m	Grid 9 M3 0.159 A/m

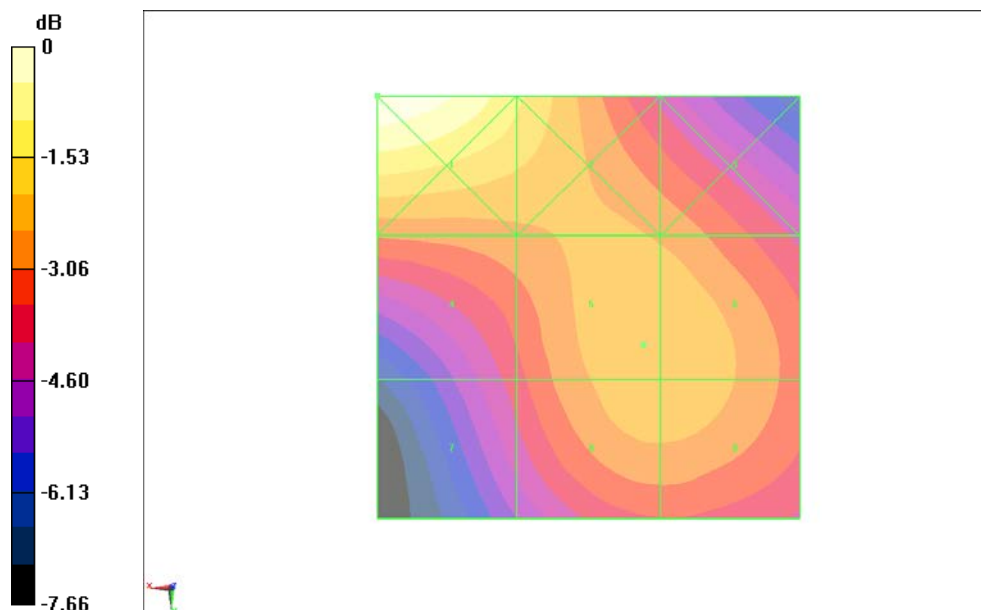

0 dB = 0.2033 A/m = -13.84 dBA/m

Fig B.16 HAC RF H-Field GSM 1900 High

### HAC RF H-Field GSM 1900 Middle

Date: 2014-5-21

Electronics: DAE4 Sn1331

Medium: Air

Medium parameters used:  $\sigma = 0$  mho/m,  $\epsilon_r = 1$ ;  $\rho = 1$  kg/m<sup>3</sup>

Ambient Temperature: 22.1°C

Communication System: DCS 1900; Frequency: 1880 MHz; Duty Cycle: 1:8.3

Probe: H3DV6 - SN6260;

### H Scan - H3DV6 - 2007: 15 mm from Probe Center to the Device 2/Hearing Aid Compatibility Test (101x101x1): Interpolated grid: dx=0.5000 mm, dy=0.5000 mm

Device Reference Point: 0, 0, -6.3 mm

Reference Value = 0.05900 A/m; Power Drift = -0.02 dB

PMR not calibrated. PMF = 2.865 is applied.

H-field emissions = 0.1563 A/m

Near-field category: M3 (AWF -5 dB)

PMF scaled H-field

Grid 1 M3 0.197 A/m	Grid 2 M3 0.167 A/m	Grid 3 M3 0.147 A/m
Grid 4 M3 0.145 A/m	Grid 5 M3 0.156 A/m	Grid 6 M3 0.156 A/m
Grid 7 M4 0.129 A/m	Grid 8 M3 0.155 A/m	Grid 9 M3 0.155 A/m

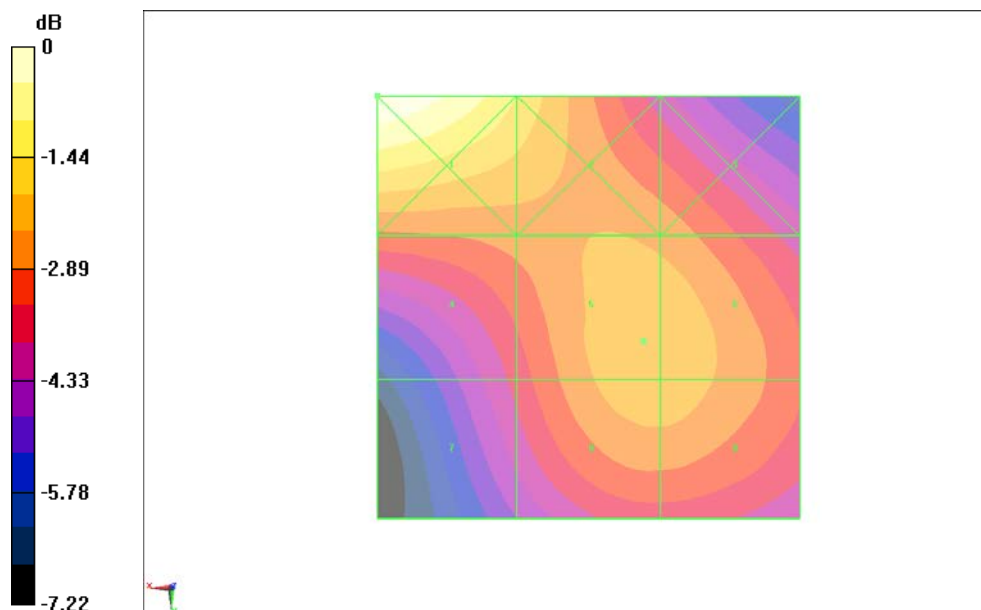

0 dB = 0.1970 A/m = -14.11 dBA/m

Fig B.17 HAC RF H-Field GSM 1900 Middle

**HAC RF H-Field GSM 1900 Low**

Date: 2014-5-21

Electronics: DAE4 Sn1331

Medium: Air

Medium parameters used:  $\sigma = 0$  mho/m,  $\epsilon_r = 1$ ;  $\rho = 1$  kg/m<sup>3</sup>

Ambient Temperature: 22.1°C

Communication System: DCS 1900; Frequency: 1850.2 MHz; Duty Cycle: 1:8.3

Probe: H3DV6 - SN6260;

**H Scan - H3DV6 - 2007: 15 mm from Probe Center to the Device 3/Hearing Aid Compatibility Test (101x101x1):** Interpolated grid: dx=0.5000 mm, dy=0.5000 mm

Device Reference Point: 0, 0, -6.3 mm

Reference Value = 0.06000 A/m; Power Drift = 0.06 dB

PMR not calibrated. PMF = 2.865 is applied.

H-field emissions = 0.1586 A/m

**Near-field category: M3 (AWF -5 dB)**

PMF scaled H-field

<b>Grid 1 M3</b> <b>0.202 A/m</b>	<b>Grid 2 M3</b> <b>0.167 A/m</b>	<b>Grid 3 M3</b> <b>0.147 A/m</b>
<b>Grid 4 M3</b> <b>0.145 A/m</b>	<b>Grid 5 M3</b> <b>0.159 A/m</b>	<b>Grid 6 M3</b> <b>0.158 A/m</b>
<b>Grid 7 M4</b> <b>0.132 A/m</b>	<b>Grid 8 M3</b> <b>0.158 A/m</b>	<b>Grid 9 M3</b> <b>0.157 A/m</b>

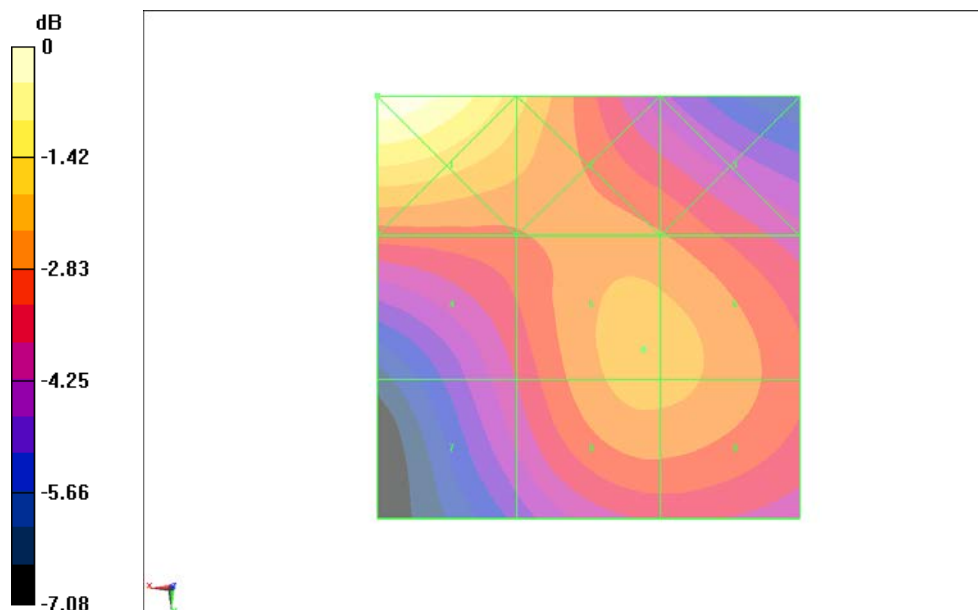

0 dB = 0.2023 A/m = -13.88 dBA/m

**Fig B.18 HAC RF H-Field GSM 1900 Low**

### HAC RF H-Field WCDMA 850 High

Date: 2014-5-21

Electronics: DAE4 Sn1331

Medium: Air

Medium parameters used:  $\sigma = 0$  mho/m,  $\epsilon_r = 1$ ;  $\rho = 1$  kg/m<sup>3</sup>

Ambient Temperature: 22.1°C

Communication System: WCDMA 850; Frequency: 846.6 MHz; Duty Cycle: 1:1

Probe: H3DV6 - SN6260;

### H Scan - H3DV6 - 2007: 15 mm from Probe Center to the Device/Hearing Aid Compatibility Test (101x101x1): Interpolated grid: dx=0.5000 mm, dy=0.5000 mm

Device Reference Point: 0, 0, -6.3 mm

Reference Value = 0.09200 A/m; Power Drift = 0.01 dB

PMR not calibrated. PMF = 1.006 is applied.

H-field emissions = 0.1152 A/m

Near-field category: M4 (AWF 0 dB)

PMF scaled H-field

<b>Grid 1 M4</b> <b>0.156 A/m</b>	<b>Grid 2 M4</b> <b>0.114 A/m</b>	<b>Grid 3 M4</b> <b>0.069 A/m</b>
<b>Grid 4 M4</b> <b>0.149 A/m</b>	<b>Grid 5 M4</b> <b>0.112 A/m</b>	<b>Grid 6 M4</b> <b>0.067 A/m</b>
<b>Grid 7 M4</b> <b>0.157 A/m</b>	<b>Grid 8 M4</b> <b>0.115 A/m</b>	<b>Grid 9 M4</b> <b>0.070 A/m</b>

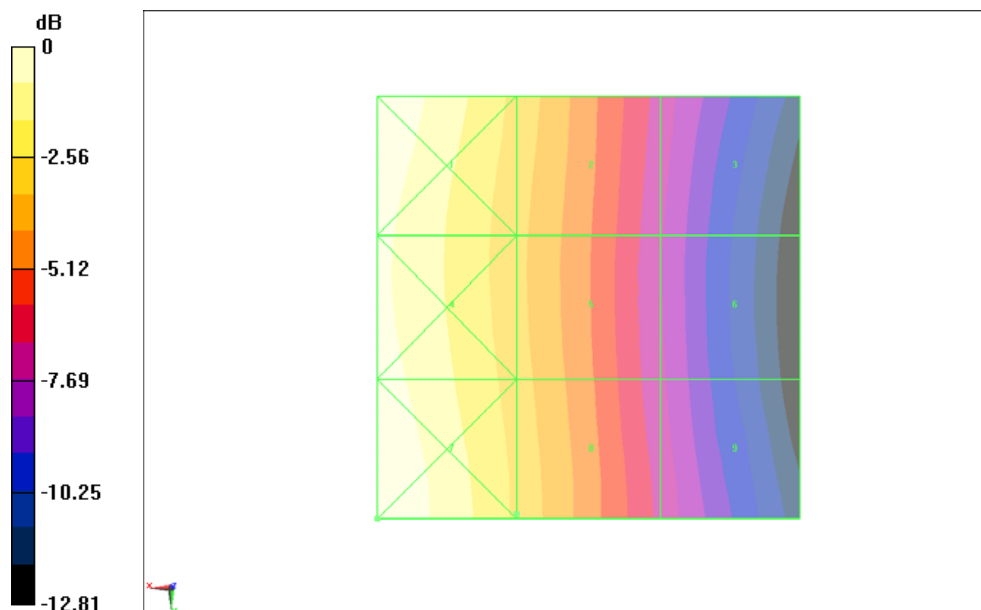

0 dB = 0.1575 A/m = -16.05 dBA/m

**Fig B.19 HAC RF H-Field WCDMA 850 High**

### HAC RF H-Field WCDMA 850 Middle

Date: 2014-5-21

Electronics: DAE4 Sn1331

Medium: Air

Medium parameters used:  $\sigma = 0$  mho/m,  $\epsilon_r = 1$ ;  $\rho = 1$  kg/m<sup>3</sup>

Ambient Temperature: 22.1°C

Communication System: WCDMA 850; Frequency: 836.4 MHz; Duty Cycle: 1:1

Probe: H3DV6 - SN6260;

### H Scan - H3DV6 - 2007: 15 mm from Probe Center to the Device 2/Hearing Aid Compatibility Test (101x101x1): Interpolated grid: dx=0.5000 mm, dy=0.5000 mm

Device Reference Point: 0, 0, -6.3 mm

Reference Value = 0.08700 A/m; Power Drift = 0.00 dB

PMR not calibrated. PMF = 1.006 is applied.

H-field emissions = 0.1100 A/m

Near-field category: M4 (AWF 0 dB)

PMF scaled H-field

Grid 1 M4 0.149 A/m	Grid 2 M4 0.107 A/m	Grid 3 M4 0.064 A/m
Grid 4 M4 0.143 A/m	Grid 5 M4 0.106 A/m	Grid 6 M4 0.063 A/m
Grid 7 M4 0.152 A/m	Grid 8 M4 0.110 A/m	Grid 9 M4 0.067 A/m

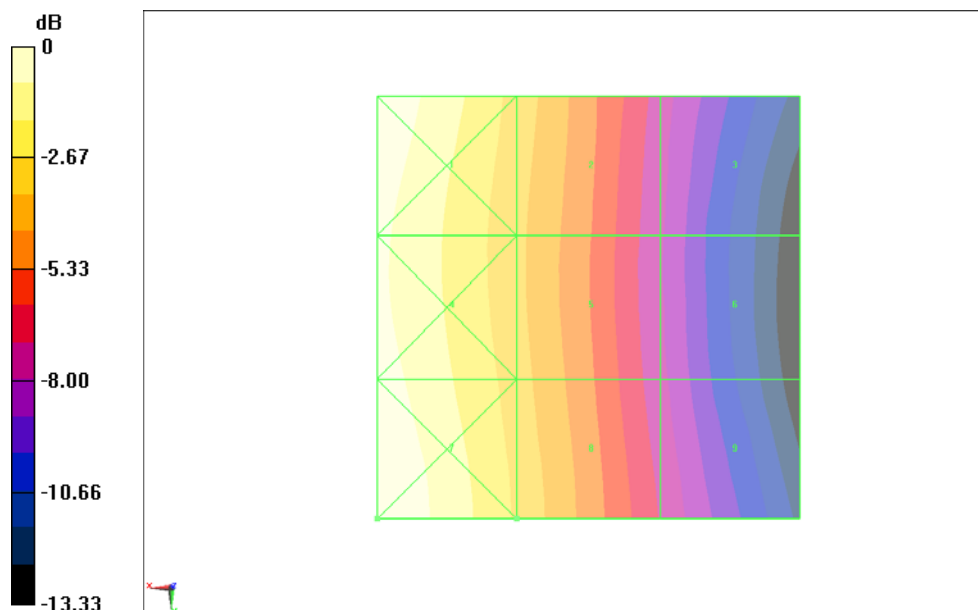

0 dB = 0.1517 A/m = -16.38 dBA/m

Fig B.20 HAC RF H-Field WCDMA 850 Middle



### HAC RF H-Field WCDMA 850 Low

Date: 2014-5-21

Electronics: DAE4 Sn1331

Medium: Air

Medium parameters used:  $\sigma = 0$  mho/m,  $\epsilon_r = 1$ ;  $\rho = 1$  kg/m<sup>3</sup>

Ambient Temperature: 22.1°C

Communication System: WCDMA 850; Frequency: 826.4 MHz; Duty Cycle: 1:1

Probe: H3DV6 - SN6260;

### H Scan - H3DV6 - 2007: 15 mm from Probe Center to the Device 3/Hearing Aid Compatibility Test (101x101x1): Interpolated grid: dx=0.5000 mm, dy=0.5000 mm

Device Reference Point: 0, 0, -6.3 mm

Reference Value = 0.08100 A/m; Power Drift = 0.03 dB

PMR not calibrated. PMF = 1.006 is applied.

H-field emissions = 0.1003 A/m

Near-field category: M4 (AWF 0 dB)

PMF scaled H-field

Grid 1 M4 0.137 A/m	Grid 2 M4 0.099 A/m	Grid 3 M4 0.060 A/m
Grid 4 M4 0.132 A/m	Grid 5 M4 0.098 A/m	Grid 6 M4 0.058 A/m
Grid 7 M4 0.138 A/m	Grid 8 M4 0.100 A/m	Grid 9 M4 0.061 A/m

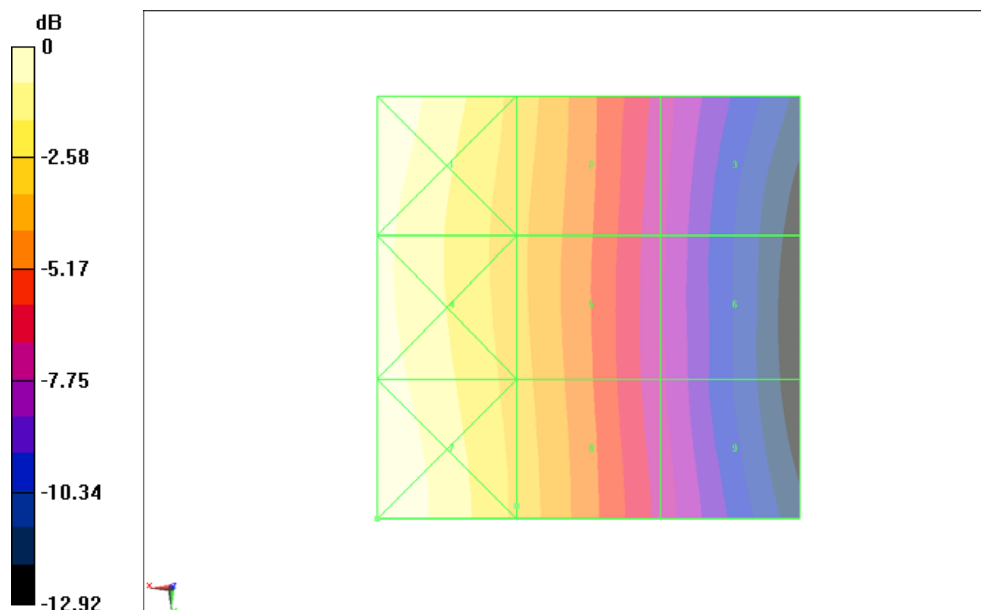

0 dB = 0.1384 A/m = -17.18 dBA/m

Fig B.21 HAC RF H-Field WCDMA 850 Low

### HAC RF H-Field WCDMA 1900 High

Date: 2014-5-21

Electronics: DAE4 Sn1331

Medium: Air

Medium parameters used:  $\sigma = 0$  mho/m,  $\epsilon_r = 1$ ;  $\rho = 1$  kg/m<sup>3</sup>

Ambient Temperature: 22.1°C

Communication System: WCDMA 1900; Frequency: 1907.6 MHz; Duty Cycle: 1:1

Probe: H3DV6 - SN6260;

### H Scan - H3DV6 - 2007: 15 mm from Probe Center to the Device/Hearing Aid Compatibility Test (101x101x1): Interpolated grid: dx=0.5000 mm, dy=0.5000 mm

Device Reference Point: 0, 0, -6.3 mm

Reference Value = 0.08600 A/m; Power Drift = 0.01 dB

PMR not calibrated. PMF = 1.004 is applied.

H-field emissions = 0.08167 A/m

Near-field category: M4 (AWF 0 dB)

PMF scaled H-field

Grid 1 M4 0.093 A/m	Grid 2 M4 0.088 A/m	Grid 3 M4 0.077 A/m
Grid 4 M4 0.075 A/m	Grid 5 M4 0.082 A/m	Grid 6 M4 0.082 A/m
Grid 7 M4 0.067 A/m	Grid 8 M4 0.081 A/m	Grid 9 M4 0.081 A/m

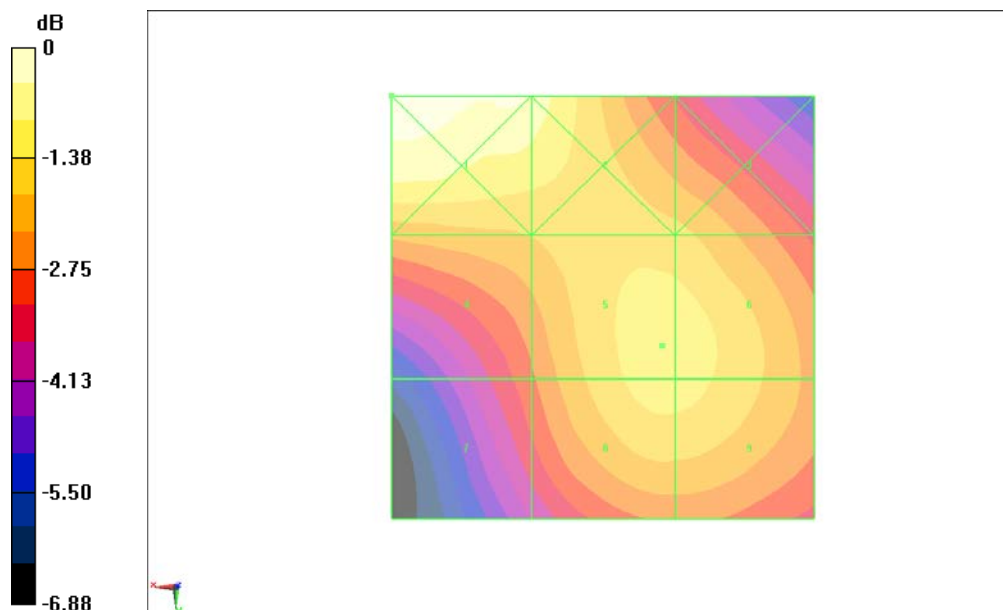

0 dB = 0.09301 A/m = -20.63 dBA/m

Fig B.22 HAC RF H-Field WCDMA 1900 High

### HAC RF H-Field WCDMA 1900 Middle

Date: 2014-5-21

Electronics: DAE4 Sn1331

Medium: Air

Medium parameters used:  $\sigma = 0$  mho/m,  $\epsilon_r = 1$ ;  $\rho = 1$  kg/m<sup>3</sup>

Ambient Temperature: 22.1°C

Communication System: WCDMA 1900; Frequency: 1880 MHz; Duty Cycle: 1:1

Probe: H3DV6 - SN6260;

### H Scan - H3DV6 - 2007: 15 mm from Probe Center to the Device 2/Hearing Aid Compatibility Test (101x101x1): Interpolated grid: dx=0.5000 mm, dy=0.5000 mm

Device Reference Point: 0, 0, -6.3 mm

Reference Value = 0.08300 A/m; Power Drift = -0.03 dB

PMR not calibrated. PMF = 1.004 is applied.

H-field emissions = 0.07721 A/m

Near-field category: M4 (AWF 0 dB)

PMF scaled H-field

Grid 1 M4 0.089 A/m	Grid 2 M4 0.082 A/m	Grid 3 M4 0.072 A/m
Grid 4 M4 0.071 A/m	Grid 5 M4 0.077 A/m	Grid 6 M4 0.077 A/m
Grid 7 M4 0.064 A/m	Grid 8 M4 0.077 A/m	Grid 9 M4 0.076 A/m

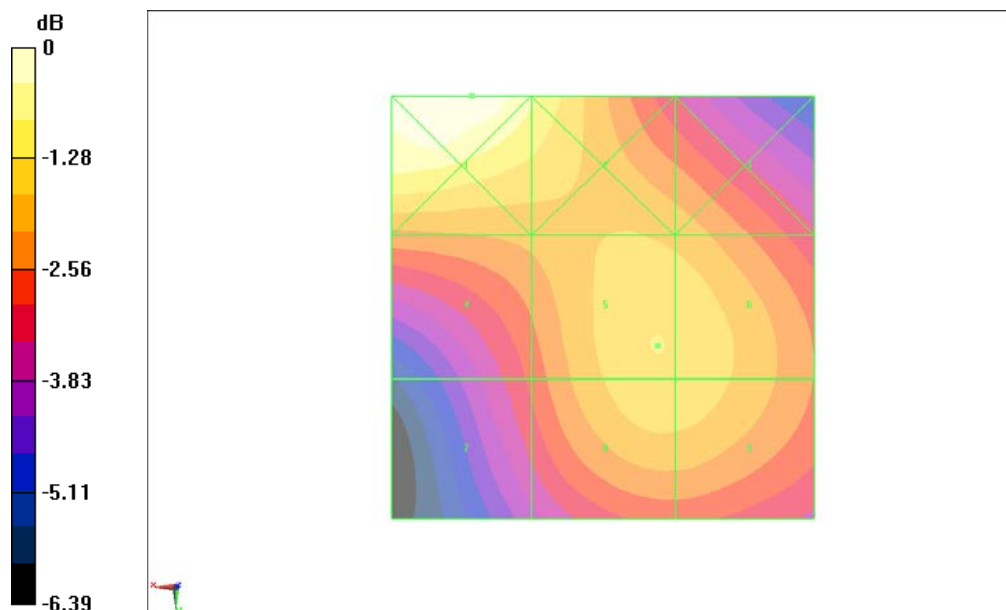

0 dB = 0.08932 A/m = -20.98 dBA/m

Fig B.23 HAC RF H-Field WCDMA 1900 Middle

**HAC RF H-Field WCDMA 1900 Low**

Date: 2014-5-21

Electronics: DAE4 Sn1331

Medium: Air

Medium parameters used:  $\sigma = 0$  mho/m,  $\epsilon_r = 1$ ;  $\rho = 1$  kg/m<sup>3</sup>

Ambient Temperature: 22.1°C

Communication System: WCDMA 1900; Frequency: 1852.4 MHz; Duty Cycle: 1:1

Probe: H3DV6 - SN6260;

**H Scan - H3DV6 - 2007: 15 mm from Probe Center to the Device 3/Hearing Aid Compatibility Test (101x101x1):** Interpolated grid: dx=0.5000 mm, dy=0.5000 mm

Device Reference Point: 0, 0, -6.3 mm

Reference Value = 0.09000 A/m; Power Drift = -0.03 dB

PMR not calibrated. PMF = 1.004 is applied.

H-field emissions = 0.08719 A/m

**Near-field category: M4 (AWF 0 dB)**

PMF scaled H-field

<b>Grid 1 M4</b> <b>0.101 A/m</b>	<b>Grid 2 M4</b> <b>0.092 A/m</b>	<b>Grid 3 M4</b> <b>0.081 A/m</b>
<b>Grid 4 M4</b> <b>0.080 A/m</b>	<b>Grid 5 M4</b> <b>0.087 A/m</b>	<b>Grid 6 M4</b> <b>0.087 A/m</b>
<b>Grid 7 M4</b> <b>0.073 A/m</b>	<b>Grid 8 M4</b> <b>0.087 A/m</b>	<b>Grid 9 M4</b> <b>0.086 A/m</b>

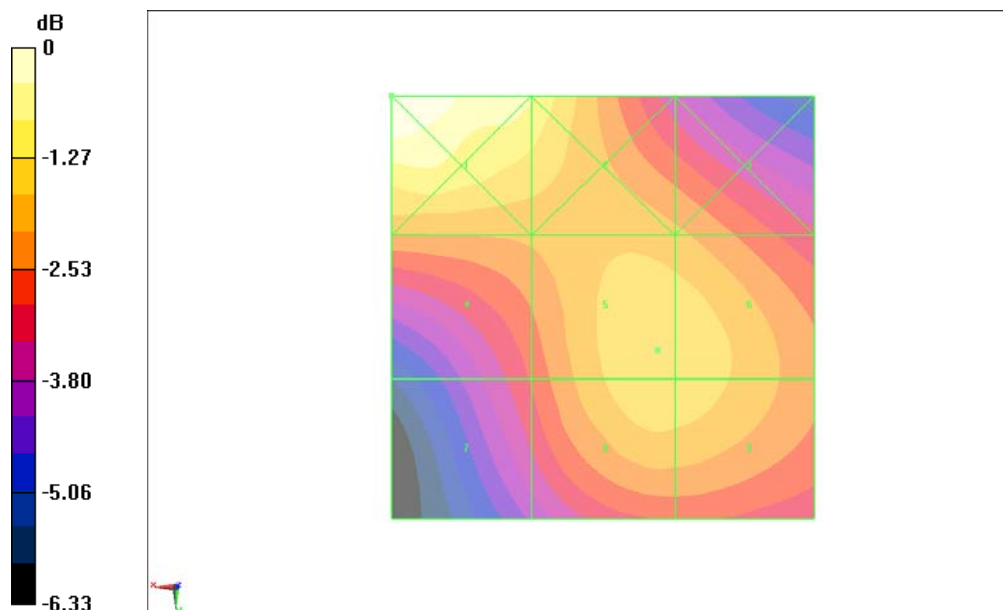

0 dB = 0.1012 A/m = -19.90 dBA/m

**Fig B.24 HAC RF H-Field WCDMA 1900 Low**

**Total M-rating of GSM 850 MHz Band**

Date: 2014-5-21

Electronics: DAE4 Sn1331

Medium: Air

Medium parameters used:  $\sigma = 0$  mho/m,  $\epsilon_r = 1$ ;  $\rho = 1000$  kg/m<sup>3</sup> Medium parameters used:  $\sigma = 0$  mho/m,  $\epsilon_r = 1$ ;  $\rho = 1$  kg/m<sup>3</sup>

Ambient Temperature: 22.1°C

Communication System: GSM 850; Frequency: 848.8 MHz; Duty Cycle: 1:8.3

Probe: ER3DV6 - SN2428 Probe: H3DV6 - SN6260; ConvF(1, 1, 1)

**E Scan - ER3DV6 - 2007: 15 mm from Probe Center to the Device/Hearing Aid Compatibility Test (101x101x1):** Interpolated grid: dx=0.5000 mm, dy=0.5000 mm

Device Reference Point: 0, 0, -6.3 mm

Reference Value = 67.21 V/m; Power Drift = 0.02 dB

PMR not calibrated. PMF = 2.876 is applied.

E-field emissions = 183.8 V/m

**Near-field category: M3 (AWF -5 dB)**

PMF scaled E-field

Grid 1 <b>M4</b> <b>134.3 V/m</b>	Grid 2 <b>M3</b> <b>181.9 V/m</b>	Grid 3 <b>M3</b> <b>182.5 V/m</b>
Grid 4 <b>M4</b> <b>116.2 V/m</b>	Grid 5 <b>M3</b> <b>182.9 V/m</b>	Grid 6 <b>M3</b> <b>183.8 V/m</b>
Grid 7 <b>M4</b> <b>121.3 V/m</b>	Grid 8 <b>M3</b> <b>179.0 V/m</b>	Grid 9 <b>M3</b> <b>179.9 V/m</b>

**H Scan - H3DV6 - 2007: 15 mm from Probe Center to the Device/Hearing Aid**

**Compatibility Test (101x101x1):** Interpolated grid: dx=0.5000 mm, dy=0.5000 mm

Device Reference Point: 0, 0, -6.3 mm

Reference Value = 0.1020 A/m; Power Drift = 0.03 dB

PMR not calibrated. PMF = 2.876 is applied.

H-field emissions = 0.3571 A/m

**Near-field category: M4 (AWF -5 dB)**

PMF scaled H-field

Grid 1 <b>M3</b> <b>0.469 A/m</b>	Grid 2 <b>M4</b> <b>0.356 A/m</b>	Grid 3 <b>M4</b> <b>0.213 A/m</b>
Grid 4 <b>M3</b> <b>0.470 A/m</b>	Grid 5 <b>M4</b> <b>0.352 A/m</b>	Grid 6 <b>M4</b> <b>0.206 A/m</b>
Grid 7 <b>M3</b> <b>0.475 A/m</b>	Grid 8 <b>M4</b> <b>0.357 A/m</b>	Grid 9 <b>M4</b> <b>0.212 A/m</b>

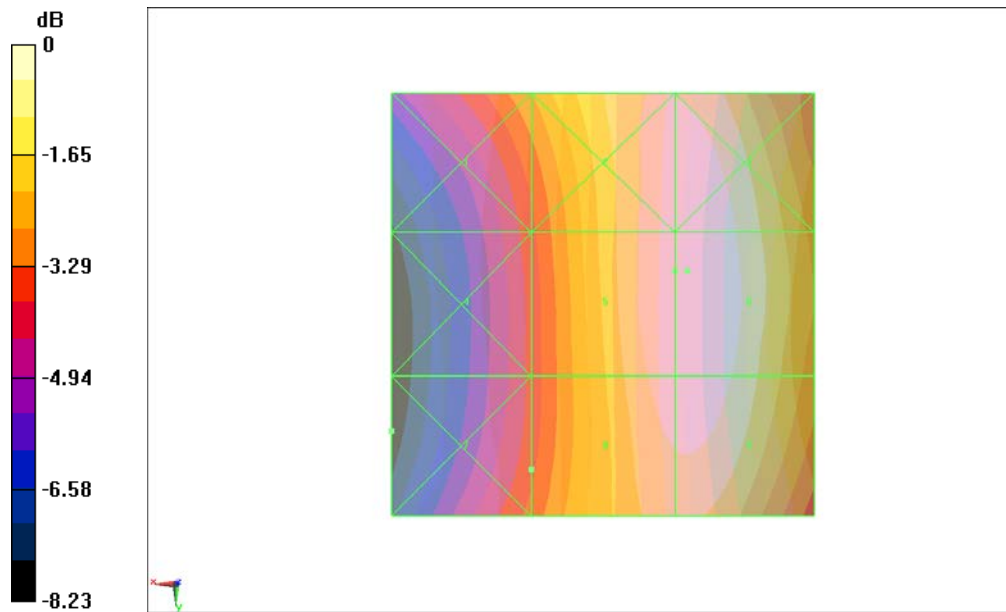

0 dB = 183.8 V/m = 45.29 dBV/m

RF RESULTS AND M-RATING	E-Field M Rating	<b>M3 (AWF -5 dB)</b>
	H-Field M Rating	<b>M4 (AWF -5 dB)</b>
	<b>Total M Rating</b>	<b>M3</b>

**Fig B.25 Total M-rating of GSM 850**

**Total M-rating of GSM 1900 MHz Band**

Date: 2014-5-21

Electronics: DAE4 Sn1331

Medium: Air

Medium parameters used:  $\sigma = 0$  mho/m,  $\epsilon_r = 1$ ;  $\rho = 1000$  kg/m<sup>3</sup> Medium parameters used:  $\sigma = 0$  mho/m,  $\epsilon_r = 1$ ;  $\rho = 1$  kg/m<sup>3</sup>

Ambient Temperature: 22.1°C

Communication System: PCS 1900; Frequency: 1909.8 MHz; Duty Cycle: 1:8.3

Probe: ER3DV6 - SN2428 Probe: H3DV6 - SN6260; ConvF(1, 1, 1)

**E Scan - ER3DV6 - 2007: 15 mm from Probe Center to the Device/Hearing Aid Compatibility Test (101x101x1):** Interpolated grid: dx=0.5000 mm, dy=0.5000 mm

Device Reference Point: 0, 0, -6.3 mm

Reference Value = 25.61 V/m; Power Drift = -3.69 dB

PMR not calibrated. PMF = 2.884 is applied.

E-field emissions = 72.61 V/m

**Near-field category: M3 (AWF -5 dB)**

PMF scaled E-field

<b>Grid 1 M3</b> <b>69.21 V/m</b>	<b>Grid 2 M3</b> <b>72.61 V/m</b>	<b>Grid 3 M3</b> <b>71.94 V/m</b>
<b>Grid 4 M3</b> <b>52.67 V/m</b>	<b>Grid 5 M3</b> <b>58.38 V/m</b>	<b>Grid 6 M3</b> <b>58.36 V/m</b>
<b>Grid 7 M3</b> <b>74.95 V/m</b>	<b>Grid 8 M4</b> <b>39.25 V/m</b>	<b>Grid 9 M4</b> <b>37.80 V/m</b>

**H Scan - H3DV6 - 2007: 15 mm from Probe Center to the Device/Hearing Aid**

**Compatibility Test (101x101x1):** Interpolated grid: dx=0.5000 mm, dy=0.5000 mm

Device Reference Point: 0, 0, -6.3 mm

Reference Value = 0.06000 A/m; Power Drift = 0.04 dB

PMR not calibrated. PMF = 2.865 is applied.

H-field emissions = 0.1604 A/m

**Near-field category: M3 (AWF -5 dB)**

PMF scaled H-field

<b>Grid 1 M3</b> <b>0.203 A/m</b>	<b>Grid 2 M3</b> <b>0.173 A/m</b>	<b>Grid 3 M3</b> <b>0.150 A/m</b>
<b>Grid 4 M3</b> <b>0.150 A/m</b>	<b>Grid 5 M3</b> <b>0.160 A/m</b>	<b>Grid 6 M3</b> <b>0.160 A/m</b>
<b>Grid 7 M4</b> <b>0.132 A/m</b>	<b>Grid 8 M3</b> <b>0.159 A/m</b>	<b>Grid 9 M3</b> <b>0.159 A/m</b>



0 dB = 74.95 V/m = 37.50 dBV/m

RFRESULTS AND M-RATING	E-Field M Rating	<b>M3 (AWF -5 dB)</b>
	H-Field M Rating	<b>M3 (AWF -5 dB)</b>
	<b>Total M Rating</b>	<b>M3</b>

**Fig B.26 Total M-rating of GSM 1900**



**Total M-rating of WCDMA 850 MHz Band**

Date: 2014-5-21

Electronics: DAE4 Sn1331

Medium: Air

Medium parameters used:  $\sigma = 0$  mho/m,  $\epsilon_r = 1$ ;  $\rho = 1000$  kg/m<sup>3</sup> Medium parameters used:  $\sigma = 0$  mho/m,  $\epsilon_r = 1$ ;  $\rho = 1$  kg/m<sup>3</sup>

Ambient Temperature: 22.1°C

Communication System: WCDMA 850; Frequency: 846.6 MHz; Frequency: 826.4 MHz

Duty Cycle: 1:1

Probe: ER3DV6 - SN2428 Probe: H3DV6 - SN6260; ConvF(1, 1, 1)

**E Scan - ER3DV6 - 2007: 15 mm from Probe Center to the Device/Hearing Aid**

**Compatibility Test (101x101x1):** Interpolated grid: dx=0.5000 mm, dy=0.5000 mm

Device Reference Point: 0, 0, -6.3 mm

Reference Value = 65.22 V/m; Power Drift = 0.01 dB

PMR not calibrated. PMF = 1.003 is applied.

E-field emissions = 59.37 V/m

**Near-field category: M4 (AWF 0 dB)**

PMF scaled E-field

Grid 1 M4 44.96 V/m	Grid 2 M4 59.00 V/m	Grid 3 M4 59.04 V/m
Grid 4 M4 40.07 V/m	Grid 5 M4 59.26 V/m	Grid 6 M4 59.37 V/m
Grid 7 M4 40.92 V/m	Grid 8 M4 57.97 V/m	Grid 9 M4 58.08 V/m

**H Scan - H3DV6 - 2007: 15 mm from Probe Center to the Device/Hearing Aid**

**Compatibility Test (101x101x1):** Interpolated grid: dx=0.5000 mm, dy=0.5000 mm

Device Reference Point: 0, 0, -6.3 mm

Reference Value = 0.09200 A/m; Power Drift = 0.01 dB

PMR not calibrated. PMF = 1.006 is applied.

H-field emissions = 0.1152 A/m

**Near-field category: M4 (AWF 0 dB)**

PMF scaled H-field

Grid 1 M4 0.156 A/m	Grid 2 M4 0.114 A/m	Grid 3 M4 0.069 A/m
Grid 4 M4 0.149 A/m	Grid 5 M4 0.112 A/m	Grid 6 M4 0.067 A/m
Grid 7 M4 0.157 A/m	Grid 8 M4 0.115 A/m	Grid 9 M4 0.070 A/m

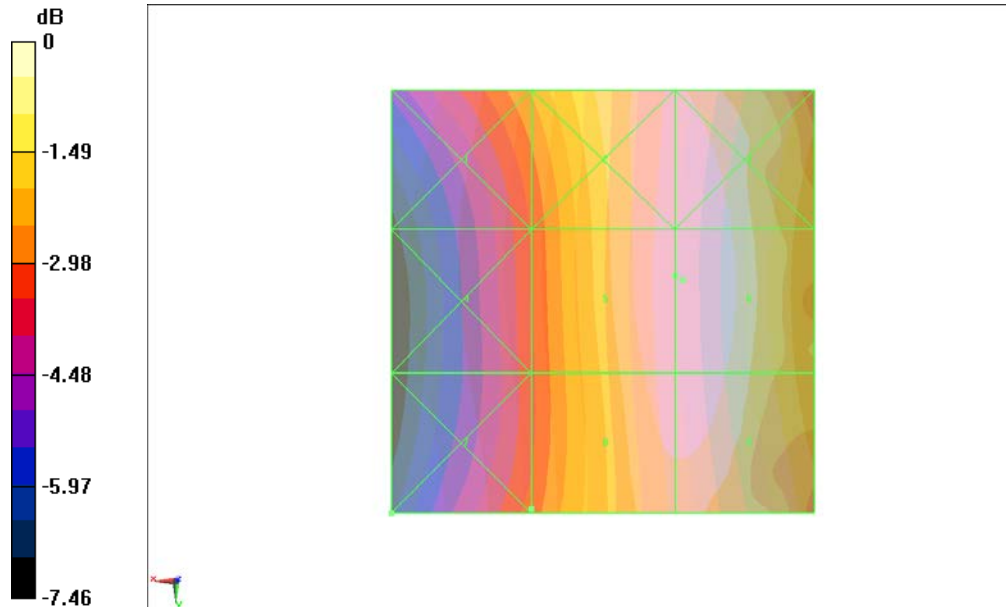

0 dB = 59.37 V/m = 35.47 dBV/m

RF RESULTS AND M-RATING	E-Field M Rating	<b>M4 (AWF 0 dB)</b>
	H-Field M Rating	<b>M4 (AWF 0 dB)</b>
	<b>Total M Rating</b>	<b>M4</b>

**Fig B.27 Total M-rating of WCDMA 850**

**Total M-rating of WCDMA 1900 MHz Band**

Date: 2014-5-21

Electronics: DAE4 Sn1331

Medium: Air

Medium parameters used:  $\sigma = 0$  mho/m,  $\epsilon_r = 1$ ;  $\rho = 1000$  kg/m<sup>3</sup> Medium parameters used:  $\sigma = 0$  mho/m,  $\epsilon_r = 1$ ;  $\rho = 1$  kg/m<sup>3</sup>

Ambient Temperature: 22.1°C

Communication System: WCDMA 1900; Frequency: 1852.4 MHz; Duty Cycle: 1:1

Probe: ER3DV6 - SN2428 Probe: H3DV6 - SN6260; ConvF(1, 1, 1)

**E Scan - ER3DV6 - 2007: 15 mm from Probe Center to the Device 3/Hearing Aid Compatibility Test (101x101x1):** Interpolated grid: dx=0.5000 mm, dy=0.5000 mm

Device Reference Point: 0, 0, -6.3 mm

Reference Value = 25.19 V/m; Power Drift = 0.03 dB

PMR not calibrated. PMF = 1.000 is applied.

E-field emissions = 31.53 V/m

**Near-field category: M4 (AWF 0 dB)**

PMF scaled E-field

<b>Grid 1 M4</b>	<b>Grid 2 M4</b>	<b>Grid 3 M4</b>
<b>33.33 V/m</b>	<b>40.94 V/m</b>	<b>40.32 V/m</b>
<b>Grid 4 M4</b>	<b>Grid 5 M4</b>	<b>Grid 6 M4</b>
<b>23.35 V/m</b>	<b>31.53 V/m</b>	<b>31.50 V/m</b>
<b>Grid 7 M4</b>	<b>Grid 8 M4</b>	<b>Grid 9 M4</b>
<b>23.25 V/m</b>	<b>22.34 V/m</b>	<b>20.07 V/m</b>

**H Scan - H3DV6 - 2007: 15 mm from Probe Center to the Device 3/Hearing Aid Compatibility Test (101x101x1):** Interpolated grid: dx=0.5000 mm, dy=0.5000 mm

Device Reference Point: 0, 0, -6.3 mm

Reference Value = 0.09000 A/m; Power Drift = -0.03 dB

PMR not calibrated. PMF = 1.000 is applied.

H-field emissions = 0.08719 A/m

**Near-field category: M4 (AWF 0 dB)**

PMF scaled H-field

<b>Grid 1 M4</b>	<b>Grid 2 M4</b>	<b>Grid 3 M4</b>
<b>0.101 A/m</b>	<b>0.092 A/m</b>	<b>0.081 A/m</b>
<b>Grid 4 M4</b>	<b>Grid 5 M4</b>	<b>Grid 6 M4</b>
<b>0.080 A/m</b>	<b>0.087 A/m</b>	<b>0.087 A/m</b>
<b>Grid 7 M4</b>	<b>Grid 8 M4</b>	<b>Grid 9 M4</b>
<b>0.073 A/m</b>	<b>0.087 A/m</b>	<b>0.086 A/m</b>

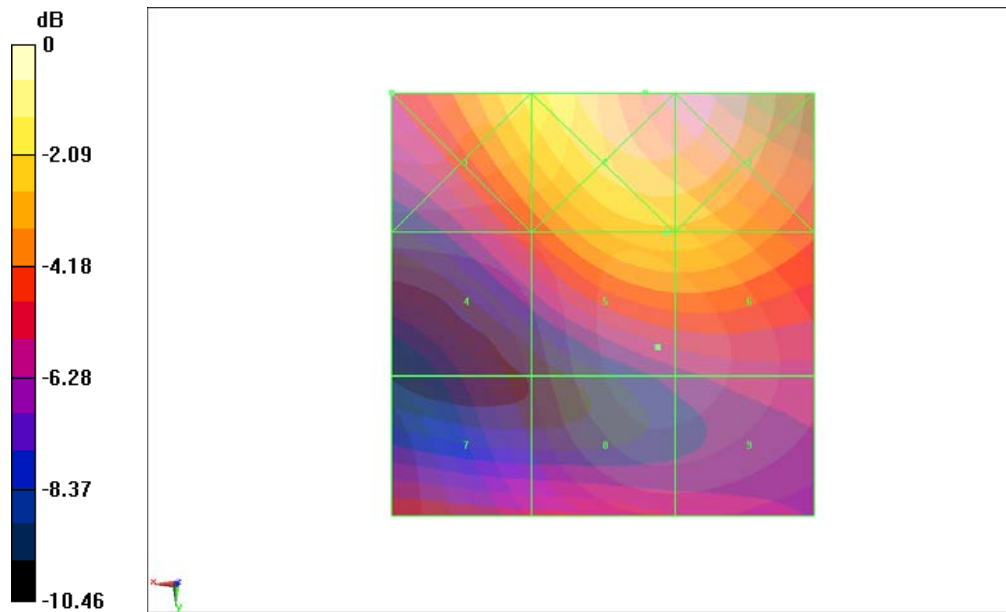

0 dB = 40.94 V/m = 32.24 dBV/m

RF RESULTS AND M-RATING	E-Field M Rating	<b>M4 (AWF 0 dB)</b>
	H-Field M Rating	<b>M4 (AWF 0 dB)</b>
	<b>Total M Rating</b>	<b>M4</b>

**Fig B.28 Total M-rating of WCDMA 1900**

## ANNEX C SYSTEM VALIDATION RESULT

### E SCAN of Dipole 835 MHz

Date: 2014-5-21

Electronics: DAE4 Sn1331

Medium: Air

Medium parameters used:  $\sigma = 0$  mho/m,  $\epsilon_r = 1$ ;  $\rho = 1000$  kg/m<sup>3</sup>

Communication System: CW; Frequency: 835 MHz; Duty Cycle: 1:1

Probe: ER3DV6 - SN2428;ConvF(1, 1, 1)

**E Scan - measurement distance from the probe sensor center to CD835 Dipole = 10mm/Hearing Aid Compatibility Test (41x361x1):** Measurement grid: dx=0.5000mm, dy=0.5000mm

Maximum value of peak Total field = 164.8 V/m

Probe Modulation Factor = 1.000

Device Reference Point: 0, 0, -6.3 mm

Reference Value = 103.6 V/m; Power Drift = -0.09 dB

**Hearing Aid Near-Field Category: M4 (AWF 0 dB)**

Peak E-field in V/m

Grid 1	Grid 2	Grid 3
157.6 M4	164.8 M4	161.2 M4
Grid 4	Grid 5	Grid 6
81.06 M4	84.05M4	82.48 M4
Grid 7	Grid 8	Grid 9
152.4 M4	162.7 M4	161.3 M4

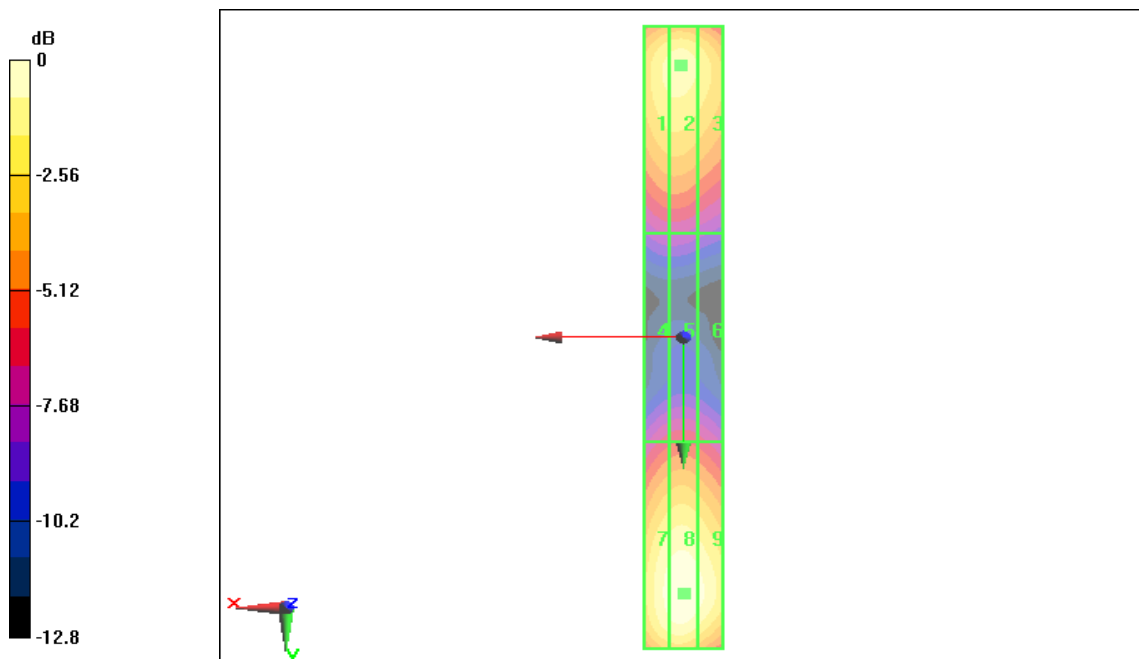

0 dB = 164.8V/m

**H SCAN of Dipole 835 MHz**

**Date: 2014-5-21**

Electronics: DAE4 Sn1331

Medium: Air

Medium parameters used:  $\sigma = 0$  mho/m,  $\epsilon_r = 1$ ;  $\rho = 1$  kg/m<sup>3</sup>

Communication System: CW; Frequency: 835 MHz; Duty Cycle: 1:1

Probe: H3DV6 - SN6260;

**H Scan - measurement distance from the probe sensor center to CD835 Dipole = 10mm/Hearing Aid Compatibility Test (41x361x1):** Measurement grid: dx=0.5000mm, dy=0.5000mm

Maximum value of peak Total field = 0.469 A/m

Probe Modulation Factor = 1.000

Device Reference Point: 0, 0, -6.3 mm

Reference Value = 0.498 A/m; Power Drift = 0.07 dB

**Hearing Aid Near-Field Category: M4 (AWF 0 dB)**

Peak H-field in A/m

Grid 1	Grid 2	Grid 3
<b>0.387 M4</b>	<b>0.417 M4</b>	<b>0.402 M4</b>
Grid 4	Grid 5	Grid 6
<b>0.435 M4</b>	<b>0.469 M4</b>	<b>0.454 M4</b>
Grid 7	Grid 8	Grid 9
<b>0.384 M4</b>	<b>0.421 M4</b>	<b>0.408 M4</b>

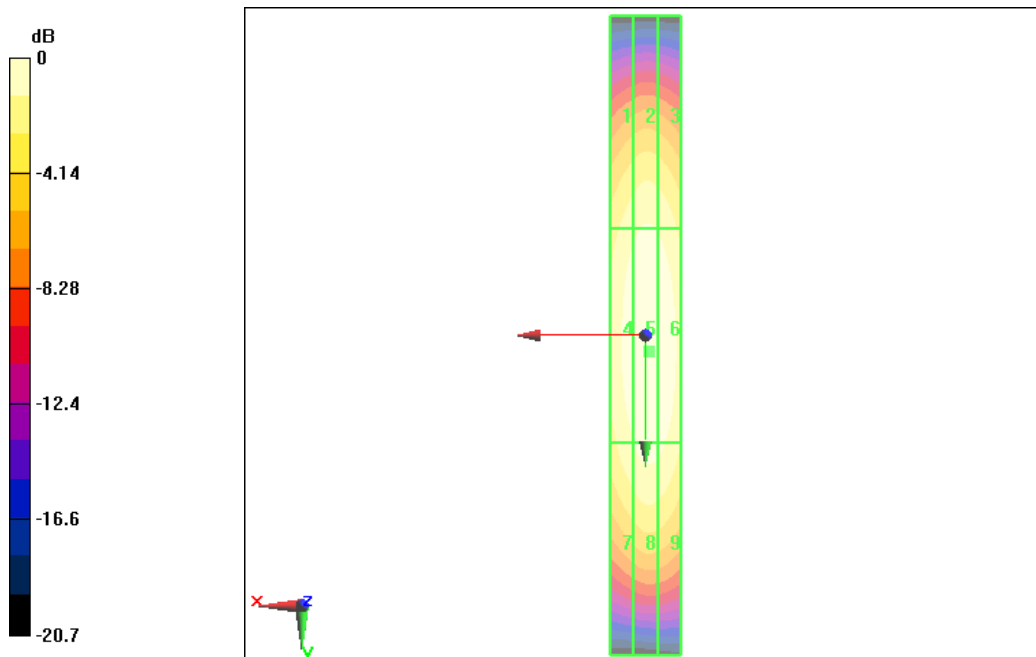

0 dB = 0.469A/m

**E SCAN of Dipole 1880 MHz**

**Date: 2014-5-21**

Electronics: DAE4 Sn1331

Medium: Air

Medium parameters used:  $\sigma = 0$  mho/m,  $\epsilon_r = 1$ ;  $\rho = 1000$  kg/m<sup>3</sup>

Communication System: CW; Frequency: 1880 MHz; Duty Cycle: 1:1

Probe: ER3DV6 - SN2428;ConvF(1, 1, 1)

**E Scan - measurement distance from the probe sensor center to CD1880 Dipole = 10mm/Hearing Aid Compatibility Test (41x181x1):** Measurement grid: dx=0.5000mm, dy=0.5000mm

Maximum value of peak Total field = 142.7 V/m

Probe Modulation Factor = 1.000

Device Reference Point: 0, 0, -6.3 mm

Reference Value = 159.6 V/m; Power Drift = 0.10 dB

**Hearing Aid Near-Field Category: M2 (AWF 0 dB)**

Peak E-field in V/m

Grid 1 <b>131.0 M2</b>	Grid 2 <b>137.9 M2</b>	Grid 3 <b>136.5 M2</b>
Grid 4 <b>88.17 M3</b>	Grid 5 <b>91.61 M3</b>	Grid 6 <b>89.12 M3</b>
Grid 7 <b>133.3 M2</b>	Grid 8 <b>142.7 M2</b>	Grid 9 <b>140.9 M2</b>

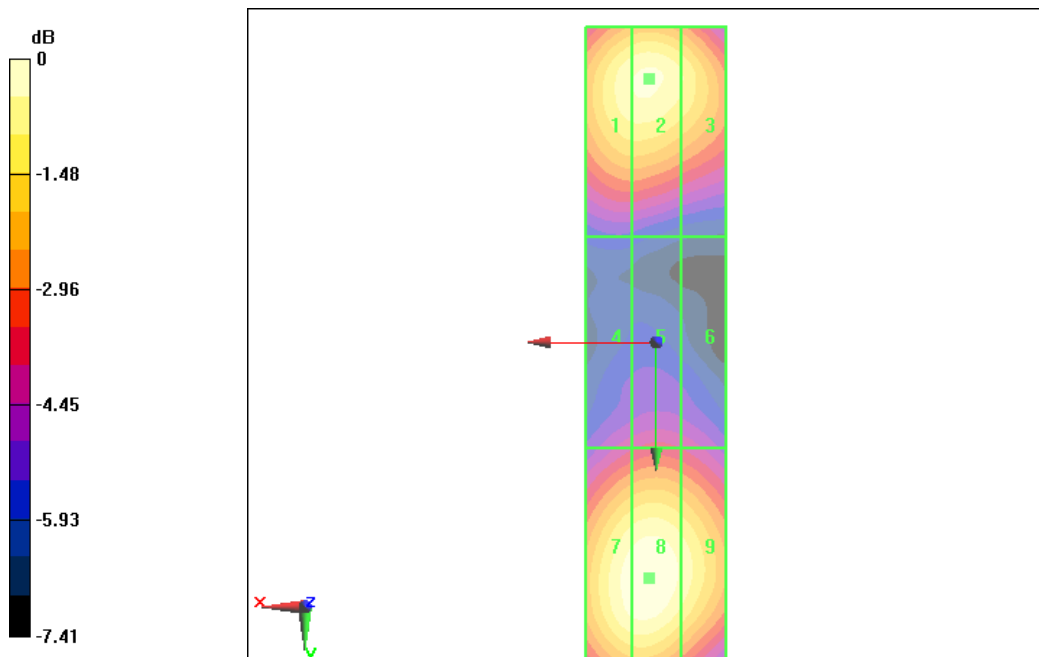

0 dB = 142.7V/m

**H SCAN of Dipole 1880 MHz**

**Date: 2014-5-21**

Electronics: DAE4 Sn1331

Medium: Air

Medium parameters used:  $\sigma = 0$  mho/m,  $\epsilon_r = 1$ ;  $\rho = 1$  kg/m<sup>3</sup>

Communication System: CW; Frequency: 1880 MHz; Duty Cycle: 1:1

Probe: H3DV6 - SN6260;

**H Scan - measurement distance from the probe sensor center to CD1880 Dipole = 10mm/Hearing Aid Compatibility Test (41x181x1):** Measurement grid: dx=0.5000mm, dy=0.5000mm

Maximum value of peak Total field = 0.459 A/m

Probe Modulation Factor = 1.000

Device Reference Point: 0, 0, -6.3 mm

Reference Value = 0.485 A/m; Power Drift = 0.06 dB

**Hearing Aid Near-Field Category: M2 (AWF 0 dB)**

Peak H-field in A/m

Grid 1	Grid 2	Grid 3
0.386 M2	0.416 M2	0.407 M2
Grid 4	Grid 5	Grid 6
0.425 M2	0.459 M2	0.447 M2
Grid 7	Grid 8	Grid 9
0.386 M2	0.423 M2	0.410 M2

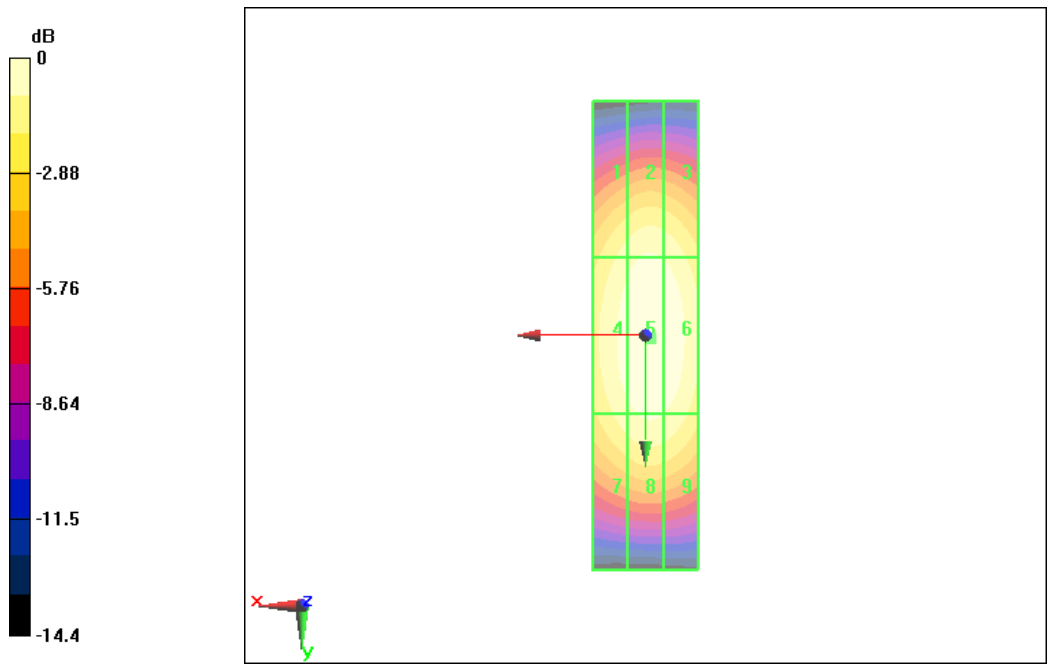

0 dB = 0.459A/m



# ANNEX D PROBE CALIBRATION CERTIFICATE

E\_Probe ER3DV6

**Calibration Laboratory of**  
Schmid & Partner  
Engineering AG  
Zeughausstrasse 43, 8004 Zurich, Switzerland



**S** Schweizerischer Kalibrierdienst  
**C** Service suisse d'étalonnage  
**S** Servizio svizzero di taratura  
Swiss Calibration Service

Accredited by the Swiss Accreditation Service (SAS)  
The Swiss Accreditation Service is one of the signatories to the EA  
Multilateral Agreement for the recognition of calibration certificates

Accreditation No.: **SCS 108**

Client **TMC Beijing (Auden)**

Certificate No: **ER3-2428\_Jan14**

## CALIBRATION CERTIFICATE

Object **ER3DV6 - SN:2428**

Calibration procedure(s) **QA CAL-02.v8, QA CAL-25.v6  
Calibration procedure for E-field probes optimized for close near field  
evaluations in air**



Calibration date: **January 27, 2014**

This calibration certificate documents the traceability to national standards, which realize the physical units of measurements (SI).  
The measurements and the uncertainties with confidence probability are given on the following pages and are part of the certificate.

All calibrations have been conducted in the closed laboratory facility: environment temperature (22 ± 3)°C and humidity < 70%.

Calibration Equipment used (M&TE critical for calibration)

Primary Standards	ID	Cal Date (Certificate No.)	Scheduled Calibration
Power meter E4419B	GB41293874	04-Apr-13 (No. 217-01733)	Apr-14
Power sensor E4412A	MY41498087	04-Apr-13 (No. 217-01733)	Apr-14
Reference 3 dB Attenuator	SN: S5054 (3c)	04-Apr-13 (No. 217-01737)	Apr-14
Reference 20 dB Attenuator	SN: S5277 (20x)	04-Apr-13 (No. 217-01735)	Apr-14
Reference 30 dB Attenuator	SN: S5129 (30b)	04-Apr-13 (No. 217-01738)	Apr-14
Reference Probe ER3DV6	SN: 2328	10-Oct-13 (No. ER3-2328_Oct13)	Oct-14
DAE4	SN: 789	15-May-13 (No. DAE4-789_May13)	May-14
Secondary Standards	ID	Check Date (in house)	Scheduled Check
RF generator HP 8648C	US3642U01700	4-Aug-99 (in house check Apr-13)	In house check: Apr-16
Network Analyzer HP 8753E	US37390585	18-Oct-01 (in house check Oct-13)	In house check: Oct-14

	Name	Function	Signature
Calibrated by:	Leif Klynsner	Laboratory Technician	
Approved by:	Katja Pokovic	Technical Manager	

Issued: January 28, 2014

This calibration certificate shall not be reproduced except in full without written approval of the laboratory.

**Calibration Laboratory of**  
Schmid & Partner  
Engineering AG  
Zeughausstrasse 43, 8004 Zurich, Switzerland



**S** Schweizerischer Kalibrierdienst  
**S** Service suisse d'étalonnage  
**S** Servizio svizzero di taratura  
**S** Swiss Calibration Service

Accredited by the Swiss Accreditation Service (SAS)

Accreditation No.: **SCS 108**

The Swiss Accreditation Service is one of the signatories to the EA  
Multilateral Agreement for the recognition of calibration certificates

**Glossary:**

NORM <sub>x,y,z</sub>	sensitivity in free space
DCP	diode compression point
CF	crest factor (1/duty_cycle) of the RF signal
A, B, C, D	modulation dependent linearization parameters
Polarization $\varphi$	$\varphi$ rotation around probe axis
Polarization $\vartheta$	$\vartheta$ rotation around an axis that is in the plane normal to probe axis (at measurement center), i.e., $\vartheta = 0$ is normal to probe axis
Connector Angle	information used in DASY system to align probe sensor X to the robot coordinate system

**Calibration is Performed According to the Following Standards:**

- IEEE Std 1309-2005, " IEEE Standard for calibration of electromagnetic field sensors and probes, excluding antennas, from 9 kHz to 40 GHz", December 2005
- CTIA Test Plan for Hearing Aid Compatibility, April 2010.

**Methods Applied and Interpretation of Parameters:**

- NORM<sub>x,y,z</sub>*: Assessed for E-field polarization  $\vartheta = 0$  for XY sensors and  $\vartheta = 90$  for Z sensor ( $f \leq 900$  MHz in TEM-cell;  $f > 1800$  MHz: R22 waveguide).
- NORM(f)<sub>x,y,z</sub>* = *NORM<sub>x,y,z</sub>* \* *frequency\_response* (see Frequency Response Chart).
- DCP<sub>x,y,z</sub>*: DCP are numerical linearization parameters assessed based on the data of power sweep with CW signal (no uncertainty required). DCP does not depend on frequency nor media.
- PAR*: PAR is the Peak to Average Ratio that is not calibrated but determined based on the signal characteristics
- A<sub>x,y,z</sub>; B<sub>x,y,z</sub>; C<sub>x,y,z</sub>; D<sub>x,y,z</sub>; VR<sub>x,y,z</sub>*: A, B, C, D are numerical linearization parameters assessed based on the data of power sweep for specific modulation signal. The parameters do not depend on frequency nor media. VR is the maximum calibration range expressed in RMS voltage across the diode.
- Spherical isotropy (3D deviation from isotropy)*: in a locally homogeneous field realized using an open waveguide setup.
- Sensor Offset*: The sensor offset corresponds to the offset of virtual measurement center from the probe tip (on probe axis). No tolerance required.
- Connector Angle*: The angle is assessed using the information gained by determining the *NORM<sub>x</sub>* (no uncertainty required).

ER3DV6 – SN:2428

January 27, 2014

# Probe ER3DV6

## SN:2428

Manufactured: September 11, 2007  
Calibrated: January 27, 2014

Calibrated for DASY/EASY Systems  
(Note: non-compatible with DASY2 system!)

ER3DV6- SN:2428

January 27, 2014

## DASY/EASY - Parameters of Probe: ER3DV6 - SN:2428

### Basic Calibration Parameters

	Sensor X	Sensor Y	Sensor Z	Unc (k=2)
Norm ( $\mu\text{V}/(\text{V}/\text{m})^2$ )	1.51	1.59	1.83	$\pm 10.1 \%$
DCP (mV) <sup>b</sup>	98.9	97.0	101.1	

### Modulation Calibration Parameters

UID	Communication System Name		A dB	B dB $\sqrt{\mu\text{V}}$	C	D dB	VR mV	Unc <sup>e</sup> (k=2)
0	CW	X	0.0	0.0	1.0	0.00	190.5	$\pm 3.3 \%$
		Y	0.0	0.0	1.0		152.5	
		Z	0.0	0.0	1.0		198.6	
10021-DAA	GSM-FDD (TDMA, GMSK)	X	20.75	99.9	29.1	9.39	119.1	$\pm 1.2 \%$
		Y	19.27	99.6	28.9		125.1	
		Z	24.43	99.4	28.5		139.5	
10039-CAA	CDMA2000 (1xRTT, RC1)	X	4.62	65.6	18.5	4.57	109.6	$\pm 0.9 \%$
		Y	4.78	66.3	18.9		121.2	
		Z	4.58	66.0	18.7		114.4	

The reported uncertainty of measurement is stated as the standard uncertainty of measurement multiplied by the coverage factor k=2, which for a normal distribution corresponds to a coverage probability of approximately 95%.

<sup>b</sup> Numerical linearization parameter: uncertainty not required.

<sup>e</sup> Uncertainty is determined using the max. deviation from linear response applying rectangular distribution and is expressed for the square of the field value.

ER3DV6- SN:2428

January 27, 2014

### Frequency Response of E-Field (TEM-Cell:ifi110 EXX, Waveguide: R22)

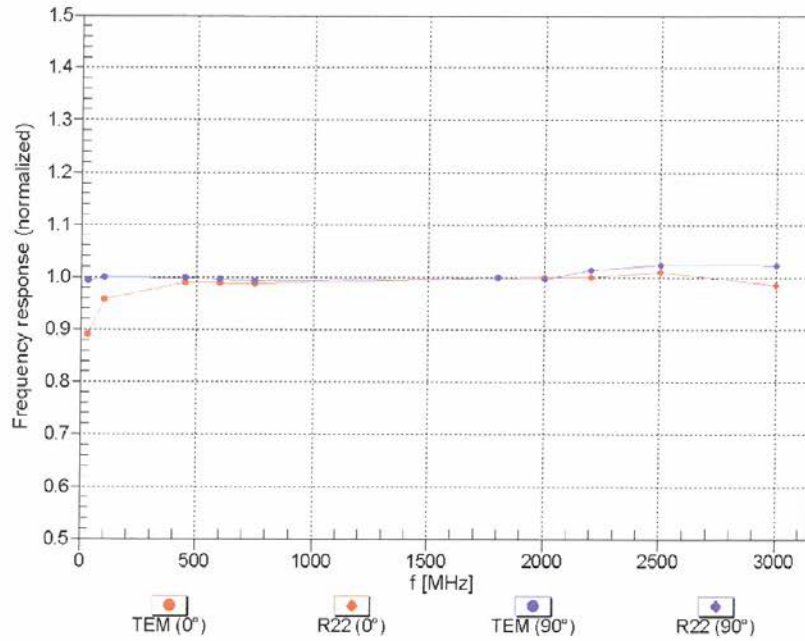

Uncertainty of Frequency Response of E-field:  $\pm 6.3\%$  (k=2)

ER3DV6- SN:2428

January 27, 2014

### Receiving Pattern ( $\phi$ ), $\vartheta = 0^\circ$

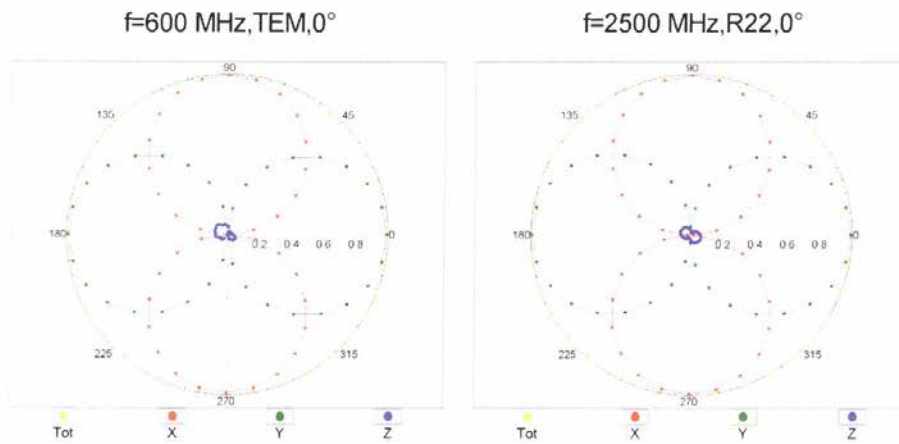

### Receiving Pattern ( $\phi$ ), $\vartheta = 90^\circ$

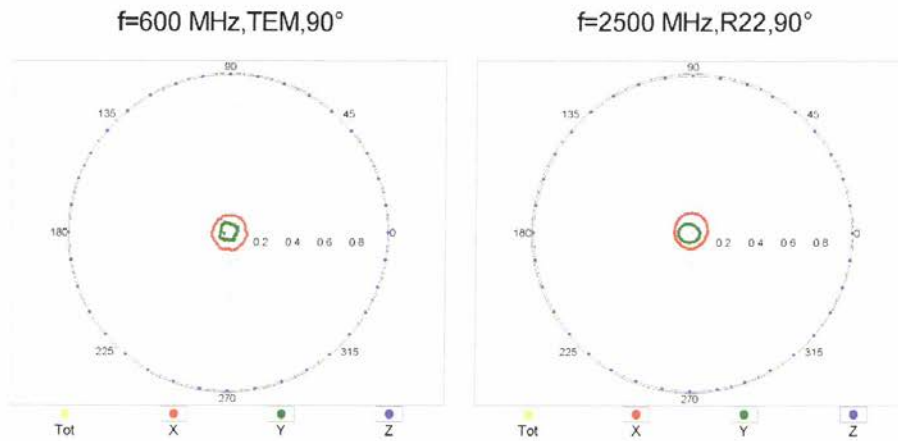

ER3DV6- SN:2428

January 27, 2014

### Receiving Pattern ( $\phi$ ), $\vartheta = 0^\circ$

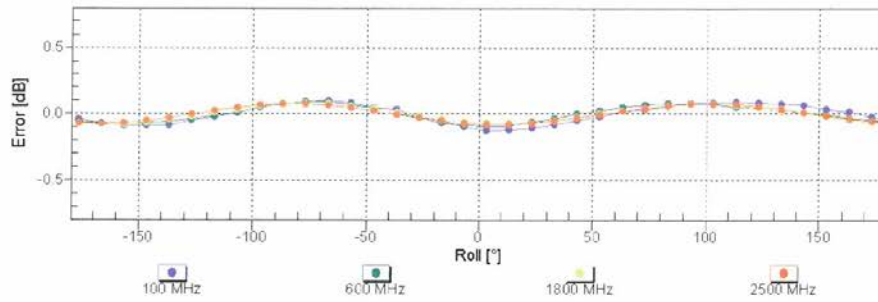

Uncertainty of Axial Isotropy Assessment:  $\pm 0.5\%$  (k=2)

### Receiving Pattern ( $\phi$ ), $\vartheta = 90^\circ$

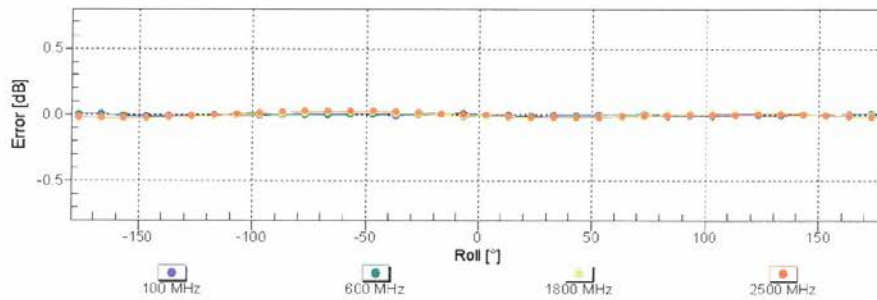

Uncertainty of Axial Isotropy Assessment:  $\pm 0.5\%$  (k=2)

ER3DV6- SN:2428

January 27, 2014

### Dynamic Range f(E-field) (TEM cell , f = 900 MHz)

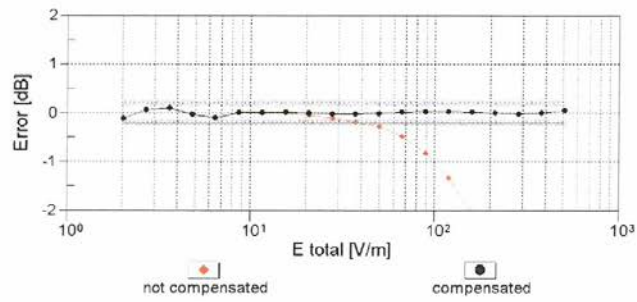
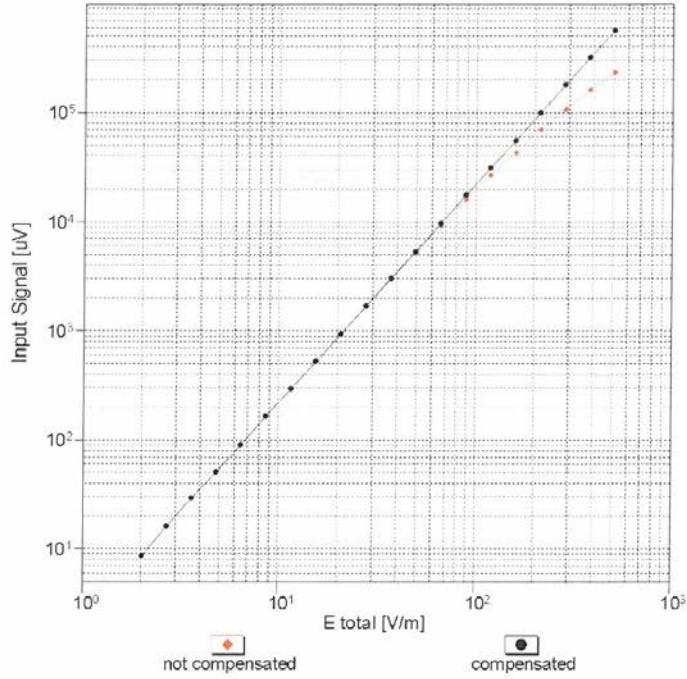

Uncertainty of Linearity Assessment:  $\pm 0.6\%$  (k=2)



ER3DV6- SN:2428

January 27, 2014

### Deviation from Isotropy in Air Error ( $\phi, \theta$ ), $f = 900$ MHz

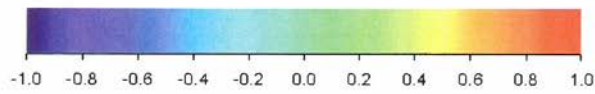
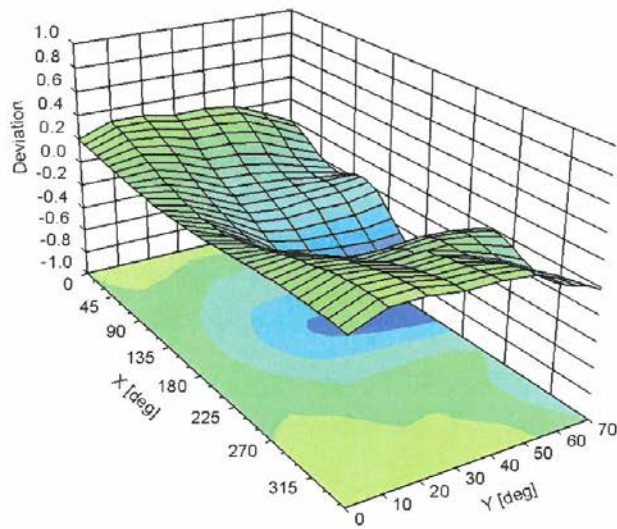

Uncertainty of Spherical Isotropy Assessment:  $\pm 2.6\%$  ( $k=2$ )

ER3DV6- SN:2428

January 27, 2014

### DASY/EASY - Parameters of Probe: ER3DV6 - SN:2428

#### Other Probe Parameters

Sensor Arrangement	Rectangular
Connector Angle (°)	-36.9
Mechanical Surface Detection Mode	enabled
Optical Surface Detection Mode	disabled
Probe Overall Length	337 mm
Probe Body Diameter	10 mm
Tip Length	10 mm
Tip Diameter	8 mm
Probe Tip to Sensor X Calibration Point	2.5 mm
Probe Tip to Sensor Y Calibration Point	2.5 mm
Probe Tip to Sensor Z Calibration Point	2.5 mm

H\_Probe H3DV6

**Calibration Laboratory of  
Schmid & Partner  
Engineering AG**  
Zeughausstrasse 43, 8004 Zurich, Switzerland



**S** Schweizerischer Kalibrierdienst  
**S** Service suisse d'étalonnage  
**S** Servizio svizzero di taratura  
**S** Swiss Calibration Service

Accredited by the Swiss Accreditation Service (SAS)  
The Swiss Accreditation Service is one of the signatories to the EA  
Multilateral Agreement for the recognition of calibration certificates

Accreditation No.: **SCS 108**

Client **TMC Beijing (Auden)**

Certificate No: **H3-6260\_Jan14**

**CALIBRATION CERTIFICATE**

Object **H3DV6 - SN:6260**

Calibration procedure(s) **QA CAL-03.v8, QA CAL-25.v6  
Calibration procedure for H-field probes optimized for close near field  
evaluations in air**



Calibration date: **January 27, 2014**

This calibration certificate documents the traceability to national standards, which realize the physical units of measurements (SI).  
The measurements and the uncertainties with confidence probability are given on the following pages and are part of the certificate.

All calibrations have been conducted in the closed laboratory facility: environment temperature (22 ± 3)°C and humidity < 70%.

Calibration Equipment used (M&TE critical for calibration)

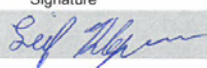
Primary Standards	ID	Cal Date (Certificate No.)	Scheduled Calibration
Power meter E4419B	GB41293874	04-Apr-13 (No. 217-01733)	Apr-14
Power sensor E4412A	MY41498087	04-Apr-13 (No. 217-01733)	Apr-14
Reference 3 dB Attenuator	SN: S5054 (3c)	04-Apr-13 (No. 217-01737)	Apr-14
Reference 20 dB Attenuator	SN: S5277 (20x)	04-Apr-13 (No. 217-01735)	Apr-14
Reference 30 dB Attenuator	SN: S5129 (30b)	04-Apr-13 (No. 217-01738)	Apr-14
Reference Probe H3DV6	SN: 6182	10-Oct-13 (No. H3-6182_Oct13)	Oct-14
DAE4	SN: 789	15-May-13 (No. DAE4-789_May13)	May-14
Secondary Standards	ID	Check Date (in house)	Scheduled Check
RF generator HP 8648C	US3642U01700	4-Aug-99 (in house check Apr-13)	In house check: Apr-16
Network Analyzer HP 8753E	US37390585	18-Oct-01 (in house check Oct-13)	In house check: Oct-14

	Name	Function	Signature
Calibrated by:	Leif Klysner	Laboratory Technician	
Approved by:	Katja Pokovic	Technical Manager	

Issued: January 28, 2014

This calibration certificate shall not be reproduced except in full without written approval of the laboratory.

**Calibration Laboratory of**  
Schmid & Partner  
Engineering AG  
Zeughausstrasse 43, 8004 Zurich, Switzerland



**S** Schweizerischer Kalibrierdienst  
**S** Service suisse d'étalonnage  
**S** Servizio svizzero di taratura  
**S** Swiss Calibration Service

Accredited by the Swiss Accreditation Service (SAS)

Accreditation No.: **SCS 108**

The Swiss Accreditation Service is one of the signatories to the EA  
Multilateral Agreement for the recognition of calibration certificates

**Glossary:**

NORM <sub>x,y,z</sub>	sensitivity in free space
DCP	diode compression point
CF	crest factor (1/duty_cycle) of the RF signal
A, B, C, D	modulation dependent linearization parameters
Polarization $\varphi$	$\varphi$ rotation around probe axis
Polarization $\vartheta$	$\vartheta$ rotation around an axis that is in the plane normal to probe axis (at measurement center), i.e., $\vartheta = 0$ is normal to probe axis
Connector Angle	information used in DASY system to align probe sensor X to the robot coordinate system

**Calibration is Performed According to the Following Standards:**

- a) IEEE Std 1309-2005, " IEEE Standard for calibration of electromagnetic field sensors and probes, excluding antennas, from 9 kHz to 40 GHz", December 2005.
- b) CTIA Test Plan for Hearing Aid Compatibility, April 2010.

**Methods Applied and Interpretation of Parameters:**

- *NORM<sub>x,y,z</sub>*: Assessed for E-field polarization  $\vartheta = 0$  for XY sensors and  $\vartheta = 90$  for Z sensor ( $f \leq 900$  MHz in TEM-cell;  $f > 1800$  MHz: R22 waveguide).
- *X, Y, Z(f)\_a0a1a2* = *X, Y, Z\_a0a1a2 \* frequency\_response* (see Frequency Response Chart).
- *DCP<sub>x,y,z</sub>*: DCP are numerical linearization parameters assessed based on the data of power sweep with CW signal (no uncertainty required). DCP does not depend on frequency nor media.
- *PAR*: PAR is the Peak to Average Ratio that is not calibrated but determined based on the signal characteristics
- *A<sub>x,y,z</sub>; B<sub>x,y,z</sub>; C<sub>x,y,z</sub>; D<sub>x,y,z</sub>; VR<sub>x,y,z</sub>*: A, B, C, D are numerical linearization parameters assessed based on the data of power sweep for specific modulation signal. The parameters do not depend on frequency nor media. VR is the maximum calibration range expressed in RMS voltage across the diode.
- *Spherical isotropy (3D deviation from isotropy)*: in a locally homogeneous field realized using an open waveguide setup.
- *Sensor Offset*: The sensor offset corresponds to the offset of virtual measurement center from the probe tip (on probe axis). No tolerance required.
- *Connector Angle*: The angle is assessed using the information gained by determining the *X\_a0a1a2* (no uncertainty required).

H3DV6 – SN:6260

January 27, 2014

# Probe H3DV6

## SN:6260

Manufactured: September 7, 2007  
Calibrated: January 27, 2014

Calibrated for DASY/EASY Systems  
(Note: non-compatible with DASY2 system!)

H3DV6- SN:6260

January 27, 2014

## DASY/EASY - Parameters of Probe: H3DV6 - SN:6260

### Basic Calibration Parameters

		Sensor X	Sensor Y	Sensor Z	Unc (k=2)
Norm (A/m / $\sqrt{(mV)}$ )	a0	2.48E-003	2.49E-003	2.92E-003	$\pm 5.1 \%$
Norm (A/m / $\sqrt{(mV)}$ )	a1	-2.51E-005	1.35E-006	2.69E-006	$\pm 5.1 \%$
Norm (A/m / $\sqrt{(mV)}$ )	a2	5.03E-005	4.10E-005	5.26E-005	$\pm 5.1 \%$
DCP (mV) <sup>B</sup>		90.9	91.8	92.6	

### Modulation Calibration Parameters

UID	Communication System Name		A dB	B dB $\sqrt{\mu V}$	C	D dB	VR mV	Unc <sup>E</sup> (k=2)
0	CW	X	0.0	0.0	1.0	0.00	138.5	$\pm 1.4 \%$
		Y	0.0	0.0	1.0		136.9	
		Z	0.0	0.0	1.0		134.3	

The reported uncertainty of measurement is stated as the standard uncertainty of measurement multiplied by the coverage factor k=2, which for a normal distribution corresponds to a coverage probability of approximately 95%.

<sup>B</sup> Numerical linearization parameter; uncertainty not required.

<sup>E</sup> Uncertainty is determined using the max. deviation from linear response applying rectangular distribution and is expressed for the square of the field value.