



ANSI C63.19

TEST REPORT

Product Name	HSDPA/HSUPA/HSPA+/UMTS Quad bands/ GSM quad bands/LTE 5 bands mobile phone
Model Name	Miata LATAM
Marketing Name	6036A
FCC ID	RAD449
Client	TCT Mobile Limited
Manufacturer	TCT Mobile Limited
Date of issue	April 4, 2014

TA Technology (Shanghai) Co., Ltd.

TA Technology (Shanghai) Co., Ltd.
Test Report

Report No. RXA1402-0022HAC01R2

Page 2 of 75

GENERAL SUMMARY

Reference Standard(s)	ANSI C63.19-2011 American National Standard Methods of Measurement of Compatibility between Wireless Communications Devices and Hearing Aids
Conclusion	This portable wireless equipment has been measured in all cases requested by the relevant standards. General Judgment: M3 (RF Emission)
Comment	The test result only responds to the measured sample.

Approved by Weizhong Yang
Weizhong Yang
Director

Revised by Minbao Ling
Minbao Ling
HAC Manager

Performed by Chen Shen
Chen Shen
HAC Engineer

TABLE OF CONTENT

1. General Information	4
1.1. Notes of the Test Report.....	4
1.2. Testing Laboratory	4
1.3. Applicant Information	5
1.4. Manufacturer Information.....	5
1.5. Information of EUT	6
1.6. The Ambient Conditions during Test.....	9
1.7. The Total M-rating of each tested band	9
1.8. Test Date	9
2. Test Information	10
2.1. Operational Conditions during Test.....	10
2.1.1. General Description of Test Procedures	10
2.1.2. GSM Test Configuration	10
2.2. HAC RF Measurements System Configuration.....	11
2.2.1. HAC Measurement Set-up.....	11
2.2.2. Probe System	12
2.2.3. Test Arch Phantom & Phone Positioner	12
2.3. RF Test Procedures.....	14
2.4. System Check.....	16
2.5. Modulation interference factor	17
2.6. Conducted Output Power Measurement.....	18
2.7. Analysis of RF Air Interface Technologies	19
2.8. Individual Mode Evaluations	19
3. Test Results	20
3.1. ANSI C63.19-2011 Limits.....	20
3.2. Summary Test Results.....	21
4. Measurement Uncertainty	23
5. Main Test Instruments	25
ANNEX A: System Check Results.....	26
ANNEX B: Graph Results.....	28
ANNEX C: E-Probe Calibration Certificate	52
ANNEX D: CD835V3 Dipole Calibration Certificate	62
ANNEX E: CD1880V3 Dipole Calibration Certificate.....	66
ANNEX F: DAE4 Calibration Certificate	71
ANNEX G: The EUT Appearances and Test Configuration	74

TA Technology (Shanghai) Co., Ltd.

Test Report

Report No. RXA1402-0022HAC01R2

Page 4 of 75

1. General Information

1.1. Notes of the Test Report

TA Technology (Shanghai) Co., Ltd. has obtained the accreditation of China National Accreditation Service for Conformity Assessment (CNAS), and accreditation number: L2264.

TA Technology (Shanghai) Co., Ltd. guarantees the reliability of the data presented in this test report, which is the results of measurements and tests performed for the items under test on the date and under the conditions stated in this test report and is based on the knowledge and technical facilities available at TA Technology (Shanghai) Co., Ltd. at the time of execution of the test.

TA Technology (Shanghai) Co., Ltd. is liable to the client for the maintenance by its personnel of the confidentiality of all information related to the items under test and the results of the test. This report only refers to the item that has undergone the test.

This report alone does not constitute or imply by its own an approval of the product by the certification Bodies or competent Authorities. This report cannot be used partially or in full for publicity and/or promotional purposes without previous written approval of **TA Technology (Shanghai) Co., Ltd.** and the Accreditation Bodies, if it applies.

If the electronic report is inconsistent with the printed one, it should be subject to the latter.

1.2. Testing Laboratory

Company: TA Technology (Shanghai) Co., Ltd.
Address: No.145, Jintang Rd, Tangzhen Industry Park, Pudong Shanghai, China
City: Shanghai
Post code: 201201
Country: P. R. China
Contact: Yang Weizhong
Telephone: +86-021-50791141/2/3
Fax: +86-021-50791141/2/3-8000
Website: <http://www.ta-shanghai.com>
E-mail: yangweizhong@ta-shanghai.com

TA Technology (Shanghai) Co., Ltd.
Test Report

Report No. RXA1402-0022HAC01R2

Page 5 of 75

1.3. Applicant Information

Company: TCT Mobile Limited
5F, E building, No. 232, Liang Jing Road ZhangJiang High-Tech Park, Pudong Area
Address: Shanghai
P.R. China
201203

1.4. Manufacturer Information

Company: TCT Mobile Limited
5F, E building, No. 232, Liang Jing Road ZhangJiang High-Tech Park, Pudong Area
Address: Shanghai
P.R. China
201203

TA Technology (Shanghai) Co., Ltd.
Test Report

Report No. RXA1402-0022HAC01R2

Page 6 of 75

1.5. Information of EUT

General Information

Device Type:	Portable Device		
State of Sample:	Prototype Unit		
Product IMEI:	014040000051949		
Hardware Version:	PIO		
Software Version:	v4E18		
Antenna Type:	Internal Antenna		
Device Operating Configurations :			
Tested Mode(s):	GSM 850/GSM 1900;		
Test Modulation:	(GSM)GMSK;		
Operating Frequency Range(s):	Mode	Tx (MHz)	Rx (MHz)
	GSM 850	824.2 ~ 848.8	869.2 ~ 893.8
	GSM 1900	1850.2 ~ 1909.8	1930.2 ~ 1989.8
Power Class:	GSM 850: 4		
	GSM 1900: 1		
Power Level	GSM 850: tested with power level 5		
	GSM 1900: tested with power level 0		
Test Channel: (Low - Middle - High)	128 - 190 - 251	(GSM 850)	(tested)
	512 - 661 - 810	(GSM 1900)	(tested)

TA Technology (Shanghai) Co., Ltd.

Test Report

Report No. RXA1402-0022HAC01R2

Page 7 of 75

Auxiliary Equipment Details

AE1: Battery 1

Model: TLi020F1
Manufacturer: BYD
S/N: B2000010C1100JEM

AE1:Battery2

Model: TLi020F2
Manufacturer: SCUD
S/N: B2000013C2Y000LF

Equipment under Test (EUT) is a mobile phone. The detail about EUT and Lithium Battery is in chapter 1.5 in this report. HAC is tested for GSM 850, GSM 1900.

The sample under test was selected by the Client.

Components list please refer to documents of the manufacturer.

TA Technology (Shanghai) Co., Ltd.
Test Report

Report No. RXA1402-0022HAC01R2

Page 8 of 75

Air-Interface	Band (MHz)	Type	HAC tested	Simultaneous Transmissions Note: Not to be tested	Reduced power 20.19(c)(1)	Voice Over Digital Transport (Data)
GSM	850	VO	Yes	Yes GPRS, EGPRS, WIFI or BT	NA	NA
	1900	VO			NO	NA
	GPRS/EGPRS	DT	NA	Yes GSM, WIFI or BT	NA	NA
WCDMA	Band II	VO	NO [#]	Yes WIFI or BT	NA	NA
	Band V	VO	NO [#]	Yes WIFI or BT	NA	NA
	HSDPA/HSUPA/RMC/HSPA+/DC-HSDPA	DT	NA	Yes WIFI or BT	NA	NA
LTE	LTE Band 1	DT	NA	Yes WIFI or BT	NA	NA
	LTE Band 2	DT	NA	Yes WIFI or BT	NA	NA
	LTE Band 4	DT	NA	Yes WIFI or BT	NA	NA
	LTE Band 7	DT	NA	Yes WIFI or BT	NA	NA
	LTE Band 17	DT	NA	Yes WIFI or BT	NA	NA
WIFI	2450	DT	NA	Yes GSM, GPRS, EGPRS, HSDPA/HSUPA/RMC/HSPA+/ DC-HSDPA	NA	Yes
Bluetooth (BT)	2400	DT	NA	Yes GSM, GPRS, EGPRS, HSDPA/HSUPA/RMC/HSPA+/ DC-HSDPA	NA	NA

VO Voice CMRS/PSTN Service only
Rating was based on concurrent voice and
V/D Voice CMRS/PSTN and Data Service
DT Digital Transport

#: Evaluated for MIF and Low power exemption

TA Technology (Shanghai) Co., Ltd.
Test Report

Report No. RXA1402-0022HAC01R2

Page 9 of 75

1.6. The Ambient Conditions during Test

Temperature	Min. = 18°C, Max. = 28 °C
Relative humidity	Min. = 0%, Max. = 80%
Ground system resistance	< 0.5 Ω
Ambient noise is checked and found very low and in compliance with requirement of standards. Reflection of surrounding objects is minimized and in compliance with requirement of standards.	

1.7. The Total M-rating of each tested band

Mode	Rating
GSM 850	M4
GSM 1900	M3

1.8. Test Date

The test performed on March 5, 2014.

2. Test Information

2.1. Operational Conditions during Test

2.1.1. General Description of Test Procedures

The phone was tested in all normal configurations for the ear use. The EUT is mounted in the device holder equivalent as for classic dosimeter measurements. The acoustic output of the EUT shall coincide with the center point of the area formed by the dielectric wire and the middle bar of the arch's top frame. The EUT shall be moved vertically upwards until it touches the frame. The fine adjustment is possible by sliding the complete. The EUT holder is on the yellow base plate of the Test Arch phantom. These test configurations are tested at the high, middle and low frequency channels of each applicable operating mode; for example, GSM, WCDMA (UMTS), CDMA and TDMA.

No associated T-coil measurement has been made in accordance with the guidance issued by OET in KDB publication 285076 D02 T-Coil testing for CMRS IP.

2.1.2. GSM Test Configuration

A communication link is set up with a System Simulator (SS) by air link, and a call is established. The EUT is commanded to operate at maximum transmitting power. Using E5515C the power lever is set to "5" for GSM 850, set to "0" for GSM 1900. The test in the bands of GSM 850 and GSM 1900 are performed in the mode of speech transfer function.

2.2. HAC RF Measurements System Configuration

2.2.1. HAC Measurement Set-up

These measurements are performed using the DASY5 automated dosimetric assessment system. It is made by Schmid & Partner Engineering AG (SPEAG) in Zurich, Switzerland. It consists of high precision robotics system (Stäubli), robot controller, Intel Core2 computer, near-field probe, probe alignment sensor. The robot is a six-axis industrial robot performing precise movements. Cell controller systems contain the power supply, robot controller, teach pendant (Joystick) and remote control, and are used to drive the robot motors. The Stäubli Robot is connected to the cell controller to allow software manipulation of the robot. A data acquisition electronic (DAE) circuit performs the signal amplification; signal multiplexing, AD-conversion, offset measurements, mechanical surface detection, collision detection, etc. is connected to the Electro-optical coupler (EOC). The EOC performs the conversion from the optical into digital electric signal of the DAE and transfers data to the PC plug-in card.

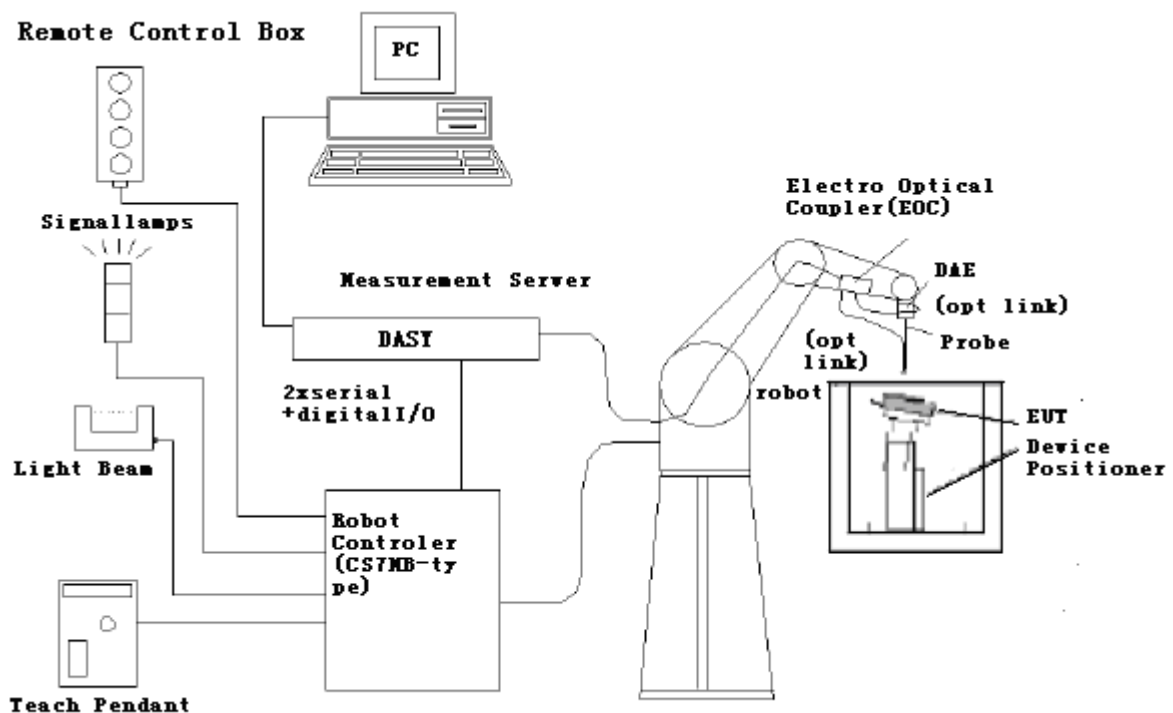

Figure 1 HAC Test Measurement Set-up

The DAE4 consists of a highly sensitive electrometer-grade preamplifier with auto-zeroing, a channel and gain-switching multiplexer, a fast 16 bit AD-converter and a command decoder and control logic unit. Transmission to the PC-card is accomplished through an optical downlink for data and status information and an optical uplink for commands and clock lines. The mechanical probe mounting device includes two different sensor systems for frontal and sidewise probe contacts. They are also used for mechanical surface detection and probe collision detection. The robot uses its own controller with a built in VME-bus computer.

2.2.2. Probe System

The HAC measurements were conducted with the E-Field Probe ER3DV6 and the H-Field Probe H3DV6 (manufactured by SPEAG), designed in the classical triangular configuration and optimized for dosimetric evaluation.

E-Field Probe Description

Construction	One dipole parallel, two dipoles normal to probe axis Built-in shielding against static charges PEEK enclosure material
Calibration	In air from 100 MHz to 3.0 GHz (absolute accuracy $\pm 6.0\%$, $k=2$)
Frequency	40 MHz to > 6 GHz (can be extended to < 20 MHz) Linearity: ± 0.2 dB (100 MHz to 3 GHz)
Directivity	± 0.2 dB in air (rotation around probe axis) ± 0.4 dB in air (rotation normal to probe axis)
Dynamic Range	2 V/m to > 1000 V/m; Linearity: ± 0.2 dB
Dimensions	Overall length: 330 mm (Tip: 16 mm) Tip diameter: 8 mm (Body: 12 mm) Distance from probe tip to dipole centers: 2.5 mm
Application	General near-field measurements up to 6 GHz Field component measurements Fast automatic scanning in phantoms



Figure 2 ER3DV6 E-field Probe

2.2.3. Test Arch Phantom & Phone Positioner

The Test Arch phantom should be positioned horizontally on a stable surface. Reference markings on the Phantom allow the complete setup of all predefined phantom positions and measurement grids by manually teaching three points in the robot. It enables easy and well defined positioning of the phone and validation dipoles as well as simple teaching of the robot (Dimensions: 370 x 370 x 370 mm).

The Device reference point is set for the EUT at 6.3 mm, the Grid reference point is on the upper surface at the origin of the coordinates, and the “user point \Height Check 0.5 mm” is 0.5mm above the center, allowing verification of the gap of 0.5mm while the probe is positioned there.

The Phone Positioner supports accurate and reliable positioning of any phone with effect on near field $< \pm 0.5$ dB.

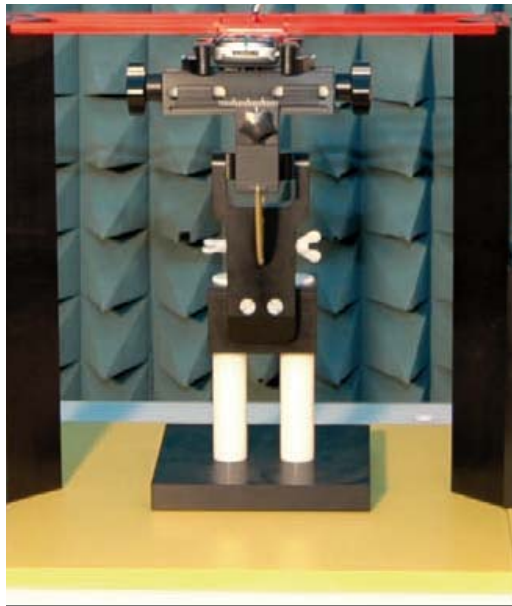

Figure 3 HAC Phantom & Device Holder

2.3. RF Test Procedures

The evaluation was performed with the following procedure:

1. Confirm proper operation of the field probe, probe measurement system and other instrumentation and the positioning system.
2. Position the WD in its intended test position. The gauge block can simplify this positioning. Note that a separate E-field gauge block will be needed if the center of the probe sensor elements is at different distances from the tip of the probe.
3. Configure the WD normal operation for maximum rated RF output power, at the desired channel and other operating parameters (e.g., test mode), as intended for the test.
4. The center sub-grid shall center on the center of the axial measurement point or the acoustic output, as appropriate. Locate the field probe at the initial test position in the 50 mm by 50 mm grid, which is contained in the measurement plane. If the field alignment method is used, align the probe for maximum field reception.
5. Record the reading.
6. Scan the entire 50 mm by 50 mm region in equally spaced increments and record the reading at each measurement point. The grid is 5 cm by 5 cm area that is divided into 9 evenly sized blocks or sub-grids. The distance between measurement points shall be sufficient to assure the identification of the maximum reading.
7. Identify the five contiguous sub-grids around the center sub-grid with the lowest maximum field strength readings. Thus the six areas to be used to determine the WD's highest emissions are identified and outlined for the final manual scan. Please note that a maximum of five blocks can be excluded for both E-field measurements for the WD output being measured. Stated another way, the center sub-grid and three others must be common to both the E-field measurements.
8. Identify the maximum field reading within the non-excluded sub-grids identified in Step 7.
9. Convert the maximum field strength reading identified in Step 8 to V/m or A/m, as appropriate. For probes which require a probe modulation factor, this conversion shall be done using the appropriate probe modulation factor and the calibration.
10. Repeat Step 1 through Step 10 for both the E-field measurements.
11. Compare this reading to the categories in ANSI C63.19 Clause 8 and record the resulting category. The lowest category number listed in 8.2, Table 8.3 obtained in Step 10 for either E-field determines the M category for the audio coupling mode assessment. Record the WD category rating.



Figure 4 WD reference and plane for RF emission measurements

2.4. System Check

Validation Procedure

Place a dipole antenna meeting the requirements given in ANSI C63.19 D.11 in the position normally occupied by the WD. The dipole antenna serves as a known source for an electrical output. Position the E-field probe so that:

The probes and their cables are parallel to the coaxial feed of the dipole antenna.

The probe cables and the coaxial feed of the dipole antenna approach the measurement area from opposite directions.

Position the E-field probe at a 15 mm distance from the center of the probe element to the top surface. Validation was performed to verify that measured E-field is within +/-18% from the target reference values provided by the manufacturer. "Values within +/-18% are acceptable. Of which 12% is deviation and 13% is measurement uncertainty."

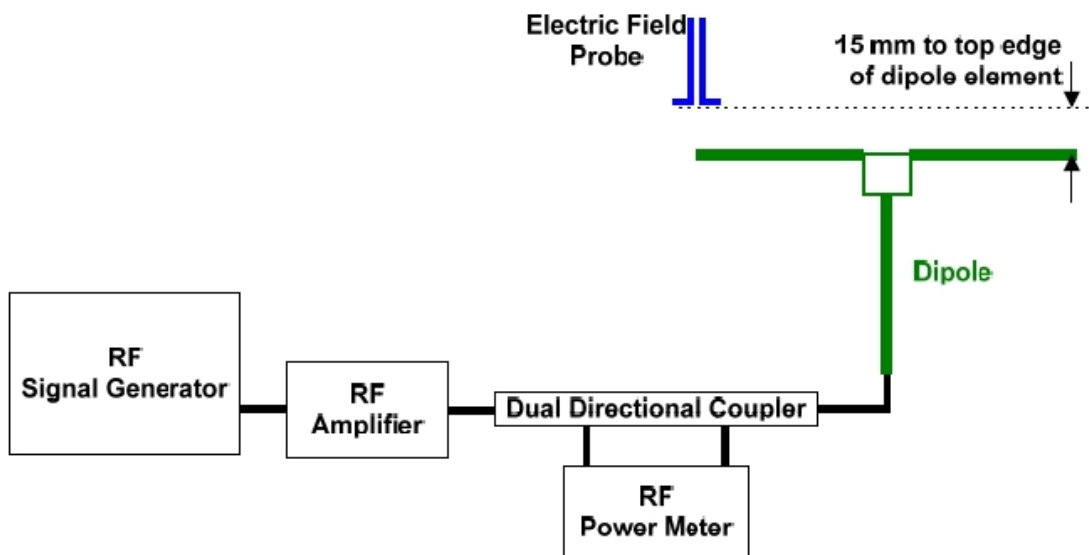

Figure 5 Dipole Validation Setup

Dipole Measurement Summary

E-Field Scan					
Mode	Frequency (MHz)	Input Power (mW)	Value		Test Date
CW	835	100	Target ¹ Value(V/m)	105.4	September 25, 2013
			Measured ² Value(V/m)	107.3	March 5, 2014
			Deviation ³ (%)	1.80	/
CW	1880	100	Target ¹ Value(V/m)	94.2	September 25, 2013
			Measured ² Value(V/m)	98.1	March 5, 2014
			Deviation ³ (%)	4.14	/

2.5. Modulation interference factor

For any specific fixed and repeatable modulated signal, a modulation interference factor (MIF, expressed in dB) may be developed that relates its interference potential to its steady-state rms signal level or average power level. This factor is a function only of the audio-frequency amplitude modulation characteristics of the signal and is the same for field-strength and conducted power measurements. It is important to emphasize that the MIF is valid only for a specific repeatable audio-frequency amplitude modulation characteristic. Any change in modulation characteristic requires determination and application of a new MIF.

The MIF may be determined using a radiated RF field or a conducted RF signal.

- a) Using RF illumination or conducted coupling, apply the specific modulated signal in question to the measurement system at a level within its confirmed operating dynamic range.
- b) Measure the steady-state rms level at the output of the fast probe or sensor.
- c) Measure the steady-state average level at the weighting output.
- d) Without changing the square-law detector or weighting system, and using RF illumination or conducted coupling, substitute for the specific modulated signal a 1 kHz, 80% amplitude modulated carrier at the same frequency and adjust its strength until the level at the weighting output equals the step d) measurement.
- e) Without changing the carrier level from step e), remove the 1 kHz modulation and again measure the steady-state rms level indicated at the output of the fast probe or sensor.
- f) The MIF for the specific modulation characteristic is provided by the ratio of the step e) measurement to the step c) measurement, expressed in dB ($20 \times \log(\text{step e})/\text{step b}$).

MIF

Band	Worst case E-Field Modulation interference factor (dB)
GSM 850	3.63
GSM 1900	3.50
WCDMA Band II	-26.35
WCDMA Band V	-24.56

TA Technology (Shanghai) Co., Ltd.
Test Report

2.6. Conducted Output Power Measurement

Summary

The EUT is tested using an E5515C communications tester as controller unit to set test channels and maximum output power to the DUT, as well as for measuring the conducted power. Conducted output power was measured using an integrated RF connector and attached RF cable. This result contains conducted output power for the EUT.

Conducted Power Results

GSM 850	Conducted Power(dBm)		
	Channel 128	Channel 190	Channel 251
Test Results	33.23	33.12	33
GSM 1900	Conducted Power(dBm)		
	Channel 512	Channel 661	Channel 810
Test Results	30.01	30.16	30.11
UMTS Band II	Conducted Power(dBm)		
	Channel 9262	Channel 9400	Channel 9538
12.2kbps RMC	23.43	23.50	23.23
UMTS Band V	Conducted Power(dBm)		
	Channel 4132	Channel 4183	Channel 4233
12.2kbps RMC	24.15	24.15	24.03

TA Technology (Shanghai) Co., Ltd.

Test Report

2.7. Analysis of RF Air Interface Technologies

RF air interface technologies that have low power have been found to produce sufficiently low RF interference potential, so that it is possible to exempt them from the product testing specified in Clause 5. As described in 5.4.4. An RF air interface technology of a device is exempt from testing when its average antenna input power plus its MIF is ≤ 17 dBm for any of its operating modes.

2.8. Individual Mode Evaluations

Air Interface	Maximum average power (dBm)	Worst case MIF (dB)	Total (power +MIF,dB)	C63.19 Testing Required
GSM 850	32	3.63	35.63	Yes
GSM 1900	29.76	3.50	33.24	Yes
WCDMA Band II	23.50	-26.35	-2.85	No
WCDMA Band V	24.15	-24.56	-0.41	No

Per ANSI C63.19-2011 RF Emissions testing for this device is required only for GSM voice modes. All other applicable air interfaces are exempt.

TA Technology (Shanghai) Co., Ltd.
Test Report

3. Test Results

3.1. ANSI C63.19-2011 Limits

Category	Telephone RF parameters < 960 MHz	
Near field	E-field emissions	
Category M1	50 to 55	dB (V/m)
Category M2	45 to 50	dB (V/m)
Category M3	40 to 45	dB (V/m)
Category M4	< 40	dB (V/m)
Category	Telephone RF parameters > 960 MHz	
Near field	E-field emissions	
Category M1	40 to 45	dB (V/m)
Category M2	35 to 40	dB (V/m)
Category M3	30 to 35	dB (V/m)
Category M4	< 30	dB (V/m)

TA Technology (Shanghai) Co., Ltd.
Test Report

3.2. Summary Test Results

GSM 850 Results

Battery 1

Channel	Frequency (MHz)	MIF(dB)	E-Field Emissions dB (V/m)	Power Drift (dB)	Category	Graph Results
High/251	848.8	3.63	37.08	0.01	M4	Figure 10
Middle/190	836.6	3.63	37.52	-0.05	M4	Figure 11
Low/128	824.2	3.63	37.74	-0.10	M4	Figure 12

Battery 2

Channel	Frequency (MHz)	MIF(dB)	E-Field Emissions dB (V/m)	Power Drift (dB)	Category	Graph Results
High/251	848.8	3.63	37.57	0.03	M4	Figure 13
Middle/190	836.6	3.63	38.11	-0.07	M4	Figure 14
Low/128	824.2	3.63	38.16	-0.11	M4	Figure 15

TA Technology (Shanghai) Co., Ltd.
Test Report

Report No. RXA1402-0022HAC01R2

Page 22 of 75

GSM 1900 Results

Battery 1

Channel	Frequency (MHz)	MIF(dB)	E-Field Emissions dB (V/m)	Power Drift (dB)	Category	Graph Results
High/810	1909.8	3.50	28.95	0.10	M4	Figure 16
Middle/661	1880	3.50	29.41	0.14	M4	Figure 17
Low/512	1850.2	3.50	30.14	0.04	M3	Figure 18

Battery 2

Channel	Frequency (MHz)	MIF(dB)	E-Field Emissions dB (V/m)	Power Drift (dB)	Category	Graph Results
High/810	1909.8	3.50	25.24	0.01	M4	Figure 19
Middle/661	1880	3.50	26.59	-0.16	M4	Figure 20
Low/512	1850.2	3.50	28.51	-0.02	M4	Figure 21

TA Technology (Shanghai) Co., Ltd.
Test Report

Report No. RXA1402-0022HAC01R2

Page 23 of 75

4. Measurement Uncertainty

No.	Error source	Type	Uncertainty Value (%)	Prob. Dist.	k	$c_{ij}E$	$c_{ij}H$	Standard Uncertainty (%) u_i (%) E	Degree of freedom V_{eff} or v_i
1	Probe Calibration	B	5.1	N	1	1	1	5.1	∞
2	Axial Isotropy	B	4.7	R	$\sqrt{3}$	1	1	2.7	∞
3	Sensor Displacement	B	16.5	R	$\sqrt{3}$	1	0.145	9.5	∞
4	Boundary Effects	B	2.4	R	$\sqrt{3}$	1	1	1.4	∞
5	Test Arch	B	7.2	R	$\sqrt{3}$	1	0	4.1	∞
6	Linearity	B	4.7	R	$\sqrt{3}$	1	1	2.7	∞
7	Scaling to Peak Envelope Power	B	2.0	R	$\sqrt{3}$	1	1	1.2	∞
8	System Detection Limit	B	1.0	R	$\sqrt{3}$	1	1	0.6	∞
9	Readout Electronics	B	0.3	N	1	1	1	0.3	∞
10	Response Time	B	0.8	R	$\sqrt{3}$	1	1	0.5	∞
11	Integration Time	B	2.6	R	$\sqrt{3}$	1	1	1.5	∞
12	RF Ambient Conditions	B	3.0	R	$\sqrt{3}$	1	1	1.7	∞
13	RF Reflections	B	12.0	R	$\sqrt{3}$	1	1	6.9	∞
14	Probe Positioner	B	1.2	R	$\sqrt{3}$	1	0.67	0.7	∞
15	Probe Positioning	A	4.7	R	$\sqrt{3}$	1	0.67	2.7	∞
16	Extra. And Interpolation	B	1.0	R	$\sqrt{3}$	1	1	0.6	∞
17	Device Positioning Vertical	B	4.7	R	$\sqrt{3}$	1	0.67	2.7	∞
18	Device Positioning Lateral	B	1.0	R	$\sqrt{3}$	1	1	0.6	∞
19	Device Holder and Phantom	B	2.4	R	$\sqrt{3}$	1	1	1.4	∞

TA Technology (Shanghai) Co., Ltd.
Test Report

Report No. RXA1402-0022HAC01R2

Page 24 of 75

20	Power Drift	B	5.0	R	$\sqrt{3}$	1	1	2.9	∞
21	Phantom Thickness	B	2.4	R	$\sqrt{3}$	1	0.67	1.4	∞
Combined standard uncertainty (%)								15.19	
Expanded Std. uncertainty on power (K=2)								30.38	
Expanded Std. uncertainty on field (K=2)								15.19	

TA Technology (Shanghai) Co., Ltd.
Test Report

Report No. RXA1402-0022HAC01R2

Page 25 of 75

5. Main Test Instruments

No.	Name	Type	Serial Number	Calibration Date	Valid Period
01	Power meter	Agilent E4417A	GB41291714	March 10, 2013	One year
02	Power sensor	Agilent N8481H	MY50350004	September 23, 2013	One year
03	Signal Generator	HP 8341B	2730A00804	September 10, 2013	One year
04	Amplifier	IXA-020	0401	No Calibration Requested	
05	BTS	E5515C	MY48360988	November 30, 2013	One year
06	E-Field Probe	ER3DV6	2428	January 27, 2014	One year
07	DAE	DAE4	1317	January 16, 2014	One year
08	Validation Kit 835MHz	CD835V3	1023	September 25, 2013	One year
09	Validation Kit 1880MHz	CD1880V3	1018	September 25, 2013	One year
10	Hygrothermograph	WS-1	64591	September 26, 2013	One year
11	Audio Interference Analyzer	AIA	1012	No Calibration Requested	

*****END OF REPORT *****

ANNEX A: System Check Results

HAC_System Performance Check at 835MHz_E

DUT: Dipole 835 MHz; Type: CD835V3; SN:1023

Date/Time: 3/5/2014 7:10:52 AM

Communication System: CW; Frequency: 835 MHz; Duty Cycle: 1:1

Medium parameters used: $\sigma = 0$ mho/m, $\epsilon_r = 1$; $\rho = 1000$ kg/m³

Ambient Temperature: 22.3 °C

Phantom section: RF Section

DASY5 Configuration:

Sensor-Surface: 4mm (Mechanical Surface Detection)

Probe: ER3DV6 - SN2428; ConvF(1, 1, 1); Calibrated: 1/27/2014

Electronics: DAE4 Sn1317; Calibrated: 1/16/2014

Phantom: HAC Test Arch with AMCC; Type: SD HAC P01 BA;

Measurement SW: DASY5, V5.2 Build 162; SEMCAD X Version 14.0 Build 59

E Scan - measurement distance from the probe sensor center to CD835 Dipole = 15mm

2/Hearing Aid Compatibility Test (41x361x1): Measurement grid: dx=5mm, dy=5mm

Maximum value of peak Total field = 107.3 V/m

Applied MIF = 0.00 dB

Device Reference Point: 0.000, 0.000, -6.30 mm

Reference Value = 112.7 V/m; Power Drift = 0.003 dB

Hearing Aid Near-Field Category: M4 (AWF 0 dB)

Peak E-field in V/m

Grid 1 101.2 M4	Grid 2 104.3 M4	Grid 3 101.5 M4
Grid 4 61.2 M4	Grid 5 64.23 M4	Grid 6 62.39 M4
Grid 7 104.5 M4	Grid 8 107.3 M4	Grid 9 104.3 M4

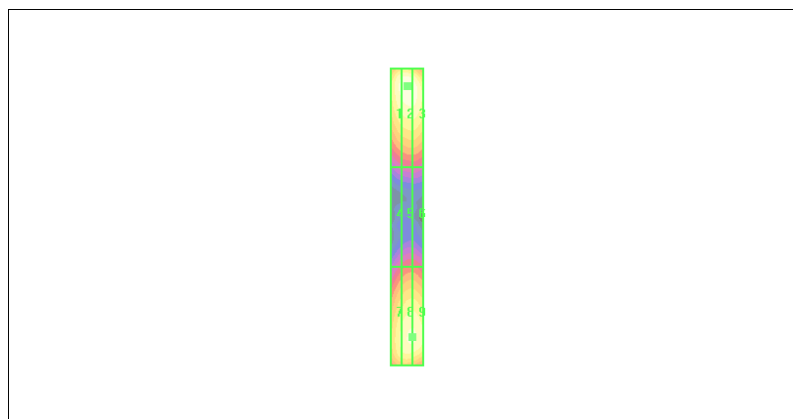
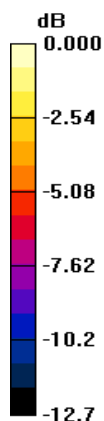

0 dB = 107.3V/m

Figure 6 System Performance Check 835MHz_E

TA Technology (Shanghai) Co., Ltd. Test Report

Report No. RXA1402-0022HAC01R2

Page 27 of 75

HAC_System Performance Check at 1880MHz_E

DUT: Dipole 1880 MHz; Type: CD1880V3; SN: 1018

Date/Time: 3/5/2014 10:39:52 AM

Communication System: CW; Frequency: 1880 MHz; Duty Cycle: 1:1

Medium parameters used: $\sigma = 0$ mho/m, $\epsilon_r = 1$; $\rho = 1000$ kg/m³

Ambient Temperature: 22.3 °C

Phantom section: RF Section

DASY5 Configuration:

Sensor-Surface: 4mm (Mechanical Surface Detection)

Probe: ER3DV6 - SN2428; ConvF(1, 1, 1); Calibrated: 1/27/2014

Electronics: DAE4 Sn1317; Calibrated: 1/16/2014

Phantom: HAC Test Arch with AMCC; Type: SD HAC P01 BA;

Measurement SW: DASY5, V5.2 Build 162; SEMCAD X Version 14.0 Build 59

E Scan - measurement distance from the probe sensor center to CD1880 Dipole = 15mm/Hearing Aid Compatibility Test (41x181x1): Measurement grid: dx=5mm, dy=5mm

Maximum value of peak Total field = 98.1 V/m

Applied MIF = 0.00 dB

Device Reference Point: 0.000, 0.000, -6.30 mm

Reference Value = 146.4 V/m; Power Drift = 0.002 dB

Hearing Aid Near-Field Category: M2 (AWF 0 dB)

Peak E-field in V/m

Grid 1 91.78 M2	Grid 2 98.10 M2	Grid 3 93.42M2
Grid 4 71.76 M3	Grid 5 73.56 M3	Grid 6 71.17 M3
Grid 7 87.15 M2	Grid 8 89.46 M2	Grid 9 89.01 M2

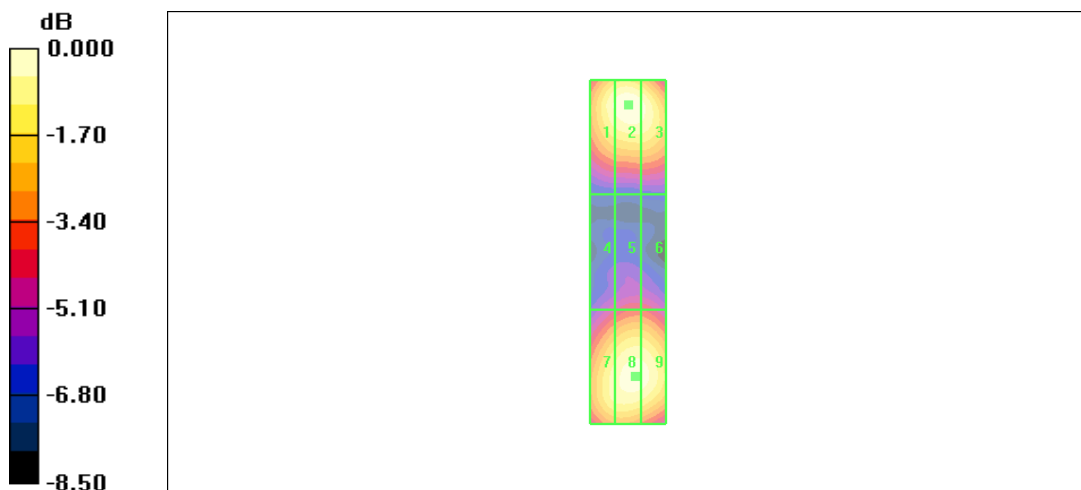

0 dB = 98.10V/m

Figure 7 System Performance Check 1880MHz_E

TA Technology (Shanghai) Co., Ltd.

Test Report

Report No. RXA1402-0022HAC01R2

Page 28 of 75

ANNEX B: Graph Results

HAC RF E-Field GSM 850 High (Battery 1)

Date/Time: 3/5/2014 8:44:52 AM

Communication System: UID 10021 - DAA, GSM-FDD (TDMA, GMSK); Frequency: 848.6 MHz; Duty Cycle: 1:8.3

Medium parameters used: $\sigma = 0$ S/m, $\epsilon_r = 1$; $\rho = 1000$ kg/m³

Ambient Temperature: 22.3 °C

Phantom section: RF Section

DASY4 Configuration:

Sensor-Surface: 4mm (Mechanical Surface Detection)

Probe: ER3DV6 - SN2428; ConvF(1, 1, 1); Calibrated: 1/27/2014;

Electronics: DAE4 Sn1317; Calibrated: 1/16/2014

Phantom: HAC Test Arch with AMCC; Type: SD HAC P01 BA;

Measurement SW: DASY52, Version 52.8 (7); SEMCAD X Version 14.6.10 (7164)

6036A GSM850 HAC RF E-Field 2011/E Scan - ER3D: 15 mm from Probe Center to the Device High/Hearing Aid Compatibility Test (101x101x1): Interpolated grid: dx=0.5000 mm, dy=0.5000 mm

Device Reference Point: 0, 0, -6.3 mm

Reference Value = 58.71 V/m; Power Drift = 0.01 dB

Applied MIF = 3.63 dB

RF audio interference level = 37.08 dBV/m

Emission category: M4

MIF scaled E-field

Grid 1 M4 36.07 dBV/m	Grid 2 M4 36.98 dBV/m	Grid 3 M4 36.9 dBV/m
Grid 4 M4 36.11 dBV/m	Grid 5 M4 37.08 dBV/m	Grid 6 M4 36.99 dBV/m
Grid 7 M4 35.98 dBV/m	Grid 8 M4 36.91 dBV/m	Grid 9 M4 36.82 dBV/m

Category	Limits for E-Field Emissions < 960MHz	Limits for E-Field Emissions > 960MHz
M1	50 dBV/m - 55 dB V/m	40 dBV/m - 45 dB V/m
M2	45 dBV/m - 50 dB V/m	35 dBV/m - 40 dB V/m
M3	40 dBV/m - 45 dB V/m	30 dBV/m - 35 dB V/m
M4	<40 dBV/m	<30 dBV/m

TA Technology (Shanghai) Co., Ltd.
Test Report

Report No. RXA1402-0022HAC01R2

Page 29 of 75

Cursor:

Total = 37.08 dBV/m

E Category: M4

Location: -5, -2.5, 8.7 mm

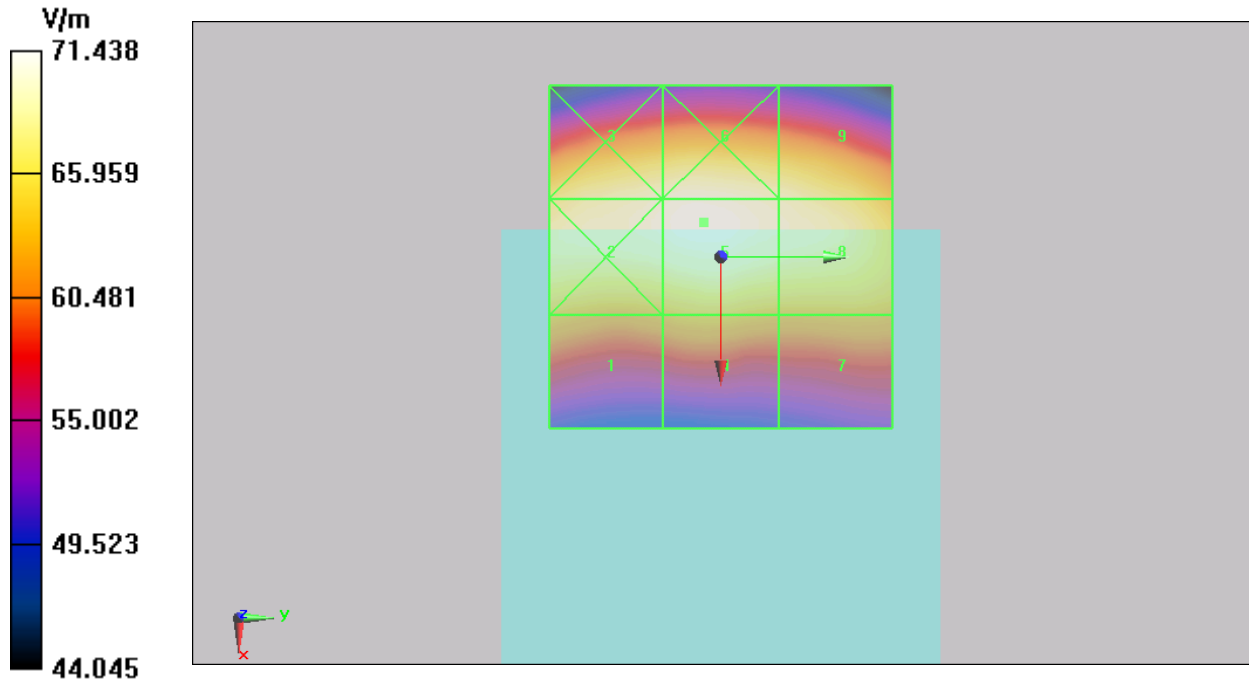

0 dB = 71.44 V/m = 37.08 dBV/m

Figure 8 HAC RF E-Field GSM 850 Channel 251

TA Technology (Shanghai) Co., Ltd.

Test Report

HAC RF E-Field GSM 850 Middle (Battery 1)

Date/Time: 3/5/2014 9:09:39 AM

Communication System: UID 10021 - DAA, GSM-FDD (TDMA, GMSK); Frequency: 836.6 MHz; Duty Cycle: 1:8.3

Medium parameters used: $\sigma = 0$ S/m, $\epsilon_r = 1$; $\rho = 1000$ kg/m³

Ambient Temperature: 22.3 °C

Phantom section: RF Section

DASY4 Configuration:

Sensor-Surface: 4mm (Mechanical Surface Detection)

Probe: ER3DV6 - SN2428; ConvF(1, 1, 1); Calibrated: 1/27/2014;

Electronics: DAE4 Sn1317; Calibrated: 1/16/2014

Phantom: HAC Test Arch with AMCC; Type: SD HAC P01 BA;

Measurement SW: DASY52, Version 52.8 (7); SEMCAD X Version 14.6.10 (7164)

6036A GSM850 HAC RF E-Field 2011/E Scan - ER3D: 15 mm from Probe Center to the Device Middle/Hearing Aid Compatibility Test (101x101x1): Interpolated grid: dx=0.5000 mm, dy=0.5000 mm

Device Reference Point: 0, 0, -6.3 mm

Reference Value = 62.65 V/m; Power Drift = -0.05 dB

Applied MIF = 3.63 dB

RF audio interference level = 37.52 dBV/m

Emission category: M4

MIF scaled E-field

Grid 1 M4 36.53 dBV/m	Grid 2 M4 37.43 dBV/m	Grid 3 M4 37.32 dBV/m
Grid 4 M4 36.6 dBV/m	Grid 5 M4 37.52 dBV/m	Grid 6 M4 37.41 dBV/m
Grid 7 M4 36.43 dBV/m	Grid 8 M4 37.33 dBV/m	Grid 9 M4 37.2 dBV/m

Category	Limits for E-Field Emissions < 960MHz	Limits for E-Field Emissions > 960MHz
M1	50 dBV/m - 55 dB V/m	40 dBV/m - 45 dB V/m
M2	45 dBV/m - 50 dB V/m	35 dBV/m - 40 dB V/m
M3	40 dBV/m - 45 dB V/m	30 dBV/m - 35 dB V/m
M4	<40 dBV/m	<30 dBV/m

Cursor:

Total = 37.52 dBV/m

E Category: M4

Location: -4.5, -4.5, 8.7 mm

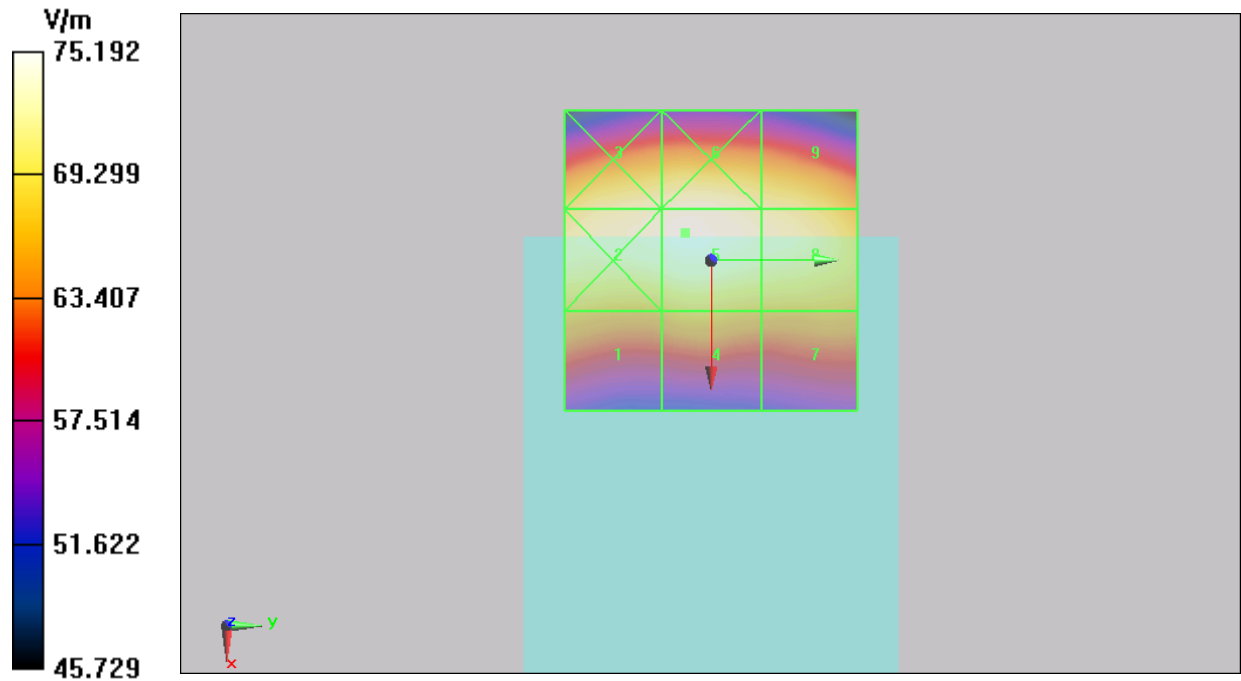

0 dB = 75.19 V/m = 37.52 dBV/m

Figure 9 HAC RF E-Field GSM 850 Channel 190

TA Technology (Shanghai) Co., Ltd.

Test Report

Report No. RXA1402-0022HAC01R2

Page 32 of 75

HAC RF E-Field GSM 850 Low (Battery 1)

Date/Time: 3/5/2014 9:30:11 AM

Communication System: UID 10021 - DAA, GSM-FDD (TDMA, GMSK); Frequency: 824.2 MHz; Duty Cycle: 1:8.3

Medium parameters used: $\sigma = 0$ S/m, $\epsilon_r = 1$; $\rho = 1000$ kg/m³

Ambient Temperature: 22.3 °C

Phantom section: RF Section

DASY4 Configuration:

Sensor-Surface: 4mm (Mechanical Surface Detection)

Probe: ER3DV6 - SN2428; ConvF(1, 1, 1); Calibrated: 1/27/2014;

Electronics: DAE4 Sn1317; Calibrated: 1/16/2014

Phantom: HAC Test Arch with AMCC; Type: SD HAC P01 BA;

Measurement SW: DASY52, Version 52.8 (7); SEMCAD X Version 14.6.10 (7164)

6036A GSM850 HAC RF E-Field 2011/E Scan - ER3D: 15 mm from Probe Center to the Device Low/Hearing Aid Compatibility Test (101x101x1): Interpolated grid: dx=0.5000 mm, dy=0.5000 mm

Device Reference Point: 0, 0, -6.3 mm

Reference Value = 64.45 V/m; Power Drift = -0.10 dB

Applied MIF = 3.63 dB

RF audio interference level = 37.74 dBV/m

Emission category: M4

MIF scaled E-field

Grid 1 M4 36.83 dBV/m	Grid 2 M4 37.61 dBV/m	Grid 3 M4 37.48 dBV/m
Grid 4 M4 36.9 dBV/m	Grid 5 M4 37.74 dBV/m	Grid 6 M4 37.6 dBV/m
Grid 7 M4 36.72 dBV/m	Grid 8 M4 37.52 dBV/m	Grid 9 M4 37.41 dBV/m

Category	Limits for E-Field Emissions < 960MHz	Limits for E-Field Emissions > 960MHz
M1	50 dBV/m - 55 dB V/m	40 dBV/m - 45 dB V/m
M2	45 dBV/m - 50 dB V/m	35 dBV/m - 40 dB V/m
M3	40 dBV/m - 45 dB V/m	30 dBV/m - 35 dB V/m
M4	<40 dBV/m	<30 dBV/m

TA Technology (Shanghai) Co., Ltd.
Test Report

Cursor:

Total = 37.74 dBV/m

E Category: M4

Location: -4, -2, 8.7 mm

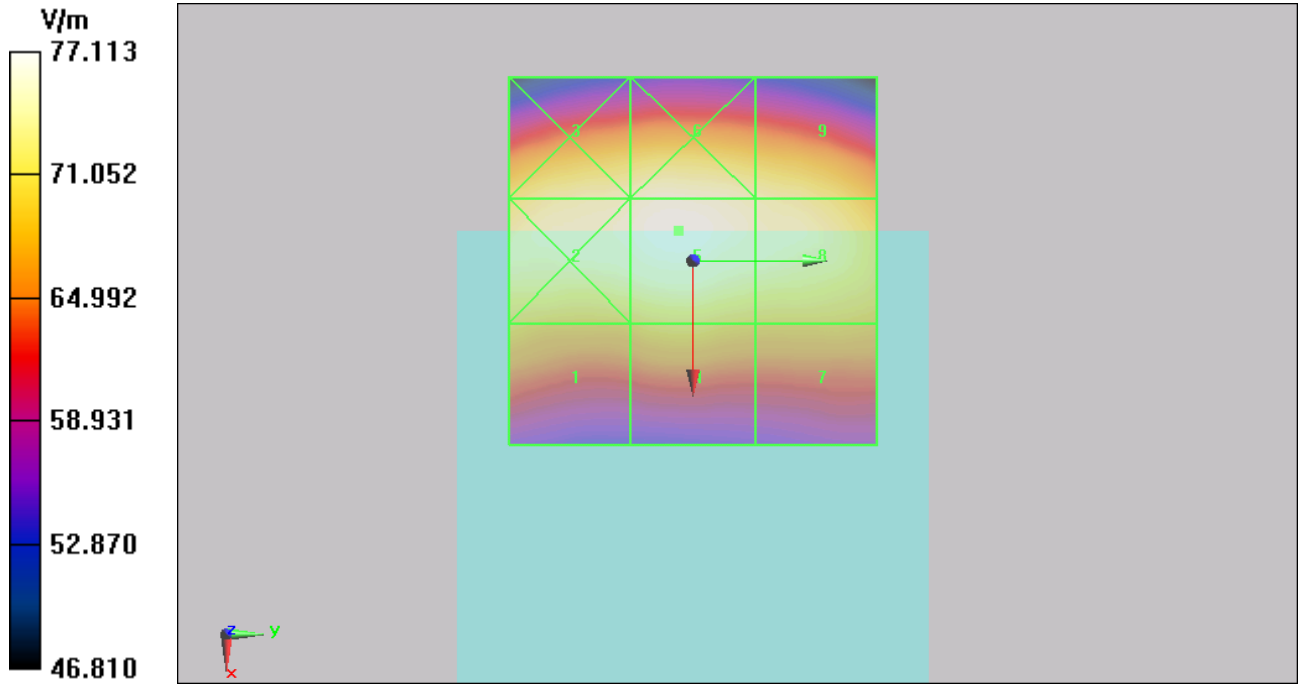

Figure 10 HAC RF E-Field GSM 850 Channel 128

TA Technology (Shanghai) Co., Ltd.

Test Report

Report No. RXA1402-0022HAC01R2

Page 34 of 75

HAC RF E-Field GSM 850 High (Battery 2)

Date/Time: 3/5/2014 10:01:45 AM

Communication System: UID 10021 - DAA, GSM-FDD (TDMA, GMSK); Frequency: 848.6 MHz; Duty Cycle: 1:8.3

Medium parameters used: $\sigma = 0$ S/m, $\epsilon_r = 1$; $\rho = 1000$ kg/m³

Ambient Temperature: 22.3 °C

Phantom section: RF Section

DASY4 Configuration:

Sensor-Surface: 4mm (Mechanical Surface Detection)

Probe: ER3DV6 - SN2428; ConvF(1, 1, 1); Calibrated: 1/27/2014;

Electronics: DAE4 Sn1317; Calibrated: 1/16/2014

Phantom: HAC Test Arch with AMCC; Type: SD HAC P01 BA;

Measurement SW: DASY52, Version 52.8 (7); SEMCAD X Version 14.6.10 (7164)

6036A with Battery F2 GSM850 HAC RF E-Field 2011/E Scan - ER3D: 15 mm from Probe Center to the Device High/Hearing Aid Compatibility Test (101x101x1): Interpolated grid: dx=0.5000 mm, dy=0.5000 mm

Device Reference Point: 0, 0, -6.3 mm

Reference Value = 63.00 V/m; Power Drift = -0.03 dB

Applied MIF = 3.63 dB

RF audio interference level = 37.57 dBV/m

Emission category: M4

MIF scaled E-field

Grid 1 M4 36.48 dBV/m	Grid 2 M4 37.45 dBV/m	Grid 3 M4 37.37 dBV/m
Grid 4 M4 36.58 dBV/m	Grid 5 M4 37.57 dBV/m	Grid 6 M4 37.47 dBV/m
Grid 7 M4 36.47 dBV/m	Grid 8 M4 37.41 dBV/m	Grid 9 M4 37.32 dBV/m

Category	Limits for E-Field Emissions < 960MHz	Limits for E-Field Emissions > 960MHz
M1	50 dBV/m - 55 dB V/m	40 dBV/m - 45 dB V/m
M2	45 dBV/m - 50 dB V/m	35 dBV/m - 40 dB V/m
M3	40 dBV/m - 45 dB V/m	30 dBV/m - 35 dB V/m
M4	<40 dBV/m	<30 dBV/m

Cursor:

Total = 37.57 dBV/m

E Category: M4

Location: -4.5, -1, 8.7 mm

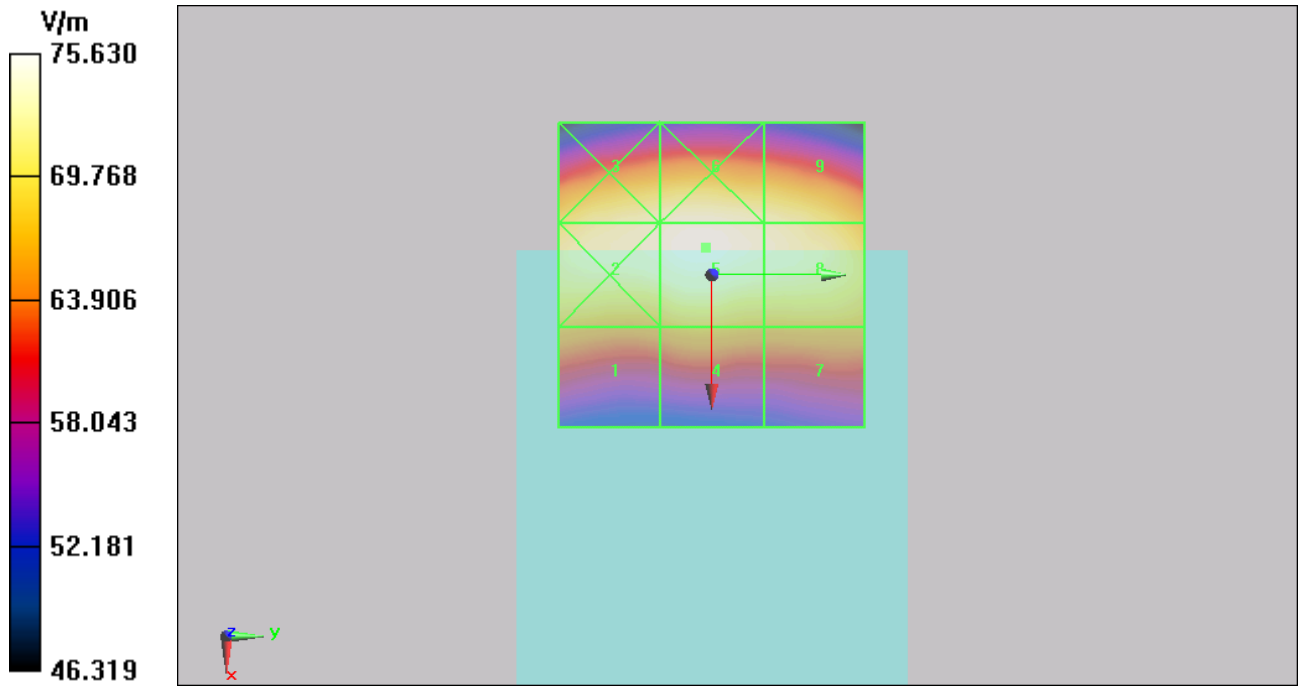

0 dB = 75.63 V/m = 37.57 dBV/m

Figure 11 HAC RF E-Field GSM 850 Channel 251

TA Technology (Shanghai) Co., Ltd.

Test Report

Report No. RXA1402-0022HAC01R2

Page 36 of 75

HAC RF E-Field GSM 850 Middle (Battery 2)

Date/Time: 3/5/2014 10:26:31 AM

Communication System: UID 10021 - DAA, GSM-FDD (TDMA, GMSK); Frequency: 836.6 MHz; Duty Cycle: 1:8.3

Medium parameters used: $\sigma = 0$ S/m, $\epsilon_r = 1$; $\rho = 1000$ kg/m³

Ambient Temperature: 22.3 °C

Phantom section: RF Section

DASY4 Configuration:

Sensor-Surface: 4mm (Mechanical Surface Detection)

Probe: ER3DV6 - SN2428; ConvF(1, 1, 1); Calibrated: 1/27/2014;

Electronics: DAE4 Sn1317; Calibrated: 1/16/2014

Phantom: HAC Test Arch with AMCC; Type: SD HAC P01 BA;

Measurement SW: DASY52, Version 52.8 (7); SEMCAD X Version 14.6.10 (7164)

6036A with Battery F2 GSM850 HAC RF E-Field 2011/E Scan - ER3D: 15 mm from Probe Center to the Device Middle/Hearing Aid Compatibility Test (101x101x1): Interpolated grid: dx=0.5000 mm, dy=0.5000 mm

Device Reference Point: 0, 0, -6.3 mm

Reference Value = 67.33 V/m; Power Drift = -0.07 dB

Applied MIF = 3.63 dB

RF audio interference level = 38.11 dBV/m

Emission category: M4

MIF scaled E-field

Grid 1 M4 37.06 dBV/m	Grid 2 M4 37.99 dBV/m	Grid 3 M4 37.84 dBV/m
Grid 4 M4 37.18 dBV/m	Grid 5 M4 38.11 dBV/m	Grid 6 M4 37.96 dBV/m
Grid 7 M4 37.04 dBV/m	Grid 8 M4 37.93 dBV/m	Grid 9 M4 37.81 dBV/m

Category	Limits for E-Field Emissions < 960MHz	Limits for E-Field Emissions > 960MHz
M1	50 dBV/m - 55 dB V/m	40 dBV/m - 45 dB V/m
M2	45 dBV/m - 50 dB V/m	35 dBV/m - 40 dB V/m
M3	40 dBV/m - 45 dB V/m	30 dBV/m - 35 dB V/m
M4	<40 dBV/m	<30 dBV/m

Cursor:

Total = 38.11 dBV/m

E Category: M4

Location: -4.5, -1, 8.7 mm

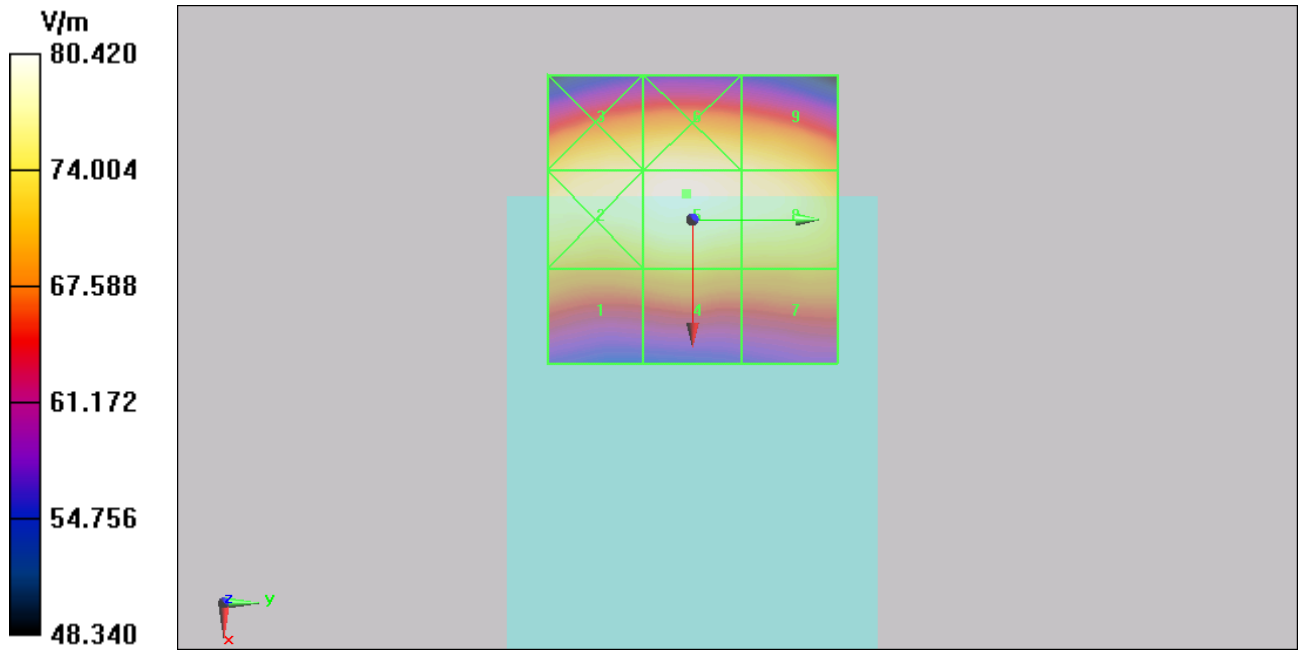

Figure 12 HAC RF E-Field GSM 850 Channel 190

TA Technology (Shanghai) Co., Ltd.

Test Report

HAC RF E-Field GSM 850 Low (Battery 2)

Date/Time: 3/5/2014 9:47:08 AM

Communication System: UID 10021 - DAA, GSM-FDD (TDMA, GMSK); Frequency: 824.2 MHz; Duty Cycle: 1:8.3

Medium parameters used: $\sigma = 0$ S/m, $\epsilon_r = 1$; $\rho = 1000$ kg/m³

Ambient Temperature: 22.3 °C

Phantom section: RF Section

DASY4 Configuration:

Sensor-Surface: 4mm (Mechanical Surface Detection)

Probe: ER3DV6 - SN2428; ConvF(1, 1, 1); Calibrated: 1/27/2014;

Electronics: DAE4 Sn1317; Calibrated: 1/16/2014

Phantom: HAC Test Arch with AMCC; Type: SD HAC P01 BA;

Measurement SW: DASY52, Version 52.8 (7); SEMCAD X Version 14.6.10 (7164)

6036A with Battery F2 GSM850 HAC RF E-Field 2011/E Scan - ER3D: 15 mm from Probe Center to the Device Low/Hearing Aid Compatibility Test (101x101x1): Interpolated grid: dx=0.5000 mm, dy=0.5000 mm

Device Reference Point: 0, 0, -6.3 mm

Reference Value = 68.11 V/m; Power Drift = -0.11 dB

Applied MIF = 3.63 dB

RF audio interference level = 38.16 dBV/m

Emission category: M4

MIF scaled E-field

Grid 1 M4 37.16 dBV/m	Grid 2 M4 38.04 dBV/m	Grid 3 M4 37.91 dBV/m
Grid 4 M4 37.3 dBV/m	Grid 5 M4 38.16 dBV/m	Grid 6 M4 38.03 dBV/m
Grid 7 M4 37.12 dBV/m	Grid 8 M4 37.98 dBV/m	Grid 9 M4 37.86 dBV/m

Category	Limits for E-Field Emissions < 960MHz	Limits for E-Field Emissions > 960MHz
M1	50 dBV/m - 55 dB V/m	40 dBV/m - 45 dB V/m
M2	45 dBV/m - 50 dB V/m	35 dBV/m - 40 dB V/m
M3	40 dBV/m - 45 dB V/m	30 dBV/m - 35 dB V/m
M4	<40 dBV/m	<30 dBV/m

Cursor:

Total = 38.16 dBV/m

E Category: M4

Location: -4, -2, 8.7 mm

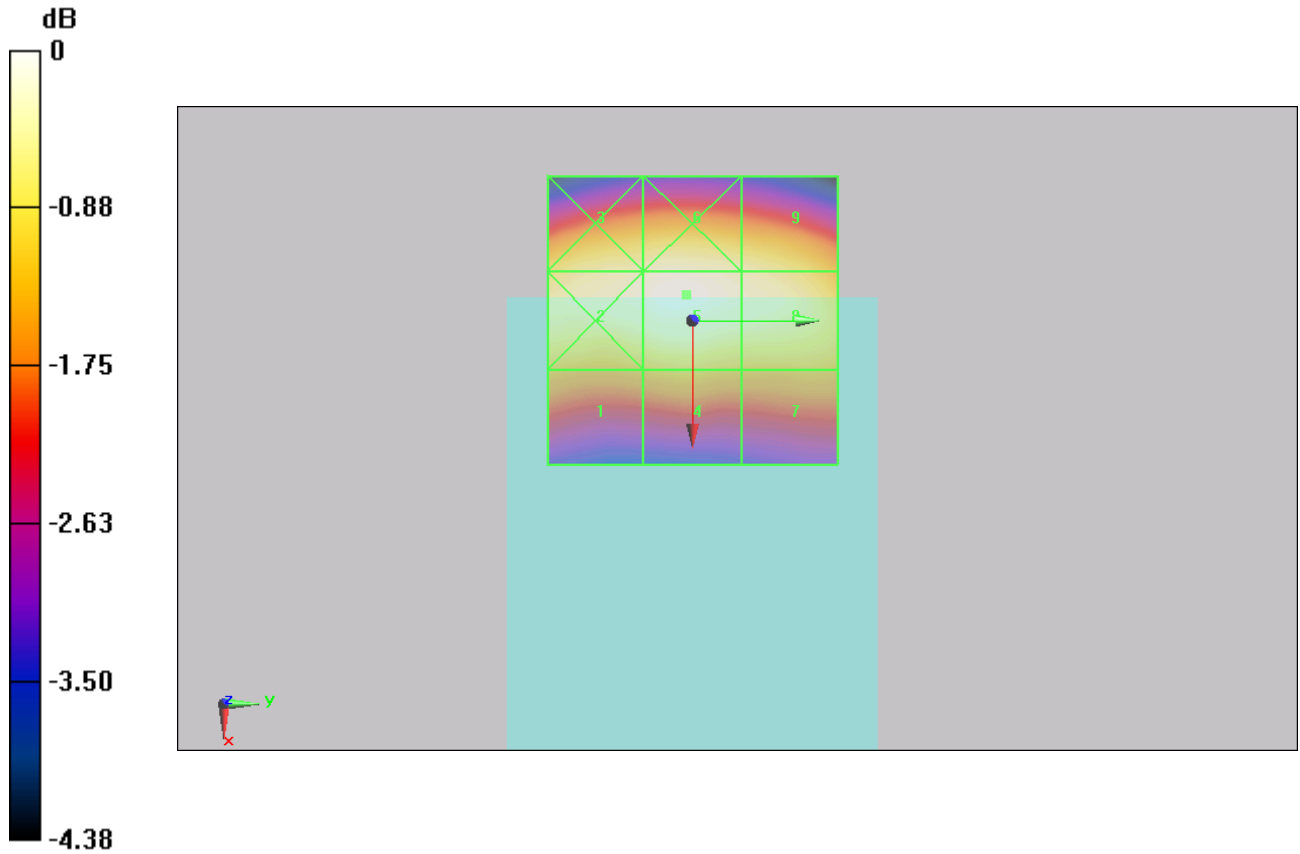

0 dB = 80.87 V/m = 38.16 dBV/m

Figure 13 HAC RF E-Field GSM 850 Channel 128

TA Technology (Shanghai) Co., Ltd.

Test Report

Report No. RXA1402-0022HAC01R2

Page 40 of 75

HAC RF E-Field GSM 1900 High (Battery 1)

Date/Time: 3/5/2014 1:04:33 AM

Communication System: UID 10021 - DAA, GSM-FDD (TDMA, GMSK); Frequency: 1909.8 MHz; Duty Cycle: 1:8.3

Medium parameters used: $\sigma = 0$ S/m, $\epsilon_r = 1$; $\rho = 1000$ kg/m³

Ambient Temperature: 22.3 °C

Phantom section: RF Section

DASY4 Configuration:

Sensor-Surface: 4mm (Mechanical Surface Detection)

Probe: ER3DV6 - SN2428; ConvF(1, 1, 1); Calibrated: 1/27/2014;

Electronics: DAE4 Sn1317; Calibrated: 1/16/2014

Phantom: HAC Test Arch with AMCC; Type: SD HAC P01 BA;

Measurement SW: DASY52, Version 52.8 (7); SEMCAD X Version 14.6.10 (7164)

6036A GSM1900 HAC RF E-Field 2011 Device E-Field measurement (E-field scan for ANSI C63.19-2007 & -2011 compliance)/E Scan - ER3D: 15 mm from Probe Center to the Device High/Hearing Aid Compatibility Test (101x101x1): Interpolated grid: dx=0.5000 mm, dy=0.5000 mm

Device Reference Point: 0, 0, -6.3 mm

Reference Value = 17.12 V/m; Power Drift = 0.10 dB

Applied MIF = 3.50dB

RF audio interference level = 28.95 dBV/m

Emission category: M4

MIF scaled E-field

Grid 1 M4 25.88 dBV/m	Grid 2 M4 25.48 dBV/m	Grid 3 M4 25.59 dBV/m
Grid 4 M4 26.56 dBV/m	Grid 5 M4 28.95 dBV/m	Grid 6 M4 28.94 dBV/m
Grid 7 M4 29.36 dBV/m	Grid 8 M3 30.4 dBV/m	Grid 9 M3 30.16 dBV/m

Category	Limits for E-Field Emissions < 960MHz	Limits for E-Field Emissions > 960MHz
M1	50 dBV/m - 55 dB V/m	40 dBV/m - 45 dB V/m
M2	45 dBV/m - 50 dB V/m	35 dBV/m - 40 dB V/m
M3	40 dBV/m - 45 dB V/m	30 dBV/m - 35 dB V/m
M4	<40 dBV/m	<30 dBV/m

Cursor:

Total = 30.40 dBV/m

E Category: M3

Location: -3.5, 25, 8.7 mm

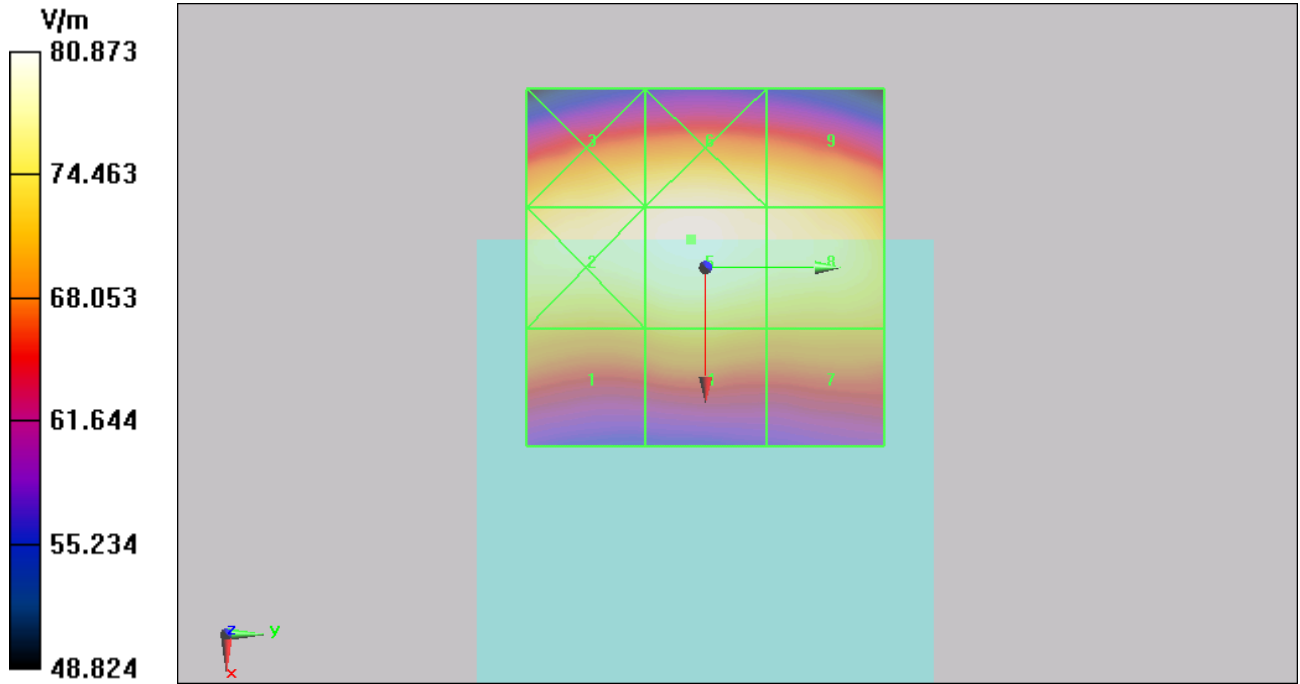

Figure 14 HAC RF E-Field GSM 1900 Channel 810

TA Technology (Shanghai) Co., Ltd.

Test Report

Report No. RXA1402-0022HAC01R2

Page 42 of 75

HAC RF E-Field GSM 1900 Middle (Battery 1)

Date/Time: 3/5/2014 1:41:15 AM

Communication System: UID 10021 - DAA, GSM-FDD (TDMA, GMSK); Frequency: 1880 MHz; Duty Cycle: 1:8.3

Medium parameters used: $\sigma = 0$ S/m, $\epsilon_r = 1$; $\rho = 1000$ kg/m³

Ambient Temperature: 22.3 °C

Phantom section: RF Section

DASY4 Configuration:

Sensor-Surface: 4mm (Mechanical Surface Detection)

Probe: ER3DV6 - SN2428; ConvF(1, 1, 1); Calibrated: 1/27/2014;

Electronics: DAE4 Sn1317; Calibrated: 1/16/2014

Phantom: HAC Test Arch with AMCC; Type: SD HAC P01 BA;

Measurement SW: DASY52, Version 52.8 (7); SEMCAD X Version 14.6.10 (7164)

6036A GSM1900 HAC RF E-Field 2011 Device E-Field measurement (E-field scan for ANSI C63.19-2007 & -2011 compliance)/E Scan - ER3D: 15 mm from Probe Center to the Device Middle/Hearing Aid Compatibility Test (101x101x1): Interpolated grid: dx=0.5000 mm, dy=0.5000 mm

Device Reference Point: 0, 0, -6.3 mm

Reference Value = 18.07 V/m; Power Drift = 0.14 dB

Applied MIF = 3.50 dB

RF audio interference level = 29.41 dBV/m

Emission category: M4

MIF scaled E-field

Grid 1 M4 26.71 dBV/m	Grid 2 M4 26.33 dBV/m	Grid 3 M4 26.57 dBV/m
Grid 4 M4 26.73 dBV/m	Grid 5 M4 29.41 dBV/m	Grid 6 M4 29.41 dBV/m
Grid 7 M4 29.47 dBV/m	Grid 8 M3 30.66 dBV/m	Grid 9 M3 30.5 dBV/m

Category	Limits for E-Field Emissions < 960MHz	Limits for E-Field Emissions > 960MHz
M1	50 dBV/m - 55 dB V/m	40 dBV/m - 45 dB V/m
M2	45 dBV/m - 50 dB V/m	35 dBV/m - 40 dB V/m
M3	40 dBV/m - 45 dB V/m	30 dBV/m - 35 dB V/m
M4	<40 dBV/m	<30 dBV/m

Cursor:

Total = 30.66 dBV/m

E Category: M3

Location: -4, 25, 8.7 mm

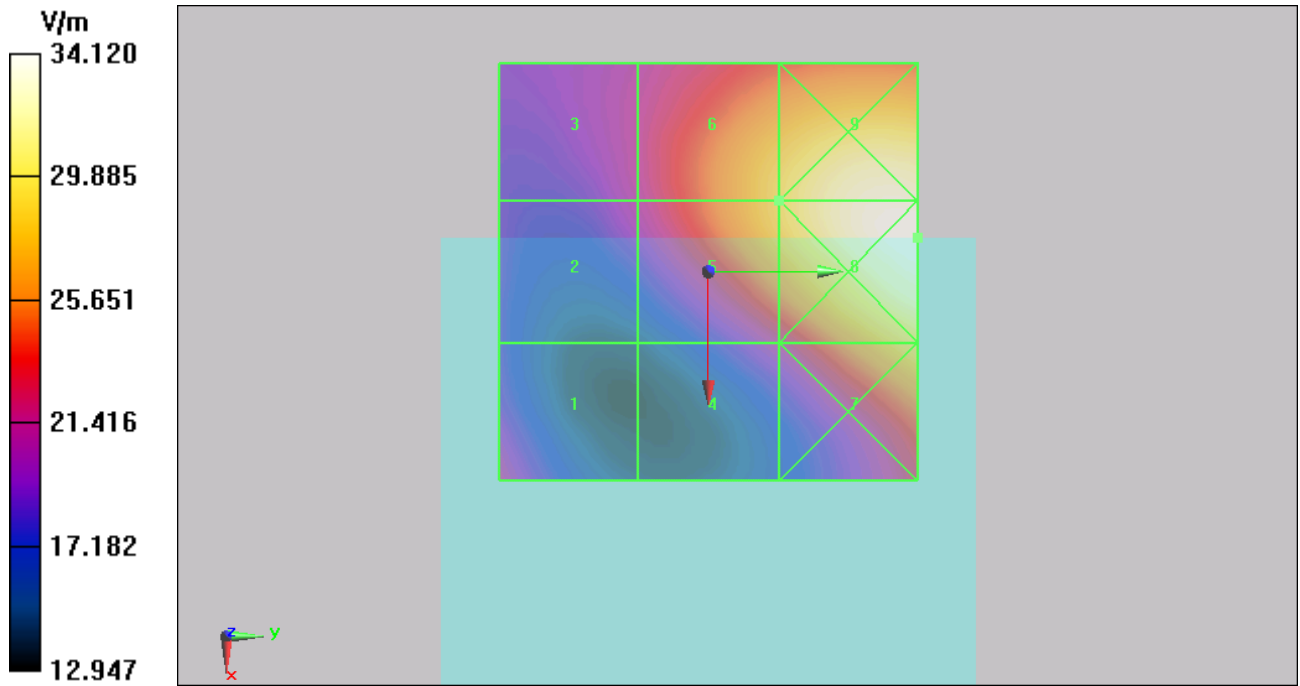

Figure 15 HAC RF E-Field GSM 1900 Channel 661

TA Technology (Shanghai) Co., Ltd.

Test Report

Report No. RXA1402-0022HAC01R2

Page 44 of 75

HAC RF E-Field GSM 1900 Low (Battery 1)

Date/Time: 3/5/2014 1:25:18 AM

Communication System: UID 10021 - DAA, GSM-FDD (TDMA, GMSK); Frequency: 1850.2 MHz; Duty Cycle: 1:8.3

Medium parameters used: $\sigma = 0 \text{ S/m}$, $\epsilon_r = 1$; $\rho = 1000 \text{ kg/m}^3$

Ambient Temperature: 22.3 °C

Phantom section: RF Section

DASY4 Configuration:

Sensor-Surface: 4mm (Mechanical Surface Detection)

Probe: ER3DV6 - SN2428; ConvF(1, 1, 1); Calibrated: 1/27/2014;

Electronics: DAE4 Sn1317; Calibrated: 1/16/2014

Phantom: HAC Test Arch with AMCC; Type: SD HAC P01 BA;

Measurement SW: DASY52, Version 52.8 (7); SEMCAD X Version 14.6.10 (7164)

6036A GSM1900 HAC RF E-Field 2011 Device E-Field measurement (E-field scan for ANSI C63.19-2007 & -2011 compliance)/E Scan - ER3D: 15 mm from Probe Center to the Device Low/Hearing Aid Compatibility Test (101x101x1): Interpolated grid: dx=0.5000 mm, dy=0.5000 mm

Device Reference Point: 0, 0, -6.3 mm

Reference Value = 19.27 V/m; Power Drift = 0.04 dB

Applied MIF = 3.50 dB

RF audio interference level = 30.14 dBV/m

Emission category: M3

MIF scaled E-field

Grid 1 M4 27.03 dBV/m	Grid 2 M4 26.7 dBV/m	Grid 3 M4 26.94 dBV/m
Grid 4 M4 27.36 dBV/m	Grid 5 M3 30.14 dBV/m	Grid 6 M3 30.14 dBV/m
Grid 7 M3 30.31 dBV/m	Grid 8 M3 31.58 dBV/m	Grid 9 M3 31.44 dBV/m

Category	Limits for E-Field Emissions < 960MHz	Limits for E-Field Emissions > 960MHz
M1	50 dBV/m - 55 dB V/m	40 dBV/m - 45 dB V/m
M2	45 dBV/m - 50 dB V/m	35 dBV/m - 40 dB V/m
M3	40 dBV/m - 45 dB V/m	30 dBV/m - 35 dB V/m
M4	<40 dBV/m	<30 dBV/m

Cursor:

Total = 31.58 dBV/m

E Category: M3

Location: -4, 25, 8.7 mm

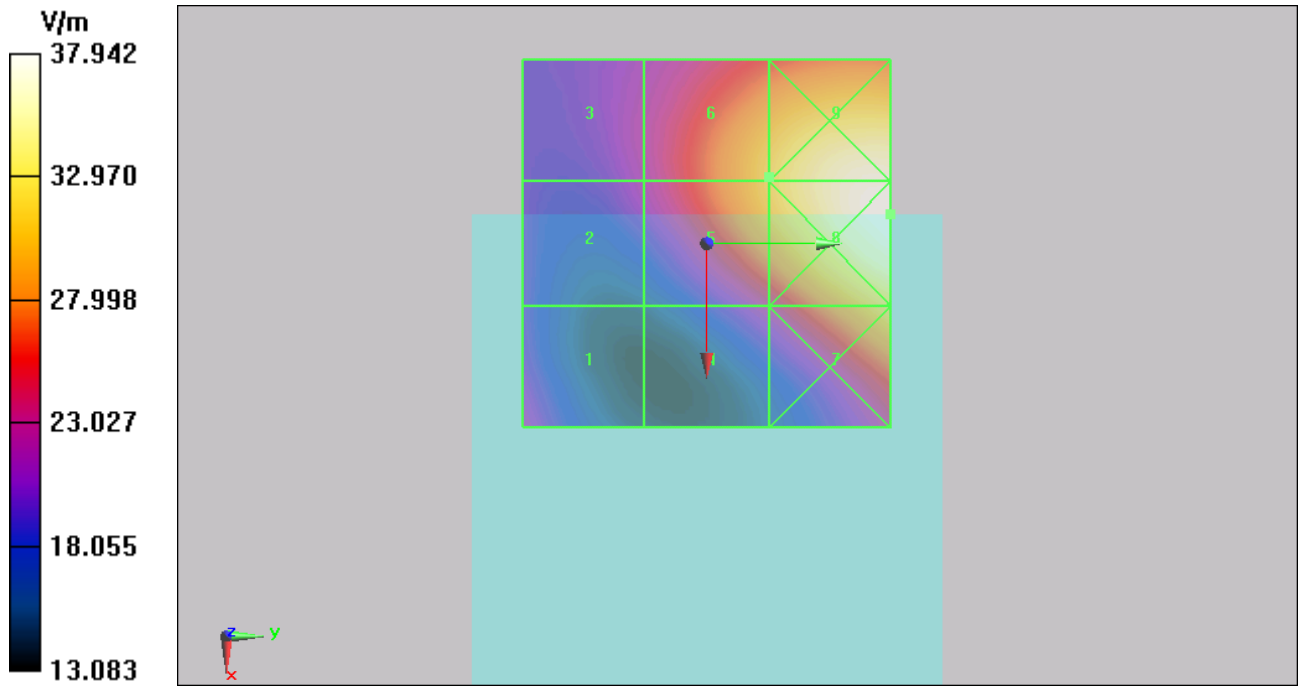

Figure 16 HAC RF E-Field GSM 1900 Channel 512

TA Technology (Shanghai) Co., Ltd.

Test Report

Report No. RXA1402-0022HAC01R2

Page 46 of 75

HAC RF E-Field GSM 1900 High (Battery 2)

Date/Time: 3/5/2014 12:01:18 AM

Communication System: UID 10021 - DAA, GSM-FDD (TDMA, GMSK); Frequency: 1909.8 MHz; Duty Cycle: 1:8.3

Medium parameters used: $\sigma = 0$ S/m, $\epsilon_r = 1$; $\rho = 1000$ kg/m³

Ambient Temperature: 22.3 °C

Phantom section: RF Section

DASY4 Configuration:

Sensor-Surface: 4mm (Mechanical Surface Detection)

Probe: ER3DV6 - SN2428; ConvF(1, 1, 1); Calibrated: 1/27/2014;

Electronics: DAE4 Sn1317; Calibrated: 1/16/2014

Phantom: HAC Test Arch with AMCC; Type: SD HAC P01 BA;

Measurement SW: DASY52, Version 52.8 (7); SEMCAD X Version 14.6.10 (7164)

6036A with Battery F2 GSM1900 HAC RF E-Field 2011/E Scan - ER3D: 15 mm from Probe Center to the Device High/Hearing Aid Compatibility Test (101x101x1): Interpolated grid:

dx=0.5000 mm, dy=0.5000 mm

Device Reference Point: 0, 0, -6.3 mm

Reference Value = 10.45 V/m; Power Drift = 0.01 dB

Applied MIF = 3.50 dB

RF audio interference level = 25.24 dBV/m

Emission category: M4

MIF scaled E-field

Grid 1 M4 21.84 dBV/m	Grid 2 M4 21.35 dBV/m	Grid 3 M4 21.66 dBV/m
Grid 4 M4 21.46 dBV/m	Grid 5 M4 25.24 dBV/m	Grid 6 M4 25.24 dBV/m
Grid 7 M4 25.11 dBV/m	Grid 8 M4 27.03 dBV/m	Grid 9 M4 26.91 dBV/m

Category	Limits for E-Field Emissions < 960MHz	Limits for E-Field Emissions > 960MHz
M1	50 dBV/m - 55 dB V/m	40 dBV/m - 45 dB V/m
M2	45 dBV/m - 50 dB V/m	35 dBV/m - 40 dB V/m
M3	40 dBV/m - 45 dB V/m	30 dBV/m - 35 dB V/m
M4	<40 dBV/m	<30 dBV/m

TA Technology (Shanghai) Co., Ltd.
Test Report

Cursor:

Total = 27.03 dBV/m

E Category: M4

Location: -5.5, 25, 8.7 mm

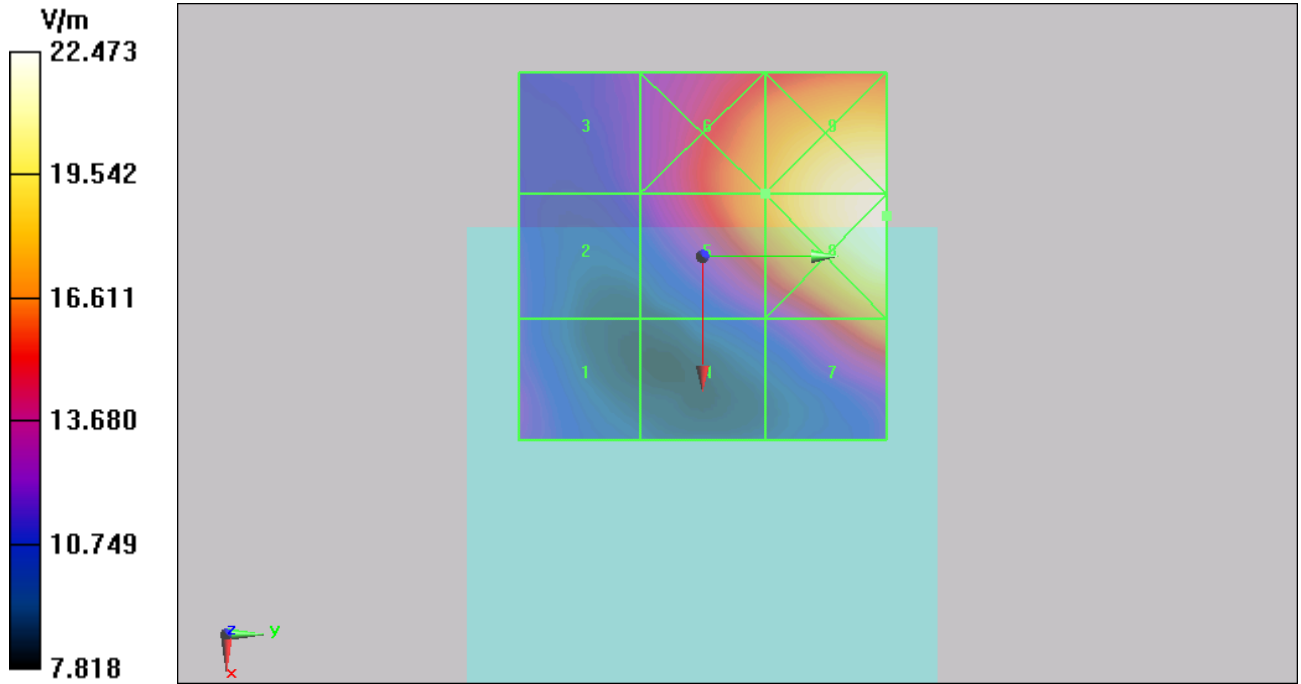

Figure 17 HAC RF E-Field GSM 1900 Channel 810

TA Technology (Shanghai) Co., Ltd.

Test Report

Report No. RXA1402-0022HAC01R2

Page 48 of 75

HAC RF E-Field GSM 1900 Middle (Battery 2)

Date/Time: 3/5/2014 12:43:55 AM

Communication System: UID 10021 - DAA, GSM-FDD (TDMA, GMSK); Frequency: 1880 MHz; Duty Cycle: 1:8.3

Medium parameters used: $\sigma = 0$ S/m, $\epsilon_r = 1$; $\rho = 1000$ kg/m³

Ambient Temperature: 22.3 °C

Phantom section: RF Section

DASY4 Configuration:

Sensor-Surface: 4mm (Mechanical Surface Detection)

Probe: ER3DV6 - SN2428; ConvF(1, 1, 1); Calibrated: 1/27/2014;

Electronics: DAE4 Sn1317; Calibrated: 1/16/2014

Phantom: HAC Test Arch with AMCC; Type: SD HAC P01 BA;

Measurement SW: DASY52, Version 52.8 (7); SEMCAD X Version 14.6.10 (7164)

6036A with Battery F2 GSM1900 HAC RF E-Field 2011/E Scan - ER3D: 15 mm from Probe Center to the Device Middle/Hearing Aid Compatibility Test (101x101x1): Interpolated grid:

dx=0.5000 mm, dy=0.5000 mm

Device Reference Point: 0, 0, -6.3 mm

Reference Value = 12.33 V/m; Power Drift = -0.16 dB

Applied MIF = 3.50 dB

RF audio interference level = 26.59 dBV/m

Emission category: M4

MIF scaled E-field

Grid 1 M4 23.26 dBV/m	Grid 2 M4 22.81 dBV/m	Grid 3 M4 23.28 dBV/m
Grid 4 M4 23.02 dBV/m	Grid 5 M4 26.59 dBV/m	Grid 6 M4 26.59 dBV/m
Grid 7 M4 26.33 dBV/m	Grid 8 M4 28.22 dBV/m	Grid 9 M4 28.11 dBV/m

Category	Limits for E-Field Emissions < 960MHz	Limits for E-Field Emissions > 960MHz
M1	50 dBV/m - 55 dB V/m	40 dBV/m - 45 dB V/m
M2	45 dBV/m - 50 dB V/m	35 dBV/m - 40 dB V/m
M3	40 dBV/m - 45 dB V/m	30 dBV/m - 35 dB V/m
M4	<40 dBV/m	<30 dBV/m

TA Technology (Shanghai) Co., Ltd.
Test Report

Cursor:

Total = 28.22 dBV/m

E Category: M4

Location: -5.5, 25, 8.7 mm

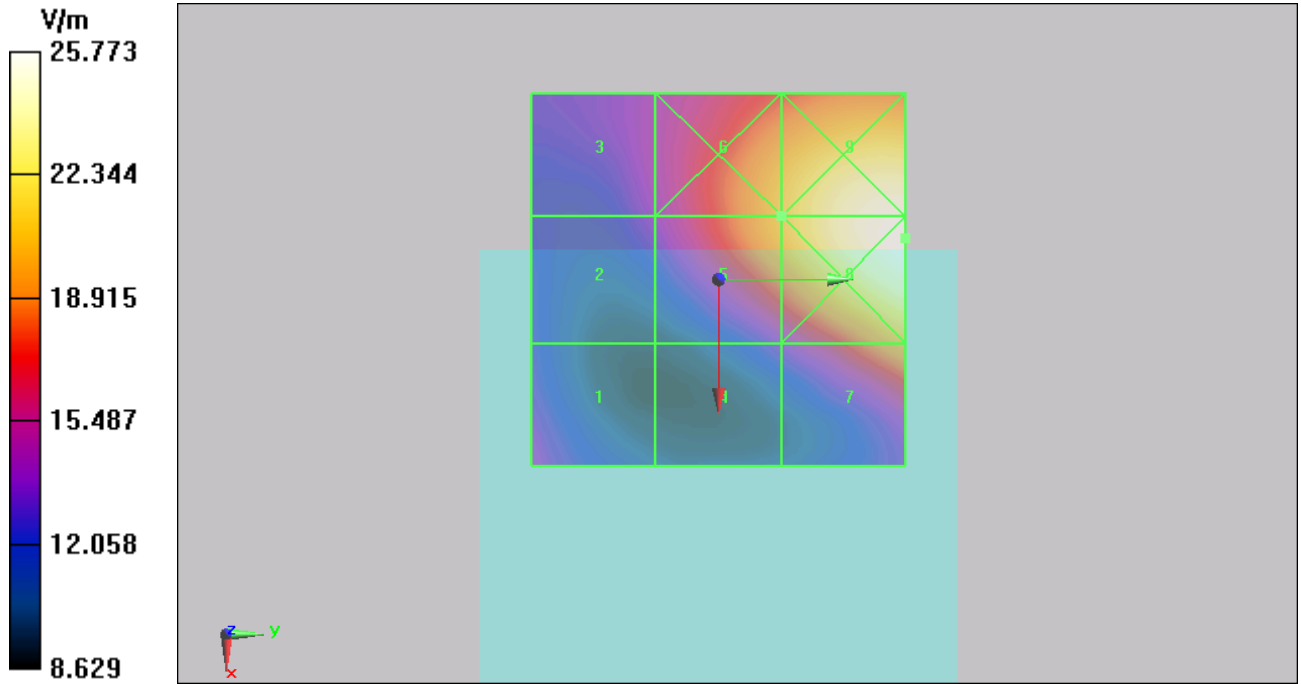

Figure 18 HAC RF E-Field GSM 1900 Channel 661

TA Technology (Shanghai) Co., Ltd.

Test Report

Report No. RXA1402-0022HAC01R2

Page 50 of 75

HAC RF E-Field GSM 1900 Low (Battery 2)

Date/Time: 3/5/2014 12:20:34 AM

Communication System: UID 10021 - DAA, GSM-FDD (TDMA, GMSK); Frequency: 1850.2 MHz; Duty Cycle: 1:8.3

Medium parameters used: $\sigma = 0$ S/m, $\epsilon_r = 1$; $\rho = 1000$ kg/m³

Ambient Temperature: 22.3 °C

Phantom section: RF Section

DASY4 Configuration:

Sensor-Surface: 4mm (Mechanical Surface Detection)

Probe: ER3DV6 - SN2428; ConvF(1, 1, 1); Calibrated: 1/27/2014;

Electronics: DAE4 Sn1317; Calibrated: 1/16/2014

Phantom: HAC Test Arch with AMCC; Type: SD HAC P01 BA;

Measurement SW: DASY52, Version 52.8 (7); SEMCAD X Version 14.6.10 (7164)

6036A with Battery F2 GSM1900 HAC RF E-Field 2011/E Scan - ER3D: 15 mm from Probe Center to the Device Low/Hearing Aid Compatibility Test (101x101x1): Interpolated grid:

dx=0.5000 mm, dy=0.5000 mm

Device Reference Point: 0, 0, -6.3 mm

Reference Value = 15.47 V/m; Power Drift = -0.02 dB

Applied MIF = 3.50 dB

RF audio interference level = 28.51 dBV/m

Emission category: M4

MIF scaled E-field

Grid 1 M4 24.33 dBV/m	Grid 2 M4 24.51 dBV/m	Grid 3 M4 24.88 dBV/m
Grid 4 M4 24.93 dBV/m	Grid 5 M4 28.51 dBV/m	Grid 6 M4 28.53 dBV/m
Grid 7 M4 28.29 dBV/m	Grid 8 M3 30.2 dBV/m	Grid 9 M3 30.08 dBV/m

Category	Limits for E-Field Emissions < 960MHz	Limits for E-Field Emissions > 960MHz
M1	50 dBV/m - 55 dB V/m	40 dBV/m - 45 dB V/m
M2	45 dBV/m - 50 dB V/m	35 dBV/m - 40 dB V/m
M3	40 dBV/m - 45 dB V/m	30 dBV/m - 35 dB V/m
M4	<40 dBV/m	<30 dBV/m

Cursor:

Total = 30.20 dBV/m

E Category: M3

Location: -5.5, 25, 8.7 mm

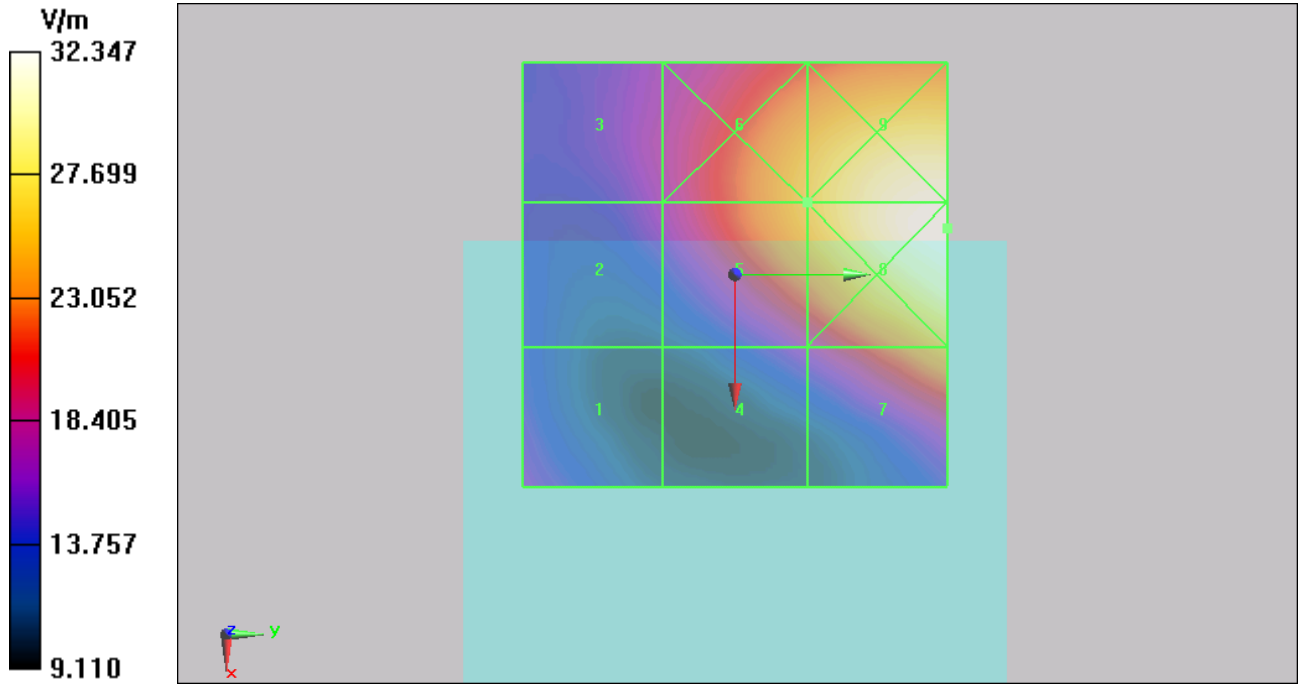

Figure 19 HAC RF E-Field GSM 1900 Channel 512

TA Technology (Shanghai) Co., Ltd.

Test Report

ANNEX C: E-Probe Calibration Certificate

**Calibration Laboratory of
Schmid & Partner
Engineering AG**
Zeughausstrasse 43, 8004 Zurich, Switzerland



S Schweizerischer Kalibrierdienst
C Service suisse d'étalonnage
S Servizio svizzero di taratura
Swiss Calibration Service

Accredited by the Swiss Accreditation Service (SAS)
The Swiss Accreditation Service is one of the signatories to the EA
Multilateral Agreement for the recognition of calibration certificates

Accreditation No.: **SCS 108**

Client **TMC Beijing (Auden)**

Certificate No: **ER3-2428_Jan14**

CALIBRATION CERTIFICATE

Object	ER3DV6 - SN:2428
Calibration procedure(s)	QA CAL-02.v8, QA CAL-25.v6 Calibration procedure for E-field probes optimized for close near field evaluations in air
Calibration date:	January 27, 2014

This calibration certificate documents the traceability to national standards, which realize the physical units of measurements (SI).
The measurements and the uncertainties with confidence probability are given on the following pages and are part of the certificate.

All calibrations have been conducted in the closed laboratory facility: environment temperature (22 ± 3)°C and humidity < 70%.

Calibration Equipment used (M&TE critical for calibration)

Primary Standards	ID	Cal Date (Certificate No.)	Scheduled Calibration
Power meter E4419B	GB41293874	04-Apr-13 (No. 217-01733)	Apr-14
Power sensor E4412A	MY41498087	04-Apr-13 (No. 217-01733)	Apr-14
Reference 3 dB Attenuator	SN: S5054 (3c)	04-Apr-13 (No. 217-01737)	Apr-14
Reference 20 dB Attenuator	SN: S5277 (20x)	04-Apr-13 (No. 217-01735)	Apr-14
Reference 30 dB Attenuator	SN: S5129 (30b)	04-Apr-13 (No. 217-01738)	Apr-14
Reference Probe ER3DV6	SN: 2328	10-Oct-13 (No. ER3-2328_Oct13)	Oct-14
DAE4	SN: 789	15-May-13 (No. DAE4-789_May13)	May-14
Secondary Standards	ID	Check Date (in house)	Scheduled Check
RF generator HP 8648C	US3642U01700	4-Aug-99 (in house check Apr-13)	In house check: Apr-16
Network Analyzer HP 8753E	US37390585	18-Oct-01 (in house check Oct-13)	In house check: Oct-14

	Name	Function	Signature
Calibrated by:	Leif Klysner	Laboratory Technician	
Approved by:	Katja Pokovic	Technical Manager	

Issued: January 28, 2014

This calibration certificate shall not be reproduced except in full without written approval of the laboratory.

TA Technology (Shanghai) Co., Ltd.

Test Report

Report No. RXA1402-0022HAC01R2

Page 53 of 75

Calibration Laboratory of
Schmid & Partner
Engineering AG
Zeughausstrasse 43, 8004 Zurich, Switzerland



S Schweizerischer Kalibrierdienst
C Service suisse d'étalonnage
S Servizio svizzero di taratura
S Swiss Calibration Service

Accredited by the Swiss Accreditation Service (SAS)
The Swiss Accreditation Service is one of the signatories to the EA
Multilateral Agreement for the recognition of calibration certificates

Accreditation No.: **SCS 108**

Glossary:

NORM _{x,y,z}	sensitivity in free space
DCP	diode compression point
CF	crest factor (1/duty_cycle) of the RF signal
A, B, C, D	modulation dependent linearization parameters
Polarization ϕ	ϕ rotation around probe axis
Polarization ϑ	ϑ rotation around an axis that is in the plane normal to probe axis (at measurement center), i.e., $\vartheta = 0$ is normal to probe axis
Connector Angle	information used in DASY system to align probe sensor X to the robot coordinate system

Calibration is Performed According to the Following Standards:

- IEEE Std 1309-2005, "IEEE Standard for calibration of electromagnetic field sensors and probes, excluding antennas, from 9 kHz to 40 GHz", December 2005
- CTIA Test Plan for Hearing Aid Compatibility, April 2010.

Methods Applied and Interpretation of Parameters:

- NORM_{x,y,z}**: Assessed for E-field polarization $\vartheta = 0$ for XY sensors and $\vartheta = 90$ for Z sensor ($f \leq 900$ MHz in TEM-cell; $f > 1800$ MHz: R22 waveguide).
- NORM(f)_{x,y,z}** = NORM_{x,y,z} * frequency_response (see Frequency Response Chart).
- DCP_{x,y,z}**: DCP are numerical linearization parameters assessed based on the data of power sweep with CW signal (no uncertainty required). DCP does not depend on frequency nor media.
- PAR**: PAR is the Peak to Average Ratio that is not calibrated but determined based on the signal characteristics
- A_{x,y,z}; B_{x,y,z}; C_{x,y,z}; D_{x,y,z}; VR_{x,y,z}**: A, B, C, D are numerical linearization parameters assessed based on the data of power sweep for specific modulation signal. The parameters do not depend on frequency nor media. VR is the maximum calibration range expressed in RMS voltage across the diode.
- Spherical isotropy (3D deviation from isotropy)**: in a locally homogeneous field realized using an open waveguide setup.
- Sensor Offset**: The sensor offset corresponds to the offset of virtual measurement center from the probe tip (on probe axis). No tolerance required.
- Connector Angle**: The angle is assessed using the information gained by determining the NORM_x (no uncertainty required).

ER3DV6 – SN:2428

January 27, 2014

Probe ER3DV6

SN:2428

Manufactured: September 11, 2007

Calibrated: January 27, 2014

Calibrated for DASY/EASY Systems

(Note: non-compatible with DASY2 system!)

TA Technology (Shanghai) Co., Ltd.

Test Report

ER3DV6- SN:2428

January 27, 2014

DASY/EASY - Parameters of Probe: ER3DV6 - SN:2428

Basic Calibration Parameters

	Sensor X	Sensor Y	Sensor Z	Unc (k=2)
Norm ($\mu\text{V}/(\text{V}/\text{m})^2$)	1.51	1.59	1.83	$\pm 10.1 \%$
DCP (mV) ^B	98.9	97.0	101.1	

Modulation Calibration Parameters

UID	Communication System Name		A dB	B dB $\sqrt{\mu\text{V}}$	C	D dB	VR mV	Unc ^E (k=2)
0	CW	X	0.0	0.0	1.0	0.00	190.5	$\pm 3.3 \%$
		Y	0.0	0.0	1.0		152.5	
		Z	0.0	0.0	1.0		198.6	
10021-DAA	GSM-FDD (TDMA, GMSK)	X	20.75	99.9	29.1	9.39	119.1	$\pm 1.2 \%$
		Y	19.27	99.6	28.9		125.1	
		Z	24.43	99.4	28.5		139.5	
10039-CAA	CDMA2000 (1xRTT, RC1)	X	4.62	65.6	18.5	4.57	109.6	$\pm 0.9 \%$
		Y	4.78	66.3	18.9		121.2	
		Z	4.58	66.0	18.7		114.4	

The reported uncertainty of measurement is stated as the standard uncertainty of measurement multiplied by the coverage factor k=2, which for a normal distribution corresponds to a coverage probability of approximately 95%.

^B Numerical linearization parameter: uncertainty not required.

^E Uncertainty is determined using the max. deviation from linear response applying rectangular distribution and is expressed for the square of the field value.

ER3DV6-SN:2428

January 27, 2014

Frequency Response of E-Field
(TEM-Cell:ifi110 EXX, Waveguide: R22)

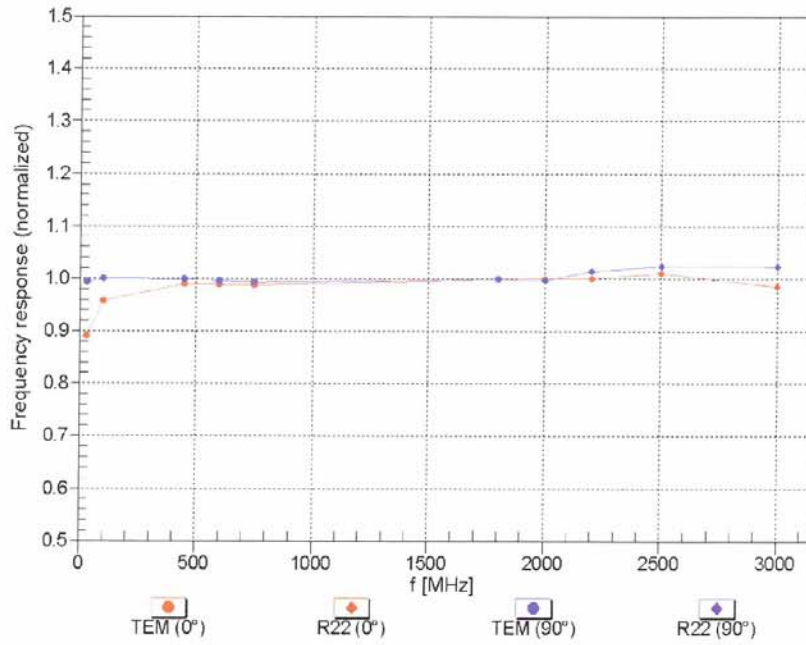

Uncertainty of Frequency Response of E-field: $\pm 6.3\%$ (k=2)

ER3DV6-SN:2428

January 27, 2014

Receiving Pattern (ϕ), $\vartheta = 0^\circ$

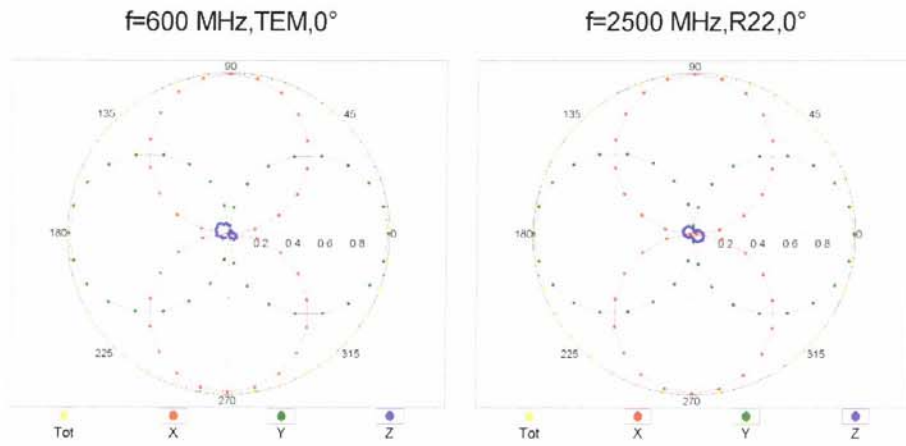

Receiving Pattern (ϕ), $\vartheta = 90^\circ$

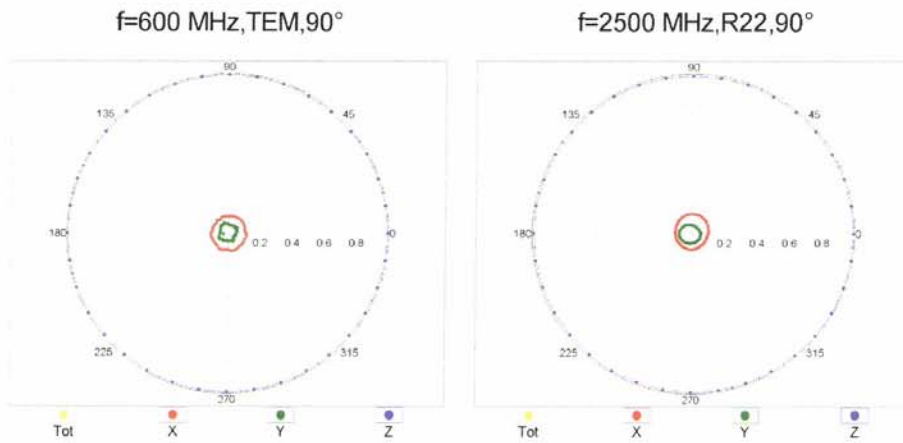

ER3DV6-SN:2428

January 27, 2014

Receiving Pattern (ϕ), $\vartheta = 0^\circ$

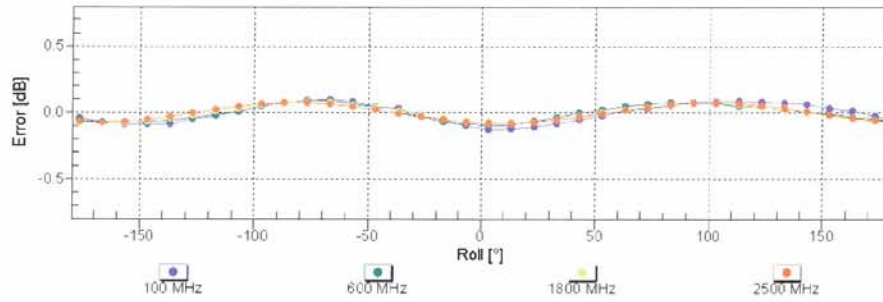

Uncertainty of Axial Isotropy Assessment: $\pm 0.5\%$ ($k=2$)

Receiving Pattern (ϕ), $\vartheta = 90^\circ$

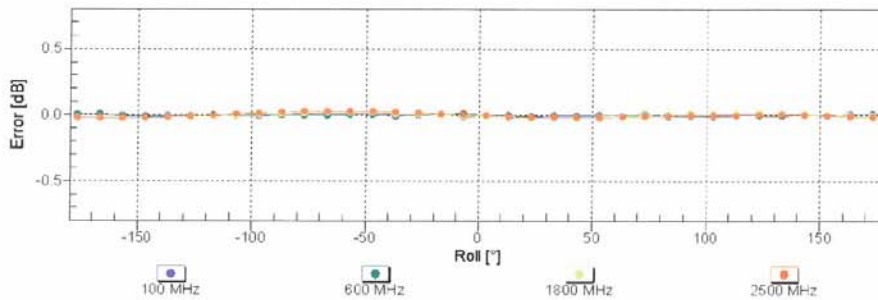

Uncertainty of Axial Isotropy Assessment: $\pm 0.5\%$ ($k=2$)

ER3DV6-SN:2428

January 27, 2014

Dynamic Range f(E-field)
(TEM cell , f = 900 MHz)

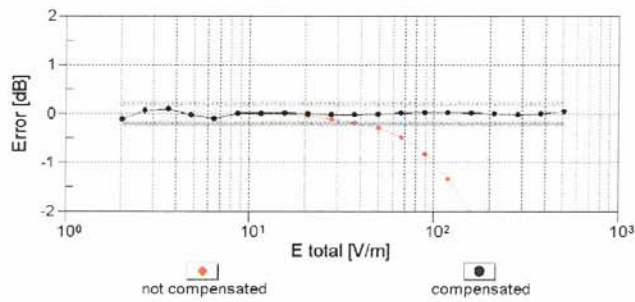
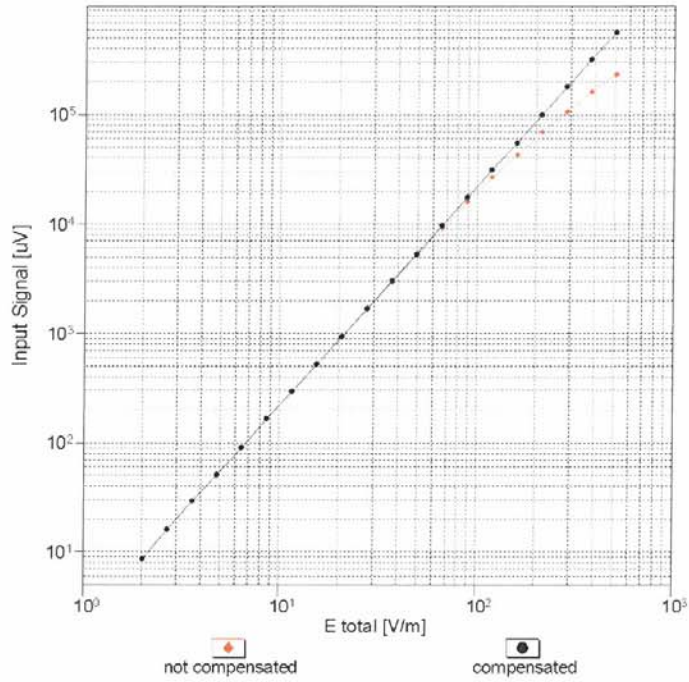

Uncertainty of Linearity Assessment: $\pm 0.6\%$ (k=2)

ER3DV6-SN:2428

January 27, 2014

Deviation from Isotropy in Air
Error (ϕ , θ), $f = 900$ MHz

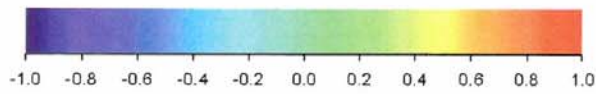
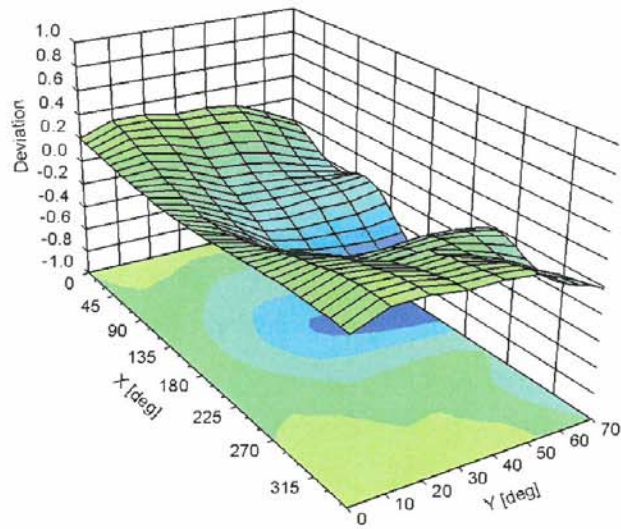

Uncertainty of Spherical Isotropy Assessment: $\pm 2.6\%$ ($k=2$)

TA Technology (Shanghai) Co., Ltd.
Test Report

Report No. RXA1402-0022HAC01R2

Page 61 of 75

ER3DV6- SN:2428

January 27, 2014

DASY/EASY - Parameters of Probe: ER3DV6 - SN:2428

Other Probe Parameters

Sensor Arrangement	Rectangular
Connector Angle (°)	-36.9
Mechanical Surface Detection Mode	enabled
Optical Surface Detection Mode	disabled
Probe Overall Length	337 mm
Probe Body Diameter	10 mm
Tip Length	10 mm
Tip Diameter	8 mm
Probe Tip to Sensor X Calibration Point	2.5 mm
Probe Tip to Sensor Y Calibration Point	2.5 mm
Probe Tip to Sensor Z Calibration Point	2.5 mm

TA Technology (Shanghai) Co., Ltd.

Test Report

Report No. RXA1402-0022HAC01R2

Page 62 of 75

ANNEX D: CD835V3 Dipole Calibration Certificate

Calibration Laboratory of
Schmid & Partner
Engineering AG
Zeughausstrasse 43, 8004 Zurich, Switzerland



S Schweizerischer Kalibrierdienst
C Service suisse d'étalonnage
S Servizio svizzero di taratura
Swiss Calibration Service

Accredited by the Swiss Accreditation Service (SAS)
The Swiss Accreditation Service is one of the signatories to the EA
Multilateral Agreement for the recognition of calibration certificates

Accreditation No.: SCS 108

Client **TMC-BJ (Auden)**

Certificate No: **CD835V3-1023_Sep13**

CALIBRATION CERTIFICATE

Object: **CD835V3 - SN: 1023**

Calibration procedure(s): **QA CAL-20.v6
Calibration procedure for dipoles in air**

Calibration date: **September 25, 2013**

This calibration certificate documents the traceability to national standards, which realize the physical units of measurements (SI).
The measurements and the uncertainties with confidence probability are given on the following pages and are part of the certificate.

All calibrations have been conducted in the closed laboratory facility: environment temperature (22 ± 3)°C and humidity < 70%.

Calibration Equipment used (M&TE critical for calibration)

Primary Standards	ID #	Cal Date (Certificate No.)	Scheduled Calibration
Power meter EPM-442A	GB37480704	01-Nov-12 (No. 217-01640)	Oct-13
Power sensor HP 8481A	US37292783	01-Nov-12 (No. 217-01640)	Oct-13
Reference 10 dB Attenuator	SN: 5047.2 (10q)	04-Apr-13 (No. 217-01731)	Apr-14
Probe ER3DV6	SN: 2336	28-Dec-12 (No. ER3-2336_Dec12)	Dec-13
Probe H3DV6	SN: 6065	28-Dec-12 (No. H3-6065_Dec12)	Dec-13
DAE4	SN: 781	13-Sep-13 (No. DAE4-781_Sep13)	Sep-14
Secondary Standards	ID #	Check Date (in house)	Scheduled Check
Power meter Agilent 4419B	SN: GB42420191	09-Oct-09 (in house check Oct-12)	In house check: Oct-13
Power sensor HP E4412A	SN: MY41495277	01-Apr-08 (in house check Oct-12)	In house check: Oct-13
Power sensor HP 8482A	SN: US37295597	09-Oct-09 (in house check Oct-12)	In house check: Oct-13
Network Analyzer HP 8753E	US37390585	18-Oct-01 (in house check Oct-12)	In house check: Oct-13
RF generator R&S SMT-06	SN: 832283/011	27-Aug-12 (in house check Oct-12)	In house check: Oct-14

Calibrated by:	Name Claudio Leubler	Function Laboratory Technician	Signature
Approved by:	Name Fin Bomholt	Function Deputy Technical Manager	Signature

Issued: September 26, 2013

This calibration certificate shall not be reproduced except in full without written approval of the laboratory.

TA Technology (Shanghai) Co., Ltd.

Test Report

Measurement Conditions

DASY system configuration, as far as not given on page 1.

DASY Version	DASY5	V52.8.7
Phantom	HAC Test Arch	
Distance Dipole Top - Probe Center	15mm	
Scan resolution	dx, dy = 5 mm	
Frequency	835 MHz \pm 1 MHz	
Input power drift	< 0.05 dB	

Maximum Field values at 835 MHz

E-field 15 mm above dipole surface	condition	Interpolated maximum
Maximum measured above high end	100 mW input power	105.4 V / m
Maximum measured above low end	100 mW input power	103.7 V / m
Averaged maximum above arm	100 mW input power	104.5 V / m \pm 12.8 % (k=2)

Appendix

Antenna Parameters

Frequency	Return Loss	Impedance
800 MHz	17.1 dB	44.0 Ω - 11.8 j Ω
835 MHz	24.8 dB	50.9 Ω + 5.7 j Ω
900 MHz	15.3 dB	61.4 Ω - 15.7 j Ω
950 MHz	23.1 dB	46.7 Ω + 5.9 j Ω
960 MHz	16.9 dB	53.8 Ω + 14.5 j Ω

3.2 Antenna Design and Handling

The calibration dipole has a symmetric geometry with a built-in two stub matching network, which leads to the enhanced bandwidth.

The dipole is built of standard semirigid coaxial cable. The internal matching line is open ended. The antenna is therefore open for DC signals.

Do not apply force to dipole arms, as they are liable to bend. The soldered connections near the feedpoint may be damaged. After excessive mechanical stress or overheating, check the impedance characteristics to ensure that the internal matching network is not affected.

After long term use with 40W radiated power, only a slight warming of the dipole near the feedpoint can be measured.

TA Technology (Shanghai) Co., Ltd. Test Report

Report No. RXA1402-0022HAC01R2

Page 64 of 75

Impedance Measurement Plot

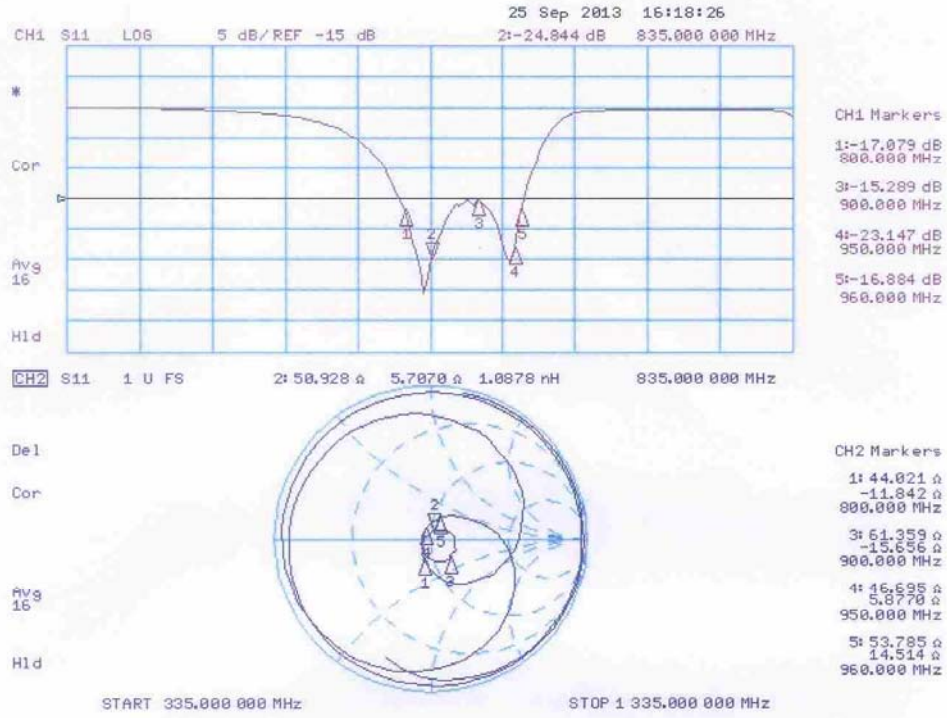

DASY5 E-field Result

Date: 25.09.2013

Test Laboratory: SPEAG Lab2

DUT: HAC-Dipole 835 MHz; Type: CD835V3; Serial: CD835V3 - SN: 1023

Communication System: UID 0 - CW ; Frequency: 835 MHz
 Medium parameters used: $\sigma = 0$ S/m, $\epsilon_r = 1$; $\rho = 1000$ kg/m³
 Phantom section: RF Section
 Measurement Standard: DASY5 (IEEE/IEC/ANSI C63.19-2007)

DASY52 Configuration:

- Probe: ER3DV6 - SN2336; ConvF(1, 1, 1); Calibrated: 28.12.2012;
- Sensor-Surface: (Fix Surface)
- Electronics: DAE4 Sn781; Calibrated: 13.09.2013
- Phantom: HAC Test Arch with AMCC; Type: SD HAC P01 BA; Serial: 1070
- DASY52 52.8.7(1137); SEMCAD X 14.6.10(7164)

Dipole E-Field measurement @ 835MHz/E-Scan - 835MHz d=15mm/Hearing Aid Compatibility Test (41x361x1):

Interpolated grid: dx=0.5000 mm, dy=0.5000 mm
 Device Reference Point: 0, 0, -6.3 mm
 Reference Value = 107.7 V/m; Power Drift = 0.03 dB
 PMR not calibrated. PMF = 1.000 is applied.
 E-field emissions = 105.4 V/m
 Near-field category: M4 (AWF 0 dB)

PMF scaled E-field

Grid 1 M4	Grid 2 M4	Grid 3 M4
101.9 V/m	103.7 V/m	102.4 V/m
Grid 4 M4	Grid 5 M4	Grid 6 M4
62.57 V/m	63.29 V/m	62.37 V/m
Grid 7 M4	Grid 8 M4	Grid 9 M4
103.1 V/m	105.4 V/m	104.3 V/m

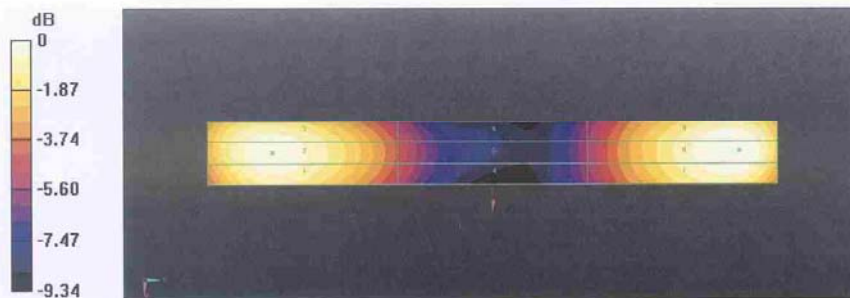

0 dB = 105.4 V/m = 40.46 dBV/m

TA Technology (Shanghai) Co., Ltd.

Test Report

Report No. RXA1402-0022HAC01R2

Page 66 of 75

ANNEX E: CD1880V3 Dipole Calibration Certificate

**Calibration Laboratory of
Schmid & Partner
Engineering AG**
Zeughausstrasse 43, 8004 Zurich, Switzerland



S Schweizerischer Kalibrierdienst
C Service suisse d'étalonnage
S Servizio svizzero di taratura
S Swiss Calibration Service

Accredited by the Swiss Accreditation Service (SAS)
The Swiss Accreditation Service is one of the signatories to the EA
Multilateral Agreement for the recognition of calibration certificates

Accreditation No.: **SCS 108**

Client **TMC-BJ (Auden)**

Certificate No: **CD1880V3-1018_Sep13**

CALIBRATION CERTIFICATE

Object: **CD1880V3 - SN: 1018**

Calibration procedure(s): **QA CAL-20.v6
Calibration procedure for dipoles in air**

Calibration date: **September 25, 2013**

This calibration certificate documents the traceability to national standards, which realize the physical units of measurements (SI).
The measurements and the uncertainties with confidence probability are given on the following pages and are part of the certificate.

All calibrations have been conducted in the closed laboratory facility: environment temperature (22 ± 3)°C and humidity < 70%.

Calibration Equipment used (M&TE critical for calibration)

Primary Standards	ID #	Cal Date (Certificate No.)	Scheduled Calibration
Power meter EPM-442A	GB37480704	01-Nov-12 (No. 217-01640)	Oct-13
Power sensor HP 8481A	US37292783	01-Nov-12 (No. 217-01640)	Oct-13
Reference 10 dB Attenuator	SN: 5047.2 (10q)	04-Apr-13 (No. 217-01731)	Apr-14
Probe ER3DV6	SN: 2336	28-Dec-12 (No. ER3-2336_Dec12)	Dec-13
Probe H3DV6	SN: 6065	28-Dec-12 (No. H3-6065_Dec12)	Dec-13
DAE4	SN: 781	13-Sep-13 (No. DAE4-781_Sep13)	Sep-14
Secondary Standards	ID #	Check Date (in house)	Scheduled Check
Power meter Agilent 4419B	SN: GB42420191	09-Oct-09 (in house check Oct-12)	In house check: Oct-13
Power sensor HP E4412A	SN: MY41495277	01-Apr-08 (in house check Oct-12)	In house check: Oct-13
Power sensor HP 8482A	SN: US37295597	09-Oct-09 (in house check Oct-12)	In house check: Oct-13
Network Analyzer HP 8753E	US37390585	18-Oct-01 (in house check Oct-12)	In house check: Oct-13
RF generator R&S SMT-06	SN: 832283/011	27-Aug-12 (in house check Oct-12)	In house check: Oct-14

	Name	Function	Signature
Calibrated by:	Claudio Leubler	Laboratory Technician	
Approved by:	Fin Bomholt	Deputy Technical Manager	

Issued: September 26, 2013

This calibration certificate shall not be reproduced except in full without written approval of the laboratory.

Calibration Laboratory of
Schmid & Partner
Engineering AG
Zeughausstrasse 43, 8004 Zurich, Switzerland



S Schweizerischer Kalibrierdienst
S Service suisse d'étalonnage
C Servizio svizzero di taratura
S Swiss Calibration Service

Accredited by the Swiss Accreditation Service (SAS)
The Swiss Accreditation Service is one of the signatories to the EA
Multilateral Agreement for the recognition of calibration certificates

Accreditation No.: SCS 108

References

- [1] ANSI-C63.19-2011
American National Standard, Methods of Measurement of Compatibility between Wireless Communications Devices and Hearing Aids.

Methods Applied and Interpretation of Parameters:

- **Coordinate System:** y-axis is in the direction of the dipole arms. z-axis is from the basis of the antenna (mounted on the table) towards its feed point between the two dipole arms. x-axis is normal to the other axes. In coincidence with the standards [1], the measurement planes (probe sensor center) are selected to be at a distance of 15 mm above the top metal edge of the dipole arms.
- **Measurement Conditions:** Further details are available from the hardcopies at the end of the certificate. All figures stated in the certificate are valid at the frequency indicated. The forward power to the dipole connector is set with a calibrated power meter connected and monitored with an auxiliary power meter connected to a directional coupler. While the dipole under test is connected, the forward power is adjusted to the same level.
- **Antenna Positioning:** The dipole is mounted on a HAC Test Arch phantom using the matching dipole positioner with the arms horizontal and the feeding cable coming from the floor. The measurements are performed in a shielded room with absorbers around the setup to reduce the reflections. It is verified before the mounting of the dipole under the Test Arch phantom, that its arms are perfectly in a line. It is installed on the HAC dipole positioner with its arms parallel below the dielectric reference wire and able to move elastically in vertical direction without changing its relative position to the top center of the Test Arch phantom. The vertical distance to the probe is adjusted after dipole mounting with a DASY5 Surface Check job. Before the measurement, the distance between phantom surface and probe tip is verified. The proper measurement distance is selected by choosing the matching section of the HAC Test Arch phantom with the proper device reference point (upper surface of the dipole) and the matching grid reference point (tip of the probe) considering the probe sensor offset. The vertical distance to the probe is essential for the accuracy.
- **Feed Point Impedance and Return Loss:** These parameters are measured using a HP 8753E Vector Network Analyzer. The impedance is specified at the SMA connector of the dipole. The influence of reflections was eliminated by applying the averaging function while moving the dipole in the air, at least 70cm away from any obstacles.
- **E-field distribution:** E field is measured in the x-y-plane with an isotropic ER3D-field probe with 100 mW forward power to the antenna feed point. In accordance with [1], the scan area is 20mm wide, its length exceeds the dipole arm length (180 or 90mm). The sensor center is 15 mm (in z) above the metal top of the dipole arms. Two 3D maxima are available near the end of the dipole arms. Assuming the dipole arms are perfectly in one line, the average of these two maxima (in subgrid 2 and subgrid 8) is determined to compensate for any non-parallelity to the measurement plane as well as the sensor displacement. The E-field value stated as calibration value represents the maximum of the interpolated 3D-E-field, in the plane above the dipole surface.

The reported uncertainty of measurement is stated as the standard uncertainty of measurement multiplied by the coverage factor $k=2$, which for a normal distribution corresponds to a coverage probability of approximately 95%.

TA Technology (Shanghai) Co., Ltd.

Test Report

Measurement Conditions

DASY system configuration, as far as not given on page 1.

DASY Version	DASY5	V52.8.7
Phantom	HAC Test Arch	
Distance Dipole Top - Probe Center	15mm	
Scan resolution	dx, dy = 5 mm	
Frequency	1880 MHz \pm 1 MHz	
Input power drift	< 0.05 dB	

Maximum Field values at 1880 MHz

E-field 15 mm above dipole surface	condition	Interpolated maximum
Maximum measured above high end	100 mW input power	94.2 V / m
Maximum measured above low end	100 mW input power	89.3 V / m
Averaged maximum above arm	100 mW input power	91.8 V / m \pm 12.8 % (k=2)

Appendix

Antenna Parameters

Frequency	Return Loss	Impedance
1730 MHz	27.8 dB	53.0 Ω + 2.9 j Ω
1880 MHz	21.6 dB	49.5 Ω + 8.3 j Ω
1900 MHz	21.9 dB	51.3 Ω + 8.0 j Ω
1950 MHz	30.5 dB	52.3 Ω + 2.0 j Ω
2000 MHz	19.3 dB	41.7 Ω + 5.6 j Ω

3.2 Antenna Design and Handling

The calibration dipole has a symmetric geometry with a built-in two stub matching network, which leads to the enhanced bandwidth.

The dipole is built of standard semirigid coaxial cable. The internal matching line is open ended. The antenna is therefore open for DC signals.

Do not apply force to dipole arms, as they are liable to bend. The soldered connections near the feedpoint may be damaged. After excessive mechanical stress or overheating, check the impedance characteristics to ensure that the internal matching network is not affected.

After long term use with 40W radiated power, only a slight warming of the dipole near the feedpoint can be measured.

TA Technology (Shanghai) Co., Ltd. Test Report

Report No. RXA1402-0022HAC01R2

Page 69 of 75

Impedance Measurement Plot

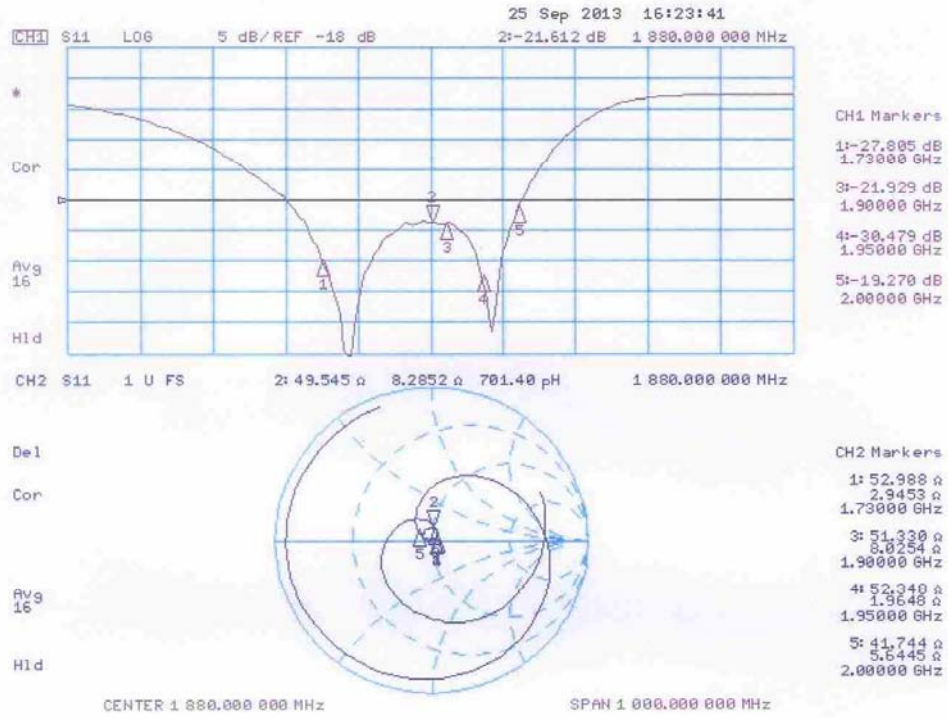

TA Technology (Shanghai) Co., Ltd. Test Report

DASY5 E-field Result

Date: 25.09.2013

Test Laboratory: SPEAG Lab2

DUT: HAC Dipole 1880 MHz; Type: CD1880V3; Serial: CD1880V3 - SN: 1018

Communication System: UID 0 - CW ; Frequency: 1880 MHz
 Medium parameters used: $\sigma = 0$ S/m, $\epsilon_r = 1$; $\rho = 1000$ kg/m³
 Phantom section: RF Section
 Measurement Standard: DASY5 (IEEE/IEC/ANSI C63.19-2007)

DASY52 Configuration:

- Probe: ER3DV6 - SN2336; ConvF(1, 1, 1); Calibrated: 28.12.2012;
- Sensor-Surface: (Fix Surface)
- Electronics: DAE4 Sn781; Calibrated: 13.09.2013
- Phantom: HAC Test Arch with AMCC; Type: SD HAC P01 BA; Serial: 1070
- DASY52 52.8.7(1137); SEMCAD X 14.6.10(7164)

Dipole E-Field measurement @ 1880MHz/E-Scan - 1880MHz d=15mm/Hearing Aid Compatibility Test (41x181x1):

Interpolated grid: dx=0.5000 mm, dy=0.5000 mm
 Device Reference Point: 0, 0, -6.3 mm
 Reference Value = 157.6 V/m; Power Drift = -0.02 dB
 PMR not calibrated. PMF = 1.000 is applied.
 E-field emissions = 94.20 V/m
 Near-field category: M3 (AWF 0 dB)

PMF scaled E-field

Grid 1 M3 91.75 V/m	Grid 2 M3 94.20 V/m	Grid 3 M3 93.34 V/m
Grid 4 M3 71.58 V/m	Grid 5 M3 72.68 V/m	Grid 6 M3 71.73 V/m
Grid 7 M3 87.01 V/m	Grid 8 M3 89.29 V/m	Grid 9 M3 88.31 V/m

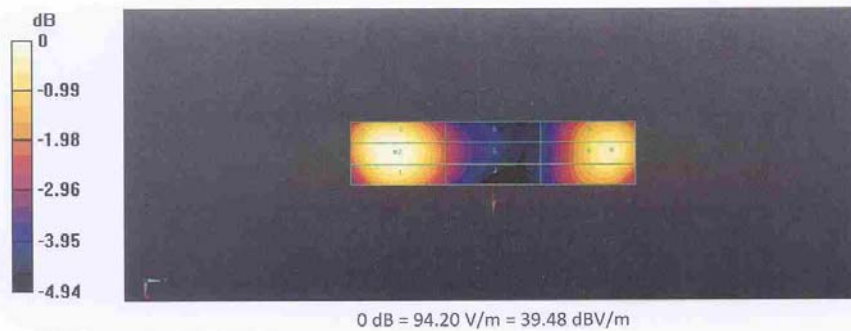

TA Technology (Shanghai) Co., Ltd. Test Report

Report No. RXA1402-0022HAC01R2

Page 71 of 75

ANNEX F: DAE4 Calibration Certificate



In Collaboration with
s p e a g
CALIBRATION LABORATORY

Add: No.52 Huayuanbei Road, Haidian District, Beijing, 100191, China
Tel: +86-10-62304633-2079 Fax: +86-10-62304633-2504
E-mail: info@emcite.com Http://www.emcite.com



Client : **TA(Shanghai)**

Certificate No: **J14-2-0052**

CALIBRATION CERTIFICATE			
Object	DAE4 - SN: 1317		
Calibration Procedure(s)	TMC-OS-E-01-198 Calibration Procedure for the Data Acquisition Electronics (DAEx)		
Calibration date:	January 16, 2014		
<p>This calibration Certificate documents the traceability to national standards, which realize the physical units of measurements(SI). The measurements and the uncertainties with confidence probability are given on the following pages and are part of the certificate.</p> <p>All calibrations have been conducted in the closed laboratory facility: environment temperature(22±3)°C and humidity<70%.</p> <p>Calibration Equipment used (M&TE critical for calibration)</p>			
Primary Standards	ID #	Cal Date(Calibrated by, Certificate No.)	Scheduled Calibration
Documenting Process Calibrator 753	1971018	01-July-13 (TMC, No:JW13-049)	July-14
Calibrated by:	Name Yu Zongying	Function SAR Test Engineer	Signature
Reviewed by:	Qi Dianyuan	SAR Project Leader	
Approved by:	Lu Bingsong	Deputy Director of the laboratory	
<p>Issued: January 16, 2014</p> <p>This calibration certificate shall not be reproduced except in full without written approval of the laboratory.</p>			

TA Technology (Shanghai) Co., Ltd.
Test Report

Report No. RXA1402-0022HAC01R2

Page 72 of 75



Glossary:

DAE data acquisition electronics
Connector angle information used in DASY system to align probe sensor X to the robot coordinate system.

Methods Applied and Interpretation of Parameters:

- *DC Voltage Measurement:* Calibration Factor assessed for use in DASY system by comparison with a calibrated instrument traceable to national standards. The figure given corresponds to the full scale range of the voltmeter in the respective range.
- *Connector angle:* The angle of the connector is assessed measuring the angle mechanically by a tool inserted. Uncertainty is not required.
- The report provide only calibration results for DAE, it does not contain other performance test results.

TA Technology (Shanghai) Co., Ltd. Test Report

Report No. RXA1402-0022HAC01R2

Page 73 of 75



In Collaboration with
s p e a g
CALIBRATION LABORATORY

Add: No.52 Huayuanbei Road, Haidian District, Beijing, 100191, China
Tel: +86-10-62304633-2079 Fax: +86-10-62304633-2504
E-mail: info@emcite.com Http://www.emcite.com

DC Voltage Measurement

A/D - Converter Resolution nominal
 High Range: 1LSB = 6.1 μ V, full range = -100...+300 mV
 Low Range: 1LSB = 61nV, full range = -1.....+3mV
 DASY measurement parameters: Auto Zero Time: 3 sec; Measuring time: 3 sec

Calibration Factors	X	Y	Z
High Range	404.058 \pm 0.15% (k=2)	404.060 \pm 0.15% (k=2)	403.954 \pm 0.15% (k=2)
Low Range	3.99002 \pm 0.7% (k=2)	3.99910 \pm 0.7% (k=2)	3.98303 \pm 0.7% (k=2)

Connector Angle

Connector Angle to be used in DASY system	119° \pm 1°
---	---------------

ANNEX G: The EUT Appearances and Test Configuration



EUT

Picture 1: Constituents of EUT



Picture 2: Test Setup