



# TEST REPORT

## No. 130130IOT01FCC

for

**TCT Mobile Limited**

**HSDPA/HSUPA/UMTS dual band / GSM quad bands mobile phone**

**Model Name: Smart III 4 NFC**

**Marketing Name: Vodafone 975N**

**FCC ID: RAD352**

**Hardware Version: PIO**

**Software Version: G5B**

**Issued Date: Feb 26<sup>th</sup>, 2013**



**Note:**

The test results in this test report relate only to the devices specified in this report. This report shall not be reproduced except in full without the written approval of TMC Beijing.

**Test Laboratory:**

**CNAS accreditation (ISO/IEC 17025(CNAS-CL01)): No. CNAS L0442**

**FCC 2.948 Listed: No.733176**

**IC O.A.T.S listed: No.6629A-1**

TMC Beijing, Telecommunication Metrology Center of Ministry of Industry and Information Technology

No. 52, Huayuanbei Road, Haidian District, Beijing, P. R. China 100191

Tel:+86-10-62304633; Fax:+86-10-62304633; Email:welcome@emcite.com; Http://www.emcite.com/

## **CONTENTS**

<b>1. TEST LABORATORY</b> .....	<b>3</b>
1.1. TESTING LOCATION .....	3
1.2. TESTING ENVIRONMENT.....	3
1.3. PROJECT DATA .....	3
1.4. SIGNATURE.....	3
<b>2. CLIENT INFORMATION</b> .....	<b>4</b>
2.1. APPLICANT INFORMATION.....	4
2.2. MANUFACTURER INFORMATION.....	4
<b>3. EQUIPMENT UNDER TEST (EUT) AND ANCILLARY EQUIPMENT (AE)</b> .....	<b>5</b>
3.1. ABOUT EUT.....	5
3.2. INTERNAL IDENTIFICATION OF EUT USED DURING THE TEST .....	5
3.3. INTERNAL IDENTIFICATION OF AE USED DURING THE TEST.....	5
3.4. GENERAL DESCRIPTION.....	6
3.5. EUT SET-UPS .....	6
<b>4. REFERENCE DOCUMENTS</b> .....	<b>7</b>
4.1. DOCUMENTS SUPPLIED BY THE APPLICANT .....	7
4.2. REGULATIONS AND STANDARDS .....	7
<b>5. LABORATORY ENVIRONMENT</b> .....	<b>8</b>
<b>6. SUMMARY OF TEST RESULTS</b> .....	<b>9</b>
6.1. SUMMARY OF TEST RESULTS.....	9
6.2. TERMS USED IN THE SUMMARY OF TEST RESULTS .....	9
6.3. STATEMENTS .....	10
<b>7. TEST EQUIPMENTS UTILIZED</b> .....	<b>11</b>
<b>ANNEX A: MEASUREMENT RESULTS</b> .....	<b>12</b>

## 1. Test Laboratory

### 1.1. Testing Location

Company Name: TMC Beijing, Telecommunication Metrology Center of MIIT  
Address: No 52, Huayuanbei Road, Haidian District, Beijing, P.R.China  
Postal Code: 100191  
Telephone: +86-10-62304633-2678  
Fax: +86-10-62304633-2504

### 1.2. Testing Environment

Ambient Temperature: 15 ~ 25 °C  
Relative Humidity: 30 ~ 60 %  
Air pressure 860 ~ 1060 mbar

### 1.3. Project Data

Receipt of Sample: Jan 30<sup>th</sup>, 2013  
Testing Start Date: Jan 31<sup>st</sup>, 2013  
Testing End Date: Feb 21<sup>st</sup>, 2013

### 1.4. Signature

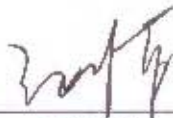

---

Sun Qian  
(Prepared this test report)

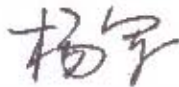

---

Yang Jun  
(Reviewed this test report)

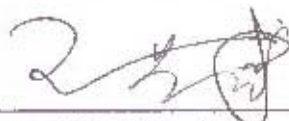

---

Wang Hongbo  
Deputy Director of the laboratory  
(Approved this test report)

## **2. Client Information**

### **2.1. Applicant Information**

Company Name: TCT Mobile Limited  
Address /Post: 5F, C building, No. 232, Liang Jing Road ZhangJiang High-Tech Park,  
Pudong Area Shanghai, P.R. China. 201203  
City: Shanghai  
Postal Code: 201203  
Country: China  
Telephone: 0086-21-61460890  
Fax: 0086-21-61460602

### **2.2. Manufacturer Information**

Company Name: TCT Mobile Limited  
Address /Post: 5F, C building, No. 232, Liang Jing Road ZhangJiang High-Tech Park,  
Pudong Area Shanghai, P.R. China. 201203  
City: Shanghai  
Postal Code: 201203  
Country: China  
Telephone: 0086-21-61460890  
Fax: 0086-21-61460602

### 3. Equipment Under Test (EUT) and Ancillary Equipment (AE)

#### 3.1. About EUT

Description:	HSDPA/HSUPA/UMTS dual band / GSM quad bands mobile phone
Model Name:	Smart III 4 NFC
Marketing Name:	Vodafone 975N
FCC ID:	RAD352
IC ID:	\
With NFC Function:	Yes
Frequency:	13.56MHz
Antenna:	Integral Antenna
Operation Voltage:	DC 3.6V ~ 4.2V
Operation Temperature:	-20~55°C

Note1: Photographs of EUT are shown in ANNEX A of this test report. For component list, please refer to documents of the manufacturer.

Note2: High and low voltage values of extreme conditions are given by the manufacturer.

#### 3.2. Internal Identification of EUT Used during the Test

##### Mobile phone identification

EUT ID*	SN / IMEI	HW Version	SW Version
EUT1	869535010053598	PIO	G5B

\*EUT ID: It is used to identify the test sample in the lab internally.

#### 3.3. Internal Identification of AE Used during the Test

AE ID*	Description	SN	Note
AE1	Opponent Phone	869535010053853	\
AE2	Battery	\	\
AE3	Battery	\	\
AE4	Travel Adapter	\	\
AE5	Travel Adapter	\	\
AE6	USB Cable	\	\
AE7	USB Cable	\	\

##### AE1

Model	Smart III 4 NFC
Manufacturer	TCT Mobile Limited
SN or IMEI	869535010053853

##### AE2

Model	CAB32A0004C2
Manufacturer	SCUD

Capacitance	1500mAh
Nominal Voltage	3.7V
<b>AE3</b>	
Model	CAB32A0004C1
Manufacturer	BYD
Capacitance	1500mAh
Nominal Voltage	3.7V
<b>AE4</b>	
Model	CBA3001AG0C1
Manufacturer	BYD
Length of cable	5cm
<b>AE5</b>	
Model	CBA3001AG0C2
Manufacturer	Tenpao
Length of cable	5cm
<b>AE6</b>	
Model	CDA6050000C1
Manufacturer	Juwei
Length of cable	100cm
<b>AE7</b>	
Model	CDA6050000C2
Manufacturer	Shenghua
Length of cable	100cm

### 3.4. General Description

The EUT is a model of HSDPA/HSUPA/UMTS dual band / GSM quad bands mobile phone with integrated antenna. It supports GSM 850/900/1800 /1900MHz bands and WCDMA Band I/VIII. It also supports GPRS function with multi-slots class 12 and EDGE class 12. It has NFC, MP3, Camera, FM radio, USB memory, Bluetooth(EDR and BLE), Wi-Fi (802.11b/g/n) and GPS functions.

Manuals and specifications of the EUT were provided to fulfil the test.

Samples undergoing test were selected by the client.

Manufacturer's declaration: NFC work does not depend on other access methods, such as WLAN, GPRS, etc.

### 3.5. EUT Set-ups

EUT Set-up No.	Combination of EUT and AE	Remarks
Set. NFC01	EUT1+AE1+AE2+AE3+AE4+AE6	--
Set. NFC02	EUT1+AE1+AE2+AE3+AE5+AE7	--
Set. NFC03	EUT1+AE2	--
Set. NFC04	EUT1+AE1+AE2+AE3	--

The Transmit State of NFC: the NFC function is on. The EUT will transmit the NFC data and command continuously during the test.

The Transmit State of without modulation: The EUT will transmit the CW signal at the operating

frequency.

## **4. Reference Documents**

### **4.1. Documents Supplied by the Applicant**

EUT feature information is supplied by the applicant or manufacturer, which is the basis of testing.

### **4.2. Regulations and Standards**

The following documents listed in this section are referred for testing.

<b>Reference</b>	<b>Title</b>	<b>Version</b>
CFR 47 Part 2	Part 2 — Frequency Allocations and Radio Treaty Matters; General Rules and Regulations.	2012
CFR 47 Part 15	Part 15 — Radio Frequency Devices. Subpart C — Intentional Radiators. § 15.207 Conducted limits. § 15.209 Radiated emission limits, general requirements. § 15.215 Additional provisions to the general radiated emission limitations. § 15.225 Operation within the band 13.110–14.010 MHz.	2012
ANSI C63.4	American National Standard for Methods of Measurement of Radio-Noise Emissions from Low-Voltage Electrical and Electronic Equipment in the Range of 9 kHz to 40 GHz.	2009

## 5. LABORATORY ENVIRONMENT

**Semi-Anechoic Chamber SAC-2** (10m×6.7m×6.15m) did not exceed following limits along the testing:

Temperature	Min. = 15 °C, Max. = 25 °C
Relative humidity	Min. = 30 %, Max. = 60 %
Shielding effectiveness	> 110 dB
Electrical insulation	> 2 MΩ
Ground system resistance	< 1 Ω
Normalised site attenuation (NSA)	< ±3.5 dB, 3 m distance, from 30 to 1000 MHz
Site voltage standing-wave ratio ( $S_{VSWR}$ )	Between 0 and 6 dB, from 1 to 18 GHz
Uniformity of field strength	Between 0 and 6 dB, from 80 to 3000 MHz

**Fully-Anechoic Chamber FAC-3** (8.6m×6.1m×3.85m) did not exceed following limits along the testing:

Temperature	Min. = 15 °C, Max. = 25 °C
Relative humidity	Min. = 30 %, Max. = 60 %
Shielding effectiveness	> 110 dB
Electrical insulation	> 2 MΩ
Ground system resistance	< 1 Ω
Site voltage standing-wave ratio ( $S_{VSWR}$ )	Between 0 and 6 dB, from 1 to 18GHz
Uniformity of field strength	Between 0 and 6 dB, from 80 to 4000 MHz

**Conducted Chamber** did not exceed following limits along the testing:

Temperature	Min. = 15 °C, Max. = 25 °C
Relative humidity	Min. = 30 %, Max. = 60 %
Shielding effectiveness	> 110 dB
Electrical insulation	> 2 MΩ
Ground system resistance	< 0.5 Ω

**Control Room** did not exceed following limits along the testing:

Temperature	Min. = 15 °C, Max. = 25 °C
Relative humidity	Min. =30 %, Max. = 60 %
Shielding effectiveness	> 110 dB
Electrical insulation	> 2 MΩ
Ground system resistance	< 0.5 Ω



## 6. SUMMARY OF TEST RESULTS

### 6.1. Summary of Test Results

No	Test Cases	Clause in Regulation	Section in This Report	Verdict
1	Electric Field Strength of Fundamental Emissions	CFR 47 § 15.225(a)	A.1	P(Set. NFC04)
2	Electric Field Strength of Outside the Allocated Bands	CFR 47 § 15.225(b) CFR 47 § 15.225(c)		P(Set. NFC04)
3	Electric Field Radiated Emissions	CFR 47 § 15.209 CFR 47 § 15.225(d)	A.2	P(Set. NFC01) P(Set. NFC02)
			A.3	P(Set. NFC01) P(Set. NFC02)
4	Frequency Tolerance	CFR 47 § 15.225(e)	A.4	P(Set. NFC03)
5	20dB Bandwidth	CFR 47 § 15.215(c)	A.5	P(Set. NFC03, 04)
6	Conducted Emissions	CFR 47 § 15.207	A.6	P(Set. NFC01) P(Set. NFC02)

The measurement is carried out according to ANSI C63.4. See **ANNEX A** for details.

#### Test Conditions:

For this report, all the test cases listed above were tested under normal Temperature, Voltage, Humidity, and Air Pressure. The specific conditions are as following:

Temperature	T min	-20 °C
	T nom	20 °C
	T max	50 °C
Voltage	V min	3.6 V
	V nom	3.7 V
	V max	4.2 V
Humidity	H nom	44%
Air Pressure	A nom	1010 mbar

### 6.2. Terms Used in the Summary of Test Results

#### Terms Used in Condition Column:

T nom	Normal Temperature
T min	Low Temperature
T max	High Temperature
V nom	Normal Voltage
V min	Low Voltage

V max	High voltage
H nom	Norm Humidity
A nom	Norm Air Pressure

**Terms Used in Verdict Column:**

P	Pass, The EUT complies with the essential requirements in the standard.
NP	Not Perform, The test was not performed by TMC
NA	Not Applicable, The test was not applicable
F	Fail, The EUT does not comply with the essential requirements in the standard

**Abbreviations:**

AC	Alternating Current
AFH	Adaptive Frequency Hopping
BW	Band Width
E.I.R.P.	equivalent isotropical radiated power
ISM	Industrial, Scientific and Medical
RF	Radio Frequency
Tx	Transmitter

**6.3. Statements**

The test cases listed in Section 6.1 of this report for the EUT specified in Section 3 were performed by TMC according to the reference documents in Section 4.

The EUT meets all applicable requirements of the regulations and standards in Section 4.2.

## 7. Test Equipments Utilized

No.	Name	Type	Serial No.	MANUFACTURER	CALIBRATION DUE DATE
1.	NFC Tester	E1141	000019	AT4 Wireless	/
2.	RFID Tester	NI PXIe-1062Q	16929DF	VI	2013-12-06
3.	H-field Antenna	HFH2-Z2	829324/0007	R&S	2013-07-02
4.	Spectrum Analyzer	RSA3408A	B 010277	Tektronix	2013-06-05
5.	Thermal Chamber	PL-2G	343074	ESPEC	2013-05-12
6.	Coil antenna	/	/	VI	/
7.	Test Receiver	ESU26	100376	R&S	2013-11-07
8.	Spectrum Analyzer	E4440A	MY48250642	Agilent	2014-03-04
9.	EMI Antenna	VULB 9163	514	Schwarzbeck	2014-11-10
10.	Signal Generator	SMF100A	101295	R&S	2013-11-08
11.	Test Receiver	ESCI	100344	R&S	2013-03-28
12.	LISN	ESH2-Z5	829991/012	R&S	2013-04-16
13.	Signal Generator	SMF100A	101295	R&S	2013-11-08
14.	Power Meter	NRVD	830954/042	R&S	2013-12-12
15.	Power Amplifier	250W1000	26339	AR	/
16.	Power Amplifier	AS0104-100/55	1034090	MILMEGA	/
17.	EMS Antenna	HL046	358714	R&S	/
18.	EMS Antenna	AT4002A	321428	AR	/
19.	Signal Generator	SML01	106247	R&S	2013-04-27
20.	Power Meter	NRVD	102040	R&S	2013-5-27
21.	Power Amplifier	150A220	0326453	AR	/
22.	Coupling/decoupling network	CDN-M2/32	9912001C	EM TEST	2014-07-31
23.	Current Clamp	F-120-9A	182	FCC	2013-04-03
24.	Ultr-compact Simulator	UCS500-N7	V0940105198	EM TEST	2013-04-24
25.	Universal Radio Communication Tester	CMU200	116455	R&S	2013-05-20
26.	Universal Radio Communication Tester	CMU200	102228	R&S	2013-07-07

## ANNEX A: MEASUREMENT RESULTS

### A.1. Electric Field Strength of Fundamental and Outside the Allocated bands

#### A.1.1. Reference

See Clause 13.5, Clause 13.4, Clause 8, and Annex E of ANSI C63.4-2009 specifically.  
See Clause 4, Clause 5, and Clause 6 of ANSI C63.4-2009 generally.

#### A.1.2. Measurement Methods

The transmitter carrier output levels (E-Field) from the EUT are measured in a semi-anechoic chamber. The EUT is placed on a non-conductive stand of 80cm high, and at a measurement distance of 3m from the receiving antenna. The center of the receiving loop antenna is 1.0 meter above the ground. The E-field is measured with a shielded loop antenna connected to a measurement receiver. Detected E-field was maximized by rotating the EUT through 360° and adjusting the receiving antenna polarizations. The maximization processes were repeated with the EUT positioned respectively in its three orthogonal axes. The measurements were performed with the peak detector and if required, the quasi-peak detector.

The measurement bandwidth is:

Frequency of Emission (MHz)	RBW/VBW
12.56-14.56	10/30 kHz

The E-field measured at 3m is calculated as:

$$\text{E-field (dB}\mu\text{V/m)} = \text{Rx (dB}\mu\text{V)} + \text{Cable Loss (dB)} + \text{AF@3m (dB/m)}$$

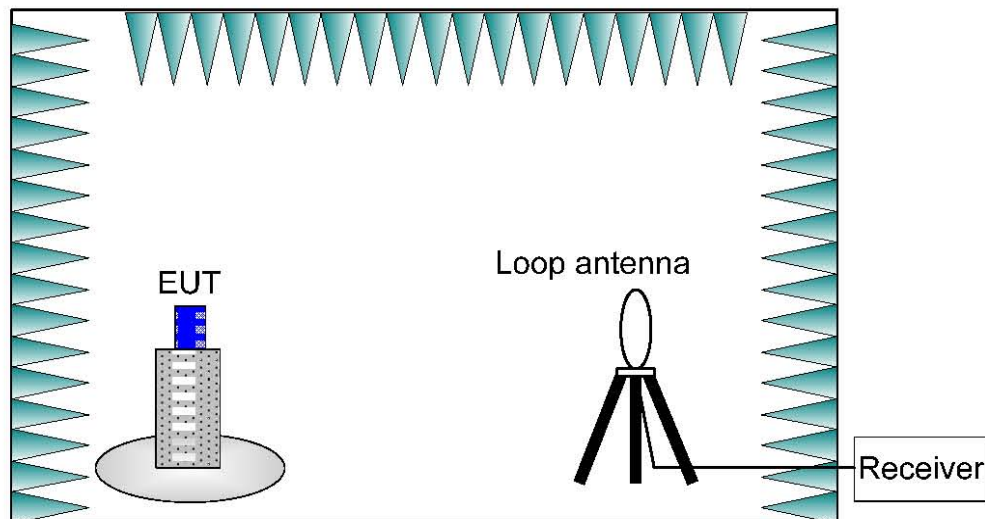

#### A.1.3. EUT Operating Mode and Test Conditions

The measurement of EUT is carried out under the transmit state of NFC (See 3.5).  
The EUT is powered by a travel adapter.

During the measurements, the ambient temperature of the electromagnetic anechoic chamber is in the range of 15 ~ 25 °C.

#### A.1.4. Limits

Frequency Range (MHz)	E-field Strength Limit @ 30 m (μV/m)	E-field Strength Limit @ 3 m (dBμV/m)
13.560 ± 0.007	+15,848	124
13.410 to 13.553 13.567 to 13.710	+334	90
13.110 to 13.410 13.710 to 14.010	+106	81

Note: Where the limits have been defined at one distance, and a signal level measured at another, the limits have been extrapolated using the following formula:

$$\text{Extrapolation(dB)} = 40\log_{10}(\text{Measurement Distance}/\text{Specification Distance})$$

#### A.1.5. Measurement Results

Measurement results of normal conditions see Figure A-1 for different set-ups of EUT. The result displayed take into account applicable antenna factors and cable losses.

**Conclusions: Set. NFC04, PASS.**

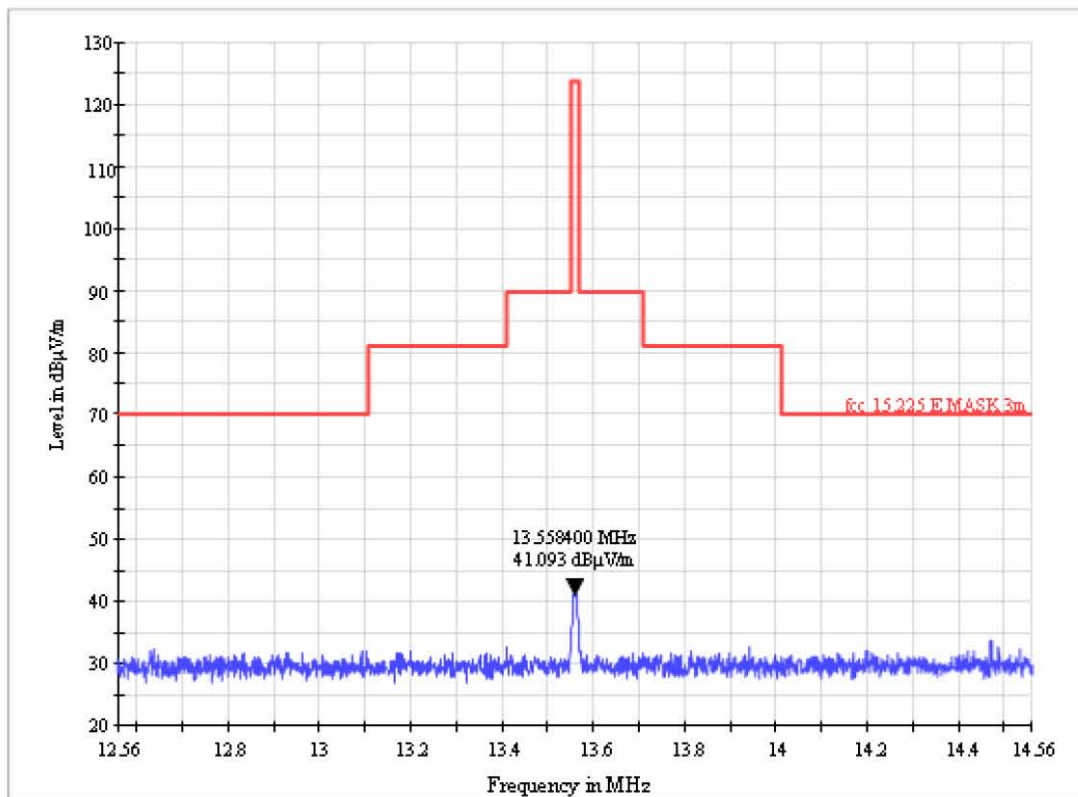

Figure A-1: Set. NFC04

## **A.2. Electric Field Radiated Emissions (< 30MHz)**

### **A.2.1. Reference**

See Clause 13.4, Clause 8 and Annex E of ANSI C63.4-2009 specifically.

See Clause 4, Clause 5, and Clause 6 of ANSI C63.4-2009 generally.

### **A.2.2. Measurement Methods**

The transmitter carrier output levels (E-Field) from the EUT are measured in a semi-anechoic chamber. The EUT is placed on a non-conductive stand of 80cm high, and at a measurement distance of 3m from the receiving antenna. The center of the receiving loop antenna is 1.0 meter above the ground. The E-field is measured with a shielded loop antenna connected to a measurement receiver. Detected E-field was maximized by rotating the EUT through 360° and adjusting the receiving antenna polarizations. The maximization processes were repeated with the EUT positioned respectively in its three orthogonal axes. The measurements were performed with the peak detector and if required, the quasi-peak detector.

The measurement bandwidth is:

Frequency of Emission (MHz)	RBW/VBW
0.009-0.15	100/300 Hz
0.15-30	10/30 kHz

The E-field measured at 3m is calculated as:

$$\text{E-field (dB}\mu\text{V/m)} = \text{Rx (dB}\mu\text{V)} + \text{Cable Loss (dB)} + \text{AF@3m (dB/m)}$$

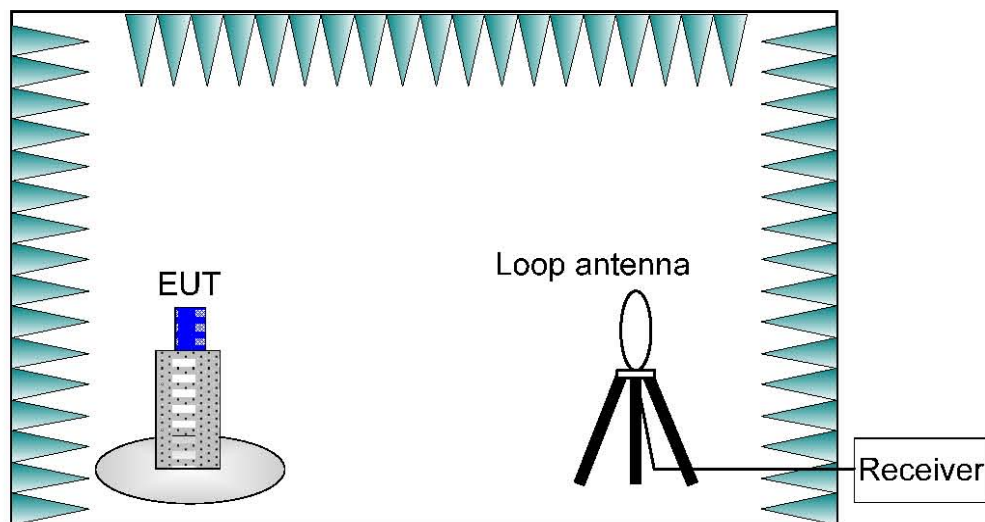

### **A.2.3. EUT Operating Mode and Test Conditions**

The measurement of EUT is carried out under the transmit state of NFC (See 3.5).

The EUT is powered by a travel adapter.

During the measurements, the ambient temperature of the electromagnetic anechoic chamber is in the range of 15 ~ 25 °C.

#### A.2.4. Limits

Frequency Range (MHz)	E-field Strength Limit @ 30m (mV/m)	E-field Strength Limit @ 3m (dBµV/m)
0.009-0.490	2400/F(kHz)	129-94
0.490-1.705	24000/F(kHz)	74-63
1.705-30	30	70

Note: Where the limits have been defined at one distance, and a signal level measured at another, the limits have been extrapolated using the following formula:

$$\text{Extrapolation(dB)} = 40\log_{10}(\text{Measurement Distance}/\text{Specification Distance})$$

#### A.2.5. Measurement Results

Measurement results of normal conditions see Figure A-2 for different set-ups of EUT. The result displayed take into account applicable antenna factors and cable losses.

**Conclusions:** Set. NFC01, **PASS**. Set. NFC02 **PASS**.

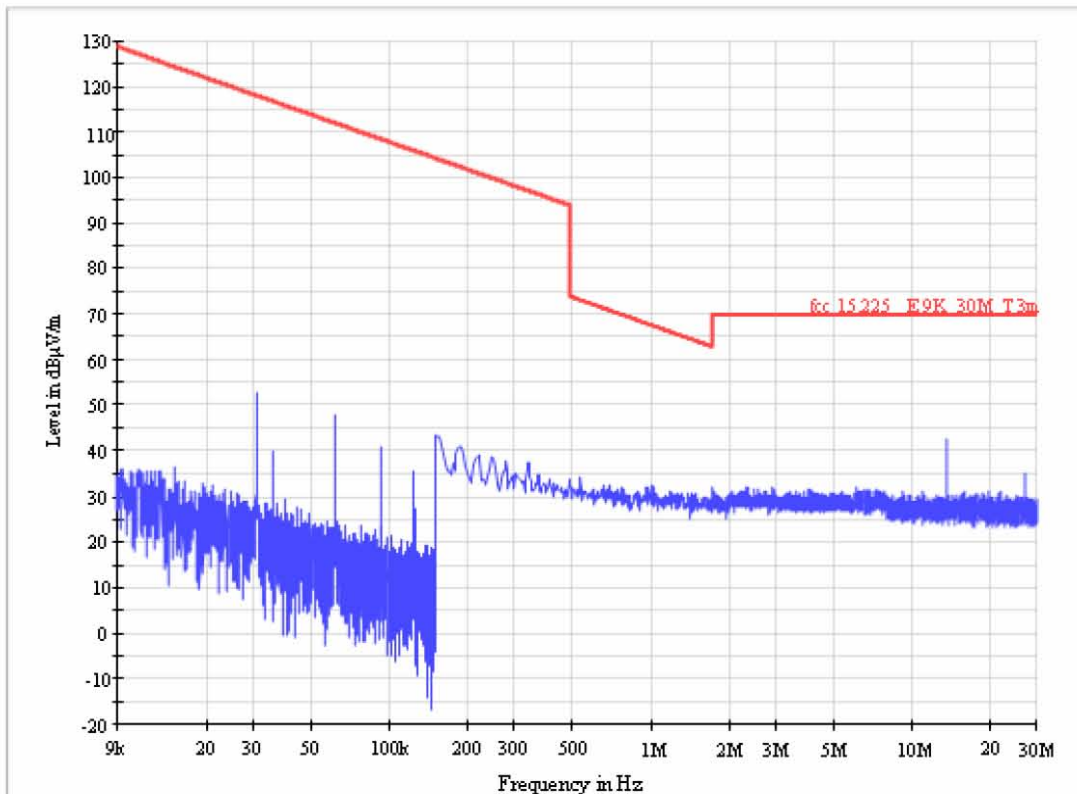

Figure A-2: Set. NFC01

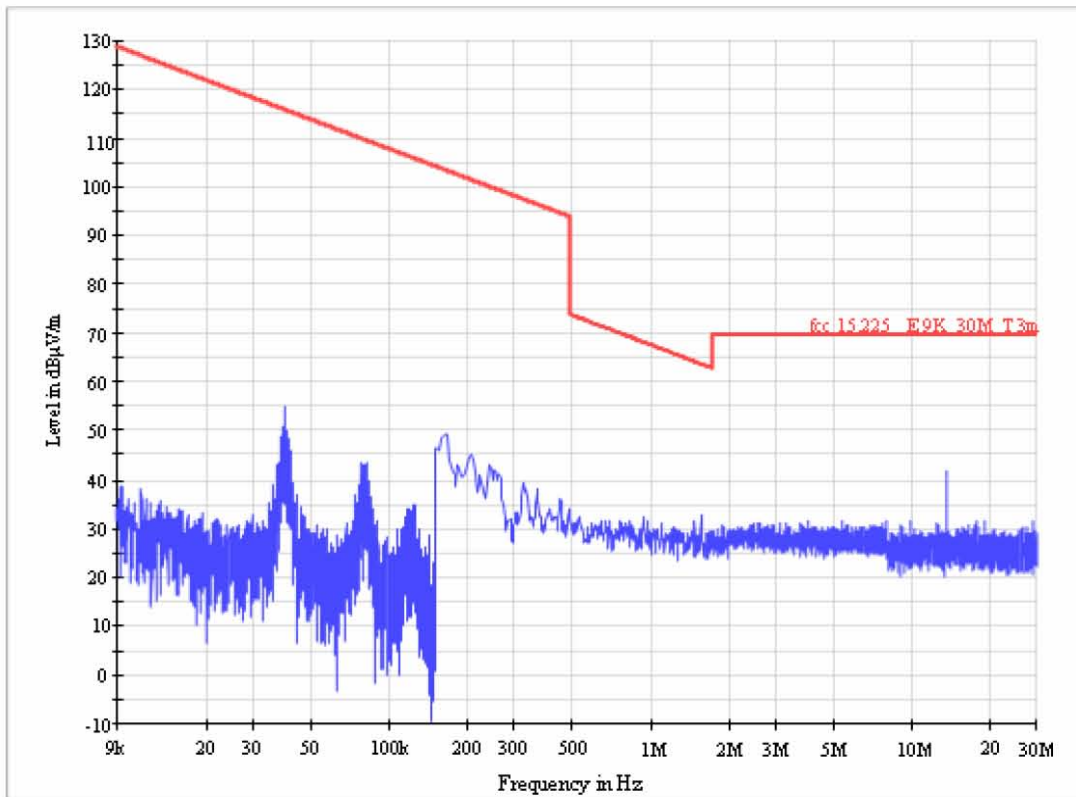

Figure A-3: Set. NFC02

### **A.3. Electric Field Radiated Emissions (≥30MHz)**

#### **A.3.1. Reference**

See Clause 13.4, Clause 8, and Annex E of ANSI C63.4-2009 specifically.

See Clause 4, Clause 5, and Clause 6 of ANSI C63.4-2009 generally.

#### **A.3.2. Measurement Methods**

The electric field radiated emissions from the EUT are measured in a semi-anechoic chamber. The EUT is placed on a non-conductive stand of 80cm high, and at a measurement distance of 3m from the receiving antenna. The receiving antennas connected to a measurement receiver comply with Clause 15 of ANSI C63.2-1996 and Clause 4.1.5 of ANSI C63.4-2009. In order to search for maximum field strength emitted from the EUT, the receiving antenna can be moved between the height of 1.0 m to 4.0 m. Detected E-field was maximized at each frequency by rotating the EUT through 360° and adjusting the receiving antenna positions for both vertical and horizontal antenna polarizations. The maximization processes were repeated with the EUT positioned respectively in its three orthogonal axes. The measurements were performed with the peak detector and if required, the quasi-peak detector.

The measurement bandwidth is:

Frequency of Emission (MHz)	RBW/VBW
30-1000	120kHz

The E-field measured at 3m is calculated as:

$$\text{E-field (dB}\mu\text{V/m)} = \text{Rx (dB}\mu\text{V)} + \text{Cable Loss (dB)} + \text{AF@3m (dB/m)}$$



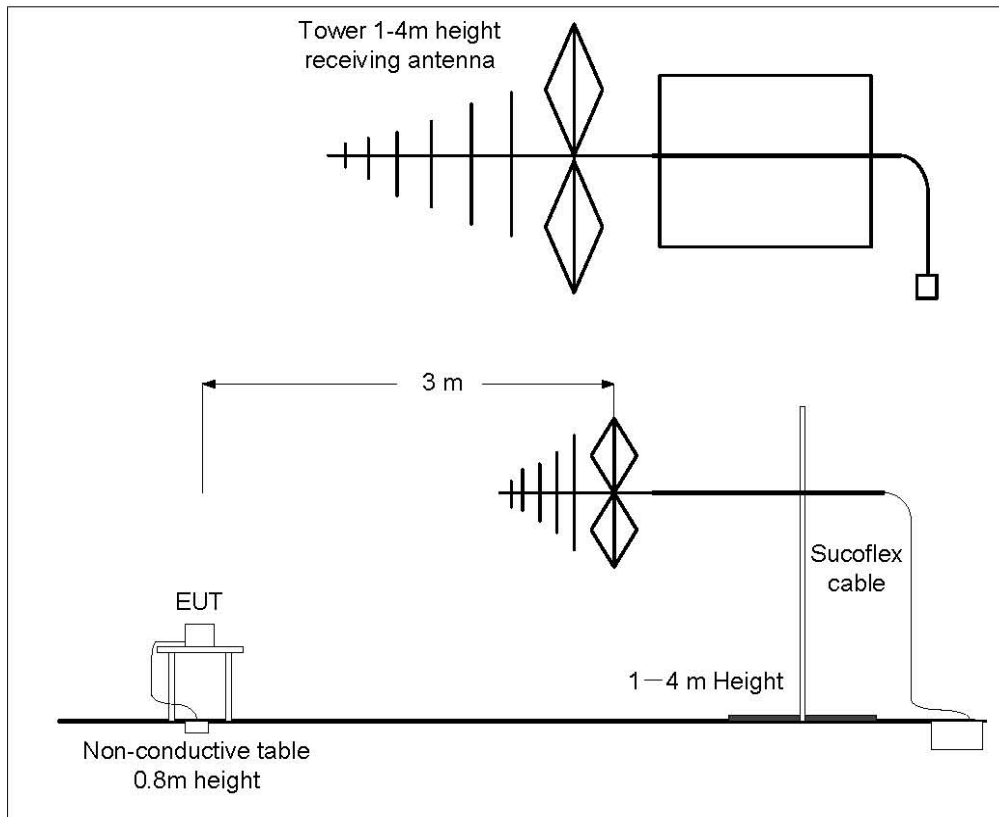

### A.3.3. EUT Operating Mode and Test Conditions

The measurement of EUT is carried out under the transmit state of NFC (See 3.5).

EUT1 had been connected to a travel adapter.

During the measurements, the ambient temperature of the electromagnetic anechoic chamber is in the range of 15 ~ 25 °C.

### A.3.4. Limits

Frequency Range (MHz)	E-field Strength Limit @ 3m (mV/m)	E-field Strength Limit @ 3m (dB $\mu$ V/m)
30-88	100	40
88-216	150	43.5
216-960	200	46

### A.3.5. Measurement Results

Measurement results of normal conditions see Figure A-3 for different set-ups of EUT. The result displayed take into account applicable antenna factors and cable losses.

**Conclusions: Set. NFC01, PASS, Set. NFC02, PASS**

RE 30MHz-1GHz

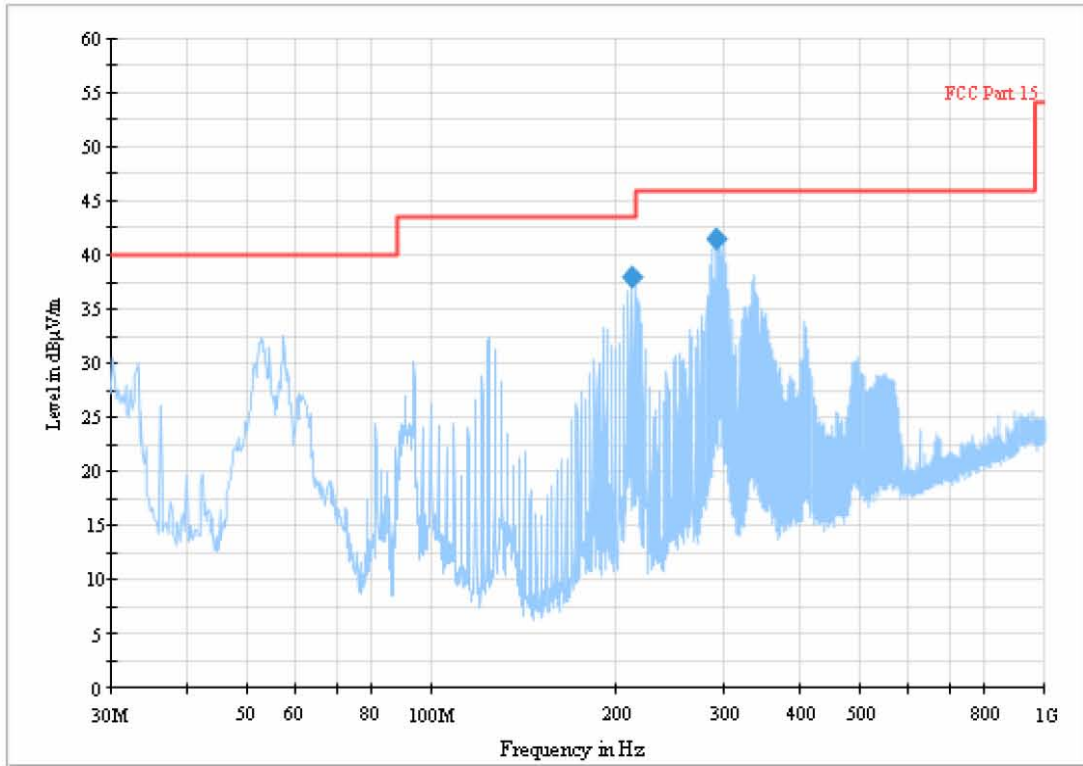

Figure A-4: Set. NFC01

### Final Result 1

Frequency (MHz)	QuasiPeak (dBµV/m)	Height (cm)	Polarization	Azimuth (deg)	Corr. (dB)	Margin (dB)
211.778000	37.9	189.0	V	1.0	-28.2	5.6
290.542000	41.6	100.0	V	1.0	-26.2	4.4

RE 30MHz-1GHz

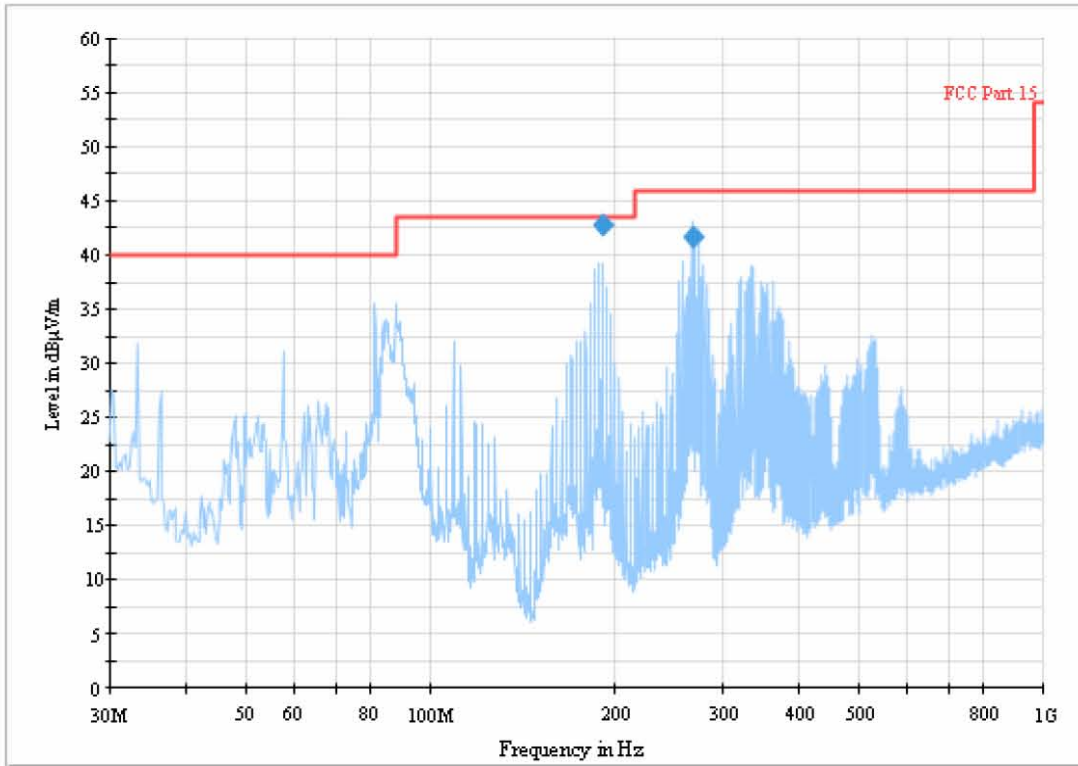

Figure A-5: Set. NFC02

### Final Result 1

Frequency (MHz)	QuasiPeak (dBµV/m)	Height (cm)	Polarization	Azimuth (deg)	Corr. (dB)	Margin (dB)
191.214000	42.7	100.0	H	24.0	-28.6	0.8
267.068000	41.6	125.0	H	45.0	-26.7	4.4

## **A.4. Frequency Tolerance**

### **A.4.1. Reference**

See Clause 13.6 of ANSI C63.4-2009 specifically.

See Clause 4, Clause 5, and Clause 6 of ANSI C63.4-2009 generally.

### **A.4.2. Measurement Methods**

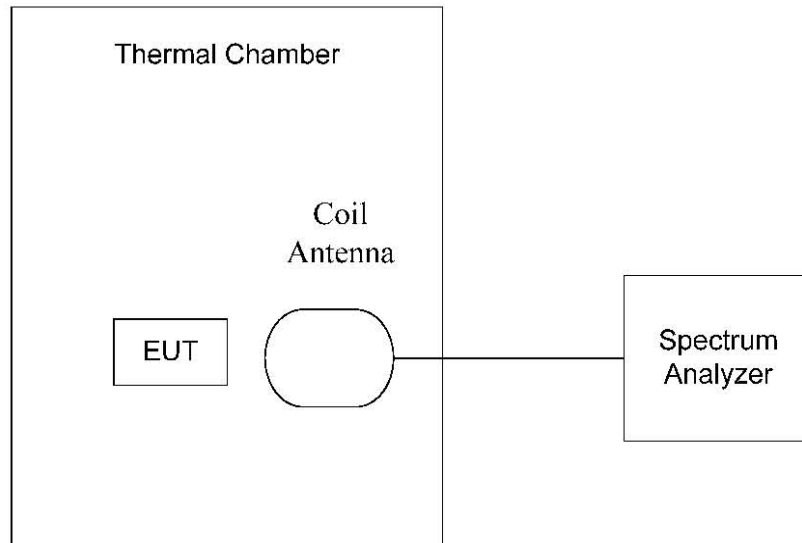

The transmitter output signal was picked up by coil antenna connected to the spectrum analyzer. The center frequency was measured with 30Hz RBW and 1kHz span. During the test, the EUT was placed in a thermal chamber until thermal balance and lasting appropriate time.

### **A.4.3. EUT Operating Mode and Test Conditions**

The measurement of EUT is carried out under the transmit state of without modulation (See 3.5).

EUT1 had been not connected to a travel adapter.

Operation Temperature: T min, T nom, and T max with V nom.

Operation Voltage: V min and V max with T nom.

### **A.4.4. Test Layouts**

See A.4.2.

### **A.4.5. Limits**

The frequency tolerance of the carrier signal shall be maintained within +/- 0.01% of the operating frequency.

### **A.4.6. Measurement Results**

Measurement results see Table A-1 for different test conditions.

**Conclusions:** Set. NFC03, **PASS**.

**Table A-1: Frequency Stability VS Temperature and Voltage**

Temperature	Voltage	Frequency Error (MHz)			
		Startup	2 Min Later	5 Min Later	10 Min Later
T min	V nom	13.5608349	13.5608317	13.5608317	13.5608253
T max	V nom	13.5607163	13.5607099	13.5607099	13.5607131
T nom	V nom	13.5607439	13.5607414	13.5607389	13.5607377
T nom	V min	13.5607312	13.5607216	13.5607086	13.5607518
T nom	V max	13.5607413	13.5607136	13.5607327	13.5607262

Temperature	Voltage	Frequency Error (%)			
		Startup	2 Min Later	5 Min Later	10 Min Later
T min	V nom	0.006	0.006	0.006	0.006
T max	V nom	0.005	0.005	0.005	0.005
T nom	V nom	0.005	0.005	0.005	0.005
T nom	V min	0.005	0.005	0.005	0.006
T nom	V max	0.005	0.005	0.005	0.005

## **A.5. 20dB Bandwidth**

### **A.5.1. Reference**

See Clause 13.7 of ANSI C63.4-2009 specifically.

See Clause 4, Clause 5, and Clause 6 of ANSI C63.4-2009 generally.

### **A.5.2. Measurement Methods**

The transmitter output signal was picked up by coil antenna to the spectrum analyzer.

The transmitter output signal was picked up by coil antenna connected to the spectrum analyzer.

The bandwidth of the center frequency was measured with 100Hz RBW, 300Hz VBW and 5kHz span.

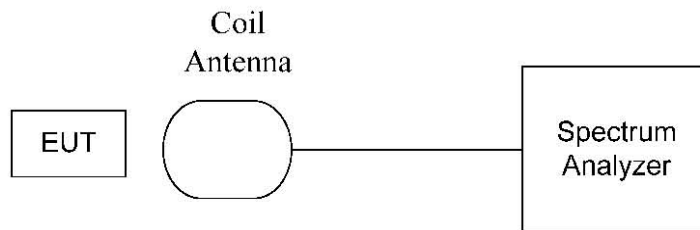

### **A.5.3. EUT Operating Mode and Test Conditions**

The measurement of EUT is carried out under the transmit state of NFC and without modulation (See 3.5).

EUT1 had been not connected to a travel adapter..

During the measurements, the ambient temperature is in the range of 15 ~ 25 °C.

### **A.5.4. Test Layouts**

See A.5.2.

### **A.5.5. Limits**

The 20dB bandwidth shall be less than 80% of the permitted frequency band. For 13.56 MHz NFC, the permitted frequency band is 14kHz, so the limit is 11.2 kHz.

### **A.5.6. Measurement Results**

Measurement results see Figure A-4 and Figure B-5.

**Conclusions:** Set. NFC03 and NFC04, **PASS**.

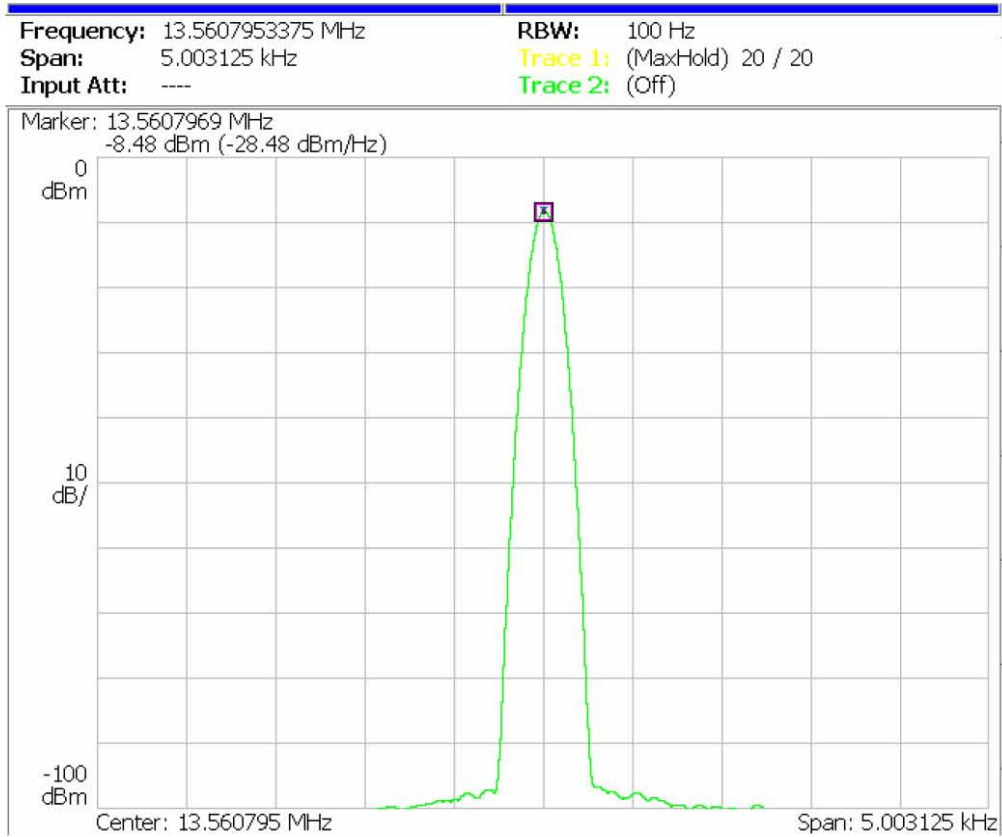

**Figure A-6: Test result of EUT1 at test set. NFC03**

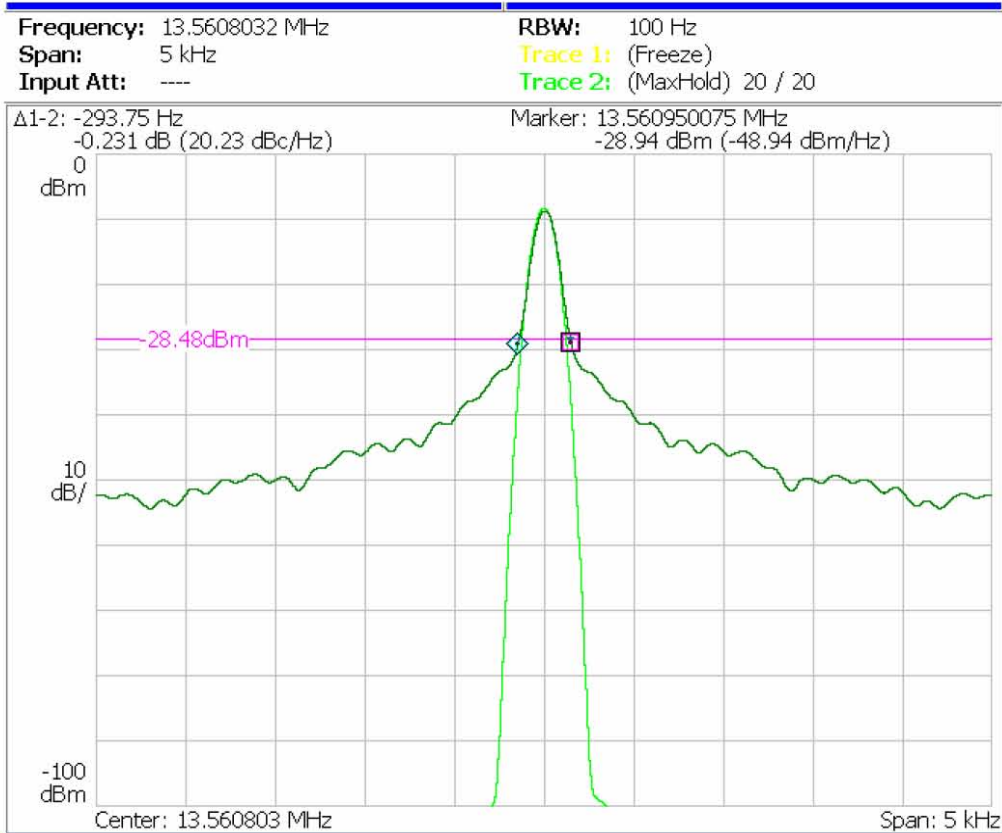

**Figure A-7: Test result of EUT1 at test set. NFC04**

## A.6 Conducted emission

### A.6.1. Reference

See Clause 13.3 and Clause 7 of ANSI C63.4-2009 specifically.

See Clause 4, Clause 5, and Clause 6 of ANSI C63.4-2009 generally.

### A.6.2. Measurement Methods

The conducted emissions from the AC port of the EUT are measured in a shielding room. The EUT is connected to a Line Impedance Stabilization Network (LISN). An overview sweep with peak detection was performed. The measurements were performed with a quasi-peak detector and if required, an average detector.

The conducted emission measurements were made with the following detector of the test receiver: Quasi-Peak / Average Detector.

The measurement bandwidth is:

Frequency of Emission (MHz)	RBW/VBW
0.15-30	9kHz

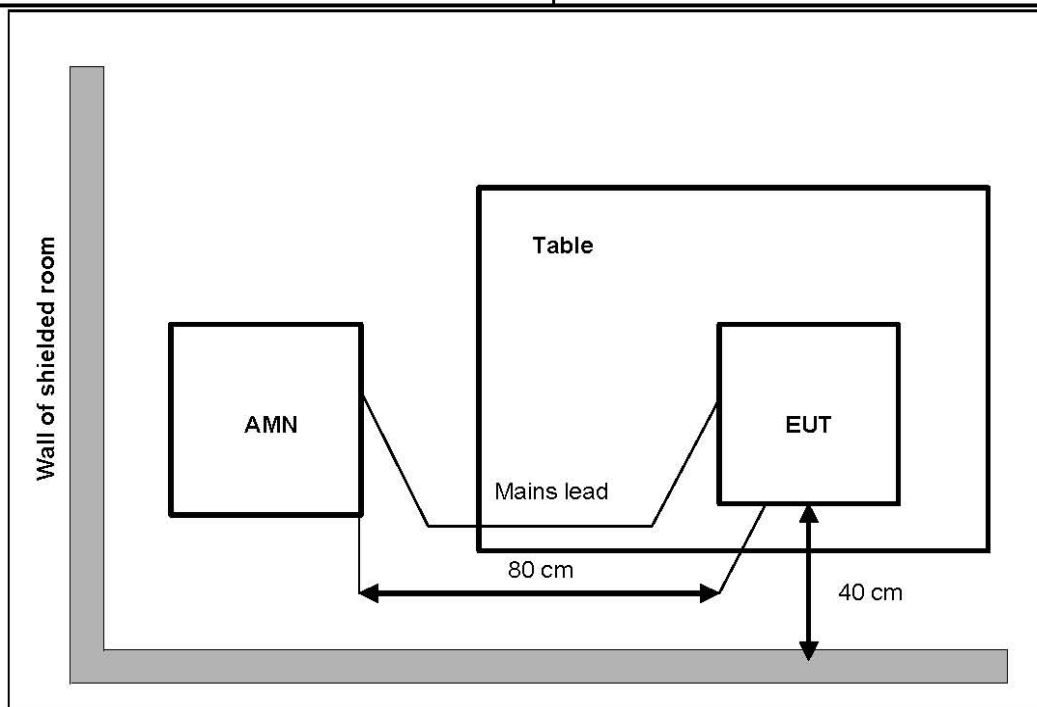

### A.6.3. EUT Operating Mode and Test Conditions

The measurement of EUT is carried out under the transmit state of NFC (See 3.5).

The EUT is powered by a travel adapter.

During the measurements, the ambient temperature is in the range of 15 ~ 25 °C.

### A.6.4. Limits

Frequency range (MHz)	Quasi-peak Limit (dB $\mu$ V)	Average Limit (dB $\mu$ V)
0.15 to 0.5	66 to 56	56 to 46
0.5 to 5	56	46
5 to 30	60	50



### A.6.5. Measurement Results

Measurement results see Figure A-6.

**Conclusions:** Set. NFC01, **PASS**. Set. NFC02, **PASS**

Note: The measurement result at 13.56MHz is the fundamental emission of NFC signal.

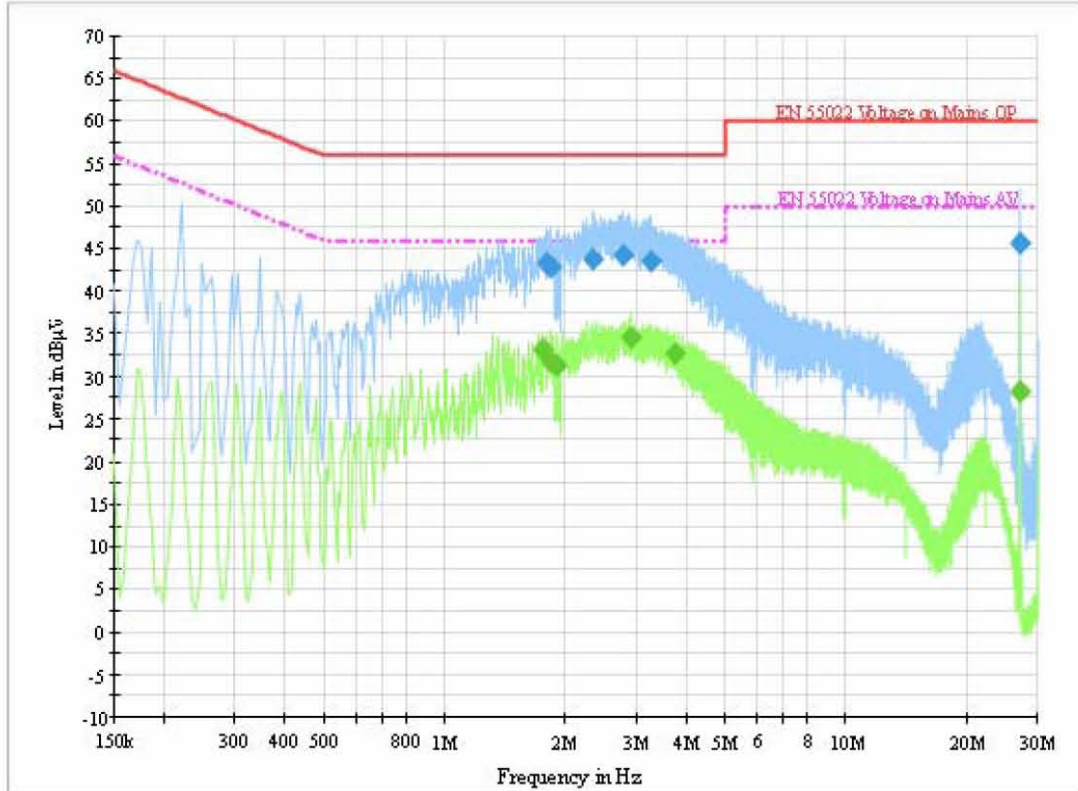

Figure A-8: Test result of EUT1 at test set. NFC01

### Final Result 1

Frequency (MHz)	QuasiPeak (dBµV)	PE	Line	Corr. (dB)	Margin (dB)	Limit (dBµV)
1.801500	43.2	GND	L1	10.0	12.8	56.0
1.833000	42.8	GND	L1	10.0	13.2	56.0
2.350500	43.9	GND	L1	10.0	12.1	56.0
2.791500	44.2	GND	L1	10.0	11.8	56.0
3.250500	43.7	GND	L1	10.0	12.3	56.0
27.123000	45.6	GND	N	9.5	14.4	60.0

### Final Result 2

Frequency (MHz)	Average (dBµV)	PE	Line	Corr. (dB)	Margin (dB)	Limit (dBµV)
1.752000	33.2	GND	L1	10.0	12.8	46.0
1.828500	31.7	GND	L1	10.0	14.3	46.0
1.909500	31.3	GND	L1	10.0	14.7	46.0
2.913000	34.5	GND	L1	10.0	11.5	46.0
3.763500	32.8	GND	L1	10.0	13.2	46.0
27.123000	28.3	GND	N	9.5	21.7	50.0

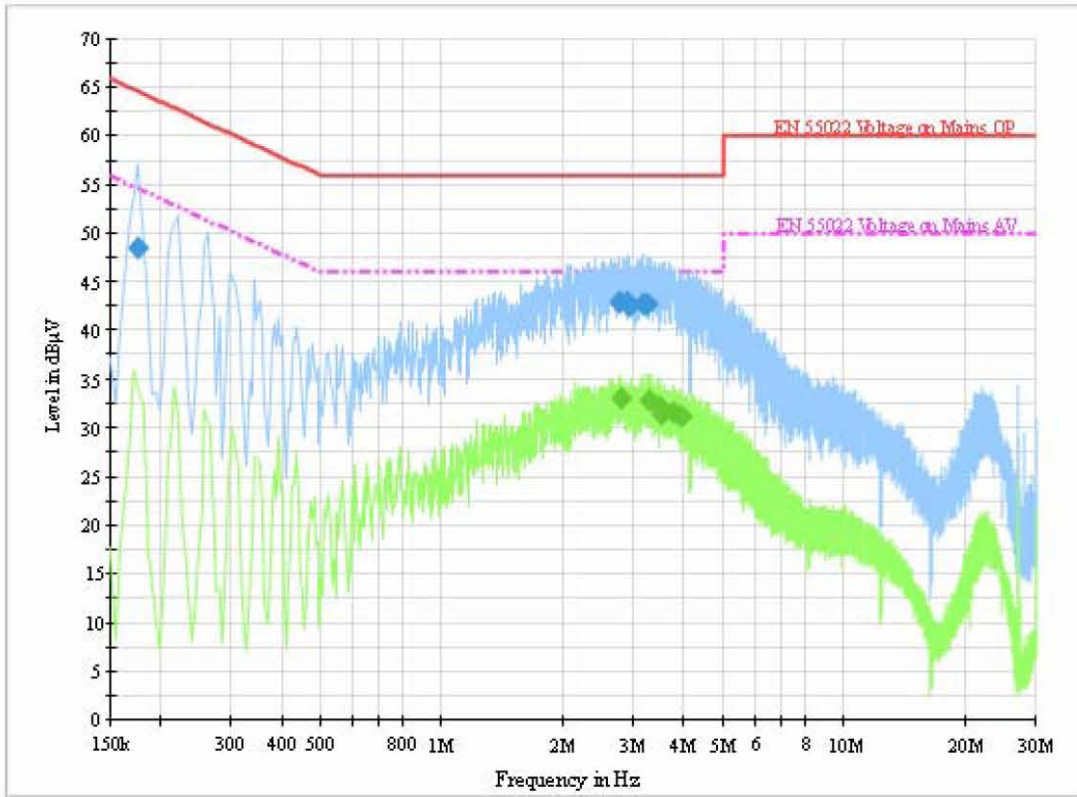

Figure A-9: Test result of EUT1 at test set. NFC02

### Final Result 1

Frequency (MHz)	QuasiPeak (dBµV)	PE	Line	Corr. (dB)	Margin (dB)	Limit (dBµV)
0.177000	48.6	GND	N	10.0	16.0	64.6
2.769000	42.9	GND	L1	10.0	13.1	56.0
2.895000	43.0	GND	L1	10.0	13.0	56.0
2.926500	42.6	GND	L1	10.0	13.4	56.0
3.151500	42.7	GND	L1	10.0	13.3	56.0
3.232500	42.8	GND	L1	10.0	13.2	56.0

### Final Result 2

Frequency (MHz)	Average (dBµV)	PE	Line	Corr. (dB)	Margin (dB)	Limit (dBµV)
2.782500	33.0	GND	L1	10.0	13.0	46.0
3.282000	32.8	GND	L1	10.0	13.2	46.0
3.475500	32.1	GND	L1	10.0	13.9	46.0
3.507000	31.3	GND	L1	10.0	14.7	46.0
3.772500	31.6	GND	L1	10.0	14.4	46.0
3.957000	31.1	GND	L1	10.0	14.9	46.0

\*\*\*END OF REPORT\*\*\*