



SAR TEST REPORT

No. 2013EEB00040

For

TCT Mobile Limited

HSUPA/HSDPA/UMTS triband / GSM quadband mobile phone

Model name: Megane 1SIM US

Marketing name: ONE TOUCH 5020A

With

Hardware Version: PIO

Software Version: v2C56-0

FCC ID: RAD343

Issued Date: 2013-03-08



Note:

The test results in this test report relate only to the devices specified in this report. This report shall not be reproduced except in full without the written approval of TMC Beijing.

Test Laboratory:

TMC Beijing, Telecommunication Metrology Center of MIIT

No. 52, Huayuan Bei Road, Haidian District, Beijing, P. R. China 100191.

Tel:+86(0)10-62304633-2079, Fax:+86(0)10-62304633 Email:welcme@emcite.com. www.emcite.com

Revision Version

Report Number	Revision	Date	Memo
2013EEB00040	00	2013-02-28	Initial creation of test report
2013EEB00040	01	2013-03-08	/

TABLE OF CONTENT

1 TEST LABORATORY	5
1.1 TESTING LOCATION	5
1.2 TESTING ENVIRONMENT.....	5
1.3 PROJECT DATA	5
1.4 SIGNATURE.....	5
2 STATEMENT OF COMPLIANCE	6
3 CLIENT INFORMATION.....	7
3.1 APPLICANT INFORMATION	7
3.2 MANUFACTURER INFORMATION	7
4 EQUIPMENT UNDER TEST (EUT) AND ANCILLARY EQUIPMENT (AE)	8
4.1 ABOUT EUT	8
4.2 INTERNAL IDENTIFICATION OF EUT USED DURING THE TEST	9
4.3 INTERNAL IDENTIFICATION OF AE USED DURING THE TEST.....	9
5 TEST METHODOLOGY	10
5.1 APPLICABLE LIMIT REGULATIONS	10
5.2 APPLICABLE MEASUREMENT STANDARDS.....	10
6 SPECIFIC ABSORPTION RATE (SAR).....	11
6.1 INTRODUCTION.....	11
6.2 SAR DEFINITION.....	11
7 TISSUE SIMULATING LIQUIDS	12
7.1 TARGETS FOR TISSUE SIMULATING LIQUID	12
7.2 DIELECTRIC PERFORMANCE	12
8 SYSTEM VERIFICATION.....	16
8.1 SYSTEM SETUP	16
8.2 SYSTEM VERIFICATION.....	17
9 MEASUREMENT PROCEDURES	18
9.1 TESTS TO BE PERFORMED	18
9.2 GENERAL MEASUREMENT PROCEDURE.....	19
9.3 BLUETOOTH & WI-FI MEASUREMENT PROCEDURES FOR SAR	20
9.4 POWER DRIFT.....	21
10 CONDUCTED OUTPUT POWER	21
10.1 MANUFACTURING TOLERANCE	21
10.2 GSM MEASUREMENT RESULT	23
10.3 WI-FI AND BT MEASUREMENT RESULT	24
11 SIMULTANEOUS TX SAR CONSIDERATIONS	25

12.1 INTRODUCTION.....	25
12.2 TRANSMIT ANTENNA SEPARATION DISTANCES.....	26
12.3 STANDALONE SAR TEST EXCLUSION CONSIDERATIONS	27
12 EVALUATION OF SIMULTANEOUS.....	28
13 SAR TEST RESULT.....	29
14.1 THE EVALUATION OF MULTI-BATTERIES	29
14.2 SAR TEST RESULT	29
14 SAR MEASUREMENT VARIABILITY.....	34
15 MEASUREMENT UNCERTAINTY	36
15.1 MEASUREMENT UNCERTAINTY FOR NORMAL SAR TESTS.....	36
16 MAIN TEST INSTRUMENTS	37
ANNEX A GRAPH RESULTS.....	38
ANNEX B SYSTEM VERIFICATION RESULTS.....	155
ANNEX C SAR MEASUREMENT SETUP	162
C.1 MEASUREMENT SET-UP	162
C.2 DASY4 OR DASY5 E-FIELD PROBE SYSTEM	163
C.3 E-FIELD PROBE CALIBRATION	163
C.4 OTHER TEST EQUIPMENT.....	164
C.4.1 DATA ACQUISITION ELECTRONICS(DAE)	164
C.4.2 ROBOT.....	165
C.4.3 MEASUREMENT SERVER.....	165
C.4.4 DEVICE HOLDER FOR PHANTOM.....	166
C.4.5 PHANTOM.....	166
ANNEX D POSITION OF THE WIRELESS DEVICE IN RELATION TO THE PHANTOM.....	168
D.1 GENERAL CONSIDERATIONS.....	168
D.2 BODY-WORN DEVICE	169
D.3 DESKBOTTOM DEVICE	169
D.4 DUT SETUP PHOTOS.....	170
ANNEX E EQUIVALENT MEDIA RECIPES	171
ANNEX F SYSTEM VALIDATION	172
ANNEX G PROBE CALIBRATION CERTIFICATE.....	173
ANNEX H DIPOLE CALIBRATION CERTIFICATE.....	184

1 Test Laboratory

1.1 Testing Location

Company Name: TMC Shenzhen, Telecommunication Metrology Center of MIIT
Address: No. 12building, Shangsha Innovation and Technology Park, Futian District, Shenzhen, P. R. China
Postal Code: 518048
Telephone: +86-755-33322000
Fax: +86-755-33322001

1.2 Testing Environment

Temperature: 18°C~25 °C,
Relative humidity: 30%~ 70%
Ground system resistance: < 0.5 Ω
Ambient noise & Reflection: < 0.012 W/kg

1.3 Project Data

Project Leader: Zhou Yi
Test Engineer: Zhu Zhiqiang
Testing Start Date: February 06, 2013
Testing End Date: February 25, 2013

1.4 Signature



Zhu Zhiqiang

(Prepared this test report)

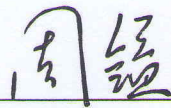

Zhou Yi

(Reviewed this test report)



Lu Minniu

Director of the laboratory
(Approved this test report)

2 Statement of Compliance

The maximum results of Specific Absorption Rate (SAR) found during testing for TCT Mobile Limited HSUPA/HSDPA/UMTS triband / GSM quadband mobile phone are as follows:

Table 2.1: Max. Reported SAR (1g)

Band	Position	Reported SAR 1g (W/Kg)
GSM 850	Head	1.000
	Body	1.403
GSM 1900	Head	0.610
	Body	1.395
WCDMA 850	Head	0.867
	Body	1.237
WCDMA 1900	Head	1.122
	Body	1.365
Wi-Fi	Head	0.220
	Body	0.106

All the tests are carried out with a micro SD card installed in the mobile phone and a fully charged battery.

The SAR values found for the Mobile Phone are below the maximum recommended levels of 1.6 W/Kg as averaged over any 1g tissue according to the ANSI C95.1-1999.

For body worn operation, this device has been tested and meets FCC RF exposure guidelines when used with any accessory that contains no metal and which provides a minimum separation distance of 10 mm between this device and the body of the user. Use of other accessories may not ensure compliance with FCC RF exposure guidelines.

It is determined by user manual for the distance between the EUT and the phantom bottom. The distance is 10mm and just applied to the condition of body worn accessory

The measurement together with the test system set-up is described in annex C of this test report. A detailed description of the equipment under test can be found in chapter 4 of this test report. The maximum reported SAR value is obtained at the case of **(Table 2.1)**, and the values are: **1.403 W/kg (1g)**.

Table 2.2: The sum of reported SAR values

	Position	GSM/WCDMA	WiFi	Sum
Maximum reported value for Head	Left hand, Touch cheek	1.122	0.146	1.268
	Right hand, Touch cheek	1.026	0.220	1.246
Maximum reported SAR value for Body	Toward Ground	1.403	0.106	1.509

According to the above table, the maximum sum of reported SAR values for GSM and WiFi is **1.509 W/kg (1g)**. The detail for simultaneous transmission consideration is described in chapter 13.

3 Client Information

3.1 Applicant Information

Company Name: TCT Mobile Limited
Address /Post: 12F/B, TCL Tower, Gaoxin Nanyi Road,Nanshan District,
Shenzhen,Guangdong, P.R. China
City: Shenzhen
Postal Code: 518000
Country: P.R.China
Contact: Lv Meixian
Email: meixian.lv@tcl.com
Telephone: 0086-755-33956929
Fax: 0086-755-36645072

3.2 Manufacturer Information

Company Name: TCT Mobile Limited
Address /Post: 12F/B, TCL Tower, Gaoxin Nanyi Road,Nanshan District,
Shenzhen,Guangdong, P.R. China
City: Shenzhen
Postal Code: 518000
Country: P.R.China
Contact: Lv Meixian
Email: meixian.lv@tcl.com
Telephone: 0086-755-33956929
Fax: 0086-755-36645072

4 Equipment Under Test (EUT) and Ancillary Equipment (AE)

4.1 About EUT

Description:	HSUPA/HSDPA/UMTS triband / GSM quadband mobile phone
Model name:	Megane 1SIM US
Marketing name:	ONE TOUCH 5020A
Operating mode(s):	GSM 850/1900,WCDMA 850/1900 , BT, WiFi
Tested Tx Frequency:	825 – 848.8 MHz (GSM 850)
	1850.2 – 1910 MHz (GSM 1900)
	826.4-846.6MHz(WCDMA 850)
	1852.4-1908MHz(WCDMA 1900)
	2412 – 2462 MHz (Wi-Fi)
Test Modulation	(GSM)GMSK; (WCDMA)QPSK
GPRS Multislot Class:	12
GPRS capability Class:	B
EGPRS Multislot Class:	12(downlink only)
Release version:	GSM: R99
	GPRS: R99
	UMTS: R6
	HSDPA: 8
	HSUPA: 6
Power class:	GSM850: tested with power level 5
	GSM1900: tested with power level 0
	WCDMA: class 3, tested with power control all up bits
Test device Production information:	Production unit
Device type:	Portable device
Antenna type:	Integrated antenna
Accessories/Body-worn configurations:	Headset
Hotspot mode:	Support simultaneous transmission of hotspot and 2/3G transmitter
Form factor:	12.1cm × 6.4 cm

4.2 Internal Identification of EUT used during the test

EUT ID*	SN or IMEI	HW Version	SW Version
EUT1	013511000150442	PIO	v2C56-0

*EUT ID: is used to identify the test sample in the lab internally.

Note: It is performed to test SAR and conducted power with the EUT1.

4.3 Internal Identification of AE used during the test

AE ID*	Description	Model	SN	Manufacturer
AE1	Battery	CAB60B0000C1	/	BYD
AE2	Battery	CAB60B0000C2	/	SCUD
AE3	Headset	CCB3160A15C1	/	Juwei
AE4	Headset	CCB3160A15C4	/	Meihao
AE5	Headset	CCB3160A11C1	/	Juwei
AE6	Headset	CCB3160A11C4	/	Meihao

*AE ID: is used to identify the test sample in the lab internally.

Note: AE3 and AE5 are the same, so they can use the same results. AE4 and AE6 are the same, so they can use the same results.

5 TEST METHODOLOGY

5.1 Applicable Limit Regulations

ANSI C95.1–1999: IEEE Standard for Safety Levels with Respect to Human Exposure to Radio Frequency Electromagnetic Fields, 3 kHz to 300 GHz.

It specifies the maximum exposure limit of **1.6 W/kg** as averaged over any 1 gram of tissue for portable devices being used within 20 cm of the user in the uncontrolled environment.

5.2 Applicable Measurement Standards

IEEE 1528–2003: Recommended Practice for Determining the Peak Spatial-Average Specific Absorption Rate (SAR) in the Human Body Due to Wireless Communications Devices: Experimental Techniques.

OET Bulletin 65 (Edition 97-01) and Supplement C(Edition 01-01): Additional Information for Evaluating Compliance of Mobile and Portable Devices with FCC Limits.

KDB447498 D01: General RF Exposure Guidance v05: Mobile and Portable Devices RF Exposure Procedures and Equipment Authorization Policies.

KDB648474 D04 SAR Handsets Multi Xmitter and Ant v01: SAR Evaluation Considerations for Wireless Handsets.

865664 D01 SAR measurement 100 MHz to 6 GHz v01: SAR Measurement Requirements for 100 MHz to 6 GHz

KDB248227 D01: SAR Measurement Procedures for 802.11a/b/g transmitters.

KDB941225 D06: SAR Evaluation Procedures for Portable Devices with Wireless Router Capabilities.

KDB941225 D01: SAR Measurement Procedures for 3G Devices.

865664 D02 SAR Reporting v01: RF Exposure Compliance Reporting and Documentation Considerations

6 Specific Absorption Rate (SAR)

6.1 Introduction

SAR is related to the rate at which energy is absorbed per unit mass in an object exposed to a radio field. The SAR distribution in a biological body is complicated and is usually carried out by experimental techniques or numerical modeling. The standard recommends limits for two tiers of groups, occupational/controlled and general population/uncontrolled, based on a person's awareness and ability to exercise control over his or her exposure. In general, occupational/controlled exposure limits are higher than the limits for general population/uncontrolled.

6.2 SAR Definition

The SAR definition is the time derivative (rate) of the incremental energy (dW) absorbed by (dissipated in) an incremental mass (dm) contained in a volume element (dv) of a given density (ρ). The equation description is as below:

$$SAR = \frac{d}{dt} \left(\frac{dW}{dm} \right) = \frac{d}{dt} \left(\frac{dW}{\rho dv} \right)$$

SAR is expressed in units of Watts per kilogram (W/kg)

SAR measurement can be either related to the temperature elevation in tissue by

$$SAR = c \left(\frac{\delta T}{\delta t} \right)$$

Where: C is the specific heat capacity, δT is the temperature rise and δt is the exposure duration, or related to the electrical field in the tissue by

$$SAR = \frac{\sigma |E|^2}{\rho}$$

Where: σ is the conductivity of the tissue, ρ is the mass density of tissue and E is the RMS electrical field strength.

However for evaluating SAR of low power transmitter, electrical field measurement is typically applied.

7 Tissue Simulating Liquids

7.1 Targets for tissue simulating liquid

Table 7.1: Targets for tissue simulating liquid

Frequency (MHz)	Liquid Type	Conductivity (σ)	$\pm 5\%$ Range	Permittivity (ϵ)	$\pm 5\%$ Range
835	Head	0.90	0.86~0.95	41.5	39.4~43.6
835	Body	0.97	0.92~1.02	55.2	52.4~58.0
1900	Head	1.40	1.33~1.47	40.0	38.0~42.0
1900	Body	1.52	1.44~1.60	53.3	50.6~56.0
2450	Head	1.80	1.71~1.89	39.2	37.2~41.2
2450	Body	1.95	1.85~2.05	52.7	50.1~55.3

7.2 Dielectric Performance

Table 7.2: Dielectric Performance of Tissue Simulating Liquid

Measurement Date (yyyy-mm-dd)	Type	Frequency	Permittivity ϵ	Drift	Conductivity σ (S/m)	Drift
2013-02-21	Head	835 MHz	41.53	0.07%	0.89	-0.11%
2013-02-06	Body	835 MHz	53.88	-2.39%	0.97	0%
2013-02-20	Body	835 MHz	53.92	-2.32%	0.97	0%
2013-02-22	Head	1900 MHz	39.18	-2.05%	1.44	2.86%
2013-02-19	Body	1900 MHz	52.38	-1.73%	1.57	3.29%
2013-02-26	Head	2450 MHz	40.09	4.34%	1.86	3.33%
2013-02-20	Body	2450 MHz	52.24	-0.87%	1.94	-0.51%

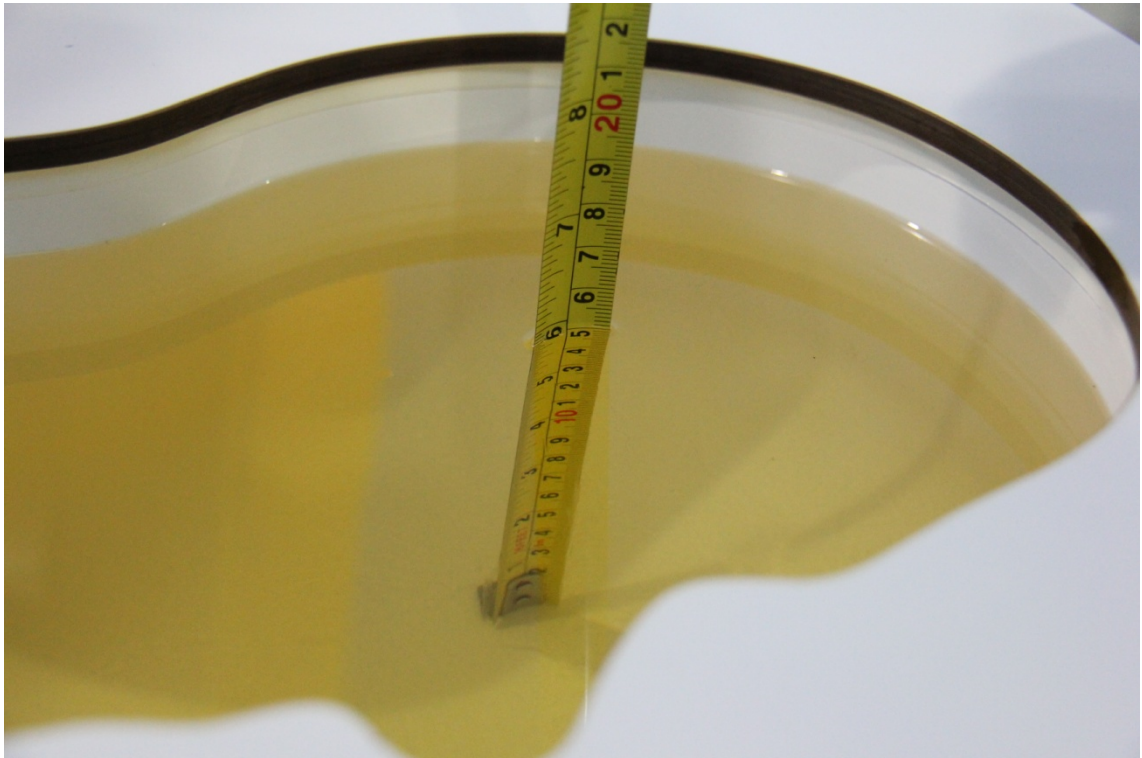

Picture 7-1: Liquid depth in the Head Phantom (835 MHz)



Picture 7-2: Liquid depth in the Flat Phantom (835 MHz)

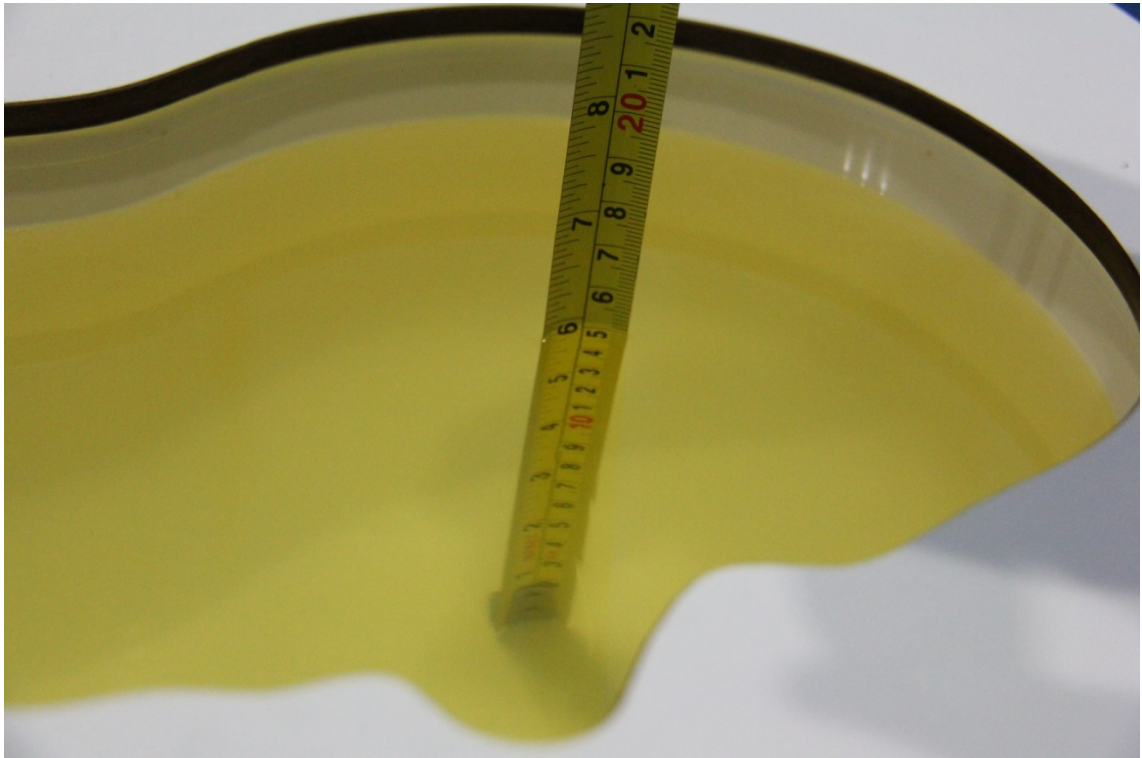

Picture 7-3: Liquid depth in the Head Phantom (1900 MHz)

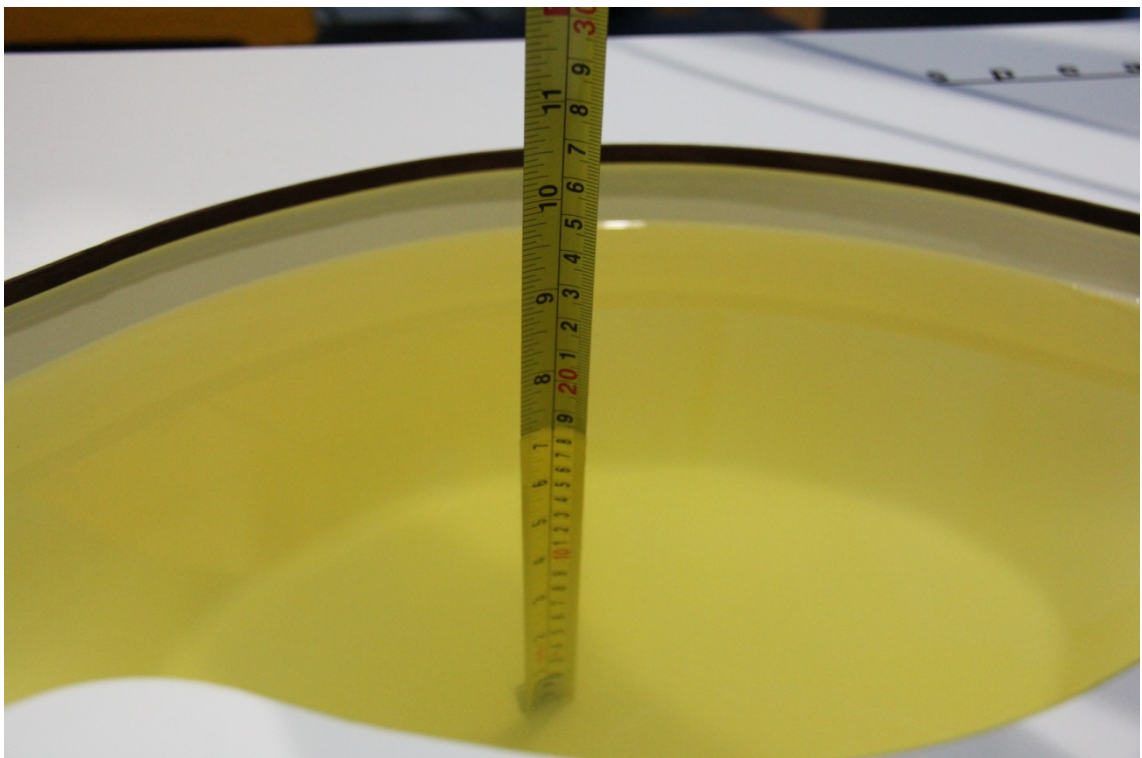

Picture 7-4 Liquid depth in the Flat Phantom (1900MHz)



Picture 7-5 Liquid depth in the Head Phantom (2450MHz)



Picture 7-6 Liquid depth in the Flat Phantom (2450MHz)

8 System verification

8.1 System Setup

In the simplified setup for system evaluation, the DUT is replaced by a calibrated dipole and the power source is replaced by a continuous wave that comes from a signal generator. The calibrated dipole must be placed beneath the flat phantom section of the SAM twin phantom with the correct distance holder. The distance holder should touch the phantom surface with a light pressure at the reference marking and be oriented parallel to the long side of the phantom. The equipment setup is shown below:

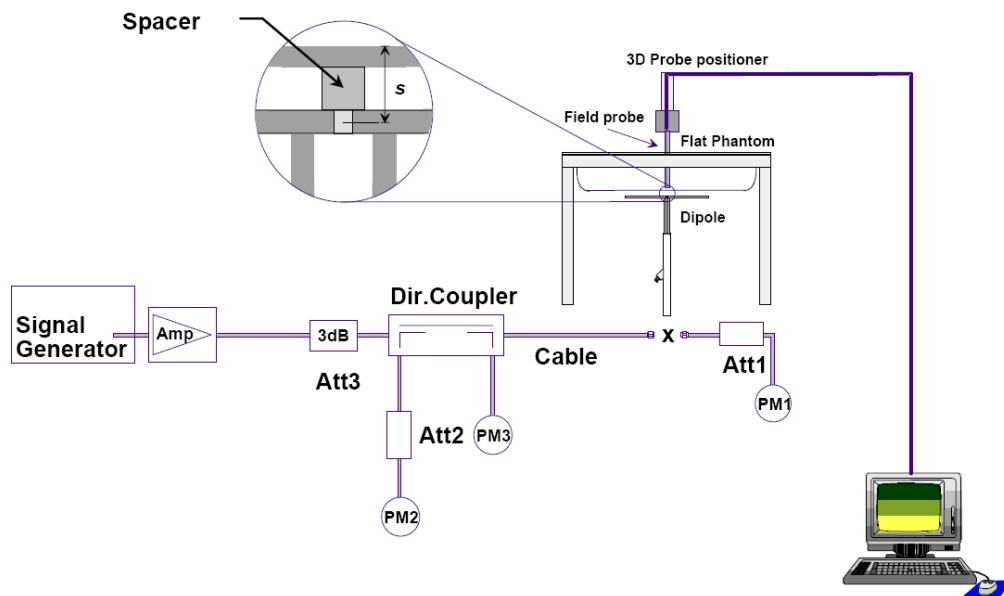

Picture 8.1 System Setup for System Evaluation



Picture 8.2 Photo of Dipole Setup

8.2 System Verification

SAR system verification is required to confirm measurement accuracy, according to the tissue dielectric media, probe calibration points and other system operating parameters required for measuring the SAR of a test device. The system verification must be performed for each frequency band and within the valid range of each probe calibration point required for testing the device.

The system verification results are required that the area scan estimated 1-g SAR is within 3% of the zoom scan 1-g SAR. The details are presented in annex B.

Table 8.1: System Verification of Head

Measurement Date (yyyy-mm-dd)	Frequency	Target value (W/kg)		Measured value (W/kg)		Deviation	
		10 g Average	1 g Average	10 g Average	1 g Average	10 g Average	1 g Average
2013-02-21	835 MHz	1.60	2.44	1.58	2.41	-1.25%	-1.23%
2013-02-22	1900 MHz	5.19	9.86	5.32	10.3	2.50%	4.46%
2013-02-25	2450 MHz	6.14	13.20	6.39	13.5	4.07%	2.27%

Table 8.2: System Verification of Body

Measurement Date (yyyy-mm-dd)	Frequency	Target value (W/kg)		Measured value (W/kg)		Deviation	
		10 g Average	1 g Average	10 g Average	1 g Average	10 g Average	1 g Average
2013-02-06	835 MHz	1.59	2.43	1.62	2.46	1.89%	1.23%
2013-02-20	835 MHz	1.59	2.43	1.65	2.54	3.77%	4.52%
2013-02-19	1900 MHz	5.40	10.20	5.66	10.50	4.81%	2.94%
2013-02-20	2450 MHz	6.01	13.00	6.13	13.60	2.00%	4.62%

9 Measurement Procedures

9.1 Tests to be performed

In order to determine the highest value of the peak spatial-average SAR of a handset, all device positions, configurations and operational modes shall be tested for each frequency band according to steps 1 to 3 below. A flowchart of the test process is shown in Picture 11.1.

Step 1: The tests described in 11.2 shall be performed at the channel that is closest to the centre of the transmit frequency band (f_c) for:

- a) all device positions (cheek and tilt, for both left and right sides of the SAM phantom, as described in Chapter 8),
- b) all configurations for each device position in a), e.g., antenna extended and retracted, and
- c) all operational modes, e.g., analogue and digital, for each device position in a) and configuration in b) in each frequency band.

If more than three frequencies need to be tested according to 11.1 (i.e., $N_c > 3$), then all frequencies, configurations and modes shall be tested for all of the above test conditions.

Step 2: For the condition providing highest peak spatial-average SAR determined in Step 1, perform all tests described in 11.2 at all other test frequencies, i.e., lowest and highest frequencies. In addition, for all other conditions (device position, configuration and operational mode) where the peak spatial-average SAR value determined in Step 1 is within 3 dB of the applicable SAR limit, it is recommended that all other test frequencies shall be tested as well.

Step 3: Examine all data to determine the highest value of the peak spatial-average SAR found in Steps 1 to 2.

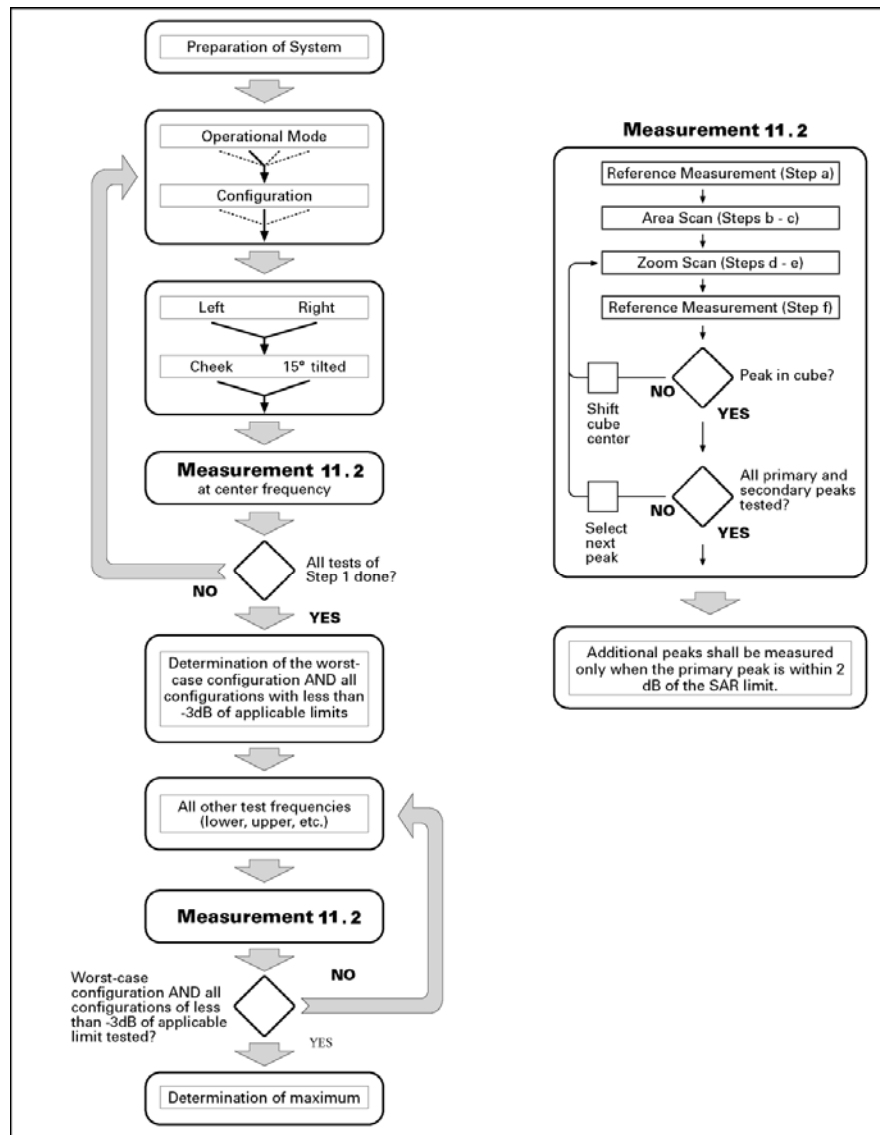

Picture 9.1 Block diagram of the tests to be performed

9.2 General Measurement Procedure

The area and zoom scan resolutions specified in the table below must be applied to the SAR measurements and fully documented in SAR reports to qualify for TCB approval. Probe boundary effect error compensation is required for measurements with the probe tip closer than half a probe tip diameter to the phantom surface. Both the probe tip diameter and sensor offset distance must satisfy measurement protocols; to ensure probe boundary effect errors are minimized and the higher fields closest to the phantom surface can be correctly measured and extrapolated to the phantom surface for computing 1-g SAR. Tolerances of the post-processing algorithms must be verified by the test laboratory for the scan resolutions used in the SAR measurements, according to the reference distribution functions specified in IEEE Std 1528-2003. The results should be documented as part of the system validation records and may be requested to support test results when all the measurement parameters in the following table are not satisfied.

		≤ 3 GHz	> 3 GHz
Maximum distance from closest measurement point (geometric center of probe sensors) to phantom surface		5 ± 1 mm	$\frac{1}{2} \cdot \delta \cdot \ln(2) \pm 0.5$ mm
Maximum probe angle from probe axis to phantom surface normal at the measurement location		$30^\circ \pm 1^\circ$	$20^\circ \pm 1^\circ$
Maximum area scan spatial resolution: $\Delta x_{Area}, \Delta y_{Area}$		≤ 2 GHz: ≤ 15 mm 2 – 3 GHz: ≤ 12 mm	3 – 4 GHz: ≤ 12 mm 4 – 6 GHz: ≤ 10 mm
		When the x or y dimension of the test device, in the measurement plane orientation, is smaller than the above, the measurement resolution must be \leq the corresponding x or y dimension of the test device with at least one measurement point on the test device.	
Maximum zoom scan spatial resolution: $\Delta x_{Zoom}, \Delta y_{Zoom}$		≤ 2 GHz: ≤ 8 mm 2 – 3 GHz: ≤ 5 mm*	3 – 4 GHz: ≤ 5 mm* 4 – 6 GHz: ≤ 4 mm*
Maximum zoom scan spatial resolution, normal to phantom surface	uniform grid: $\Delta z_{Zoom}(n)$	≤ 5 mm	3 – 4 GHz: ≤ 4 mm 4 – 5 GHz: ≤ 3 mm 5 – 6 GHz: ≤ 2 mm
	graded grid	$\Delta z_{Zoom}(1)$: between 1 st two points closest to phantom surface	≤ 4 mm
		$\Delta z_{Zoom}(n>1)$: between subsequent points	$\leq 1.5 \cdot \Delta z_{Zoom}(n-1)$
Minimum zoom scan volume	x, y, z	≥ 30 mm	3 – 4 GHz: ≥ 28 mm 4 – 5 GHz: ≥ 25 mm 5 – 6 GHz: ≥ 22 mm
Note: δ is the penetration depth of a plane-wave at normal incidence to the tissue medium; see draft standard IEEE P1528-2011 for details. * When zoom scan is required and the <i>reported</i> SAR from the area scan based <i>1-g SAR estimation</i> procedures of KDB 447498 is ≤ 1.4 W/kg, ≤ 8 mm, ≤ 7 mm and ≤ 5 mm zoom scan resolution may be applied, respectively, for 2 GHz to 3 GHz, 3 GHz to 4 GHz and 4 GHz to 6 GHz.			

9.3 Bluetooth & Wi-Fi Measurement Procedures for SAR

Normal network operating configurations are not suitable for measuring the SAR of 802.11 transmitters in general. Unpredictable fluctuations in network traffic and antenna diversity conditions can introduce undesirable variations in SAR results. The SAR for these devices should be measured using chipset based test mode software to ensure that the results are consistent and reliable.

Chipset based test mode software is hardware dependent and generally varies among manufacturers. The device operating parameters established in a test mode for SAR measurements must be identical to those programmed in production units, including output power levels, amplifier gain settings and other RF performance tuning parameters. The test frequencies should correspond to actual channel frequencies defined for domestic use. SAR for devices with switched diversity should be measured with only one antenna transmitting at a time during each SAR measurement, according to a fixed modulation and data rate. The same data pattern should be used for all measurements.

9.4 Power Drift

To control the output power stability during the SAR test, DASY5 system calculates the power drift by measuring the E-field at the same location at the beginning and at the end of the measurement for each test position. These drift values can be found in Table 14.1 to Table 14.11 labeled as: (Power Drift [dB]). This ensures that the power drift during one measurement is within 5%.

10 Conducted Output Power

10.1 Manufacturing tolerance

Table 10.1: GSM Speech

GSM 850			
Channel	Channel 251	Channel 190	Channel 128
Target (dBm)	32	32	32
Tolerance \pm (dB)	1	1	1
GSM 1900			
Channel	Channel 810	Channel 661	Channel 512
Target (dBm)	29	29	29
Tolerance \pm (dB)	1	1	1

Table 10.2: GPRS (GMSK Modulation)

GSM 850 GPRS				
Channel		251	190	128
1 Txslot	Target (dBm)	32	32	32
	Tolerance \pm (dB)	1	1	1
2 Txslots	Target (dBm)	29.5	29.5	29.5
	Tolerance \pm (dB)	1	1	1
3Txslots	Target (dBm)	27.5	27.5	27.5
	Tolerance \pm (dB)	1	1	1
4 Txslots	Target (dBm)	27	27	27
	Tolerance \pm (dB)	1	1	1
GSM 850 EGPRS				
Channel		251	190	128
1 Txslot	Target (dBm)	32	32	32
	Tolerance \pm (dB)	1	1	1
2 Txslots	Target (dBm)	29.5	29.5	29.5
	Tolerance \pm (dB)	1	1	1
3Txslots	Target (dBm)	27.5	27.5	27.5
	Tolerance \pm (dB)	1	1	1
4 Txslots	Target (dBm)	27	27	27
	Tolerance \pm (dB)	1	1	1
GSM 1900 GPRS				
Channel		810	661	512

1 Txslot	Target (dBm)	29	29	29
	Tolerance \pm (dB)	1	1	1
2 Txslots	Target (dBm)	27	27	27
	Tolerance \pm (dB)	1	1	1
3Txslots	Target (dBm)	25.5	25.5	25.5
	Tolerance \pm (dB)	1	1	1
4 Txslots	Target (dBm)	25	25	25
	Tolerance \pm (dB)	1	1	1
GSM 1900 EGPRS				
Channel		810	661	512
1 Txslot	Target (dBm)	30.0	30.0	30.0
	Tolerance \pm (dB)	1	1	1
2 Txslots	Target (dBm)	27	27	27
	Tolerance \pm (dB)	1	1	1
3Txslots	Target (dBm)	25.5	25.5	25.5
	Tolerance \pm (dB)	1	1	1
4 Txslots	Target (dBm)	25	25	25
	Tolerance \pm (dB)	1	1	1

Table 10.3: WCDMA

WCDMA 850 CS			
Channel	Channel 4132	Channel 4182	Channel 4233
Target (dBm)	22.5	22.5	22.5
Tolerance \pm (dB)	1	1	1
WCDMA 1900 CS			
Channel	Channel 9262	Channel 9400	Channel 9538
Target (dBm)	22.5	22.5	22.5
Tolerance \pm (dB)	1	1	1

Table 10.4: WiFi

WiFi 802.11b			
Channel	Channel 1	Channel 6	Channel 11
Target (dBm)	12.5	12.5	12.5
Tolerance \pm (dB)	1	1	1
WiFi 802.11g			
Channel	Channel 1	Channel 6	Channel 11
Target (dBm)	12.5	12.5	12.5
Tolerance \pm (dB)	1	1	1
WiFi 802.11n			
Channel	Channel 1	Channel 6	Channel 11
Target (dBm)	12.5	12.5	12.5
Tolerance \pm (dB)	1	1	1

10.2 GSM Measurement result

During the process of testing, the EUT was controlled via Agilent Digital Radio Communication tester (E5515C) to ensure the maximum power transmission and proper modulation. This result contains conducted output power for the EUT. In all cases, the measured peak output power should be greater and within 5% than EMI measurement.

Table 10.5: The conducted power measurement results for GSM850/1900

GSM 850MHZ	Conducted Power (dBm)		
	Channel 251(848.8MHz)	Channel 190(836.6MHz)	Channel 128(824.2MHz)
	32.59	32.57	32.45
GSM 1900MHZ	Conducted Power (dBm)		
	Channel 810(1909.8MHz)	Channel 661(1880MHz)	Channel 512(1850.2MHz)
	29.40	29.32	29.24

Table 10.6: The conducted power measurement results for GPRS and EGPRS

GSM 850 GPRS (GMSK)	Measured Power (dBm)			calculation	Averaged Power (dBm)		
	251	190	128		251	190	128
1 Txslot	32.59	32.57	32.44	-9.03dB	23.56	23.54	23.41
2 Txslots	29.45	29.40	29.28	-6.02dB	23.43	23.38	23.26
3Txslots	27.56	27.50	27.35	-4.26dB	23.3	23.24	23.09
4 Txslots	27.55	27.50	27.32	-3.01dB	24.54	24.49	24.31
GSM 850 EGPRS (GMSK)	Measured Power (dBm)			calculation	Averaged Power (dBm)		
	251	190	128		251	190	128
1 Txslot	32.58	32.55	32.41	-9.03dB	23.55	23.52	23.38
2 Txslots	29.44	29.38	29.25	-6.02dB	23.42	23.36	23.23
3Txslots	27.52	27.44	27.32	-4.26dB	23.26	23.18	23.06
4 Txslots	27.51	27.48	27.30	-3.01dB	24.5	24.47	24.29
PCS1900 GPRS (GMSK)	Measured Power (dBm)			calculation	Averaged Power (dBm)		
	810	661	512		810	661	512
1 Txslot	29.36	29.29	29.22	-9.03dB	20.33	20.26	20.19
2 Txslots	27.17	27.10	27.08	-6.02dB	21.15	21.08	21.06
3Txslots	25.50	25.44	25.42	-4.26dB	21.24	21.18	21.16
4 Txslots	24.54	24.48	24.48	-3.01dB	21.53	21.47	21.47
PCS1900 EGPRS (GMSK)	Measured Power (dBm)			calculation	Averaged Power (dBm)		
	810	661	512		810	661	512
1 Txslot	29.30	29.26	29.21	-9.03dB	20.27	20.23	20.18
2 Txslots	27.16	27.10	27.07	-6.02dB	21.14	21.08	21.05
3Txslots	25.48	25.41	25.40	-4.26dB	21.22	21.15	21.14
4 Txslots	24.53	24.44	24.46	-3.01dB	21.52	21.43	21.45

NOTES:

1) Division Factors

To average the power, the division factor is as follows:

1TX-slot = 1 transmit time slot out of 8 time slots=> conducted power divided by (8/1) => -9.03dB

2TX-slots = 2 transmit time slots out of 8 time slots=> conducted power divided by (8/2) => -6.02dB

3TX-slots = 3 transmit time slots out of 8 time slots=> conducted power divided by (8/3) => -4.26dB

4TX-slots = 4 transmit time slots out of 8 time slots=> conducted power divided by (8/4) => -3.01dB

According to the conducted power as above, the body measurements are performed with 4Txslots for GSM850 and GSM1900.

Note: According to the KDB941225 D03, “when SAR tests for EDGE or EGPRS mode is necessary, GMSK modulation should be used”.

10.3 WCDMA conducted power Measurement result

Table 10.7: The conducted power measurement results for WCDMA

Item	band	FDDII result			FDDV result		
	ARFCN	4132	4183	4233	9262	9400	9538
5.2(WCDMA)	\	22.83	23.24	23.00	22.62	22.90	22.83
5.2AA (HSDPA)	1	22.20	22.63	22.46	22.12	22.33	22.31
	2	21.37	21.78	21.52	21.32	21.41	21.44
	3	20.88	21.02	20.95	20.81	20.96	20.95
	4	20.23	20.46	20.32	20.19	20.32	20.28
5.2B (HSUPA)	1	22.19	22.55	22.42	22.13	22.31	22.26
	2	22.16	22.52	22.48	22.23	22.33	22.31
	3	21.86	22.21	22.16	21.96	22.03	21.96
	4	21.12	21.53	21.63	21.52	21.21	21.33
	5	21.32	21.64	21.78	21.65	21.35	21.46

Note: HSUPA body SAR are not required, because maximum average output power of each RF channel with HSDPA active is not 1/4 dB higher than that measured without HSUPA and the maximum SAR for WCDMA850 and WCDMA1900 are not above 75% of the SAR limit.

10.3 Wi-Fi and BT Measurement result

The output power of BT antenna is as following:

Modulation/Channel	Ch 0 (2402 MHz)	Ch 39 (2441 MHz)	Ch 78 (2480 MHz)
GFSK	6.68	8.19	8.61
EDR2M-4_DQPSK	6.58	8.06	8.48
EDR3M-8DPSK	6.82	8.30	8.73

The average conducted power for Wi-Fi is as following:

802.11b (dBm)

Channel\data rate	1Mbps	2Mbps	5.5Mbps	11Mbps
1	12.96	12.92	13.01	12.90
6	13.35	13.36	13.36	13.34
11	13.14	13.17	13.22	13.18

802.11g (dBm)

Channel\data rate	6Mbps	9Mbps	12Mbps	18Mbps	24Mbps	36Mbps	48Mbps	54Mbps
1	12.60	12.43	12.58	12.46	12.30	12.34	12.35	12.13
6	13.04	13.01	12.81	12.91	12.71	12.70	12.74	12.69
11	12.93	12.82	12.83	12.90	12.76	12.73	12.79	12.52

20M 802.11n (dBm)

Channel\data rate	MCS0	MCS1	MCS2	MCS3	MCS4	MCS5	MCS6	MCS7
1	12.59	12.50	12.59	12.38	12.21	12.39	12.15	10.46
6	13.02	12.77	12.87	12.85	12.85	12.64	12.64	10.78
11	12.86	12.76	12.85	12.83	12.60	12.82	12.57	10.77

40M 802.11n (dBm)

Channel\data rate	MCS0	MCS1	MCS2	MCS3	MCS4	MCS5	MCS6	MCS7
1	12.68	12.64	12.60	12.32	12.35	12.30	12.37	10.39
6	12.74	12.59	12.56	12.51	12.54	12.51	12.56	10.50
11	12.65	12.67	12.64	12.61	12.60	12.34	12.36	10.52

SAR is not required for 802.11g/n channels if the output power is less than 0.25dB higher than that measured on the corresponding 802.11b channels, and for each frequency band, testing at higher data rates and higher order modulations is not required when the maximum average output power for each of these configurations is less than 0.25dB higher than those measured at the lowest data rate. According to the above conducted power, the EUT should be tested for “802.11b, 1Mbps, channel 6”.

11 Simultaneous TX SAR Considerations

11.1 Introduction

The following procedures adopted from “FCC SAR Considerations for Cell Phones with Multiple Transmitters” are applicable to handsets with built-in unlicensed transmitters such as 802.11 a/b/g and Bluetooth devices which may simultaneously transmit with the licensed transmitter.

For this device, the BT and Wi-Fi can transmit simultaneous with other transmitters.

11.2 Transmit Antenna Separation Distances

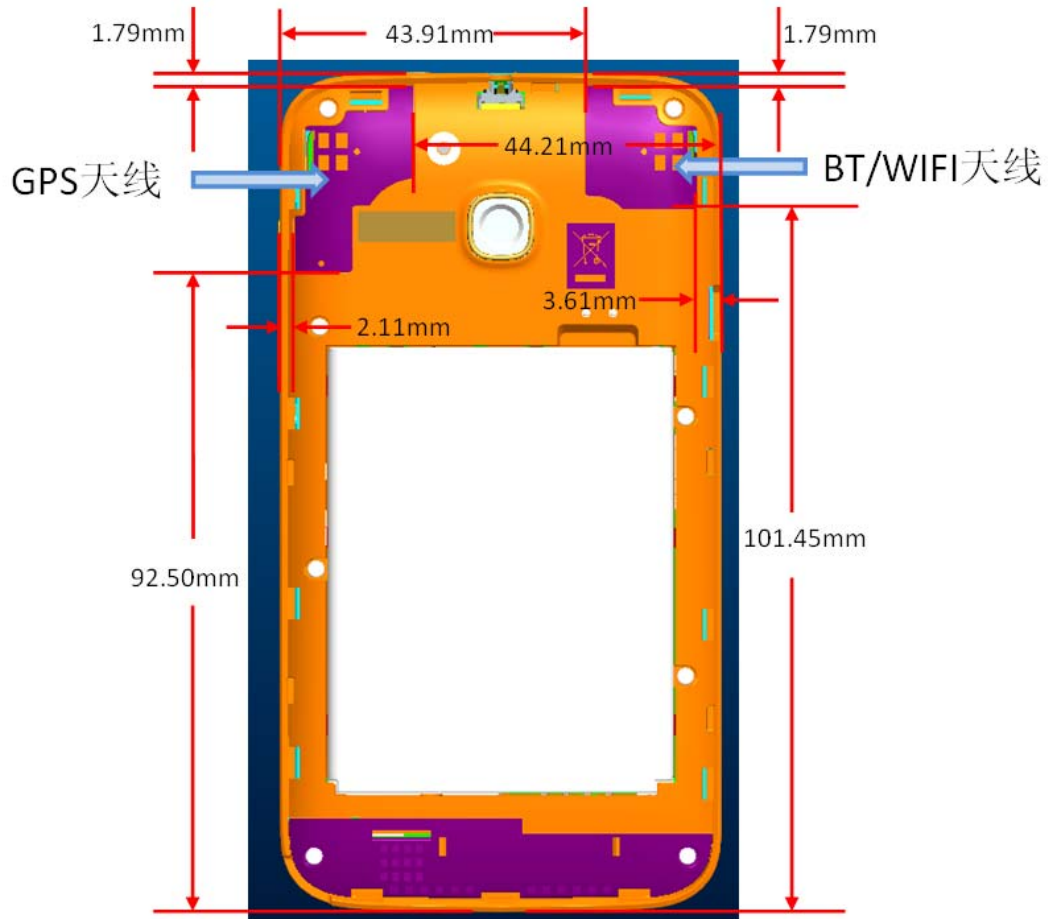

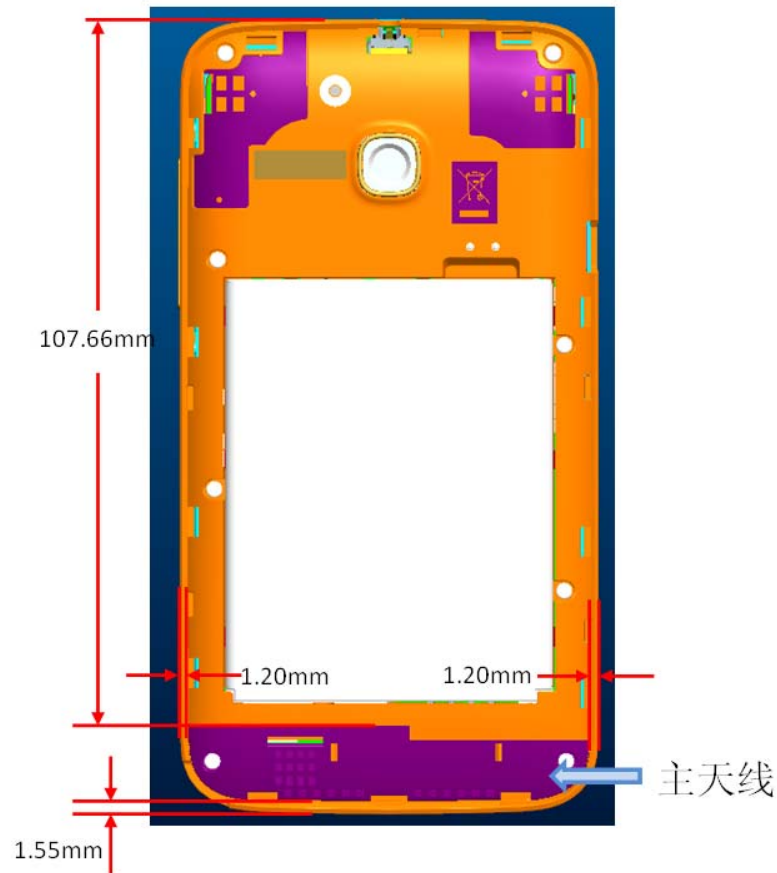

Picture 11.1 Antenna Locations

11.3 Standalone SAR Test Exclusion Considerations

Standalone 1-g head or body SAR evaluation by measurement or numerical simulation is not required when the corresponding SAR Exclusion Threshold condition, listed below, is satisfied. The 1-g SAR test exclusion threshold for 100 MHz to 6 GHz at test separation distances ≤ 50 mm are determined by:

$$\left[\frac{\text{(max. power of channel, including tune-up tolerance, mW)}}{\text{(min. test separation distance, mm)}} \right] \cdot \sqrt{f(\text{GHz})} \leq 3.0$$
 for 1-g SAR, where

- f(GHz) is the RF channel transmit frequency in GHz
- Power and distance are rounded to the nearest mW and mm before calculation
- The result is rounded to one decimal place for comparison

According to the KDB447498 appendix A, the SAR test exclusion threshold for 2450MHz at 10m test separation distances is 19mW.

Appendix A

SAR Test Exclusion Thresholds for 100 MHz – 6 GHz and ≤ 50 mm

Approximate SAR Test Exclusion Power Thresholds at Selected Frequencies and Test Separation Distances are illustrated in the following Table.

MHz	5	10	15	20	25	mm
150	39	77	116	155	194	SAR Test Exclusion Threshold (mW)
300	27	55	82	110	137	
450	22	45	67	89	112	
835	16	33	49	66	82	
900	16	32	47	63	79	
1500	12	24	37	49	61	
1900	11	22	33	44	54	
2450	10	19	29	38	48	
3600	8	16	24	32	40	
5200	7	13	20	26	33	
5400	6	13	19	26	32	
5800	6	12	19	25	31	

Picture 11.2 Power Thresholds

12 Evaluation of Simultaneous

Table 13.1: Summary of Transmitters

Band/Mode	F(GHz)	SAR test exclusion threshold (mW)	RF output power (mW)
Bluetooth	2.441	19	7.46
2.4GHz WLAN 802.11 b	2.45	19	21.68

According to the conducted power measurement result, we can draw the conclusion that: stand-alone SAR for WiFi should be performed. Then, simultaneous transmission SAR for WiFi is considered with measurement results of GSM and WiFi. Stand-alone SAR and simultaneous transmission SAR for Bluetooth should not be performed.

Table 13.2: The sum of reported SAR values

	Position	GSM/WCDMA	WiFi	Sum
Maximum reported value for Head	Left hand, Touch cheek	1.122	0.146	1.268
	Right hand, Touch cheek	1.026	0.220	1.246
Maximum reported SAR value for Body	Toward Ground	1.403	0.106	1.509

According to the above table, the sum of reported SAR values for GSM and WiFi < 1.6W/kg. So the simultaneous transmission SAR is not required for WiFi transmitter.

13 SAR Test Result

It is determined by user manual for the distance between the EUT and the phantom bottom.

The distance is 10mm and just applied to the condition of body worn accessory.

It is performed for all SAR measurements with area scan and zoom scan based 1-g SAR estimation.

In this report, measured SAR results are scaled to the maximum tune-up tolerance limit according the power applied to the individual channels, and the results are shown in the column “reported SAR”.

13.1 The evaluation of multi-batteries

We'll perform the head measurement in all bands with the primary battery depending on the evaluation of multi-batteries and retest on highest value point with other batteries. Then, repeat the measurement in the Body test.

Table 13.1: The evaluation of multi-batteries for Head Test

Frequency		Side	Test Position	Battery Type	SAR(1g)	Power Drift(dB)
MHz	Ch.				(W/kg)	
836.6	190	Left	Touch	CAB60B0000C1	0.910	0.06
836.6	190	Left	Touch	CAB60B0000C2	0.715	-0.11

Note: According to the values in the above table, the battery, CAB60B0000C1, is the primary battery. We'll perform the head measurement with this battery and retest on highest value point with others.

Table 13.2: The evaluation of multi-batteries for Body Test

Frequency		Test Position	Spacing (mm)	Battery Type	SAR(1g)	Power Drift(dB)
MHz	Ch.				(W/kg)	
826.4	4132	Ground	10	CAB60B0000C1	1.06	0.01
826.4	4132	Ground	10	CAB60B0000C2	1.04	-0.01

Note: According to the values in the above table, the battery, CAB60B0000C1, is the primary battery. We'll perform the Body measurement with this battery and retest on highest value point with others.

13.2 SAR Test Result

Table 13.3: Duty Cycle

	Duty Cycle
Speech for GSM850/1900	1:8.3
GPRS for GSM850/1900	1:2
WCDMA 850/1900	1:1
WiFi 2450	1:1

Table 13.4: SAR Values (GSM 850 MHz Band - Head) with battery CAB60B0000C1

Frequency		Side	Test Position	Conducted Power (dBm)	Measured SAR(10g) (W/kg)	Reported SAR(10g) (W/kg)	Measured SAR(1g) (W/kg)	Reported SAR(1g) (W/kg)	Power Drift (dB)
MHz	Ch.								
848.8	251	Left	Touch	32.59	0.690	0.758	0.910	1.000	0.06
836.6	190	Left	Touch	32.57	0.575	0.635	0.757	0.836	0.12
824.2	128	Left	Touch	32.45	0.408	0.463	0.535	0.607	-0.12
848.8	251	Left	Tilt	32.59	0.332	0.365	0.430	0.473	-0.16
836.6	190	Left	Tilt	32.57	0.274	0.303	0.349	0.385	-0.03
824.2	128	Left	Tilt	32.45	0.218	0.247	0.278	0.316	0.06
848.8	251	Right	Touch	32.59	0.582	0.640	0.765	0.841	0
836.6	190	Right	Touch	32.57	0.476	0.526	0.626	0.691	-0.04
824.2	128	Right	Touch	32.45	0.344	0.390	0.448	0.508	0.06
848.8	251	Right	Tilt	32.59	0.346	0.380	0.452	0.497	-0.04
836.6	190	Right	Tilt	32.57	0.297	0.328	0.385	0.425	0.01
824.2	128	Right	Tilt	32.45	0.227	0.258	0.292	0.331	0

Table 13.5: SAR Values (GSM 850 MHz Band - Body) with battery CAB60B0000C1

Frequency		Mode (number of timeslots)	Test Position	Conducted Power (dBm)	Measured SAR(10g) (W/kg)	Reported SAR(10g) (W/kg)	Measured SAR(1g) (W/kg)	Reported SAR(1g) (W/kg)	Power Drift (dB)
MHz	Ch.								
836.6	190	GPRS (4)	Phantom	27.50	0.765	0.858	1.01	1.133	-0.04
848.8	251	GPRS (4)	Ground	27.55	0.845	0.937	1.14	1.264	-0.07
836.6	190	GPRS (4)	Ground	27.50	0.925	1.038	1.25	1.403	-0.05
824.2	128	GPRS (4)	Ground	27.32	0.886	1.036	1.2	1.403	0.03
848.8	251	GPRS (4)	Left	27.55	0.599	0.664	0.864	0.958	-0.02
836.6	190	GPRS (4)	Left	27.50	0.570	0.640	0.818	0.918	-0.19
824.2	128	GPRS (4)	Left	27.32	0.547	0.640	0.784	0.917	0.03
848.8	251	GPRS (4)	Right	27.55	0.614	0.681	0.892	0.989	-0.01
836.6	190	GPRS (4)	Right	27.50	0.591	0.663	0.856	0.960	-0.06
824.2	128	GPRS (4)	Right	27.32	0.477	0.558	0.690	0.807	0
836.6	190	GPRS (4)	bottom	27.50	0.084	0.094	0.146	0.164	0.10
836.6	190	Speech	Ground (AE3)	27.50	0.634	0.711	0.854	0.958	0.04
836.6	190	Speech	Ground (AE4)	27.50	0.729	0.818	0.976	1.095	-0.02
836.6	190	EGPRS(4)	Ground	27.48	0.881	0.993	1.18	1.330	0

Note: The distance between the EUT and the phantom bottom is 10mm.

Table 13.6: SAR Values (GSM 1900 MHz Band - Head) with battery CAB60B0000C1

Frequency		Side	Test Position	Conducted Power (dBm)	Measured SAR(10g) (W/kg)	Reported SAR(10g) (W/kg)	Measured SAR(1g) (W/kg)	Reported SAR(1g) (W/kg)	Power Drift (dB)
MHz	Ch.								
1909.8	810	Left	Touch	29.40	0.238	0.273	0.403	0.463	-0.07
1880	661	Left	Touch	29.32	0.257	0.301	0.424	0.496	0.04
1850.2	512	Left	Touch	29.24	0.309	0.368	0.512	0.610	-0.05
1909.8	810	Left	Tilt	29.40	0.081	0.093	0.143	0.164	0.04
1880	661	Left	Tilt	29.32	0.069	0.081	0.123	0.144	0.01
1850.2	512	Left	Tilt	29.24	0.075	0.089	0.134	0.160	0.19
1909.8	810	Right	Touch	29.40	0.230	0.264	0.399	0.458	0.13
1880	661	Right	Touch	29.32	0.236	0.276	0.404	0.472	0.03
1850.2	512	Right	Touch	29.24	0.250	0.298	0.421	0.502	0.06
1909.8	810	Right	Tilt	29.40	0.080	0.092	0.140	0.161	0.03
1880	661	Right	Tilt	29.32	0.074	0.087	0.125	0.146	0.04
1850.2	512	Right	Tilt	29.24	0.083	0.099	0.135	0.161	0

Table 13.7: SAR Values (GSM 1900 MHz Band - Body) with battery CAB60B0000C1

Frequency		Mode (number of timeslots)	Test Position	Conducted Power (dBm)	Measured SAR(10g) (W/kg)	Reported SAR(10g) (W/kg)	Measured SAR(1g) (W/kg)	Reported SAR(1g) (W/kg)	Power Drift (dB)
MHz	Ch.								
1880	661	GPRS (4)	Phantom	24.48	0.382	0.542	0.625	0.887	-0.20
1909.8	810	GPRS (4)	Ground	24.54	0.542	0.759	0.922	1.290	0.04
1880	661	GPRS (4)	Ground	24.48	0.562	0.798	0.944	1.340	-0.02
1850.2	512	GPRS (4)	Ground	24.48	0.592	0.840	0.983	1.395	0.04
1880	661	GPRS (4)	Left	24.48	0.108	0.153	0.175	0.248	0.19
1880	661	GPRS (4)	Right	24.48	0.097	0.138	0.163	0.231	0.11
1880	661	GPRS (4)	Bottom	24.48	0.388	0.551	0.683	0.969	0.13
1850.2	512	Speech	Ground (AE3)	24.48	0.425	0.603	0.705	1.000	-0.08
1850.2	512	Speech	Ground (AE4)	24.48	0.467	0.663	0.789	1.120	0.06
1850.2	512	EGPRS (4)	Ground	24.46	0.498	0.710	0.841	1.199	0.05

Note: The distance between the EUT and the phantom bottom is 10mm.

Table 13.8: SAR Values (WCDMA 850 MHz Band - Head) with battery CAB60B0000C1

Frequency		Side	Test Position	Conducted Power (dBm)	Measured SAR(10g) (W/kg)	Reported SAR(10g) (W/kg)	Measured SAR(1g) (W/kg)	Reported SAR(1g) (W/kg)	Power Drift (dB)
MHz	Ch.								
846.6	4233	Left	Touch	23.00	0.588	0.660	0.773	0.867	0.12
836.6	4183	Left	Touch	23.24	0.572	0.607	0.749	0.795	0.04
826.4	4132	Left	Touch	22.83	0.561	0.655	0.734	0.856	-0.13
846.6	4233	Left	Tilt	23.00	0.302	0.339	0.391	0.439	0.08
836.6	4183	Left	Tilt	23.24	0.304	0.323	0.392	0.416	-0.07
826.4	4132	Left	Tilt	22.83	0.271	0.316	0.348	0.406	0
846.6	4233	Right	Touch	23.00	0.482	0.541	0.633	0.710	0.02
836.6	4183	Right	Touch	23.24	0.490	0.520	0.644	0.684	-0.03
826.4	4132	Right	Touch	22.83	0.399	0.466	0.524	0.611	-0.04
846.6	4233	Right	Tilt	23.00	0.305	0.342	0.394	0.442	0.03
836.6	4183	Right	Tilt	23.24	0.311	0.330	0.400	0.425	-0.04
826.4	4132	Right	Tilt	22.83	0.306	0.357	0.395	0.461	-0.01

Table 13.9: SAR Values (WCDMA 850 MHz Band - Body) with battery CAB60B0000C1

Frequency		Mode	Test Position	Conducted Power (dBm)	Measured SAR(10g) (W/kg)	Reported SAR(10g) (W/kg)	Measured SAR(1g) (W/kg)	Reported SAR(1g) (W/kg)	Power Drift (dB)
MHz	Ch.								
846.6	4233	RMC	Phantom	23.00	0.653	0.733	0.864	0.969	0.07
836.6	4183	RMC	Phantom	23.24	0.651	0.691	0.862	0.915	0.01
826.4	4132	RMC	Phantom	22.83	0.592	0.691	0.784	0.915	0.02
846.6	4233	RMC	Ground	23.00	0.759	0.852	1.02	1.144	0.01
836.6	4183	RMC	Ground	23.24	0.781	0.829	1.05	1.115	0.03
826.4	4132	RMC	Ground	22.83	0.785	0.916	1.06	1.237	0.01
836.6	4183	RMC	Left	23.24	0.466	0.495	0.670	0.711	-0.03
836.6	4183	RMC	Right	23.24	0.542	0.575	0.795	0.844	0
836.6	4183	RMC	Bottom	23.24	0.063	0.067	0.103	0.109	0.10
826.4	4132	Speech	Ground (AE3)	22.83	0.507	0.592	0.681	0.795	0.03
826.4	4132	Speech	Ground (AE4)	22.83	0.614	0.716	0.835	0.974	0.06

Note: The distance between the EUT and the phantom bottom is 10mm.

Table 13.10: SAR Values (WCDMA 1900 MHz Band - Head) with battery CAB60B0000C1

Frequency		Side	Test Position	Conducted Power (dBm)	Measured SAR(10g) (W/kg)	Reported SAR(10g) (W/kg)	Measured SAR(1g) (W/kg)	Reported SAR(1g) (W/kg)	Power Drift (dB)
MHz	Ch.								
1908	9538	Left	Touch	22.83	0.433	0.505	0.723	0.844	0.11
1880	9400	Left	Touch	22.90	0.450	0.517	0.745	0.855	0.14
1852.4	9262	Left	Touch	22.62	0.558	0.683	0.916	1.122	0.08
1908	9538	Left	Tilt	22.83	0.131	0.153	0.235	0.274	-0.02
1880	9400	Left	Tilt	22.90	0.107	0.123	0.193	0.222	0.06
1852.4	9262	Left	Tilt	22.62	0.126	0.154	0.227	0.278	-0.16
1908	9538	Right	Touch	22.83	0.454	0.530	0.767	0.895	0.03
1880	9400	Right	Touch	22.90	0.444	0.510	0.746	0.857	-0.13
1852.4	9262	Right	Touch	22.62	0.505	0.618	0.838	1.026	0.02
1908	9538	Right	Tilt	22.83	0.139	0.162	0.245	0.286	0.04
1880	9400	Right	Tilt	22.90	0.118	0.135	0.204	0.234	0
1852.4	9262	Right	Tilt	22.62	0.146	0.179	0.248	0.304	0.03

Table 13.11: SAR Values (WCDMA 1900 MHz Band - Body) with battery CAB60B0000C1

Frequency		Mode	Test Position	Conducted Power (dBm)	Measured SAR(10g) (W/kg)	Reported SAR(10g) (W/kg)	Measured SAR(1g) (W/kg)	Reported SAR(1g) (W/kg)	Power Drift (dB)
MHz	Ch.								
1880	9400	RMC	Phantom	22.90	0.401	0.460	0.655	0.752	0.01
1908	9538	RMC	Ground	22.83	0.695	0.811	1.17	1.365	0.02
1880	9400	RMC	Ground	22.90	0.613	0.704	1.05	1.206	-0.02
1852.4	9262	RMC	Ground	22.62	0.650	0.796	1.1	1.347	-0.02
1880	9400	RMC	Left	22.90	0.137	0.157	0.221	0.254	-0.04
1880	9400	RMC	Right	22.90	0.122	0.140	0.202	0.232	-0.03
1908	9538	RMC	Bottom	22.83	0.539	0.629	0.935	1.091	0.16
1880	9400	RMC	Bottom	22.90	0.489	0.561	0.848	0.974	0.13
1852.4	9262	RMC	Bottom	22.62	0.597	0.731	1.07	1.310	0.12
1908	9538	Speech	Ground (AE3)	22.90	0.654	0.751	1.12	1.286	-0.01
1908	9538	Speech	Ground (AE4)	22.90	0.692	0.795	1.17	1.343	0.03

Note: The distance between the EUT and the phantom bottom is 10mm.

Table 13.12: SAR Values (Wi-Fi 802.11b - Head) with battery CAB60B0000C1

Frequency		Side	Test Position	Conducted Power (dBm)	Measured SAR(10g) (W/kg)	Reported SAR(10g) (W/kg)	Measured SAR(1g) (W/kg)	Reported SAR(1g) (W/kg)	Power Drift (dB)
MHz	Ch.								
2437	6	Left	Touch	13.35	0.079	0.082	0.141	0.146	0.06
2437	6	Left	Tilt	13.35	0.065	0.067	0.124	0.128	0.12
2462	11	Right	Touch	13.14	0.080	0.087	0.161	0.175	0.17
2437	6	Right	Touch	13.35	0.098	0.101	0.194	0.201	0.12
2412	1	Right	Touch	12.96	0.097	0.110	0.194	0.220	0.11
2437	6	Right	Tilt	13.35	0.061	0.063	0.127	0.131	0.18

Table 13.13: SAR Values (Wi-Fi 802.11b - Body) with battery CAB60B0000C1

Frequency		Test Position	Conducted Power (dBm)	Measured SAR(10g) (W/kg)	Reported SAR(10g) (W/kg)	Measured SAR(1g) (W/kg)	Reported SAR(1g) (W/kg)	Power Drift (dB)
MHz	Ch.							
2437	6	Phantom	13.35	0.043	0.045	0.071	0.073	0.12
2437	6	Ground	13.35	0.053	0.055	0.088	0.091	0.12
2437	6	Left	13.35	0.054	0.056	0.102	0.106	0.17
2437	6	Right	13.35	0.022	0.023	0.039	0.040	0.15
2437	6	Top	13.35	0.037	0.038	0.069	0.071	0.15

Note: The distance between the EUT and the phantom bottom is 10mm.

Table 13.14: SAR Values (WCDMA 1900 MHz Band - Head) with battery CAB60B0000C2

Frequency		Side	Test Position	Conducted Power (dBm)	Measured SAR(10g) (W/kg)	Reported SAR(10g) (W/kg)	Measured SAR(1g) (W/kg)	Reported SAR(1g) (W/kg)	Power Drift (dB)
MHz	Ch.								
1852.4	9262	Left	Touch	22.62	0.517	0.633	0.860	1.053	0.17

Table 13.15: SAR Values (GSM 850 MHz Band - Body) with battery CAB60B0000C2

Frequency		Mode (number of timeslots)	Test Position	Conducted Power (dBm)	Measured SAR(10g) (W/kg)	Reported SAR(10g) (W/kg)	Measured SAR(1g) (W/kg)	Reported SAR(1g) (W/kg)	Power Drift (dB)
MHz	Ch.								
836.8	190	GPRS (4)	Ground	27.50	0.911	1.022	1.22	1.369	-0.01

Note: The distance between the EUT and the phantom bottom is 10mm.

14 SAR Measurement Variability

SAR measurement variability must be assessed for each frequency band, which is determined by the SAR probe calibration point and tissue-equivalent medium used for the device measurements. When both head and body tissue-equivalent media are required for SAR measurements in a frequency band, the variability measurement procedures should be applied to the tissue medium with the highest measured SAR, using the highest measured SAR configuration for that tissue-equivalent medium.

The following procedures are applied to determine if repeated measurements are required.

- 1) Repeated measurement is not required when the original highest measured SAR is < 0.80 W/kg; steps 2) through 4) do not apply.
- 2) When the original highest measured SAR is ≥ 0.80 W/kg, repeat that measurement once.
- 3) Perform a second repeated measurement only if the ratio of largest to smallest SAR for the original and first repeated measurements is > 1.20 or when the original or repeated measurement is ≥ 1.45 W/kg (~ 10% from the 1-g SAR limit).
- 4) Perform a third repeated measurement only if the original, first or second repeated measurement is ≥ 1.5 W/kg and the ratio of largest to smallest SAR for the original, first and second repeated measurements is > 1.20 .

Table 14.1: SAR Measurement Variability for Head GSM 850 (1g)

Frequency		Side	Test Position	Original SAR (W/kg)	First Repeated SAR (W/kg)	The Ratio	Second Repeated SAR (W/kg)
MHz	Ch.						
848.6	251	Left	Cheek	0.910	0.905	0.99	/

Table 14.2: SAR Measurement Variability for Body GSM 850 (1g)

Frequency		Test Position	Spacing (mm)	Original SAR (W/kg)	First Repeated SAR (W/kg)	The Ratio	Second Repeated SAR (W/kg)
MHz	Ch.						
836.8	190	Ground	10	1.25	1.24	0.98	/

Table 14.3: SAR Measurement Variability for Body GSM 1900 (1g)

Frequency		Test Position	Spacing (mm)	Original SAR (W/kg)	First Repeated SAR (W/kg)	The Ratio	Second Repeated SAR (W/kg)
MHz	Ch.						
1850.2	512	Ground	10	0.983	0.976	0.99	/

Table 14.4: SAR Measurement Variability for Head WCDMA 850 (1g)

Frequency		Test Position	Spacing (mm)	Original SAR (W/kg)	First Repeated SAR (W/kg)	The Ratio	Second Repeated SAR (W/kg)
MHz	Ch.						
846.6	4233	Ground	10	1.06	1.09	1.03	/

Table 14.5: SAR Measurement Variability for Head WCDMA 1900 (1g)

Frequency		Side	Test Position	Original SAR (W/kg)	First Repeated SAR (W/kg)	The Ratio	Second Repeated SAR (W/kg)
MHz	Ch.						
1852.4	9262	Left	Cheek	0.916	0.921	1.01	/

Table 14.6: SAR Measurement Variability for Head WCDMA 1900 (1g)

Frequency		Test Position	Spacing (mm)	Original SAR (W/kg)	First Repeated SAR (W/kg)	The Ratio	Second Repeated SAR (W/kg)
MHz	Ch.						
1908	9538	Ground	10	1.17	1.15	0.98	/

15 Measurement Uncertainty

15.1 Measurement Uncertainty for Normal SAR Tests

No.	Error Description	Type	Uncertainty value	Probably Distribution	Div.	(Ci) 1g	(Ci) 10g	Std. Unc. (1g)	Std. Unc. (10g)	Degree of freedom
Measurement system										
1	Probe calibration	B	5.5	N	1	1	1	5.5	5.5	∞
2	Isotropy	B	4.7	R	$\sqrt{3}$	0.7	0.7	1.9	1.9	∞
3	Boundary effect	B	1.0	R	$\sqrt{3}$	1	1	0.6	0.6	∞
4	Linearity	B	4.7	R	$\sqrt{3}$	1	1	2.7	2.7	∞
5	Detection limit	B	1.0	N	1	1	1	0.6	0.6	∞
6	Readout electronics	B	0.3	R	$\sqrt{3}$	1	1	0.3	0.3	∞
7	Response time	B	0.8	R	$\sqrt{3}$	1	1	0.5	0.5	∞
8	Integration time	B	2.6	R	$\sqrt{3}$	1	1	1.5	1.5	∞
9	RF ambient conditions-noise	B	0	R	$\sqrt{3}$	1	1	0	0	∞
10	RF ambient conditions-reflection	B	0	R	$\sqrt{3}$	1	1	0	0	∞
11	Probe positioned mech. restrictions	B	0.4	R	$\sqrt{3}$	1	1	0.2	0.2	∞
12	Probe positioning with respect to phantom shell	B	2.9	R	$\sqrt{3}$	1	1	1.7	1.7	∞
13	Post-processing	B	1.0	R	$\sqrt{3}$	1	1	0.6	0.6	∞
Test sample related										
14	Test sample positioning	A	3.3	N	1	1	1	3.3	3.3	71
15	Device holder uncertainty	A	3.4	N	1	1	1	3.4	3.4	5
16	Drift of output power	B	5.0	R	$\sqrt{3}$	1	1	2.9	2.9	∞
Phantom and set-up										
17	Phantom uncertainty	B	4.0	R	$\sqrt{3}$	1	1	2.3	2.3	∞
18	Liquid conductivity (target)	B	5.0	R	$\sqrt{3}$	0.64	0.43	1.8	1.2	∞
19	Liquid conductivity (meas.)	A	2.06	N	1	0.64	0.43	1.32	0.89	43
20	Liquid permittivity (target)	B	5.0	R	$\sqrt{3}$	0.6	0.49	1.7	1.4	∞
21	Liquid permittivity (meas.)	A	1.6	N	1	0.6	0.49	1.0	0.8	521

Combined standard uncertainty	$u_c = \sqrt{\sum_{i=1}^{21} c_i^2 u_i^2}$					9.25	9.12	257
Expanded uncertainty (confidence interval of 95 %)	$u_e = 2u_c$					18.5	18.2	

16 MAIN TEST INSTRUMENTS

Table 16.1: List of Main Instruments

No.	Name	Type	Serial Number	Calibration Date	Valid Period
01	Network analyzer	Agilent E5071C	MY46103759	January 15,2013	One year
02	Power meter	NRVD	101253	March 8,2012	One year
03	Power sensor	NRV-Z5	100333		
04	Signal Generator	E4438C	MY45095825	January 15, 2013	One year
05	Amplifier	VTL5400	0404	No Calibration Requested	
06	BTS	E5515C	GB47460133	September 20, 2012	One year
07	E-field Probe	SPEAG ES3DV3	3151	April 24, 2012	One year
08	DAE	SPEAG DAE4	786	November 20, 2012	One year
09	Dipole Validation Kit	SPEAG D835V2	4d057	October 24,2012	One year
10	Dipole Validation Kit	SPEAG D1900V2	5d088	October 17,2012	One year
11	Dipole Validation Kit	SPEAG D2450V2	873	October 18,2012	One year

END OF REPORT BODY

ANNEX A GRAPH RESULTS

850 Left Cheek High

Date/Time: 2/21/2013

Electronics: DAE4 Sn786

Medium: Head 850MHz

Medium parameters used (interpolated): $f = 848.8$ MHz; $\sigma = 0.902$ S/m; $\epsilon_r = 41.375$; $\rho = 1000$ kg/m³

Ambient Temperature: 22.0°C Liquid Temperature: 21.6°C

Communication System: GSM Frequency: 848.8 MHz Duty Cycle: 1:8.30042

Probe: ES3DV3 - SN3151 ConvF(6.27, 6.27, 6.27); Calibrated: 4/24/2012

Left Cheek High/Area Scan (61x91x1): Interpolated grid: dx=1.500 mm, dy=1.500 mm

Reference Value = 8.577 V/m; Power Drift = 0.06 dB

Maximum value of SAR (interpolated) = 0.955 W/kg

Left Cheek High/Zoom Scan (5x5x7)/Cube 0: Measurement grid: dx=8mm, dy=8mm, dz=5mm

Reference Value = 8.577 V/m; Power Drift = 0.06 dB

Peak SAR (extrapolated) = 1.12 W/kg

SAR(1 g) = 0.910 W/kg; SAR(10 g) = 0.690 W/kg

Maximum value of SAR (measured) = 0.955 W/kg

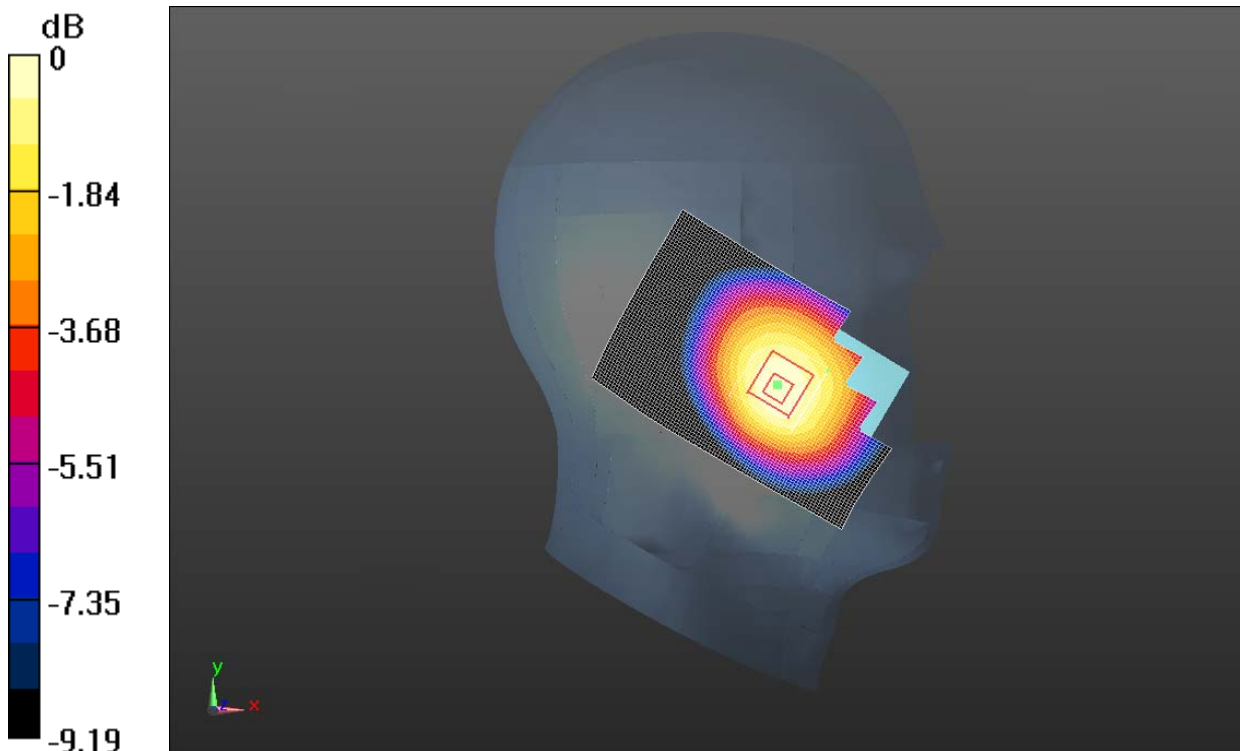

0 dB = 0.955 W/kg = -0.20 dBW/kg

Fig. 1 850MHz CH251

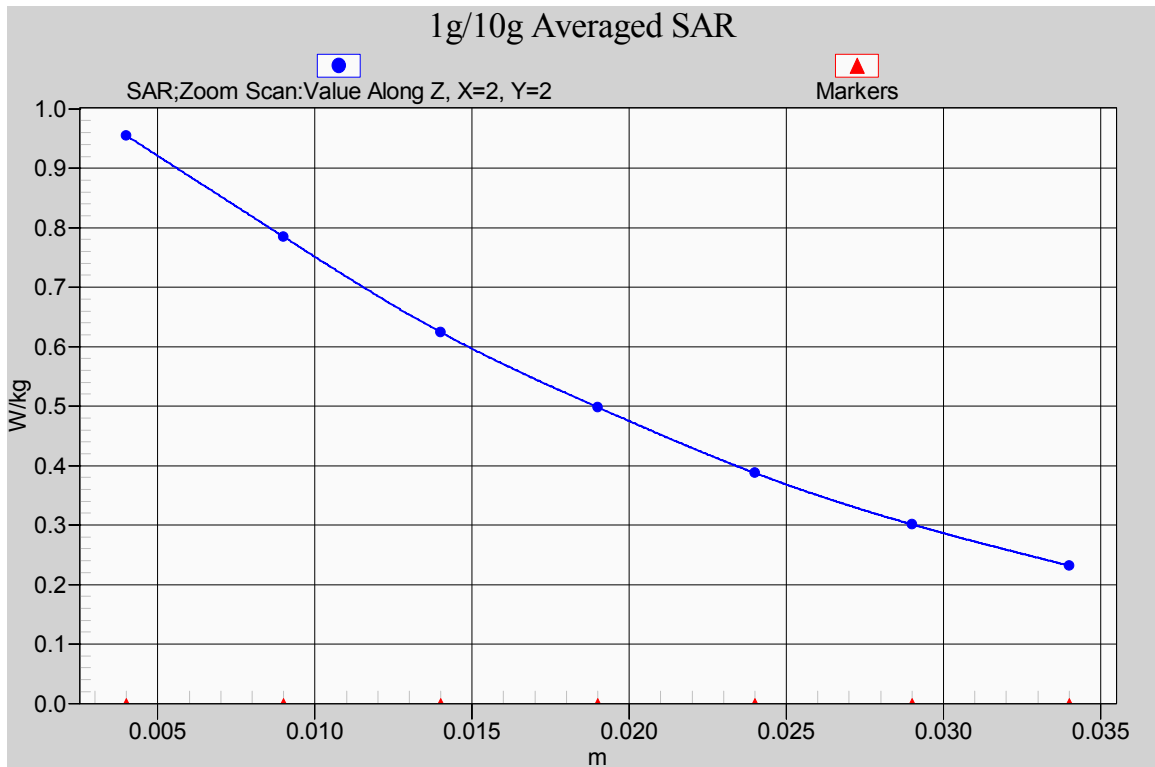

Fig. 1-1 Z-Scan at power reference point (850 MHz CH251)

850 Left Cheek Middle

Date/Time: 2/21/2013

Electronics: DAE4 Sn786

Medium: Head 850MHz

Medium parameters used (interpolated): $f = 836.6$ MHz; $\sigma = 0.89$ S/m; $\epsilon_r = 41.523$; $\rho = 1000$ kg/m³

Ambient Temperature: 22.0°C Liquid Temperature: 21.6°C

Communication System: GSM Frequency: 836.6 MHz Duty Cycle: 1:8.30042

Probe: ES3DV3 - SN3151 ConvF(6.27, 6.27, 6.27); Calibrated: 4/24/2012

Left Cheek Middle/Area Scan (61x91x1): Interpolated grid: dx=1.500 mm, dy=1.500 mm

Reference Value = 7.696 V/m; Power Drift = 0.12 dB

Maximum value of SAR (interpolated) = 0.823 W/kg

Left Cheek Middle/Zoom Scan (5x5x7)/Cube 0: Measurement grid: dx=8mm, dy=8mm, dz=5mm

Reference Value = 7.696 V/m; Power Drift = 0.12 dB

Peak SAR (extrapolated) = 0.925 W/kg

SAR(1 g) = 0.757 W/kg; SAR(10 g) = 0.575 W/kg

Maximum value of SAR (measured) = 0.793 W/kg

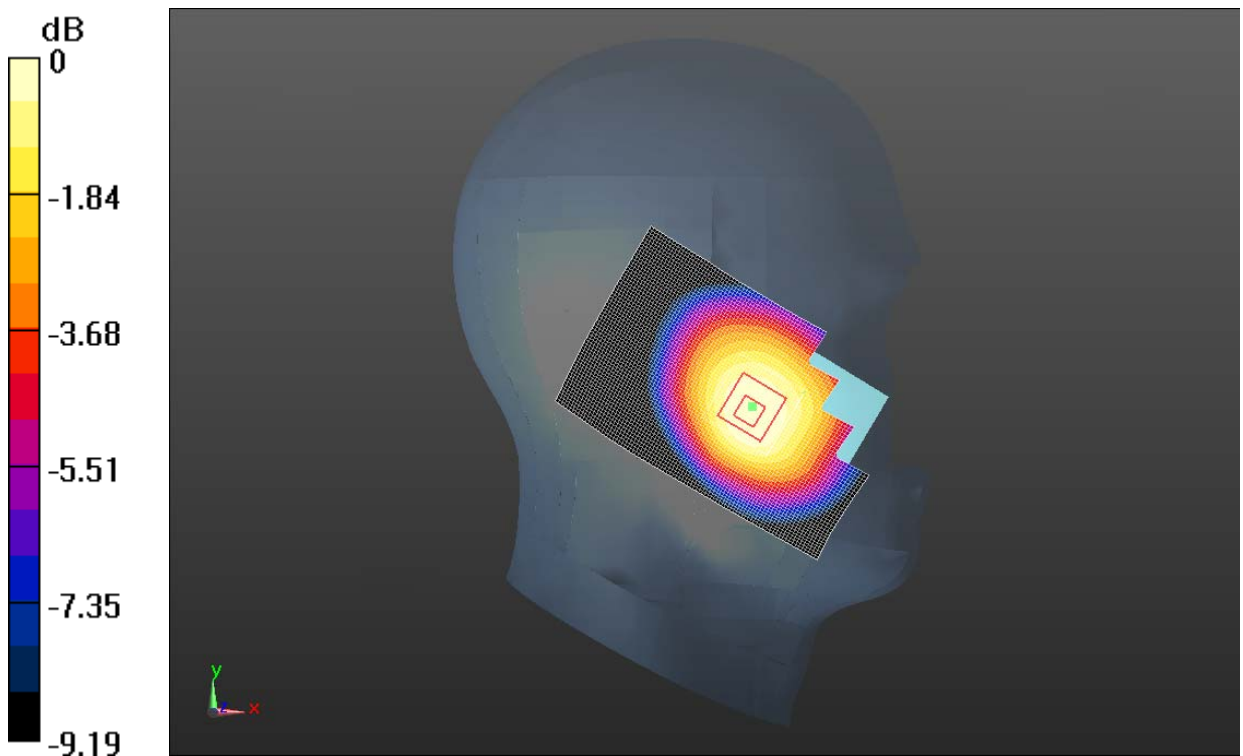

0 dB = 0.793 W/kg = -1.00 dBW/kg

Fig. 2 850 MHz CH190

850 Left Cheek Low

Date/Time: 2/21/2013

Electronics: DAE4 Sn786

Medium: Head 850MHz

Medium parameters used (interpolated): $f = 824.2$ MHz; $\sigma = 0.878$ S/m; $\epsilon_r = 41.68$; $\rho = 1000$ kg/m³

Ambient Temperature: 22.0°C Liquid Temperature: 21.6°C

Communication System: GSM Frequency: 824.2 MHz Duty Cycle: 1:8.30042

Probe: ES3DV3 - SN3151 ConvF(6.27, 6.27, 6.27); Calibrated: 4/24/2012

Left Cheek Low/Area Scan (61x91x1): Interpolated grid: dx=1.500 mm, dy=1.500 mm

Reference Value = 6.975 V/m; Power Drift = -0.12 dB

Maximum value of SAR (interpolated) = 0.564 W/kg

Left Cheek Low/Zoom Scan (5x5x7)/Cube 0: Measurement grid: dx=8mm, dy=8mm, dz=5mm

Reference Value = 6.975 V/m; Power Drift = -0.12 dB

Peak SAR (extrapolated) = 0.653 W/kg

SAR(1 g) = 0.535 W/kg; SAR(10 g) = 0.408 W/kg

Maximum value of SAR (measured) = 0.561 W/kg

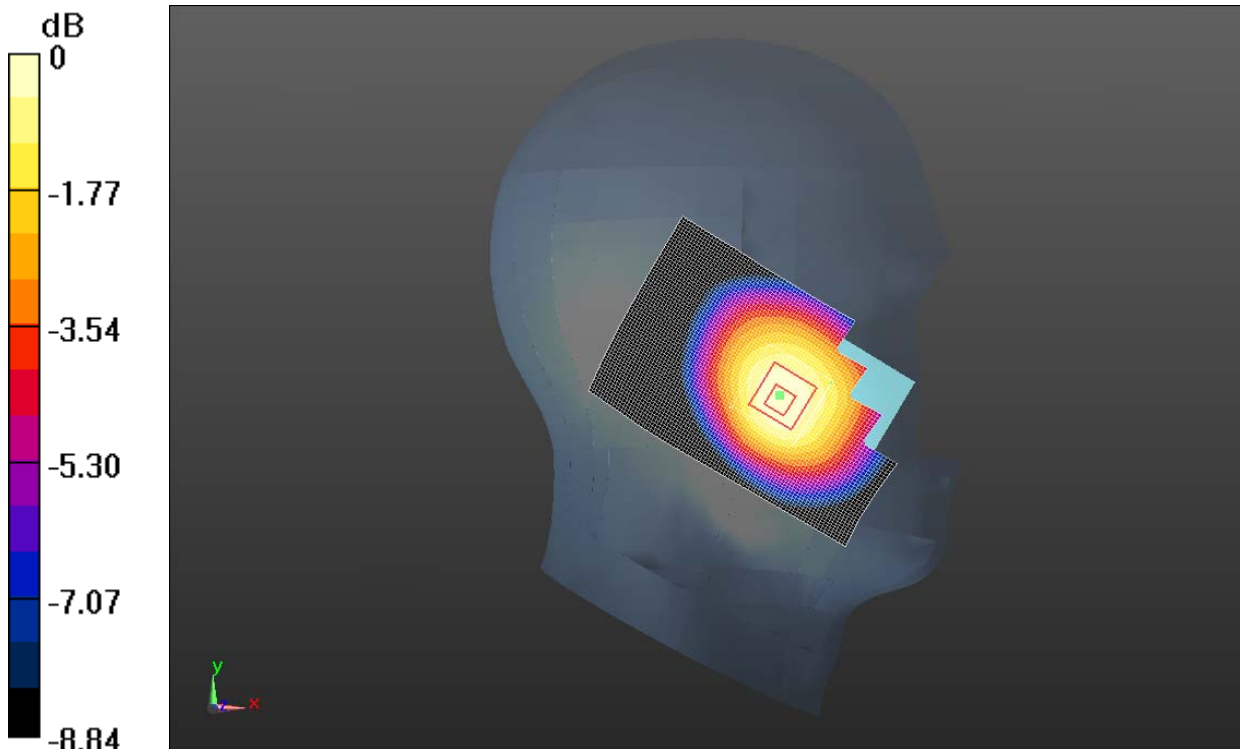

0 dB = 0.561 W/kg = -2.51 dBW/kg

Fig. 3 850 MHz CH128

850 Left Tilt High

Date/Time: 2/21/2013

Electronics: DAE4 Sn786

Medium: Head 850MHz

Medium parameters used (interpolated): $f = 848.8$ MHz; $\sigma = 0.902$ S/m; $\epsilon_r = 41.375$; $\rho = 1000$ kg/m³

Ambient Temperature: 22.0°C Liquid Temperature: 21.6°C

Communication System: GSM Frequency: 848.8 MHz Duty Cycle: 1:8.30042

Probe: ES3DV3 - SN3151 ConvF(6.27, 6.27, 6.27); Calibrated: 4/24/2012

Left Tilt High/Area Scan (61x91x1): Interpolated grid: dx=1.500 mm, dy=1.500 mm

Reference Value = 13.631 V/m; Power Drift = -0.16 dB

Maximum value of SAR (interpolated) = 0.447 W/kg

Left Tilt High/Zoom Scan (5x5x7)/Cube 0: Measurement grid: dx=8mm, dy=8mm, dz=5mm

Reference Value = 13.631 V/m; Power Drift = -0.16 dB

Peak SAR (extrapolated) = 0.512 W/kg

SAR(1 g) = 0.430 W/kg; SAR(10 g) = 0.332 W/kg

Maximum value of SAR (measured) = 0.446 W/kg

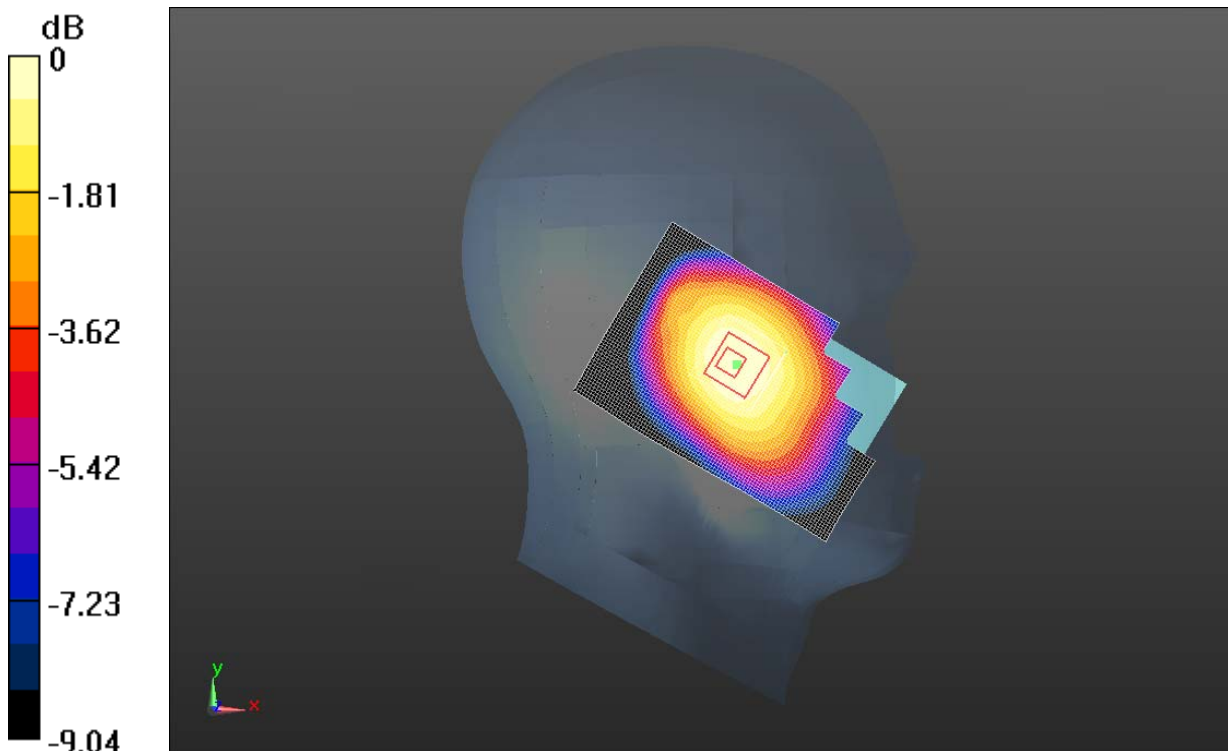

0 dB = 0.446 W/kg = -3.51 dBW/kg

Fig.4 850 MHz CH251

850 Left Tilt Middle

Date/Time: 2/21/2013

Electronics: DAE4 Sn786

Medium: Head 850MHz

Medium parameters used (interpolated): $f = 836.6$ MHz; $\sigma = 0.89$ S/m; $\epsilon_r = 41.523$; $\rho = 1000$ kg/m³

Ambient Temperature: 22.0°C Liquid Temperature: 21.6°C

Communication System: GSM Frequency: 836.6 MHz Duty Cycle: 1:8.30042

Probe: ES3DV3 - SN3151 ConvF(6.27, 6.27, 6.27); Calibrated: 4/24/2012

Left Tilt Middle/Area Scan (61x91x1): Interpolated grid: dx=1.500 mm, dy=1.500 mm

Reference Value = 12.390 V/m; Power Drift = -0.03 dB

Maximum value of SAR (interpolated) = 0.366 W/kg

Left Tilt Middle/Zoom Scan (5x5x7)/Cube 0: Measurement grid: dx=8mm, dy=8mm, dz=5mm

Reference Value = 12.390 V/m; Power Drift = -0.03 dB

Peak SAR (extrapolated) = 0.412 W/kg

SAR(1 g) = 0.349 W/kg; SAR(10 g) = 0.274 W/kg

Maximum value of SAR (measured) = 0.362 W/kg

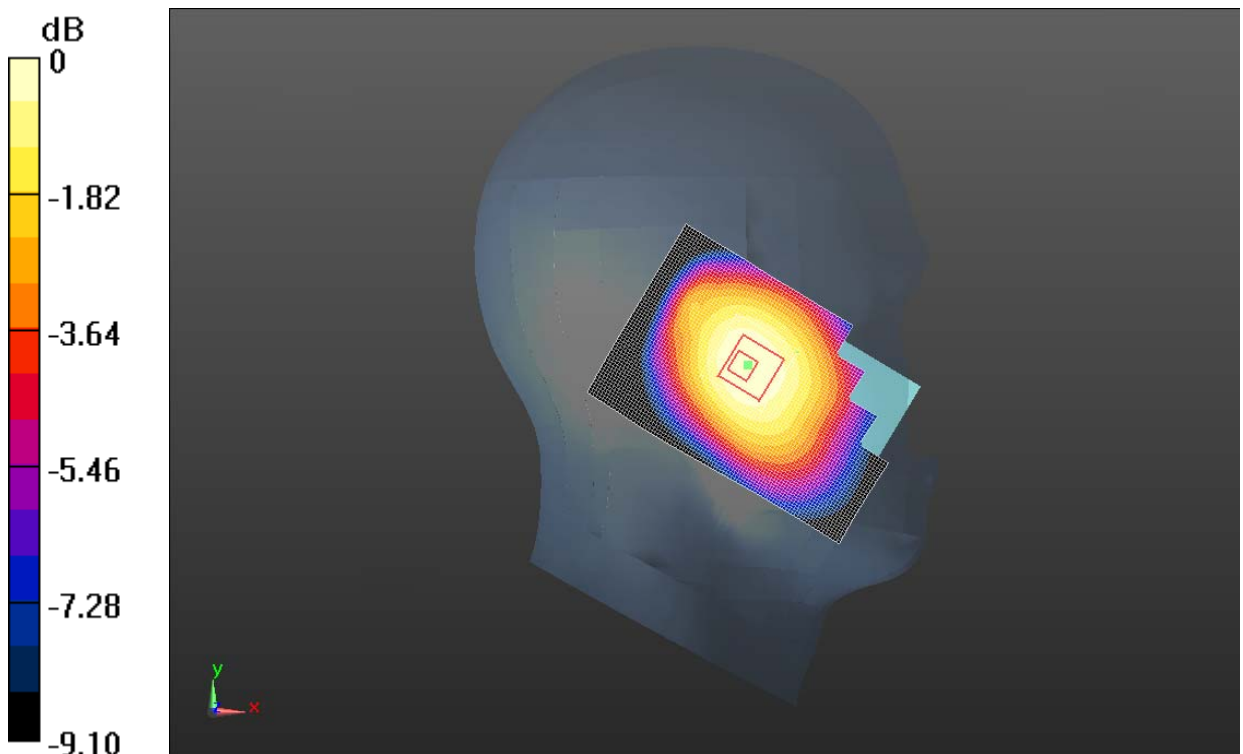

0 dB = 0.362 W/kg = -4.41 dBW/kg

Fig.5 850 MHz CH190

850 Left Tilt Low

Date/Time: 2/21/2013

Electronics: DAE4 Sn786

Medium: Head 850MHz

Medium parameters used (interpolated): $f = 824.2$ MHz; $\sigma = 0.878$ S/m; $\epsilon_r = 41.68$; $\rho = 1000$ kg/m³

Ambient Temperature: 22.0°C Liquid Temperature: 21.6°C

Communication System: GSM Frequency: 824.2 MHz Duty Cycle: 1:8.30042

Probe: ES3DV3 - SN3151 ConvF(6.27, 6.27, 6.27); Calibrated: 4/24/2012

Left Tilt Low/Area Scan (61x91x1): Interpolated grid: dx=1.500 mm, dy=1.500 mm

Reference Value = 11.111 V/m; Power Drift = 0.06 dB

Maximum value of SAR (interpolated) = 0.289 W/kg

Left Tilt Low/Zoom Scan (5x5x7)/Cube 0: Measurement grid: dx=8mm, dy=8mm, dz=5mm

Reference Value = 11.111 V/m; Power Drift = 0.06 dB

Peak SAR (extrapolated) = 0.328 W/kg

SAR(1 g) = 0.278 W/kg; SAR(10 g) = 0.218 W/kg

Maximum value of SAR (measured) = 0.288 W/kg

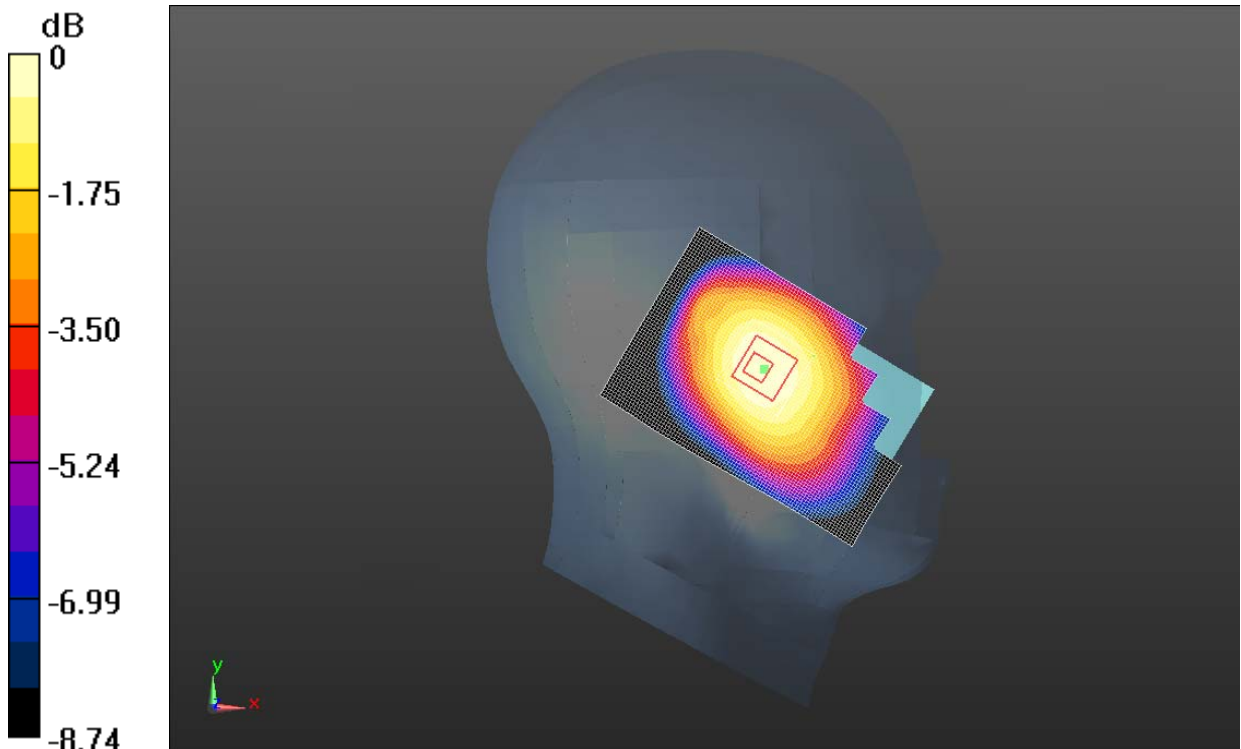

0 dB = 0.288 W/kg = -5.40 dBW/kg

Fig. 6 850 MHz CH128

850 Right Cheek High

Date/Time: 2/21/2013

Electronics: DAE4 Sn786

Medium: Head 850MHz

Medium parameters used (interpolated): $f = 848.8$ MHz; $\sigma = 0.902$ S/m; $\epsilon_r = 41.375$; $\rho = 1000$ kg/m³

Ambient Temperature: 22.0°C Liquid Temperature: 21.6°C

Communication System: GSM Frequency: 848.8 MHz Duty Cycle: 1:8.30042

Probe: ES3DV3 - SN3151 ConvF(6.27, 6.27, 6.27); Calibrated: 4/24/2012

Right Cheek High/Area Scan (61x91x1): Interpolated grid: dx=1.500 mm, dy=1.500 mm

Reference Value = 9.970 V/m; Power Drift = -0.00 dB

Maximum value of SAR (interpolated) = 0.806 W/kg

Right Cheek High/Zoom Scan (5x5x7)/Cube 0: Measurement grid: dx=8mm, dy=8mm, dz=5mm

Reference Value = 9.970 V/m; Power Drift = -0.00 dB

Peak SAR (extrapolated) = 0.918 W/kg

SAR(1 g) = 0.765 W/kg; SAR(10 g) = 0.582 W/kg

Maximum value of SAR (measured) = 0.805 W/kg

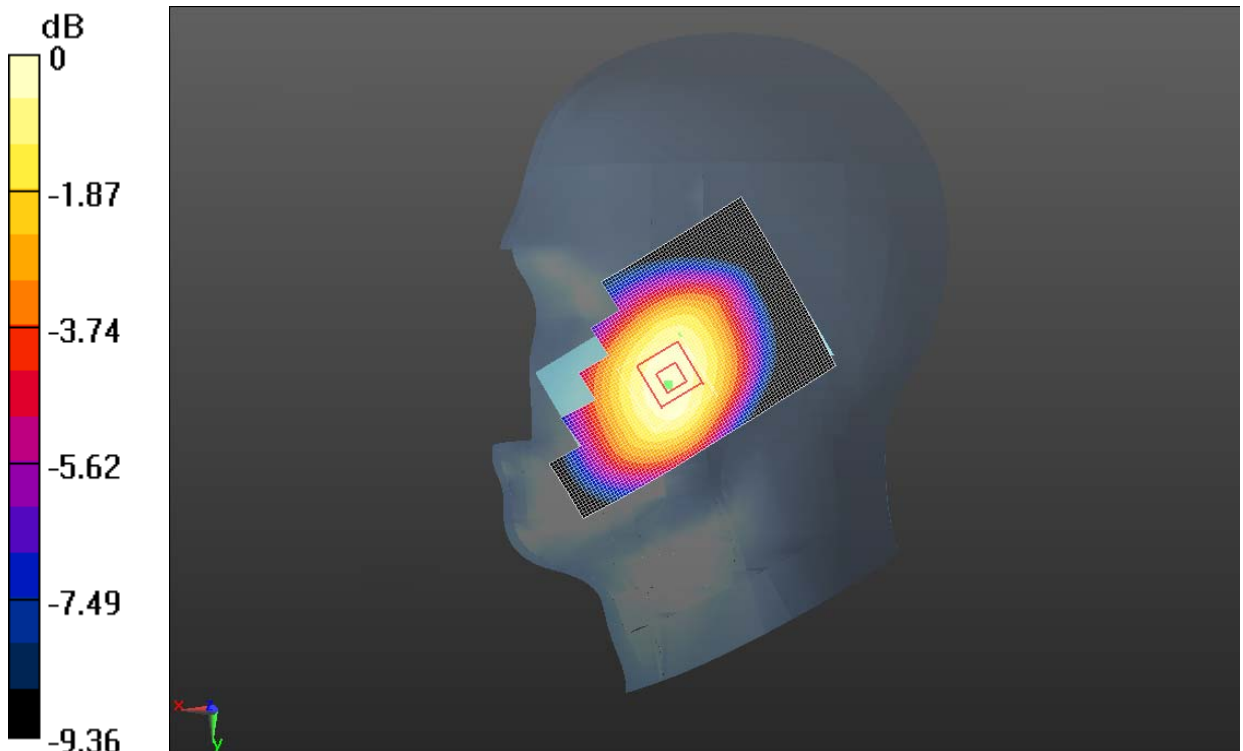

0 dB = 0.805 W/kg = -0.94 dBW/kg

Fig. 7 850 MHz CH251

850 Right Cheek Middle

Date/Time: 2/21/2013

Electronics: DAE4 Sn786

Medium: Head 850MHz

Medium parameters used (interpolated): $f = 836.6$ MHz; $\sigma = 0.89$ S/m; $\epsilon_r = 41.523$; $\rho = 1000$ kg/m³

Ambient Temperature: 22.0°C Liquid Temperature: 21.6°C

Communication System: GSM Frequency: 836.6 MHz Duty Cycle: 1:8.30042

Probe: ES3DV3 - SN3151 ConvF(6.27, 6.27, 6.27); Calibrated: 4/24/2012

Right Cheek Middle/Area Scan (61x91x1): Interpolated grid: dx=1.500 mm, dy=1.500 mm

Reference Value = 9.109 V/m; Power Drift = -0.04 dB

Maximum value of SAR (interpolated) = 0.660 W/kg

Right Cheek Middle/Zoom Scan (5x5x7)/Cube 0: Measurement grid: dx=8mm, dy=8mm, dz=5mm

Reference Value = 9.109 V/m; Power Drift = -0.04 dB

Peak SAR (extrapolated) = 0.760 W/kg

SAR(1 g) = 0.626 W/kg; SAR(10 g) = 0.476 W/kg

Maximum value of SAR (measured) = 0.655 W/kg

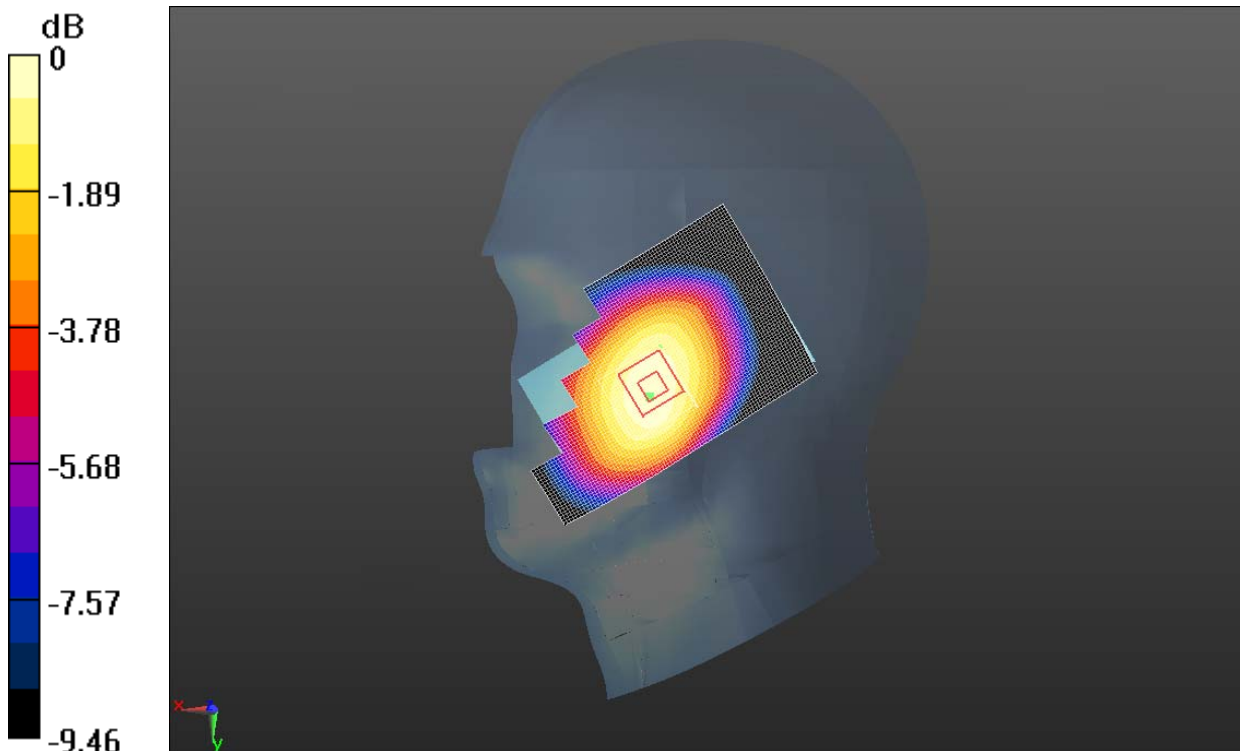

0 dB = 0.655 W/kg = -1.83 dBW/kg

Fig. 8 850 MHz CH190

850 Right Cheek Low

Date/Time: 2/21/2013

Electronics: DAE4 Sn786

Medium: Head 850MHz

Medium parameters used (interpolated): $f = 824.2$ MHz; $\sigma = 0.878$ S/m; $\epsilon_r = 41.68$; $\rho = 1000$ kg/m³

Ambient Temperature: 22.0°C Liquid Temperature: 21.6°C

Communication System: GSM Frequency: 824.2 MHz Duty Cycle: 1:8.30042

Probe: ES3DV3 - SN3151 ConvF(6.27, 6.27, 6.27); Calibrated: 4/24/2012

Right Cheek Low/Area Scan (61x91x1): Interpolated grid: dx=1.500 mm, dy=1.500 mm

Reference Value = 7.794 V/m; Power Drift = 0.06 dB

Maximum value of SAR (interpolated) = 0.477 W/kg

Right Cheek Low/Zoom Scan (5x5x7)/Cube 0: Measurement grid: dx=8mm, dy=8mm, dz=5mm

Reference Value = 7.794 V/m; Power Drift = 0.06 dB

Peak SAR (extrapolated) = 0.541 W/kg

SAR(1 g) = 0.448 W/kg; SAR(10 g) = 0.344 W/kg

Maximum value of SAR (measured) = 0.468 W/kg

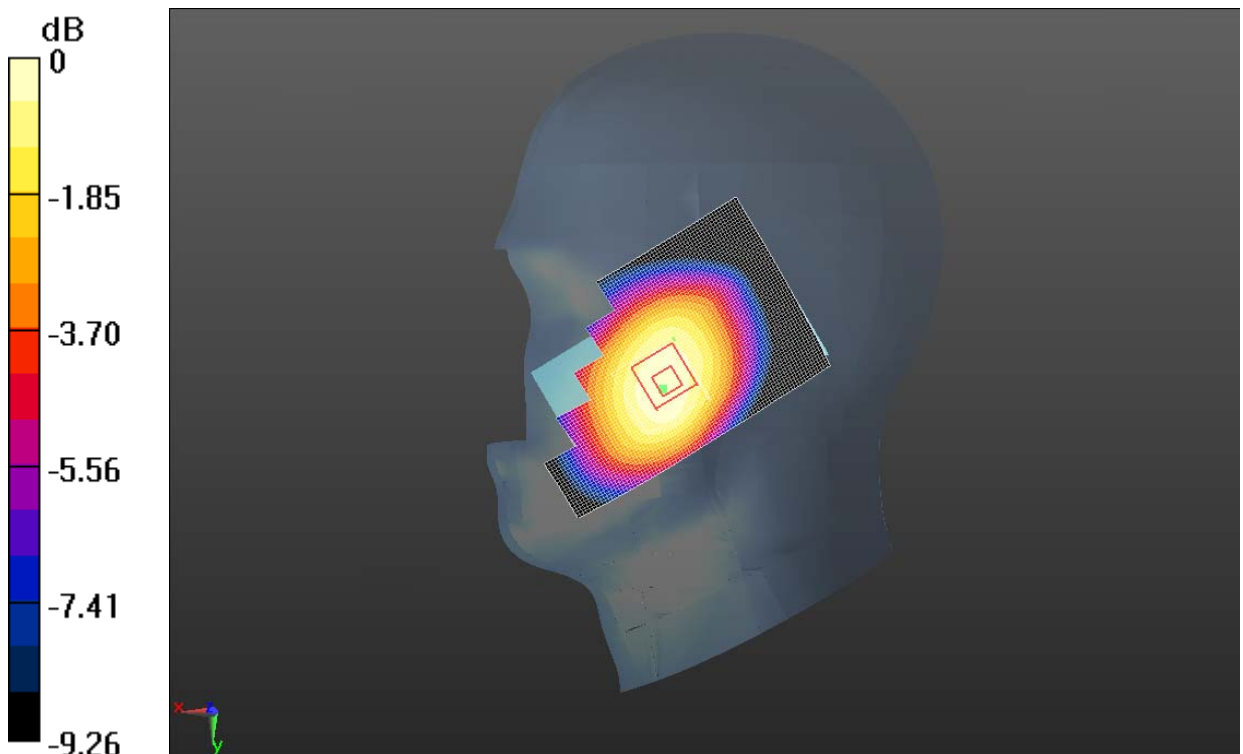

0 dB = 0.468 W/kg = -3.30 dBW/kg

Fig. 9 850 MHz CH128

850 Right Tilt High

Date/Time: 2/21/2013

Electronics: DAE4 Sn786

Medium: Head 850MHz

Medium parameters used (interpolated): $f = 848.8$ MHz; $\sigma = 0.902$ S/m; $\epsilon_r = 41.375$; $\rho = 1000$ kg/m³

Ambient Temperature: 22.0°C Liquid Temperature: 21.6°C

Communication System: GSM Frequency: 848.8 MHz Duty Cycle: 1:8.30042

Probe: ES3DV3 - SN3151 ConvF(6.27, 6.27, 6.27); Calibrated: 4/24/2012

Right Tilt High/Area Scan (61x91x1): Interpolated grid: dx=1.500 mm, dy=1.500 mm

Reference Value = 15.054 V/m; Power Drift = -0.04 dB

Maximum value of SAR (interpolated) = 0.478 W/kg

Right Tilt High/Zoom Scan (5x5x7)/Cube 0: Measurement grid: dx=8mm, dy=8mm, dz=5mm

Reference Value = 15.054 V/m; Power Drift = -0.04 dB

Peak SAR (extrapolated) = 0.539 W/kg

SAR(1 g) = 0.452 W/kg; SAR(10 g) = 0.346 W/kg

Maximum value of SAR (measured) = 0.475 W/kg

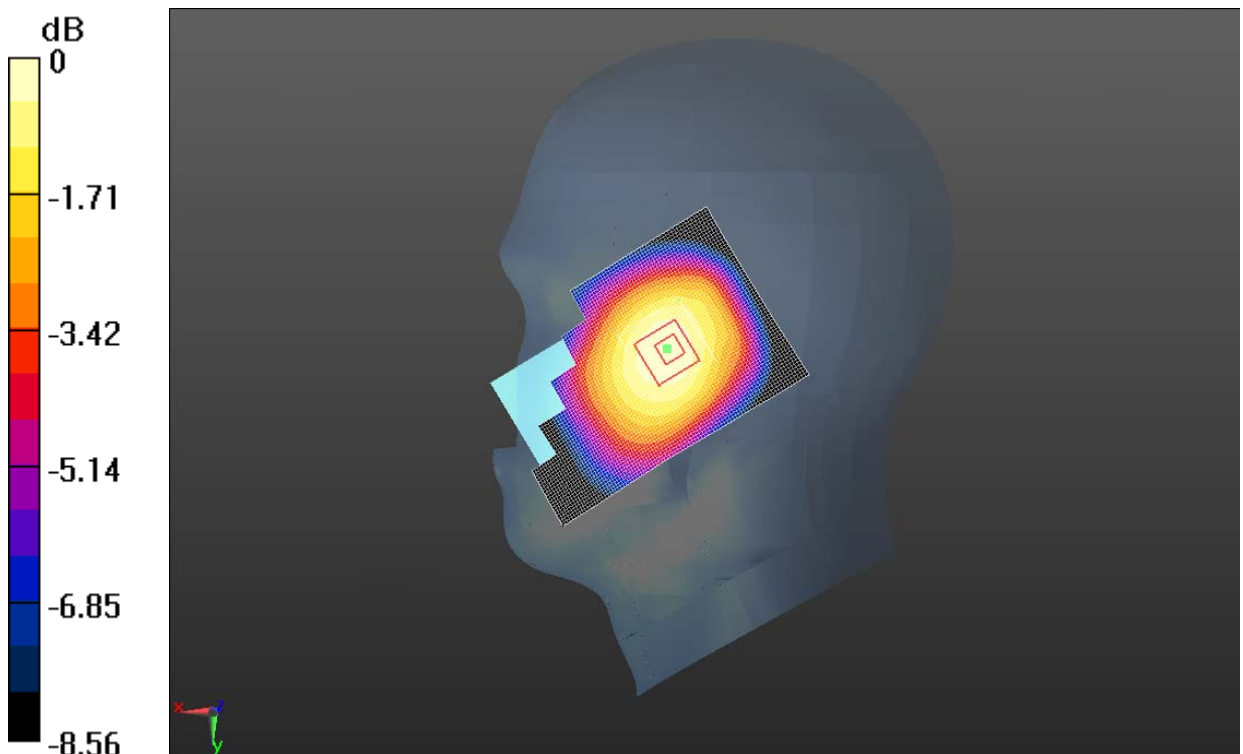

0 dB = 0.475 W/kg = -3.24 dBW/kg

Fig.10 850 MHz CH251

850 Right Tilt Middle

Date/Time: 2/21/2013

Electronics: DAE4 Sn786

Medium: Head 850MHz

Medium parameters used (interpolated): $f = 836.6$ MHz; $\sigma = 0.89$ S/m; $\epsilon_r = 41.523$; $\rho = 1000$ kg/m³

Ambient Temperature: 22.0°C Liquid Temperature: 21.6°C

Communication System: GSM Frequency: 836.6 MHz Duty Cycle: 1:8.30042

Probe: ES3DV3 - SN3151 ConvF(6.27, 6.27, 6.27); Calibrated: 4/24/2012

Right Tilt Middle/Area Scan (61x91x1): Interpolated grid: dx=1.500 mm, dy=1.500 mm

Reference Value = 14.049 V/m; Power Drift = 0.01 dB

Maximum value of SAR (interpolated) = 0.403 W/kg

Right Tilt Middle/Zoom Scan (5x5x7)/Cube 0: Measurement grid: dx=8mm, dy=8mm, dz=5mm

Reference Value = 14.049 V/m; Power Drift = 0.01 dB

Peak SAR (extrapolated) = 0.462 W/kg

SAR(1 g) = 0.385 W/kg; SAR(10 g) = 0.297 W/kg

Maximum value of SAR (measured) = 0.404 W/kg

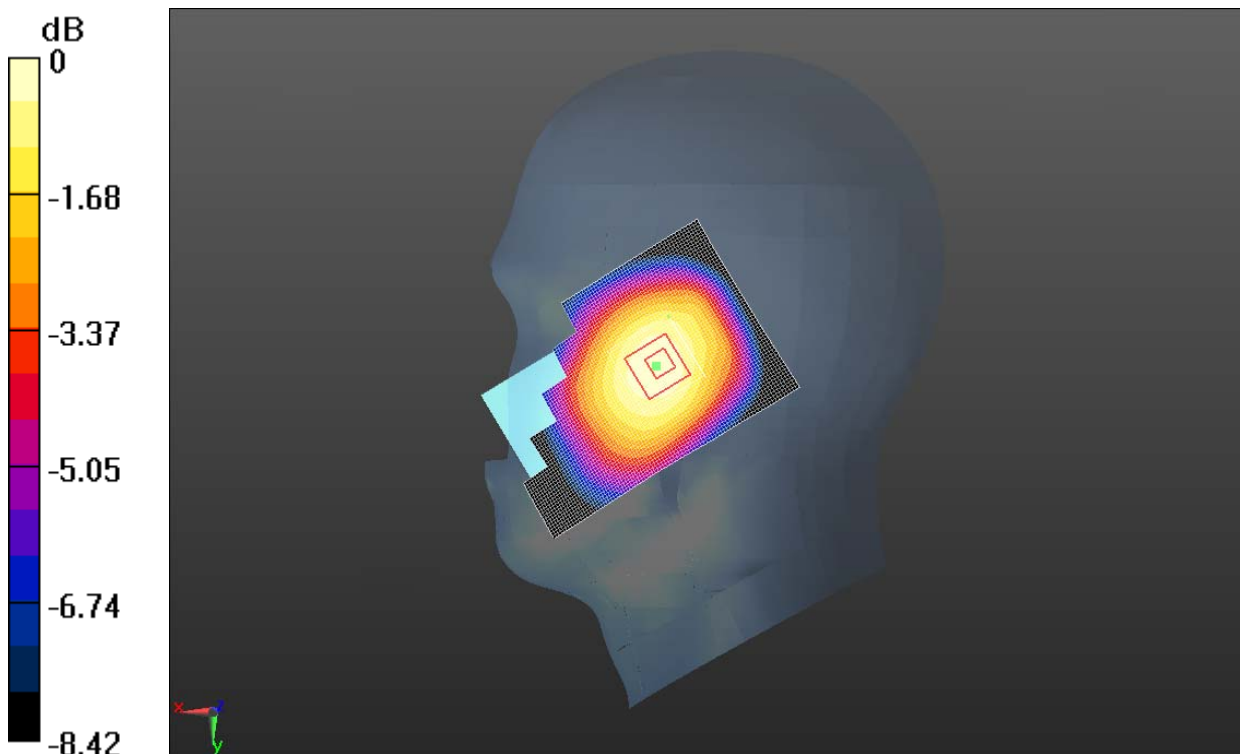

0 dB = 0.404 W/kg = -3.93 dBW/kg

Fig.11 850 MHz CH190

850 Right Tilt Low

Date/Time: 2/21/2013

Electronics: DAE4 Sn786

Medium: Head 850MHz

Medium parameters used (interpolated): $f = 824.2$ MHz; $\sigma = 0.878$ S/m; $\epsilon_r = 41.68$; $\rho = 1000$ kg/m³

Ambient Temperature: 22.0°C Liquid Temperature: 21.6°C

Communication System: GSM Frequency: 824.2 MHz Duty Cycle: 1:8.30042

Probe: ES3DV3 - SN3151 ConvF(6.27, 6.27, 6.27); Calibrated: 4/24/2012

Right Tilt Low/Area Scan (61x91x1): Interpolated grid: dx=1.500 mm, dy=1.500 mm

Reference Value = 12.422 V/m; Power Drift = 0.00 dB

Maximum value of SAR (interpolated) = 0.308 W/kg

Right Tilt Low/Zoom Scan (5x5x7)/Cube 0: Measurement grid: dx=8mm, dy=8mm, dz=5mm

Reference Value = 12.422 V/m; Power Drift = 0.00 dB

Peak SAR (extrapolated) = 0.345 W/kg

SAR(1 g) = 0.292 W/kg; SAR(10 g) = 0.227 W/kg

Maximum value of SAR (measured) = 0.303 W/kg

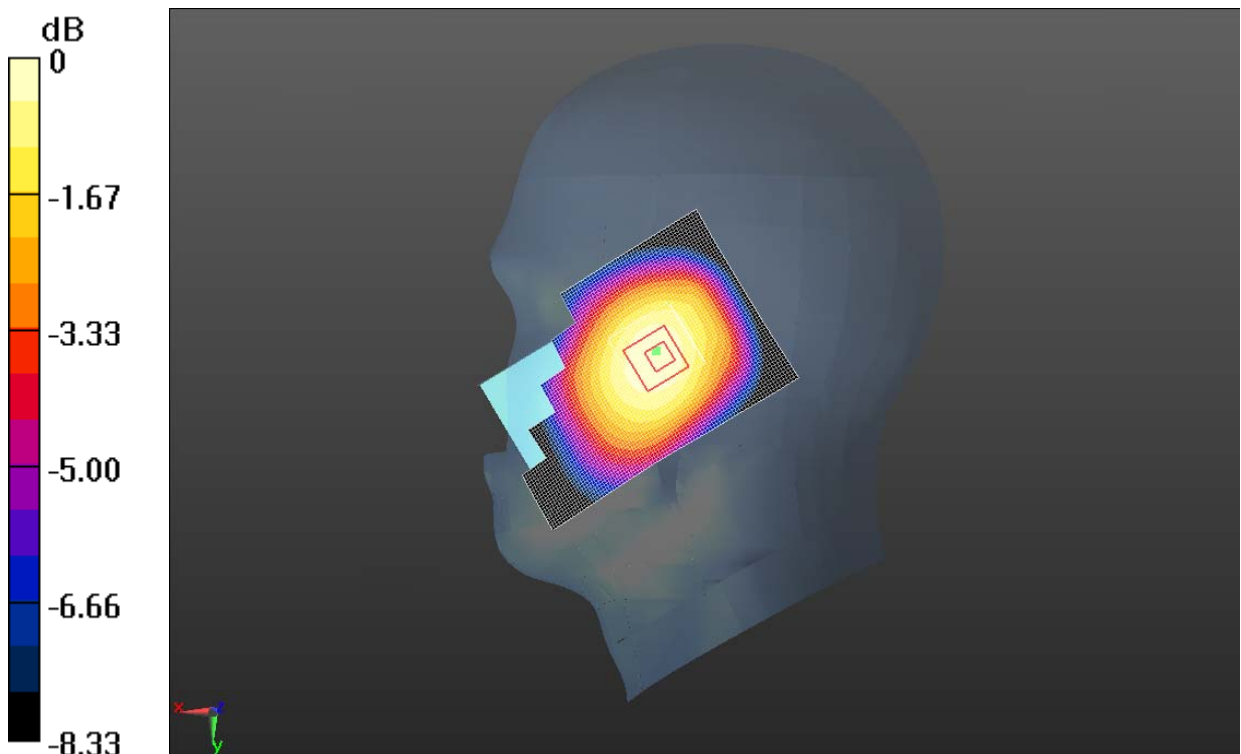

0 dB = 0.303 W/kg = -5.18 dBW/kg

Fig. 12 850 MHz CH128

850 Body Toward Phantom Middle with GPRS

Date/Time: 2/6/2013

Electronics: DAE4 Sn786

Medium: Body 900

Medium parameters used (interpolated): $f = 836.6$ MHz; $\sigma = 0.978$ S/m; $\epsilon_r = 54.315$; $\rho = 1000$ kg/m³

Ambient Temperature: 21.2°C Liquid Temperature: 20.7°C

Communication System: 4 slot GPRS Frequency: 836.6 MHz Duty Cycle: 1:2.08018

Probe: ES3DV3 - SN3151 ConvF(6.07, 6.07, 6.07); Calibrated: 4/24/2012

Towards Phantom Middle/Area Scan (51x101x1): Interpolated grid: dx=1.500 mm, dy=1.500 mm

Reference Value = 27.479 V/m; Power Drift = -0.04 dB

Maximum value of SAR (interpolated) = 1.05 W/kg

Towards Phantom Middle/Zoom Scan (5x5x7)/Cube 0: Measurement grid: dx=8mm, dy=8mm, dz=5mm

Reference Value = 27.479 V/m; Power Drift = -0.04 dB

Peak SAR (extrapolated) = 1.25 W/kg

SAR(1 g) = 1.01 W/kg; SAR(10 g) = 0.765 W/kg

Maximum value of SAR (measured) = 1.06 W/kg

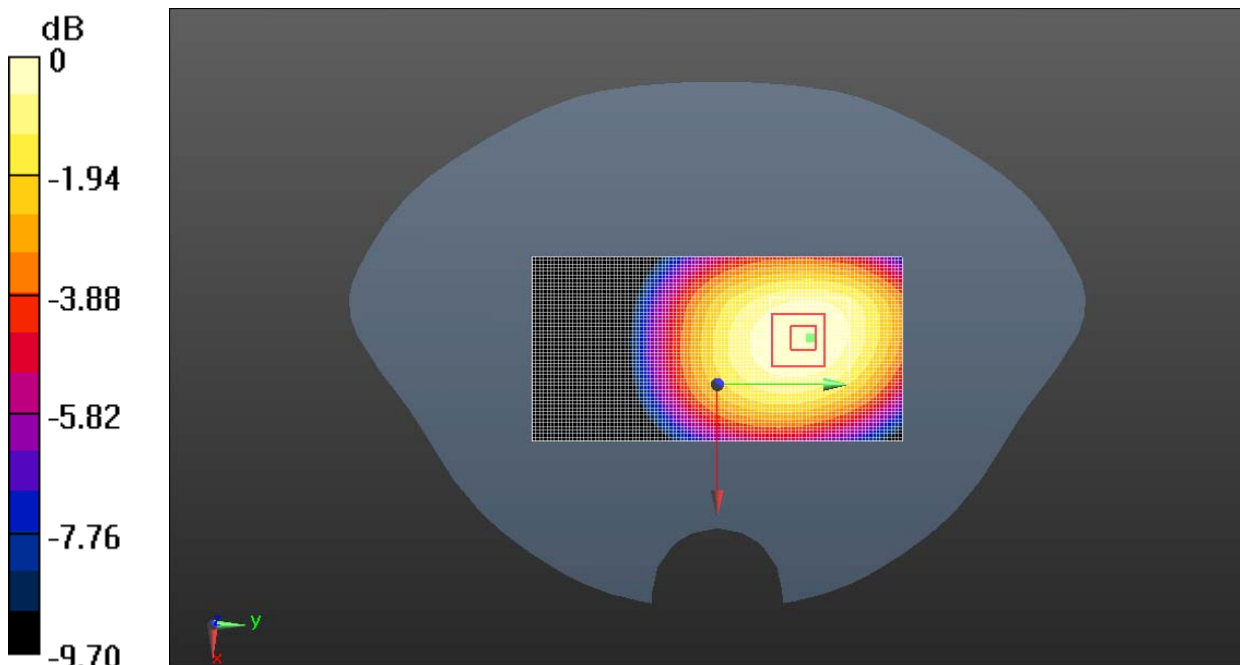

0 dB = 1.06 W/kg = 0.24 dBW/kg

Fig. 13 850 MHz CH190

850 Body Toward Ground High with GPRS

Date/Time: 2/6/2013

Electronics: DAE4 Sn786

Medium: Body 900

Medium parameters used (interpolated): $f = 848.8$ MHz; $\sigma = 0.991$ S/m; $\epsilon_r = 54.231$; $\rho = 1000$ kg/m³

Ambient Temperature: 21.2°C Liquid Temperature: 20.7°C

Communication System: 4 slot GPRS Frequency: 848.8 MHz Duty Cycle: 1:2.08018

Probe: ES3DV3 - SN3151 ConvF(6.07, 6.07, 6.07); Calibrated: 4/24/2012

Towards Ground High/Area Scan (51x101x1): Interpolated grid: dx=1.500 mm, dy=1.500 mm

Reference Value = 30.372 V/m; Power Drift = -0.07 dB

Maximum value of SAR (interpolated) = 1.21 W/kg

Towards Ground High/Zoom Scan (5x5x7)/Cube 0: Measurement grid: dx=8mm, dy=8mm, dz=5mm

Reference Value = 30.372 V/m; Power Drift = -0.07 dB

Peak SAR (extrapolated) = 1.45 W/kg

SAR(1 g) = 1.14 W/kg; SAR(10 g) = 0.845 W/kg

Maximum value of SAR (measured) = 1.20 W/kg

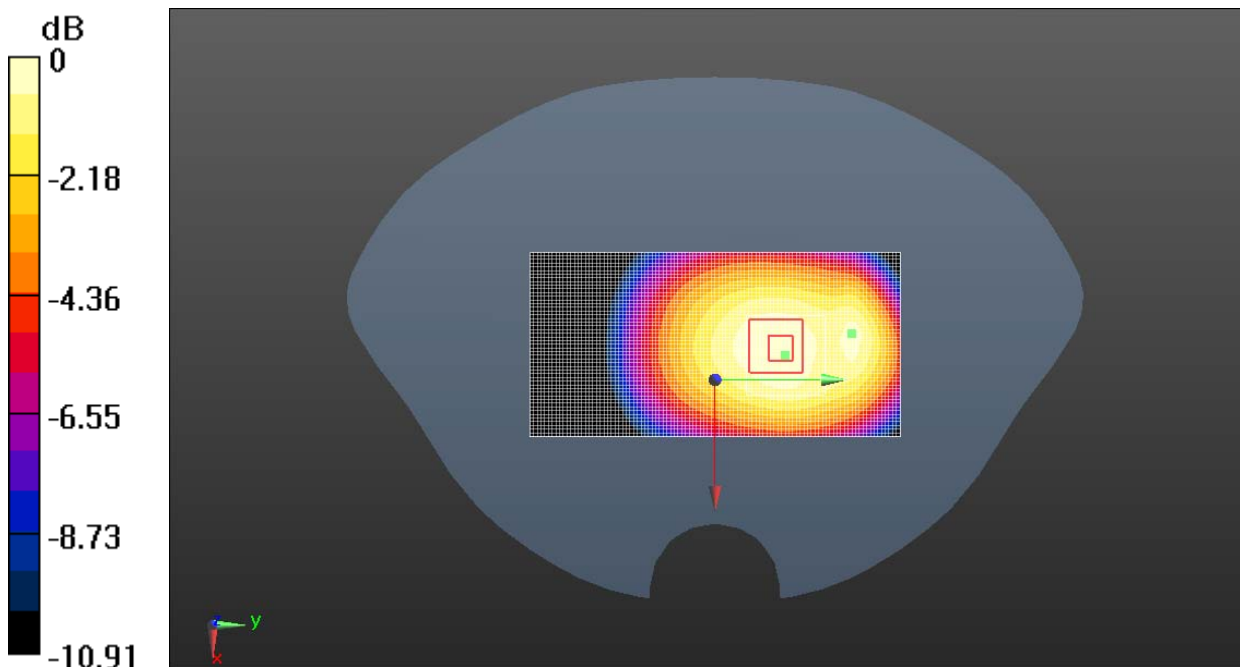

0 dB = 1.20 W/kg = 0.77 dBW/kg

Fig. 14 850 MHz CH251

850 Body Toward Ground Middle with GPRS

Date/Time: 2/6/2013

Electronics: DAE4 Sn786

Medium: Body 900

Medium parameters used (interpolated): $f = 836.6$ MHz; $\sigma = 0.978$ S/m; $\epsilon_r = 54.315$; $\rho = 1000$ kg/m³

Ambient Temperature: 21.2°C Liquid Temperature: 20.7°C

Communication System: 4 slot GPRS Frequency: 836.6 MHz Duty Cycle: 1:2.08018

Probe: ES3DV3 - SN3151 ConvF(6.07, 6.07, 6.07); Calibrated: 4/24/2012

Towards Ground Middle/Area Scan (51x101x1): Interpolated grid: dx=1.500 mm, dy=1.500 mm

Reference Value = 30.748 V/m; Power Drift = -0.05 dB

Maximum value of SAR (interpolated) = 1.32 W/kg

Towards Ground Middle/Zoom Scan (5x5x7)/Cube 0: Measurement grid: dx=8mm, dy=8mm, dz=5mm

Reference Value = 30.748 V/m; Power Drift = -0.05 dB

Peak SAR (extrapolated) = 1.58 W/kg

SAR(1 g) = 1.25 W/kg; SAR(10 g) = 0.925 W/kg

Maximum value of SAR (measured) = 1.32 W/kg

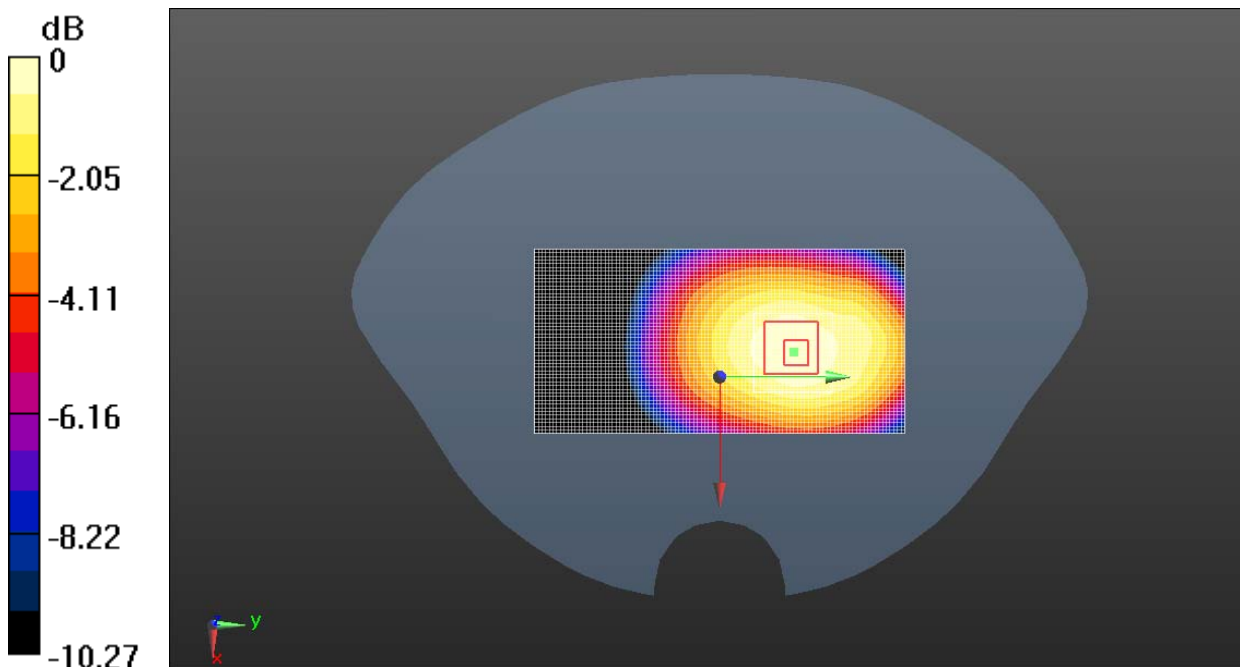

0 dB = 1.32 W/kg = 1.20 dBW/kg

Fig. 15 850 MHz CH190

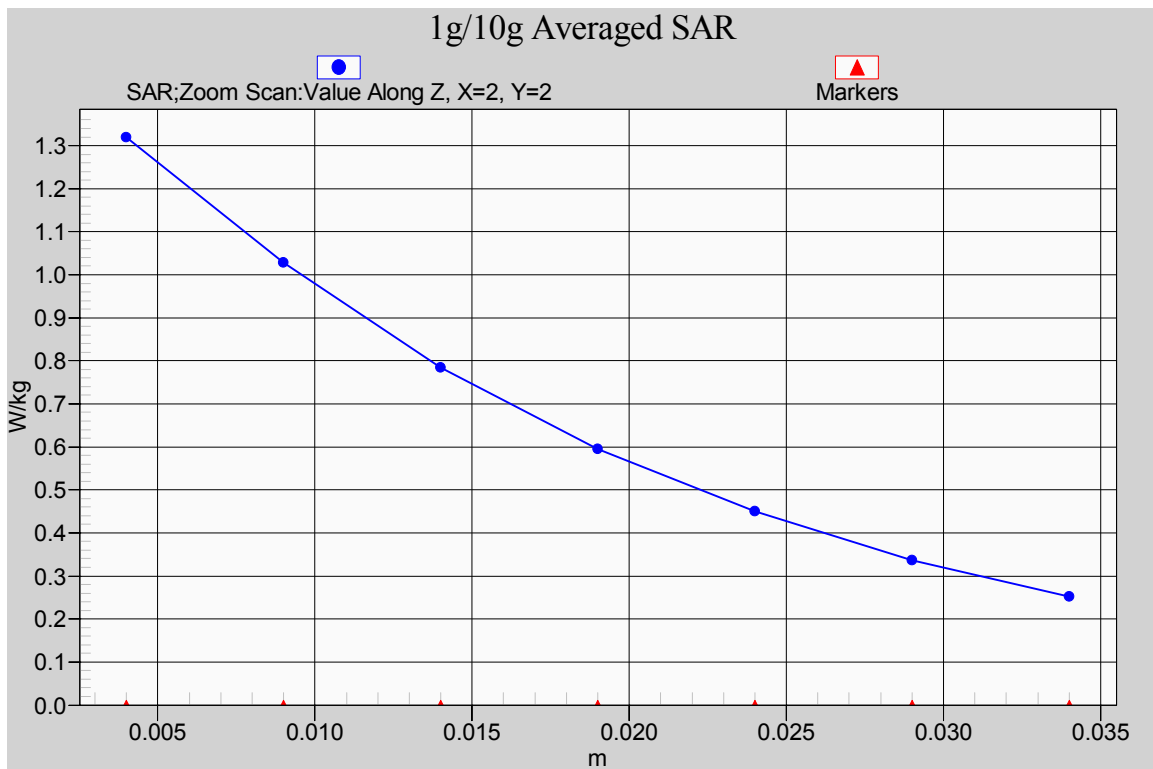

Fig. 15-1 Z-Scan at power reference point (850 MHz CH190)

850 Body Toward Ground Low with GPRS

Date/Time: 2/6/2013

Electronics: DAE4 Sn786

Medium: Body 900

Medium parameters used (interpolated): $f = 824.2$ MHz; $\sigma = 0.965$ S/m; $\epsilon_r = 54.407$; $\rho = 1000$ kg/m³

Ambient Temperature: 21.2°C Liquid Temperature: 20.7°C

Communication System: 4 slot GPRS Frequency: 824.2 MHz Duty Cycle: 1:2.08018

Probe: ES3DV3 - SN3151 ConvF(6.07, 6.07, 6.07); Calibrated: 4/24/2012

Towards Ground Low/Area Scan (51x101x1): Interpolated grid: dx=1.500 mm, dy=1.500 mm

Reference Value = 30.577 V/m; Power Drift = 0.03 dB

Maximum value of SAR (interpolated) = 1.28 W/kg

Towards Ground Low/Zoom Scan (5x5x7)/Cube 0: Measurement grid: dx=8mm, dy=8mm, dz=5mm

Reference Value = 30.577 V/m; Power Drift = 0.03 dB

Peak SAR (extrapolated) = 1.52 W/kg

SAR(1 g) = 1.2 W/kg; SAR(10 g) = 0.886 W/kg

Maximum value of SAR (measured) = 1.26 W/kg

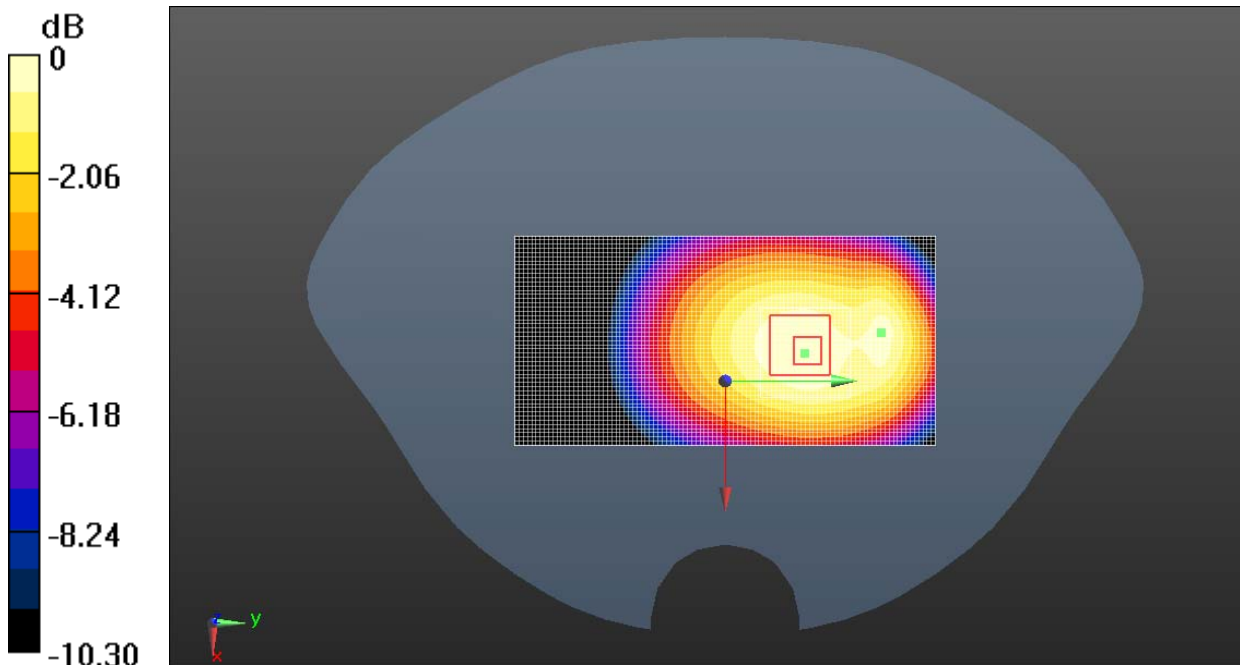

0 dB = 1.26 W/kg = 1.00 dBW/kg

Fig. 16 850 MHz CH128

850 Body Left Side High with GPRS

Date/Time: 2/6/2013

Electronics: DAE4 Sn786

Medium: Body 900

Medium parameters used (interpolated): $f = 848.8$ MHz; $\sigma = 0.991$ S/m; $\epsilon_r = 54.231$; $\rho = 1000$ kg/m³

Ambient Temperature: 21.2°C Liquid Temperature: 20.7°C

Communication System: 4 slot GPRS Frequency: 848.8 MHz Duty Cycle: 1:2.08018

Probe: ES3DV3 - SN3151 ConvF(6.07, 6.07, 6.07); Calibrated: 4/24/2012

Left side High/Area Scan (51x101x1): Interpolated grid: dx=1.500 mm, dy=1.500 mm

Reference Value = 28.522 V/m; Power Drift = -0.02 dB

Maximum value of SAR (interpolated) = 0.928 W/kg

Left side High/Zoom Scan (5x5x7)/Cube 0: Measurement grid: dx=8mm, dy=8mm, dz=5mm

Reference Value = 28.522 V/m; Power Drift = -0.02 dB

Peak SAR (extrapolated) = 1.19 W/kg

SAR(1 g) = 0.864 W/kg; SAR(10 g) = 0.599 W/kg

Maximum value of SAR (measured) = 0.924 W/kg

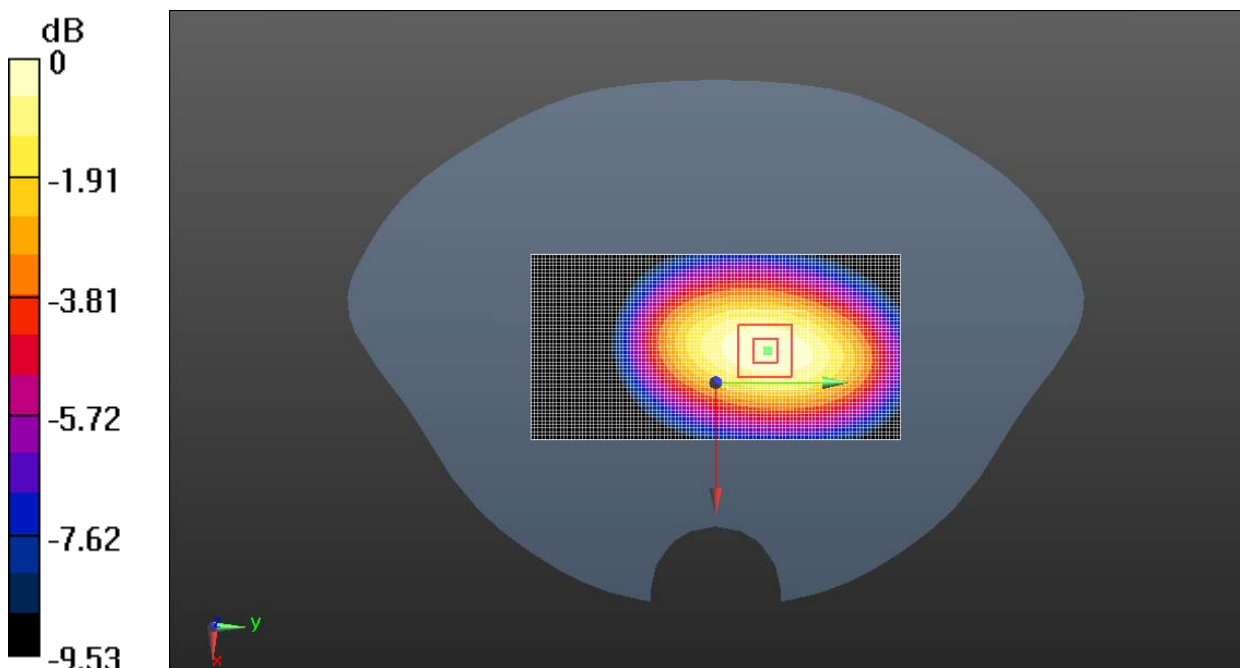

0 dB = 0.924 W/kg = -0.34 dBW/kg

Fig. 17 850 MHz CH251

850 Body Left Side Middle with GPRS

Date/Time: 2/6/2013

Electronics: DAE4 Sn786

Medium: Body 900

Medium parameters used (interpolated): $f = 836.6$ MHz; $\sigma = 0.978$ S/m; $\epsilon_r = 54.315$; $\rho = 1000$ kg/m³

Ambient Temperature: 21.2°C Liquid Temperature: 20.7°C

Communication System: 4 slot GPRS Frequency: 836.6 MHz Duty Cycle: 1:2.08018

Probe: ES3DV3 - SN3151 ConvF(6.07, 6.07, 6.07); Calibrated: 4/24/2012

Left side Middle/Area Scan (51x101x1): Interpolated grid: dx=1.500 mm, dy=1.500 mm

Reference Value = 29.839 V/m; Power Drift = -0.19 dB

Maximum value of SAR (interpolated) = 0.875 W/kg

Left side Middle/Zoom Scan (5x5x7)/Cube 0: Measurement grid: dx=8mm, dy=8mm, dz=5mm

Reference Value = 29.839 V/m; Power Drift = -0.19 dB

Peak SAR (extrapolated) = 1.11 W/kg

SAR(1 g) = 0.818 W/kg; SAR(10 g) = 0.570 W/kg

Maximum value of SAR (measured) = 0.875 W/kg

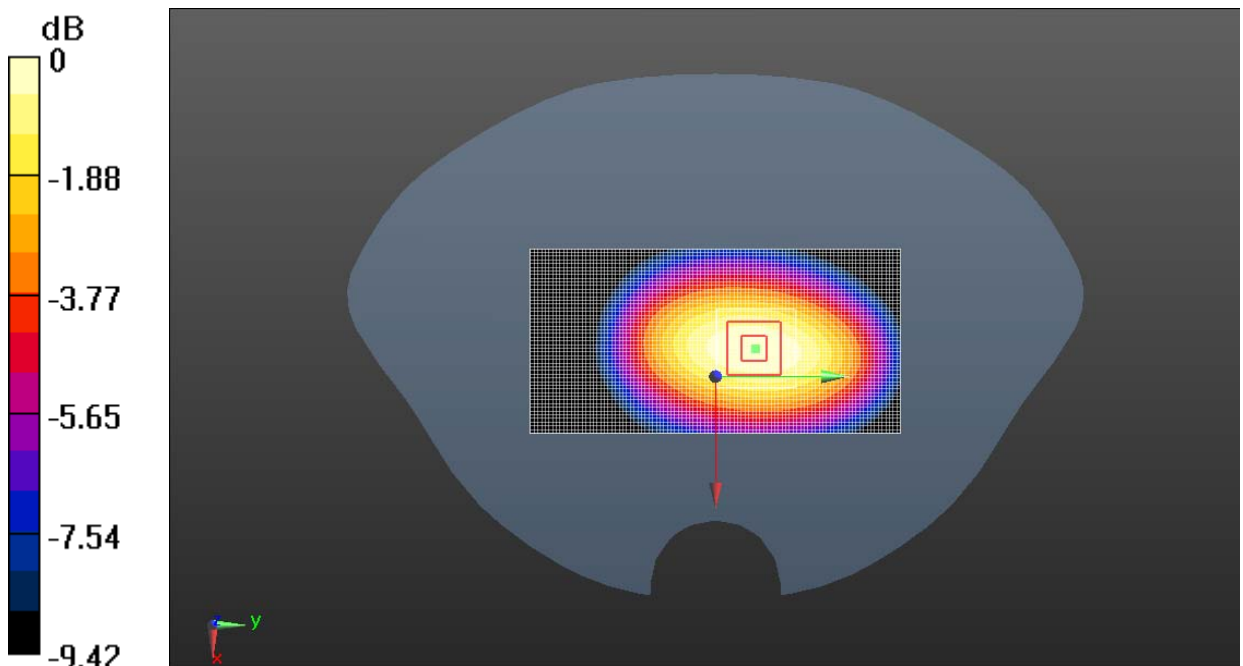

0 dB = 0.875 W/kg = -0.58 dBW/kg

Fig. 18 850 MHz CH190

850 Body Left Side Low with GPRS

Date/Time: 2/6/2013

Electronics: DAE4 Sn786

Medium: Body 900

Medium parameters used (interpolated): $f = 824.2$ MHz; $\sigma = 0.965$ S/m; $\epsilon_r = 54.407$; $\rho = 1000$ kg/m³

Ambient Temperature: 21.2°C Liquid Temperature: 20.7°C

Communication System: 4 slot GPRS Frequency: 824.2 MHz Duty Cycle: 1:2.08018

Probe: ES3DV3 - SN3151 ConvF(6.07, 6.07, 6.07); Calibrated: 4/24/2012

Left side Low/Area Scan (51x101x1): Interpolated grid: dx=1.500 mm, dy=1.500 mm

Reference Value = 27.870 V/m; Power Drift = 0.03 dB

Maximum value of SAR (interpolated) = 0.842 W/kg

Left side Low/Zoom Scan (5x5x7)/Cube 0: Measurement grid: dx=8mm, dy=8mm, dz=5mm

Reference Value = 27.870 V/m; Power Drift = 0.03 dB

Peak SAR (extrapolated) = 1.07 W/kg

SAR(1 g) = 0.784 W/kg; SAR(10 g) = 0.547 W/kg

Maximum value of SAR (measured) = 0.838 W/kg

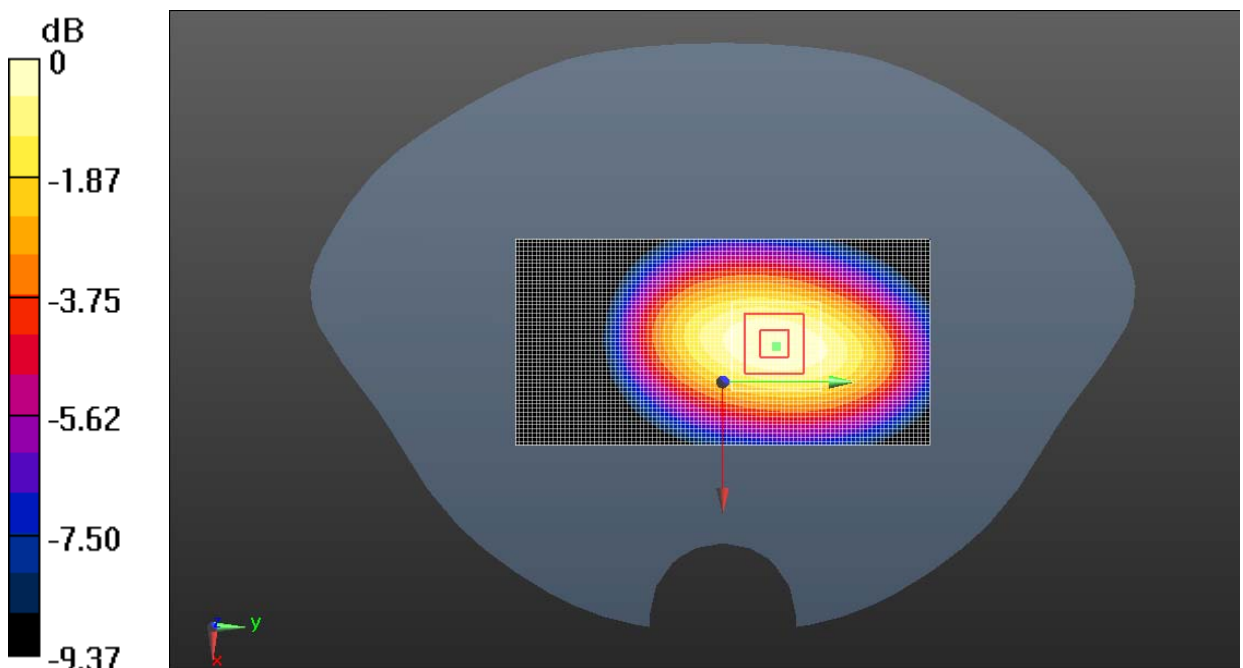

0 dB = 0.838 W/kg = -0.77 dBW/kg

Fig. 19 850 MHz CH128

850 Body Right Side High with GPRS

Date/Time: 2/6/2013

Electronics: DAE4 Sn786

Medium: Body 900

Medium parameters used (interpolated): $f = 848.8$ MHz; $\sigma = 0.991$ S/m; $\epsilon_r = 54.231$; $\rho = 1000$ kg/m³

Ambient Temperature: 21.2°C Liquid Temperature: 20.7°C

Communication System: 4 slot GPRS Frequency: 848.8 MHz Duty Cycle: 1:2.08018

Probe: ES3DV3 - SN3151 ConvF(6.07, 6.07, 6.07); Calibrated: 4/24/2012

Right side High/Area Scan (51x101x1): Interpolated grid: dx=1.500 mm, dy=1.500 mm

Reference Value = 27.039 V/m; Power Drift = -0.01 dB

Maximum value of SAR (interpolated) = 0.953 W/kg

Right side High/Zoom Scan (5x5x7)/Cube 0: Measurement grid: dx=8mm, dy=8mm, dz=5mm

Reference Value = 27.039 V/m; Power Drift = -0.01 dB

Peak SAR (extrapolated) = 1.23 W/kg

SAR(1 g) = 0.892 W/kg; SAR(10 g) = 0.614 W/kg

Maximum value of SAR (measured) = 0.957 W/kg

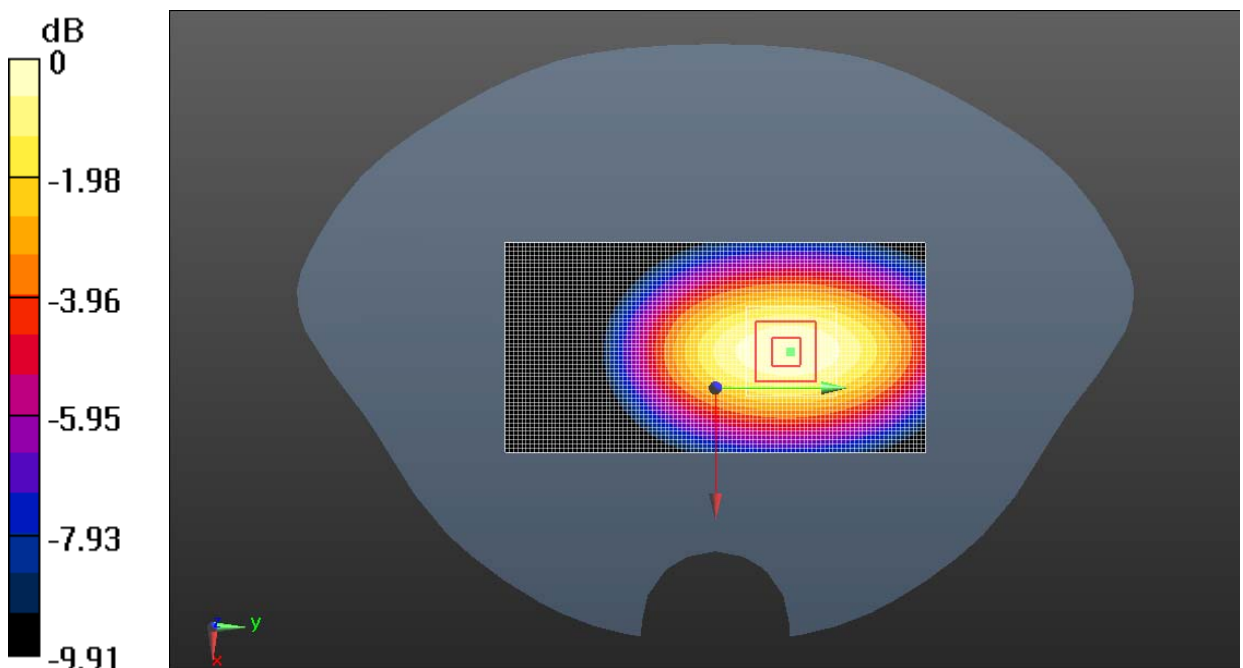

0 dB = 0.957 W/kg = -0.19 dBW/kg

Fig. 20 850 MHz CH251

850 Body Right Side Middle with GPRS

Date/Time: 2/6/2013

Electronics: DAE4 Sn786

Medium: Body 900

Medium parameters used (interpolated): $f = 836.6$ MHz; $\sigma = 0.978$ S/m; $\epsilon_r = 54.315$; $\rho = 1000$ kg/m³

Ambient Temperature: 21.2°C Liquid Temperature: 20.7°C

Communication System: 4 slot GPRS Frequency: 836.6 MHz Duty Cycle: 1:2.08018

Probe: ES3DV3 - SN3151 ConvF(6.07, 6.07, 6.07); Calibrated: 4/24/2012

Right side Middle/Area Scan (51x101x1): Interpolated grid: dx=1.500 mm, dy=1.500 mm

Reference Value = 25.849 V/m; Power Drift = -0.06 dB

Maximum value of SAR (interpolated) = 0.919 W/kg

Right side Middle/Zoom Scan (5x5x7)/Cube 0: Measurement grid: dx=8mm, dy=8mm, dz=5mm

Reference Value = 25.849 V/m; Power Drift = -0.06 dB

Peak SAR (extrapolated) = 1.17 W/kg

SAR(1 g) = 0.856 W/kg; SAR(10 g) = 0.591 W/kg

Maximum value of SAR (measured) = 0.916 W/kg

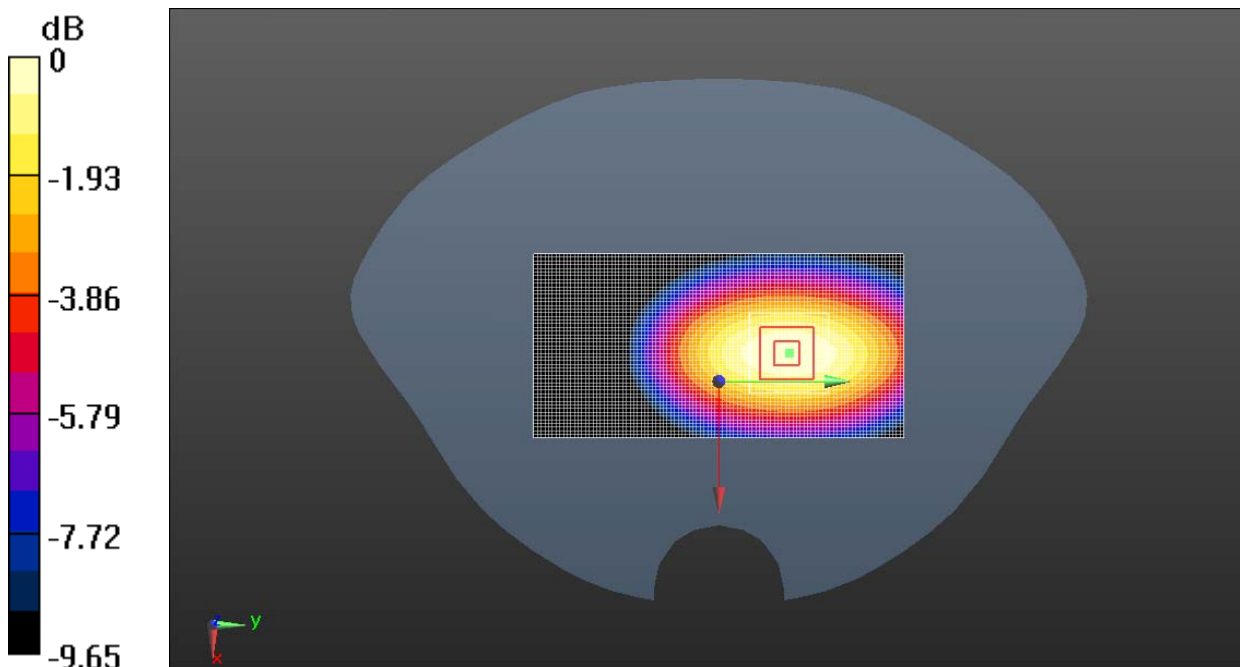

0 dB = 0.916 W/kg = -0.38 dBW/kg

Fig. 21 850 MHz CH190

850 Body Right Side Low with GPRS

Date/Time: 2/6/2013

Electronics: DAE4 Sn786

Medium: Body 900

Medium parameters used (interpolated): $f = 824.2$ MHz; $\sigma = 0.965$ S/m; $\epsilon_r = 54.407$; $\rho = 1000$ kg/m³

Ambient Temperature: 21.2°C Liquid Temperature: 20.7°C

Communication System: 4 slot GPRS Frequency: 824.2 MHz Duty Cycle: 1:2.08018

Probe: ES3DV3 - SN3151 ConvF(6.07, 6.07, 6.07); Calibrated: 4/24/2012

Right side Low/Area Scan (51x101x1): Interpolated grid: dx=1.500 mm, dy=1.500 mm

Reference Value = 23.563 V/m; Power Drift = 0.00 dB

Maximum value of SAR (interpolated) = 0.734 W/kg

Right side Low/Zoom Scan (5x5x7)/Cube 0: Measurement grid: dx=8mm, dy=8mm, dz=5mm

Reference Value = 23.563 V/m; Power Drift = 0.00 dB

Peak SAR (extrapolated) = 0.944 W/kg

SAR(1 g) = 0.690 W/kg; SAR(10 g) = 0.477 W/kg

Maximum value of SAR (measured) = 0.741 W/kg

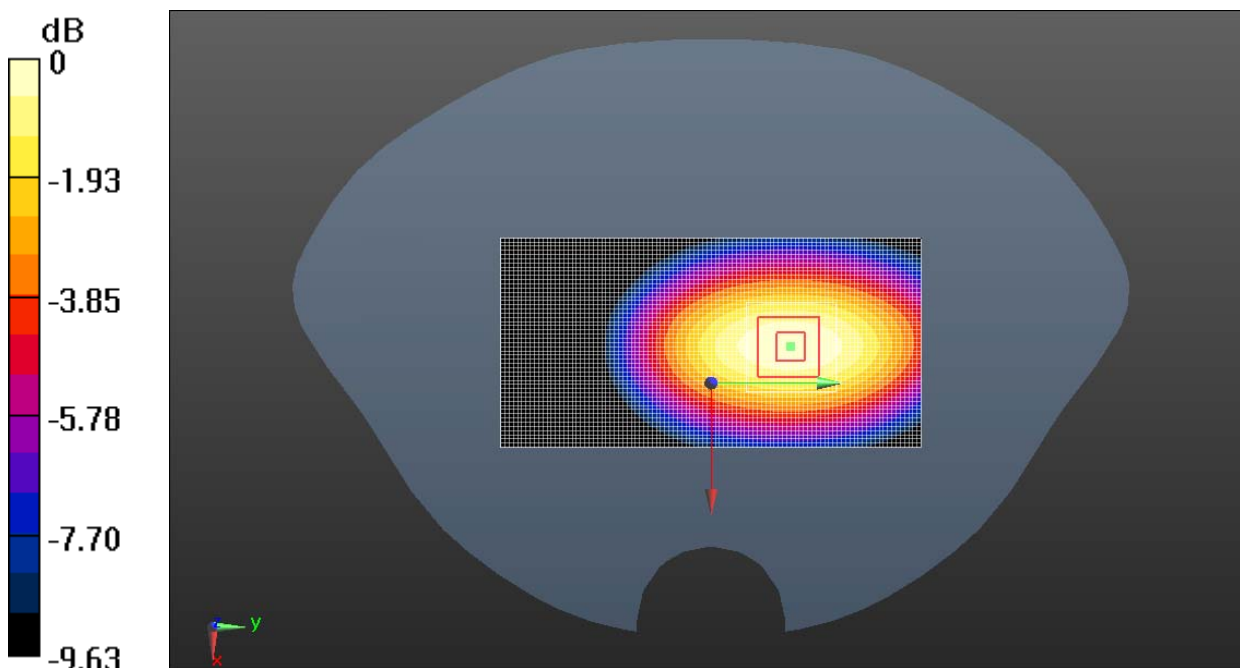

0 dB = 0.741 W/kg = -1.30 dBW/kg

Fig. 22 850 MHz CH128

850 Body Bottom Side Middle with GPRS

Date/Time: 2/6/2013

Electronics: DAE4 Sn786

Medium: Body 900

Medium parameters used (interpolated): $f = 836.6$ MHz; $\sigma = 0.978$ S/m; $\epsilon_r = 54.315$; $\rho = 1000$ kg/m³

Ambient Temperature: 21.2°C Liquid Temperature: 20.7°C

Communication System: 4 slot GPRS Frequency: 836.6 MHz Duty Cycle: 1:2.08018

Probe: ES3DV3 - SN3151 ConvF(6.07, 6.07, 6.07); Calibrated: 4/24/2012

Bottom side Middle/Area Scan (41x61x1): Interpolated grid: dx=1.500 mm, dy=1.500 mm

Reference Value = 10.465 V/m; Power Drift = 0.10 dB

Maximum value of SAR (interpolated) = 0.161 W/kg

Bottom side Middle/Zoom Scan (5x5x7)/Cube 0: Measurement grid: dx=8mm, dy=8mm, dz=5mm

Reference Value = 10.465 V/m; Power Drift = 0.10 dB

Peak SAR (extrapolated) = 0.258 W/kg

SAR(1 g) = 0.146 W/kg; SAR(10 g) = 0.084 W/kg

Maximum value of SAR (measured) = 0.162 W/kg

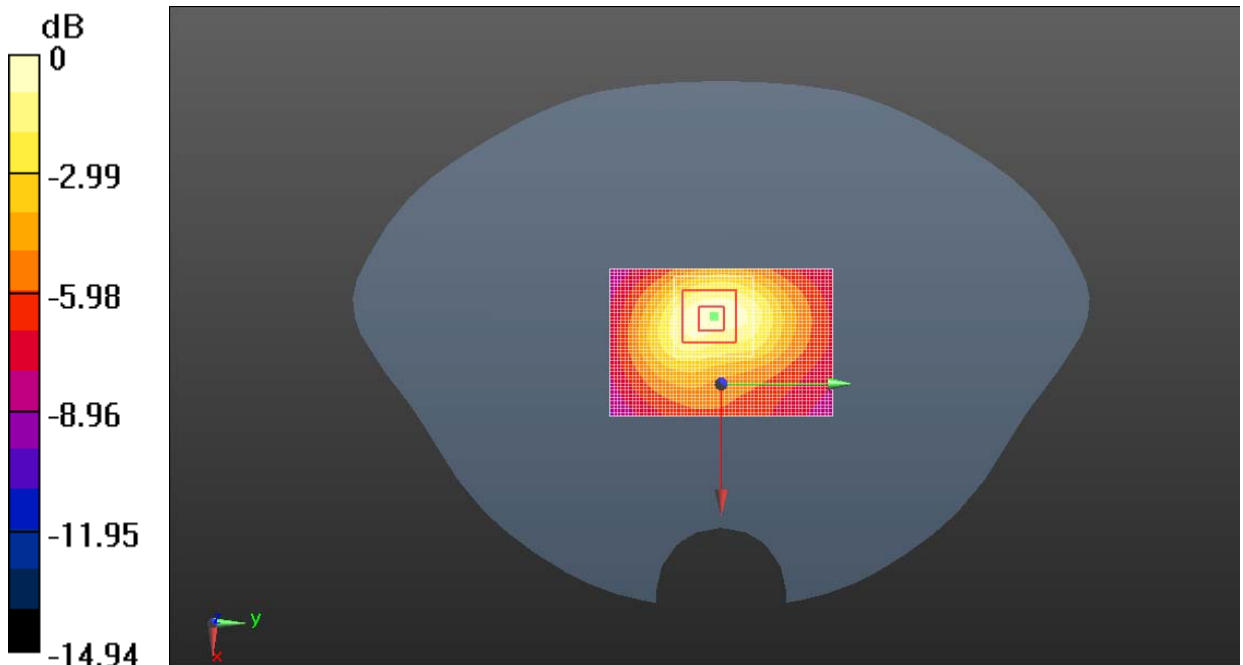

0 dB = 0.162 W/kg = -7.91 dBW/kg

Fig. 23 850 MHz CH190

850 Body Toward Ground Middle with Headset AE3

Date/Time: 2/6/2013

Electronics: DAE4 Sn786

Medium: Body 900

Medium parameters used (interpolated): $f = 836.6$ MHz; $\sigma = 0.978$ S/m; $\epsilon_r = 54.315$; $\rho = 1000$ kg/m³

Ambient Temperature: 21.2°C Liquid Temperature: 20.7°C

Communication System: GSM Frequency: 836.6 MHz Duty Cycle: 1:8.30042

Probe: ES3DV3 - SN3151 ConvF(6.07, 6.07, 6.07); Calibrated: 4/24/2012

Towards Ground Middle With headset AE3/Area Scan (51x101x1): Interpolated grid: dx=1.500 mm, dy=1.500 mm

Reference Value = 26.574 V/m; Power Drift = 0.04 dB

Maximum value of SAR (interpolated) = 0.898 W/kg

Towards Ground Middle With headset AE3/Zoom Scan (5x5x7)/Cube 0:

Measurement grid: dx=8mm, dy=8mm, dz=5mm

Reference Value = 26.574 V/m; Power Drift = 0.04 dB

Peak SAR (extrapolated) = 1.07 W/kg

SAR(1 g) = 0.854 W/kg; SAR(10 g) = 0.634 W/kg

Maximum value of SAR (measured) = 0.899 W/kg

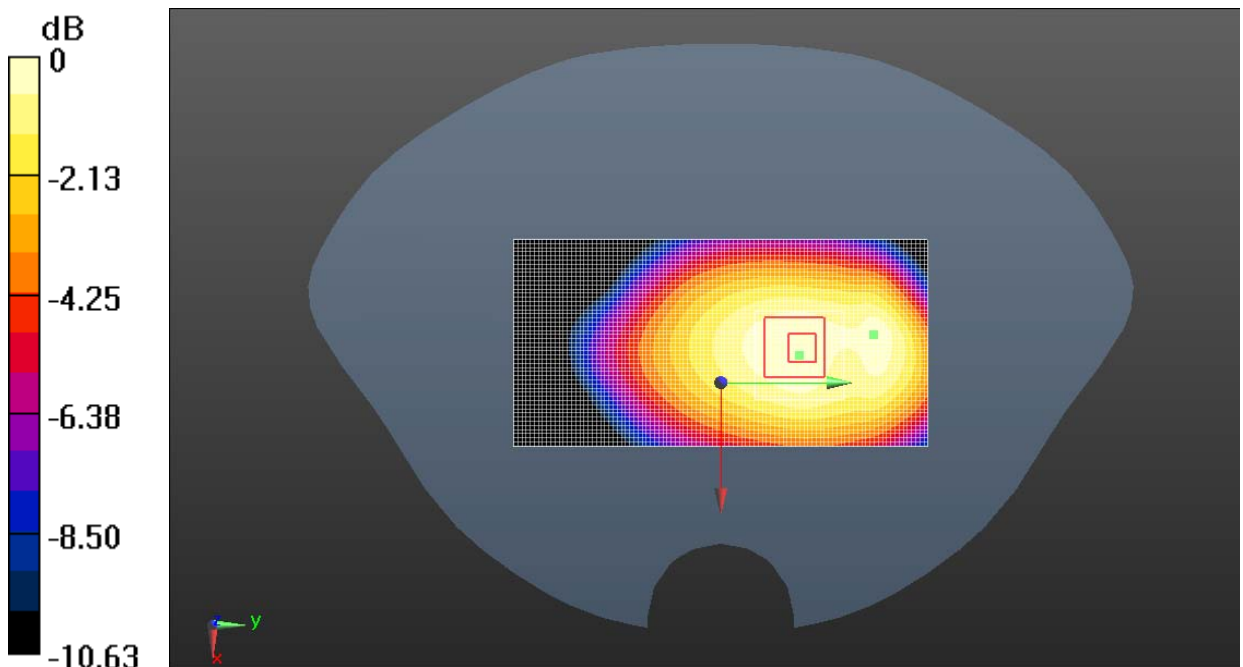

0 dB = 0.899 W/kg = -0.46 dBW/kg

Fig. 24 850 MHz CH190

850 Body Toward Ground Middle with Headset AE4

Date/Time: 2/6/2013

Electronics: DAE4 Sn786

Medium: Body 900

Medium parameters used (interpolated): $f = 836.6$ MHz; $\sigma = 0.978$ S/m; $\epsilon_r = 54.315$; $\rho = 1000$ kg/m³

Ambient Temperature: 21.2°C Liquid Temperature: 20.7°C

Communication System: GSM Frequency: 836.6 MHz Duty Cycle: 1:8.30042

Probe: ES3DV3 - SN3151 ConvF(6.07, 6.07, 6.07); Calibrated: 4/24/2012

Towards Ground Middle With headset AE4/Area Scan (51x101x1): Interpolated grid: dx=1.500 mm, dy=1.500 mm

Reference Value = 28.076 V/m; Power Drift = -0.02 dB

Maximum value of SAR (interpolated) = 1.02 W/kg

Towards Ground Middle With headset AE4/Zoom Scan (5x5x7)/Cube 0:

Measurement grid: dx=8mm, dy=8mm, dz=5mm

Reference Value = 28.076 V/m; Power Drift = -0.02 dB

Peak SAR (extrapolated) = 1.22 W/kg

SAR(1 g) = 0.976 W/kg; SAR(10 g) = 0.729 W/kg

Maximum value of SAR (measured) = 1.03 W/kg

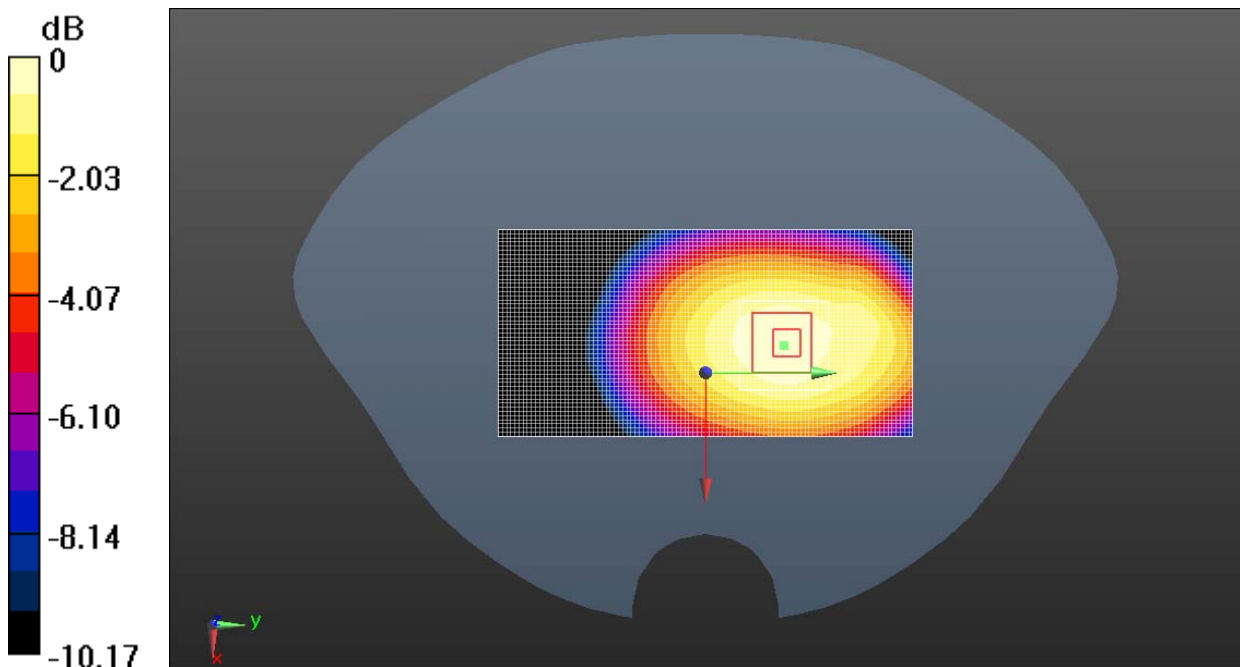

0 dB = 1.03 W/kg = 0.12 dBW/kg

Fig. 25 850 MHz CH190

850 Body Toward Ground Middle with EGPRS

Date/Time: 2/6/2013

Electronics: DAE4 Sn786

Medium: Body 900

Medium parameters used (interpolated): $f = 836.6$ MHz; $\sigma = 0.978$ S/m; $\epsilon_r = 54.315$; $\rho = 1000$ kg/m³

Ambient Temperature: 21.2°C Liquid Temperature: 20.7°C

Communication System: 4 slot GPRS Frequency: 836.6 MHz Duty Cycle: 1:2.08018

Probe: ES3DV3 - SN3151 ConvF(6.07, 6.07, 6.07); Calibrated: 4/24/2012

Towards Ground Middle _E/Area Scan (51x101x1): Interpolated grid: dx=1.500 mm, dy=1.500 mm

Reference Value = 34.262 V/m; Power Drift = 0.00 dB

Maximum value of SAR (interpolated) = 1.24 W/kg

Towards Ground Middle _E/Zoom Scan (5x5x7)/Cube 0: Measurement grid: dx=8mm, dy=8mm, dz=5mm

Reference Value = 34.262 V/m; Power Drift = 0.00 dB

Peak SAR (extrapolated) = 1.49 W/kg

SAR(1 g) = 1.18 W/kg; SAR(10 g) = 0.881 W/kg

Maximum value of SAR (measured) = 1.24 W/kg

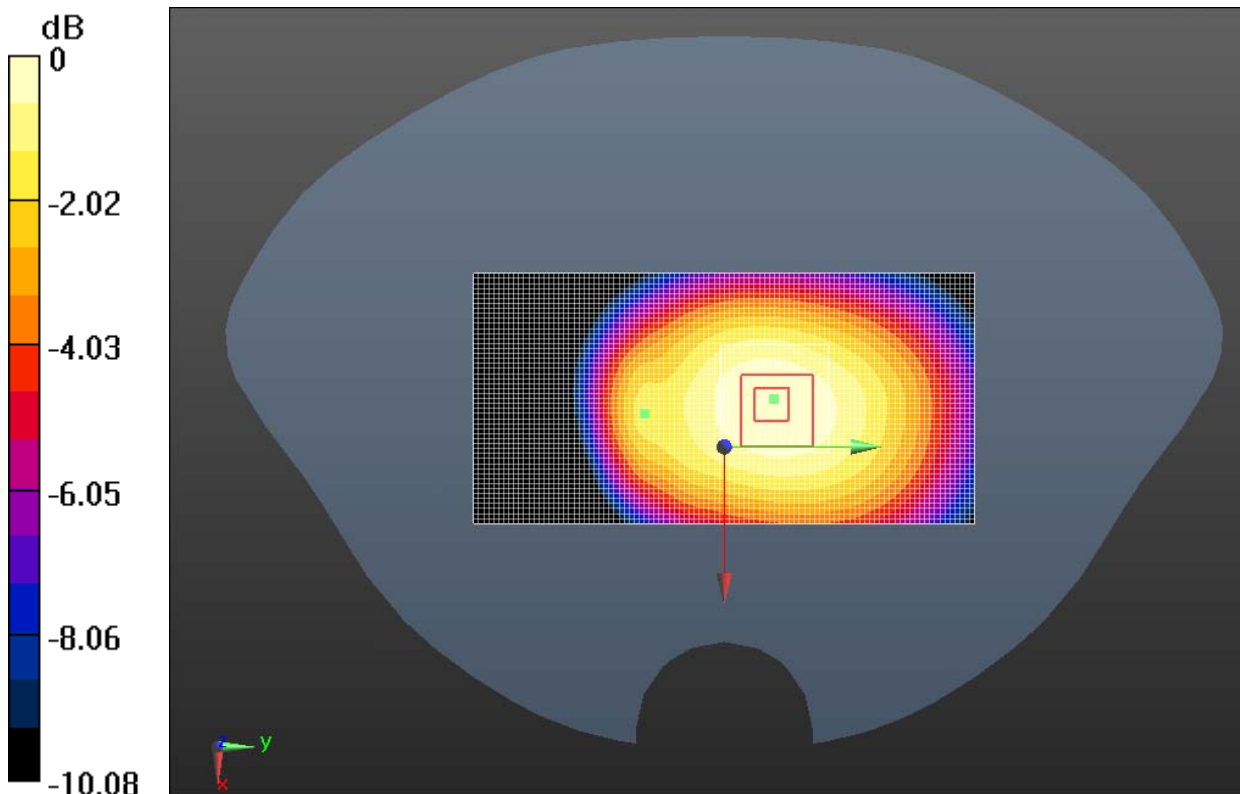

0 dB = 1.24 W/kg = 0.95 dBW/kg

Fig. 26 850 MHz CH190

GSM 1900 Left Cheek High

Date/Time: 2/22/2013

Electronics: DAE4 Sn786

Medium: Head 1900

Medium parameters used: $f = 1910$ MHz; $\sigma = 1.451$ S/m; $\epsilon_r = 39.149$; $\rho = 1000$ kg/m³

Ambient Temperature: 22.1°C Liquid Temperature: 21.7°C

Communication System: GSM Frequency: 1910 MHz Duty Cycle: 1:8.30042

Probe: ES3DV3 - SN3151 ConvF(5.06, 5.06, 5.06); Calibrated: 4/24/2012

Left Cheek High/Area Scan (61x91x1): Interpolated grid: dx=1.500 mm, dy=1.500 mm

Reference Value = 7.159 V/m; Power Drift = -0.07 dB

Maximum value of SAR (interpolated) = 0.449 W/kg

Left Cheek High/Zoom Scan (5x5x7)/Cube 0: Measurement grid: dx=8mm, dy=8mm, dz=5mm

Reference Value = 7.159 V/m; Power Drift = -0.07 dB

Peak SAR (extrapolated) = 0.651 W/kg

SAR(1 g) = 0.403 W/kg; SAR(10 g) = 0.238 W/kg

Maximum value of SAR (measured) = 0.442 W/kg

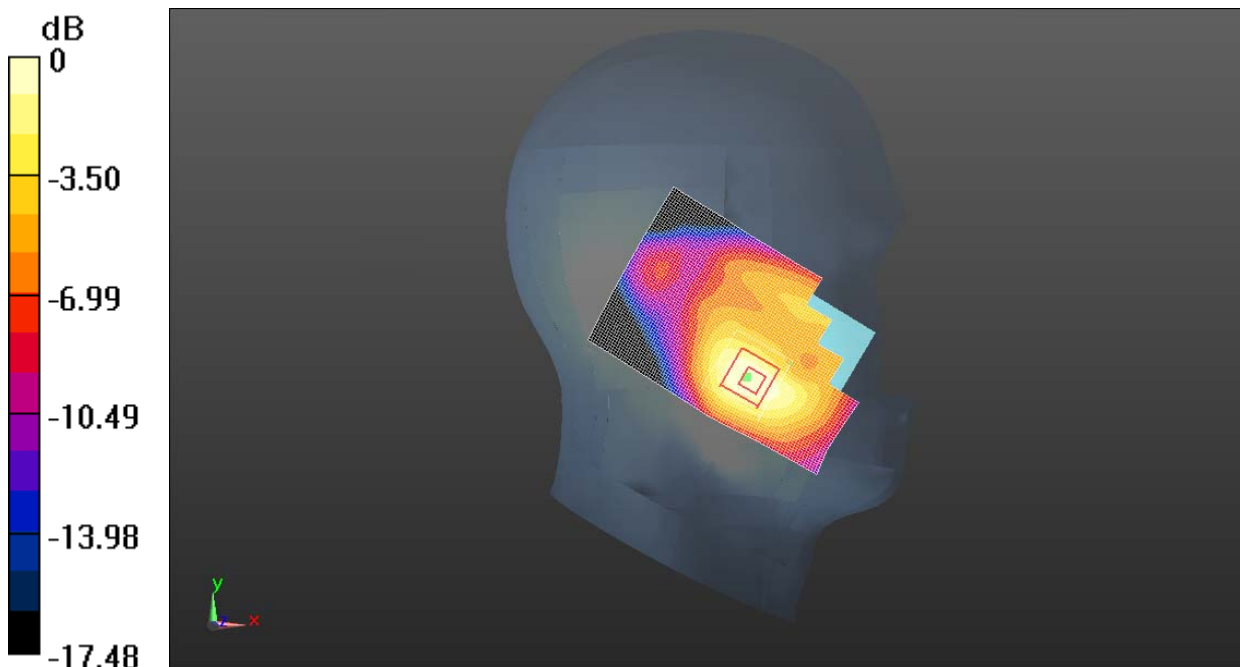

0 dB = 0.442 W/kg = -3.55 dBW/kg

Fig. 27 1900 MHz CH810

GSM 1900 Left Cheek Middle

Date/Time: 2/22/2013

Electronics: DAE4 Sn786

Medium: Head 1900

Medium parameters used: $f = 1880$ MHz; $\sigma = 1.424$ S/m; $\epsilon_r = 39.231$; $\rho = 1000$ kg/m³

Ambient Temperature: 22.1°C Liquid Temperature: 21.7°C

Communication System: GSM Frequency: 1880 MHz Duty Cycle: 1:8.30042

Probe: ES3DV3 - SN3151 ConvF(5.06, 5.06, 5.06); Calibrated: 4/24/2012

Left Cheek Middle/Area Scan (51x91x1): Interpolated grid: dx=1.500 mm, dy=1.500 mm

Reference Value = 6.481 V/m; Power Drift = 0.04 dB

Maximum value of SAR (interpolated) = 0.476 W/kg

Left Cheek Middle/Zoom Scan (5x5x7)/Cube 0: Measurement grid: dx=8mm, dy=8mm, dz=5mm

Reference Value = 6.481 V/m; Power Drift = 0.04 dB

Peak SAR (extrapolated) = 0.666 W/kg

SAR(1 g) = 0.424 W/kg; SAR(10 g) = 0.257 W/kg

Maximum value of SAR (measured) = 0.465 W/kg

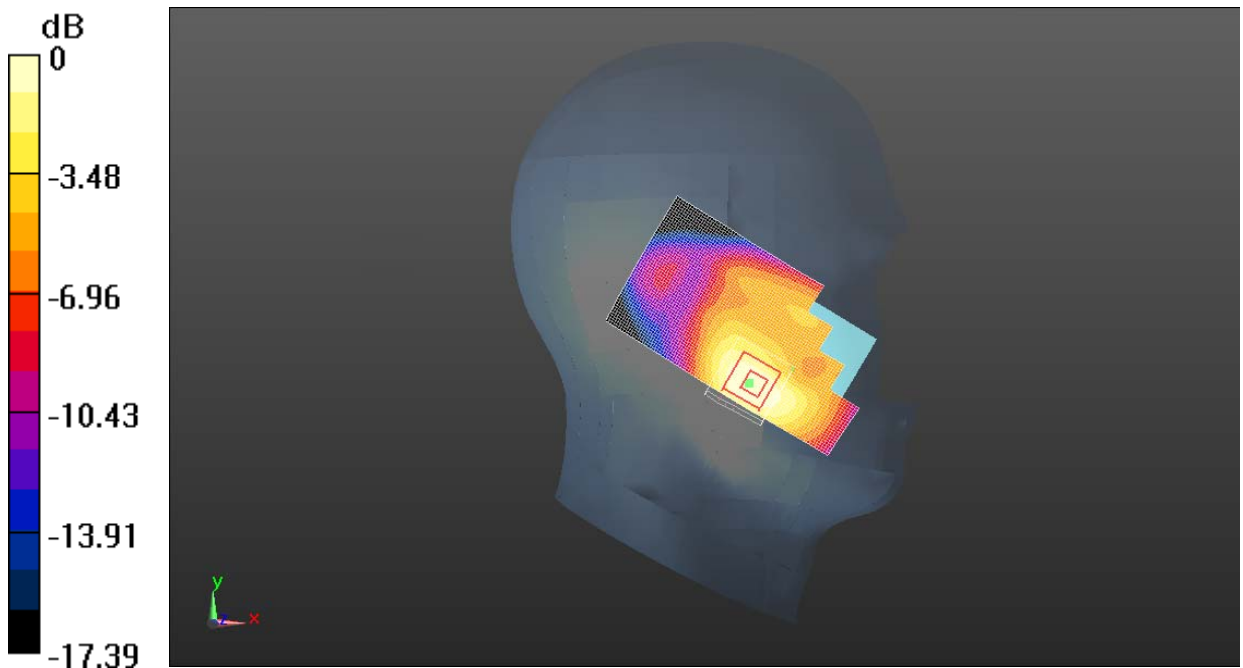

0 dB = 0.465 W/kg = -3.33 dBW/kg

Fig. 28 1900 MHz CH661

GSM 1900 Left Cheek Low

Date/Time: 2/22/2013

Electronics: DAE4 Sn786

Medium: Head 1900

Medium parameters used (interpolated): $f = 1850.2$ MHz; $\sigma = 1.395$ S/m; $\epsilon_r = 39.335$; $\rho = 1000$ kg/m³

Ambient Temperature: 22.1°C Liquid Temperature: 21.7°C

Communication System: GSM Frequency: 1850.2 MHz Duty Cycle: 1:8.30042

Probe: ES3DV3 - SN3151 ConvF(5.06, 5.06, 5.06); Calibrated: 4/24/2012

Left Cheek Low/Area Scan (61x91x1): Interpolated grid: dx=1.500 mm, dy=1.500 mm

Reference Value = 7.032 V/m; Power Drift = -0.05 dB

Maximum value of SAR (interpolated) = 0.571 W/kg

Left Cheek Low/Zoom Scan (5x5x7)/Cube 0: Measurement grid: dx=8mm, dy=8mm, dz=5mm

Reference Value = 7.032 V/m; Power Drift = -0.05 dB

Peak SAR (extrapolated) = 0.808 W/kg

SAR(1 g) = 0.512 W/kg; SAR(10 g) = 0.309 W/kg

Maximum value of SAR (measured) = 0.559 W/kg

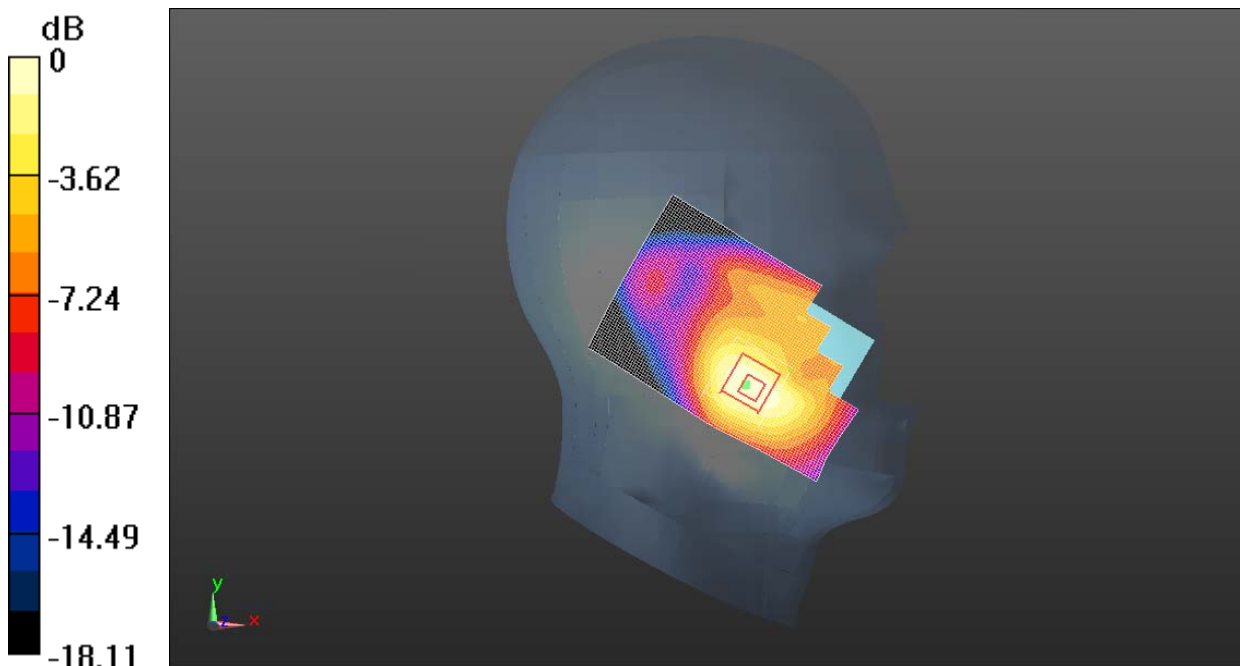

0 dB = 0.559 W/kg = -2.53 dBW/kg

Fig. 29 1900 MHz CH512

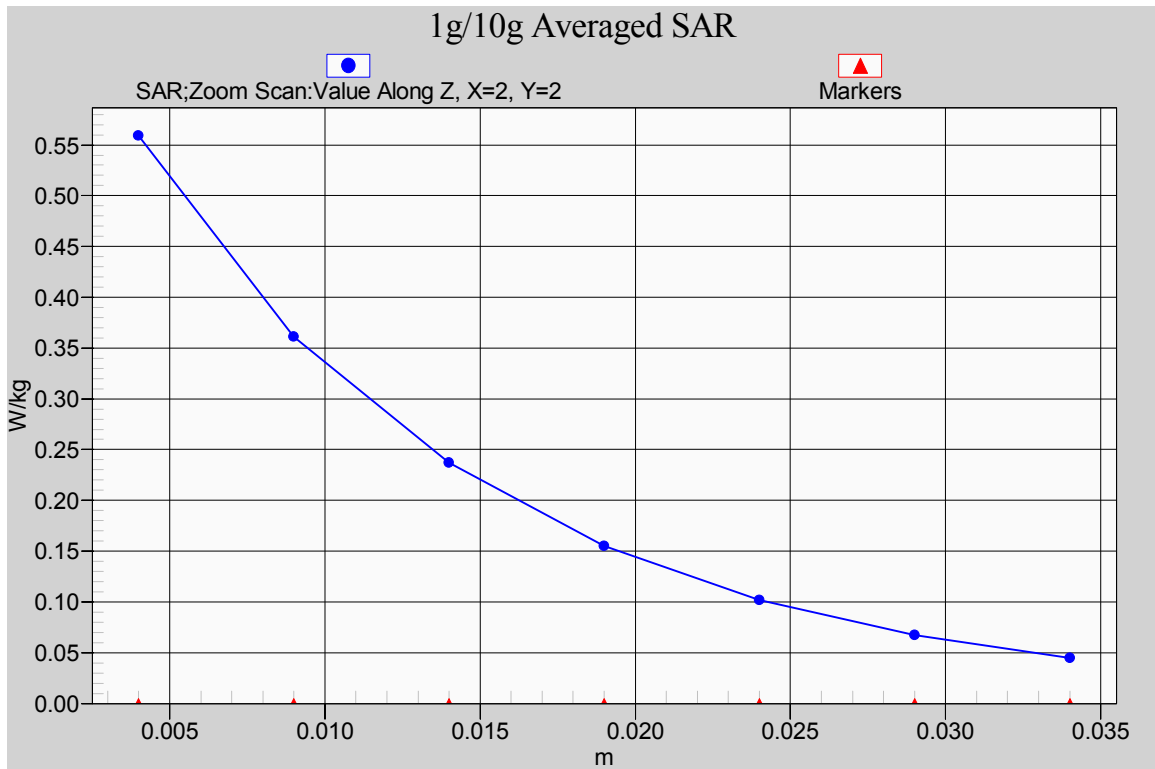

Fig. 29-1 Z-Scan at power reference point (1900 MHz CH512)

GSM 1900 Left Tilt High

Date/Time: 2/22/2013

Electronics: DAE4 Sn786

Medium: Head 1900

Medium parameters used: $f = 1910$ MHz; $\sigma = 1.451$ S/m; $\epsilon_r = 39.149$; $\rho = 1000$ kg/m³

Ambient Temperature: 22.1°C Liquid Temperature: 21.7°C

Communication System: GSM Frequency: 1910 MHz Duty Cycle: 1:8.30042

Probe: ES3DV3 - SN3151 ConvF(5.06, 5.06, 5.06); Calibrated: 4/24/2012

Left Tilt High/Area Scan (51x91x1): Interpolated grid: dx=1.500 mm, dy=1.500 mm

Reference Value = 10.665 V/m; Power Drift = 0.04 dB

Maximum value of SAR (interpolated) = 0.164 W/kg

Left Tilt High/Zoom Scan (5x5x7)/Cube 0: Measurement grid: dx=8mm, dy=8mm, dz=5mm

Reference Value = 10.665 V/m; Power Drift = 0.04 dB

Peak SAR (extrapolated) = 0.237 W/kg

SAR(1 g) = 0.143 W/kg; SAR(10 g) = 0.081 W/kg

Maximum value of SAR (measured) = 0.159 W/kg

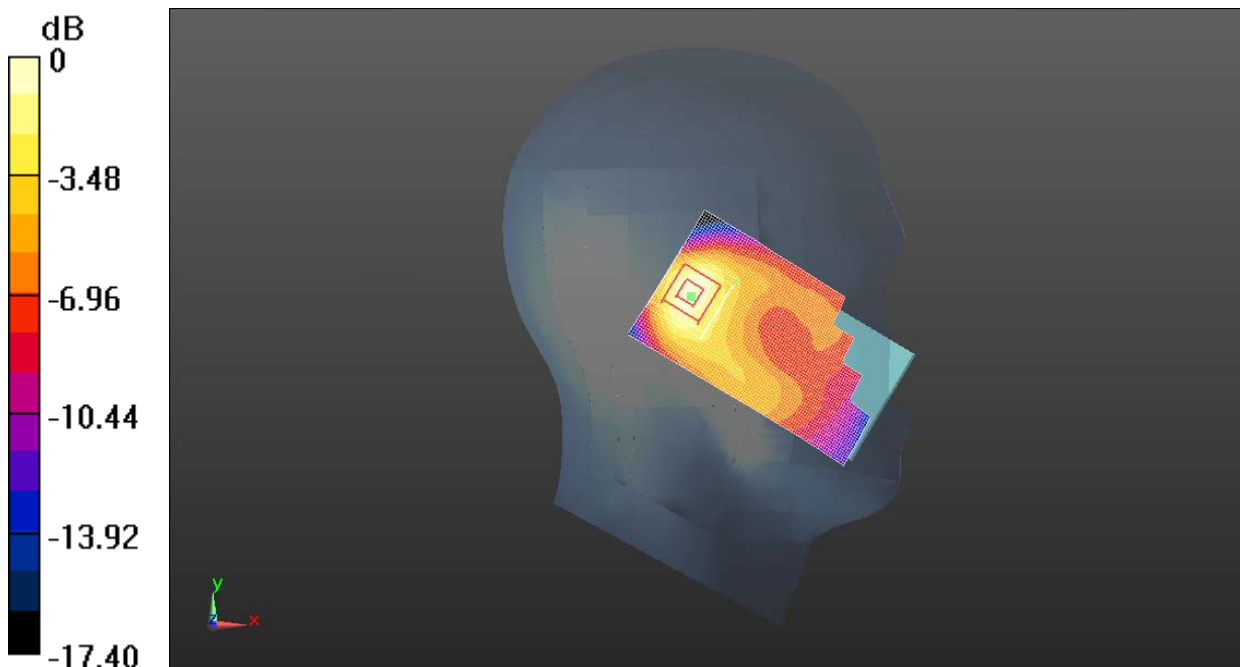

0 dB = 0.159 W/kg = -7.99 dBW/kg

Fig. 30 1900 MHz CH810

GSM 1900 Left Tilt Middle

Date/Time: 2/22/2013

Electronics: DAE4 Sn786

Medium: Head 1900

Medium parameters used: $f = 1880$ MHz; $\sigma = 1.424$ S/m; $\epsilon_r = 39.231$; $\rho = 1000$ kg/m³

Ambient Temperature: 22.1°C Liquid Temperature: 21.7°C

Communication System: GSM Frequency: 1880 MHz Duty Cycle: 1:8.30042

Probe: ES3DV3 - SN3151 ConvF(5.06, 5.06, 5.06); Calibrated: 4/24/2012

Left Tilt Middle/Area Scan (51x91x1): Interpolated grid: dx=1.500 mm, dy=1.500 mm

Reference Value = 9.969 V/m; Power Drift = 0.01 dB

Maximum value of SAR (interpolated) = 0.142 W/kg

Left Tilt Middle/Zoom Scan (5x5x7)/Cube 0: Measurement grid: dx=8mm, dy=8mm, dz=5mm

Reference Value = 9.969 V/m; Power Drift = 0.01 dB

Peak SAR (extrapolated) = 0.202 W/kg

SAR(1 g) = 0.123 W/kg; SAR(10 g) = 0.069 W/kg

Maximum value of SAR (measured) = 0.137 W/kg

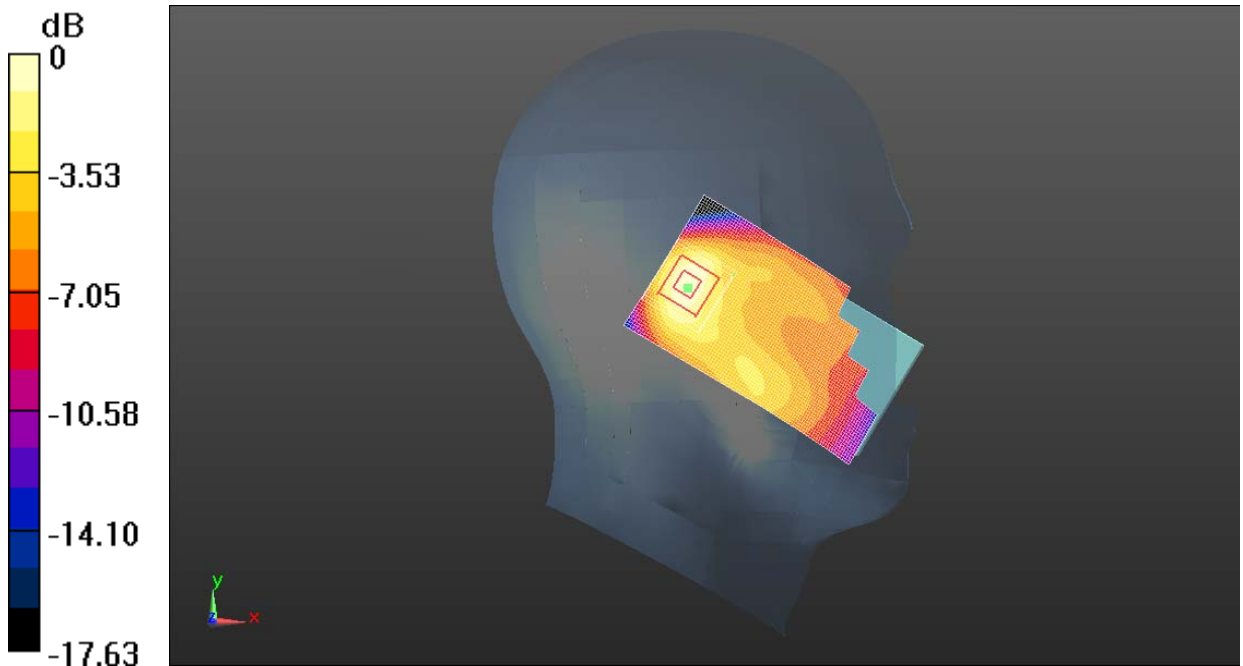

0 dB = 0.137 W/kg = -8.65 dBW/kg

Fig. 31 1900 MHz CH661

GSM 1900 Left Tilt Low

Date/Time: 2/22/2013

Electronics: DAE4 Sn786

Medium: Head 1900

Medium parameters used (interpolated): $f = 1850.2$ MHz; $\sigma = 1.395$ S/m; $\epsilon_r = 39.335$; $\rho = 1000$ kg/m³

Ambient Temperature: 22.1°C Liquid Temperature: 21.7°C

Communication System: GSM Frequency: 1850.2 MHz Duty Cycle: 1:8.30042

Probe: ES3DV3 - SN3151 ConvF(5.06, 5.06, 5.06); Calibrated: 4/24/2012

Left Tilt Low/Area Scan (51x91x1): Interpolated grid: dx=1.500 mm, dy=1.500 mm

Reference Value = 10.068 V/m; Power Drift = 0.19 dB

Maximum value of SAR (interpolated) = 0.153 W/kg

Left Tilt Low/Zoom Scan (5x5x7)/Cube 0: Measurement grid: dx=8mm, dy=8mm, dz=5mm

Reference Value = 10.068 V/m; Power Drift = 0.19 dB

Peak SAR (extrapolated) = 0.221 W/kg

SAR(1 g) = 0.134 W/kg; SAR(10 g) = 0.075 W/kg

Maximum value of SAR (measured) = 0.149 W/kg

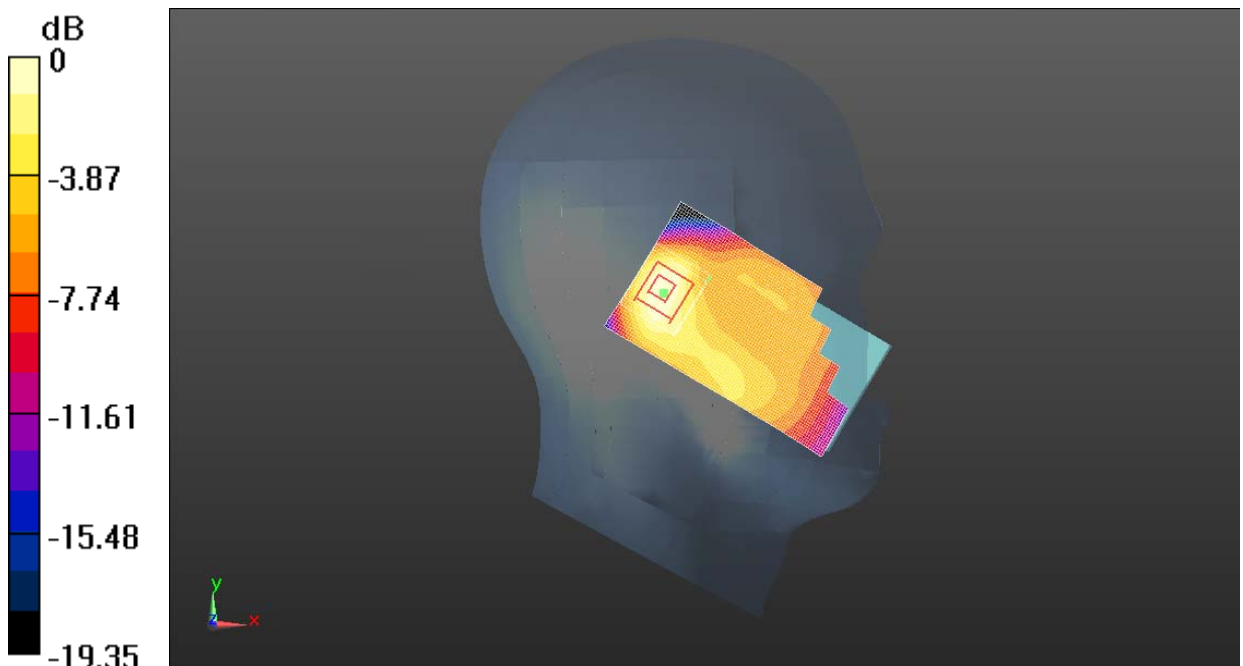

0 dB = 0.149 W/kg = -8.28 dBW/kg

Fig. 32 1900 MHz CH512

GSM 1900 Right Cheek High

Date/Time: 2/22/2013

Electronics: DAE4 Sn786

Medium: Head 1900

Medium parameters used: $f = 1910$ MHz; $\sigma = 1.451$ S/m; $\epsilon_r = 39.149$; $\rho = 1000$ kg/m³

Ambient Temperature: 22.1°C Liquid Temperature: 21.7°C

Communication System: GSM Frequency: 1910 MHz Duty Cycle: 1:8.30042

Probe: ES3DV3 - SN3151 ConvF(5.06, 5.06, 5.06); Calibrated: 4/24/2012

Right Cheek High/Area Scan (51x91x1): Interpolated grid: dx=1.500 mm, dy=1.500 mm

Reference Value = 6.499 V/m; Power Drift = 0.13 dB

Maximum value of SAR (interpolated) = 0.446 W/kg

Right Cheek High/Zoom Scan (5x5x7)/Cube 0: Measurement grid: dx=8mm, dy=8mm, dz=5mm

Reference Value = 6.499 V/m; Power Drift = 0.13 dB

Peak SAR (extrapolated) = 0.641 W/kg

SAR(1 g) = 0.399 W/kg; SAR(10 g) = 0.230 W/kg

Maximum value of SAR (measured) = 0.440 W/kg

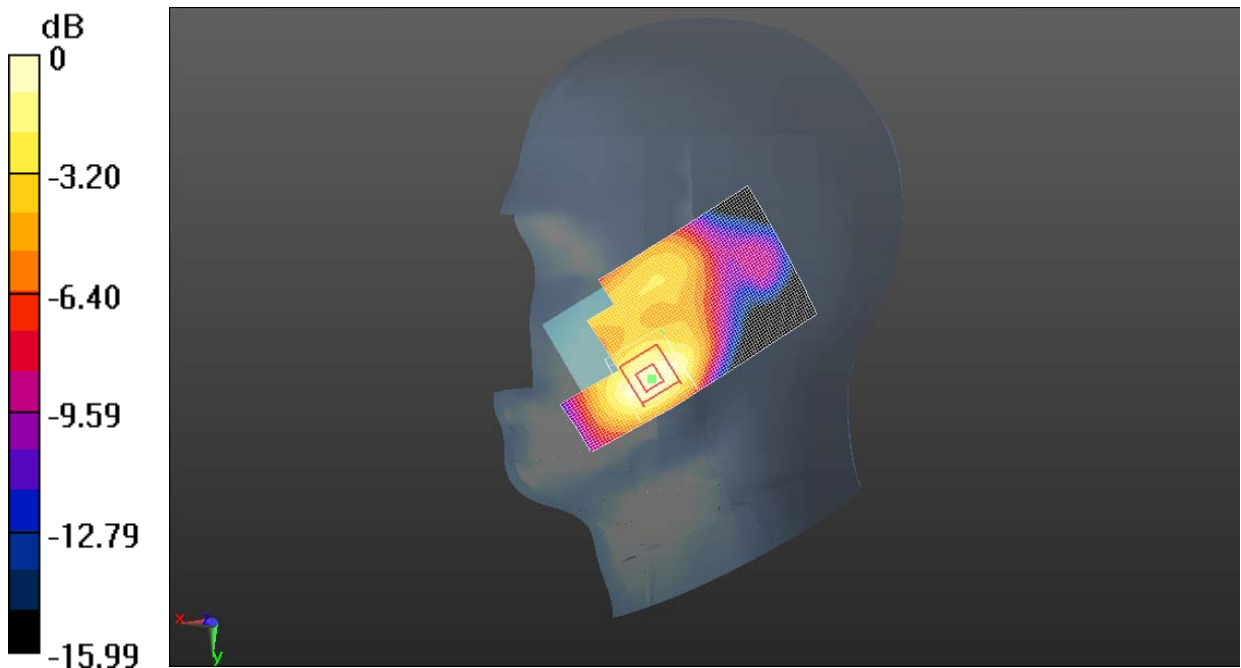

0 dB = 0.440 W/kg = -3.57 dBW/kg

Fig. 33 1900 MHz CH810

GSM 1900 Right Cheek Middle

Date/Time: 2/22/2013

Electronics: DAE4 Sn786

Medium: Head 1900

Medium parameters used: $f = 1880$ MHz; $\sigma = 1.424$ S/m; $\epsilon_r = 39.231$; $\rho = 1000$ kg/m³

Ambient Temperature: 22.1°C Liquid Temperature: 21.7°C

Communication System: GSM Frequency: 1880 MHz Duty Cycle: 1:8.30042

Probe: ES3DV3 - SN3151 ConvF(5.06, 5.06, 5.06); Calibrated: 4/24/2012

Right Cheek Middle/Area Scan (51x91x1): Interpolated grid: dx=1.500 mm, dy=1.500 mm

Reference Value = 6.635 V/m; Power Drift = 0.03 dB

Maximum value of SAR (interpolated) = 0.450 W/kg

Right Cheek Middle/Zoom Scan (5x5x7)/Cube 0: Measurement grid: dx=8mm, dy=8mm, dz=5mm

Reference Value = 6.635 V/m; Power Drift = 0.03 dB

Peak SAR (extrapolated) = 0.639 W/kg

SAR(1 g) = 0.404 W/kg; SAR(10 g) = 0.236 W/kg

Maximum value of SAR (measured) = 0.441 W/kg

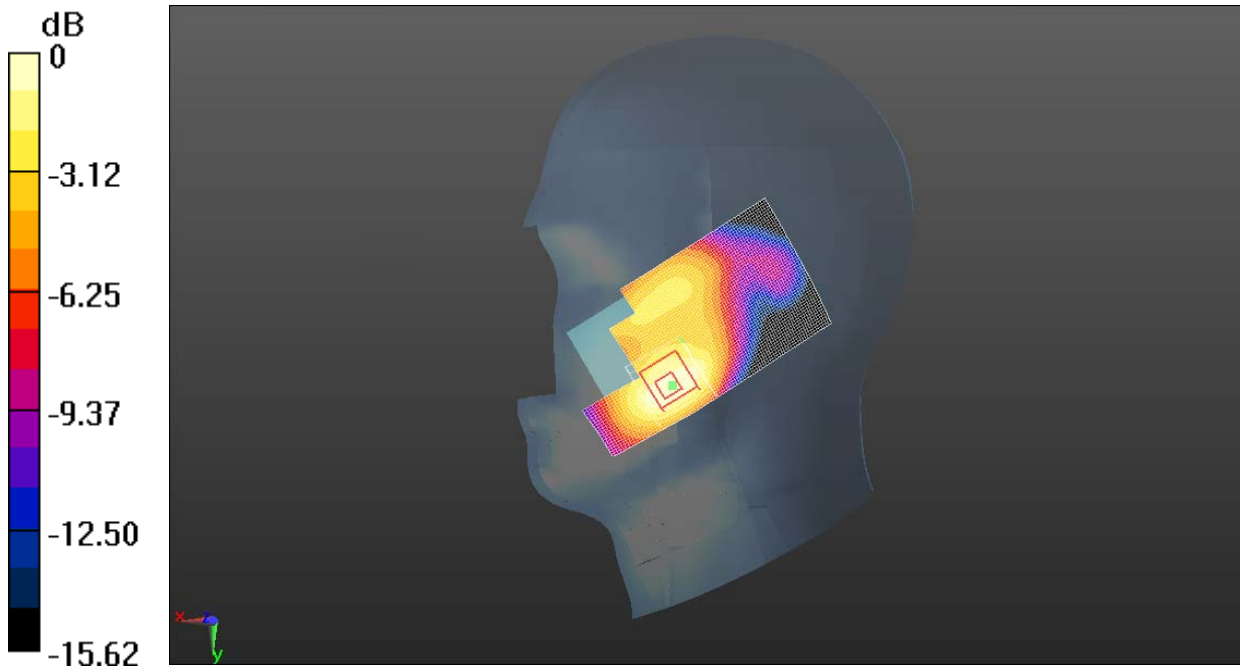

0 dB = 0.441 W/kg = -3.55 dBW/kg

Fig. 34 1900 MHz CH661

GSM 1900 Right Cheek Low

Date/Time: 2/22/2013

Electronics: DAE4 Sn786

Medium: Head 1900

Medium parameters used (interpolated): $f = 1850.2$ MHz; $\sigma = 1.395$ S/m; $\epsilon_r = 39.335$; $\rho = 1000$ kg/m³

Ambient Temperature: 22.1°C Liquid Temperature: 21.7°C

Communication System: GSM Frequency: 1850.2 MHz Duty Cycle: 1:8.30042

Probe: ES3DV3 - SN3151 ConvF(5.06, 5.06, 5.06); Calibrated: 4/24/2012

Right Cheek Low/Area Scan (51x91x1): Interpolated grid: dx=1.500 mm, dy=1.500 mm

Reference Value = 7.142 V/m; Power Drift = 0.06 dB

Maximum value of SAR (interpolated) = 0.466 W/kg

Right Cheek Low/Zoom Scan (5x5x7)/Cube 0: Measurement grid: dx=8mm, dy=8mm, dz=5mm

Reference Value = 7.142 V/m; Power Drift = 0.06 dB

Peak SAR (extrapolated) = 0.658 W/kg

SAR(1 g) = 0.421 W/kg; SAR(10 g) = 0.250 W/kg

Maximum value of SAR (measured) = 0.461 W/kg

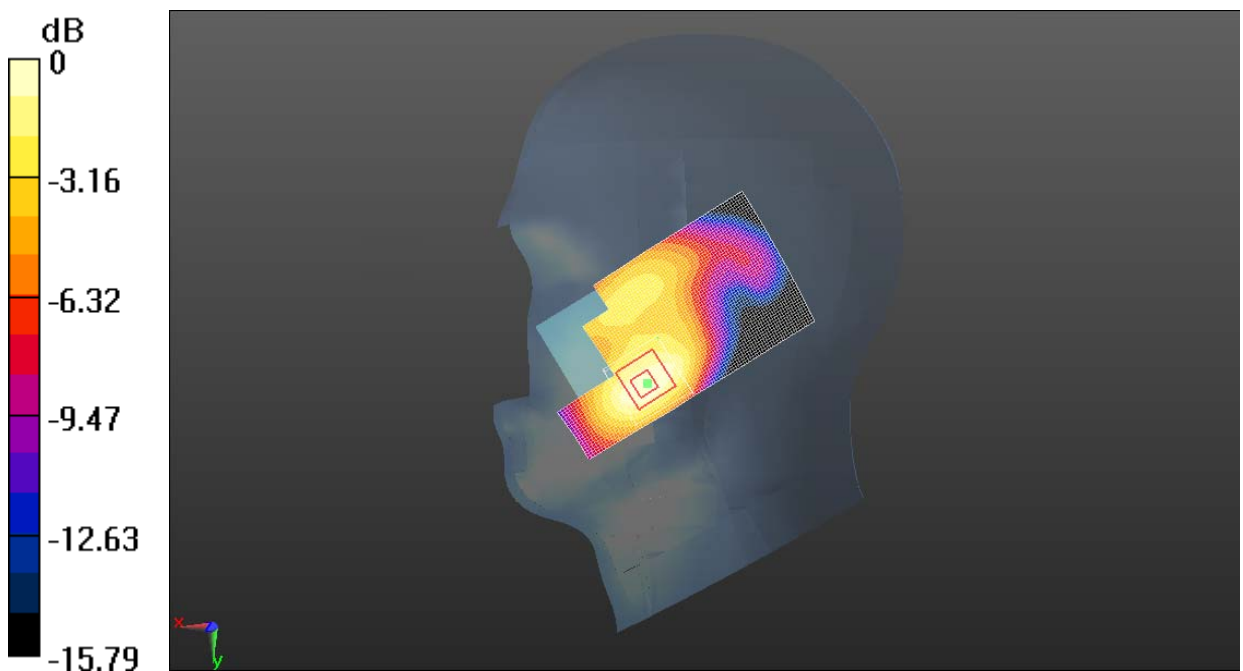

0 dB = 0.461 W/kg = -3.37 dBW/kg

Fig. 35 1900 MHz CH512

1900 Right Tilt High

Date/Time: 2/22/2013

Electronics: DAE4 Sn786

Medium: Head 1900

Medium parameters used: $f = 1910$ MHz; $\sigma = 1.451$ S/m; $\epsilon_r = 39.149$; $\rho = 1000$ kg/m³

Ambient Temperature: 22.1°C Liquid Temperature: 21.7°C

Communication System: GSM Frequency: 1910 MHz Duty Cycle: 1:8.30042

Probe: ES3DV3 - SN3151 ConvF(5.06, 5.06, 5.06); Calibrated: 4/24/2012

Right Tilt High/Area Scan (51x91x1): Interpolated grid: dx=1.500 mm, dy=1.500 mm

Reference Value = 10.542 V/m; Power Drift = 0.03 dB

Maximum value of SAR (interpolated) = 0.160 W/kg

Right Tilt High/Zoom Scan (5x5x7)/Cube 0: Measurement grid: dx=8mm, dy=8mm, dz=5mm

Reference Value = 10.542 V/m; Power Drift = 0.03 dB

Peak SAR (extrapolated) = 0.232 W/kg

SAR(1 g) = 0.140 W/kg; SAR(10 g) = 0.080 W/kg

Maximum value of SAR (measured) = 0.154 W/kg

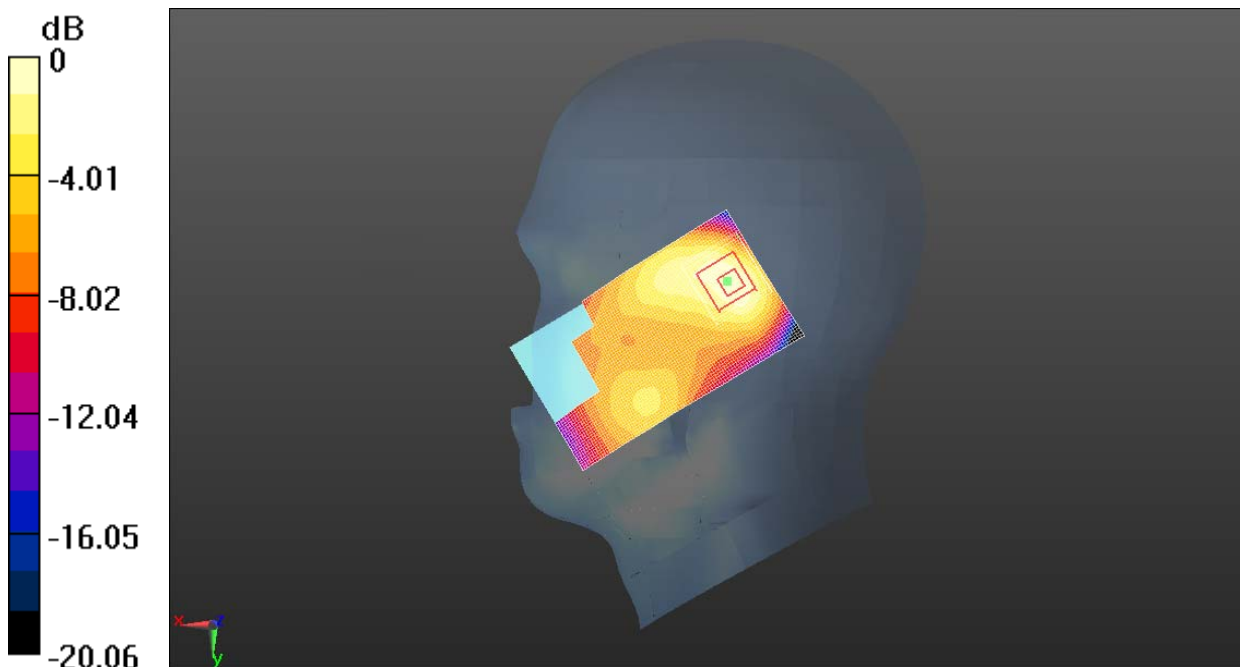

0 dB = 0.154 W/kg = -8.13 dBW/kg

Fig. 36 1900 MHz CH810

1900 Right Tilt Middle

Date/Time: 2/22/2013

Electronics: DAE4 Sn786

Medium: Head 1900

Medium parameters used: $f = 1880$ MHz; $\sigma = 1.424$ S/m; $\epsilon_r = 39.231$; $\rho = 1000$ kg/m³

Ambient Temperature: 22.1°C Liquid Temperature: 21.7°C

Communication System: GSM Frequency: 1880 MHz Duty Cycle: 1:8.30042

Probe: ES3DV3 - SN3151 ConvF(5.06, 5.06, 5.06); Calibrated: 4/24/2012

Right Tilt Middle/Area Scan (51x91x1): Interpolated grid: dx=1.500 mm, dy=1.500 mm

Reference Value = 10.072 V/m; Power Drift = 0.04 dB

Maximum value of SAR (interpolated) = 0.149 W/kg

Right Tilt Middle/Zoom Scan (5x5x7)/Cube 0: Measurement grid: dx=8mm, dy=8mm, dz=5mm

Reference Value = 10.072 V/m; Power Drift = 0.04 dB

Peak SAR (extrapolated) = 0.201 W/kg

SAR(1 g) = 0.125 W/kg; SAR(10 g) = 0.074 W/kg

Maximum value of SAR (measured) = 0.138 W/kg

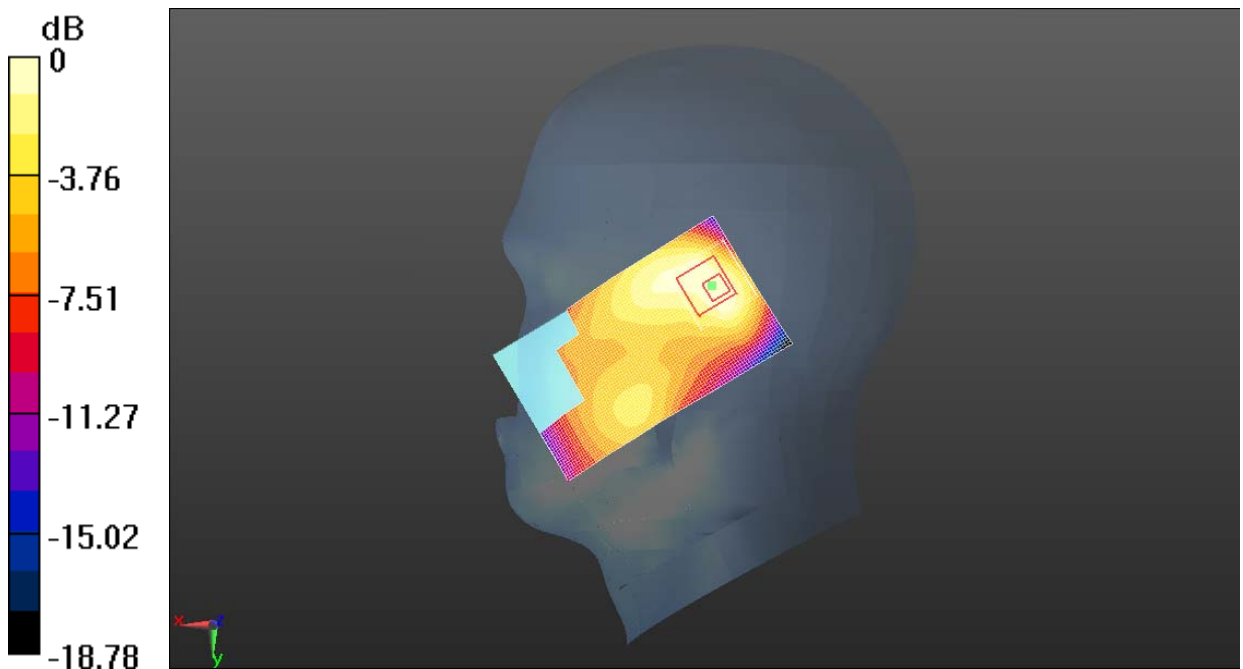

0 dB = 0.138 W/kg = -8.60 dBW/kg

Fig.37 1900 MHz CH661

1900 Right Tilt Low

Date/Time: 2/22/2013

Electronics: DAE4 Sn786

Medium: Head 1900

Medium parameters used (interpolated): $f = 1850.2$ MHz; $\sigma = 1.395$ S/m; $\epsilon_r = 39.335$; $\rho = 1000$ kg/m³

Ambient Temperature: 22.1°C Liquid Temperature: 21.7°C

Communication System: GSM Frequency: 1850.2 MHz Duty Cycle: 1:8.30042

Probe: ES3DV3 - SN3151 ConvF(5.06, 5.06, 5.06); Calibrated: 4/24/2012

Right Tilt Low/Area Scan (51x101x1): Interpolated grid: dx=1.500 mm, dy=1.500 mm

Reference Value = 10.467 V/m; Power Drift = -0.00 dB

Maximum value of SAR (interpolated) = 0.156 W/kg

Right Tilt Low/Zoom Scan (5x5x7)/Cube 0: Measurement grid: dx=8mm, dy=8mm, dz=5mm

Reference Value = 10.467 V/m; Power Drift = -0.00 dB

Peak SAR (extrapolated) = 0.218 W/kg

SAR(1 g) = 0.135 W/kg; SAR(10 g) = 0.083 W/kg

Maximum value of SAR (measured) = 0.148 W/kg

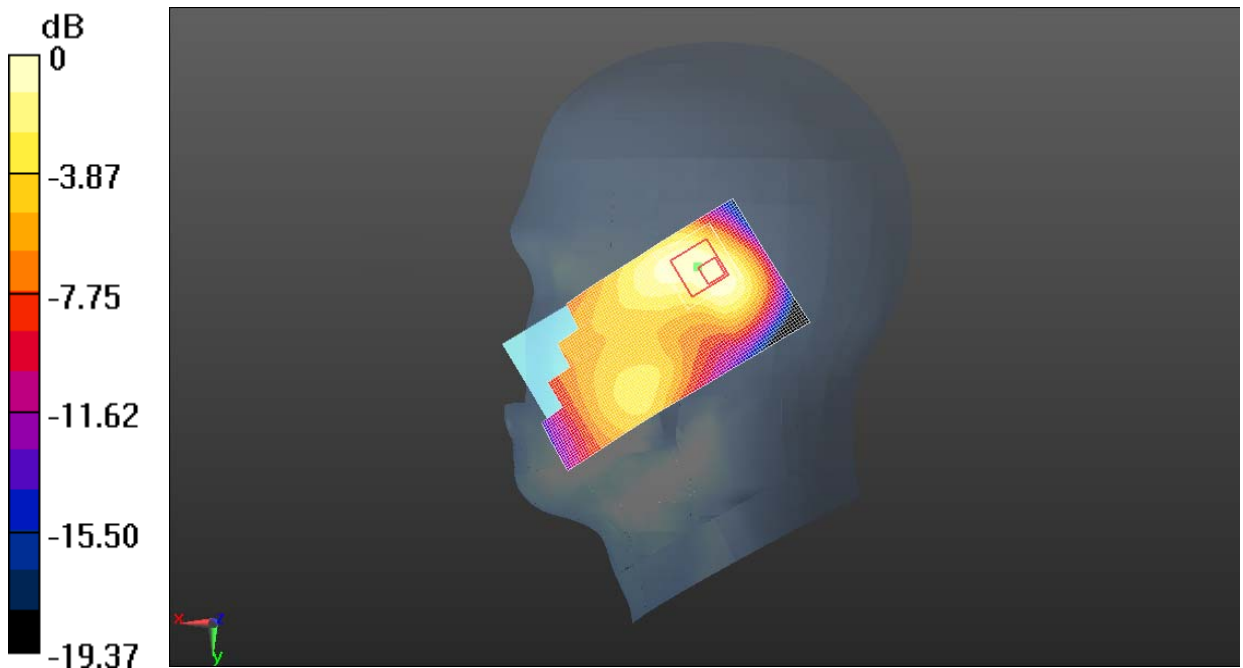

0 dB = 0.148 W/kg = -8.31 dBW/kg

Fig. 38 1900 MHz CH512

1900 Body Toward Phantom Middle with GPRS

Date/Time: 2/20/2013

Electronics: DAE4 Sn786

Medium: Body 1900MHz

Medium parameters used: $f = 1880$ MHz; $\sigma = 1.531$ S/m; $\epsilon_r = 51.92$; $\rho = 1000$ kg/m³

Ambient Temperature: 21.8°C Liquid Temperature: 21.4°C

Communication System: 4 slot GPRS Frequency: 1880 MHz Duty Cycle: 1:2.08018

Probe: ES3DV3 - SN3151 ConvF(4.7, 4.7, 4.7); Calibrated: 4/24/2012

Towards PhantomMiddle/Area Scan (51x101x1): Interpolated grid: dx=1.500 mm, dy=1.500 mm

Reference Value = 11.795 V/m; Power Drift = -0.20 dB

Maximum value of SAR (interpolated) = 0.694 W/kg

Towards PhantomMiddle/Zoom Scan (5x5x7)/Cube 0: Measurement grid: dx=8mm, dy=8mm, dz=5mm

Reference Value = 11.795 V/m; Power Drift = -0.20 dB

Peak SAR (extrapolated) = 0.988 W/kg

SAR(1 g) = 0.625 W/kg; SAR(10 g) = 0.382 W/kg

Maximum value of SAR (measured) = 0.679 W/kg

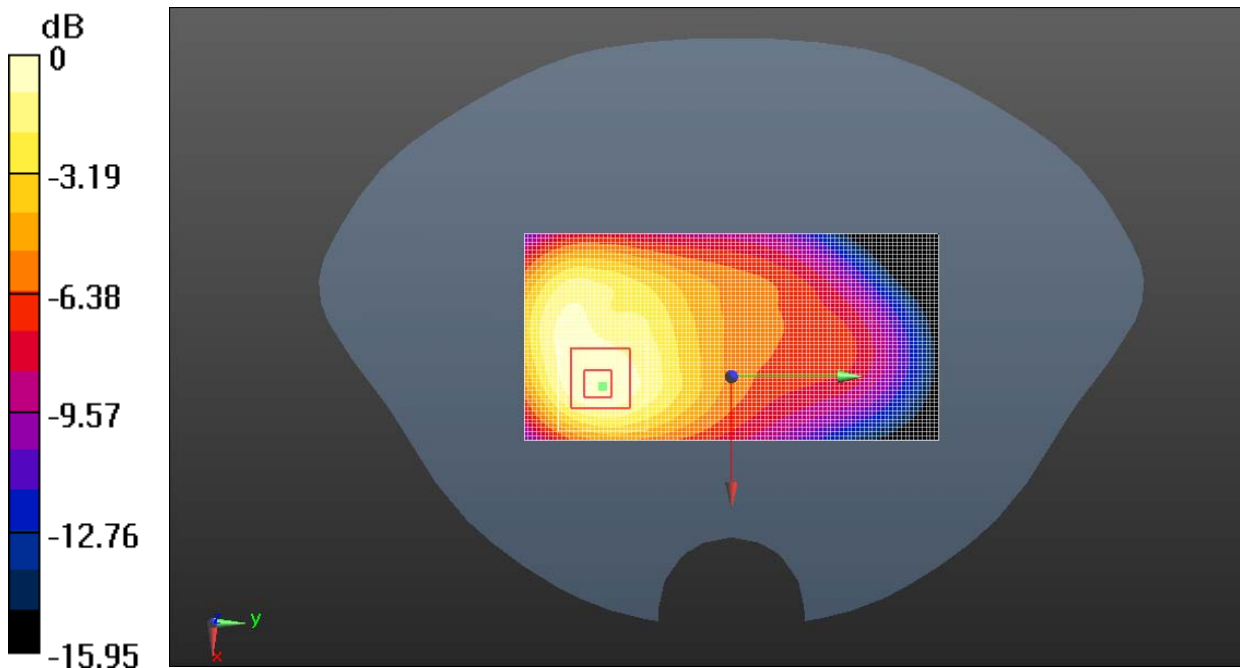

0 dB = 0.679 W/kg = -1.68 dBW/kg

Fig. 39 1900 MHz CH661

1900 Body Toward Ground High with GPRS

Date/Time: 2/20/2013

Electronics: DAE4 Sn786

Medium: Body 1900MHz

Medium parameters used: $f = 1910$ MHz; $\sigma = 1.561$ S/m; $\epsilon_r = 51.882$; $\rho = 1000$ kg/m³

Ambient Temperature: 21.8°C Liquid Temperature: 21.4°C

Communication System: 4 slot GPRS Frequency: 1909.8 MHz Duty Cycle: 1:2.08018

Probe: ES3DV3 - SN3151 ConvF(4.7, 4.7, 4.7); Calibrated: 4/24/2012

Towards Ground High/Area Scan (51x101x1): Interpolated grid: dx=1.500 mm, dy=1.500 mm

Reference Value = 14.942 V/m; Power Drift = 0.04 dB

Maximum value of SAR (interpolated) = 1.03 W/kg

Towards Ground High/Zoom Scan (5x5x7)/Cube 0: Measurement grid: dx=8mm, dy=8mm, dz=5mm

Reference Value = 14.942 V/m; Power Drift = 0.04 dB

Peak SAR (extrapolated) = 1.54 W/kg

SAR(1 g) = 0.922 W/kg; SAR(10 g) = 0.542 W/kg

Maximum value of SAR (measured) = 0.984 W/kg

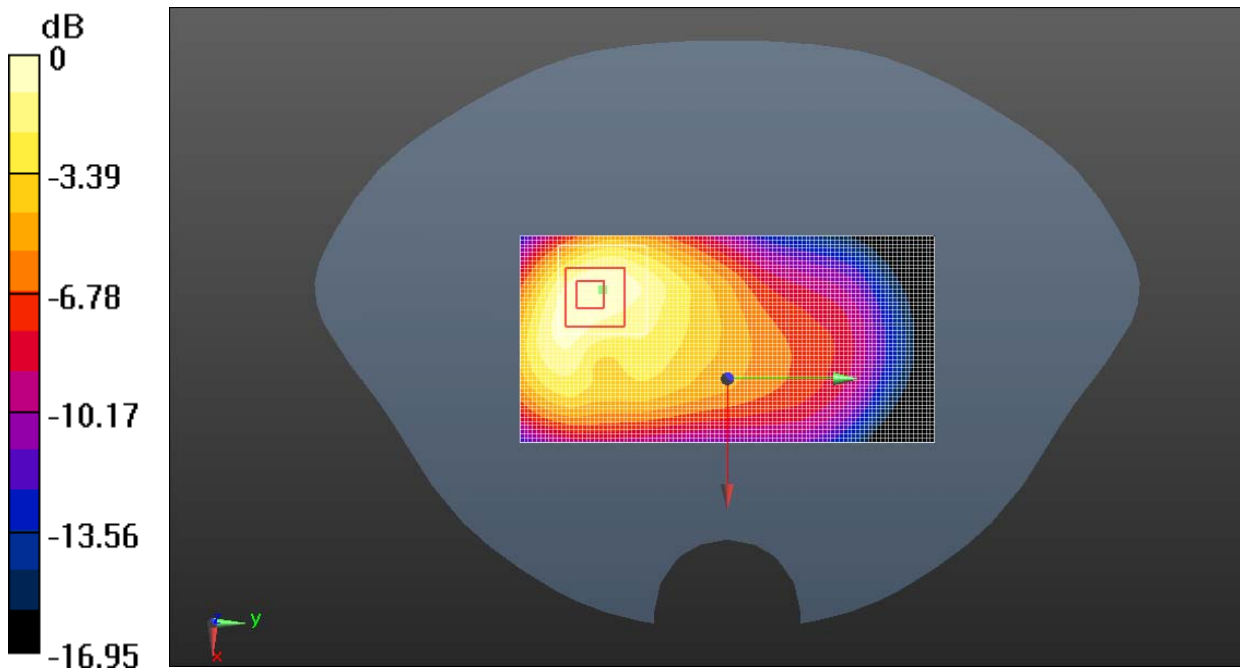

0 dB = 0.984 W/kg = -0.07 dBW/kg

Fig. 40 1900 MHz CH810

1900 Body Toward Ground Middle with GPRS

Date/Time: 2/20/2013

Electronics: DAE4 Sn786

Medium: Body 1900MHz

Medium parameters used: $f = 1880$ MHz; $\sigma = 1.531$ S/m; $\epsilon_r = 51.92$; $\rho = 1000$ kg/m³

Ambient Temperature: 21.8°C Liquid Temperature: 21.4°C

Communication System: 4 slot GPRS Frequency: 1880 MHz Duty Cycle: 1:2.08018

Probe: ES3DV3 - SN3151 ConvF(4.7, 4.7, 4.7); Calibrated: 4/24/2012

Towards Ground Middle/Area Scan (51x101x1): Interpolated grid: dx=1.500 mm, dy=1.500 mm

Reference Value = 14.862 V/m; Power Drift = -0.02 dB

Maximum value of SAR (interpolated) = 1.07 W/kg

Towards Ground Middle/Zoom Scan (5x5x7)/Cube 0: Measurement grid: dx=8mm, dy=8mm, dz=5mm

Reference Value = 14.862 V/m; Power Drift = -0.02 dB

Peak SAR (extrapolated) = 1.54 W/kg

SAR(1 g) = 0.944 W/kg; SAR(10 g) = 0.562 W/kg

Maximum value of SAR (measured) = 1.02 W/kg

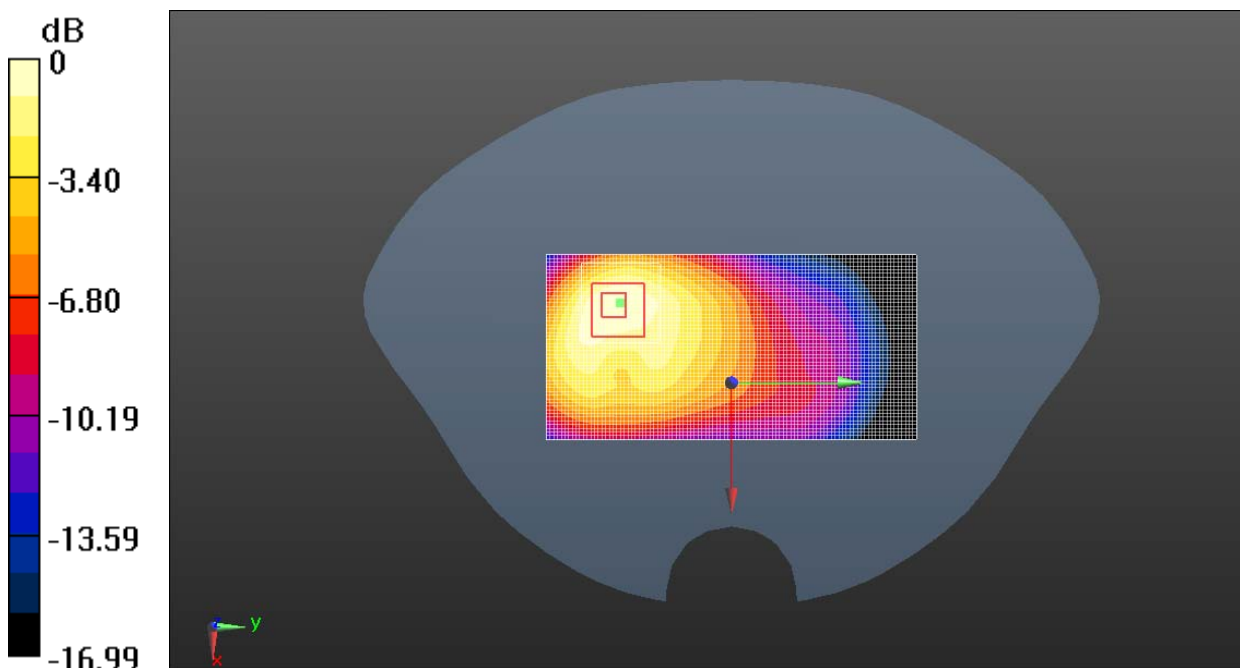

0 dB = 1.02 W/kg = 0.11 dBW/kg

Fig. 41 1900 MHz CH661

1900 Body Toward Ground Low with GPRS

Date/Time: 2/20/2013

Electronics: DAE4 Sn786

Medium: Body 1900MHz

Medium parameters used (interpolated): $f = 1850.2$ MHz; $\sigma = 1.503$ S/m; $\epsilon_r = 51.976$; $\rho = 1000$ kg/m³

Ambient Temperature: 21.8°C Liquid Temperature: 21.4°C

Communication System: 4 slot GPRS Frequency: 1850.2 MHz Duty Cycle: 1:2.08018

Probe: ES3DV3 - SN3151 ConvF(4.7, 4.7, 4.7); Calibrated: 4/24/2012

Towards Ground Low/Area Scan (51x101x1): Interpolated grid: dx=1.500 mm, dy=1.500 mm

Reference Value = 13.531 V/m; Power Drift = 0.04 dB

Maximum value of SAR (interpolated) = 1.12 W/kg

Towards Ground Low/Zoom Scan (5x5x7)/Cube 0: Measurement grid: dx=8mm, dy=8mm, dz=5mm

Reference Value = 13.531 V/m; Power Drift = 0.04 dB

Peak SAR (extrapolated) = 1.58 W/kg

SAR(1 g) = 0.983 W/kg; SAR(10 g) = 0.592 W/kg

Maximum value of SAR (measured) = 1.08 W/kg

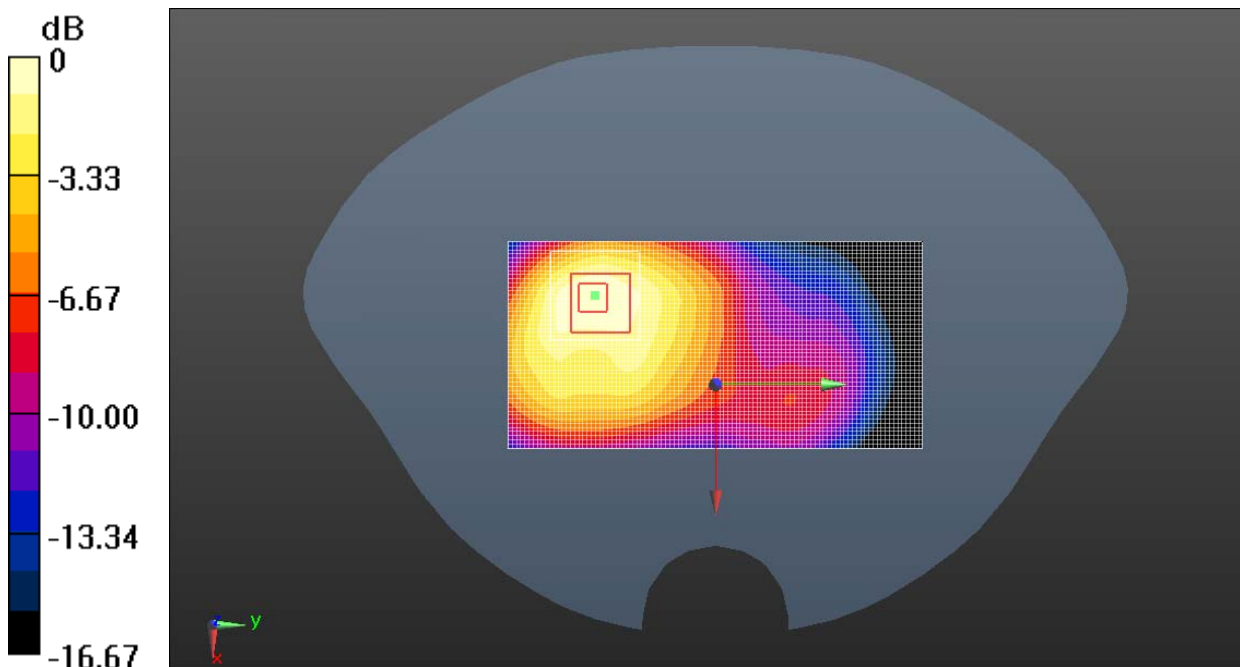

0 dB = 1.08 W/kg = 0.31 dBW/kg

Fig. 42 1900 MHz CH512

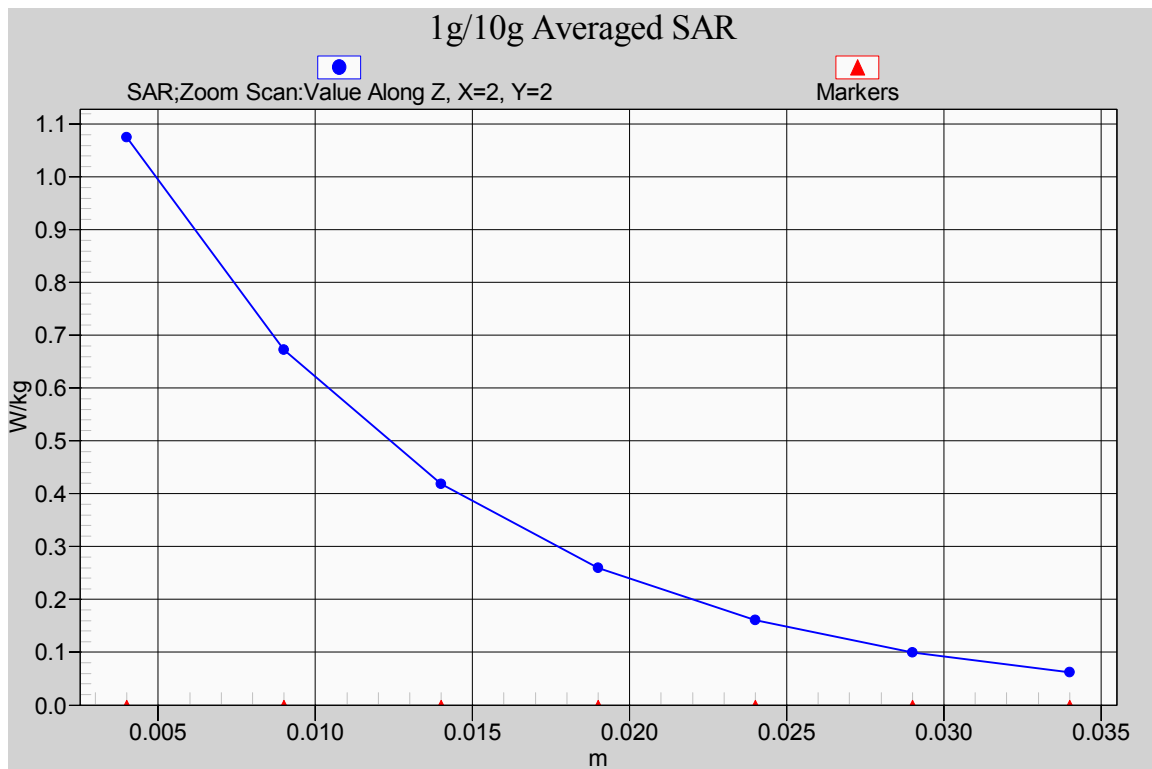

Fig. 42-1 Z-Scan at power reference point (1900 MHz CH512)

1900 Body Left Side Middle with GPRS

Date/Time: 2/20/2013

Electronics: DAE4 Sn786

Medium: Body 1900MHz

Medium parameters used: $f = 1880$ MHz; $\sigma = 1.531$ S/m; $\epsilon_r = 51.92$; $\rho = 1000$ kg/m³

Ambient Temperature: 21.8°C Liquid Temperature: 21.4°C

Communication System: 4 slot GPRS Frequency: 1880 MHz Duty Cycle: 1:2.08018

Probe: ES3DV3 - SN3151 ConvF(4.7, 4.7, 4.7); Calibrated: 4/24/2012

Left Side Middle/Area Scan (41x111x1): Interpolated grid: dx=1.500 mm, dy=1.500 mm

Reference Value = 8.688 V/m; Power Drift = 0.19 dB

Maximum value of SAR (interpolated) = 0.186 W/kg

Left Side Middle/Zoom Scan (5x5x7)/Cube 0: Measurement grid: dx=8mm, dy=8mm, dz=5mm

Reference Value = 8.688 V/m; Power Drift = 0.19 dB

Peak SAR (extrapolated) = 0.272 W/kg

SAR(1 g) = 0.175 W/kg; SAR(10 g) = 0.108 W/kg

Maximum value of SAR (measured) = 0.191 W/kg

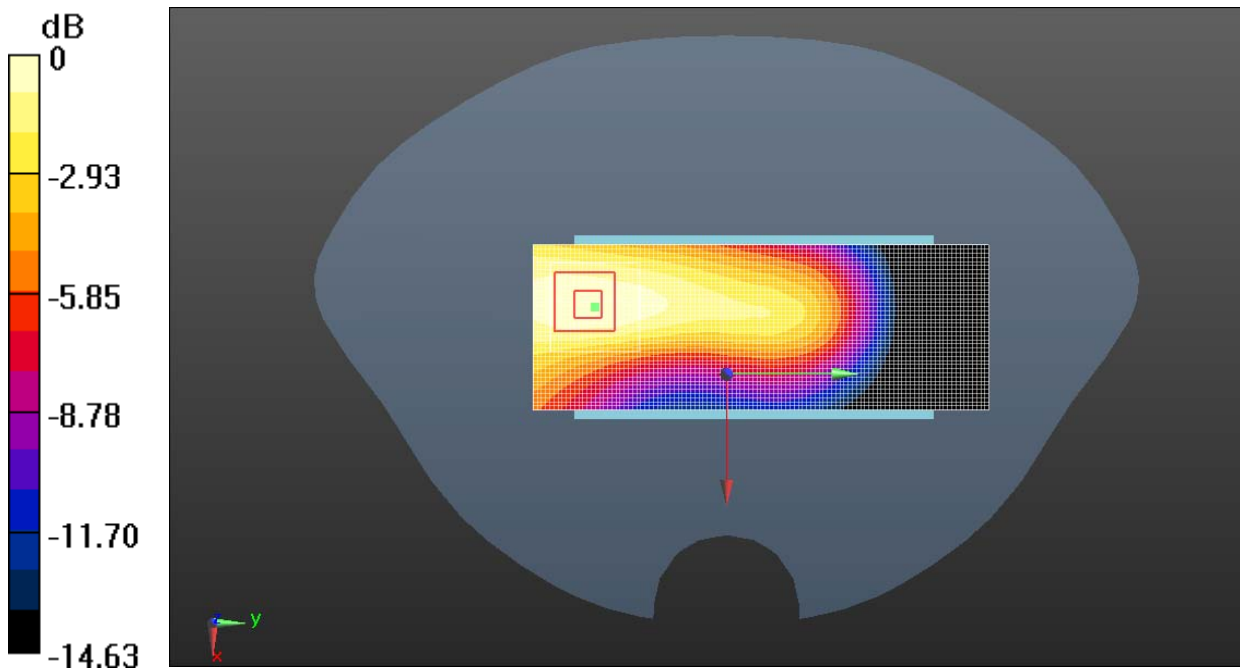

0 dB = 0.191 W/kg = -7.19 dBW/kg

Fig. 43 1900 MHz CH661

1900 Body Right Side Middle with GPRS

Date/Time: 2/20/2013

Electronics: DAE4 Sn786

Medium: Body 1900MHz

Medium parameters used: $f = 1880$ MHz; $\sigma = 1.531$ S/m; $\epsilon_r = 51.92$; $\rho = 1000$ kg/m³

Ambient Temperature: 21.8°C Liquid Temperature: 21.4°C

Communication System: 4 slot GPRS Frequency: 1880 MHz Duty Cycle: 1:2.08018

Probe: ES3DV3 - SN3151 ConvF(4.7, 4.7, 4.7); Calibrated: 4/24/2012

Right Side Middle/Area Scan (41x111x1): Interpolated grid: dx=1.500 mm, dy=1.500 mm

Reference Value = 9.577 V/m; Power Drift = 0.11 dB

Maximum value of SAR (interpolated) = 0.177 W/kg

Right Side Middle/Zoom Scan (5x5x7)/Cube 0: Measurement grid: dx=8mm, dy=8mm, dz=5mm

Reference Value = 9.577 V/m; Power Drift = 0.11 dB

Peak SAR (extrapolated) = 0.255 W/kg

SAR(1 g) = 0.163 W/kg; SAR(10 g) = 0.097 W/kg

Maximum value of SAR (measured) = 0.180 W/kg

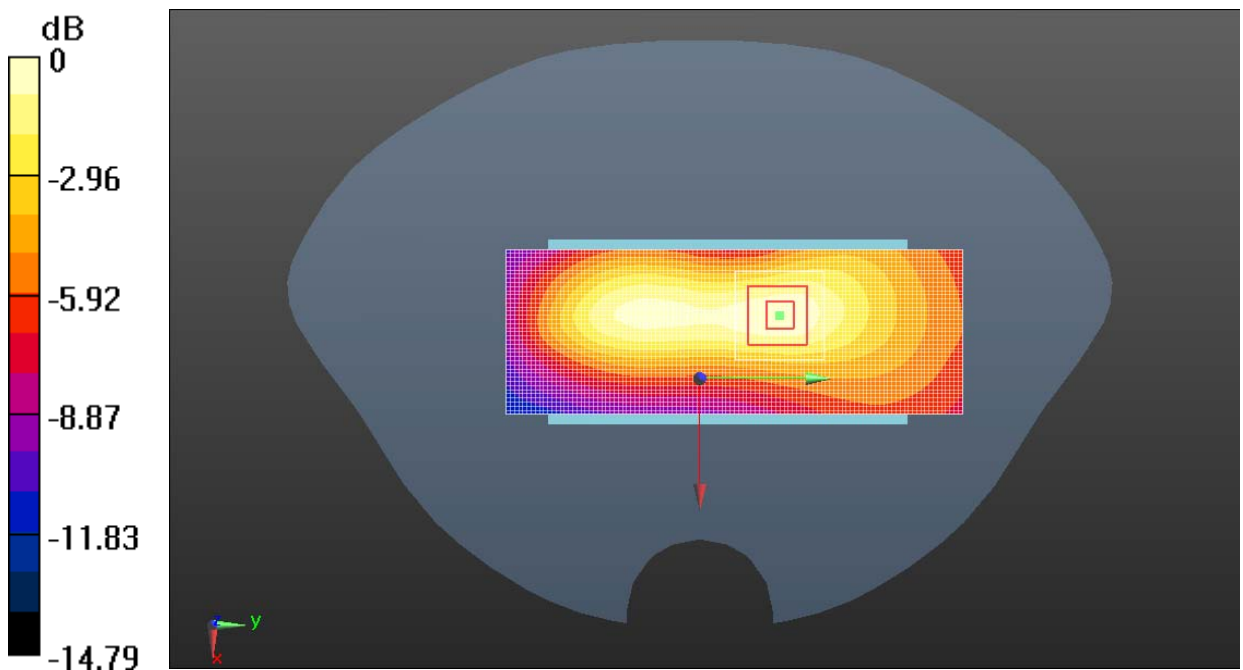

0 dB = 0.180 W/kg = -7.44 dBW/kg

Fig. 44 1900 MHz CH661

1900 Body Bottom Side Middle with GPRS

Date/Time: 2/20/2013

Electronics: DAE4 Sn786

Medium: Body 1900MHz

Medium parameters used: $f = 1880$ MHz; $\sigma = 1.531$ S/m; $\epsilon_r = 51.92$; $\rho = 1000$ kg/m³

Ambient Temperature: 21.8°C Liquid Temperature: 21.4°C

Communication System: 4 slot GPRS Frequency: 1880 MHz Duty Cycle: 1:2.08018

Probe: ES3DV3 - SN3151 ConvF(4.7, 4.7, 4.7); Calibrated: 4/24/2012

Bottom Side Middle/Area Scan (41x61x1): Interpolated grid: dx=1.500 mm, dy=1.500 mm

Reference Value = 21.392 V/m; Power Drift = 0.13 dB

Maximum value of SAR (interpolated) = 0.777 W/kg

Bottom Side Middle/Zoom Scan (5x5x7)/Cube 0: Measurement grid: dx=8mm, dy=8mm, dz=5mm

Reference Value = 21.392 V/m; Power Drift = 0.13 dB

Peak SAR (extrapolated) = 1.10 W/kg

SAR(1 g) = 0.683 W/kg; SAR(10 g) = 0.388 W/kg

Maximum value of SAR (measured) = 0.753 W/kg

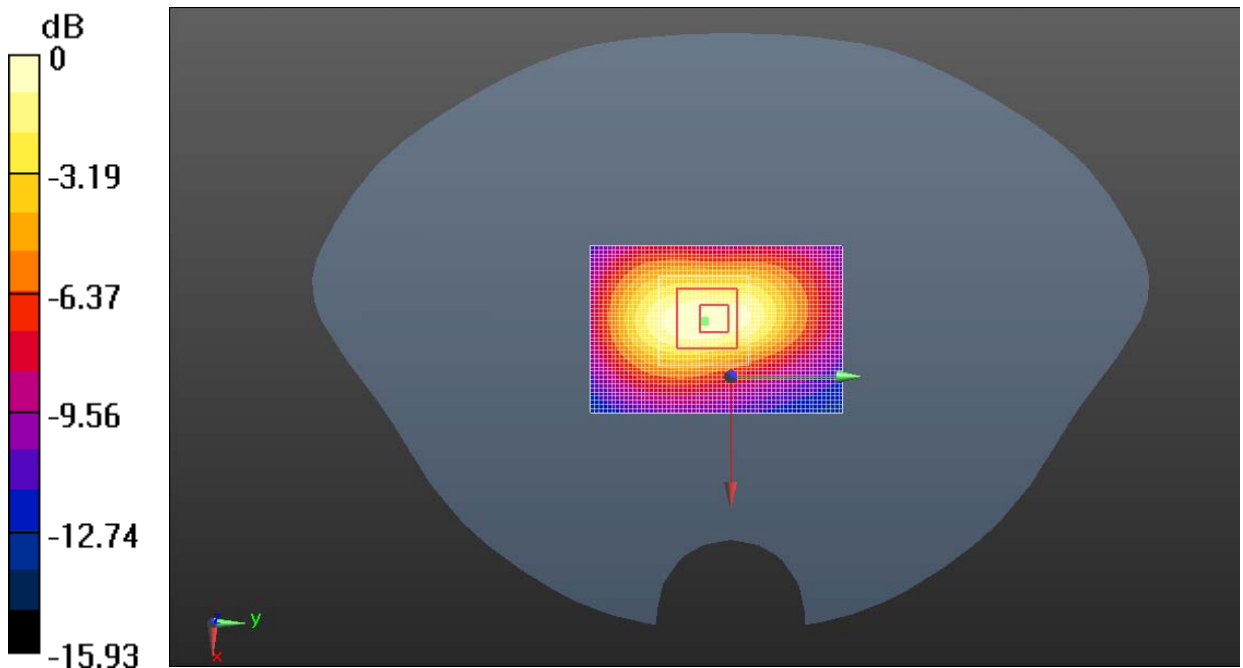

0 dB = 0.753 W/kg = -1.23 dBW/kg

Fig. 45 1900 MHz CH661

1900 Body Toward Ground Low with Headset C1

Date/Time: 2/20/2013

Electronics: DAE4 Sn786

Medium: Body 1900MHz

Medium parameters used (interpolated): $f = 1850.2$ MHz; $\sigma = 1.503$ S/m; $\epsilon_r = 51.976$; $\rho = 1000$ kg/m³

Ambient Temperature: 21.8°C Liquid Temperature: 21.4°C

Communication System: GSM Frequency: 1850.2 MHz Duty Cycle: 1:8.30042

Probe: ES3DV3 - SN3151 ConvF(4.7, 4.7, 4.7); Calibrated: 4/24/2012

Towards Ground Low _Speech C1/Area Scan (51x101x1): Interpolated grid:

$dx=1.500$ mm, $dy=1.500$ mm

Reference Value = 11.137 V/m; Power Drift = -0.08 dB

Maximum value of SAR (interpolated) = 0.795 W/kg

Towards Ground Low _Speech C1/Zoom Scan (5x5x7)/Cube 0: Measurement grid:

$dx=8$ mm, $dy=8$ mm, $dz=5$ mm

Reference Value = 11.137 V/m; Power Drift = -0.08 dB

Peak SAR (extrapolated) = 1.14 W/kg

SAR(1 g) = 0.705 W/kg; SAR(10 g) = 0.425 W/kg

Maximum value of SAR (measured) = 0.764 W/kg

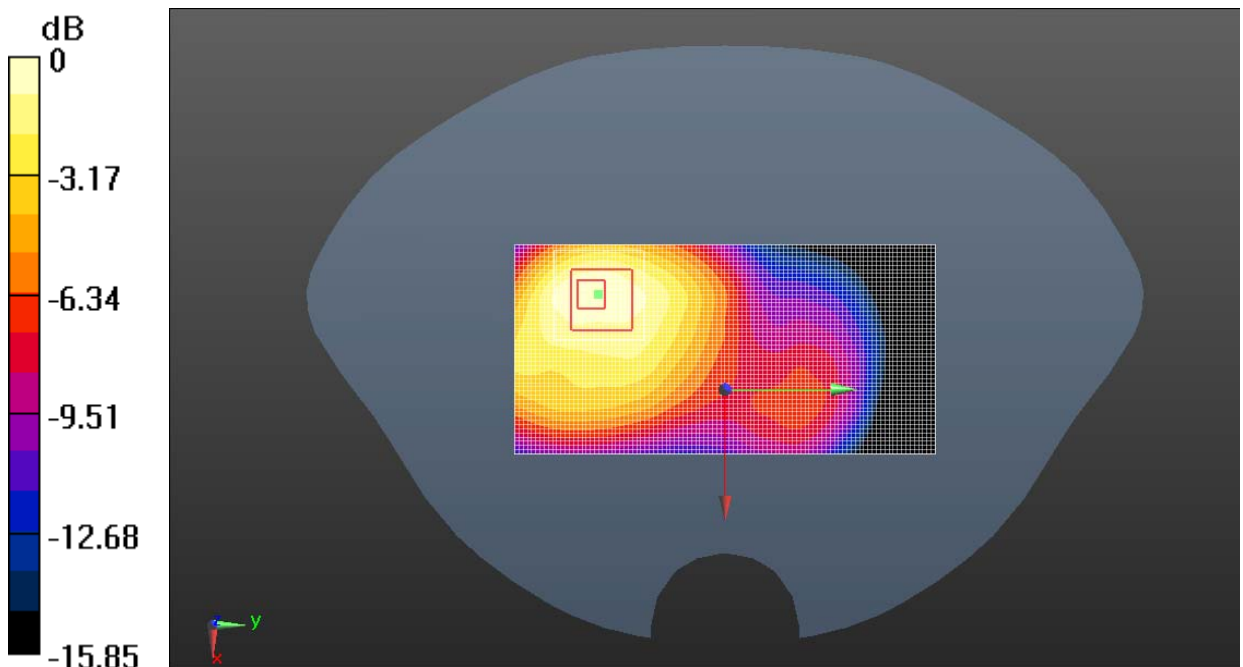

0 dB = 0.764 W/kg = -1.17 dBW/kg

Fig. 46 1900 MHz CH512

1900 Body Toward Ground Low with Headset C4

Date/Time: 2/20/2013

Electronics: DAE4 Sn786

Medium: Body 1900MHz

Medium parameters used (interpolated): $f = 1850.2$ MHz; $\sigma = 1.503$ S/m; $\epsilon_r = 51.976$; $\rho = 1000$ kg/m³

Ambient Temperature: 21.8°C Liquid Temperature: 21.4°C

Communication System: GSM Frequency: 1850.2 MHz Duty Cycle: 1:8.30042

Probe: ES3DV3 - SN3151 ConvF(4.7, 4.7, 4.7); Calibrated: 4/24/2012

Towards Ground Low _Speech C4/Area Scan (51x101x1): Interpolated grid:
dx=1.500 mm, dy=1.500 mm

Reference Value = 11.749 V/m; Power Drift = 0.06 dB

Maximum value of SAR (interpolated) = 0.903 W/kg

Towards Ground Low _Speech C4/Zoom Scan (5x5x7)/Cube 0: Measurement grid:
dx=8mm, dy=8mm, dz=5mm

Reference Value = 11.749 V/m; Power Drift = 0.06 dB

Peak SAR (extrapolated) = 1.29 W/kg

SAR(1 g) = 0.789 W/kg; SAR(10 g) = 0.467 W/kg

Maximum value of SAR (measured) = 0.862 W/kg

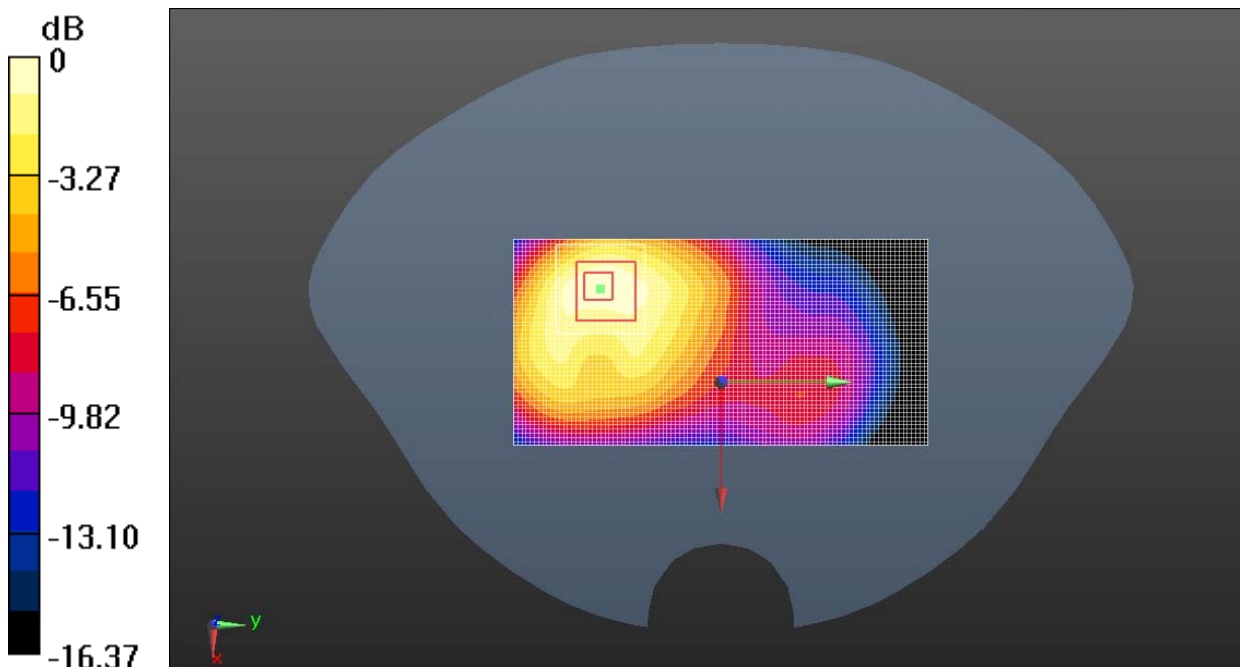

0 dB = 0.862 W/kg = -0.65 dBW/kg

Fig. 47 1900 MHz CH512

1900 Body Toward Ground Low with EGPRS

Date/Time: 2/20/2013

Electronics: DAE4 Sn786

Medium: Body 1900MHz

Medium parameters used (interpolated): $f = 1850.2$ MHz; $\sigma = 1.503$ S/m; $\epsilon_r = 51.976$; $\rho = 1000$ kg/m³

Ambient Temperature: 21.8°C Liquid Temperature: 21.4°C

Communication System: 4 slot GPRS Frequency: 1850.2 MHz Duty Cycle: 1:2.08018

Probe: ES3DV3 - SN3151 ConvF(4.7, 4.7, 4.7); Calibrated: 4/24/2012

Towards Ground Low/Area Scan (51x101x1): Interpolated grid: dx=1.500 mm, dy=1.500 mm

Reference Value = 13.580 V/m; Power Drift = 0.05 dB

Maximum value of SAR (interpolated) = 0.958 W/kg

Towards Ground Low/Zoom Scan (5x5x7)/Cube 0: Measurement grid: dx=8mm, dy=8mm, dz=5mm

Reference Value = 13.580 V/m; Power Drift = 0.05 dB

Peak SAR (extrapolated) = 1.37 W/kg

SAR(1 g) = 0.841 W/kg; SAR(10 g) = 0.498 W/kg

Maximum value of SAR (measured) = 0.921 W/kg

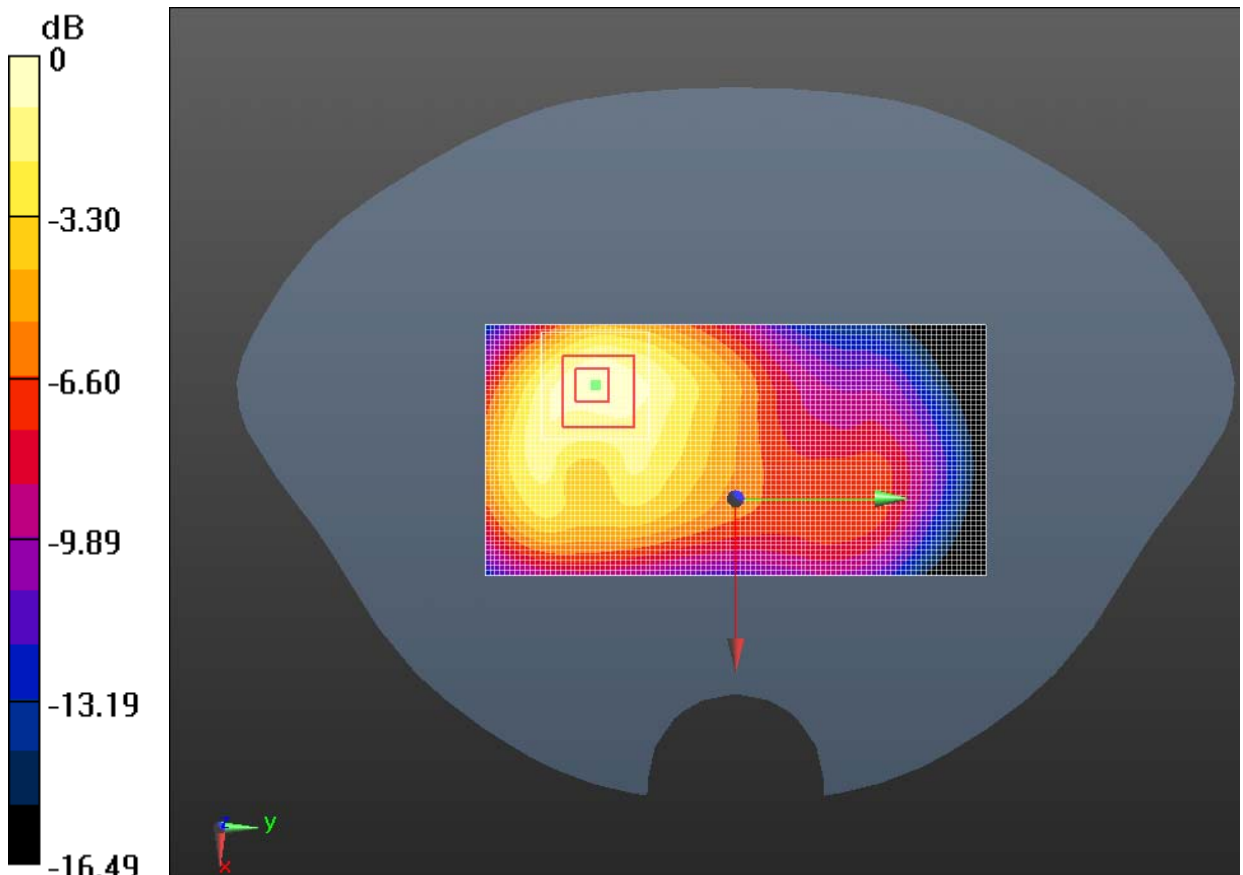

0 dB = 0.921 W/kg = -0.36 dBW/kg

Fig. 48 1900 MHz CH512

W850 Left Cheek High

Date/Time: 2/21/2013

Electronics: DAE4 Sn786

Medium: Head 850MHz

Medium parameters used (interpolated): $f = 846.6$ MHz; $\sigma = 0.9$ S/m; $\epsilon_r = 41.402$; $\rho = 1000$ kg/m³

Ambient Temperature: 21.8°C Liquid Temperature: 21.4°C

Communication System: WCDMA Frequency: 846.6 MHz Duty Cycle: 1:1

Probe: ES3DV3 - SN3151 ConvF(6.27, 6.27, 6.27); Calibrated: 4/24/2012

Left Cheek High/Area Scan (51x91x1): Interpolated grid: dx=1.500 mm, dy=1.500 mm

Reference Value = 7.635 V/m; Power Drift = 0.12 dB

Maximum value of SAR (interpolated) = 0.813 W/kg

Left Cheek High/Zoom Scan (5x5x7)/Cube 0: Measurement grid: dx=8mm, dy=8mm, dz=5mm

Reference Value = 7.635 V/m; Power Drift = 0.12 dB

Peak SAR (extrapolated) = 0.934 W/kg

SAR(1 g) = 0.773 W/kg; SAR(10 g) = 0.588 W/kg

Maximum value of SAR (measured) = 0.813 W/kg

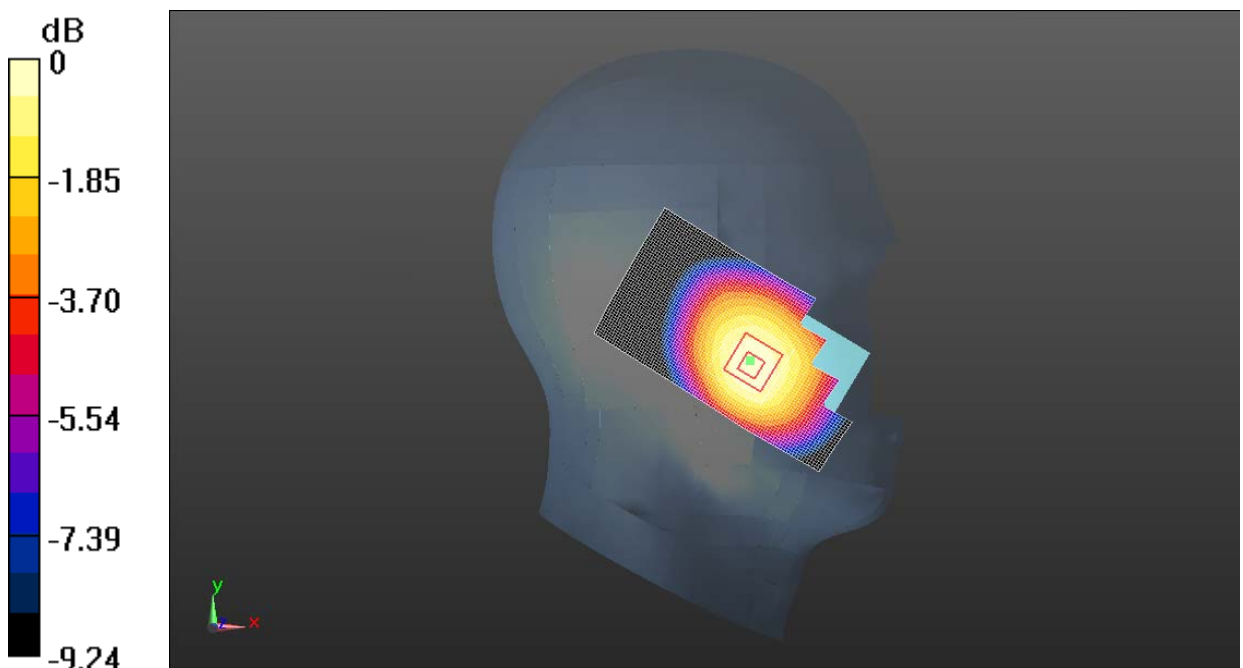

0 dB = 0.813 W/kg = -0.90 dBW/kg

Fig. 49 W850 MHz CH4233

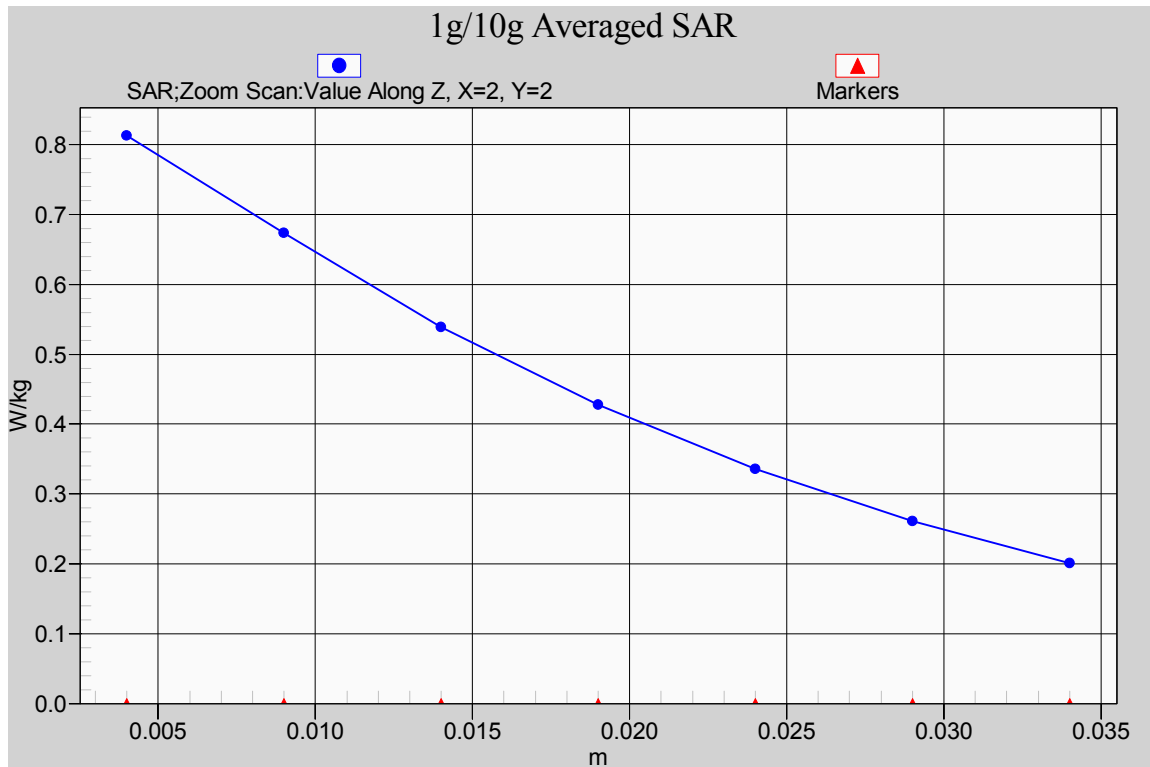

Fig. 49-1 Z-Scan at power reference point (850 MHz CH4233)

W850 Left Cheek Middle

Date/Time: 2/21/2013

Electronics: DAE4 Sn786

Medium: Head 850MHz

Medium parameters used (interpolated): $f = 836.6$ MHz; $\sigma = 0.89$ S/m; $\epsilon_r = 41.523$; $\rho = 1000$ kg/m³

Ambient Temperature: 21.8°C Liquid Temperature: 21.4°C

Communication System: WCDMA Frequency: 836.6 MHz Duty Cycle: 1:1

Probe: ES3DV3 - SN3151 ConvF(6.27, 6.27, 6.27); Calibrated: 4/24/2012

Left Cheek Middle/Area Scan (51x91x1): Interpolated grid: dx=1.500 mm, dy=1.500 mm

Reference Value = 7.637 V/m; Power Drift = 0.04 dB

Maximum value of SAR (interpolated) = 0.788 W/kg

Left Cheek Middle/Zoom Scan (5x5x7)/Cube 0: Measurement grid: dx=8mm, dy=8mm, dz=5mm

Reference Value = 7.637 V/m; Power Drift = 0.04 dB

Peak SAR (extrapolated) = 0.896 W/kg

SAR(1 g) = 0.749 W/kg; SAR(10 g) = 0.572 W/kg

Maximum value of SAR (measured) = 0.787 W/kg

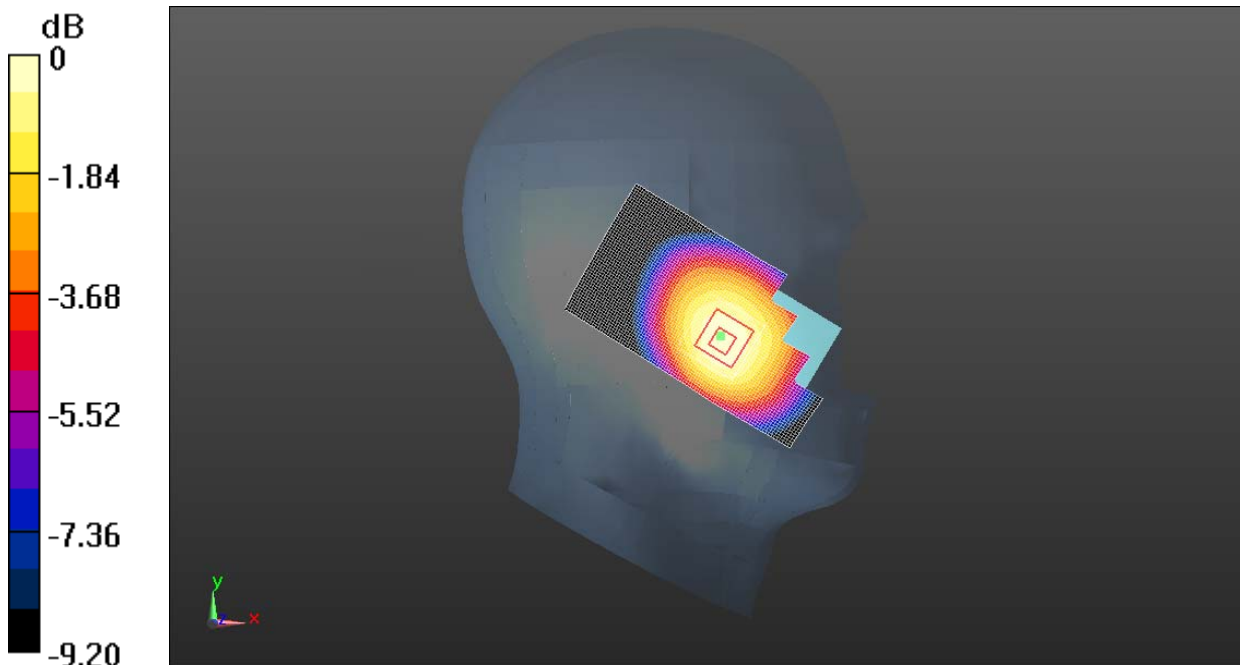

0 dB = 0.787 W/kg = -1.04 dBW/kg

Fig. 50 W850 MHz CH4183

W850 Left Cheek Low

Date/Time: 2/21/2013

Electronics: DAE4 Sn786

Medium: Head 850MHz

Medium parameters used (interpolated): $f = 826.4$ MHz; $\sigma = 0.88$ S/m; $\epsilon_r = 41.652$; $\rho = 1000$ kg/m³

Ambient Temperature: 21.8°C Liquid Temperature: 21.4°C

Communication System: WCDMA Frequency: 826.4 MHz Duty Cycle: 1:1

Probe: ES3DV3 - SN3151 ConvF(6.27, 6.27, 6.27); Calibrated: 4/24/2012

Left Cheek Low/Area Scan (51x91x1): Interpolated grid: dx=1.500 mm, dy=1.500 mm

Reference Value = 7.953 V/m; Power Drift = -0.13 dB

Maximum value of SAR (interpolated) = 0.774 W/kg

Left Cheek Low/Zoom Scan (5x5x7)/Cube 0: Measurement grid: dx=8mm, dy=8mm, dz=5mm

Reference Value = 7.953 V/m; Power Drift = -0.13 dB

Peak SAR (extrapolated) = 0.885 W/kg

SAR(1 g) = 0.734 W/kg; SAR(10 g) = 0.561 W/kg

Maximum value of SAR (measured) = 0.771 W/kg

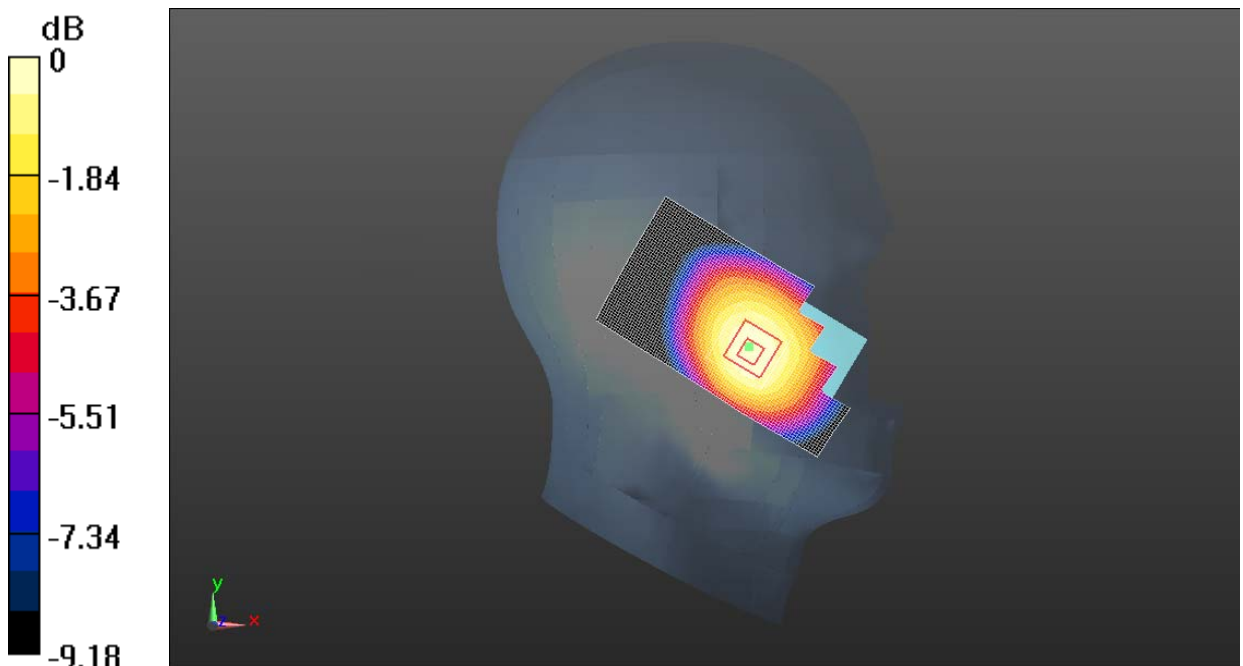

0 dB = 0.771 W/kg = -1.13 dBW/kg

Fig. 51 W850 MHz CH4132

W850 Left Tilt High

Date/Time: 2/22/2013

Electronics: DAE4 Sn786

Medium: Head 850MHz

Medium parameters used (interpolated): $f = 846.6$ MHz; $\sigma = 0.9$ S/m; $\epsilon_r = 41.402$; $\rho = 1000$ kg/m³

Ambient Temperature: 21.8°C Liquid Temperature: 21.4°C

Communication System: WCDMA Frequency: 846.6 MHz Duty Cycle: 1:1

Probe: ES3DV3 - SN3151 ConvF(6.27, 6.27, 6.27); Calibrated: 4/24/2012

Left Tilt High/Area Scan (51x91x1): Interpolated grid: dx=1.500 mm, dy=1.500 mm

Reference Value = 12.842 V/m; Power Drift = 0.08 dB

Maximum value of SAR (interpolated) = 0.407 W/kg

Left Tilt High/Zoom Scan (5x5x7)/Cube 0: Measurement grid: dx=8mm, dy=8mm, dz=5mm

Reference Value = 12.842 V/m; Power Drift = 0.08 dB

Peak SAR (extrapolated) = 0.464 W/kg

SAR(1 g) = 0.391 W/kg; SAR(10 g) = 0.302 W/kg

Maximum value of SAR (measured) = 0.406 W/kg

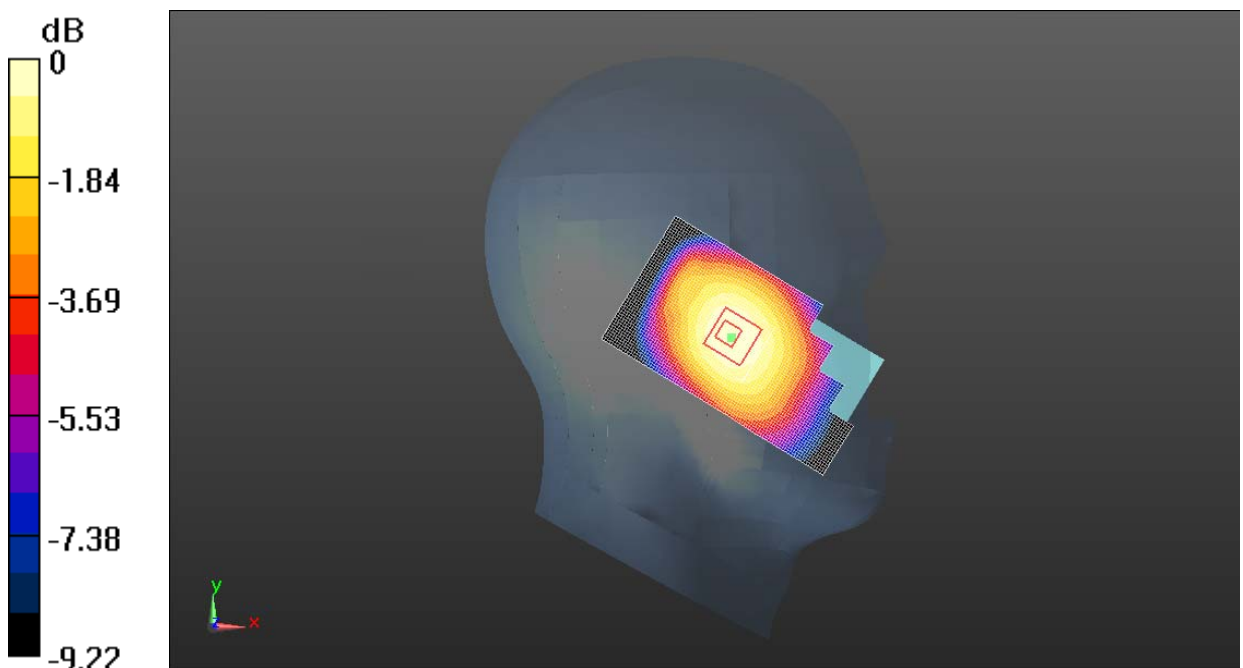

0 dB = 0.406 W/kg = -3.91 dBW/kg

Fig. 52 W850 MHz CH4233

W850 Left Tilt Middle

Date/Time: 2/22/2013

Electronics: DAE4 Sn786

Medium: Head 850MHz

Medium parameters used (interpolated): $f = 836.6$ MHz; $\sigma = 0.89$ S/m; $\epsilon_r = 41.523$; $\rho = 1000$ kg/m³

Ambient Temperature: 21.8°C Liquid Temperature: 21.4°C

Communication System: WCDMA Frequency: 836.6 MHz Duty Cycle: 1:1

Probe: ES3DV3 - SN3151 ConvF(6.27, 6.27, 6.27); Calibrated: 4/24/2012

Left Tilt Middle/Area Scan (51x91x1): Interpolated grid: dx=1.500 mm, dy=1.500 mm

Reference Value = 13.233 V/m; Power Drift = -0.07 dB

Maximum value of SAR (interpolated) = 0.409 W/kg

Left Tilt Middle/Zoom Scan (5x5x7)/Cube 0: Measurement grid: dx=8mm, dy=8mm, dz=5mm

Reference Value = 13.233 V/m; Power Drift = -0.07 dB

Peak SAR (extrapolated) = 0.466 W/kg

SAR(1 g) = 0.392 W/kg; SAR(10 g) = 0.304 W/kg

Maximum value of SAR (measured) = 0.407 W/kg

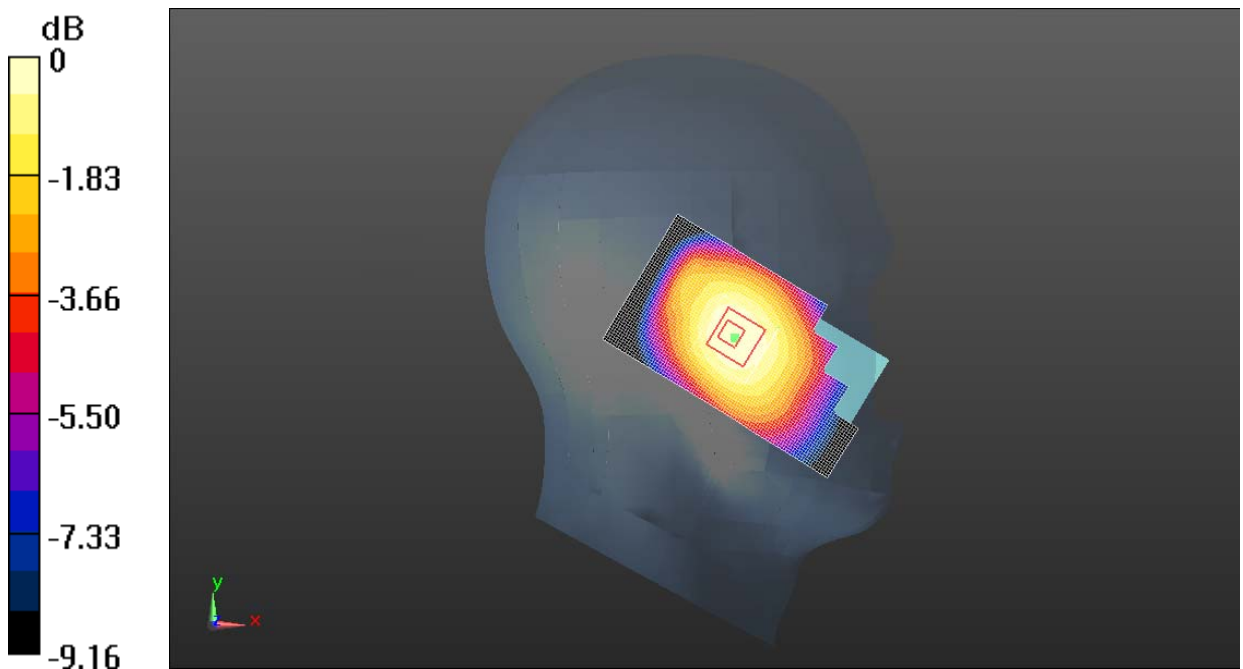

0 dB = 0.407 W/kg = -3.90 dBW/kg

Fig. 53 W850 MHz CH4183

W850 Left Tilt Low

Date/Time: 2/22/2013

Electronics: DAE4 Sn786

Medium: Head 850MHz

Medium parameters used (interpolated): $f = 826.4$ MHz; $\sigma = 0.88$ S/m; $\epsilon_r = 41.652$; $\rho = 1000$ kg/m³

Ambient Temperature: 21.8°C Liquid Temperature: 21.4°C

Communication System: WCDMA Frequency: 826.4 MHz Duty Cycle: 1:1

Probe: ES3DV3 - SN3151 ConvF(6.27, 6.27, 6.27); Calibrated: 4/24/2012

Left Tilt Low/Area Scan (51x91x1): Interpolated grid: dx=1.500 mm, dy=1.500 mm

Reference Value = 12.500 V/m; Power Drift = -0.00 dB

Maximum value of SAR (interpolated) = 0.363 W/kg

Left Tilt Low/Zoom Scan (5x5x7)/Cube 0: Measurement grid: dx=8mm, dy=8mm, dz=5mm

Reference Value = 12.500 V/m; Power Drift = -0.00 dB

Peak SAR (extrapolated) = 0.412 W/kg

SAR(1 g) = 0.348 W/kg; SAR(10 g) = 0.271 W/kg

Maximum value of SAR (measured) = 0.361 W/kg

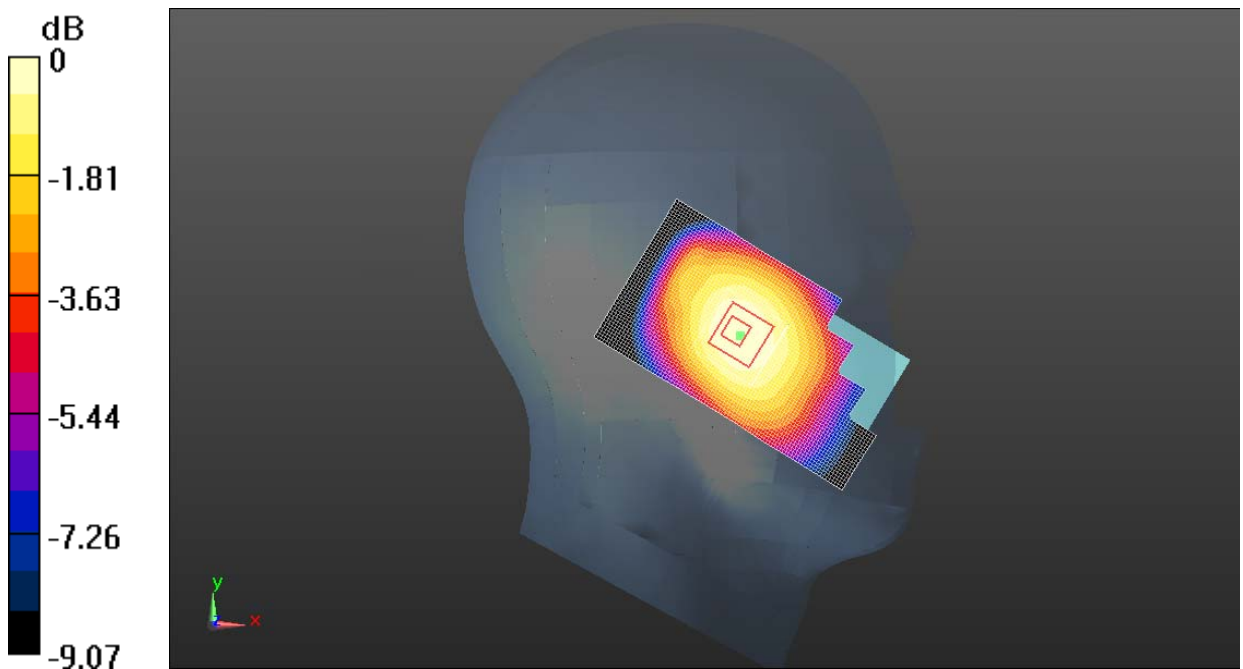

0 dB = 0.361 W/kg = -4.42 dBW/kg

Fig. 54 W850 MHz CH4132

W850 Right Cheek High

Date/Time: 2/21/2013

Electronics: DAE4 Sn786

Medium: Head 850MHz

Medium parameters used (interpolated): $f = 846.6$ MHz; $\sigma = 0.9$ S/m; $\epsilon_r = 41.402$; $\rho = 1000$ kg/m³

Ambient Temperature: 21.8°C Liquid Temperature: 21.4°C

Communication System: WCDMA Frequency: 846.6 MHz Duty Cycle: 1:1

Probe: ES3DV3 - SN3151 ConvF(6.27, 6.27, 6.27); Calibrated: 4/24/2012

Right Cheek High/Area Scan (51x91x1): Interpolated grid: dx=1.500 mm, dy=1.500 mm

Reference Value = 7.830 V/m; Power Drift = 0.02 dB

Maximum value of SAR (interpolated) = 0.669 W/kg

Right Cheek High/Zoom Scan (5x5x7)/Cube 0: Measurement grid: dx=8mm, dy=8mm, dz=5mm

Reference Value = 7.830 V/m; Power Drift = 0.02 dB

Peak SAR (extrapolated) = 0.774 W/kg

SAR(1 g) = 0.633 W/kg; SAR(10 g) = 0.482 W/kg

Maximum value of SAR (measured) = 0.670 W/kg

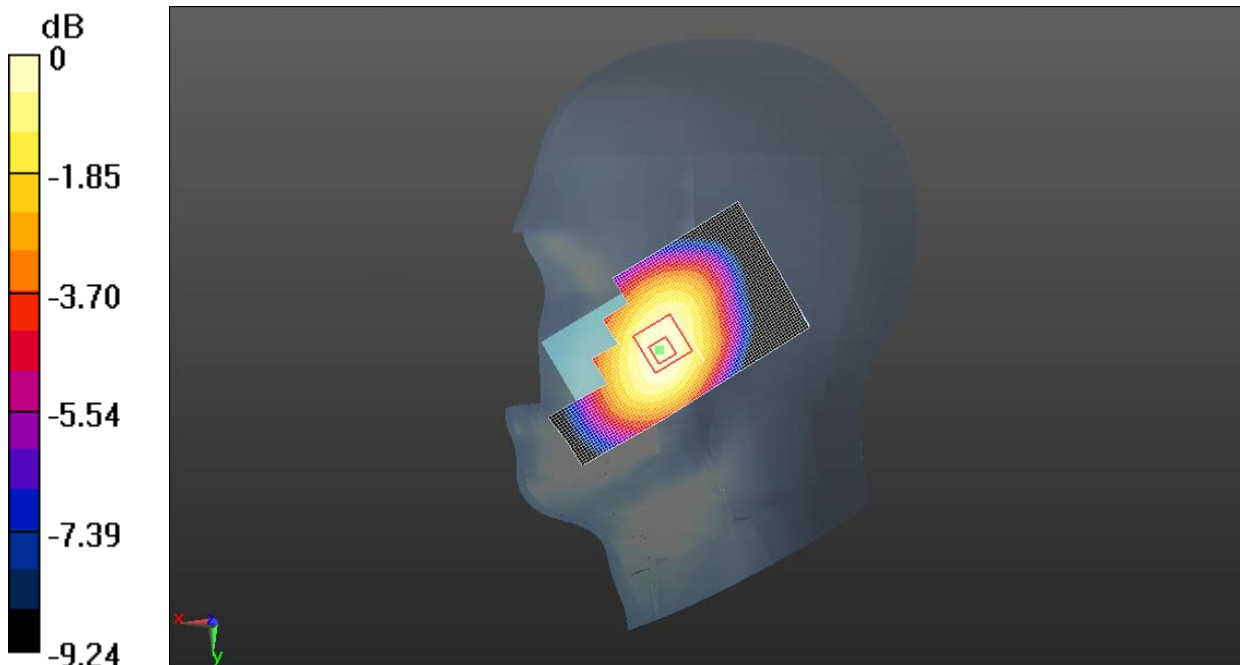

0 dB = 0.670 W/kg = -1.74 dBW/kg

Fig. 55 W850 MHz CH4233

W850 Right Cheek Middle

Date/Time: 2/21/2013

Electronics: DAE4 Sn786

Medium: Head 850MHz

Medium parameters used (interpolated): $f = 836.6$ MHz; $\sigma = 0.89$ S/m; $\epsilon_r = 41.523$; $\rho = 1000$ kg/m³

Ambient Temperature: 21.8°C Liquid Temperature: 21.4°C

Communication System: WCDMA Frequency: 836.6 MHz Duty Cycle: 1:1

Probe: ES3DV3 - SN3151 ConvF(6.27, 6.27, 6.27); Calibrated: 4/24/2012

Right Cheek Middle/Area Scan (51x91x1): Interpolated grid: dx=1.500 mm, dy=1.500 mm

Reference Value = 8.008 V/m; Power Drift = -0.03 dB

Maximum value of SAR (interpolated) = 0.682 W/kg

Right Cheek Middle/Zoom Scan (5x5x7)/Cube 0: Measurement grid: dx=8mm, dy=8mm, dz=5mm

Reference Value = 8.008 V/m; Power Drift = -0.03 dB

Peak SAR (extrapolated) = 0.788 W/kg

SAR(1 g) = 0.644 W/kg; SAR(10 g) = 0.490 W/kg

Maximum value of SAR (measured) = 0.679 W/kg

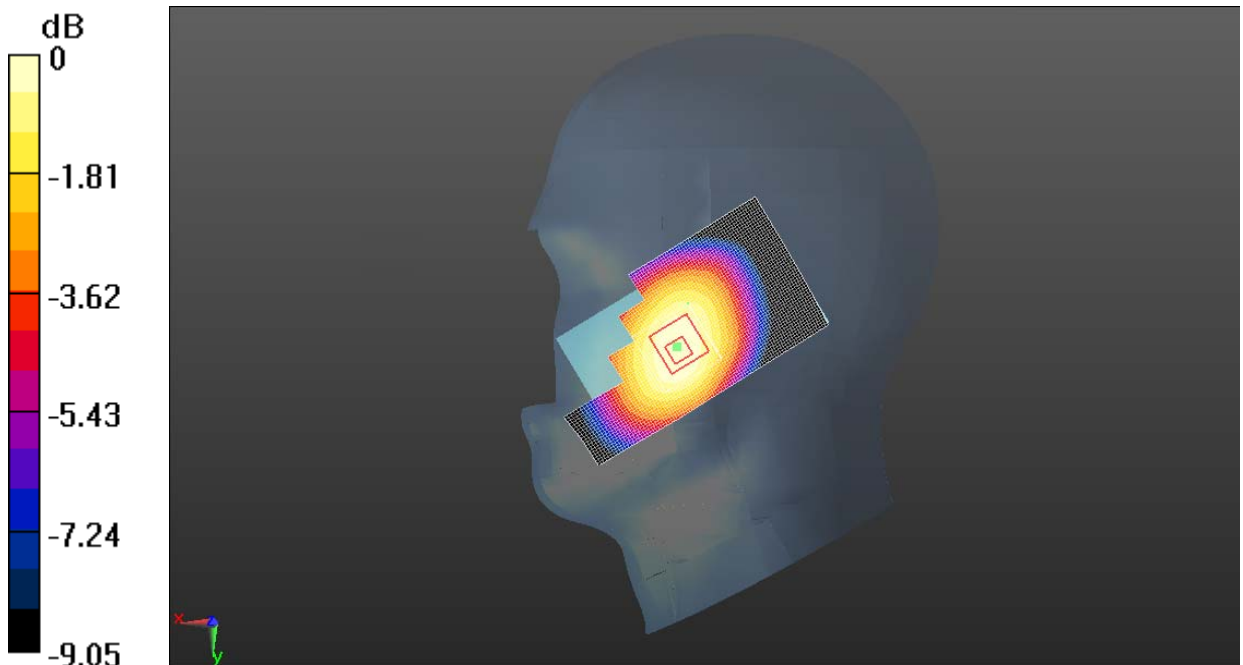

0 dB = 0.679 W/kg = -1.68 dBW/kg

Fig. 56 W850 MHz CH4183

W850 Right Cheek Low

Date/Time: 2/21/2013

Electronics: DAE4 Sn786

Medium: Head 850MHz

Medium parameters used (interpolated): $f = 826.4$ MHz; $\sigma = 0.88$ S/m; $\epsilon_r = 41.652$; $\rho = 1000$ kg/m³

Ambient Temperature: 21.8°C Liquid Temperature: 21.4°C

Communication System: WCDMA Frequency: 826.4 MHz Duty Cycle: 1:1

Probe: ES3DV3 - SN3151 ConvF(6.27, 6.27, 6.27); Calibrated: 4/24/2012

Right Cheek Low/Area Scan (51x91x1): Interpolated grid: dx=1.500 mm, dy=1.500 mm

Reference Value = 7.644 V/m; Power Drift = -0.04 dB

Maximum value of SAR (interpolated) = 0.558 W/kg

Right Cheek Low/Zoom Scan (5x5x7)/Cube 0: Measurement grid: dx=8mm, dy=8mm, dz=5mm

Reference Value = 7.644 V/m; Power Drift = -0.04 dB

Peak SAR (extrapolated) = 0.639 W/kg

SAR(1 g) = 0.524 W/kg; SAR(10 g) = 0.399 W/kg

Maximum value of SAR (measured) = 0.554 W/kg

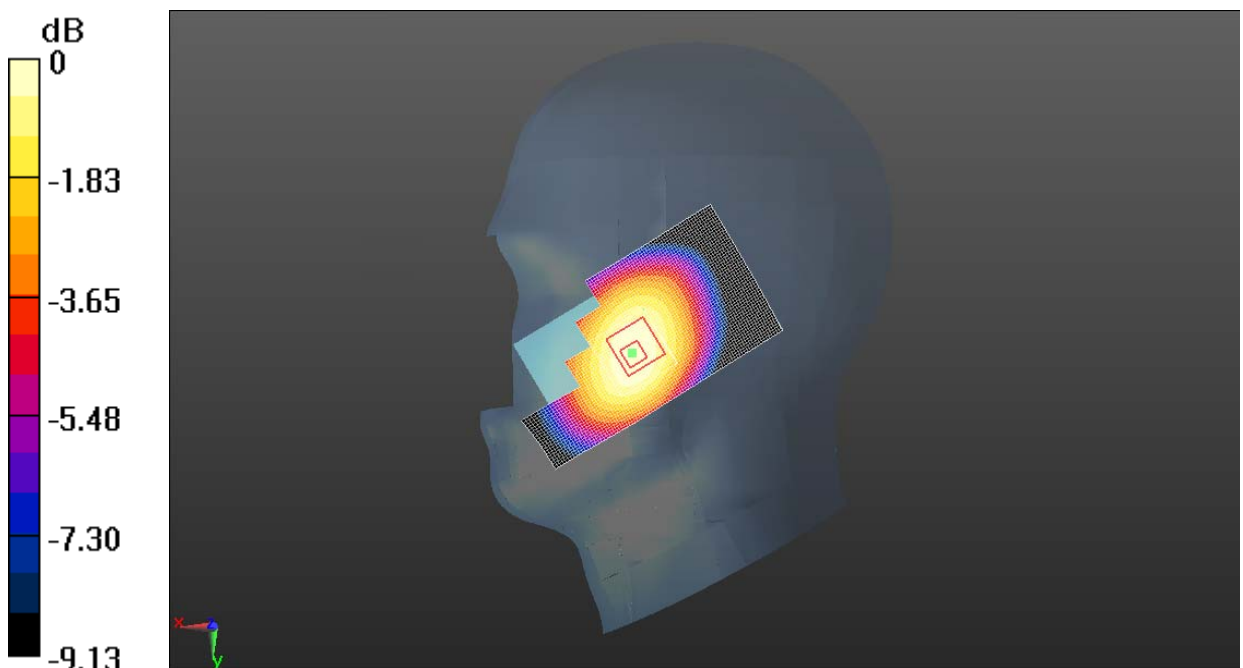

0 dB = 0.554 W/kg = -2.56 dBW/kg

Fig. 57 W850 MHz CH4132

W850 Right Tilt High

Date/Time: 2/21/2013

Electronics: DAE4 Sn786

Medium: Head 850MHz

Medium parameters used (interpolated): $f = 846.6$ MHz; $\sigma = 0.9$ S/m; $\epsilon_r = 41.402$; $\rho = 1000$ kg/m³

Ambient Temperature: 21.8°C Liquid Temperature: 21.4°C

Communication System: WCDMA Frequency: 846.6 MHz Duty Cycle: 1:1

Probe: ES3DV3 - SN3151 ConvF(6.27, 6.27, 6.27); Calibrated: 4/24/2012

Right Tilt High/Area Scan (51x91x1): Interpolated grid: dx=1.500 mm, dy=1.500 mm

Reference Value = 13.165 V/m; Power Drift = 0.03 dB

Maximum value of SAR (interpolated) = 0.411 W/kg

Right Tilt High/Zoom Scan (5x5x7)/Cube 0: Measurement grid: dx=8mm, dy=8mm, dz=5mm

Reference Value = 13.165 V/m; Power Drift = 0.03 dB

Peak SAR (extrapolated) = 0.466 W/kg

SAR(1 g) = 0.394 W/kg; SAR(10 g) = 0.305 W/kg

Maximum value of SAR (measured) = 0.413 W/kg

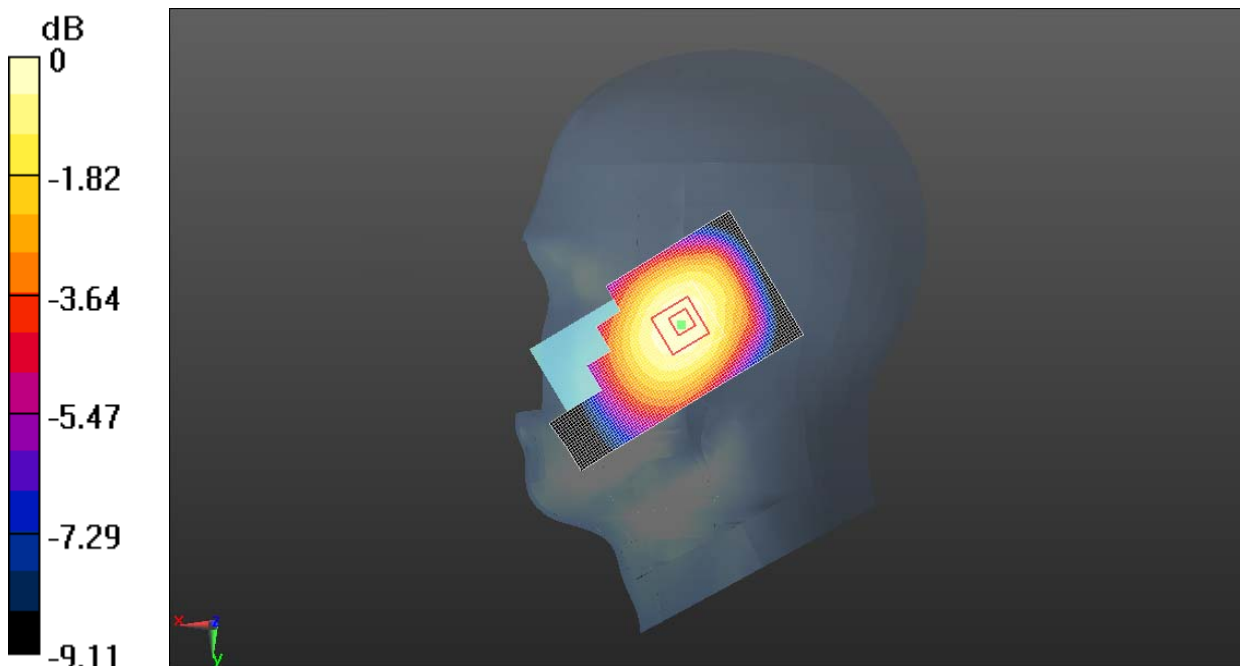

0 dB = 0.413 W/kg = -3.85 dBW/kg

Fig. 58 W850 MHz CH4233