



# HAC RF TEST REPORT

No. 2013EEB00041

For

**TCT Mobile Limited**

**HSUPA/HSDPA/UMTS triband/GSM quadband mobile phone**

**Model name: Megane 1SIM US**

With

**Hardware Version: PIO**

**Software Version: v2C56-0**

**FCC ID: RAD343**

**Results Summary: M Category = M4** (for WCDMA 850/1900)

**M Category = M3** (for GSM 850/1900)

**Issued Date: 2013-02-28**

**Note:**

The test results in this test report relate only to the devices specified in this report. This report shall not be reproduced except in full without the written approval of TMC Beijing.

**Test Laboratory:**

TMC Beijing, Telecommunication Metrology Center of MIIT

No. 52, Huayuan Bei Road, Haidian District, Beijing, P. R. China 100191.

Tel:+86(0)10-62304633-2079, Fax:+86(0)10-62304793 Email:welcme@emcite.com. [www.emcite.com](http://www.emcite.com)

## TABLE OF CONTENT

<b>1 TEST LABORATORY</b> .....	<b>3</b>
1.1 TESTING LOCATION .....	3
1.2 TESTING ENVIRONMENT.....	3
1.3 PROJECT DATA .....	3
1.4 SIGNATURE.....	3
<b>2 CLIENT INFORMATION</b> .....	<b>4</b>
2.1 APPLICANT INFORMATION .....	4
2.2 MANUFACTURER INFORMATION .....	4
<b>3 EQUIPMENT UNDER TEST (EUT) AND ANCILLARY EQUIPMENT (AE)</b> .....	<b>5</b>
3.1 ABOUT EUT .....	5
3.2 INTERNAL IDENTIFICATION OF EUT USED DURING THE TEST .....	5
3.3 INTERNAL IDENTIFICATION OF AE USED DURING THE TEST.....	5
<b>4 CONDUCTED OUTPUT POWER MEASUREMENT</b> .....	<b>6</b>
4.1 SUMMARY .....	6
4.2 CONDUCTED POWER .....	6
<b>5. REFERENCE DOCUMENTS</b> .....	<b>6</b>
5.1 REFERENCE DOCUMENTS FOR TESTING .....	6
<b>6 OPERATIONAL CONDITIONS DURING TEST</b> .....	<b>7</b>
6.1 HAC MEASUREMENT SET-UP .....	7
6.2 PROBE SPECIFICATION .....	8
6.3 TEST ARCH PHANTOM & PHONE POSITIONER.....	9
6.4 ROBOTIC SYSTEM SPECIFICATIONS.....	9
<b>7 EUT ARRANGEMENT</b> .....	<b>10</b>
7.1 WD RF EMISSION MEASUREMENTS REFERENCE AND PLANE .....	10
<b>8 SYSTEM VALIDATION</b> .....	<b>11</b>
8.1 VALIDATION PROCEDURE .....	11
8.2 VALIDATION RESULT .....	11
<b>9 PROBE MODULATION FACTOR</b> .....	<b>12</b>
9.1 MODULATION FACTOR TEST PROCEDURE.....	12
9.2 MODULATION FACTOR.....	13
<b>10 RF TEST PROCEDURES</b> .....	<b>14</b>
<b>11 HAC RF TEST DATA SUMMARY</b> .....	<b>15</b>
11.1 MEASUREMENT RESULTS (E-FIELD).....	15
11.2 MEASUREMENT RESULTS (H-FIELD) .....	15
11.3 TOTAL M-RATING .....	16
<b>12 ANSI C 63.19-2007 LIMITS</b> .....	<b>16</b>
<b>13 MEASUREMENT UNCERTAINTY</b> .....	<b>17</b>
<b>14 MAIN TEST INSTRUMENTS</b> .....	<b>18</b>
<b>15 CONCLUSION</b> .....	<b>18</b>
<b>ANNEX A TEST LAYOUT</b> .....	<b>19</b>
<b>ANNEX B TEST PLOTS</b> .....	<b>20</b>
<b>ANNEX C SYSTEM VALIDATION RESULT</b> .....	<b>52</b>
<b>ANNEX D PROBE CALIBRATION CERTIFICATE</b> .....	<b>56</b>

## 1 Test Laboratory

### 1.1 Testing Location

Company Name: TMC Shenzhen, Telecommunication Metrology Center of MIIT  
Address: No. 12building, Shangsha Innovation and Technology Park, Futian District, Shenzhen, P. R. China  
Postal Code: 518048  
Telephone: +86-755-33322000  
Fax: +86-755-33322001

### 1.2 Testing Environment

Temperature: 18°C~25 °C,  
Relative humidity: 30%~ 70%  
Ground system resistance: < 0.5 Ω

Ambient noise is checked and found very low and in compliance with requirement of standards.  
Reflection of surrounding objects is minimized and in compliance with requirement of standards.

### 1.3 Project Data

Project Leader: Zhou Yi  
Test Engineer: Zhu Zhiqiang  
Testing Start Date: Feb 1<sup>st</sup>, 2013  
Testing End Date: Feb 1<sup>st</sup>, 2013

### 1.4 Signature



---

Zhu Zhiqiang

(Prepared this test report)

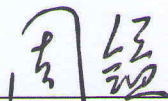

---

Zhou Yi

(Reviewed this test report)



---

Lu Minniu

Director of the laboratory

(Approved this test report)

## 2 Client Information

### 2.1 Applicant Information

Company Name: TCT Mobile Limited  
Address /Post: 12F/B, TCL Tower, Gaoxin Nanyi Road, Nanshan District, Shenzhen,  
Guangdong, P.R. China. 518057  
City: Guangdong,  
Postal Code: /  
Country: P. R. China  
Contact: Lv Meixian  
E-mail: meixian.lv@tcl.co  
Telephone: 0086-755-33956929  
Fax: 0086-755-36645072

### 2.2 Manufacturer Information

Company Name: TCT Mobile Limited  
Address /Post: 12F/B, TCL Tower, Gaoxin Nanyi Road, Nanshan District, Shenzhen,  
Guangdong, P.R. China. 518057  
City: Guangdong,  
Postal Code: /  
Country: P. R. China  
Contact: Lv Meixian  
E-mail: meixian.lv@tcl.co  
Telephone: 0086-755-33956929  
Fax: 0086-755-36645072

### 3 Equipment Under Test (EUT) and Ancillary Equipment (AE)

#### 3.1 About EUT

Description:	HSUPA/HSDPA/UMTS triband / GSM quadband mobile phone
Model name:	Megane 1SIM US
Marketing name:	ONE TOUCH 5020A
Operating mode(s):	GSM 850/1900,WCDMA 850/1900 , BT, WiFi
Tested Tx Frequency:	825 – 848.8 MHz (GSM 850)
	1850.2 – 1910 MHz (GSM 1900)
	826.4-846.6MHz(WCDMA 850)
	1852.4-1908MHz(WCDMA 1900)
Test Modulation	(GSM)GMSK; (WCDMA)QPSK
GPRS Multislot Class:	12
GPRS capability Class:	B
EGPRS Multislot Class:	12(downlink only)
Release version:	GSM: R99
	GPRS: R99
	UMTS: R6
	HSDPA: 8
	HSUPA: 6
Power class:	GSM850: tested with power level 5
	GSM1900: tested with power level 0
	WCDMA: class 3, tested with power control all up bits
Test device Production information:	Production unit
Device type:	Portable device
Antenna type:	Integrated antenna
Accessories/Body-worn configurations:	Headset
Hotspot mode:	Support simultaneous transmission of hotspot and voice(or data)
Form factor:	121.5* 64*11.8

#### 3.2 Internal Identification of EUT used during the test

EUT ID*	SN or IMEI	HW Version	SW Version
EUT1	013511000150012	PIO	v2C56-0

\*EUT ID: is used to identify the test sample in the lab internally.

#### 3.3 Internal Identification of AE used during the test

AE ID*	Description	Model	SN	Manufacturer
AE1	Battery	CAB60B0000C1	/	BYD

## 4 CONDUCTED OUTPUT POWER MEASUREMENT

### 4.1 Summary

During the process of testing, the EUT was controlled via Rhode & Schwarz Digital Radio Communication tester (CMU-200) to ensure the maximum power transmission and proper modulation. This result contains conducted output power for the EUT. In all cases, the measured output power should be greater and within 5% than EMI measurement.

### 4.2 Conducted Power

GSM 850MHz	Conducted Power (dBm)		
	Channel 251(848.8MHz)	Channel 190(836.6MHz)	Channel 128(824.2MHz)
	32.59	32.57	32.45
GSM 1900MHz	Conducted Power (dBm)		
	Channel 810(1909.8MHz)	Channel 661(1880MHz)	Channel 512(1850.2MHz)
	29.40	29.32	29.24
WCDMA 850MHz	Conducted Power (dBm)		
	Channel 4233(846.6MHz)	Channel 4182(836.4MHz)	Channel 4132(826.4MHz)
	23.00	23.24	22.83
WCDMA 1900MHz	Conducted Power (dBm)		
	Channel 9538(1907.6MHz)	Channel 9400(1880MHz)	Channel 9262(1852.4MHz)
	22.83	22.90	22.62

## 5. Reference Documents

### 5.1 Reference Documents for testing

The following document listed in this section is referred for testing.

Reference	Title	Version
ANSI C63.19-2007	American National Standard for Methods of Measurement of Compatibility between Wireless Communication Devices and Hearing Aids	2007 Edition

## 6 OPERATIONAL CONDITIONS DURING TEST

### 6.1 HAC MEASUREMENT SET-UP

These measurements are performed using the DASY5 NEO automated dosimetric assessment system. It is made by Schmid & Partner Engineering AG (SPEAG) in Zurich, Switzerland. It consists of high precision robotics system (Stäubli), robot controller, Intel Core2 computer, near-field probe, probe alignment sensor. The robot is a six-axis industrial robot performing precise movements. A cell controller system contains the power supply, robot controller, teach pendant (Joystick), and remote control, is used to drive the robot motors. The PC consists of the HP Intel Core2 1.86 GHz computer with Windows XP system and HAC Measurement Software DASY5 NEO, A/D interface card, monitor, mouse, and keyboard. The Stäubli Robot is connected to the cell controller to allow software manipulation of the robot. A data acquisition electronic (DAE) circuit performs the signal amplification, signal multiplexing, AD-conversion, offset measurements, mechanical surface detection, collision detection, etc. is connected to the Electro-optical coupler (EOC). The EOC performs the conversion from the optical into digital electric signal of the DAE and transfers data to the PC plug-in card.

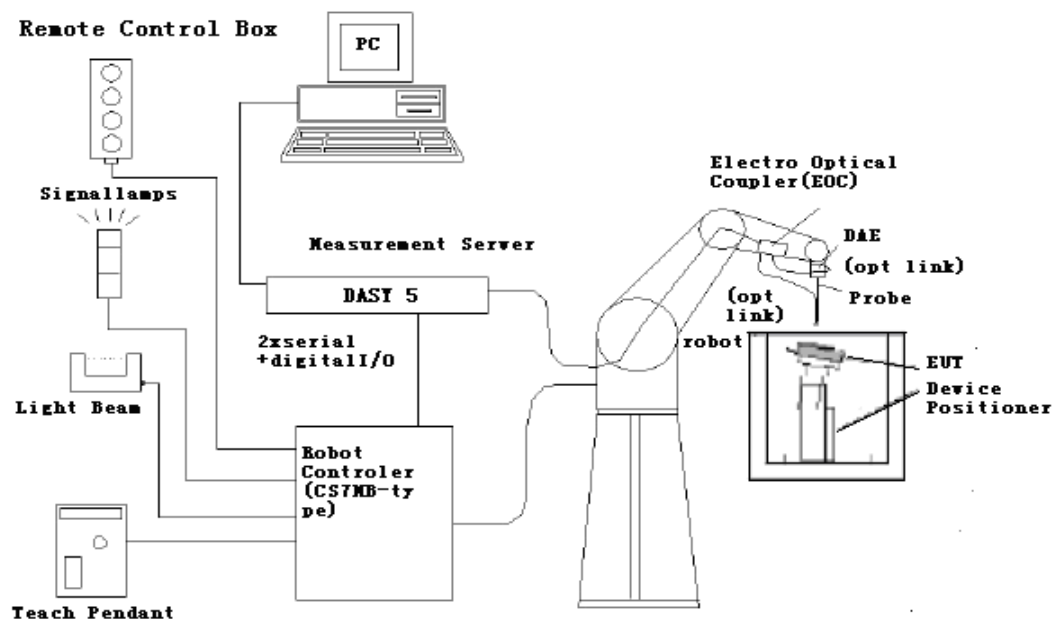

**Fig. 1 HAC Test Measurement Set-up**

The DAE4 consists of a highly sensitive electrometer-grade preamplifier with auto-zeroing, a channel and gain-switching multiplexer, a fast 16 bit AD-converter and a command decoder and control logic unit. Transmission to the PC-card is accomplished through an optical downlink for data and status information and an optical uplink for commands and clock lines. The mechanical probe mounting device includes two different sensor systems for frontal and sidewise probe contacts. They are also used for mechanical surface detection and probe collision detection. The robot uses its own controller with a built in VME-bus computer.

## 6.2 Probe Specification

### 6.2.1 E-Field Probe Description

Construction	One dipole parallel, two dipoles normal to probe axis Built-in shielding against static charges PEEK enclosure material
Calibration	In air from 100 MHz to 3.0 GHz (absolute accuracy $\pm 6.0\%$ , $k=2$ )
Frequency	40 MHz to > 6 GHz (can be extended to < 20 MHz) Linearity: $\pm 0.2$ dB (100 MHz to 3 GHz)
Directivity	$\pm 0.2$ dB in air (rotation around probe axis) $\pm 0.4$ dB in air (rotation normal to probe axis)
Dynamic Range	2 V/m to > 1000 V/m; Linearity: $\pm 0.2$ dB
Dimensions	Overall length: 330 mm (Tip: 16 mm) Tip diameter: 8 mm (Body: 12 mm) Distance from probe tip to dipole centers: 2.5 mm
Application	General near-field measurements up to 6 GHz Field component measurements Fast automatic scanning in phantoms



[ER3DV6]

### 6.2.2 H-Field Probe Description

Construction	Three concentric loop sensors with 3.8 mm loop diameters Resistively loaded detector diodes for linear response Built-in shielding against static charges PEEK enclosure material (resistant to organic solvents, e.g., glycoether)
Frequency	200 MHz to 3 GHz (absolute accuracy $\pm 6.0\%$ , $k=2$ ); Output linearized
Directivity	$\pm 0.2$ dB (spherical isotropy error)
Dynamic Range	10 mA/m to 2 A/m at 1 GHz
E-Field Interference	< 10% at 3 GHz (for plane wave)
Dimensions	Overall length: 330 mm (Tip: 40 mm) Tip diameter: 6 mm (Body: 12 mm) Distance from probe tip to dipole centers: 3 mm
Application	General magnetic near-field measurements up to 3 GHz (in air or liquids) Field component measurements Surface current measurements Low interaction with the measured field

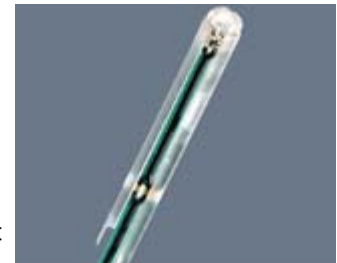

[H3DV6]



### 6.3 Test Arch Phantom & Phone Positioner

The Test Arch phantom should be positioned horizontally on a stable surface. Reference markings on the Phantom allow the complete setup of all predefined phantom positions and measurement grids by manually teaching three points in the robot. It enables easy and well defined positioning of the phone and validation dipoles as well as simple teaching of the robot (Dimensions: 370 x 370 x 370 mm).

The Phone Positioner supports accurate and reliable positioning of any phone with effect on near field  $< \pm 0.5$  dB.



Fig. 2 HAC Phantom & Device Holder

### 6.4 Robotic System Specifications

#### Specifications

**Positioner:** Stäubli Unimation Corp. Robot Model: TX90L

**Repeatability:**  $\pm 0.02$  mm

**No. of Axis:** 6

#### Data Acquisition Electronic (DAE) System

##### Cell Controller

**Processor:** Intel Core2

**Clock Speed:** 1.86 GHz

**Operating System:** Windows XP

##### Data Converter

**Features:** Signal Amplifier, multiplexer, A/D converter, and control logic

**Software:** DASY5 software

**Connecting Lines:** Optical downlink for data and status info.

Optical uplink for commands and clock

## 7 EUT ARRANGEMENT

### 7.1 WD RF Emission Measurements Reference and Plane

Figure 4 illustrates the references and reference plane that shall be used in the WD emissions measurement.

- The grid is 5 cm by 5 cm area that is divided into 9 evenly sized blocks or sub-grids.
- The grid is centered on the audio frequency output transducer of the WD (speaker or T-coil).
- The grid is located by reference to a reference plane. This reference plane is the planar area that contains the highest point in the area of the WD that normally rests against the user's ear
- The measurement plane is located parallel to the reference plane and 15 mm from it, out from the phone. The grid is located in the measurement plane.

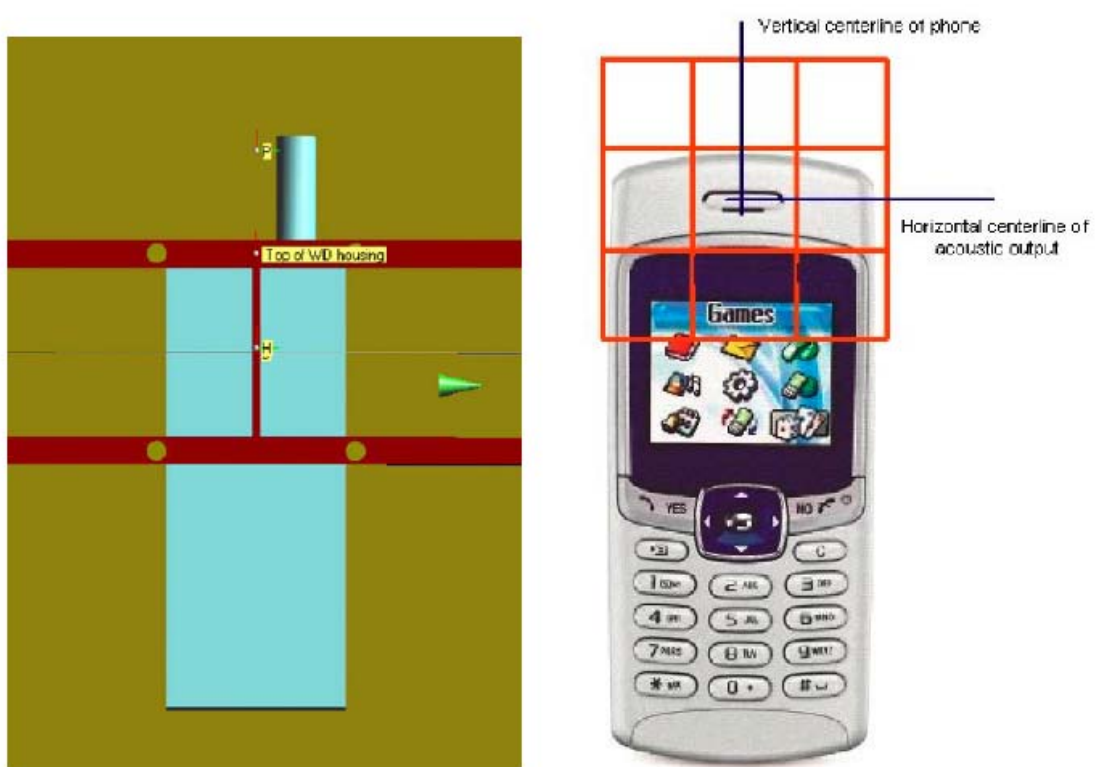

Fig. 3 WD reference and plane for RF emission measurements

## 8 SYSTEM VALIDATION

### 8.1 Validation Procedure

Place a dipole antenna meeting the requirements given in ANSI C63.19 D.5 in the position normally occupied by the WD. The dipole antenna serves as a known source for an electrical and magnetic output. Position the E-field and H-field probes so that:

- The probes and their cables are parallel to the coaxial feed of the dipole antenna
- The probe cables and the coaxial feed of the dipole antenna approach the measurement area from opposite directions
- The center point of the probe element(s) are 10 mm from the closest surface of the dipole elements.

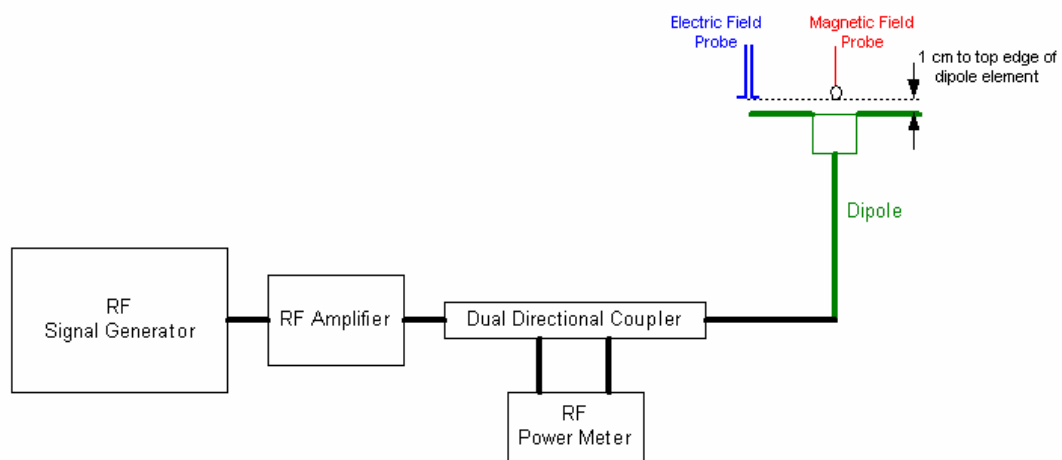

Fig. 4 Dipole Validation Setup

### 8.2 Validation Result

E-Field Scan							
Mode	Frequency (MHz)	Input Power (mW)	Power	Measured <sup>1</sup> Value(V/m)	Target <sup>2</sup> Value(V/m)	Deviation <sup>3</sup> (%)	Limit <sup>4</sup> (%)
CW	835	100		163.7	160.4	2.06	±25
CW	1880	100		144.2	138.9	3.82	±25
H-Field Scan							
Mode	Frequency (MHz)	Input Power (mW)	Power	Measured Value(A/m)	Target Value(A/m)	Deviation (%)	Limit (%)
CW	835	100		0.467	0.461	1.30	±25
CW	1880	100		0.463	0.463	0	±25

Notes:

1. Please refer to the attachment for detailed measurement data and plot.
2. Target value is provided by SPEAD in the calibration certificate of specific dipoles.
3. Deviation (%) = 100 \* (Measured value minus Target value) divided by Target value.
4. ANSI C63.19 requires values within ± 25% are acceptable, of which 12% is deviation and 13% is measurement uncertainty. Values independently validated for the dipole actually used in the measurements should be used, when available.

## 9 Probe Modulation Factor

The Probe Modulation Factor (PMF) is defined as the ratio of the field readings for a CW and a modulated signal with the equivalent Field Envelope Peak as defined in ANSI C63.19 (Chapter C.3.1). Calibration shall be made of the modulation response of the probe and its instrumentation chain. This Calibration shall be performed with the field probe, attached to the instrumentation that is to be used with it during the measurement. The response of the probe system to a CW field at the frequency(s) of interest is compared to its response to a modulated signal with equal peak amplitude. The field level of the test signals shall be more than 10dB above the ambient level and the noise floor of the instrumentation being used. The ratio of the CW reading to that taken with a modulated field shall be applied to the readings taken of modulated fields of the specified type.

### 9.1 Modulation Factor Test Procedure

This may be done using the following procedure:

1. Fix the field probe in a set location relative to a field generating device, such as the reference dipole antenna, as illustrated in Figure 6.
2. Illuminate the probe using the wireless device connected to the reference dipole with a test signal at the intended measurement frequency, Ensure there is sufficient field coupling between the probe and the antenna so the resulting reading is greater than 10 dB above the probe system noise floor but within the systems operating range.
3. Record the amplitude applied to the antenna during transmission and the field strength measured by the E-field probe located near the tip of the dipole antenna
4. Replace the wireless device with an RF signal generator producing an unmodulated CW signal and set to the wireless device operating frequency.
5. Set the amplitude of the unmodulated signal to equal that recorded from the wireless device.
6. Record the reading of the probe measurement system of the unmodulated signal.
7. The ratio, in linear units, of the probe reading in Step 6) to the reading in Step 3) is the E-field modulation factor.  $PMF_E = E_{CW} / E_{mod}$  ( $PMF_H = H_{CW} / H_{mod}$ )
8. Repeat the previous steps using the H-field probe, except locate the probe at the center of the dipole.

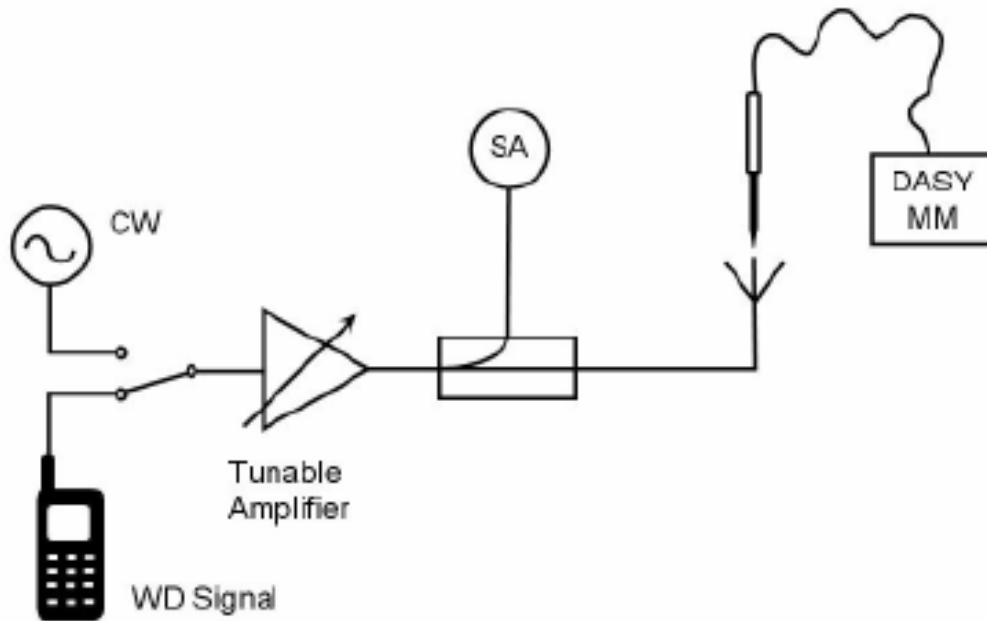

Fig. 5 Probe Modulation Factor Test Setup

## 9.2 Modulation Factor

### 9.2.1 E-Field

Frequency (MHz)	Mode	Input Power (mW)	E-Field Measured Value (V/m)	Probe Modulation Factor
835	<b>CW</b>	<b>100</b>	<b>164.1</b>	\
	WCDMA	100	172.5	<b>1.00</b>
	GSM	100	59.2	<b>2.88</b>
1880	<b>CW</b>	<b>100</b>	<b>139.7</b>	\
	WCDMA	100	135.8	<b>1.00</b>
	GSM	100	46.5	<b>2.88</b>

### 9.2.2 H-Field

Frequency (MHz)	Mode	Input Power (mW)	H-Field Measured Value (A/m)	Probe Modulation Factor
835	<b>CW</b>	<b>100</b>	<b>0.465</b>	\
	WCDMA	100	0.435	<b>1.00</b>
	GSM	100	0.138	<b>2.88</b>
1880	<b>CW</b>	<b>100</b>	<b>0.462</b>	\
	WCDMA	100	0.421	<b>1.00</b>
	GSM	100	0.146	<b>2.88</b>

## 10 RF TEST PROCEDURES

**The evaluation was performed with the following procedure:**

- 1) Confirm proper operation of the field probe, probe measurement system and other instrumentation and the positioning system.
- 2) Position the WD in its intended test position. The gauge block can simplify this positioning. Note that a separate E-field and H-field gauge block will be needed if the center of the probe sensor elements are at different distances from the tip of the probe.
- 3) Configure the WD normal operation for maximum rated RF output power, at the desired channel and other operating parameters (e.g., test mode), as intended for the test.
- 4) The center sub-grid shall be centered on the center of the T-Coil mode axial measurement point or the acoustic output, as appropriate. Locate the field probe at the initial test position in the 50 mm by 50 mm grid, which is contained in the measurement plane. If the field alignment method is used, align the probe for maximum field reception.
- 5) Record the reading.
- 6) Scan the entire 50 mm by 50 mm region in equally spaced increments and record the reading at each measurement point. The distance between measurement points shall be sufficient to assure the identification of the maximum reading.
- 7) Identify the five contiguous sub-grids around the center sub-grid with the lowest maximum field strength readings. Thus the six areas to be used to determine the WD's highest emissions are identified and outlined for the final manual scan. Please note that a maximum of five blocks can be excluded for both E-field and H-field measurements for the WD output being measured. Stated another way, the center sub-grid and three others must be common to both the E-field and H-field measurements.
- 8) Identify the maximum field reading within the non-excluded sub-grids identified in Step 7)
- 9) Convert the maximum field strength reading identified in Step 8) to V/m or A/m, as appropriate. For probes which require a probe modulation factor, this conversion shall be done using the appropriate probe modulation factor and the calibration.
- 10) Repeat Step 1) through Step 10) for both the E-field and H-field measurements.
- 11) Compare this reading to the categories in ANSI C63.19 Clause 7 and record the resulting category. The lowest category number listed in 7.2, Table 7.4, or Table 7.5 obtained in Step 10) for either E- or H-field determines the M category for the audio coupling mode assessment. Record the WD category rating.

## 11 HAC RF TEST DATA SUMMARY

### 11.1 Measurement Results (E-Field)

Frequency		AWF	Measured Value (V/m)	Power Drift (dB)	Category
MHz	Channel				
<b>GSM 850</b>					
848.8	251	-5	226.2	0.00	<b>M3</b> (see Fig B.1)
836.6	190	-5	206.4	0.03	<b>M3</b> (see Fig B.2)
824.2	128	-5	185.8	-0.05	<b>M3</b> (see Fig B.3)
<b>GSM 1900</b>					
1909.8	810	-5	57.71	0.02	<b>M3</b> (see Fig B.4)
1880	661	-5	58.85	-0.01	<b>M3</b> (see Fig B.5)
1850.2	512	-5	60.72	0.01	<b>M3</b> (see Fig B.6)
<b>WCDMA 850</b>					
846.6	4233	0	70.90	0.00	<b>M4</b> (see Fig B.7)
836.4	4182	0	73.35	-0.02	<b>M4</b> (see Fig B.8)
826.4	4132	0	72.84	-0.02	<b>M4</b> (see Fig B.9)
<b>WCDMA 1900</b>					
1907.6	9538	0	27.71	-0.00	<b>M4</b> (see Fig B.10)
1880	9400	0	28.38	-0.01	<b>M4</b> (see Fig B.11)
1852.4	9262	0	30.35	-0.01	<b>M4</b> (see Fig B.12)

### 11.2 Measurement Results (H-Field)

Frequency		AWF	Measured Value (A/m)	Power Drift (dB)	Category
MHz	Channel				
<b>GSM 850</b>					
848.8	251	-5	0.330	0.01	<b>M4</b> (see Fig B.13)
836.6	190	-5	0.286	-0.06	<b>M4</b> (see Fig B.14)
824.2	128	-5	0.258	-0.04	<b>M4</b> (see Fig B.15)
<b>GSM 1900</b>					
1909.8	810	-5	0.177	-0.00	<b>M3</b> (see Fig B.16)
1880	661	-5	0.167	-0.01	<b>M3</b> (see Fig B.17)
1850.2	512	-5	0.174	0.07	<b>M3</b> (see Fig B.18)
<b>WCDMA 850</b>					
846.6	4233	0	0.0982	0.03	<b>M4</b> (see Fig B.19)
836.4	4182	0	0.0995	0.00	<b>M4</b> (see Fig B.20)
826.4	4132	0	0.0984	-0.04	<b>M4</b> (see Fig B.21)
<b>WCDMA 1900</b>					
1907.6	9538	0	0.0761	-0.02	<b>M4</b> (see Fig B.22)
1880	9400	0	0.0741	-0.01	<b>M4</b> (see Fig B.23)
1852.4	9262	0	0.0813	-0.00	<b>M4</b> (see Fig B.24)

### 11.3 Total M-rating

Mode	Maximum value of peak Total E-Field (V/m)	Maximum value of peak Total H-Field (A/m)	E-Field M Rating	H-Field M Rating	Total M Rating
<b>GSM 850</b>	226.2	0.330	M3 (AWF -5 dB)	M4 (AWF -5 dB)	<b>M3</b> (see Fig B.25)
<b>GSM 1900</b>	60.72	0.177	M3 (AWF -5 dB)	M3 (AWF -5 dB)	<b>M3</b> (see Fig B.26)
<b>WCDMA 850</b>	73.35	0.0995	M4 (AWF 0 dB)	M4 (AWF 0 dB)	<b>M4</b> (see Fig B.27)
<b>WCDMA 1900</b>	30.35	0.0813	M4 (AWF 0 dB)	M4 (AWF 0 dB)	<b>M4</b> (see Fig B.28)

## 12 ANSI C 63.19-2007 LIMITS

Table 1: Telephone near-field categories in linear units

Category		Telephone RF parameters < 960 MHz			
Near field	AWF	E-field emissions		H-field emissions	
Category M1/T1	0	631.0 to 1122.0	V/m	1.91 to 3.39	A/m
	-5	473.2 to 841.4	V/m	1.43 to 2.54	A/m
Category M2/T2	0	354.8 to 631.0	V/m	1.07 to 1.91	A/m
	-5	266.1 to 473.2	V/m	0.80 to 1.43	A/m
Category M3/T3	0	199.5 to 354.8	V/m	0.60 to 1.07	A/m
	-5	149.6 to 266.1	V/m	0.45 to 0.80	A/m
Category M4/T4	0	< 199.5	V/m	< 0.60	A/m
	-5	< 149.6	V/m	< 0.45	A/m
Category		Telephone RF parameters > 960 MHz			
Near field	AWF	E-field emissions		H-field emissions	
Category M1/T1	0	199.5 to 354.8	V/m	0.60 to 1.07	A/m
	-5	149.6 to 266.1	V/m	0.45 to 0.80	A/m
Category M2/T2	0	112.2 to 199.5	V/m	0.34 to 0.60	A/m
	-5	84.1 to 149.6	V/m	0.25 to 0.45	A/m
Category M3/T3	0	63.1 to 112.2	V/m	0.19 to 0.34	A/m
	-5	47.3 to 84.1	V/m	0.14 to 0.25	A/m
Category M4/T4	0	< 63.1	V/m	< 0.19	A/m
	-5	< 47.3	V/m	< 0.14	A/m



### 13 MEASUREMENT UNCERTAINTY

No.	Error source	Type	Uncertainty Value (%)	Prob. Dist.	k	$c_i$ E	$c_i$ H	Standard Uncertainty (%) $u_i$ (%) E	Standard Uncertainty (%) $u_i$ (%) H	Degree of freedom $V_{eff}$ or $\nu_i$
<b>Measurement System</b>										
1	Probe Calibration	B	5.	N	1	1	1	5.1	5.1	$\infty$
2	Axial Isotropy	B	4.7	R	$\sqrt{3}$	1	1	2.7	2.7	$\infty$
3	Sensor Displacement	B	16.5	R	$\sqrt{3}$	1	0.145	9.5	1.4	$\infty$
4	Boundary Effects	B	2.4	R	$\sqrt{3}$	1	1	1.4	1.4	$\infty$
5	Linearity	B	4.7	R	$\sqrt{3}$	1	1	2.7	2.7	$\infty$
6	Scaling to Peak Envelope Power	B	2.0	R	$\sqrt{3}$	1	1	1.2	1.2	$\infty$
7	System Detection Limit	B	1.0	R	$\sqrt{3}$	1	1	0.6	0.6	$\infty$
8	Readout Electronics	B	0.3	N	1	1	1	0.3	0.3	$\infty$
9	Response Time	B	0.8	R	$\sqrt{3}$	1	1	0.5	0.5	$\infty$
10	Integration Time	B	2.6	R	$\sqrt{3}$	1	1	1.5	1.5	$\infty$
11	RF Ambient Conditions	B	3.0	R	$\sqrt{3}$	1	1	1.7	1.7	$\infty$
12	RF Reflections	B	12.0	R	$\sqrt{3}$	1	1	6.9	6.9	$\infty$
13	Probe Positioner	B	1.2	R	$\sqrt{3}$	1	0.67	0.7	0.5	$\infty$
14	Probe Positioning	A	4.7	R	$\sqrt{3}$	1	0.67	2.7	1.8	$\infty$
15	Extra. And Interpolation	B	1.0	R	$\sqrt{3}$	1	1	0.6	0.6	$\infty$
<b>Test Sample Related</b>										
16	Device Positioning Vertical	B	4.7	R	$\sqrt{3}$	1	0.67	2.7	1.8	$\infty$
17	Device Positioning Lateral	B	1.0	R	$\sqrt{3}$	1	1	0.6	0.6	$\infty$

18	Device Holder and Phantom	B	2.4	R	$\sqrt{3}$	1	1	1.4	1.4	$\infty$
19	Power Drift	B	5.0	R	$\sqrt{3}$	1	1	2.9	2.9	$\infty$
<b>Phantom and Setup related</b>										
20s	Phantom Thickness	B	2.4	R	$\sqrt{3}$	1	0.67	1.4	0.9	$\infty$
Combined standard uncertainty(%)								14.7	10.9	
Expanded uncertainty (confidence interval of 95 %)		$u_e = 2u_c$		N	k=2			29.4	21.8	

## 14 MAIN TEST INSTRUMENTS

**Table 2: List of Main Instruments**

No.	Name	Type	Serial Number	Calibration Date	Valid Period
01	E-Field Probe	ER3DV6	2424	July 18, 2012	One year
02	H-Field Probe	H3DV6	6264	July 18, 2012	One year
03	HAC Dipole	CD835V3	1023	August 30, 2012	One year
04	HAC Dipole	CD1880V3	1018	August 30, 2012	One year
05	BTS	E5515C	GB47460133	September 20, 2012	One year
06	DAE	DAE4	786	November 20, 2012	One year

## 15 CONCLUSION

The HAC measurement indicates that the EUT complies with the HAC limits of the ANSI C63.19-2007. The total M-ratings are **M4** for **WCDMA 850/1900** and **M3** for **GSM 850/1900**.

\*\*\*END OF REPORT BODY\*\*\*

## ANNEX A TEST LAYOUT

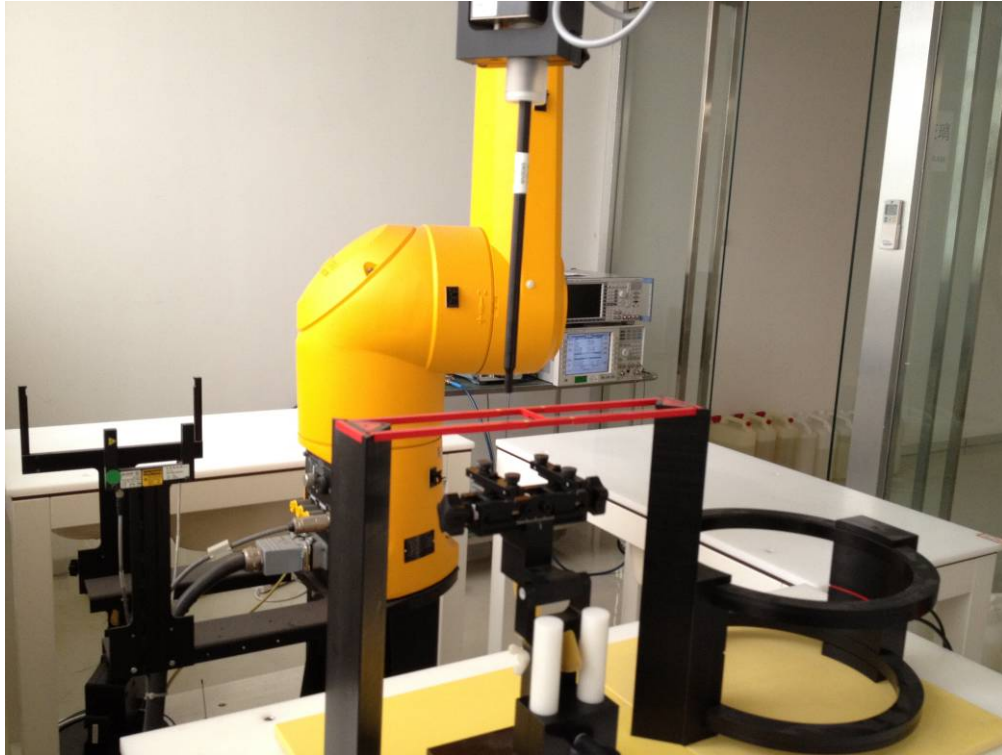

Picture A1: HAC RF System Layout

## ANNEX B TEST PLOTS

### HAC RF E-Field GSM 850 High

Date/Time: 2/1/2013 10:23:47 AM

Electronics: DAE4 Sn786

Medium: Air

Medium parameters used:  $\sigma = 0$  S/m,  $\epsilon_r = 1$ ;  $\rho = 0$  kg/m<sup>3</sup>

Communication System: GSM Frequency: 848.8 MHz Duty Cycle: 1:8.30042

Probe: ER3DV6 - SN2424 ConvF(1, 1, 1); Calibrated: 7/18/2012

**Device E-Field measurement (E-field scan for ANSI C63.19-2007 & -2011 compliance)/E Scan GSM850 Channel High/Hearing Aid Compatibility Test (101x101x1):** Interpolated grid: dx=0.5000 mm, dy=0.5000 mm

Device Reference Point: 0, 0, -6.3 mm

Reference Value = 100.4 V/m; Power Drift = 0.00 dB

PMR not calibrated. PMF = 2.881 is applied.

E-field emissions = 226.2 V/m

**Near-field category: M3 (AWF -5 dB)**

PMF scaled E-field

Grid 1 M3 <b>205.6 V/m</b>	Grid 2 M3 <b>223.1 V/m</b>	Grid 3 M3 <b>215.4 V/m</b>
Grid 4 M3 <b>207.8 V/m</b>	Grid 5 M3 <b>226.2 V/m</b>	Grid 6 M3 <b>220.3 V/m</b>
Grid 7 M3 <b>203.1 V/m</b>	Grid 8 M3 <b>222.8 V/m</b>	Grid 9 M3 <b>217.2 V/m</b>

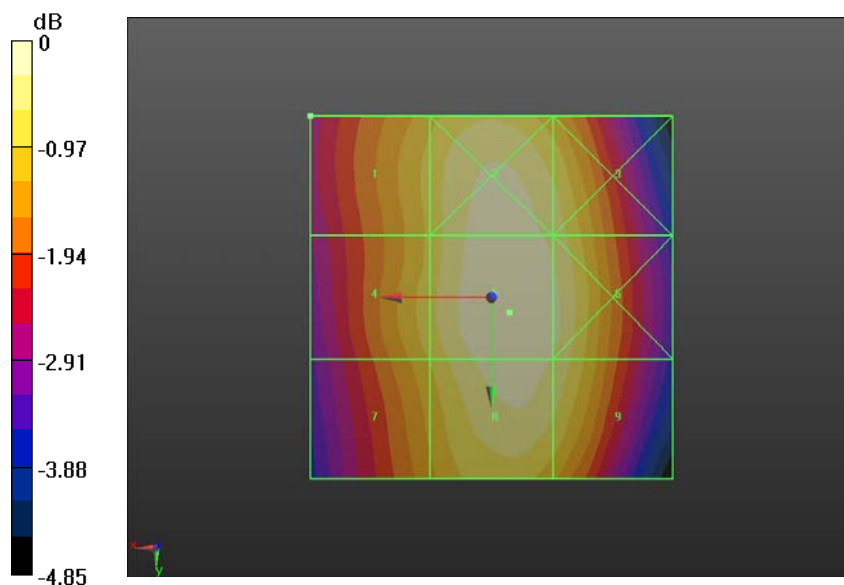

0 dB = 226.2 V/m = 47.09 dBV/m

**Fig B.1 HAC RF E-Field GSM 850 High**

**HAC RF E-Field GSM 850 Middle**

Date/Time: 2/1/2013 10:18:25 AM

Electronics: DAE4 Sn786

Medium: Air

Medium parameters used:  $\sigma = 0$  S/m,  $\epsilon_r = 1$ ;  $\rho = 0$  kg/m<sup>3</sup>

Communication System: GSM Frequency: 836.6 MHz Duty Cycle: 1:8.30042

Probe: ER3DV6 - SN2424 ConvF(1, 1, 1); Calibrated: 7/18/2012

**Device E-Field measurement (E-field scan for ANSI C63.19-2007 & -2011 compliance)/E Scan GSM850 Channel Mid/Hearing Aid Compatibility Test (101x101x1):** Interpolated

grid: dx=0.5000 mm, dy=0.5000 mm

Device Reference Point: 0, 0, -6.3 mm

Reference Value = 91.15 V/m; Power Drift = 0.03 dB

PMR not calibrated. PMF = 2.881 is applied.

E-field emissions = 206.4 V/m

**Near-field category: M3 (AWF -5 dB)**

PMF scaled E-field

Grid 1 M3 <b>188.9 V/m</b>	Grid 2 M3 <b>204.3 V/m</b>	Grid 3 M3 <b>197.8 V/m</b>
Grid 4 M3 <b>190.5 V/m</b>	Grid 5 M3 <b>206.4 V/m</b>	Grid 6 M3 <b>200.8 V/m</b>
Grid 7 M3 <b>185.5 V/m</b>	Grid 8 M3 <b>203.0 V/m</b>	Grid 9 M3 <b>198.1 V/m</b>

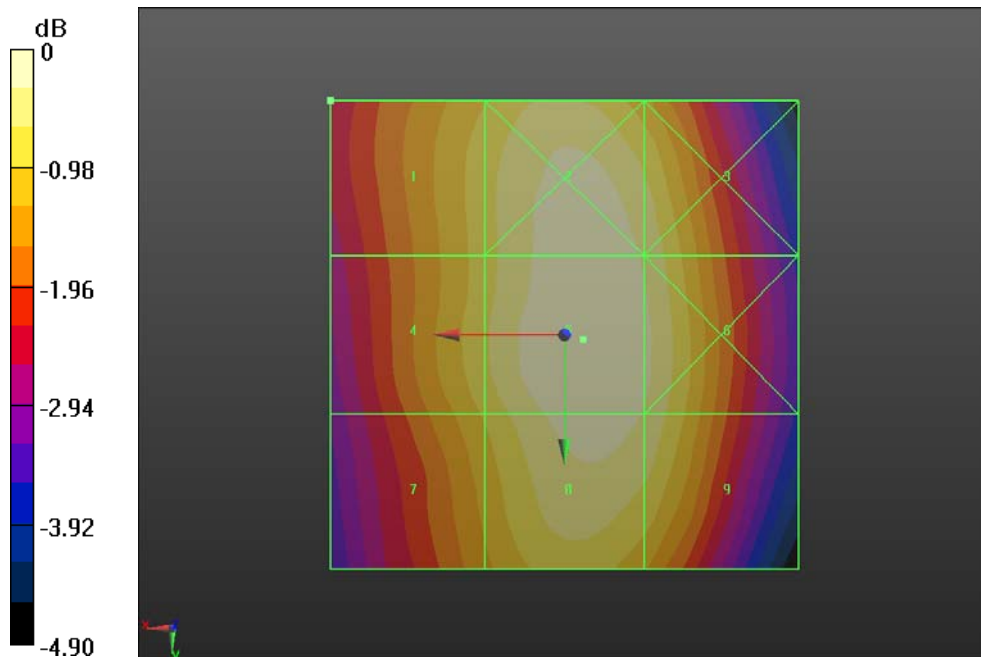

0 dB = 206.4 V/m = 46.29 dBV/m

**Fig B.2 HAC RF E-Field GSM 850 Middle**

**HAC RF E-Field GSM 850 Low**

Date/Time: 2/1/2013 10:29:55 AM

Electronics: DAE4 Sn786

Medium: Air

Medium parameters used:  $\sigma = 0$  S/m,  $\epsilon_r = 1$ ;  $\rho = 0$  kg/m<sup>3</sup>

Communication System: GSM Frequency: 824.2 MHz Duty Cycle: 1:8.30042

Probe: ER3DV6 - SN2424 ConvF(1, 1, 1); Calibrated: 7/18/2012

**Device E-Field measurement (E-field scan for ANSI C63.19-2007 & -2011 compliance)/E Scan GSM850 Channel Low/Hearing Aid Compatibility Test (101x101x1):** Interpolated

grid: dx=0.5000 mm, dy=0.5000 mm

Device Reference Point: 0, 0, -6.3 mm

Reference Value = 82.22 V/m; Power Drift = -0.05 dB

PMR not calibrated. PMF = 2.881 is applied.

E-field emissions = 185.8 V/m

**Near-field category: M3 (AWF -5 dB)**

PMF scaled E-field

Grid 1 M3 <b>169.7 V/m</b>	Grid 2 M3 <b>183.6 V/m</b>	Grid 3 M3 <b>177.4 V/m</b>
Grid 4 M3 <b>171.3 V/m</b>	Grid 5 M3 <b>185.8 V/m</b>	Grid 6 M3 <b>180.6 V/m</b>
Grid 7 M3 <b>167.3 V/m</b>	Grid 8 M3 <b>182.7 V/m</b>	Grid 9 M3 <b>177.9 V/m</b>

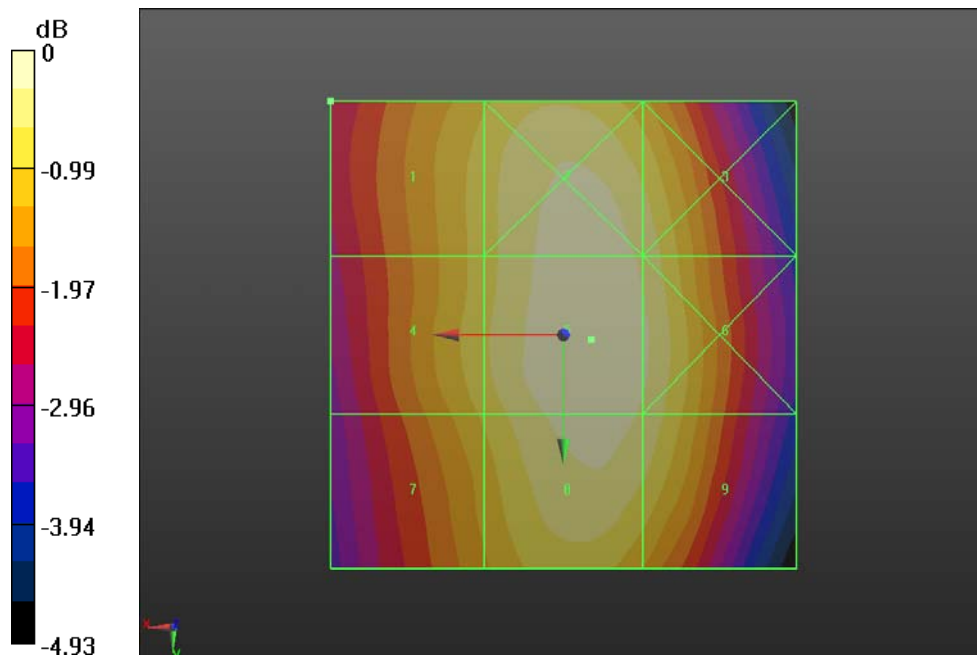

0 dB = 185.8 V/m = 45.38 dBV/m

**Fig B.3 HAC RF E-Field GSM 850 Low**

### HAC RF E-Field GSM 1900 High

Date/Time: 2/1/2013 10:41:46 AM

Electronics: DAE4 Sn786

Medium: Air

Medium parameters used:  $\sigma = 0$  S/m,  $\epsilon_r = 1$ ;  $\rho = 0$  kg/m<sup>3</sup>

Communication System: GSM Frequency: 1910 MHz Duty Cycle: 1:8.30042

Probe: ER3DV6 - SN2424 ConvF(1, 1, 1); Calibrated: 7/18/2012

### Device E-Field measurement (E-field scan for ANSI C63.19-2007 & -2011 compliance)/E Scan GSM1900 Channel High/Hearing Aid Compatibility Test (101x101x1): Interpolated

grid: dx=0.5000 mm, dy=0.5000 mm

Device Reference Point: 0, 0, -6.3 mm

Reference Value = 17.01 V/m; Power Drift = 0.02 dB

PMR not calibrated. PMF = 2.881 is applied.

E-field emissions = 57.71 V/m

Near-field category: M3 (AWF -5 dB)

PMF scaled E-field

<b>Grid 1 M3</b> <b>67.88 V/m</b>	<b>Grid 2 M3</b> <b>74.22 V/m</b>	<b>Grid 3 M3</b> <b>71.41 V/m</b>
<b>Grid 4 M3</b> <b>49.12 V/m</b>	<b>Grid 5 M3</b> <b>57.71 V/m</b>	<b>Grid 6 M3</b> <b>57.46 V/m</b>
<b>Grid 7 M3</b> <b>51.10 V/m</b>	<b>Grid 8 M4</b> <b>44.39 V/m</b>	<b>Grid 9 M4</b> <b>41.21 V/m</b>

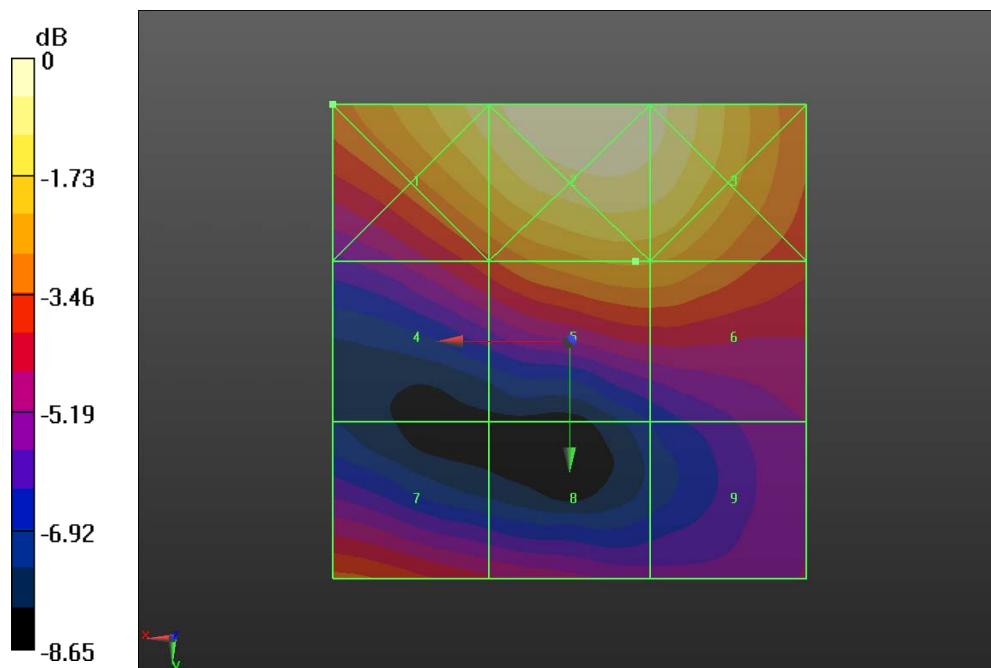

0 dB = 74.22 V/m = 37.41 dBV/m

**Fig B.4 HAC RF E-Field GSM 1900 High**

**HAC RF E-Field GSM 1900 Middle**

Date/Time: 2/1/2013 10:36:26 AM

Electronics: DAE4 Sn786

Medium: Air

Medium parameters used:  $\sigma = 0$  S/m,  $\epsilon_r = 1$ ;  $\rho = 0$  kg/m<sup>3</sup>

Communication System: GSM Frequency: 1880 MHz Duty Cycle: 1:8.30042

Probe: ER3DV6 - SN2424 ConvF(1, 1, 1); Calibrated: 7/18/2012

**Device E-Field measurement (E-field scan for ANSI C63.19-2007 & -2011 compliance)/E Scan GSM1900 Channel Mid/Hearing Aid Compatibility Test (101x101x1):** Interpolated

grid: dx=0.5000 mm, dy=0.5000 mm

Device Reference Point: 0, 0, -6.3 mm

Reference Value = 17.43 V/m; Power Drift = -0.01 dB

PMR not calibrated. PMF = 2.881 is applied.

E-field emissions = 58.85 V/m

**Near-field category: M3 (AWF -5 dB)**

PMF scaled E-field

<b>Grid 1 M3</b> <b>64.95 V/m</b>	<b>Grid 2 M3</b> <b>74.22 V/m</b>	<b>Grid 3 M3</b> <b>72.67 V/m</b>
<b>Grid 4 M3</b> <b>48.21 V/m</b>	<b>Grid 5 M3</b> <b>58.85 V/m</b>	<b>Grid 6 M3</b> <b>58.76 V/m</b>
<b>Grid 7 M4</b> <b>47.26 V/m</b>	<b>Grid 8 M4</b> <b>43.53 V/m</b>	<b>Grid 9 M4</b> <b>44.76 V/m</b>

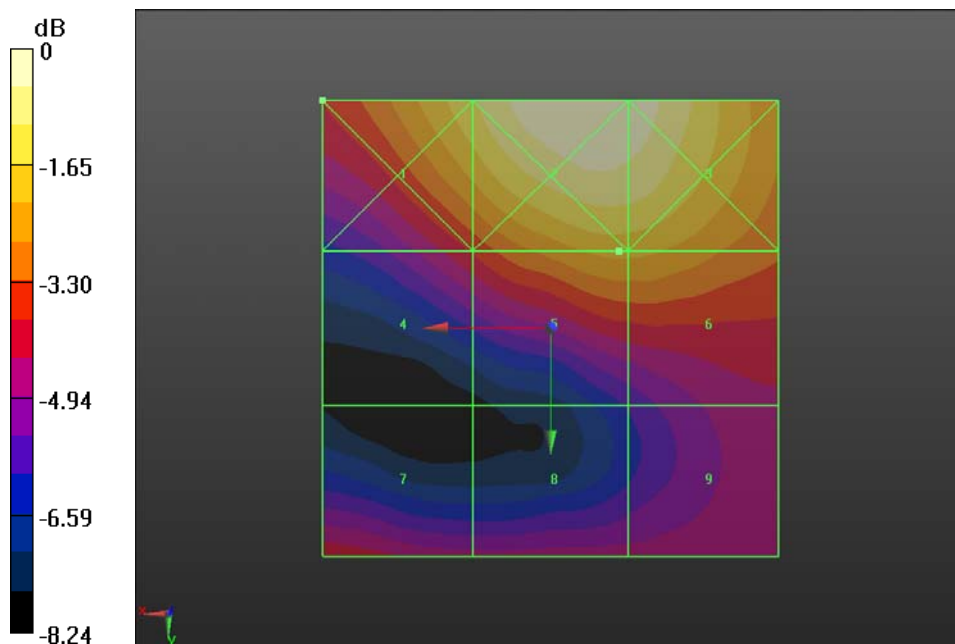

0 dB = 74.22 V/m = 37.41 dBV/m

**Fig B.5 HAC RF E-Field GSM 1900 Middle**



**HAC RF E-Field GSM 1900 Low**

Date/Time: 2/1/2013 10:47:07 AM

Electronics: DAE4 Sn786

Medium: Air

Medium parameters used:  $\sigma = 0$  S/m,  $\epsilon_r = 1$ ;  $\rho = 0$  kg/m<sup>3</sup>

Communication System: GSM Frequency: 1850.2 MHz Duty Cycle: 1:8.30042

Probe: ER3DV6 - SN2424 ConvF(1, 1, 1); Calibrated: 7/18/2012

**Device E-Field measurement (E-field scan for ANSI C63.19-2007 & -2011 compliance)/E Scan GSM1900 Channel Low/Hearing Aid Compatibility Test (101x101x1):** Interpolated

grid: dx=0.5000 mm, dy=0.5000 mm

Device Reference Point: 0, 0, -6.3 mm

Reference Value = 17.01 V/m; Power Drift = 0.01 dB

PMR not calibrated. PMF = 2.881 is applied.

E-field emissions = 60.72 V/m

**Near-field category: M3 (AWF -5 dB)**

PMF scaled E-field

<b>Grid 1 M3</b> <b>73.49 V/m</b>	<b>Grid 2 M3</b> <b>81.40 V/m</b>	<b>Grid 3 M3</b> <b>79.00 V/m</b>
<b>Grid 4 M3</b> <b>52.03 V/m</b>	<b>Grid 5 M3</b> <b>60.72 V/m</b>	<b>Grid 6 M3</b> <b>60.52 V/m</b>
<b>Grid 7 M3</b> <b>52.83 V/m</b>	<b>Grid 8 M3</b> <b>50.79 V/m</b>	<b>Grid 9 M3</b> <b>48.50 V/m</b>

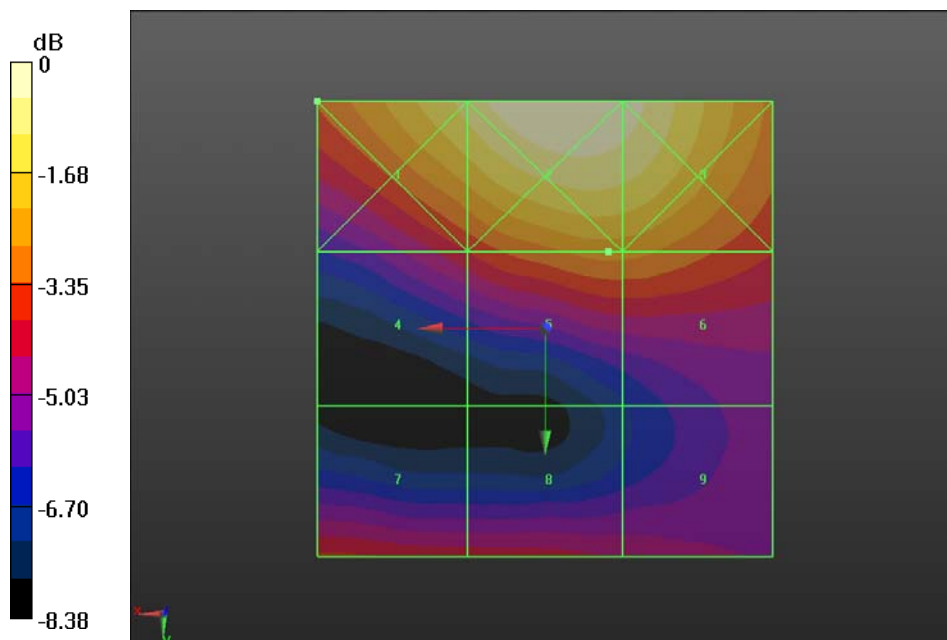

0 dB = 81.40 V/m = 38.21 dBV/m

**Fig B.6 HAC RF E-Field GSM 1900 Low**

### HAC RF E-Field WCDMA 850 High

Date/Time: 2/1/2013 3:05:55 PM

Electronics: DAE4 Sn786

Medium: Air

Medium parameters used:  $\sigma = 0$  S/m,  $\epsilon_r = 1$ ;  $\rho = 0$  kg/m<sup>3</sup>

Communication System: WCDMA Frequency: 846.6 MHz Duty Cycle: 1:1

Probe: ER3DV6 - SN2424 ConvF(1, 1, 1); Calibrated: 7/18/2012

#### Device E-Field measurement (E-field scan for ANSI C63.19-2007 & -2011 compliance)/E Scan W850 Channel High/Hearing Aid Compatibility Test (101x101x1): Interpolated grid:

dx=0.5000 mm, dy=0.5000 mm

Device Reference Point: 0, 0, -6.3 mm

Reference Value = 90.20 V/m; Power Drift = 0.00 dB

PMR not calibrated. PMF = 1.000 is applied.

E-field emissions = 70.90 V/m

Near-field category: M4 (AWF 0 dB)

PMF scaled E-field

Grid 1 M4 <b>63.40 V/m</b>	Grid 2 M4 <b>69.89 V/m</b>	Grid 3 M4 <b>68.10 V/m</b>
Grid 4 M4 <b>64.10 V/m</b>	Grid 5 M4 <b>70.90 V/m</b>	Grid 6 M4 <b>69.36 V/m</b>
Grid 7 M4 <b>62.63 V/m</b>	Grid 8 M4 <b>69.69 V/m</b>	Grid 9 M4 <b>68.37 V/m</b>

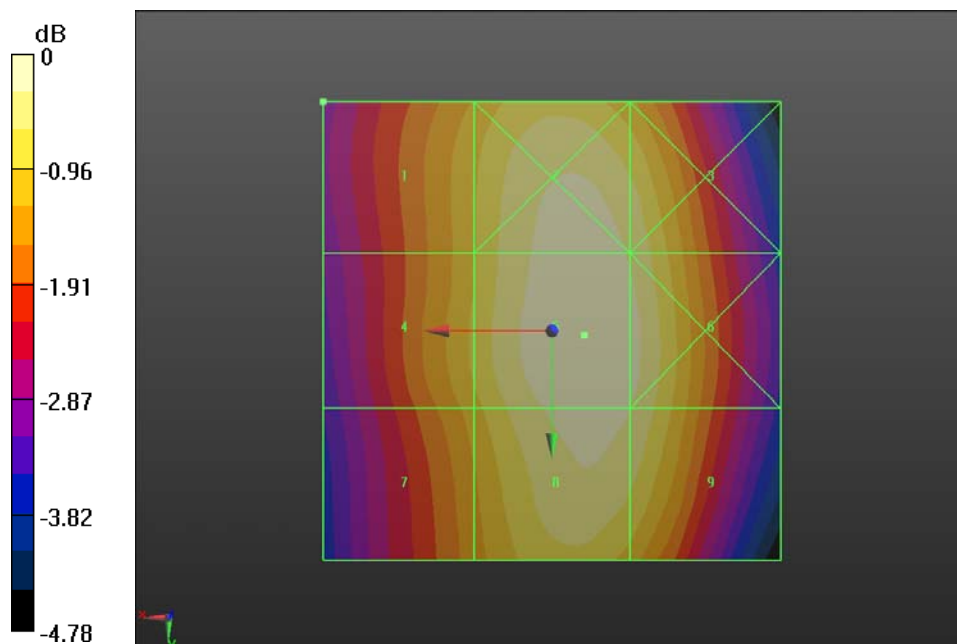

0 dB = 70.90 V/m = 37.01 dBV/m

**Fig B.7 HAC RF E-Field WCDMA 850 High**

**HAC RF E-Field WCDMA 850 Middle**

Date/Time: 2/1/2013 3:00:30 PM

Electronics: DAE4 Sn786

Medium: Air

Medium parameters used:  $\sigma = 0$  S/m,  $\epsilon_r = 1$ ;  $\rho = 0$  kg/m<sup>3</sup>

Communication System: WCDMA Frequency: 836.6 MHz Duty Cycle: 1:1

Probe: ER3DV6 - SN2424 ConvF(1, 1, 1); Calibrated: 7/18/2012

**Device E-Field measurement (E-field scan for ANSI C63.19-2007 & -2011 compliance)/E Scan W850 Channel Middle/Hearing Aid Compatibility Test (101x101x1):** Interpolated

grid: dx=0.5000 mm, dy=0.5000 mm

Device Reference Point: 0, 0, -6.3 mm

Reference Value = 93.49 V/m; Power Drift = -0.02 dB

PMR not calibrated. PMF = 1.000 is applied.

E-field emissions = 73.35 V/m

**Near-field category: M4 (AWF 0 dB)**

PMF scaled E-field

Grid 1 M4 <b>65.96 V/m</b>	Grid 2 M4 <b>72.43 V/m</b>	Grid 3 M4 <b>70.63 V/m</b>
Grid 4 M4 <b>66.56 V/m</b>	Grid 5 M4 <b>73.35 V/m</b>	Grid 6 M4 <b>71.68 V/m</b>
Grid 7 M4 <b>64.91 V/m</b>	Grid 8 M4 <b>71.96 V/m</b>	Grid 9 M4 <b>70.53 V/m</b>

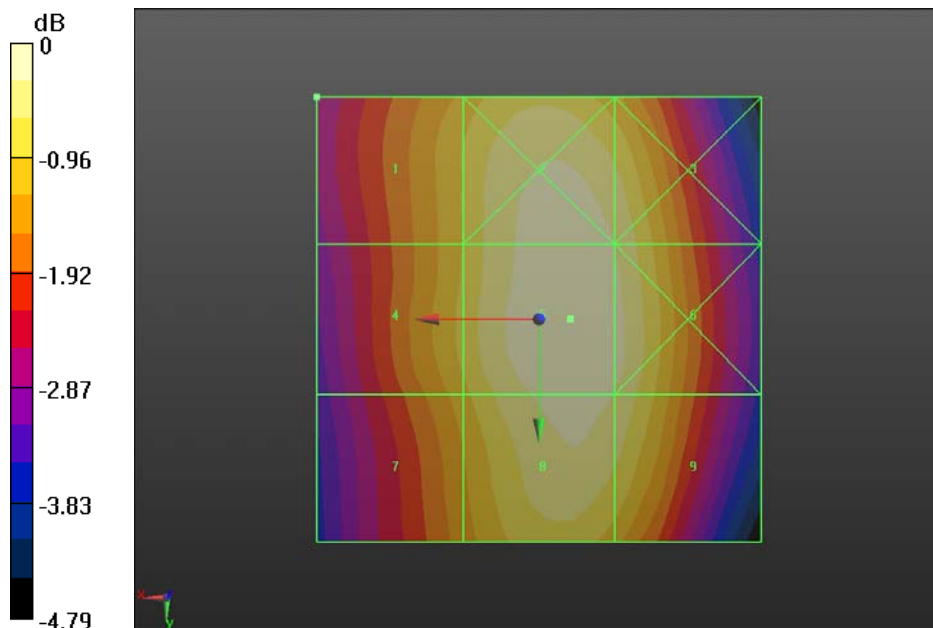

0 dB = 73.35 V/m = 37.31 dBV/m

**Fig B.8 HAC RF E-Field WCDMA 850 Middle**

**HAC RF E-Field WCDMA 850 Low**

Date/Time: 2/1/2013 3:11:19 PM

Electronics: DAE4 Sn786

Medium: Air

Medium parameters used:  $\sigma = 0$  S/m,  $\epsilon_r = 1$ ;  $\rho = 0$  kg/m<sup>3</sup>

Communication System: WCDMA Frequency: 826.4 MHz Duty Cycle: 1:1

Probe: ER3DV6 - SN2424 ConvF(1, 1, 1); Calibrated: 7/18/2012

**Device E-Field measurement (E-field scan for ANSI C63.19-2007 & -2011 compliance)/E Scan W850 Channel Low/Hearing Aid Compatibility Test (101x101x1):** Interpolated grid:

dx=0.5000 mm, dy=0.5000 mm

Device Reference Point: 0, 0, -6.3 mm

Reference Value = 92.66 V/m; Power Drift = -0.02 dB

PMR not calibrated. PMF = 1.000 is applied.

E-field emissions = 72.84 V/m

**Near-field category: M4 (AWF 0 dB)**

PMF scaled E-field

Grid 1 M4 <b>65.49 V/m</b>	Grid 2 M4 <b>71.82 V/m</b>	Grid 3 M4 <b>69.86 V/m</b>
Grid 4 M4 <b>66.25 V/m</b>	Grid 5 M4 <b>72.84 V/m</b>	Grid 6 M4 <b>71.29 V/m</b>
Grid 7 M4 <b>64.59 V/m</b>	Grid 8 M4 <b>71.56 V/m</b>	Grid 9 M4 <b>70.15 V/m</b>

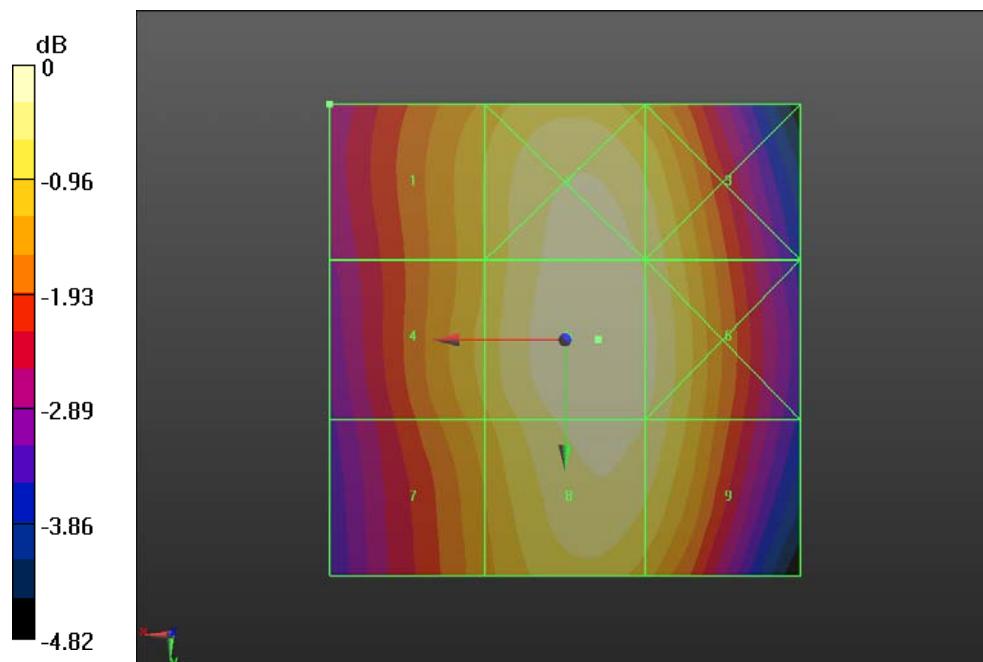

0 dB = 72.84 V/m = 37.25 dBV/m

**Fig B.9 HAC RF E-Field WCDMA 850 Low**

### HAC RF E-Field WCDMA 1900 High

Date/Time: 2/1/2013 2:48:54 PM

Electronics: DAE4 Sn786

Medium: Air

Medium parameters used:  $\sigma = 0$  S/m,  $\epsilon_r = 1$ ;  $\rho = 0$  kg/m<sup>3</sup>

Communication System: WCDMA Frequency: 1908 MHz Duty Cycle: 1:1

Probe: ER3DV6 - SN2424 ConvF(1, 1, 1); Calibrated: 7/18/2012

### Device E-Field measurement (E-field scan for ANSI C63.19-2007 & -2011 compliance)/E Scan W1900 Channel High/Hearing Aid Compatibility Test (101x101x1): Interpolated

grid: dx=0.5000 mm, dy=0.5000 mm

Device Reference Point: 0, 0, -6.3 mm

Reference Value = 24.04 V/m; Power Drift = -0.00 dB

PMR not calibrated. PMF = 1.000 is applied.

E-field emissions = 27.71 V/m

Near-field category: M4 (AWF 0 dB)

PMF scaled E-field

Grid 1 M4 30.01 V/m	Grid 2 M4 34.08 V/m	Grid 3 M4 33.16 V/m
Grid 4 M4 22.39 V/m	Grid 5 M4 27.71 V/m	Grid 6 M4 27.63 V/m
Grid 7 M4 22.24 V/m	Grid 8 M4 19.27 V/m	Grid 9 M4 19.32 V/m

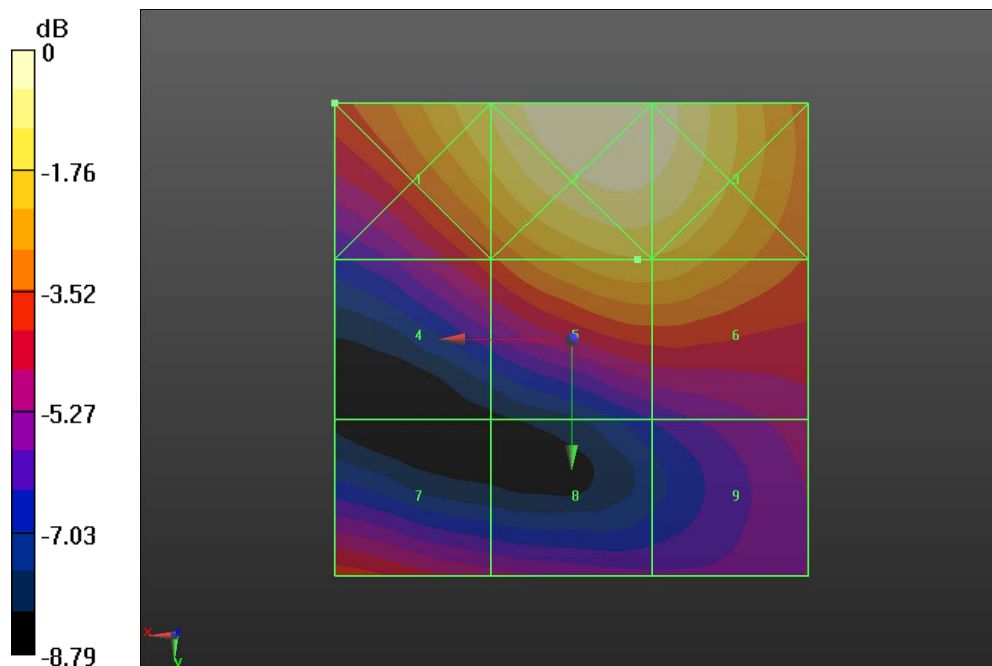

$$0 \text{ dB} = 34.08 \text{ V/m} = 30.65 \text{ dBV/m}$$

Fig B.10 HAC RF E-Field WCDMA 1900 High

**HAC RF E-Field WCDMA 1900 Middle**

Date/Time: 2/1/2013 2:43:38 PM

Electronics: DAE4 Sn786

Medium: Air

Medium parameters used:  $\sigma = 0$  S/m,  $\epsilon_r = 1$ ;  $\rho = 0$  kg/m<sup>3</sup>

Communication System: WCDMA Frequency: 1880 MHz Duty Cycle: 1:1

Probe: ER3DV6 - SN2424 ConvF(1, 1, 1); Calibrated: 7/18/2012

**Device E-Field measurement (E-field scan for ANSI C63.19-2007 & -2011 compliance)/E Scan W1900 Channel Middle/Hearing Aid Compatibility Test (101x101x1):** Interpolated

grid: dx=0.5000 mm, dy=0.5000 mm

Device Reference Point: 0, 0, -6.3 mm

Reference Value = 24.63 V/m; Power Drift = -0.01 dB

PMR not calibrated. PMF = 1.000 is applied.

E-field emissions = 28.38 V/m

**Near-field category: M4 (AWF 0 dB)**

PMF scaled E-field

<b>Grid 1 M4</b> <b>29.44 V/m</b>	<b>Grid 2 M4</b> <b>34.63 V/m</b>	<b>Grid 3 M4</b> <b>34.06 V/m</b>
<b>Grid 4 M4</b> <b>22.29 V/m</b>	<b>Grid 5 M4</b> <b>28.38 V/m</b>	<b>Grid 6 M4</b> <b>28.37 V/m</b>
<b>Grid 7 M4</b> <b>21.18 V/m</b>	<b>Grid 8 M4</b> <b>19.61 V/m</b>	<b>Grid 9 M4</b> <b>20.77 V/m</b>

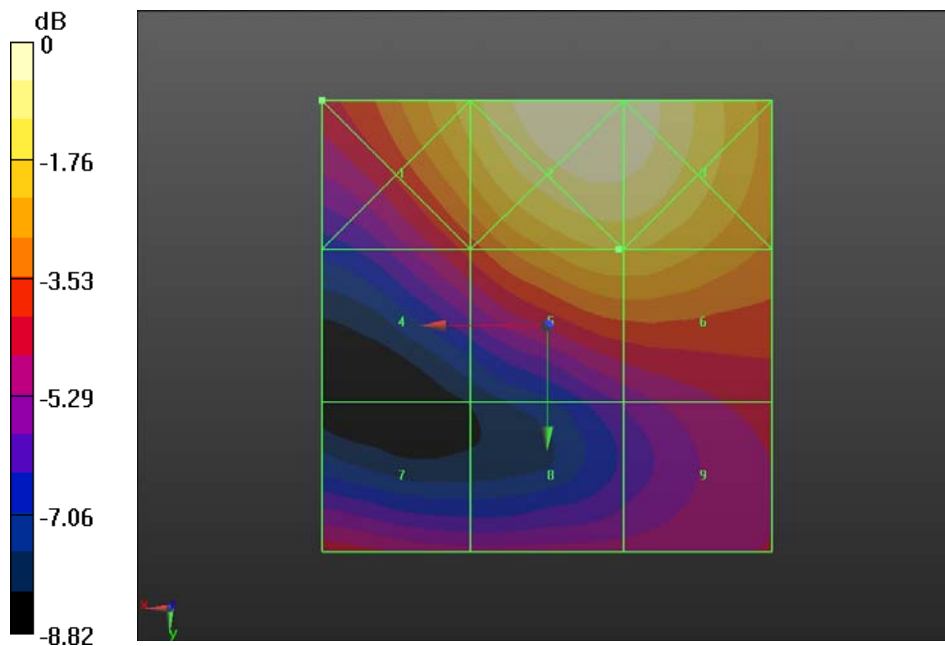

0 dB = 34.63 V/m = 30.79 dBV/m

**Fig B.11 HAC RF E-Field WCDMA 1900 Middle**

**HAC RF E-Field WCDMA 1900 Low**

Date/Time: 2/1/2013 2:38:24 PM

Electronics: DAE4 Sn786

Medium: Air

Medium parameters used:  $\sigma = 0$  S/m,  $\epsilon_r = 1$ ;  $\rho = 0$  kg/m<sup>3</sup>

Communication System: WCDMA Frequency: 1852.4 MHz Duty Cycle: 1:1

Probe: ER3DV6 - SN2424 ConvF(1, 1, 1); Calibrated: 7/18/2012

**Device E-Field measurement (E-field scan for ANSI C63.19-2007 & -2011 compliance)/E Scan W1900 Channel Low/Hearing Aid Compatibility Test (101x101x1):** Interpolated grid:

dx=0.5000 mm, dy=0.5000 mm

Device Reference Point: 0, 0, -6.3 mm

Reference Value = 25.34 V/m; Power Drift = -0.01 dB

PMR not calibrated. PMF = 1.000 is applied.

E-field emissions = 30.35 V/m

**Near-field category: M4 (AWF 0 dB)**

PMF scaled E-field

<b>Grid 1 M4</b> <b>35.00 V/m</b>	<b>Grid 2 M4</b> <b>39.45 V/m</b>	<b>Grid 3 M4</b> <b>38.39 V/m</b>
<b>Grid 4 M4</b> <b>24.98 V/m</b>	<b>Grid 5 M4</b> <b>30.35 V/m</b>	<b>Grid 6 M4</b> <b>30.29 V/m</b>
<b>Grid 7 M4</b> <b>24.87 V/m</b>	<b>Grid 8 M4</b> <b>23.31 V/m</b>	<b>Grid 9 M4</b> <b>22.37 V/m</b>

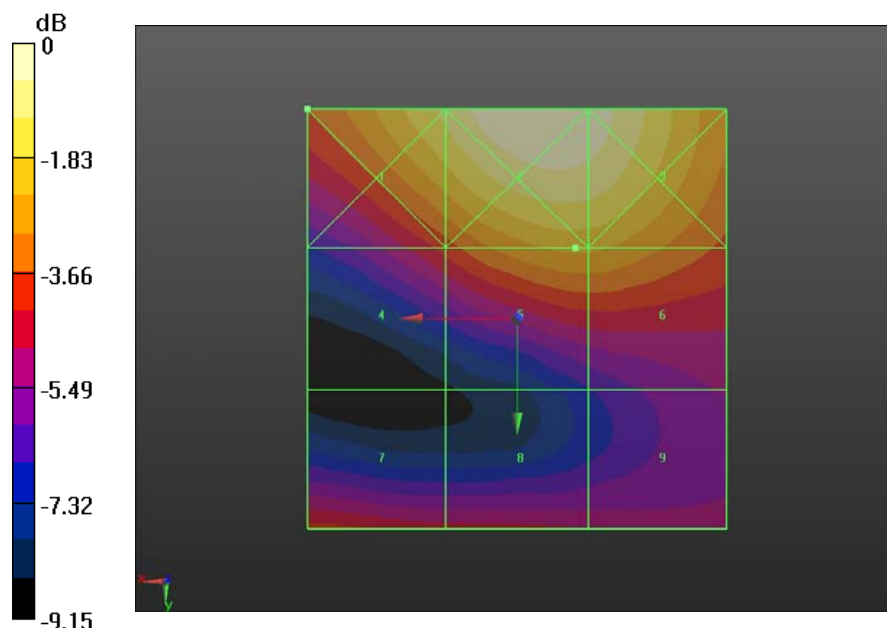

0 dB = 39.46 V/m = 31.92 dBV/m

**Fig B.12 HAC RF E-Field WCDMA 1900 Low**

### HAC RF H-Field GSM 850 High

Date/Time: 2/1/2013 11:34:52 AM

Electronics: DAE4 Sn786

Medium: Air

Medium parameters used:  $\sigma = 0$  S/m,  $\epsilon_r = 1$ ;  $\rho = 0$  kg/m<sup>3</sup>

Communication System: GSM Frequency: 848.8 MHz Duty Cycle: 1:8.30042

Probe: H3DV6 - SN6264

### Device H-Field measurement with H3DV6 probe (H-field scan for ANSI C63.19-2007 compliance)/H Scan GSM850 Channel High/Hearing Aid Compatibility Test

(101x101x1): Interpolated grid: dx=0.5000 mm, dy=0.5000 mm

Device Reference Point: 0, 0, -6.3 mm

Reference Value = 0.08400 A/m; Power Drift = 0.01 dB

PMR not calibrated. PMF = 2.881 is applied.

H-field emissions = 0.3303 A/m

Near-field category: M4 (AWF -5 dB)

PMF scaled H-field

Grid 1 M3 0.482 A/m	Grid 2 M4 0.330 A/m	Grid 3 M4 0.200 A/m
Grid 4 M4 0.449 A/m	Grid 5 M4 0.309 A/m	Grid 6 M4 0.185 A/m
Grid 7 M3 0.474 A/m	Grid 8 M4 0.326 A/m	Grid 9 M4 0.196 A/m

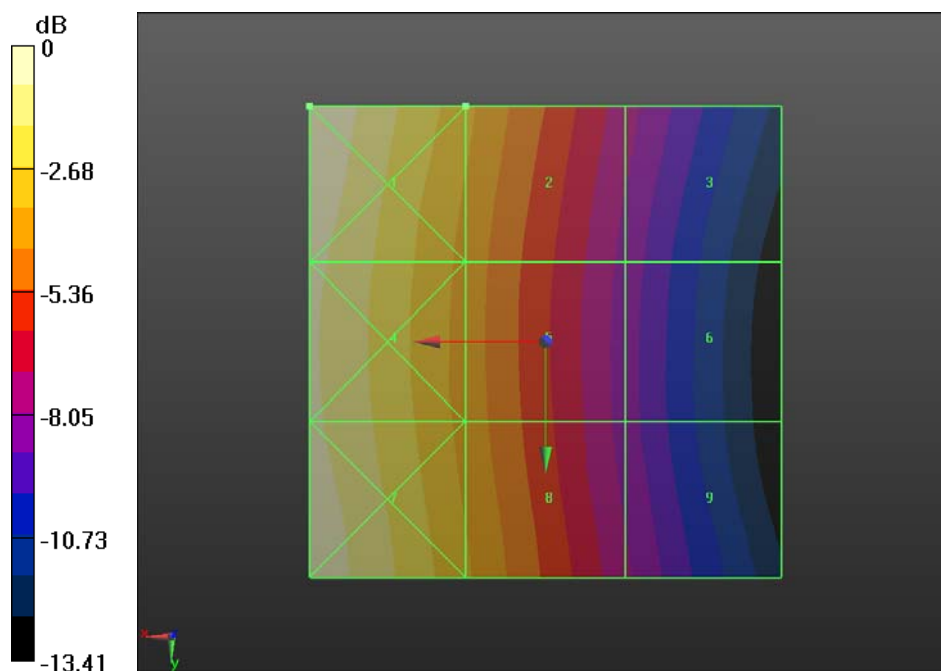

0 dB = 0.4820 A/m = -6.34 dBA/m

Fig B.13 HAC RF H-Field GSM 850 High



**HAC RF H-Field GSM 850 Middle**

Date/Time: 2/1/2013 11:29:35 AM

Electronics: DAE4 Sn786

Medium: Air

Medium parameters used:  $\sigma = 0$  S/m,  $\epsilon_r = 1$ ;  $\rho = 0$  kg/m<sup>3</sup>

Communication System: GSM Frequency: 836.6 MHz Duty Cycle: 1:8.30042

Probe: H3DV6 - SN6264

**Device H-Field measurement with H3DV6 probe (H-field scan for ANSI C63.19-2007 compliance)/H Scan GSM850 Channel Middle/Hearing Aid Compatibility Test**

**(101x101x1):** Interpolated grid: dx=0.5000 mm, dy=0.5000 mm

Device Reference Point: 0, 0, -6.3 mm

Reference Value = 0.07200 A/m; Power Drift = -0.06 dB

PMR not calibrated. PMF = 2.881 is applied.

H-field emissions = 0.2859 A/m

**Near-field category: M4 (AWF -5 dB)**

PMF scaled H-field

<b>Grid 1 M4</b> <b>0.419 A/m</b>	<b>Grid 2 M4</b> <b>0.286 A/m</b>	<b>Grid 3 M4</b> <b>0.172 A/m</b>
<b>Grid 4 M4</b> <b>0.389 A/m</b>	<b>Grid 5 M4</b> <b>0.266 A/m</b>	<b>Grid 6 M4</b> <b>0.156 A/m</b>
<b>Grid 7 M4</b> <b>0.413 A/m</b>	<b>Grid 8 M4</b> <b>0.286 A/m</b>	<b>Grid 9 M4</b> <b>0.173 A/m</b>

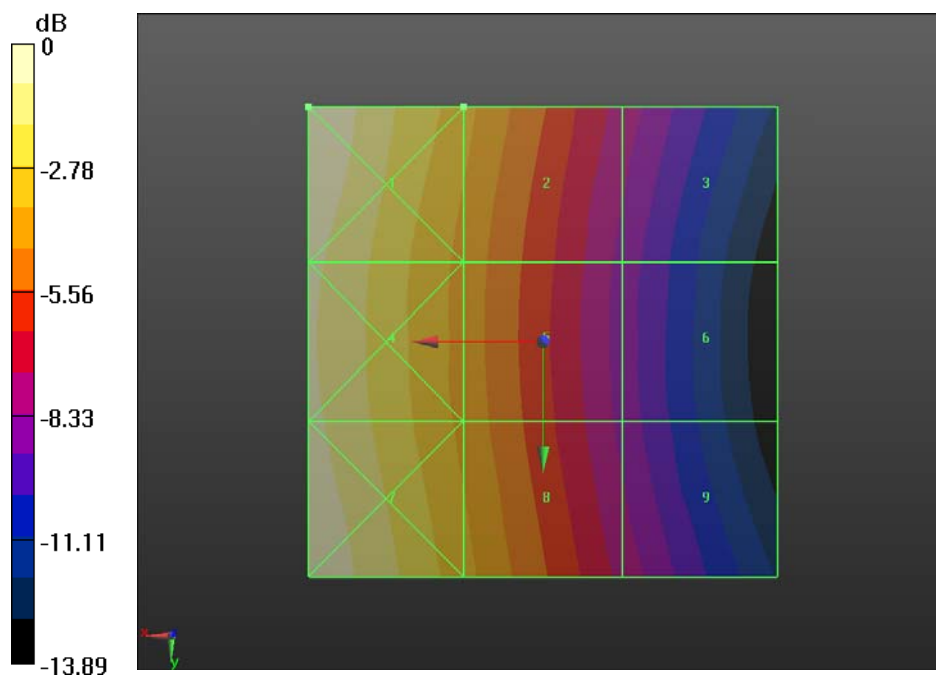

0 dB = 0.4192 A/m = -7.55 dBA/m

**Fig B.14 HAC RF H-Field GSM 850 Middle**

**HAC RF H-Field GSM 850 Low**

Date/Time: 2/1/2013 11:24:15 AM

Electronics: DAE4 Sn786

Medium: Air

Medium parameters used:  $\sigma = 0$  S/m,  $\epsilon_r = 1$ ;  $\rho = 0$  kg/m<sup>3</sup>

Communication System: GSM Frequency: 824.2 MHz Duty Cycle: 1:8.30042

Probe: H3DV6 - SN6264

**Device H-Field measurement with H3DV6 probe (H-field scan for ANSI C63.19-2007 compliance)/H Scan GSM850 Channel Low/Hearing Aid Compatibility Test**

**(101x101x1):** Interpolated grid: dx=0.5000 mm, dy=0.5000 mm

Device Reference Point: 0, 0, -6.3 mm

Reference Value = 0.06400 A/m; Power Drift = -0.04 dB

PMR not calibrated. PMF = 2.881 is applied.

H-field emissions = 0.2584 A/m

**Near-field category: M4 (AWF -5 dB)**

PMF scaled H-field

<b>Grid 1 M4</b> <b>0.367 A/m</b>	<b>Grid 2 M4</b> <b>0.250 A/m</b>	<b>Grid 3 M4</b> <b>0.150 A/m</b>
<b>Grid 4 M4</b> <b>0.344 A/m</b>	<b>Grid 5 M4</b> <b>0.238 A/m</b>	<b>Grid 6 M4</b> <b>0.141 A/m</b>
<b>Grid 7 M4</b> <b>0.372 A/m</b>	<b>Grid 8 M4</b> <b>0.258 A/m</b>	<b>Grid 9 M4</b> <b>0.159 A/m</b>

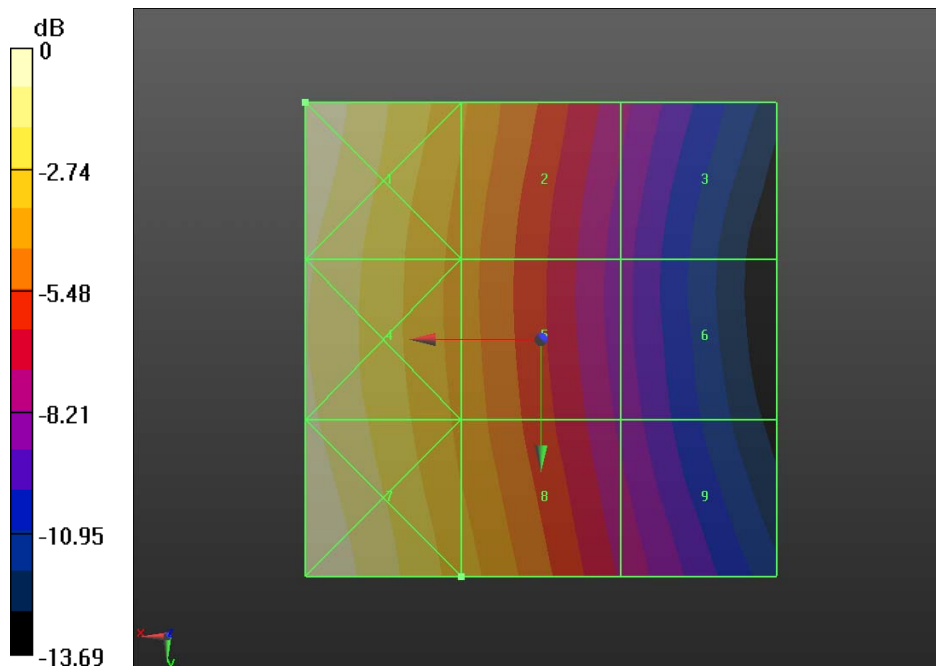

0 dB = 0.3717 A/m = -8.60 dBA/m

**Fig B.15 HAC RF H-Field GSM 850 Low**

### HAC RF H-Field GSM 1900 High

Date/Time: 2/1/2013 11:18:16 AM

Electronics: DAE4 Sn786

Medium: Air

Medium parameters used:  $\sigma = 0$  S/m,  $\epsilon_r = 1$ ;  $\rho = 0$  kg/m<sup>3</sup>

Communication System: GSM Frequency: 1910 MHz Duty Cycle: 1:8.30042

Probe: H3DV6 - SN6264

### Device H-Field measurement with H3DV6 probe (H-field scan for ANSI C63.19-2007 compliance)/H Scan GSM1900 Channel High/Hearing Aid Compatibility Test

(101x101x1): Interpolated grid: dx=0.5000 mm, dy=0.5000 mm

Device Reference Point: 0, 0, -6.3 mm

Reference Value = 0.06500 A/m; Power Drift = -0.00 dB

PMR not calibrated. PMF = 2.881 is applied.

H-field emissions = 0.1766 A/m

Near-field category: M3 (AWF -5 dB)

PMF scaled H-field

Grid 1 M3 0.199 A/m	Grid 2 M3 0.160 A/m	Grid 3 M3 0.156 A/m
Grid 4 M3 0.157 A/m	Grid 5 M3 0.177 A/m	Grid 6 M3 0.176 A/m
Grid 7 M3 0.156 A/m	Grid 8 M3 0.177 A/m	Grid 9 M3 0.176 A/m

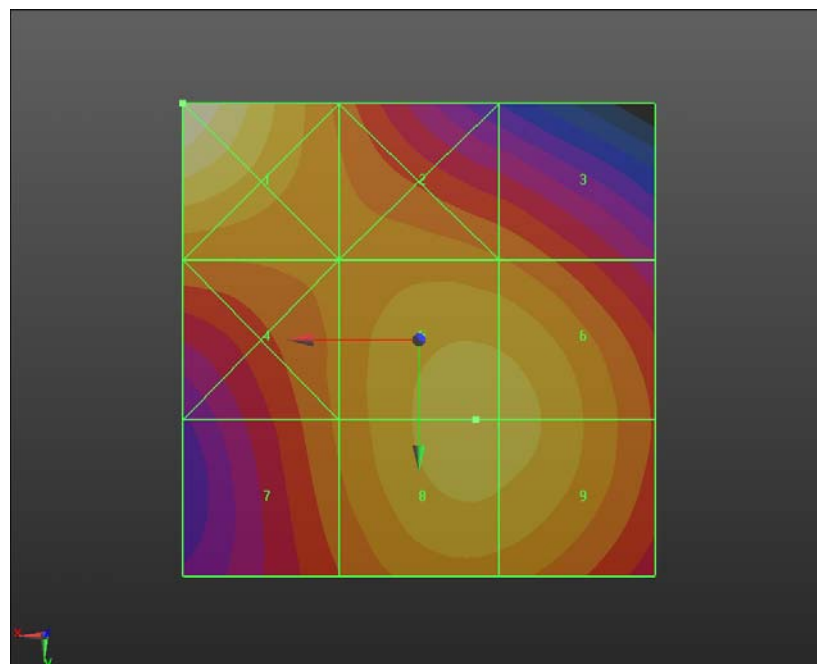
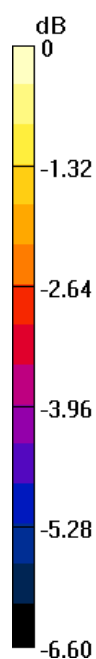

0 dB = 0.1993 A/m = -14.01 dBA/m

Fig B.16 HAC RF H-Field GSM 1900 High

**HAC RF H-Field GSM 1900 Middle**

Date/Time: 2/1/2013 11:12:55 AM

Electronics: DAE4 Sn786

Medium: Air

Medium parameters used:  $\sigma = 0$  S/m,  $\epsilon_r = 1$ ;  $\rho = 0$  kg/m<sup>3</sup>

Communication System: GSM Frequency: 1880 MHz Duty Cycle: 1:8.30042

Probe: H3DV6 - SN6264

**Device H-Field measurement with H3DV6 probe (H-field scan for ANSI C63.19-2007 compliance)/H Scan GSM1900 Channel Middle/Hearing Aid Compatibility Test**

**(101x101x1):** Interpolated grid: dx=0.5000 mm, dy=0.5000 mm

Device Reference Point: 0, 0, -6.3 mm

Reference Value = 0.06200 A/m; Power Drift = -0.01 dB

PMR not calibrated. PMF = 2.881 is applied.

H-field emissions = 0.1670 A/m

**Near-field category: M3 (AWF -5 dB)**

PMF scaled H-field

<b>Grid 1 M3</b> <b>0.201 A/m</b>	<b>Grid 2 M3</b> <b>0.157 A/m</b>	<b>Grid 3 M3</b> <b>0.147 A/m</b>
<b>Grid 4 M3</b> <b>0.149 A/m</b>	<b>Grid 5 M3</b> <b>0.167 A/m</b>	<b>Grid 6 M3</b> <b>0.166 A/m</b>
<b>Grid 7 M3</b> <b>0.148 A/m</b>	<b>Grid 8 M3</b> <b>0.167 A/m</b>	<b>Grid 9 M3</b> <b>0.166 A/m</b>

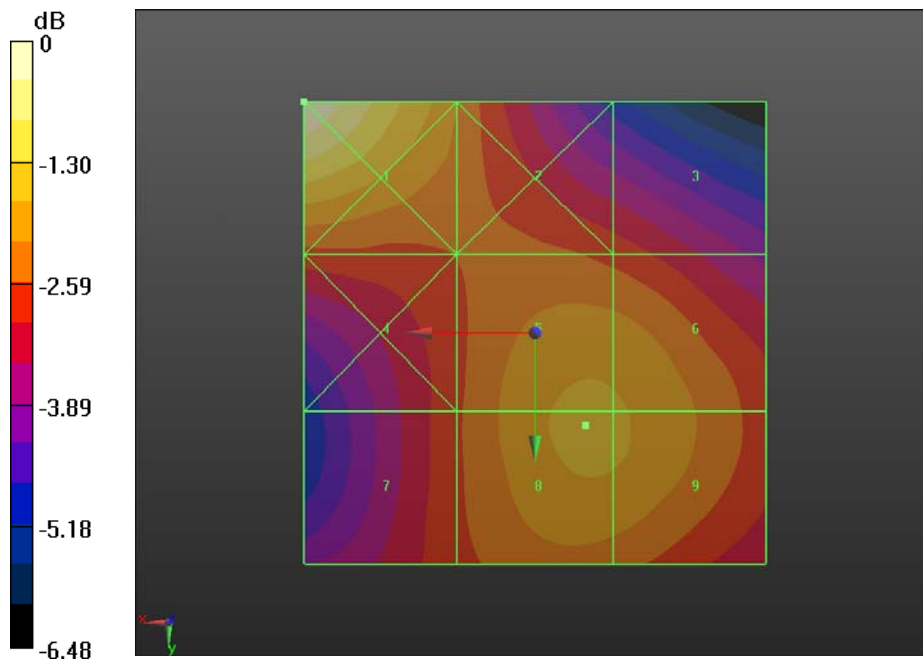

0 dB = 0.2008 A/m = -13.94 dBA/m

**Fig B.17 HAC RF H-Field GSM 1900 Middle**

**HAC RF H-Field GSM 1900 Low**

Date/Time: 2/1/2013 11:07:34 AM

Electronics: DAE4 Sn786

Medium: Air

Medium parameters used:  $\sigma = 0$  S/m,  $\epsilon_r = 1$ ;  $\rho = 0$  kg/m<sup>3</sup>

Communication System: GSM Frequency: 1850.2 MHz Duty Cycle: 1:8.30042

Probe: H3DV6 - SN6264

**Device H-Field measurement with H3DV6 probe (H-field scan for ANSI C63.19-2007 compliance)/H Scan GSM1900 Channel Low/Hearing Aid Compatibility Test**

**(101x101x1):** Interpolated grid: dx=0.5000 mm, dy=0.5000 mm

Device Reference Point: 0, 0, -6.3 mm

Reference Value = 0.06600 A/m; Power Drift = 0.07 dB

PMR not calibrated. PMF = 2.881 is applied.

H-field emissions = 0.1743 A/m

**Near-field category: M3 (AWF -5 dB)**

PMF scaled H-field

<b>Grid 1 M3</b> <b>0.212 A/m</b>	<b>Grid 2 M3</b> <b>0.162 A/m</b>	<b>Grid 3 M3</b> <b>0.155 A/m</b>
<b>Grid 4 M3</b> <b>0.159 A/m</b>	<b>Grid 5 M3</b> <b>0.174 A/m</b>	<b>Grid 6 M3</b> <b>0.173 A/m</b>
<b>Grid 7 M3</b> <b>0.155 A/m</b>	<b>Grid 8 M3</b> <b>0.174 A/m</b>	<b>Grid 9 M3</b> <b>0.173 A/m</b>

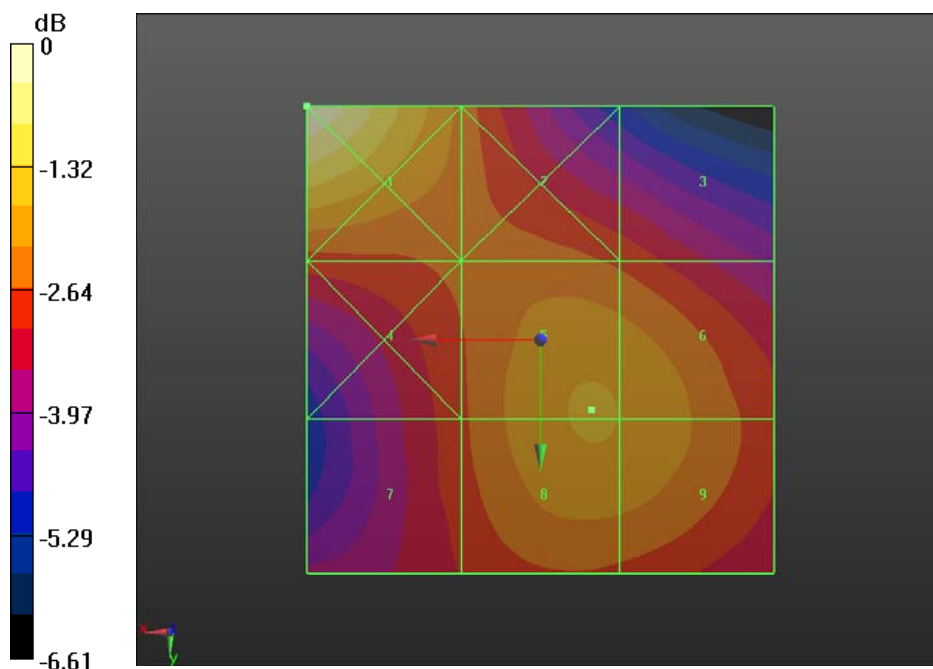

0 dB = 0.2124 A/m = -13.46 dBA/m

**Fig B.18 HAC RF H-Field GSM 1900 Low**

### HAC RF H-Field WCDMA 850 High

Date/Time: 2/1/2013 1:46:42 PM

Electronics: DAE4 Sn786

Medium: Air

Medium parameters used:  $\sigma = 0$  S/m,  $\epsilon_r = 1$ ;  $\rho = 0$  kg/m<sup>3</sup>

Communication System: WCDMA Frequency: 846.6 MHz Duty Cycle: 1:1

Probe: H3DV6 - SN6264

### Device H-Field measurement with H3DV6 probe (H-field scan for ANSI C63.19-2007 compliance)/H Scan W850 Channel High/Hearing Aid Compatibility Test

(101x101x1): Interpolated grid: dx=0.5000 mm, dy=0.5000 mm

Device Reference Point: 0, 0, -6.3 mm

Reference Value = 0.07100 A/m; Power Drift = 0.03 dB

PMR not calibrated. PMF = 1.000 is applied.

H-field emissions = 0.09821 A/m

Near-field category: M4 (AWF 0 dB)

PMF scaled H-field

Grid 1 M4 <b>0.140 A/m</b>	Grid 2 M4 <b>0.097 A/m</b>	Grid 3 M4 <b>0.059 A/m</b>
Grid 4 M4 <b>0.129 A/m</b>	Grid 5 M4 <b>0.091 A/m</b>	Grid 6 M4 <b>0.055 A/m</b>
Grid 7 M4 <b>0.139 A/m</b>	Grid 8 M4 <b>0.098 A/m</b>	Grid 9 M4 <b>0.060 A/m</b>

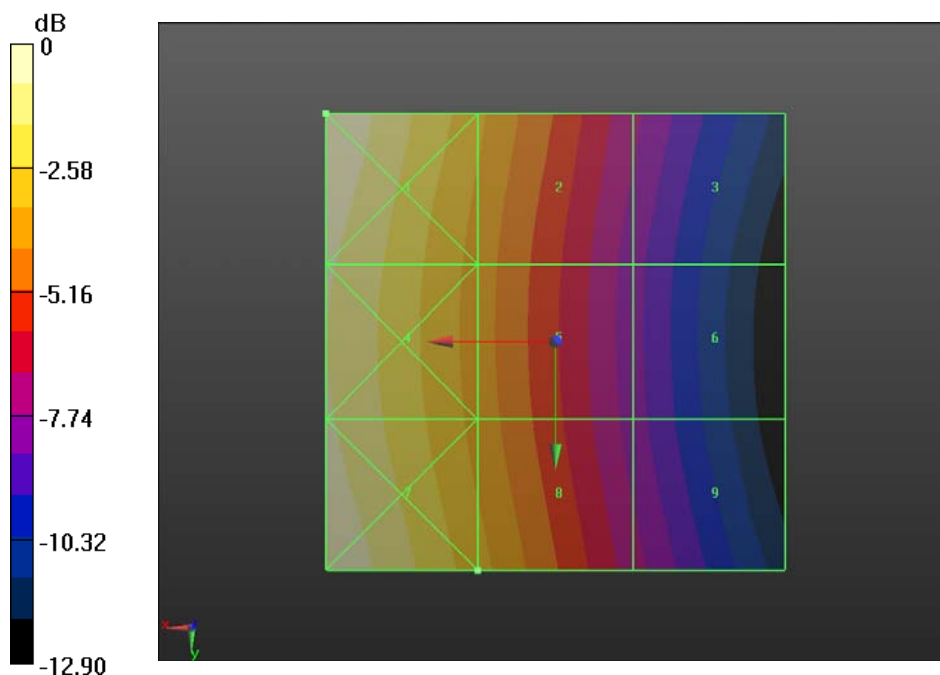

0 dB = 0.1400 A/m = -17.08 dBA/m

Fig B.19 HAC RF H-Field WCDMA 850 High

**HAC RF H-Field WCDMA 850 Middle**

Date/Time: 2/1/2013 1:52:09 PM

Electronics: DAE4 Sn786

Medium: Air

Medium parameters used:  $\sigma = 0$  S/m,  $\epsilon_r = 1$ ;  $\rho = 0$  kg/m<sup>3</sup>

Communication System: WCDMA Frequency: 836.6 MHz Duty Cycle: 1:1

Probe: H3DV6 - SN6264

**Device H-Field measurement with H3DV6 probe (H-field scan for ANSI C63.19-2007 compliance)/H Scan W850 Channel Middle/Hearing Aid Compatibility Test**

**(101x101x1):** Interpolated grid: dx=0.5000 mm, dy=0.5000 mm

Device Reference Point: 0, 0, -6.3 mm

Reference Value = 0.07100 A/m; Power Drift = 0.00 dB

PMR not calibrated. PMF = 1.000 is applied.

H-field emissions = 0.09949 A/m

**Near-field category: M4 (AWF 0 dB)**

PMF scaled H-field

<b>Grid 1 M4</b> <b>0.142 A/m</b>	<b>Grid 2 M4</b> <b>0.097 A/m</b>	<b>Grid 3 M4</b> <b>0.059 A/m</b>
<b>Grid 4 M4</b> <b>0.130 A/m</b>	<b>Grid 5 M4</b> <b>0.092 A/m</b>	<b>Grid 6 M4</b> <b>0.054 A/m</b>
<b>Grid 7 M4</b> <b>0.142 A/m</b>	<b>Grid 8 M4</b> <b>0.099 A/m</b>	<b>Grid 9 M4</b> <b>0.061 A/m</b>

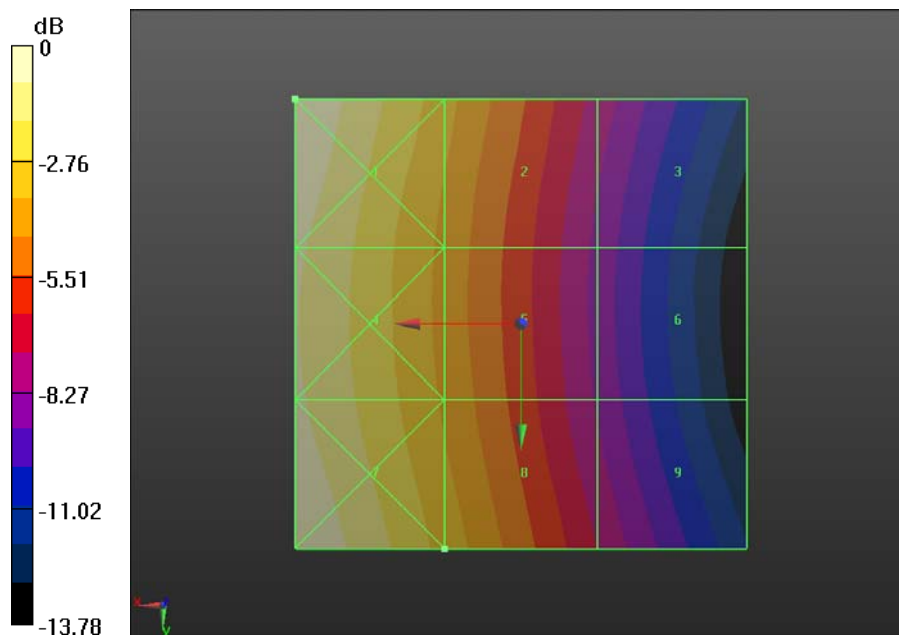

0 dB = 0.1418 A/m = -16.97 dBA/m

**Fig B.20 HAC RF H-Field WCDMA 850 Middle**

**HAC RF H-Field WCDMA 850 Low**

Date/Time: 2/1/2013 1:57:25 PM

Electronics: DAE4 Sn786

Medium: Air

Medium parameters used:  $\sigma = 0$  S/m,  $\epsilon_r = 1$ ;  $\rho = 0$  kg/m<sup>3</sup>

Communication System: WCDMA Frequency: 826.4 MHz Duty Cycle: 1:1

Probe: H3DV6 - SN6264

**Device H-Field measurement with H3DV6 probe (H-field scan for ANSI C63.19-2007 compliance)/H Scan W850 Channel Low/Hearing Aid Compatibility Test**

**(101x101x1):** Interpolated grid: dx=0.5000 mm, dy=0.5000 mm

Device Reference Point: 0, 0, -6.3 mm

Reference Value = 0.07000 A/m; Power Drift = -0.04 dB

PMR not calibrated. PMF = 1.000 is applied.

H-field emissions = 0.09839 A/m

**Near-field category: M4 (AWF 0 dB)**

PMF scaled H-field

<b>Grid 1 M4</b> <b>0.137 A/m</b>	<b>Grid 2 M4</b> <b>0.094 A/m</b>	<b>Grid 3 M4</b> <b>0.057 A/m</b>
<b>Grid 4 M4</b> <b>0.127 A/m</b>	<b>Grid 5 M4</b> <b>0.089 A/m</b>	<b>Grid 6 M4</b> <b>0.054 A/m</b>
<b>Grid 7 M4</b> <b>0.140 A/m</b>	<b>Grid 8 M4</b> <b>0.098 A/m</b>	<b>Grid 9 M4</b> <b>0.061 A/m</b>

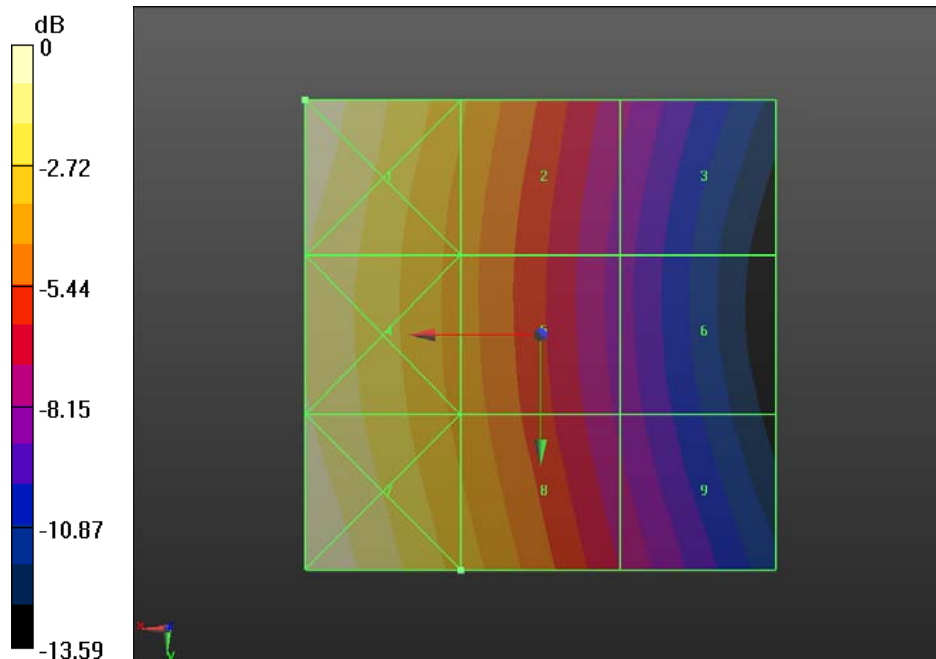

0 dB = 0.1398 A/m = -17.09 dBA/m

**Fig B.21 HAC RF H-Field WCDMA 850 Low**



### HAC RF H-Field WCDMA 1900 High

Date/Time: 2/1/2013 2:08:55 PM

Electronics: DAE4 Sn786

Medium: Air

Medium parameters used:  $\sigma = 0$  S/m,  $\epsilon_r = 1$ ;  $\rho = 0$  kg/m<sup>3</sup>

Communication System: WCDMA Frequency: 1908 MHz Duty Cycle: 1:1

Probe: H3DV6 - SN6264

### Device H-Field measurement with H3DV6 probe (H-field scan for ANSI C63.19-2007 compliance)/H Scan W1900 Channel High/Hearing Aid Compatibility Test

(101x101x1): Interpolated grid: dx=0.5000 mm, dy=0.5000 mm

Device Reference Point: 0, 0, -6.3 mm

Reference Value = 0.08000 A/m; Power Drift = -0.02 dB

PMR not calibrated. PMF = 1.000 is applied.

H-field emissions = 0.07614 A/m

Near-field category: M4 (AWF 0 dB)

PMF scaled H-field

Grid 1 M4 <b>0.088 A/m</b>	Grid 2 M4 <b>0.069 A/m</b>	Grid 3 M4 <b>0.066 A/m</b>
Grid 4 M4 <b>0.068 A/m</b>	Grid 5 M4 <b>0.076 A/m</b>	Grid 6 M4 <b>0.076 A/m</b>
Grid 7 M4 <b>0.067 A/m</b>	Grid 8 M4 <b>0.076 A/m</b>	Grid 9 M4 <b>0.076 A/m</b>

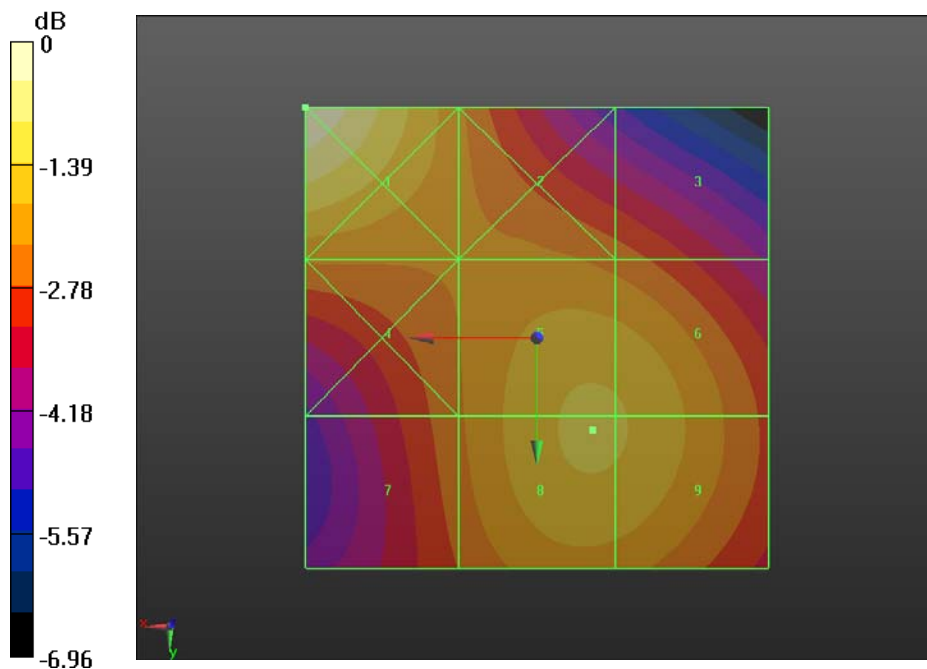

0 dB = 0.08845 A/m = -21.07 dBA/m

Fig B.22 HAC RF H-Field WCDMA 1900 High

**HAC RF H-Field WCDMA 1900 Middle**

Date/Time: 2/1/2013 2:14:32 PM

Electronics: DAE4 Sn786

Medium: Air

Medium parameters used:  $\sigma = 0$  S/m,  $\epsilon_r = 1$ ;  $\rho = 0$  kg/m<sup>3</sup>

Communication System: WCDMA Frequency: 1880 MHz Duty Cycle: 1:1

Probe: H3DV6 - SN6264

**Device H-Field measurement with H3DV6 probe (H-field scan for ANSI C63.19-2007 compliance)/H Scan W1900 Channel Middle/Hearing Aid Compatibility Test**

**(101x101x1):** Interpolated grid: dx=0.5000 mm, dy=0.5000 mm

Device Reference Point: 0, 0, -6.3 mm

Reference Value = 0.07800 A/m; Power Drift = -0.01 dB

PMR not calibrated. PMF = 1.000 is applied.

H-field emissions = 0.07409 A/m

**Near-field category: M4 (AWF 0 dB)**

PMF scaled H-field

<b>Grid 1 M4</b> <b>0.090 A/m</b>	<b>Grid 2 M4</b> <b>0.071 A/m</b>	<b>Grid 3 M4</b> <b>0.064 A/m</b>
<b>Grid 4 M4</b> <b>0.066 A/m</b>	<b>Grid 5 M4</b> <b>0.074 A/m</b>	<b>Grid 6 M4</b> <b>0.074 A/m</b>
<b>Grid 7 M4</b> <b>0.066 A/m</b>	<b>Grid 8 M4</b> <b>0.074 A/m</b>	<b>Grid 9 M4</b> <b>0.074 A/m</b>

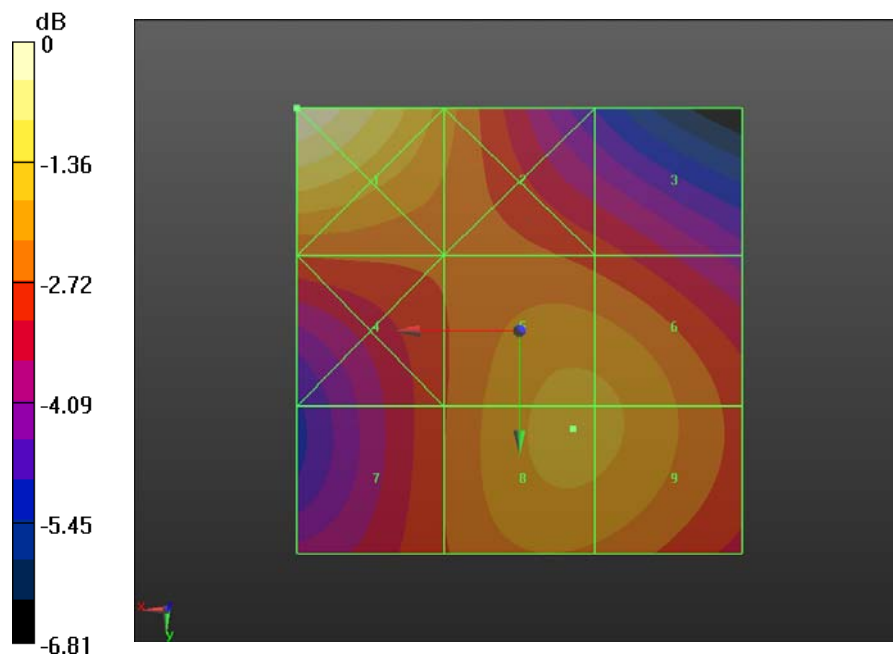

0 dB = 0.08955 A/m = -20.96 dBA/m

**Fig B.23 HAC RF H-Field WCDMA 1900 Middle**

**HAC RF H-Field WCDMA 1900 Low**

Date/Time: 2/1/2013 2:19:54 PM

Electronics: DAE4 Sn786

Medium: Air

Medium parameters used:  $\sigma = 0$  S/m,  $\epsilon_r = 1$ ;  $\rho = 0$  kg/m<sup>3</sup>

Communication System: WCDMA Frequency: 1852.4 MHz Duty Cycle: 1:1

Probe: H3DV6 - SN6264

**Device H-Field measurement with H3DV6 probe (H-field scan for ANSI C63.19-2007 compliance)/H Scan W1900 Channel Low/Hearing Aid Compatibility Test**

**(101x101x1):** Interpolated grid: dx=0.5000 mm, dy=0.5000 mm

Device Reference Point: 0, 0, -6.3 mm

Reference Value = 0.08800 A/m; Power Drift = -0.00 dB

PMR not calibrated. PMF = 1.000 is applied.

H-field emissions = 0.08134 A/m

**Near-field category: M4 (AWF 0 dB)**

PMF scaled H-field

<b>Grid 1 M4</b> <b>0.099 A/m</b>	<b>Grid 2 M4</b> <b>0.076 A/m</b>	<b>Grid 3 M4</b> <b>0.071 A/m</b>
<b>Grid 4 M4</b> <b>0.073 A/m</b>	<b>Grid 5 M4</b> <b>0.081 A/m</b>	<b>Grid 6 M4</b> <b>0.081 A/m</b>
<b>Grid 7 M4</b> <b>0.072 A/m</b>	<b>Grid 8 M4</b> <b>0.081 A/m</b>	<b>Grid 9 M4</b> <b>0.081 A/m</b>

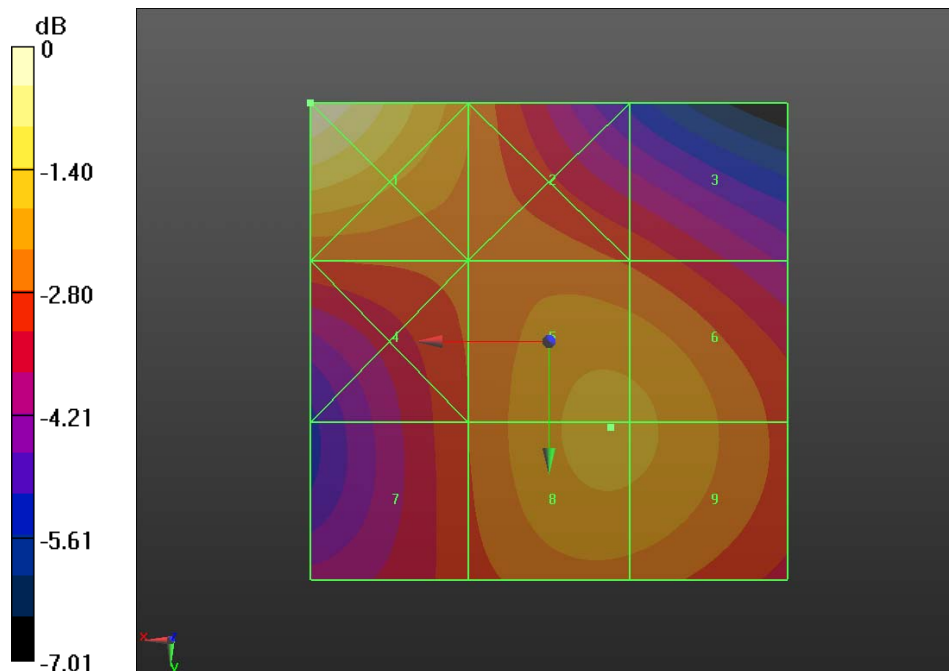

0 dB = 0.09915 A/m = -20.07 dBA/m

**Fig B.24 HAC RF H-Field WCDMA 1900 Low**

**Total M-rating of GSM 850 MHz Band**

Date/Time: 2/1/2013 10:23:47 AM

Electronics: DAE4 Sn786

Medium: Air

Medium parameters used:  $\sigma = 0 \text{ S/m}$ ,  $\epsilon_r = 1$ ;  $\rho = 0 \text{ kg/m}^3$

Ambient Temperature: 21.7°C      Liquid Temperature: 21.3°C

Communication System: GSM Frequency: 848.8 MHz Duty Cycle: 1:8.30042

Probe: ER3DV6 - SN2424 ConvF(1, 1, 1); Probe: H3DV6 - SN6264

**Device E-Field measurement (E-field scan for ANSI C63.19-2007 & -2011 compliance)/E Scan GSM850 Channel High/Hearing Aid Compatibility Test (101x101x1):** Interpolated

grid: dx=0.5000 mm, dy=0.5000 mm

Device Reference Point: 0, 0, -6.3 mm

Reference Value = 100.4 V/m; Power Drift = 0.00 dB

PMR not calibrated. PMF = 2.881 is applied.

E-field emissions = 226.2 V/m

**Near-field category: M3 (AWF -5 dB)**

PMF scaled E-field

<b>Grid 1 M3</b> <b>205.6 V/m</b>	<b>Grid 2 M3</b> <b>223.1 V/m</b>	<b>Grid 3 M3</b> <b>215.4 V/m</b>
<b>Grid 4 M3</b> <b>207.8 V/m</b>	<b>Grid 5 M3</b> <b>226.2 V/m</b>	<b>Grid 6 M3</b> <b>220.3 V/m</b>
<b>Grid 7 M3</b> <b>203.1 V/m</b>	<b>Grid 8 M3</b> <b>222.8 V/m</b>	<b>Grid 9 M3</b> <b>217.2 V/m</b>

**Device H-Field measurement with H3DV6 probe (H-field scan for ANSI C63.19-2007 compliance)/H Scan GSM850 Channel High/Hearing Aid Compatibility Test**

**(101x101x1):** Interpolated grid: dx=0.5000 mm, dy=0.5000 mm

Device Reference Point: 0, 0, -6.3 mm

Reference Value = 0.08400 A/m; Power Drift = 0.01 dB

PMR not calibrated. PMF = 2.881 is applied.

**H-field emissions = 0.3303 A/m**

**Near-field category: M4 (AWF -5 dB)**

PMF scaled H-field

<b>Grid 1 M3</b> <b>0.482 A/m</b>	<b>Grid 2 M4</b> <b>0.330 A/m</b>	<b>Grid 3 M4</b> <b>0.200 A/m</b>
<b>Grid 4 M4</b> <b>0.449 A/m</b>	<b>Grid 5 M4</b> <b>0.309 A/m</b>	<b>Grid 6 M4</b> <b>0.185 A/m</b>
<b>Grid 7 M3</b> <b>0.474 A/m</b>	<b>Grid 8 M4</b> <b>0.326 A/m</b>	<b>Grid 9 M4</b> <b>0.196 A/m</b>

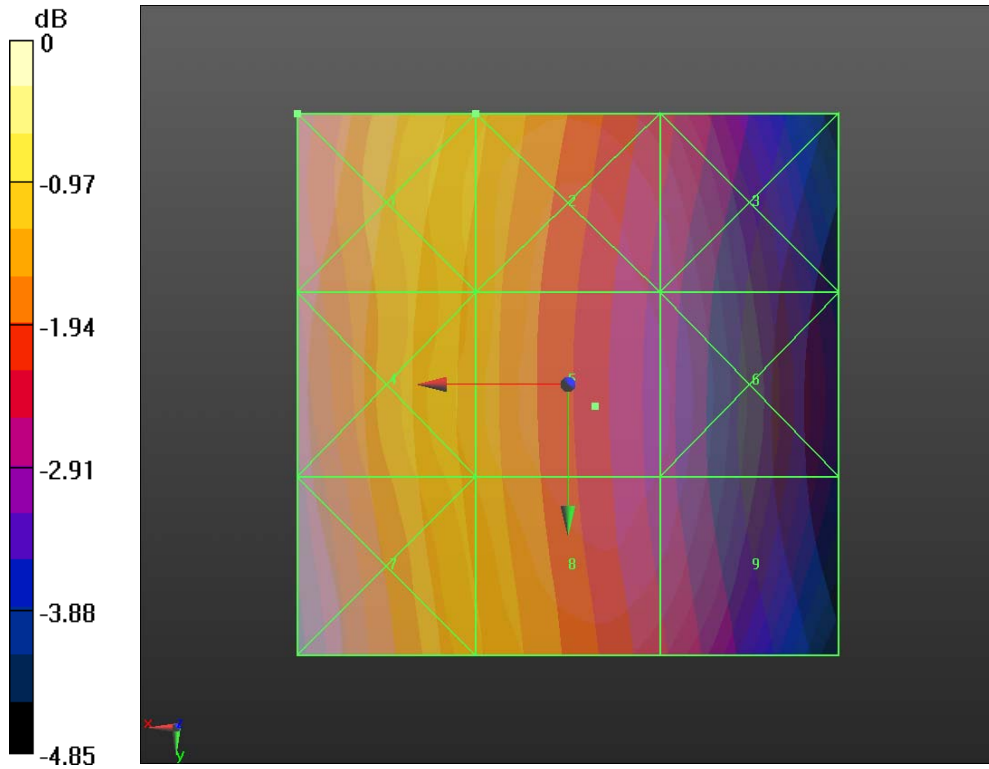

0 dB = 226.2 V/m = 47.09 dBV/m

RF RESULTS AND M-RATING	E-Field M Rating	<b>M3 (AWF -5 dB)</b>
	H-Field M Rating	<b>M4 (AWF -5 dB)</b>
	<b>Total M Rating</b>	<b>M3</b>

**Fig B.25 Total M-rating of GSM 850**

**Total M-rating of GSM 1900 MHz Band**

Date/Time: 2/1/2013 10:47:07 AM

Electronics: DAE4 Sn786

Medium: Air

Medium parameters used:  $\sigma = 0 \text{ S/m}$ ,  $\epsilon_r = 1$ ;  $\rho = 0 \text{ kg/m}^3$

Ambient Temperature: 21.7°C      Liquid Temperature: 21.3°C

Communication System: GSM Frequency: 1850.2 MHz Duty Cycle: 1:8.30042

Probe: ER3DV6 - SN2424 ConvF(1, 1, 1); Probe: H3DV6 - SN6264

**Device E-Field measurement (E-field scan for ANSI C63.19-2007 & -2011 compliance)/E Scan GSM1900 Channel Low/Hearing Aid Compatibility Test (101x101x1):** Interpolated

grid: dx=0.5000 mm, dy=0.5000 mm

Device Reference Point: 0, 0, -6.3 mm

Reference Value = 17.01 V/m; Power Drift = 0.01 dB

PMR not calibrated. PMF = 2.881 is applied.

E-field emissions = 60.72 V/m

**Near-field category: M3 (AWF -5 dB)**

PMF scaled E-field

<b>Grid 1 M3</b> 73.49 V/m	<b>Grid 2 M3</b> 81.40 V/m	<b>Grid 3 M3</b> 79.00 V/m
<b>Grid 4 M3</b> 52.03 V/m	<b>Grid 5 M3</b> 60.72 V/m	<b>Grid 6 M3</b> 60.52 V/m
<b>Grid 7 M3</b> 52.83 V/m	<b>Grid 8 M3</b> 50.79 V/m	<b>Grid 9 M3</b> 48.50 V/m

**Device H-Field measurement with H3DV6 probe (H-field scan for ANSI C63.19-2007 compliance)/H Scan GSM1900 Channel High/Hearing Aid Compatibility Test (101x101x1):** Interpolated grid: dx=0.5000 mm, dy=0.5000 mm

Device Reference Point: 0, 0, -6.3 mm

Reference Value = 0.06500 A/m; Power Drift = -0.00 dB

PMR not calibrated. PMF = 2.881 is applied.

H-field emissions = 0.1766 A/m

H-field emissions = 0.1766 A/m

**Near-field category: M3 (AWF -5 dB)**

PMF scaled H-field

<b>Grid 1 M3</b> 0.199 A/m	<b>Grid 2 M3</b> 0.160 A/m	<b>Grid 3 M3</b> 0.156 A/m
<b>Grid 4 M3</b> 0.157 A/m	<b>Grid 5 M3</b> 0.177 A/m	<b>Grid 6 M3</b> 0.176 A/m
<b>Grid 7 M3</b> 0.156 A/m	<b>Grid 8 M3</b> 0.177 A/m	<b>Grid 9 M3</b> 0.176 A/m

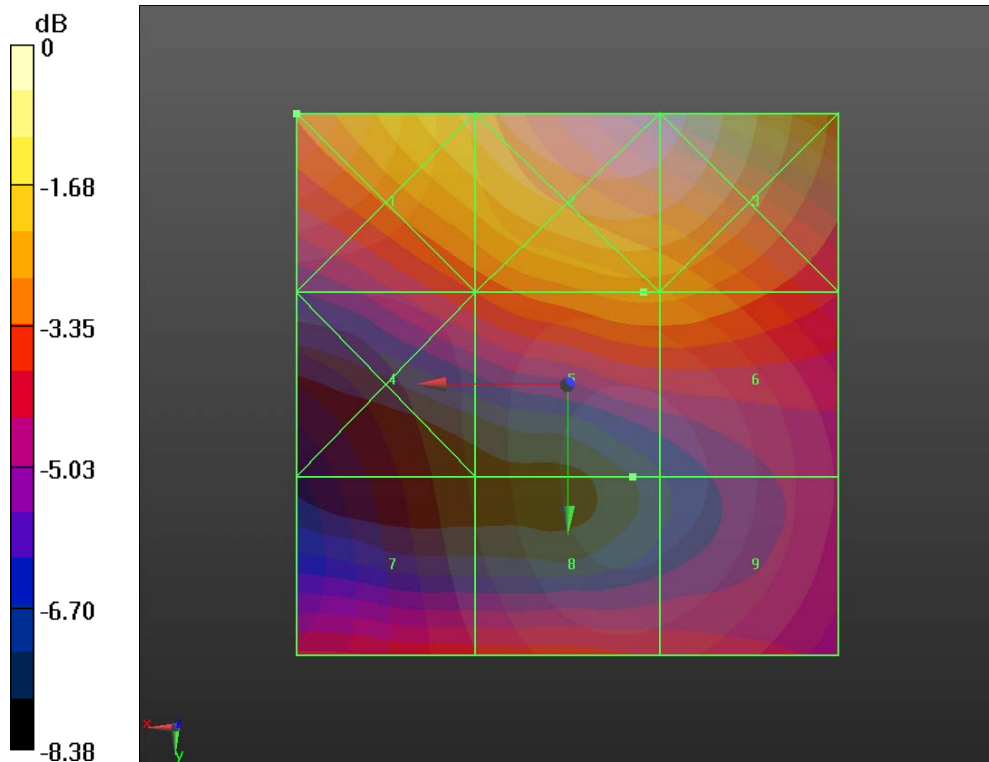

0 dB = 81.40 V/m = 38.21 dBV/m

RF RESULTS AND M-RATING	E-Field M Rating	<b>M3 (AWF -5 dB)</b>
	H-Field M Rating	<b>M3 (AWF -5 dB)</b>
	<b>Total M Rating</b>	<b>M3</b>

**Fig B.26 Total M-rating of GSM 1900**

**Total M-rating of WCDMA 850 MHz Band**

Date/Time: 2/1/2013 3:00:30 PM

Electronics: DAE4 Sn786

Medium: Air

Medium parameters used:  $\sigma = 0$  S/m,  $\epsilon_r = 1$ ;  $\rho = 0$  kg/m<sup>3</sup>

Ambient Temperature: 21.7°C      Liquid Temperature: 21.3°C

Communication System: WCDMA Frequency: 836.6 MHz Duty Cycle: 1:1

Probe: ER3DV6 - SN2424 ConvF(1, 1, 1); Probe: H3DV6 - SN6264

**Device E-Field measurement (E-field scan for ANSI C63.19-2007 & -2011 compliance)/E**

**Scan W850 Channel Middle/Hearing Aid Compatibility Test (101x101x1):** Interpolated

grid: dx=0.5000 mm, dy=0.5000 mm

Device Reference Point: 0, 0, -6.3 mm

Reference Value = 93.49 V/m; Power Drift = -0.02 dB

PMR not calibrated. PMF = 1.000 is applied.

E-field emissions = 73.35 V/m

**Near-field category: M4 (AWF 0 dB)**

PMF scaled E-field

Grid 1 M4 65.96 V/m	Grid 2 M4 72.43 V/m	Grid 3 M4 70.63 V/m
Grid 4 M4 66.56 V/m	Grid 5 M4 73.35 V/m	Grid 6 M4 71.68 V/m
Grid 7 M4 64.91 V/m	Grid 8 M4 71.96 V/m	Grid 9 M4 70.53 V/m

**Device H-Field measurement with H3DV6 probe (H-field scan for ANSI C63.19-2007 compliance)/H Scan W850 Channel Middle/Hearing Aid Compatibility Test (101x101x1):**

Interpolated grid: dx=0.5000 mm, dy=0.5000 mm

Device Reference Point: 0, 0, -6.3 mm

Reference Value = 0.07100 A/m; Power Drift = 0.00 dB

PMR not calibrated. PMF = 1.000 is applied.

H-field emissions = 0.09949 A/m

**Near-field category: M4 (AWF 0 dB)**

PMF scaled H-field

Grid 1 M4 0.142 A/m	Grid 2 M4 0.097 A/m	Grid 3 M4 0.059 A/m
Grid 4 M4 0.130 A/m	Grid 5 M4 0.092 A/m	Grid 6 M4 0.054 A/m
Grid 7 M4 0.142 A/m	Grid 8 M4 0.099 A/m	Grid 9 M4 0.061 A/m



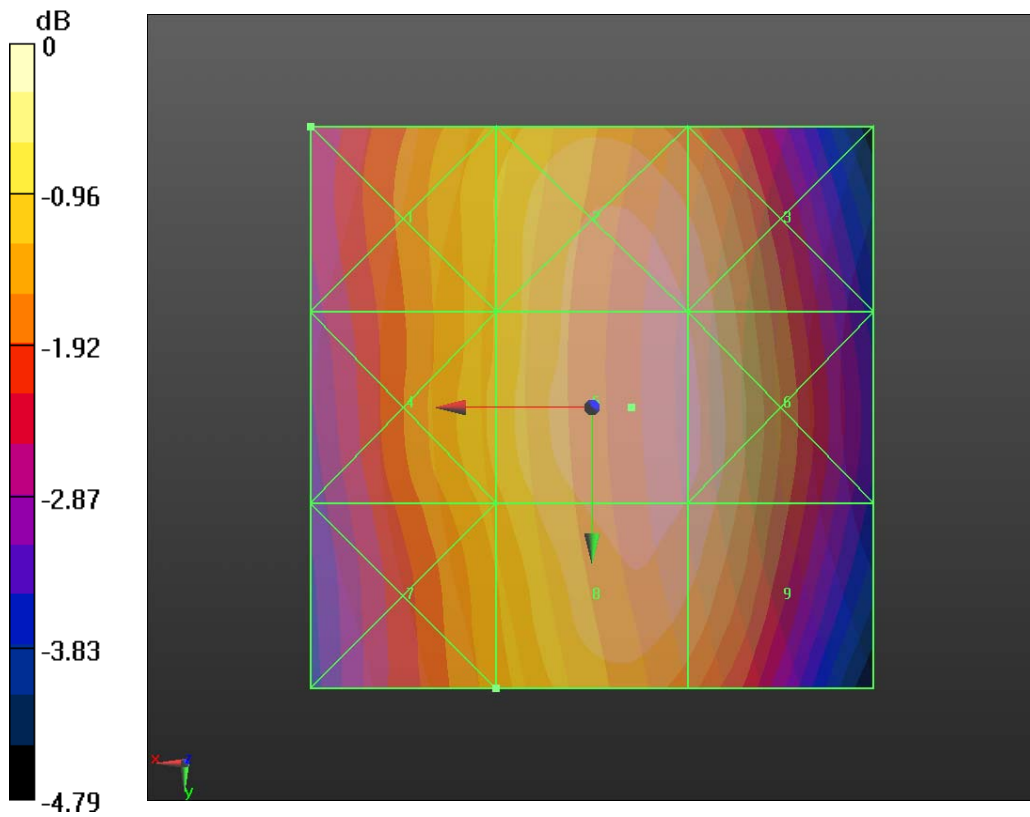

0 dB = 73.35 V/m = 37.31 dBV/m

RF RESULTS AND M-RATING	E-Field M Rating	<b>M4 (AWF 0 dB)</b>
	H-Field M Rating	<b>M4 (AWF 0 dB)</b>
	<b>Total M Rating</b>	<b>M4</b>

**Fig B.27**Total M-rating of WCDMA 850

**Total M-rating of WCDMA 1900 MHz Band**

Date/Time: 2/1/2013 2:38:24 PM

Electronics: DAE4 Sn786

Medium: Air

Medium parameters used:  $\sigma = 0$  S/m,  $\epsilon_r = 1$ ;  $\rho = 0$  kg/m<sup>3</sup>

Ambient Temperature: 21.7°C      Liquid Temperature: 21.3°C

Communication System: WCDMA Frequency: 1852.4 MHz Duty Cycle: 1:1

Probe: ER3DV6 - SN2424 ConvF(1, 1, 1); Calibrated: 7/18/2012

**Device E-Field measurement (E-field scan for ANSI C63.19-2007 & -2011 compliance)/E Scan W1900 Channel Low/Hearing Aid Compatibility Test (101x101x1):** Interpolated

grid: dx=0.5000 mm, dy=0.5000 mm

Device Reference Point: 0, 0, -6.3 mm

Reference Value = 25.34 V/m; Power Drift = -0.01 dB

PMR not calibrated. PMF = 1.000 is applied.

E-field emissions = 30.35 V/m

**Near-field category: M4 (AWF 0 dB)**

PMF scaled E-field

<b>Grid 1 M4</b> <b>35.00 V/m</b>	<b>Grid 2 M4</b> <b>39.45 V/m</b>	<b>Grid 3 M4</b> <b>38.39 V/m</b>
<b>Grid 4 M4</b> <b>24.98 V/m</b>	<b>Grid 5 M4</b> <b>30.35 V/m</b>	<b>Grid 6 M4</b> <b>30.29 V/m</b>
<b>Grid 7 M4</b> <b>24.87 V/m</b>	<b>Grid 8 M4</b> <b>23.31 V/m</b>	<b>Grid 9 M4</b> <b>22.37 V/m</b>

**Device H-Field measurement with H3DV6 probe (H-field scan for ANSI C63.19-2007 compliance)/H Scan W1900 Channel Low/Hearing Aid Compatibility Test (101x101x1):**

Interpolated grid: dx=0.5000 mm, dy=0.5000 mm

Device Reference Point: 0, 0, -6.3 mm

Reference Value = 0.08800 A/m; Power Drift = -0.00 dB

PMR not calibrated. PMF = 1.000 is applied.

H-field emissions = 0.08134 A/m

**Near-field category: M4 (AWF 0 dB)**

PMF scaled H-field

<b>Grid 1 M4</b> <b>0.099 A/m</b>	<b>Grid 2 M4</b> <b>0.076 A/m</b>	<b>Grid 3 M4</b> <b>0.071 A/m</b>
<b>Grid 4 M4</b> <b>0.073 A/m</b>	<b>Grid 5 M4</b> <b>0.081 A/m</b>	<b>Grid 6 M4</b> <b>0.081 A/m</b>
<b>Grid 7 M4</b> <b>0.072 A/m</b>	<b>Grid 8 M4</b> <b>0.081 A/m</b>	<b>Grid 9 M4</b> <b>0.081 A/m</b>

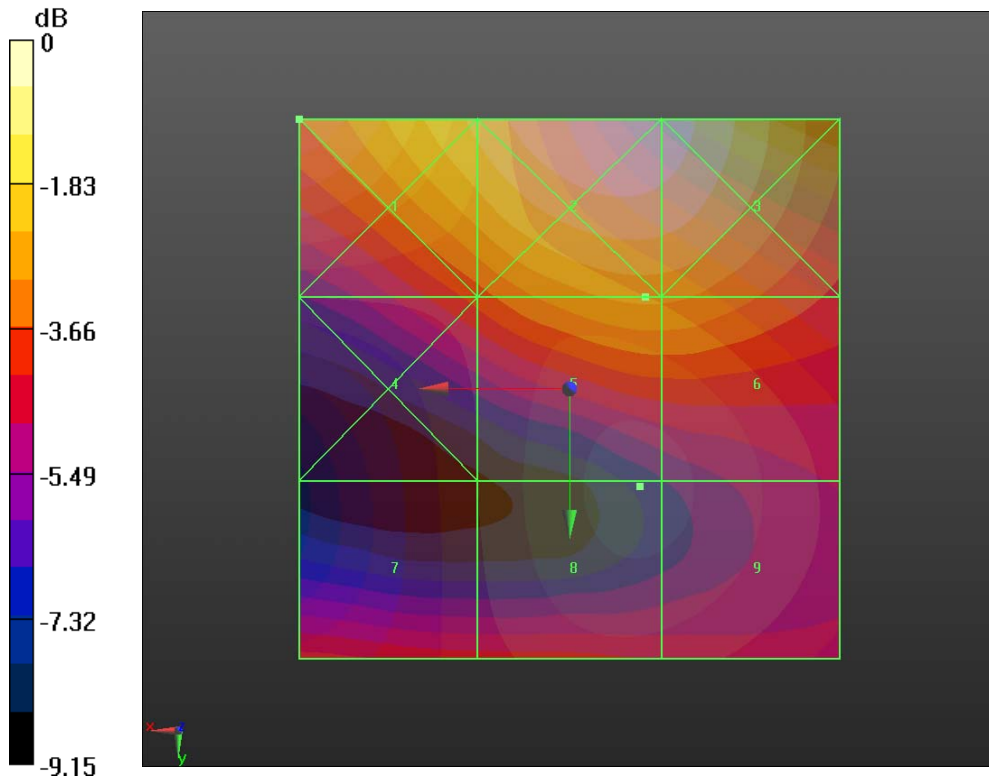

0 dB = 39.46 V/m = 31.92 dBV/m

RF RESULTS AND M-RATING	E-Field M Rating	<b>M4 (AWF 0 dB)</b>
	H-Field M Rating	<b>M4 (AWF 0 dB)</b>
	<b>Total M Rating</b>	<b>M4</b>

**Fig B.28 Total M-rating of WCDMA 1900**

## ANNEX C SYSTEM VALIDATION RESULT

### E SCAN of Dipole 835 MHz

Date: 2/1/2013

Electronics: DAE4 Sn786

Medium: Air

Medium parameters used:  $\sigma = 0$  mho/m,  $\epsilon_r = 1$ ;  $\rho = 0$  kg/m<sup>3</sup>

Communication System: CW; Frequency: 835 MHz; Duty Cycle: 1:1

Probe: ER3DV6 - SN2424 ConvF(1, 1, 1); Calibrated: 7/18/2012

E Scan - measurement distance from the probe sensor center to CD835 Dipole = 10mm/Hearing Aid Compatibility Test (41x361x1): Measurement grid: dx=5mm, dy=5mm

Maximum value of peak Total field = 163.7 V/m

Probe Modulation Factor = 1

Device Reference Point: 0, 0, -6.3 mm

Reference Value = 106.8 V/m; Power Drift = 0.065 dB

Hearing Aid Near-Field Category: M4 (AWF 0 dB)

Peak E-field in V/m

Grid 1	Grid 2	Grid 3
<b>158.5 M4</b>	<b>163.7 M4</b>	<b>149.5 M4</b>
Grid 4	Grid 5	Grid 6
<b>88.1 M4</b>	<b>90.8 M4</b>	<b>88.3 M4</b>
Grid 7	Grid 8	Grid 9
<b>153.4 M4</b>	<b>162.1 M4</b>	<b>159.8 M4</b>

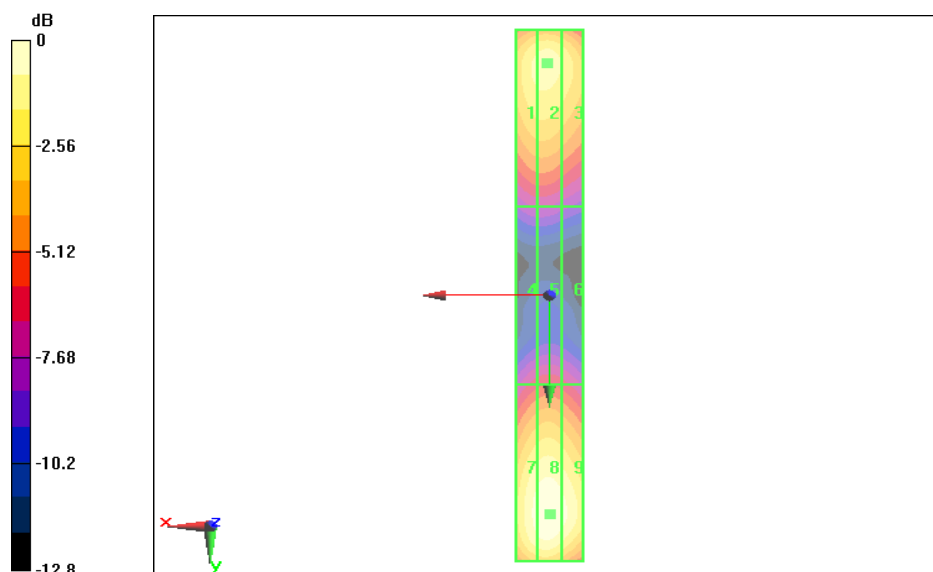

0 dB = 163.5V/m

### H SCAN of Dipole 835 MHz

Date: 2/1/2013

Electronics: DAE4 Sn786

Medium: Air

Medium parameters used:  $\sigma = 0$  mho/m,  $\epsilon_r = 1$ ;  $\rho = 0$  kg/m<sup>3</sup>

Communication System: CW; Frequency: 835 MHz; Duty Cycle: 1:1

Probe: H3DV6 - SN6264

H Scan - measurement distance from the probe sensor center to CD835 Dipole = 10mm/Hearing Aid Compatibility Test (41x361x1): Measurement grid: dx=5mm, dy=5mm

Maximum value of peak Total field = 0.467 A/m

Probe Modulation Factor = 1

Device Reference Point: 0, 0, -6.3 mm

Reference Value = 0.497 A/m; Power Drift = -0.04 dB

Hearing Aid Near-Field Category: M4 (AWF 0 dB)

Peak H-field in A/m

Grid 1	Grid 2	Grid 3
<b>0.387 M4</b>	<b>0.406 M4</b>	<b>0.397 M4</b>
Grid 4	Grid 5	Grid 6
<b>0.435 M4</b>	<b>0.467 M4</b>	<b>0.442 M4</b>
Grid 7	Grid 8	Grid 9
<b>0.378 M4</b>	<b>0.405 M4</b>	<b>0.397 M4</b>

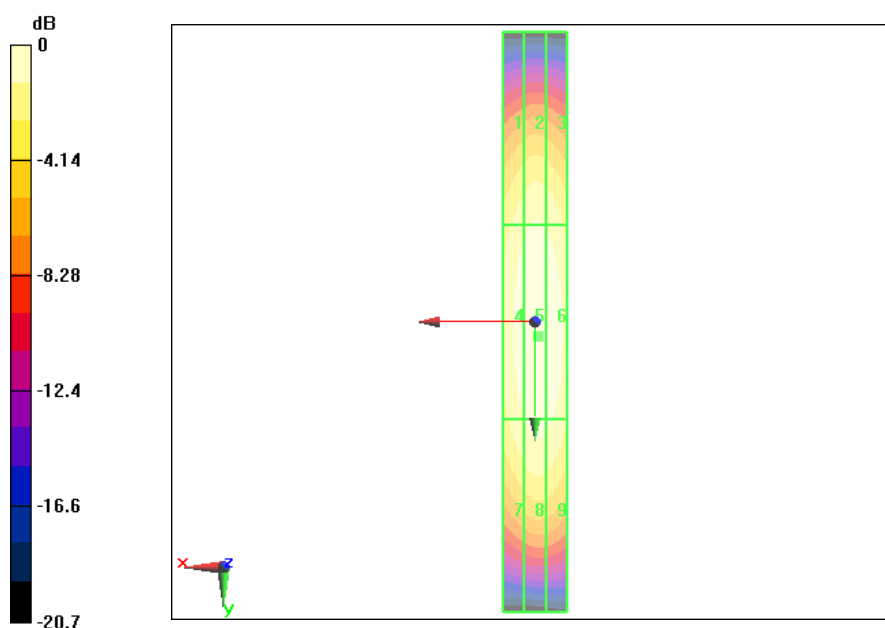

0 dB = 0.466A/m

### E SCAN of Dipole 1880 MHz

Date: 2/1/2013

Electronics: DAE4 Sn786

Medium: Air

Medium parameters used:  $\sigma = 0$  mho/m,  $\epsilon_r = 1$ ;  $\rho = 0$ kg/m<sup>3</sup>

Communication System: CW; Frequency: 1880 MHz; Duty Cycle: 1:1

Probe: ER3DV6 - SN2424 ConvF(1, 1, 1); Calibrated: 7/18/2012

E Scan - measurement distance from the probe sensor center to CD1880 Dipole = 10mm/Hearing Aid Compatibility Test (41x181x1): Measurement grid: dx=5mm, dy=5mm

Maximum value of peak Total field = 144.2 V/m

Probe Modulation Factor = 1

Device Reference Point: 0, 0, -6.3 mm

Reference Value = 161.6 V/m; Power Drift = -0.048 dB

Hearing Aid Near-Field Category: M2 (AWF 0 dB)

Peak E-field in V/m

Grid 1	Grid 2	Grid 3
<b>134.9 M2</b>	<b>139.2 M2</b>	<b>138.1 M2</b>
Grid 4	Grid 5	Grid 6
<b>90.6 M3</b>	<b>93.7 M3</b>	<b>90.8 M3</b>
Grid 7	Grid 8	Grid 9
<b>134.7 M2</b>	<b>144.2M2</b>	<b>142.3 M2</b>

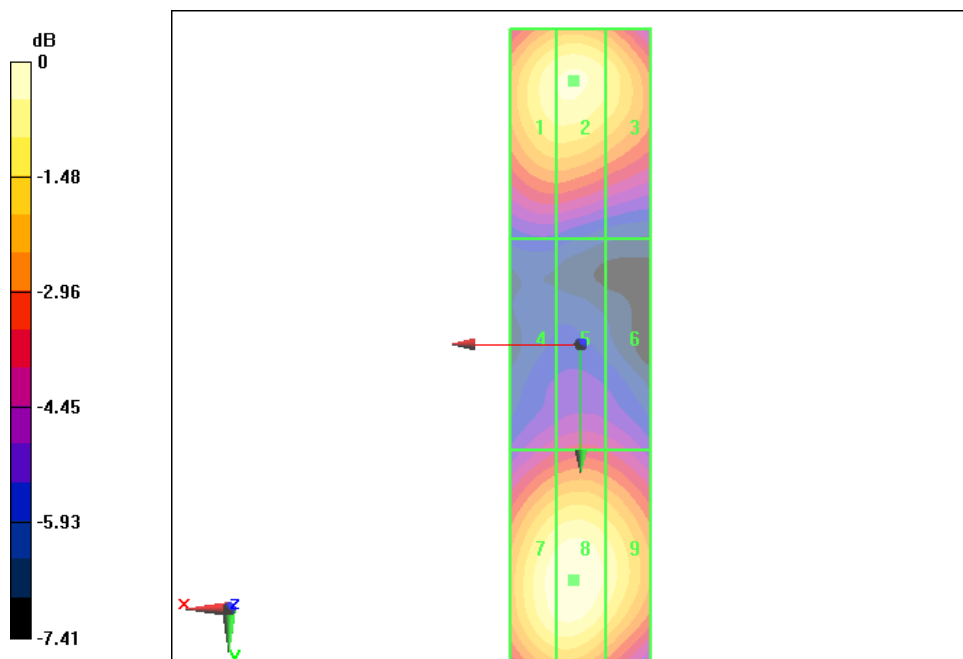

0 dB = 144.0V/m

### H SCAN of Dipole 1880 MHz

Date: 2/1/2013

Electronics: DAE4 Sn786

Medium: Air

Medium parameters used:  $\sigma = 0$  mho/m,  $\epsilon_r = 1$ ;  $\rho = 0$  kg/m<sup>3</sup>

Communication System: CW; Frequency: 1880 MHz; Duty Cycle: 1:1

Probe: H3DV6 - SN6264

H Scan - measurement distance from the probe sensor center to CD1880 Dipole = 10mm/Hearing Aid Compatibility Test (41x181x1): Measurement grid: dx=5mm, dy=5mm

Maximum value of peak Total field = 0.463 A/m

Probe Modulation Factor = 1

Device Reference Point: 0, 0, -6.3 mm

Reference Value = 0.492 A/m; Power Drift = 0.071 dB

Hearing Aid Near-Field Category: M2 (AWF 0 dB)

Peak H-field in A/m

Grid 1	Grid 2	Grid 3
<b>0.395 M2</b>	<b>0.426 M2</b>	<b>0.397 M2</b>
Grid 4	Grid 5	Grid 6
<b>0.443 M2</b>	<b>0.463 M2</b>	<b>0.455 M2</b>
Grid 7	Grid 8	Grid 9
<b>0.405 M2</b>	<b>0.431 M2</b>	<b>0.412 M2</b>

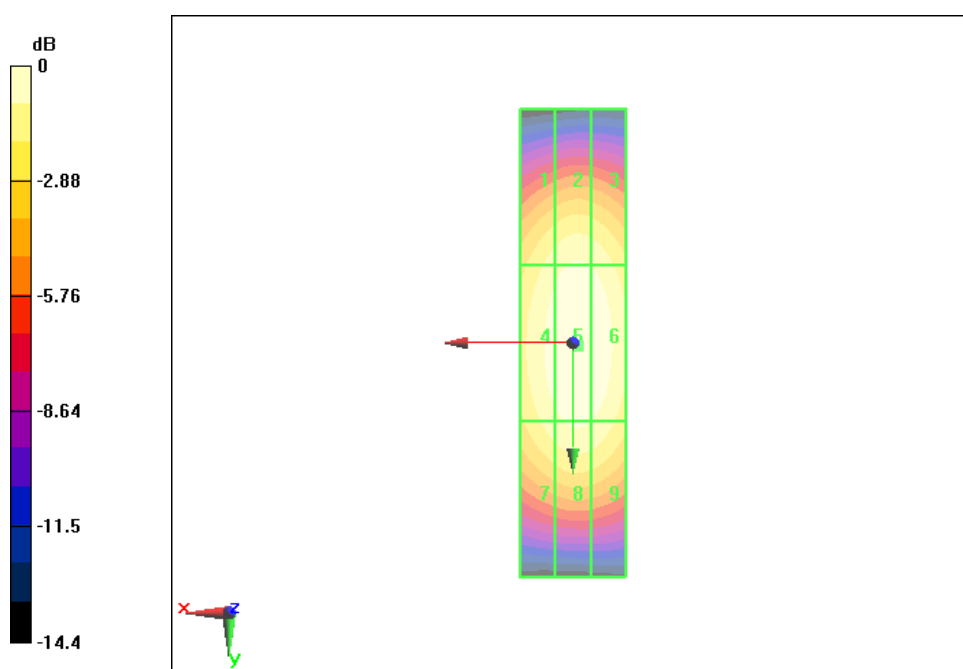

0 dB = 0.464A/m

# ANNEX D PROBE CALIBRATION CERTIFICATE

E\_Probe:ER3DV6

**Calibration Laboratory of  
Schmid & Partner  
Engineering AG**  
Zeughausstrasse 43, 8004 Zurich, Switzerland



**S** Schweizerischer Kalibrierdienst  
**C** Service suisse d'étalonnage  
**S** Servizio svizzero di taratura  
**S** Swiss Calibration Service

Accredited by the Swiss Accreditation Service (SAS)  
The Swiss Accreditation Service is one of the signatories to the EA  
Multilateral Agreement for the recognition of calibration certificates

Accreditation No.: **SCS 108**

Client **TMC-SZ (Auden)**

Certificate No: **ER3-2424\_Jul12**

## CALIBRATION CERTIFICATE

Object: **ER3DV6 - SN:2424**

Calibration procedure(s): **QA CAL-02.v6, QA CAL-25.v4**  
Calibration procedure for E-field probes optimized for close near field evaluations in air

Calibration date: **July 18, 2012**

受控文件  
TMC-CC-12-282-SZ02

This calibration certificate documents the traceability to national standards, which realize the physical units of measurements (SI).  
The measurements and the uncertainties with confidence probability are given on the following pages and are part of the certificate.

All calibrations have been conducted in the closed laboratory facility: environment temperature (22 ± 3)°C and humidity < 70%.

Calibration Equipment used (M&TE critical for calibration)

Primary Standards	ID	Cal Date (Certificate No.)	Scheduled Calibration
Power meter E4419B	GB41293874	29-Mar-12 (No. 217-01508)	Apr-13
Power sensor E4412A	MY41498087	29-Mar-12 (No. 217-01508)	Apr-13
Reference 3 dB Attenuator	SN: S5054 (3c)	27-Mar-12 (No. 217-01531)	Apr-13
Reference 20 dB Attenuator	SN: S5086 (20b)	27-Mar-12 (No. 217-01529)	Apr-13
Reference 30 dB Attenuator	SN: S5129 (30b)	27-Mar-12 (No. 217-01532)	Apr-13
Reference Probe ER3DV6	SN: 2328	11-Oct-11 (No. ER3-2328_Oct11)	Oct-12
DAE4	SN: 789	30-Jan-12 (No. DAE4-789_Jan12)	Jan-13
Secondary Standards	ID	Check Date (in house)	Scheduled Check
RF generator HP 8648C	US3642U01700	4-Aug-99 (in house check Apr-11)	In house check: Apr-13
Network Analyzer HP 8753E	US37390585	18-Oct-01 (in house check Oct-11)	In house check: Oct-12

Calibrated by:	Name <b>Claudio Leubler</b>	Function Laboratory Technician	Signature 
Approved by:	Name <b>Katja Pokovic</b>	Function Technical Manager	Signature 

Issued: July 20, 2012

This calibration certificate shall not be reproduced except in full without written approval of the laboratory.



**Calibration Laboratory of**  
Schmid & Partner  
Engineering AG  
Zeughausstrasse 43, 8004 Zurich, Switzerland



**S** Schweizerischer Kalibrierdienst  
**C** Service suisse d'étalonnage  
**S** Servizio svizzero di taratura  
Swiss Calibration Service

Accredited by the Swiss Accreditation Service (SAS)

Accreditation No.: **SCS 108**

The Swiss Accreditation Service is one of the signatories to the EA  
Multilateral Agreement for the recognition of calibration certificates

**Glossary:**

NORM <sub>x,y,z</sub>	sensitivity in free space
DCP	diode compression point
CF	crest factor (1/duty_cycle) of the RF signal
A, B, C	modulation dependent linearization parameters
Polarization $\phi$	$\phi$ rotation around probe axis
Polarization $\vartheta$	$\vartheta$ rotation around an axis that is in the plane normal to probe axis (at measurement center), i.e., $\vartheta = 0$ is normal to probe axis
Connector Angle	information used in DASY system to align probe sensor X to the robot coordinate system

**Calibration is Performed According to the Following Standards:**

- a) IEEE Std 1309-2005, "IEEE Standard for calibration of electromagnetic field sensors and probes, excluding antennas, from 9 kHz to 40 GHz", December 2005
- b) CTIA Test Plan for Hearing Aid Compatibility, April 2010.

**Methods Applied and Interpretation of Parameters:**

- **NORM<sub>x,y,z</sub>**: Assessed for E-field polarization  $\vartheta = 0$  for XY sensors and  $\vartheta = 90$  for Z sensor ( $f \leq 900$  MHz in TEM-cell;  $f > 1800$  MHz: R22 waveguide).
- **NORM(f)<sub>x,y,z</sub>** = NORM<sub>x,y,z</sub> \* frequency\_response (see Frequency Response Chart).
- **DCP<sub>x,y,z</sub>**: DCP are numerical linearization parameters assessed based on the data of power sweep with CW signal (no uncertainty required). DCP does not depend on frequency nor media.
- **PAR**: PAR is the Peak to Average Ratio that is not calibrated but determined based on the signal characteristics
- **A<sub>x,y,z</sub>; B<sub>x,y,z</sub>; C<sub>x,y,z</sub>; VR<sub>x,y,z</sub>**: A, B, C are numerical linearization parameters assessed based on the data of power sweep for specific modulation signal. The parameters do not depend on frequency nor media. VR is the maximum calibration range expressed in RMS voltage across the diode.
- **Spherical isotropy (3D deviation from isotropy)**: in a locally homogeneous field realized using an open waveguide setup.
- **Sensor Offset**: The sensor offset corresponds to the offset of virtual measurement center from the probe tip (on probe axis). No tolerance required.
- **Connector Angle**: The angle is assessed using the information gained by determining the NORM<sub>x</sub> (no uncertainty required).

ER3DV6 – SN:2424

July 18, 2012

DASY/EASY - Parameters of Probe: ER3DV6 - SN:2424

Basic Calibration Parameters

Parameter	Value
Gain (V/V)	1.00
Offset (mV)	0.00
Linearity (mV/V)	0.00

# Probe ER3DV6

Parameter	Value
Gain (V/V)	1.00
Offset (mV)	0.00
Linearity (mV/V)	0.00

SN:2424

Manufactured: November 12, 2007  
Calibrated: July 18, 2012

Calibrated for DASY/EASY Systems  
(Note: non-compatible with DASY2 system!)

ER3DV6- SN:2424

July 18, 2012

## DASY/EASY - Parameters of Probe: ER3DV6 - SN:2424

### Basic Calibration Parameters

	Sensor X	Sensor Y	Sensor Z	Unc (k=2)
Norm ( $\mu\text{V}/(\text{V}/\text{m})^2$ )	1.52	1.53	1.87	$\pm 10.1\%$
DCP ( $\text{mV}$ ) <sup>a</sup>	98.6	100.0	99.8	

### Modulation Calibration Parameters

UID	Communication System Name	PAR		A dB	B dB	C dB	VR mV	Unc <sup>E</sup> (k=2)
0	CW	0.00	X	0.00	0.00	1.00	192.9	$\pm 4.1\%$
			Y	0.00	0.00	1.00	207.9	
			Z	0.00	0.00	1.00	201.5	

The reported uncertainty of measurement is stated as the standard uncertainty of measurement multiplied by the coverage factor  $k=2$ , which for a normal distribution corresponds to a coverage probability of approximately 95%.

<sup>a</sup> Numerical linearization parameter: uncertainty not required.

<sup>E</sup> Uncertainty is determined using the max. deviation from linear response applying rectangular distribution and is expressed for the square of the field value.

ER3DV6- SN:2424

July 18, 2012

### Frequency Response of E-Field (TEM-Cell:ifi1110 EXX, Waveguide: R22)

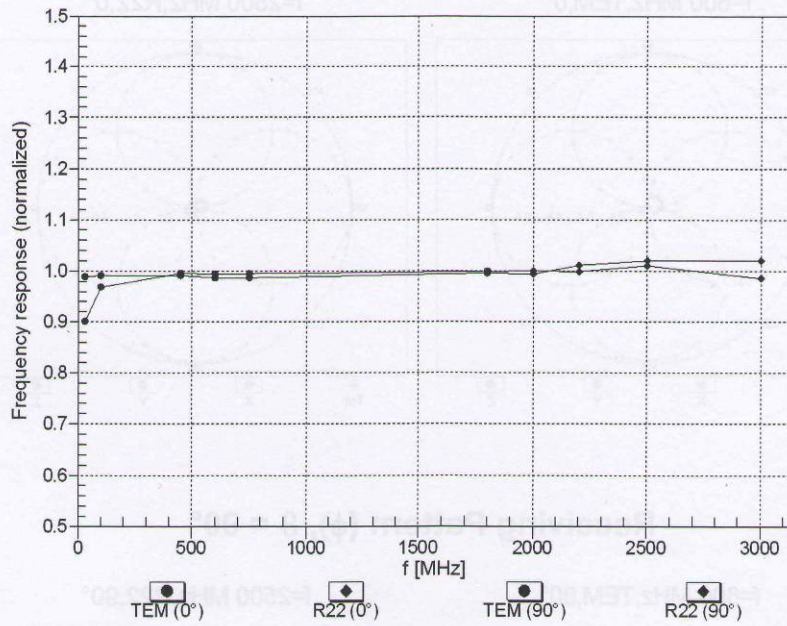

Uncertainty of Frequency Response of E-field:  $\pm 6.3\%$  (k=2)

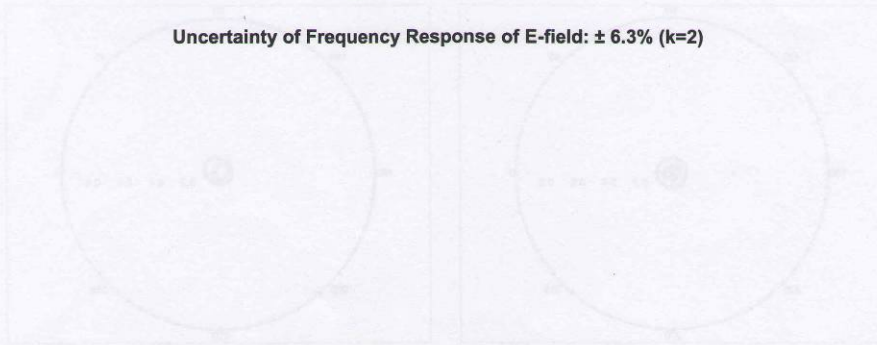

ER3DV6- SN:2424

July 18, 2012

### Receiving Pattern ( $\phi$ ), $\vartheta = 0^\circ$

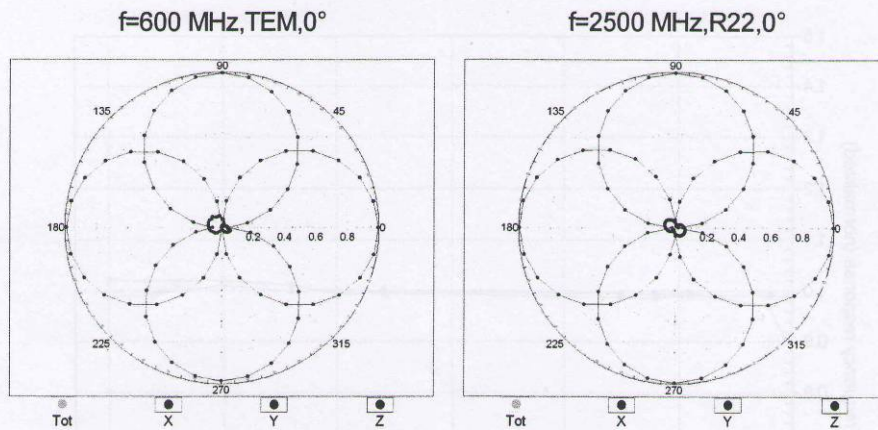

### Receiving Pattern ( $\phi$ ), $\vartheta = 90^\circ$

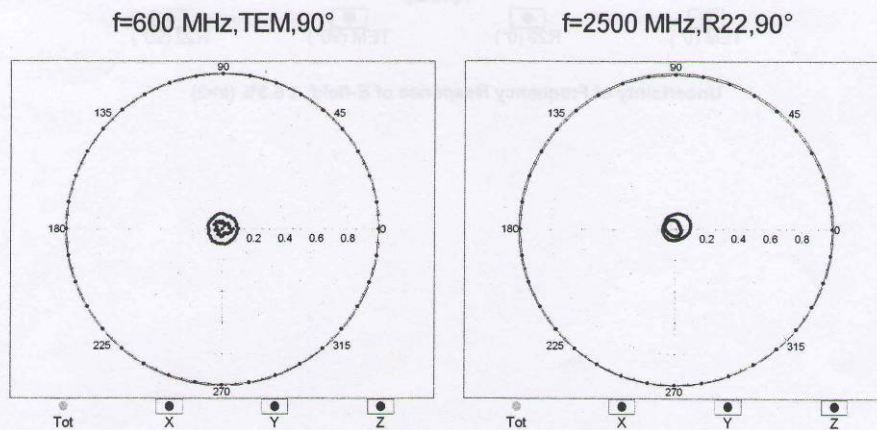

ER3DV6-SN:2424

July 18, 2012

### Receiving Pattern ( $\phi$ ), $\vartheta = 0^\circ$

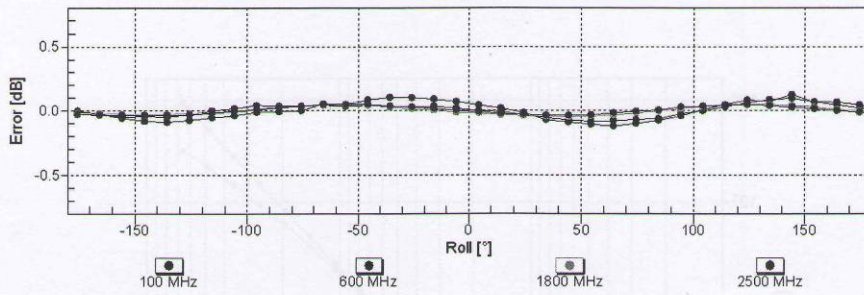

Uncertainty of Axial Isotropy Assessment:  $\pm 0.5\%$  (k=2)

### Receiving Pattern ( $\phi$ ), $\vartheta = 90^\circ$

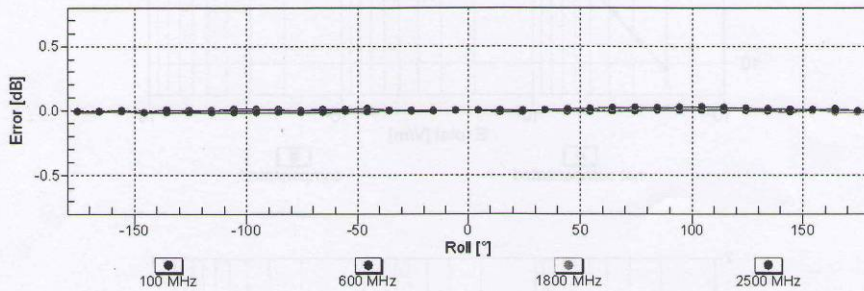

Uncertainty of Axial Isotropy Assessment:  $\pm 0.5\%$  (k=2)

ER3DV6- SN:2424

July 18, 2012

### Dynamic Range f(E-field) (TEM cell , f = 900 MHz)

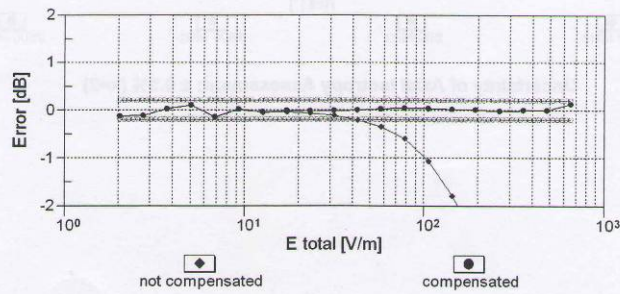
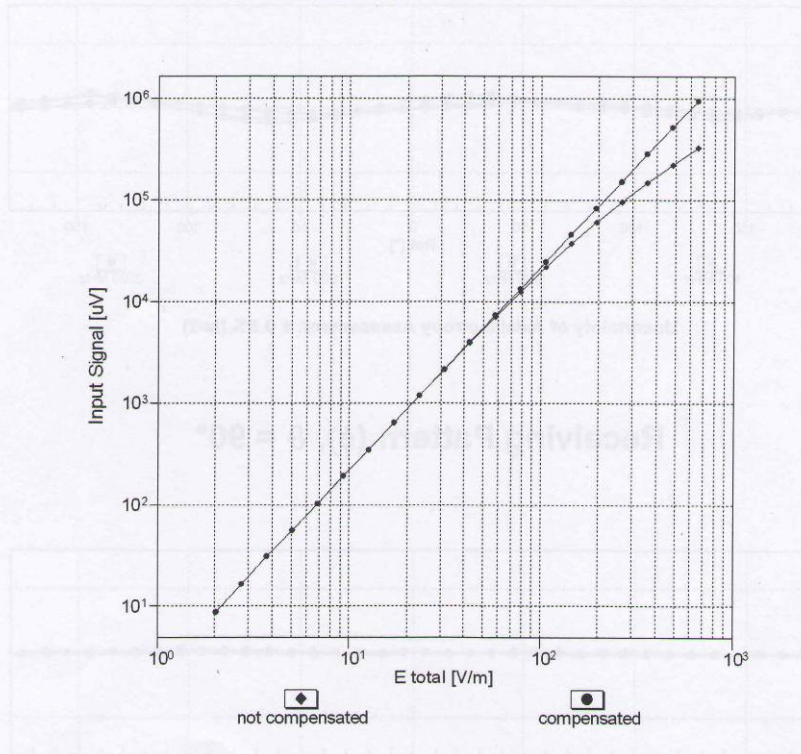

Uncertainty of Linearity Assessment:  $\pm 0.6\%$  (k=2)

ER3DV6-SN:2424

July 18, 2012

### Deviation from Isotropy in Air

Error ( $\phi, \theta$ ),  $f = 900$  MHz

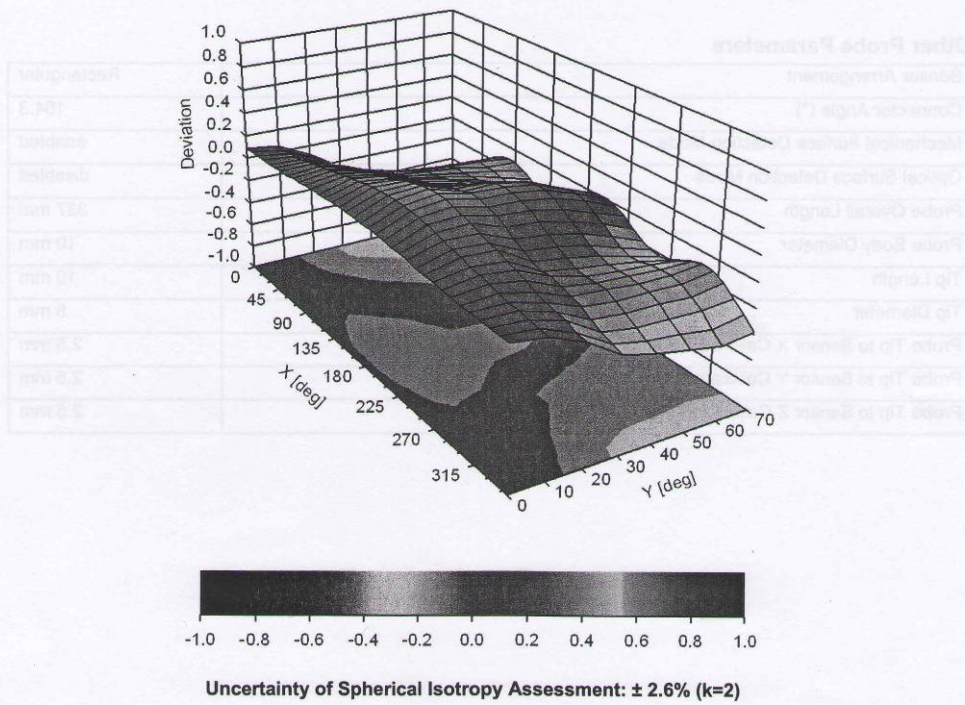



ER3DV6- SN:2424

July 18, 2012

### DASY/EASY - Parameters of Probe: ER3DV6 - SN:2424

#### Other Probe Parameters

Sensor Arrangement	Rectangular
Connector Angle (°)	164.3
Mechanical Surface Detection Mode	enabled
Optical Surface Detection Mode	disabled
Probe Overall Length	337 mm
Probe Body Diameter	10 mm
Tip Length	10 mm
Tip Diameter	8 mm
Probe Tip to Sensor X Calibration Point	2.5 mm
Probe Tip to Sensor Y Calibration Point	2.5 mm
Probe Tip to Sensor Z Calibration Point	2.5 mm

H\_Probe H3DV6

**Calibration Laboratory of  
Schmid & Partner  
Engineering AG**  
Zeughausstrasse 43, 8004 Zurich, Switzerland



**S** Schweizerischer Kalibrierdienst  
**S** Service suisse d'étalonnage  
**C** Servizio svizzero di taratura  
**S** Swiss Calibration Service

Accredited by the Swiss Accreditation Service (SAS)  
The Swiss Accreditation Service is one of the signatories to the EA  
Multilateral Agreement for the recognition of calibration certificates

Accreditation No.: **SCS 108**

Client **TMC-SZ (Auden)**

Certificate No: **H3-6264 Jul12**

**CALIBRATION CERTIFICATE**

Object **H3DV6 - SN:6264**

Calibration procedure(s) **QA CAL-03.v6, QA CAL-25.v4  
Calibration procedure for H-field probes optimized for close near field  
evaluations in air**

Calibration date: **July 20, 2012**

This calibration certificate documents the traceability to national standards, which realize the physical units of measurements (SI).  
The measurements and the uncertainties with confidence probability are given on the following pages and are part of the certificate.

All calibrations have been conducted in the closed laboratory facility: environment temperature (22 ± 3)°C and humidity < 70%.

Calibration Equipment used (M&TE critical for calibration)

Primary Standards	ID	Cal Date (Certificate No.)	Scheduled Calibration
Power meter E4419B	GB41293874	29-Mar-12 (No. 217-01508)	Apr-13
Power sensor E4412A	MY41498087	29-Mar-12 (No. 217-01508)	Apr-13
Reference 3 dB Attenuator	SN: S5054 (3c)	27-Mar-12 (No. 217-01531)	Apr-13
Reference 20 dB Attenuator	SN: S5086 (20b)	27-Mar-12 (No. 217-01529)	Apr-13
Reference 30 dB Attenuator	SN: S5129 (30b)	27-Mar-12 (No. 217-01532)	Apr-13
Reference Probe H3DV6	SN: 6182	11-Oct-11 (No. H3-6182_Oct11)	Oct-12
DAE4	SN: 789	30-Jan-12 (No. DAE4-789_Jan12)	Jan-13
Secondary Standards	ID	Check Date (in house)	Scheduled Check
RF generator HP 8648C	US3642U01700	4-Aug-99 (in house check Apr-11)	In house check: Apr-13
Network Analyzer HP 8753E	US37390585	18-Oct-01 (in house check Oct-11)	In house check: Oct-12

	Name	Function	Signature
Calibrated by:	Israa El-Naouq	Laboratory Technician	
Approved by:	Katja Pokovic	Technical Manager	

Issued: July 23, 2012

This calibration certificate shall not be reproduced except in full without written approval of the laboratory.

**Calibration Laboratory of**  
Schmid & Partner  
Engineering AG  
Zeughausstrasse 43, 8004 Zurich, Switzerland



S Schweizerischer Kalibrierdienst  
C Service suisse d'étalonnage  
S Servizio svizzero di taratura  
S Swiss Calibration Service

Accredited by the Swiss Accreditation Service (SAS)

Accreditation No.: **SCS 108**

The Swiss Accreditation Service is one of the signatories to the EA  
Multilateral Agreement for the recognition of calibration certificates

**Glossary:**

NORM<sub>x,y,z</sub> sensitivity in free space  
DCP diode compression point  
CF crest factor (1/duty\_cycle) of the RF signal  
A, B, C modulation dependent linearization parameters  
Polarization  $\phi$   $\phi$  rotation around probe axis  
Polarization  $\vartheta$   $\vartheta$  rotation around an axis that is in the plane normal to probe axis (at measurement center),  
i.e.,  $\vartheta = 0$  is normal to probe axis  
Connector Angle information used in DASY system to align probe sensor X to the robot coordinate system

**Calibration is Performed According to the Following Standards:**

- a) IEEE Std 1309-2005, "IEEE Standard for calibration of electromagnetic field sensors and probes, excluding antennas, from 9 kHz to 40 GHz", December 2005.
- b) CTIA Test Plan for Hearing Aid Compatibility, April 2010.

**Methods Applied and Interpretation of Parameters:**

- NORM<sub>x,y,z</sub>: Assessed for E-field polarization  $\vartheta = 0$  for XY sensors and  $\vartheta = 90$  for Z sensor ( $f \leq 900$  MHz in TEM-cell;  $f > 1800$  MHz: R22 waveguide).
- $X, Y, Z(f)_{a0a1a2} = X, Y, Z_{a0a1a2} \cdot \text{frequency\_response}$  (see Frequency Response Chart).
- DCP<sub>x,y,z</sub>: DCP are numerical linearization parameters assessed based on the data of power sweep with CW signal (no uncertainty required). DCP does not depend on frequency nor media.
- PAR: PAR is the Peak to Average Ratio that is not calibrated but determined based on the signal characteristics
- $A_{x,y,z}; B_{x,y,z}; C_{x,y,z}; VR_{x,y,z}$ : A, B, C are numerical linearization parameters assessed based on the data of power sweep for specific modulation signal. The parameters do not depend on frequency nor media. VR is the maximum calibration range expressed in RMS voltage across the diode.
- Spherical isotropy (3D deviation from isotropy): in a locally homogeneous field realized using an open waveguide setup.
- Sensor Offset: The sensor offset corresponds to the offset of virtual measurement center from the probe tip (on probe axis). No tolerance required.
- Connector Angle: The angle is assessed using the information gained by determining the  $X_{a0a1a2}$  (no uncertainty required).

H3DV6 – SN:6264

July 20, 2012

Unit (mV)	Sensor X	Sensor Y	Sensor Z
± 0.1 %	± 0.1 %	± 0.1 %	± 0.1 %
± 0.1 %	± 0.1 %	± 0.1 %	± 0.1 %
± 0.1 %	± 0.1 %	± 0.1 %	± 0.1 %

# Probe H3DV6

Unit (mV)	VR	VR	VR	VR
± 0.1 %	± 0.1 %	± 0.1 %	± 0.1 %	± 0.1 %
± 0.1 %	± 0.1 %	± 0.1 %	± 0.1 %	± 0.1 %
± 0.1 %	± 0.1 %	± 0.1 %	± 0.1 %	± 0.1 %

## SN:6264

The reported accuracy of measurement is based on the standard uncertainty of measurement multiplied by the coverage factor  $k=2$ , which for a normal distribution corresponds to a coverage probability of approximately 95%.

Manufactured: September 7, 2007  
Calibrated: July 20, 2012

Calibrated for DASYS/EASY Systems  
(Note: non-compatible with DASYS2 system!)

H3DV6- SN:6264

July 20, 2012

### DASY/EASY - Parameters of Probe: H3DV6 - SN:6264

#### Basic Calibration Parameters

		Sensor X	Sensor Y	Sensor Z	Unc (k=2)
Norm (A/m / $\sqrt{\text{mV}}$ )	a0	2.48E-003	2.55E-003	2.95E-003	$\pm 5.1 \%$
Norm (A/m / $\sqrt{\text{mV}}$ )	a1	-7.25E-005	-6.92E-005	-9.44E-005	$\pm 5.1 \%$
Norm (A/m / $\sqrt{\text{mV}}$ )	a2	2.96E-005	8.62E-006	3.28E-005	$\pm 5.1 \%$
DCP (mV) <sup>B</sup>		92.7	91.3	90.0	

#### Modulation Calibration Parameters

UID	Communication System Name	PAR		A dB	B dB	C dB	VR mV	Unc <sup>E</sup> (k=2)
0	CW	0.00	X	0.00	0.00	1.00	140.6	$\pm 4.4 \%$
			Y	0.00	0.00	1.00	137.4	
			Z	0.00	0.00	1.00	137.5	

The reported uncertainty of measurement is stated as the standard uncertainty of measurement multiplied by the coverage factor k=2, which for a normal distribution corresponds to a coverage probability of approximately 95%.

<sup>B</sup> Numerical linearization parameter: uncertainty not required.

<sup>E</sup> Uncertainty is determined using the max. deviation from linear response applying rectangular distribution and is expressed for the square of the field value.

H3DV6- SN:6264

July 20, 2012

### Frequency Response of H-Field (TEM-Cell:ifi110 EXX, Waveguide: R22)

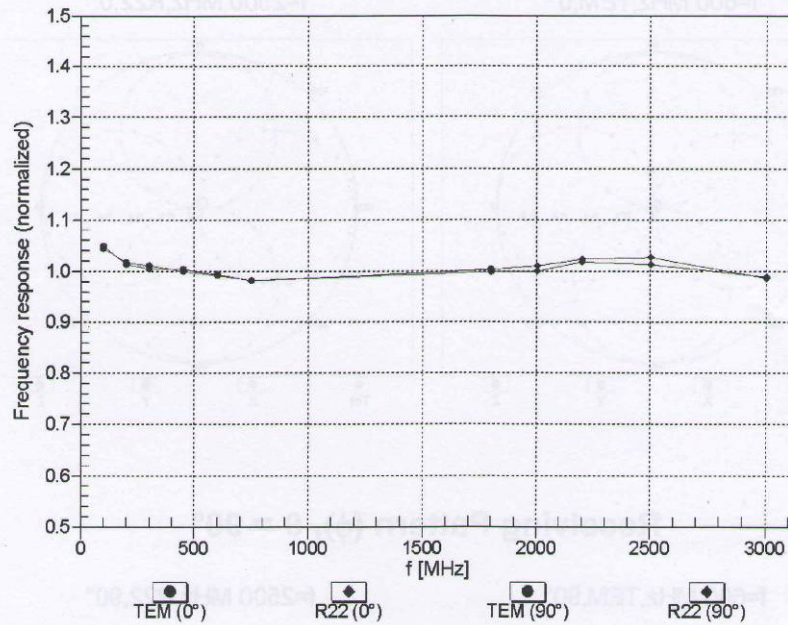

Uncertainty of Frequency Response of H-field:  $\pm 6.3\%$  (k=2)

H3DV6-SN:6264

July 20, 2012

**Receiving Pattern ( $\phi$ ),  $\vartheta = 0^\circ$**

f=600 MHz, TEM,  $0^\circ$

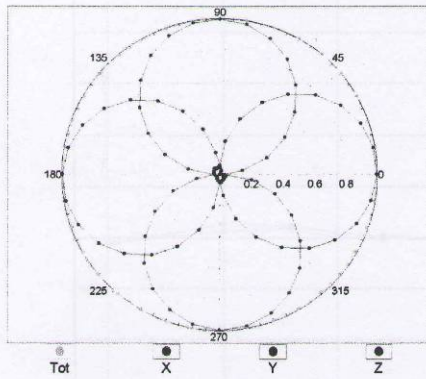

f=2500 MHz, R22,  $0^\circ$

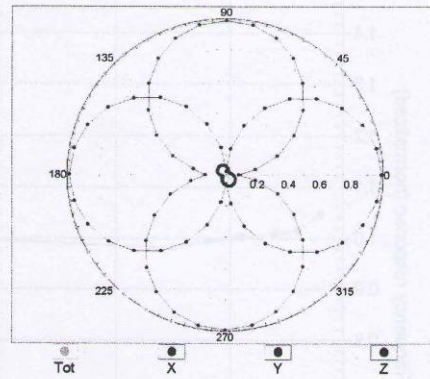

**Receiving Pattern ( $\phi$ ),  $\vartheta = 90^\circ$**

f=600 MHz, TEM,  $90^\circ$

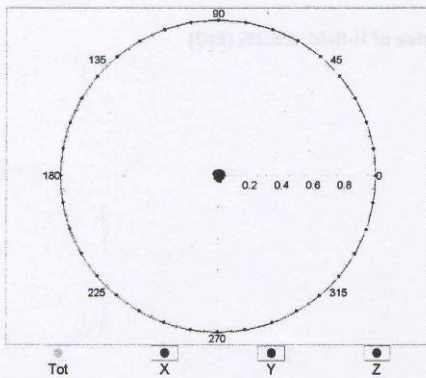

f=2500 MHz, R22,  $90^\circ$

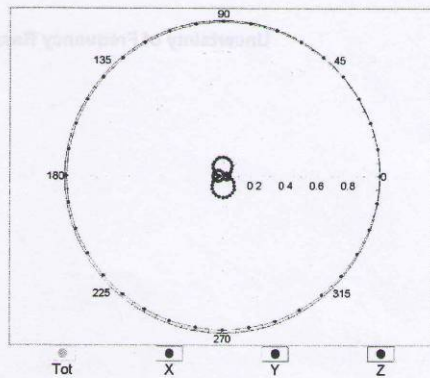

H3DV6-SN:6264

July 20, 2012

### Receiving Pattern ( $\phi$ ), $\vartheta = 0^\circ$

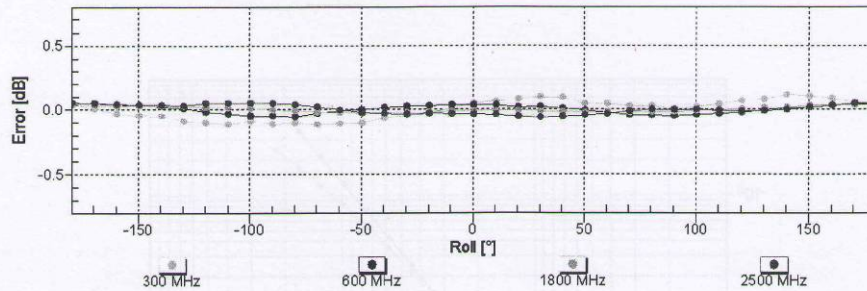

Uncertainty of Axial Isotropy Assessment:  $\pm 0.5\%$  ( $k=2$ )

### Receiving Pattern ( $\phi$ ), $\vartheta = 90^\circ$

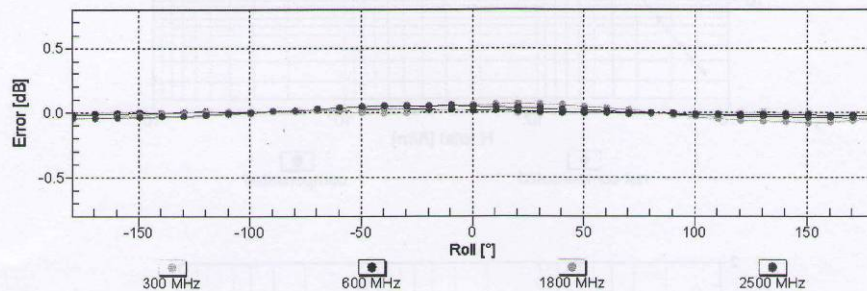

Uncertainty of Axial Isotropy Assessment:  $\pm 0.5\%$  ( $k=2$ )



H3DV6- SN:6264

July 20, 2012

### Dynamic Range f(H-field) (TEM cell, f = 900 MHz)

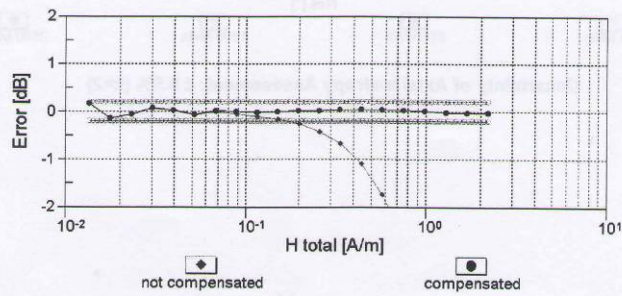
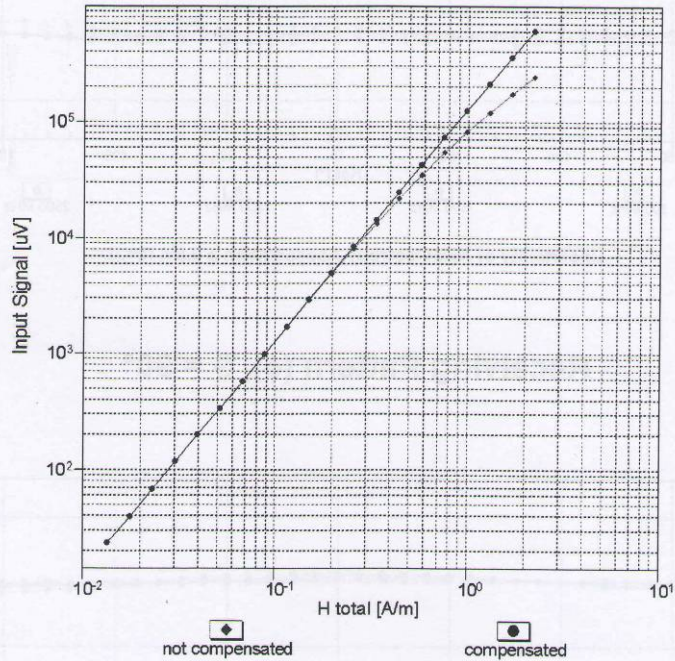

Uncertainty of Linearity Assessment:  $\pm 0.6\%$  (k=2)

H3DV6- SN:6264

July 20, 2012

### Deviation from Isotropy in Air

Error ( $\phi, \theta$ ),  $f = 900$  MHz

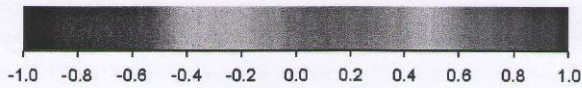
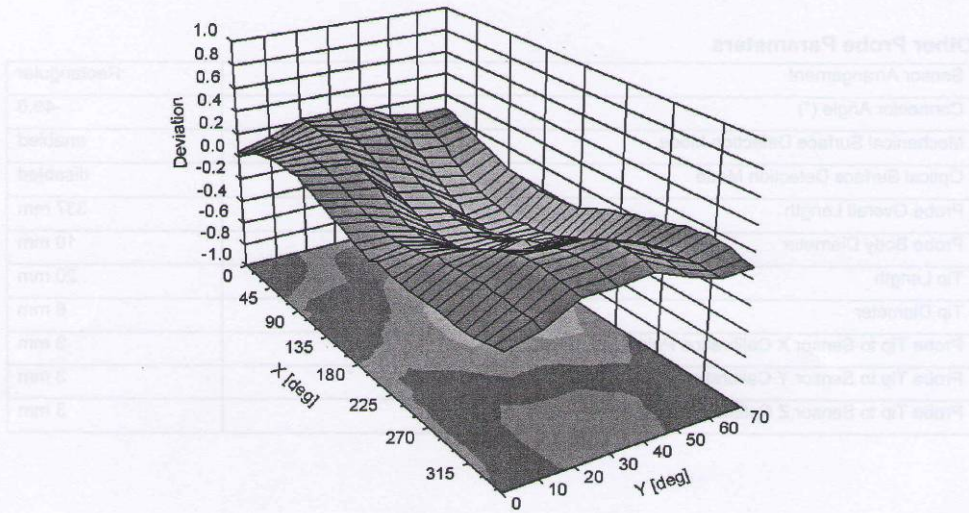

Uncertainty of Spherical Isotropy Assessment:  $\pm 2.6\%$  ( $k=2$ )

H3DV6- SN:6264

July 20, 2012

### DASY/EASY - Parameters of Probe: H3DV6 - SN:6264

#### Other Probe Parameters

Sensor Arrangement	Rectangular
Connector Angle (°)	-49.6
Mechanical Surface Detection Mode	enabled
Optical Surface Detection Mode	disabled
Probe Overall Length	337 mm
Probe Body Diameter	10 mm
Tip Length	20 mm
Tip Diameter	6 mm
Probe Tip to Sensor X Calibration Point	3 mm
Probe Tip to Sensor Y Calibration Point	3 mm
Probe Tip to Sensor Z Calibration Point	3 mm