



# SAR TEST REPORT

No. 2013SAR00051

For

**TCT Mobile Limited**

**GSM dual band mobile phone**

**Model name: Ginger US**

**Marketing name: ALCATEL 1030A**

With

**Hardware Version: PIO**

**Software Version: v52B**

**FCC ID: RAD326**

**Issued Date: 2013-04-07**



**Note:**

The test results in this test report relate only to the devices specified in this report. This report shall not be reproduced except in full without the written approval of TMC Beijing.

**Test Laboratory:**

TMC Beijing, Telecommunication Metrology Center of MIIT

No. 52, Huayuan Bei Road, Haidian District, Beijing, P. R. China 100191.

Tel:+86(0)10-62304633-2079, Fax:+86(0)10-62304633 Email:welcome@emcite.com. [www.emcite.com](http://www.emcite.com)

### Revision Version

<b>Report Number</b>	<b>Revision</b>	<b>Date</b>	<b>Memo</b>
2013SAR00051	00	2013-04-07	Initial creation of test report

## TABLE OF CONTENT

<b>1 TEST LABORATORY .....</b>	<b>5</b>
1.1 TESTING LOCATION .....	5
1.2 TESTING ENVIRONMENT.....	5
1.3 PROJECT DATA .....	5
1.4 SIGNATURE.....	5
<b>2 STATEMENT OF COMPLIANCE .....</b>	<b>6</b>
<b>3 CLIENT INFORMATION .....</b>	<b>7</b>
3.1 APPLICANT INFORMATION .....	7
3.2 MANUFACTURER INFORMATION .....	7
<b>4 EQUIPMENT UNDER TEST (EUT) AND ANCILLARY EQUIPMENT (AE) .....</b>	<b>8</b>
4.1 ABOUT EUT .....	8
4.2 INTERNAL IDENTIFICATION OF EUT USED DURING THE TEST .....	8
4.3 INTERNAL IDENTIFICATION OF AE USED DURING THE TEST .....	8
<b>5 TEST METHODOLOGY .....</b>	<b>9</b>
5.1 APPLICABLE LIMIT REGULATIONS .....	9
5.2 APPLICABLE MEASUREMENT STANDARDS.....	9
<b>6 SPECIFIC ABSORPTION RATE (SAR).....</b>	<b>10</b>
6.1 INTRODUCTION.....	10
6.2 SAR DEFINITION.....	10
<b>7 TISSUE SIMULATING LIQUIDS .....</b>	<b>11</b>
7.1 TARGETS FOR TISSUE SIMULATING LIQUID .....	11
7.2 DIELECTRIC PERFORMANCE .....	11
<b>8 SYSTEM VERIFICATION .....</b>	<b>14</b>
8.1 SYSTEM SETUP.....	14
8.2 SYSTEM VERIFICATION.....	15
<b>9 MEASUREMENT PROCEDURES .....</b>	<b>16</b>
9.1 TESTS TO BE PERFORMED .....	16
9.2 GENERAL MEASUREMENT PROCEDURE.....	17
9.3 POWER DRIFT.....	18
<b>10 AREA SCAN BASED 1-G SAR.....</b>	<b>19</b>
10.1 REQUIREMENT OF KDB.....	19
10.2 FAST SAR ALGORITHMS .....	19
<b>11 CONDUCTED OUTPUT POWER.....</b>	<b>20</b>
11.1 MANUFACTURING TOLERANCE .....	20
11.2 GSM MEASUREMENT RESULT .....	20

<b>12 SAR TEST RESULT .....</b>	<b>21</b>
12.1 THE EVALUATION OF MULTI-BATTERIES .....	21
12.2 SAR RESULTS FOR FAST SAR.....	22
12.3 SAR RESULTS FOR STANDARD PROCEDURE.....	25
<b>13 SAR MEASUREMENT VARIABILITY.....</b>	<b>26</b>
<b>14 MEASUREMENT UNCERTAINTY .....</b>	<b>27</b>
<b>15 MAIN TEST INSTRUMENTS.....</b>	<b>29</b>
<b>ANNEX A GRAPH RESULTS.....</b>	<b>30</b>
<b>ANNEX B SYSTEM VERIFICATION RESULTS .....</b>	<b>38</b>
<b>ANNEX C SAR MEASUREMENT SETUP .....</b>	<b>43</b>
C.1 MEASUREMENT SET-UP .....	43
C.2 DASY4 OR DASY5 E-FIELD PROBE SYSTEM .....	44
C.3 E-FIELD PROBE CALIBRATION .....	44
C.4 OTHER TEST EQUIPMENT.....	45
C.4.1 DATA ACQUISITION ELECTRONICS(DAE) .....	45
C.4.2 ROBOT.....	46
C.4.3 MEASUREMENT SERVER.....	46
C.4.4 DEVICE HOLDER FOR PHANTOM.....	47
C.4.5 PHANTOM.....	47
<b>ANNEX D POSITION OF THE WIRELESS DEVICE IN RELATION TO THE PHANTOM .....</b>	<b>49</b>
D.1 GENERAL CONSIDERATIONS.....	49
D.2 BODY-WORN DEVICE .....	50
D.3 DESKTOP DEVICE.....	50
D.4 DUT SETUP PHOTOS.....	51
<b>ANNEX E EQUIVALENT MEDIA RECIPES.....</b>	<b>52</b>
<b>ANNEX F SYSTEM VALIDATION .....</b>	<b>53</b>
<b>ANNEX G PROBE CALIBRATION CERTIFICATE.....</b>	<b>54</b>
<b>ANNEX H DIPOLE CALIBRATION CERTIFICATE .....</b>	<b>65</b>

## 1 Test Laboratory

### 1.1 Testing Location

Company Name: TMC Beijing, Telecommunication Metrology Center of MIIT  
Address: No 52, Huayuan beilu, Haidian District, Beijing, P.R.China  
Postal Code: 100191  
Telephone: +86-10-62304633  
Fax: +86-10-62304793

### 1.2 Testing Environment

Temperature: 18°C~25 °C,  
Relative humidity: 30%~ 70%  
Ground system resistance: < 0.5  $\Omega$   
Ambient noise & Reflection: < 0.012 W/kg

### 1.3 Project Data

Project Leader: Qi Dianyuan  
Test Engineer: Lin Xiaojun  
Testing Start Date: March 20, 2013  
Testing End Date: March 22, 2013

### 1.4 Signature



---

Lin Xiaojun

(Prepared this test report)

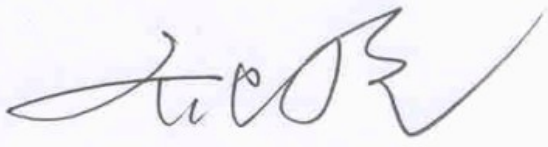

---

Qi Dianyuan

(Reviewed this test report)



---

Xiao Li

Deputy Director of the laboratory

(Approved this test report)

## 2 Statement of Compliance

The maximum results of Specific Absorption Rate (SAR) found during testing for TCT Mobile Limited GSM dual band mobile phone Ginger US / ALCATEL 1030A are as follows.

**Table 2.1: Highest Reported SAR (1g)**

Exposure Configuration	Technology Band	Highest Reported SAR 1g (W/Kg)	Equipment Class
Head (Separation Distance 0mm)	GSM 850	1.28	PCE
	PCS 1900	0.59	
Body-worn (Separation Distance 10mm)	GSM 850	0.68	PCE
	PCS 1900	0.86	

The SAR values found for the Mobile Phone are below the maximum recommended levels of 1.6 W/Kg as averaged over any 1g tissue according to the ANSI C95.1-1999.

For body worn operation, this device has been tested and meets FCC RF exposure guidelines when used with any accessory that contains no metal and which provides a minimum separation distance of 10 mm between this device and the body of the user. Use of other accessories may not ensure compliance with FCC RF exposure guidelines.

The EUT battery must be fully charged and checked periodically during the test to ascertain uniform power output.

The measurement together with the test system set-up is described in annex C of this test report. A detailed description of the equipment under test can be found in chapter 4 of this test report.

The maximum reported SAR value is obtained at the case of **(Table 2.1)**, and the values are: **1.28 W/kg (1g)**.

### 3 Client Information

#### 3.1 Applicant Information

Company Name: TCT Mobile Limited  
Address /Post: 5F, C building, No. 232, Liang Jing Road ZhangJiang High-Tech Park,  
Pudong Area Shanghai, P.R. China. 201203  
City: ShangHai  
Postal Code: 201203  
Country: P.R.China  
Contact: Gong Zhizhou  
Email: zhizhou.gong@jrdcom.com  
Telephone: 0086-21-61460890  
Fax: 0086-21-61460602

#### 3.2 Manufacturer Information

Company Name: TCT Mobile Limited  
Address /Post: 5F, C building, No. 232, Liang Jing Road ZhangJiang High-Tech Park,  
Pudong Area Shanghai, P.R. China. 201203  
City: ShangHai  
Postal Code: 201203  
Country: P.R.China  
Contact: Gong Zhizhou  
Email: zhizhou.gong@jrdcom.com  
Telephone: 0086-21-61460890  
Fax: 0086-21-61460602

## 4 Equipment Under Test (EUT) and Ancillary Equipment (AE)

### 4.1 About EUT

Description:	GSM dual band mobile phone
Model name:	Ginger US
Marketing name:	ALCATEL 1030A
Operating mode(s):	GSM 850/1900
Tested Tx Frequency:	825 – 848.8 MHz (GSM 850)
	1850.2 – 1910 MHz (GSM 1900)
GSM release:	Rel5
Test device Production information:	Production unit
Device type:	Portable device
Antenna type:	Integrated antenna
Accessories/Body-worn configurations:	Headset
Form factor:	9.4cm × 4.6 cm

### 4.2 Internal Identification of EUT used during the test

EUT ID*	SN or IMEI	HW Version	SW Version
EUT1	013494000000265	PIO	v52B
EUT2	013494000000232	PIO	v52B

\*EUT ID: is used to identify the test sample in the lab internally.

**Note:** It is performed to test SAR with the EUT1 and conducted power with the EUT2.

### 4.3 Internal Identification of AE used during the test

AE ID*	Description	Model	SN	Manufacturer
AE1	Battery	CAB0400000C1	/	BYD
AE2	Battery	CAB24Q0000C1	/	BAK
AE3	Battery	CAB2170000C1	/	BYD
AE4	Headset	CCB3160A11C1	/	juwei
AE5	Headset	CCB3160A11C2	/	Shunda
AE6	Headset	CCB3160A15C1	/	juwei
AE7	Headset	CCB3160A15C2	/	Shunda

\*AE ID: is used to identify the test sample in the lab internally.

**Note:** AE4 and AE6 are the same, so they can use the same results. AE5 and AE7 are the same, so they can use the same results.



## 5 TEST METHODOLOGY

### 5.1 Applicable Limit Regulations

**ANSI C95.1–1999:** IEEE Standard for Safety Levels with Respect to Human Exposure to Radio Frequency Electromagnetic Fields, 3 kHz to 300 GHz.

It specifies the maximum exposure limit of **1.6 W/kg** as averaged over any 1 gram of tissue for portable devices being used within 20 cm of the user in the uncontrolled environment.

### 5.2 Applicable Measurement Standards

**IEEE 1528–2003:** Recommended Practice for Determining the Peak Spatial-Average Specific Absorption Rate (SAR) in the Human Body Due to Wireless Communications Devices: Experimental Techniques.

**OET Bulletin 65 (Edition 97-01) and Supplement C(Edition 01-01):** Additional Information for Evaluating Compliance of Mobile and Portable Devices with FCC Limits.

**KDB447498 D01: General RF Exposure Guidance v05:** Mobile and Portable Devices RF Exposure Procedures and Equipment Authorization Policies.

**865664 D01 SAR measurement 100 MHz to 6 GHz v01:** SAR Measurement Requirements for 100 MHz to 6 GHz

**865664 D02 SAR Reporting v01:** RF Exposure Compliance Reporting and Documentation Considerations

## 6 Specific Absorption Rate (SAR)

### 6.1 Introduction

SAR is related to the rate at which energy is absorbed per unit mass in an object exposed to a radio field. The SAR distribution in a biological body is complicated and is usually carried out by experimental techniques or numerical modeling. The standard recommends limits for two tiers of groups, occupational/controlled and general population/uncontrolled, based on a person's awareness and ability to exercise control over his or her exposure. In general, occupational/controlled exposure limits are higher than the limits for general population/uncontrolled.

### 6.2 SAR Definition

The SAR definition is the time derivative (rate) of the incremental energy ( $dW$ ) absorbed by (dissipated in) an incremental mass ( $dm$ ) contained in a volume element ( $dv$ ) of a given density ( $\rho$ ). The equation description is as below:

$$SAR = \frac{d}{dt} \left( \frac{dW}{dm} \right) = \frac{d}{dt} \left( \frac{dW}{\rho dv} \right)$$

SAR is expressed in units of Watts per kilogram (W/kg)

SAR measurement can be either related to the temperature elevation in tissue by

$$SAR = c \left( \frac{\delta T}{\delta t} \right)$$

Where:  $C$  is the specific heat capacity,  $\delta T$  is the temperature rise and  $\delta t$  is the exposure duration, or related to the electrical field in the tissue by

$$SAR = \frac{\sigma |E|^2}{\rho}$$

Where:  $\sigma$  is the conductivity of the tissue,  $\rho$  is the mass density of tissue and  $E$  is the RMS electrical field strength.

However for evaluating SAR of low power transmitter, electrical field measurement is typically applied.

## 7 Tissue Simulating Liquids

### 7.1 Targets for tissue simulating liquid

**Table 7.1: Targets for tissue simulating liquid**

Frequency (MHz)	Liquid Type	Conductivity ( $\sigma$ )	$\pm 5\%$ Range	Permittivity ( $\epsilon$ )	$\pm 5\%$ Range
835	Head	0.90	0.86~0.95	41.5	39.4~43.6
835	Body	0.97	0.92~1.02	55.2	52.4~58.0
1900	Head	1.40	1.33~1.47	40.0	38.0~42.0
1900	Body	1.52	1.44~1.60	53.3	50.6~56.0

### 7.2 Dielectric Performance

**Table 7.2: Dielectric Performance of Tissue Simulating Liquid**

Measurement Date (yyyy-mm-dd)	Type	Frequency	Permittivity $\epsilon$	Drift (%)	Conductivity $\sigma$ (S/m)	Drift (%)
2013-03-20	Head	835 MHz	40.26	-2.99	0.89	-1.11
	Body	835 MHz	56.75	2.81	0.981	1.13
2013-03-22	Head	1900 MHz	39.32	-1.70	1.431	2.21
	Body	1900 MHz	52.28	-1.91	1.537	1.12

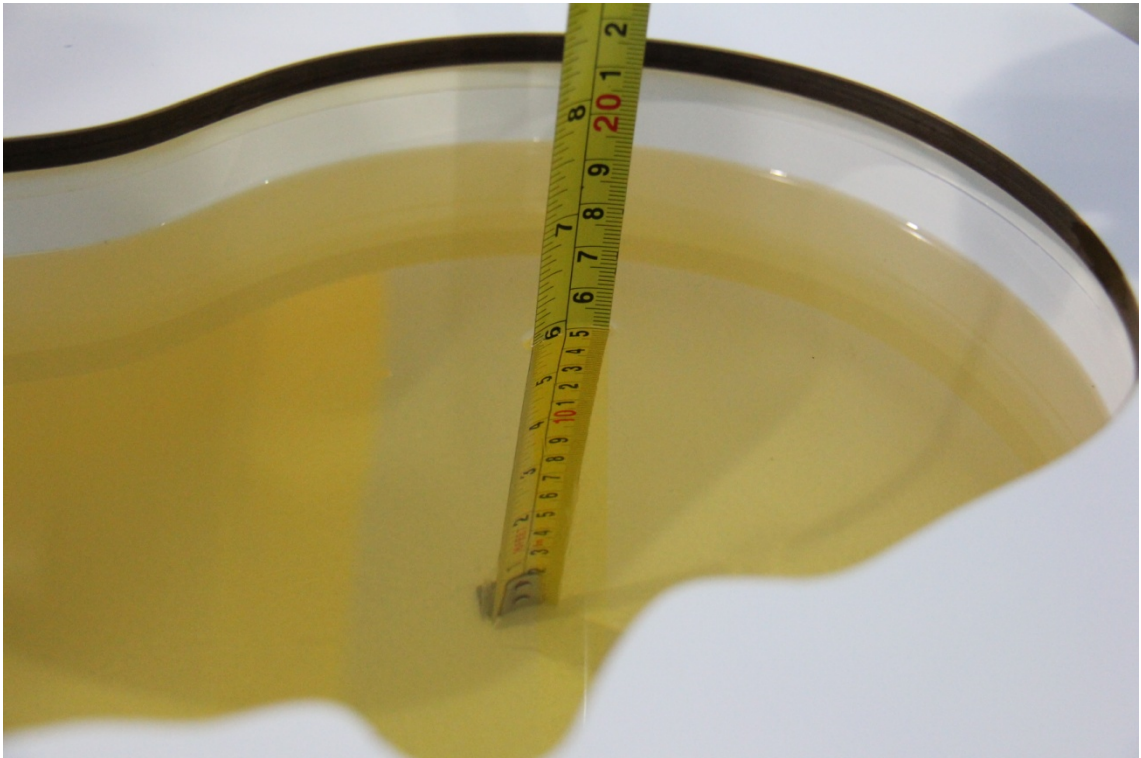

**Picture 7-1: Liquid depth in the Head Phantom (835 MHz)**

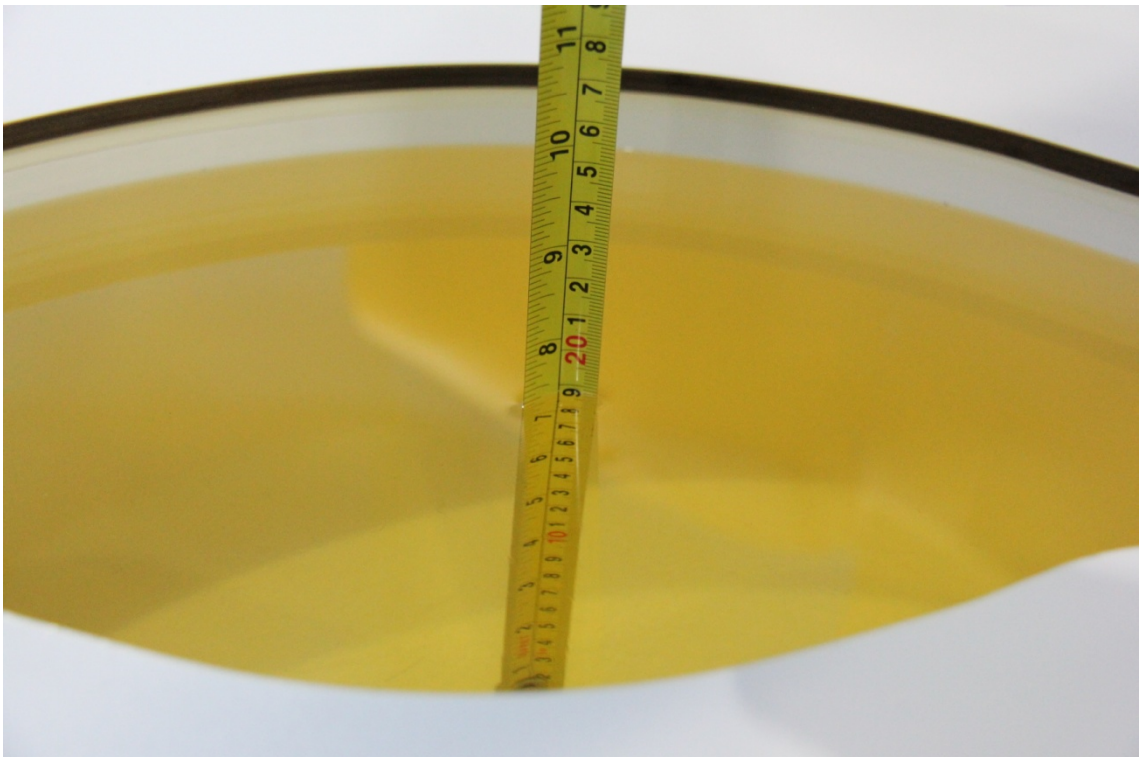

**Picture 7-2: Liquid depth in the Flat Phantom (835 MHz)**



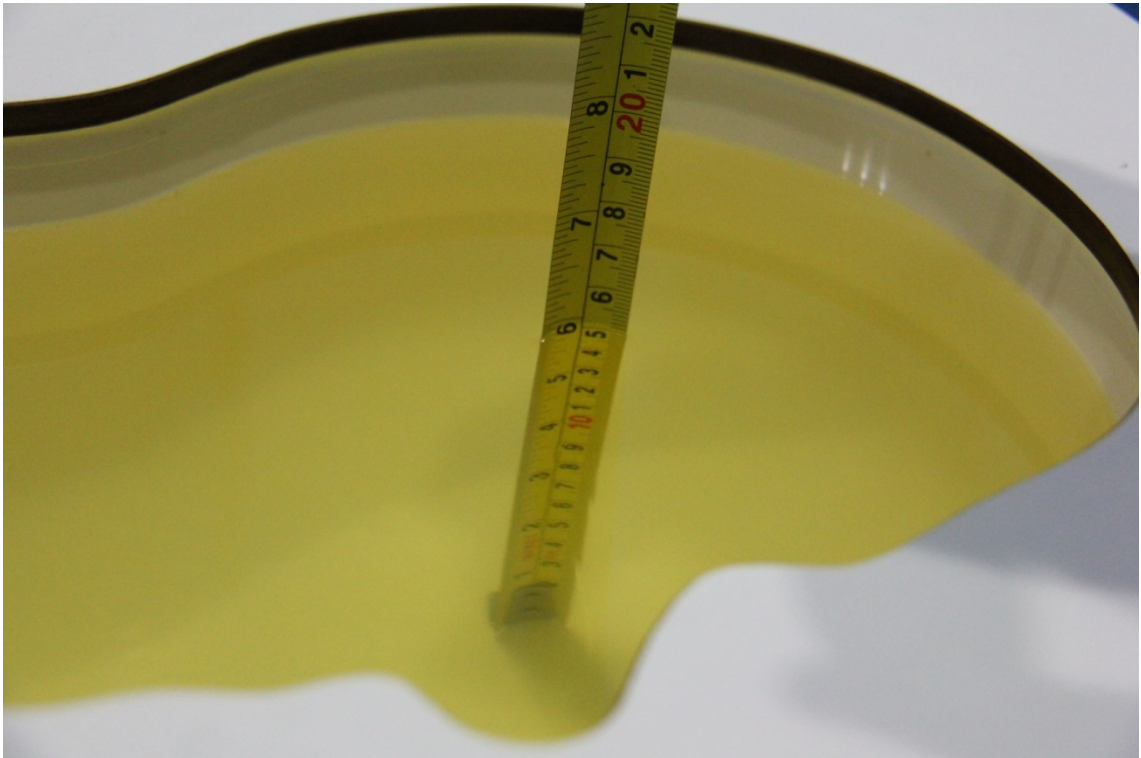

**Picture 7-3: Liquid depth in the Head Phantom (1900 MHz)**

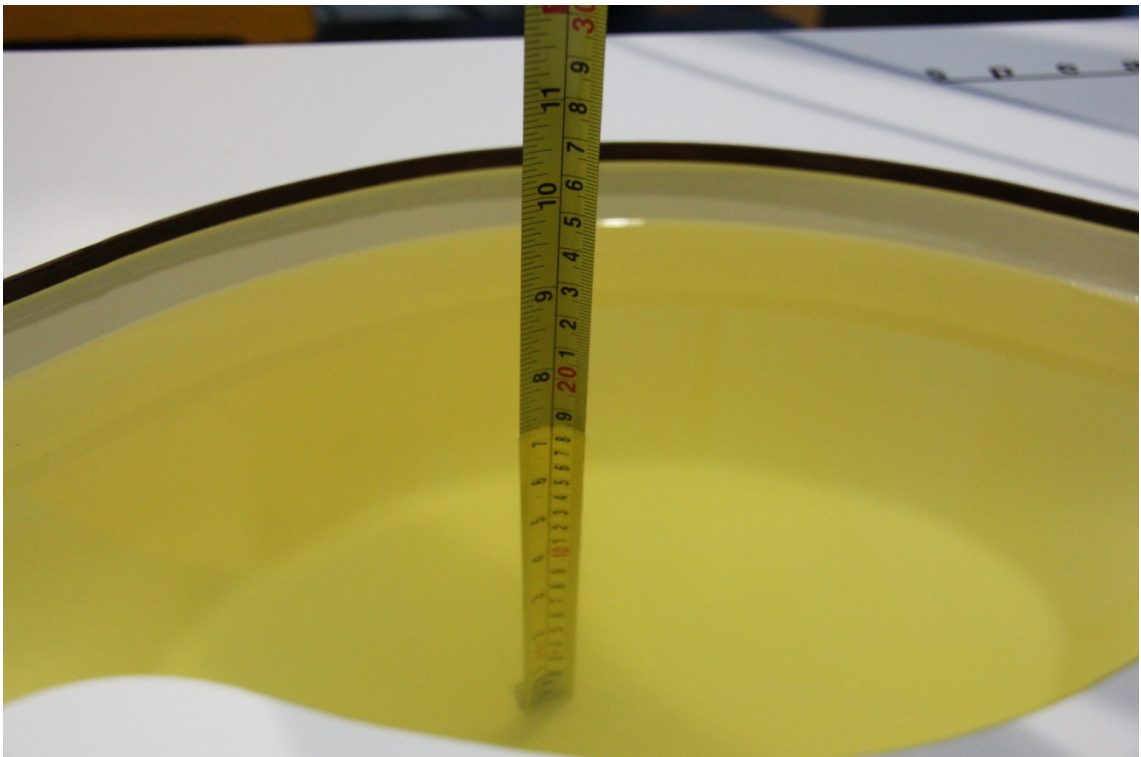

**Picture 7-4 Liquid depth in the Flat Phantom (1900MHz)**

## 8 System verification

### 8.1 System Setup

In the simplified setup for system evaluation, the DUT is replaced by a calibrated dipole and the power source is replaced by a continuous wave that comes from a signal generator. The calibrated dipole must be placed beneath the flat phantom section of the SAM twin phantom with the correct distance holder. The distance holder should touch the phantom surface with a light pressure at the reference marking and be oriented parallel to the long side of the phantom. The equipment setup is shown below:

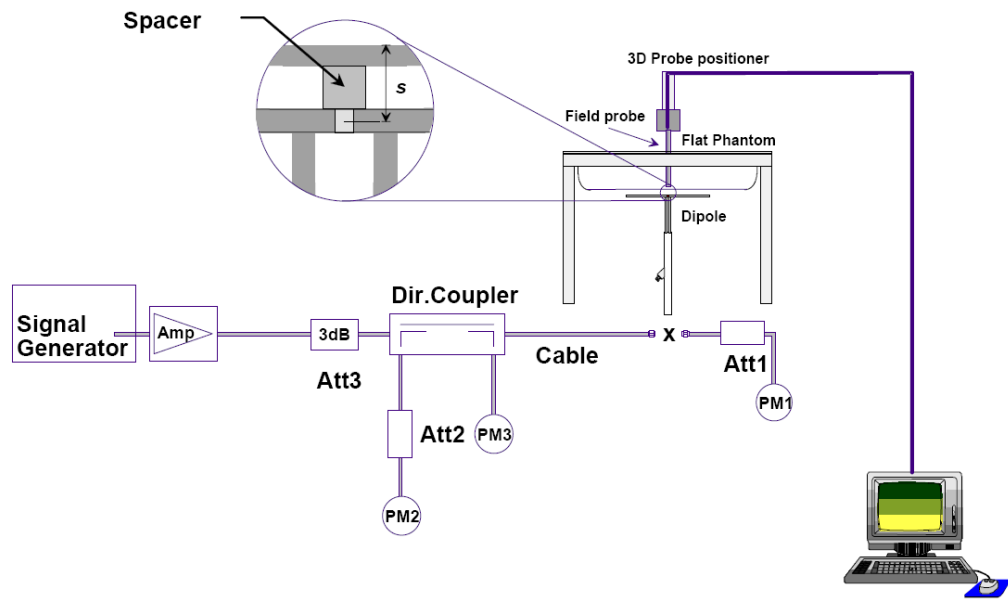

Picture 8.1 System Setup for System Evaluation

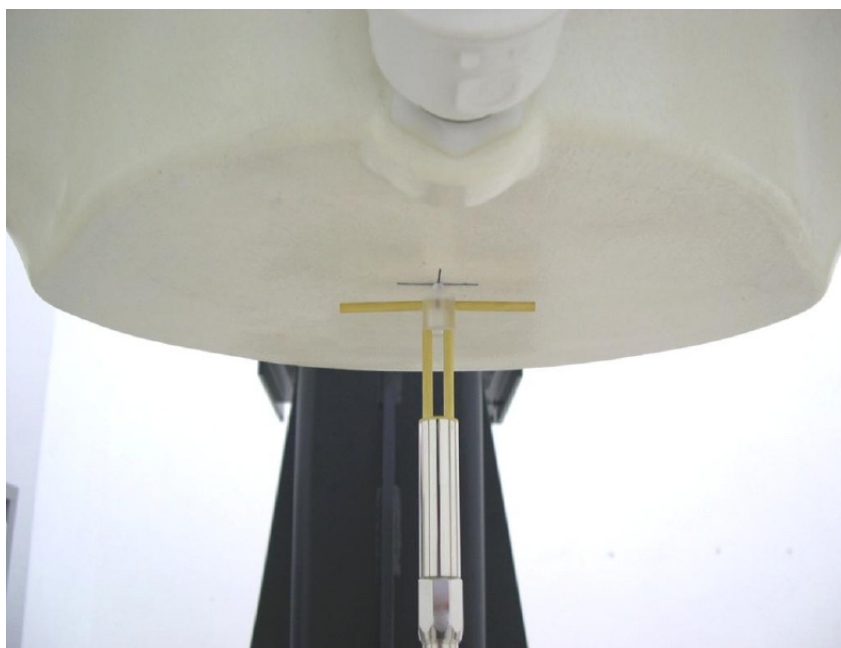

Picture 8.2 Photo of Dipole Setup

## 8.2 System Verification

SAR system verification is required to confirm measurement accuracy, according to the tissue dielectric media, probe calibration points and other system operating parameters required for measuring the SAR of a test device. The system verification must be performed for each frequency band and within the valid range of each probe calibration point required for testing the device.

The system verification results are required that the area scan estimated 1-g SAR is within 3% of the zoom scan 1-g SAR. The details are presented in annex B.

**Table 8.1: System Verification of Head**

Measurement Date (yyyy-mm-dd)	Frequency	Target value (W/kg)		Measured value (W/kg)		Deviation	
		10 g Average	1 g Average	10 g Average	1 g Average	10 g Average	1 g Average
2013-03-20	835 MHz	6.07	9.30	6.00	9.32	-1.15%	0.22%
2013-03-22	1900 MHz	20.6	39.1	20.20	38.44	-1.94%	-1.69%

**Table 8.2: System Verification of Body**

Measurement Date (yyyy-mm-dd)	Frequency	Target value (W/kg)		Measured value (W/kg)		Deviation	
		10 g Average	1 g Average	10 g Average	1 g Average	10 g Average	1 g Average
2013-03-20	835 MHz	6.20	9.36	6.32	9.56	1.94%	2.14%
2013-03-22	1900 MHz	21.3	39.9	21.48	40.40	0.85%	1.25%

## 9 Measurement Procedures

### 9.1 Tests to be performed

In order to determine the highest value of the peak spatial-average SAR of a handset, all device positions, configurations and operational modes shall be tested for each frequency band according to steps 1 to 3 below. A flowchart of the test process is shown in picture 9.1.

**Step 1:** The tests described in 9.2 shall be performed at the channel that is closest to the centre of the transmit frequency band ( $f_c$ ) for:

- a) all device positions (cheek and tilt, for both left and right sides of the SAM phantom, as described in annex D),
- b) all configurations for each device position in a), e.g., antenna extended and retracted, and
- c) all operational modes, e.g., analogue and digital, for each device position in a) and configuration in b) in each frequency band.

If more than three frequencies need to be tested according to 11.1 (i.e.,  $N_c > 3$ ), then all frequencies, configurations and modes shall be tested for all of the above test conditions.

**Step 2:** For the condition providing highest peak spatial-average SAR determined in Step 1, perform all tests described in 9.2 at all other test frequencies, i.e., lowest and highest frequencies. In addition, for all other conditions (device position, configuration and operational mode) where the peak spatial-average SAR value determined in Step 1 is within 3 dB of the applicable SAR limit, it is recommended that all other test frequencies shall be tested as well.

**Step 3:** Examine all data to determine the highest value of the peak spatial-average SAR found in Steps 1 to 2.



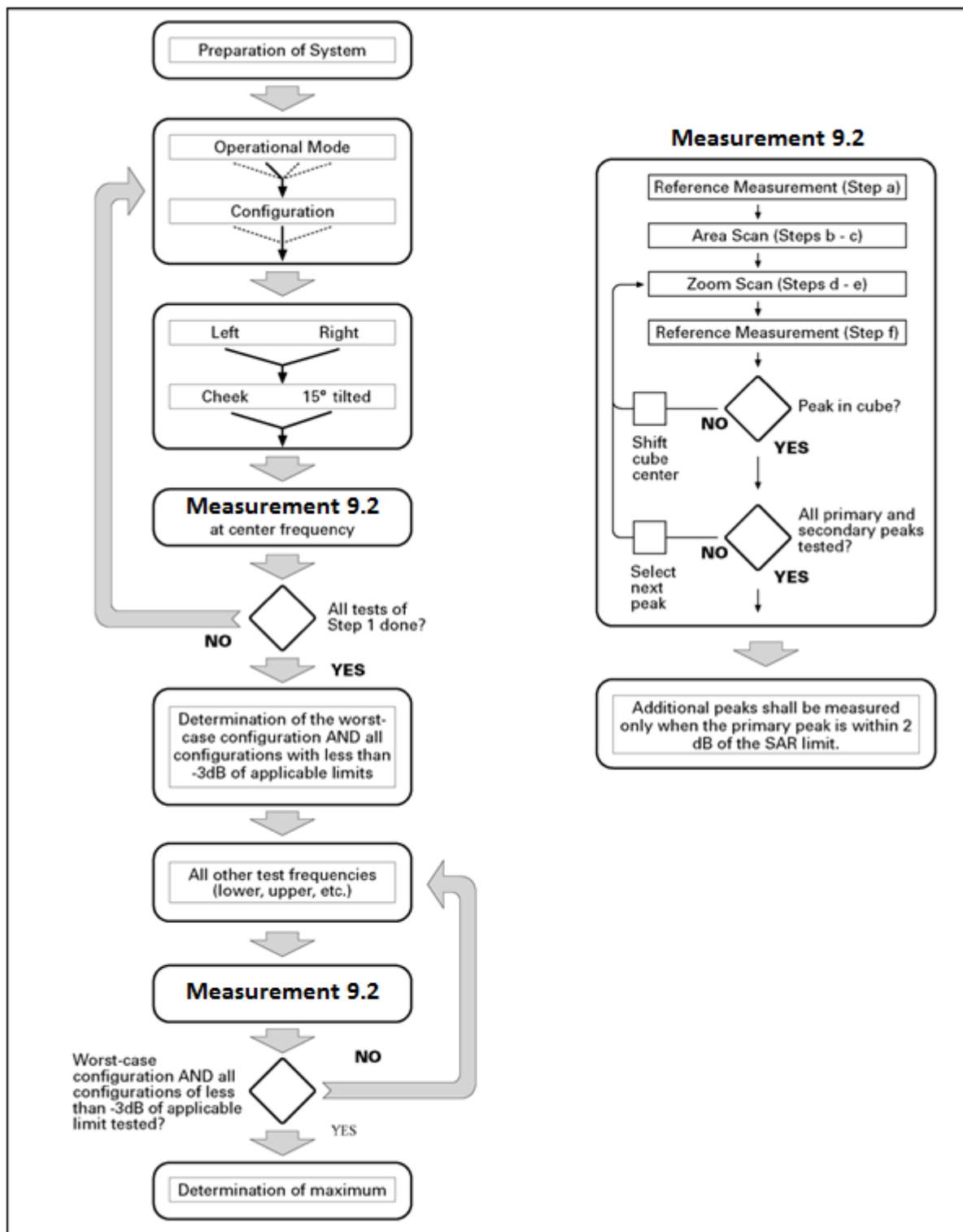

Picture 9.1 Block diagram of the tests to be performed

## 9.2 General Measurement Procedure

The area and zoom scan resolutions specified in the table below must be applied to the SAR measurements and fully documented in SAR reports to qualify for TCB approval. Probe boundary effect error compensation is required for measurements with the probe tip closer than half a probe

tip diameter to the phantom surface. Both the probe tip diameter and sensor offset distance must satisfy measurement protocols; to ensure probe boundary effect errors are minimized and the higher fields closest to the phantom surface can be correctly measured and extrapolated to the phantom surface for computing 1-g SAR. Tolerances of the post-processing algorithms must be verified by the test laboratory for the scan resolutions used in the SAR measurements, according to the reference distribution functions specified in IEEE Std 1528-2003. The results should be documented as part of the system validation records and may be requested to support test results when all the measurement parameters in the following table are not satisfied.

		$\leq 3$ GHz	$> 3$ GHz	
Maximum distance from closest measurement point (geometric center of probe sensors) to phantom surface		$5 \pm 1$ mm	$\frac{1}{2} \delta \ln(2) \pm 0.5$ mm	
Maximum probe angle from probe axis to phantom surface normal at the measurement location		$30^\circ \pm 1^\circ$	$20^\circ \pm 1^\circ$	
Maximum area scan spatial resolution: $\Delta x_{Area}, \Delta y_{Area}$		$\leq 2$ GHz: $\leq 15$ mm 2 – 3 GHz: $\leq 12$ mm	3 – 4 GHz: $\leq 12$ mm 4 – 6 GHz: $\leq 10$ mm	
		When the x or y dimension of the test device, in the measurement plane orientation, is smaller than the above, the measurement resolution must be $\leq$ the corresponding x or y dimension of the test device with at least one measurement point on the test device.		
Maximum zoom scan spatial resolution: $\Delta x_{Zoom}, \Delta y_{Zoom}$		$\leq 2$ GHz: $\leq 8$ mm 2 – 3 GHz: $\leq 5$ mm*	3 – 4 GHz: $\leq 5$ mm* 4 – 6 GHz: $\leq 4$ mm*	
Maximum zoom scan spatial resolution, normal to phantom surface	uniform grid: $\Delta z_{Zoom}(n)$	$\leq 5$ mm	3 – 4 GHz: $\leq 4$ mm 4 – 5 GHz: $\leq 3$ mm 5 – 6 GHz: $\leq 2$ mm	
	graded grid	$\Delta z_{Zoom}(1)$ : between 1 <sup>st</sup> two points closest to phantom surface	$\leq 4$ mm	3 – 4 GHz: $\leq 3$ mm 4 – 5 GHz: $\leq 2.5$ mm 5 – 6 GHz: $\leq 2$ mm
		$\Delta z_{Zoom}(n>1)$ : between subsequent points	$\leq 1.5 \cdot \Delta z_{Zoom}(n-1)$	
Minimum zoom scan volume	x, y, z	$\geq 30$ mm	3 – 4 GHz: $\geq 28$ mm 4 – 5 GHz: $\geq 25$ mm 5 – 6 GHz: $\geq 22$ mm	
<p>Note: <math>\delta</math> is the penetration depth of a plane-wave at normal incidence to the tissue medium; see draft standard IEEE P1528-2011 for details.</p> <p>* When zoom scan is required and the <i>reported</i> SAR from the area scan based 1-g SAR estimation procedures of KDB 447498 is <math>\leq 1.4</math> W/kg, <math>\leq 8</math> mm, <math>\leq 7</math> mm and <math>\leq 5</math> mm zoom scan resolution may be applied, respectively, for 2 GHz to 3 GHz, 3 GHz to 4 GHz and 4 GHz to 6 GHz.</p>				

### 9.3 Power Drift

To control the output power stability during the SAR test, DASY4 system calculates the power drift by measuring the E-field at the same location at the beginning and at the end of the measurement for each test position. These drift values can be found in Table 12.2 to Table 12.13 labeled as: (Power Drift [dB]). This ensures that the power drift during one measurement is within 5%.

## 10 Area Scan Based 1-g SAR

### 10.1 Requirement of KDB

According to the KDB447498 D01 v05, when the implementation is based the specific polynomial fit algorithm as presented at the 29th Bioelectromagnetics Society meeting (2007) and the estimated 1-g SAR is  $\leq 1.2$  W/kg, a zoom scan measurement is not required provided it is also not needed for any other purpose; for example, if the peak SAR location required for simultaneous transmission SAR test exclusion can be determined accurately by the SAR system or manually to discriminate between distinctive peaks and scattered noisy SAR distributions from area scans.

There must not be any warning or alert messages due to various measurement concerns identified by the SAR system; for example, noise in measurements, peaks too close to scan boundary, peaks are too sharp, spatial resolution and uncertainty issues etc. The SAR system verification must also demonstrate that the area scan estimated 1-g SAR is within 3% of the zoom scan 1-g SAR (See Annex B). When all the SAR results for each exposure condition in a frequency band and wireless mode are based on estimated 1-g SAR, the 1-g SAR for the highest SAR configuration must be determined by a zoom scan.

### 10.2 Fast SAR Algorithms

The approach is based on the area scan measurement applying a frequency dependent attenuation parameter. This attenuation parameter was empirically determined by analyzing a large number of phones. The MOTOROLA FAST SAR was developed and validated by the MOTOROLA Research Group in Ft. Lauderdale.

In the initial study, an approximation algorithm based on Linear fit was developed. The accuracy of the algorithm has been demonstrated across a broad frequency range (136-2450 MHz) and for both 1- and 10-g averaged SAR using a sample of 264 SAR measurements from 55 wireless handsets. For the sample size studied, the root-mean-squared errors of the algorithm are 1.2% and 5.8% for 1- and 10-g averaged SAR, respectively. The paper describing the algorithm in detail is expected to be published in August 2004 within the Special Issue of Transactions on MTT.

In the second step, the same research group optimized the fitting algorithm to an Polynomial fit whereby the frequency validity was extended to cover the range 30-6000MHz. Details of this study can be found in the BEMS 2007 Proceedings.

Both algorithms are implemented in DASY software.

## 11 Conducted Output Power

### 11.1 Manufacturing tolerance

**Table 11.1: GSM Speech**

GSM 850			
Channel	Channel 251	Channel 190	Channel 128
Target (dBm)	32	32	32
Tolerance $\pm$ (dB)	1	1	1
GSM 1900			
Channel	Channel 810	Channel 661	Channel 512
Target (dBm)	29.3	29.3	29.3
Tolerance $\pm$ (dB)	1	1	1

### 11.2 GSM Measurement result

During the process of testing, the EUT was controlled via Agilent Digital Radio Communication tester (E5515C) to ensure the maximum power transmission and proper modulation. This result contains conducted output power for the EUT. In all cases, the measured peak output power should be greater and within 5% than EMI measurement.

**Table 11.2: The conducted power measurement results for GSM850/1900**

GSM	Conducted Power (dBm)		
	Channel 251(848.8MHz)	Channel 190(836.6MHz)	Channel 128(824.2MHz)
850MHZ	32.30	32.31	32.39
GSM	Conducted Power (dBm)		
	Channel 810(1909.8MHz)	Channel 661(1880MHz)	Channel 512(1850.2MHz)
1900MHZ	29.45	29.56	29.59

## 12 SAR Test Result

It is determined by user manual for the distance between the EUT and the phantom bottom.

The distance is 10mm and just applied to the condition of body worn accessory.

It is performed for all SAR measurements with area scan based 1-g SAR estimation (Fast SAR). A zoom scan measurement is added when the estimated 1-g SAR is the highest measured SAR in each exposure configuration, wireless mode and frequency band combination or more than 1.2W/kg.

The Reported SAR is obtained by the following formula:

$$\text{Reported SAR} = \text{Measured SAR} \times 10^{(P_{\text{Target}} - P_{\text{Measured}})/10}$$

Where  $P_{\text{Target}}$  is the power of manufacturing upper limit;

$P_{\text{Measured}}$  is the measured power in chapter 11.

**Table 12.1: Duty Cycle**

	Duty Cycle
Speech for GSM850/1900	1:8.3

### 12.1 The evaluation of multi-batteries

We'll perform the head measurement in all bands with the primary battery depending on the evaluation of multi-batteries and retest on highest value point with other batteries. Then, repeat the measurement in the Body test.

**Table 12.2: The evaluation of multi-batteries for Head Test**

Frequency		Side	Test Position	Battery Type	SAR(1g)	Power Drift(dB)
MHz	Ch.				(W/kg)	
848.8	251	Left	Touch	CAB0400000C1	1.05	-0.18
848.8	251	Left	Touch	CAB24Q0000C1	1.09	-0.17
848.8	251	Left	Touch	CAB2170000C1	1.04	-0.13

Note: According to the values in the above table, the battery, CAB24Q0000C1, is the primary battery. We'll perform the head measurement with this battery and retest on highest value point with others.

**Table 12.3: The evaluation of multi-batteries for Body Test**

Frequency		Test Position	Type	Spacing (mm)	Battery Type	SAR(1g)	Power Drift(dB)
MHz	Ch.					(W/kg)	
1880	661	Ground	Fold	10	CAB0400000C1	0.700	-0.01
1880	661	Ground	Fold	10	CAB24Q0000C1	0.723	-0.02
1880	661	Ground	Fold	10	CAB2170000C1	0.650	-0.04

Note: According to the values in the above table, the battery, CAB24Q0000C1, is the primary battery. We'll perform the Body measurement with this battery and retest on highest value point with others.

## 12.2 SAR results for Fast SAR

**Table 12.4: SAR Values (GSM 850 MHz Band - Head) with battery CAB24Q0000C1**

Frequency		Side	Test Position	Figure No.	Ambient Temperature: 22.5 °C		Liquid Temperature: 22.0 °C			Power Drift (dB)
MHz	Ch.				Conducted Power (dBm)	Measured SAR(10g) (W/kg)	Reported SAR(10g) (W/kg)	Measured SAR(1g) (W/kg)	Reported SAR(1g) (W/kg)	
848.8	251	Left	Touch	Fig.1	32.30	0.686	0.81	1.09	1.28	-0.17
836.6	190	Left	Touch	/	32.31	0.615	0.72	1.01	1.18	0.11
824.2	128	Left	Touch	/	32.39	0.570	0.66	0.943	1.09	0.14
848.8	251	Left	Tilt	/	32.30	0.223	0.26	0.326	0.38	-0.03
836.6	190	Left	Tilt	/	32.31	0.202	0.24	0.295	0.35	-0.01
824.2	128	Left	Tilt	/	32.39	0.171	0.20	0.247	0.28	-0.07
848.8	251	Right	Touch	/	32.30	0.515	0.61	0.807	0.95	-0.10
836.6	190	Right	Touch	/	32.31	0.525	0.62	0.805	0.94	-0.16
824.2	128	Right	Touch	/	32.39	0.498	0.57	0.777	0.89	0.19
848.8	251	Right	Tilt	/	32.30	0.293	0.34	0.434	0.51	-0.01
836.6	190	Right	Tilt	/	32.31	0.268	0.31	0.396	0.46	0.19
824.2	128	Right	Tilt	/	32.39	0.238	0.27	0.352	0.41	-0.11

**Table 12.5: SAR Values (GSM 850 MHz Band - Body) with battery CAB24Q0000C1**

Frequency		Test Position	Type	Headset	Figure No.	Ambient Temperature: 22.5 °C		Liquid Temperature: 22.0 °C			Power Drift (dB)
MHz	Ch.					Conducted Power (dBm)	Measured SAR(10g) (W/kg)	Reported SAR(10g) (W/kg)	Measured SAR(1g) (W/kg)	Reported SAR(1g) (W/kg)	
836.6	190	Phantom	Fold	/	/	32.30	0.154	0.18	0.226	0.27	-0.15
848.8	251	Phantom	Fold	/	/	32.31	0.210	0.25	0.307	0.36	-0.08
836.6	190	Phantom	Fold	/	/	32.39	0.273	0.31	0.399	0.46	-0.04
848.8	251	Ground	Fold	/	/	32.30	0.269	0.32	0.392	0.46	0.00
836.6	190	Ground	Fold	/	/	32.31	0.327	0.38	0.477	0.56	0.03
824.2	128	Ground	Fold	/	Fig.2	32.39	0.414	0.48	0.588	0.68	0.06
848.8	251	Ground	Unfold	/	/	32.30	0.271	0.32	0.398	0.47	0.07
836.6	190	Ground	Unfold	/	/	32.31	0.290	0.34	0.401	0.47	-0.04
824.2	128	Ground	Unfold	/	/	32.39	0.272	0.31	0.397	0.46	-0.02
824.2	128	Ground	Fold	Headset1	/	32.39	0.370	0.43	0.547	0.63	0.07
824.2	128	Ground	Fold	Headset2	/	32.39	0.379	0.44	0.561	0.65	0.03

Note1: The distance between the EUT and the phantom bottom is 10mm.

Note2: The type of Headset1 is CCB3160A11C1, the type of Headset2 is CCB3160A11C2.

**Table 12.6: SAR Values (GSM 1900 MHz Band - Head) with battery CAB24Q0000C1**

Frequency		Side	Test Position	Figure No.	Ambient Temperature: 22.7 °C		Liquid Temperature: 22.2 °C			Power Drift (dB)
MHz	Ch.				Conducted Power (dBm)	Measured SAR(10g) (W/kg)	Reported SAR(10g) (W/kg)	Measured SAR(1g) (W/kg)	Reported SAR(1g) (W/kg)	
1909.8	810	Left	Touch	Fig.3	29.45	0.275	0.33	0.488	0.59	0.18
1880	661	Left	Touch	/	29.56	0.227	0.27	0.395	0.47	-0.14
1850.2	512	Left	Touch	/	29.59	0.202	0.24	0.350	0.41	0.18
1909.8	810	Left	Tilt	/	29.45	0.030	0.04	0.053	0.06	0.12
1880	661	Left	Tilt	/	29.56	0.033	0.04	0.057	0.07	-0.10
1850.2	512	Left	Tilt	/	29.59	0.035	0.04	0.059	0.07	0.09
1909.8	810	Right	Touch	/	29.45	0.111	0.13	0.258	0.31	0.13
1880	661	Right	Touch	/	29.56	0.131	0.16	0.290	0.34	0.12
1850.2	512	Right	Touch	/	29.59	0.131	0.15	0.280	0.33	-0.17
1909.8	810	Right	Tilt	/	29.45	0.034	0.04	0.060	0.07	0.17
1880	661	Right	Tilt	/	29.56	0.033	0.04	0.059	0.07	-0.15
1850.2	512	Right	Tilt	/	29.59	0.031	0.04	0.056	0.07	0.12

**Table 12.7: SAR Values (GSM 1900 MHz Band - Body) with battery CAB24Q0000C1**

Frequency		Test Position	Type	Headset	Figure No.	Ambient Temperature: 22.7 °C		Liquid Temperature: 22.2 °C			Power Drift (dB)
MHz	Ch.					Conducted Power (dBm)	Measured SAR(10g) (W/kg)	Reported SAR(10g) (W/kg)	Measured SAR(1g) (W/kg)	Reported SAR(1g) (W/kg)	
1909.8	810	Phantom	Fold	/	/	29.45	0.194	0.24	0.314	0.38	0.00
1880	661	Phantom	Fold	/	/	29.56	0.233	0.28	0.378	0.45	0.01
1850.2	512	Phantom	Fold	/	/	29.59	0.237	0.28	0.391	0.46	0.04
1909.8	810	Ground	Fold	/	/	29.45	0.385	0.47	0.641	0.78	0.07
1880	661	Ground	Fold	/	Fig.4	29.56	0.428	0.51	0.723	0.86	-0.02
1850.2	512	Ground	Fold	/	/	29.59	0.398	0.47	0.677	0.80	0.00
1909.8	810	Ground	Unfold	/	/	29.45	0.340	0.41	0.567	0.69	-0.09
1880	661	Ground	Unfold	/	/	29.56	0.379	0.45	0.622	0.74	0.04
1850.2	512	Ground	Unfold	/	/	29.59	0.344	0.41	0.584	0.69	-0.05
1880	661	Ground	Fold	Headset1	/	29.56	0.347	0.41	0.613	0.73	0.01
1880	661	Ground	Fold	Headset2	/	29.56	0.389	0.46	0.664	0.79	-0.07

Note1: The distance between the EUT and the phantom bottom is 10mm.

Note2: The type of Headset1 is CCB3160A11C1, the type of Headset2 is CCB3160A11C2.

**Table 12.8: SAR Values (GSM 850 MHz Band - Head)**

Ambient Temperature: 22.5 °C					Liquid Temperature: 22.0 °C					
Frequency		Side	Test Position	Battery type	Conducted Power (dBm)	Measured SAR(10g) (W/kg)	Reported SAR(10g) (W/kg)	Measured SAR(1g) (W/kg)	Reported SAR(1g) (W/kg)	Power Drift (dB)
MHz	Ch.									
848.8	251	Left	Touch	CAB0400000C1	32.30	0.664	<b>0.78</b>	1.05	<b>1.23</b>	-0.18
848.8	251	Left	Touch	CAB2170000C1	32.30	0.666	<b>0.78</b>	1.04	<b>1.22</b>	-0.13

**Table 12.9: SAR Values (GSM 1900 MHz Band - Body)**

Ambient Temperature: 22.7 °C					Liquid Temperature: 22.2 °C					
Frequency		Test Position	Type	Battery type	Conducted Power (dBm)	Measured SAR(10g) (W/kg)	Reported SAR(10g) (W/kg)	Measured SAR(1g) (W/kg)	Reported SAR(1g) (W/kg)	Power Drift (dB)
MHz	Ch.									
1880	661	Ground	Fold	CAB0400000C1	29.56	0.411	<b>0.49</b>	0.700	<b>0.83</b>	-0.01
1880	661	Ground	Fold	CAB2170000C1	29.56	0.386	<b>0.46</b>	0.650	<b>0.77</b>	-0.04

Note: The distance between the EUT and the phantom bottom is 10mm.



### 12.3 SAR results for Standard procedure

There is not zoom scan measurement to be added except the highest measured SAR in each exposure configuration and band, because all SAR values are < 1.2 W/kg.

**Table 12.10: SAR Values (GSM 850 MHz Band - Head) with battery CAB24Q0000C1**

Ambient Temperature: 22.5 °C					Liquid Temperature: 22.0 °C					
Frequency		Side	Test Position	Figure No.	Conducted Power (dBm)	Measured SAR(10g) (W/kg)	Reported SAR(10g) (W/kg)	Measured SAR(1g) (W/kg)	Reported SAR(1g) (W/kg)	Power Drift (dB)
MHz	Ch.									
848.8	251	Left	Touch	Fig.1	32.30	0.686	<b>0.81</b>	1.09	<b>1.28</b>	-0.17

**Table 12.11: SAR Values (GSM 850 MHz Band - Body) with battery CAB24Q0000C1**

Ambient Temperature: 22.5 °C					Liquid Temperature: 22.0 °C						
Frequency		Test Position	Type	Headset	Figure No.	Conducted Power (dBm)	Measured SAR(10g) (W/kg)	Reported SAR(10g) (W/kg)	Measured SAR(1g) (W/kg)	Reported SAR(1g) (W/kg)	Power Drift (dB)
MHz	Ch.										
824.2	128	Ground	Fold	/	Fig.2	32.39	0.414	<b>0.48</b>	0.588	<b>0.68</b>	0.06

Note1: The distance between the EUT and the phantom bottom is 10mm.

**Table 12.12: SAR Values (GSM 1900 MHz Band - Head) with battery CAB24Q0000C1**

Ambient Temperature: 22.7 °C					Liquid Temperature: 22.2 °C					
Frequency		Side	Test Position	Figure No.	Conducted Power (dBm)	Measured SAR(10g) (W/kg)	Reported SAR(10g) (W/kg)	Measured SAR(1g) (W/kg)	Reported SAR(1g) (W/kg)	Power Drift (dB)
MHz	Ch.									
1909.8	810	Left	Touch	Fig.3	29.45	0.275	<b>0.33</b>	0.488	<b>0.59</b>	0.18

**Table 12.13: SAR Values (GSM 1900 MHz Band - Body) with battery CAB24Q0000C1**

Ambient Temperature: 22.7 °C					Liquid Temperature: 22.2 °C						
Frequency		Test Position	Type	Headset	Figure No.	Conducted Power (dBm)	Measured SAR(10g) (W/kg)	Reported SAR(10g) (W/kg)	Measured SAR(1g) (W/kg)	Reported SAR(1g) (W/kg)	Power Drift (dB)
MHz	Ch.										
1880	661	Ground	Fold	/	Fig.4	29.56	0.428	<b>0.51</b>	0.723	<b>0.86</b>	-0.02

Note1: The distance between the EUT and the phantom bottom is 10mm.

### 13 SAR Measurement Variability

SAR measurement variability must be assessed for each frequency band, which is determined by the SAR probe calibration point and tissue-equivalent medium used for the device measurements. When both head and body tissue-equivalent media are required for SAR measurements in a frequency band, the variability measurement procedures should be applied to the tissue medium with the highest measured SAR, using the highest measured SAR configuration for that tissue-equivalent medium.

The following procedures are applied to determine if repeated measurements are required.

- 1) Repeated measurement is not required when the original highest measured SAR is  $< 0.80$  W/kg; steps 2) through 4) do not apply.
- 2) When the original highest measured SAR is  $\geq 0.80$  W/kg, repeat that measurement once.
- 3) Perform a second repeated measurement only if the ratio of largest to smallest SAR for the original and first repeated measurements is  $> 1.20$  or when the original or repeated measurement is  $\geq 1.45$  W/kg (~ 10% from the 1-g SAR limit).
- 4) Perform a third repeated measurement only if the original, first or second repeated measurement is  $\geq 1.5$  W/kg and the ratio of largest to smallest SAR for the original, first and second repeated measurements is  $> 1.20$ .

**Table 13.1: SAR Measurement Variability for Head GSM 850 (1g)**

Frequency		Side	Test Position	Original SAR (W/kg)	First Repeated SAR (W/kg)	The Ratio	Second Repeated SAR (W/kg)
MHz	Ch.						
848.8	251	Left	Touch	1.09	1	1.09	/

## 14 Measurement Uncertainty

### 14.1 Measurement Uncertainty for Normal SAR Tests

No.	Error Description	Type	Uncertainty value	Probably Distribution	Div.	(Ci) 1g	(Ci) 10g	Std. Unc. (1g)	Std. Unc. (10g)	Degree of freedom
<b>Measurement system</b>										
1	Probe calibration	B	5.5	N	1	1	1	5.5	5.5	$\infty$
2	Isotropy	B	4.7	R	$\sqrt{3}$	0.7	0.7	1.9	1.9	$\infty$
3	Boundary effect	B	1.0	R	$\sqrt{3}$	1	1	0.6	0.6	$\infty$
4	Linearity	B	4.7	R	$\sqrt{3}$	1	1	2.7	2.7	$\infty$
5	Detection limit	B	1.0	N	1	1	1	0.6	0.6	$\infty$
6	Readout electronics	B	0.3	R	$\sqrt{3}$	1	1	0.3	0.3	$\infty$
7	Response time	B	0.8	R	$\sqrt{3}$	1	1	0.5	0.5	$\infty$
8	Integration time	B	2.6	R	$\sqrt{3}$	1	1	1.5	1.5	$\infty$
9	RF ambient conditions-noise	B	0	R	$\sqrt{3}$	1	1	0	0	$\infty$
10	RF ambient conditions-reflection	B	0	R	$\sqrt{3}$	1	1	0	0	$\infty$
11	Probe positioned mech. restrictions	B	0.4	R	$\sqrt{3}$	1	1	0.2	0.2	$\infty$
12	Probe positioning with respect to phantom shell	B	2.9	R	$\sqrt{3}$	1	1	1.7	1.7	$\infty$
13	Post-processing	B	1.0	R	$\sqrt{3}$	1	1	0.6	0.6	$\infty$
<b>Test sample related</b>										
14	Test sample positioning	A	3.3	N	1	1	1	3.3	3.3	71
15	Device holder uncertainty	A	3.4	N	1	1	1	3.4	3.4	5
16	Drift of output power	B	5.0	R	$\sqrt{3}$	1	1	2.9	2.9	$\infty$
<b>Phantom and set-up</b>										
17	Phantom uncertainty	B	4.0	R	$\sqrt{3}$	1	1	2.3	2.3	$\infty$
18	Liquid conductivity (target)	B	5.0	R	$\sqrt{3}$	0.64	0.43	1.8	1.2	$\infty$
19	Liquid conductivity (meas.)	A	2.06	N	1	0.64	0.43	1.32	0.89	43
20	Liquid permittivity (target)	B	5.0	R	$\sqrt{3}$	0.6	0.49	1.7	1.4	$\infty$
21	Liquid permittivity (meas.)	A	1.6	N	1	0.6	0.49	1.0	0.8	521

Combined standard uncertainty	$u_c = \sqrt{\sum_{i=1}^{21} c_i^2 u_i^2}$					9.25	9.12	257
Expanded uncertainty (confidence interval of 95 %)	$u_e = 2u_c$					18.5	18.2	

### 14.2 Measurement Uncertainty for Fast SAR Tests

No.	Error Description	Type	Uncertainty value	Probably Distribution	Div.	(Ci) 1g	(Ci) 10g	Std. Unc. (1g)	Std. Unc. (10g)	Degree of freedom
<b>Measurement system</b>										
1	Probe calibration	B	5.5	N	1	1	1	5.5	5.5	$\infty$
2	Isotropy	B	4.7	R	$\sqrt{3}$	0.7	0.7	1.9	1.9	$\infty$
3	Boundary effect	B	1.0	R	$\sqrt{3}$	1	1	0.6	0.6	$\infty$
4	Linearity	B	4.7	R	$\sqrt{3}$	1	1	2.7	2.7	$\infty$
5	Detection limit	B	1.0	N	1	1	1	0.6	0.6	$\infty$
6	Readout electronics	B	0.3	R	$\sqrt{3}$	1	1	0.3	0.3	$\infty$
7	Response time	B	0.8	R	$\sqrt{3}$	1	1	0.5	0.5	$\infty$
8	Integration time	B	2.6	R	$\sqrt{3}$	1	1	1.5	1.5	$\infty$
9	RF ambient conditions-noise	B	0	R	$\sqrt{3}$	1	1	0	0	$\infty$
10	RF ambient conditions-reflection	B	0	R	$\sqrt{3}$	1	1	0	0	$\infty$
11	Probe positioned mech. Restrictions	B	0.4	R	$\sqrt{3}$	1	1	0.2	0.2	$\infty$
12	Probe positioning with respect to phantom shell	B	2.9	R	$\sqrt{3}$	1	1	1.7	1.7	$\infty$
13	Post-processing	B	1.0	R	$\sqrt{3}$	1	1	0.6	0.6	$\infty$
14	Fast SAR z-Approximation	B	7.0	R	$\sqrt{3}$	1	1	4.0	4.0	$\infty$
<b>Test sample related</b>										
15	Test sample positioning	A	3.3	N	1	1	1	3.3	3.3	71
16	Device holder uncertainty	A	3.4	N	1	1	1	3.4	3.4	5
17	Drift of output power	B	5.0	R	$\sqrt{3}$	1	1	2.9	2.9	$\infty$
<b>Phantom and set-up</b>										
18	Phantom uncertainty	B	4.0	R	$\sqrt{3}$	1	1	2.3	2.3	$\infty$
19	Liquid conductivity (target)	B	5.0	R	$\sqrt{3}$	0.64	0.43	1.8	1.2	$\infty$

20	Liquid conductivity (meas.)	A	2.06	N	1	0.64	0.43	1.32	0.89	43
21	Liquid permittivity (target)	B	5.0	R	$\sqrt{3}$	0.6	0.49	1.7	1.4	$\infty$
22	Liquid permittivity (meas.)	A	1.6	N	1	0.6	0.49	1.0	0.8	521
Combined standard uncertainty		$u_c = \sqrt{\sum_{i=1}^{22} c_i^2 u_i^2}$						10.1	9.95	257
Expanded uncertainty (confidence interval of 95 %)		$u_e = 2u_c$						20.2	19.9	

## 15 MAIN TEST INSTRUMENTS

Table 15.1: List of Main Instruments

No.	Name	Type	Serial Number	Calibration Date	Valid Period
01	Network analyzer	E5071C	MY46110673	February 15, 2013	One year
02	Power meter	NRVD	102083	September 11, 2012	One year
03	Power sensor	NRV-Z5	100542		
04	Signal Generator	E4438C	MY49070393	November 13, 2012	One Year
05	Amplifier	VTL5400	0505	No Calibration Requested	
06	BTS	E5515C	MY48363198	July 11, 2012	One year
07	E-field Probe	SPEAG ES3DV3	3149	April 24, 2012	One year
08	DAE	SPEAG DAE4	771	November 20, 2012	One year
09	Dipole Validation Kit	SPEAG D835V2	443	May 03, 2012	One year
10	Dipole Validation Kit	SPEAG D1900V2	541	May 09, 2012	One year

\*\*\*END OF REPORT BODY\*\*\*

## ANNEX A GRAPH RESULTS

### 850 Left Cheek High

Date: 2013-3-20

Electronics: DAE4 Sn771

Medium: Head 835 MHz

Medium parameters used (interpolated):  $f = 848.8$  MHz;  $\sigma = 0.913$  mho/m;  $\epsilon_r = 40.078$ ;  $\rho = 1000$  kg/m<sup>3</sup>

Ambient Temperature: 22.5°C      Liquid Temperature: 22.0°C

Communication System: GSM; Frequency: 848.8 MHz; Duty Cycle: 1:8.3

Probe: ES3DV3 - SN3149 ConvF(6.26, 6.26, 6.26)

**Cheek High/Area Scan (51x141x1):** Measurement grid: dx=10mm, dy=10mm

Maximum value of SAR (interpolated) = 1.14 W/kg

**Cheek High/Zoom Scan (7x7x7)/Cube 0:** Measurement grid: dx=5mm, dy=5mm, dz=5mm

Reference Value = 3.088 V/m; Power Drift = -0.17 dB

Peak SAR (extrapolated) = 1.79 W/kg

**SAR(1 g) = 1.09 W/kg; SAR(10 g) = 0.686 W/kg**

Maximum value of SAR (measured) = 1.15 W/kg

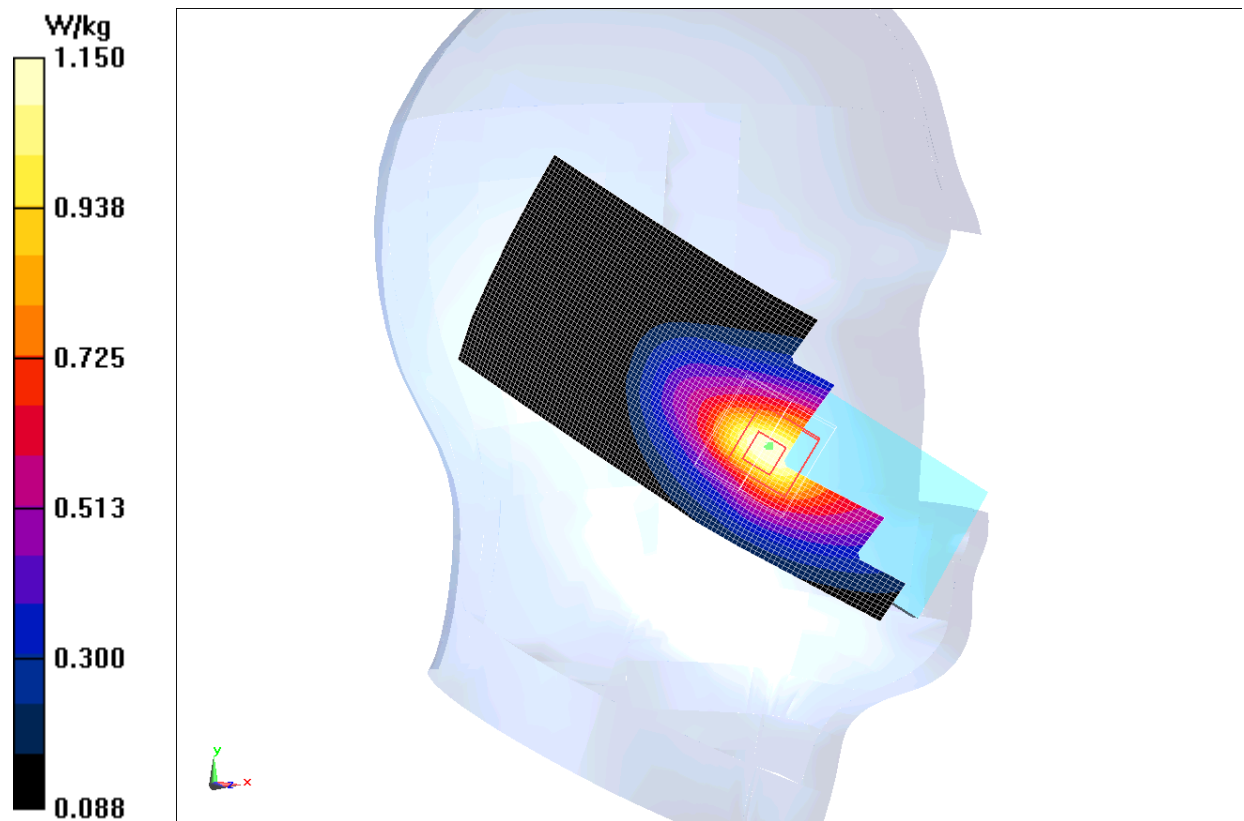
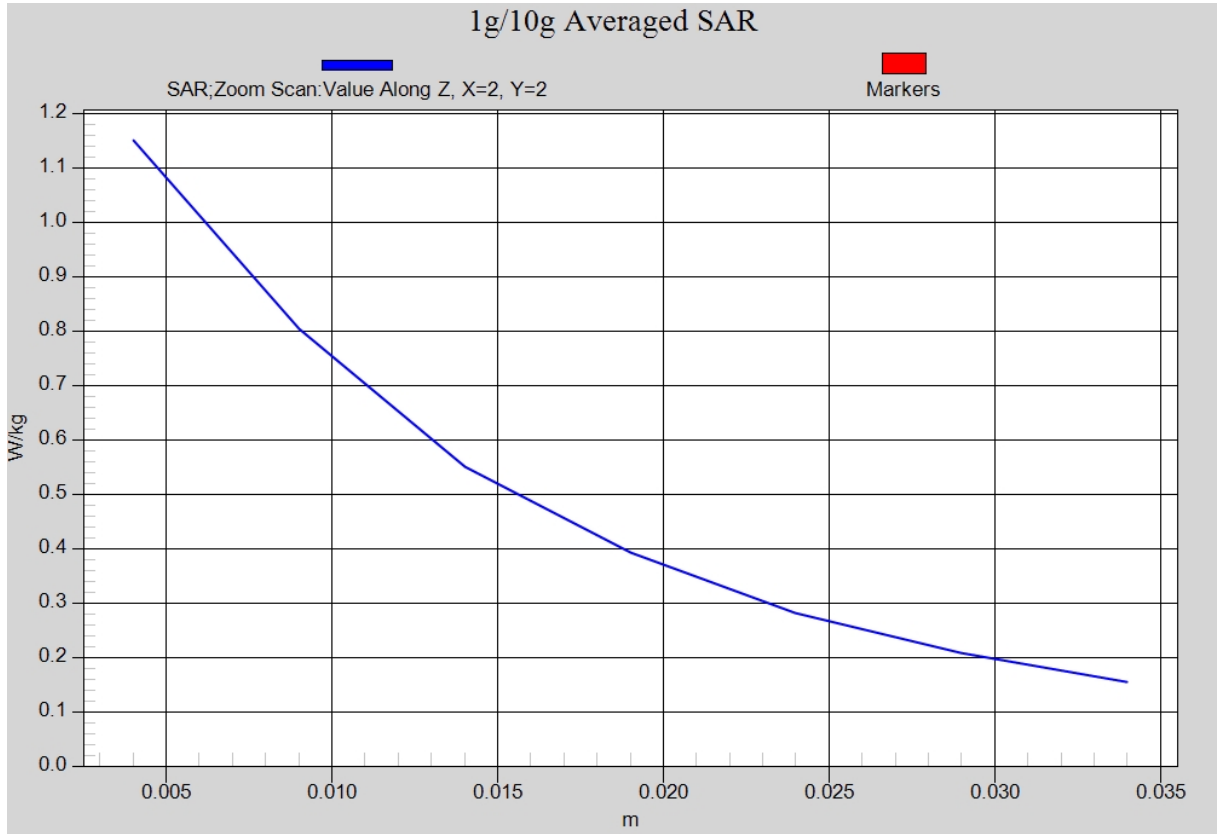

Fig. A.1 850 MHz CH251



**Fig. A.1-1 Z-Scan at power reference point (850 MHz CH251)**

### 850 Body Toward Ground Low - Fold

Date: 2013-3-20

Electronics: DAE4 Sn771

Medium: Body 835 MHz

Medium parameters used:  $f = 825$  MHz;  $\sigma = 0.976$  mho/m;  $\epsilon_r = 56.903$ ;  $\rho = 1000$  kg/m<sup>3</sup>

Ambient Temperature: 22.5°C      Liquid Temperature: 22.0°C

Communication System: GSM 850 Frequency: 824.2 MHz Duty Cycle: 1:8.3

Probe: ES3DV3 - SN3149 ConvF(6.14, 6.14, 6.14)

**Toward Ground Low/Area Scan (51x91x1):** Measurement grid: dx=10mm, dy=10mm

Maximum value of SAR (interpolated) = 0.637 W/kg

**Toward Ground Low/Zoom Scan (7x7x7)/Cube 0:** Measurement grid: dx=5mm, dy=5mm, dz=5mm

Reference Value = 19.190 V/m; Power Drift = 0.06 dB

Peak SAR (extrapolated) = 0.774 W/kg

**SAR(1 g) = 0.588 W/kg; SAR(10 g) = 0.414 W/kg**

Maximum value of SAR (measured) = 0.628 W/kg

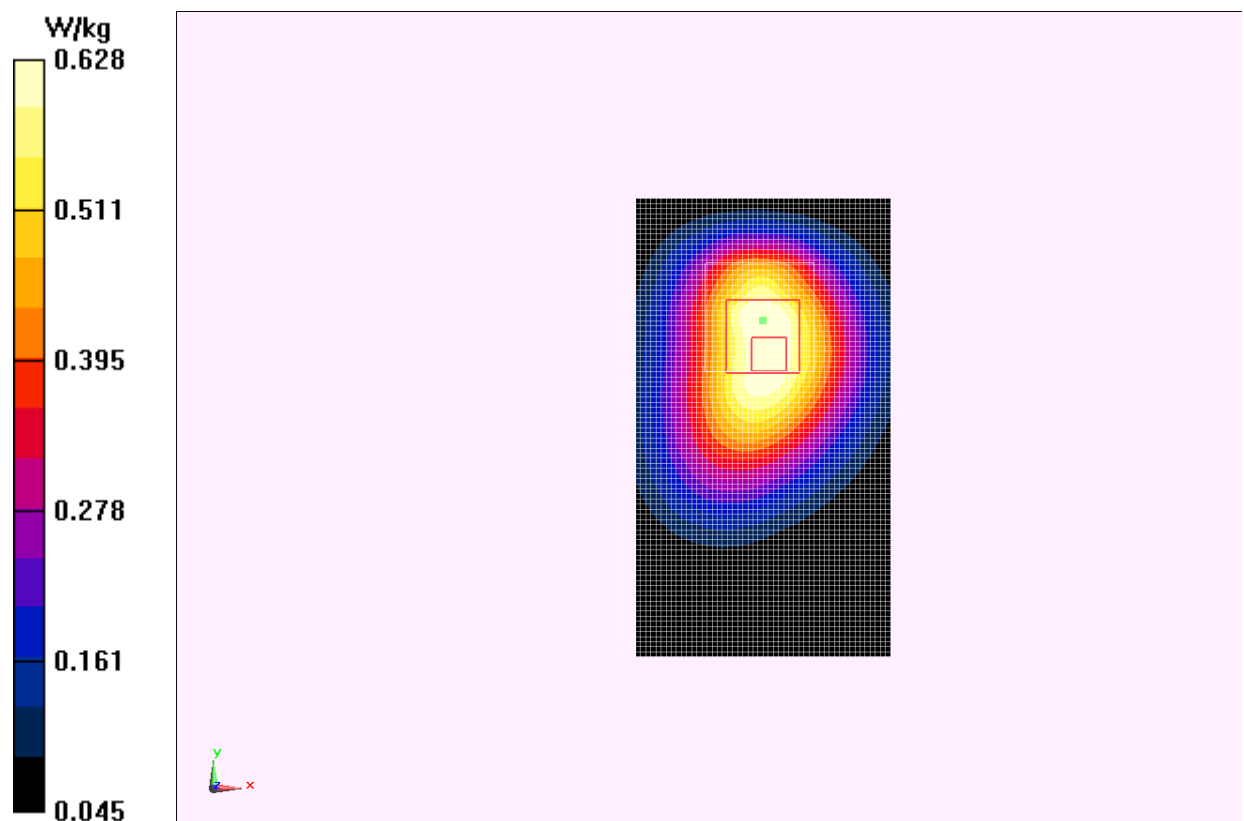
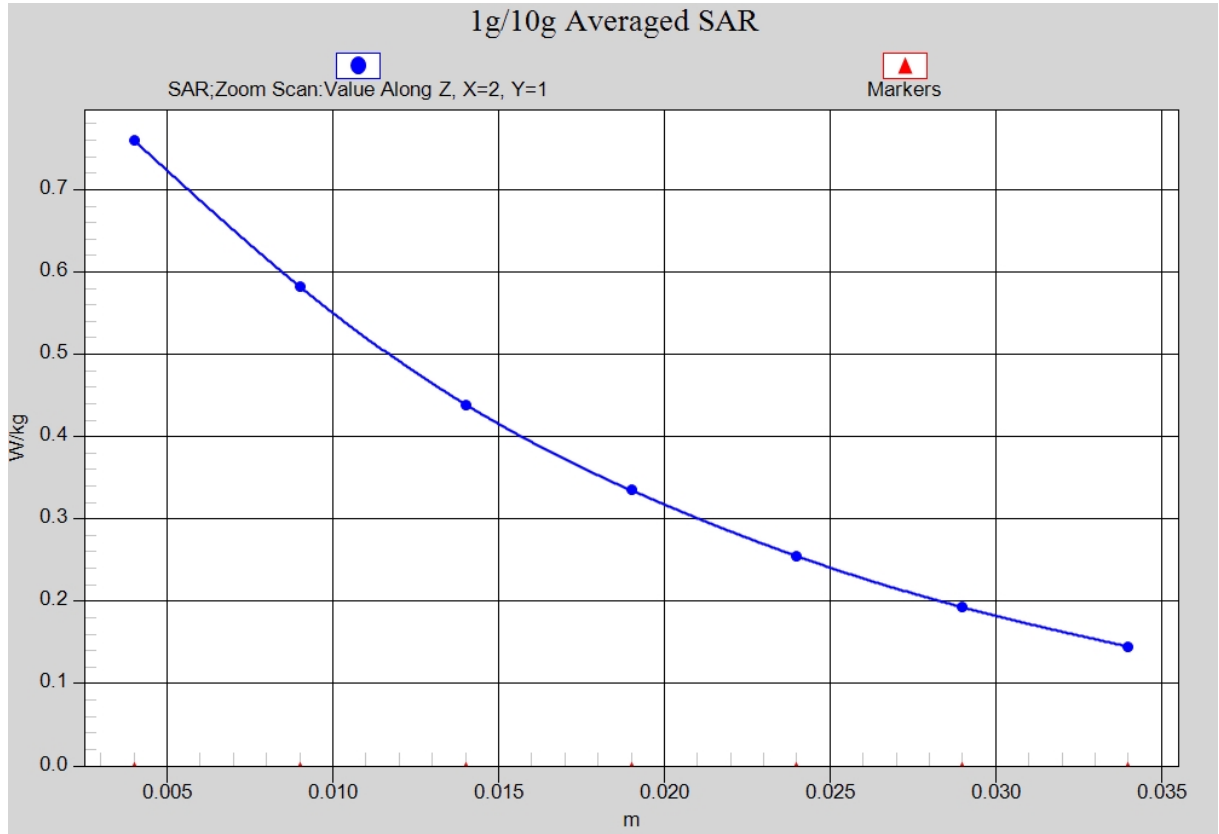

Fig. A.2 850 MHz CH128





**Fig. A.2-1 Z-Scan at power reference point (850 MHz CH128)**

### 1900 Left Cheek High

Date: 2013-3-22

Electronics: DAE4 Sn771

Medium: Head GSM1900

Medium parameters used:  $f = 1910$  MHz;  $\sigma = 1.423$  mho/m;  $\epsilon_r = 39.346$ ;  $\rho = 1000$  kg/m<sup>3</sup>

Ambient Temperature: 22.7°C      Liquid Temperature: 22.2°C

Communication System: GSM 1900MHz Frequency: 1909.8 MHz Duty Cycle: 1:8.3

Probe: ES3DV3 - SN3149 ConvF(5.19, 5.19, 5.19)

**Cheek High/Area Scan (51x131x1):** Measurement grid: dx=10mm, dy=10mm

Maximum value of SAR (interpolated) = 0.509 mW/g

**Cheek High/Zoom Scan (7x7x7)/Cube 0:** Measurement grid: dx=5mm, dy=5mm, dz=5mm

Reference Value = 1.526 V/m; Power Drift = 0.18 dB

Peak SAR (extrapolated) = 0.818 mW/g

**SAR(1 g) = 0.488 mW/g; SAR(10 g) = 0.275 mW/g**

Maximum value of SAR (measured) = 0.531 mW/g

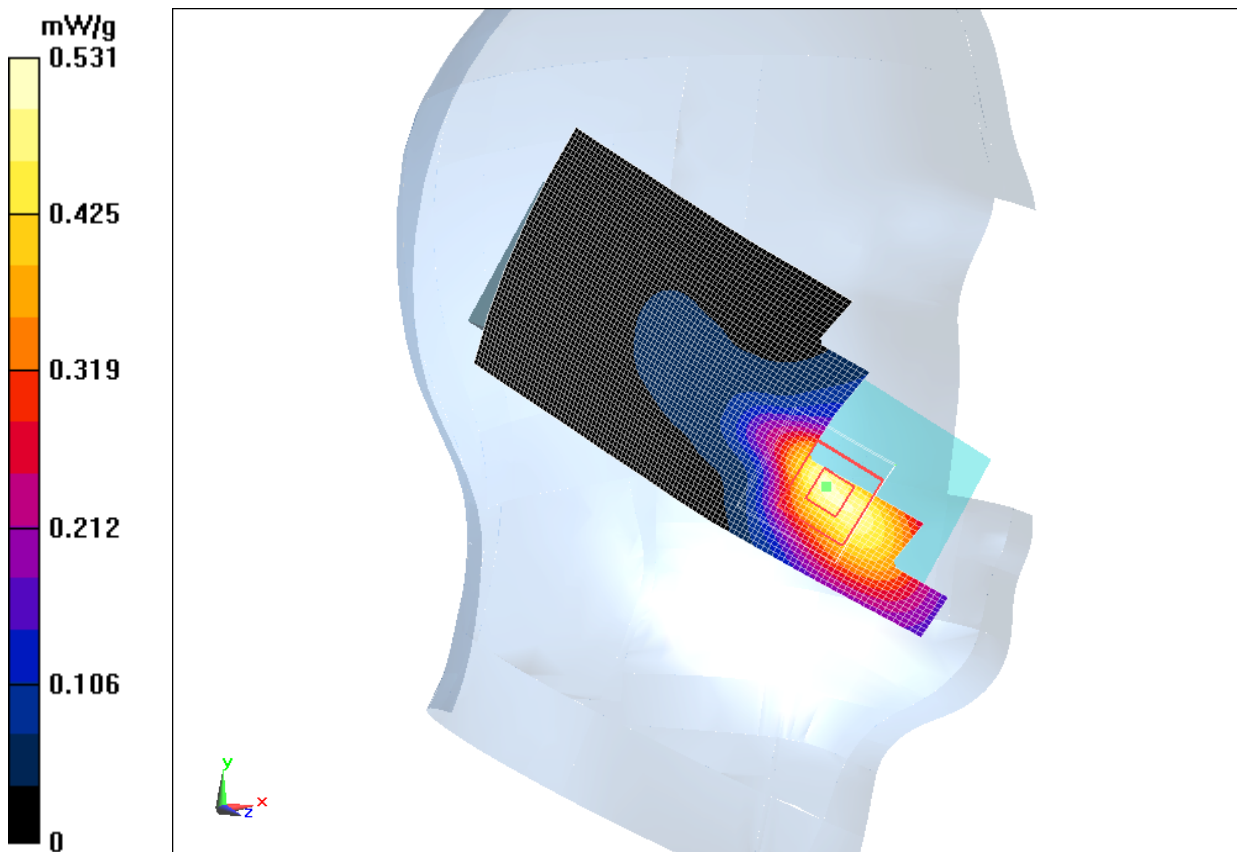
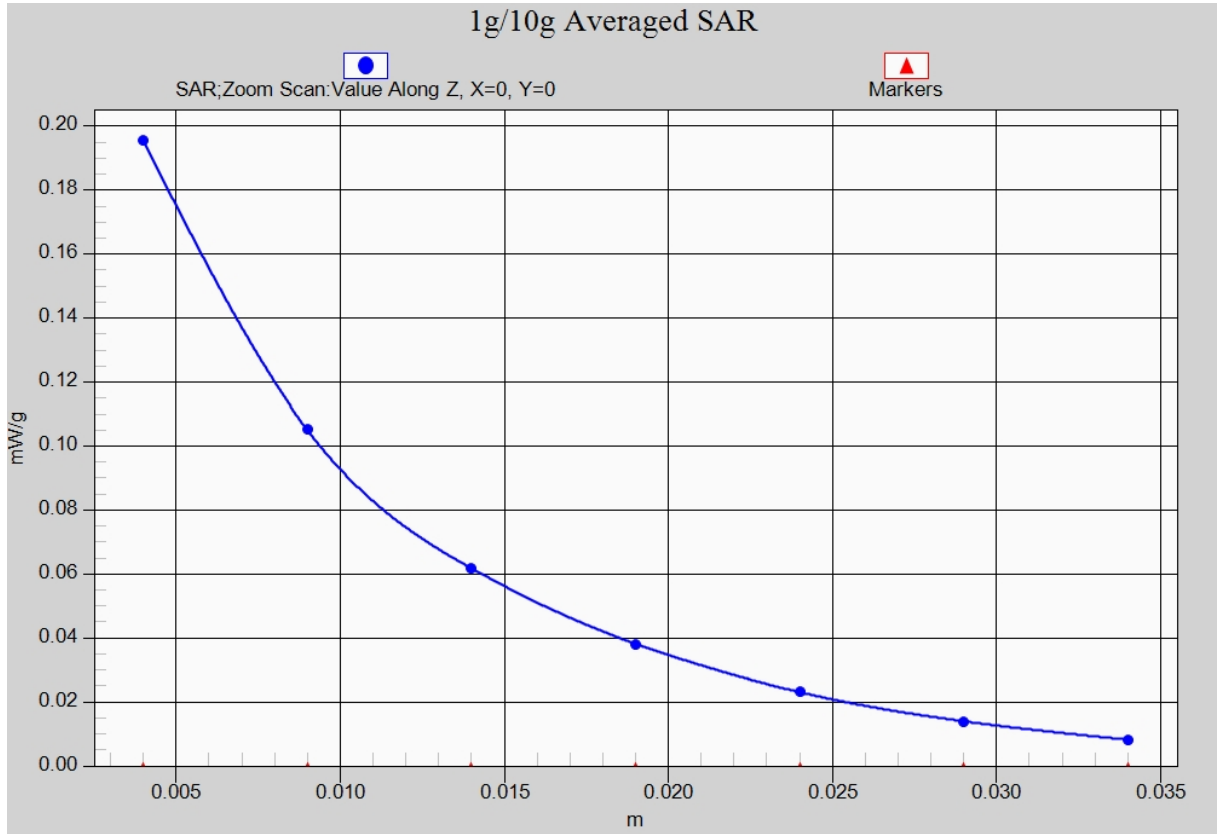

Fig. A.3 1900 MHz CH810



**Fig. A.3-1 Z-Scan at power reference point (1900 MHz CH810)**

### 1900 Body Toward Ground Middle - Fold

Date: 2013-3-22

Electronics: DAE4 Sn771

Medium: Body 1900 MHz

Medium parameters used:  $f = 1880$  MHz;  $\sigma = 1.509$  mho/m;  $\epsilon_r = 52.297$ ;  $\rho = 1000$  kg/m<sup>3</sup>

Ambient Temperature: 22.7°C      Liquid Temperature: 22.2°C

Communication System: GSM 1900MHz Frequency: 1880 MHz Duty Cycle: 1:8.3

Probe: ES3DV3 - SN3149 ConvF(4.64, 4.64, 4.64)

**Toward Ground Middle/Area Scan (61x91x1):** Measurement grid: dx=10mm, dy=10mm

Maximum value of SAR (interpolated) = 0.735 mW/g

**Toward Ground Middle/Zoom Scan (7x7x7)/Cube 0:** Measurement grid: dx=5mm, dy=5mm, dz=5mm

Reference Value = 17.042 V/m; Power Drift = -0.02 dB

Peak SAR (extrapolated) = 1.153 mW/g

**SAR(1 g) = 0.723 mW/g; SAR(10 g) = 0.428 mW/g**

Maximum value of SAR (measured) = 0.796 mW/g

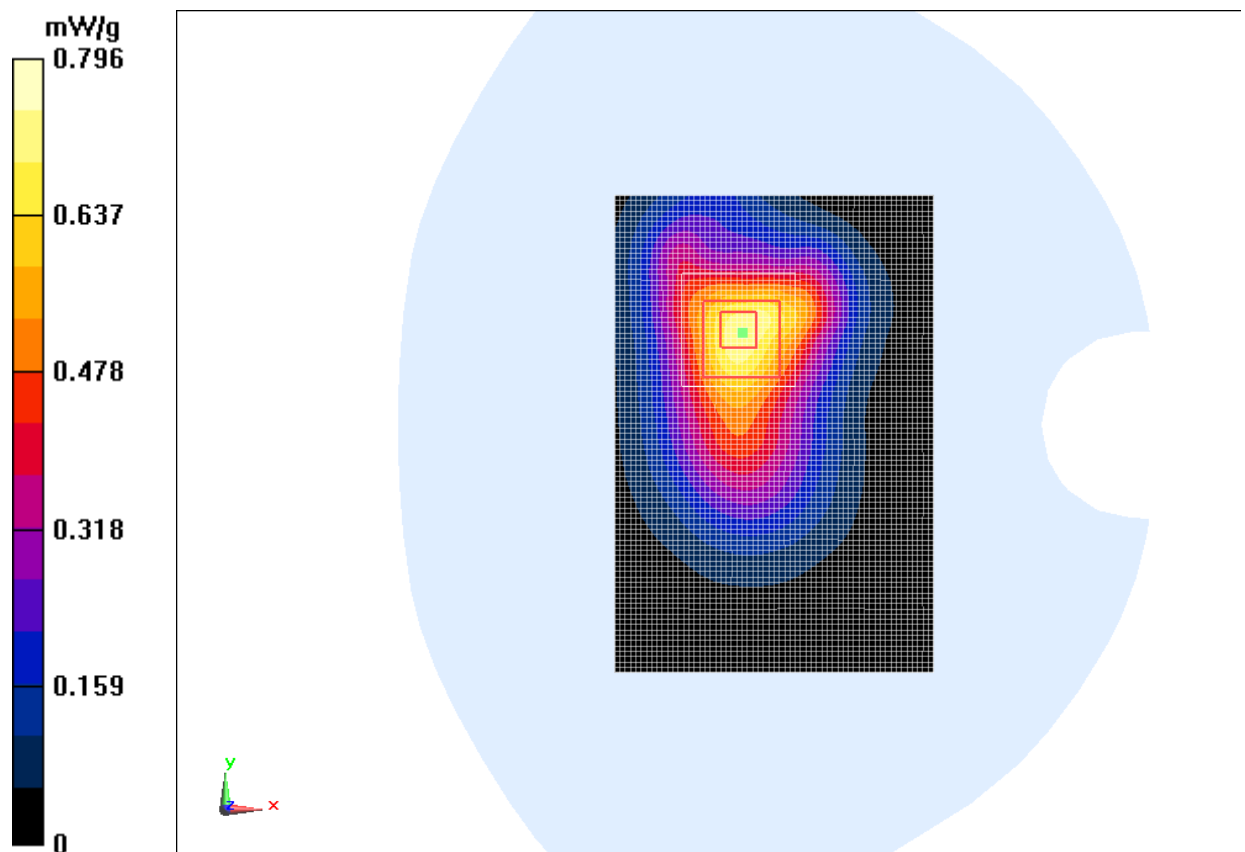

Fig. A.4 1900 MHz CH661

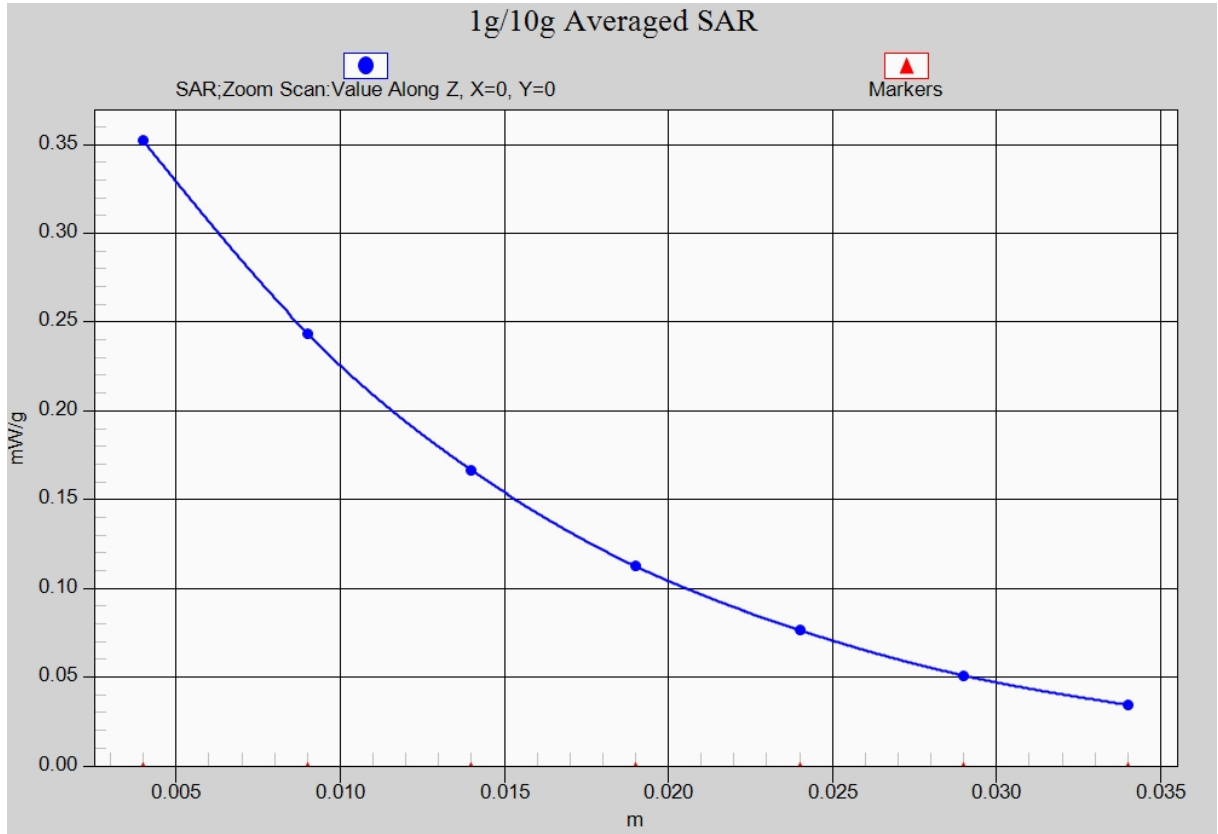

Fig. A.4-1 Z-Scan at power reference point (1900 MHz CH661)

## ANNEX B System Verification Results

### 835MHz

Date: 2013-3-20

Electronics: DAE4 Sn771

Medium: Head 850 MHz

Medium parameters used:  $f = 835$  MHz;  $\sigma = 0.89$  mho/m;  $\epsilon_r = 40.26$ ;  $\rho = 1000$  kg/m<sup>3</sup>

Ambient Temperature: 22.5°C      Liquid Temperature: 22.0°C

Communication System: CW Frequency: 835 MHz Duty Cycle: 1:1

Probe: ES3DV3 - SN3149 ConvF(6.26, 6.26, 6.26)

**System Validation /Area Scan (81x161x1):** Measurement grid: dx=10mm, dy=10mm

Reference Value = 51.272 V/m; Power Drift = -0.09 dB

**Fast SAR: SAR(1 g) = 2.29 mW/g; SAR(10 g) = 1.47 mW/g**

Maximum value of SAR (interpolated) = 2.51 mW/g

**System Validation /Zoom Scan (7x7x7)/Cube 0:** Measurement grid: dx=5mm, dy=5mm, dz=5mm

Reference Value = 51.272 V/m; Power Drift = -0.09 dB

Peak SAR (extrapolated) = 3.471 W/kg

**SAR(1 g) = 2.33 mW/g; SAR(10 g) = 1.50 mW/g**

Maximum value of SAR (measured) = 2.52 mW/g

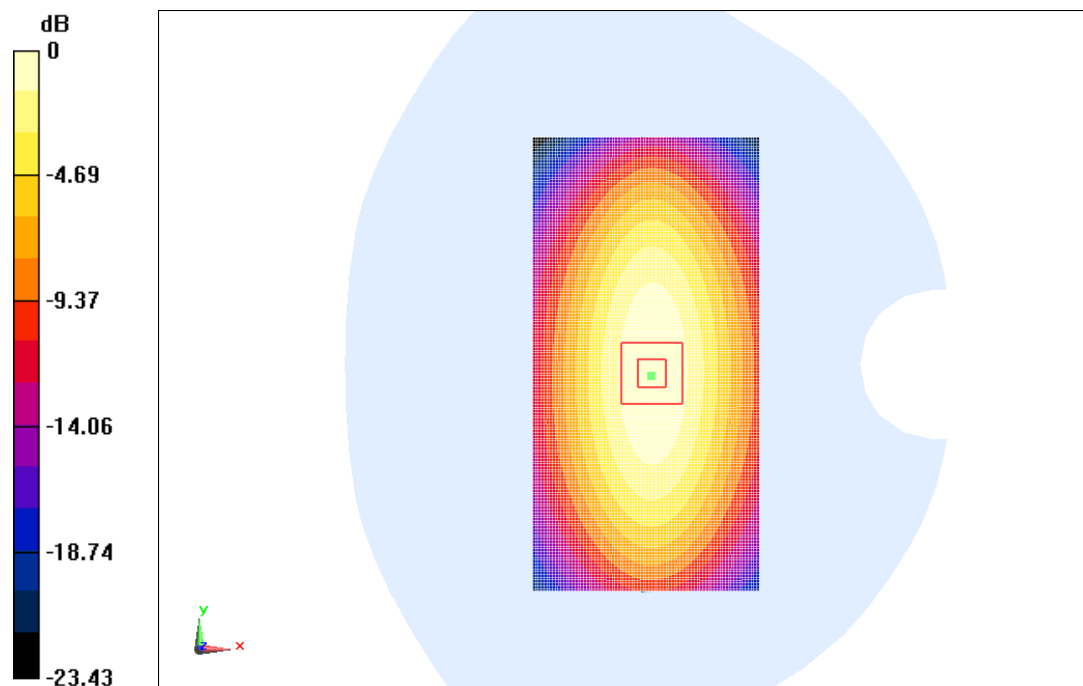

0 dB = 2.51 mW/g = 7.99 dB mW/g

**Fig.B.1 validation 835MHz 250mW**

## 835MHz

Date: 2013-3-20

Electronics: DAE4 Sn771

Medium: Body 850 MHz

Medium parameters used:  $f = 835 \text{ MHz}$ ;  $\sigma = 0.981 \text{ mho/m}$ ;  $\epsilon_r = 56.75$ ;  $\rho = 1000 \text{ kg/m}^3$

Ambient Temperature:  $22.5^\circ\text{C}$       Liquid Temperature:  $22.0^\circ\text{C}$

Communication System: CW Frequency: 835 MHz Duty Cycle: 1:1

Probe: ES3DV3 - SN3149 ConvF(6.14, 6.14, 6.14)

**System Validation /Area Scan (81x171x1):** Measurement grid:  $dx=10\text{mm}$ ,  $dy=10\text{mm}$

Reference Value =  $46.023 \text{ V/m}$ ; Power Drift =  $-0.084 \text{ dB}$

**Fast SAR: SAR(1 g) =  $2.38 \text{ mW/g}$ ; SAR(10 g) =  $1.56 \text{ mW/g}$**

Maximum value of SAR (interpolated) =  $2.59 \text{ mW/g}$

**System Validation /Zoom Scan (7x7x7)/Cube 0:** Measurement grid:  $dx=5\text{mm}$ ,  $dy=5\text{mm}$ ,  $dz=5\text{mm}$

Reference Value =  $46.023 \text{ V/m}$ ; Power Drift =  $-0.084 \text{ dB}$

Peak SAR (extrapolated) =  $3.586 \text{ W/kg}$

**SAR(1 g) =  $2.39 \text{ mW/g}$ ; SAR(10 g) =  $1.58 \text{ mW/g}$**

Maximum value of SAR (measured) =  $2.59 \text{ mW/g}$

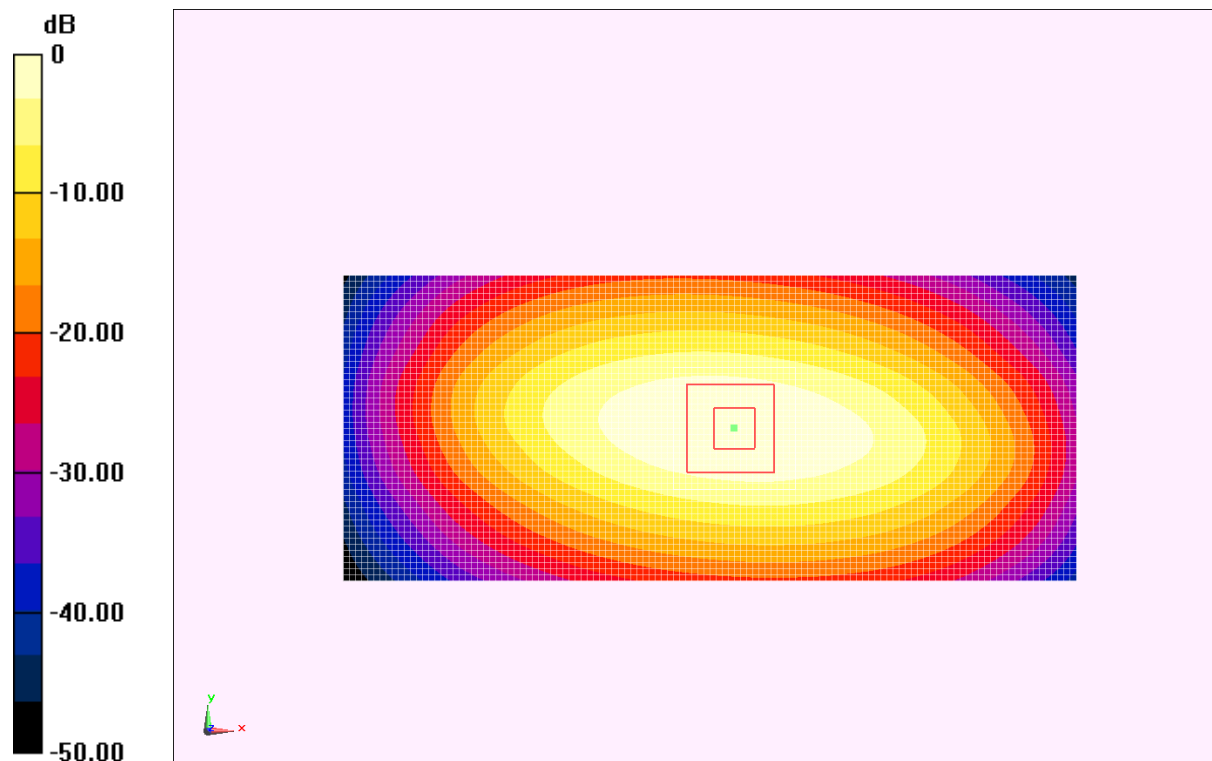

$$0 \text{ dB} = 2.59 \text{ mW/g} = 8.27 \text{ dB mW/g}$$

**Fig.B.2 validation 835MHz 250mW**

## 1900MHz

Date: 2013-3-22

Electronics: DAE4 Sn771

Medium: Head 1900 MHz

Medium parameters used:  $f = 1900 \text{ MHz}$ ;  $\sigma = 1.431 \text{ mho/m}$ ;  $\epsilon_r = 39.32$ ;  $\rho = 1000 \text{ kg/m}^3$

Ambient Temperature:  $22.7^\circ\text{C}$       Liquid Temperature:  $22.2^\circ\text{C}$

Communication System: CW Frequency: 1900 MHz Duty Cycle: 1:1

Probe: ES3DV3 - SN3149 ConvF(5.19, 5.19, 5.19)

**System Validation/Area Scan (81x121x1):** Measurement grid:  $dx=10\text{mm}$ ,  $dy=10\text{mm}$

Reference Value =  $93.579 \text{ V/m}$ ; Power Drift =  $-0.06 \text{ dB}$

**Fast SAR: SAR(1 g) =  $9.73 \text{ mW/g}$ ; SAR(10 g) =  $5.13 \text{ mW/g}$**

Maximum value of SAR (interpolated) =  $11.0 \text{ mW/g}$

**System Validation/Zoom Scan (7x7x7)/Cube 0:** Measurement grid:  $dx=5\text{mm}$ ,  $dy=5\text{mm}$ ,  $dz=5\text{mm}$

Reference Value =  $93.579 \text{ V/m}$ ; Power Drift =  $-0.06 \text{ dB}$

Peak SAR (extrapolated) =  $17.93 \text{ W/kg}$

**SAR(1 g) =  $9.61 \text{ mW/g}$ ; SAR(10 g) =  $5.05 \text{ mW/g}$**

Maximum value of SAR (measured) =  $10.9 \text{ mW/g}$

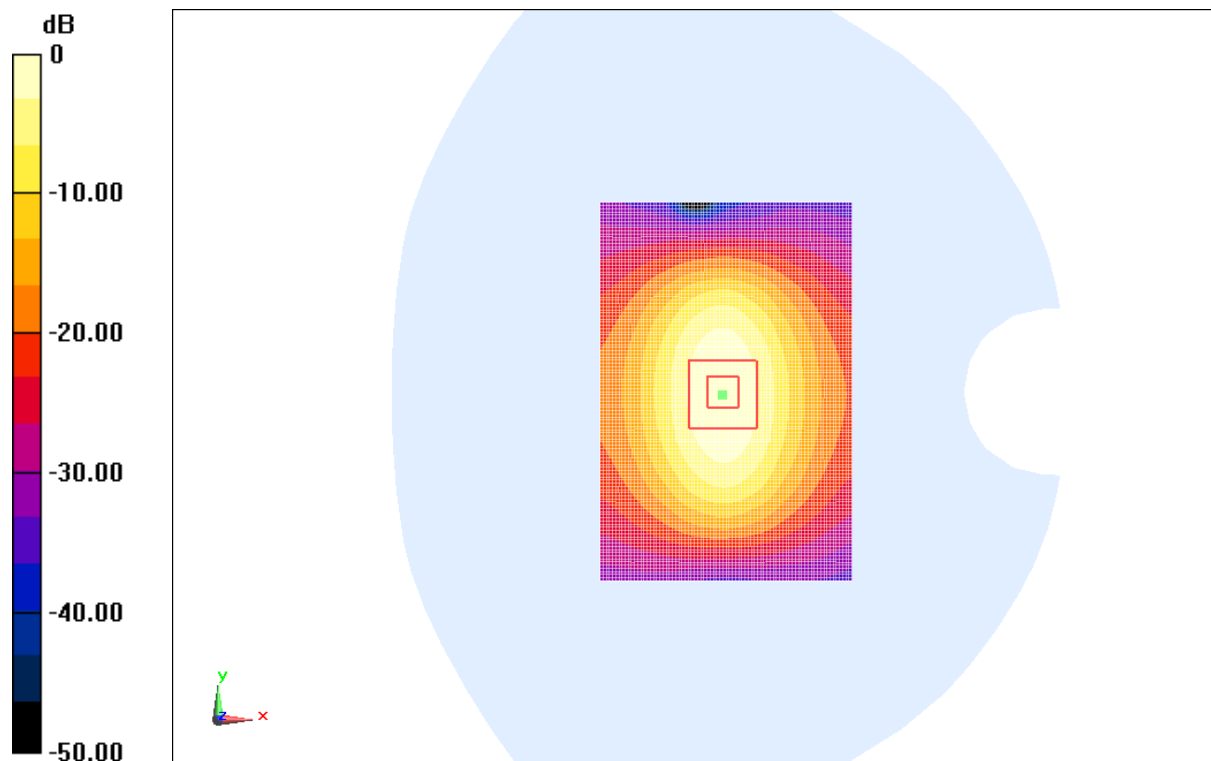

0 dB =  $11.0 \text{ mW/g}$  =  $20.83 \text{ dB mW/g}$

**Fig.B.3 validation 1900MHz 250mW**



## 1900MHz

Date: 2013-3-22

Electronics: DAE4 Sn771

Medium: Body 1900 MHz

Medium parameters used:  $f = 1900 \text{ MHz}$ ;  $\sigma = 1.537 \text{ mho/m}$ ;  $\epsilon_r = 52.28$ ;  $\rho = 1000 \text{ kg/m}^3$

Ambient Temperature:  $22.7^\circ\text{C}$       Liquid Temperature:  $22.2^\circ\text{C}$

Communication System: CW Frequency: 1900 MHz Duty Cycle: 1:1

Probe: ES3DV3 - SN3149 ConvF(4.64, 4.64, 4.64)

**System Validation/Area Scan (81x121x1):** Measurement grid:  $dx=10\text{mm}$ ,  $dy=10\text{mm}$

Reference Value =  $85.846 \text{ V/m}$ ; Power Drift =  $-0.05 \text{ dB}$

**Fast SAR: SAR(1 g) =  $10.0 \text{ mW/g}$ ; SAR(10 g) =  $5.28 \text{ mW/g}$**

Maximum value of SAR (interpolated) =  $11.5 \text{ mW/g}$

**System Validation/Zoom Scan (7x7x7)/Cube 0:** Measurement grid:  $dx=5\text{mm}$ ,  $dy=5\text{mm}$ ,  $dz=5\text{mm}$

Reference Value =  $85.846 \text{ V/m}$ ; Power Drift =  $-0.05 \text{ dB}$

Peak SAR (extrapolated) =  $17.586 \text{ W/kg}$

**SAR(1 g) =  $10.1 \text{ mW/g}$ ; SAR(10 g) =  $5.37 \text{ mW/g}$**

Maximum value of SAR (measured) =  $11.6 \text{ mW/g}$

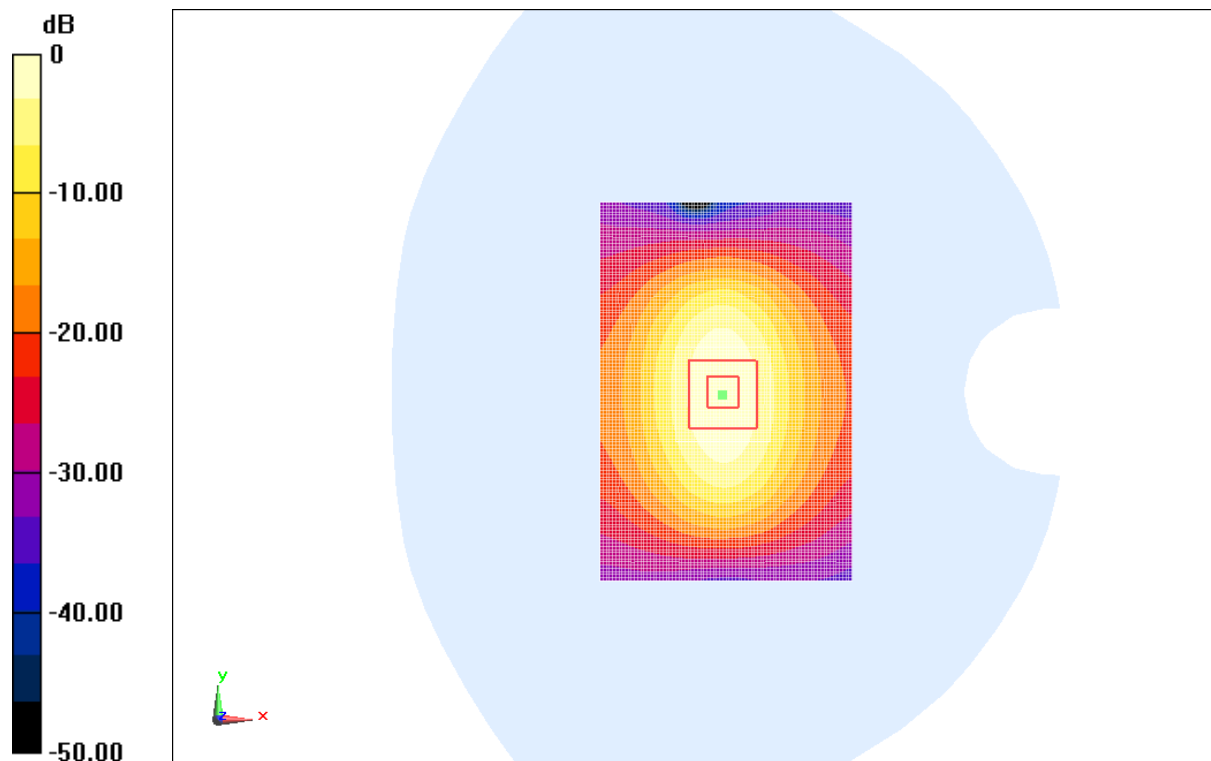

0 dB =  $11.5 \text{ mW/g} = 21.21 \text{ dB mW/g}$

**Fig.B.4 validation 1900MHz 250mW**

The SAR system verification must be required that the area scan estimated 1-g SAR is within 3% of the zoom scan 1-g SAR.

**Table B.1 Comparison between area scan and zoom scan for system verification**

<b>Band</b>	<b>Position</b>	<b>Area scan (1g)</b>	<b>Zoom scan (1g)</b>	<b>Drift (%)</b>
835	Head	2.29	2.33	-1.72
835	Body	2.38	2.39	-0.42
1900	Head	9.73	9.61	1.25
1900	Body	10.0	10.1	-0.99

## ANNEX C SAR Measurement Setup

### C.1 Measurement Set-up

The Dasy4 or DASY5 system for performing compliance tests is illustrated above graphically. This system consists of the following items:

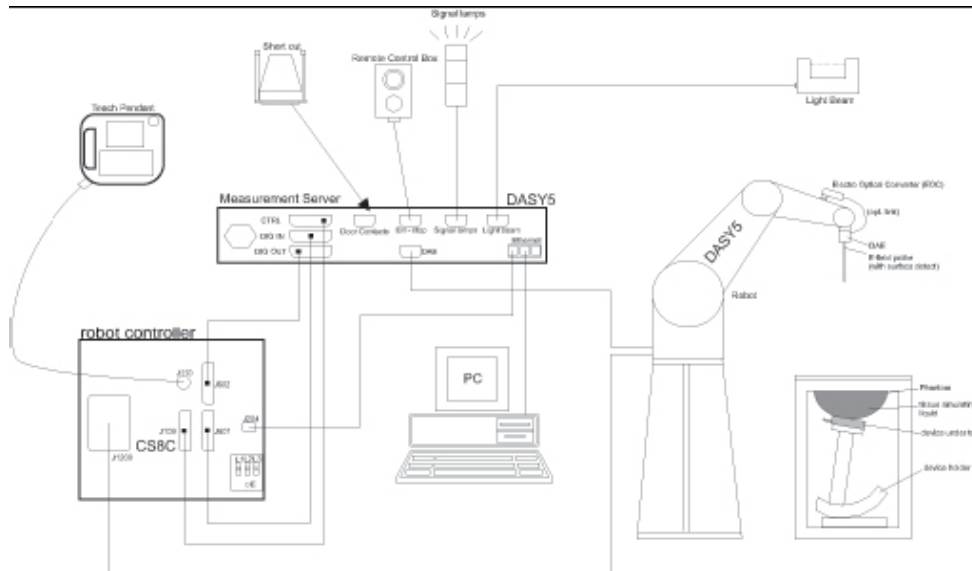

**Picture C.1 SAR Lab Test Measurement Set-up**

- A standard high precision 6-axis robot (Stäubli TX=RX family) with controller, teach pendant and software. An arm extension for accommodating the data acquisition electronics (DAE).
- An isotropic field probe optimized and calibrated for the targeted measurement.
- A data acquisition electronics (DAE) which performs the signal amplification, signal multiplexing, AD-conversion, offset measurements, mechanical surface detection, collision detection, etc. The unit is battery powered with standard or rechargeable batteries. The signal is optically transmitted to the EOC.
- The Electro-optical converter (EOC) performs the conversion from optical to electrical signals for the digital communication to the DAE. To use optical surface detection, a special version of the EOC is required. The EOC signal is transmitted to the measurement server.
- The function of the measurement server is to perform the time critical tasks such as signal filtering, control of the robot operation and fast movement interrupts.
- The Light Beam used is for probe alignment. This improves the (absolute) accuracy of the probe positioning.
- A computer running WinXP and the DASY4 or DASY5 software.
- Remote control and teach pendant as well as additional circuitry for robot safety such as
- warning lamps, etc.
- The phantom, the device holder and other accessories according to the targeted measurement.

## C.2 Dasy4 or DASY5 E-field Probe System

The SAR measurements were conducted with the dosimetric probe designed in the classical triangular configuration and optimized for dosimetric evaluation. The probe is constructed using the thick film technique; with printed resistive lines on ceramic substrates. The probe is equipped with an optical multifiber line ending at the front of the probe tip. It is connected to the EOC box on the robot arm and provides an automatic detection of the phantom surface. Half of the fibers are connected to a pulsed infrared transmitter, the other half to a synchronized receiver. As the probe approaches the surface, the reflection from the surface produces a coupling from the transmitting to the receiving fibers. This reflection increases first during the approach, reaches maximum and then decreases. If the probe is flatly touching the surface, the coupling is zero. The distance of the coupling maximum to the surface is independent of the surface reflectivity and largely independent of the surface to probe angle. The DASY4 or DASY5 software reads the reflection during a software approach and looks for the maximum using 2<sup>nd</sup> order curve fitting. The approach is stopped at reaching the maximum.

### Probe Specifications:

<b>Model:</b>	<b>ES3DV3, EX3DV4</b>
<b>Frequency</b>	<b>10MHz — 6.0GHz(EX3DV4)</b>
<b>Range:</b>	<b>10MHz — 4GHz(ES3DV3)</b>
<b>Calibration:</b>	<b>In head and body simulating tissue at Frequencies from 835 up to 5800MHz</b>
<b>Linearity:</b>	<b>± 0.2 dB(30 MHz to 6 GHz) for EX3DV4 ± 0.2 dB(30 MHz to 4 GHz) for ES3DV3</b>
<b>Dynamic Range:</b>	<b>10 mW/kg — 100W/kg</b>
<b>Probe Length:</b>	<b>330 mm</b>
<b>Probe Tip</b>	
<b>Length:</b>	<b>20 mm</b>
<b>Body Diameter:</b>	<b>12 mm</b>
<b>Tip Diameter:</b>	<b>2.5 mm (3.9 mm for ES3DV3)</b>
<b>Tip-Center:</b>	<b>1 mm (2.0mm for ES3DV3)</b>
<b>Application:</b>	<b>SAR Dosimetry Testing Compliance tests of mobile phones Dosimetry in strong gradient fields</b>



Picture C.2 Near-field Probe



Picture C.3 E-field Probe

## C.3 E-field Probe Calibration

Each E-Probe/Probe Amplifier combination has unique calibration parameters. A TEM cell calibration procedure is conducted to determine the proper amplifier settings to enter in the probe parameters. The amplifier settings are determined for a given frequency by subjecting the probe to a known E-field density ( $1 \text{ mW/cm}^2$ ) using an RF Signal generator, TEM cell, and RF Power Meter.

The free space E-field from amplified probe outputs is determined in a test chamber. This calibration can be performed in a TEM cell if the frequency is below 1 GHz and in a waveguide or other methodologies above 1 GHz for free space. For the free space calibration, the probe is placed

in the volumetric center of the cavity and at the proper orientation with the field. The probe is then rotated 360 degrees until the three channels show the maximum reading. The power density readings equates to 1 mW/ cm<sup>2</sup>:

E-field temperature correlation calibration is performed in a flat phantom filled with the appropriate simulated brain tissue. The E-field in the medium correlates with the temperature rise in the dielectric medium. For temperature correlation calibration a RF transparent thermistor-based temperature probe is used in conjunction with the E-field probe.

$$SAR = C \frac{\Delta T}{\Delta t}$$

Where:

$\Delta t$  = Exposure time (30 seconds),

C = Heat capacity of tissue (brain or muscle),

$\Delta T$  = Temperature increase due to RF exposure.

$$SAR = \frac{|E|^2 \cdot \sigma}{\rho}$$

Where:

$\sigma$  = Simulated tissue conductivity,

$\rho$  = Tissue density (kg/m<sup>3</sup>).

## C.4 Other Test Equipment

### C.4.1 Data Acquisition Electronics(DAE)

The data acquisition electronics consist of a highly sensitive electrometer-grade preamplifier with auto-zeroing, a channel and gain-switching multiplexer, a fast 16 bit AD-converter and a command decoder with a control logic unit. Transmission to the measurement server is accomplished through an optical downlink for data and status information, as well as an optical uplink for commands and the clock.

The mechanical probe mounting device includes two different sensor systems for frontal and sideways probe contacts. They are used for mechanical surface detection and probe collision detection.

The input impedance of the DAE is 200 MOhm; the inputs are symmetrical and floating. Common mode rejection is above 80 dB.

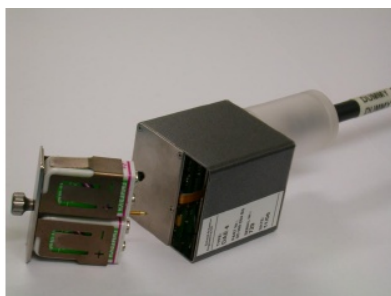

PictureC.4: DAE

### C.4.2 Robot

The SPEAG DASY system uses the high precision robots (DASY4: RX90XL; DASY5: RX160L) type from Stäubli SA (France). For the 6-axis controller system, the robot controller version from Stäubli is used. The Stäubli robot series have many features that are important for our application:

- High precision (repeatability 0.02mm)
- High reliability (industrial design)
- Low maintenance costs (virtually maintenance free due to direct drive gears; no belt drives)
- Jerk-free straight movements (brushless synchron motors; no stepper motors)
- Low ELF interference (motor control fields shielded via the closed metallic construction shields)



Picture C.5 DASY 4



Picture C.6 DASY 5

### C.4.3 Measurement Server

The Measurement server is based on a PC/104 CPU board with CPU (dasy4: 166 MHz, Intel Pentium; DASY5: 400 MHz, Intel Celeron), chipdisk (DASY4: 32 MB; DASY5: 128MB), RAM (DASY4: 64 MB, DASY5: 128MB). The necessary circuits for communication with the DAE electronic box, as well as the 16 bit AD converter system for optical detection and digital I/O interface are contained on the DASY I/O board, which is directly connected to the PC/104 bus of the CPU board.

The measurement server performs all real-time data evaluation of field measurements and surface detection, controls robot movements and handles safety operation. The PC operating system cannot interfere with these time critical processes. All connections are supervised by a watchdog, and disconnection of any of the cables to the measurement server will automatically disarm the robot and disable all program-controlled robot movements. Furthermore, the measurement server is equipped with an expansion port which is reserved for future applications. Please note that this expansion port does not have a standardized pinout, and therefore only devices provided by SPEAG can be connected. Devices from any other supplier could seriously damage the measurement server.





Picture C.7 Server for DASY 4



Picture C.8 Server for DASY 5

#### C.4.4 Device Holder for Phantom

The SAR in the phantom is approximately inversely proportional to the square of the distance between the source and the liquid surface. For a source at 5mm distance, a positioning uncertainty of  $\pm 0.5\text{mm}$  would produce a SAR uncertainty of  $\pm 20\%$ . Accurate device positioning is therefore crucial for accurate and repeatable measurements. The positions in which the devices must be measured are defined by the standards.

The DASY device holder is designed to cope with the different positions given in the standard. It has two scales for device rotation (with respect to the body axis) and device inclination (with respect to the line between the ear reference points). The rotation centers for both scales is the ear reference point (ERP). Thus the device needs no repositioning when changing the angles.

The DASY device holder is constructed of low-loss

POM material having the following dielectric

parameters: relative permittivity  $\epsilon = 3$  and loss tangent  $\delta = 0.02$ . The amount of dielectric material has been reduced in the closest vicinity of the device, since measurements have suggested that the influence of the clamp on the test results could thus be lowered.

<Laptop Extension Kit>

The extension is lightweight and made of POM, acrylic glass and foam. It fits easily on the upper part of the Mounting Device in place of the phone positioner. The extension is fully compatible with the Twin-SAM and ELI phantoms.



Picture C.9-1: Device Holder

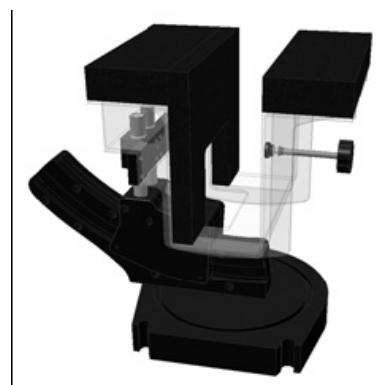

Picture C.9-2: Laptop Extension Kit

#### C.4.5 Phantom

The SAM Twin Phantom V4.0 is constructed of a fiberglass shell integrated in a table. The shape of the shell is based on data from an anatomical study designed to represent the 90<sup>th</sup> percentile of the population. The phantom enables the dissymmetric evaluation

of SAR for both left and right handed handset usage, as well as body-worn usage using the flat phantom region. Reference markings on the Phantom allow the complete setup of all predefined phantom positions and measurement grids by manually teaching three points in the robot. The shell phantom has a 2mm shell thickness (except the ear region where shell thickness increases to 6 mm).

Shell Thickness:  $2 \pm 0.2$  mm

Filling Volume: Approx. 25 liters

Dimensions: 810 x 1000 x 500 mm (H x L x W)

Available: Special



**Picture C.10: SAM Twin Phantom**



## ANNEX D Position of the wireless device in relation to the phantom

### D.1 General considerations

This standard specifies two handset test positions against the head phantom – the “cheek” position and the “tilt” position.

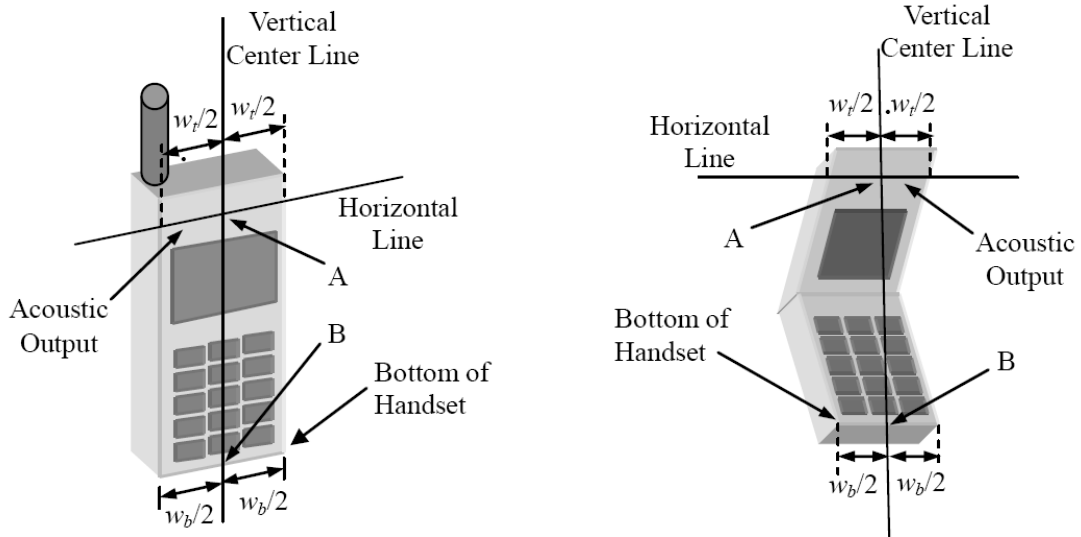

- $w_t$  Width of the handset at the level of the acoustic
- $w_b$  Width of the bottom of the handset
- A Midpoint of the width  $w_t$  of the handset at the level of the acoustic output
- B Midpoint of the width  $w_b$  of the bottom of the handset

Picture D.1-a Typical “fixed” case handset      Picture D.1-b Typical “clam-shell” case handset

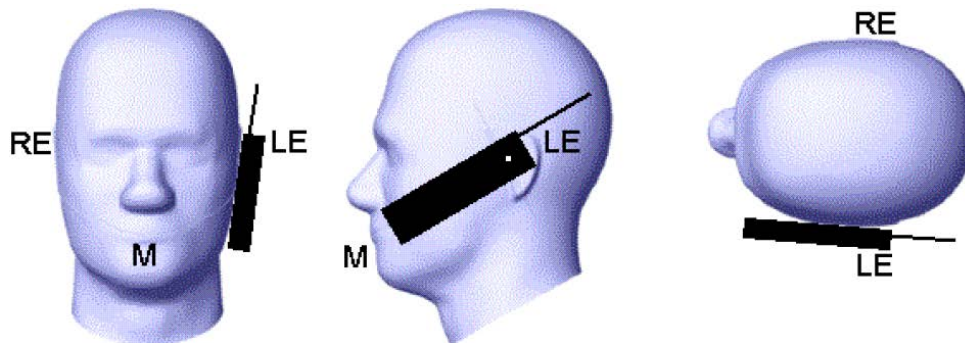

Picture D.2 Cheek position of the wireless device on the left side of SAM

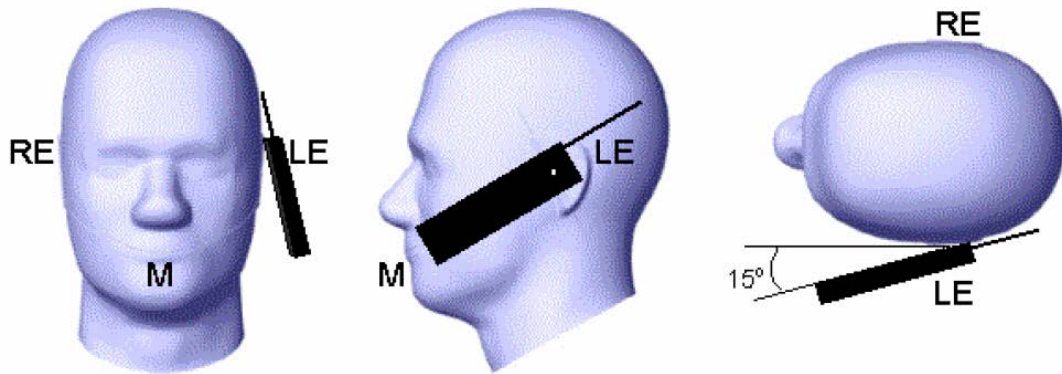

Picture D.3 Tilt position of the wireless device on the left side of SAM

## D.2 Body-worn device

A typical example of a body-worn device is a mobile phone, wireless enabled PDA or other battery operated wireless device with the ability to transmit while mounted on a person's body using a carry accessory approved by the wireless device manufacturer.

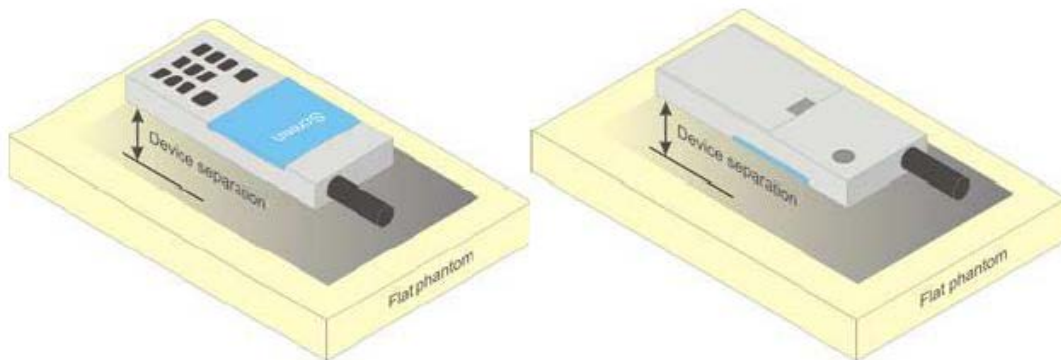

Picture D.4 Test positions for body-worn devices

## D.3 Desktop device

A typical example of a desktop device is a wireless enabled desktop computer placed on a table or desk when used.

The DUT shall be positioned at the distance and in the orientation to the phantom that corresponds to the intended use as specified by the manufacturer in the user instructions. For devices that employ an external antenna with variable positions, tests shall be performed for all antenna positions specified. Picture 8.5 show positions for desktop device SAR tests. If the intended use is not specified, the device shall be tested directly against the flat phantom.

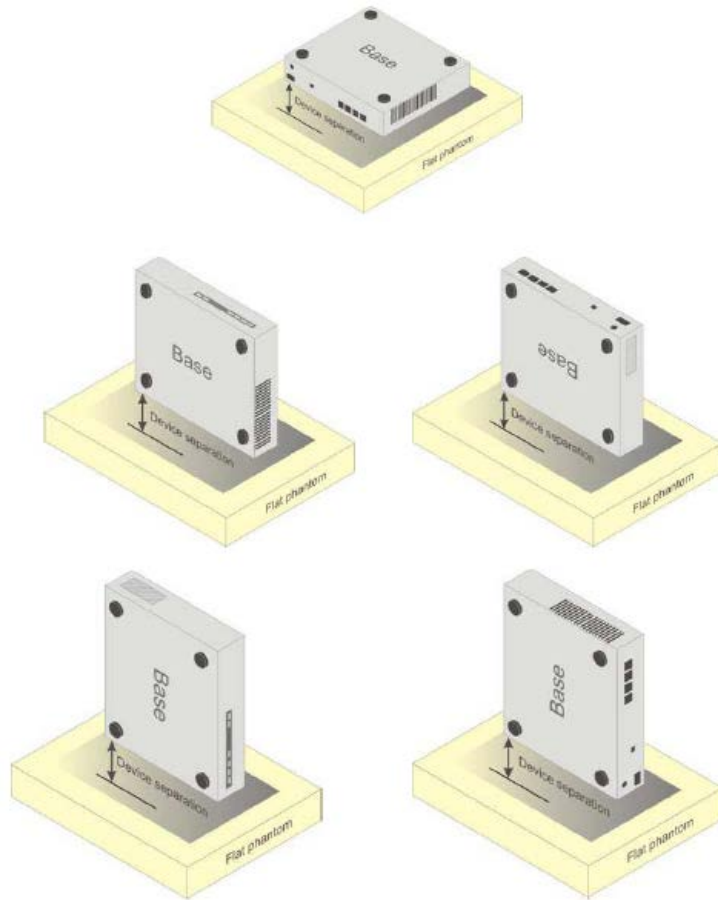

Picture D.5 Test positions for desktop devices

#### D.4 DUT Setup Photos



Picture D.6

## ANNEX E Equivalent Media Recipes

The liquid used for the frequency range of 800-3000 MHz consisted of water, sugar, salt, preventol, glycol monobutyl and Cellulose. The liquid has been previously proven to be suited for worst-case. The Table E.1 shows the detail solution. It's satisfying the latest tissue dielectric parameters requirements proposed by the IEEE 1528 and IEC 62209.

**Table E.1: Composition of the Tissue Equivalent Matter**

Frequency (MHz)	835 Head	835 Body	1900 Head	1900 Body	2450 Head	2450 Body
Ingredients (% by weight)						
Water	41.45	52.5	55.242	69.91	58.79	72.60
Sugar	56.0	45.0	\	\	\	\
Salt	1.45	1.4	0.306	0.13	0.06	0.18
Preventol	0.1	0.1	\	\	\	\
Cellulose	1.0	1.0	\	\	\	\
Glycol Monobutyl	\	\	44.452	29.96	41.15	27.22
Dielectric Parameters Target Value	$\epsilon=41.5$ $\sigma=0.90$	$\epsilon=55.2$ $\sigma=0.97$	$\epsilon=40.0$ $\sigma=1.40$	$\epsilon=53.3$ $\sigma=1.52$	$\epsilon=39.2$ $\sigma=1.80$	$\epsilon=52.7$ $\sigma=1.95$

## ANNEX F System Validation

The SAR system must be validated against its performance specifications before it is deployed. When SAR probes, system components or software are changed, upgraded or recalibrated, these must be validated with the SAR system(s) that operates with such components.

**Table F.1: System Validation**

Probe SN.	Liquid name	Validation date	Frequency point	Status (OK or Not)
3149	Head 750MHz	Sep. 17, 2012	750 MHz	OK
3149	Head 850MHz	Sep. 17, 2012	850 MHz	OK
3149	Head 900MHz	Sep. 17, 2012	900 MHz	OK
3149	Head 1800MHz	Sep. 18, 2012	1800 MHz	OK
3149	Head 1900MHz	Sep. 18, 2012	1900 MHz	OK
3149	Head 2000MHz	Sep. 18, 2012	2000 MHz	OK
3149	Head 2100MHz	Sep. 18, 2012	2100 MHz	OK
3149	Head 2450MHz	Sep. 19, 2012	2450 MHz	OK
3149	Head 2550MHz	Sep. 19, 2012	2550 MHz	OK
3149	Head 2600MHz	Sep. 19, 2012	2600 MHz	OK
3149	Body 750MHz	Sep. 20, 2012	750 MHz	OK
3149	Body 850MHz	Sep. 20, 2012	850 MHz	OK
3149	Body 900MHz	Sep. 20, 2012	900 MHz	OK
3149	Body 1800MHz	Sep. 21, 2012	1800 MHz	OK
3149	Body 1900MHz	Sep. 21, 2012	1900 MHz	OK
3149	Body 2000MHz	Sep. 21, 2012	2000 MHz	OK
3149	Body 2100MHz	Sep. 21, 2012	2100 MHz	OK
3149	Body 2450MHz	Sep. 22, 2012	2450 MHz	OK
3149	Body 2550MHz	Sep. 22, 2012	2550 MHz	OK
3149	Body 2600MHz	Sep. 22, 2012	2600 MHz	OK



## ANNEX G Probe Calibration Certificate

Calibration Laboratory of  
Schmid & Partner  
Engineering AG  
Zeughausstrasse 43, 8004 Zurich, Switzerland



S Schweizerischer Kalibrierdienst  
S Service suisse d'étalonnage  
S Servizio svizzero di taratura  
S Swiss Calibration Service

Accredited by the Swiss Accreditation Service (SAS)  
The Swiss Accreditation Service is one of the signatories to the EA  
Multilateral Agreement for the recognition of calibration certificates

Accreditation No.: SCS 108

Client TMC Beijing

Certificate No: ES3-3149\_Apr12

### CALIBRATION CERTIFICATE

Object ES3DV3 - SN:3149

Calibration procedure(s) QA CAL-01.v8, QA CAL-23.v4, QA CAL-25.v4  
Calibration procedure for dosimetric E-field probes



Calibration date: April 24, 2012

This calibration certificate documents the traceability to national standards, which realize the physical units of measurements (SI).  
The measurements and the uncertainties with confidence probability are given on the following pages and are part of the certificate.

All calibrations have been conducted in the closed laboratory facility: environment temperature (22 ± 3)°C and humidity < 70%.

Calibration Equipment used (M&TE critical for calibration)

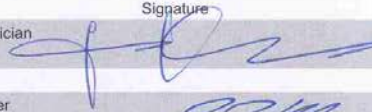
Primary Standards	ID	Cal Date (Certificate No.)	Scheduled Calibration
Power meter E4419B	GB41293874	29-Mar-12 (No. 217-01508)	Apr-13
Power sensor E4412A	MY41498087	29-Mar-12 (No. 217-01508)	Apr-13
Reference 3 dB Attenuator	SN: S5054 (3c)	27-Mar-12 (No. 217-01531)	Apr-13
Reference 20 dB Attenuator	SN: S5086 (20b)	27-Mar-12 (No. 217-01529)	Apr-13
Reference 30 dB Attenuator	SN: S5129 (30b)	27-Mar-12 (No. 217-01532)	Apr-13
Reference Probe ES3DV2	SN: 3013	29-Dec-11 (No. ES3-3013_Dec11)	Dec-12
DAE4	SN: 660	10-Jan-12 (No. DAE4-660_Jan12)	Jan-13
Secondary Standards	ID	Check Date (in house)	Scheduled Check
RF generator HP 8648C	US3642U01700	4-Aug-99 (in house check Apr-11)	In house check: Apr-13
Network Analyzer HP 8753E	US37390585	18-Oct-01 (in house check Oct-11)	In house check: Oct-12

	Name	Function	Signature
Calibrated by:	Jeton Kastrati	Laboratory Technician	
Approved by:	Katja Pokovic	Technical Manager	

Issued: April 24, 2012

This calibration certificate shall not be reproduced except in full without written approval of the laboratory.

Calibration Laboratory of  
Schmid & Partner  
Engineering AG  
Zeughausstrasse 43, 8004 Zurich, Switzerland



S Schweizerischer Kalibrierdienst  
S Service suisse d'étalonnage  
S Servizio svizzero di taratura  
S Swiss Calibration Service

Accredited by the Swiss Accreditation Service (SAS)  
The Swiss Accreditation Service is one of the signatories to the EA  
Multilateral Agreement for the recognition of calibration certificates

Accreditation No.: SCS 108

**Glossary:**

TSL	tissue simulating liquid
NORM <sub>x,y,z</sub>	sensitivity in free space
ConvF	sensitivity in TSL / NORM <sub>x,y,z</sub>
DCP	diode compression point
CF	crest factor (1/duty_cycle) of the RF signal
A, B, C	modulation dependent linearization parameters
Polarization $\phi$	$\phi$ rotation around probe axis
Polarization $\vartheta$	$\vartheta$ rotation around an axis that is in the plane normal to probe axis (at measurement center), i.e., $\vartheta = 0$ is normal to probe axis

**Calibration is Performed According to the Following Standards:**

- a) IEEE Std 1528-2003, "IEEE Recommended Practice for Determining the Peak Spatial-Averaged Specific Absorption Rate (SAR) in the Human Head from Wireless Communications Devices: Measurement Techniques", December 2003
- b) IEC 62209-1, "Procedure to measure the Specific Absorption Rate (SAR) for hand-held devices used in close proximity to the ear (frequency range of 300 MHz to 3 GHz)", February 2005

**Methods Applied and Interpretation of Parameters:**

- **NORM<sub>x,y,z</sub>:** Assessed for E-field polarization  $\vartheta = 0$  ( $f \leq 900$  MHz in TEM-cell;  $f > 1800$  MHz: R22 waveguide). NORM<sub>x,y,z</sub> are only intermediate values, i.e., the uncertainties of NORM<sub>x,y,z</sub> does not affect the E<sup>2</sup>-field uncertainty inside TSL (see below ConvF).
- **NORM(f)<sub>x,y,z</sub> = NORM<sub>x,y,z</sub> \* frequency\_response** (see Frequency Response Chart). This linearization is implemented in DASY4 software versions later than 4.2. The uncertainty of the frequency response is included in the stated uncertainty of ConvF.
- **DCP<sub>x,y,z</sub>:** DCP are numerical linearization parameters assessed based on the data of power sweep with CW signal (no uncertainty required). DCP does not depend on frequency nor media.
- **PAR:** PAR is the Peak to Average Ratio that is not calibrated but determined based on the signal characteristics
- **A<sub>x,y,z</sub>; B<sub>x,y,z</sub>; C<sub>x,y,z</sub>; VR<sub>x,y,z</sub>:** A, B, C are numerical linearization parameters assessed based on the data of power sweep for specific modulation signal. The parameters do not depend on frequency nor media. VR is the maximum calibration range expressed in RMS voltage across the diode.
- **ConvF and Boundary Effect Parameters:** Assessed in flat phantom using E-field (or Temperature Transfer Standard for  $f \leq 800$  MHz) and inside waveguide using analytical field distributions based on power measurements for  $f > 800$  MHz. The same setups are used for assessment of the parameters applied for boundary compensation (alpha, depth) of which typical uncertainty values are given. These parameters are used in DASY4 software to improve probe accuracy close to the boundary. The sensitivity in TSL corresponds to NORM<sub>x,y,z</sub> \* ConvF whereby the uncertainty corresponds to that given for ConvF. A frequency dependent ConvF is used in DASY version 4.4 and higher which allows extending the validity from  $\pm 50$  MHz to  $\pm 100$  MHz.
- **Spherical isotropy (3D deviation from isotropy):** in a field of low gradients realized using a flat phantom exposed by a patch antenna.
- **Sensor Offset:** The sensor offset corresponds to the offset of virtual measurement center from the probe tip (on probe axis). No tolerance required.

ES3DV3 – SN:3149

April 24, 2012

# Probe ES3DV3

## SN:3149

Manufactured: June 12, 2007  
Calibrated: April 24, 2012

Calibrated for DASY/EASY Systems  
(Note: non-compatible with DASY2 system!)



ES3DV3– SN:3149

April 24, 2012

## DASY/EASY - Parameters of Probe: ES3DV3 - SN:3149

### Basic Calibration Parameters

	Sensor X	Sensor Y	Sensor Z	Unc (k=2)
Norm ( $\mu\text{V}/(\text{V}/\text{m})^2$ ) <sup>A</sup>	1.21	1.24	1.24	$\pm 10.1 \%$
DCP (mV) <sup>B</sup>	101.1	100.9	100.5	

### Modulation Calibration Parameters

UID	Communication System Name	PAR		A dB	B dB	C dB	VR mV	Unc <sup>E</sup> (k=2)
0	CW	0.00	X	0.00	0.00	1.00	112.7	$\pm 2.2 \%$
			Y	0.00	0.00	1.00	114.2	
			Z	0.00	0.00	1.00	118.9	

The reported uncertainty of measurement is stated as the standard uncertainty of measurement multiplied by the coverage factor  $k=2$ , which for a normal distribution corresponds to a coverage probability of approximately 95%.

<sup>A</sup> The uncertainties of NormX,Y,Z do not affect the  $E^2$ -field uncertainty inside TSL (see Pages 5 and 6).

<sup>B</sup> Numerical linearization parameter: uncertainty not required.

<sup>E</sup> Uncertainty is determined using the max. deviation from linear response applying rectangular distribution and is expressed for the square of the field value.

ES3DV3– SN:3149

April 24, 2012

## DASY/EASY - Parameters of Probe: ES3DV3 - SN:3149

### Calibration Parameter Determined in Head Tissue Simulating Media

f (MHz) <sup>C</sup>	Relative Permittivity <sup>F</sup>	Conductivity (S/m) <sup>F</sup>	ConvF X	ConvF Y	ConvF Z	Alpha	Depth (mm)	Unct. (k=2)
750	41.9	0.89	6.50	6.50	6.50	0.24	2.36	± 12.0 %
850	41.5	0.92	6.26	6.26	6.26	0.25	2.14	± 12.0 %
900	41.5	0.97	6.17	6.17	6.17	0.21	2.55	± 12.0 %
1800	40.0	1.40	5.23	5.23	5.23	0.43	1.64	± 12.0 %
1900	40.0	1.40	5.19	5.19	5.19	0.45	1.64	± 12.0 %
2000	40.0	1.40	5.11	5.11	5.11	0.52	1.46	± 12.0 %
2100	39.8	1.49	5.12	5.12	5.12	0.49	1.52	± 12.0 %
2450	39.2	1.80	4.49	4.49	4.49	0.71	1.37	± 12.0 %
2550	39.1	1.91	4.34	4.34	4.34	0.69	1.26	± 12.0 %
2600	39.0	1.96	4.26	4.26	4.26	0.55	1.29	± 12.0 %

<sup>C</sup> Frequency validity of ± 100 MHz only applies for DASY v4.4 and higher (see Page 2), else it is restricted to ± 50 MHz. The uncertainty is the RSS of the ConvF uncertainty at calibration frequency and the uncertainty for the indicated frequency band.

<sup>F</sup> At frequencies below 3 GHz, the validity of tissue parameters ( $\epsilon$  and  $\sigma$ ) can be relaxed to ± 10% if liquid compensation formula is applied to measured SAR values. At frequencies above 3 GHz, the validity of tissue parameters ( $\epsilon$  and  $\sigma$ ) is restricted to ± 5%. The uncertainty is the RSS of the ConvF uncertainty for indicated target tissue parameters.

ES3DV3– SN:3149

April 24, 2012

## DASY/EASY - Parameters of Probe: ES3DV3 - SN:3149

### Calibration Parameter Determined in Body Tissue Simulating Media

f (MHz) <sup>C</sup>	Relative Permittivity <sup>F</sup>	Conductivity (S/m) <sup>F</sup>	ConvF X	ConvF Y	ConvF Z	Alpha	Depth (mm)	Unct. (k=2)
750	55.5	0.96	6.29	6.29	6.29	0.43	1.56	± 12.0 %
850	55.2	0.99	6.14	6.14	6.14	0.41	1.63	± 12.0 %
900	55.0	1.05	6.16	6.16	6.16	0.63	1.30	± 12.0 %
1800	53.3	1.52	4.84	4.84	4.84	0.28	2.97	± 12.0 %
1900	53.3	1.52	4.64	4.64	4.64	0.34	2.25	± 12.0 %
2000	53.3	1.52	4.63	4.63	4.63	0.35	2.21	± 12.0 %
2100	53.2	1.62	4.91	4.91	4.91	0.36	2.20	± 12.0 %
2450	52.7	1.95	4.15	4.15	4.15	0.80	0.61	± 12.0 %
2550	52.6	2.09	4.07	4.07	4.07	0.80	0.50	± 12.0 %
2600	52.5	2.16	3.99	3.99	3.99	0.80	0.51	± 12.0 %

<sup>C</sup> Frequency validity of ± 100 MHz only applies for DASY v4.4 and higher (see Page 2), else it is restricted to ± 50 MHz. The uncertainty is the RSS of the ConvF uncertainty at calibration frequency and the uncertainty for the indicated frequency band.

<sup>F</sup> At frequencies below 3 GHz, the validity of tissue parameters ( $\epsilon$  and  $\sigma$ ) can be relaxed to ± 10% if liquid compensation formula is applied to measured SAR values. At frequencies above 3 GHz, the validity of tissue parameters ( $\epsilon$  and  $\sigma$ ) is restricted to ± 5%. The uncertainty is the RSS of the ConvF uncertainty for indicated target tissue parameters.

ES3DV3-SN:3149

April 24, 2012

### Frequency Response of E-Field (TEM-Cell:ifi110 EXX, Waveguide: R22)

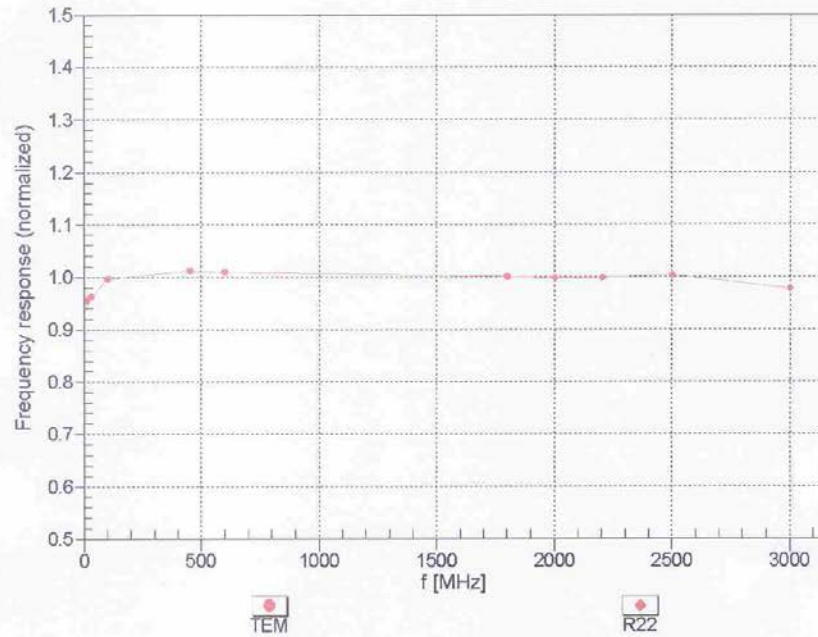

Uncertainty of Frequency Response of E-field:  $\pm 6.3\%$  (k=2)

ES3DV3- SN:3149

April 24, 2012

### Receiving Pattern ( $\phi$ ), $\theta = 0^\circ$

f=600 MHz,TEM

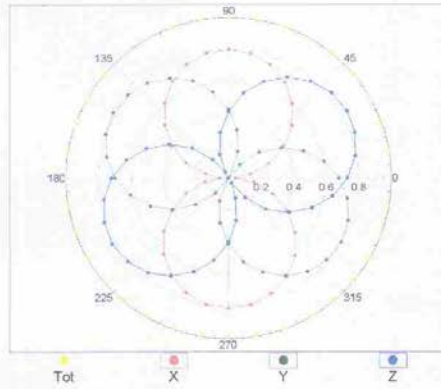

f=1800 MHz,R22

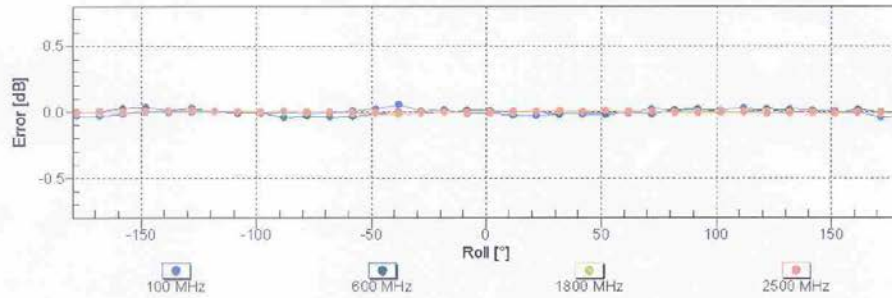
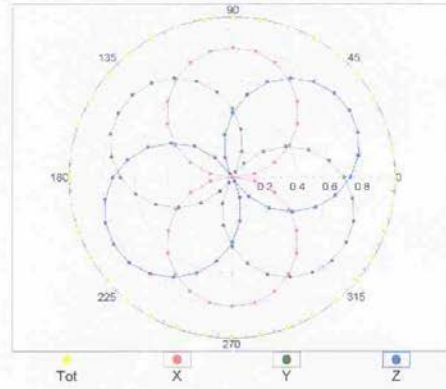

Uncertainty of Axial Isotropy Assessment:  $\pm 0.5\%$  ( $k=2$ )



ES3DV3- SN:3149

April 24, 2012

### Dynamic Range f(SAR<sub>head</sub>) (TEM cell , f = 900 MHz)

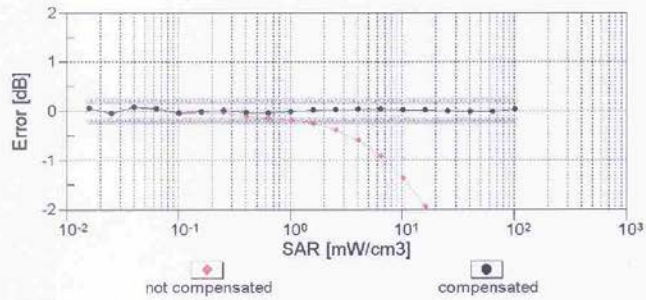
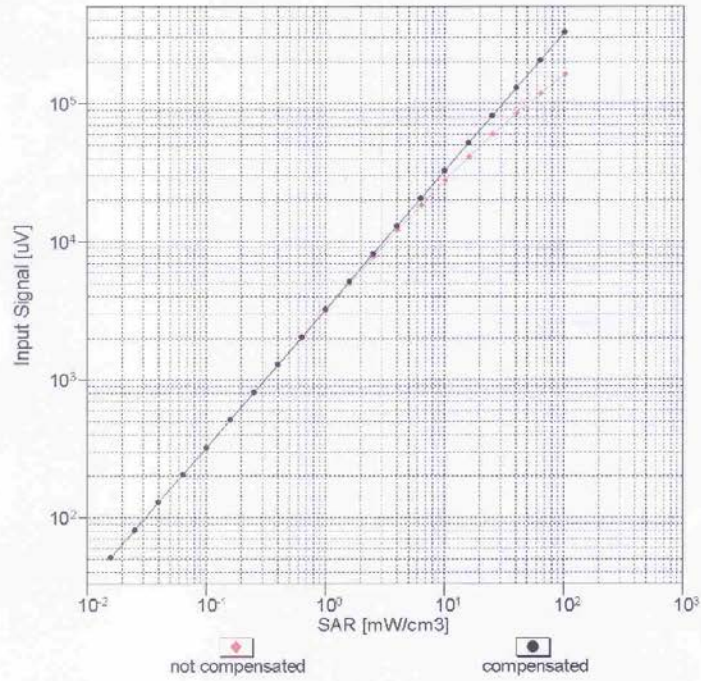

Uncertainty of Linearity Assessment: ± 0.6% (k=2)

ES3DV3-SN:3149

April 24, 2012

### Conversion Factor Assessment

f = 900 MHz, WGLS R9 (H\_convF)

f = 1900 MHz, WGLS R22 (H\_convF)

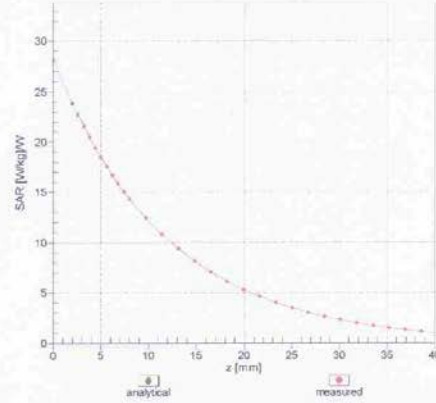
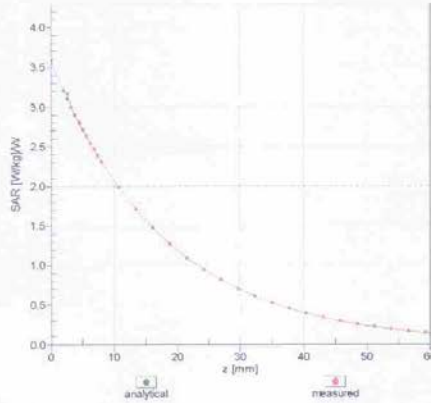

### Deviation from Isotropy in Liquid Error ( $\phi, \theta$ ), f = 900 MHz

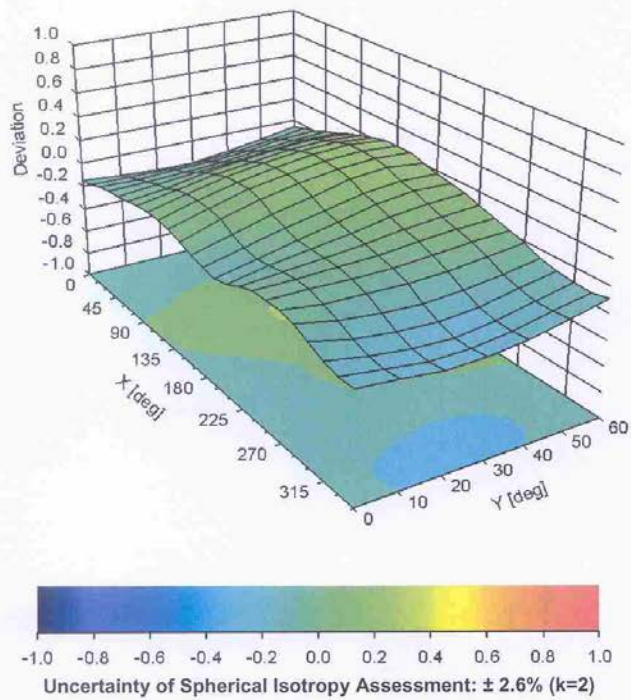

ES3DV3-SN:3149

April 24, 2012

## DASY/EASY - Parameters of Probe: ES3DV3 - SN:3149

### Other Probe Parameters

Sensor Arrangement	Triangular
Connector Angle (°)	51.8
Mechanical Surface Detection Mode	enabled
Optical Surface Detection Mode	disabled
Probe Overall Length	337 mm
Probe Body Diameter	10 mm
Tip Length	10 mm
Tip Diameter	4 mm
Probe Tip to Sensor X Calibration Point	2 mm
Probe Tip to Sensor Y Calibration Point	2 mm
Probe Tip to Sensor Z Calibration Point	2 mm
Recommended Measurement Distance from Surface	3 mm



## ANNEX H Dipole Calibration Certificate

### 835 MHz Dipole Calibration Certificate

Calibration Laboratory of  
Schmid & Partner  
Engineering AG  
Zeughausstrasse 43, 8004 Zurich, Switzerland



S Schweizerischer Kalibrierdienst  
C Service suisse d'étalonnage  
S Servizio svizzero di taratura  
S Swiss Calibration Service

Accredited by the Swiss Accreditation Service (SAS)  
The Swiss Accreditation Service is one of the signatories to the EA  
Multilateral Agreement for the recognition of calibration certificates

Accreditation No.: SCS 108

Client **TMC Beijing**

Certificate No: **D835V2-443\_May12**

### CALIBRATION CERTIFICATE

Object: **D835V2 - SN: 443**

Calibration procedure(s): **QA CAL-05.v8  
Calibration procedure for dipole validation kits above 700 MHz**



Calibration date: **May 03, 2012**

This calibration certificate documents the traceability to national standards, which realize the physical units of measurements (SI).  
The measurements and the uncertainties with confidence probability are given on the following pages and are part of the certificate.

All calibrations have been conducted in the closed laboratory facility: environment temperature  $(22 \pm 3)^\circ\text{C}$  and humidity  $< 70\%$ .

Calibration Equipment used (M&TE critical for calibration)

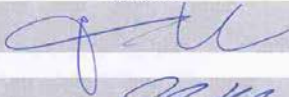
Primary Standards	ID #	Cal Date (Certificate No.)	Scheduled Calibration
Power meter EPM-442A	GB37480704	05-Oct-11 (No. 217-01451)	Oct-12
Power sensor HP 8481A	US37292783	05-Oct-11 (No. 217-01451)	Oct-12
Reference 20 dB Attenuator	SN: 5058 (20k)	27-Mar-12 (No. 217-01530)	Apr-13
Type-N mismatch combination	SN: 5047.2 / 06327	27-Mar-12 (No. 217-01533)	Apr-13
Reference Probe ES3DV3	SN: 3205	30-Dec-11 (No. ES3-3205_Dec11)	Dec-12
DAE4	SN: 601	04-Jul-11 (No. DAE4-601_Jul11)	Jul-12
Secondary Standards	ID #	Check Date (in house)	Scheduled Check
Power sensor HP 8481A	MY41092317	18-Oct-02 (in house check Oct-11)	In house check: Oct-13
RF generator R&S SMT-06	100005	04-Aug-99 (in house check Oct-11)	In house check: Oct-13
Network Analyzer HP 8753E	US37390585 S4206	18-Oct-01 (in house check Oct-11)	In house check: Oct-12

	Name	Function	Signature
Calibrated by:	Jeton Kastrati	Laboratory Technician	
Approved by:	Katja Pokovic	Technical Manager	

Issued: May 3, 2012

This calibration certificate shall not be reproduced except in full without written approval of the laboratory.

**Calibration Laboratory of**  
Schmid & Partner  
Engineering AG  
Zeughausstrasse 43, 8004 Zurich, Switzerland



**S** Schweizerischer Kalibrierdienst  
**C** Service suisse d'étalonnage  
**S** Servizio svizzero di taratura  
**S** Swiss Calibration Service

Accredited by the Swiss Accreditation Service (SAS)  
The Swiss Accreditation Service is one of the signatories to the EA  
Multilateral Agreement for the recognition of calibration certificates

Accreditation No.: **SCS 108**

**Glossary:**

TSL	tissue simulating liquid
ConvF	sensitivity in TSL / NORM x,y,z
N/A	not applicable or not measured

**Calibration is Performed According to the Following Standards:**

- a) IEEE Std 1528-2003, "IEEE Recommended Practice for Determining the Peak Spatial-Averaged Specific Absorption Rate (SAR) in the Human Head from Wireless Communications Devices: Measurement Techniques", December 2003
- b) IEC 62209-1, "Procedure to measure the Specific Absorption Rate (SAR) for hand-held devices used in close proximity to the ear (frequency range of 300 MHz to 3 GHz)", February 2005
- c) Federal Communications Commission Office of Engineering & Technology (FCC OET), "Evaluating Compliance with FCC Guidelines for Human Exposure to Radiofrequency Electromagnetic Fields; Additional Information for Evaluating Compliance of Mobile and Portable Devices with FCC Limits for Human Exposure to Radiofrequency Emissions", Supplement C (Edition 01-01) to Bulletin 65

**Additional Documentation:**

- d) DASY4/5 System Handbook

**Methods Applied and Interpretation of Parameters:**

- *Measurement Conditions:* Further details are available from the Validation Report at the end of the certificate. All figures stated in the certificate are valid at the frequency indicated.
- *Antenna Parameters with TSL:* The dipole is mounted with the spacer to position its feed point exactly below the center marking of the flat phantom section, with the arms oriented parallel to the body axis.
- *Feed Point Impedance and Return Loss:* These parameters are measured with the dipole positioned under the liquid filled phantom. The impedance stated is transformed from the measurement at the SMA connector to the feed point. The Return Loss ensures low reflected power. No uncertainty required.
- *Electrical Delay:* One-way delay between the SMA connector and the antenna feed point. No uncertainty required.
- *SAR measured:* SAR measured at the stated antenna input power.
- *SAR normalized:* SAR as measured, normalized to an input power of 1 W at the antenna connector.
- *SAR for nominal TSL parameters:* The measured TSL parameters are used to calculate the nominal SAR result.

The reported uncertainty of measurement is stated as the standard uncertainty of measurement multiplied by the coverage factor  $k=2$ , which for a normal distribution corresponds to a coverage probability of approximately 95%.



### Measurement Conditions

DASY system configuration, as far as not given on page 1.

DASY Version	DASY5	V52.8.1
Extrapolation	Advanced Extrapolation	
Phantom	Modular Flat Phantom	
Distance Dipole Center - TSL	15 mm	with Spacer
Zoom Scan Resolution	dx, dy, dz = 5 mm	
Frequency	835 MHz $\pm$ 1 MHz	

### Head TSL parameters

The following parameters and calculations were applied.

	Temperature	Permittivity	Conductivity
Nominal Head TSL parameters	22.0 °C	41.5	0.90 mho/m
Measured Head TSL parameters	(22.0 $\pm$ 0.2) °C	41.1 $\pm$ 6 %	0.90 mho/m $\pm$ 6 %
Head TSL temperature change during test	< 0.5 °C	----	----

### SAR result with Head TSL

SAR averaged over 1 cm <sup>3</sup> (1 g) of Head TSL	Condition	
SAR measured	250 mW input power	2.33 mW / g
SAR for nominal Head TSL parameters	normalized to 1W	<b>9.30 mW / g <math>\pm</math> 17.0 % (k=2)</b>

SAR averaged over 10 cm <sup>3</sup> (10 g) of Head TSL	condition	
SAR measured	250 mW input power	1.52 mW / g
SAR for nominal Head TSL parameters	normalized to 1W	<b>6.07 mW / g <math>\pm</math> 16.5 % (k=2)</b>

### Body TSL parameters

The following parameters and calculations were applied.

	Temperature	Permittivity	Conductivity
Nominal Body TSL parameters	22.0 °C	55.2	0.97 mho/m
Measured Body TSL parameters	(22.0 $\pm$ 0.2) °C	54.5 $\pm$ 6 %	1.01 mho/m $\pm$ 6 %
Body TSL temperature change during test	< 0.5 °C	----	----

### SAR result with Body TSL

SAR averaged over 1 cm <sup>3</sup> (1 g) of Body TSL	Condition	
SAR measured	250 mW input power	2.42 mW / g
SAR for nominal Body TSL parameters	normalized to 1W	<b>9.36 mW / g <math>\pm</math> 17.0 % (k=2)</b>

SAR averaged over 10 cm <sup>3</sup> (10 g) of Body TSL	condition	
SAR measured	250 mW input power	1.59 mW / g
SAR for nominal Body TSL parameters	normalized to 1W	<b>6.20 mW / g <math>\pm</math> 16.5 % (k=2)</b>

## Appendix

### Antenna Parameters with Head TSL

Impedance, transformed to feed point	50.8 $\Omega$ - 6.7 j $\Omega$
Return Loss	- 23.5 dB

### Antenna Parameters with Body TSL

Impedance, transformed to feed point	46.8 $\Omega$ - 7.8 j $\Omega$
Return Loss	- 21.2 dB

### General Antenna Parameters and Design

Electrical Delay (one direction)	1.387 ns
----------------------------------	----------

After long term use with 100W radiated power, only a slight warming of the dipole near the feedpoint can be measured.

The dipole is made of standard semirigid coaxial cable. The center conductor of the feeding line is directly connected to the second arm of the dipole. The antenna is therefore short-circuited for DC-signals. On some of the dipoles, small end caps are added to the dipole arms in order to improve matching when loaded according to the position as explained in the "Measurement Conditions" paragraph. The SAR data are not affected by this change. The overall dipole length is still according to the Standard.

No excessive force must be applied to the dipole arms, because they might bend or the soldered connections near the feedpoint may be damaged.

### Additional EUT Data

Manufactured by	SPEAG
Manufactured on	July 26, 2001

**DASY5 Validation Report for Head TSL**

Date: 03.05.2012

Test Laboratory: SPEAG, Zurich, Switzerland

**DUT: Dipole 835 MHz; Type: D835V2; Serial: D835V2 - SN: 443**

Communication System: CW; Frequency: 835 MHz

Medium parameters used:  $f = 835 \text{ MHz}$ ;  $\sigma = 0.9 \text{ mho/m}$ ;  $\epsilon_r = 41.1$ ;  $\rho = 1000 \text{ kg/m}^3$

Phantom section: Flat Section

Measurement Standard: DASY5 (IEEE/IEC/ANSI C63.19-2007)

DASY52 Configuration:

- Probe: ES3DV3 - SN3205; ConvF(6.07, 6.07, 6.07); Calibrated: 30.12.2011;
- Sensor-Surface: 3mm (Mechanical Surface Detection)
- Electronics: DAE4 Sn601; Calibrated: 04.07.2011
- Phantom: Flat Phantom 4.9L; Type: QD000P49AA; Serial: 1001
- DASY52 52.8.1(838); SEMCAD X 14.6.5(6469)

**Dipole Calibration for Head Tissue/Pin=250 mW, d=15mm/Zoom Scan (7x7x7)/Cube 0:**

Measurement grid:  $dx=5\text{mm}$ ,  $dy=5\text{mm}$ ,  $dz=5\text{mm}$

Reference Value = 56.826 V/m; Power Drift = -0.01 dB

Peak SAR (extrapolated) = 3.423 mW/g

**SAR(1 g) = 2.33 mW/g; SAR(10 g) = 1.52 mW/g**

Maximum value of SAR (measured) = 2.71 mW/g

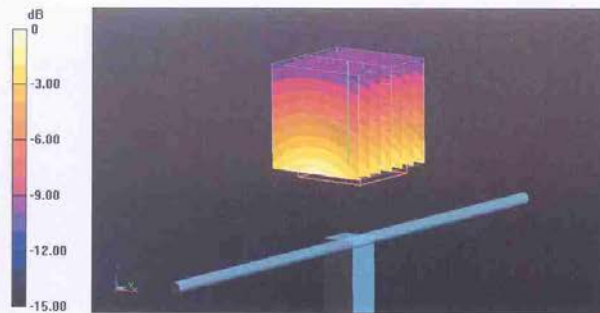

0 dB = 2.71 mW/g = 8.66 dB mW/g

### Impedance Measurement Plot for Head TSL

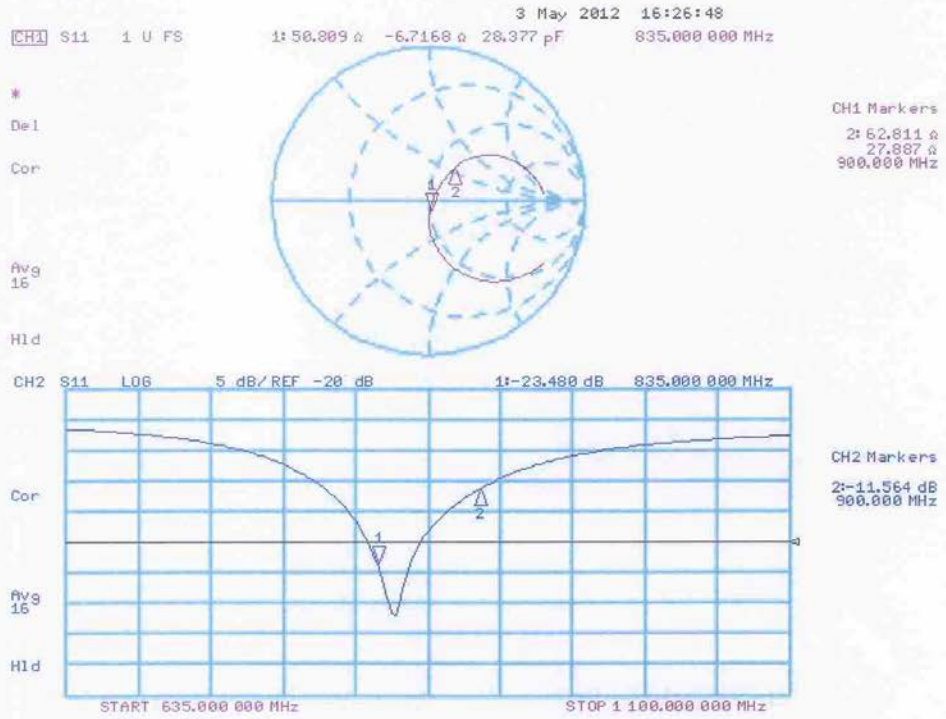



**DASY5 Validation Report for Body TSL**

Date: 03.05.2012

Test Laboratory: SPEAG, Zurich, Switzerland

**DUT: Dipole 835 MHz; Type: D835V2; Serial: D835V2 - SN: 443**

Communication System: CW; Frequency: 835 MHz

Medium parameters used:  $f = 835 \text{ MHz}$ ;  $\sigma = 1.01 \text{ mho/m}$ ;  $\epsilon_r = 54.5$ ;  $\rho = 1000 \text{ kg/m}^3$

Phantom section: Flat Section

Measurement Standard: DASY5 (IEEE/IEC/ANSI C63.19-2007)

DASY52 Configuration:

- Probe: ES3DV3 - SN3205; ConvF(6.02, 6.02, 6.02); Calibrated: 30.12.2011;
- Sensor-Surface: 3mm (Mechanical Surface Detection)
- Electronics: DAE4 Sn601; Calibrated: 04.07.2011
- Phantom: Flat Phantom 4.9L; Type: QD000P49AA; Serial: 1001
- DASY52 52.8.1(838); SEMCAD X 14.6.5(6469)

**Dipole Calibration for Body Tissue/Pin=250 mW, d=15mm/Zoom Scan (7x7x7)/Cube 0:**

Measurement grid:  $dx=5\text{mm}$ ,  $dy=5\text{mm}$ ,  $dz=5\text{mm}$

Reference Value = 54.758 V/m; Power Drift = 0.01 dB

Peak SAR (extrapolated) = 3.514 mW/g

**SAR(1 g) = 2.42 mW/g; SAR(10 g) = 1.59 mW/g**

Maximum value of SAR (measured) = 2.82 mW/g

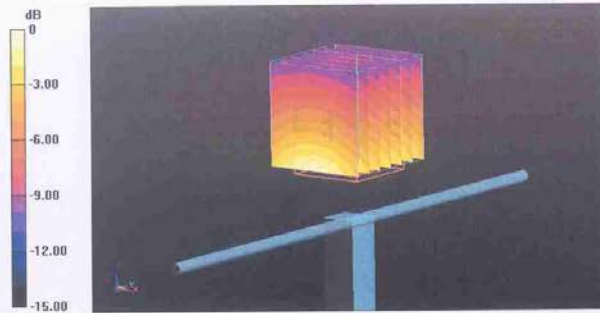

0 dB = 2.82 mW/g = 9.00 dB mW/g

### Impedance Measurement Plot for Body TSL

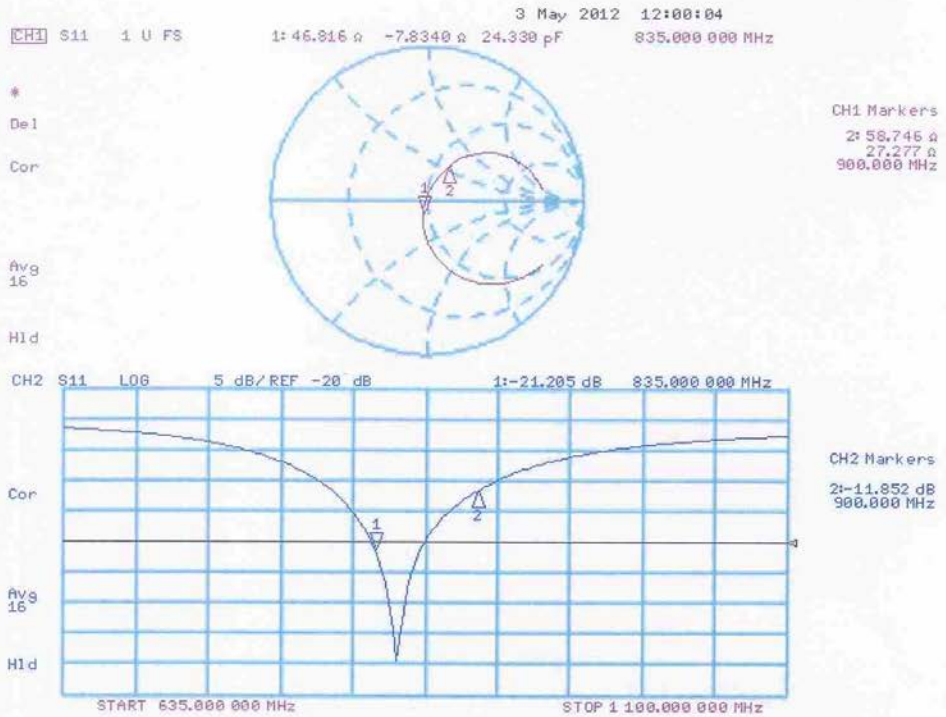



### 1900 MHz Dipole Calibration Certificate

**Calibration Laboratory of  
Schmid & Partner  
Engineering AG**  
Zeughausstrasse 43, 8004 Zurich, Switzerland



**S** Schweizerischer Kalibrierdienst  
**S** Service suisse d'étalonnage  
**C** Servizio svizzero di taratura  
**S** Swiss Calibration Service

Accredited by the Swiss Accreditation Service (SAS)  
The Swiss Accreditation Service is one of the signatories to the EA  
Multilateral Agreement for the recognition of calibration certificates

Accreditation No.: **SCS 108**

Client **TMC Beijing**

Certificate No: **D1900V2-541\_May12**

## CALIBRATION CERTIFICATE

Object: **D1900V2 - SN: 541**

Calibration procedure(s): **QA CAL-05.v8  
Calibration procedure for dipole validation kits above 700 MHz**



Calibration date: **May 09, 2012**

This calibration certificate documents the traceability to national standards, which realize the physical units of measurements (SI).  
The measurements and the uncertainties with confidence probability are given on the following pages and are part of the certificate.

All calibrations have been conducted in the closed laboratory facility: environment temperature (22 ± 3)°C and humidity < 70%.

Calibration Equipment used (M&TE critical for calibration)

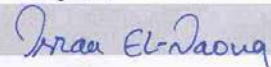
Primary Standards	ID #	Cal Date (Certificate No.)	Scheduled Calibration
Power meter EPM-442A	GB37480704	05-Oct-11 (No. 217-01451)	Oct-12
Power sensor HP 8481A	US37292783	05-Oct-11 (No. 217-01451)	Oct-12
Reference 20 dB Attenuator	SN: 5058 (20k)	27-Mar-12 (No. 217-01530)	Apr-13
Type-N mismatch combination	SN: 5047.2 / 06327	27-Mar-12 (No. 217-01533)	Apr-13
Reference Probe ES3DV3	SN: 3205	30-Dec-11 (No. ES3-3205_Dec11)	Dec-12
DAE4	SN: 601	04-Jul-11 (No. DAE4-601_Jul11)	Jul-12
Secondary Standards	ID #	Check Date (in house)	Scheduled Check
Power sensor HP 8481A	MY41092317	18-Oct-02 (in house check Oct-11)	In house check: Oct-13
RF generator R&S SMT-06	100005	04-Aug-99 (in house check Oct-11)	In house check: Oct-13
Network Analyzer HP 8753E	US37390585 S4206	18-Oct-01 (in house check Oct-11)	In house check: Oct-12

	Name	Function	Signature
Calibrated by:	Israe El-Naouq	Laboratory Technician	
Approved by:	Katja Pokovic	Technical Manager	

Issued: May 9, 2012

This calibration certificate shall not be reproduced except in full without written approval of the laboratory.

**Calibration Laboratory of**  
Schmid & Partner  
Engineering AG  
Zeughausstrasse 43, 8004 Zurich, Switzerland



**S** Schweizerischer Kalibrierdienst  
**C** Service suisse d'étalonnage  
**S** Servizio svizzero di taratura  
**S** Swiss Calibration Service

Accredited by the Swiss Accreditation Service (SAS)  
The Swiss Accreditation Service is one of the signatories to the EA  
Multilateral Agreement for the recognition of calibration certificates

Accreditation No.: **SCS 108**

**Glossary:**

TSL	tissue simulating liquid
ConvF	sensitivity in TSL / NORM x,y,z
N/A	not applicable or not measured

**Calibration is Performed According to the Following Standards:**

- a) IEEE Std 1528-2003, "IEEE Recommended Practice for Determining the Peak Spatial-Averaged Specific Absorption Rate (SAR) in the Human Head from Wireless Communications Devices: Measurement Techniques", December 2003
- b) IEC 62209-1, "Procedure to measure the Specific Absorption Rate (SAR) for hand-held devices used in close proximity to the ear (frequency range of 300 MHz to 3 GHz)", February 2005
- c) Federal Communications Commission Office of Engineering & Technology (FCC OET), "Evaluating Compliance with FCC Guidelines for Human Exposure to Radiofrequency Electromagnetic Fields; Additional Information for Evaluating Compliance of Mobile and Portable Devices with FCC Limits for Human Exposure to Radiofrequency Emissions", Supplement C (Edition 01-01) to Bulletin 65

**Additional Documentation:**

- d) DASY4/5 System Handbook

**Methods Applied and Interpretation of Parameters:**

- *Measurement Conditions:* Further details are available from the Validation Report at the end of the certificate. All figures stated in the certificate are valid at the frequency indicated.
- *Antenna Parameters with TSL:* The dipole is mounted with the spacer to position its feed point exactly below the center marking of the flat phantom section, with the arms oriented parallel to the body axis.
- *Feed Point Impedance and Return Loss:* These parameters are measured with the dipole positioned under the liquid filled phantom. The impedance stated is transformed from the measurement at the SMA connector to the feed point. The Return Loss ensures low reflected power. No uncertainty required.
- *Electrical Delay:* One-way delay between the SMA connector and the antenna feed point. No uncertainty required.
- *SAR measured:* SAR measured at the stated antenna input power.
- *SAR normalized:* SAR as measured, normalized to an input power of 1 W at the antenna connector.
- *SAR for nominal TSL parameters:* The measured TSL parameters are used to calculate the nominal SAR result.

The reported uncertainty of measurement is stated as the standard uncertainty of measurement multiplied by the coverage factor  $k=2$ , which for a normal distribution corresponds to a coverage probability of approximately 95%.



### Measurement Conditions

DASY system configuration, as far as not given on page 1.

DASY Version	DASY5	V52.8.1
Extrapolation	Advanced Extrapolation	
Phantom	Modular Flat Phantom	
Distance Dipole Center - TSL	10 mm	with Spacer
Zoom Scan Resolution	dx, dy, dz = 5 mm	
Frequency	1900 MHz $\pm$ 1 MHz	

### Head TSL parameters

The following parameters and calculations were applied.

	Temperature	Permittivity	Conductivity
Nominal Head TSL parameters	22.0 °C	40.0	1.40 mho/m
Measured Head TSL parameters	(22.0 $\pm$ 0.2) °C	40.5 $\pm$ 6 %	1.37 mho/m $\pm$ 6 %
Head TSL temperature change during test	< 0.5 °C	----	----

### SAR result with Head TSL

SAR averaged over 1 cm <sup>3</sup> (1 g) of Head TSL	Condition	
SAR measured	250 mW input power	9.62 mW / g
SAR for nominal Head TSL parameters	normalized to 1W	<b>39.1 mW / g <math>\pm</math> 17.0 % (k=2)</b>

SAR averaged over 10 cm <sup>3</sup> (10 g) of Head TSL	condition	
SAR measured	250 mW input power	5.11 mW / g
SAR for nominal Head TSL parameters	normalized to 1W	<b>20.6 mW / g <math>\pm</math> 16.5 % (k=2)</b>

### Body TSL parameters

The following parameters and calculations were applied.

	Temperature	Permittivity	Conductivity
Nominal Body TSL parameters	22.0 °C	53.3	1.52 mho/m
Measured Body TSL parameters	(22.0 $\pm$ 0.2) °C	52.9 $\pm$ 6 %	1.52 mho/m $\pm$ 6 %
Body TSL temperature change during test	< 0.5 °C	----	----

### SAR result with Body TSL

SAR averaged over 1 cm <sup>3</sup> (1 g) of Body TSL	Condition	
SAR measured	250 mW input power	10.0 mW / g
SAR for nominal Body TSL parameters	normalized to 1W	<b>39.9 mW / g <math>\pm</math> 17.0 % (k=2)</b>

SAR averaged over 10 cm <sup>3</sup> (10 g) of Body TSL	condition	
SAR measured	250 mW input power	5.33 mW / g
SAR for nominal Body TSL parameters	normalized to 1W	<b>21.3 mW / g <math>\pm</math> 16.5 % (k=2)</b>

## Appendix

### Antenna Parameters with Head TSL

Impedance, transformed to feed point	$52.6 \Omega + 6.2 j\Omega$
Return Loss	- 23.7 dB

### Antenna Parameters with Body TSL

Impedance, transformed to feed point	$48.6 \Omega + 6.9 j\Omega$
Return Loss	- 23.0 dB

### General Antenna Parameters and Design

Electrical Delay (one direction)	1.197 ns
----------------------------------	----------

After long term use with 100W radiated power, only a slight warming of the dipole near the feedpoint can be measured.

The dipole is made of standard semirigid coaxial cable. The center conductor of the feeding line is directly connected to the second arm of the dipole. The antenna is therefore short-circuited for DC-signals. On some of the dipoles, small end caps are added to the dipole arms in order to improve matching when loaded according to the position as explained in the "Measurement Conditions" paragraph. The SAR data are not affected by this change. The overall dipole length is still according to the Standard.

No excessive force must be applied to the dipole arms, because they might bend or the soldered connections near the feedpoint may be damaged.

### Additional EUT Data

Manufactured by	SPEAG
Manufactured on	July 26, 2001

**DASY5 Validation Report for Head TSL**

Date: 09.05.2012

Test Laboratory: SPEAG, Zurich, Switzerland

**DUT: Dipole 1900 MHz; Type: D1900V2; Serial: D1900V2 - SN: 541**

Communication System: CW; Frequency: 1900 MHz

Medium parameters used:  $f = 1900 \text{ MHz}$ ;  $\sigma = 1.37 \text{ mho/m}$ ;  $\epsilon_r = 40.5$ ;  $\rho = 1000 \text{ kg/m}^3$

Phantom section: Flat Section

Measurement Standard: DASY5 (IEEE/IEC/ANSI C63.19-2007)

DASY52 Configuration:

- Probe: ES3DV3 - SN3205; ConvF(5.01, 5.01, 5.01); Calibrated: 30.12.2011;
- Sensor-Surface: 3mm (Mechanical Surface Detection)
- Electronics: DAE4 Sn601; Calibrated: 04.07.2011
- Phantom: Flat Phantom 5.0 (front); Type: QD000P50AA; Serial: 1001
- DASY52 52.8.1(838); SEMCAD X 14.6.5(6469)

**Dipole Calibration for Head Tissue/Pin=250 mW, d=10mm/Zoom Scan (7x7x7)/Cube 0:**

Measurement grid:  $dx=5\text{mm}$ ,  $dy=5\text{mm}$ ,  $dz=5\text{mm}$

Reference Value = 96.763 V/m; Power Drift = 0.06 dB

Peak SAR (extrapolated) = 17.071 mW/g

**SAR(1 g) = 9.62 mW/g; SAR(10 g) = 5.11 mW/g**

Maximum value of SAR (measured) = 12.0 mW/g

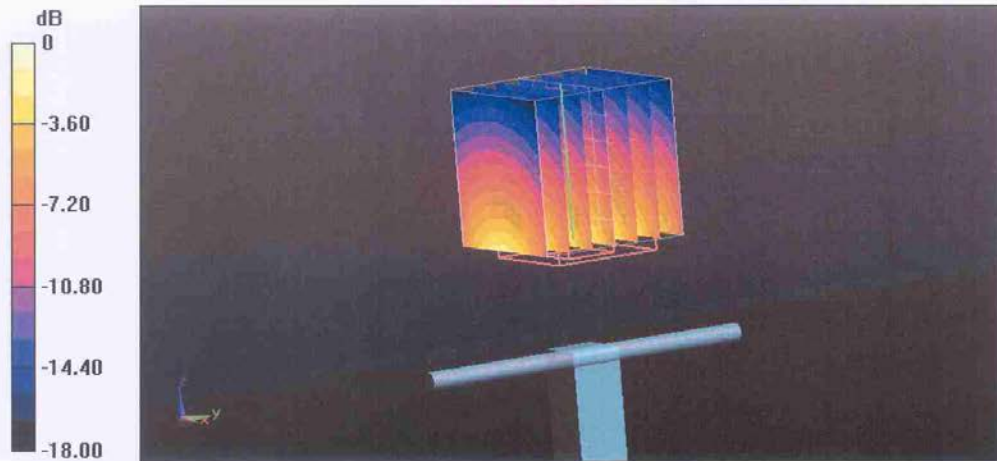

0 dB = 12.0 mW/g = 21.58 dB mW/g

### Impedance Measurement Plot for Head TSL

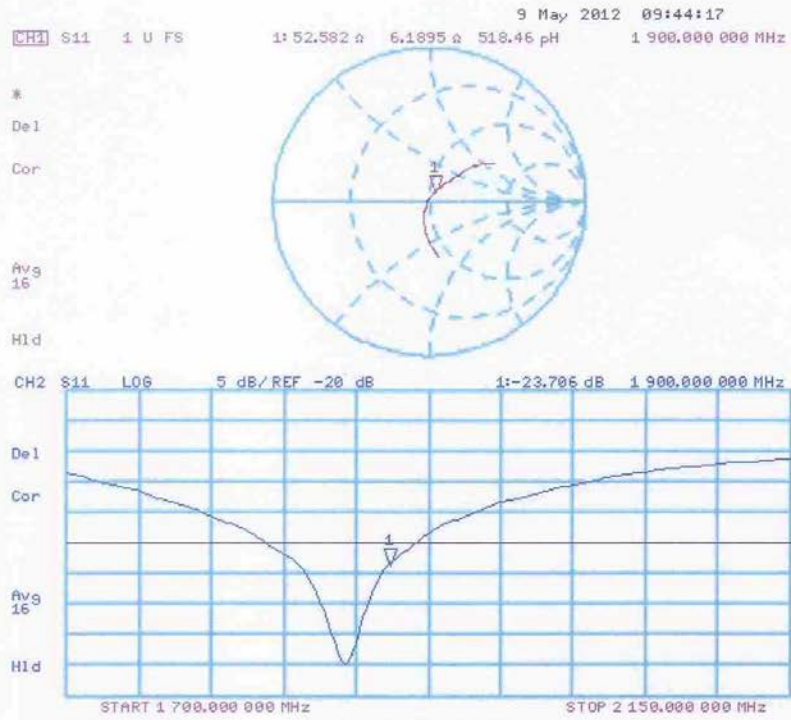



**DASY5 Validation Report for Body TSL**

Date: 04.05.2012

Test Laboratory: SPEAG, Zurich, Switzerland

**DUT: Dipole 1900 MHz; Type: D1900V2; Serial: D1900V2 - SN: 541**

Communication System: CW; Frequency: 1900 MHz

Medium parameters used:  $f = 1900$  MHz;  $\sigma = 1.52$  mho/m;  $\epsilon_r = 52.9$ ;  $\rho = 1000$  kg/m<sup>3</sup>

Phantom section: Flat Section

Measurement Standard: DASY5 (IEEE/IEC/ANSI C63.19-2007)

DASY52 Configuration:

- Probe: ES3DV3 - SN3205; ConvF(4.62, 4.62, 4.62); Calibrated: 30.12.2011;
- Sensor-Surface: 3mm (Mechanical Surface Detection)
- Electronics: DAE4 Sn601; Calibrated: 04.07.2011
- Phantom: Flat Phantom 5.0 (back); Type: QD000P50AA; Serial: 1002
- DASY52 52.8.1(838); SEMCAD X 14.6.5(6469)

**Dipole Calibration for Body Tissue/Pin=250 mW, d=10mm/Zoom Scan (7x7x7)/Cube 0:**

Measurement grid: dx=5mm, dy=5mm, dz=5mm

Reference Value = 95.165 V/m; Power Drift = -0.01 dB

Peak SAR (extrapolated) = 17.442 mW/g

**SAR(1 g) = 10 mW/g; SAR(10 g) = 5.33 mW/g**

Maximum value of SAR (measured) = 12.7 mW/g

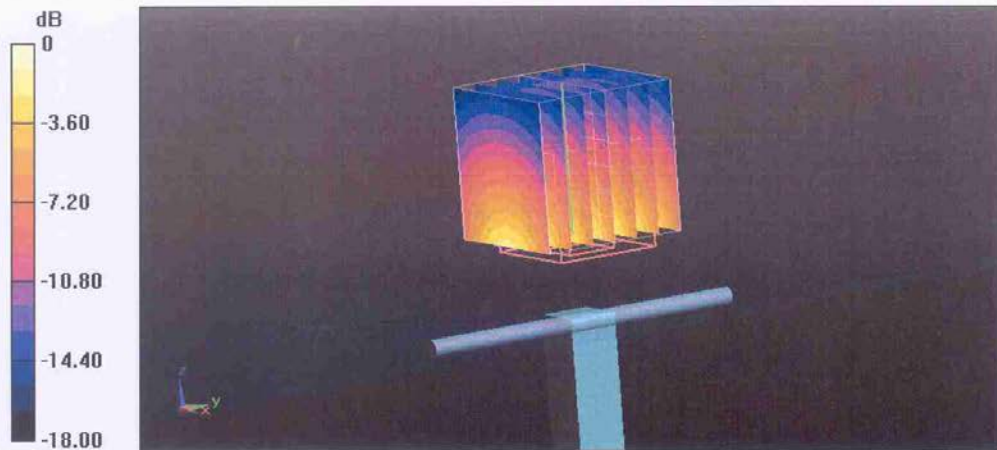

0 dB = 12.7 mW/g = 22.08 dB mW/g

### Impedance Measurement Plot for Body TSL

4 May 2012 17:14:11  
 CH1 S11 1 U FS 1: 48.572  $\Omega$  6.8672  $\Omega$  575.24 pF 1.900.000 000 MHz

\*  
 De1  
 Cor

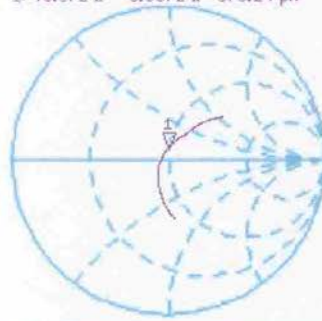

Avg  
 16

H1d

CH2 S11 L06 5 dB/REF -20 dB 1: -22.978 dB 1.900.000 000 MHz

Cor

Avg  
 16

H1d

