



# SAR TEST REPORT

HCT CO., LTD

EUT Type:	PCS CDMA Phone with Bluetooth/WLAN	
FCC ID:	RAD285	
Model:	Walleye	
Date of Issue:	May 11, 2012	
Test report No.:	HCTA1205FS04	
Test Laboratory:	<b>HCT CO., LTD.</b> 105-1, Jangam-ri, Majang-myeon, Icheon-si, Gyeonggi-do, Korea 467-811 TEL: +82 31 645 6485 FAX: +82 31 645 6401	
Applicant :	<b>TCT MOBILE LIMITED.</b> 5F, E building, No.232, Liang Jing Road, ZhangJiang High-Tech Park, Pudong Area.	
Testing has been carried out in accordance with:	RSS-102 Issue 4; Health Canada Safety Code 6 47CFR §2.1093 FCC OET Bulletin 65(Edition 97-01), Supplement C (Edition 01-01) ANSI/ IEEE C95.1 – 1992 IEEE 1528-2003	
Test result:	The tested device complies with the requirements in respect of all parameters subject to the test. The test results and statements relate only to the items tested. The test report shall not be reproduced except in full, without written approval of the laboratory.	
Signature	 <hr/> Report prepared by : Young-Soo Jang Test Engineer of SAR Part	 <hr/> Approved by : Jae-Sang So Manager of SAR Part

---

# Table of Contents

---

1. INTRODUCTION .....	3
2. DESCRIPTION OF DEVICE.....	4
3. DESCRIPTION OF TEST EQUIPMENT .....	5
4. SAR MEASUREMENT PROCEDURE .....	1 2
5. DESCRIPTION OF TEST POSITION.....	1 3
5.1 HEAD POSITION .....	1 3
5.2 Body Holster/Belt Clip Configurations .....	1 4
6. MEASUREMENT UNCERTAINTY .....	1 5
7. ANSI/ IEEE C95.1 - 1992 RF EXPOSURE LIMITS.....	1 6
8. SYSTEM VERIFICATION .....	1 7
8.1 Tissue Verification .....	1 7
8.2 System Validation.....	1 7
8.3 System Validation Procedure .....	1 7
9. RF CONDUCTED POWER MEASUREMENT .....	1 8
10. Antenna Information.....	2 3
11. SAR Evaluation Considerations for Handsets with Multiple Transmitters and Antennas .....	2 4
12. SAR TEST DATA SUMMARY .....	2 6
12.1 Measurement Results (PCS1900 Head SAR) .....	2 6
12.2 Measurement Results (802.11b/g/n Head).....	2 7
12.3 Measurement Results (PCS1900 Body-worn SAR).....	2 8
12.4 Measurement Results (802.11b Body-worn SAR) .....	2 9
13. CONCLUSION .....	3 0
14. REFERENCES .....	3 1
Attachment 1. – SAR Test Plots.....	3 2
Attachment 2. – Dipole Validation Plots.....	5 4
Attachment 3. – Probe Calibration Data .....	6 5
Attachment 4. – Dipole Calibration Data .....	7 9

# 1. INTRODUCTION

The FCC has adopted the guidelines for evaluating the environmental effects of radio frequency radiation in ET Docket 93-62 on Aug. 6, 1996 to protect the public and workers from the potential hazards of RF emissions due to FCC-regulated portable devices.

The safety limits used for the environmental evaluation measurements are based on the criteria published by the American National Standards Institute (ANSI) for localized specific absorption rate (SAR) in IEEE/ANSI C95.1-2005 Standard for Safety Levels with Respect to Human Exposure to Radio Frequency Electromagnetic Fields, 3 kHz to 300 GHz. 1992 by the Institute of Electrical and Electronics Engineers, Inc., New York, New York 10017. The measurement procedure described in IEEE/ANSI C95.3-1992 Recommended Practice for the Measurement of Potentially Hazardous Electromagnetic Fields - RF and Microwave is used for guidance in measuring SAR due to the RF radiation exposure from the Equipment Under Test (EUT). These criteria for SAR evaluation are similar to those recommended by the National Council on Radiation Protection and Measurements (NCRP) in Biological Effects and Exposure Criteria for Radio frequency Electromagnetic Fields,” NCRP Report No. 86 NCRP, 1986, Bethesda, MD 20814. SAR is a measure of the rate of energy absorption due to exposure to an RF transmitting source. SAR values have been related to threshold levels for potential biological hazards.

## SAR Definition

Specific Absorption Rate (SAR) is defined as the time derivative of the incremental electromagnetic energy (dW) absorbed by (dissipated in) an incremental mass (dm) contained in a volume element (dV) of a given density (ρ). It is also defined as the rate of RF energy absorption per unit mass at a point in an absorbing body.

$$SAR = \frac{d}{dt} \left( \frac{dU}{dm} \right) = \frac{d}{dt} \left( \frac{dU}{\rho dV} \right)$$

**Figure 2. SAR Mathematical Equation**

**SAR is expressed in units of Watts per Kilogram (W/kg).**

where:

$SAR$	=	$\sigma E^2 / \rho$
$\sigma$	=	conductivity of the tissue-simulant material (S/m)
$\rho$	=	mass density of the tissue-simulant material (kg/m <sup>3</sup> )
$E$	=	Total RMS electric field strength (V/m)

NOTE: The primary factors that control rate of energy absorption were found to be the wavelength of the incident field in relations to the dimensions and geometry of the irradiated organism, the orientation of the organism in relation to the polarity of field vectors, the presence of reflecting surfaces, and whether conductive contact is made by the organism with a ground plane.

## 2. DESCRIPTION OF DEVICE

Environmental evaluation measurements of specific absorption rate (SAR) distributions in emulated human head and body tissues exposed to radio frequency (RF) radiation from wireless portable devices for compliance with the rules and regulations of the U.S. Federal Communications Commission (FCC).

EUT Type:	PCS CDMA Phone with Bluetooth/ WLAN		
FCC ID:	RAD285		
Model:	Walleye	Marketing name	Juke-A556C
Trade Name	TCT MOBILE LIMITED	Serial Number(s)	#1
Application Type	Certification		
Mode(s) of Operation	PCS1900/ 802.11b/g/n		
Tx Frequency	1 851.25 MHz - 1 908.75 MHz (PCS CDMA) 2402 MHz - 2480 MHz (Bluetooth) 2 412- 2 462 MHz (WLAN)		
Rx Frequency	1 931.25 MHz - 1 988.75 MHz (PCS CDMA) 2402 MHz - 2480 MHz (Bluetooth) 2 412- 2 462 MHz (WLAN)		
FCC Classification	Licensed Portable Transmitter Held to Ear (PCE)		
Production Unit or Identical Prototype	Prototype		
Max SAR	Band	1g SAR (W/kg)	
		Head	Body-worn
	PCS1900	1.17	0.617
	802.11b	0.139	0.029
Date(s) of Tests	May 8, 2012 ~ May 9, 2012		
HW version	V3A	SW version	VI49
MEID	270 113 178 406 841 504		
Antenna Type	Integral Antenna		

## 3. DESCRIPTION OF TEST EQUIPMENT

### 3.1 SAR MEASUREMENT SETUP

These measurements are performed using the DASY4 automated dosimetric assessment system. It is made by Schmid & Partner Engineering AG (SPEAG) in Zurich, Switzerland. It consists of high precision robotics system (Staubli), robot controller, Pentium III computer, near-field probe, probe alignment sensor, and the generic twin phantom containing the brain equivalent material. The robot is a six-axis industrial robot performing precise movements to position the probe to the location (points) of maximum electromagnetic field (EMF) (see Figure.3.1).

A cell controller system contains the power supply, robot controller, teach pendant (Joystick), and remote control, is used to drive the robot motors. The PC consists of the HP Pentium IV 3.0 GHz computer with Windows XP system and SAR Measurement Software DASY4, A/D interface card, monitor, mouse, and keyboard. The Staubli Robot is connected to the cell controller to allow software manipulation of the robot. A data acquisition electronic (DAE) circuit performs the signal amplification, signal multiplexing, AD-conversion, offset measurements, mechanical surface detection, collision detection, etc. is connected to the Electro-optical coupler (EOC). The EOC performs the conversion from the optical into digital electric signal of the DAE and transfers data to the PC plug-in card.

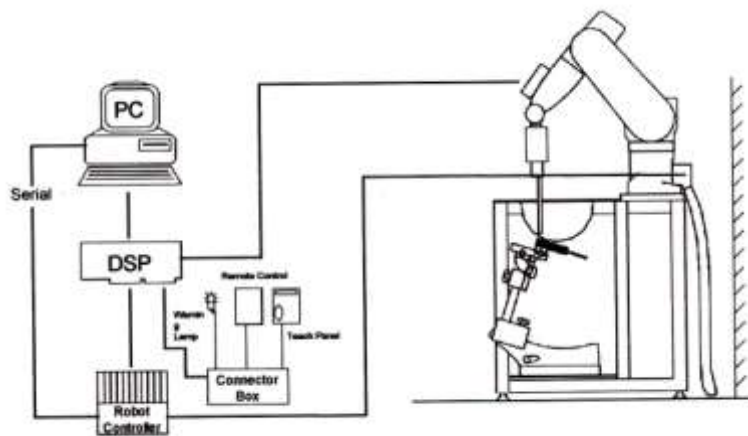

Figure 3.1 HCT SAR Lab. Test Measurement Set-up

The DAE4 consists of a highly sensitive electrometer-grade preamplifier with auto-zeroing, a channel and gain-switching multiplexer, a fast 16 bit AD-converter and a command decoder and control logic unit. Transmission to the PC-card is accomplished through an optical downlink for data and status information and an optical uplink for commands and clock lines. The mechanical probe mounting device includes two different sensor systems for frontal and sidewise probe contacts. They are also used for mechanical surface detection and probe collision detection. The robot uses its own controller with a built in VME-bus computer. The system is described in detail in.

## 3.2 DASY4 E-FIELD PROBE SYSTEM

### 3.2.1 ET3DV6 Probe Specification

Construction	Symmetrical design with triangular core Built-in optical fiber for surface detection System Built-in shielding against static charges
Calibration	In air from 10 MHz to 2.5 GHz In brain and muscle simulating tissue at Frequencies of 450 MHz, 900 MHz and 1.8 GHz (accuracy: 8 %)
Frequency	10 MHz to > 6 GHz; Linearity: $\pm 0.2$ dB (30 MHz to 3 GHz)
Directivity	$\pm 0.2$ dB in brain tissue (rotation around probe axis) $\pm 0.4$ dB in brain tissue (rotation normal probe axis)
Dynamic	5 $\mu$ W/g to > 100 mW/g;
Range Linearity:	$\pm 0.2$ dB
Surface Detection	$\pm 0.2$ mm repeatability in air and clear liquids over diffuse reflecting surfaces.
Dimensions	Overall length: 330 mm Tip length: 16 mm Body diameter: 12 mm Tip diameter: 6.8 mm Distance from probe tip to dipole centers: 2.7 mm
Application	General dissymmetry up to 3 GHz Compliance tests of mobile phones Fast automatic scanning in arbitrary phantoms



Figure 3.2 Photograph of the probe

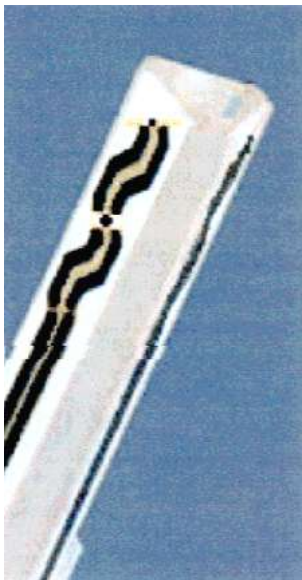

Figure 3.3 ET3DV6 E-field Probe

The SAR measurements were conducted with the dosimetric probe ET3DV6, designed in the classical triangular configuration and optimized for dosimetric evaluation. The probe is constructed using the thick film technique; with printed resistive lines on ceramic substrates. The probe is equipped with an optical multifiber line ending at the front of the probe tip. It is connected to the EOC box on the robot arm and provides an automatic detection of the phantom surface. Half of the fibers are connected to a pulsed infrared transmitter, the other half to a synchronized receiver. As the probe approaches the surface, the reflection from the surface produces a coupling from the transmitting to the receiving fibers. This reflection increases first during the approach, reaches a maximum and then decreases. If the probe is flatly touching the surface, the coupling is zero. The distance of the coupling maximum to the surface is independent of the surface reflectivity and largely independent of the surface to probe angle. The DASY4 software reads the reflection during a software approach and looks for the maximum using a 2<sup>nd</sup> order fitting. The approach is stopped at reaching the maximum.

### 3.3 PROBE CALIBRATION PROCESS

#### 3.3.1 E-Probe Calibration

Each probe is calibrated according to a dosimetric assessment procedure with an accuracy better than ± 10 %. The spherical isotropy was evaluated with the proper procedure and found to be better than ± 0.25 dB. The sensitivity parameters (NormX, NormY, NormZ), the diode compression parameter (DCP) and the conversion factor (ConvF) of the probe is tested.

The free space E-field from amplified probe outputs is determined in a test chamber. This is performed in a TEM cell for frequencies below 1 GHz, and in a waveguide above 1 GHz for free space. For the free space calibration, the probe is placed in the volumetric center of the cavity and at the proper orientation with the field. The probe is then rotated 360 degrees.

E-field temperature correlation calibration is performed in a flat phantom filled with the appropriate simulated brain tissue. The measured free space E-field in the medium correlates to temperature rise in a dielectric medium. For temperature correlation calibration a RF transparent thermistor-based temperature probe is used in conjunction with the E-field probe.

$$SAR = C \frac{\Delta T}{\Delta t}$$

where:

- Δt = exposure time (30 seconds),
- C = heat capacity of tissue (brain or muscle),
- ΔT = temperature increase due to RF exposure.

SAR is proportional to ΔT/ Δt, the initial rate of tissue heating, before thermal diffusion takes place. Now it's possible to quantify the electric field in the simulated tissue by equating the thermally derived SAR to the E- field;

$$SAR = \frac{|E|^2 \cdot \sigma}{\rho}$$

where:

- σ = simulated tissue conductivity,
- ρ = Tissue density (1.25 g/cm<sup>3</sup> for brain tissue)

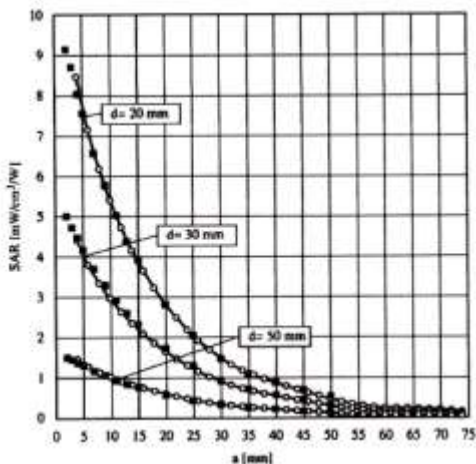

Figure 3.4 E-Field and Temperature measurements at 900 MHz

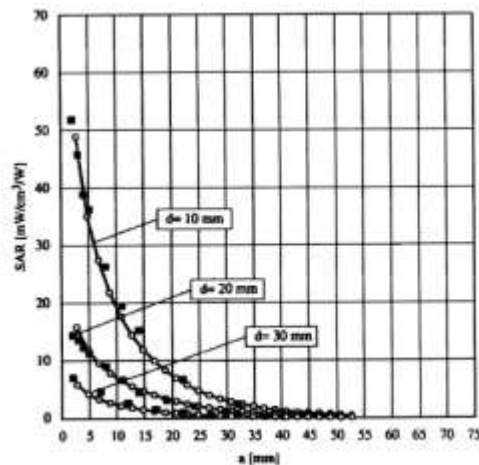

Figure 3.5 E-Field and temperature measurements at 1.8 GHz

### 3.3.2 Data Extrapolation

The DASY4 software automatically executes the following procedures to calculate the field units from the microvolt readings at the probe connector. The first step of the evaluation is a linearization of the filtered input signal to account for the compression characteristics of the detector diode. The compensation depends on the input signal, the diode type and the DC-transmission factor from the diode to the evaluation electronics. If the exciting field is pulsed, the crest factor of the signal must be known to correctly compensate for peak power. The formula for each channel can be given like below;

$$V_i = U_i + U_i^2 \cdot \frac{cf}{dcp_i}$$

with  $V_i$  = compensated signal of channel i (i=x,y,z)  
 $U_i$  = input signal of channel i (i=x,y,z)  
 $cf$  = crest factor of exciting field (DASY parameter)  
 $dcp_i$  = diode compression point (DASY parameter)

From the compensated input signals the primary field data for each channel can be evaluated:

E-field probes:

$$E_i = \sqrt{\frac{V_i}{Norm_i \cdot ConvF}}$$

with  $V_i$  = compensated signal of channel i (i = x,y,z)  
 $Norm_i$  = sensor sensitivity of channel i (i = x,y,z)  
 $\mu V/(V/m)^2$  for E-field probes  
 $ConvF$  = sensitivity of enhancement in solution  
 $E_i$  = electric field strength of channel i in V/m

The RSS value of the field components gives the total field strength (Hermetian magnitude):

$$E_{tot} = \sqrt{E_x^2 + E_y^2 + E_z^2}$$

The primary field data are used to calculate the derived field units.

$$SAR = E_{tot}^2 \cdot \frac{\sigma}{\rho \cdot 1000}$$

with  $SAR$  = local specific absorption rate in W/g  
 $E_{tot}$  = total field strength in V/m  
 $\sigma$  = conductivity in [mho/m] or [Siemens/m]  
 $\rho$  = equivalent tissue density in g/cm<sup>3</sup>

The power flow density is calculated assuming the excitation field to be a free space field.

$$P_{free} = \frac{E_{tot}^2}{3770}$$

with  $P_{free}$  = equivalent power density of a plane wave in W/cm<sup>2</sup>  
 $E_{tot}$  = total electric field strength in V/m



### 3.4 SAM Phantom

The shell corresponds to the specifications of the Specific Anthropomorphic Mannequin (SAM) phantom defined in IEEE 1528 and IEC 62209-1. It enables the dosimetric evaluation of left and right hand phone usage as well as body mounted usage at the flat phantom region. A cover prevents evaporation of the liquid. Reference markings on the phantom allow the complete setup of all predefined phantom positions and measurement grids by teaching three points with the robot.



Figure 3.6 SAM Phantom

Shell Thickness	2.0 mm
Filling Volume	about 25 L
Dimensions	1 000 mm x 500 mm (L x W)

### 3.5 Device Holder for Transmitters

In combination with the SAM Phantom V 4.0, the Mounting Device (POM) enables the rotation of the mounted transmitter in spherical coordinates whereby the rotation points is the ear opening. The devices can be easily, accurately, and repeatably positioned according to the FCC and CENELEC specifications. The device holder can be locked at different phantom locations (left head, right head, flat phantom).

Note: A simulating human hand is not used due to the complex anatomical and geometrical structure of the hand that may produce an infinite number of configurations. To produce the Worst-case condition (the hand absorbs antenna output power), the hand is omitted during the tests.



Figure 3.7 Device Holder

### 3.6 Brain & Muscle Simulating Mixture Characterization

The brain and muscle mixtures consist of a viscous gel using hydrox-ethyl cellulose (HEC) gelling agent and saline solution (see Table 3.1). Preservation with a bactericide is added and visual inspection is made to make sure air bubbles are not trapped during the mixing process. The mixture is calibrated to obtain proper dielectric constant (permittivity) and conductivity of the desired tissue. The mixture characterizations used for the brain and muscle tissue simulating liquids are according to the data by C. Gabriel and G. Hartsgrove.

Ingredients (% by weight)	Frequency (MHz)									
	450		835		915		1 900		2 450	
Tissue Type	Head	Body	Head	Body	Head	Body	Head	Body	Head	Body
Water	38.56	51.16	41.45	52.4	41.05	56.0	54.9	40.4	62.7	73.2
Salt (NaCl)	3.95	1.49	1.45	1.4	1.35	0.76	0.18	0.5	0.5	0.04
Sugar	56.32	46.78	56.0	45.0	56.5	41.76	0.0	58.0	0.0	0.0
HEC	0.98	0.52	1.0	1.0	1.0	1.21	0.0	1.0	0.0	0.0
Bactericide	0.19	0.05	0.1	0.1	0.1	0.27	0.0	0.1	0.0	0.0
Triton X-100	0.0	0.0	0.0	0.0	0.0	0.0	0.0	0.0	36.8	0.0
DGBE	0.0	0.0	0.0	0.0	0.0	0.0	44.92	0.0	0.0	26.7

Salt: 99 % Pure Sodium Chloride                      Sugar: 98 % Pure Sucrose  
 Water: De-ionized, 16M resistivity                      HEC: Hydroxyethyl Cellulose  
 DGBE: 99 % Di(ethylene glycol) butyl ether,[2-(2-butoxyethoxy) ethanol]  
 Triton X-100(ultra pure): Polyethylene glycol mono[4-(1,1,3,3-tetramethylbutyl)phenyl] ether

**Table 3.1 Composition of the Tissue Equivalent Matter**

### 3.7 SAR TEST EQUIPMENT

Manufacturer	Type / Model	S/N	Calib. Date	Calib.Interval	Calib.Due
SPEAG	SAM Phantom	-	N/A	N/A	N/A
Staubli	Robot RX90L	F01/5K09A1/A/01	N/A	N/A	N/A
Staubli	Robot ControllerCS7MB	F99/5A82A1/C/01	N/A	N/A	N/A
HP	Pavilion t000_puffer	KRJ51201TV	N/A	N/A	N/A
SPEAG	Light Alignment Sensor	265	N/A	N/A	N/A
Staubli	Teach Pendant (Joystick)	D221340.01	N/A	N/A	N/A
SPEAG	DAE3	446	Sep. 27, 2011	Annual	Sep. 27, 2012
SPEAG	E-Field Probe ET3DV6	1630	Nov. 18, 2011	Annual	Nov. 18, 2012
SPEAG	Validation Dipole D1900V2	5d032	July 22, 2011	Annual	July 22, 2012
SPEAG	Validation Dipole D2450V2	743	Aug. 29, 2011	Annual	Aug. 29, 2012
Agilent	Power Meter(F) E4419B	MY41291386	Nov. 04, 2011	Annual	Nov. 04, 2012
Agilent	Power Sensor(G) 8481	MY41090870	Nov. 04, 2011	Annual	Nov. 04, 2012
HP	Dielectric Probe Kit 85070C	00721521	N/A	N/A	N/A
HP	Dual Directional Coupler	16072	Nov. 04, 2011	Annual	Nov. 04, 2012
R&S	Base Station CMU200	110740	July 26, 2011	Annual	July 26, 2012
Agilent	Base Station E5515C	GB44400269	Feb. 10, 2012	Annual	Feb. 10, 2013
HP	Signal Generator E4438C	MY42082646	Nov. 11, 2011	Annual	Nov. 11, 2012
HP	Network Analyzer 8753ES	JP39240221	Apr. 3, 2012	Annual	Apr. 3, 2013
R&S	Base Station CMW500	101901	Aug.5,2011	Annual	Aug. 5,2012

**NOTE:**

The E-field probe was calibrated by SPEAG, by the waveguide technique procedure. Dipole Validation measurement is performed by HCT Lab. before each test. The brain simulating material is calibrated by HCT using the dielectric probe system and network analyzer to determine the conductivity and permittivity (dielectric constant) of the brain-equivalent material.

## 4. SAR MEASUREMENT PROCEDURE

---

The evaluation was performed with the following procedure:

1. The SAR value at a fixed location above the ear point was measured and was used as a reference value for assessing the power drop.
2. The SAR distribution at the exposed side of the head was measured at a distance of 3.9 mm from the inner surface of the shell. The area covered the entire dimension of the head and the horizontal grid spacing was 20 mm x 20 mm. Based on this data, the area of the maximum absorption was determined by spline interpolation.
3. Around this point, a volume of 32 mm x 32 mm x 30 mm was assessed by measuring 5 x 5 x 7 points. On this basis of this data set, the spatial peak SAR value was evaluated with the following procedure:
  - a. The data at the surface were extrapolated, since the center of the dipoles is 2.7 mm away from the tip of the probe and the distance between the surface and the lowest measuring point is 1.2 mm. The extrapolation was based on a least square algorithm. A polynomial of the fourth order was calculated through the points in z-axes. This polynomial was then used to evaluate the points between the surface and the probe tip.
  - b. The maximum interpolated value was searched with a straight-forward algorithm. Around this maximum the SAR values averaged over the spatial volumes (1 g or 10 g) were computed using the 3D-Spline interpolation algorithm. The 3D-spline is composed of three one-dimensional splines with the "Not a knot" condition (in x, y, and z directions. The volume was integrated with the trapezoidal algorithm. One thousand points (10 x 10 x 10) were interpolated to calculate the average.
  - c. All neighboring volumes were evaluated until no neighboring volume with a higher average value was found.
4. The SAR value, at the same location as procedure #1, was re-measured. If the value changed by more than 5 %, the evaluation is repeated.

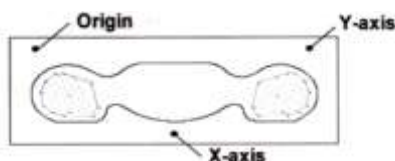

Figure 4.1 SAR Measurement Point in Area Scan

## 5. DESCRIPTION OF TEST POSITION

### 5.1 HEAD POSITION

The device was placed in a normal operating position with the Point A on the device, as illustrated in following drawing, aligned with the location of the RE(ERP) on the phantom. With the ear-piece pressed against the head, the vertical center line of the body of the handset was aligned with an imaginary plane consisting of the RE, LE and M. While maintaining these alignments, the body of the handset was gradually moved towards the cheek until any point on the mouth-piece or keypad contacted the cheek. This is a cheek/touch position. For ear/tilt position, while maintain the device aligned with the BM and FN lines, the device was pivot against ERP back for 15° or until the device antenna touch the phantom. Please refer to IEEE 1528-2003 illustration below.

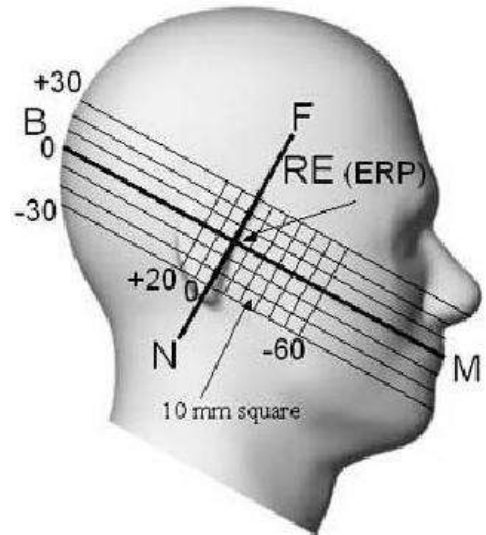

Figure 5.1 Side view of the phantom

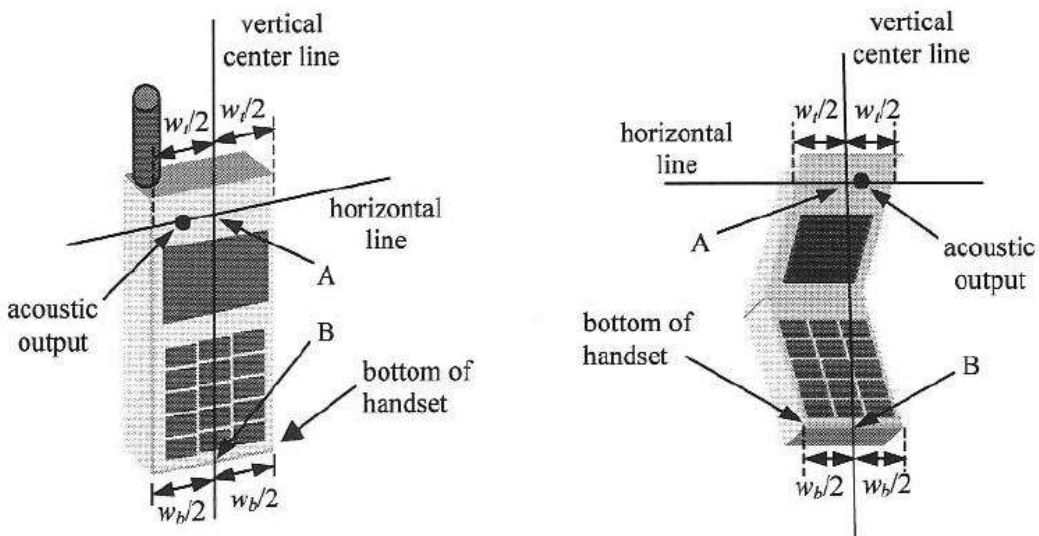

Figure 5.2 Handset vertical and horizontal reference lines

## **5.2 Body Holster/Belt Clip Configurations**

Body-worn operating configurations are tested with the belt-clips and holsters attached to the device and positioned against a flat phantom in a normal use configuration. A device with a headset output is tested with a headset connected to the device. Body dielectric parameters are used.

Accessories for Body-worn operation configurations are divided into two categories: those that do not contain metallic components and those that contain metallic components. When multiple accessories that do not contain metallic components are supplied with the device, the device is tested with only the accessory that dictates the closest spacing to the body. Then multiple accessories that contain metallic components are tested with each accessory. If multiple accessory share an identical metallic component (i.e. the same metallic belt-clip used with different holsters with no other metallic components) only the accessory that dictates the closest spacing to the body is tested.

Body-worn accessories may not always be supplied or available as options for some Devices intended to be authorized for body-worn use. In this case, a test configuration with a separation distance between the back of the device and the flat phantom is used.

Since this EUT does not supply any body worn accessory to the end user a distance of 2.0 cm from the EUT back surface to the liquid interface is configured for the generic test.

"See the Test SET-UP Photo"

Transmitters that are designed to operate in front of a person's face, as in push-to-talk configurations, are tested for SAR compliance with the front of the device positioned to face the flat phantom. For devices that are carried next to the body such as a shoulder, waist or chest-worn transmitters, SAR compliance is tested with the accessory(ies), including headsets and microphones, attached to the device and positioned against a flat phantom in a normal use configuration.

In all cases SAR measurements are performed to investigate the worst-case positioning. Worstcase positioning is then documented and used to perform Body SAR testing.

## 6. MEASUREMENT UNCERTAINTY

Error Description	Tol (± %)	Prob. dist.	Div.	$c_i$	Standard Uncertainty (± %)	$V_{eff}$
<b>1. Measurement System</b>						
Probe Calibration	6.00	N	1	1	6.00	∞
Axial Isotropy	4.70	R	1.73	0.7	1.90	∞
Hemispherical Isotropy	9.60	R	1.73	0.7	3.88	∞
Boundary Effects	1.00	R	1.73	1	0.58	∞
Linearity	4.70	R	1.73	1	2.71	∞
System Detection Limits	1.00	R	1.73	1	0.58	∞
Readout Electronics	0.30	N	1.00	1	0.30	∞
Response Time	0.8	R	1.73	1	0.46	∞
Integration Time	2.6	R	1.73	1	1.50	∞
RF Ambient Conditions	3.00	R	1.73	1	1.73	∞
Probe Positioner	0.40	R	1.73	1	0.23	∞
Probe Positioning	2.90	R	1.73	1	1.67	∞
Max SAR Eval	1.00	R	1.73	1	0.58	∞
<b>2. Test Sample Related</b>						
Device Positioning	2.90	N	1.00	1	2.90	145
Device Holder	3.60	N	1.00	1	3.60	5
Power Drift	5.00	R	1.73	1	2.89	∞
<b>3. Phantom and Setup</b>						
Phantom Uncertainty	4.00	R	1.73	1	2.31	∞
Liquid Conductivity(target)	5.00	R	1.73	0.64	1.85	∞
Liquid Conductivity(meas.)	2.07	N	1	0.64	1.32	9
Liquid Permittivity(target)	5.00	R	1.73	0.6	1.73	∞
Liquid Permittivity(meas.)	5.02	N	1	0.6	3.01	9
<b>Combine Standard Uncertainty</b>					11.13	
<b>Coverage Factor for 95 %</b>					$k = 2$	
<b>Expanded STD Uncertainty</b>					22.25	

Table 6.1 Uncertainty (800 MHz- 2450 MHz)

## 7. ANSI/ IEEE C95.1 - 1992 RF EXPOSURE LIMITS

HUMAN EXPOSURE	UNCONTROLLED ENVIRONMENT General Population (W/kg) or (mW/g)	CONTROLLED ENVIRONMENT Occupational (W/kg) or (mW/g)
SPATIAL PEAK SAR * (Brain)	1.60	8.00
SPATIAL AVERAGE SAR ** (Whole Body)	0.08	0.40
SPATIAL PEAK SAR *** (Hands / Feet / Ankle / Wrist)	4.00	20.00

**Table 7.1 Safety Limits for Partial Body Exposure**

**NOTES:**

\* The Spatial Peak value of the SAR averaged over any 1 g of tissue (defined as a tissue volume in the shape of a cube) and over the appropriate averaging time.

\*\* The Spatial Average value of the SAR averaged over the whole-body.

\*\*\* The Spatial Peak value of the SAR averaged over any 10 g of tissue (defined as a tissue volume in the shape of a cube) and over the appropriate averaging time.

**Uncontrolled Environments** are defined as locations where there is the exposure of individuals who have no knowledge or control of their exposure.

**Controlled Environments** are defined as locations where there is exposure that may be incurred by persons who are aware of the potential for exposure, (i.e.as a result of employment or occupation).



## 8. SYSTEM VERIFICATION

### 8.1 Tissue Verification

Freq. [MHz]	Date	Liquid	Liquid Temp.[°C]	Parameters	Target Value	Measured Value	Deviation [%]	Limit [%]
1 900	May 8, 2012	Head	21.1	$\epsilon r$	40.0	39.1	- 2.25	$\pm 5$
				$\sigma$	1.40	1.39	- 0.71	$\pm 5$
1 900	May 8, 2012	Body		$\epsilon r$	53.3	53.5	+ 0.38	$\pm 5$
				$\sigma$	1.52	1.49	- 1.97	$\pm 5$
2 450	May 9, 2012	Head	21.1	$\epsilon r$	39.7	38.5	- 3.02	$\pm 5$
				$\sigma$	1.84	1.87	+ 1.63	$\pm 5$
2 450	May 9, 2012	Body		$\epsilon r$	52.7	51.7	- 1.90	$\pm 5$
				$\sigma$	1.95	1.89	- 3.08	$\pm 5$

The Tissue dielectronic parameters were measured prior to the SAR evaluation using an Agilent 85070C Dielectronic Probe Kit and Agilent Network Analyzer.

### 8.2 System Validation

Prior to assessment, the system is verified to the  $\pm 10\%$  of the specifications at 1900 MHz / 2 450 MHz by using the system validation kit. (Graphic Plots Attached)

Freq. [MHz]	Date	Probe (SN)	Liquid	Amb. Temp. [°C]	Liquid Temp. [°C]	1 W Target SAR <sub>1g</sub> (SPEAG) (mW/g)	Measured SAR <sub>1g</sub> (mW/g)	1 W Normalized SAR <sub>1g</sub> (mW/g)	Deviation [%]	Limit [%]
1 900	May 8, 2012	1630	Head	21.3	21.1	39.9	4.03	40.3	+ 1.00	$\pm 10$
	May 8, 2012		Body							
2 450	May 9, 2012		Head	21.3	21.1	53.8	5.32	53.2	- 1.12	$\pm 10$
	May 9, 2012		Body							

### 8.3 System Validation Procedure

SAR measurement was prior to assessment, the system is verified to the  $\pm 10\%$  of the specifications at each frequency band by using the system validation kit. (Graphic Plots Attached)

- Cabling the system, using the validation kit equipments.
- Generate about 100 mW Input Level from the Signal generator to the Dipole Antenna.
- Dipole Antenna was placed below the Flat phantom.
- The measured one-gram SAR at the surface of the phantom above the dipole feed-point should be within 10 % of the target reference value.
- The results are normalized to 1 W input power.

Note;

SAR Verification was performed according to the FCC KDB 450824.

## 9. RF CONDUCTED POWER MEASUREMENT

Power measurements were performed using a base station simulator under digital average power. The handset was placed into a simulated call using a base station simulator in a shielded chamber. Such test signals offer a consistent means for testing SAR and are recommended for evaluation SAR. SAR measurements were taken with a fully charged battery. In order to verify that the device was tested and maintained at full power, this was configured with the base station simulator. The SAR measurement Software calculates a reference point at the start and end of the test to check for power drifts. If conducted Power deviations of more than 5 % occurred, the tests were repeated.

Conducted output power measurements were performed using a base station simulator under digital average power.



SAR Test for WWAN were performed with a base station simulator Agilent E5515C. Communication between the device and the emulator was established by air link. Set base station emulator to allow DUT to radiate maximum output power during all tests.

### 9.1 CDMA & EVDO

#### 9.1.1 Output Power Verification

See 3GPP2 C.S0011/TIA-98-E as recommended by "SAR Measurement Procedures for 3G Devices", May 2006. MMaximum output power is verified on the High, Middle and Low channels according to procedures defined in section 4.4.5.2 of 3GPP2 C.S0011/TIA-98-E. SO55 tests were measured with power control bits in "All Up" condition.

1. If the mobile station supports Reverse TCH RC 1 and Forward TCH RC 1, set up a call using Fundamental Channel Test Mode 1 (RC=1/1) with 9 600 bps data rate only.
2. Under RC1, C.S0011 Table 4.4.5.2-1 (Table 9.1) parameters were applied.
3. If the MS supports the RC 3 Reverse FCH, RC3 Reverse SCH0 and demodulation of RC 3, 4, or 5, set up a call using Supplemental Channel Test Mode 3 (RC 3/3) with 9 600 bps Fundamental Channel and 9 600 bps SCH0 data rate Channel and 9 600 bps SCH0 data rate.
4. Under RC3, C.S0011 Table 4.4.5.2-2(Table 9.2) was applied.
5. FCHs were configured at full rate for mMaximum SAR with "All Up" power control bits.

Parameters for Max. Power for RC1

Parameter	Units	Value
$\frac{I_{or}}{I_{or}}$	dBm/1.23 MHz	-104
$\frac{Pilot E_c}{I_{or}}$	dB	-7
$\frac{Traffic E_c}{I_{or}}$	dB	-7.4

Table 9.1

Parameters for Max. Power for RC3

Parameter	Units	Value
$\frac{I_{or}}{I_{or}}$	dBm/1.23 MHz	-86
$\frac{Pilot E_c}{I_{or}}$	dB	-7
$\frac{Traffic E_c}{I_{or}}$	dB	-7.4

Table 9.2

## 9.1.2 Head SAR Measurement

SAR for head exposure configurations is measured in RC3 with the DUT configured to transmit at full rate using Loopback Service Option SO55. SAR for RC1 is not required when the mMaximum average output of each channel is less than ¼ dB higher than that measured in RC3. Otherwise, SAR is measured on the mMaximum output channel in RC1 using the exposure configuration that results in the highest SAR for that channel in RC3.

## 9.1.3 Body SAR Measurement

SAR for body exposure configurations is measured in RC3 with the DUT configured to transmit at full rate on FCH with all other code channels disabled using TDSO / SO32. SAR for multiple code channels (FCH + SCHn) is not required when the mMaximum average output of each RF channel is less than ¼ dB higher than that measured with FCH only. Otherwise, SAR is measured on the mMaximum output channel (FCH + SCHn) with FCH at full rate and SCH0 enabled at 9 600 bps using the exposure configuration that results in the highest SAR for that channel with FCH only. When multiple code channels are enabled, the DUT output may shift by more than 0.5 dB and lead to higher SAR drifts and SCH dropouts.

Body SAR in RC1 is not required when the mMaximum average output of each channel is less than ¼ dB higher than that measured in RC3. Otherwise, SAR is measured on the mMaximum output channel in RC1; with Loopback Service Option SO55, at full rate, using the body exposure configuration that results in the highest SAR for that channel in RC3.

## 9.1.4 Handsets with EV-DO

For handsets with Ev-Do capabilities, when the mMaximum average output of each channel in Rev. 0 is less than ¼ dB higher than that measured in RC3 (1x RTT), body SAR for Ev-Do is not required. Otherwise, SAR for Rev. 0 is measured on the mMaximum output channel at 153.6 kbps using the body exposure configuration that results in the highest SAR for that channel in RC3. SAR for Rev. A is not required when the mMaximum average output of each channel is less than that measured in Rev. 0 or less than ¼ dB higher than that measured in RC3. Otherwise, SAR is measured on the mMaximum output channel for Rev. A using a Reverse Data Channel payload size of 4 096 bits and a Termination Target of 16 slots defined for Subtype 2 Physical Layer configurations. A Forward Traffic Channel data rate corresponding to the 2-slot version of 307.2 kbps with the ACK Channel transmitting in all slots should be configured in the downlink for both Rev. 0 and Rev. A.

### 9.1.4.1 EVDO Release 0 (RTAP)

Application Config > Enhanced Test Application Protocol > RTAP

RTAP Rate > 153.6 kbps

Protocol Rev > 0 (1x EVDO)

Power: All Up bits

### 9.1.4.2 EVDO Release 0 (FTAP)

Application Config > Enhanced Test Application Protocol > FTAP

RTAP Rate > 307.2 kbps

Protocol Rev > 0 (1x EVDO)

Power: All Up bits

### 9.1.4.3 EVDO Release A (RETAP)

Protocol Rev > A (1x EVDO A)

Application Config > Enhanced Test Application Protocol > RETAP

R-Data Pkt Size > 4096

Power: All Up bits

### 9.1.4.4 EVDO Release A (FETAP)

Protocol Rev > A (1x EVDO A)

Application Config > Enhanced Test Application Protocol > FETAP

F-Traffic Format > 4 (1024, 2, 128) Canonical (307.2k, QPSK)

Power: All Up bits

Band	Channel	SO2	SO2	SO55	SO55	TDSO SO32	1xEvDO Rev.O	1xEvDO Rev.O	1xEvDO Rev.A	1xEvDO Rev.A
		RC1/1 (dBm)	RC3/3 (dBm)	RC1/1 (dBm)	RC3/3 (dBm)	RC3/3 (dBm)	(FTAP)	(RTAP)	(FETAP)	(RETAP)
PCS	25	24.49	24.55	24.32	24.27	24.40	24.43	24.36	24.37	24.33
	600	24.25	24.42	24.44	24.48	24.37	24.24	24.36	24.14	24.11
	1175	24.48	24.42	24.48	24.51	24.35	24.21	24.22	24.17	24.18

Maximum Average Conducted output powers

## 9.2 WiFi

### 9.2.1 SAR Testing for 802.11a/b/g/n modes

#### General Device Setup

Normal Network operating configurations are not suitable for measuring the SAR of 802.11 a/b/g transmitters. Unpredictable fluctuations in network traffic and antenna diversity conditions can introduce undesirable variations in SAR results. The SAR for these devices should be measured using chipset based test mode software to ensure the results are consistent and reliable.

Chipset based test mode software is hardware dependent and generally varies among manufacturers. The device operating parameters established in test mode for SAR measurements must be identical to those programmed in production units, including output power levels, amplifier gain settings and other RF performance tuning parameters. The test frequencies should correspond to actual channel frequencies defined for domestic use. SAR for devices with switched diversity should be measured with only one antenna transmitting at a time during each SAR measurement, according to a fixed modulation and data rate. The same data pattern should be used for all measurements.

#### Frequency Channel Configurations

80.11 a/b/g and 4.9 GHz operating modes are tested independently according to the service requirements in each frequency band. 80.211 b/g modes are tested on channels 1, 6 and 11. 802.11a is tested for UNII operations on channels 36 and 48 in the 5.15-5.25 GHz band; channels 52 and 64 in the 5.25-5.35 GHz band; Channels 104, 116, 124 and 136 in the 5.470-5.725 GHz band; and channels 149 and 161 in the 5.8 GHz band. When 5.8 GHz § 15.247 is also available, channels 149, 157 and 165 should be tested instead of the UNII channels. 4.9 GHz is tested on channels 1, 10 and 5 or 6, whichever has the higher output power, for 5 MHz channels; channels 11, 15 and 19 for 10 MHz channels; and channels 21 and 25 for 20 MHz channels. These are referred to as the “default test channels”. 802.11g mode was evaluated only if the output power was 0.25 dB higher than the 802.11b mode.

Mode	GHz	Channel	Turbo Channel	"Default Test Channels"		
				§15.247 802.11b	802.11g	UNII
802.11 b/g	2.412	1		√	∇	
	2.437	6	6	√	∇	
	2.462	11		√	∇	
802.11a	5.18	36				√
	5.20	40	42 (5.21 GHz)			*
	5.22	44				*
	5.24	48	50 (5.25 GHz)			√
	5.26	52				√
	5.28	56	58 (5.29 GHz)			*
	5.30	60				*
	5.32	64				√
	5.500	100	Unknown			*
	5.520	104				√
	5.540	108				*
	5.560	112				*
	5.580	116				√
	5.600	120				*
	5.620	124				√
	5.640	128				*
5.660	132			*		
5.680	136			√		
5.700	140			*		
UNII or §15.247	5.745	149		√		√
	5.765	153	152 (5.76 GHz)		*	*
	5.785	157		√		*
	5.805	161	160 (5.80 GHz)		*	√
§15.247	5.825	165		√		

Band	Channel	Mbps (dBm)			
		1	2	5.5	11
IEEE 802.11b	1	14.68	14.87	15.02	14.52
	6	14.49	14.61	14.59	14.28
	11	14.30	14.51	14.55	14.10

Average IEEE 802.11b Conducted output power

Band	Channel	Mbps (dBm)							
		6	9	12	18	24	36	48	54
IEEE 802.11g	1	13.51	13.44	13.25	13.08	12.75	12.36	11.96	11.88
	6	13.45	13.41	13.16	13.00	12.71	12.44	12.06	11.82
	11	13.51	13.27	13.29	12.85	12.76	12.32	11.91	11.87

Average IEEE 802.11g Conducted output power

Band	Channel	Mbps (dBm)							
		6.5	13	20	26	39	52	58	65
IEEE 802.11n (HT-20)	1	12.82	12.55	12.41	12.15	11.87	11.40	11.34	11.19
	6	12.90	12.53	12.43	121.20	11.86	11.63	11.48	11.37
	11	12.87	12.62	12.45	12.34	11.79	11.50	11.18	11.04

Average IEEE 802.11n Conducted output power

## 10. Antenna Information

### 10.1 Antenna and Device Information

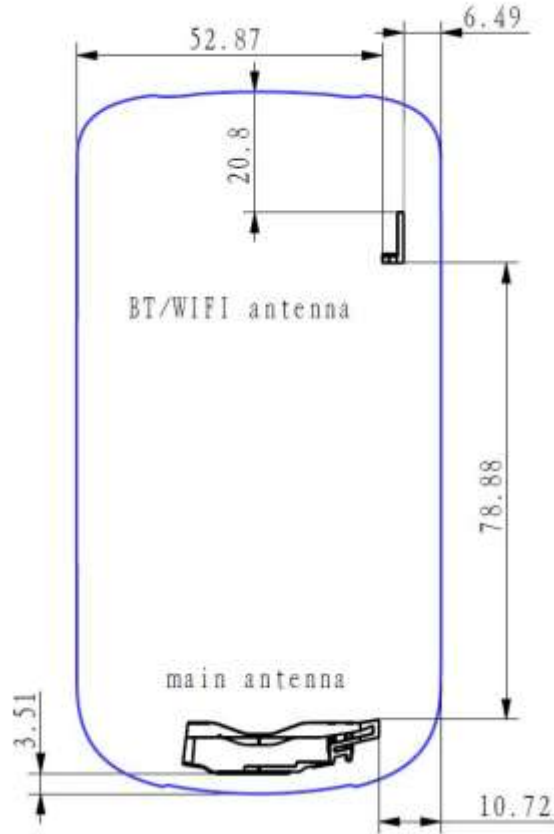

**Note;**

Please see the separate Antenna distance document.

# 11. SAR Evaluation Considerations for Handsets with Multiple Transmitters and Antennas

## 11.1 SAR Evaluation Considerations

These procedures were followed according to FCC "SAR Evaluation Considerations for Handsets with Multiple Transmitters and Antennas", May 2008. The procedures are applicable to phones with built-in unlicensed transmitters, such as 802.11 a/b/g and Bluetooth devices.

	<b>2.45</b>	<b>5.15 - 5.35</b>	<b>5.47 - 5.85</b>	<b>GHz</b>
<b>P<sub>Ref</sub></b>	<b>12</b>	<b>6</b>	<b>5</b>	<b>mW</b>

Device output power should be rounded to the nearest mW to compare with values specified in this

Table. 11.1 Output Power Thresholds for Unlicensed Transmitters

	Individual Transmitter	Simultaneous Transmission
<b>Licensed Transmitters</b>	<u>Routine evaluation required</u>	<b>SAR not required:</b> <u>Unlicensed only</u>
<b>Unlicensed Transmitters</b>	<p><u>When there is no simultaneous transmission –</u></p> <ul style="list-style-type: none"> <li>o output ≤ 60/f: SAR not required</li> <li>o output &gt; 60/f: stand-alone SAR required</li> </ul> <p><u>When there is simultaneous transmission –</u></p> <p><u>Stand-alone SAR not required when</u></p> <ul style="list-style-type: none"> <li>o output ≤ 2·P<sub>Ref</sub> and antenna is ≥ 5.0 cm from other antennas</li> <li>o output ≤ P<sub>Ref</sub> and antenna is ≥ 2.5 cm from other antennas</li> <li>o output ≤ P<sub>Ref</sub> and antenna is &lt; 2.5 cm from other antennas, each with either output power ≤ P<sub>Ref</sub> or 1-g SAR &lt; 1.2 W/kg</li> </ul> <p><u>Otherwise stand-alone SAR is required</u></p> <p><u>When stand-alone SAR is required</u></p> <ul style="list-style-type: none"> <li>o test SAR on highest output channel for each wireless mode and exposure condition</li> <li>o if SAR for highest output channel is &gt; 50% of SAR limit, evaluate all channels according to normal procedures</li> </ul>	<ul style="list-style-type: none"> <li>o when stand-alone 1-g SAR is not required and antenna is ≥ 5 cm from other antennas</li> </ul> <p><u>Licensed &amp; Unlicensed</u></p> <ul style="list-style-type: none"> <li>o when the sum of the 1-g SAR is &lt; 1.6 W/kg for all simultaneous transmitting antennas</li> <li>o when SAR to peak location separation ratio of simultaneous transmitting antenna pair is &lt; 0.3</li> </ul> <p><b>SAR required:</b></p> <p><u>Licensed &amp; Unlicensed</u></p> <p>antenna pairs with SAR to peak location separation ratio ≥ 0.3; test is only required for the configuration that results in the highest SAR in stand-alone configuration for each wireless mode and exposure condition</p> <p><b>Note: simultaneous transmission exposure conditions for head and body can be different for different style phones; therefore, different test requirements may apply</b></p>
<b>Jaw, Mouth and Nose</b>	<p><u>Flat phantom SAR required</u></p> <ul style="list-style-type: none"> <li>o when measurement is required in tight regions of SAM and it is not feasible or the results can be questionable due to probe tilt, calibration, positioning and orientation issues</li> <li>o position rectangular and clam-shell phones according to flat phantom procedures and conduct SAR measurements for these specific locations</li> </ul>	When simultaneous transmission SAR testing is required, contact the FCC Laboratory for interim guidance.

Table. 11.2 SAR Evaluation Requirements for Cellphones with Multiple Transmitters

FCC ID: RAD285

Antenna separation distance between Main and BT: 78.88 mm

BT Max. RF output power: 2.70 mW



## 11.2 Simultaneous Transmission

Simultaneous Transmission Summation for Held to Ear

Simultaneous TX	configuration	1900 CDMA SAR(W/kg)	2.4GHz WIFI SAR (W/kg)	$\Sigma$ SAR (W/kg)
Head SAR	Left Cheek	1.09	0.088	1.178
	Left Tilt	0.55	0.033	0.583
	Right Cheek	1.17	0.139	1.309
	Right Tilt	0.394	0.051	0.445

The above tables represent a held to ear voice call with 2.4 GHz WLAN.

Simultaneous TX	configuration	1900 CDMA SAR(W/kg)	2.4GHz WIFI SAR (W/kg)	$\Sigma$ SAR (W/kg)
Body SAR	Back	0.617	0.029	0.646

The above tables represent a body-worn call with 2.4 GHz WLAN.

- Main antenna can transmit simultaneously with BT antenna.
- Main antenna can transmit simultaneously with WLAN antenna
- WiFi cannot transmit simultaneously with BT.

## 11.3 Simultaneous Transmission Conclusion

The above numerical summed SAR was below the SAR limit. Therefore, the above analysis is sufficient to determine that simultaneous transmission cases will not exceed the SAR limit. No volumetric SAR summation is required per FCC KDB Publication 648474.

The above tables represent the worst-case simultaneous transmission scenarios possibility with this device.

The conducted output power level of the BT transmitter is less than  $2 \cdot P_{ref}$ , the BT antenna is more than 5 cm from the other antenna, therefore, a stand-alone BT SAR evaluation is not required.

Antenna Pair	Justification	Simultaneous SAR required
Wifi / BT	BT SAR is not required.	No
Wifi / WWAN	The sum of WLAN and WWAN SAR is less than 1.6 mW/g	No
BT / WWAN	Antenna separation is $\geq 5$ cm, BT transmitter is less than $2 \cdot P_{ref}$	No

## 12. SAR TEST DATA SUMMARY

### 12.1 Measurement Results (PCS1900 Head SAR)

Frequency		Modulation	Conducted Power (dBm)	Power Drift (dB)	Battery	Phantom Position	Antenna Type	SAR(mW/g)
MHz	Channel							
1 851.25	25 (Low)	PCS1900	24.27	-0.079	Standard	Left Ear	Intenna	1.09
1 880.00	600 (Mid)	PCS1900	24.48	0.067	Standard	Left Ear	Intenna	1.07
1 908.75	1175(High)	PCS1900	24.51	-0.074	Standard	Left Ear	Intenna	0.95
1 880.00	600 (Mid)	PCS1900	24.48	0.069	Standard	Left Tilt 15°	Intenna	0.55
1 851.25	25 (Low)	PCS1900	24.27	0.053	Standard	Right Ear	Intenna	1.09
1 880.00	600 (Mid)	PCS1900	24.48	0.108	Standard	Right Ear	Intenna	1.1
1 908.75	1175(High)	PCS1900	24.51	-0.099	Standard	Right Ear	Intenna	1.17
1 880.00	600 (Mid)	PCS1900	24.48	0.072	Standard	Right Tilt 15	Intenna	0.394
<b>ANSI/ IEEE C95.1 - 1992– Safety Limit</b>						<b>Head</b>		
<b>Spatial Peak</b>						<b>1.6 W/kg (mW/g)</b>		
<b>Uncontrolled Exposure/ General Population</b>						<small>Averaged over 1 gram</small>		

**NOTES:**

- 1 The test data reported are the worst-case SAR value with the antenna-head position set in a typical configuration. Test procedures used are according to FCC/OET Bulletin 65, Supplement C [July 2001].
- 2 All modes of operation were investigated and the worst-case are reported.
- 3 Measured Depth of Simulating Tissue is 15.0 cm ± 0.2 cm.
- 4 Tissue parameters and temperatures are listed on the SAR plot.
- 5 Battery Type                     Standard                     Extended                     Slim  
Batteries are fully charged for all readings.
- 6 Test Signal Call Mode         Manual Test cord         Base Station Simulator
- 7 Justification for reduced test configurations: per FCC/OET Supplement C (July, 2001), if the SAR measured at the middle channel for each test configuration (Left, right, cheek/touch, tilt/ear, extended and retracted) is at least 3.0 dB lower than the SAR limit, testing at the high and low channels is optional for such test configuration(s).
- 8 PCS CDMA mode was tested under RC3/SO55.

## 12.2 Measurement Results (802.11b/g/n Head)

Frequency		Modulation	Conducted Power (dBm)	Power Drift (dB)	Battery	Data Rate	Phantom Position	Antenna Type	SAR(mW/g)
MHz	Channel								
2 412	1 (Low)	802.11b	14.68	0.078	Standard	1 Mbps	Left Ear	Intenna	0.082
2 412	1 (Low)	802.11b	15.02	-0.089	Standard	5.5 Mbps	Left Ear	Intenna	0.088
2 412	1 (Low)	802.11b	14.68	-0.028	Standard	1 Mbps	Left Tilt 15°	Intenna	0.033
2 412	1 (Low)	802.11b	15.02	-0.01	Standard	5.5 Mbps	Left Tilt 15°	Intenna	0.033
2 412	1 (Low)	802.11b	14.68	-0.072	Standard	1 Mbps	Right Ear	Intenna	0.135
2 412	1 (Low)	802.11b	15.02	-0.066	Standard	5.5 Mbps	Right Ear	Intenna	0.139
2 412	1 (Low)	802.11b	14.68	0.080	Standard	1 Mbps	Right Tilt 15	Intenna	0.047
2 412	1 (Low)	802.11b	15.02	-0.07	Standard	5.5 Mbps	Right Tilt 15	Intenna	0.051
<b>ANSI/ IEEE C95.1 - 1992– Safety Limit</b>							<b>Head</b>		
<b>Spatial Peak</b>							<b>1.6 W/kg (mW/g)</b>		
<b>Uncontrolled Exposure/ General Population</b>							<small>Averaged over 1 gram</small>		

**NOTES:**

- The test data reported are the worst-case SAR value with the antenna-head position set in a typical configuration. Test procedures used are according to FCC/OET Bulletin 65, Supplement C [July 2001].
- All modes of operation were investigated and the worst-case are reported.
- Measured Depth of Simulating Tissue is 15.0 cm ± 0.2 cm.
- Tissue parameters and temperatures are listed on the SAR plot.
- Battery Type  Standard  Extended  Slim  
Batteries are fully charged for all readings.
- Test Signal Call Mode  Manual Test cord  Base Station Simulator
- IEEE 802.11g(including 802.11n) SAR testing is required when the conducted powers are equal to or greater than 0.25 dB Than the conducted powers in IEEE 802.11b.
- For 2.4GHz WLAN, Highest average power channel for the lowest data rate was selected for SAR evaluation based on KDB 248227. Other channels are not necessary because 1g-average SAR < 0.8 W/Kg and peak SAR < 1.6W/Kg per KDB 248227.

## 12.3 Measurement Results (PCS1900 Body-worn SAR)

Frequency		Modulation	Conducted Power (dBm)	Power Drift (dB)	Configuration	Separation Distance	SAR(mW/g)
MHz	Channel						
1 880.00	600 (Mid)	PCS1900	24.48	0.032	Rear	2.0 cm	0.617
<b>ANSI/ IEEE C95.1 2005 – Safety Limit Spatial Peak Uncontrolled Exposure/ General Population</b>						<b>Body 1.6 W/kg (mW/g) Averaged over 1 gram</b>	

**NOTES:**

- 1 The test data reported are the worst-case SAR value with the antenna-head position set in a typical configuration. Test procedures used are according to FCC/OET Bulletin 65, Supplement C [July 2001].
- 2 All modes of operation were investigated and the worst-case are reported.
- 3 Measured Depth of Simulating Tissue is 15.0 cm ± 0.2 cm.
- 4 Tissue parameters and temperatures are listed on the SAR plot.
- 5 Battery Type                     Standard                     Extended                     Slim  
Batteries are fully charged for all readings.
- 6 Test Signal Call Mode         Manual Test cord             Base Station Simulator
- 7 Test Configuration             With Holster                     Without Holster
- 8 Justification for reduced test configurations: per FCC/OET Supplement C (July, 2001), if the SAR measured at the middle channel for each test configuration (Left, right, cheek/touch, tilt/ear, extended and retracted) is at least 3.0 dB lower than the SAR limit, testing at the high and low channels is optional for such test configuration(s).
- 8 PCS CDMA mode was tested under RC3/SO32.

## 12.4 Measurement Results (802.11b Body-worn SAR)

Frequency		Modulation	Conducted Power (dBm)	Power Drift (dB)	Configuration	Separation Distance	Data Rate	SAR(mW/g)
MHz	Channel							
2 412	1 (Low)	802.11b	14.68	-0.024	Rear	2.0 cm	1 Mbps	0.029
2 412	1 (Low)	802.11b	15.02	-0.03	Rear	2.0 cm	5.5 Mbps	0.027
<b>ANSI/ IEEE C95.1 2005 – Safety Limit</b>						<b>Body</b>		
<b>Spatial Peak</b>						<b>1.6 W/kg (mW/g)</b>		
<b>Uncontrolled Exposure/ General Population</b>						<small>Averaged over 1 gram</small>		

**NOTES:**

- 1 The test data reported are the worst-case SAR value with the antenna-head position set in a typical configuration. Test procedures used are according to FCC/OET Bulletin 65, Supplement C [July 2001].
- 2 All modes of operation were investigated and the worst-case are reported.
- 3 Measured Depth of Simulating Tissue is 15.0 cm ± 0.2 cm.
- 4 Tissue parameters and temperatures are listed on the SAR plot.
- 5 Battery Type                     Standard with Charger     Extended                     Slim  
Batteries are fully charged for all readings.
- 6 Test Signal Call Mode         Manual Test code             Base Station Simulator
- 7 IEEE 802.11g(including 802.11n) SAR testing is required when the conducted powers are equal to or greater than 0.25 dB Than the conducted powers in IEEE 802.11b.
- 8 For 2.4GHz WLAN, Highest average power channel for the lowest data rate was selected for SAR evaluation based on KDB 248227. Other channels are not necessary because 1g-average SAR < 0.8 W/Kg and peak SAR < 1.6W/Kg per KDB 248227.

## **13. CONCLUSION**

---

The SAR measurement indicates that the EUT complies with the RF radiation exposure limits of the ANSI/IEEE C95.1 1992.

These measurements are taken to simulate the RF effects exposure under worst-case conditions. Precise laboratory measures were taken to assure repeatability of the tests.

## 14. REFERENCES

---

- [1] Federal Communications Commission, OET Bulletin 65 (Edition 97-01), Supplement C (Edition 01-01), Evaluating Compliance with FCC Guidelines for Human Exposure to Radio frequency Electromagnetic Fields, July 2001.
- [2] IEEE Standards Coordinating Committee 34 – IEEE Std. 1528-2003, IEE Recommended Practice or Determining the Peak Spatial-Average Specific Absorption Rate (SAR) in the Human Body from Wireless Communications Devices.
- [3] Federal Communications Commission, ET Docket 93-62, Guidelines for Evaluating the Environmental Effects of Radio frequency Radiation, Aug. 1996.
- [4] ANSI/IEEE C95.1 - 1991, American National Standard safety levels with respect to human exposure to radio frequency electromagnetic fields, 300 kHz to 100 GHz, New York: IEEE, Aug. 1992
- [5] ANSI/IEEE C95.3 - 1991, IEEE Recommended Practice for the Measurement of Potentially Hazardous Electromagnetic Fields - RF and Microwave, New York: IEEE, 1992.
- [6] NCRP, National Council on Radiation Protection and Measurements, Biological Effects and Exposure Criteria for Radio Frequency Electromagnetic Fields, NCRP Report No. 86, 1986. Reprinted Feb. 1995.
- [7] T. Schmid, O. Egger, N. Kuster, Automated E-field scanning system for dosimetric assessments, IEEE Transaction on Microwave Theory and Techniques, vol. 44, Jan. 1996, pp. 105-113.
- [8] K. Pokovic, T. Schmid, N. Kuster, Robust setup for precise calibration of E-field probes in tissue simulating liquids at mobile communications frequencies, ICECOM97, Oct. 1997, pp. 120-124.
- [9] K. Pokovic, T. Schmid, and N. Kuster, E-field Probe with improved isotropy in brain simulating liquids, Proceedings of the ELMAR, Zadar, Croatia, June 23-25, 1996, pp. 172-175.
- [10] Schmid & Partner Engineering AG, Application Note: Data Storage and Evaluation, June 1998, p2.
- [11] V. Hombach, K. Meier, M. Burkhardt, E. Kuhn, N. Kuster, The Dependence of EM Energy Absorption upon Human Head Modeling at 900 MHz, IEEE Transaction on Microwave Theory and Techniques, vol. 44 no. 10, Oct. 1996, pp. 1865-1873.
- [12] N. Kuster and Q. Balzano, Energy absorption mechanism by biological bodies in the near field of dipole antennas above 300 MHz, IEEE Transaction on Vehicular Technology, vol. 41, no. 1, Feb. 1992, pp. 17-23.
- [13] G. Hartsgrove, A. Kraszewski, A. Surowiec, Simulated Biological Materials for Electromagnetic Radiation Absorption Studies, University of Ottawa, Bioelectromagnetics, Canada: 1987, pp. 29-36.
- [14] Q. Balzano, O. Garay, T. Manning Jr., Electromagnetic Energy Exposure of Simulated Users of Portable Cellular Telephones, IEEE Transactions on Vehicular Technology, vol. 44, no.3, Aug. 1995.
- [15] W. Gander, Computer mathematick, Birkhaeuser, Basel, 1992.
- [16] W.H. Press, S.A. Teukolsky, W.T. Vetterling, and B.P. Flannery, Numerical Recipes in C, The Art of Scientific Computing, Second edition, Cambridge University Press, 1992.
- [17] Federal Communications Commission, OET Bulletin 65, Evaluating Compliance with FCC Guidelines for Human Exposure to Radiofrequency Electromagnetic Fields. Supplement C, Dec. 1997.
- [18] N. Kuster, R. Kastle, T. Schmid, Dosimetric evaluation of mobile communications equipment with known precision, IEEE Transaction on Communications, vol. E80-B, no. 5, May 1997, pp. 645-652.
- [19] CENELEC CLC/SC111B, European Prestandard (prENV 50166-2), Human Exposure to Electromagnetic Fields High-frequency: 10 kHz-300 GHz, Jan. 1995.
- [20] Prof. Dr. Niels Kuster, ETH, Eidgenössische Technische Hochschule Zürich, Dosimetric Evaluation of the Cellular Phone.
- [21] SAR Evaluation of Handsets with Multiple Transmitters and Antennas #648474.
- [22] SAR Measurement Procedure for 802.11 a/b/g Transmitters #KDB 248227.

## Attachment 1. – SAR Test Plots



Test Laboratory: HCT CO., LTD  
EUT Type: PCS CDMA Phone with Bluetooth/WLAN  
Liquid Temperature: 21.1 °C  
Ambient Temperature: 21.3 °C  
Test Date: May 8, 2012

**DUT: Walleye; Type: bar; Serial: #1**

Communication System: PCS 1900MHz FCC; Frequency: 1851.25 MHz; Duty Cycle: 1:1  
Medium parameters used (interpolated):  $f = 1851.25$  MHz;  $\sigma = 1.34$  mho/m;  $\epsilon_r = 39.3$ ;  $\rho = 1000$  kg/m<sup>3</sup>  
Phantom section: Left Section ; Measurement SW: DASY4, V4.7 Build 71; Postprocessing SW: SEMCAD, V1.8 Build 184

DASY4 Configuration:

- Probe: ET3DV6 - SN1630; ConvF(5.17, 5.17, 5.17); Calibrated: 2011-11-18
- Sensor-Surface: 2mm (Mechanical Surface Detection)
- Electronics: DAE3 Sn446; Calibrated: 2011-09-27
- Phantom: 1800/1900 Phantom; Type: SAM

**Left touch 25/Area Scan (61x91x1):** Measurement grid: dx=15mm, dy=15mm

[Info: Interpolated medium parameters used for SAR evaluation.](#)

Maximum value of SAR (interpolated) = 1.23 mW/g

**Left touch 25/Zoom Scan (5x5x7)/Cube 0:** Measurement grid: dx=8mm, dy=8mm, dz=5mm

Reference Value = 26.3 V/m; Power Drift = -0.079 dB

Peak SAR (extrapolated) = 1.83 W/kg

**SAR(1 g) = 1.09 mW/g; SAR(10 g) = 0.638 mW/g**

Maximum value of SAR (measured) = 1.19 mW/g

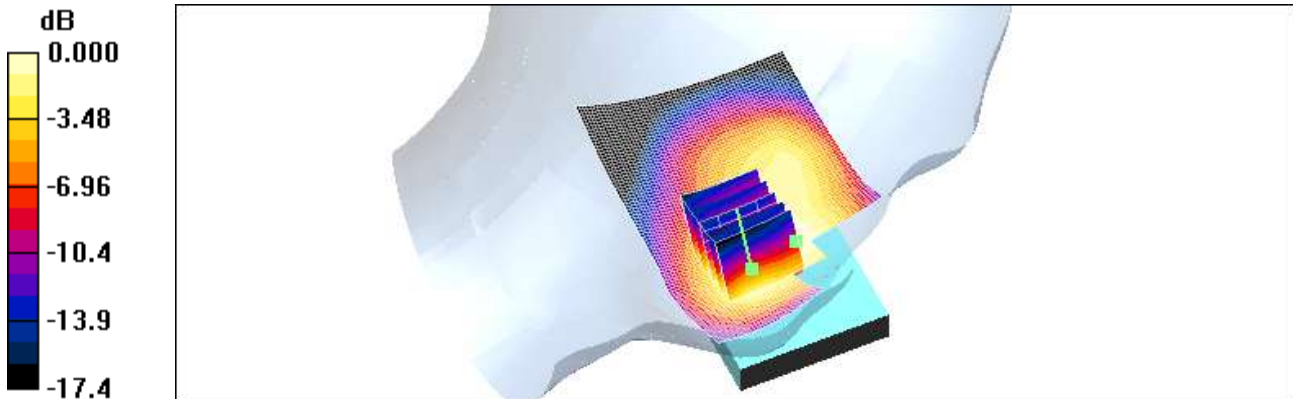

0 dB = 1.19mW/g

Test Laboratory: HCT CO., LTD  
EUT Type: PCS CDMA Phone with Bluetooth/WLAN  
Liquid Temperature: 21.1 °C  
Ambient Temperature: 21.3 °C  
Test Date: May 8,2012

**DUT: Walleye; Type: bar; Serial: #1**

Communication System: PCS 1900MHz FCC; Frequency: 1880 MHz;Duty Cycle: 1:1  
Medium parameters used:  $f = 1880$  MHz;  $\sigma = 1.37$  mho/m;  $\epsilon_r = 39.2$ ;  $\rho = 1000$  kg/m<sup>3</sup>  
Phantom section: Left Section ; Measurement SW: DASY4, V4.7 Build 71; Postprocessing SW: SEMCAD, V1.8 Build 184

DASY4 Configuration:

- Probe: ET3DV6 - SN1630; ConvF(5.17, 5.17, 5.17); Calibrated: 2011-11-18
- Sensor-Surface: 2mm (Mechanical Surface Detection)
- Electronics: DAE3 Sn446; Calibrated: 2011-09-27
- Phantom: 1800/1900 Phantom; Type: SAM

**Left touch 600/Area Scan (61x91x1):** Measurement grid: dx=15mm, dy=15mm  
Maximum value of SAR (interpolated) = 1.14 mW/g

**Left touch 600/Zoom Scan (5x5x7)/Cube 0:** Measurement grid: dx=8mm, dy=8mm, dz=5mm  
Reference Value = 24.5 V/m; Power Drift = 0.067 dB  
Peak SAR (extrapolated) = 1.79 W/kg  
**SAR(1 g) = 1.07 mW/g; SAR(10 g) = 0.620 mW/g**  
Maximum value of SAR (measured) = 1.17 mW/g

**Left touch 600/Zoom Scan (5x5x7)/Cube 1:** Measurement grid: dx=8mm, dy=8mm, dz=5mm  
Reference Value = 24.5 V/m; Power Drift = 0.067 dB  
Peak SAR (extrapolated) = 1.43 W/kg  
**SAR(1 g) = 0.945 mW/g; SAR(10 g) = 0.590 mW/g**  
Maximum value of SAR (measured) = 1.04 mW/g

**Left touch 600/Zoom Scan (5x5x7)/Cube 2:** Measurement grid: dx=8mm, dy=8mm, dz=5mm  
Reference Value = 24.5 V/m; Power Drift = 0.067 dB  
Peak SAR (extrapolated) = 1.36 W/kg  
**SAR(1 g) = 0.883 mW/g; SAR(10 g) = 0.548 mW/g**  
Maximum value of SAR (measured) = 1.000 mW/g

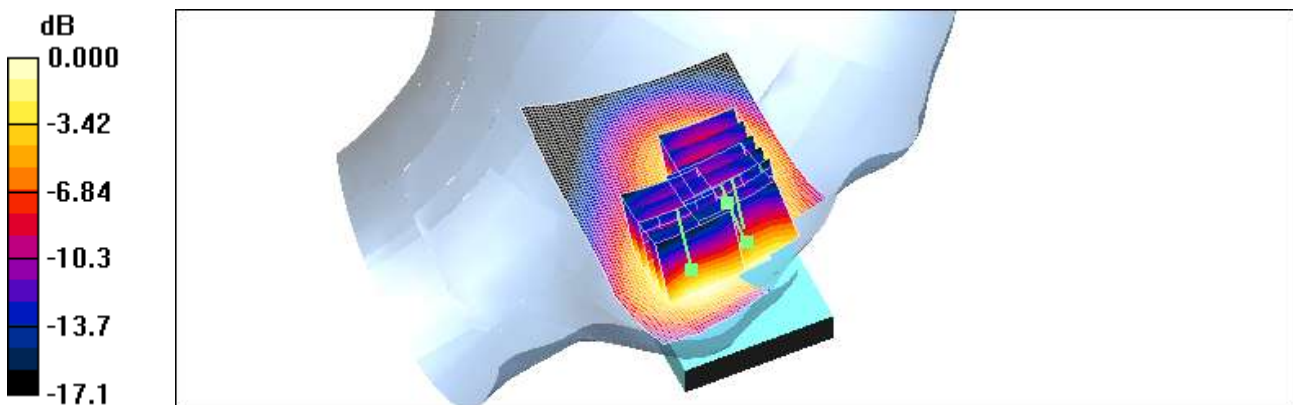

0 dB = 1.00mW/g

Test Laboratory: HCT CO., LTD  
EUT Type: PCS CDMA Phone with Bluetooth/WLAN  
Liquid Temperature: 21.1 °C  
Ambient Temperature: 21.3 °C  
Test Date: May 8,2012

**DUT: Walleye; Type: bar; Serial: #1**

Communication System: PCS 1900MHz FCC; Frequency: 1908.75 MHz;Duty Cycle: 1:1  
Medium parameters used (interpolated):  $f = 1908.75$  MHz;  $\sigma = 1.4$  mho/m;  $\epsilon_r = 39$ ;  $\rho = 1000$  kg/m<sup>3</sup>  
Phantom section: Left Section ; Measurement SW: DASY4, V4.7 Build 71; Postprocessing SW: SEMCAD, V1.8 Build 184

DASY4 Configuration:

- Probe: ET3DV6 - SN1630; ConvF(5.17, 5.17, 5.17); Calibrated: 2011-11-18
- Sensor-Surface: 2mm (Mechanical Surface Detection)
- Electronics: DAE3 Sn446; Calibrated: 2011-09-27
- Phantom: 1800/1900 Phantom; Type: SAM

**Left touch 1175/Area Scan (61x91x1):** Measurement grid: dx=15mm, dy=15mm

Maximum value of SAR (interpolated) = 1.08 mW/g

**Left touch 1175/Zoom Scan (5x5x7)/Cube 0:** Measurement grid: dx=8mm, dy=8mm, dz=5mm

Reference Value = 23.7 V/m; Power Drift = -0.074 dB

Peak SAR (extrapolated) = 1.64 W/kg

**SAR(1 g) = 0.950 mW/g; SAR(10 g) = 0.542 mW/g**

Maximum value of SAR (measured) = 1.02 mW/g

**Left touch 1175/Zoom Scan (5x5x7)/Cube 1:** Measurement grid: dx=8mm, dy=8mm, dz=5mm

Reference Value = 23.7 V/m; Power Drift = -0.074 dB

Peak SAR (extrapolated) = 1.34 W/kg

SAR(1 g) = 0.875 mW/g; SAR(10 g) = 0.531 mW/g

Maximum value of SAR (measured) = 0.967 mW/g

**Left touch 1175/Zoom Scan (5x5x7)/Cube 2:** Measurement grid: dx=8mm, dy=8mm, dz=5mm

Reference Value = 23.7 V/m; Power Drift = -0.074 dB

Peak SAR (extrapolated) = 1.16 W/kg

SAR(1 g) = 0.731 mW/g; SAR(10 g) = 0.454 mW/g

Maximum value of SAR (measured) = 0.784 mW/g

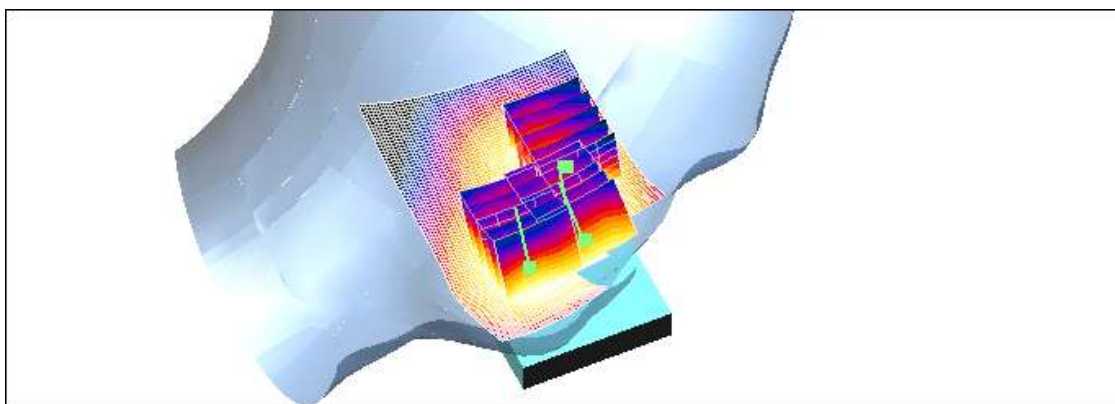
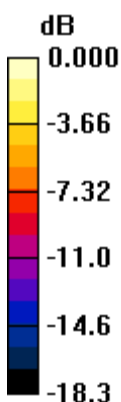

0 dB = 0.784mW/g

Test Laboratory: HCT CO., LTD  
EUT Type: PCS CDMA Phone with Bluetooth/WLAN  
Liquid Temperature: 21.1 °C  
Ambient Temperature: 21.3 °C  
Test Date: May 8,2012

**DUT: Walleye; Type: bar; Serial: #1**

Communication System: PCS 1900MHz FCC; Frequency: 1880 MHz;Duty Cycle: 1:1  
Medium parameters used:  $f = 1880$  MHz;  $\sigma = 1.37$  mho/m;  $\epsilon_r = 39.2$ ;  $\rho = 1000$  kg/m<sup>3</sup>  
Phantom section: Left Section ; Measurement SW: DASY4, V4.7 Build 71; Postprocessing SW: SEMCAD, V1.8 Build 184

DASY4 Configuration:

- Probe: ET3DV6 - SN1630; ConvF(5.17, 5.17, 5.17); Calibrated: 2011-11-18
- Sensor-Surface: 2mm (Mechanical Surface Detection)
- Electronics: DAE3 Sn446; Calibrated: 2011-09-27
- Phantom: 1800/1900 Phantom; Type: SAM

**Left tilt 600/Area Scan (61x91x1):** Measurement grid: dx=15mm, dy=15mm  
Maximum value of SAR (interpolated) = 0.584 mW/g

**Left tilt 600/Zoom Scan (5x5x7)/Cube 0:** Measurement grid: dx=8mm, dy=8mm, dz=5mm  
Reference Value = 8.56 V/m; Power Drift = 0.069 dB  
Peak SAR (extrapolated) = 0.850 W/kg  
**SAR(1 g) = 0.550 mW/g; SAR(10 g) = 0.334 mW/g**  
Maximum value of SAR (measured) = 0.600 mW/g

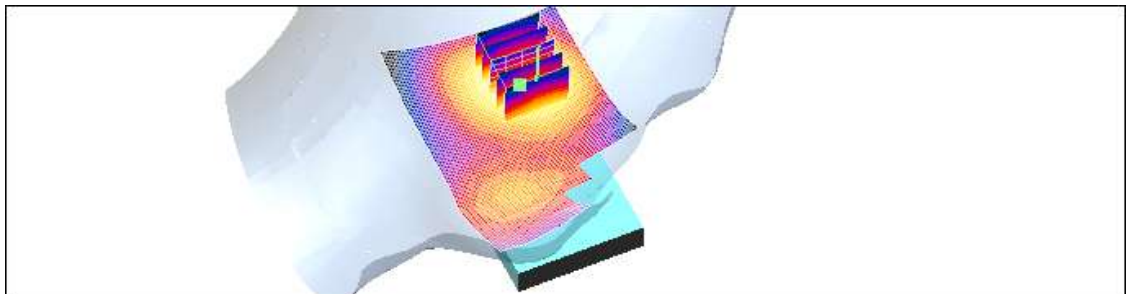
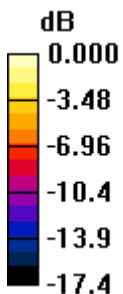

0 dB = 0.600mW/g

Test Laboratory: HCT CO., LTD  
EUT Type: PCS CDMA Phone with Bluetooth/WLAN  
Liquid Temperature: 21.1 °C  
Ambient Temperature: 21.3 °C  
Test Date: May 8,2012

**DUT: Walleye; Type: bar; Serial: #1**

Communication System: PCS 1900MHz FCC; Frequency: 1851.25 MHz;Duty Cycle: 1:1  
Medium parameters used (interpolated):  $f = 1851.25$  MHz;  $\sigma = 1.34$  mho/m;  $\epsilon_r = 39.3$ ;  $\rho = 1000$  kg/m<sup>3</sup>  
Phantom section: Right Section ; Measurement SW: DASY4, V4.7 Build 71; Postprocessing SW: SEMCAD, V1.8 Build 184

DASY4 Configuration:

- Probe: ET3DV6 - SN1630; ConvF(5.17, 5.17, 5.17); Calibrated: 2011-11-18
- Sensor-Surface: 2mm (Mechanical Surface Detection)
- Electronics: DAE3 Sn446; Calibrated: 2011-09-27
- Phantom: 1800/1900 Phantom; Type: SAM

**Right touch 25/Area Scan (61x91x1):** Measurement grid: dx=15mm, dy=15mm

[Info: Interpolated medium parameters used for SAR evaluation.](#)

Maximum value of SAR (interpolated) = 1.20 mW/g

**Right touch 25/Zoom Scan (5x5x7)/Cube 0:** Measurement grid: dx=8mm, dy=8mm, dz=5mm

Reference Value = 23.6 V/m; Power Drift = 0.053 dB

Peak SAR (extrapolated) = 1.69 W/kg

**SAR(1 g) = 1.09 mW/g; SAR(10 g) = 0.637 mW/g**

[Info: Interpolated medium parameters used for SAR evaluation.](#)

Maximum value of SAR (measured) = 1.18 mW/g

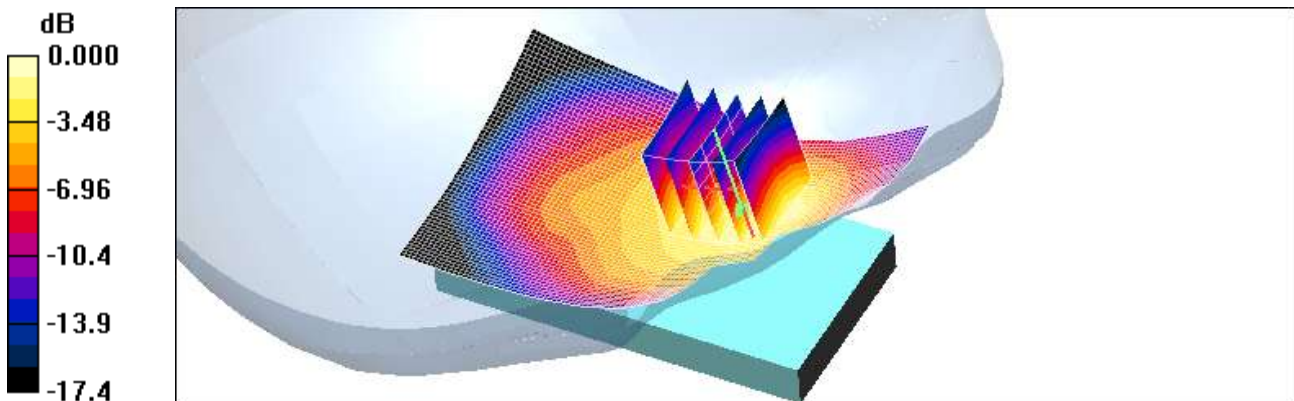

0 dB = 1.18mW/g

Test Laboratory: HCT CO., LTD  
EUT Type: PCS CDMA Phone with Bluetooth/WLAN  
Liquid Temperature: 21.1 °C  
Ambient Temperature: 21.3 °C  
Test Date: May 8,2012

**DUT: Walleye; Type: bar; Serial: #1**

Communication System: PCS 1900MHz FCC; Frequency: 1880 MHz;Duty Cycle: 1:1  
Medium parameters used:  $f = 1880$  MHz;  $\sigma = 1.37$  mho/m;  $\epsilon_r = 39.2$ ;  $\rho = 1000$  kg/m<sup>3</sup>  
Phantom section: Right Section ; Measurement SW: DASY4, V4.7 Build 71; Postprocessing SW: SEMCAD, V1.8 Build 184

DASY4 Configuration:

- Probe: ET3DV6 - SN1630; ConvF(5.17, 5.17, 5.17); Calibrated: 2011-11-18
- Sensor-Surface: 2mm (Mechanical Surface Detection)
- Electronics: DAE3 Sn446; Calibrated: 2011-09-27
- Phantom: 1800/1900 Phantom; Type: SAM

**Right touch 600/Area Scan (61x91x1):** Measurement grid: dx=15mm, dy=15mm  
Maximum value of SAR (interpolated) = 1.20 mW/g

**Right touch 600/Zoom Scan (5x5x7)/Cube 0:** Measurement grid: dx=8mm, dy=8mm, dz=5mm  
Reference Value = 22.4 V/m; Power Drift = 0.108 dB  
Peak SAR (extrapolated) = 1.74 W/kg  
**SAR(1 g) = 1.1 mW/g; SAR(10 g) = 0.638 mW/g**  
Maximum value of SAR (measured) = 1.20 mW/g

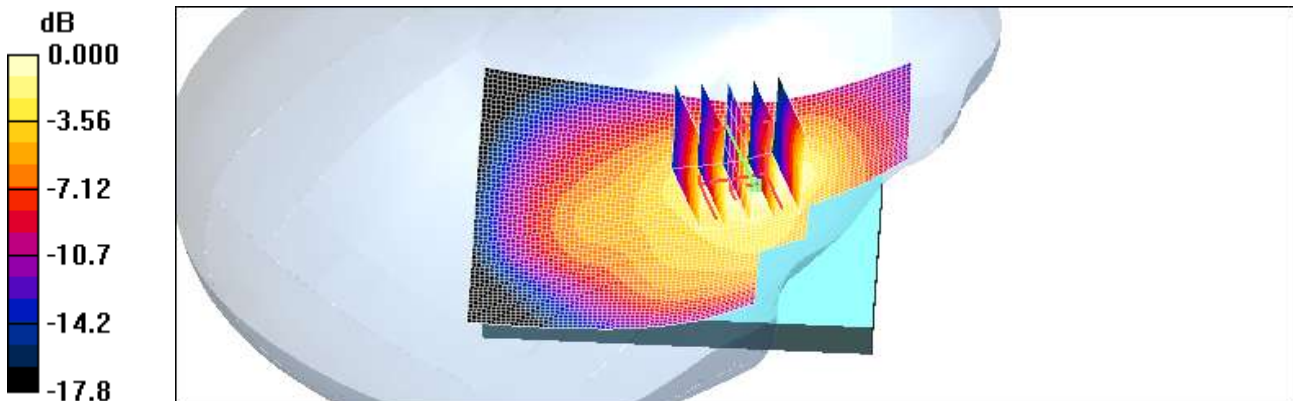

0 dB = 1.20mW/g

Test Laboratory: HCT CO., LTD  
EUT Type: PCS CDMA Phone with Bluetooth/WLAN  
Liquid Temperature: 21.1 °C  
Ambient Temperature: 21.3 °C  
Test Date: May 8,2012

**DUT: Walleye; Type: bar; Serial: #1**

Communication System: PCS 1900MHz FCC; Frequency: 1908.75 MHz;Duty Cycle: 1:1  
Medium parameters used (interpolated):  $f = 1908.75$  MHz;  $\sigma = 1.4$  mho/m;  $\epsilon_r = 39$ ;  $\rho = 1000$  kg/m<sup>3</sup>  
Phantom section: Right Section ; Measurement SW: DASY4, V4.7 Build 71; Postprocessing SW: SEMCAD, V1.8 Build 184

DASY4 Configuration:

- Probe: ET3DV6 - SN1630; ConvF(5.17, 5.17, 5.17); Calibrated: 2011-11-18
- Sensor-Surface: 2mm (Mechanical Surface Detection)
- Electronics: DAE3 Sn446; Calibrated: 2011-09-27
- Phantom: 1800/1900 Phantom; Type: SAM

**Right touch 1175/Area Scan (61x91x1):** Measurement grid: dx=15mm, dy=15mm

[Info: Interpolated medium parameters used for SAR evaluation.](#)

Maximum value of SAR (interpolated) = 1.19 mW/g

**Right touch 1175/Zoom Scan (5x5x7)/Cube 0:** Measurement grid: dx=8mm, dy=8mm, dz=5mm

Reference Value = 22.5 V/m; Power Drift = -0.099 dB

Peak SAR (extrapolated) = 1.88 W/kg

**SAR(1 g) = 1.17 mW/g; SAR(10 g) = 0.663 mW/g**

[Info: Interpolated medium parameters used for SAR evaluation.](#)

Maximum value of SAR (measured) = 1.28 mW/g

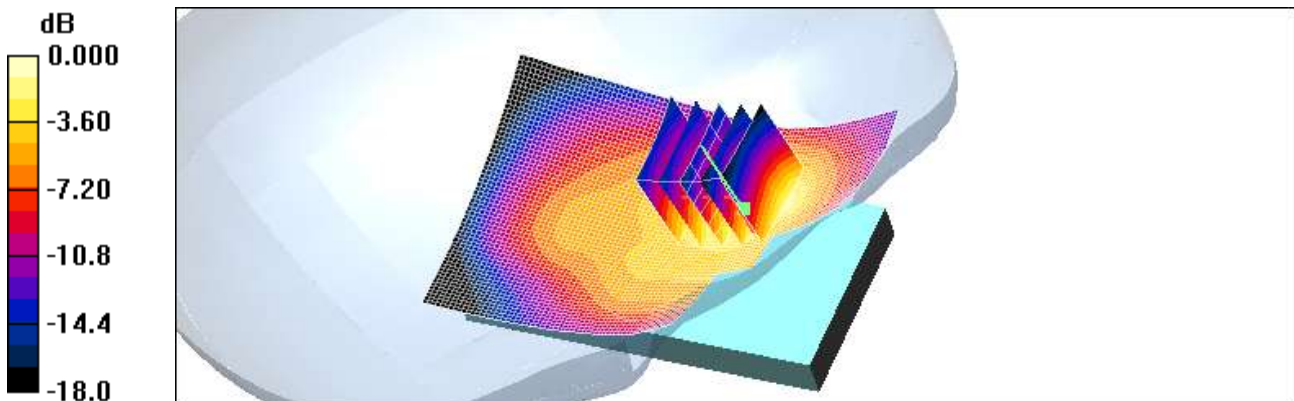

0 dB = 1.28mW/g

Test Laboratory: HCT CO., LTD  
EUT Type: PCS CDMA Phone with Bluetooth/WLAN  
Liquid Temperature: 21.1 °C  
Ambient Temperature: 21.3 °C  
Test Date: May 8,2012

**DUT: Walleye; Type: bar; Serial: #1**

Communication System: PCS 1900MHz FCC; Frequency: 1880 MHz;Duty Cycle: 1:1  
Medium parameters used:  $f = 1880$  MHz;  $\sigma = 1.37$  mho/m;  $\epsilon_r = 39.2$ ;  $\rho = 1000$  kg/m<sup>3</sup>  
Phantom section: Right Section ; Measurement SW: DASY4, V4.7 Build 71; Postprocessing SW: SEMCAD, V1.8 Build 184

DASY4 Configuration:

- Probe: ET3DV6 - SN1630; ConvF(5.17, 5.17, 5.17); Calibrated: 2011-11-18
- Sensor-Surface: 2mm (Mechanical Surface Detection)
- Electronics: DAE3 Sn446; Calibrated: 2011-09-27
- Phantom: 1800/1900 Phantom; Type: SAM

**Right tilt 600/Area Scan (61x91x1):** Measurement grid: dx=15mm, dy=15mm  
Maximum value of SAR (interpolated) = 0.438 mW/g

**Right tilt 600/Zoom Scan (5x5x7)/Cube 0:** Measurement grid: dx=8mm, dy=8mm, dz=5mm  
Reference Value = 7.93 V/m; Power Drift = 0.072 dB  
Peak SAR (extrapolated) = 0.608 W/kg  
**SAR(1 g) = 0.394 mW/g; SAR(10 g) = 0.238 mW/g**  
Maximum value of SAR (measured) = 0.423 mW/g

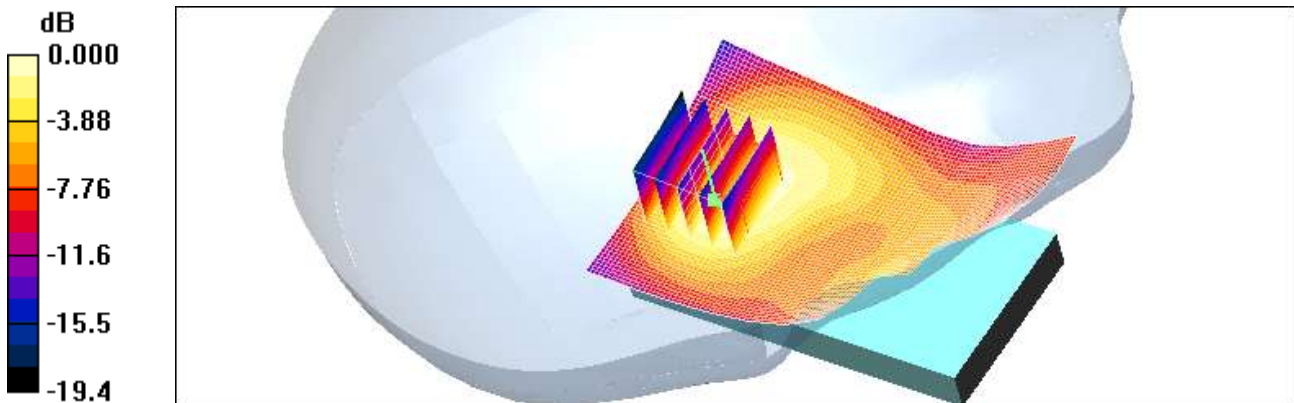

0 dB = 0.423mW/g



Test Laboratory: HCT CO., LTD  
EUT Type: PCS CDMA Phone with Bluetooth/WLAN  
Liquid Temperature: 21.1 °C  
Ambient Temperature: 21.3 °C  
Test Date: May 9,2012

**DUT: Walleye; Type: bar; Serial: #1**

Communication System: 2450MHz FCC; Frequency: 2412 MHz;Duty Cycle: 1:1  
Medium parameters used (interpolated):  $f = 2412$  MHz;  $\sigma = 1.83$  mho/m;  $\epsilon_r = 38.7$ ;  $\rho = 1000$  kg/m<sup>3</sup>  
Phantom section: Left Section ; Measurement SW: DASY4, V4.7 Build 71; Postprocessing SW: SEMCAD, V1.8 Build 184

DASY4 Configuration:

- Probe: ET3DV6 - SN1630; ConvF(4.57, 4.57, 4.57); Calibrated: 2011-11-18
- Sensor-Surface: 2mm (Mechanical Surface Detection)
- Electronics: DAE3 Sn446; Calibrated: 2011-09-27
- Phantom: 1800/1900 Phantom; Type: SAM

**Left touch 1ch 1Mbps/Area Scan (61x91x1):** Measurement grid: dx=15mm, dy=15mm

[Info: Interpolated medium parameters used for SAR evaluation.](#)

Maximum value of SAR (interpolated) = 0.091 mW/g

**Left touch 1ch 1Mbps/Zoom Scan (5x5x7)/Cube 0:** Measurement grid: dx=8mm, dy=8mm, dz=5mm

Reference Value = 2.96 V/m; Power Drift = 0.078 dB

Peak SAR (extrapolated) = 0.165 W/kg

**SAR(1 g) = 0.082 mW/g; SAR(10 g) = 0.040 mW/g**

[Info: Interpolated medium parameters used for SAR evaluation.](#)

Maximum value of SAR (measured) = 0.092 mW/g

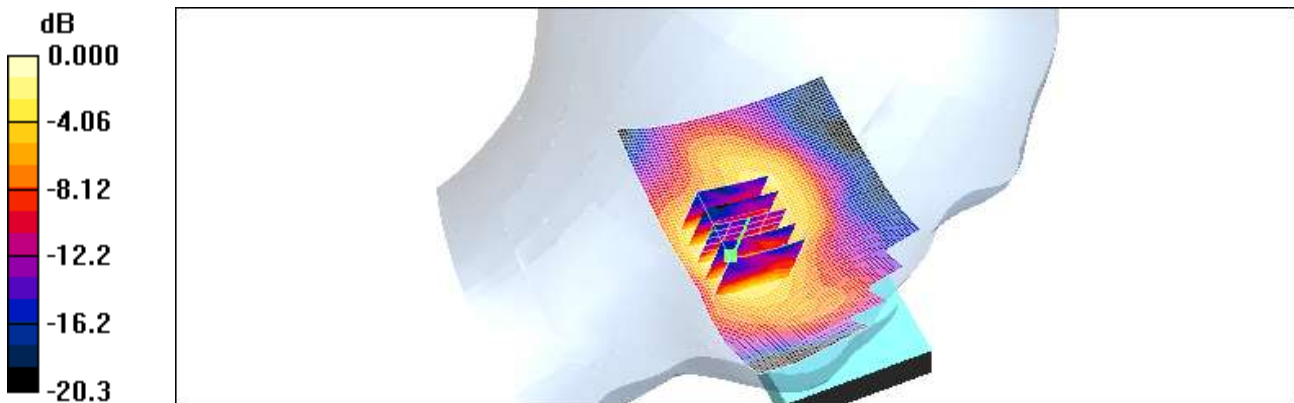

0 dB = 0.092mW/g

Test Laboratory: HCT CO., LTD  
EUT Type: PCS CDMA Phone with Bluetooth/WLAN  
Liquid Temperature: 21.1 °C  
Ambient Temperature: 21.3 °C  
Test Date: May 9,2012

**DUT: Walleye; Type: bar; Serial: #1**

Communication System: 2450MHz FCC; Frequency: 2412 MHz;Duty Cycle: 1:1  
Medium parameters used (interpolated):  $f = 2412$  MHz;  $\sigma = 1.83$  mho/m;  $\epsilon_r = 38.7$ ;  $\rho = 1000$  kg/m<sup>3</sup>  
Phantom section: Left Section ; Measurement SW: DASY4, V4.7 Build 71; Postprocessing SW: SEMCAD, V1.8 Build 184

DASY4 Configuration:

- Probe: ET3DV6 - SN1630; ConvF(4.57, 4.57, 4.57); Calibrated: 2011-11-18
- Sensor-Surface: 2mm (Mechanical Surface Detection)
- Electronics: DAE3 Sn446; Calibrated: 2011-09-27
- Phantom: 1800/1900 Phantom; Type: SAM

**Left touch 1ch 5.5Mbps/Area Scan (61x91x1):** Measurement grid: dx=15mm, dy=15mm

[Info: Interpolated medium parameters used for SAR evaluation.](#)

Maximum value of SAR (interpolated) = 0.103 mW/g

**Left touch 1ch 5.5Mbps/Zoom Scan (5x5x7)/Cube 0:** Measurement grid: dx=8mm, dy=8mm, dz=5mm

Reference Value = 3.30 V/m; Power Drift = -0.089 dB

Peak SAR (extrapolated) = 0.172 W/kg

**SAR(1 g) = 0.088 mW/g; SAR(10 g) = 0.044 mW/g**

[Info: Interpolated medium parameters used for SAR evaluation.](#)

Maximum value of SAR (measured) = 0.099 mW/g

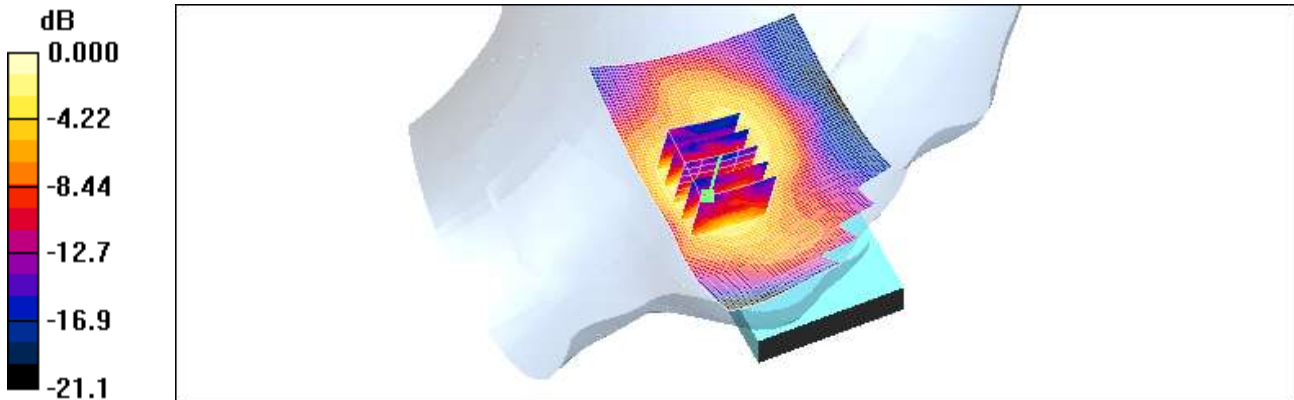

0 dB = 0.099mW/g

Test Laboratory: HCT CO., LTD  
EUT Type: PCS CDMA Phone with Bluetooth/WLAN  
Liquid Temperature: 21.1 °C  
Ambient Temperature: 21.3 °C  
Test Date: May 9,2012

**DUT: Walleye; Type: bar; Serial: #1**

Communication System: 2450MHz FCC; Frequency: 2412 MHz;Duty Cycle: 1:1  
Medium parameters used (interpolated):  $f = 2412$  MHz;  $\sigma = 1.83$  mho/m;  $\epsilon_r = 38.7$ ;  $\rho = 1000$  kg/m<sup>3</sup>  
Phantom section: Left Section ; Measurement SW: DASY4, V4.7 Build 71; Postprocessing SW: SEMCAD, V1.8 Build 184

DASY4 Configuration:

- Probe: ET3DV6 - SN1630; ConvF(4.57, 4.57, 4.57); Calibrated: 2011-11-18
- Sensor-Surface: 2mm (Mechanical Surface Detection)
- Electronics: DAE3 Sn446; Calibrated: 2011-09-27
- Phantom: 1800/1900 Phantom; Type: SAM

**Left tilt 1ch 1Mbps/Area Scan (61x91x1):** Measurement grid: dx=15mm, dy=15mm

[Info: Interpolated medium parameters used for SAR evaluation.](#)

Maximum value of SAR (interpolated) = 0.038 mW/g

**Left tilt 1ch 1Mbps/Zoom Scan (5x5x7)/Cube 0:** Measurement grid: dx=8mm, dy=8mm, dz=5mm

Reference Value = 1.60 V/m; Power Drift = -0.028 dB

Peak SAR (extrapolated) = 0.055 W/kg

**SAR(1 g) = 0.033 mW/g; SAR(10 g) = 0.016 mW/g**

[Info: Interpolated medium parameters used for SAR evaluation.](#)

Maximum value of SAR (measured) = 0.038 mW/g

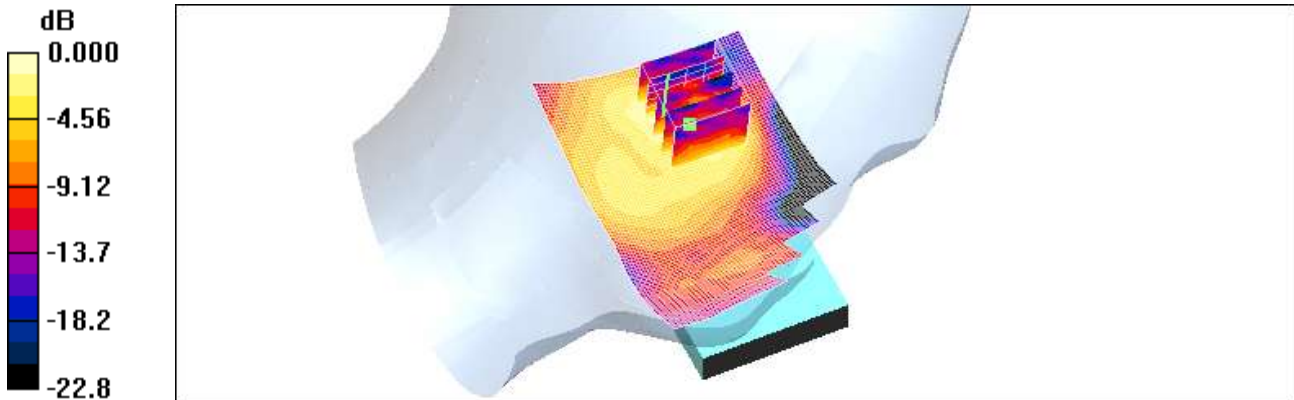

0 dB = 0.038mW/g

Test Laboratory: HCT CO., LTD  
EUT Type: PCS CDMA Phone with Bluetooth/WLAN  
Liquid Temperature: 21.1 °C  
Ambient Temperature: 21.3 °C  
Test Date: May 9,2012

**DUT: Walleye; Type: bar; Serial: #1**

Communication System: 2450MHz FCC; Frequency: 2412 MHz;Duty Cycle: 1:1  
Medium parameters used (interpolated):  $f = 2412$  MHz;  $\sigma = 1.83$  mho/m;  $\epsilon_r = 38.7$ ;  $\rho = 1000$  kg/m<sup>3</sup>  
Phantom section: Left Section ; Measurement SW: DASY4, V4.7 Build 71; Postprocessing SW: SEMCAD, V1.8 Build 184

DASY4 Configuration:

- Probe: ET3DV6 - SN1630; ConvF(4.57, 4.57, 4.57); Calibrated: 2011-11-18
- Sensor-Surface: 2mm (Mechanical Surface Detection)
- Electronics: DAE3 Sn446; Calibrated: 2011-09-27
- Phantom: 1800/1900 Phantom; Type: SAM

**Left tilt 1ch 5.5Mbps/Area Scan (61x91x1):** Measurement grid: dx=15mm, dy=15mm

[Info: Interpolated medium parameters used for SAR evaluation.](#)

Maximum value of SAR (interpolated) = 0.041 mW/g

**Left tilt 1ch 5.5Mbps/Zoom Scan (5x5x7)/Cube 0:** Measurement grid: dx=8mm, dy=8mm, dz=5mm

Reference Value = 1.64 V/m; Power Drift = -0.01 dB

Peak SAR (extrapolated) = 0.056 W/kg

**SAR(1 g) = 0.033 mW/g; SAR(10 g) = 0.016 mW/g**

[Info: Interpolated medium parameters used for SAR evaluation.](#)

Maximum value of SAR (measured) = 0.038 mW/g

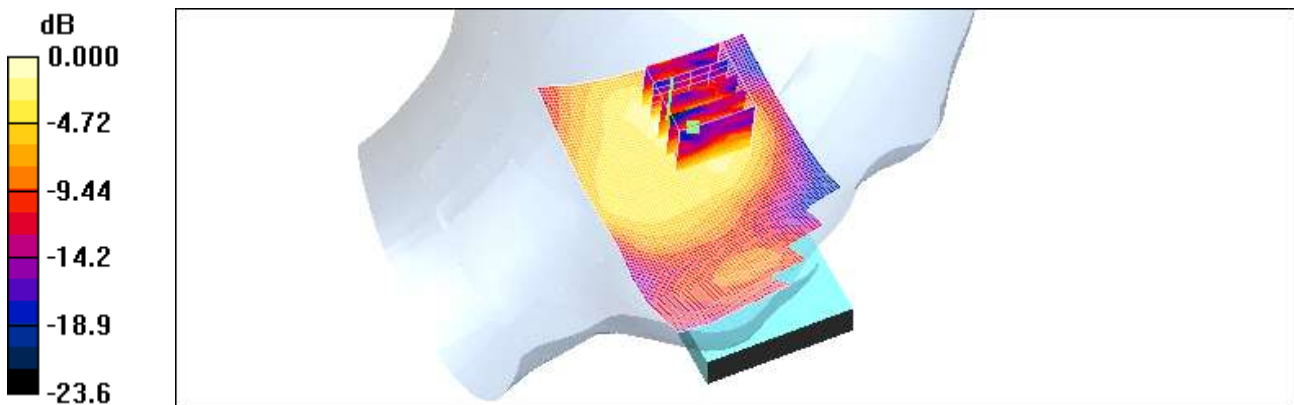

Test Laboratory: HCT CO., LTD  
EUT Type: PCS CDMA Phone with Bluetooth/WLAN  
Liquid Temperature: 21.1 °C  
Ambient Temperature: 21.3 °C  
Test Date: May 9,2012

**DUT: Walleye; Type: bar; Serial: #1**

Communication System: 2450MHz FCC; Frequency: 2412 MHz;Duty Cycle: 1:1  
Medium parameters used (interpolated):  $f = 2412$  MHz;  $\sigma = 1.83$  mho/m;  $\epsilon_r = 38.7$ ;  $\rho = 1000$  kg/m<sup>3</sup>  
Phantom section: Right Section ; Measurement SW: DASY4, V4.7 Build 71; Postprocessing SW: SEMCAD, V1.8 Build 184

DASY4 Configuration:

- Probe: ET3DV6 - SN1630; ConvF(4.57, 4.57, 4.57); Calibrated: 2011-11-18
- Sensor-Surface: 2mm (Mechanical Surface Detection)
- Electronics: DAE3 Sn446; Calibrated: 2011-09-27
- Phantom: 1800/1900 Phantom; Type: SAM

**Right touch 1ch 1Mbps/Area Scan (61x91x1):** Measurement grid: dx=15mm, dy=15mm

[Info: Interpolated medium parameters used for SAR evaluation.](#)

Maximum value of SAR (interpolated) = 0.163 mW/g

**Right touch 1ch 1Mbps/Zoom Scan (5x5x7)/Cube 0:** Measurement grid: dx=8mm, dy=8mm, dz=5mm

Reference Value = 3.13 V/m; Power Drift = -0.072 dB

Peak SAR (extrapolated) = 0.322 W/kg

**SAR(1 g) = 0.135 mW/g; SAR(10 g) = 0.063 mW/g**

[Info: Interpolated medium parameters used for SAR evaluation.](#)

Maximum value of SAR (measured) = 0.149 mW/g

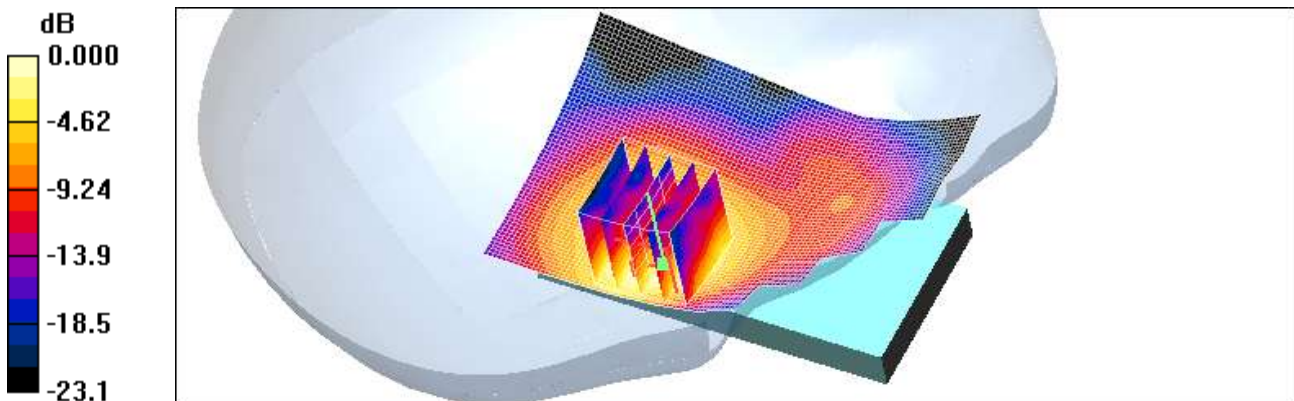

0 dB = 0.149mW/g

Test Laboratory: HCT CO., LTD  
EUT Type: PCS CDMA Phone with Bluetooth/WLAN  
Liquid Temperature: 21.1 °C  
Ambient Temperature: 21.3 °C  
Test Date: May 9,2012

**DUT: Walleye; Type: bar; Serial: #1**

Communication System: 2450MHz FCC; Frequency: 2412 MHz;Duty Cycle: 1:1  
Medium parameters used (interpolated):  $f = 2412$  MHz;  $\sigma = 1.83$  mho/m;  $\epsilon_r = 38.7$ ;  $\rho = 1000$  kg/m<sup>3</sup>  
Phantom section: Right Section ; Measurement SW: DASY4, V4.7 Build 71; Postprocessing SW: SEMCAD, V1.8 Build 184

DASY4 Configuration:

- Probe: ET3DV6 - SN1630; ConvF(4.57, 4.57, 4.57); Calibrated: 2011-11-18
- Sensor-Surface: 2mm (Mechanical Surface Detection)
- Electronics: DAE3 Sn446; Calibrated: 2011-09-27
- Phantom: 1800/1900 Phantom; Type: SAM

**Right touch 1ch 5.5Mbps/Area Scan (61x91x1):** Measurement grid: dx=15mm, dy=15mm

[Info: Interpolated medium parameters used for SAR evaluation.](#)

Maximum value of SAR (interpolated) = 0.177 mW/g

**Right touch 1ch 5.5Mbps/Zoom Scan (5x5x7)/Cube 0:** Measurement grid: dx=8mm, dy=8mm, dz=5mm

Reference Value = 4.57 V/m; Power Drift = -0.066 dB

Peak SAR (extrapolated) = 0.272 W/kg

**SAR(1 g) = 0.139 mW/g; SAR(10 g) = 0.069 mW/g**

[Info: Interpolated medium parameters used for SAR evaluation.](#)

Maximum value of SAR (measured) = 0.156 mW/g

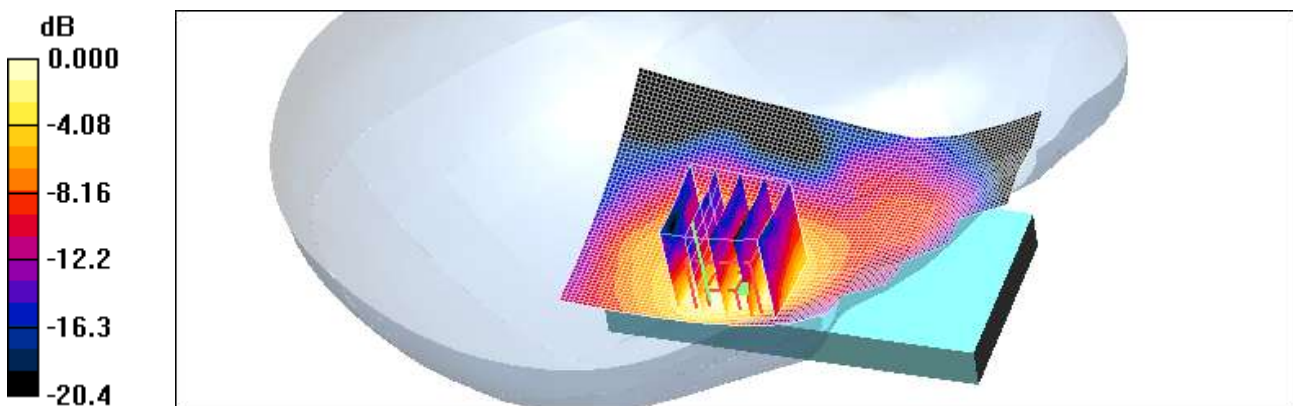

0 dB = 0.156mW/g

Test Laboratory: HCT CO., LTD  
EUT Type: PCS CDMA Phone with Bluetooth/WLAN  
Liquid Temperature: 21.1 °C  
Ambient Temperature: 21.3 °C  
Test Date: May 9,2012

**DUT: Walleye; Type: bar; Serial: #1**

Communication System: 2450MHz FCC; Frequency: 2412 MHz;Duty Cycle: 1:1  
Medium parameters used (interpolated):  $f = 2412$  MHz;  $\sigma = 1.83$  mho/m;  $\epsilon_r = 38.7$ ;  $\rho = 1000$  kg/m<sup>3</sup>  
Phantom section: Right Section ; Measurement SW: DASY4, V4.7 Build 71; Postprocessing SW: SEMCAD, V1.8 Build 184

DASY4 Configuration:

- Probe: ET3DV6 - SN1630; ConvF(4.57, 4.57, 4.57); Calibrated: 2011-11-18
- Sensor-Surface: 2mm (Mechanical Surface Detection)
- Electronics: DAE3 Sn446; Calibrated: 2011-09-27
- Phantom: 1800/1900 Phantom; Type: SAM

**Right tilt 1ch 1Mbps/Area Scan (61x91x1):** Measurement grid: dx=15mm, dy=15mm

[Info: Interpolated medium parameters used for SAR evaluation.](#)

Maximum value of SAR (interpolated) = 0.044 mW/g

**Right tilt 1ch 1Mbps/Zoom Scan (5x5x7)/Cube 0:** Measurement grid: dx=8mm, dy=8mm, dz=5mm

Reference Value = 1.43 V/m; Power Drift = 0.080 dB

Peak SAR (extrapolated) = 0.088 W/kg

**SAR(1 g) = 0.047 mW/g; SAR(10 g) = 0.023 mW/g**

[Info: Interpolated medium parameters used for SAR evaluation.](#)

Maximum value of SAR (measured) = 0.052 mW/g

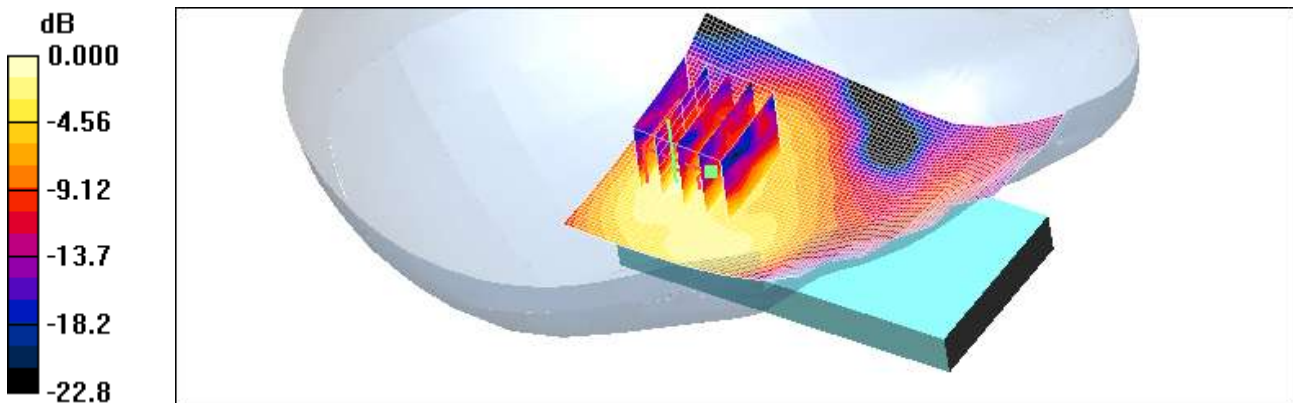

0 dB = 0.052mW/g

Test Laboratory: HCT CO., LTD  
EUT Type: PCS CDMA Phone with Bluetooth/WLAN  
Liquid Temperature: 21.1 °C  
Ambient Temperature: 21.3 °C  
Test Date: May 9,2012

**DUT: Walleye; Type: bar; Serial: #1**

Communication System: 2450MHz FCC; Frequency: 2412 MHz;Duty Cycle: 1:1  
Medium parameters used (interpolated):  $f = 2412$  MHz;  $\sigma = 1.83$  mho/m;  $\epsilon_r = 38.7$ ;  $\rho = 1000$  kg/m<sup>3</sup>  
Phantom section: Right Section ; Measurement SW: DASY4, V4.7 Build 71; Postprocessing SW: SEMCAD, V1.8 Build 184

DASY4 Configuration:

- Probe: ET3DV6 - SN1630; ConvF(4.57, 4.57, 4.57); Calibrated: 2011-11-18
- Sensor-Surface: 2mm (Mechanical Surface Detection)
- Electronics: DAE3 Sn446; Calibrated: 2011-09-27
- Phantom: 1800/1900 Phantom; Type: SAM

**Right tilt 1ch 5.5Mbps/Area Scan (61x91x1):** Measurement grid: dx=15mm, dy=15mm

[Info: Interpolated medium parameters used for SAR evaluation.](#)

Maximum value of SAR (interpolated) = 0.047 mW/g

**Right tilt 1ch 5.5Mbps/Zoom Scan (5x5x7)/Cube 0:** Measurement grid: dx=8mm, dy=8mm, dz=5mm

Reference Value = 1.90 V/m; Power Drift = -0.07 dB

Peak SAR (extrapolated) = 0.108 W/kg

**SAR(1 g) = 0.051 mW/g; SAR(10 g) = 0.024 mW/g**

[Info: Interpolated medium parameters used for SAR evaluation.](#)

Maximum value of SAR (measured) = 0.055 mW/g

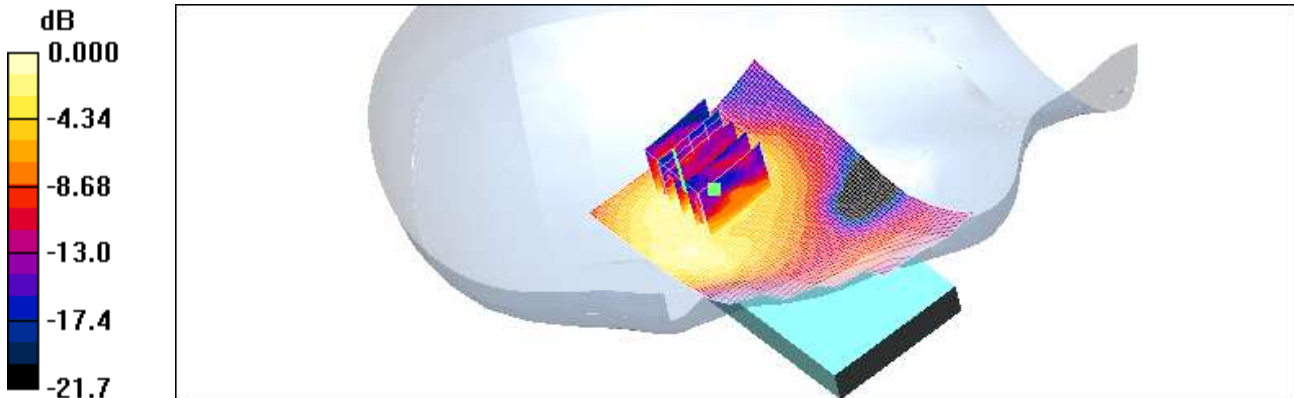

0 dB = 0.055mW/g



Test Laboratory: HCT CO., LTD  
EUT Type: PCS CDMA Phone with Bluetooth/WLAN  
Liquid Temperature: 21.1 °C  
Ambient Temperature: 21.3 °C  
Test Date: May 8,2012

**DUT: Walleye; Type: bar; Serial: #1**

Communication System: PCS 1900MHz FCC; Frequency: 1880 MHz;Duty Cycle: 1:1  
Medium parameters used:  $f = 1880$  MHz;  $\sigma = 1.47$  mho/m;  $\epsilon_r = 53.6$ ;  $\rho = 1000$  kg/m<sup>3</sup>  
Phantom section: Flat Section ; Measurement SW: DASY4, V4.7 Build 71; Postprocessing SW: SEMCAD, V1.8 Build 184

DASY4 Configuration:

- Probe: ET3DV6 - SN1630; ConvF(4.75, 4.75, 4.75); Calibrated: 2011-11-18
- Sensor-Surface: 2mm (Mechanical Surface Detection)
- Electronics: DAE3 Sn466; Calibrated: 2012-02-21
- Phantom: 1800/1900 Phantom; Type: SAM

**Body rear 600/Area Scan (51x101x1):** Measurement grid: dx=15mm, dy=15mm  
Maximum value of SAR (interpolated) = 0.657 mW/g

**Body rear 600/Zoom Scan (5x5x7)/Cube 0:** Measurement grid: dx=8mm, dy=8mm, dz=5mm  
Reference Value = 13.1 V/m; Power Drift = 0.032 dB  
Peak SAR (extrapolated) = 0.942 W/kg  
**SAR(1 g) = 0.617 mW/g; SAR(10 g) = 0.387 mW/g**  
Maximum value of SAR (measured) = 0.672 mW/g

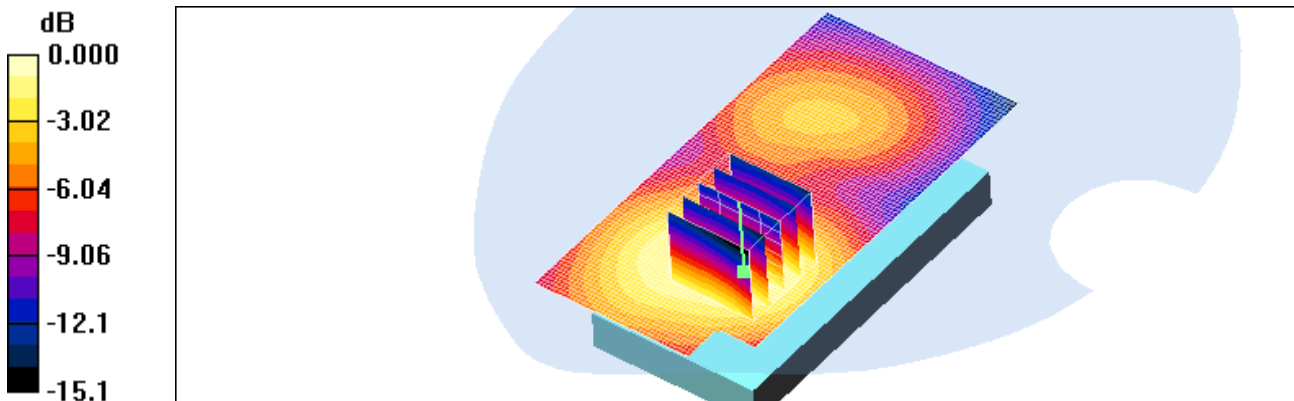

0 dB = 0.672mW/g

Test Laboratory: HCT CO., LTD  
EUT Type: PCS CDMA Phone with Bluetooth/WLAN  
Liquid Temperature: 21.1 °C  
Ambient Temperature: 21.3 °C  
Test Date: May 9,2012

**DUT: Walleye; Type: bar; Serial: #1**

Communication System: 2450MHz FCC; Frequency: 2412 MHz;Duty Cycle: 1:1  
Medium parameters used (interpolated):  $f = 2412$  MHz;  $\sigma = 1.83$  mho/m;  $\epsilon_r = 51.8$ ;  $\rho = 1000$  kg/m<sup>3</sup>  
Phantom section: Flat Section ; Measurement SW: DASY4, V4.7 Build 71; Postprocessing SW: SEMCAD, V1.8 Build 184

DASY4 Configuration:

- Probe: ET3DV6 - SN1630; ConvF(4.3, 4.3, 4.3); Calibrated: 2011-11-18
- Sensor-Surface: 2mm (Mechanical Surface Detection)
- Electronics: DAE3 Sn446; Calibrated: 2011-09-27
- Phantom: 835/900 Phantom ; Type: SAM

**Body rear 1ch 1Mbps/Area Scan (51x91x1):** Measurement grid: dx=15mm, dy=15mm

[Info: Interpolated medium parameters used for SAR evaluation.](#)

Maximum value of SAR (interpolated) = 0.031 mW/g

**Body rear 1ch 1Mbps/Zoom Scan (5x5x7)/Cube 0:** Measurement grid: dx=8mm, dy=8mm, dz=5mm

Reference Value = 2.92 V/m; Power Drift = -0.024 dB

Peak SAR (extrapolated) = 0.075 W/kg

**SAR(1 g) = 0.029 mW/g; SAR(10 g) = 0.014 mW/g**

[Info: Interpolated medium parameters used for SAR evaluation.](#)

Maximum value of SAR (measured) = 0.030 mW/g

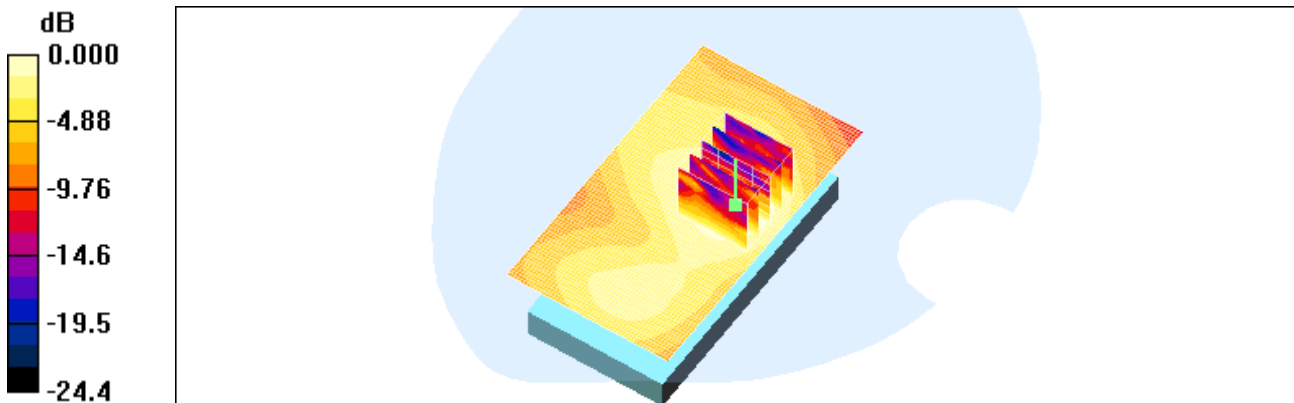

0 dB = 0.030mW/g

Test Laboratory: HCT CO., LTD  
EUT Type: PCS CDMA Phone with Bluetooth/WLAN  
Liquid Temperature: 21.1 °C  
Ambient Temperature: 21.3 °C  
Test Date: May 9,2012

**DUT: Walleye; Type: bar; Serial: #1**

Communication System: 2450MHz FCC; Frequency: 2412 MHz;Duty Cycle: 1:1  
Medium parameters used (interpolated):  $f = 2412$  MHz;  $\sigma = 1.83$  mho/m;  $\epsilon_r = 51.8$ ;  $\rho = 1000$  kg/m<sup>3</sup>  
Phantom section: Flat Section ; Measurement SW: DASY4, V4.7 Build 71; Postprocessing SW: SEMCAD, V1.8 Build 184

DASY4 Configuration:

- Probe: ET3DV6 - SN1630; ConvF(4.3, 4.3, 4.3); Calibrated: 2011-11-18
- Sensor-Surface: 2mm (Mechanical Surface Detection)
- Electronics: DAE3 Sn446; Calibrated: 2011-09-27
- Phantom: 835/900 Phantom ; Type: SAM

**Body rear 1ch 5.5Mbps/Area Scan (51x91x1):** Measurement grid: dx=15mm, dy=15mm

[Info: Interpolated medium parameters used for SAR evaluation.](#)

Maximum value of SAR (interpolated) = 0.030 mW/g

**Body rear 1ch 5.5Mbps/Zoom Scan (5x5x7)/Cube 0:** Measurement grid: dx=8mm, dy=8mm, dz=5mm

Reference Value = 2.74 V/m; Power Drift = -0.03 dB

Peak SAR (extrapolated) = 0.075 W/kg

**SAR(1 g) = 0.027 mW/g; SAR(10 g) = 0.013 mW/g**

[Info: Interpolated medium parameters used for SAR evaluation.](#)

Maximum value of SAR (measured) = 0.030 mW/g

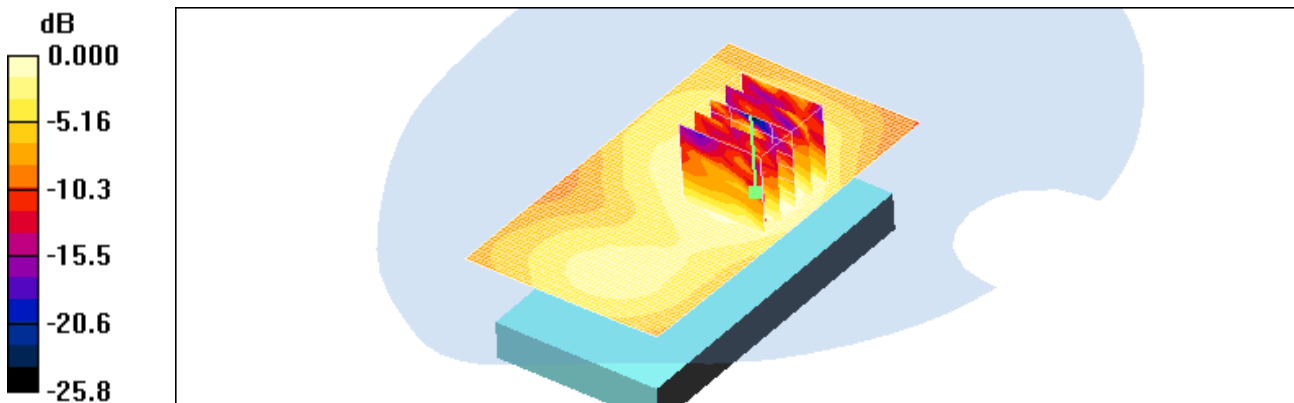

0 dB = 0.030mW/g

Test Laboratory: HCT CO., LTD  
EUT Type: PCS CDMA Phone with Bluetooth/WLAN  
Liquid Temperature: 21.1 °C  
Ambient Temperature: 21.3 °C  
Test Date: May 8, 2012

**DUT: Walleye; Type: bar; Serial: #1**

Communication System: PCS 1900MHz FCC; Frequency: 1880 MHz; Duty Cycle: 1:1  
Medium parameters used:  $f = 1880$  MHz;  $\sigma = 1.37$  mho/m;  $\epsilon_r = 39.2$ ;  $\rho = 1000$  kg/m<sup>3</sup>  
Phantom section: Left Section ; Measurement SW: DASY4, V4.7 Build 71; Postprocessing SW: SEMCAD, V1.8 Build 184

DASY4 Configuration:

- Probe: ET3DV6 - SN1630; ConvF(5.17, 5.17, 5.17); Calibrated: 2011-11-18
- Sensor-Surface: 2mm (Mechanical Surface Detection)
- Electronics: DAE3 Sn446; Calibrated: 2011-09-27
- Phantom: 1800/1900 Phantom; Type: SAM

**Left touch 600/Area Scan (61x91x1):** Measurement grid: dx=15mm, dy=15mm  
Maximum value of SAR (interpolated) = 1.14 mW/g

**Left touch 600/Zoom Scan (5x5x7)/Cube 0:** Measurement grid: dx=8mm, dy=8mm, dz=5mm  
Reference Value = 24.5 V/m; Power Drift = 0.067 dB  
Peak SAR (extrapolated) = 1.79 W/kg  
**SAR(1 g) = 1.07 mW/g; SAR(10 g) = 0.620 mW/g**  
Maximum value of SAR (measured) = 1.17 mW/g

**Left touch 600/Zoom Scan (5x5x7)/Cube 1:** Measurement grid: dx=8mm, dy=8mm, dz=5mm  
Reference Value = 24.5 V/m; Power Drift = 0.067 dB  
Peak SAR (extrapolated) = 1.43 W/kg  
SAR(1 g) = 0.945 mW/g; SAR(10 g) = 0.590 mW/g  
Maximum value of SAR (measured) = 1.04 mW/g

**Left touch 600/Zoom Scan (5x5x7)/Cube 2:** Measurement grid: dx=8mm, dy=8mm, dz=5mm  
Reference Value = 24.5 V/m; Power Drift = 0.067 dB  
Peak SAR (extrapolated) = 1.36 W/kg  
SAR(1 g) = 0.883 mW/g; SAR(10 g) = 0.548 mW/g  
Maximum value of SAR (measured) = 1.000 mW/g

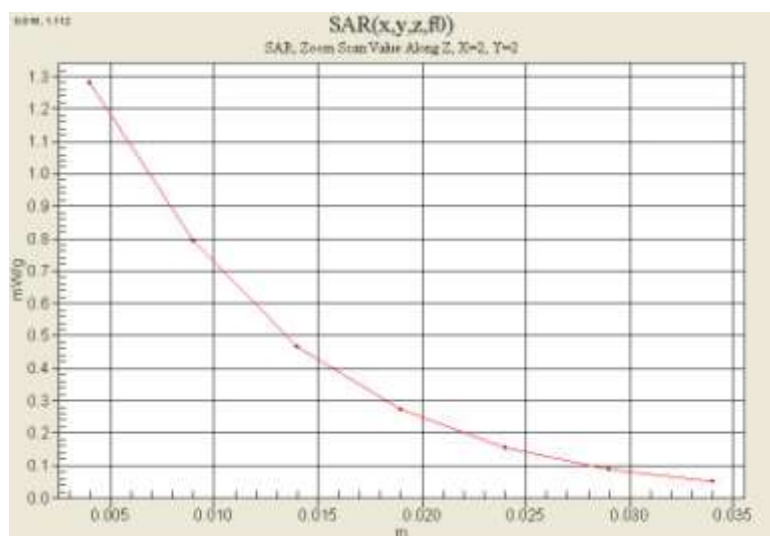

Test Laboratory: HCT CO., LTD  
EUT Type: PCS CDMA Phone with Bluetooth/WLAN  
Liquid Temperature: 21.1 °C  
Ambient Temperature: 21.3 °C  
Test Date: May 8, 2012

**DUT: Walleye; Type: bar; Serial: #1**

Communication System: PCS 1900MHz FCC; Frequency: 1880 MHz; Duty Cycle: 1:1  
Medium parameters used:  $f = 1880$  MHz;  $\sigma = 1.47$  mho/m;  $\epsilon_r = 53.6$ ;  $\rho = 1000$  kg/m<sup>3</sup>  
Phantom section: Flat Section ; Measurement SW: DASY4, V4.7 Build 71; Postprocessing SW: SEMCAD, V1.8 Build 184

DASY4 Configuration:

- Probe: ET3DV6 - SN1630; ConvF(4.75, 4.75, 4.75); Calibrated: 2011-11-18
- Sensor-Surface: 2mm (Mechanical Surface Detection)
- Electronics: DAE3 Sn466; Calibrated: 2012-02-21
- Phantom: 1800/1900 Phantom; Type: SAM

**Body rear 600/Area Scan (51x101x1):** Measurement grid: dx=15mm, dy=15mm  
Maximum value of SAR (interpolated) = 0.657 mW/g

**Body rear 600/Zoom Scan (5x5x7)/Cube 0:** Measurement grid: dx=8mm, dy=8mm, dz=5mm  
Reference Value = 13.1 V/m; Power Drift = 0.032 dB  
Peak SAR (extrapolated) = 0.942 W/kg  
**SAR(1 g) = 0.617 mW/g; SAR(10 g) = 0.387 mW/g**  
Maximum value of SAR (measured) = 0.672 mW/g

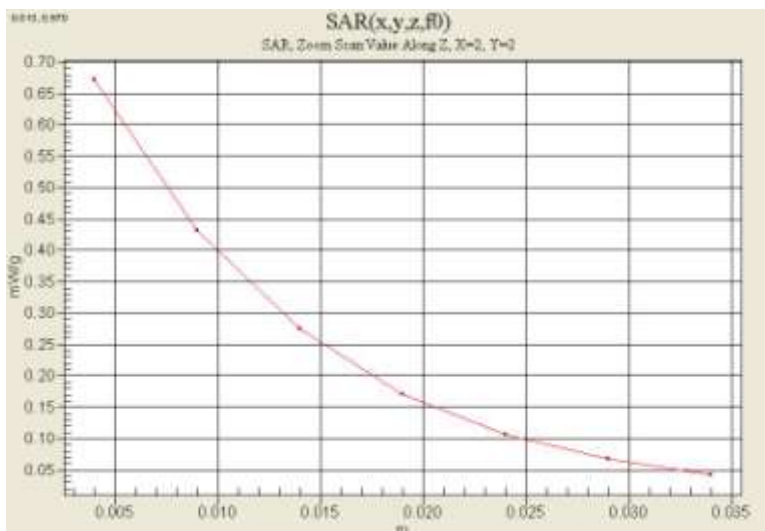

## Attachment 2. – Dipole Validation Plots

## ■ Validation Data (1900 MHz Head)

Test Laboratory: HCT CO., LTD  
Input Power 100 mW (20 dBm)  
Liquid Temp: 21.1 °C  
Test Date: May 8, 2012

**DUT: Dipole 1900 MHz; Type: D1900V2; Serial: D1900V2 – SN:5d032**

Communication System: CW; Frequency: 1900 MHz; Duty Cycle: 1:1  
Medium parameters used:  $f = 1900$  MHz;  $\sigma = 1.39$  mho/m;  $\epsilon_r = 39.1$ ;  $\rho = 1000$  kg/m<sup>3</sup>  
Phantom section: Flat Section ; Measurement SW: DASY4, V4.7 Build 71; Postprocessing SW: SEMCAD, V1.8 Build 184

DASY4 Configuration:

- Probe: ET3DV6 – SN1630; ConvF(5.17, 5.17, 5.17); Calibrated: 2011-11-18
- Sensor-Surface: 2mm (Mechanical Surface Detection)
- Electronics: DAE3 Sn446; Calibrated: 2011-09-27
- Phantom: SAM 835/900 MHz; Type: SAM

**Dipole 1900MHz Validation/Area Scan (61x61x1):** Measurement grid: dx=15mm, dy=15mm  
Maximum value of SAR (interpolated) = 4.52 mW/g

**Dipole 1900MHz Validation/Zoom Scan (5x5x7)/Cube 0:** Measurement grid: dx=8mm, dy=8mm, dz=5mm  
Reference Value = 59.8 V/m; Power Drift = -0.012 dB  
Peak SAR (extrapolated) = 6.87 W/kg  
**SAR(1 g) = 4.03 mW/g; SAR(10 g) = 2.25 mW/g**  
Maximum value of SAR (measured) = 4.44 mW/g

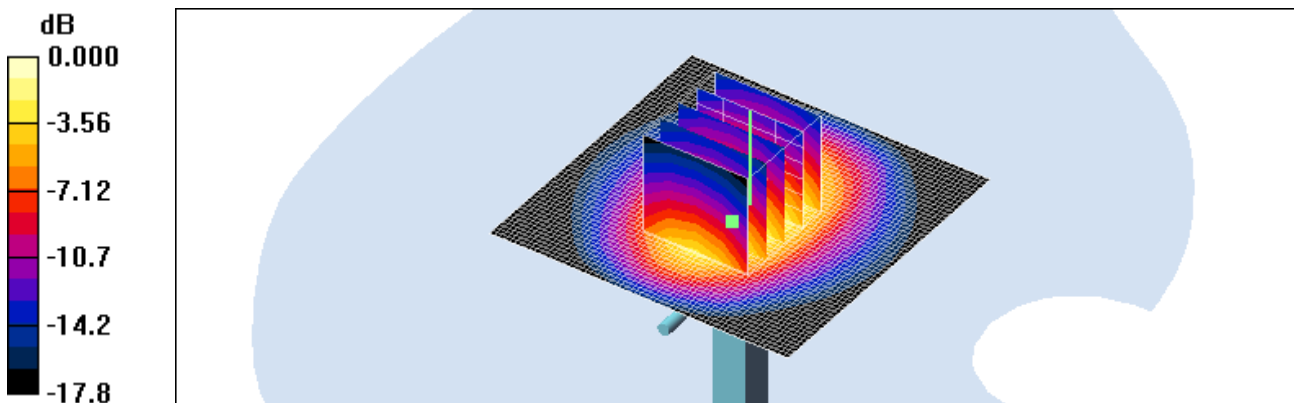

## ■ Validation Data (1900 MHz Body)

Test Laboratory: HCT CO., LTD  
Input Power 100 mW (20 dBm)  
Liquid Temp: 21.1 °C  
Test Date: May 8,2012

**DUT: Dipole 1900 MHz; Type: D1900V2; Serial: D1900V2 – SN:5d032**

Communication System: CW; Frequency: 1900 MHz;Duty Cycle: 1:1  
Medium parameters used:  $f = 1900$  MHz;  $\sigma = 1.49$  mho/m;  $\epsilon_r = 53.5$ ;  $\rho = 1000$  kg/m<sup>3</sup>  
Phantom section: Flat Section ; Measurement SW: DASY4, V4.7 Build 71; Postprocessing SW: SEMCAD, V1.8 Build 184

DASY4 Configuration:

- Probe: ET3DV6 – SN1630; ConvF(4.75, 4.75, 4.75); Calibrated: 2011-11-18
- Sensor-Surface: 2mm (Mechanical Surface Detection)
- Electronics: DAE3 Sn446; Calibrated: 2011-09-27
- Phantom: SAM 1800/1900 MHz; Type: SAM

**Dipole 1900MHz Validation/Area Scan (61x61x1):** Measurement grid: dx=15mm, dy=15mm  
Maximum value of SAR (interpolated) = 4.98 mW/g

**Dipole 1900MHz Validation/Zoom Scan (5x5x7)/Cube 0:** Measurement grid: dx=8mm, dy=8mm, dz=5mm  
Reference Value = 61.6 V/m; Power Drift = -0.191 dB

Peak SAR (extrapolated) = 7.21 W/kg

**SAR(1 g) = 4.24 mW/g; SAR(10 g) = 2.22 mW/g**

Maximum value of SAR (measured) = 4.78 mW/g

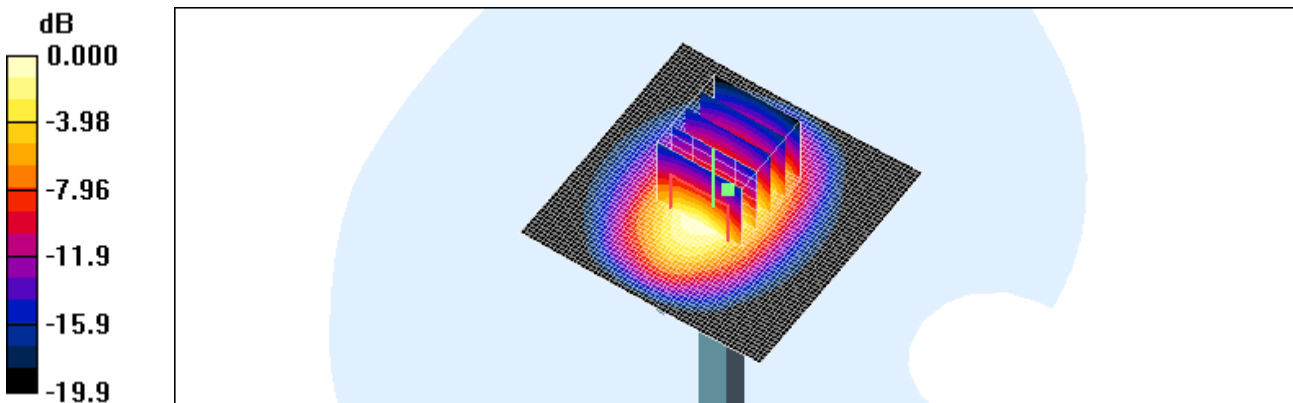

0 dB = 4.78mW/g



## Validation Data (2450 MHz Head)

Test Laboratory: HCT CO., LTD  
Input Power 100 mW (20 dBm)  
Liquid Temp: 21.1 °C  
Test Date: May 9,2012

**DUT: Dipole 2450 MHz; Type: D2450V2; Serial: D2450V2 – SN:743**

Communication System: CW; Frequency: 2450 MHz;Duty Cycle: 1:1  
Medium parameters used:  $f = 2450$  MHz;  $\sigma = 1.87$  mho/m;  $\epsilon_r = 38.5$ ;  $\rho = 1000$  kg/m<sup>3</sup>  
Phantom section: Flat Section ; Measurement SW: DASY4, V4.7 Build 71; Postprocessing SW: SEMCAD, V1.8 Build 184

DASY4 Configuration:

- Probe: ET3DV6 – SN1630; ConvF(4.57, 4.57, 4.57); Calibrated: 2011-11-18
- Sensor-Surface: 2mm (Mechanical Surface Detection)
- Electronics: DAE3 Sn446; Calibrated: 2011-09-27
- Phantom: SAM 1800/1900 MHz; Type: SAM

**Validation 2450MHz/Area Scan (61x61x1):** Measurement grid: dx=15mm, dy=15mm  
Maximum value of SAR (interpolated) = 6.46 mW/g

**Validation 2450MHz/Zoom Scan (5x5x7)/Cube 0:** Measurement grid: dx=8mm, dy=8mm, dz=5mm  
Reference Value = 58.6 V/m; Power Drift = -0.029 dB  
Peak SAR (extrapolated) = 12.5 W/kg  
**SAR(1 g) = 5.32 mW/g; SAR(10 g) = 2.43 mW/g**  
Maximum value of SAR (measured) = 5.78 mW/g

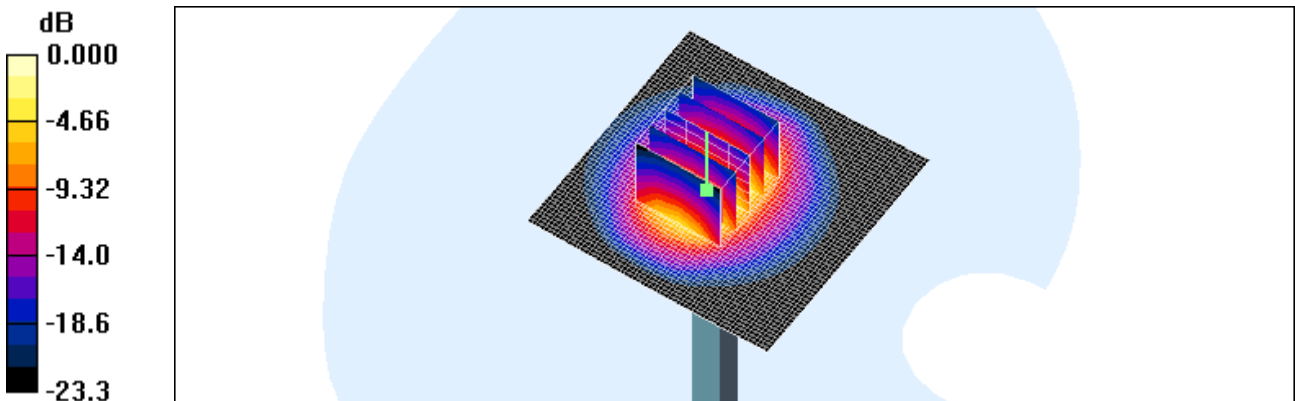

0 dB = 5.78mW/g

## ■ Validation Data (2450 MHz Body)

Test Laboratory: HCT CO., LTD  
Input Power 100 mW (20 dBm)  
Liquid Temp: 21.1 °C  
Test Date: May 9,2012

**DUT: Dipole 2450 MHz; Type: D2450V2; Serial: D2450V2 – SN:743**

Communication System: CW; Frequency: 2450 MHz;Duty Cycle: 1:1  
Medium parameters used:  $f = 2450$  MHz;  $\sigma = 1.89$  mho/m;  $\epsilon_r = 51.7$ ;  $\rho = 1000$  kg/m<sup>3</sup>  
Phantom section: Flat Section ; Measurement SW: DASY4, V4.7 Build 71; Postprocessing SW: SEMCAD, V1.8 Build 184

DASY4 Configuration:

- Probe: ET3DV6 – SN1630; ConvF(4.3, 4.3, 4.3); Calibrated: 2011-11-18
- Sensor-Surface: 2mm (Mechanical Surface Detection)
- Electronics: DAE3 Sn446; Calibrated: 2011-09-27
- Phantom: SAM 1800/1900 MHz; Type: SAM

**Validation 2450MHz/Area Scan (61x61x1):** Measurement grid: dx=15mm, dy=15mm  
Maximum value of SAR (interpolated) = 6.01 mW/g

**Validation 2450MHz/Zoom Scan (5x5x7)/Cube 0:** Measurement grid: dx=8mm, dy=8mm, dz=5mm  
Reference Value = 54.6 V/m; Power Drift = 0.004 dB  
Peak SAR (extrapolated) = 12.0 W/kg  
**SAR(1 g) = 5 mW/g; SAR(10 g) = 2.23 mW/g**  
Maximum value of SAR (measured) = 5.50 mW/g

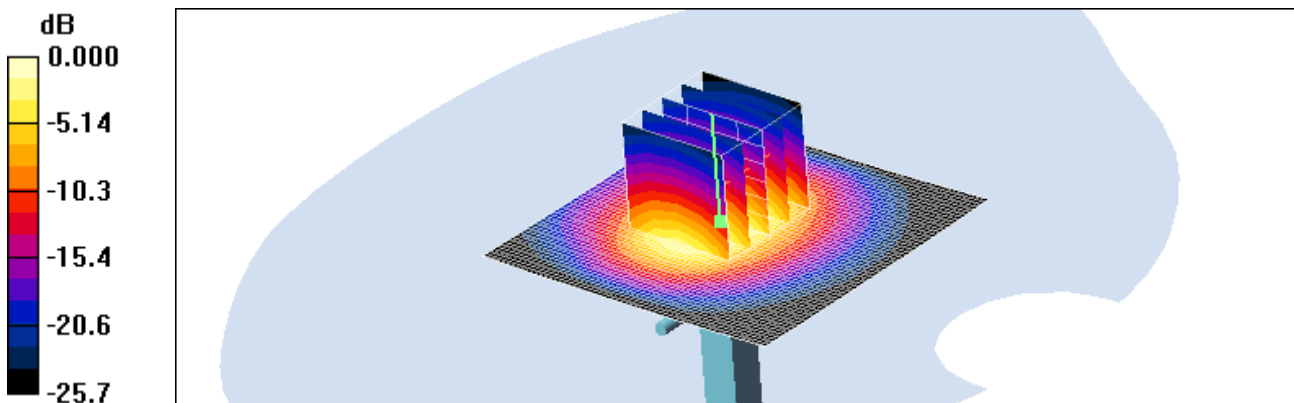

0 dB = 5.50mW/g

## Validation Data (2450 MHz Head)

Test Laboratory: HCT CO., LTD  
Input Power: 100 mW (20 dBm)  
Liquid Temp: 21.1 °C  
Test Date: May 9, 2012

**DUT: Dipole 2450 MHz; Type: D2450V2; Serial: D2450V2 – SN:743**

Communication System: CW; Frequency: 2450 MHz; Duty Cycle: 1:1  
Medium parameters used:  $f = 2450$  MHz;  $\sigma = 1.87$  mho/m;  $\epsilon_r = 38.5$ ;  $\rho = 1000$  kg/m<sup>3</sup>  
Phantom section: Flat Section ; Measurement SW: DASY4, V4.7 Build 71; Postprocessing SW: SEMCAD, V1.8 Build 184

DASY4 Configuration:

- Probe: ET3DV6 – SN1630; ConvF(4.57, 4.57, 4.57); Calibrated: 2011-11-18
- Sensor-Surface: 2mm (Mechanical Surface Detection)
- Electronics: DAE3 Sn446; Calibrated: 2011-09-27
- Phantom: SAM 1800/1900 MHz; Type: SAM

**Validation 2450MHz/Area Scan (61x61x1):** Measurement grid: dx=15mm, dy=15mm  
Maximum value of SAR (interpolated) = 6.46 mW/g

**Validation 2450MHz/Zoom Scan (5x5x7)/Cube 0:** Measurement grid: dx=8mm, dy=8mm, dz=5mm  
Reference Value = 58.6 V/m; Power Drift = -0.029 dB  
Peak SAR (extrapolated) = 12.5 W/kg  
**SAR(1 g) = 5.32 mW/g; SAR(10 g) = 2.43 mW/g**  
Maximum value of SAR (measured) = 5.78 mW/g

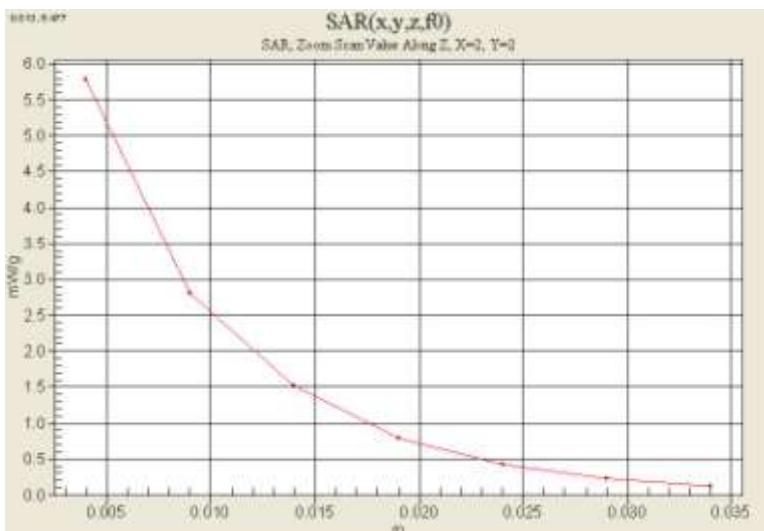

## ■ Validation Data (2450 MHz Body)

Test Laboratory: HCT CO., LTD  
Input Power 100 mW (20 dBm)  
Liquid Temp: 21.1 °C  
Test Date: May 9, 2012

**DUT: Dipole 2450 MHz; Type: D2450V2; Serial: D2450V2 – SN:743**

Communication System: CW; Frequency: 2450 MHz; Duty Cycle: 1:1  
Medium parameters used:  $f = 2450$  MHz;  $\sigma = 1.89$  mho/m;  $\epsilon_r = 51.7$ ;  $\rho = 1000$  kg/m<sup>3</sup>  
Phantom section: Flat Section ; Measurement SW: DASY4, V4.7 Build 71; Postprocessing SW: SEMCAD, V1.8 Build 184

DASY4 Configuration:

- Probe: ET3DV6 – SN1630; ConvF(4.3, 4.3, 4.3); Calibrated: 2011-11-18
- Sensor-Surface: 2mm (Mechanical Surface Detection)
- Electronics: DAE3 Sn446; Calibrated: 2011-09-27
- Phantom: SAM 1800/1900 MHz; Type: SAM

**Validation 2450MHz/Area Scan (61x61x1):** Measurement grid: dx=15mm, dy=15mm  
Maximum value of SAR (interpolated) = 6.01 mW/g

**Validation 2450MHz/Zoom Scan (5x5x7)/Cube 0:** Measurement grid: dx=8mm, dy=8mm, dz=5mm  
Reference Value = 54.6 V/m; Power Drift = 0.004 dB

Peak SAR (extrapolated) = 12.0 W/kg

**SAR(1 g) = 5 mW/g; SAR(10 g) = 2.23 mW/g**

Maximum value of SAR (measured) = 5.50 mW/g

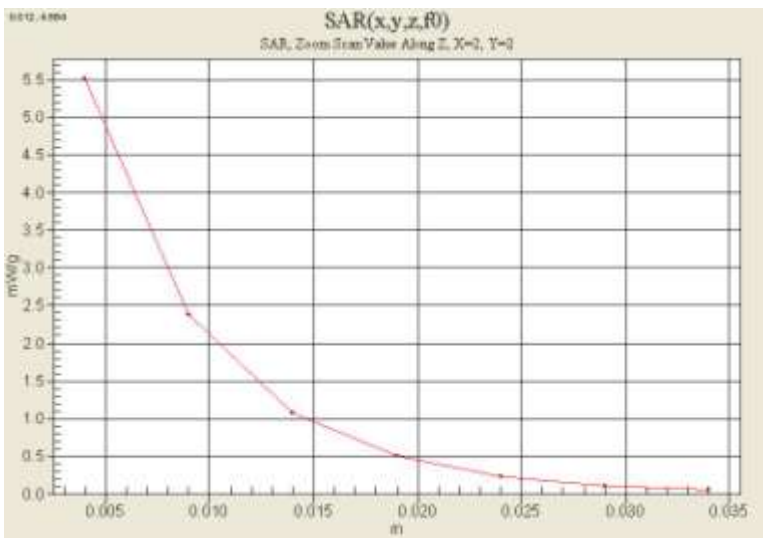

**■ Dielectric Parameter (1900 MHz Head)**

Title Walleye  
SubTitle 1900(Head)  
Test Date May 8,2012

Frequency	e'	e''
1800000000.0000	39.4710	12.8551
1810000000.0000	39.4151	12.8844
1820000000.0000	39.3884	12.9200
1830000000.0000	39.3613	12.9527
1840000000.0000	39.3211	12.9816
1850000000.0000	39.2872	13.0185
1860000000.0000	39.2366	13.0361
1870000000.0000	39.2072	13.0525
1880000000.0000	39.1713	13.0849
1890000000.0000	39.1370	13.1133
1900000000.0000	39.0948	13.1321
1910000000.0000	39.0354	13.1589
1920000000.0000	39.0130	13.2095
1930000000.0000	38.9591	13.2273
1940000000.0000	38.9304	13.2731
1950000000.0000	38.8859	13.2882
1960000000.0000	38.8428	13.3171
1970000000.0000	38.8047	13.3430
1980000000.0000	38.7729	13.3677
1990000000.0000	38.7202	13.4208
2000000000.0000	38.7101	13.4400

**■ Dielectric Parameter (1900 MHz Body)**

Title Walleye  
SubTitle 1900(Body)  
Test Date May 8,2012

Frequency	e'	e''
1850000000.0000	53.6860	13.9311
1855000000.0000	53.6798	13.9475
1860000000.0000	53.6822	13.9390
1865000000.0000	53.6616	13.9859
1870000000.0000	53.6407	13.9802
1875000000.0000	53.6071	14.0065
1880000000.0000	53.5732	14.0213
1885000000.0000	53.5509	14.0188
1890000000.0000	53.5045	14.0704
1895000000.0000	53.4742	14.0727
1900000000.0000	53.4509	14.0899
1905000000.0000	53.4274	14.1119
1910000000.0000	53.3954	14.1226
1915000000.0000	53.3510	14.1489
1920000000.0000	53.3517	14.1931
1925000000.0000	53.3402	14.2023
1930000000.0000	53.3101	14.2204
1935000000.0000	53.3310	14.2466
1940000000.0000	53.3205	14.2471
1945000000.0000	53.3055	14.2973
1950000000.0000	53.3043	14.2921

**■ Dielectric Parameter (2450 MHz Head)**

Title Walleye  
SubTitle 2450(Head)  
Test Date May 9,2012

Frequency	e'	e''
2400000000.0000	38.7763	13.5694
2405000000.0000	38.7209	13.5878
2410000000.0000	38.6997	13.6186
2415000000.0000	38.6348	13.6085
2420000000.0000	38.5822	13.6830
2425000000.0000	38.5836	13.6942
2430000000.0000	38.5409	13.6801
2435000000.0000	38.5310	13.7093
2440000000.0000	38.5112	13.7308
2445000000.0000	38.5493	13.7306
2450000000.0000	38.5372	13.7485
2455000000.0000	38.5446	13.7765
2460000000.0000	38.5663	13.7653
2465000000.0000	38.5960	13.8119
2470000000.0000	38.6121	13.8050
2475000000.0000	38.5951	13.8540
2480000000.0000	38.6100	13.8188
2485000000.0000	38.5670	13.8431
2490000000.0000	38.5995	13.8655
2495000000.0000	38.5657	13.8718
2500000000.0000	38.5547	13.8746

**■ Dielectric Parameter (2450 MHz Body)**

Title Walleye  
SubTitle 2450(Body)  
Test Date May 9,2012

Frequency	e'	e''
2400000000.0000	51.8484	13.5885
2405000000.0000	51.8801	13.5854
2410000000.0000	51.8063	13.6106
2415000000.0000	51.7874	13.6228
2420000000.0000	51.7732	13.6739
2425000000.0000	51.7533	13.6730
2430000000.0000	51.7159	13.7315
2435000000.0000	51.7099	13.7468
2440000000.0000	51.6875	13.8017
2445000000.0000	51.6576	13.8328
2450000000.0000	51.6771	13.8758
2455000000.0000	51.6350	13.8968
2460000000.0000	51.6418	13.9115
2465000000.0000	51.6425	13.9679
2470000000.0000	51.5963	13.9497
2475000000.0000	51.5978	13.9680
2480000000.0000	51.5990	14.0092
2485000000.0000	51.5574	14.0083
2490000000.0000	51.5650	14.0189
2495000000.0000	51.5485	14.0310
2500000000.0000	51.5727	14.0653



## Attachment 3. – Probe Calibration Data

**Calibration Laboratory of  
Schmid & Partner  
Engineering AG**  
Zeughausstrasse 43, 8004 Zurich, Switzerland



S Schweizerischer Kalibrierdienst  
S Service suisse d'étalonnage  
S Servizio svizzero di taratura  
S Swiss Calibration Service

Accredited by the Swiss Accreditation Service (SAS)  
The Swiss Accreditation Service is one of the signatories to the EA  
Multilateral Agreement for the recognition of calibration certificates

Accreditation No.: SCS 108

Client **HCT (Dymstec)**

Certificate No: **ET3-1630\_Nov11**

**CALIBRATION CERTIFICATE**

Object **ET3DV6 - SN:1630**

Calibration procedure(s) **QA CAL-01.v8, QA CAL-12.v7, QA CAL-23.v4, QA CAL-25.v4  
Calibration procedure for dosimetric E-field probes**

Calibration date: **November 18, 2011**

This calibration certificate documents the traceability to national standards, which realize the physical units of measurements (SI).  
The measurements and the uncertainties with confidence probability are given on the following pages and are part of the certificate.

All calibrations have been conducted in the closed laboratory facility, environment temperature (22 ± 3)°C and humidity < 70%.

Calibration Equipment used (M&TE critical for calibration)

Primary Standards	ID	Cal Date (Certificate No.)	Scheduled Calibration
Power meter E4419B	GB41293674	31-Mar-11 (No. 217-01372)	Apr-12
Power sensor E4412A	MY41498067	31-Mar-11 (No. 217-01372)	Apr-12
Reference 3 dB Attenuator	SN: S5054 (3c)	29-Mar-11 (No. 217-01369)	Apr-12
Reference 20 dB Attenuator	SN: S5086 (20b)	29-Mar-11 (No. 217-01367)	Apr-12
Reference 30 dB Attenuator	SN: S5129 (30b)	29-Mar-11 (No. 217-01370)	Apr-12
Reference Probe ES3DV2	SN: 3013	29-Dec-10 (No. ES3-3013_Dec10)	Dec-11
DAE4	SN: 654	3-May-11 (No. DAE4-654_May11)	May-12
Secondary Standards	ID	Check Date (in house)	Scheduled Check
RF generator HP 8648C	US3642U01700	4-Aug-99 (in house check Apr-11)	in house check: Apr-13
Network Analyzer HP 8753E	US37390585	18-Oct-01 (in house check Oct-11)	in house check: Oct-12

	Name	Function	Signature
Calibrated by:	Jeton Kasrati	Laboratory Technician	
Approved by:	Katja Pokovic	Technical Manager	

Issued: November 18, 2011

This calibration certificate shall not be reproduced except in full without written approval of the laboratory.

Calibration Laboratory of  
Schmid & Partner  
Engineering AG  
Zeughausstrasse 43, 8004 Zurich, Switzerland



S  
C  
S  
Schweizerischer Kalibrierdienst  
Service suisse d'étalonnage  
Servizio svizzero di taratura  
Swiss Calibration Service

Accredited by the Swiss Accreditation Service (SAS)  
The Swiss Accreditation Service is one of the signatories to the EA  
Multilateral Agreement for the recognition of calibration certificates

Accreditation No.: SCS 108

**Glossary:**

TSL	tissue simulating liquid
NORM <sub>x,y,z</sub>	sensitivity in free space
ConvF	sensitivity in TSL / NORM <sub>x,y,z</sub>
DCP	diode compression point
CF	crest factor (1/duty_cycle) of the RF signal
A, B, C	modulation dependent linearization parameters
Polarization $\varphi$	$\varphi$ rotation around probe axis
Polarization $\theta$	$\theta$ rotation around an axis that is in the plane normal to probe axis (at measurement center), i.e., $\theta = 0$ is normal to probe axis

**Calibration is Performed According to the Following Standards:**

- a) IEEE Std 1528-2003, "IEEE Recommended Practice for Determining the Peak Spatial-Averaged Specific Absorption Rate (SAR) in the Human Head from Wireless Communications Devices: Measurement Techniques", December 2003
- b) IEC 62209-1, "Procedure to measure the Specific Absorption Rate (SAR) for hand-held devices used in close proximity to the ear (frequency range of 300 MHz to 3 GHz)", February 2005

**Methods Applied and Interpretation of Parameters:**

- NORM<sub>x,y,z</sub>: Assessed for E-field polarization  $\theta = 0$  ( $f < 900$  MHz in TEM-cell;  $f > 1800$  MHz: R22 waveguide). NORM<sub>x,y,z</sub> are only intermediate values, i.e., the uncertainties of NORM<sub>x,y,z</sub> does not affect the E<sup>2</sup>-field uncertainty inside TSL (see below ConvF).
- NORM( $\theta$ )<sub>x,y,z</sub> = NORM<sub>x,y,z</sub> \* frequency\_response (see Frequency Response Chart). This linearization is implemented in DASY4 software versions later than 4.2. The uncertainty of the frequency response is included in the stated uncertainty of ConvF.
- DCP<sub>x,y,z</sub>: DCP are numerical linearization parameters assessed based on the data of power sweep with CW signal (no uncertainty required). DCP does not depend on frequency nor media.
- PAR: PAR is the Peak to Average Ratio that is not calibrated but determined based on the signal characteristics
- Ax,y,z; Bx,y,z; Cx,y,z; VRx,y,z; A, B, C are numerical linearization parameters assessed based on the data of power sweep for specific modulation signal. The parameters do not depend on frequency nor media. VR is the maximum calibration range expressed in RMS voltage across the diode.
- ConvF and Boundary Effect Parameters: Assessed in flat phantom using E-field (or Temperature Transfer Standard for  $f < 800$  MHz) and inside waveguide using analytical field distributions based on power measurements for  $f > 800$  MHz. The same setups are used for assessment of the parameters applied for boundary compensation (alpha, depth) of which typical uncertainty values are given. These parameters are used in DASY4 software to improve probe accuracy close to the boundary. The sensitivity in TSL corresponds to NORM<sub>x,y,z</sub> \* ConvF whereby the uncertainty corresponds to that given for ConvF. A frequency dependent ConvF is used in DASY version 4.4 and higher which allows extending the validity from  $\pm 50$  MHz to  $\pm 100$  MHz.
- Spherical isotropy (3D deviation from isotropy): in a field of low gradients realized using a flat phantom exposed by a patch antenna.
- Sensor Offset: The sensor offset corresponds to the offset of virtual measurement center from the probe tip (on probe axis). No tolerance required.

ET3DV6 – SN:1630

November 18, 2011

# Probe ET3DV6

## SN:1630

Manufactured: October 12, 2001  
Calibrated: November 18, 2011

Calibrated for DASY/EASY Systems  
(Note: non-compatible with DASY2 system!)

ET3DV6- SN:1630

November 18, 2011

## DASY/EASY - Parameters of Probe: ET3DV6 - SN:1630

### Basic Calibration Parameters

	Sensor X	Sensor Y	Sensor Z	Unc (k=2)
Norm ( $\mu\text{V}/(\text{V/m})^2$ ) <sup>A</sup>	1.71	1.62	1.60	$\pm 10.1 \%$
DCP (mV) <sup>B</sup>	100.3	99.5	101.7	

### Modulation Calibration Parameters

UID	Communication System Name	PAR		A dB	B dB	C dB	VR mV	Unc <sup>C</sup> (k=2)
10000	CW	0.00	X	0.00	0.00	1.00	98.2	$\pm 2.7 \%$
			Y	0.00	0.00	1.00	101.9	
			Z	0.00	0.00	1.00	98.0	

The reported uncertainty of measurement is stated as the standard uncertainty of measurement multiplied by the coverage factor k=2, which for a normal distribution corresponds to a coverage probability of approximately 95%.

<sup>A</sup> The uncertainties of NormX,Y,Z do not affect the E<sup>2</sup>-field uncertainty inside TSL (see Pages 5 and 6).

<sup>B</sup> Numerical linearization parameter; uncertainty not required.

<sup>C</sup> Uncertainty is determined using the max. deviation from linear response applying rectangular distribution and is expressed for the square of the field value.

ET3DV6-SN 1630

November 18, 2011

## DASY/EASY - Parameters of Probe: ET3DV6 - SN:1630

### Calibration Parameter Determined in Head Tissue Simulating Media

f (MHz) <sup>c</sup>	Relative Permittivity <sup>d</sup>	Conductivity (S/m) <sup>d</sup>	ConvF X	ConvF Y	ConvF Z	Alpha	Depth (mm)	Unct. (kw2)
300	45.3	0.87	8.13	8.13	8.13	0.31	1.60	± 13.4 %
450	43.5	0.87	7.40	7.40	7.40	0.22	2.27	± 13.4 %
750	41.9	0.89	6.61	6.61	6.61	0.82	1.68	± 12.0 %
835	41.5	0.90	6.27	6.27	6.27	0.72	1.84	± 12.0 %
900	41.5	0.97	6.16	6.16	6.16	0.68	1.92	± 12.0 %
1450	40.5	1.20	5.57	5.57	5.57	0.54	2.48	± 12.0 %
1750	40.1	1.37	5.43	5.43	5.43	0.60	2.26	± 12.0 %
1900	40.0	1.40	5.17	5.17	5.17	0.63	2.15	± 12.0 %
1950	40.0	1.40	5.05	5.05	5.05	0.63	2.13	± 12.0 %
2450	39.2	1.80	4.57	4.57	4.57	0.81	1.74	± 12.0 %

<sup>c</sup> Frequency validity of ± 100 MHz only applies for DASY v4.4 and higher (see Page 2), else it is restricted to ± 50 MHz. The uncertainty is the RSS of the ConvF uncertainty at calibration frequency and the uncertainty for the indicated frequency band.

<sup>d</sup> At frequencies below 3 GHz, the validity of tissue parameters ( $\epsilon$  and  $\sigma$ ) can be relaxed to ± 10% if liquid compensation formula is applied to measured SAR values. At frequencies above 3 GHz, the validity of tissue parameters ( $\epsilon$  and  $\sigma$ ) is restricted to ± 5%. The uncertainty is the RSS of the ConvF uncertainty for indicated target tissue parameters.

ET3DV6- SN:1630

November 18, 2011

## DASY/EASY - Parameters of Probe: ET3DV6 - SN:1630

### Calibration Parameter Determined in Body Tissue Simulating Media

f (MHz) <sup>①</sup>	Relative Permittivity <sup>②</sup>	Conductivity (S/m) <sup>③</sup>	ConvF X	ConvF Y	ConvF Z	Alpha	Depth (mm)	Unct. (k=2)
300	58.2	0.92	7.96	7.96	7.96	0.29	2.29	± 13.4 %
450	56.7	0.94	7.74	7.74	7.74	0.16	2.25	± 13.4 %
750	55.5	0.96	6.36	6.36	6.36	0.75	1.84	± 12.0 %
835	55.2	0.97	6.27	6.27	6.27	0.72	1.88	± 12.0 %
1450	54.0	1.30	5.46	5.46	5.46	0.70	1.97	± 12.0 %
1750	53.4	1.49	4.95	4.95	4.95	0.58	2.72	± 12.0 %
1900	53.3	1.52	4.75	4.75	4.75	0.60	2.56	± 12.0 %
2450	52.7	1.95	4.30	4.30	4.30	1.00	1.29	± 12.0 %

<sup>①</sup> Frequency validity of ± 100 MHz only applies for DASY v4.4 and higher (see Page 2), else it is restricted to ± 50 MHz. The uncertainty is the RSS of the ConvF uncertainty at calibration frequency and the uncertainty for the indicated frequency band.

<sup>②</sup> At frequencies below 3 GHz, the validity of tissue parameters ( $\epsilon$  and  $\sigma$ ) can be relaxed to ± 10% if liquid compensation formula is applied to measured BAR values. At frequencies above 3 GHz, the validity of tissue parameters ( $\epsilon$  and  $\sigma$ ) is restricted to ± 5%. The uncertainty in the RSS of the ConvF uncertainty for indicated target tissue parameters.

ET30V6-SN:1630

November 18, 2011

### Frequency Response of E-Field (TEM-Cell:ifi110 EXX, Waveguide: R22)

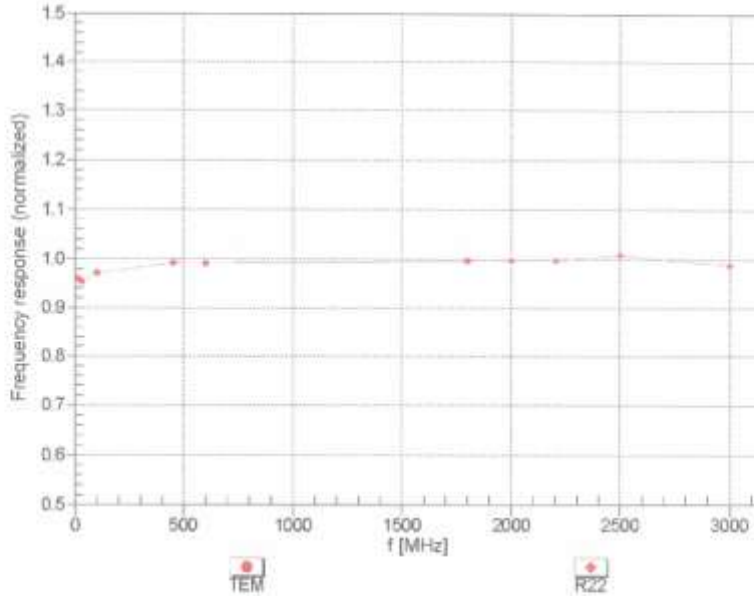

Uncertainty of Frequency Response of E-field:  $\pm 6.3\%$  (k=2)



ET30V6-SN.1630

November 18, 2011

### Receiving Pattern ( $\phi$ ), $\theta = 0^\circ$

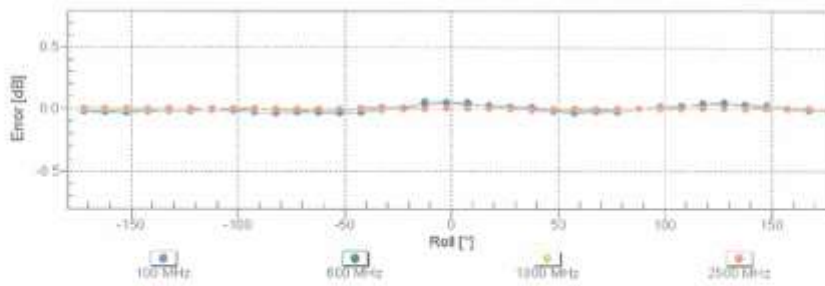
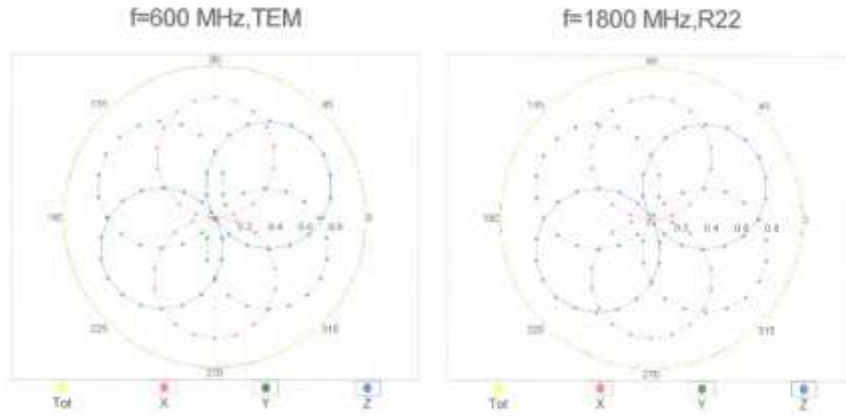

Uncertainty of Axial Isotropy Assessment:  $\pm 0.5\%$  (k=2)

ET3DV6- SN:1630

November 18, 2011

**Dynamic Range f(SAR<sub>head</sub>)**  
(TEM cell , f = 900 MHz)

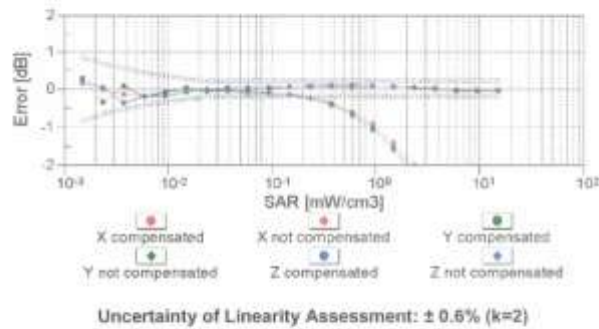
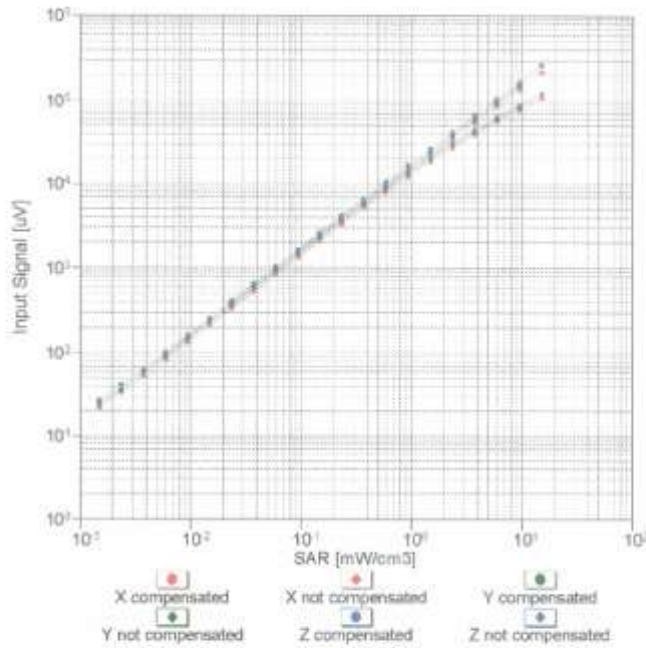

ET3DV6 - SN:1630

November 18, 2011

### Conversion Factor Assessment

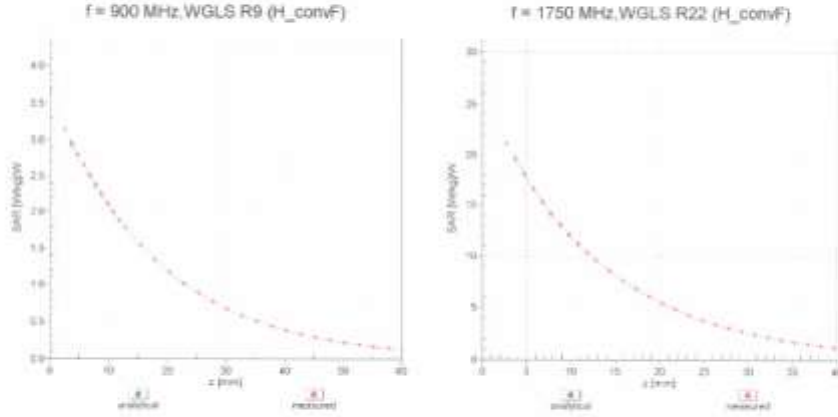

### Deviation from Isotropy in Liquid

Error ( $\phi, \theta$ ), f = 900 MHz

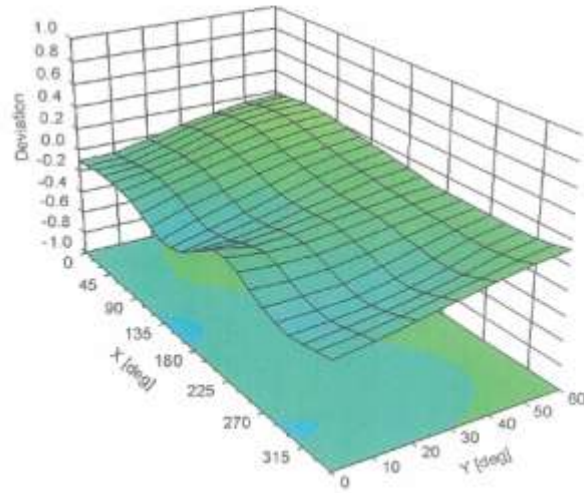

Uncertainty of Spherical Isotropy Assessment:  $\pm 2.6\%$  (k=2)

ET3DV6- SN:1630

November 18, 2011

**DASY/EASY - Parameters of Probe: ET3DV6 - SN:1630****Other Probe Parameters**

Sensor Arrangement	Triangular
Connector Angle (°)	Not applicable
Mechanical Surface Detection Mode	enabled
Optical Surface Detection Mode	disabled
Probe Overall Length	337 mm
Probe Body Diameter	10 mm
Tip Length	10 mm
Tip Diameter	6.8 mm
Probe Tip to Sensor X Calibration Point	2.7 mm
Probe Tip to Sensor Y Calibration Point	2.7 mm
Probe Tip to Sensor Z Calibration Point	2.7 mm
Recommended Measurement Distance from Surface	4 mm

Schmid &amp; Partner Engineering AG

**s p e a g**Zeughausstrasse 43, 8004 Zurich, Switzerland  
Phone +41 44 245 9700, Fax +41 44 245 9779  
info@speag.com, http://www.speag.com

### Additional Conversion Factors for Dosimetric E-Field Probe

Type:

ET3DV6

Serial Number:

1630

Place of Assessment:

Zurich

Date of Assessment:

November 21, 2011

Probe Calibration Date:

November 18, 2011

Schmid & Partner Engineering AG hereby certifies that conversion factor(s) of this probe have been evaluated on the date indicated above. The assessment was performed using the FDTD numerical code SEMCAD of Schmid & Partner Engineering AG. Since the evaluation is coupled with measured conversion factors, it has to be recalculated yearly, i.e., following the recalibration schedule of the probe. The uncertainty of the numerical assessment is based on the extrapolation from measured value at 450, 900 MHz or at 1750 MHz.

Assessed by:



ET3DV6-SN:1630

Page 1 of 2

November 21, 2011

Schmid &amp; Partner Engineering AG

**s p e a g**Zeughausstrasse 43, 8004 Zurich, Switzerland  
Phone +41 44 245 9700, Fax +41 44 245 9779  
info@speag.com, <http://www.speag.com>**Dosimetric E-Field Probe ET3DV6 - SN:1630**Conversion factor ( $\pm$  standard deviation)150  $\pm$  50 MHz      *ConvF*      8.03  $\pm$  10% $\epsilon_r = 52.3 \pm 5\%$   
 $\sigma = 0.76 \pm 5\% \text{ mho/m}$   
(head tissue)150  $\pm$  50 MHz      *ConvF*      8.29  $\pm$  10% $\epsilon_r = 61.9 \pm 5\%$   
 $\sigma = 0.80 \pm 5\% \text{ mho/m}$   
(body tissue)**Important Note:**

For numerically assessed probe conversion factors, parameters Alpha and Delta in the DASY software must have the following entries: Alpha = 0 and Delta = 1.

Please see also DASY Manual.

## Attachment 4. – Dipole Calibration Data

**Calibration Laboratory of  
Schmid & Partner  
Engineering AG**  
Zeughausstrasse 43, 8004 Zurich, Switzerland



**S** Schweizerischer Kalibrierdienst  
**C** Service suisse d'étalonnage  
**S** Servizio svizzero di taratura  
**S** Swiss Calibration Service

Accredited by the Swiss Accreditation Service (SAS)  
The Swiss Accreditation Service is one of the signatories to the EA  
Multilateral Agreement for the recognition of calibration certificates

Accreditation No.: SCS 108

Client: **HCT (Dymstec)**

Certificate No: D835V2-441\_May11

**CALIBRATION CERTIFICATE**

Object: D835V2 - SN: 441

Calibration procedure(s): QA CAL-05.v8  
Calibration procedure for dipole validation kits above 700 MHz

Calibration date: May 16, 2011

This calibration certificate documents the traceability to national standards, which realize the physical units of measurements (SI).  
The measurements and the uncertainties with confidence probability are given on the following pages and are part of the certificate.

All calibrations have been conducted in the closed laboratory facility: environment temperature (22 ± 3)°C and humidity < 70%.

Calibration Equipment used (M&TE critical for calibration)

Primary Standards	ID #	Cal Date (Certificate No.)	Scheduled Calibration
Power meter EPM-442A	GB37480704	06-Oct-10 (No. 217-01266)	Oct-11
Power sensor HP 8481A	US37292783	06-Oct-10 (No. 217-01266)	Oct-11
Reference 20 dB Attenuator	SN: S5086 (20b)	29-Mar-11 (No. 217-01367)	Apr-12
Type-N mismatch combination	SN: 5047.2 / 06327	29-Mar-11 (No. 217-01371)	Apr-12
Reference Probe ES3DV3	SN: 3205	29-Apr-11 (No. ES3-3205_Apr11)	Apr-12
DAE4	SN: 601	10-Jun-10 (No. DAE4-601_Jun10)	Jun-11
Secondary Standards	ID #	Check Date (in house)	Scheduled Check
Power sensor HP 8481A	MY41092317	18-Oct-02 (in house check Oct-09)	In house check: Oct-11
RF generator R&S SMT-06	100005	4-Aug-99 (in house check Oct-09)	In house check: Oct-11
Network Analyzer HP 8753E	US37390585 84206	18-Oct-01 (in house check Oct-10)	In house check: Oct-11

Calibrated by:	Name: Dimce Iliev	Function: Laboratory Technician	Signature:
Approved by:	Name: Katja Pokovic	Function: Technical Manager	Signature:

Issued: May 16, 2011

This calibration certificate shall not be reproduced except in full without written approval of the laboratory.



Calibration Laboratory of  
Schmid & Partner  
Engineering AG  
Zeughausstrasse 43, 8004 Zurich, Switzerland



S Schweizerischer Kalibrierdienst  
C Service suisse d'étalonnage  
S Servizio svizzero di taratura  
S Swiss Calibration Service

Accredited by the Swiss Accreditation Service (SAS)  
The Swiss Accreditation Service is one of the signatories to the EA  
Multilateral Agreement for the recognition of calibration certificates

Accreditation No.: SCS 108

**Glossary:**

TSL	tissue simulating liquid
ConvF	sensitivity in TSL / NORM x,y,z
N/A	not applicable or not measured

**Calibration is Performed According to the Following Standards:**

- IEEE Std 1528-2003, "IEEE Recommended Practice for Determining the Peak Spatial-Averaged Specific Absorption Rate (SAR) in the Human Head from Wireless Communications Devices: Measurement Techniques", December 2003
- IEC 62209-1, "Procedure to measure the Specific Absorption Rate (SAR) for hand-held devices used in close proximity to the ear (frequency range of 300 MHz to 3 GHz)", February 2005
- Federal Communications Commission Office of Engineering & Technology (FCC OET), "Evaluating Compliance with FCC Guidelines for Human Exposure to Radiofrequency Electromagnetic Fields; Additional Information for Evaluating Compliance of Mobile and Portable Devices with FCC Limits for Human Exposure to Radiofrequency Emissions", Supplement C (Edition 01-01) to Bulletin 65

**Additional Documentation:**

- DASY4/5 System Handbook

**Methods Applied and Interpretation of Parameters:**

- Measurement Conditions:** Further details are available from the Validation Report at the end of the certificate. All figures stated in the certificate are valid at the frequency indicated.
- Antenna Parameters with TSL:** The dipole is mounted with the spacer to position its feed point exactly below the center marking of the flat phantom section, with the arms oriented parallel to the body axis.
- Feed Point Impedance and Return Loss:** These parameters are measured with the dipole positioned under the liquid filled phantom. The impedance stated is transformed from the measurement at the SMA connector to the feed point. The Return Loss ensures low reflected power. No uncertainty required.
- Electrical Delay:** One-way delay between the SMA connector and the antenna feed point. No uncertainty required.
- SAR measured:** SAR measured at the stated antenna input power.
- SAR normalized:** SAR as measured, normalized to an input power of 1 W at the antenna connector.
- SAR for nominal TSL parameters:** The measured TSL parameters are used to calculate the nominal SAR result.

**Measurement Conditions**

DASY system configuration, as far as not given on page 1.

DASY Version	DASY5	V52.6.2
Extrapolation	Advanced Extrapolation	
Phantom	Modular Flat Phantom	
Distance Dipole Center - TSL	15 mm	with Spacer
Zoom Scan Resolution	dx, dy, dz = 5 mm	
Frequency	835 MHz ± 1 MHz	

**Head TSL parameters**

The following parameters and calculations were applied.

	Temperature	Permittivity	Conductivity
Nominal Head TSL parameters	22.0 °C	41.5	0.90 mho/m
Measured Head TSL parameters	(22.0 ± 0.2) °C	40.4 ± 6 %	0.88 mho/m ± 6 %
Head TSL temperature change during test	< 0.5 °C	----	----

**SAR result with Head TSL**

SAR averaged over 1 cm <sup>3</sup> (1 g) of Head TSL	Condition	
SAR measured	250 mW input power	2.31 mW / g
SAR for nominal Head TSL parameters	normalized to 1W	9.34 mW / g ± 17.0 % (k=2)

SAR averaged over 10 cm <sup>3</sup> (10 g) of Head TSL	condition	
SAR measured	250 mW input power	1.51 mW / g
SAR for nominal Head TSL parameters	normalized to 1W	6.09 mW / g ± 16.5 % (k=2)

**Body TSL parameters**

The following parameters and calculations were applied.

	Temperature	Permittivity	Conductivity
Nominal Body TSL parameters	22.0 °C	55.2	0.97 mho/m
Measured Body TSL parameters	(22.0 ± 0.2) °C	53.9 ± 6 %	1.00 mho/m ± 6 %
Body TSL temperature change during test	< 0.5 °C	----	----

**SAR result with Body TSL**

SAR averaged over 1 cm <sup>3</sup> (1 g) of Body TSL	Condition	
SAR measured	250 mW input power	2.43 mW / g
SAR for nominal Body TSL parameters	normalized to 1W	9.45 mW / g ± 17.0 % (k=2)

SAR averaged over 10 cm <sup>3</sup> (10 g) of Body TSL	condition	
SAR measured	250 mW input power	1.60 mW / g
SAR for nominal Body TSL parameters	normalized to 1W	6.27 mW / g ± 16.5 % (k=2)

**Appendix****Antenna Parameters with Head TSL**

Impedance, transformed to feed point	50.2 $\Omega$ - 9.8 $j\Omega$
Return Loss	- 20.2 dB

**Antenna Parameters with Body TSL**

Impedance, transformed to feed point	46.3 $\Omega$ - 10.3 $j\Omega$
Return Loss	- 18.9 dB

**General Antenna Parameters and Design**

Electrical Delay (one direction)	1.374 ns
----------------------------------	----------

After long term use with 100W radiated power, only a slight warming of the dipole near the feedpoint can be measured.

The dipole is made of standard semirigid coaxial cable. The center conductor of the feeding line is directly connected to the second arm of the dipole. The antenna is therefore short-circuited for DC-signals.

No excessive force must be applied to the dipole arms, because they might bend or the soldered connections near the feedpoint may be damaged.

**Additional EUT Data**

Manufactured by	SPEAG
Manufactured on	March 09, 2001

**DASY5 Validation Report for Head TSL**

Date: 16.05.2011

Test Laboratory: SPEAG, Zurich, Switzerland

**DUT: Dipole 835 MHz; Type: D835V2; Serial: D835V2 - SN: 441**

Communication System: CW; Frequency: 835 MHz; Duty Cycle: 1:1

Medium: HSL900

Medium parameters used:  $f = 835$  MHz;  $\sigma = 0.88$  mho/m;  $\epsilon_r = 40.4$ ;  $\rho = 1000$  kg/m<sup>3</sup>

Phantom section: Flat Section

Measurement Standard: DASY5 (IEEE/IEC/ANSI C63.19-2007)

DASY5 Configuration:

- Probe: ES3DV3 - SN3205; ConvF(6.07, 6.07, 6.07); Calibrated: 29.04.2011
- Sensor-Surface: 3mm (Mechanical Surface Detection)
- Electronics: DAE4 Sn601; Calibrated: 10.06.2010
- Phantom: Flat Phantom 4.9L; Type: QD000P49AA; Serial: 1001
- Measurement SW: DASY52, V52.6.2 Build (424)
- Postprocessing SW: SEMCAD X, V14.4.4 Build (2829)

**Dipole Calibration for Head Tissue/Pin=250 mW, d=15mm/Zoom Scan (7x7x7)/Cube 0:**

Measurement grid: dx=5mm, dy=5mm, dz=5mm

Reference Value = 57.041 V/m; Power Drift = 0.03 dB

Peak SAR (extrapolated) = 3.442 W/kg

**SAR(1 g) = 2.31 mW/g; SAR(10 g) = 1.51 mW/g**

Maximum value of SAR (measured) = 2.703 mW/g

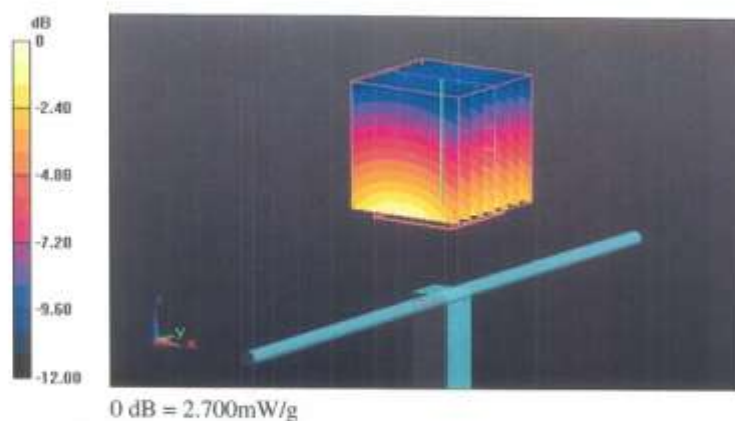

Impedance Measurement Plot for Head TSL

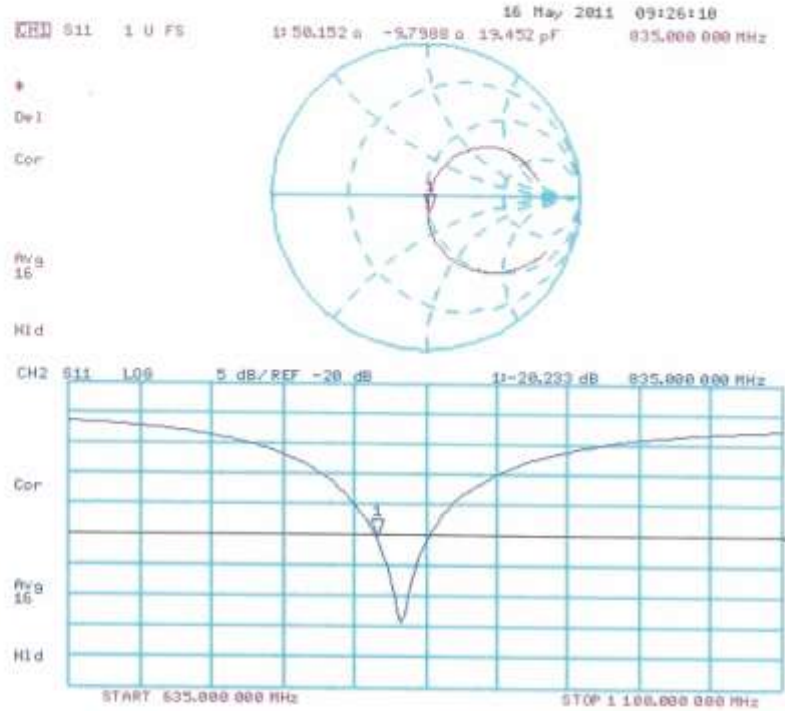

**DASY5 Validation Report for Body TSL**

Date: 16.05.2011

Test Laboratory: SPEAG, Zurich, Switzerland

**DUT: Dipole 835 MHz; Type: D835V2; Serial: D835V2 - SN:441**

Communication System: CW; Frequency: 835 MHz; Duty Cycle: 1:1

Medium: MSL900

Medium parameters used:  $f = 835$  MHz;  $\sigma = 1$  mho/m;  $\epsilon_r = 53.9$ ;  $\rho = 1000$  kg/m<sup>3</sup>

Phantom section: Flat Section

Measurement Standard: DASY5 (IEEE/IEC/ANSI C63.19-2007)

**DASY5 Configuration:**

- Probe: ES3DV3 - SN3205; ConvF(6.02, 6.02, 6.02); Calibrated: 29.04.2011
- Sensor-Surface: 3mm (Mechanical Surface Detection)
- Electronics: DAE4 Sn601; Calibrated: 10.06.2010
- Phantom: Flat Phantom 4.9L; Type: QD000P49AA; Serial: 1001
- Measurement SW: DASY52, V52.6.2 Build (424)
- Postprocessing SW: SEMCAD X, V14.4.4 Build (2829)

**Dipole Calibration for Body Tissue/Pin=250 mW, d=15mm/Zoom Scan (7x7x7)/Cube 0:**

Measurement grid: dx=5mm, dy=5mm, dz=5mm

Reference Value = 55.302 V/m; Power Drift = 0.02 dB

Peak SAR (extrapolated) = 3.553 W/kg

**SAR(1 g) = 2.43 mW/g; SAR(10 g) = 1.6 mW/g**

Maximum value of SAR (measured) = 2.833 mW/g

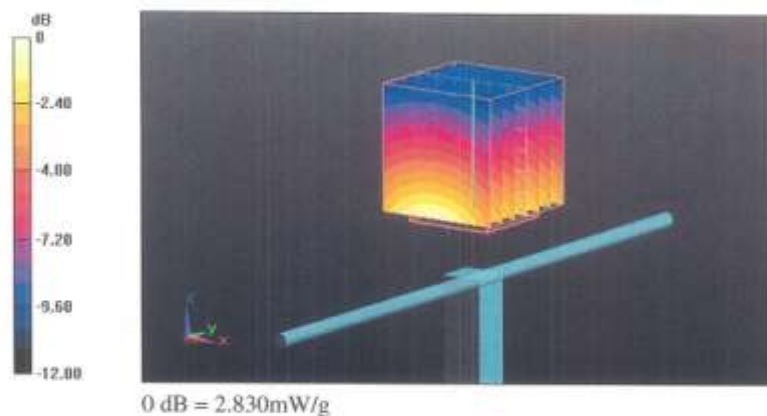

Impedance Measurement Plot for Body TSL

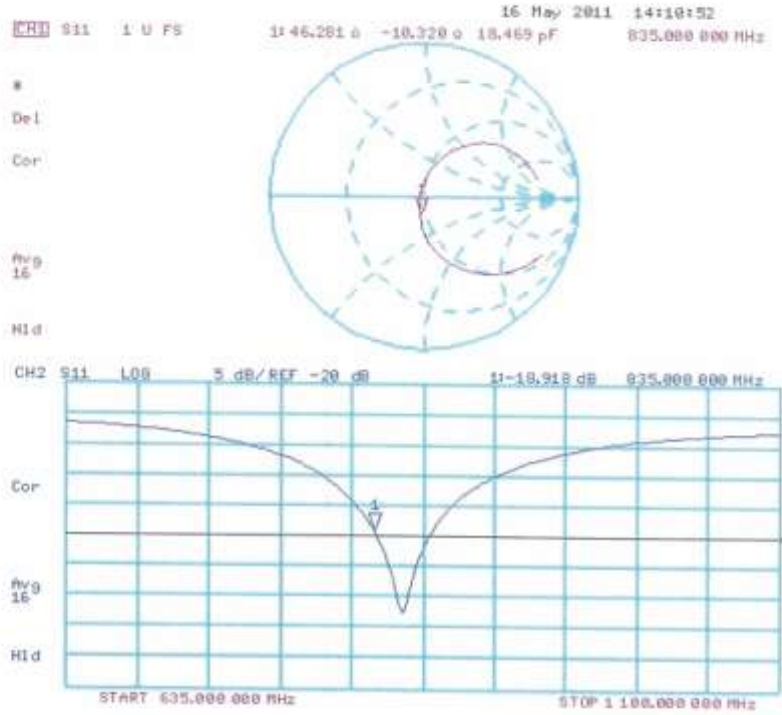

Calibration Laboratory of  
Schmid & Partner  
Engineering AG  
Zeughausstrasse 43, 8004 Zurich, Switzerland



S Schweizerischer Kalibrierdienst  
C Service suisse d'étalonnage  
S Servizio svizzero di taratura  
S Swiss Calibration Service

Accredited by the Swiss Accreditation Service (SAS)  
The Swiss Accreditation Service is one of the signatories to the EA  
Multilateral Agreement for the recognition of calibration certificates

Accreditation No.: SCS 108

Client: HCT (Dymstec)

Certificate No: D2450V2-743\_Aug11

CALIBRATION CERTIFICATE																																															
Object	D2450V2 - SN: 743																																														
Calibration procedure(s)	QA CAL-05.v8 Calibration procedure for dipole validation kits above 700 MHz																																														
Calibration date:	August 29, 2011																																														
<p>This calibration certificate documents the traceability to national standards, which realize the physical units of measurements (SI). The measurements and the uncertainties with confidence probability are given on the following pages and are part of the certificate.</p> <p>All calibrations have been conducted in the closed laboratory facility: environment temperature (22 ± 3/°C and humidity &lt; 70%.</p> <p>Calibration Equipment used (M&amp;TE critical for calibration)</p> <table border="1"> <thead> <tr> <th>Primary Standards</th> <th>ID #</th> <th>Cal Date (Certificate No.)</th> <th>Scheduled Calibration</th> </tr> </thead> <tbody> <tr> <td>Power meter EPM-442A</td> <td>GB37480704</td> <td>06-Oct-10 (No. 217-01266)</td> <td>Oct-11</td> </tr> <tr> <td>Power sensor HP 8481A</td> <td>US37292783</td> <td>06-Oct-10 (No. 217-01266)</td> <td>Oct-11</td> </tr> <tr> <td>Reference 20 dB Attenuator</td> <td>SN: 55086 (20b)</td> <td>29-Mar-11 (No. 217-01367)</td> <td>Apr-12</td> </tr> <tr> <td>Type-N mismatch combination</td> <td>SN: 5047.2 / 06327</td> <td>29-Mar-11 (No. 217-01371)</td> <td>Apr-12</td> </tr> <tr> <td>Reference Probe ES3DV3</td> <td>SN: 3205</td> <td>29-Apr-11 (No. ES3-3205_Apr11)</td> <td>Apr-12</td> </tr> <tr> <td>DAE4</td> <td>SN: 601</td> <td>04-Jul-11 (No. DAE4-601_Jul11)</td> <td>Jul-12</td> </tr> </tbody> </table> <table border="1"> <thead> <tr> <th>Secondary Standards</th> <th>ID #</th> <th>Check Date (in house)</th> <th>Scheduled Check</th> </tr> </thead> <tbody> <tr> <td>Power sensor HP 8481A</td> <td>MY41092317</td> <td>18-Oct-02 (in house check Oct-09)</td> <td>in house check: Oct-11</td> </tr> <tr> <td>RF generator R&amp;S SMT-06</td> <td>100005</td> <td>04-Aug-99 (in house check Oct-09)</td> <td>in house check: Oct-11</td> </tr> <tr> <td>Network Analyzer HP 8753E</td> <td>US37390585 54206</td> <td>18-Oct-01 (in house check Oct-10)</td> <td>in house check: Oct-11</td> </tr> </tbody> </table>				Primary Standards	ID #	Cal Date (Certificate No.)	Scheduled Calibration	Power meter EPM-442A	GB37480704	06-Oct-10 (No. 217-01266)	Oct-11	Power sensor HP 8481A	US37292783	06-Oct-10 (No. 217-01266)	Oct-11	Reference 20 dB Attenuator	SN: 55086 (20b)	29-Mar-11 (No. 217-01367)	Apr-12	Type-N mismatch combination	SN: 5047.2 / 06327	29-Mar-11 (No. 217-01371)	Apr-12	Reference Probe ES3DV3	SN: 3205	29-Apr-11 (No. ES3-3205_Apr11)	Apr-12	DAE4	SN: 601	04-Jul-11 (No. DAE4-601_Jul11)	Jul-12	Secondary Standards	ID #	Check Date (in house)	Scheduled Check	Power sensor HP 8481A	MY41092317	18-Oct-02 (in house check Oct-09)	in house check: Oct-11	RF generator R&S SMT-06	100005	04-Aug-99 (in house check Oct-09)	in house check: Oct-11	Network Analyzer HP 8753E	US37390585 54206	18-Oct-01 (in house check Oct-10)	in house check: Oct-11
Primary Standards	ID #	Cal Date (Certificate No.)	Scheduled Calibration																																												
Power meter EPM-442A	GB37480704	06-Oct-10 (No. 217-01266)	Oct-11																																												
Power sensor HP 8481A	US37292783	06-Oct-10 (No. 217-01266)	Oct-11																																												
Reference 20 dB Attenuator	SN: 55086 (20b)	29-Mar-11 (No. 217-01367)	Apr-12																																												
Type-N mismatch combination	SN: 5047.2 / 06327	29-Mar-11 (No. 217-01371)	Apr-12																																												
Reference Probe ES3DV3	SN: 3205	29-Apr-11 (No. ES3-3205_Apr11)	Apr-12																																												
DAE4	SN: 601	04-Jul-11 (No. DAE4-601_Jul11)	Jul-12																																												
Secondary Standards	ID #	Check Date (in house)	Scheduled Check																																												
Power sensor HP 8481A	MY41092317	18-Oct-02 (in house check Oct-09)	in house check: Oct-11																																												
RF generator R&S SMT-06	100005	04-Aug-99 (in house check Oct-09)	in house check: Oct-11																																												
Network Analyzer HP 8753E	US37390585 54206	18-Oct-01 (in house check Oct-10)	in house check: Oct-11																																												
Calibrated by:	Name Dimce Riev	Function Laboratory Technician	Signature 																																												
Approved by:	Katja Pekovic	Technical Manager																																													
Issued: August 29, 2011																																															
This calibration certificate shall not be reproduced except in full without written approval of the laboratory.																																															



Calibration Laboratory of  
Schmid & Partner  
Engineering AG  
Zeughausstrasse 43, 8004 Zurich, Switzerland



S Schweizerischer Kalibrierdienst  
C Service suisse d'étalonnage  
S Servizio svizzero di taratura  
S Swiss Calibration Service

Accredited by the Swiss Accreditation Service (SAS)  
The Swiss Accreditation Service is one of the signatories to the EA  
Multilateral Agreement for the recognition of calibration certificates

Accreditation No.: SCS 108

**Glossary:**

TSL tissue simulating liquid  
ConvF sensitivity in TSL / NORM x,y,z  
N/A not applicable or not measured

**Calibration is Performed According to the Following Standards:**

- IEEE Std 1528-2003, "IEEE Recommended Practice for Determining the Peak Spatial-Averaged Specific Absorption Rate (SAR) in the Human Head from Wireless Communications Devices: Measurement Techniques", December 2003
- IEC 62209-1, "Procedure to measure the Specific Absorption Rate (SAR) for hand-held devices used in close proximity to the ear (frequency range of 300 MHz to 3 GHz)", February 2005
- Federal Communications Commission Office of Engineering & Technology (FCC OET), "Evaluating Compliance with FCC Guidelines for Human Exposure to Radiofrequency Electromagnetic Fields; Additional Information for Evaluating Compliance of Mobile and Portable Devices with FCC Limits for Human Exposure to Radiofrequency Emissions", Supplement C (Edition 01-01) to Bulletin 65

**Additional Documentation:**

- DASY4/5 System Handbook

**Methods Applied and Interpretation of Parameters:**

- Measurement Conditions:* Further details are available from the Validation Report at the end of the certificate. All figures stated in the certificate are valid at the frequency indicated.
- Antenna Parameters with TSL:* The dipole is mounted with the spacer to position its feed point exactly below the center marking of the flat phantom section, with the arms oriented parallel to the body axis.
- Feed Point Impedance and Return Loss:* These parameters are measured with the dipole positioned under the liquid filled phantom. The impedance stated is transformed from the measurement at the SMA connector to the feed point. The Return Loss ensures low reflected power. No uncertainty required.
- Electrical Delay:* One-way delay between the SMA connector and the antenna feed point. No uncertainty required.
- SAR measured:* SAR measured at the stated antenna input power.
- SAR normalized:* SAR as measured, normalized to an input power of 1 W at the antenna connector.
- SAR for nominal TSL parameters:* The measured TSL parameters are used to calculate the nominal SAR result.

**Measurement Conditions**

DASY system configuration, as far as not given on page 1.

DASY Version	DASY5	V52.6.2
Extrapolation	Advanced Extrapolation	
Phantom	Modular Flat Phantom	
Distance Dipole Center - TSL	10 mm	with Spacer
Zoom Scan Resolution	dx, dy, dz = 5 mm	
Frequency	2450 MHz ± 1 MHz	

**Head TSL parameters**

The following parameters and calculations were applied.

	Temperature	Permittivity	Conductivity
Nominal Head TSL parameters	22.0 °C	39.2	1.80 mho/m
Measured Head TSL parameters	(22.0 ± 0.2) °C	38.4 ± 6 %	1.85 mho/m ± 6 %
Head TSL temperature change during test	< 0.5 °C	---	---

**SAR result with Head TSL**

SAR averaged over 1 cm <sup>3</sup> (1 g) of Head TSL	Condition	
SAR measured	250 mW input power	13.7 mW / g
SAR for nominal Head TSL parameters	normalized to 1W	53.8 mW / g ± 17.0 % (k=2)

SAR averaged over 10 cm <sup>3</sup> (10 g) of Head TSL	condition	
SAR measured	250 mW input power	6.40 mW / g
SAR for nominal Head TSL parameters	normalized to 1W	25.4 mW / g ± 16.5 % (k=2)

**Body TSL parameters**

The following parameters and calculations were applied.

	Temperature	Permittivity	Conductivity
Nominal Body TSL parameters	22.0 °C	52.7	1.95 mho/m
Measured Body TSL parameters	(22.0 ± 0.2) °C	51.8 ± 6 %	2.02 mho/m ± 6 %
Body TSL temperature change during test	< 0.5 °C	---	---

**SAR result with Body TSL**

SAR averaged over 1 cm <sup>3</sup> (1 g) of Body TSL	Condition	
SAR measured	250 mW input power	13.2 mW / g
SAR for nominal Body TSL parameters	normalized to 1W	51.7 mW / g ± 17.0 % (k=2)

SAR averaged over 10 cm <sup>3</sup> (10 g) of Body TSL	condition	
SAR measured	250 mW input power	6.11 mW / g
SAR for nominal Body TSL parameters	normalized to 1W	24.2 mW / g ± 16.5 % (k=2)

**Appendix****Antenna Parameters with Head TSL**

Impedance, transformed to feed point	55.0 $\Omega$ + 4.8 j $\Omega$
Return Loss	- 23.6 dB

**Antenna Parameters with Body TSL**

Impedance, transformed to feed point	50.3 $\Omega$ + 5.8 j $\Omega$
Return Loss	- 24.8 dB

**General Antenna Parameters and Design**

Electrical Delay (one direction)	1.180 ns
----------------------------------	----------

After long term use with 100W radiated power, only a slight warming of the dipole near the feedpoint can be measured.

The dipole is made of standard semirigid coaxial cable. The center conductor of the feeding line is directly connected to the second arm of the dipole. The antenna is therefore short-circuited for DC-signals.

No excessive force must be applied to the dipole arms, because they might bend or the soldered connections near the feedpoint may be damaged.

**Additional EUT Data**

Manufactured by	SPEAG
Manufactured on	December 01, 2003

**DASY5 Validation Report for Head TSL**

Date: 29.08.2011

Test Laboratory: SPEAG, Zurich, Switzerland

**DUT: Dipole 2450 MHz; Type: D2450V2; Serial: D2450V2 - SN: 743**

Communication System: CW; Frequency: 2450 MHz

Medium parameters used:  $f = 2450$  MHz;  $\sigma = 1.85$  mho/m;  $\epsilon_r = 38.4$ ;  $\rho = 1000$  kg/m<sup>3</sup>

Phantom section: Flat Section

Measurement Standard: DASY5 (IEEE/IEC/ANSI C63.19-2007)

DASY52 Configuration:

- Probe: ES3DV3 - SN3205; ConvF(4.45, 4.45, 4.45); Calibrated: 29.04.2011
- Sensor-Surface: 3mm (Mechanical Surface Detection)
- Electronics: DAE4 Sn601; Calibrated: 04.07.2011
- Phantom: Flat Phantom 5.0 (front); Type: QD000P50AA; Serial: 1001
- DASY52 52.6.2(482); SEMCAD X 14.4.5(3634)

**Dipole Calibration for Head Tissue/Pin=250 mW, d=10mm/Zoom Scan (7x7x7)/Cube 0:**

Measurement grid: dx=5mm, dy=5mm, dz=5mm

Reference Value = 101.2 V/m; Power Drift = 0.03 dB

Peak SAR (extrapolated) = 28.291 W/kg

**SAR(1 g) = 13.7 mW/g; SAR(10 g) = 6.4 mW/g**

Maximum value of SAR (measured) = 17.657 mW/g

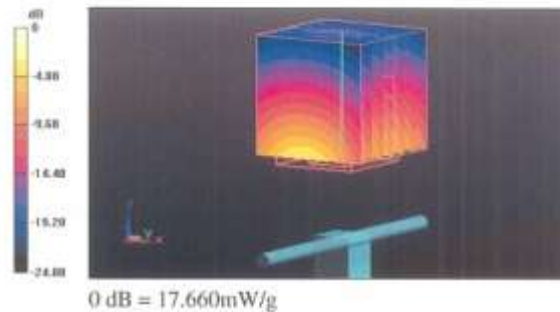

Impedance Measurement Plot for Head TSL

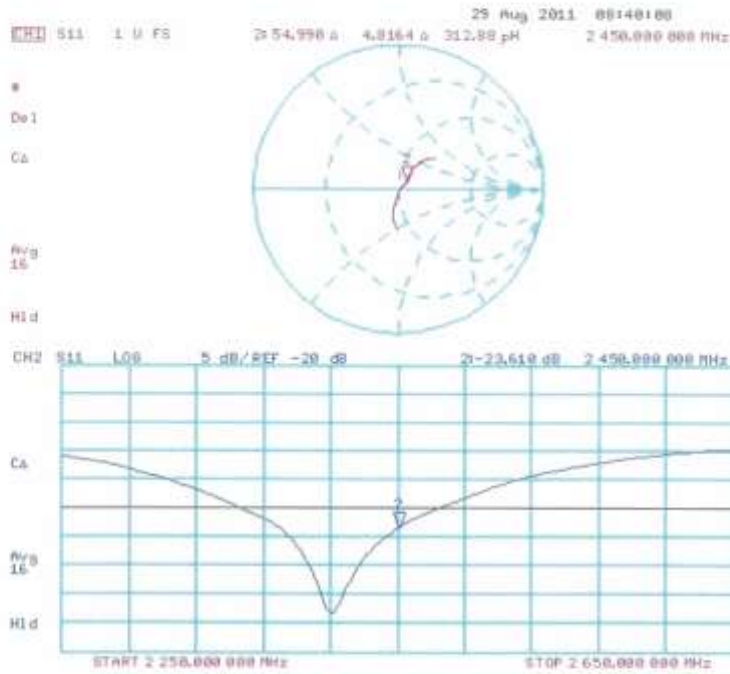

**DASY5 Validation Report for Body TSL**

Date: 29.08.2011

Test Laboratory: SPEAG, Zurich, Switzerland

**DUT: Dipole 2450 MHz; Type: D2450V2; Serial: D2450V2 - SN: 743**

Communication System: CW; Frequency: 2450 MHz

Medium parameters used:  $f = 2450$  MHz;  $\sigma = 2.02$  mho/m;  $\epsilon_r = 51.8$ ;  $\rho = 1000$  kg/m<sup>3</sup>

Phantom section: Flat Section

Measurement Standard: DASY5 (IEEE/IEC/ANSI C63.19-2007)

DASY52 Configuration:

- Probe: ES3DV3 - SN3205; ConvF(4.26, 4.26, 4.26); Calibrated: 29.04.2011
- Sensor-Surface: 3mm (Mechanical Surface Detection)
- Electronics: DAE4 Sn601; Calibrated: 04.07.2011
- Phantom: Flat Phantom 5.0 (back); Type: QD000P50AA; Serial: 1002
- DASY52 52.6.2(482); SEMCAD X 14.4.5(3634)

**Dipole Calibration for Body Tissue/Pin=250 mW, d=10mm/Zoom Scan (7x7x7)/Cube 0:**

Measurement grid: dx=5mm, dy=5mm, dz=5mm

Reference Value = 95.903 V/m; Power Drift = -0.0051 dB

Peak SAR (extrapolated) = 27.107 W/kg

**SAR(1 g) = 13.2 mW/g; SAR(10 g) = 6.11 mW/g**

Maximum value of SAR (measured) = 17.329 mW/g

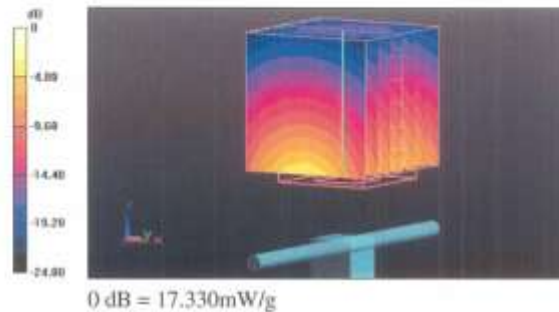

Impedance Measurement Plot for Body TSL

