



SAR TEST REPORT

No. 2012SAR00083

For

TCT Mobile Limited

HSDPA/HSUPA/UMTS dual band / GSM quad bands mobile phone

Medoc Lite US

ONE TOUCH 983A

With

Hardware Version: PIO

Software Version: V526

FCC ID: RAD283

Issued Date: 2012-08-16



No. DGA-PL-114/01-02

Note:

The test results in this test report relate only to the devices specified in this report. This report shall not be reproduced except in full without the written approval of TMC Beijing.

Test Laboratory:

TMC Beijing, Telecommunication Metrology Center of MIIT

No. 52, Huayuan Bei Road, Haidian District, Beijing, P. R. China 100191.

Tel:+86(0)10-62304633-2079, Fax:+86(0)10-62304633 Email:welcome@emcite.com. www.emcite.com

Revision Version

Report Number	Revision	Date	Memo
2012SAR00083	00	2012-08-09	Initial creation of test report
2012SAR00083	01	2012-08-16	Update the product description and SW

TABLE OF CONTENT

1 TEST LABORATORY	5
1.1 TESTING LOCATION	5
1.2 TESTING ENVIRONMENT.....	5
1.3 PROJECT DATA	5
1.4 SIGNATURE.....	5
2 STATEMENT OF COMPLIANCE	6
3 CLIENT INFORMATION.....	7
3.1 APPLICANT INFORMATION	7
3.2 MANUFACTURER INFORMATION	7
4 EQUIPMENT UNDER TEST (EUT) AND ANCILLARY EQUIPMENT (AE)	8
4.1 ABOUT EUT	8
4.2 INTERNAL IDENTIFICATION OF EUT USED DURING THE TEST	8
4.3 INTERNAL IDENTIFICATION OF AE USED DURING THE TEST.....	8
5 TEST METHODOLOGY	9
5.1 APPLICABLE LIMIT REGULATIONS	9
5.2 APPLICABLE MEASUREMENT STANDARDS.....	9
6 SPECIFIC ABSORPTION RATE (SAR).....	10
6.1 INTRODUCTION.....	10
6.2 SAR DEFINITION.....	10
7 SAR MEASUREMENT SETUP.....	11
7.1 MEASUREMENT SET-UP	11
7.2 DASY4 OR DASY5 E-FIELD PROBE SYSTEM	12
7.3 E-FIELD PROBE CALIBRATION	12
7.4 OTHER TEST EQUIPMENT	13
7.4.1 DATA ACQUISITION ELECTRONICS(DAE).....	13
7.4.2 ROBOT.....	14
7.4.3 MEASUREMENT SERVER.....	14
7.4.4 DEVICE HOLDER FOR PHANTOM.....	15
7.4.5 PHANTOM.....	15
8. POSITION OF THE WIRELESS DEVICE IN RELATION TO THE PHANTOM.....	17
8.1 GENERAL CONSIDERATIONS.....	17
8.2 BODY-WORN DEVICE	18
8.3 DESKTOP DEVICE.....	18
8.4 DUT SETUP PHOTOS	20
9 TISSUE SIMULATING LIQUIDS	21
9.1 EQUIVALENT TISSUES	21
9.2 DIELECTRIC PERFORMANCE	21

10 SYSTEM VALIDATION	23
10.1 SYSTEM VALIDATION	23
10.2 SYSTEM SETUP	23
11 MEASUREMENT PROCEDURES	25
11.1 TESTS TO BE PERFORMED	25
11.2 MEASUREMENT PROCEDURE	26
11.3 WCDMA MEASUREMENT PROCEDURES FOR SAR	27
11.4 BLUETOOTH & WI-FI MEASUREMENT PROCEDURES FOR SAR	28
11.5 POWER DRIFT	28
12 CONDUCTED OUTPUT POWER	29
12.1 GSM MEASUREMENT RESULT	29
12.2 WCDMA MEASUREMENT RESULT	30
12.3 WI-FI AND BT MEASUREMENT RESULT	30
13 SIMULTANEOUS TX SAR CONSIDERATIONS	32
13.1 INTRODUCTION	32
13.2 TRANSMIT ANTENNA SEPARATION DISTANCES	32
13.3 SIMULTANEOUS TRANSMISSION FOR EUT	33
14 SAR TEST RESULT	34
14.1 SAR TEST RESULT	34
15 MEASUREMENT UNCERTAINTY	37
16 MAIN TEST INSTRUMENTS	38
ANNEX A GRAPH RESULTS	39
ANNEX B SYSTEM VALIDATION RESULTS	151
ANNEX C PROBE CALIBRATION CERTIFICATE	157
ANNEX D DIPOLE CALIBRATION CERTIFICATE	168

1 Test Laboratory

1.1 Testing Location

Company Name: TMC Beijing, Telecommunication Metrology Center of MIIT
Address: No 52, Huayuan beilu, Haidian District, Beijing, P.R.China
Postal Code: 100191
Telephone: +86-10-62304633
Fax: +86-10-62304793

1.2 Testing Environment

Temperature: 18°C~25 °C,
Relative humidity: 30%~ 70%
Ground system resistance: < 0.5 Ω
Ambient noise & Reflection: < 0.012 W/kg

1.3 Project Data

Project Leader: Qi Dianyuan
Test Engineer: Lin Xiaojun
Testing Start Date: July 25, 2012
Testing End Date: July 27, 2012

1.4 Signature



Lin Xiaojun
(Prepared this test report)

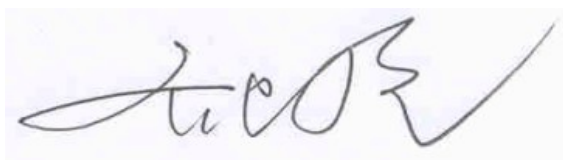

Qi Dianyuan
(Reviewed this test report)



Xiao Li
Deputy Director of the laboratory
(Approved this test report)

2 Statement of Compliance

The maximum results of Specific Absorption Rate (SAR) found during testing for TCT Mobile Limited HSDPA/HSUPA/UMTS dual band / GSM quad bands mobile phone Medoc Lite US / ONE TOUCH 983A are as follows (with expanded uncertainty 18.5%)

Table 2.1: Max. SAR Measured (1g)

Band	Position	SAR 1g (W/Kg)
GSM 850	Head	1.04
	Body	1.04
GSM 1900	Head	1.03
	Body	1.03
WCDMA 850	Head	0.703
	Body	0.958
WCDMA 1900	Head	1.04
	Body	1.04
Wi-Fi	Head	0.376
	Body	0.539

The SAR values found for the Mobile Phone are below the maximum recommended levels of 1.6 W/Kg as averaged over any 1g tissue according to the ANSI C95.1-1999.

For body worn operation, this device has been tested and meets FCC RF exposure guidelines when used with any accessory that contains no metal. Use of other accessories may not ensure compliance with FCC RF exposure guidelines.

The measurement together with the test system set-up is described in chapter 7 of this test report. A detailed description of the equipment under test can be found in chapter 3 of this test report.

The maximum SAR value is obtained at the case of **(Table 2.1)**, and the values are: **1.04 (1g)**.

3 Client Information

3.1 Applicant Information

Company Name: TCT Mobile Limited
Address /Post: 5F, E building, No. 232, Liang Jing Road ZhangJiang High-Tech Park,
Pudong Area Shanghai, P.R. China. 201203
City: ShangHai
Postal Code: 201203
Country: P.R.China
Contact: Gong Zhizhou
Email: zhizhou.gong@jrdcom.com
Telephone: 0086-21-61460890
Fax: 0086-21-61460602

3.2 Manufacturer Information

Company Name: TCT Mobile Limited
Address /Post: 5F, E building, No. 232, Liang Jing Road ZhangJiang High-Tech Park,
Pudong Area Shanghai, P.R. China. 201203
City: ShangHai
Postal Code: 201203
Country: P.R.China
Contact: Gong Zhizhou
Email: zhizhou.gong@jrdcom.com
Telephone: 0086-21-61460890
Fax: 0086-21-61460602

4 Equipment Under Test (EUT) and Ancillary Equipment (AE)

4.1 About EUT

Description:	HSDPA/HSUPA/UMTS dual band / GSM quad bands mobile phone
Model name:	Medoc Lite US
Marketing name:	ONE TOUCH 983A
Operating mode(s):	GSM 850/1900, WCDMA 850/1900/, BT, Wi-Fi
Tested Tx Frequency:	825 – 848.8 MHz (GSM 850) 1850.2 – 1910 MHz (GSM 1900) 826.4 – 846.6(WCDMA 850) 1852.4 – 1907.6(WCDMA 1900) 2412 – 2462 MHz (Wi-Fi)
GPRS Multislot Class:	12
GPRS capability Class:	B
EGPRS Multislot Class:	12
Test device Production information:	Production unit
Device type:	Portable device
Antenna type:	Integrated antenna
Accessories/Body-worn configurations:	Headset
Hotspot mode:	Support simultaneous transmission of hotspot and voice(or data)
Form factor:	11.3 cm × 6.1 cm

4.2 Internal Identification of EUT used during the test

EUT ID*	SN or IMEI	HW Version	SW Version
EUT1	013301000020476 / 013301000020617	PIO	V526

*EUT ID: is used to identify the test sample in the lab internally.

Note: It is performed to test SAR with the EUT (013301000020476) and conducted power with the EUT (013301000020617).

4.3 Internal Identification of AE used during the test

AE ID*	Description	Model	SN	Manufacturer
AE1	Battery	CAB31P0000C1	\	BYD
AE2	Headset	CCB3000A12C1	\	Shunda
AE3	Headset	CCB3000A12C2	\	Juwei

*AE ID: is used to identify the test sample in the lab internally.

5 TEST METHODOLOGY

5.1 Applicable Limit Regulations

ANSI C95.1–1999: IEEE Standard for Safety Levels with Respect to Human Exposure to Radio Frequency Electromagnetic Fields, 3 kHz to 300 GHz.

It specifies the maximum exposure limit of **1.6 W/kg** as averaged over any 1 gram of tissue for portable devices being used within 20 cm of the user in the uncontrolled environment.

5.2 Applicable Measurement Standards

IC RSS-102 ISSUE4: Radio Frequency (RF) Exposure Compliance of Radiocommunication Apparatus (All Frequency Bands)

IEEE 1528–2003: Recommended Practice for Determining the Peak Spatial-Average Specific Absorption Rate (SAR) in the Human Body Due to Wireless Communications Devices: Experimental Techniques.

OET Bulletin 65 (Edition 97-01) and Supplement C(Edition 01-01): Additional Information for Evaluating Compliance of Mobile and Portable Devices with FCC Limits.

KDB648474 D01 SAR Handsets Multi Xmitter and Ant, v01r05: SAR Evaluation Considerations for Handsets with Multiple Transmitters and Antennas.

KDB248227: SAR measurement procedures for 802.112abg transmitters.

KDB941225 : SAR Evaluation Procedures for Portable Devices with Wireless Router Capabilities

6 Specific Absorption Rate (SAR)

6.1 Introduction

SAR is related to the rate at which energy is absorbed per unit mass in an object exposed to a radio field. The SAR distribution in a biological body is complicated and is usually carried out by experimental techniques or numerical modeling. The standard recommends limits for two tiers of groups, occupational/controlled and general population/uncontrolled, based on a person's awareness and ability to exercise control over his or her exposure. In general, occupational/controlled exposure limits are higher than the limits for general population/uncontrolled.

6.2 SAR Definition

The SAR definition is the time derivative (rate) of the incremental energy (dW) absorbed by (dissipated in) an incremental mass (dm) contained in a volume element (dv) of a given density (ρ). The equation description is as below:

$$SAR = \frac{d}{dt} \left(\frac{dW}{dm} \right) = \frac{d}{dt} \left(\frac{dW}{\rho dv} \right)$$

SAR is expressed in units of Watts per kilogram (W/kg)

SAR measurement can be either related to the temperature elevation in tissue by

$$SAR = c \left(\frac{\delta T}{\delta t} \right)$$

Where: C is the specific heat capacity, δT is the temperature rise and δt is the exposure duration, or related to the electrical field in the tissue by

$$SAR = \frac{\sigma |E|^2}{\rho}$$

Where: σ is the conductivity of the tissue, ρ is the mass density of tissue and E is the RMS electrical field strength.

However for evaluating SAR of low power transmitter, electrical field measurement is typically applied.

7 SAR MEASUREMENT SETUP

7.1 Measurement Set-up

The Dasy4 or DASY5 system for performing compliance tests is illustrated above graphically. This system consists of the following items:

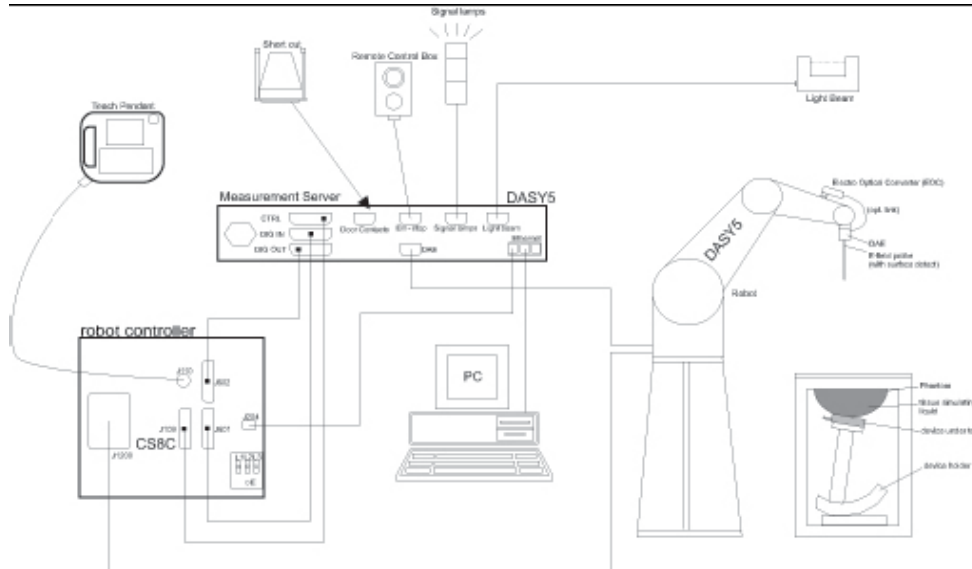

Picture 7.1 SAR Lab Test Measurement Set-up

- A standard high precision 6-axis robot (Stäubli TX=RX family) with controller, teach pendant and software. An arm extension for accommodating the data acquisition electronics (DAE).
- An isotropic field probe optimized and calibrated for the targeted measurement.
- A data acquisition electronics (DAE) which performs the signal amplification, signal multiplexing, AD-conversion, offset measurements, mechanical surface detection, collision detection, etc. The unit is battery powered with standard or rechargeable batteries. The signal is optically transmitted to the EOC.
- The Electro-optical converter (EOC) performs the conversion from optical to electrical signals for the digital communication to the DAE. To use optical surface detection, a special version of the EOC is required. The EOC signal is transmitted to the measurement server.
- The function of the measurement server is to perform the time critical tasks such as signal filtering, control of the robot operation and fast movement interrupts.
- The Light Beam used is for probe alignment. This improves the (absolute) accuracy of the probe positioning.
- A computer running WinXP and the DASY4 or DASY5 software.
- Remote control and teach pendant as well as additional circuitry for robot safety such as
- warning lamps, etc.
- The phantom, the device holder and other accessories according to the targeted measurement.

7.2 Dasy4 or DASY5 E-field Probe System

The SAR measurements were conducted with the dosimetric probe designed in the classical triangular configuration and optimized for dosimetric evaluation. The probe is constructed using the thick film technique; with printed resistive lines on ceramic substrates. The probe is equipped with an optical multifiber line ending at the front of the probe tip. It is connected to the EOC box on the robot arm and provides an automatic detection of the phantom surface. Half of the fibers are connected to a pulsed infrared transmitter, the other half to a synchronized receiver. As the probe approaches the surface, the reflection from the surface produces a coupling from the transmitting to the receiving fibers. This reflection increases first during the approach, reaches maximum and then decreases. If the probe is flatly touching the surface, the coupling is zero. The distance of the coupling maximum to the surface is independent of the surface reflectivity and largely independent of the surface to probe angle. The DASY4 or DASY5 software reads the reflection during a software approach and looks for the maximum using 2nd order curve fitting. The approach is stopped at reaching the maximum.

Probe Specifications:

Model:	ES3DV3, EX3DV4
Frequency	10MHz — 6.0GHz(EX3DV4)
Range:	10MHz — 4GHz(ES3DV3)
Calibration:	In head and body simulating tissue at Frequencies from 835 up to 5800MHz
Linearity:	± 0.2 dB(30 MHz to 6 GHz) for EX3DV4 ± 0.2 dB(30 MHz to 4 GHz) for ES3DV3
Dynamic Range:	10 mW/kg — 100W/kg
Probe Length:	330 mm
Probe Tip	
Length:	20 mm
Body Diameter:	12 mm
Tip Diameter:	2.5 mm (3.9 mm for ES3DV3)
Tip-Center:	1 mm (2.0mm for ES3DV3)
Application:	SAR Dosimetry Testing Compliance tests of mobile phones Dosimetry in strong gradient fields



Picture 7.2 Near-field Probe



Picture 7.3 E-field Probe

7.3 E-field Probe Calibration

Each E-Probe/Probe Amplifier combination has unique calibration parameters. A TEM cell calibration procedure is conducted to determine the proper amplifier settings to enter in the probe parameters. The amplifier settings are determined for a given frequency by subjecting the probe to a known E-field density (1 mW/cm^2) using an RF Signal generator, TEM cell, and RF Power Meter.

The free space E-field from amplified probe outputs is determined in a test chamber. This calibration can be performed in a TEM cell if the frequency is below 1 GHz and in a waveguide or other methodologies above 1 GHz for free space. For the free space calibration, the probe is placed

in the volumetric center of the cavity and at the proper orientation with the field. The probe is then rotated 360 degrees until the three channels show the maximum reading. The power density readings equates to 1 mW/ cm²:

E-field temperature correlation calibration is performed in a flat phantom filled with the appropriate simulated brain tissue. The E-field in the medium correlates with the temperature rise in the dielectric medium. For temperature correlation calibration a RF transparent thermistor-based temperature probe is used in conjunction with the E-field probe.

$$SAR = C \frac{\Delta T}{\Delta t}$$

Where:

Δt = Exposure time (30 seconds),

C = Heat capacity of tissue (brain or muscle),

ΔT = Temperature increase due to RF exposure.

$$SAR = \frac{|E|^2 \cdot \sigma}{\rho}$$

Where:

σ = Simulated tissue conductivity,

ρ = Tissue density (kg/m³).

7.4 Other Test Equipment

7.4.1 Data Acquisition Electronics(DAE)

The data acquisition electronics consist of a highly sensitive electrometer-grade preamplifier with auto-zeroing, a channel and gain-switching multiplexer, a fast 16 bit AD-converter and a command decoder with a control logic unit. Transmission to the measurement server is accomplished through an optical downlink for data and status information, as well as an optical uplink for commands and the clock.

The mechanical probe mounting device includes two different sensor systems for frontal and sideways probe contacts. They are used for mechanical surface detection and probe collision detection.

The input impedance of the DAE is 200 MOhm; the inputs are symmetrical and floating. Common mode rejection is above 80 dB.

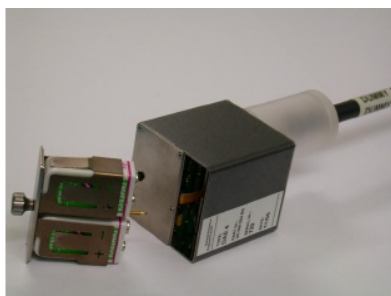

Picture7.4: DAE

7.4.2 Robot

The SPEAG DASY system uses the high precision robots (DASY4: RX90XL; DASY5: RX160L) type from Stäubli SA (France). For the 6-axis controller system, the robot controller version from Stäubli is used. The Stäubli robot series have many features that are important for our application:

- High precision (repeatability 0.02mm)
- High reliability (industrial design)
- Low maintenance costs (virtually maintenance free due to direct drive gears; no belt drives)
- Jerk-free straight movements (brushless synchron motors; no stepper motors)
- Low ELF interference (motor control fields shielded via the closed metallic construction shields)



Picture 7.5 DASY 4



Picture 7.6 DASY 5

7.4.3 Measurement Server

The Measurement server is based on a PC/104 CPU board with CPU (dasy4: 166 MHz, Intel Pentium; DASY5: 400 MHz, Intel Celeron), chipdisk (DASY4: 32 MB; DASY5: 128MB), RAM (DASY4: 64 MB, DASY5: 128MB). The necessary circuits for communication with the DAE electronic box, as well as the 16 bit AD converter system for optical detection and digital I/O interface are contained on the DASY I/O board, which is directly connected to the PC/104 bus of the CPU board.

The measurement server performs all real-time data evaluation of field measurements and surface detection, controls robot movements and handles safety operation. The PC operating system cannot interfere with these time critical processes. All connections are supervised by a watchdog, and disconnection of any of the cables to the measurement server will automatically disarm the robot and disable all program-controlled robot movements. Furthermore, the measurement server is equipped with an expansion port which is reserved for future applications. Please note that this expansion port does not have a standardized pinout, and therefore only devices provided by SPEAG can be connected. Devices from any other supplier could seriously damage the measurement server.



Picture 7.7 Server for DASY 4



Picture 7.8 Server for DASY 5

7.4.4 Device Holder for Phantom

The SAR in the phantom is approximately inversely proportional to the square of the distance between the source and the liquid surface. For a source at 5mm distance, a positioning uncertainty of $\pm 0.5\text{mm}$ would produce a SAR uncertainty of $\pm 20\%$. Accurate device positioning is therefore crucial for accurate and repeatable measurements. The positions in which the devices must be measured are defined by the standards.

The DASY device holder is designed to cope with the different positions given in the standard. It has two scales for device rotation (with respect to the body axis) and device inclination (with respect to the line between the ear reference points). The rotation centers for both scales is the ear reference point (ERP). Thus the device needs no repositioning when changing the angles.

The DASY device holder is constructed of low-loss

POM material having the following dielectric

parameters: relative permittivity $\epsilon = 3$ and loss tangent $\delta = 0.02$. The amount of dielectric material has been reduced in the closest vicinity of the device, since measurements have suggested that the influence of the clamp on the test results could thus be lowered.

<Laptop Extension Kit>

The extension is lightweight and made of POM, acrylic glass and foam. It fits easily on the upper part of the Mounting Device in place of the phone positioner. The extension is fully compatible with the Twin-SAM and ELI phantoms.



Picture 7.9-1: Device Holder

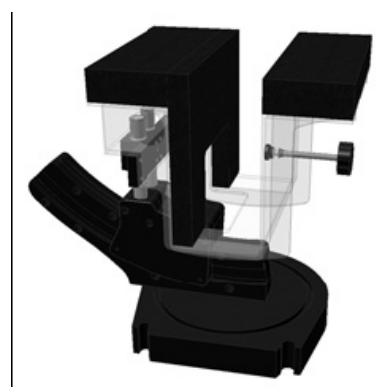

Picture 7.9-2: Laptop Extension Kit

7.4.5 Phantom

The SAM Twin Phantom V4.0 is constructed of a fiberglass shell integrated in a table. The shape of the shell is based on data from an anatomical study designed to represent the 90th percentile of the population. The phantom enables the dissymmetric evaluation

of SAR for both left and right handed handset usage, as well as body-worn usage using the flat phantom region. Reference markings on the Phantom allow the complete setup of all predefined phantom positions and measurement grids by manually teaching three points in the robot. The shell phantom has a 2mm shell thickness (except the ear region where shell thickness increases to 6 mm).

Shell Thickness: 2 ± 0.2 mm

Filling Volume: Approx. 25 liters

Dimensions: 810 x 1000 x 500 mm (H x L x W)

Available: Special



Picture 7.10: SAM Twin Phantom

8. Position of the wireless device in relation to the phantom

8.1 General considerations

This standard specifies two handset test positions against the head phantom – the “cheek” position and the “tilt” position.

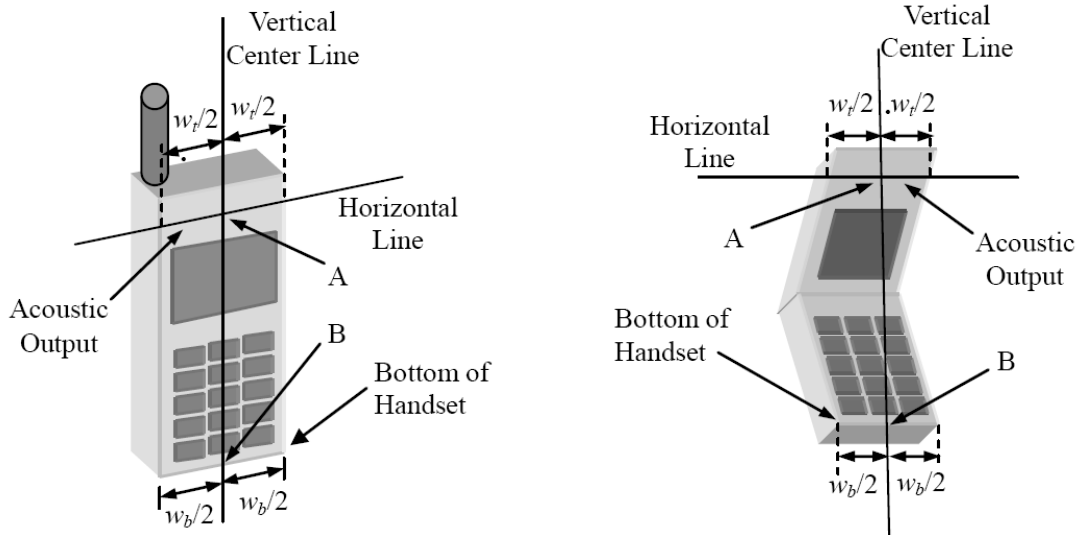

- w_t Width of the handset at the level of the acoustic
- w_b Width of the bottom of the handset
- A Midpoint of the width w_t of the handset at the level of the acoustic output
- B Midpoint of the width w_b of the bottom of the handset

Picture 8.1-a Typical “fixed” case handset Picture 8.1-b Typical “clam-shell” case handset

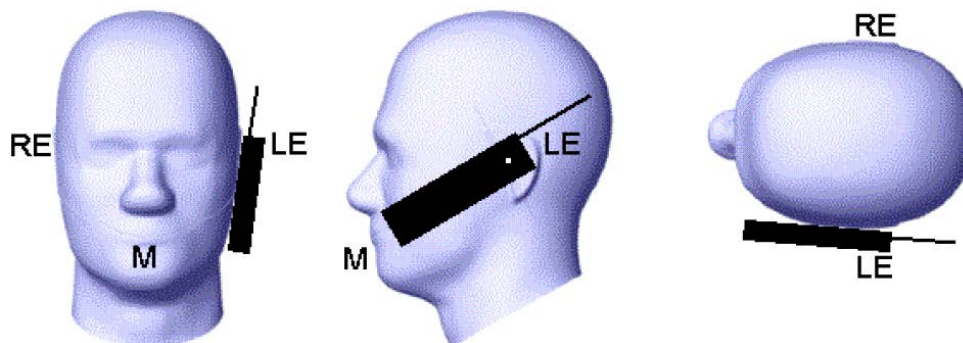

Picture 8.2 Cheek position of the wireless device on the left side of SAM

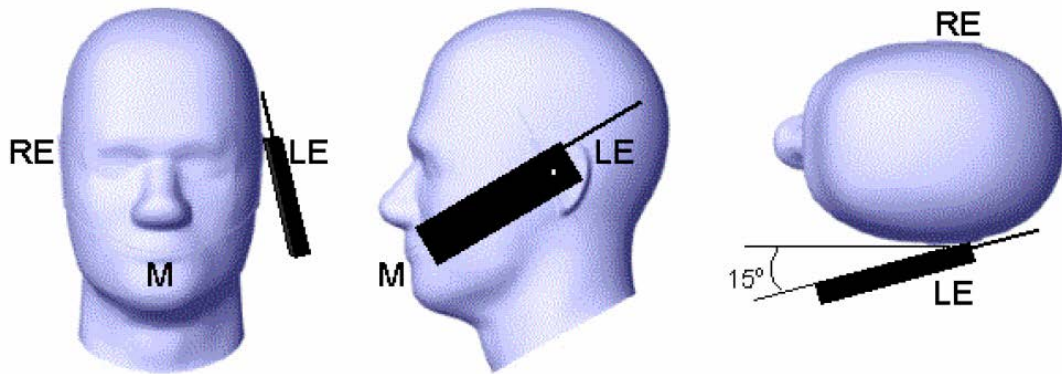

Picture 8.3 Tilt position of the wireless device on the left side of SAM

8.2 Body-worn device

A typical example of a body-worn device is a mobile phone, wireless enabled PDA or other battery operated wireless device with the ability to transmit while mounted on a person's body using a carry accessory approved by the wireless device manufacturer.

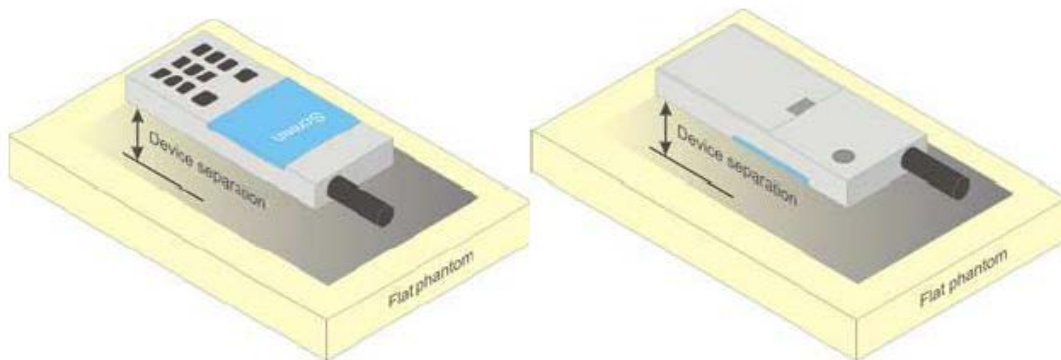

Picture 8.4 Test positions for body-worn devices

8.3 Desktop device

A typical example of a desktop device is a wireless enabled desktop computer placed on a table or desk when used.

The DUT shall be positioned at the distance and in the orientation to the phantom that corresponds to the intended use as specified by the manufacturer in the user instructions. For devices that employ an external antenna with variable positions, tests shall be performed for all antenna positions specified. Picture 8.5 show positions for desktop device SAR tests. If the intended use is not specified, the device shall be tested directly against the flat phantom.

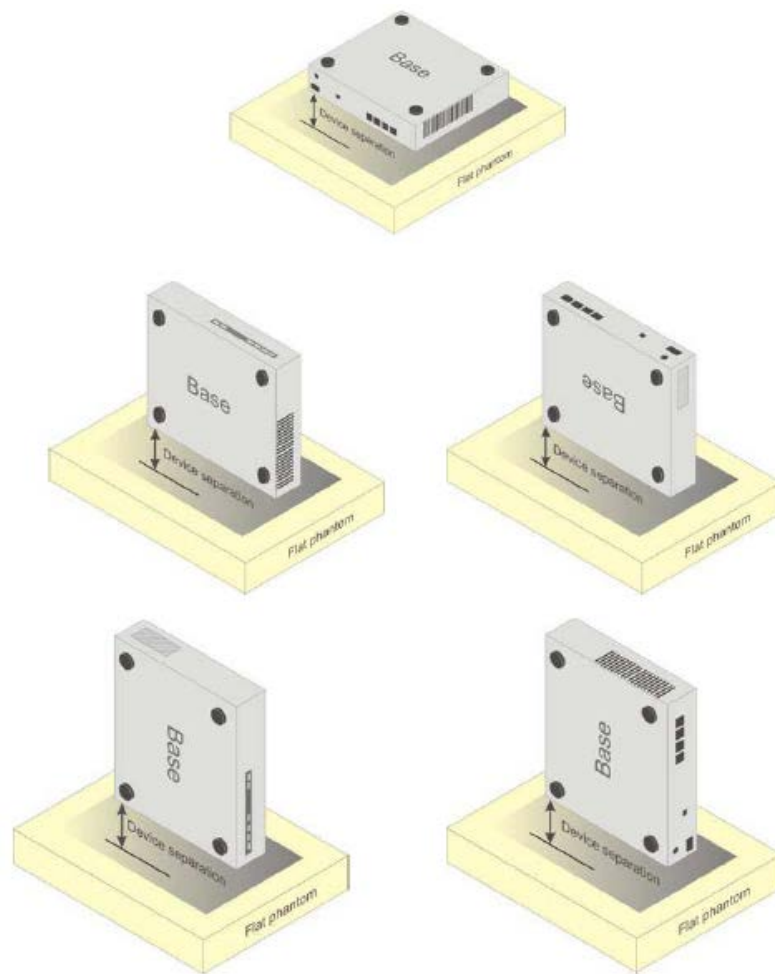

Picture 8.5 Test positions for desktop devices

8.4 DUT Setup Photos



Picture 8.6

9 Tissue Simulating Liquids

9.1 Equivalent Tissues

The liquid used for the frequency range of 800-3000 MHz consisted of water, sugar, salt, preventol, glycol monobutyl and Cellulose. The liquid has been previously proven to be suited for worst-case. The Table 9.1 shows the detail solution. It's satisfying the latest tissue dielectric parameters requirements proposed by the IEEE 1528 and IEC 62209.

Table 9.1: Composition of the Tissue Equivalent Matter

Frequency (MHz)	835 Head	835 Body	1900 Head	1900 Body	2450 Head	2450 Body
Ingredients (% by weight)						
Water	41.45	52.5	55.242	69.91	58.79	72.60
Sugar	56.0	45.0	\	\	\	\
Salt	1.45	1.4	0.306	0.13	0.06	0.18
Preventol	0.1	0.1	\	\	\	\
Cellulose	1.0	1.0	\	\	\	\
Glycol Monobutyl	\	\	44.452	29.96	41.15	27.22
Dielectric Parameters Target Value	$\epsilon=41.5$ $\sigma=0.90$	$\epsilon=55.2$ $\sigma=0.97$	$\epsilon=40.0$ $\sigma=1.40$	$\epsilon=53.3$ $\sigma=1.52$	$\epsilon=39.2$ $\sigma=1.80$	$\epsilon=52.7$ $\sigma=1.95$

Table 9.2: Targets for tissue simulating liquid

Frequency (MHz)	Liquid Type	Conductivity (σ)	$\pm 5\%$ Range	Permittivity (ϵ)	$\pm 5\%$ Range
835	Head	0.90	0.86~0.95	41.5	39.4~43.6
835	Body	0.97	0.92~1.02	55.2	52.4~58.0
1900	Head	1.40	1.33~1.47	40.0	38.0~42.0
1900	Body	1.52	1.44~1.60	53.3	50.6~56.0
2450	Head	1.80	1.71~1.89	39.2	37.2~41.2
2450	Body	1.95	1.85~2.05	52.7	50.1~55.3

9.2 Dielectric Performance

Table 9.3: Dielectric Performance of Tissue Simulating Liquid

Measurement Date : 835 MHz <u>July 25, 2012</u> 1900 MHz <u>July 26, 2012</u> 2450 MHz <u>July 27, 2012</u>				
/	Type	Frequency	Permittivity ϵ	Conductivity σ (S/m)
Measurement value	Head	835 MHz	41.05	0.884
	Body	835 MHz	54.43	0.985
	Head	1900 MHz	41.21	1.388
	Body	1900 MHz	52.69	1.513
	Head	2450 MHz	38.7	1.84
	Body	2450 MHz	52.17	1.959

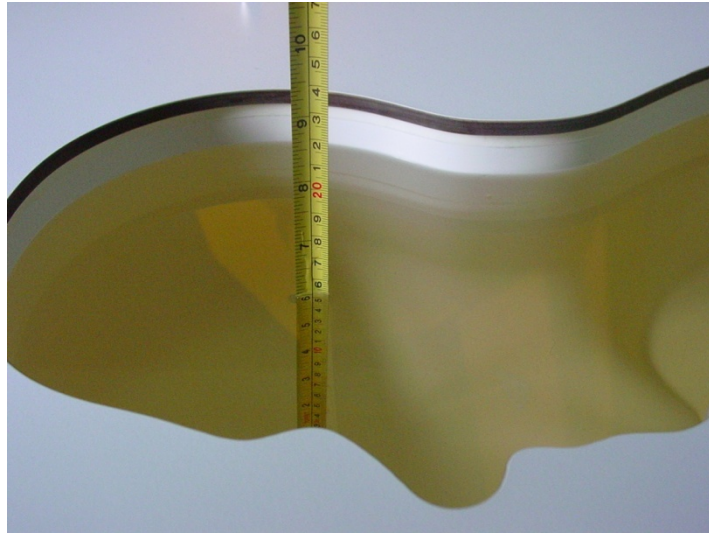

Picture 9.1: Liquid depth in the Head Phantom (850 MHz)



Picture 9.2 Liquid depth in the Flat Phantom (1900MHz)



Picture 9.3 Liquid depth in the Flat Phantom (2450MHz)

10 System Validation

10.1 System Validation

Each DASY system is equipped with one or more system validation kits. These units, together with the predefined measurement procedures within the DASY software, enable the user to conduct the system performance check and system validation. System validation kit includes a dipole, tripod holder to fix it underneath the flat phantom and a corresponding distance holder.

10.2 System Setup

In the simplified setup for system evaluation, the DUT is replaced by a calibrated dipole and the power source is replaced by a continuous wave that comes from a signal generator. The calibrated dipole must be placed beneath the flat phantom section of the SAM twin phantom with the correct distance holder. The distance holder should touch the phantom surface with a light pressure at the reference marking and be oriented parallel to the long side of the phantom. The equipment setup is shown below:

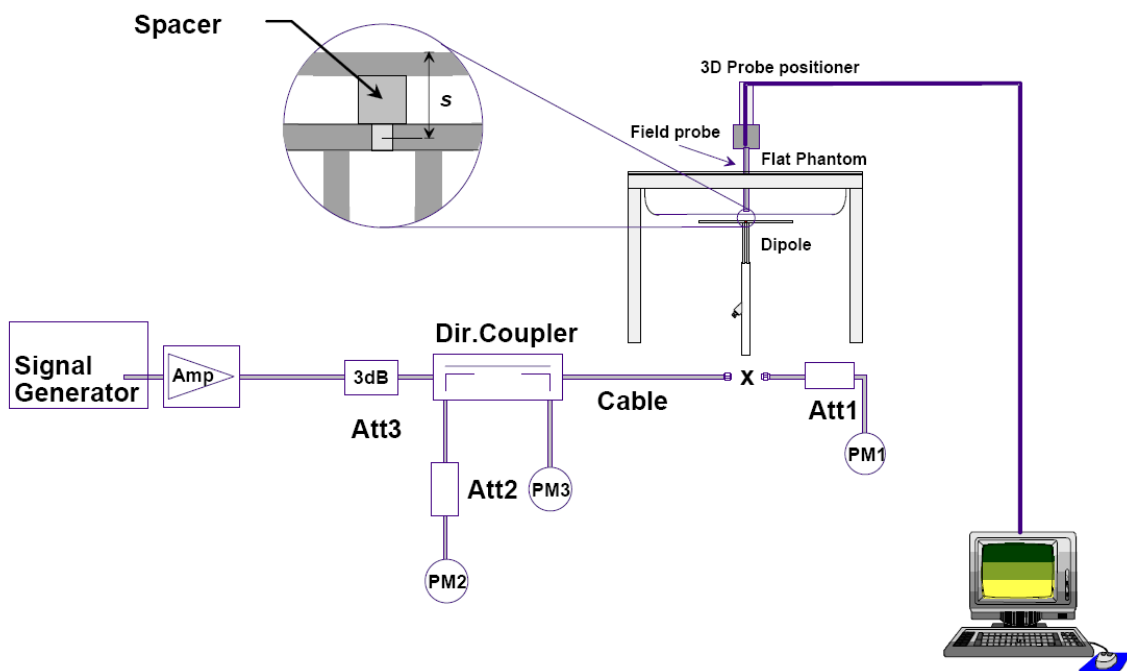

Picture 10.1 System Setup for System Evaluation

The output power on dipole port must be calibrated to 24 dBm (250mW) before dipole is connected.

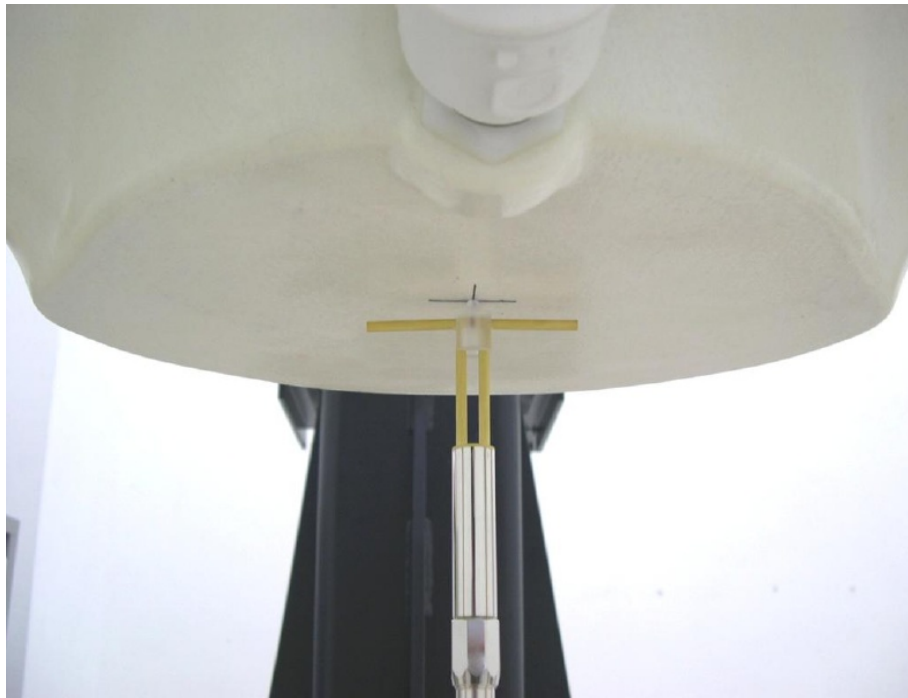

Picture 10.2 Photo of Dipole Setup

Table 10.1: System Validation of Head

Measurement Date : 835 MHz <u>July 25, 2012</u> 1900 MHz <u>July 26, 2012</u> 2450 MHz <u>July 27, 2012</u>							
Verification results	Frequency	Target value (W/kg)		Measured value (W/kg)		Deviation	
		10 g Average	1 g Average	10 g Average	1 g Average	10 g Average	1 g Average
	835 MHz	6.07	9.30	6.24	9.60	2.80%	3.23%
	1900 MHz	20.6	39.1	20.00	38.28	-2.91%	-2.10%
2450 MHz	24.4	52.4	23.84	51.20	-2.13%	-2.30%	

Table 10.2: System Validation of Body

Measurement Date : 835 MHz <u>July 25, 2012</u> 1900 MHz <u>July 26, 2012</u> 2450 MHz <u>July 27, 2012</u>							
Verification results	Frequency	Target value (W/kg)		Measured value (W/kg)		Deviation	
		10 g Average	1 g Average	10 g Average	1 g Average	10 g Average	1 g Average
	835 MHz	6.20	9.36	6.36	9.56	2.58%	2.14%
	1900 MHz	21.3	39.9	21.64	40.80	1.60%	2.26%
2450 MHz	23.6	50.4	23.44	51.20	-0.68%	1.59%	

11 Measurement Procedures

11.1 Tests to be performed

In order to determine the highest value of the peak spatial-average SAR of a handset, all device positions, configurations and operational modes shall be tested for each frequency band according to steps 1 to 3 below. A flowchart of the test process is shown in Picture 11.1.

Step 1: The tests described in 11.2 shall be performed at the channel that is closest to the centre of the transmit frequency band (f_c) for:

- a) all device positions (cheek and tilt, for both left and right sides of the SAM phantom, as described in Chapter 8),
- b) all configurations for each device position in a), e.g., antenna extended and retracted, and
- c) all operational modes, e.g., analogue and digital, for each device position in a) and configuration in b) in each frequency band.

If more than three frequencies need to be tested according to 11.1 (i.e., $N_c > 3$), then all frequencies, configurations and modes shall be tested for all of the above test conditions.

Step 2: For the condition providing highest peak spatial-average SAR determined in Step 1, perform all tests described in 11.2 at all other test frequencies, i.e., lowest and highest frequencies. In addition, for all other conditions (device position, configuration and operational mode) where the peak spatial-average SAR value determined in Step 1 is within 3 dB of the applicable SAR limit, it is recommended that all other test frequencies shall be tested as well.

Step 3: Examine all data to determine the highest value of the peak spatial-average SAR found in Steps 1 to 2.

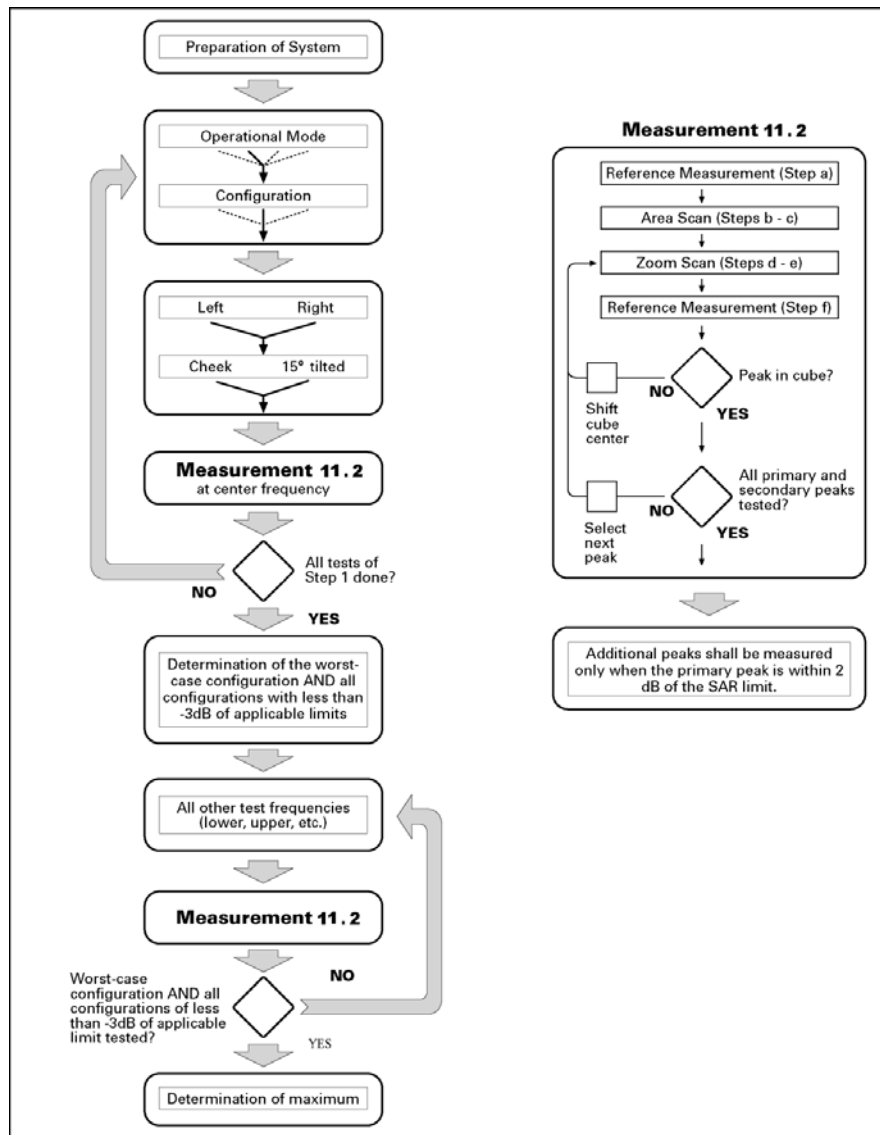

Picture 11.1 Block diagram of the tests to be performed

11.2 Measurement procedure

The following procedure shall be performed for each of the test conditions (see Picture 11.1) described in 11.1:

- a) Measure the local SAR at a test point within 8 mm or less in the normal direction from the inner surface of the phantom.
- b) Measure the two-dimensional SAR distribution within the phantom (area scan procedure). The boundary of the measurement area shall not be closer than 20 mm from the phantom side walls. The distance between the measurement points should enable the detection of the location of local maximum with an accuracy of better than half the linear dimension of the tissue cube after interpolation. A maximum grip spacing of 20 mm for frequencies below 3 GHz and $(60/f \text{ [GHz]})$ mm for frequencies of 3GHz and greater is recommended. The maximum distance between the geometrical centre of the probe detectors and the inner surface of the phantom shall be 5 mm for frequencies below 3 GHz and $\delta \ln(2)/2$ mm for frequencies of 3 GHz and greater, where δ is the

plane wave skin depth and $\ln(x)$ is the natural logarithm. The maximum variation of the sensor-phantom surface shall be ± 1 mm for frequencies below 3 GHz and ± 0.5 mm for frequencies of 3 GHz and greater. At all measurement points the angle of the probe with respect to the line normal to the surface should be less than 5° . If this cannot be achieved for a measurement distance to the phantom inner surface shorter than the probe diameter, additional uncertainty evaluation is needed.

c) From the scanned SAR distribution, identify the position of the maximum SAR value, in addition identify the positions of any local maxima with SAR values within 2 dB of the maximum value that are not within the zoom-scan volume; additional peaks shall be measured only when the primary peak is within 2 dB of the SAR limit. This is consistent with the 2 dB threshold already stated;

d) Measure the three-dimensional SAR distribution at the local maxima locations identified in step c). The horizontal grid step shall be $(24/f[\text{GHz}])$ mm or less but not more than 8 mm. The minimum zoom size of 30 mm by 30 mm and 30 mm for frequencies below 3 GHz. For higher frequencies, the minimum zoom size of 22 mm by 22 mm and 22 mm. The grid step in the vertical direction shall be $(8-f[\text{GHz}])$ mm or less but not more than 5 mm, if uniform spacing is used. If variable spacing is used in the vertical direction, the maximum spacing between the two closest measured points to the phantom shell shall be $(12 / f[\text{GHz}])$ mm or less but not more than 4 mm, and the spacing between further points shall increase by an incremental factor not exceeding 1.5. When variable spacing is used, extrapolation routines shall be tested with the same spacing as used in measurements. The maximum distance between the geometrical centre of the probe detectors and the inner surface of the phantom shall be 5 mm for frequencies below 3 GHz and $\delta \ln(2)/2$ mm for frequencies of 3 GHz and greater, where δ is the plane wave skin depth and $\ln(x)$ is the natural logarithm. Separate grids shall be centered on each of the local SAR maxima found in step c). Uncertainties due to field distortion between the media boundary and the dielectric enclosure of the probe should also be minimized, which is achieved if the distance between the phantom surface and physical tip of the probe is larger than probe tip diameter. Other methods may utilize correction procedures for these boundary effects that enable high precision measurements closer than half the probe diameter. For all measurement points, the angle of the probe with respect to the flat phantom surface shall be less than 5° . If this cannot be achieved an additional uncertainty evaluation is needed.

e) Use post processing (e.g. interpolation and extrapolation) procedures to determine the local SAR values at the spatial resolution needed for mass averaging.

11.3 WCDMA Measurement Procedures for SAR

The following procedures are applicable to WCDMA handsets operating under 3GPP Release99, Release 5 and Release 6. The default test configuration is to measure SAR with an established radio link between the DUT and a communication test set using a 12.2kbps RMC (reference measurement channel) configured in Test Loop Mode 1. SAR is selectively confirmed for other physical channel configurations (DPCCH & DPDCH_n), HSDPA and HSPA (HSUPA/HSDPA) modes according to output power, exposure conditions and device operating capabilities. Both uplink and downlink should be configured with the same RMC or AMR, when required. SAR for Release 5 HSDPA and Release 6 HSPA are measured using the applicable FRC (fixed reference channel) and E-DCH reference channel configurations. Maximum output power is verified according to applicable versions of 3GPP TS 34.121 and SAR must be measured according to these maximum output

conditions. When Maximum Power Reduction (MPR) is not implemented according to Cubic Metric (CM) requirements for Release 6 HSPA, the following procedures do not apply.

For Release 5 HSDPA Data Devices:

Sub-test	β_c	β_d	β_d (SF)	β_c / β_d	β_{hs}	CM/dB
1	2/15	15/15	64	2/15	4/15	0.0
2	12/15	15/15	64	12/15	24/25	1.0
3	15/15	8/15	64	15/8	30/15	1.5
4	15/15	4/15	64	15/4	30/15	1.5

For Release 6 HSDPA Data Devices

Sub-test	β_c	β_d	β_d (SF)	β_c / β_d	β_{hs}	β_{ec}	β_{ed}	β_{ed} (SF)	β_{ed} (codes)	CM (dB)	MPR (dB)	AG Index	E-TFCI
1	11/15	15/15	64	11/15	22/15	209/225	1039/225	4	1	1.0	0.0	20	75
2	6/15	15/15	64	6/15	12/15	12/15	12/15	4	1	3.0	2.0	12	67
3	15/15	9/15	64	15/9	30/15	30/15	$\beta_{ed1}:47/15$ $\beta_{ed2}:47/15$	4	2	2.0	1.0	15	92
4	2/15	15/15	64	2/15	4/15	4/15	56/75	4	1	3.0	2.0	17	71
5	15/15	15/15	64	15/15	24/15	30/15	134/15	4	1	1.0	0.0	21	81

11.4 Bluetooth & Wi-Fi Measurement Procedures for SAR

Normal network operating configurations are not suitable for measuring the SAR of 802.11 transmitters in general. Unpredictable fluctuations in network traffic and antenna diversity conditions can introduce undesirable variations in SAR results. The SAR for these devices should be measured using chipset based test mode software to ensure that the results are consistent and reliable.

Chipset based test mode software is hardware dependent and generally varies among manufacturers. The device operating parameters established in a test mode for SAR measurements must be identical to those programmed in production units, including output power levels, amplifier gain settings and other RF performance tuning parameters. The test frequencies should correspond to actual channel frequencies defined for domestic use. SAR for devices with switched diversity should be measured with only one antenna transmitting at a time during each SAR measurement, according to a fixed modulation and data rate. The same data pattern should be used for all measurements.

11.5 Power Drift

To control the output power stability during the SAR test, DASY4 system calculates the power drift by measuring the E-field at the same location at the beginning and at the end of the measurement for each test position. These drift values can be found in Table 14.1 to Table 14.10 labeled as: (Power Drift [dB]). This ensures that the power drift during one measurement is within 5%.

12 Conducted Output Power

12.1 GSM Measurement result

During the process of testing, the EUT was controlled via Agilent Digital Radio Communication tester (E5515C) to ensure the maximum power transmission and proper modulation. This result contains conducted output power for the EUT. In all cases, the measured peak output power should be greater and within 5% than EMI measurement.

Table 12.1: The conducted power measurement results for GSM850/1900

GSM 850MHZ	Conducted Power (dBm)		
	Channel 251(848.8MHz)	Channel 190(836.6MHz)	Channel 128(824.2MHz)
	33.28	33.32	33.36
GSM 1900MHZ	Conducted Power (dBm)		
	Channel 810(1909.8MHz)	Channel 661(1800MHz)	Channel 512(1850.2MHz)
	30.55	30.64	30.63

Table 12.2: The conducted power measurement results for GPRS

GSM 850 GPRS	Measured Power (dBm)			calculation	Averaged Power (dBm)		
	251	190	128		251	190	128
1 Txslot	33.32	33.36	33.40	-9.03dB	24.29	24.33	24.37
2 Txslots	29.73	29.78	29.83	-6.02dB	23.71	23.76	23.81
3Txslots	27.79	27.85	27.89	-4.26dB	23.53	23.59	23.63
4 Txslots	25.87	25.92	25.96	-3.01dB	22.86	22.91	22.95
GSM 850 EGPRS	Measured Power (dBm)			calculation	Averaged Power (dBm)		
	251	190	128		251	190	128
1 Txslot	33.37	33.40	33.44	-9.03dB	24.34	24.37	24.41
2 Txslots	29.79	29.83	29.87	-6.02dB	23.77	23.81	23.85
3Txslots	27.85	27.90	27.95	-4.26dB	23.59	23.64	23.69
4 Txslots	25.92	25.97	26.01	-3.01dB	22.91	22.96	23.00
PCS1900 GPRS	Measured Power (dBm)			calculation	Averaged Power (dBm)		
	810	661	512		810	661	512
1 Txslot	30.55	30.63	30.62	-9.03dB	21.52	21.60	21.59
2 Txslots	27.12	27.27	27.11	-6.02dB	21.10	21.25	21.09
3Txslots	25.14	25.29	25.13	-4.26dB	20.88	21.03	20.87
4 Txslots	23.21	23.36	23.16	-3.01dB	20.20	20.35	20.15
PCS1900 EGPRS	Measured Power (dBm)			calculation	Averaged Power (dBm)		
	810	661	512		810	661	512
1 Txslot	30.56	30.65	30.64	-9.03dB	21.53	21.62	21.61
2 Txslots	27.13	27.28	27.12	-6.02dB	21.11	21.26	21.10
3Txslots	25.15	25.30	25.14	-4.26dB	20.89	21.04	20.88
4 Txslots	23.22	23.37	23.17	-3.01dB	20.21	20.36	20.16

NOTES:

1) Division Factors

To average the power, the division factor is as follows:

1TX-slot = 1 transmit time slot out of 8 time slots=> conducted power divided by (8/1) => -9.03dB

2TX-slots = 2 transmit time slots out of 8 time slots=> conducted power divided by (8/2) => -6.02dB

3TX-slots = 3 transmit time slots out of 8 time slots=> conducted power divided by (8/3) => -4.26dB

4TX-slots = 4 transmit time slots out of 8 time slots=> conducted power divided by (8/4) => -3.01dB

According to the conducted power as above, the body measurements are performed with 1Txslots for GSM850 and GSM1900.

12.2 WCDMA Measurement result

Table 10: The conducted Power for WCDMA850/1900

Item	band	FDDV result		
	ARFCN	4132 (826.4MHz)	4182 (836.4MHz)	4233 (846.6MHz)
WCDMA	\	23.43	23.24	23.44
HSUPA	1	20.09	20.24	20.12
	2	19.83	19.96	19.85
	3	20.40	20.60	20.44
	4	20.35	20.61	20.39
	5	22.54	22.66	22.46
Item	band	FDDII result		
	ARFCN	9262 (1852.4MHz)	9400 (1880MHz)	9538 (1907.6MHz)
WCDMA	\	22.25	22.60	22.38
HSUPA	1	20.00	20.63	20.72
	2	19.56	20.05	20.03
	3	20.41	20.98	21.02
	4	19.49	20.12	20.08
	5	21.57	22.13	22.06

Note: HSUPA body SAR are not required, because maximum average output power of each RF channel with HSDPA active is not 1/4 dB higher than that measured without HSUPA and the maximum SAR for WCDMA850 and WCDMA1900 are not above 75% of the SAR limit.

12.3 Wi-Fi and BT Measurement result

The output power of BT antenna is as following:

Channel	Ch 0 2402 MHz	Ch 39 2441 Mhz	Ch 78 2480 MHz
Peak Conducted Output Power(dBm)	6.47	7.10	8.46

The average conducted power for Wi-Fi is as following:

802.11b (dBm)

Channel\data rate	1Mbps	2Mbps	5.5Mbps	11Mbps
1	15.97	15.93	15.99	15.71
6	15.83	15.81	15.86	15.64
11	15.93	15.92	15.96	15.69

802.11g (dBm)

Channel\data rate	6Mbps	9Mbps	12Mbps	18Mbps	24Mbps	36Mbps	48Mbps	54Mbps
1	12.66	12.41	12.01	11.78	11.69	11.38	11.00	10.87
6	12.57	12.46	12.31	12.07	11.91	11.41	11.08	10.93
11	12.62	12.51	12.41	12.19	11.99	11.48	11.15	11.11

20M 802.11n (dBm)

Channel\data rate	MCS0	MCS1	MCS2	MCS3	MCS4	MCS5	MCS6	MCS7
1	10.49	10.19	9.96	9.78	9.43	9.05	8.93	8.73
6	10.47	10.18	9.98	9.76	9.35	8.98	8.96	8.70
11	10.54	10.21	10.09	9.88	9.41	9.09	8.97	8.86

The peak conducted power for Wi-Fi is as following:

802.11b (dBm)

Channel\data rate	1Mbps	2Mbps	5.5Mbps	11Mbps
1	19.45	19.72	21.17	22.58
6	/	/	/	22.58
11	/	/	/	22.61

802.11g (dBm)

Channel\data rate	6Mbps	9Mbps	12Mbps	18Mbps	24Mbps	36Mbps	48Mbps	54Mbps
1	21.25	21.18	21.05	21.01	21.53	21.14	21.46	21.41
6	/	/	/	/	21.55	/	/	/
11	/	/	/	/	21.65	/	/	/

802.11n (dBm)

Channel\data rate	MCS0	MCS1	MCS2	MCS3	MCS4	MCS5	MCS6	MCS7
1	19.07	18.99	18.75	19.34	19.27	19.36	19.38	19.31
6	/	/	/	/	/	/	19.41	/
11	/	/	/	/	/	/	19.40	/

SAR is not required for 802.11g/n channels if the output power is less than 0.25dB higher than that measured on the corresponding 802.11b channels, and for each frequency band, testing at higher data rates and higher order modulations is not required when the maximum average output power for each of these configurations is less than 0.25dB higher than those measured at the lowest data rate. According to the above conducted power, the EUT should be tested for “802.11b, 1Mbps, channel 1”.

13 Simultaneous TX SAR Considerations

13.1 Introduction

The following procedures adopted from “FCC SAR Considerations for Cell Phones with Multiple Transmitters” are applicable to handsets with built-in unlicensed transmitters such as 802.11 a/b/g and Bluetooth devices which may simultaneously transmit with the licensed transmitter. For this device, the BT and Wi-Fi can transmit simultaneous with other transmitters.

13.2 Transmit Antenna Separation Distances

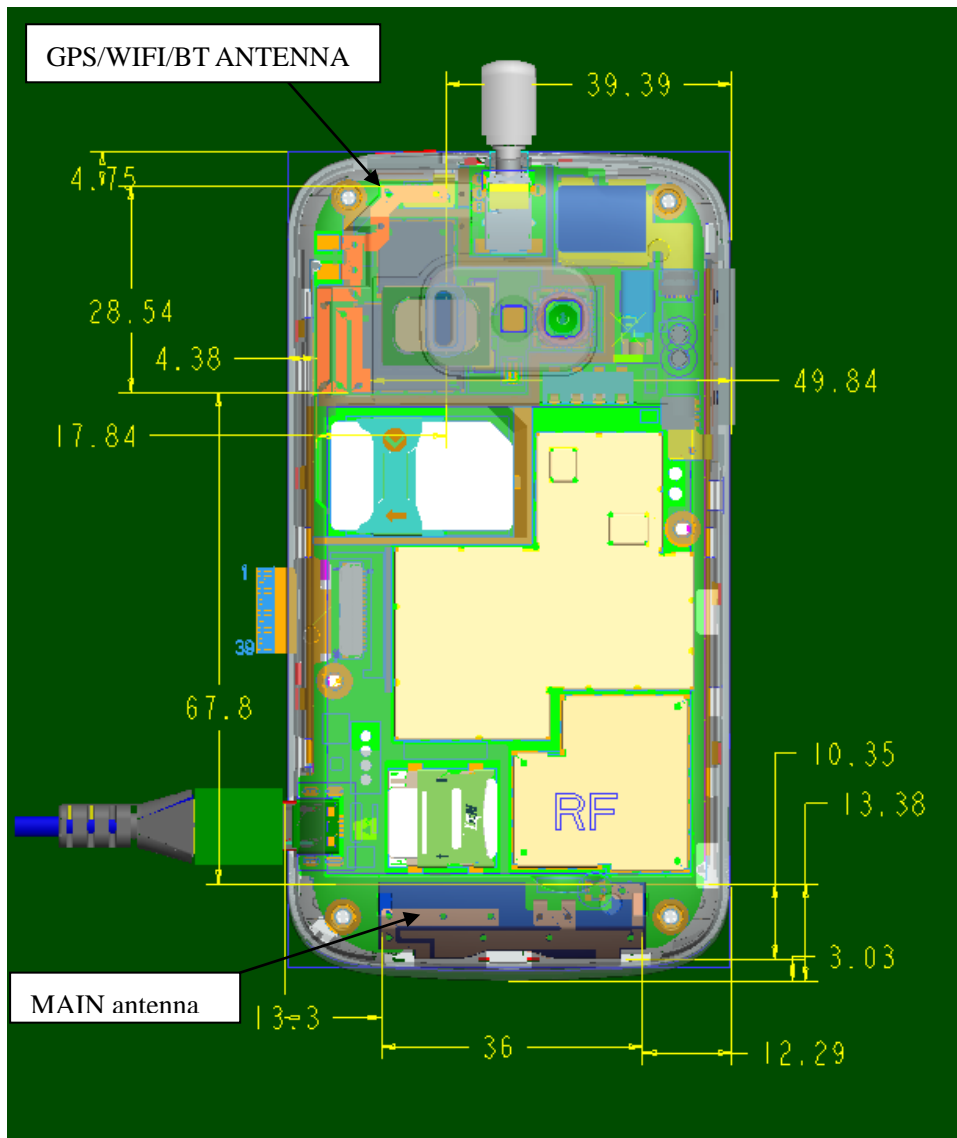

Picture 13.1 Antenna Locations

13.3 Simultaneous Transmission for EUT

Table 13.1: Summary of Transmitters

Band/Mode	F(GHz)	60/f power threshold (mW)	RF output power (mW)
Bluetooth	2.441	24.6	7.01
2.4GHz WLAN 802.11 b/g	2.45	24.5	39.54

According to the conducted power measurement result, we can draw the conclusion that: stand-alone SAR for WiFi should be performed. Then, simultaneous transmission SAR for WiFi is considered with measurement results of GSM/WCDMA and WiFi. Stand-alone SAR and simultaneous transmission SAR for Bluetooth should not be performed.

Table 13.2 SAR Evaluation Requirements for Multiple Transmitter Handsets

	Individual Transmitter	Simultaneous Transmission
Licensed Transmitters	<u>Routine evaluation required</u>	SAR not required: <u>Unlicensed only</u>
Unlicensed Transmitters	<p><u>When there is no simultaneous transmission –</u></p> <ul style="list-style-type: none"> ○ output $\leq 60/f$: SAR not required ○ output $> 60/f$: stand-alone SAR required <p><u>When there is simultaneous transmission –</u></p> <p><u>Stand-alone SAR not required when</u></p> <ul style="list-style-type: none"> ○ output $\leq 2 \cdot P_{Ref}$ and antenna is ≥ 5.0 cm from other antennas ○ output $\leq P_{Ref}$ and antenna is ≥ 2.5 cm from other antennas ○ output $\leq P_{Ref}$ and antenna is < 2.5 cm from other antennas, each with either output power $\leq P_{Ref}$ or 1-g SAR < 1.2 W/kg <p><u>Otherwise stand-alone SAR is required</u></p> <p><u>When stand-alone SAR is required</u></p> <ul style="list-style-type: none"> ○ test SAR on highest output channel for each wireless mode and exposure condition ○ if SAR for highest output channel is $> 50\%$ of SAR limit, evaluate all channels according to normal procedures 	<p><u>Licensed & Unlicensed</u></p> <ul style="list-style-type: none"> ○ when the sum of the 1-g SAR is < 1.6 W/kg for all simultaneous transmitting antennas ○ when SAR to peak location separation ratio of simultaneous transmitting antenna pair is < 0.3 <p>SAR required:</p> <p><u>Licensed & Unlicensed</u></p> <p>antenna pairs with SAR to peak location separation ratio ≥ 0.3; test is only required for the configuration that results in the highest SAR in stand-alone configuration for each wireless mode and exposure condition</p> <p>Note: simultaneous transmission exposure conditions for head and body can be different for different style phones; therefore, different test requirements may apply</p>

Table 13.3: The sum of SAR values

	Position	GSM / WCDMA	WiFi	Sum
Maximum SAR value for Head	Left hand, Touch cheek	1.04	0.376	1.416
Maximum SAR value for Body	Toward Ground	1.04	0.539	1.579

According to the above table, the sum of SAR values for GSM and WiFi < 1.6 W/kg. So the simultaneous transmission SAR is not required for WiFi transmitter.

14 SAR Test Result

14.1 SAR Test Result

Table 14.1: SAR Values (GSM 850 MHz Band - Head)

Frequency		Mode/Band	Side	Test Position	Battery Type	SAR(1g)	Power Drift(dB)
MHz	Ch.					(W/kg)	
848.8	251	GSM850	Left	Touch	CAB31P0000C1	1.04	-0.15
836.6	190	GSM850	Left	Touch	CAB31P0000C1	0.980	-0.00
824.2	128	GSM850	Left	Touch	CAB31P0000C1	0.765	0.08
848.8	251	GSM850	Left	Tilt	CAB31P0000C1	0.441	-0.02
836.6	190	GSM850	Left	Tilt	CAB31P0000C1	0.444	0.07
824.2	128	GSM850	Left	Tilt	CAB31P0000C1	0.359	0.18
848.8	251	GSM850	Right	Touch	CAB31P0000C1	0.875	-0.07
836.6	190	GSM850	Right	Touch	CAB31P0000C1	0.880	0.03
824.2	128	GSM850	Right	Touch	CAB31P0000C1	0.710	0.03
848.8	251	GSM850	Right	Tilt	CAB31P0000C1	0.402	-0.08
836.6	190	GSM850	Right	Tilt	CAB31P0000C1	0.487	0.01
824.2	128	GSM850	Right	Tilt	CAB31P0000C1	0.401	0.05

Table 14.2: SAR Values (GSM 850 MHz Band - Body)

Frequency		Mode/Band	Headset	Test Position	Spacing (mm)	Battery Type	SAR(1g)	Power Drift(dB)
MHz	Ch.						(W/kg)	
848.8	251	GPRS	\	Phantom	10	CAB31P0000C1	0.940	-0.07
836.6	190	GPRS	\	Phantom	10	CAB31P0000C1	0.976	-0.04
824.2	128	GPRS	\	Phantom	10	CAB31P0000C1	0.819	0.00
848.8	251	GPRS	\	Ground	10	CAB31P0000C1	1.000	0.00
836.6	190	GPRS	\	Ground	10	CAB31P0000C1	1.04	-0.04
824.2	128	GPRS	\	Ground	10	CAB31P0000C1	0.921	0.01
824.2	128	GPRS	\	Left	10	CAB31P0000C1	0.463	-0.00
824.2	128	GPRS	\	Right	10	CAB31P0000C1	0.423	-0.03
824.2	128	GPRS	\	Bottom	10	CAB31P0000C1	0.106	-0.06
836.6	190	EGPRS	\	Ground	10	CAB31P0000C1	0.919	-0.04
836.6	190	Speech	CCB3000A12C1	Ground	10	CAB31P0000C1	0.783	-0.02
836.6	190	Speech	CCB3000A12C2	Ground	10	CAB31P0000C1	0.836	-0.01

Table 14.3: SAR Values (GSM 1900 MHz Band - Head)

Frequency		Mode/Band	Side	Test Position	Battery Type	SAR(1g)	Power Drift(dB)
MHz	Ch.					(W/kg)	
1909.8	810	GSM1900	Left	Touch	CAB31P0000C1	0.936	-0.12
1880	661	GSM1900	Left	Touch	CAB31P0000C1	0.999	-0.06
1850.2	512	GSM1900	Left	Touch	CAB31P0000C1	1.03	0.00
1909.8	810	GSM1900	Left	Tilt	CAB31P0000C1	0.267	-0.02

1880	661	GSM1900	Left	Tilt	CAB31P0000C1	0.292	-0.02
1850.2	512	GSM1900	Left	Tilt	CAB31P0000C1	0.296	-0.03
1909.8	810	GSM1900	Right	Touch	CAB31P0000C1	0.442	-0.16
1880	661	GSM1900	Right	Touch	CAB31P0000C1	0.460	0.10
1850.2	512	GSM1900	Right	Touch	CAB31P0000C1	0.527	-0.11
1909.8	810	GSM1900	Right	Tilt	CAB31P0000C1	0.280	-0.03
1880	661	GSM1900	Right	Tilt	CAB31P0000C1	0.322	-0.01
1850.2	512	GSM1900	Right	Tilt	CAB31P0000C1	0.353	0.12

Table 14.4: SAR Values (GSM 1900 MHz Band - Body)

Frequency		Mode/Band	Headset	Test Position	Spacing (mm)	Battery Type	SAR(1g)	Power Drift(dB)
MHz	Ch.						(W/kg)	
1909.8	810	GPRS	\	Phantom	10	CAB31P0000C1	0.790	0.02
1880	661	GPRS	\	Phantom	10	CAB31P0000C1	0.920	0.01
1850.2	512	GPRS	\	Phantom	10	CAB31P0000C1	0.960	0.02
1909.8	810	GPRS	\	Ground	10	CAB31P0000C1	0.823	-0.02
1880	661	GPRS	\	Ground	10	CAB31P0000C1	1.03	0.08
1850.2	512	GPRS	\	Ground	10	CAB31P0000C1	0.977	-0.04
1880	661	GPRS	\	Left	10	CAB31P0000C1	0.196	-0.06
1880	661	GPRS	\	Right	10	CAB31P0000C1	0.127	-0.07
1880	661	GPRS	\	Bottom	10	CAB31P0000C1	0.352	-0.08
1880	661	EGPRS	\	Ground	10	CAB31P0000C1	0.806	-0.16
1880	661	Speech	CCB3000A12C1	Ground	10	CAB31P0000C1	0.765	0.09
1880	661	Speech	CCB3000A12C2	Ground	10	CAB31P0000C1	0.798	-0.02

Table 14.5: SAR Values (WCDMA 850 MHz Band - Head)

Frequency		Mode/Band	Side	Test Position	Battery Type	SAR(1g)	Power Drift(dB)
MHz	Ch.					(W/kg)	
846.6	4233	WCDMA850	Left	Touch	CAB31P0000C1	0.703	0.03
836.4	4182	WCDMA850	Left	Touch	CAB31P0000C1	0.672	0.07
826.4	4132	WCDMA850	Left	Touch	CAB31P0000C1	0.449	-0.03
846.6	4233	WCDMA850	Left	Tilt	CAB31P0000C1	0.332	0.07
836.4	4182	WCDMA850	Left	Tilt	CAB31P0000C1	0.343	-0.04
826.4	4132	WCDMA850	Left	Tilt	CAB31P0000C1	0.234	0.01
846.6	4233	WCDMA850	Right	Touch	CAB31P0000C1	0.610	-0.17
836.4	4182	WCDMA850	Right	Touch	CAB31P0000C1	0.594	0.18
826.4	4132	WCDMA850	Right	Touch	CAB31P0000C1	0.397	0.09
846.6	4233	WCDMA850	Right	Tilt	CAB31P0000C1	0.327	0.03
836.4	4182	WCDMA850	Right	Tilt	CAB31P0000C1	0.352	0.15
826.4	4132	WCDMA850	Right	Tilt	CAB31P0000C1	0.245	0.17

Table 14.6: SAR Values (WCDMA 850 MHz Band - Body)

Frequency		Headset	Test Position	Spacing (mm)	Battery Type	SAR(1g)	Power Drift(dB)
MHz	Ch.					(W/kg)	
846.6	4233	\	Phantom	10	CAB31P0000C1	0.879	-0.10
836.4	4182	\	Phantom	10	CAB31P0000C1	0.857	-0.09
826.4	4132	\	Phantom	10	CAB31P0000C1	0.677	-0.05
846.6	4233	\	Ground	10	CAB31P0000C1	0.958	0.07
836.4	4182	\	Ground	10	CAB31P0000C1	0.902	-0.08
826.4	4132	\	Ground	10	CAB31P0000C1	0.703	0.01
846.6	4233	\	Left	10	CAB31P0000C1	0.450	-0.11
846.6	4233	\	Right	10	CAB31P0000C1	0.421	-0.09
846.6	4233	\	Bottom	10	CAB31P0000C1	0.136	-0.17
846.6	4233	CCB3000A12C1	Ground	10	CAB31P0000C1	0.703	-0.12
846.6	4233	CCB3000A12C2	Ground	10	CAB31P0000C1	0.851	0.03

Table 14.7: SAR Values (WCDMA 1900 MHz Band - Head)

Frequency		Mode/Band	Side	Test Position	Battery Type	SAR(1g)	Power Drift(dB)
MHz	Ch.					(W/kg)	
1907.6	9538	WCDMA1900	Left	Touch	CAB31P0000C1	1.02	0.15
1880	9400	WCDMA1900	Left	Touch	CAB31P0000C1	1.04	0.05
1852.4	9262	WCDMA1900	Left	Touch	CAB31P0000C1	0.923	0.11
1907.6	9538	WCDMA1900	Left	Tilt	CAB31P0000C1	0.316	-0.10
1880	9400	WCDMA1900	Left	Tilt	CAB31P0000C1	0.317	-0.00
1852.4	9262	WCDMA1900	Left	Tilt	CAB31P0000C1	0.280	0.13
1907.6	9538	WCDMA1900	Right	Touch	CAB31P0000C1	0.780	0.19
1880	9400	WCDMA1900	Right	Touch	CAB31P0000C1	0.797	-0.13
1852.4	9262	WCDMA1900	Right	Touch	CAB31P0000C1	0.707	0.05
1907.6	9538	WCDMA1900	Right	Tilt	CAB31P0000C1	0.383	-0.07
1880	9400	WCDMA1900	Right	Tilt	CAB31P0000C1	0.405	-0.01
1852.4	9262	WCDMA1900	Right	Tilt	CAB31P0000C1	0.356	0.18

Table 14.8: SAR Values (WCDMA 1900 MHz Band - Body)

Frequency		Headset	Test Position	Spacing (mm)	Battery Type	SAR(1g)	Power Drift(dB)
MHz	Ch.					(W/kg)	
1907.6	9538	\	Phantom	10	CAB31P0000C1	1.01	0.03
1880	9400	\	Phantom	10	CAB31P0000C1	1.03	0.09
1852.4	9262	\	Phantom	10	CAB31P0000C1	0.910	-0.12
1907.6	9538	\	Ground	10	CAB31P0000C1	1.02	0.10
1880	9400	\	Ground	10	CAB31P0000C1	1.04	-0.01
1852.4	9262	\	Ground	10	CAB31P0000C1	0.926	-0.06
1880	9400	\	Left	10	CAB31P0000C1	0.271	0.13
1880	9400	\	Right	10	CAB31P0000C1	0.177	0.14
1880	9400	\	Bottom	10	CAB31P0000C1	0.350	-0.10
1880	9400	CCB3000A12C1	Ground	10	CAB31P0000C1	0.996	0.02
1880	9400	CCB3000A12C2	Ground	10	CAB31P0000C1	0.878	0.01

Table 14.9: SAR Values (Wi-Fi 802.11b - Head)

Frequency		Mode/Band	Side	Test Position	Battery Type	SAR(10g)	Power Drift(dB)
MHz	Ch.					(W/kg)	
2412	1	802.11 b	Left	Touch	CAB31P0000C1	0.376	-0.15
2412	1	802.11 b	Left	Tilt	CAB31P0000C1	0.294	0.19
2412	1	802.11 b	Right	Touch	CAB31P0000C1	0.143	-0.18
2412	1	802.11 b	Right	Tilt	CAB31P0000C1	0.136	0.00

Table 14.10: SAR Values (Wi-Fi 802.11b - Body)

Frequency		Mode/Band	Test Position	Spacing (mm)	Battery Type	SAR(10g)	Power Drift(dB)
MHz	Ch.					(W/kg)	
2412	1	802.11 b	Phantom	10	CAB31P0000C1	0.077	-0.09
2412	1	802.11 b	Ground	10	CAB31P0000C1	0.539	0.05
2412	1	802.11 b	Right	10	CAB31P0000C1	0.220	0.05
2412	1	802.11 b	Top	10	CAB31P0000C1	0.139	0.16

15 Measurement Uncertainty

No.	Error Description	Type	Uncertainty value	Probably Distribution	Div.	(Ci) 1g	(Ci) 10g	Std. Unc. (1g)	Std. Unc. (10g)	Degree of freedom
Measurement system										
1	Probe calibration	B	5.5	N	1	1	1	5.5	5.5	∞
2	Isotropy	B	4.7	R	$\sqrt{3}$	0.7	0.7	1.9	1.9	∞
3	Boundary effect	B	1.0	R	$\sqrt{3}$	1	1	0.6	0.6	∞
4	Linearity	B	4.7	R	$\sqrt{3}$	1	1	2.7	2.7	∞
5	Detection limit	B	1.0	N	1	1	1	0.6	0.6	∞
6	Readout electronics	B	0.3	R	$\sqrt{3}$	1	1	0.3	0.3	∞
7	Response time	B	0.8	R	$\sqrt{3}$	1	1	0.5	0.5	∞
8	Integration time	B	2.6	R	$\sqrt{3}$	1	1	1.5	1.5	∞
9	RF ambient conditions-noise	B	0	R	$\sqrt{3}$	1	1	0	0	∞
10	RF ambient conditions-reflection	B	0	R	$\sqrt{3}$	1	1	0	0	∞
11	Probe positioned mech. restrictions	B	0.4	R	$\sqrt{3}$	1	1	0.2	0.2	∞
12	Probe positioning with respect to phantom shell	B	2.9	R	$\sqrt{3}$	1	1	1.7	1.7	∞
13	Post-processing	B	1.0	R	$\sqrt{3}$	1	1	0.6	0.6	∞

Test sample related										
14	Test sample positioning	A	3.3	N	1	1	1	3.3	3.3	71
15	Device holder uncertainty	A	3.4	N	1	1	1	3.4	3.4	5
16	Drift of output power	B	5.0	R	$\sqrt{3}$	1	1	2.9	2.9	∞
Phantom and set-up										
17	Phantom uncertainty	B	4.0	R	$\sqrt{3}$	1	1	2.3	2.3	∞
18	Liquid conductivity (target)	B	5.0	R	$\sqrt{3}$	0.64	0.43	1.8	1.2	∞
19	Liquid conductivity (meas.)	A	2.06	N	1	0.64	0.43	1.32	0.89	43
20	Liquid permittivity (target)	B	5.0	R	$\sqrt{3}$	0.6	0.49	1.7	1.4	∞
21	Liquid permittivity (meas.)	A	1.6	N	1	0.6	0.49	1.0	0.8	521
Combined standard uncertainty		$u_c = \sqrt{\sum_{i=1}^{21} c_i^2 u_i^2}$						9.25	9.12	257
Expanded uncertainty (confidence interval of 95 %)		$u_e = 2u_c$						18.5	18.2	

16 MAIN TEST INSTRUMENTS

Table 16.1: List of Main Instruments

No.	Name	Type	Serial Number	Calibration Date	Valid Period
01	Network analyzer	E5071C	MY46110673	February 14, 2012	One year
02	Power meter	NRVD	102083	September 10, 2011	One year
03	Power sensor	NRV-Z5	100542		
04	Signal Generator	E4438C	MY49070393	November 12, 2011	One Year
05	Amplifier	VTL5400	0505	No Calibration Requested	
06	BTS	E5515C	MY48365192	November 17, 2011	One year
07	E-field Probe	SPEAG ES3DV3	3149	April 24, 2012	One year
08	DAE	SPEAG DAE4	771	November 20, 2011	One year
09	Dipole Validation Kit	SPEAG D835V2	443	May 03, 2012	One year
10	Dipole Validation Kit	SPEAG D1900V2	541	May 09, 2012	One year
11	Dipole Validation Kit	SPEAG D2450V2	853	May 02, 2012	One year

END OF REPORT BODY

ANNEX A GRAPH RESULTS

850 Left Cheek High

Date: 2012-7-25

Electronics: DAE4 Sn771

Medium: Head 850 MHz

Medium parameters used (interpolated): $f = 848.8$ MHz; $\sigma = 0.897$ mho/m; $\epsilon_r = 40.868$; $\rho = 1000$ kg/m³

Ambient Temperature: 22.4°C Liquid Temperature: 22.0°C

Communication System: GSM 850 Frequency: 848.8 MHz Duty Cycle: 1:8.3

Probe: ES3DV3 - SN3149 ConvF(6.26, 6.26, 6.26)

Cheek High/Area Scan (61x101x1): Measurement grid: dx=10mm, dy=10mm

Maximum value of SAR (interpolated) = 1.11 mW/g

Cheek High/Zoom Scan (7x7x7)/Cube 0: Measurement grid: dx=5mm, dy=5mm, dz=5mm

Reference Value = 9.772 V/m; Power Drift = -0.15 dB

Peak SAR (extrapolated) = 1.571 mW/g

SAR(1 g) = 1.04 mW/g; SAR(10 g) = 0.691 mW/g

Maximum value of SAR (measured) = 1.11 mW/g

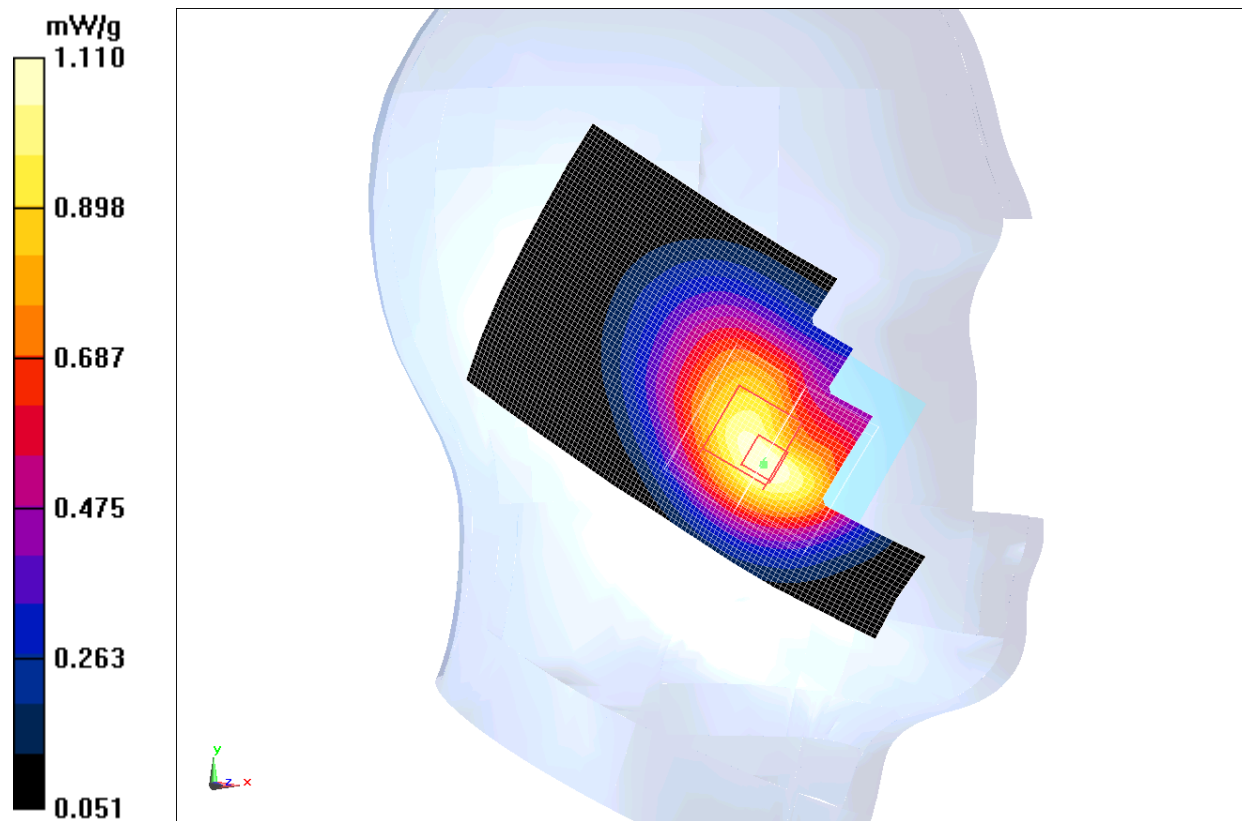

Fig. 1 850MHz CH251

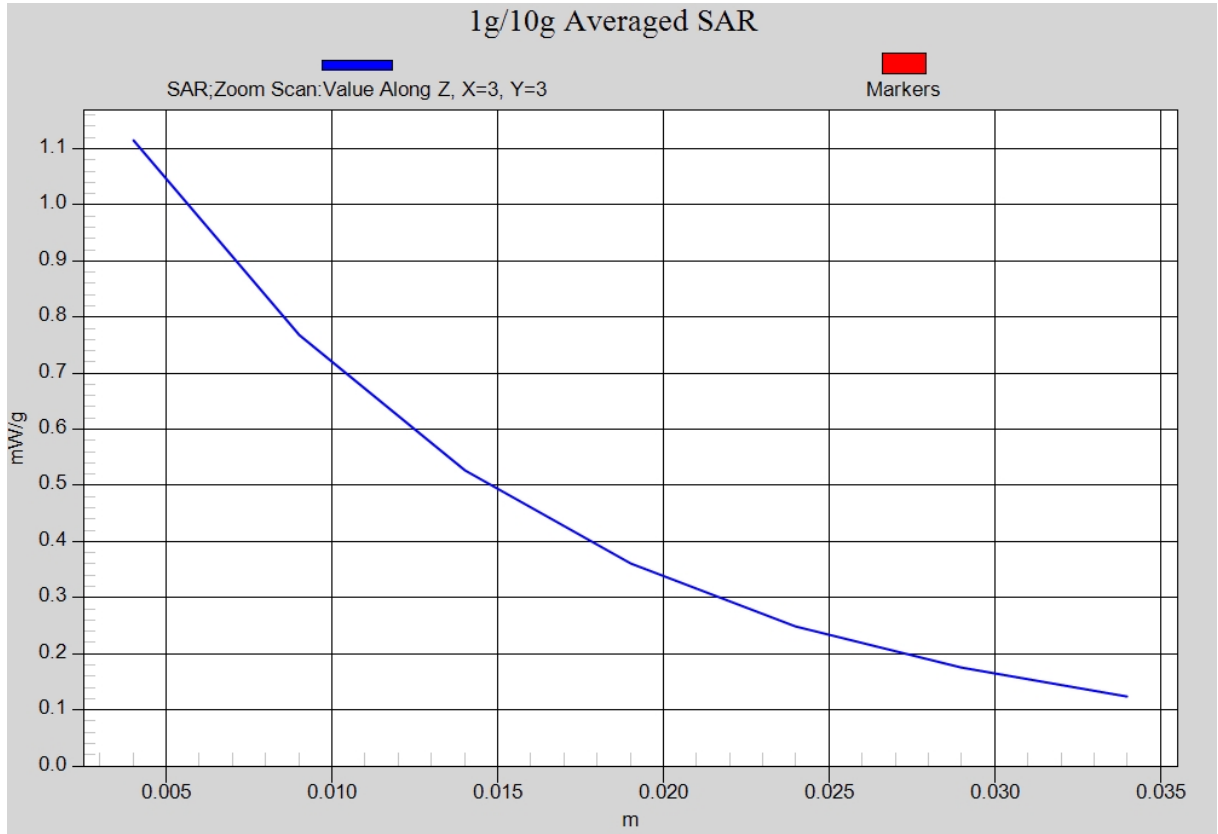

Fig. 1-1 Z-Scan at power reference point (850 MHz CH251)

850 Left Cheek Middle

Date: 2012-7-25

Electronics: DAE4 Sn771

Medium: Head 850 MHz

Medium parameters used (interpolated): $f = 836.6$ MHz; $\sigma = 0.885$ mho/m; $\epsilon_r = 41.025$; $\rho = 1000$ kg/m³

Ambient Temperature: 22.4°C Liquid Temperature: 22.0°C

Communication System: GSM; Frequency: 836.6 MHz; Duty Cycle: 1:8.3

Probe: ES3DV3 - SN3149 ConvF(6.26, 6.26, 6.26)

Cheek Middle/Area Scan (61x101x1): Measurement grid: dx=10mm, dy=10mm

Maximum value of SAR (interpolated) = 1.05 mW/g

Cheek Middle/Zoom Scan (7x7x7)/Cube 0: Measurement grid: dx=5mm, dy=5mm, dz=5mm

Reference Value = 9.566 V/m; Power Drift = -0.00 dB

Peak SAR (extrapolated) = 1.467 mW/g

SAR(1 g) = 0.980 mW/g; SAR(10 g) = 0.657 mW/g

Maximum value of SAR (measured) = 1.05 mW/g

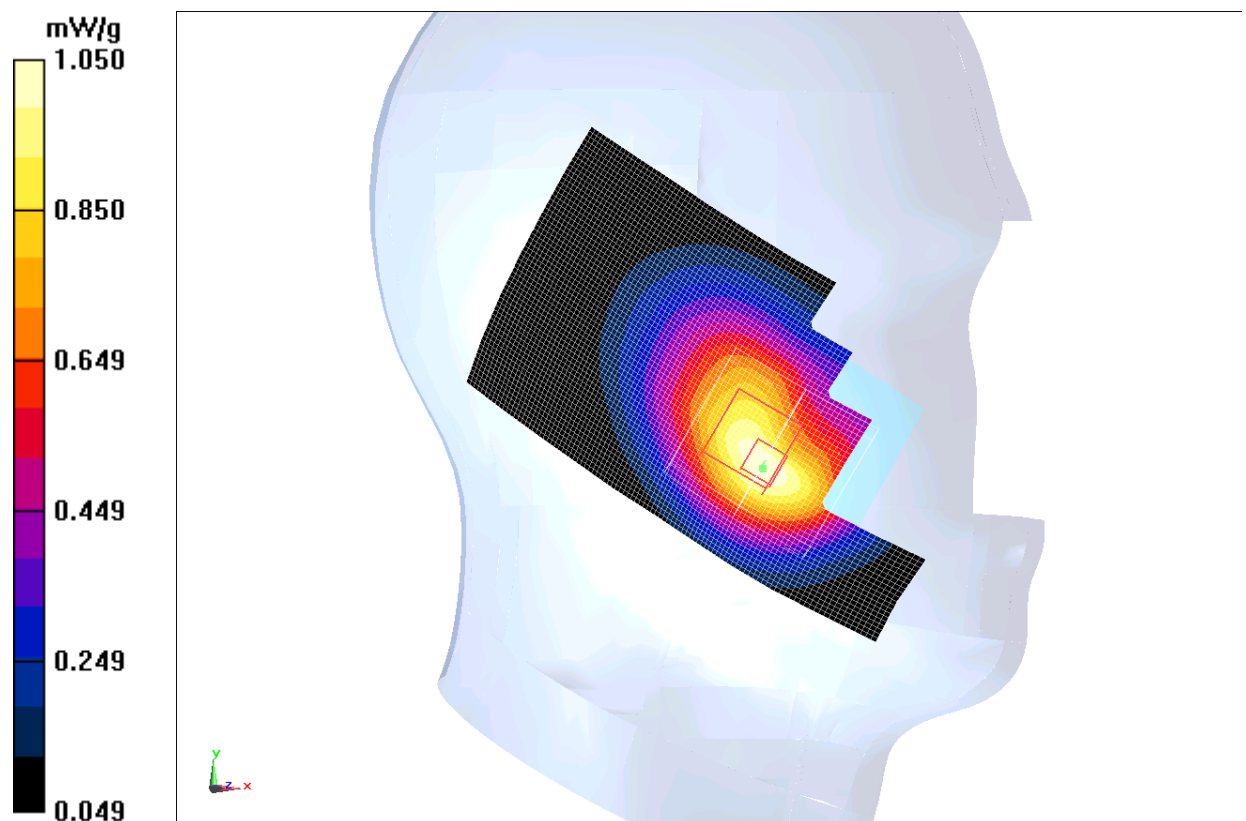

Fig. 2 850 MHz CH190

850 Left Cheek Low

Date: 2012-7-25

Electronics: DAE4 Sn771

Medium: Head 850 MHz

Medium parameters used: $f = 825 \text{ MHz}$; $\sigma = 0.874 \text{ mho/m}$; $\epsilon_r = 41.165$; $\rho = 1000 \text{ kg/m}^3$

Ambient Temperature: 22.4°C Liquid Temperature: 22.0°C

Communication System: GSM; Frequency: 824.2 MHz ; Duty Cycle: 1:8.3

Probe: ES3DV3 - SN3149 ConvF(6.26, 6.26, 6.26)

Cheek Low/Area Scan (61x101x1): Measurement grid: $dx=10\text{mm}$, $dy=10\text{mm}$

Maximum value of SAR (interpolated) = 0.818 mW/g

Cheek Low/Zoom Scan (7x7x7)/Cube 0: Measurement grid: $dx=5\text{mm}$, $dy=5\text{mm}$, $dz=5\text{mm}$

Reference Value = 8.674 V/m ; Power Drift = 0.08 dB

Peak SAR (extrapolated) = 1.121 mW/g

SAR(1 g) = 0.765 mW/g ; SAR(10 g) = 0.518 mW/g

Maximum value of SAR (measured) = 0.814 mW/g

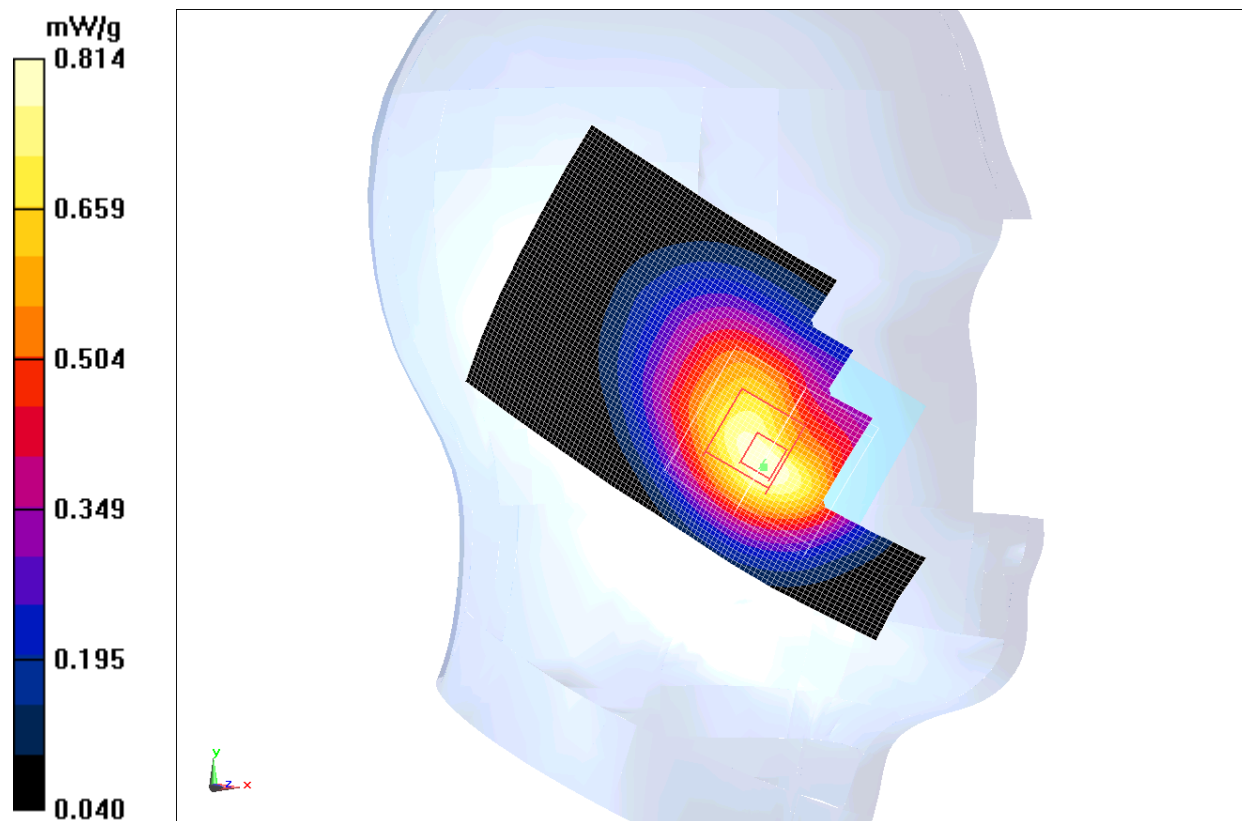

Fig. 3 850 MHz CH128

850 Left Tilt High

Date: 2012-7-25

Electronics: DAE4 Sn771

Medium: Head 850 MHz

Medium parameters used (interpolated): $f = 848.8$ MHz; $\sigma = 0.897$ mho/m; $\epsilon_r = 40.868$; $\rho = 1000$ kg/m³

Ambient Temperature: 22.4°C Liquid Temperature: 22.0°C

Communication System: GSM 850 Frequency: 848.8 MHz Duty Cycle: 1:8.3

Probe: ES3DV3 - SN3149 ConvF(6.26, 6.26, 6.26)

Tilt High/Area Scan (61x101x1): Measurement grid: dx=10mm, dy=10mm

Maximum value of SAR (interpolated) = 0.464 mW/g

Tilt High/Zoom Scan (7x7x7)/Cube 0: Measurement grid: dx=5mm, dy=5mm, dz=5mm

Reference Value = 17.157 V/m; Power Drift = -0.02 dB

Peak SAR (extrapolated) = 0.549 mW/g

SAR(1 g) = 0.441 mW/g; SAR(10 g) = 0.334 mW/g

Maximum value of SAR (measured) = 0.463 mW/g

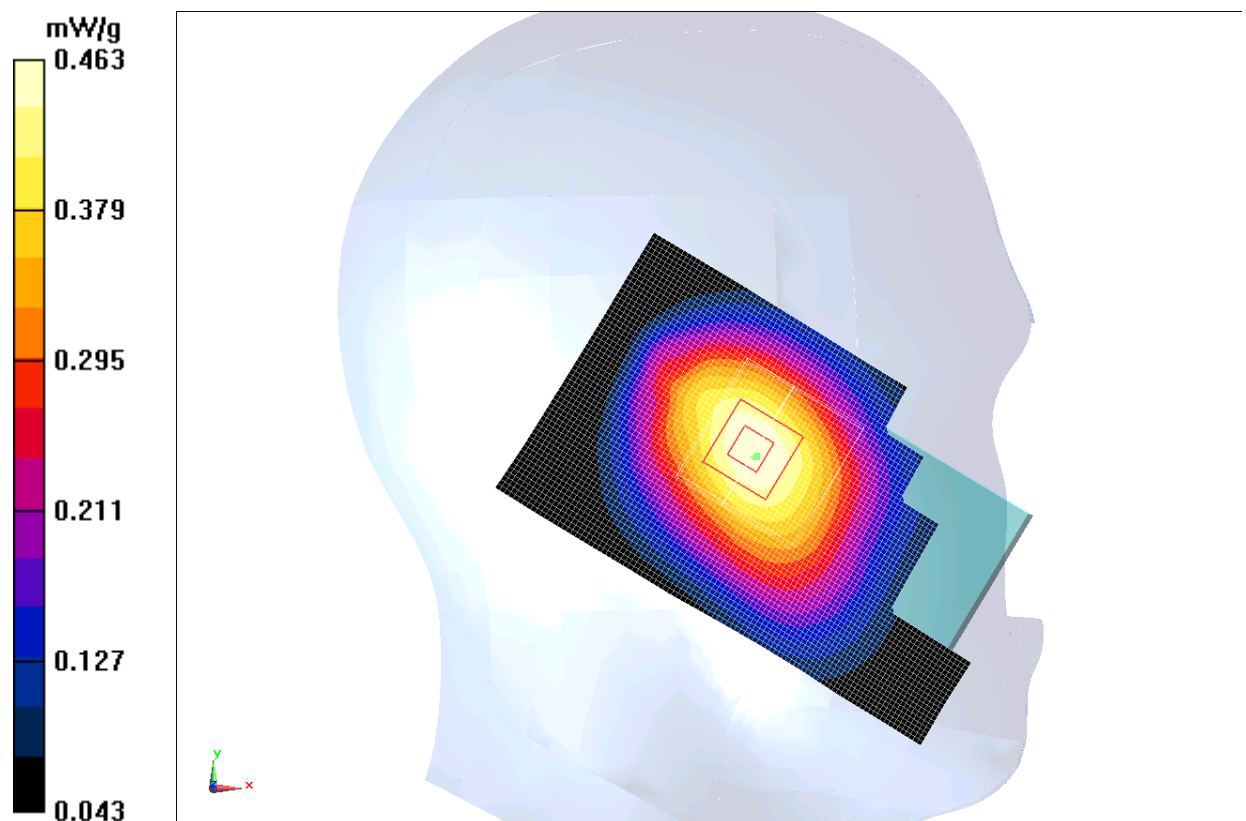

Fig.4 850 MHz CH251

850 Left Tilt Middle

Date: 2012-7-25

Electronics: DAE4 Sn771

Medium: Head 850 MHz

Medium parameters used (interpolated): $f = 836.6$ MHz; $\sigma = 0.885$ mho/m; $\epsilon_r = 41.025$; $\rho = 1000$ kg/m³

Ambient Temperature: 22.4°C Liquid Temperature: 22.0°C

Communication System: GSM; Frequency: 836.6 MHz; Duty Cycle: 1:8.3

Probe: ES3DV3 - SN3149 ConvF(6.26, 6.26, 6.26)

Tilt Middle/Area Scan (61x101x1): Measurement grid: dx=10mm, dy=10mm

Maximum value of SAR (interpolated) = 0.468 mW/g

Tilt Middle/Zoom Scan (7x7x7)/Cube 0: Measurement grid: dx=5mm, dy=5mm, dz=5mm

Reference Value = 17.273 V/m; Power Drift = 0.07 dB

Peak SAR (extrapolated) = 0.555 mW/g

SAR(1 g) = 0.444 mW/g; SAR(10 g) = 0.338 mW/g

Maximum value of SAR (measured) = 0.467 mW/g

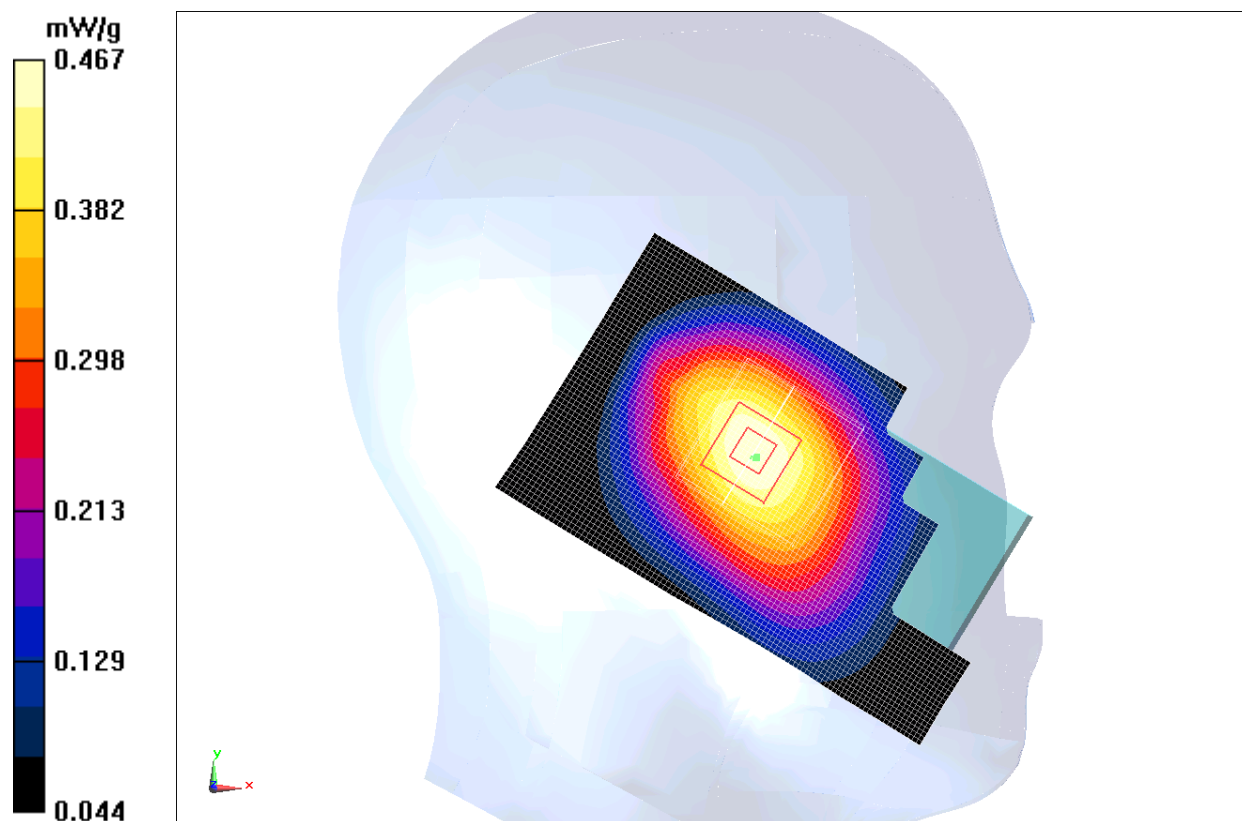

Fig.5 850 MHz CH190

850 Left Tilt Low

Date: 2012-7-25

Electronics: DAE4 Sn771

Medium: Head 850 MHz

Medium parameters used: $f = 825$ MHz; $\sigma = 0.874$ mho/m; $\epsilon_r = 41.165$; $\rho = 1000$ kg/m³

Ambient Temperature: 22.4°C Liquid Temperature: 22.0°C

Communication System: GSM 850 Frequency: 824.2 MHz Duty Cycle: 1:8.3

Probe: ES3DV3 - SN3149 ConvF(6.26, 6.26, 6.26)

Tilt Low/Area Scan (61x101x1): Measurement grid: dx=10mm, dy=10mm

Maximum value of SAR (interpolated) = 0.375 mW/g

Tilt Low/Zoom Scan (7x7x7)/Cube 0: Measurement grid: dx=5mm, dy=5mm, dz=5mm

Reference Value = 15.405 V/m; Power Drift = 0.18 dB

Peak SAR (extrapolated) = 0.447 mW/g

SAR(1 g) = 0.359 mW/g; SAR(10 g) = 0.273 mW/g

Maximum value of SAR (measured) = 0.378 mW/g

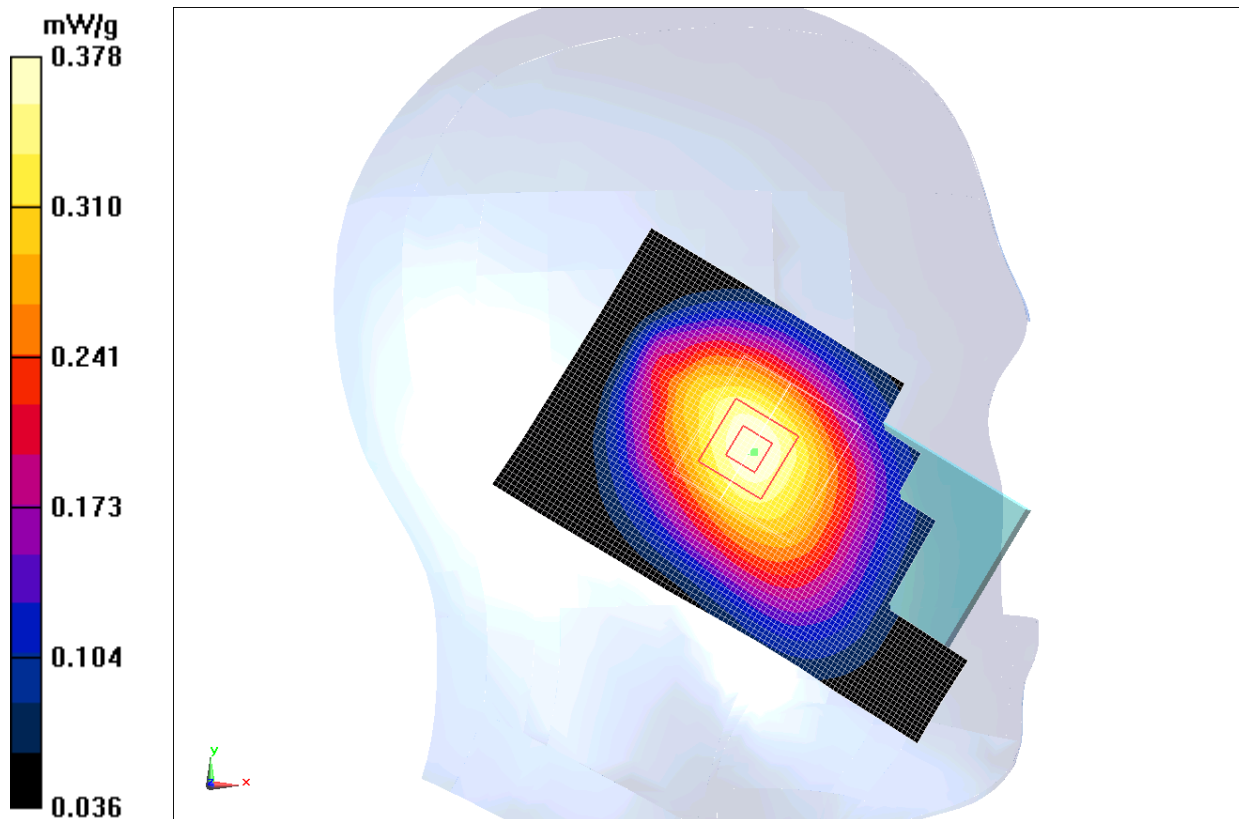

Fig. 6 850 MHz CH128

850 Right Cheek High

Date: 2012-7-25

Electronics: DAE4 Sn771

Medium: Head 850 MHz

Medium parameters used (interpolated): $f = 848.8$ MHz; $\sigma = 0.897$ mho/m; $\epsilon_r = 40.868$; $\rho = 1000$ kg/m³

Ambient Temperature: 22.4°C Liquid Temperature: 22.0°C

Communication System: GSM; Frequency: 848.8 MHz; Duty Cycle: 1:8.3

Probe: ES3DV3 - SN3149 ConvF(6.26, 6.26, 6.26)

Cheek High/Area Scan (61x101x1): Measurement grid: dx=10mm, dy=10mm

Maximum value of SAR (interpolated) = 0.917 mW/g

Cheek High/Zoom Scan (7x7x7)/Cube 0: Measurement grid: dx=5mm, dy=5mm, dz=5mm

Reference Value = 8.680 V/m; Power Drift = -0.07 dB

Peak SAR (extrapolated) = 1.254 mW/g

SAR(1 g) = 0.875 mW/g; SAR(10 g) = 0.614 mW/g

Maximum value of SAR (measured) = 0.928 mW/g

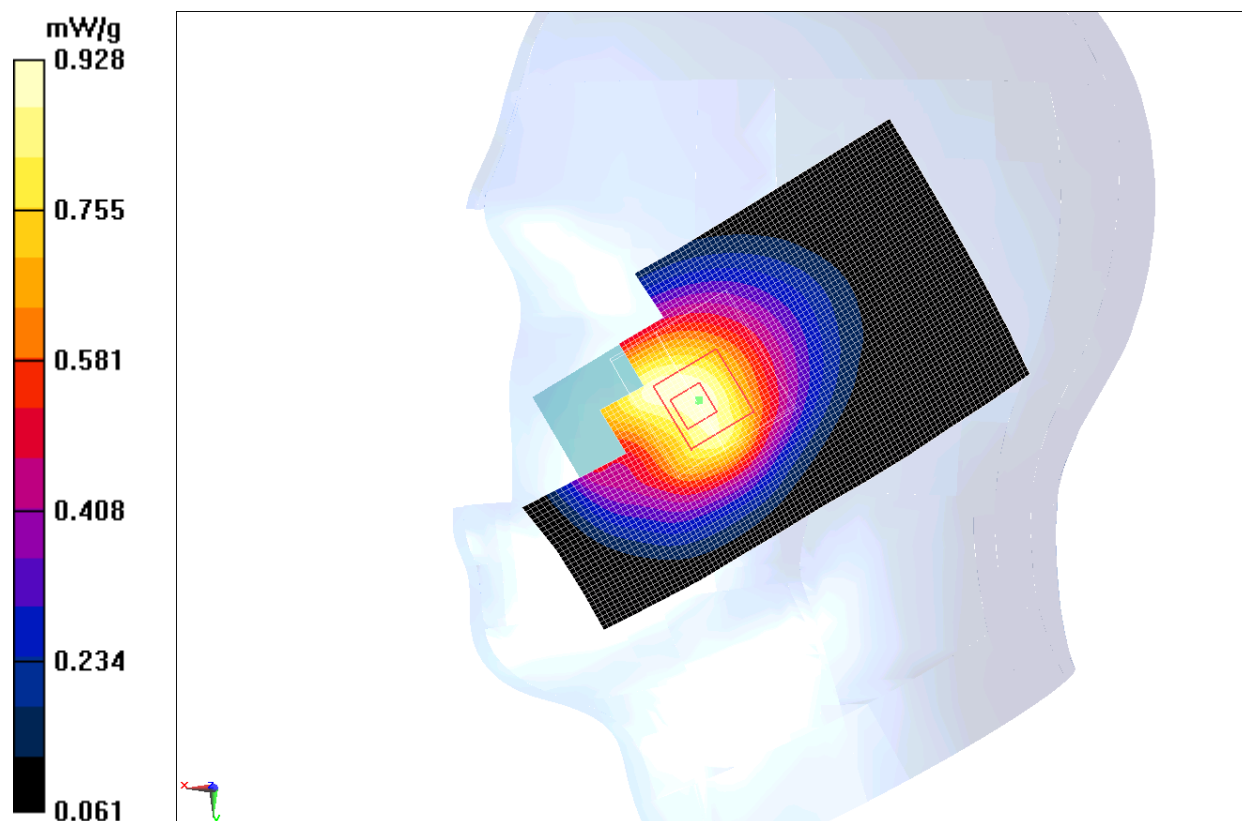

Fig. 7 850 MHz CH251

850 Right Cheek Middle

Date: 2012-7-25

Electronics: DAE4 Sn771

Medium: Head 850 MHz

Medium parameters used (interpolated): $f = 836.6$ MHz; $\sigma = 0.885$ mho/m; $\epsilon_r = 41.025$; $\rho = 1000$ kg/m³

Ambient Temperature: 22.4°C Liquid Temperature: 22.0°C

Communication System: GSM; Frequency: 836.6 MHz; Duty Cycle: 1:8.3

Probe: ES3DV3 - SN3149 ConvF(6.26, 6.26, 6.26)

Cheek Middle/Area Scan (61x101x1): Measurement grid: dx=10mm, dy=10mm

Maximum value of SAR (interpolated) = 0.916 mW/g

Cheek Middle/Zoom Scan (7x7x7)/Cube 0: Measurement grid: dx=5mm, dy=5mm, dz=5mm

Reference Value = 8.903 V/m; Power Drift = 0.03 dB

Peak SAR (extrapolated) = 1.257 mW/g

SAR(1 g) = 0.880 mW/g; SAR(10 g) = 0.620 mW/g

Maximum value of SAR (measured) = 0.935 mW/g

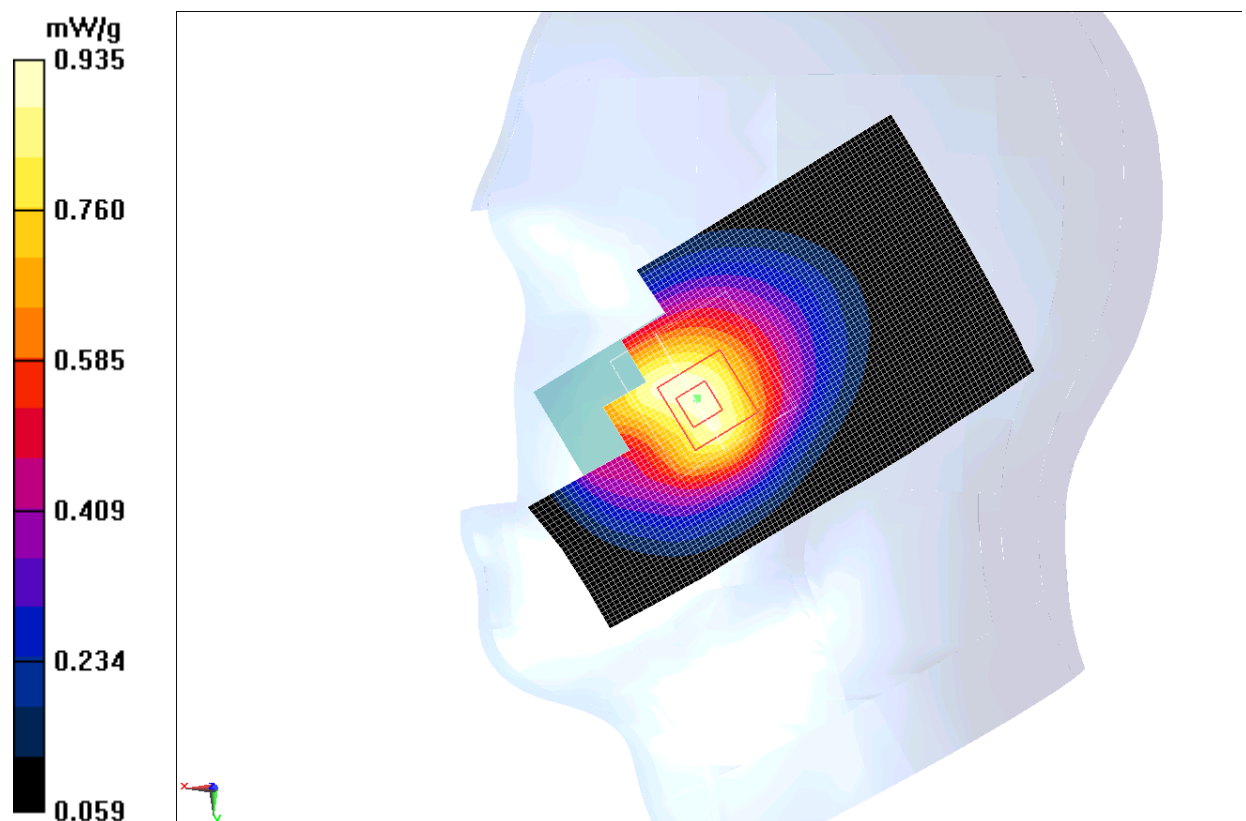

Fig. 8 850 MHz CH190

850 Right Cheek Low

Date: 2012-7-25

Electronics: DAE4 Sn771

Medium: Head 850 MHz

Medium parameters used: $f = 825$ MHz; $\sigma = 0.874$ mho/m; $\epsilon_r = 41.165$; $\rho = 1000$ kg/m³

Ambient Temperature: 22.4°C Liquid Temperature: 22.0°C

Communication System: GSM; Frequency: 824.2 MHz; Duty Cycle: 1:8.3

Probe: ES3DV3 - SN3149 ConvF(6.26, 6.26, 6.26)

Cheek Low/Area Scan (61x101x1): Measurement grid: dx=10mm, dy=10mm

Maximum value of SAR (interpolated) = 0.741 mW/g

Cheek Low/Zoom Scan (7x7x7)/Cube 0: Measurement grid: dx=5mm, dy=5mm, dz=5mm

Reference Value = 8.268 V/m; Power Drift = 0.03 dB

Peak SAR (extrapolated) = 1.000 mW/g

SAR(1 g) = 0.710 mW/g; SAR(10 g) = 0.505 mW/g

Maximum value of SAR (measured) = 0.751 mW/g

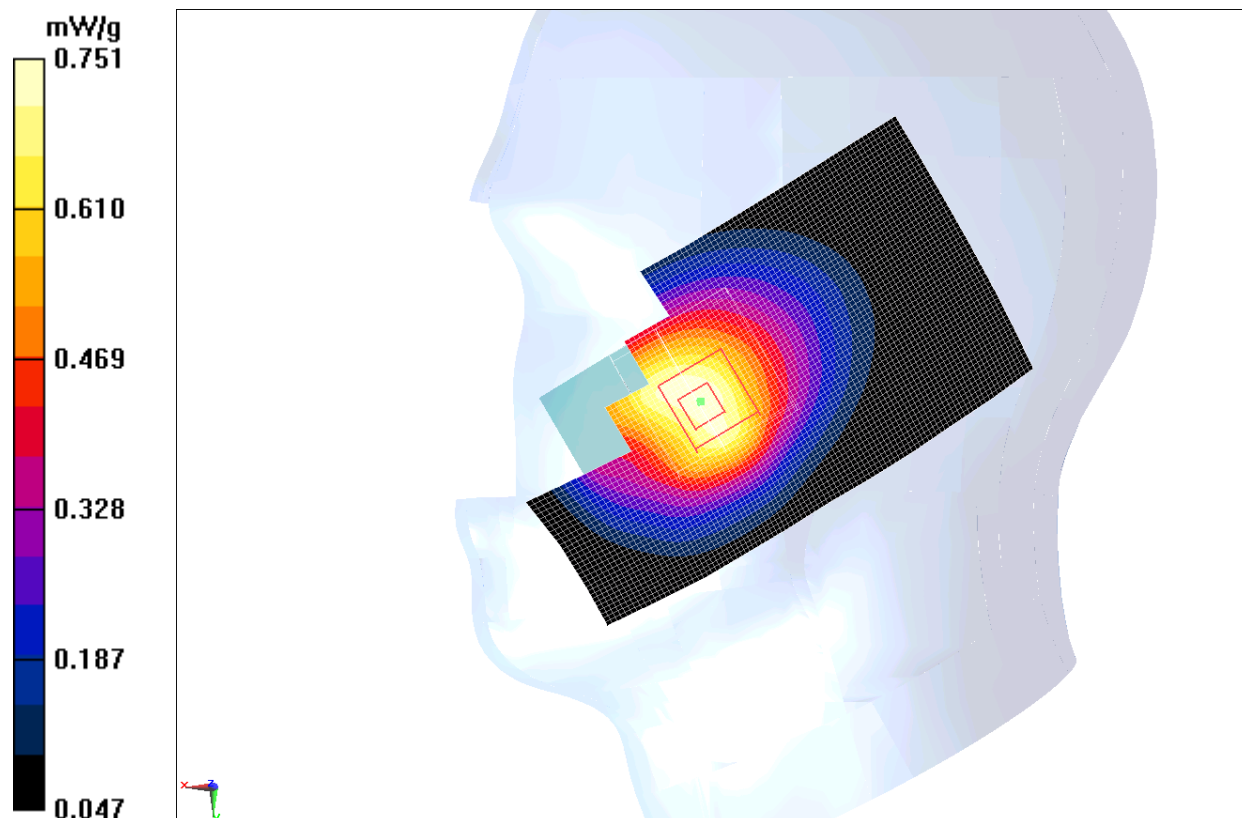

Fig. 9 850 MHz CH128

850 Right Tilt High

Date: 2012-7-25

Electronics: DAE4 Sn771

Medium: Head 850 MHz

Medium parameters used (interpolated): $f = 848.8$ MHz; $\sigma = 0.897$ mho/m; $\epsilon_r = 40.868$; $\rho = 1000$ kg/m³

Ambient Temperature: 22.4°C Liquid Temperature: 22.0°C

Communication System: GSM 850 Frequency: 848.8 MHz Duty Cycle: 1:8.3

Probe: ES3DV3 - SN3149 ConvF(6.26, 6.26, 6.26)

Tilt High/Area Scan (61x101x1): Measurement grid: dx=10mm, dy=10mm

Maximum value of SAR (interpolated) = 0.425 mW/g

Tilt High/Zoom Scan (7x7x7)/Cube 0: Measurement grid: dx=5mm, dy=5mm, dz=5mm

Reference Value = 13.810 V/m; Power Drift = -0.08 dB

Peak SAR (extrapolated) = 0.490 mW/g

SAR(1 g) = 0.402 mW/g; SAR(10 g) = 0.311 mW/g

Maximum value of SAR (measured) = 0.422 mW/g

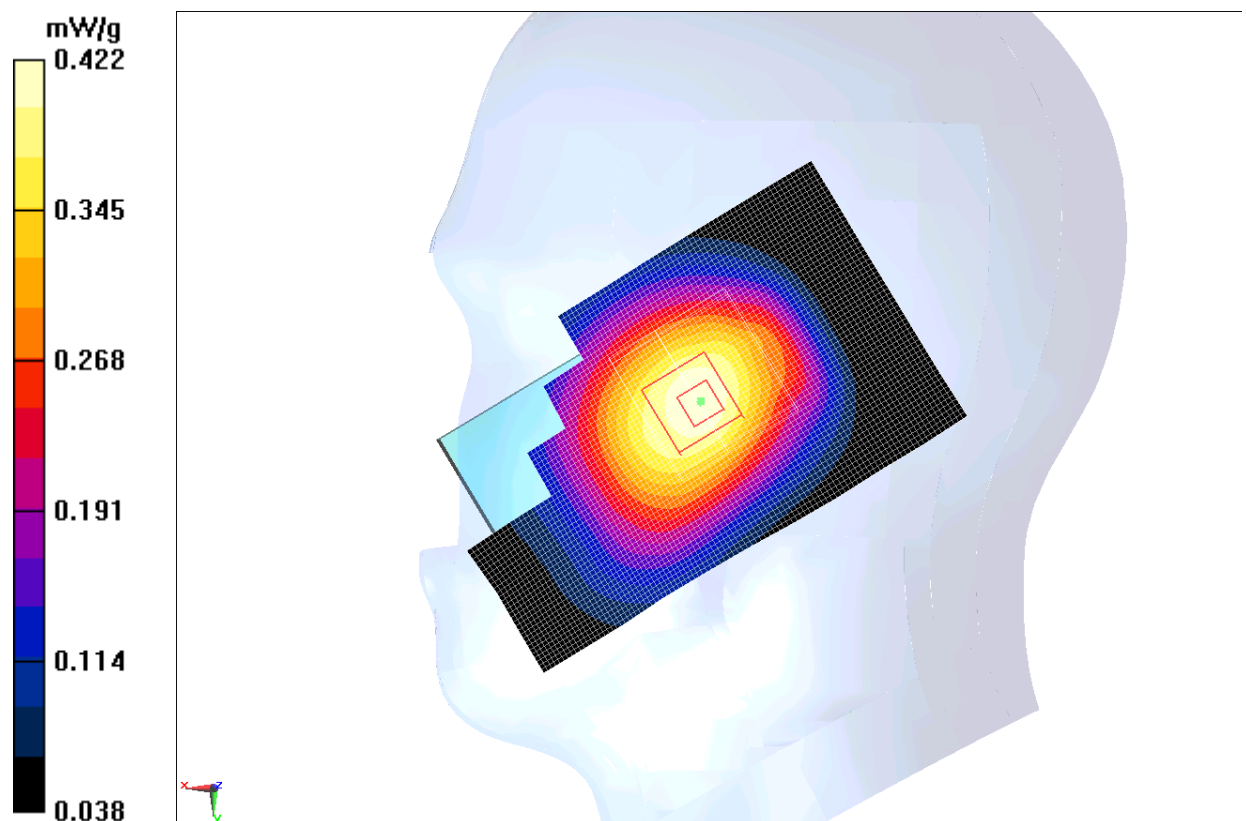

Fig.10 850 MHz CH251

850 Right Tilt Middle

Date: 2012-7-25

Electronics: DAE4 Sn771

Medium: Head 850 MHz

Medium parameters used (interpolated): $f = 836.6$ MHz; $\sigma = 0.885$ mho/m; $\epsilon_r = 41.025$; $\rho = 1000$ kg/m³

Ambient Temperature: 22.4°C Liquid Temperature: 22.0°C

Communication System: GSM 850 Frequency: 836.6 MHz Duty Cycle: 1:8.3

Probe: ES3DV3 - SN3149 ConvF(6.26, 6.26, 6.26)

Tilt Middle/Area Scan (61x101x1): Measurement grid: dx=10mm, dy=10mm

Maximum value of SAR (interpolated) = 0.508 mW/g

Tilt Middle/Zoom Scan (7x7x7)/Cube 0: Measurement grid: dx=5mm, dy=5mm, dz=5mm

Reference Value = 18.353 V/m; Power Drift = 0.01 dB

Peak SAR (extrapolated) = 0.604 mW/g

SAR(1 g) = 0.487 mW/g; SAR(10 g) = 0.372 mW/g

Maximum value of SAR (measured) = 0.509 mW/g

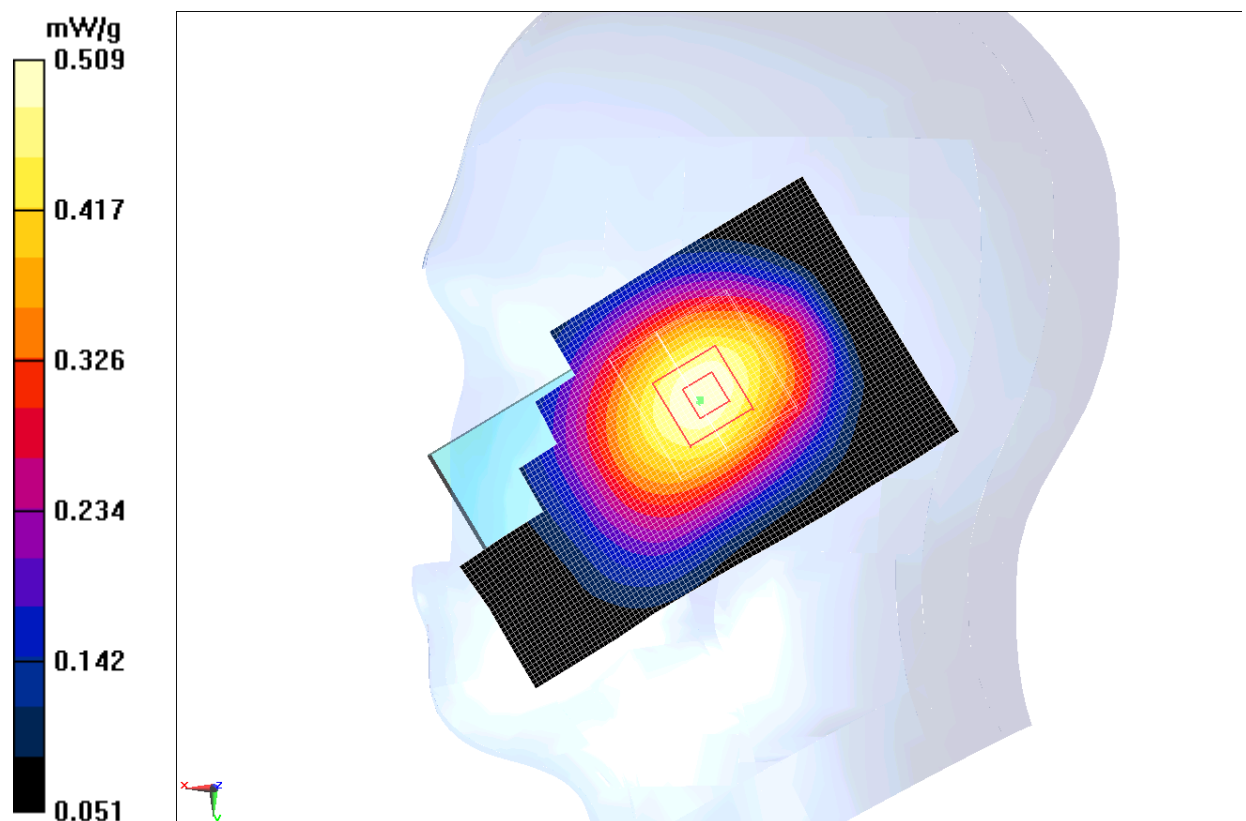

Fig.11 850 MHz CH190

850 Right Tilt Low

Date: 2012-7-25

Electronics: DAE4 Sn771

Medium: Head 850 MHz

Medium parameters used: $f = 825$ MHz; $\sigma = 0.874$ mho/m; $\epsilon_r = 41.165$; $\rho = 1000$ kg/m³

Ambient Temperature: 22.4°C Liquid Temperature: 22.0°C

Communication System: GSM 850 Frequency: 824.2 MHz Duty Cycle: 1:8.3

Probe: ES3DV3 - SN3149 ConvF(6.26, 6.26, 6.26)

Tilt Low/Area Scan (61x101x1): Measurement grid: dx=10mm, dy=10mm

Maximum value of SAR (interpolated) = 0.421 mW/g

Tilt Low/Zoom Scan (7x7x7)/Cube 0: Measurement grid: dx=5mm, dy=5mm, dz=5mm

Reference Value = 16.673 V/m; Power Drift = 0.05 dB

Peak SAR (extrapolated) = 0.495 mW/g

SAR(1 g) = 0.401 mW/g; SAR(10 g) = 0.309 mW/g

Maximum value of SAR (measured) = 0.418 mW/g

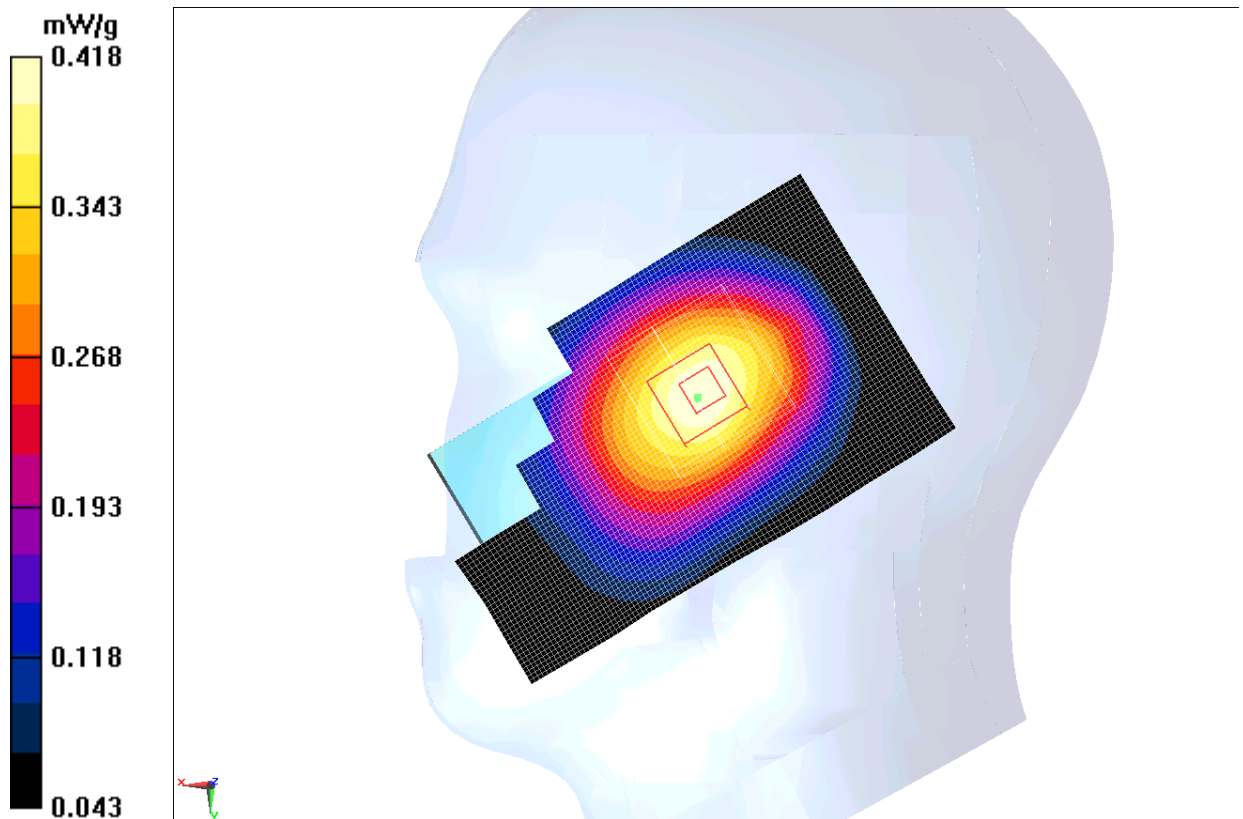

Fig. 12 850 MHz CH128

850 Body Towards Phantom High

Date: 2012-7-25

Electronics: DAE4 Sn771

Medium: Body 850 MHz

Medium parameters used (interpolated): $f = 848.8$ MHz; $\sigma = 1.004$ mho/m; $\epsilon_r = 54.301$; $\rho = 1000$ kg/m³

Ambient Temperature: 22.4°C Liquid Temperature: 22.0°C

Communication System: GSM 850 GPRS Frequency: 848.8 MHz Duty Cycle: 1:8.3

Probe: ES3DV3 - SN3149 ConvF(6.14, 6.14, 6.14)

Toward Phantom High/Area Scan (61x101x1): Measurement grid: dx=10mm, dy=10mm

Maximum value of SAR (interpolated) = 1.02 mW/g

Toward Phantom High/Zoom Scan (7x7x7)/Cube 0: Measurement grid: dx=5mm, dy=5mm, dz=5mm

Reference Value = 25.833 V/m; Power Drift = -0.07 dB

Peak SAR (extrapolated) = 1.368 mW/g

SAR(1 g) = 0.940 mW/g; SAR(10 g) = 0.649 mW/g

Maximum value of SAR (measured) = 1.00 mW/g

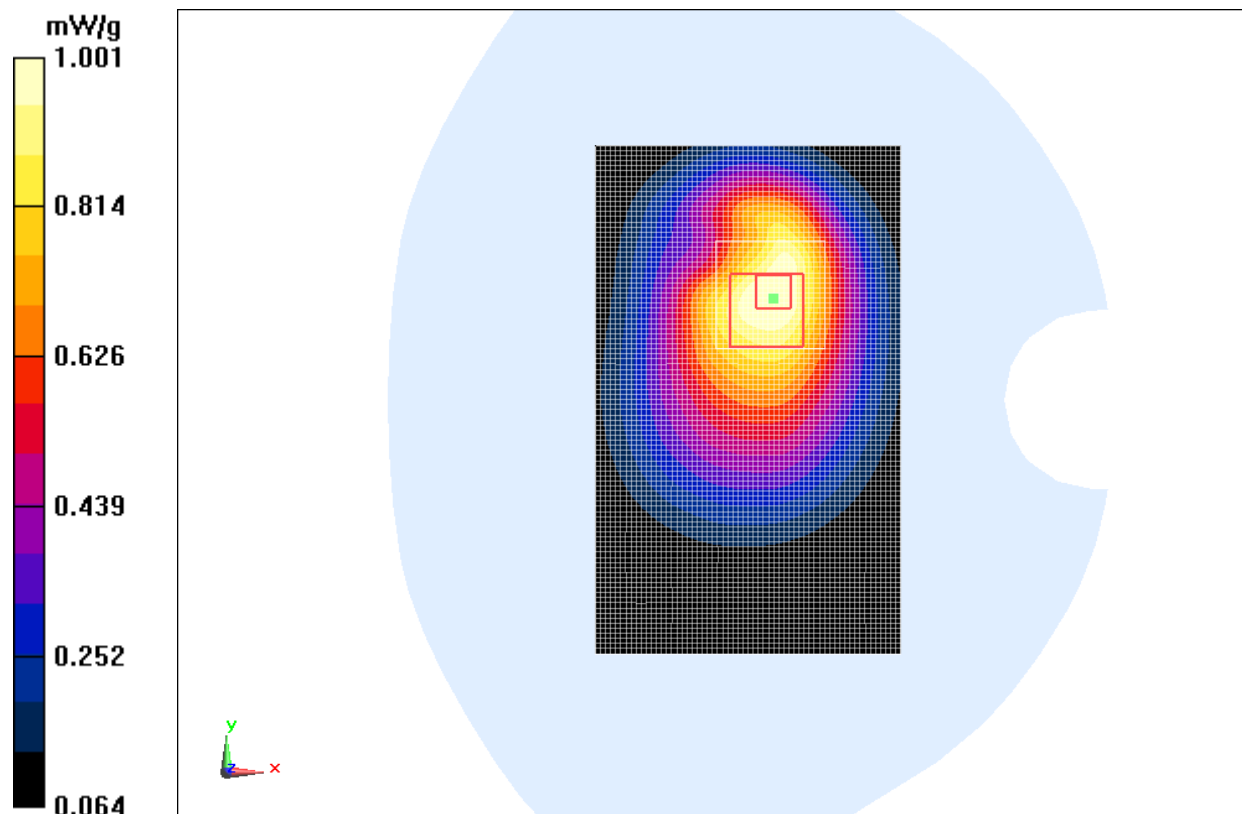

Fig. 13 850 MHz CH251

850 Body Towards Phantom Middle

Date: 2012-7-25

Electronics: DAE4 Sn771

Medium: Body 850 MHz

Medium parameters used (interpolated): $f = 836.6$ MHz; $\sigma = 0.991$ mho/m; $\epsilon_r = 54.417$; $\rho = 1000$ kg/m³

Ambient Temperature: 22.4°C Liquid Temperature: 22.0°C

Communication System: GSM 850 GPRS Frequency: 836.6 MHz Duty Cycle: 1:8.3

Probe: ES3DV3 - SN3149 ConvF(6.14, 6.14, 6.14)

Toward Phantom Middle/Area Scan (61x101x1): Measurement grid: dx=10mm, dy=10mm

Maximum value of SAR (interpolated) = 1.03 mW/g

Toward Phantom Middle/Zoom Scan (7x7x7)/Cube 0: Measurement grid: dx=5mm, dy=5mm, dz=5mm

Reference Value = 26.166 V/m; Power Drift = -0.04 dB

Peak SAR (extrapolated) = 1.410 mW/g

SAR(1 g) = 0.976 mW/g; SAR(10 g) = 0.673 mW/g

Maximum value of SAR (measured) = 1.05 mW/g

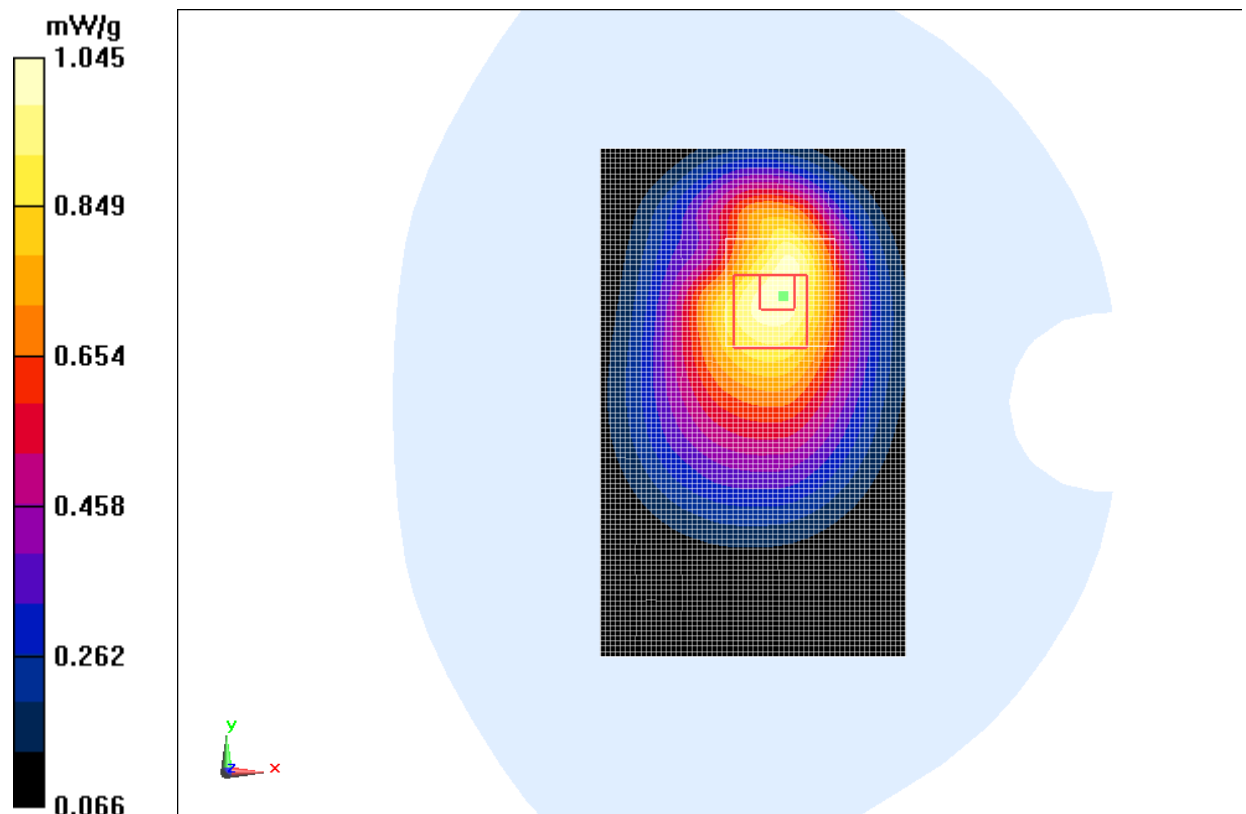

Fig. 14 850 MHz CH190

850 Body Towards Phantom Low

Date: 2012-7-25

Electronics: DAE4 Sn771

Medium: Body 850 MHz

Medium parameters used: $f = 825$ MHz; $\sigma = 0.978$ mho/m; $\epsilon_r = 54.544$; $\rho = 1000$ kg/m³

Ambient Temperature: 22.4°C Liquid Temperature: 22.0°C

Communication System: GSM 850 GPRS Frequency: 824.2 MHz Duty Cycle: 1:8.3

Probe: ES3DV3 - SN3149 ConvF(6.14, 6.14, 6.14)

Toward Phantom Low/Area Scan (61x101x1): Measurement grid: dx=10mm, dy=10mm

Maximum value of SAR (interpolated) = 0.878 mW/g

Toward Phantom Low/Zoom Scan (7x7x7)/Cube 0: Measurement grid: dx=5mm, dy=5mm, dz=5mm

Reference Value = 24.030 V/m; Power Drift = 0.00 dB

Peak SAR (extrapolated) = 1.159 mW/g

SAR(1 g) = 0.819 mW/g; SAR(10 g) = 0.566 mW/g

Maximum value of SAR (measured) = 0.878 mW/g

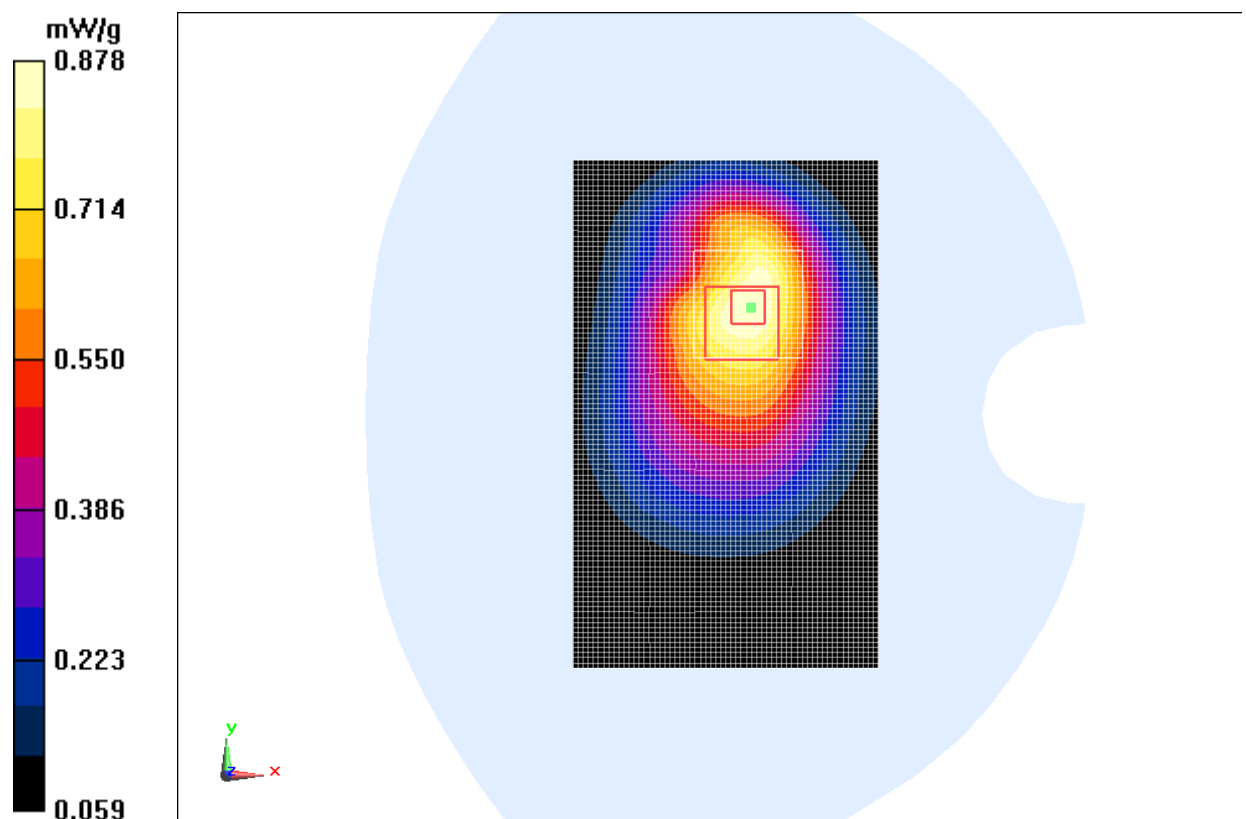

Fig. 15 850 MHz CH128

850 Body Towards Ground High

Date: 2012-7-25

Electronics: DAE4 Sn771

Medium: Body 850 MHz

Medium parameters used (interpolated): $f = 848.8$ MHz; $\sigma = 1.004$ mho/m; $\epsilon_r = 54.301$; $\rho = 1000$ kg/m³

Ambient Temperature: 22.4°C Liquid Temperature: 22.0°C

Communication System: GSM 850 GPRS Frequency: 848.8 MHz Duty Cycle: 1:8.3

Probe: ES3DV3 - SN3149 ConvF(6.14, 6.14, 6.14)

Toward Ground High/Area Scan (61x101x1): Measurement grid: dx=10mm, dy=10mm

Maximum value of SAR (interpolated) = 1.09 mW/g

Toward Ground High/Zoom Scan (7x7x7)/Cube 0: Measurement grid: dx=5mm, dy=5mm, dz=5mm

Reference Value = 26.598 V/m; Power Drift = 0.00 dB

Peak SAR (extrapolated) = 1.445 mW/g

SAR(1 g) = 1.000 mW/g; SAR(10 g) = 0.688 mW/g

Maximum value of SAR (measured) = 1.07 mW/g

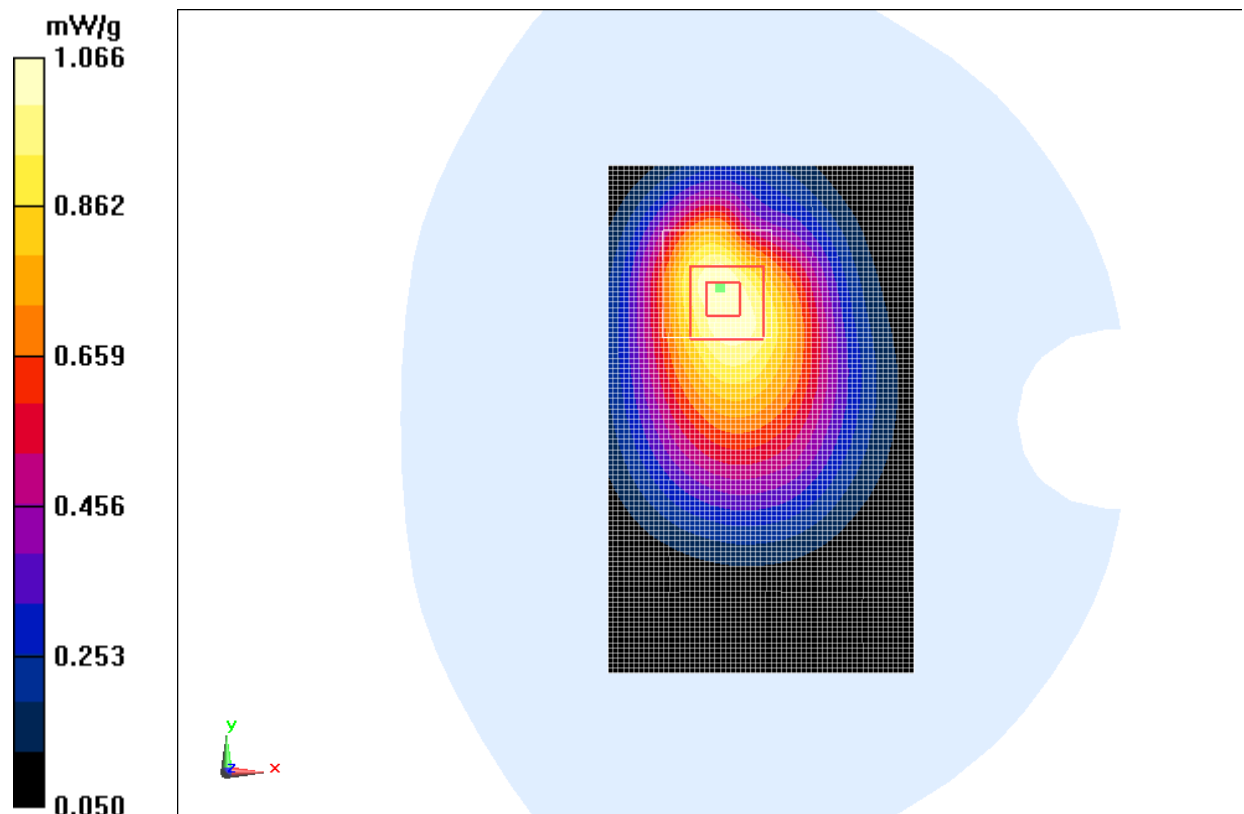

Fig. 16 850 MHz CH251

850 Body Towards Ground Middle

Date: 2012-7-25

Electronics: DAE4 Sn771

Medium: Body 850 MHz

Medium parameters used (interpolated): $f = 836.6$ MHz; $\sigma = 0.991$ mho/m; $\epsilon_r = 54.417$; $\rho = 1000$ kg/m³

Ambient Temperature: 22.4°C Liquid Temperature: 22.0°C

Communication System: GSM 850 GPRS Frequency: 836.6 MHz Duty Cycle: 1:8.3

Probe: ES3DV3 - SN3149 ConvF(6.14, 6.14, 6.14)

Toward Ground Middle/Area Scan (61x101x1): Measurement grid: dx=10mm, dy=10mm

Maximum value of SAR (interpolated) = 1.15 mW/g

Toward Ground Middle/Zoom Scan (7x7x7)/Cube 0: Measurement grid: dx=5mm, dy=5mm, dz=5mm

Reference Value = 27.066 V/m; Power Drift = -0.04 dB

Peak SAR (extrapolated) = 1.498 mW/g

SAR(1 g) = 1.04 mW/g; SAR(10 g) = 0.721 mW/g

Maximum value of SAR (measured) = 1.11 mW/g

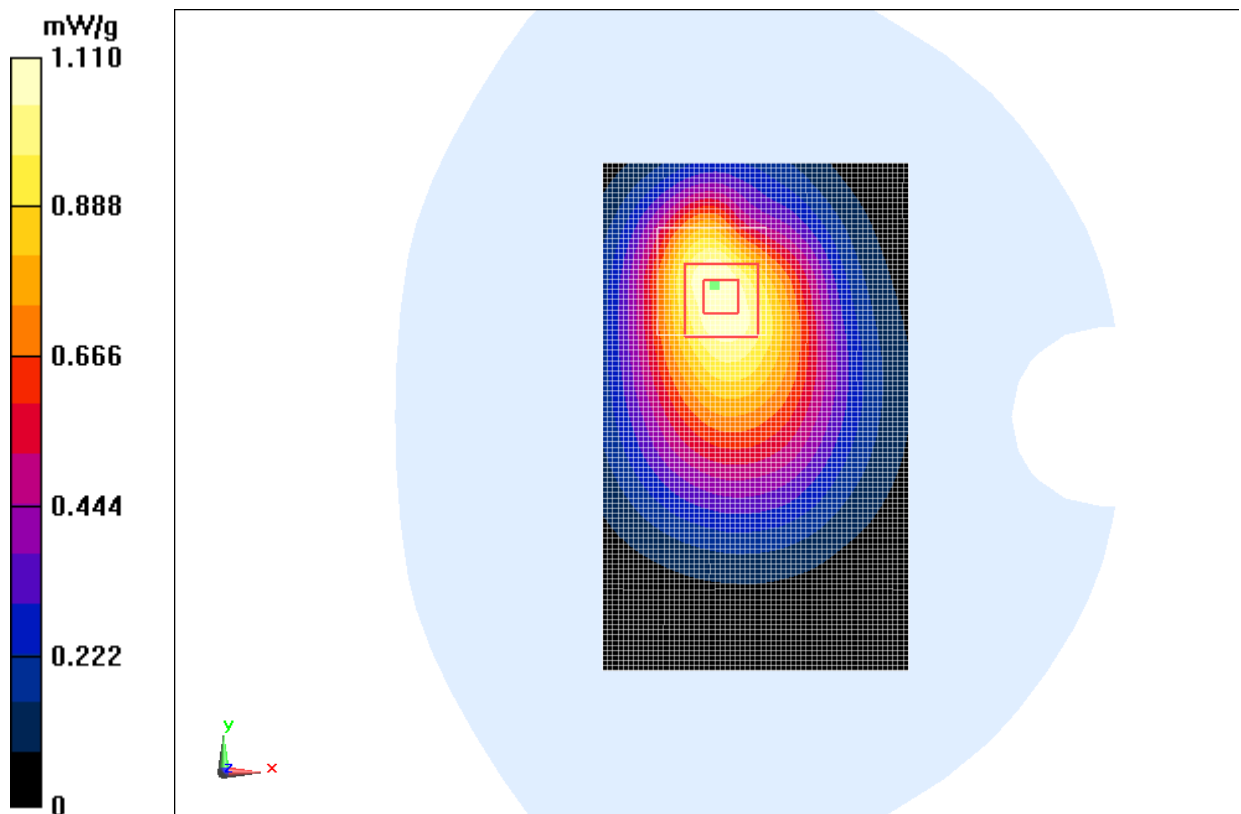

Fig. 17 850 MHz CH190

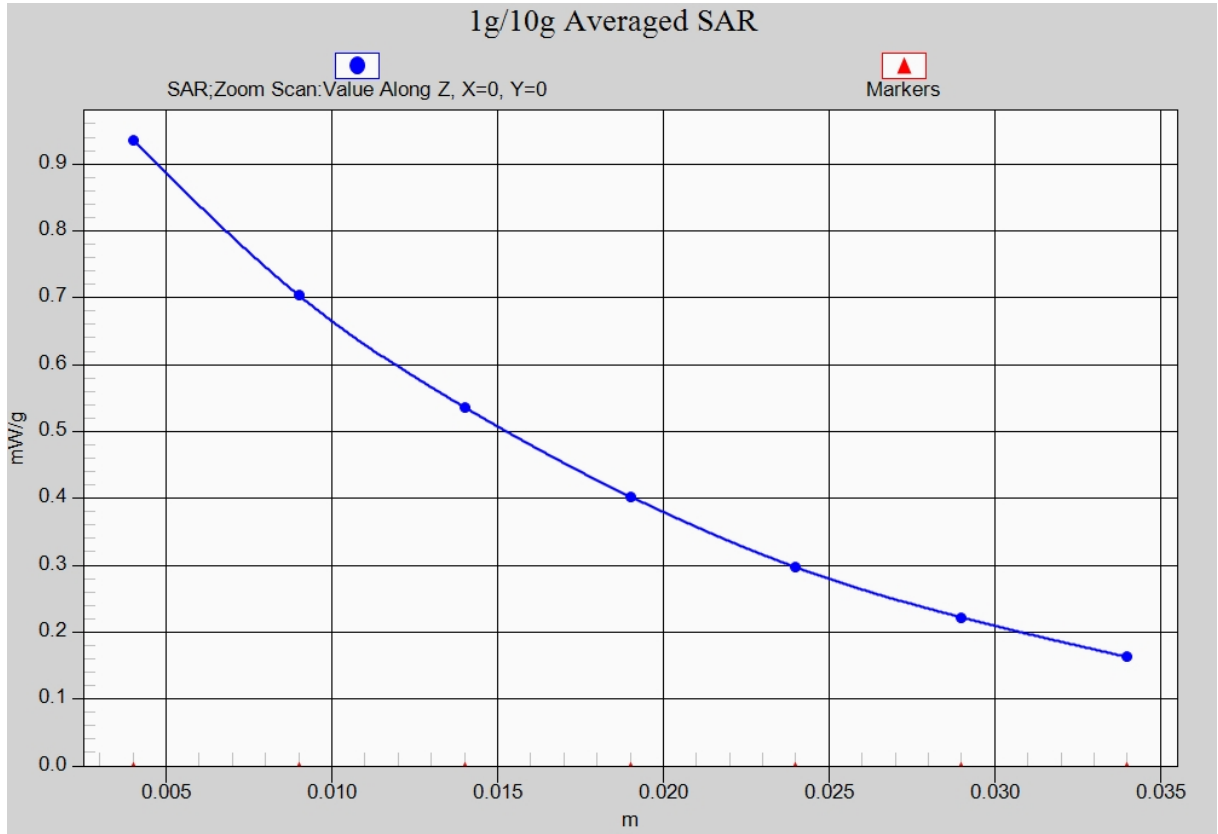

Fig. 17-1 Z-Scan at power reference point (850 MHz CH190)

850 Body Towards Ground Low

Date: 2012-7-25

Electronics: DAE4 Sn771

Medium: Body 850 MHz

Medium parameters used: $f = 825$ MHz; $\sigma = 0.978$ mho/m; $\epsilon_r = 54.544$; $\rho = 1000$ kg/m³

Ambient Temperature: 22.4°C Liquid Temperature: 22.0°C

Communication System: GSM 850 GPRS Frequency: 824.2 MHz Duty Cycle: 1:8.3

Probe: ES3DV3 - SN3149 ConvF(6.14, 6.14, 6.14)

Toward Ground Low/Area Scan (61x101x1): Measurement grid: dx=10mm, dy=10mm

Maximum value of SAR (interpolated) = 1.01 mW/g

Toward Ground Low/Zoom Scan (7x7x7)/Cube 0: Measurement grid: dx=5mm, dy=5mm, dz=5mm

Reference Value = 25.260 V/m; Power Drift = 0.01 dB

Peak SAR (extrapolated) = 1.330 mW/g

SAR(1 g) = 0.921 mW/g; SAR(10 g) = 0.636 mW/g

Maximum value of SAR (measured) = 0.973 mW/g

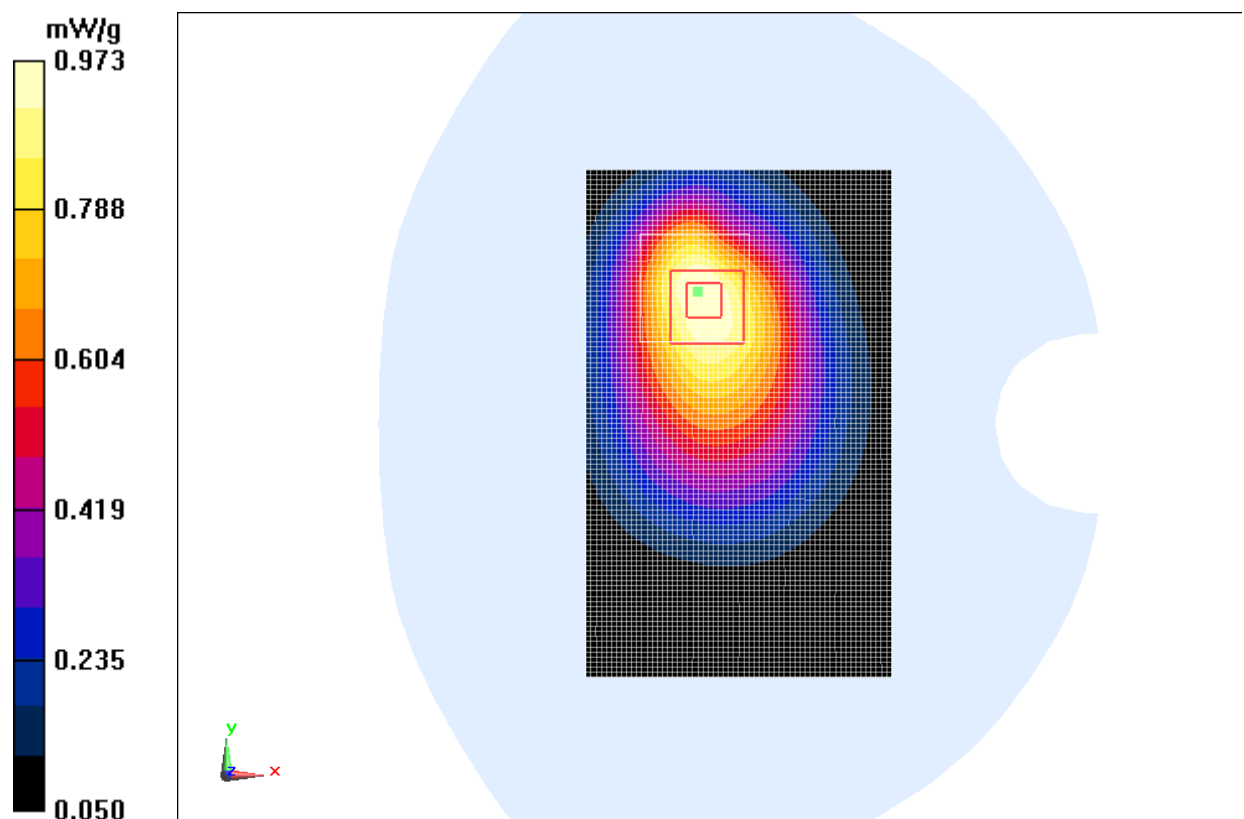

Fig. 18 850 MHz CH128

850 Body Left Side Low

Date: 2012-7-25

Electronics: DAE4 Sn771

Medium: Body 850 MHz

Medium parameters used: $f = 825$ MHz; $\sigma = 0.978$ mho/m; $\epsilon_r = 54.544$; $\rho = 1000$ kg/m³

Ambient Temperature: 22.4°C Liquid Temperature: 22.0°C

Communication System: GSM 850 GPRS Frequency: 824.2 MHz Duty Cycle: 1:8.3

Probe: ES3DV3 - SN3149 ConvF(6.14, 6.14, 6.14)

Left Side Low/Area Scan (61x101x1): Measurement grid: dx=10mm, dy=10mm

Maximum value of SAR (interpolated) = 0.493 mW/g

Left Side Low/Zoom Scan (7x7x7)/Cube 0: Measurement grid: dx=5mm, dy=5mm, dz=5mm

Reference Value = 21.398 V/m; Power Drift = -0.00 dB

Peak SAR (extrapolated) = 0.655 mW/g

SAR(1 g) = 0.463 mW/g; SAR(10 g) = 0.315 mW/g

Maximum value of SAR (measured) = 0.498 mW/g

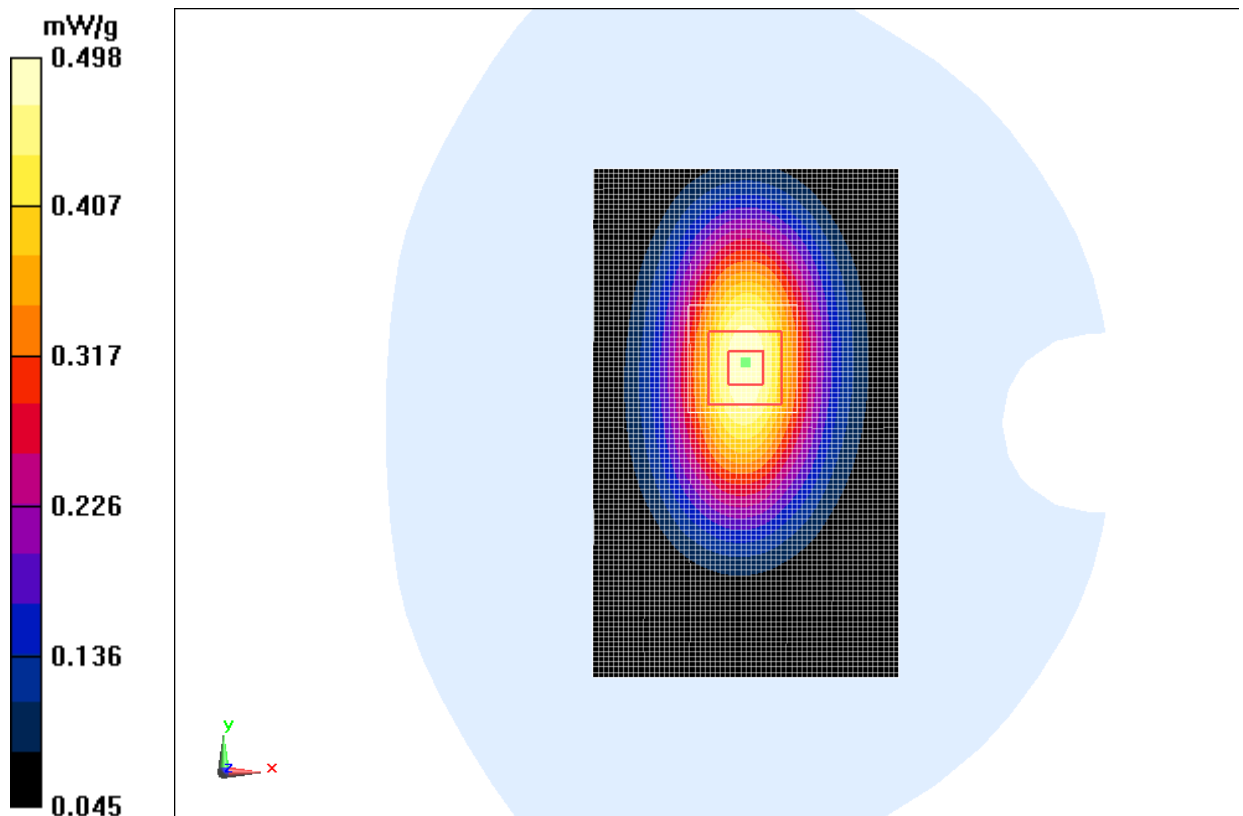

Fig. 19 850 MHz CH128

850 Body Right Side Low

Date: 2012-7-25

Electronics: DAE4 Sn771

Medium: Body 850 MHz

Medium parameters used: $f = 825 \text{ MHz}$; $\sigma = 0.978 \text{ mho/m}$; $\epsilon_r = 54.544$; $\rho = 1000 \text{ kg/m}^3$

Ambient Temperature: 22.4°C Liquid Temperature: 22.0°C

Communication System: GSM 850 GPRS Frequency: 824.2 MHz Duty Cycle: 1:8.3

Probe: ES3DV3 - SN3149 ConvF(6.14, 6.14, 6.14)

Right Side Low/Area Scan (61x101x1): Measurement grid: $dx=10\text{mm}$, $dy=10\text{mm}$

Maximum value of SAR (interpolated) = 0.455 mW/g

Right Side Low/Zoom Scan (7x7x7)/Cube 0: Measurement grid: $dx=5\text{mm}$, $dy=5\text{mm}$, $dz=5\text{mm}$

Reference Value = 21.298 V/m ; Power Drift = -0.03 dB

Peak SAR (extrapolated) = 0.590 mW/g

SAR(1 g) = 0.423 mW/g ; SAR(10 g) = 0.291 mW/g

Maximum value of SAR (measured) = 0.453 mW/g

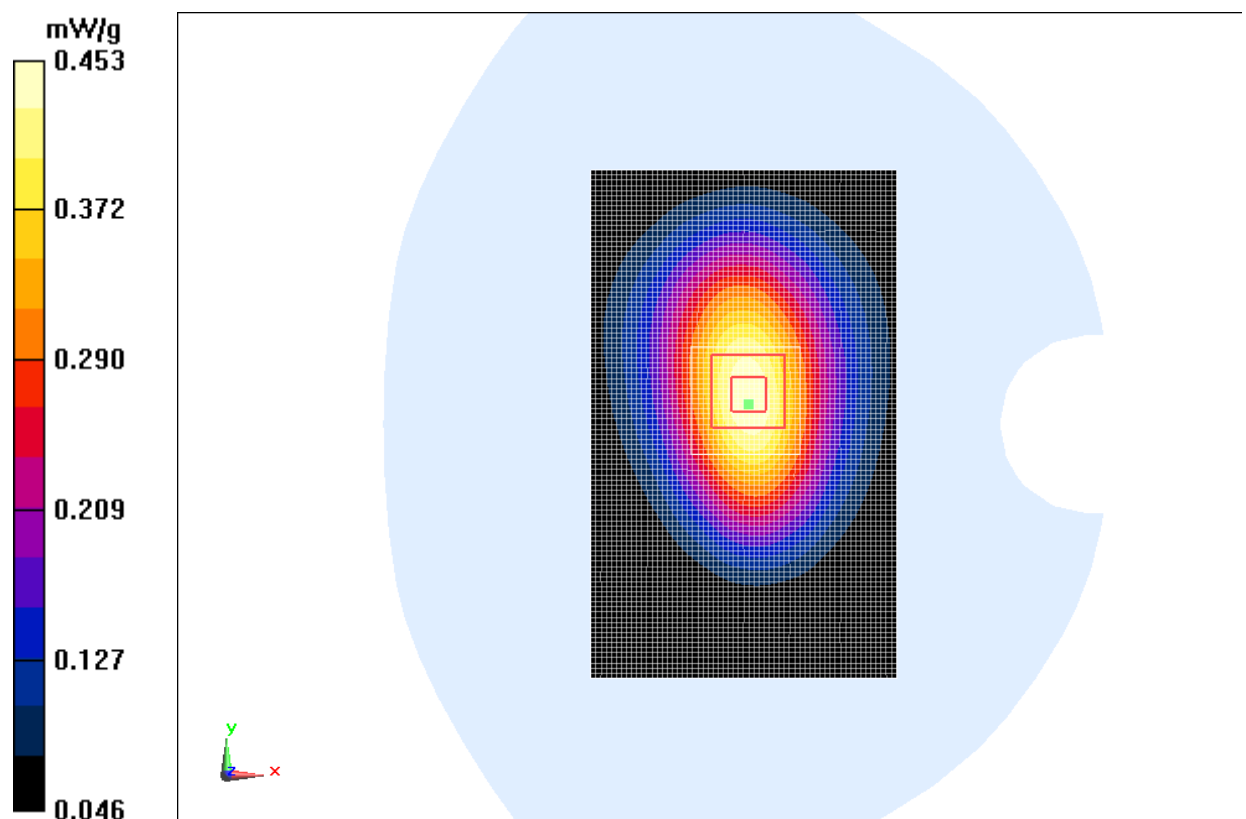

Fig. 20 850 MHz CH128

850 Body Bottom Side Low

Date: 2012-7-25

Electronics: DAE4 Sn771

Medium: Body 850 MHz

Medium parameters used: $f = 825 \text{ MHz}$; $\sigma = 0.978 \text{ mho/m}$; $\epsilon_r = 54.544$; $\rho = 1000 \text{ kg/m}^3$

Ambient Temperature: 22.4°C Liquid Temperature: 22.0°C

Communication System: GSM 850 GPRS Frequency: 824.2 MHz Duty Cycle: 1:8.3

Probe: ES3DV3 - SN3149 ConvF(6.14, 6.14, 6.14)

Bottom Side Low/Area Scan (61x101x1): Measurement grid: $dx=10\text{mm}$, $dy=10\text{mm}$

Maximum value of SAR (interpolated) = 0.104 mW/g

Bottom Side Low/Zoom Scan (7x7x7)/Cube 0: Measurement grid: $dx=5\text{mm}$, $dy=5\text{mm}$, $dz=5\text{mm}$

Reference Value = 7.264 V/m ; Power Drift = -0.06 dB

Peak SAR (extrapolated) = 0.204 mW/g

SAR(1 g) = 0.106 mW/g ; SAR(10 g) = 0.056 mW/g

Maximum value of SAR (measured) = 0.122 mW/g

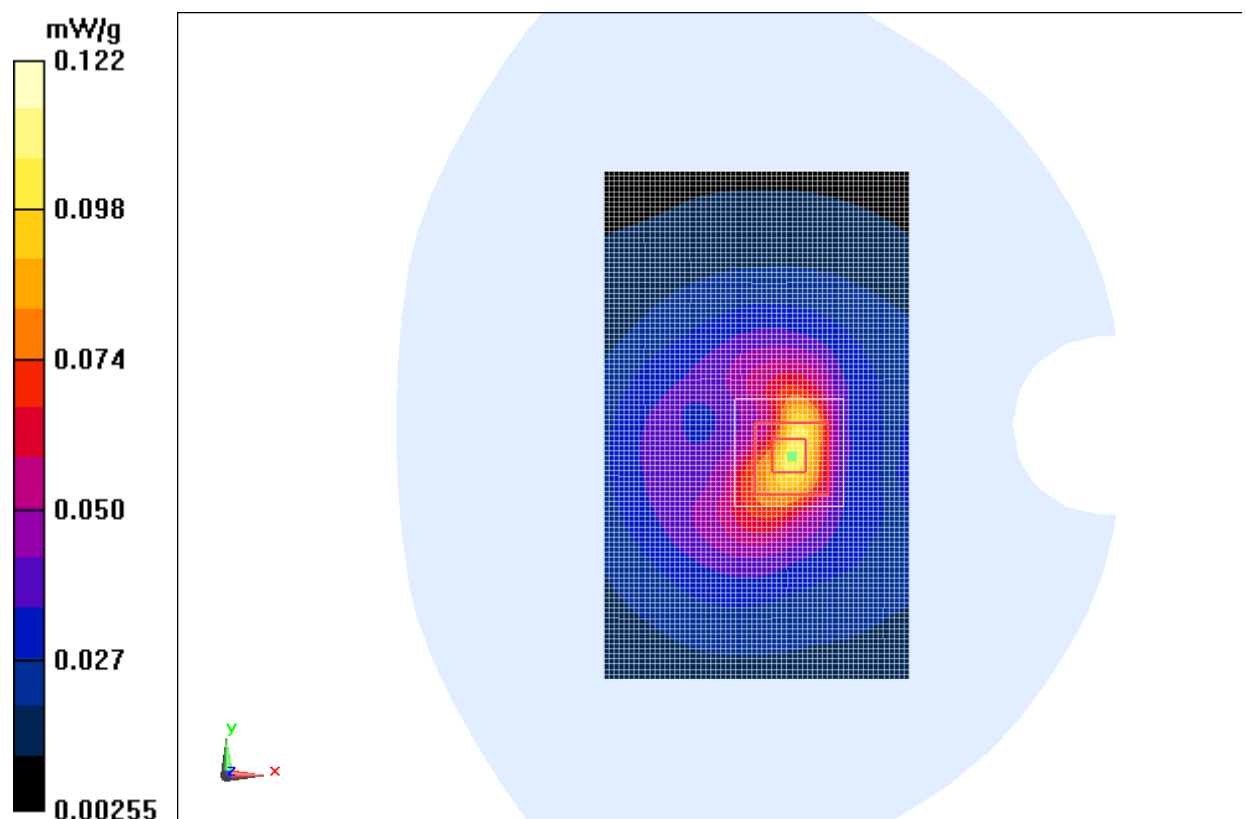

Fig. 21 850 MHz CH128

850 Body Towards Ground Middle with EGPRS

Date: 2012-7-25

Electronics: DAE4 Sn771

Medium: Body 850 MHz

Medium parameters used (interpolated): $f = 836.6$ MHz; $\sigma = 0.991$ mho/m; $\epsilon_r = 54.417$; $\rho = 1000$ kg/m³

Ambient Temperature: 22.4°C Liquid Temperature: 22.0°C

Communication System: GSM 850 EGPRS Frequency: 836.6 MHz Duty Cycle: 1:8.3

Probe: ES3DV3 - SN3149 ConvF(6.14, 6.14, 6.14)

Toward Ground Middle/Area Scan (61x101x1): Measurement grid: dx=10mm, dy=10mm

Maximum value of SAR (interpolated) = 0.996 mW/g

Toward Ground Middle/Zoom Scan (7x7x7)/Cube 0: Measurement grid: dx=5mm, dy=5mm, dz=5mm

Reference Value = 24.874 V/m; Power Drift = -0.04 dB

Peak SAR (extrapolated) = 1.274 mW/g

SAR(1 g) = 0.919 mW/g; SAR(10 g) = 0.645 mW/g

Maximum value of SAR (measured) = 0.977 mW/g

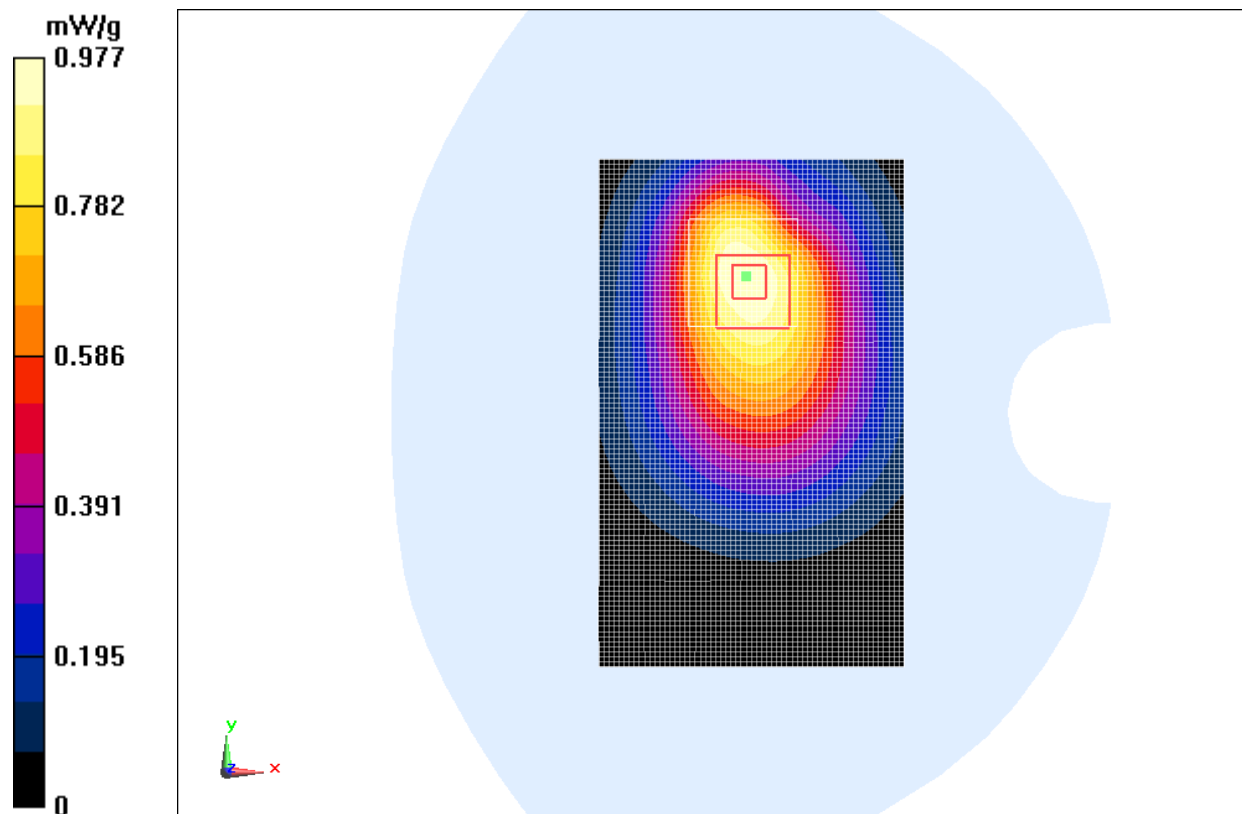

Fig. 22 850 MHz CH190

850 Body Towards Ground Middle with Headset CCB3000A12C1

Date: 2012-7-25

Electronics: DAE4 Sn771

Medium: Body 850 MHz

Medium parameters used (interpolated): $f = 836.6$ MHz; $\sigma = 0.991$ mho/m; $\epsilon_r = 54.417$; $\rho = 1000$ kg/m³

Ambient Temperature: 22.4°C Liquid Temperature: 22.0°C

Communication System: GSM 850 Frequency: 836.6 MHz Duty Cycle: 1:8.3

Probe: ES3DV3 - SN3149 ConvF(6.14, 6.14, 6.14)

Toward Ground Middle/Area Scan (61x101x1): Measurement grid: dx=10mm, dy=10mm

Maximum value of SAR (interpolated) = 0.863 mW/g

Toward Ground Middle/Zoom Scan (7x7x7)/Cube 0: Measurement grid: dx=5mm, dy=5mm, dz=5mm

Reference Value = 22.336 V/m; Power Drift = -0.02 dB

Peak SAR (extrapolated) = 1.155 mW/g

SAR(1 g) = 0.783 mW/g; SAR(10 g) = 0.532 mW/g

Maximum value of SAR (measured) = 0.832 mW/g

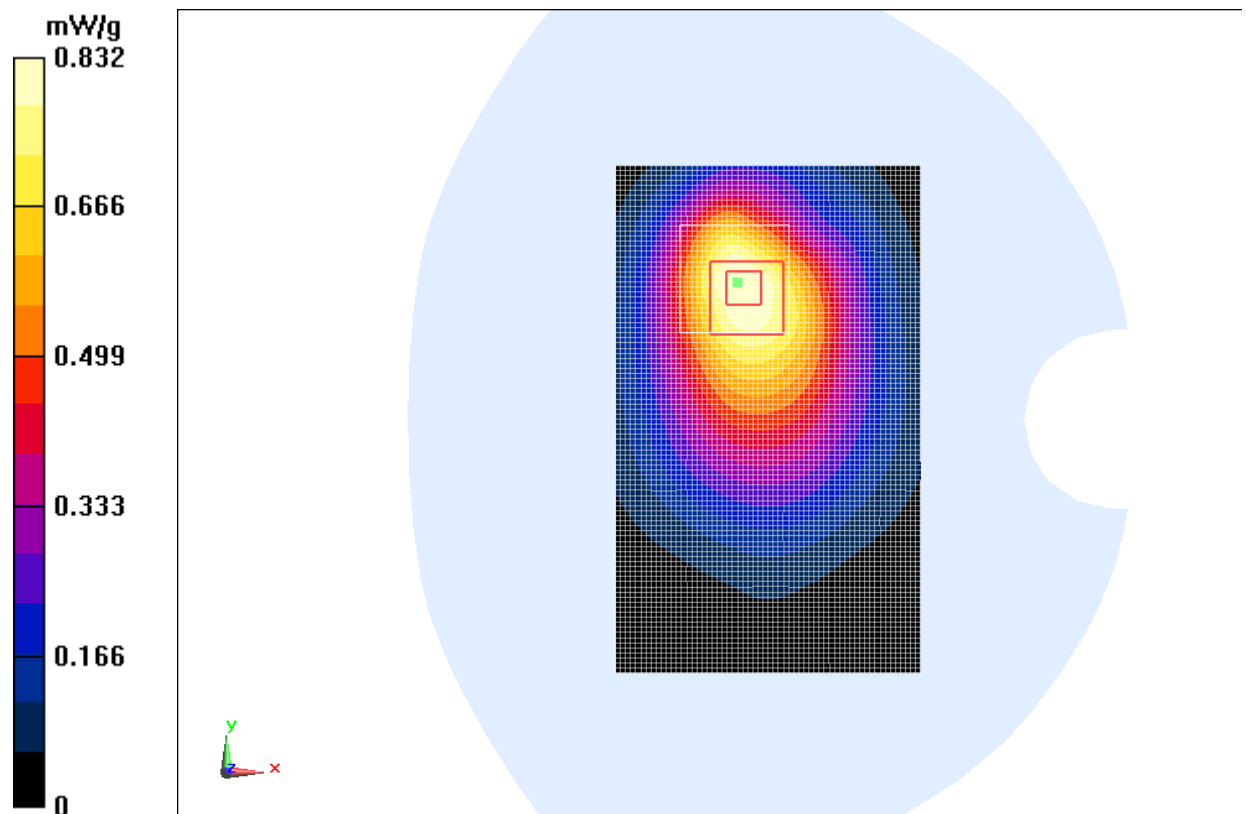

Fig. 23 850 MHz CH190

850 Body Towards Ground Middle with Headset CCB3000A12C2

Date: 2012-7-25

Electronics: DAE4 Sn771

Medium: Body 850 MHz

Medium parameters used (interpolated): $f = 836.6$ MHz; $\sigma = 0.991$ mho/m; $\epsilon_r = 54.417$; $\rho = 1000$ kg/m³

Ambient Temperature: 22.4°C Liquid Temperature: 22.0°C

Communication System: GSM 850 Frequency: 836.6 MHz Duty Cycle: 1:8.3

Probe: ES3DV3 - SN3149 ConvF(6.14, 6.14, 6.14)

Toward Ground Middle/Area Scan (61x101x1): Measurement grid: dx=10mm, dy=10mm

Maximum value of SAR (interpolated) = 0.924 mW/g

Toward Ground Middle/Zoom Scan (7x7x7)/Cube 0: Measurement grid: dx=5mm, dy=5mm, dz=5mm

Reference Value = 21.123 V/m; Power Drift = -0.01 dB

Peak SAR (extrapolated) = 1.231 mW/g

SAR(1 g) = 0.836 mW/g; SAR(10 g) = 0.564 mW/g

Maximum value of SAR (measured) = 0.893 mW/g

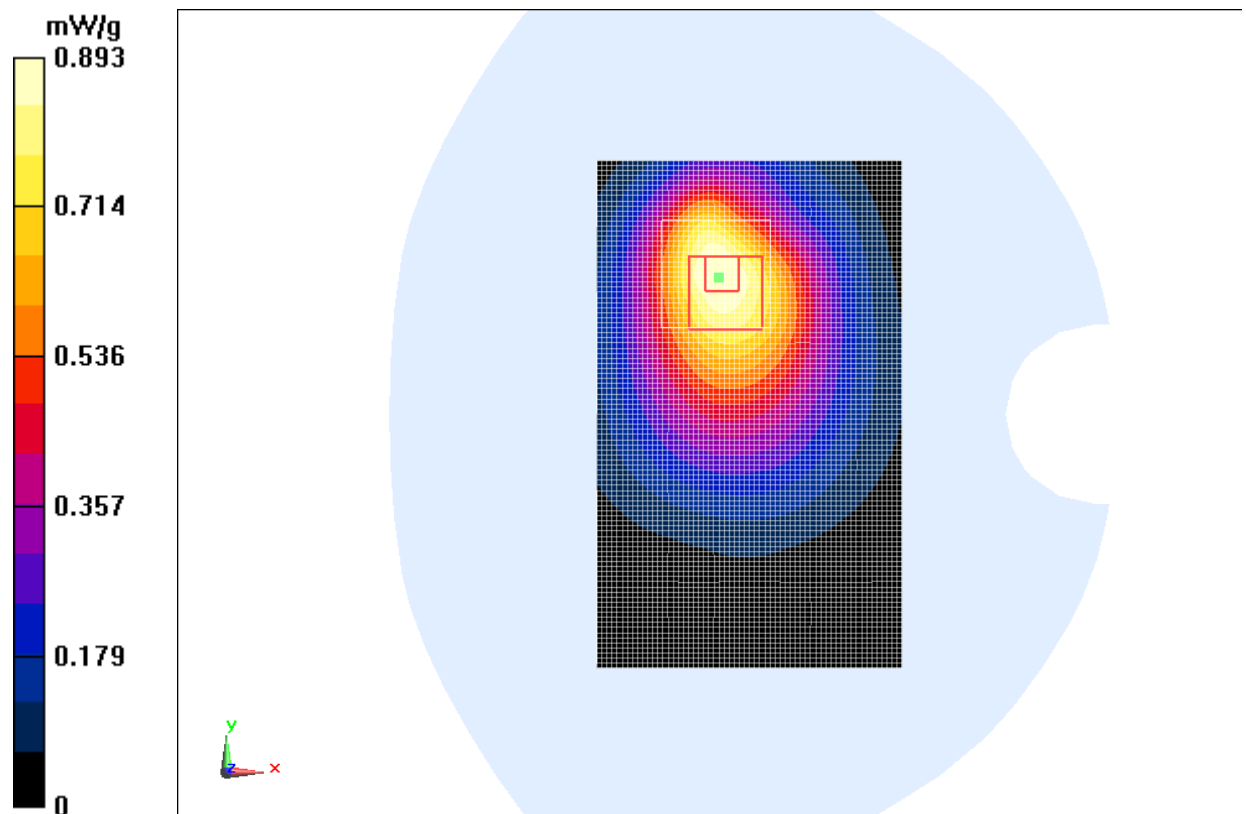

Fig. 24 850 MHz CH190

1900 Left Cheek High

Date: 2012-7-26

Electronics: DAE4 Sn771

Medium: Head 1900 MHz

Medium parameters used: $f = 1910$ MHz; $\sigma = 1.399$ mho/m; $\epsilon_r = 41.176$; $\rho = 1000$ kg/m³

Ambient Temperature: 22.5°C Liquid Temperature: 22.0°C

Communication System: GSM 1900MHz Frequency: 1909.8 MHz Duty Cycle: 1:8.3

Probe: ES3DV3 - SN3149 ConvF(5.19, 5.19, 5.19)

Cheek High/Area Scan (61x101x1): Measurement grid: dx=10mm, dy=10mm

Maximum value of SAR (interpolated) = 1.08 mW/g

Cheek High/Zoom Scan (7x7x7)/Cube 0: Measurement grid: dx=5mm, dy=5mm, dz=5mm

Reference Value = 9.332 V/m; Power Drift = -0.12 dB

Peak SAR (extrapolated) = 1.424 mW/g

SAR(1 g) = 0.936 mW/g; SAR(10 g) = 0.542 mW/g

Maximum value of SAR (measured) = 1.02 mW/g

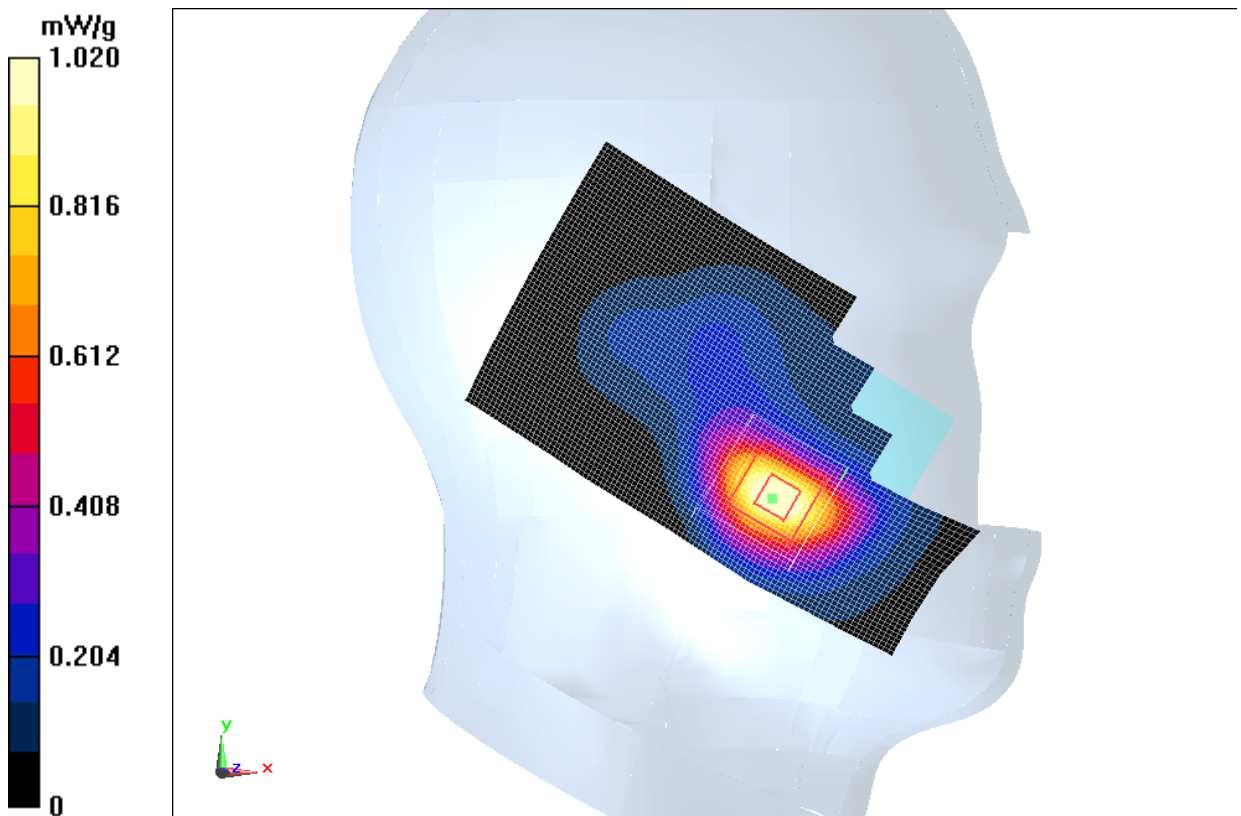

Fig. 25 1900 MHz CH810

1900 Left Cheek Middle

Date: 2012-7-26

Electronics: DAE4 Sn771

Medium: Head GSM1900

Medium parameters used: $f = 1880$ MHz; $\sigma = 1.371$ mho/m; $\epsilon_r = 41.288$; $\rho = 1000$ kg/m³

Ambient Temperature: 22.5°C Liquid Temperature: 22.0°C

Communication System: GSM 1900MHz Frequency: 1880 MHz Duty Cycle: 1:8.3

Probe: ES3DV3 - SN3149 ConvF(5.19, 5.19, 5.19)

Cheek Middle/Area Scan (61x101x1): Measurement grid: dx=10mm, dy=10mm

Maximum value of SAR (interpolated) = 1.14 mW/g

Cheek Middle/Zoom Scan (7x7x7)/Cube 0: Measurement grid: dx=5mm, dy=5mm, dz=5mm

Reference Value = 9.140 V/m; Power Drift = -0.06 dB

Peak SAR (extrapolated) = 1.513 mW/g

SAR(1 g) = 0.999 mW/g; SAR(10 g) = 0.583 mW/g

Maximum value of SAR (measured) = 1.09 mW/g

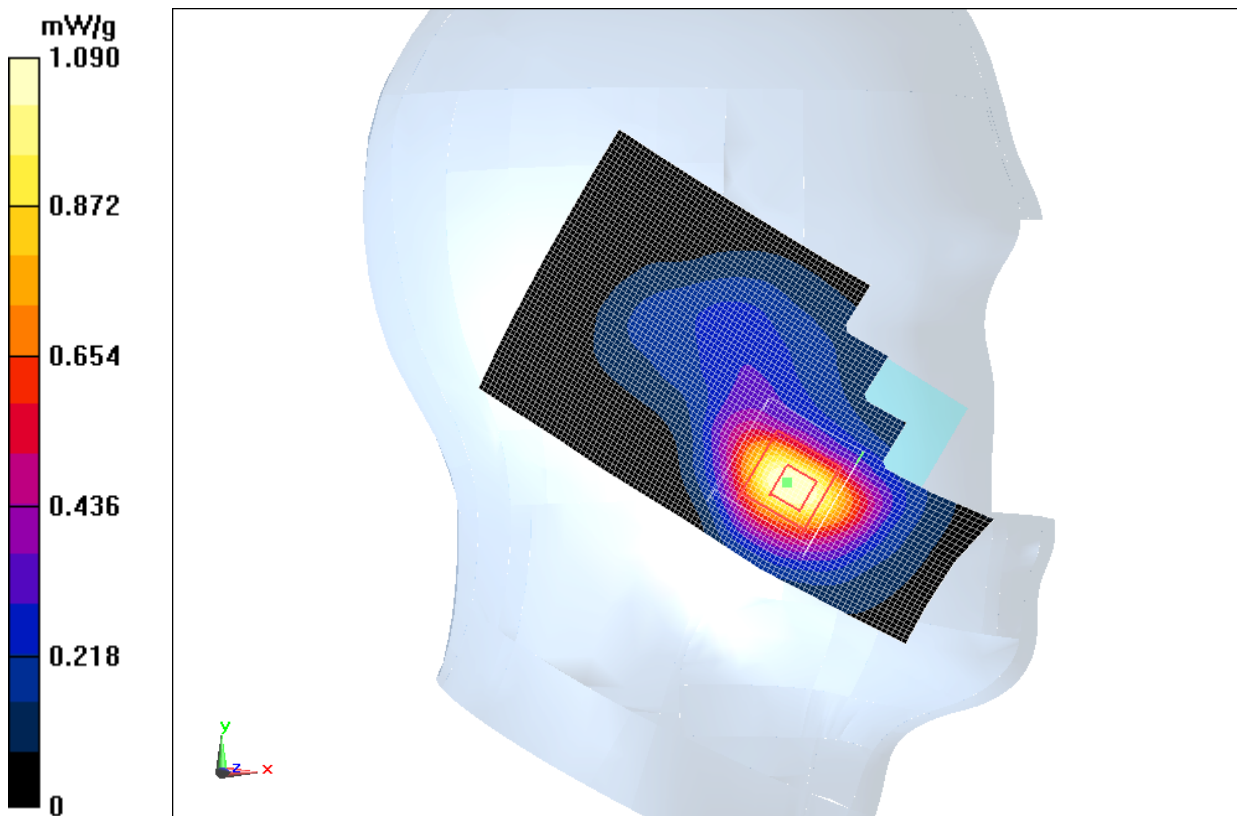

Fig. 26 1900 MHz CH661

1900 Left Cheek Low

Date: 2012-7-26

Electronics: DAE4 Sn771

Medium: Head 1900 MHz

Medium parameters used (interpolated): $f = 1850.2$ MHz; $\sigma = 1.341$ mho/m; $\epsilon_r = 41.381$; $\rho = 1000$ kg/m³

Ambient Temperature: 22.5°C Liquid Temperature: 22.0°C

Communication System: GSM 1900MHz Frequency: 1850.2 MHz Duty Cycle: 1:8.3

Probe: ES3DV3 - SN3149 ConvF(5.19, 5.19, 5.19)

Cheek Low/Area Scan (61x101x1): Measurement grid: dx=10mm, dy=10mm

Maximum value of SAR (interpolated) = 1.17 mW/g

Cheek Low/Zoom Scan (7x7x7)/Cube 0: Measurement grid: dx=5mm, dy=5mm, dz=5mm

Reference Value = 8.868 V/m; Power Drift = 0.00 dB

Peak SAR (extrapolated) = 1.529 mW/g

SAR(1 g) = 1.03 mW/g; SAR(10 g) = 0.606 mW/g

Maximum value of SAR (measured) = 1.13 mW/g

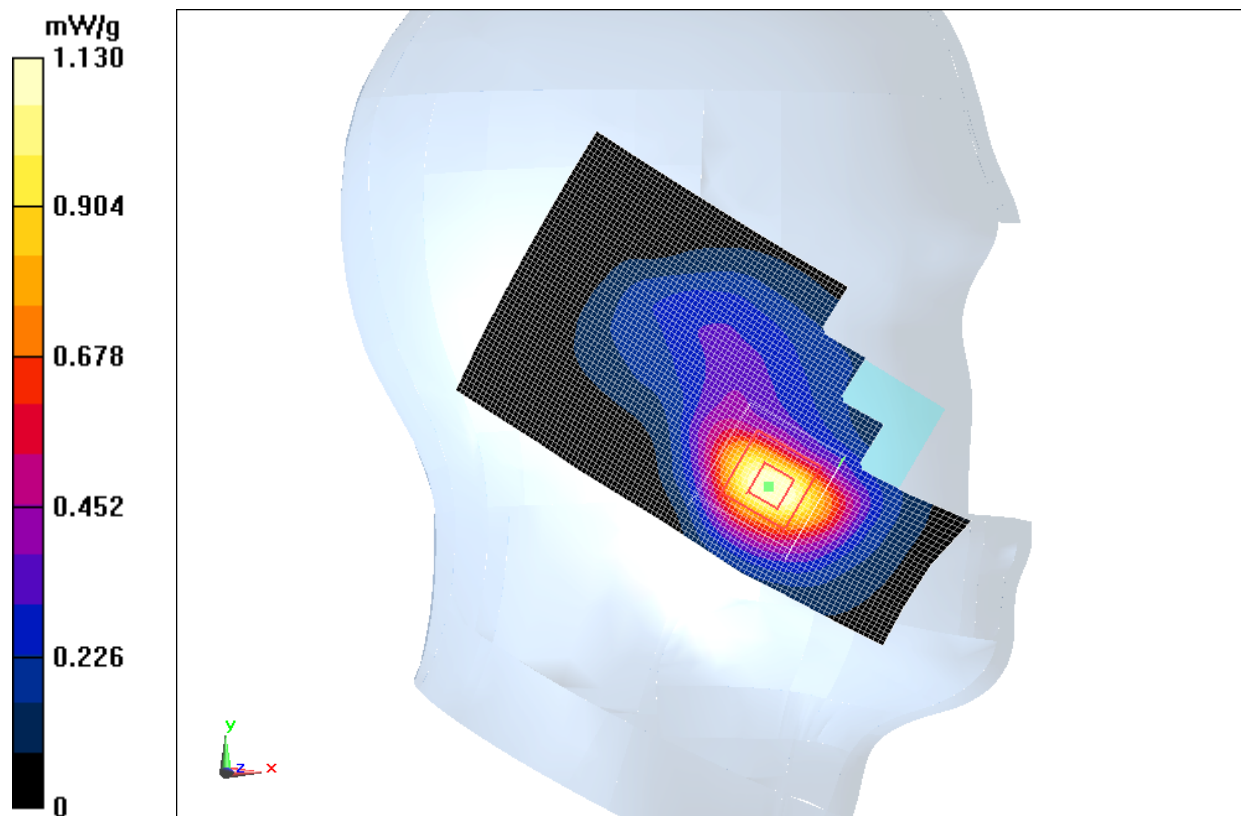

Fig. 27 1900 MHz CH512

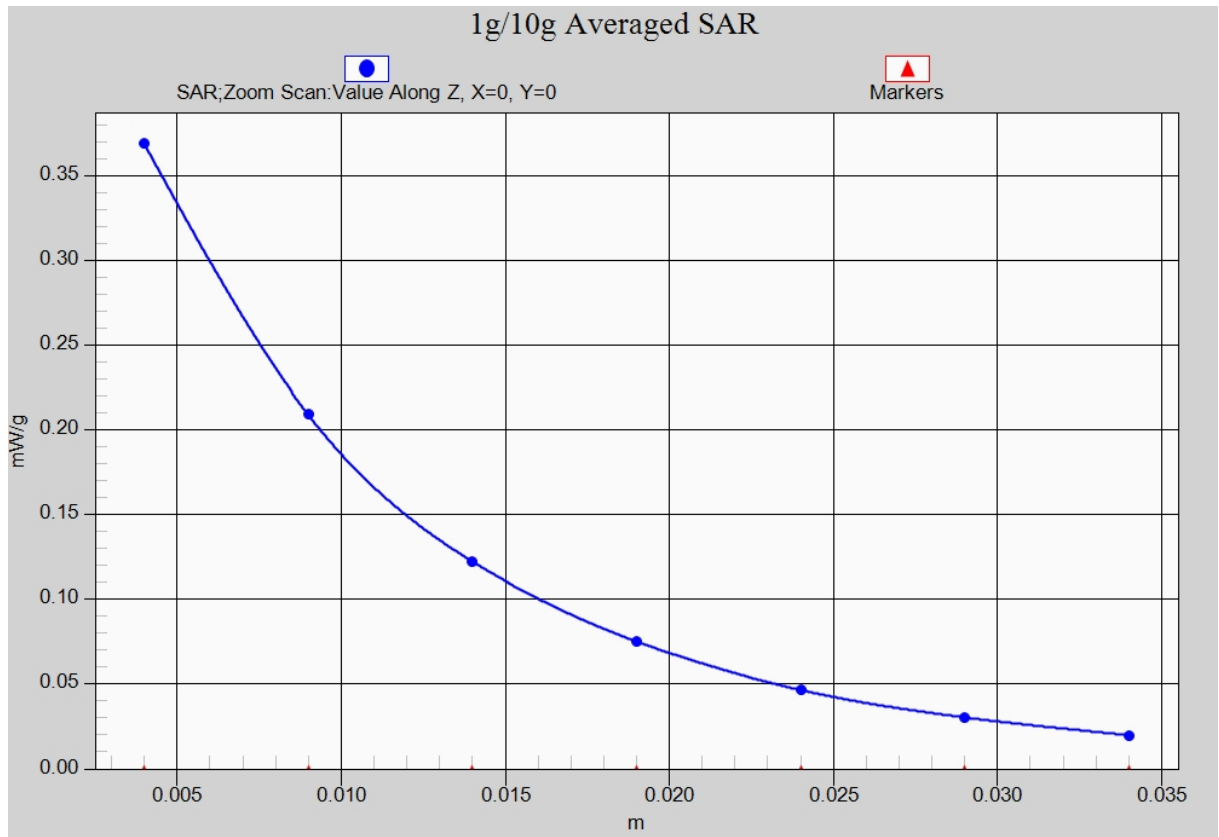

Fig. 27-1 Z-Scan at power reference point (1900 MHz CH512)

1900 Left Tilt High

Date: 2012-7-26

Electronics: DAE4 Sn771

Medium: Head 1900 MHz

Medium parameters used: $f = 1910$ MHz; $\sigma = 1.399$ mho/m; $\epsilon_r = 41.176$; $\rho = 1000$ kg/m³

Ambient Temperature: 22.5°C Liquid Temperature: 22.0°C

Communication System: GSM 1900MHz Frequency: 1909.8 MHz Duty Cycle: 1:8.3

Probe: ES3DV3 - SN3149 ConvF(5.19, 5.19, 5.19)

Tilt High/Area Scan (61x101x1): Measurement grid: dx=10mm, dy=10mm

Maximum value of SAR (interpolated) = 0.317 mW/g

Tilt High/Zoom Scan (7x7x7)/Cube 0: Measurement grid: dx=5mm, dy=5mm, dz=5mm

Reference Value = 12.816 V/m; Power Drift = -0.02 dB

Peak SAR (extrapolated) = 0.436 mW/g

SAR(1 g) = 0.267 mW/g; SAR(10 g) = 0.153 mW/g

Maximum value of SAR (measured) = 0.296 mW/g

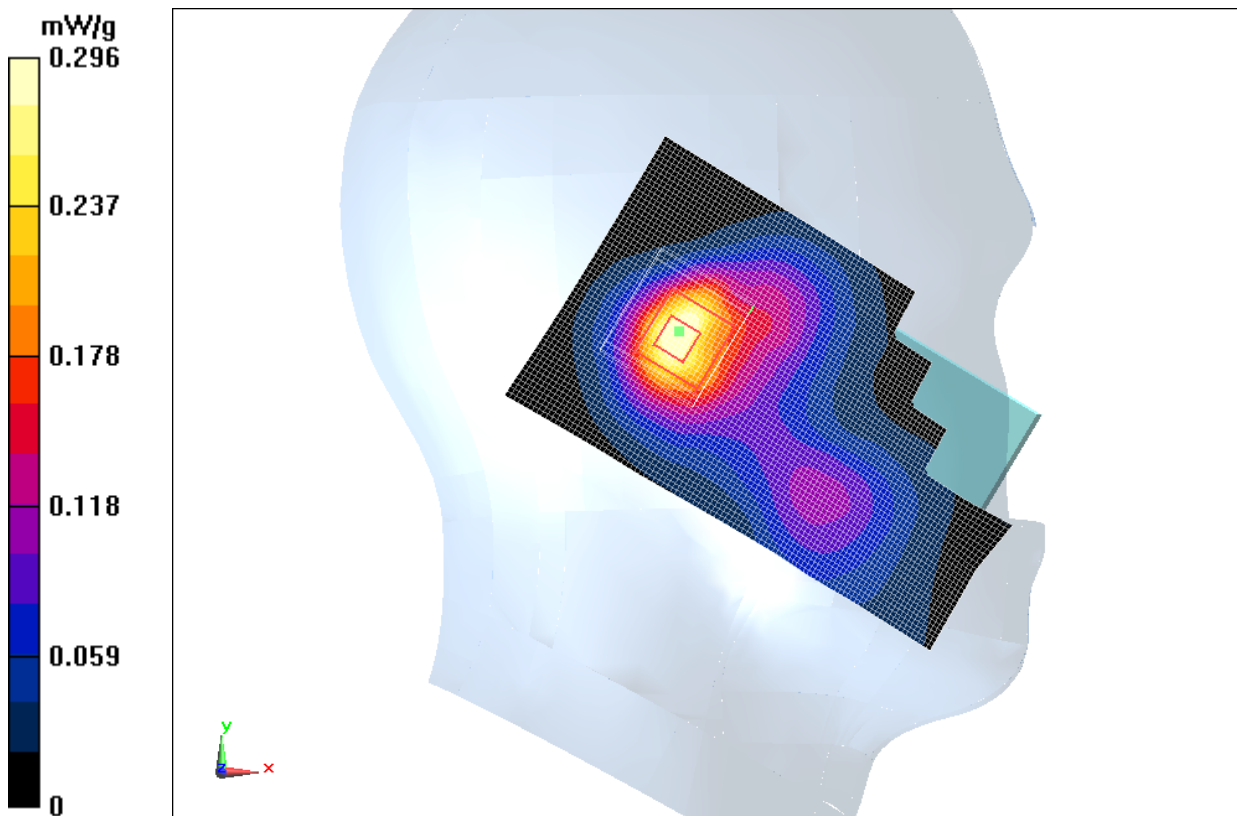

Fig. 28 1900 MHz CH810

1900 Left Tilt Middle

Date: 2012-7-26

Electronics: DAE4 Sn771

Medium: Head 1900 MHz

Medium parameters used: $f = 1880$ MHz; $\sigma = 1.371$ mho/m; $\epsilon_r = 41.288$; $\rho = 1000$ kg/m³

Ambient Temperature: 22.5°C Liquid Temperature: 22.0°C

Communication System: GSM 1900MHz Frequency: 1880 MHz Duty Cycle: 1:8.3

Probe: ES3DV3 - SN3149 ConvF(5.19, 5.19, 5.19)

Tilt Middle/Area Scan (61x101x1): Measurement grid: dx=10mm, dy=10mm

Maximum value of SAR (interpolated) = 0.358 mW/g

Tilt Middle/Zoom Scan (7x7x7)/Cube 0: Measurement grid: dx=5mm, dy=5mm, dz=5mm

Reference Value = 13.507 V/m; Power Drift = -0.02 dB

Peak SAR (extrapolated) = 0.471 mW/g

SAR(1 g) = 0.292 mW/g; SAR(10 g) = 0.172 mW/g

Maximum value of SAR (measured) = 0.321 mW/g

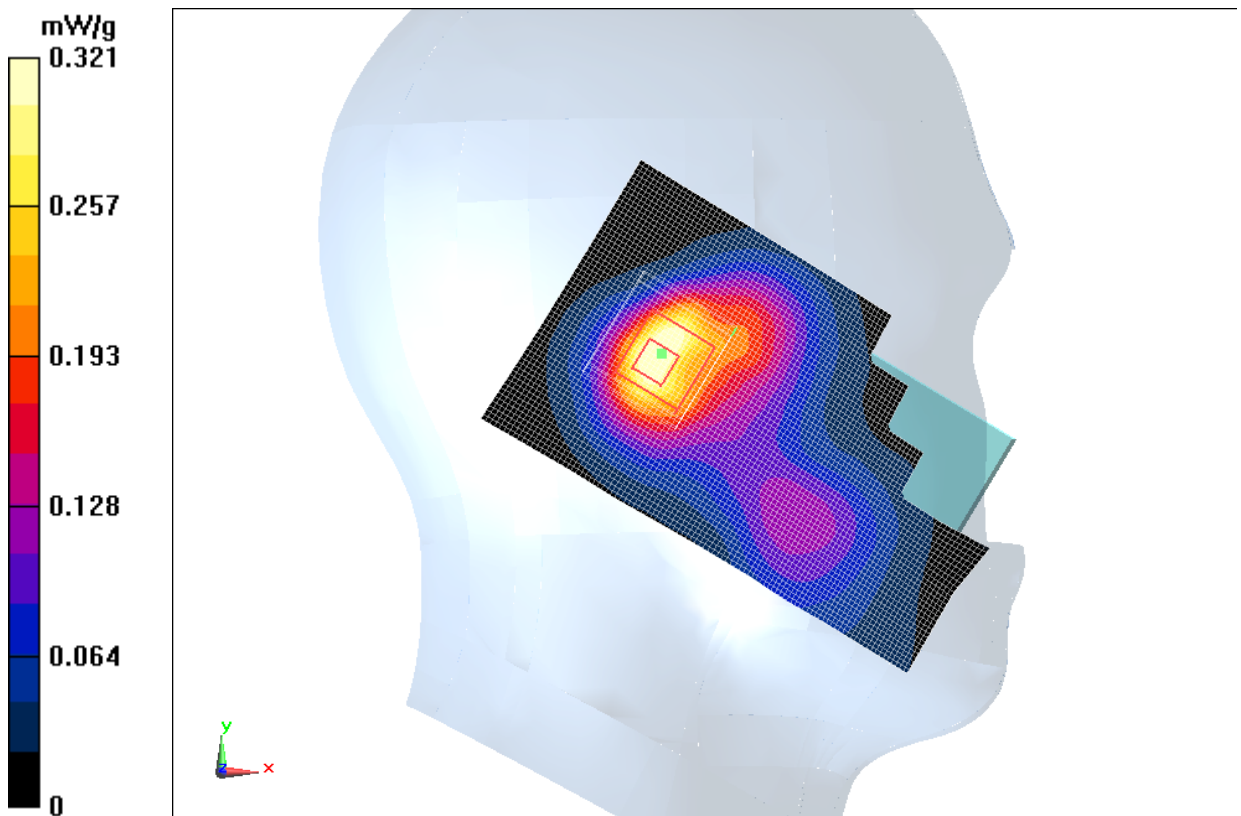

Fig. 29 1900 MHz CH661

1900 Left Tilt Low

Date: 2012-7-26

Electronics: DAE4 Sn771

Medium: Head 1900 MHz

Medium parameters used (interpolated): $f = 1850.2$ MHz; $\sigma = 1.341$ mho/m; $\epsilon_r = 41.381$; $\rho = 1000$ kg/m³

Ambient Temperature: 22.5°C Liquid Temperature: 22.0°C

Communication System: GSM 1900MHz Frequency: 1850.2 MHz Duty Cycle: 1:8.3

Probe: ES3DV3 - SN3149 ConvF(5.19, 5.19, 5.19)

Tilt Low/Area Scan (61x101x1): Measurement grid: dx=10mm, dy=10mm

Maximum value of SAR (interpolated) = 0.371 mW/g

Tilt Low/Zoom Scan (7x7x7)/Cube 0: Measurement grid: dx=5mm, dy=5mm, dz=5mm

Reference Value = 13.512 V/m; Power Drift = -0.03 dB

Peak SAR (extrapolated) = 0.469 mW/g

SAR(1 g) = 0.296 mW/g; SAR(10 g) = 0.182 mW/g

Maximum value of SAR (measured) = 0.317 mW/g

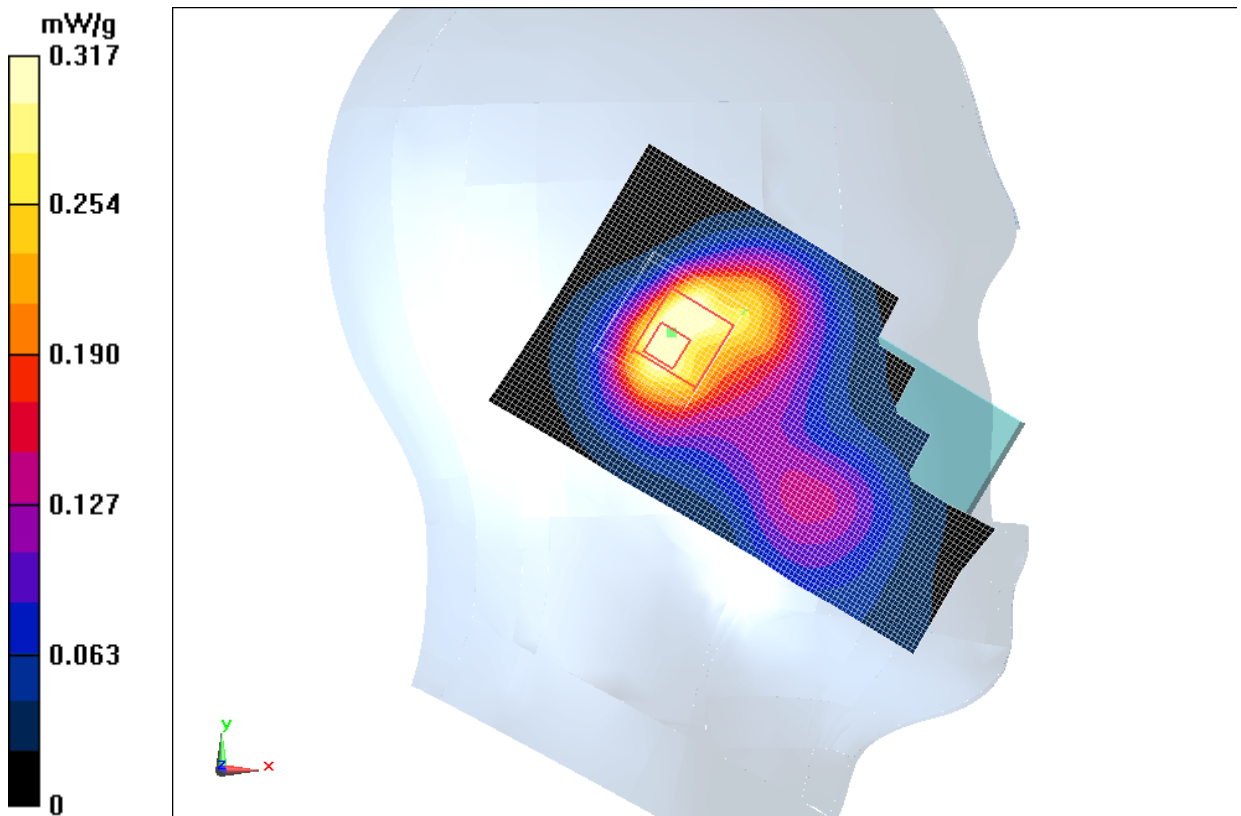

Fig. 30 1900 MHz CH512

1900 Right Cheek High

Date: 2012-7-26

Electronics: DAE4 Sn771

Medium: Head 1900 MHz

Medium parameters used: $f = 1910$ MHz; $\sigma = 1.399$ mho/m; $\epsilon_r = 41.176$; $\rho = 1000$ kg/m³

Ambient Temperature: 22.5°C Liquid Temperature: 22.0°C

Communication System: GSM 1900MHz Frequency: 1909.8 MHz Duty Cycle: 1:8.3

Probe: ES3DV3 - SN3149 ConvF(5.19, 5.19, 5.19)

Cheek High/Area Scan (61x101x1): Measurement grid: dx=10mm, dy=10mm

Maximum value of SAR (interpolated) = 0.460 mW/g

Cheek High/Zoom Scan (7x7x7)/Cube 0: Measurement grid: dx=5mm, dy=5mm, dz=5mm

Reference Value = 10.329 V/m; Power Drift = -0.16 dB

Peak SAR (extrapolated) = 0.646 mW/g

SAR(1 g) = 0.442 mW/g; SAR(10 g) = 0.279 mW/g

Maximum value of SAR (measured) = 0.471 mW/g

Cheek High/Zoom Scan (7x7x7)/Cube 1: Measurement grid: dx=5mm, dy=5mm, dz=5mm

Reference Value = 10.329 V/m; Power Drift = -0.16 dB

Peak SAR (extrapolated) = 0.421 mW/g

SAR(1 g) = 0.274 mW/g; SAR(10 g) = 0.167 mW/g

Maximum value of SAR (measured) = 0.301 mW/g

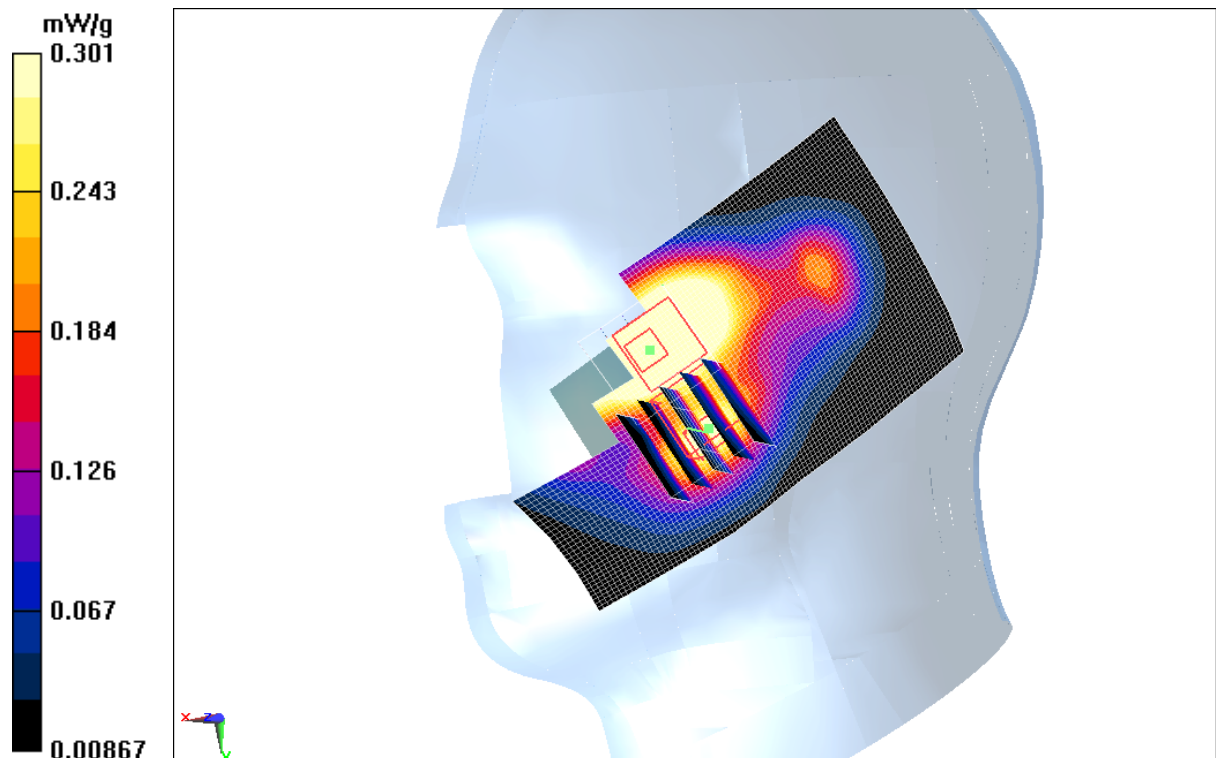

Fig. 31 1900 MHz CH810

1900 Right Cheek Middle

Date: 2012-7-26

Electronics: DAE4 Sn771

Medium: Head 1900 MHz

Medium parameters used: $f = 1880$ MHz; $\sigma = 1.371$ mho/m; $\epsilon_r = 41.288$; $\rho = 1000$ kg/m³

Ambient Temperature: 22.5°C Liquid Temperature: 22.0°C

Communication System: GSM 1900MHz Frequency: 1880 MHz Duty Cycle: 1:8.3

Probe: ES3DV3 - SN3149 ConvF(5.19, 5.19, 5.19)

Cheek Middle/Area Scan (61x101x1): Measurement grid: dx=10mm, dy=10mm

Maximum value of SAR (interpolated) = 0.476 mW/g

Cheek Middle/Zoom Scan (7x7x7)/Cube 0: Measurement grid: dx=5mm, dy=5mm, dz=5mm

Reference Value = 10.252 V/m; Power Drift = 0.10 dB

Peak SAR (extrapolated) = 0.673 mW/g

SAR(1 g) = 0.460 mW/g; SAR(10 g) = 0.294 mW/g

Maximum value of SAR (measured) = 0.493 mW/g

Cheek Middle/Zoom Scan (7x7x7)/Cube 1: Measurement grid: dx=5mm, dy=5mm, dz=5mm

Reference Value = 10.252 V/m; Power Drift = 0.10 dB

Peak SAR (extrapolated) = 0.525 mW/g

SAR(1 g) = 0.352 mW/g; SAR(10 g) = 0.213 mW/g

Maximum value of SAR (measured) = 0.383 mW/g

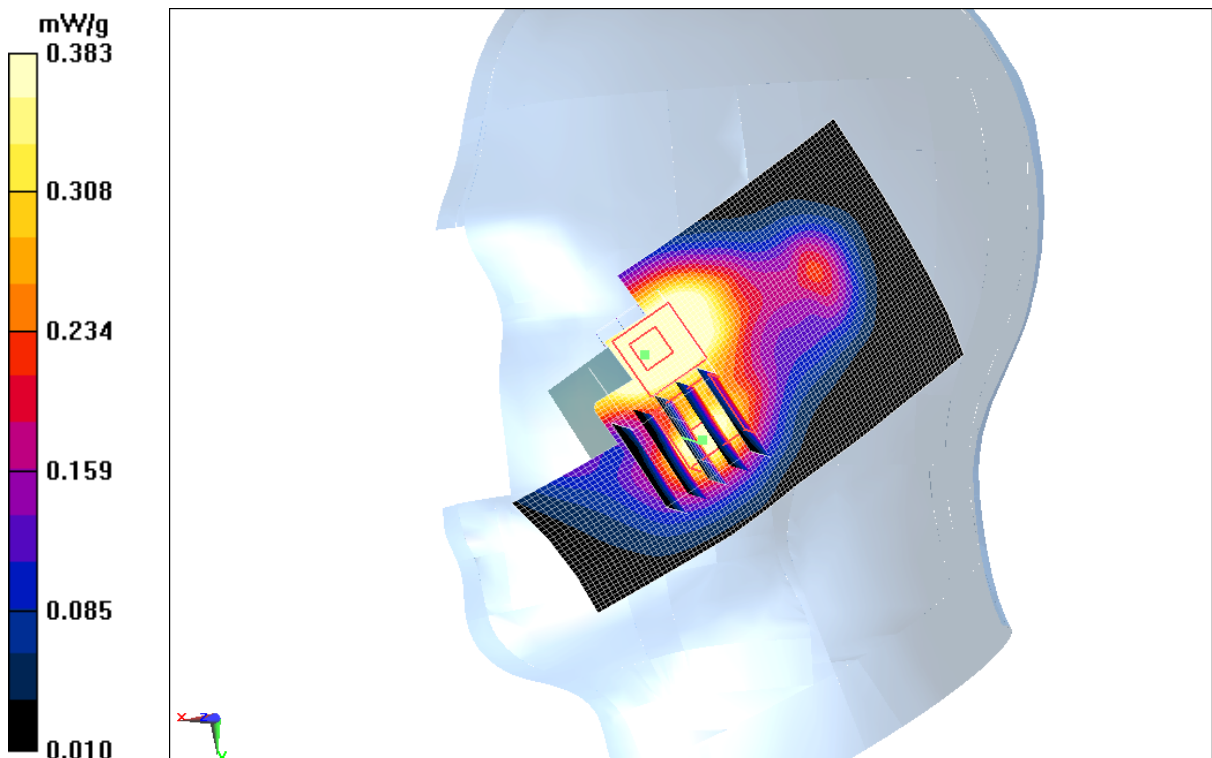

Fig. 32 1900 MHz CH661

1900 Right Cheek Low

Date: 2012-7-26

Electronics: DAE4 Sn771

Medium: Head 1900 MHz

Medium parameters used (interpolated): $f = 1850.2$ MHz; $\sigma = 1.341$ mho/m; $\epsilon_r = 41.381$; $\rho = 1000$ kg/m³

Ambient Temperature: 22.5°C Liquid Temperature: 22.0°C

Communication System: GSM 1900MHz Frequency: 1850.2 MHz Duty Cycle: 1:8.3

Probe: ES3DV3 - SN3149 ConvF(5.19, 5.19, 5.19)

Cheek Low/Area Scan (61x101x1): Measurement grid: dx=10mm, dy=10mm

Maximum value of SAR (interpolated) = 0.552 mW/g

Cheek Low/Zoom Scan (7x7x7)/Cube 0: Measurement grid: dx=5mm, dy=5mm, dz=5mm

Reference Value = 10.325 V/m; Power Drift = -0.11 dB

Peak SAR (extrapolated) = 0.715 mW/g

SAR(1 g) = 0.489 mW/g; SAR(10 g) = 0.299 mW/g

Maximum value of SAR (measured) = 0.536 mW/g

Cheek Low/Zoom Scan (7x7x7)/Cube 1: Measurement grid: dx=5mm, dy=5mm, dz=5mm

Reference Value = 10.325 V/m; Power Drift = -0.11 dB

Peak SAR (extrapolated) = 0.763 mW/g

SAR(1 g) = 0.527 mW/g; SAR(10 g) = 0.337 mW/g

Maximum value of SAR (measured) = 0.545 mW/g

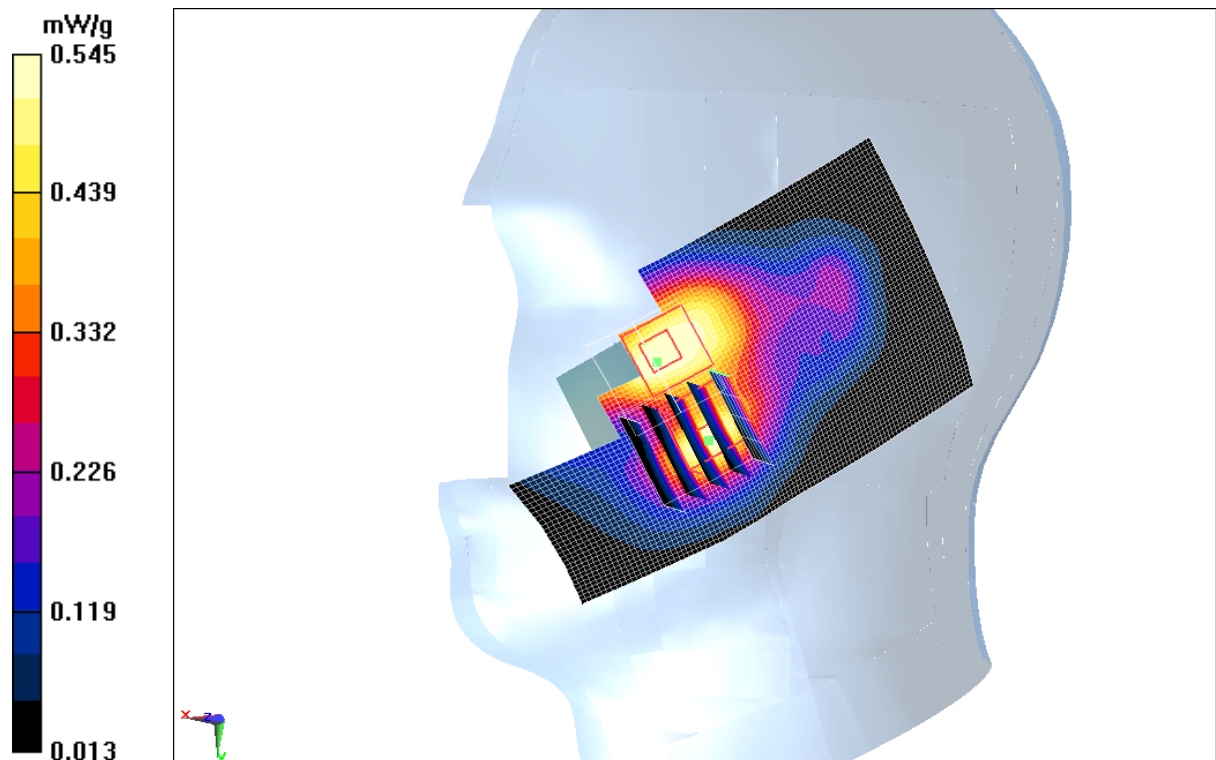

Fig. 33 1900 MHz CH512

1900 Right Tilt High

Date: 2012-7-26

Electronics: DAE4 Sn771

Medium: Head 1900 MHz

Medium parameters used: $f = 1910$ MHz; $\sigma = 1.399$ mho/m; $\epsilon_r = 41.176$; $\rho = 1000$ kg/m³

Ambient Temperature: 22.5°C Liquid Temperature: 22.0°C

Communication System: GSM 1900MHz Frequency: 1909.8 MHz Duty Cycle: 1:8.3

Probe: ES3DV3 - SN3149 ConvF(5.19, 5.19, 5.19)

Tilt High/Area Scan (61x101x1): Measurement grid: dx=10mm, dy=10mm

Maximum value of SAR (interpolated) = 0.336 mW/g

Tilt High/Zoom Scan (7x7x7)/Cube 0: Measurement grid: dx=5mm, dy=5mm, dz=5mm

Reference Value = 13.669 V/m; Power Drift = -0.03 dB

Peak SAR (extrapolated) = 0.454 mW/g

SAR(1 g) = 0.280 mW/g; SAR(10 g) = 0.158 mW/g

Maximum value of SAR (measured) = 0.306 mW/g

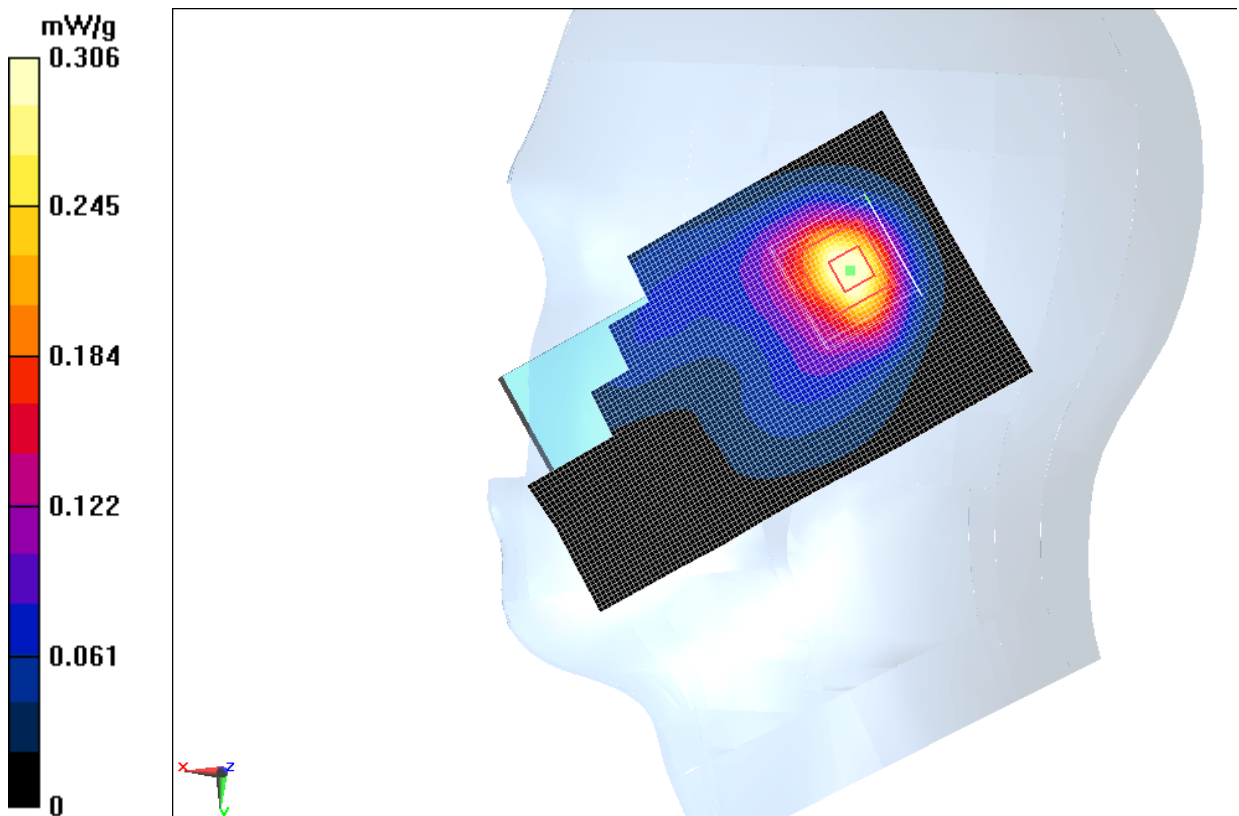

Fig. 34 1900 MHz CH810

1900 Right Tilt Middle

Date: 2012-7-26

Electronics: DAE4 Sn771

Medium: Head 1900 MHz

Medium parameters used: $f = 1880$ MHz; $\sigma = 1.371$ mho/m; $\epsilon_r = 41.288$; $\rho = 1000$ kg/m³

Ambient Temperature: 22.5°C Liquid Temperature: 22.0°C

Communication System: GSM 1900MHz Frequency: 1880 MHz Duty Cycle: 1:8.3

Probe: ES3DV3 - SN3149 ConvF(5.19, 5.19, 5.19)

Tilt Middle/Area Scan (61x101x1): Measurement grid: dx=10mm, dy=10mm

Maximum value of SAR (interpolated) = 0.378 mW/g

Tilt Middle/Zoom Scan (7x7x7)/Cube 0: Measurement grid: dx=5mm, dy=5mm, dz=5mm

Reference Value = 14.649 V/m; Power Drift = -0.01 dB

Peak SAR (extrapolated) = 0.521 mW/g

SAR(1 g) = 0.322 mW/g; SAR(10 g) = 0.183 mW/g

Maximum value of SAR (measured) = 0.349 mW/g

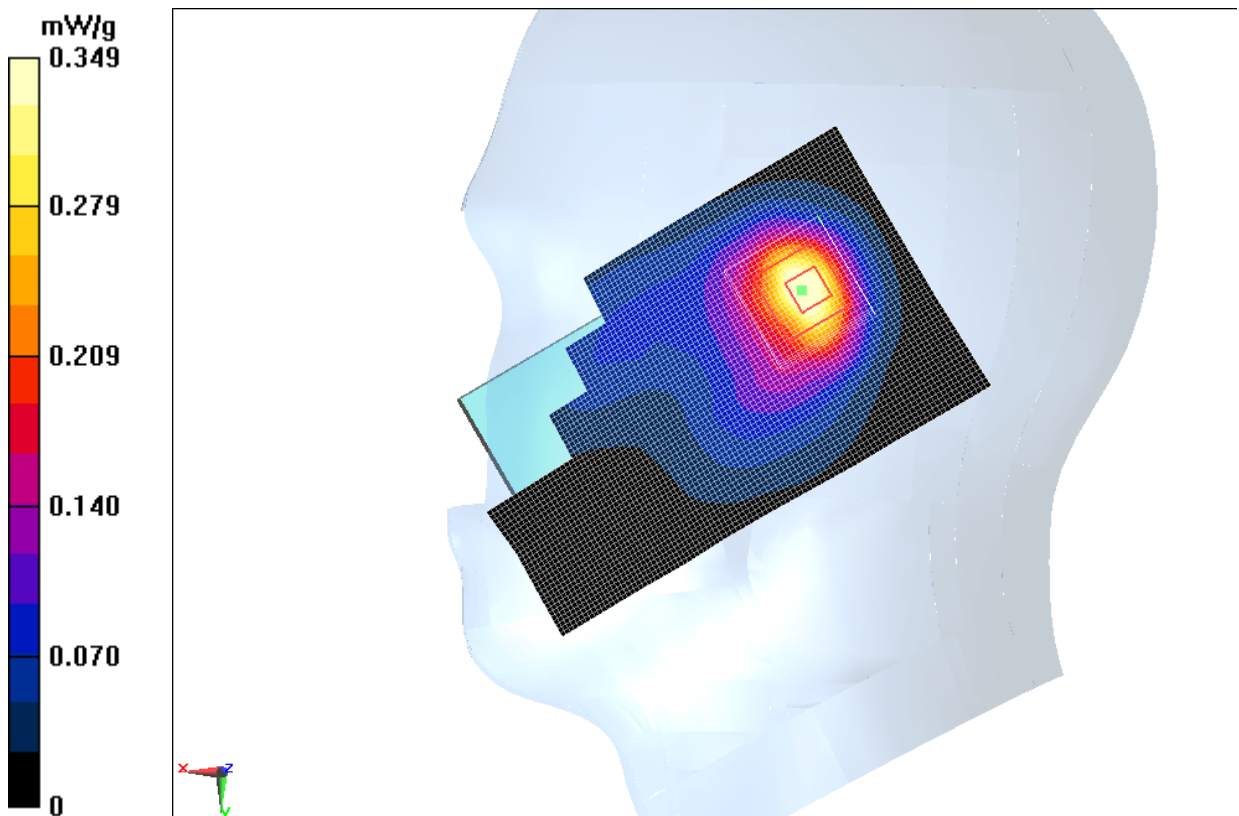

Fig.35 1900 MHz CH661

1900 Right Tilt Low

Date: 2012-7-26

Electronics: DAE4 Sn771

Medium: Head 1900 MHz

Medium parameters used (interpolated): $f = 1850.2$ MHz; $\sigma = 1.341$ mho/m; $\epsilon_r = 41.381$; $\rho = 1000$ kg/m³

Ambient Temperature: 22.5°C Liquid Temperature: 22.0°C

Communication System: GSM 1900MHz Frequency: 1850.2 MHz Duty Cycle: 1:8.3

Probe: ES3DV3 - SN3149 ConvF(5.19, 5.19, 5.19)

Tilt Low/Area Scan (61x101x1): Measurement grid: dx=10mm, dy=10mm

Maximum value of SAR (interpolated) = 0.418 mW/g

Tilt Low/Zoom Scan (7x7x7)/Cube 0: Measurement grid: dx=5mm, dy=5mm, dz=5mm

Reference Value = 14.658 V/m; Power Drift = 0.12 dB

Peak SAR (extrapolated) = 0.561 mW/g

SAR(1 g) = 0.353 mW/g; SAR(10 g) = 0.207 mW/g

Maximum value of SAR (measured) = 0.387 mW/g

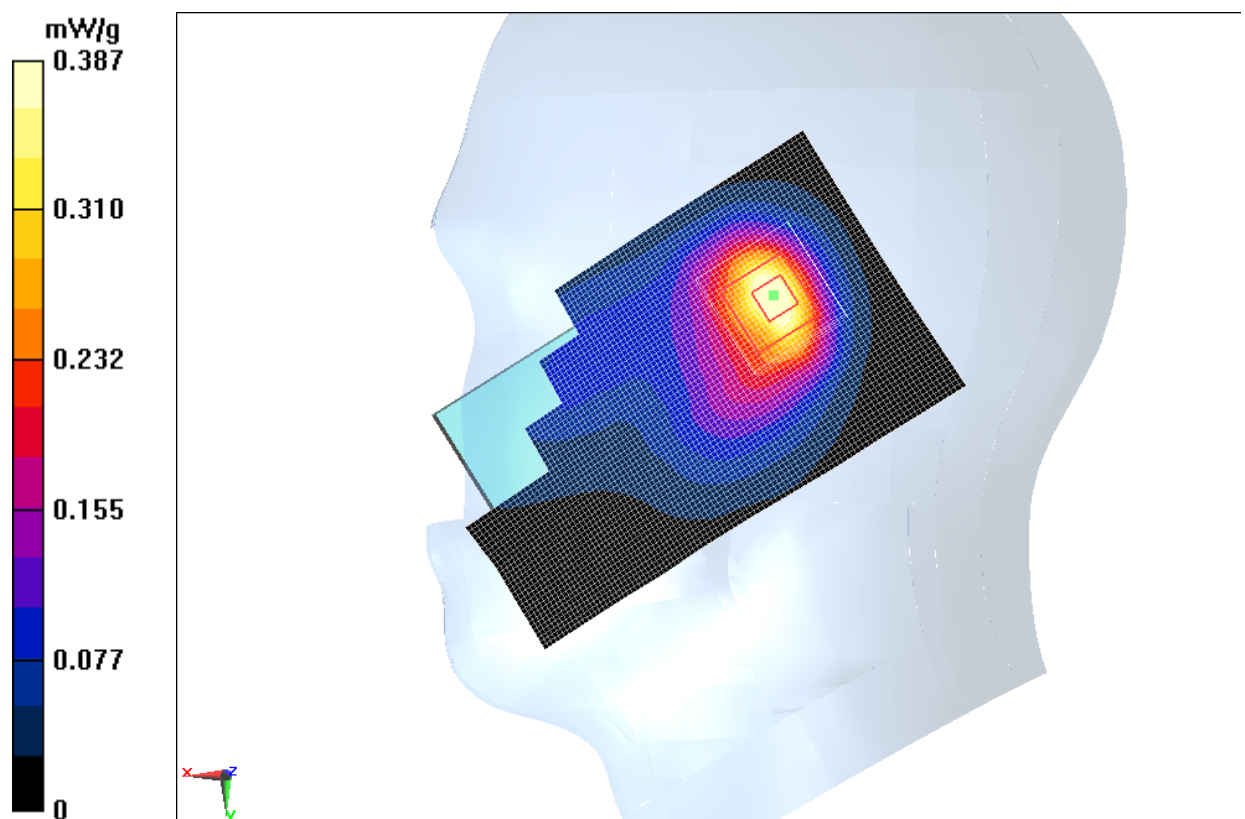

Fig. 36 1900 MHz CH512

1900 Body Towards Phantom High

Date: 2012-7-26

Electronics: DAE4 Sn771

Medium: Body 1900 MHz

Medium parameters used: $f = 1910$ MHz; $\sigma = 1.523$ mho/m; $\epsilon_r = 52.651$; $\rho = 1000$ kg/m³

Ambient Temperature: 22.5°C Liquid Temperature: 22.0°C

Communication System: GSM 1900MHz GPRS Frequency: 1909.8 MHz Duty Cycle: 1:8.3

Probe: ES3DV3 - SN3149 ConvF(4.64, 4.64, 4.64)

Toward Phantom High/Area Scan (61x101x1): Measurement grid: dx=10mm, dy=10mm

Maximum value of SAR (interpolated) = 0.891 mW/g

Toward Phantom High/Zoom Scan (7x7x7)/Cube 0: Measurement grid: dx=5mm, dy=5mm, dz=5mm

Reference Value = 12.053 V/m; Power Drift = 0.02 dB

Peak SAR (extrapolated) = 1.250 mW/g

SAR(1 g) = 0.790 mW/g; SAR(10 g) = 0.466 mW/g

Maximum value of SAR (measured) = 0.864 mW/g

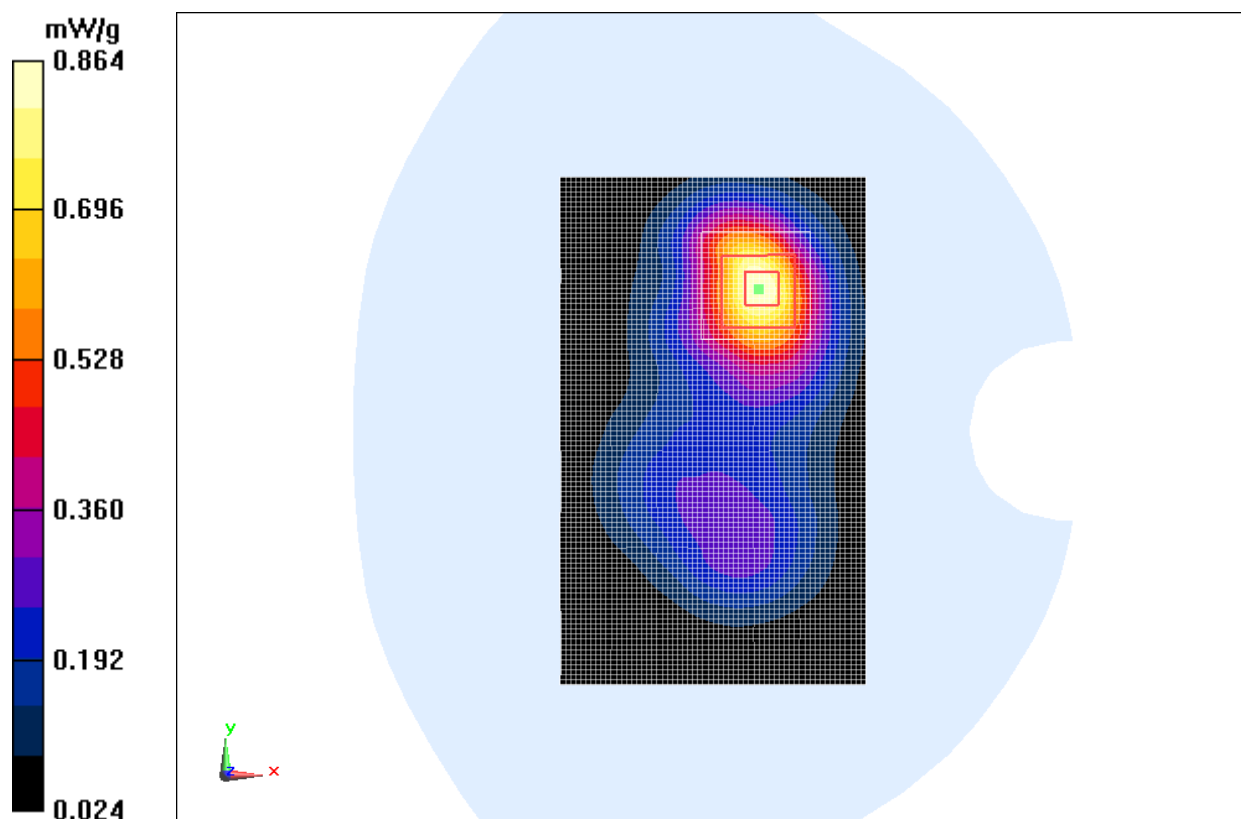

Fig. 37 1900 MHz CH810

1900 Body Towards Phantom Middle

Date: 2012-7-26

Electronics: DAE4 Sn771

Medium: Body 1900 MHz

Medium parameters used: $f = 1880$ MHz; $\sigma = 1.493$ mho/m; $\epsilon_r = 52.773$; $\rho = 1000$ kg/m³

Ambient Temperature: 22.5°C Liquid Temperature: 22.0°C

Communication System: GSM 1900MHz GPRS Frequency: 1880 MHz Duty Cycle: 1:8.3

Probe: ES3DV3 - SN3149 ConvF(4.64, 4.64, 4.64)

Toward Phantom Middle/Area Scan (61x101x1): Measurement grid: dx=10mm, dy=10mm

Maximum value of SAR (interpolated) = 1.02 mW/g

Toward Phantom Middle/Zoom Scan (7x7x7)/Cube 0: Measurement grid: dx=5mm, dy=5mm, dz=5mm

Reference Value = 11.569 V/m; Power Drift = 0.01 dB

Peak SAR (extrapolated) = 1.439 mW/g

SAR(1 g) = 0.920 mW/g; SAR(10 g) = 0.543 mW/g

Maximum value of SAR (measured) = 1.01 mW/g

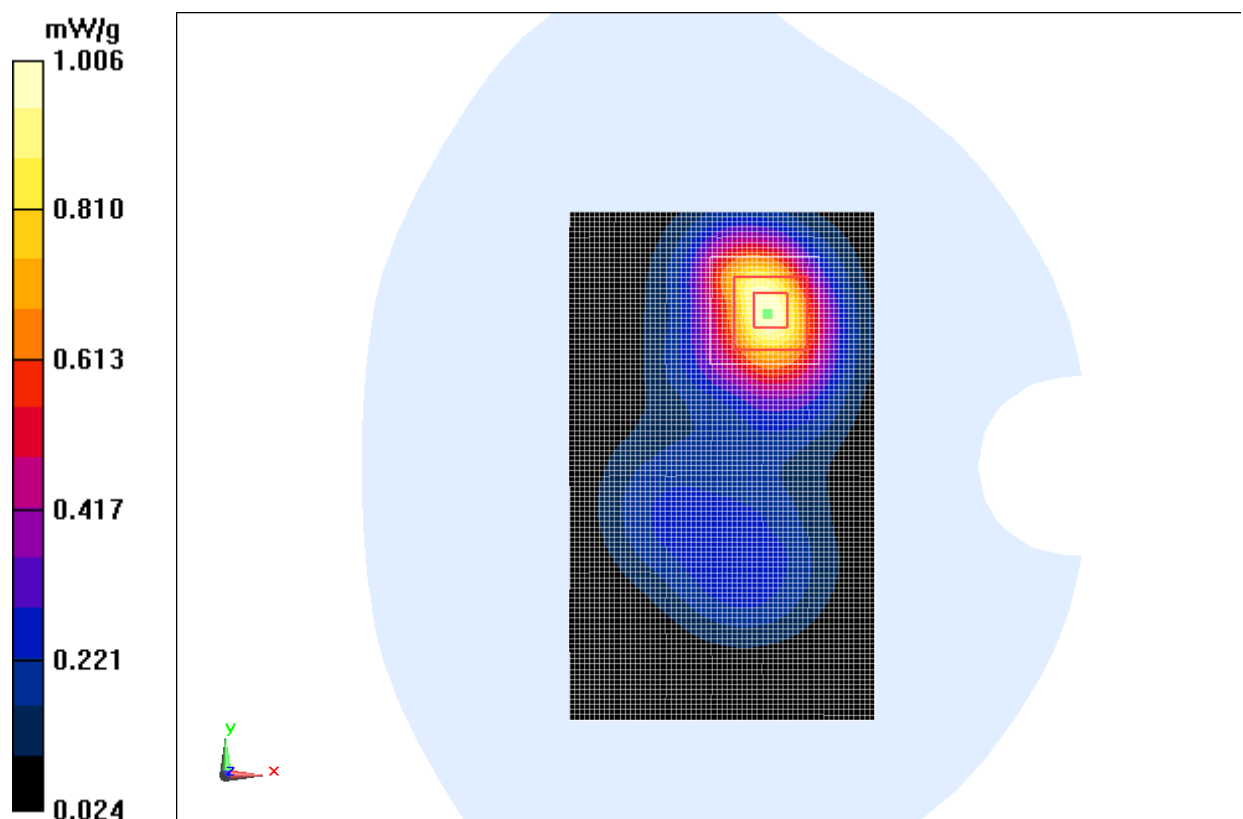

Fig. 38 1900 MHz CH661

1900 Body Towards Phantom Low

Date: 2012-7-26

Electronics: DAE4 Sn771

Medium: Body 1900 MHz

Medium parameters used (interpolated): $f = 1850.2$ MHz; $\sigma = 1.46$ mho/m; $\epsilon_r = 52.908$; $\rho = 1000$ kg/m³

Ambient Temperature: 22.5°C Liquid Temperature: 22.0°C

Communication System: GSM 1900MHz GPRS Frequency: 1850.2 MHz Duty Cycle: 1:8.3

Probe: ES3DV3 - SN3149 ConvF(4.64, 4.64, 4.64)

Toward Phantom Low/Area Scan (61x101x1): Measurement grid: dx=10mm, dy=10mm

Maximum value of SAR (interpolated) = 1.08 mW/g

Toward Phantom Low/Zoom Scan (7x7x7)/Cube 0: Measurement grid: dx=5mm, dy=5mm, dz=5mm

Reference Value = 12.651 V/m; Power Drift = 0.02 dB

Peak SAR (extrapolated) = 1.521 mW/g

SAR(1 g) = 0.960 mW/g; SAR(10 g) = 0.567 mW/g

Maximum value of SAR (measured) = 1.05 mW/g

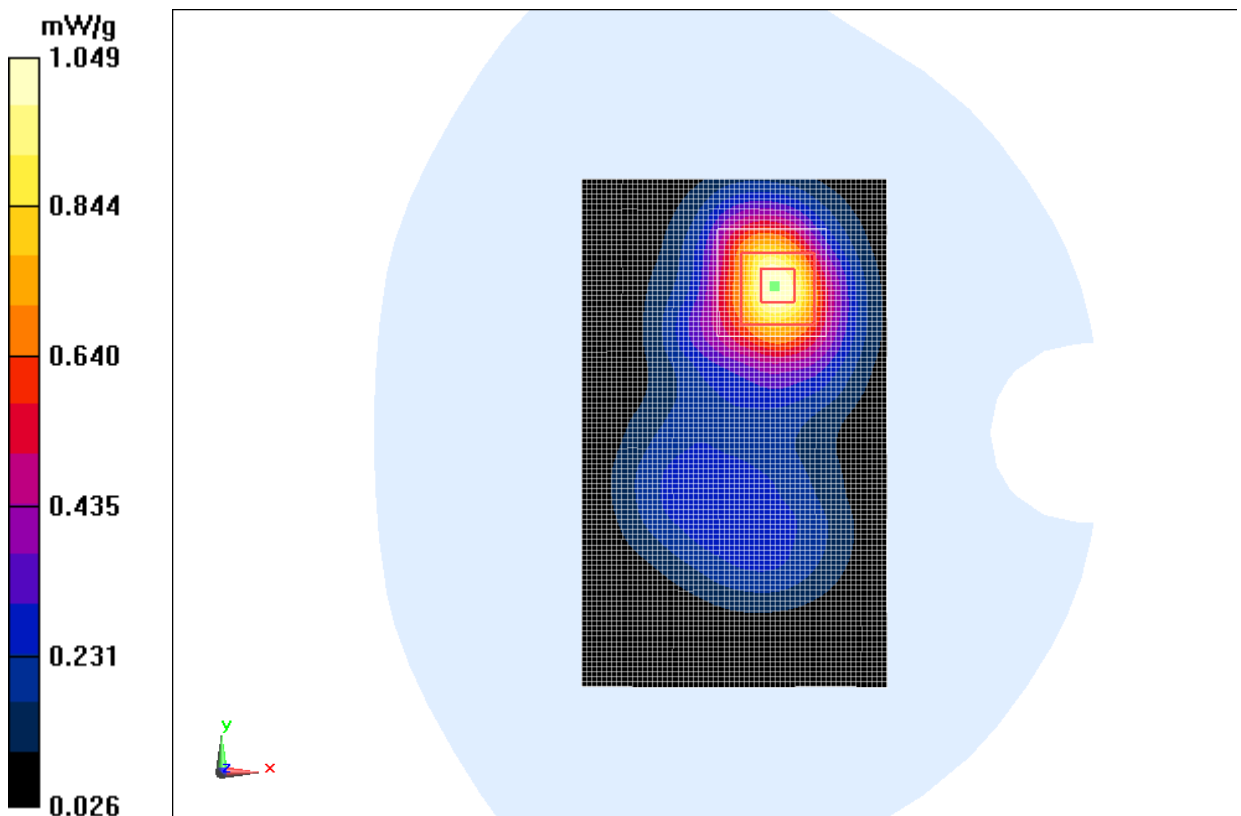

Fig. 39 1900 MHz CH512