

HCT CO., LTD.



105-1, Jangam-ri, Majang-myeon, Icheon-si, Gyeonggi-do, Korea 467-811

TEL: +82 31 645 64851 FAX: +82 31 645 6401 www.hct.co.kr

HAC RF Emission TEST REPORT

TCT MOBILE LIMITED.

5F, E building, No.232, Liang Jing Road,
ZhangJiang High-Tech Park, Pudong Area.

Date of Issue: Apr. 19, 2012
Test Report No.: HCTA1204FS05
Test Site: HCT CO., LTD.

FCC I D: RAD278

APPLICANT: TCT MOBILE LIMITED.

Application Type	Certification
EUT Type	Cellular/AWS/PCS CDMA/EVDO Phone with Bluetooth and WLAN
Tx Frequency	824.70 – 848.31 MHz (CDMA) 1 851.25 – 1 908.75 MHz (PCS CDMA) 1 711.25 – 1 753.75 MHz (AWS CDMA)
Maximum Conducted Power (HAC)	0.371 W CDMA (25.70 dBm)/ 0.339 W PCS CDMA (25.3 dBm) 0.339 W AWS CDMA (25.3 dBm)
Trade Name/Model(s)	ONE TOUCH 960C
FCC Classification	Licensed Portable Transmitter Held to Ear (PCE)
FCC Rule Part(s)	§20.19
HAC Standard	ANSI C63.19-2007

Hearing Aid Near-Field Category: M4

This wireless portable device has been shown to be hearing-aid compatible under the above rated category, specified in ANSI/IEEE Std. C63.19-2007 and had been tested in accordance with the specified measurement procedures. Hearing-Aid Compatibility is based on the assumption that all production units will be designed electrically identical to the device tested in this report.

I attest to the accuracy of data. All measurements reported herein were performed by me or were made under my supervision and are correct to the best of my knowledge and belief. I assume full responsibility for the completeness of these measurements and vouch for the qualifications of all persons taking them.

HCT Co., Ltd. Certifies that no party to this application has been denied FCC benefits pursuant to section 5301 of the Anti- Drug Abuse Act of 1998, 21 U.S. C. 862.

Report prepared by
: Young-Soo Jang
Test Engineer of SAR Part

Approved by
: Jae-Sang So
Manager of SAR Part

Table of Contents

1. APPLICANT / EUT DESCRIPTION -----	3
2. HAC MEASUREMENT SET- UP -----	4
3. SYSTEM SPECIFICATIONS -----	5
4. EUT ARRANGEMENT -----	7
5. SYSTEM VALIDATION -----	8
6. PROBE MODULATION FACTOR -----	10
7. FCC 3G MEASUREMENTS – MAY / JUNE 2006 -----	13
8. TEST PROCEDURE -----	15
9. ANSI/IEEE C63.19 PERFORMANCE CATEGORIES -----	17
10. MEASUREMENT UNCERTAINTIES -----	18
11. HAC TEST DATA SUMMARY -----	20
12. HAC TEST EQUIPMENT LIST -----	23
13. CONCLUSION -----	24

Appendix A_HAC TEST PLOTS

Appendix B_TEST SET-UP PHOTO

Appendix C_DIPOLE VALIDATION PLOTS

Appendix D_PROBE CALIBRATION DATA

Appendix E_DIPOLE CALIBRATION DATA

HAC MEASUREMENT REPORT

1. APPLICANT / EUT DESCRIPTION

1.1 Applicant

- Company Name: TCT MOBILE LIMITED.
- Address: 5F, E building, No.232, Liang Jing Road, Zhangjiang High-Tech Park, Pudong Area

1.2 EUT Description

- EUT Type: Cellular/AWS/PCS CDMA/EVDO Phone with Bluetooth and WLAN
- Trade Name: TCT MOBILE LIMITED
- Model(s): ONE TOUCH 960C
- FCC ID: RAD278
- Serial Number(s): #1
- Tx Frequency: 824.70 – 848.31 MHz (CDMA)
1 711.25 – 1 753.75 MHz (AWS CDMA)
1 851.25 – 1 908.75 MHz (PCS CDMA)
- FCC Classification: Licensed Portable Transmitter Held to Ear (PCE)
- FCC Rule Part(s): § 20.19(b); §6.3(v), §7.3(v)
- Modulation(s): CDMA835/AWS1700/PCS1900
- Antenna Type: Intenna
- Date(s) of Tests: Apr. 17, 2012
- Place of Tests: HCT CO., LTD.
Icheon, Kyoung ki-Do, KOREA
- Report Serial No.: HCTA1204FM05
- Max E-Field Emission: PCS channel 25, 1 851.25 MHz = 33.2 dBV/m (M4)
- Max H-Field Emission: AWS channel 450, 1 732.5 MHz = - 20.3 dBA/m (M4)

Air-Interface	Band (MHz)	Type	C63.19-2007	Simultaneous Transmissions Note: Not to be tested	Reduced Power 20.19(C)(1)	Voice Over Digital Transport(Data)
CDMA	Cellular835	VO	Yes	Yes: BT, WIFI	NA	NA
	PCS1900					NA
	AWS1700					NA
	EVDO Rev.0	DT	NA	Yes: BT, WIFI	NA	NA
WIFI	2450	DT	NA	Yes: CDMA	NA	Yes
BT	2450	DT	NA	Yes: CDMA	NA	NA

VO Voice CMRS/PSTN Service Only
V/D Voice CMRS /PSTN and Data Service
DT Digital Transport

* HAC Rating was not based on concurrent voice and data modes, Non current mode was found to represent worst case rating, for both M and T rating

2. HAC MEASUREMENT SET-UP

These measurements are performed using the DASY4 automated dosimetric assessment system. It is made by Schmid & Partner Engineering AG (SPEAG) in Zurich, Switzerland. It consists of high precision robotics system (Staubli), robot controller, Pentium IV computer, near-field probe, probe alignment sensor. The robot is a six-axis industrial robot performing precise movements. A cell controller system contains the power supply, robot controller, teach pendant (Joystick), and remote control, is used to drive the robot motors. The PC consists of the HP Pentium IV 3.0 GHz computer with Windows XP system and HAC Measurement Software DASY4, A/D interface card, monitor, mouse, and keyboard. The Staubli Robot is connected to the cell controller to allow software manipulation of the robot. A data acquisition electronic (DAE) circuit performs the signal amplification, signal multiplexing, AD-conversion, offset measurements, mechanical surface detection, collision detection, etc. is connected to the Electro-optical coupler (EOC). The EOC performs the conversion from the optical into digital electric signal of the DAE and transfers data to the PC plug-in card.

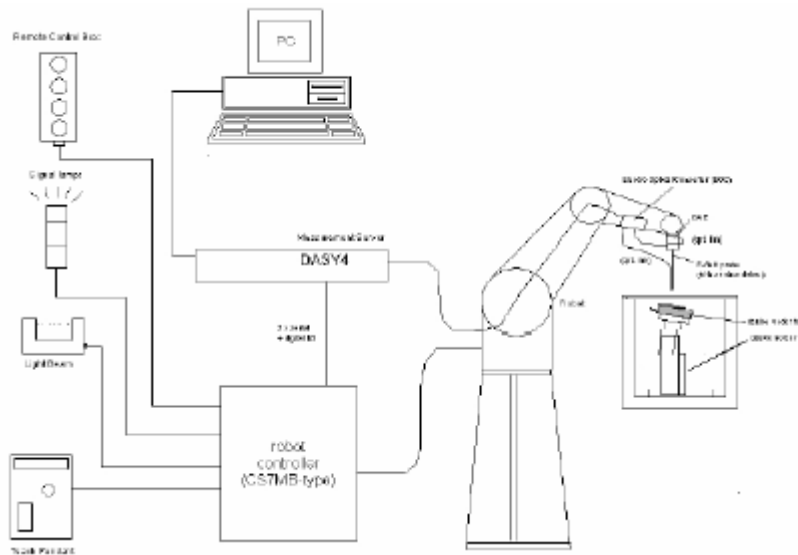



Figure 1. HAC Test Measurement Set-up

The DAE4 consists of a highly sensitive electrometer-grade preamplifier with auto-zeroing, a channel and gain-switching multiplexer, a fast 16 bit AD-converter and a command decoder and control logic unit. Transmission to the PC-card is accomplished through an optical downlink for data and status information and an optical uplink for commands and clock lines. The mechanical probe mounting device includes two different sensor systems for frontal and sidewise probe contacts. They are also used for mechanical surface detection and probe collision detection. The robot uses its own controller with a built in VME-bus computer.

3. SYSTEM SPECIFICATIONS

3.1 Probe

3.1.1 E-Field Probe Description

Construction	One dipole parallel, two dipoles normal to probe axis Built-in shielding against static charges	 <p>[E-Field Probe]</p>
Calibration	In air from 100 MHz to 3.0 GHz (absolute accuracy $\pm 6.0\%$, $k = 2$)	
Frequency	100 MHz to > 6 GHz; Linearity: ± 0.2 dB (100 MHz to 3 GHz)	
Directivity	± 0.2 dB in air (rotation around probe axis) ± 0.4 dB in air (rotation normal to probe axis)	
Dynamic Range	2 V/m to > 1000 V/m (M3 or better device readings fall well below diode compression point)	
Linearity	± 0.2 dB	
Dimensions	Overall length: 330 mm (Tip: 16 mm) Tip diameter: 8 mm (Body: 12 mm) Distance from probe tip to dipole centers: 2.5 mm	

3.1.2 H-Field Probe Description

Construction	Three concentric loop sensors with 3.8 mm loop diameters resistively loaded detector diodes for linear response Built-in shielding against static charges PEEK enclosure material (resistant to organic solvents, e.g., glycoether)	 <p>[H-Field Probe]</p>
Frequency	200 MHz to > 3 GHz (absolute accuracy $\pm 6.0\%$, $k = 2$); Output linearized	
Directivity	± 0.25 dB (spherical isotropy error)	
Dynamic Range	10 mA/m to 2 A/m at 1 GHz	
E-Field Interference	< 10 % at 3 GHz (for plane wave)	
Dimensions	Overall length: 330 mm (Tip: 40 mm) Tip diameter: 6 mm (Body: 12 mm) Distance from probe tip to dipole centers: 3 mm The closest part of the sensor element is 1.9 mm closer to the tip	

3.2 Phantom & Device Holder



Figure 2. HAC Phantom & Device Holder

The Test Arch phantom should be positioned horizontally on a stable surface. Reference markings on the Phantom allow the complete setup of all predefined phantom positions and measurement grids by manually teaching three points in the robot.

The devices can be easily, accurately, and repeatably positioned according to the FCC specifications.

3.3 Robotic System Specifications

Specifications	
POSITIONER:	Stäubli Unimation Corp. Robot Model: RX90LB
Repeatability:	0.02 mm
No. of axis:	6
Data Acquisition Electronic (DAE) System	
Cell Controller	
Processor:	Pentium IV
Clock Speed:	3.0 GHz
Operating System:	Windows XP
Data Card:	DASY4 PC-Board
Data Converter	
Features:	Signal Amplifier, multiplexer, A/D converter, and control logic
Software:	DASY4 software
Connecting Lines:	Optical downlink for data and status info. Optical uplink for commands and clock
PC Interface Card	
Function:	24 bit (64 MHz) DSP for real time processing Link to DAE 16 bit A/D converter for surface detection system serial link to robot direct emergency stop output for robot

4. EUT ARRANGEMENT

4.1 WD RF Emission Measurements Reference and Plane

Figure 3. Illustrate the references and reference plane that shall be used in the WD emissions measurement.

- The grid is 5 cm by 5 cm area that is divided into 9 evenly sized blocks or sub-grids.
- The grid is centered on the audio frequency output transducer of the WD (speaker or T-coil).
- The grid is in a reference plane, which is defined as the planar area that contains the highest point in the area of the phone that normally rests against the user's ear. It is parallel to the centerline of the receiver area of the phone and is defined by the points of the receiver-end of the WD handset, which, in normal handset use, rest against the ear.
- The measurement plane is parallel to, and 1.5 cm in front of, the reference plane.



Figure 3. WD reference and plane for RF emission measurements

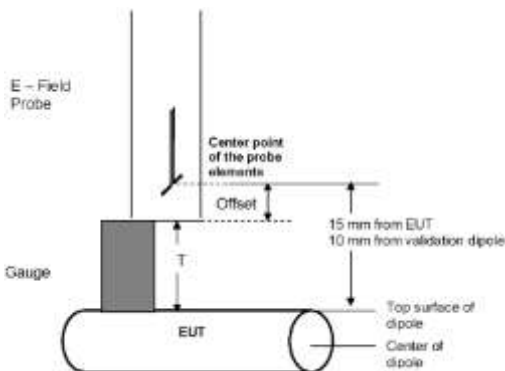

Figure 4. Gauge Block with E-Field Probe

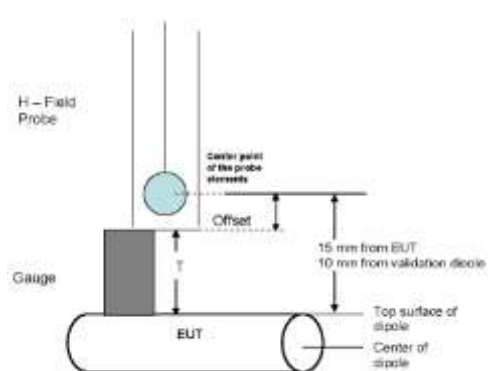

Figure 5. Gauge Block with H-Field Probe

5. SYSTEM VALIDATION

The test setup was validated when configured and verified periodically thereafter to ensure proper function. The procedure is a validation procedure using dipole antennas for which the field levels were computed by FDTD modeling.

5.1 Validation Procedure

Place a dipole antenna meeting the requirements given in ANSI-C63.19 in the position normally occupied by the WD. The dipole antenna serves as a known source for an electrical and magnetic output. Position the E-field and H-field probes so that:

- the probes and their cables are parallel to the coaxial feed of the dipole antenna
- the probe cables and the coaxial feed of the dipole antenna approach the measurement area from opposite directions; and
- the probes are 10 mm from the surface of the dipole elements.

Scan the length of the dipole with both E-field and H-field probes and record the maximum values for each. Compare the readings to expected values.

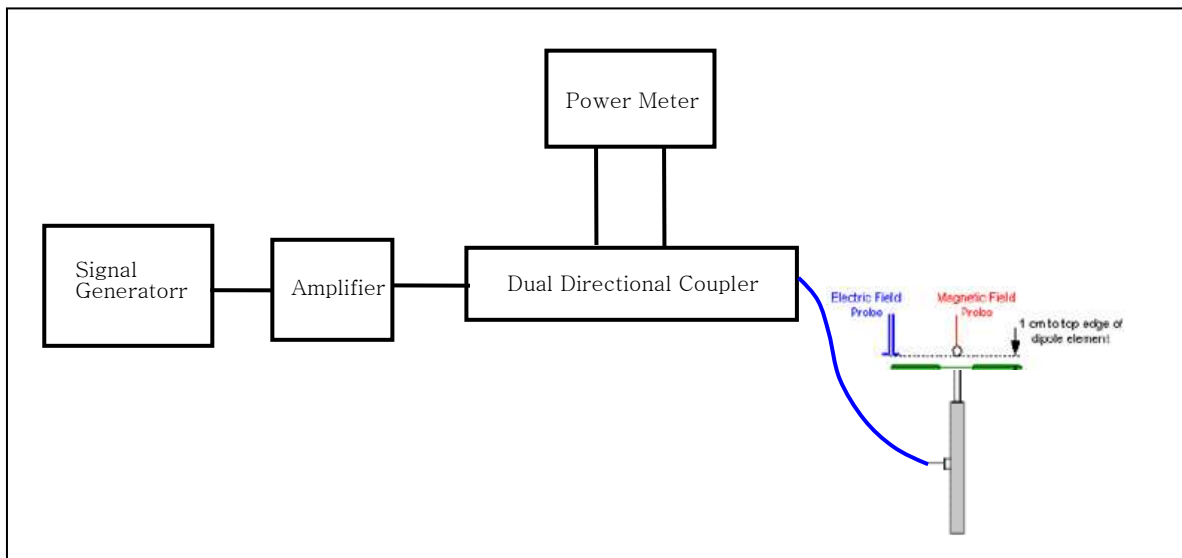

Figure 6. Dipole Validation SET-UP

5.2 Validation Result

5.2.1 E-Field Scan

Mode	Freq. [MHz]	Input Power [dBm]	Measured Value [V/m]	Target Value [V/m] SPEAG	Deviation [%]	Limit [%]
CW	835	20	162.95	164.35	- 0.85	± 25
CW	1 880	20	142.75	138.2	+ 3.29	± 25

5.2.2 H-Field Scan

Mode	Freq. [MHz]	Input Power [dBm]	Measured Value [A/m]	Target Value [A/m] SPEAG	Deviation [%]	Limit [%]
CW	835	20	0.456	0.46	- 0.87	± 25
CW	1 880	20	0.440	0.46	- 4.35	± 25

Notes:

- 1) Deviation (%) = 100 * (Measured value minus Target value) divided by Target value.
ANSI-C63.19 requires values to be within 25 % of their targets. 12 % is deviation and 13 % is measurement uncertainty.
- 2) The maximum E-field or H-field were evaluated and compared to the target values provided by SPEAG in the calibration certificate of specific dipoles.
- 3) Please refer to the attachment for detailed measurement data and plot.

6. Probe Modulation Factor

A calibration was made of the modulation response of the probe and its instrumentation chain. This calibration was performed with the field probe, attached to its instrumentation. The response of the probe system to a CW field at the frequency of interest is compared to its response to a modulated signal with equal peak amplitude to that of a CW signal. The field level of the test signals are ensured to be more than 10 dB above the ambient level and the noise floor of the instrumentation being used. The ratio of the CW reading to that taken with a modulated reading was applied to the DUT measurements.

All voice modes for this device have been investigated in this section of the report. According to the FCC 3G Measurement Procedures, May 2006 for RF Emissions, variations in peak field and power readings.

This was done using the following procedure:

1. The probe was illuminated with a CW signal at the intended measurement frequency and wireless device power.
2. The probe was positioned at the field maxima over the dipole antenna (determined after an area scan over the dipole) illuminated with the CW signal.
3. The reading of the probe measurement system of the CW signal at the maximum point was recorded.
4. Using a Spectrum Analyzer, the modulated signal adjusted with the same peak level of the CW signal was determined.
5. The probe measurement system reading was recorded with the modulated signal. The appropriate system crest factors for the modulation type were configured in the software to the system measurements.
6. The ratio of the CW reading to modulated signal reading is the probe modulation factor (PMF) for the modulation and field probe combination. This was repeated for 80 % AM.
7. Steps 1-6 were repeated at all frequency bands and for both E and H field probes.

The modulation factors obtained were applied to readings taken of the actual wireless device, in order to obtain an accurate peak field reading using the formula:

$$\text{Peak} = 20 \cdot \log (\text{Raw} \cdot \text{PMF})$$

This method correlates well with the modulation using the DUT in the alternative substitution method. See below for correlation of signal:



Figure. 7
Signal Generator Modulated Signal

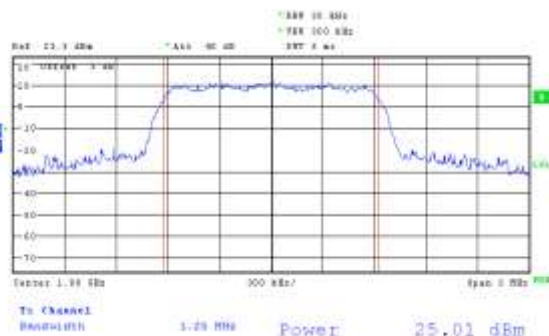

Figure. 8
Wireless Device Modulated Signal

6.2 Modulation Factor

6.2.1 E-Field

Mode	Freq. [MHz]	Input Power [dB]	E-Field measured value [V/m]	Probe Modulation Factor
CW	835	25.7	307.7	-
80 % AM		25.7	178.9	1.720
CDMA (Full Rate)		25.7	321.1	0.958
CDMA (1/8 Rate)		25.7	97.46	2.983
CW	1 880	25.3	238.4	-
80 % AM		25.3	127.3	1.873
CDMA (Full Rate)		25.3	249.8	0.954
CDMA (1/8 Rate)		25.3	71.15	2.971

6.2.2 H-Field

Mode	Freq. [MHz]	Input Power [dB]	H-Field measured value [A/m]	Probe Modulation Factor
CW	835	25.7	0.963	-
80 % AM		25.7	0.618	1.558
CDMA (Full Rate)		25.7	1.124	0.857
CDMA (1/8 Rate)		25.7	0.338	2.787
CW	1 880	25.3	0.811	-
80 % AM		25.3	0.548	1.480
CDMA (Full Rate)		25.3	0.995	0.815
CDMA (1/8 Rate)		25.3	0.286	2.780

Notes:

- 1) Modulation Factor = CW / WD_CDMA

6.2.3 PMF Peak Power Measurement Plots

Probe Modulation Factor (CW)

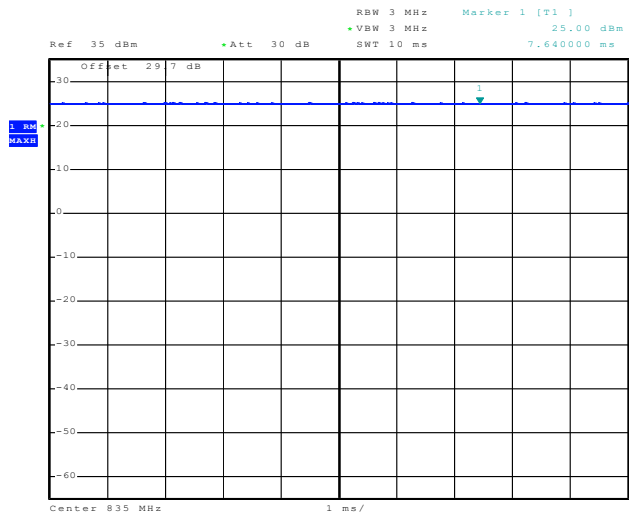

Date: 3.JUL.2007 14:06:31

Probe Modulation Factor (AM 80 %)

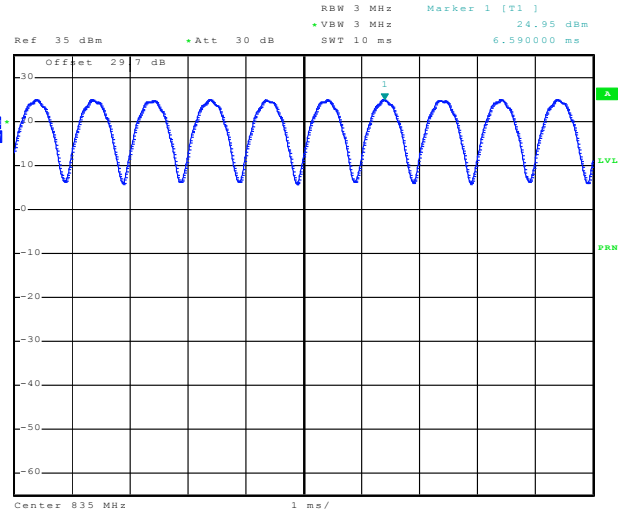

Date: 3.JUL.2007 14:07:23

Probe Modulation Factor (CDMA: full rate)

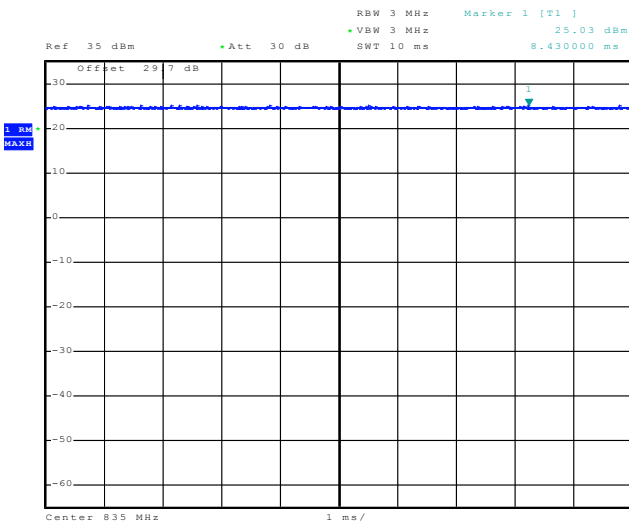

Date: 3.JUL.2007 14:10:56

Probe Modulation Factor (CDMA: 1/8 rate)

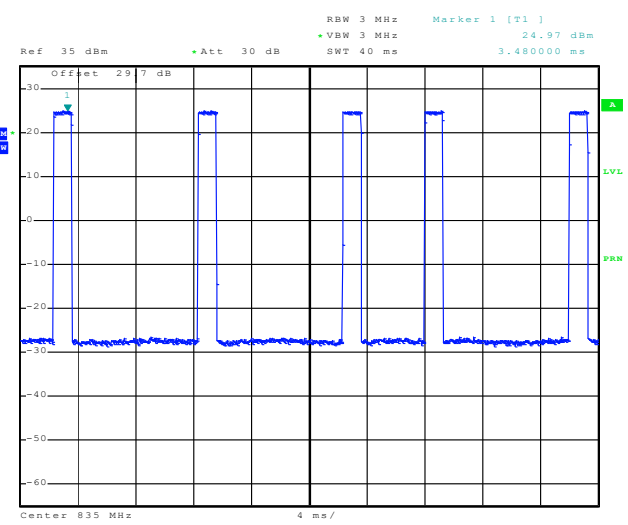

Date: 3.JUL.2007 14:15:45

Spectrum Analyzer Settings

- Input Power: 25.7 dBm
- RBW: 3 MHz
- Video Bandwidth: 3 MHz
- Span: Zero
- Sweep Time: 10 ms
- Detection: Peak detection (RMS)

7. FCC 3G MEASUREMENTS – MAY / JUNE 2006

Power measurements were performed using a base station simulator under digital average power.

7.1 Procedures Used to Establish RF Signal for HAC Testing

The handset was placed into a simulated call using a base station simulator in a shielded chamber.

Such test signals offer a consistent means for testing HAC and are recommended for evaluating HAC.

Measurements were taken with a fully charged battery. In order to verify that the device was tested and maintained at full power, this was configured with the base station simulator. The HAC measurement software calculates a reference point at the start and end of the test to check for power drifts. If conducted power deviations of more than 5 % occurred, the tests were repeated.

7.1 HAC Measurement Conditions for UMTS

Output Power Verification

Maximum output power is verified on the High, Middle and Low channel according to the general description in section 5.2 of 3GPP TS 34.121, using the appropriate RMC or AMR with TPC(transmit power control) set to all "1s".

HAC Measurements

HAC is measured using the 12.2 kbps RMC with TPC bits configured to all "1s". HAC in AMR configurations is not required when the maximum average output of each RF channel for 12.2 kbps AMR is less than 1/4 dB higher than that measured in 12.2 kbps RMC. Otherwise, HAC is measured on the maximum output channel in AMR with a 3.4kbps SRB (signaling radio bearer) using the configuration that results in the highest HAC for that RF channel in 12.2 RMC.

Average Output Power Measurement for FCC ID: RAD278

Band	Channel	SO2	SO2	SO55	SO55	TDSO	1xEvDO	1xEvDO	1xEvDO	1xEvDO
		RC1/1	RC3/3	RC1/1	RC3/3	RC3/3	Rev.0	Rev.0	Rev.A	Rev.A
		(dBm)	(dBm)	(dBm)	(dBm)	(dBm)	(FTAP)	(RTAP)	(FETAP)	(RETAP)
CDMA	1013	25.68	25.7	25.69	25.7	25.7	25.65	25.55	25.67	25.68
	384	25.56	25.57	25.57	25.55	25.59	25.64	25.53	25.64	25.7
	777	25.55	25.54	25.55	25.54	25.56	25.56	25.49	25.6	25.69
AWS	25	25.14	25.14	25.12	25.01	25.15	24.91	24.94	24.98	24.93
	450	24.84	24.89	24.83	24.86	24.89	24.72	24.74	24.73	24.72
	875	24.79	24.8	24.73	24.8	24.79	24.94	25.04	24.93	25.03
PCS	25	24.82	24.84	24.76	24.8	24.81	24.84	24.84	24.84	25.03
	600	24.89	24.87	24.86	24.86	24.88	24.81	24.86	24.8	24.83
	1175	25.19	25.16	25.14	25.1	25.19	25.24	25.11	25.18	25.17

7.2 Worst-Case Probe Location Measurements

Below are RC/SO mode investigation results of the device at the worst-case (maximum) field point location.

The worst-case RC/SO was used for HAC testing.

Mode	Channel	Backlight	RC/SO	Battery	Antenna	Conducted Power [dBm]	Time Avg. Field [V/m]	Peak Field [dBV/m]	FCC Limit [dBV/m]	FCC MARGIN [dB]	RESULT
PCS	25	off	SO55/RC3	Standard	Intenna	24.8	49.16	33.4	41	-7.58	M4
PCS	25	on	SO55/RC3	Standard	Intenna	24.8	49.09	33.4	41	-7.59	M4
PCS	25	off	SO2/RC1	Standard	Intenna	24.82	48.94	33.4	41	-7.62	M4
PCS	25	off	SO3/RC1	Standard	Intenna	24.85	17.27	34.2	41	-6.80	M4
PCS	25	off	SO55/RC1	Standard	Intenna	24.76	49.02	33.4	41	-7.60	M4
PCS	25	off	SO9/RC2	Standard	Intenna	24.6	48.96	33.4	41	-7.61	M4
PCS	25	off	SO2/RC3	Standard	Intenna	24.84	48.99	33.4	41	-7.61	M4
PCS	25	off	SO3/RC3	Standard	Intenna	24.81	49.13	33.4	41	-7.58	M4

8. TEST PROCEDURE

Test Instructions

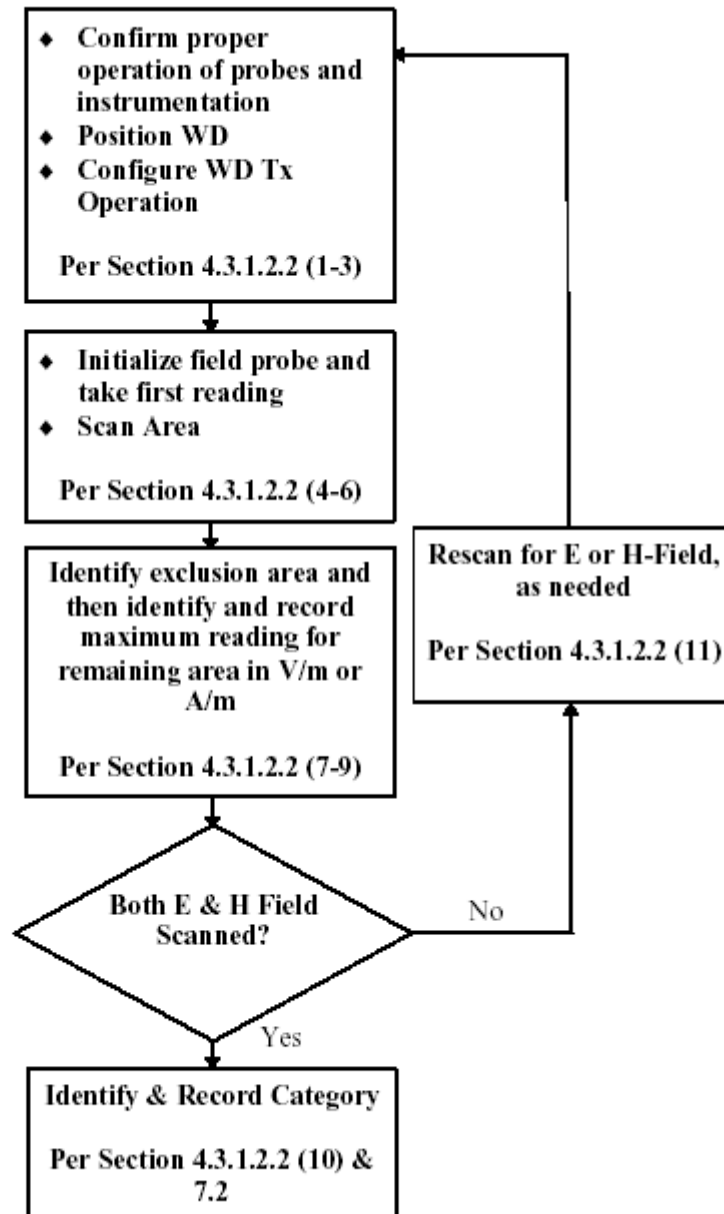

Figure 9. WD near-field emission automated test flowchart

The evaluation was performed with the following procedure:

1. Confirm proper operation of the field probe, probe measurement system and other instrumentation and the positioning system.
2. Position the WD in its intended test position. The measurement should be performed at a distance 1.5 cm from the probe elements so the gauge block can simplify this positioning.
3. Configure the WD normal operation for maximum rated RF output power, at the desired channel and other operating parameters, as intended for the test.
4. The center sub-grid shall be centered on the center of the WD output (acoustic or T-Coil output), as appropriate.
5. A Surface calibration was performed before each setup change to ensure repeatable spacing and proper maintenance of the measurement plane using the HAC Phantom.
6. Locate the field probe at reference location and measure the field strength.
7. Scan the entire 5 cm by 5 cm region at 5 mm increments and record the reading at each measurement point.
8. Identify the maximum field reading within the non-excluded sub-grids identified in Step 7.
9. Move the probe to the location of maximum scan measurement and then 360° rotating the probe to align it for the maximum reading at that position.
10. Locate the field probe at the reference location and measure the field strength for drift evaluation. If conducted power deviations of more than 5 % occurred, the tests were repeated.
11. Convert the maximum field strength reading identified in Step 8 to V/m or A/m, as appropriate. For probes which require a probe modulation factor, this conversion shall be done using the appropriate probe modulation.
12. Repeat Step 1 through Step 11 for both the E and H field measurements.

9. ANSI/IEEE C63.19 PERFORMANCE CATEGORIES

The EUT must meet the following M3 or M4 category:

Category	Telephone RF Parameters		
Near Field	AWF [dB]	E-Field Emissions dB [V/m]	H-Field Emissions dB [A/m]
Frequency < 960 MHz			
M1	0	56 to 61	+ 5.6 to + 10.6
	-5	53.5 to 58.5	+ 3.1 to + 8.1
M2	0	51 to 56	+ 0.6 to + 5.6
	-5	48.5 to 53.5	- 1.9 to + 3.1
M3	0	46 to 51	- 4.4 to + 0.6
	-5	43.5 to 48.5	- 6.9 to - 1.9
M4	0	< 46	< - 4.4
	-5	< 43.5	< - 6.9
Frequency > 960 MHz			
M1	0	46 to 51	- 4.4 to 0.6
	-5	43.5 to 48.5	- 6.9 to -1.9
M2	0	41 to 46	- 9.4 to - 4.4
	-5	38.5 to 43.5	-11.9 to - 6.9
M3	0	36 to 41	- 14.4 to - 9.4
	-5	33.5 to 38.5	- 16.9 to -11.9
M4	0	< 36	< - 14.4
	-5	< 33.5	< - 16.9

Table 9.1. Telephone near-field categories in linear units

10. MEASUREMENT UNCERTAINTIES

10.1 E-Field

HAC (E-Field) Uncertainty Budget [According to ANSI C63.19]										Note/ Comment
Error Description	Uncertainty [%]	Probability Distribution	Divisor	ci [E]	Standard Uncertainty [E]	Stand Uncert*2	(Stand Uncert*2) X (ci*2)	Vi & Veff		
Measurement system										
1	Probe Calibration	5.1 %	Normal	1.00	1	5.1 %	26.01	26.01	∞	
2	Axial Isotropy	4.7 %	Rectangular	1.73	1	2.7 %	7.36	7.36	∞	
3	Sensor Displacement	16.5 %	Rectangular	1.73	1	9.5 %	90.75	90.75	∞	
4	Boundary effect	2.4 %	Rectangular	1.73	1	1.4 %	1.92	1.92	∞	
5	Linearity	4.7 %	Rectangular	1.73	1	2.7 %	7.36	7.36	∞	
6	Scaling to peak Envelope Power	2.0 %	Rectangular	1.73	1	1.2 %	1.33	1.33	∞	
7	System Detection limits	1.0 %	Rectangular	1.73	1	0.6 %	0.33	0.33	∞	
8	Readout Electronics	0.3 %	Normal	1.00	1	0.3 %	0.09	0.09	∞	
9	Response time	0.8 %	Rectangular	1.73	1	0.5 %	0.21	0.21	∞	
10	Integration time	2.6 %	Rectangular	1.73	1	1.5 %	2.25	2.25	∞	
11	RF Ambient Conditions	3.0 %	Rectangular	1.73	1	1.7 %	3.00	3.00	∞	
12	RF Reflections	1.2 %	Rectangular	1.73	1	0.7 %	0.50	0.50	∞	
13	Probe positioner	1.2 %	Rectangular	1.73	1	0.7 %	0.48	0.48	∞	
14	Probe positioning	4.7 %	Rectangular	1.73	1	2.7 %	7.36	7.36	∞	
15	Extrap. And Interpolation	1.0 %	Rectangular	1.73	1	0.6 %	0.33	0.33	∞	
Test Sample Related										
16	Device Positioning Vertical	4.7 %	Rectangular	1.73	1	2.7 %	7.36	7.36	∞	
17	Device Positioning Lateral	1.0 %	Rectangular	1.73	1	0.6 %	0.33	0.33	∞	
18	Device Holder and Phantom	2.4 %	Rectangular	1.73	1	1.4 %	1.92	1.92	∞	
19	Test Sample	0.4 %	Normal	1.00	1	0.4 %	0.16	0.16	9	0.17 dB
20	Power drift	3.0 %	Rectangular	1.73	1	1.7 %	3.00	3.00	∞	
PMF Calculations										
21	Power Sensor	1.0 %	Rectangular	1.73	1	0.6 %	0.32	0.32	∞	
22	Dual Directional Coupler	1.0 %	Rectangular	1.73	1	0.6 %	0.32	0.32	∞	
Phantom and Setup Related										
23	Phantom Thickness	2.4 %	Rectangular	1.73	1	1.4 %	1.92	1.92	∞	
Combined standard Uncertainty [%]						12.8 %		164.64		0.523 dB
Expanded standard Uncertainty [k = 2 , Confidence 95 %]						25.7 %				0.993 dB

Table 10.1. Uncertainties (E-Field)

Notes:

1. Worst-Case uncertainty budget for HAC free field assessment according to ANSI-C 63.19[1].The budget is valid for the frequency range 800 MHz-3 GHz and represents a worst-Case analysis. For specific test sand configurations, the uncertainty could be considerably smaller. Some of the parameters are dependent on the user situations and need adjustment according to the actual laboratory conditions.
2. * Uncertainty specifications from Schmidt & Partner Engineering AG (not site specific)

10.2 H-Field

HAC (H-Field) Uncertainty Budget [According to ANSI C63.19]										Note/ Comment
Error Description	Uncertainty [%]	Probability Distribution	Divisor	ci [H]	Standard Uncertainty [H]	Stand Uncert*2	(Stand Uncert*2) X (ci^2)	Vi & Veff		
Measurement system										
1	Probe Calibration	5.1 %	Normal	1.00	1	5.1 %	26.01	26.01	∞	
2	Axial Isotropy	4.7 %	Rectangular	1.73	1	2.7 %	7.36	7.36	∞	
3	Sensor Displacement	16.5 %	Rectangular	1.73	0.145	1.4 %	1.91	0.04	∞	
4	Boundary effect	2.4 %	Rectangular	1.73	1	1.4 %	1.92	1.92	∞	
5	Linearity	4.7 %	Rectangular	1.73	1	2.7 %	7.36	7.36	∞	
6	Scaling to peak Envelope Power	2.0 %	Rectangular	1.73	1	1.2 %	1.33	1.33	∞	
7	System Detection limits	1.0 %	Rectangular	1.73	1	0.6 %	0.33	0.33	∞	
8	Readout Electronics	0.3 %	Normal	1.00	1	0.3 %	0.09	0.09	∞	
9	Response time	0.8 %	Rectangular	1.73	1	0.5 %	0.21	0.21	∞	
10	Integration time	2.6 %	Rectangular	1.73	1	1.5 %	2.25	2.25	∞	
11	RF Ambient Conditions	3.0 %	Rectangular	1.73	1	1.7 %	3.00	3.00	∞	
12	RF Reflections	1.1 %	Rectangular	1.00	1	1.1 %	1.14	1.14	∞	
13	Probe positioner	1.2 %	Rectangular	1.73	0.67	0.5 %	0.22	0.10	∞	
14	Probe positioning	4.7 %	Rectangular	1.73	0.67	1.8 %	3.31	1.48	∞	
15	Extrap. And Interpolation	1.0 %	Rectangular	1.73	1	0.6 %	0.33	0.33	∞	
Test Sample Related										
16	Device Positioning Vertical	4.7 %	Rectangular	1.73	0.67	1.8 %	3.31	7.32	∞	
17	Device Positioning Lateral	1.0 %	Rectangular	1.73	1	0.6 %	0.33	0.33	∞	
18	Device Holder and Phantom	2.4 %	Rectangular	1.73	1	1.4 %	1.92	1.92	∞	
19	Test Sample	0.3 %	Normal	1.00	1	0.3 %	0.08	0.08	9	0.013 dB
20	Power drift	3.0 %	Rectangular	1.73	1	1.7 %	3.00	3.00	∞	
PMF Calculations										
21	Power Sensor	1.0 %	Rectangular	1.73	1	0.6 %	0.32	0.10	∞	
22	Dual Directional Coupler	1.0 %	Rectangular	1.73	1	0.6 %	0.32	0.32	∞	
Phantom and Setup Related										
23	Phantom Thickness	2.4 %	Rectangular	1.73	0.67	0.9 %	0.86	0.39	∞	
Combined standard Uncertainty [%]						8.2 %		66.44		0.342 dB
Expanded standard Uncertainty [k = 2 , Confidence 95 %]						16.3 %				0.6558 dB

Table 10.2. Uncertainties (H-Field)

Notes:

1. Worst-Case uncertainty budget for HAC free field assessment according to ANSI-C 63.19[1].The budget is valid for the frequency range 800 MHz-3 GHz and represents a worst-Case analysis. For specific test sand configurations, the uncertainty could be considerably smaller. Some of the parameters are dependent on the user situations and need adjustment according to the actual laboratory conditions.

2. * Uncertainty specifications from Schmidt & Partner Engineering AG (not site specific)

11. HAC TEST DATA SUMMARY

Ambient TEMPERATURE (°C): 21.5 °C

S/N: #1

11.1 Measurement Results (E-Field CDMA / PCS DATA/ AWS DATA)

Mode	Ch.	Backlight	RC/SO	Battery	Antenna	Conducted Power (dBm)	Time Avg. Field (V/m)	Peak Field (dBV/m)	FCC Limit (dBV/m)	FCC MARGIN (dB)	Exclusion Block	RESULT
CDMA	1013	off	SO55/RC3	Standard	Intenna	25.7	68.3	36.3	51	-14.69	none	M4
CDMA	384	off	SO55/RC3	Standard	Intenna	25.55	60.6	35.3	51	-15.73	none	M4
CDMA	777	off	SO55/RC3	Standard	Intenna	25.54	64.6	35.8	51	-15.17	none	M4
PCS	25	off	SO55/RC3	Standard	Intenna	25.01	48.2	33.2	41	-7.75	none	M4
PCS	600	off	SO55/RC3	Standard	Intenna	24.86	42.1	32.1	41	-8.92	none	M4
PCS	1175	off	SO55/RC3	Standard	Intenna	24.8	43.0	32.3	41	-8.74	none	M4
AWS	25	off	SO55/RC3	Standard	Intenna	24.8	44.2	32.5	41	-8.51	none	M4
AWS	450	off	SO55/RC3	Standard	Intenna	24.86	48.0	33.2	41	-7.79	none	M4
AWS	875	off	SO55/RC3	Standard	Intenna	25.1	47.4	33.1	41	-7.90	none	M4

NOTES:

- All modes of operation were investigated and the worst-case are reported.
- Battery Type Standard Extended Fixed
- Power Measured Conducted EIRP ERP
- Test Signal Call Mode Manual Test cord Base Station Simulator
- SAR Measurement System SPEAG

11. HAC TEST DATA SUMMARY

Ambient TEMPERATURE (°C): 21.5 °C
 S/N: #1

11.2 Measurement Results (H-Field CDMA / PCS DATA/ AWS DATA)

Mode	Ch.	Backlight	RC/SO	Battery	Antenna	Conducted Power (dBm)	Time Avg. Field (A/m)	Peak Field (dBA/m)	FCC Limit (dBA/m)	FCC MARGIN (dB)	Exclusion Block	RESULT
CDMA	1013	off	SO55/RC3	Standard	Intenna	25.7	0.151	-17.7	0.6	-18.34	none	M4
CDMA	384	off	SO55/RC3	Standard	Intenna	25.55	0.136	-18.7	0.6	-19.30	none	M4
CDMA	777	off	SO55/RC3	Standard	Intenna	25.54	0.142	-18.3	0.6	-18.88	none	M4
PCS	25	off	SO55/RC3	Standard	Intenna	25.01	0.119	-20.3	-9.4	-10.90	none	M4
PCS	600	off	SO55/RC3	Standard	Intenna	24.86	0.105	-21.3	-9.4	-11.94	none	M4
PCS	1175	off	SO55/RC3	Standard	Intenna	24.8	0.112	-20.8	-9.4	-11.42	none	M4
AWS	25	off	SO55/RC3	Standard	Intenna	24.8	0.116	-20.5	-9.4	-11.10	none	M4
AWS	450	off	SO55/RC3	Standard	Intenna	24.86	0.119	-20.3	-9.4	-10.88	none	M4
AWS	875	off	SO55/RC3	Standard	Intenna	25.1	0.118	-20.4	-9.4	-10.97	none	M4

NOTES:

1. All modes of operation were investigated and the worst-case are reported.
2. Battery Type Standard Extended Fixed
3. Power Measured Conducted EIRP ERP
4. Test Signal Call Mode Manual Test cord Base Station Simulator
5. SAR Measurement System SPEAG

11.3 Worst-case Configuration Evaluation

Ambient TEMPERATURE (°C): 21.5 °C

S/N: #1

Peak Reading 360° Probe Rotation at Azimuth axis

Mode	Chan nel	Backlight	Antenna	Conducted Power (dBm)	Time Avg. Field (V/m)	Peak Field (dBV/m)	FCC Limit (dBV/m)	FCC MARGIN (dB)	RESULT	Exclusion Block
PCS	25	off	Standard	25.01	48.7	33.3	41	-7.66	M4	none

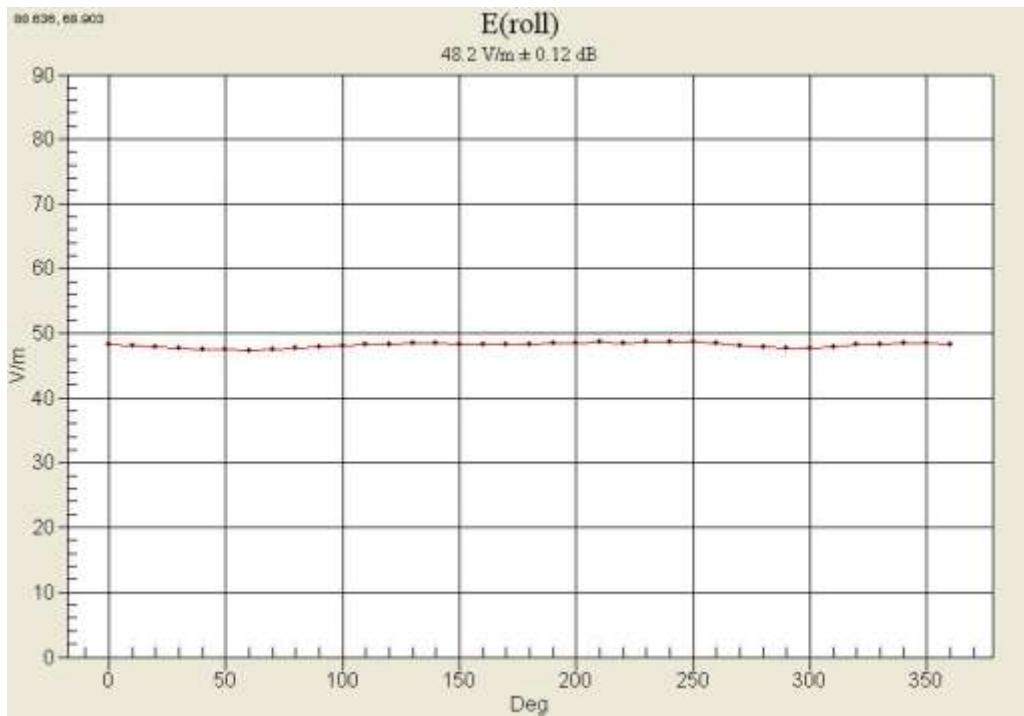

Worst-Case Probe Rotation about Azimuth axis

12. HAC TEST EQUIPMENT LIST

Manufacturer	Type / Model	S/N	Calib. Date	Calib. Interval	Calib. Due
Staubli	Robot RX90L	F01/ 5K09A1/A/01	N/A	N/A	N/A
Staubli	Robot ControllerCS7MB	F99/5A82A1/C/01	N/A	N/A	N/A
Staubli	Teach Pendant (Joystick)	D221340.01	N/A	N/A	N/A
HP	Pavilion t000_puffer	KRJ51201TV	N/A	N/A	N/A
SPEAG	SPEAG HAC Phantom	-	N/A	N/A	N/A
SPEAG	Light Alignment Sensor	265	N/A	N/A	N/A
SPEAG	DAE4	446	09/27/11	Annual	09/27/12
SPEAG	E-Field Probe	2343	05/16/11	Annual	05/16/12
SPEAG	H-Field Probe	6101	05/18/11	Annual	05/18/12
SPEAG	Validation Dipole CD835V2	1024	03/19/12	Annual	03/19/13
SPEAG	Validation Dipole CD1880V2	1019	03/19/12	Annual	03/19/13
Agilent	Power Meter(F) E4419B	MY41291386	11/04/11	Annual	11/04/12
Agilent	Power Sensor(G) 8481	MY41090870	11/04/11	Annual	11/04/12
HP	Signal Generator E4438C	MY42082646	11/11/11	Annual	11/11/12
EM POWER	Power Amp BBS3Q7ELU	1009D/C0028	11/04/11	Annual	11/04/12
HP	Dual Directional Coupler 778D	16072	11/04/11	Annual	11/04/12
R&S	Base Station CMU200	110740	07/26/11	Annual	07/26/12
Agilent	Base Station E5515C	GB444400269	02/10/12	Annual	02/10/13
R&S	Spectrum Analyzer FSP30	839117/011	02/09/12	Annual	02/09/13

NOTE:

The probe was calibrated by SPEAG, by the waveguide technique procedure. Dipole Validation measurement is performed by HCT Lab. before each test.

13. CONCLUSION

The HAC measurement indicates that the EUT complies with the HAC limits of the ANSI-C63.19-2007. These measurements are taken to simulate the RF effects exposure under worst-case conditions. Precise Laboratory measures were taken to assure repeatability of the tests.