



ANSI C63.19

TEST REPORT

Product Name HSUPA/HSDPA/UMTS triband / GSM quadband mobile phone

Model Name ONE TOUCH 991S

FCC ID RAD256

Client TCT Mobile Limited

TA Technology (Shanghai) Co., Ltd.

TA Technology (Shanghai) Co., Ltd.
Test Report

Report No. RXA1204-0069HAC01R1

Page 2 of 134

GENERAL SUMMARY

Product Name	HSUPA/HSDPA/UMTS triband / GSM quadband mobile phone	Model	ONE TOUCH 991S
Report No.	RXA1204-0069HAC01R1	FCC ID	RAD256
Client	TCT Mobile Limited		
Manufacturer	TCT Mobile Limited		
Reference Standard(s)	ANSI C63.19-2007: American National Standard Methods of Measurement of Compatibility between Wireless Communications Devices and Hearing Aids.		
Conclusion	<p>This portable wireless equipment has been measured in all cases requested by the relevant standards.</p> <p>General Judgment: M3 (RF Emission)</p> <div style="text-align: right;">  <p>(Stamp) Date of issue: May 31st, 2012</p> </div>		
Comment	The test result only responds to the measured sample.		

Approved by 杨伟中
Director

Revised by 凌敏宝
SAR Manager

Performed by 沈辰
SAR Engineer

TABLE OF CONTENT

1. General Information	4
1.1. Notes of the Test Report.....	4
1.2. Testing Laboratory	4
1.3. Applicant Information	5
1.4. Manufacturer Information.....	5
1.5. Information of EUT.....	6
1.6. The Ambient Conditions during Test.....	8
1.7. The Total M-rating of each tested band	8
1.8. Test Date	8
2. Test Information	9
2.1. Operational Conditions during Test.....	9
2.1.1. General Description of Test Procedures	9
2.1.2. GSM/WCDMA Test Configuration	9
2.2. HAC RF Measurements System Configuration.....	10
2.2.1. HAC Measurement Set-up.....	10
2.2.2. Probe System	11
2.2.3. Test Arch Phantom & Phone Positioner	12
2.3. RF Test Procedures.....	13
2.4. System Check.....	15
2.5. Probe Modulation Factor.....	17
2.6. Conducted Output Power Measurement.....	19
3. Test Results	20
3.1. ANSI C63.19-2007 Limits	20
3.2. Summary Test Results.....	21
4. Measurement Uncertainty	25
5. Main Test Instruments	27
ANNEX A: System Check Results.....	28
ANNEX B: Graph Results.....	32
ANNEX C: E-Probe Calibration Certificate	96
ANNEX D: H-Probe Calibration Certificate.....	106
ANNEX E: CD835V3 Dipole Calibration Certificate.....	116
ANNEX F: CD1880V3 Dipole Calibration Certificate.....	122
ANNEX G: DAE4 Calibration Certificate.....	128
ANNEX H: The EUT Appearances and Test Configuration.....	133

1. General Information

1.1. Notes of the Test Report

TA Technology (Shanghai) Co., Ltd. guarantees the reliability of the data presented in this test report, which is the results of measurements and tests performed for the items under test on the date and under the conditions stated in this test report and is based on the knowledge and technical facilities available at TA Technology (Shanghai) Co., Ltd. at the time of execution of the test.

TA Technology (Shanghai) Co., Ltd. is liable to the client for the maintenance by its personnel of the confidentiality of all information related to the items under test and the results of the test. This report only refers to the item that has undergone the test.

This report standalone dose not constitute or imply by its own an approval of the product by the certification Bodies or competent Authorities. This report cannot be used partially or in full for publicity and/or promotional purposes without previous written approval of **TA Technology (Shanghai) Co., Ltd.** and the Accreditation Bodies, if it applies.

If the electrical report is inconsistent with the printed one, it should be subject to the latter.

1.2. Testing Laboratory

Company: TA Technology (Shanghai) Co., Ltd.
Address: No.145, Jintang Rd, Tangzhen Industry Park, Pudong Shanghai, China
City: Shanghai
Post code: 201201
Country: P. R. China
Contact: Yang Weizhong
Telephone: +86-021-50791141/2/3
Fax: +86-021-50791141/2/3-8000
Website: <http://www.ta-shanghai.com>
E-mail: yangweizhong@ta-shanghai.com

TA Technology (Shanghai) Co., Ltd.
Test Report

Report No. RXA1204-0069HAC01R1

Page 5 of 134

1.3. Applicant Information

Company: TCT Mobile Limited
Address: 5F, E building, No. 232, Liang Jing Road ZhangJiang High-Tech Park, Pudong Area
Shanghai, P.R. China. 201203
City: Shanghai
Postal Code: 201203
Country: P.R. China
Contact: Gong Zhizhou
Telephone: 0086-21-61460890
Fax: 0086-21-61460602

1.4. Manufacturer Information

Company: TCT Mobile Limited
Address: 5F, E building, No. 232, Liang Jing Road ZhangJiang High-Tech Park, Pudong Area
Shanghai, P.R. China. 201203
City: Shanghai
Postal Code: 201203
Country: P.R. China
Telephone: 0086-21-61460890
Fax: 0086-21-61460602

TA Technology (Shanghai) Co., Ltd.

Test Report

Report No. RXA1204-0069HAC01R1

Page 6 of 134

1.5. Information of EUT

General Information

Device Type:	Portable Device		
Product Name:	HSUPA/HSDPA/UMTS triband / GSM quadband mobile phone		
IMEI:	013112000020642		
Hardware Version:	PIO02		
Software Version:	vF1J_AWS		
Antenna Type:	Internal Antenna		
Device Operating Configurations:			
Supporting Mode(s):	GSM 850/GSM 1900; (tested)		
	WCDMA Band IV/WCDMA Band V; (tested)		
	GSM 900/GSM 1800; (untested)		
	WCDMA Band I; (untested)		
	Bluetooth/WiFi(b/g/n HT20); (untested)		
Test Modulation:	(GSM)GMSK; (WCDMA) QPSK		
Device Class:	B		
HSDPA UE Category:	8		
HSUPA UE Category:	6		
GPRS Multislot Class(12):	Max Number of Timeslots in Uplink	4	
	Max Number of Timeslots in Downlink	4	
	Max Total Timeslot	5	
EGPRS Multislot Class(12):	Max Number of Timeslots in Uplink	4	
	Max Number of Timeslots in Downlink	4	
	Max Total Timeslot	5	
Operating Frequency Range(s):	Mode	Tx (MHz)	Rx (MHz)
	GSM 850	824.2 ~ 848.8	869.2 ~ 893.8
	GSM 1900	1850.2 ~ 1909.8	1930.2 ~ 1989.8
	WCDMA Band IV	1712.4 ~ 1752.6	2112.4 ~ 2152.6
	WCDMA Band V	826.4 ~ 846.6	871.4 ~ 891.6
Test Channel: (Low - Middle - High)	128-190-251	(GSM 850) (tested)	
	512-661-810	(GSM 1900) (tested)	
	1312 - 1413 - 1513	(WCDMA Band IV) (tested)	
	4132 - 4183 - 4233	(WCDMA Band V) (tested)	
Power Class:	GSM 850: 4, tested with power level 5		
	GSM 1900: 1, tested with power level 0		
	WCDMA Band IV: 3, tested with power control all up bits		
	WCDMA Band V: 3, tested with power control all up bits		

TA Technology (Shanghai) Co., Ltd.
Test Report

Report No. RXA1204-0069HAC01R1

Page 7 of 134

Auxiliary Equipment Details

Name	Model	Manufacturer	S/N
Battery 1	CAB31P0000C1	BYD	B31806018EA
Battery 2	CAB31P0000C2	BAK	BAK2011060100311

Equipment Under Test (EUT) is a HSUPA/HSDPA/UMTS triband / GSM quadband mobile phone. The detail about EUT and Lithium Battery is in chapter 1.5 in this report. The device has an internal antenna for GSM/WCDMA Tx/Rx, and the other is BT/WiFi antenna that is used for Tx/Rx. It has Proximity Sensor function .HAC is tested for GSM 850, GSM 1900, WCDMA Band IV and WCDMA Band V. BT/WiFi mode doesn't have voice capability, and does not operate in the held to ear mode for providing handset service.

The sample under test was selected by the Client.

Components list please refer to documents of the manufacturer.

TA Technology (Shanghai) Co., Ltd.
Test Report

Report No. RXA1204-0069HAC01R1

Page 8 of 134

1.6. The Ambient Conditions during Test

Temperature	Min. = 18°C, Max. = 28 °C
Relative humidity	Min. = 0%, Max. = 80%
Ground system resistance	< 0.5 Ω
Ambient noise is checked and found very low and in compliance with requirement of standards. Reflection of surrounding objects is minimized and in compliance with requirement of standards.	

1.7. The Total M-rating of each tested band

Mode	Rating
GSM 850	M3
GSM 1900	M3
WCDMA Band IV	M4
WCDMA Band V	M4

1.8. Test Date

The test performed on May 7, 2012.

2. Test Information

2.1. Operational Conditions during Test

2.1.1. General Description of Test Procedures

The phone was tested in all normal configurations for the ear use. The EUT is mounted in the device holder equivalent as for classic dosimeter measurements. The acoustic output of the EUT shall coincide with the center point of the area formed by the dielectric wire and the middle bar of the arch's top frame. The EUT shall be moved vertically upwards until it touches the frame. The fine adjustment is possible by sliding the complete. The EUT holder is on the yellow base plate of the Test Arch phantom. These test configurations are tested at the high, middle and low frequency channels of each applicable operating mode; for example, GSM, WCDMA (UMTS), CDMA and TDMA.

2.1.2. GSM/WCDMA Test Configuration

A communication link is set up with a System Simulator (SS) by air link, and a call is established. The Absolute Radiofrequency Channel Number (ARFCN) is allocated to 128, 190 and 251 in the case of GSM 850, to 512, 661 and 810 in the case of GSM 1900, to 1312, 1413 and 1513 in the case of WCDMA Band IV, to 4132, 4183 and 4233 in the case of WCDMA Band V. The EUT is commanded to operate at maximum transmitting power. Using E5515C the power level is set to "5" for GSM 850, set to "0" for GSM 1900. Set to all up bits for WCDMA. The test in the bands of GSM 850/GSM 1900 and WCDMA Band IV /WCDMA Band V are performed in the mode of speech transfer function.

2.2. HAC RF Measurements System Configuration

2.2.1. HAC Measurement Set-up

These measurements are performed using the DASY4 automated dosimetric assessment system. It is made by Schmid & Partner Engineering AG (SPEAG) in Zurich, Switzerland. It consists of high precision robotics system (Stäubli), robot controller, Intel Core2 computer, near-field probe, probe alignment sensor. The robot is a six-axis industrial robot performing precise movements. Cell controller systems contain the power supply, robot controller, teach pendant (Joystick) and remote control, and are used to drive the robot motors. The Stäubli Robot is connected to the cell controller to allow software manipulation of the robot. A data acquisition electronic (DAE) circuit performs the signal amplification; signal multiplexing, AD-conversion, offset measurements, mechanical surface detection, collision detection, etc. is connected to the Electro-optical coupler (EOC). The EOC performs the conversion from the optical into digital electric signal of the DAE and transfers data to the PC plug-in card.

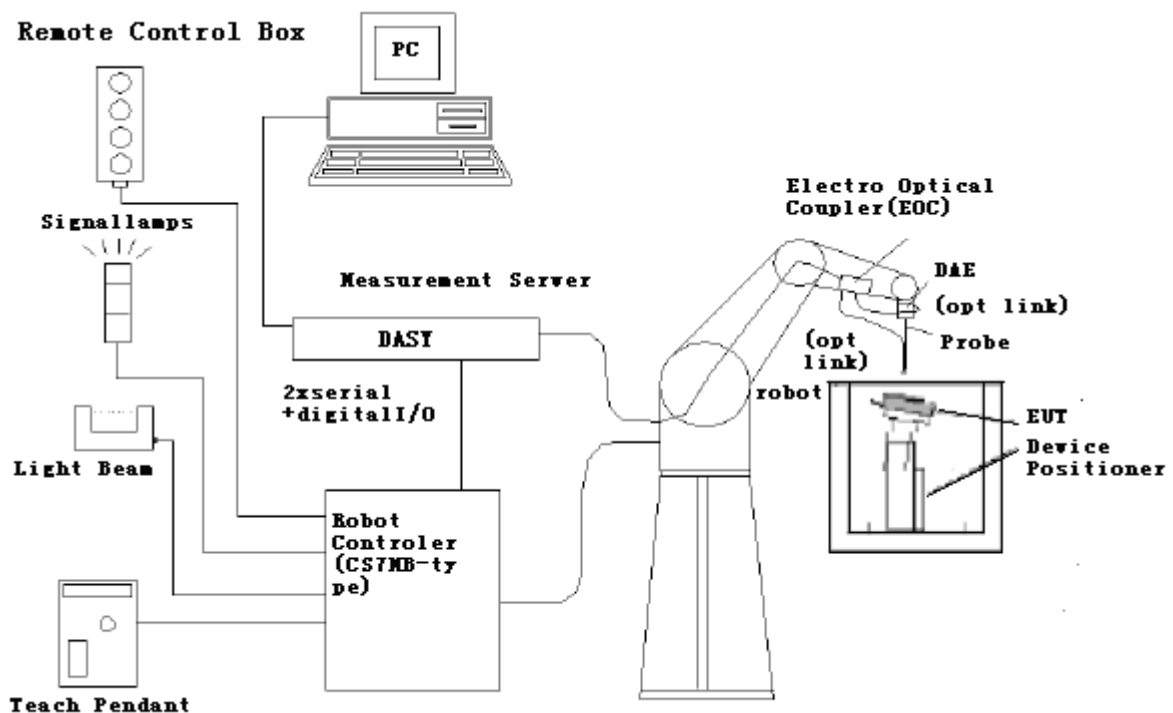

Figure 1 HAC Test Measurement Set-up

The DAE4 consists of a highly sensitive electrometer-grade preamplifier with auto-zeroing, a channel and gain-switching multiplexer, a fast 16 bit AD-converter and a command decoder and control logic unit. Transmission to the PC-card is accomplished through an optical downlink for data and status information and an optical uplink for commands and clock lines. The mechanical probe mounting device includes two different sensor systems for frontal and sidewise probe contacts. They are also used for mechanical surface detection and probe collision detection. The robot uses its own controller with a built in VME-bus computer.

2.2.2. Probe System

The HAC measurements were conducted with the E-Field Probe ER3DV6 and the H-Field Probe H3DV6 (manufactured by SPEAG), designed in the classical triangular configuration and optimized for dosimetric evaluation.

E-Field Probe Description

Construction	One dipole parallel, two dipoles normal to probe axis Built-in shielding against static charges PEEK enclosure material
Calibration	In air from 100 MHz to 3.0 GHz (absolute accuracy $\pm 6.0\%$, $k=2$)
Frequency	40 MHz to > 6 GHz (can be extended to < 20 MHz) Linearity: ± 0.2 dB (100 MHz to 3 GHz)
Directivity	± 0.2 dB in air (rotation around probe axis) ± 0.4 dB in air (rotation normal to probe axis)
Dynamic Range	2 V/m to > 1000 V/m; Linearity: ± 0.2 dB
Dimensions	Overall length: 330 mm (Tip: 16 mm) Tip diameter: 8 mm (Body: 12 mm) Distance from probe tip to dipole centers: 2.5 mm
Application	General near-field measurements up to 6 GHz Field component measurements Fast automatic scanning in phantoms



Figure 2 ER3DV6 E-field Probe

H-Field Probe Description

Construction	Three concentric loop sensors with 3.8 mm loop diameters Resistively loaded detector diodes for linear response Built-in shielding against static charges PEEK enclosure material (resistant to organic solvents, e.g., glycolether)
Frequency	200 MHz to 3 GHz (absolute accuracy $\pm 6.0\%$, $k=2$); Output linearized
Directivity	± 0.2 dB (spherical isotropy error)
Dynamic Range	10 mA/m to 2 A/m at 1 GHz
E-Field Interference	< 10% at 3 GHz (for plane wave)
Dimensions	Overall length: 330 mm (Tip: 40 mm) Tip diameter: 6 mm (Body: 12 mm) Distance from probe tip to dipole centers: 3 mm



Figure 3 H3DV6 H-field Probe

Application General magnetic near-field measurements up to 3
 GHz (in air or liquids)
 Field component measurements
 Surface current measurements
 Low interaction with the measured field

2.2.3. Test Arch Phantom & Phone Positioner

The Test Arch phantom should be positioned horizontally on a stable surface. Reference markings on the Phantom allow the complete setup of all predefined phantom positions and measurement grids by manually teaching three points in the robot. It enables easy and well defined positioning of the phone and validation dipoles as well as simple teaching of the robot (Dimensions: 370 x 370 x 370 mm).

The Device reference point is set for the EUT at 6.3 mm, the Grid reference point is on the upper surface at the origin of the coordinates, and the “user point \Height Check 0.5 mm” is 0.5mm above the center, allowing verification of the gap of 0.5mm while the probe is positioned there.

The Phone Positioner supports accurate and reliable positioning of any phone with effect on near field $<\pm 0.5$ dB.

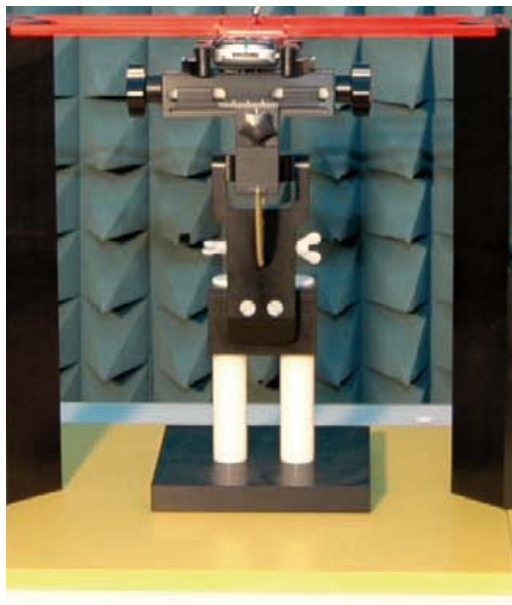

Figure 4 HAC Phantom & Device Holder

2.3. RF Test Procedures

The evaluation was performed with the following procedure:

1. Confirm proper operation of the field probe, probe measurement system and other instrumentation and the positioning system.
2. Position the WD in its intended test position. The gauge block can simplify this positioning. Note that a separate E-field and H-field gauge block will be needed if the center of the probe sensor elements is at different distances from the tip of the probe.
3. Configure the WD normal operation for maximum rated RF output power, at the desired channel and other operating parameters (e.g., test mode), as intended for the test.
4. The center sub-grid shall center on the center of the axial measurement point or the acoustic output, as appropriate. Locate the field probe at the initial test position in the 50 mm by 50 mm grid, which is contained in the measurement plane. If the field alignment method is used, align the probe for maximum field reception.
5. Record the reading.
6. Scan the entire 50 mm by 50 mm region in equally spaced increments and record the reading at each measurement point. The grid is 5 cm by 5 cm area that is divided into 9 evenly sized blocks or sub-grids. The distance between measurement points shall be sufficient to assure the identification of the maximum reading.
7. Identify the five contiguous sub-grids around the center sub-grid with the lowest maximum field strength readings. Thus the six areas to be used to determine the WD's highest emissions are identified and outlined for the final manual scan. Please note that a maximum of five blocks can be excluded for both E-field and H-field measurements for the WD output being measured. Stated another way, the center sub-grid and three others must be common to both the E-field and H-field measurements.
8. Identify the maximum field reading within the non-excluded sub-grids identified in Step 7.
9. Convert the maximum field strength reading identified in Step 8 to V/m or A/m, as appropriate. For probes which require a probe modulation factor, this conversion shall be done using the appropriate probe modulation factor and the calibration.
10. Repeat Step 1 through Step 10 for both the E-field and H-field measurements.
11. Compare this reading to the categories in ANSI C63.19 Clause 7 and record the resulting category. The lowest category number listed in 7.2, Table 7.4, or Table 7.5 obtained in Step 10 for either E- or H-field determines the M category for the audio coupling mode assessment. Record the WD category rating.



Figure 5 WD reference and plane for RF emission measurements

2.4. System Check

Validation Procedure

Place a dipole antenna meeting the requirements given in ANSI C63.19 D.5 in the position normally occupied by the WD. The dipole antenna serves as a known source for an electrical and magnetic output. Position the E-field and H-field probes so that:

The probes and their cables are parallel to the coaxial feed of the dipole antenna.

The probe cables and the coaxial feed of the dipole antenna approach the measurement area from opposite directions.

The center point of the probe element(s) are 10 mm from the closest surface of the dipole elements. Validation was performed to verify that measured E-field and H-field values are within +/-25% from the target reference values provided by the manufacturer. "Values within +/-25% are acceptable. Of which 12% is deviation and 13% is measurement uncertainty."

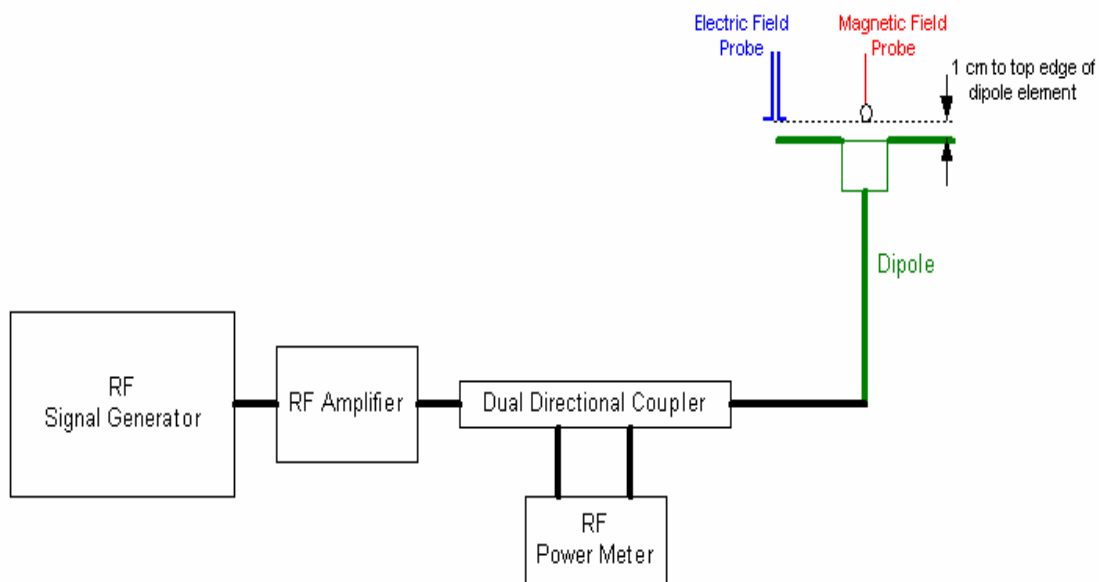

Figure 6 Dipole Validation Setup

TA Technology (Shanghai) Co., Ltd.
Test Report

Report No. RXA1204-0069HAC01R1

Page 16 of 134

Dipole Measurement Summary

E-Field Scan					
Mode	Frequency (MHz)	Input Power (mW)	Value		Test Date
CW	835	100	Target ¹ Value(V/m)	161.4	February 21, 2012
			Measured ² Value(V/m)	157	May 7, 2012
			Deviation ³ (%)	2.73	/
CW	1880	100	Target ¹ Value(V/m)	143.4	February 21, 2012
			Measured ² Value(V/m)	136	May 7, 2012
			Deviation ³ (%)	5.16	/
H-Field Scan					
Mode	Frequency (MHz)	Input Power (mW)	Value		Test Date
CW	835	100	Target ¹ Value(A/m)	0.46	February 21, 2012
			Measured ² Value(A/m)	0.473	May 7, 2012
			Deviation ³ (%)	2.83	/
CW	1880	100	Target ¹ Value(A/m)	0.47	February 21, 2012
			Measured ² Value(A/m)	0.463	May 7, 2012
			Deviation ³ (%)	1.49	/
<p>Notes: 1. Target value is provided by SPEAD in the calibration certificate of specific dipoles. 2. Please refer to the attachment for detailed measurement data and plot. 3. Deviation (%) = 100 * (Target value minus Measured value) divided by Target value.</p>					

2.5. Probe Modulation Factor

The Probe Modulation Factor (PMF) is defined as the ratio of the field readings for a CW and a modulated signal with the equivalent Field Envelope Peak as defined in ANSI C63.19 (Chapter C.3.1). Calibration shall be made of the modulation response of the probe and its instrumentation chain. This Calibration shall be performed with the field probe, attached to the instrumentation that is to be used with it during the measurement. The response of the probe system to a CW field at the frequency(s) of interest is compared to its response to a modulated signal with equal peak amplitude. The field level of the test signals shall be more than 10dB above the ambient level and the noise floor of the instrumentation being used. The ratio of the CW reading to that taken with a modulated field shall be applied to the readings taken of modulated fields of the specified type.

Modulation Factor Test Procedure

This may be done using the following procedure:

1. Fix the field probe in a set location relative to a field generating device, such as the reference dipole antenna.
2. Illuminate the probe using the wireless device connected to the reference dipole with a test signal at the intended measurement frequency, Ensure there is sufficient field coupling between the probe and the antenna so the resulting reading is greater than 10 dB above the probe system noise floor but within the systems operating range.
3. Record the amplitude applied to the antenna during transmission and the field strength measured by the E-field probe located near the tip of the dipole antenna
4. Replace the wireless device with an RF signal generator producing an unmodulated CW signal and set to the wireless device operating frequency.
5. Set the amplitude of the unmodulated signal to equal that recorded from the wireless device.
6. Record the reading of the probe measurement system of the unmodulated signal.
7. The ratio, in linear units, of the probe reading in Step 6 to the reading in Step 3 is the E-field modulation factor. $PMF_E = E_{CW} / E_{mod}$ ($PMF_H = H_{CW} / H_{mod}$)
8. Repeat the previous steps using the H-field probe, except locate the probe at the center of the dipole.

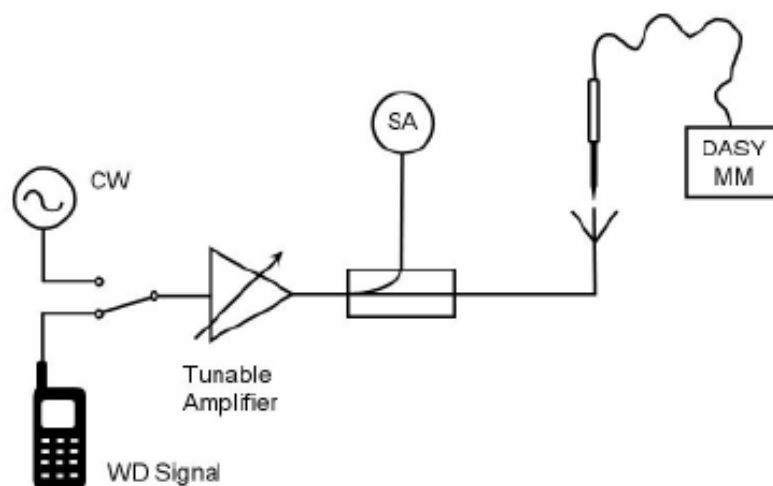

Figure 7 Probe Modulation Factor Test Setup

TA Technology (Shanghai) Co., Ltd.
Test Report

Report No. RXA1204-0069HAC01R1

Page 18 of 134

PMF

Band	E-Field Probe Modulation Factor	H-Field Probe Modulation Factor
GSM 850	2.81	2.75
GSM 1900	2.84	2.84
WCDMA Band IV	1.02	1.01
WCDMA Band V	1.03	1.01

TA Technology (Shanghai) Co., Ltd.
Test Report

2.6. Conducted Output Power Measurement

Summary

The EUT is tested using an E5515C communications tester as controller unit to set test channels and maximum output power to the DUT, as well as for measuring the conducted power. Conducted output power was measured using an integrated RF connector and attached RF cable. This result contains conducted output power for the EUT.

Conducted Power Results

GSM 850	Conducted Power(dBm)		
	Channel 128	Channel 190	Channel 251
Test Results	33.5	33.36	33.28
GSM 1900	Conducted Power(dBm)		
	Channel 512	Channel 661	Channel 810
Test Results	30.22	30.05	30.28
WCDMA Band IV	Conducted Power(dBm)		
	Channel 1312	Channel 1413	Channel 1513
Test Results	22.4	22.59	22.3
WCDMA Band V	Conducted Power(dBm)		
	Channel 4132	Channel 4183	Channel 4233
Test Results	23.07	23.05	23.02

TA Technology (Shanghai) Co., Ltd.
Test Report

3. Test Results

3.1. ANSI C63.19-2007 Limits

Category		Telephone RF parameters < 960 MHz			
Near field	AWF	E-field emissions		H-field emissions	
Category M1	0	631.0 to 1122.0	V/m	1.91 to 3.39	A/m
	-5	473.2 to 841.4	V/m	1.43 to 2.54	A/m
Category M2	0	354.8 to 631.0	V/m	1.07 to 1.91	A/m
	-5	266.1 to 473.2	V/m	0.80 to 1.43	A/m
Category M3	0	199.5 to 354.8	V/m	0.60 to 1.07	A/m
	-5	149.6 to 266.1	V/m	0.45 to 0.80	A/m
Category M4	0	< 199.5	V/m	< 0.60	A/m
	-5	< 149.6	V/m	< 0.45	A/m
Category		Telephone RF parameters > 960 MHz			
Near field	AWF	E-field emissions		H-field emissions	
Category M1	0	199.5 to 354.8	V/m	0.60 to 1.07	A/m
	-5	149.6 to 266.1	V/m	0.45 to 0.80	A/m
Category M2	0	112.2 to 199.5	V/m	0.34 to 0.60	A/m
	-5	84.1 to 149.6	V/m	0.25 to 0.45	A/m
Category M3	0	63.1 to 112.2	V/m	0.19 to 0.34	A/m
	-5	47.3 to 84.1	V/m	0.14 to 0.25	A/m
Category M4	0	< 63.1	V/m	< 0.19	A/m
	-5	< 47.3	V/m	< 0.14	A/m

TA Technology (Shanghai) Co., Ltd.
Test Report

3.2. Summary Test Results

GSM 850 Results

E-Field with Battery 1					
Channel	Frequency (MHz)	Peak Field (V/m)	Power Drift (dB)	Rating	Graph Results
High/251	848.8	175.3	0.078	M3	Figure 12
Middle/190	836.6	154.3	0.122	M3	Figure 13
Low/128	824.2	142.2	-0.046	M3	Figure 14
E-Field with Battery 2					
High/251	848.8	165.4	0.104	M3	Figure 15
H-Field with Battery 1					
Channel	Frequency (MHz)	Peak Field (A/m)	Power Drift (dB)	Rating	Graph Results
High/251	848.8	0.253	-0.011	M4	Figure 16
Middle/190	836.6	0.218	-0.079	M4	Figure 17
Low/128	824.2	0.192	-0.106	M4	Figure 18
H-Field with Battery 2					
High/251	848.8	0.256	0.054	M4	Figure 19

TA Technology (Shanghai) Co., Ltd.
Test Report

Report No. RXA1204-0069HAC01R1

Page 22 of 134

GSM 1900 Results

E-Field with Battery 1					
Channel	Frequency (MHz)	Peak Field (V/m)	Power Drift (dB)	Rating	Graph Results
High/810	1909.8	70.4	0.028	M3	Figure 20
Middle/661	1880	67.4	0.075	M3	Figure 21
Low/512	1850.2	61.1	0.052	M3	Figure 22
E-Field with Battery 2					
High/810	1909.8	69.2	0.009	M3	Figure 23
H-Field with Battery 1					
Channel	Frequency (MHz)	Peak Field (A/m)	Power Drift (dB)	Rating	Graph Results
High/810	1909.8	0.200	0.037	M3	Figure 24
Middle/661	1880	0.184	-0.018	M3	Figure 25
Low/512	1850.2	0.182	0.040	M3	Figure 26
H-Field with Battery 2					
High/810	1909.8	0.196	0.054	M3	Figure 27

TA Technology (Shanghai) Co., Ltd.
Test Report

Report No. RXA1204-0069HAC01R1

Page 23 of 134

WCDMA Band IV Results

E-Field with Battery 1					
Channel	Frequency (MHz)	Peak Field (V/m)	Power Drift (dB)	Rating	Graph Results
High/1513	1752.6	43.3	0.052	M4	Figure 28
Middle/1413	1732.6	39.2	0.081	M4	Figure 29
Low/1312	1712.4	42.8	0.086	M4	Figure 30
E-Field with Battery 2					
High/1513	1752.6	43.5	0.119	M4	Figure 31
H-Field with Battery 1					
Channel	Frequency (MHz)	Peak Field (A/m)	Power Drift (dB)	Rating	Graph Results
High/1513	1752.6	0.117	-0.017	M4	Figure 32
Middle/1413	1732.6	0.106	0.032	M4	Figure 33
Low/1312	1712.4	0.118	0.029	M4	Figure 34
H-Field with Battery 2					
Low/1312	1712.4	0.119	-0.018	M4	Figure 35

TA Technology (Shanghai) Co., Ltd.
Test Report

Report No. RXA1204-0069HAC01R1

Page 24 of 134

WCDMA Band V Results

E-Field with Battery 1					
Channel	Frequency (MHz)	Peak Field (V/m)	Power Drift (dB)	Rating	Graph Results
High/4233	846.6	63.9	-0.024	M4	Figure 36
Middle/4183	836.6	63.4	0.072	M4	Figure 37
Low/4132	826.4	55.8	-0.123	M4	Figure 38
E-Field with Battery 2					
Low/4132	826.4	63.3	0.013	M4	Figure 39
H-Field with Battery 1					
Channel	Frequency (MHz)	Peak Field (A/m)	Power Drift (dB)	Rating	Graph Results
High/4233	846.6	0.085	0.045	M4	Figure 40
Middle/4183	836.6	0.084	0.067	M4	Figure 41
Low/4132	826.4	0.072	0.199	M4	Figure 42
H-Field with Battery 2					
Low/4132	826.4	0.086	-0.010	M4	Figure 43

TA Technology (Shanghai) Co., Ltd.

Test Report

Report No. RXA1204-0069HAC01R1

Page 25 of 134

4. Measurement Uncertainty

No.	Error source	Type	Uncertainty Value (%)	Prob. Dist.	k	c_{iE}	c_{iH}	Standard Uncertainty (%) u_i (%) E	Standard Uncertainty (%) u_i (%) H	Degree of freedom V_{eff} or v_i
Measurement System										
1	Probe Calibration	B	5.1	N	1	1	1	5.1	5.1	∞
2	Axial Isotropy	B	4.7	R	$\sqrt{3}$	1	1	2.7	2.7	∞
3	Sensor Displacement	B	16.5	R	$\sqrt{3}$	1	0.145	9.5	1.4	∞
4	Boundary Effects	B	2.4	R	$\sqrt{3}$	1	1	1.4	1.4	∞
5	Test Arch	B	7.2	R	$\sqrt{3}$	1	0	4.1	0	∞
6	Linearity	B	4.7	R	$\sqrt{3}$	1	1	2.7	2.7	∞
7	Scaling to Peak Envelope Power	B	2.0	R	$\sqrt{3}$	1	1	1.2	1.2	∞
8	System Detection Limit	B	1.0	R	$\sqrt{3}$	1	1	0.6	0.6	∞
9	Readout Electronics	B	0.3	N	1	1	1	0.3	0.3	∞
10	Response Time	B	0.8	R	$\sqrt{3}$	1	1	0.5	0.5	∞
11	Integration Time	B	2.6	R	$\sqrt{3}$	1	1	1.5	1.5	∞
12	RF Ambient Conditions	B	3.0	R	$\sqrt{3}$	1	1	1.7	1.7	∞
13	RF Reflections	B	12.0	R	$\sqrt{3}$	1	1	6.9	6.9	∞
14	Probe Positioner	B	1.2	R	$\sqrt{3}$	1	0.67	0.7	0.5	∞
15	Probe Positioning	A	4.7	R	$\sqrt{3}$	1	0.67	2.7	1.8	∞
16	Extra. And Interpolation	B	1.0	R	$\sqrt{3}$	1	1	0.6	0.6	∞
Test Sample Related										
17	Device Positioning Vertical	B	4.7	R	$\sqrt{3}$	1	0.67	2.7	1.8	∞
18	Device Positioning Lateral	B	1.0	R	$\sqrt{3}$	1	1	0.6	0.6	∞

TA Technology (Shanghai) Co., Ltd.
Test Report

Report No. RXA1204-0069HAC01R1

Page 26 of 134

19	Device Holder and Phantom	B	2.4	R	$\sqrt{3}$	1	1	1.4	1.4	∞
20	Power Drift	B	5.0	R	$\sqrt{3}$	1	1	2.9	2.9	∞
Phantom and Setup related										
21	Phantom Thickness	B	2.4	R	$\sqrt{3}$	1	0.67	1.4	0.9	∞
Combined standard uncertainty (%)								15.19	10.82	
Expanded Std. uncertainty on power (K=2)								30.38	21.65	
Expanded Std. uncertainty on field (K=2)								15.19	10.82	

TA Technology (Shanghai) Co., Ltd.
Test Report

Report No. RXA1204-0069HAC01R1

Page 27 of 134

5. Main Test Instruments

No.	Name	Type	Serial Number	Calibration Date	Valid Period
01	Power meter	Agilent E4417A	GB41291714	March 11, 2012	One year
02	Power sensor	Agilent N8481H	MY50350004	September 25, 2011	One year
03	Signal Generator	HP 8341B	2730A00804	September 12, 2011	One year
04	Amplifier	IXA-020	0401	No Calibration Requested	
05	BTS	E5515C	MY48360988	December 2, 2011	One year
06	E-Field Probe	ER3DV6	2303	February 21, 2012	One year
07	H-Field Probe	H3DV6	6138	February 21, 2012	One year
08	DAE	DAE4	1317	January 23, 2012	One year
09	Validation Kit 835MHz	CD835V3	1133	February 21, 2012	One year
10	Validation Kit 1880MHz	CD1880V3	1115	February 21, 2012	One year
11	Hygrothermograph	WS-1	64591	September 28, 2011	One year

*****END OF REPORT *****

ANNEX A: System Check Results

HAC_System Performance Check at 835MHz_E

DUT: Dipole 835 MHz; Type: CD835V3; SN:1133

Date/Time: 5/6/2012 9:45:46 PM

Communication System: CW; Frequency: 835 MHz;Duty Cycle: 1:1

Medium parameters used: $\sigma = 0$ mho/m, $\epsilon_r = 1$; $\rho = 1000$ kg/m³

Ambient Temperature:22.3 °C

Phantom section: RF Section

DASY4 Configuration:

Probe: ER3DV6 - SN2303; ConvF(1, 1, 1); Calibrated: 2/21/2012

Electronics: DAE4 Sn1317; Calibrated: 1/23/2012

Phantom: HAC Test Arch; Type: SD HAC P01 BA;

Measurement SW: DASY4, V4.7 Build 80; Postprocessing SW: SEMCAD, V1.8 Build 186

E Scan - measurement distance from the probe sensor center to CD835 Dipole = 10mm/Hearing Aid Compatibility Test (41x361x1): Measurement grid: dx=5mm, dy=5mm

Maximum value of peak Total field = 157.0 V/m

Probe Modulation Factor = 1.00

Device Reference Point: 0.000, 0.000, -6.30 mm

Reference Value = 117.0 V/m; Power Drift = 0.157 dB

Hearing Aid Near-Field Category: M4 (AWF 0 dB)

Peak E-field in V/m

Grid 1 158.9 M4	Grid 2 173.9 M4	Grid 3 172.0 M4
Grid 4 81.4 M4	Grid 5 86.5 M4	Grid 6 86.0 M4
Grid 7 147.1 M4	Grid 8 157.0 M4	Grid 9 156.2 M4

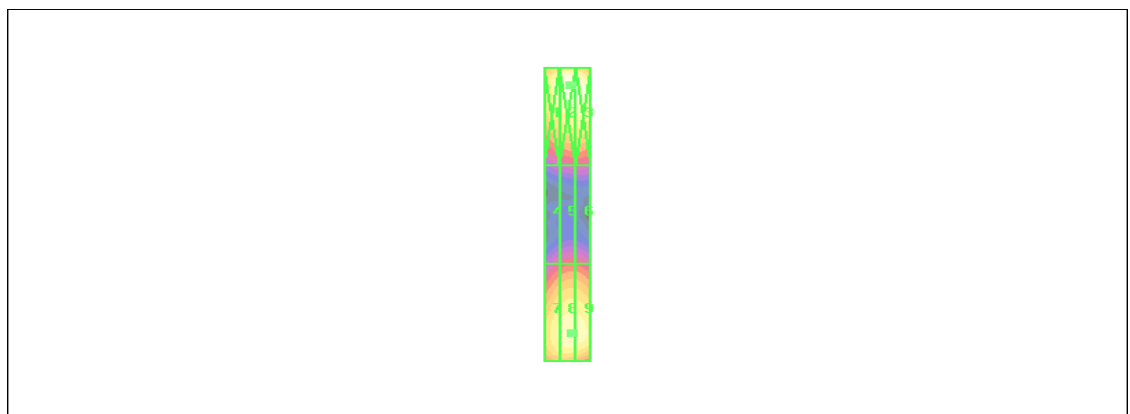
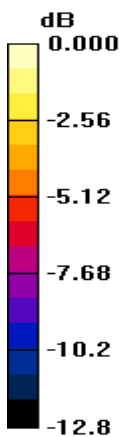

0 dB = 173.9V/m

Figure 8 System Performance Check 835MHz_E

TA Technology (Shanghai) Co., Ltd. Test Report

Report No. RXA1204-0069HAC01R1

Page 29 of 134

HAC_System Performance Check at 835MHz_H

DUT: Dipole 835 MHz; Type: CD835V3; SN: 1133

Date/Time: 5/7/2012 10:23:56 AM

Communication System: CW; Frequency: 835 MHz; Duty Cycle: 1:1

Medium parameters used: $\sigma = 0$ mho/m, $\epsilon_r = 1$; $\rho = 1$ kg/m³

Ambient Temperature: 22.3 °C

Phantom section: RF Section

DASY4 Configuration:

Probe: H3DV6 - SN6138; ; Calibrated: 2/21/2012

Electronics: DAE4 Sn1317; Calibrated: 1/23/2012

Phantom: HAC Test Arch; Type: SD HAC P01 BA;

Measurement SW: DASY4, V4.7 Build 80; Postprocessing SW: SEMCAD, V1.8 Build 186

H Scan - measurement distance from the probe sensor center to CD835 Dipole = 10mm/Hearing Aid Compatibility Test (41x381x1): Measurement grid: dx=5mm, dy=5mm

Maximum value of peak Total field = 0.473 A/m

Probe Modulation Factor = 1.00

Device Reference Point: 0.000, 0.000, -6.30 mm

Reference Value = 0.504 A/m; Power Drift = -0.009 dB

Hearing Aid Near-Field Category: M4 (AWF 0 dB)

Peak H-field in A/m

Grid 1	Grid 2	Grid 3
0.394 M4	0.412 M4	0.390 M4
Grid 4	Grid 5	Grid 6
0.450 M4	0.473 M4	0.447 M4
Grid 7	Grid 8	Grid 9
0.387 M4	0.412 M4	0.392 M4

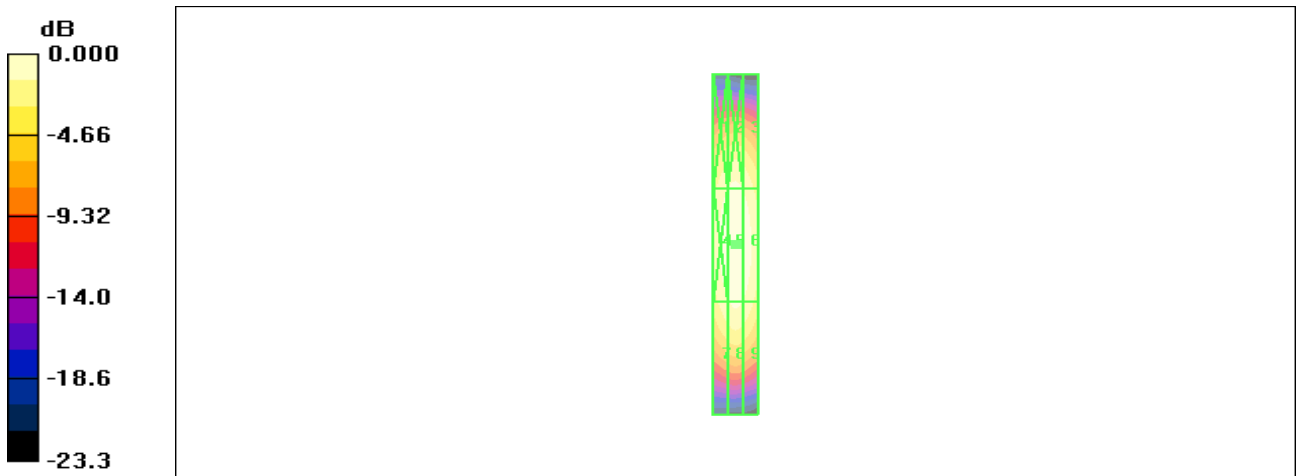

0 dB = 0.473A/m

Figure 9 System Performance Check 835MHz_H

TA Technology (Shanghai) Co., Ltd. Test Report

HAC_System Performance Check at 1880MHz_E

DUT: Dipole 1880 MHz; Type: CD1880V3; SN: 1115

Date/Time: 5/6/2012 9:59:03 PM

Communication System: CW; Frequency: 1880 MHz; Duty Cycle: 1:1

Medium parameters used: $\sigma = 0$ mho/m, $\epsilon_r = 1$; $\rho = 1000$ kg/m³

Ambient Temperature: 22.3 °C

Phantom section: RF Section

DASY4 Configuration:

Probe: ER3DV6 - SN2303; ConvF(1, 1, 1); Calibrated: 2/21/2012

Electronics: DAE4 Sn1317; Calibrated: 1/23/2012

Phantom: HAC Test Arch; Type: SD HAC P01 BA;

Measurement SW: DASY4, V4.7 Build 80; Postprocessing SW: SEMCAD, V1.8 Build 186

E Scan - measurement distance from the probe sensor center to CD1880 Dipole = 10mm/Hearing Aid Compatibility Test (41x181x1): Measurement grid: dx=5mm, dy=5mm

Maximum value of peak Total field = 136.0 V/m

Probe Modulation Factor = 1.00

Device Reference Point: 0.000, 0.000, -6.30 mm

Reference Value = 144.9 V/m; Power Drift = -0.035 dB

Hearing Aid Near-Field Category: M2 (AWF 0 dB)

Peak E-field in V/m

Grid 1 129.0 M2	Grid 2 136.0 M2	Grid 3 132.5 M2
Grid 4 82.4 M3	Grid 5 89.0 M3	Grid 6 88.8 M3
Grid 7 130.5 M2	Grid 8 139.1 M2	Grid 9 138.7 M2

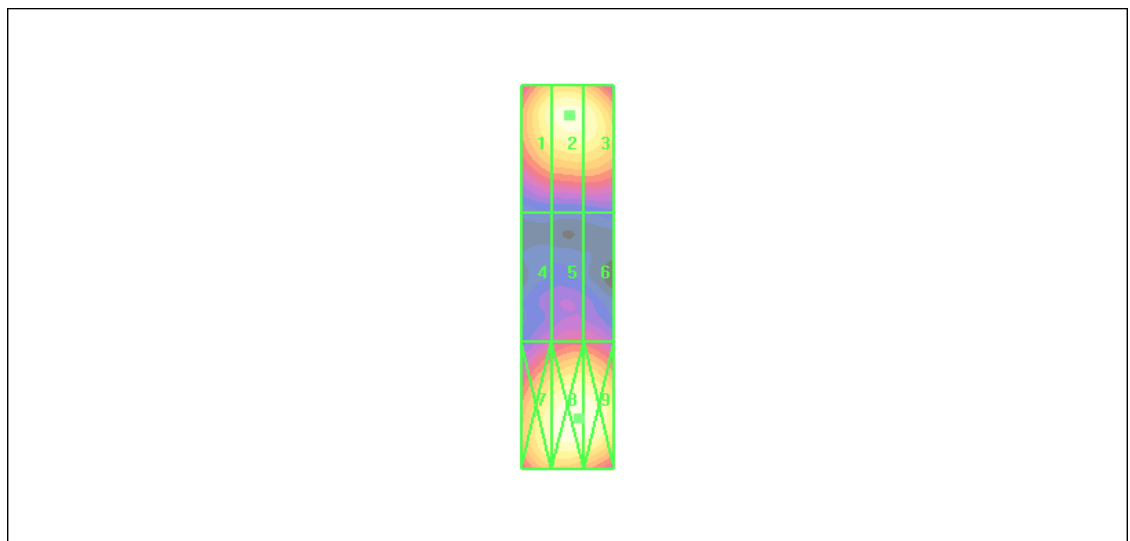
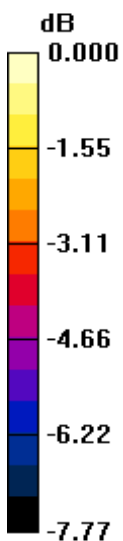

0 dB = 139.1V/m

Figure 10 System Performance Check 1880MHz_E

TA Technology (Shanghai) Co., Ltd. Test Report

HAC_System Performance Check at 1880MHz_H

DUT: Dipole 1880 MHz; Type: CD1880V3; SN: 1115

Date/Time: 5/7/2012 10:13:09 AM

Communication System: CW; Frequency: 1880 MHz; Duty Cycle: 1:1

Medium parameters used: $\sigma = 0$ mho/m, $\epsilon_r = 1$; $\rho = 1$ kg/m³

Ambient Temperature: 22.3 °C

Phantom section: RF Section

DASY4 Configuration:

Probe: H3DV6 - SN6138; ; Calibrated: 2/21/2012

Electronics: DAE4 Sn1317; Calibrated: 1/23/2012

Phantom: HAC Test Arch; Type: SD HAC P01 BA;

Measurement SW: DASY4, V4.7 Build 80; Postprocessing SW: SEMCAD, V1.8 Build 186

H Scan - measurement distance from the probe sensor center to Dipole = 10mm/Hearing Aid

Compatibility Test (41x181x1): Measurement grid: dx=5mm, dy=5mm

Maximum value of peak Total field = 0.463 A/m

Probe Modulation Factor = 1.00

Device Reference Point: 0.000, 0.000, -6.30 mm

Reference Value = 0.489 A/m; Power Drift = 0.011 dB

Hearing Aid Near-Field Category: M2 (AWF 0 dB)

Peak H-field in A/m

Grid 1 0.398 M2	Grid 2 0.412 M2	Grid 3 0.393 M2
Grid 4 0.444 M2	Grid 5 0.463 M2	Grid 6 0.441 M2
Grid 7 0.418 M2	Grid 8 0.441 M2	Grid 9 0.417 M2

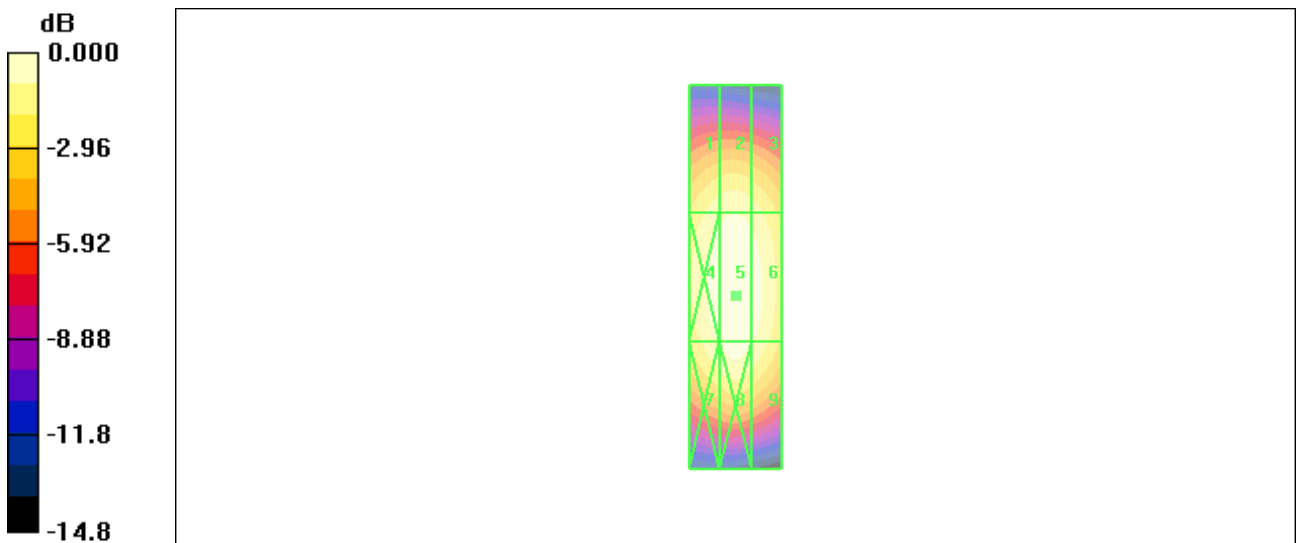

0 dB = 0.463A/m

Figure 11 System Performance Check 1880MHz_H

TA Technology (Shanghai) Co., Ltd.
Test Report

Report No. RXA1204-0069HAC01R1

Page 32 of 134

ANNEX B: Graph Results

HAC RF E-Field GSM 850 High (Battery 1)

Date/Time: 5/7/2012 7:04:38 PM

Communication System: GSM850; Frequency: 848.8 MHz; Duty Cycle: 1:8.3

Medium parameters used: $\sigma = 0$ mho/m, $\epsilon_r = 1$; $\rho = 1000$ kg/m³

Ambient Temperature: 22.3 °C

Phantom section: RF Section

DASY4 Configuration:

Probe: ER3DV6 - SN2303; ConvF(1, 1, 1); Calibrated: 2/21/2012

Electronics: DAE4 Sn1317; Calibrated: 1/23/2012

Phantom: HAC Test Arch; Type: SD HAC P01 BA;

Measurement SW: DASY4, V4.7 Build 80; Postprocessing SW: SEMCAD, V1.8 Build 186

E Scan - ER3D - 2007: 15 mm from Probe Center to the Device High/Hearing Aid Compatibility Test (101x101x1): Measurement grid: dx=5mm, dy=5mm

Maximum value of peak Total field = 175.3 V/m

Probe Modulation Factor = 2.81

Device Reference Point: 0.000, 0.000, -6.30 mm

Reference Value = 78.1 V/m; Power Drift = 0.078 dB

Hearing Aid Near-Field Category: M3 (AWF -5 dB)

Peak E-field in V/m

Grid 1	Grid 2	Grid 3
151.0 M3	172.0 M3	169.2 M3
Grid 4	Grid 5	Grid 6
154.9 M3	175.3 M3	174.0 M3
Grid 7	Grid 8	Grid 9
152.0 M3	172.0 M3	170.5 M3

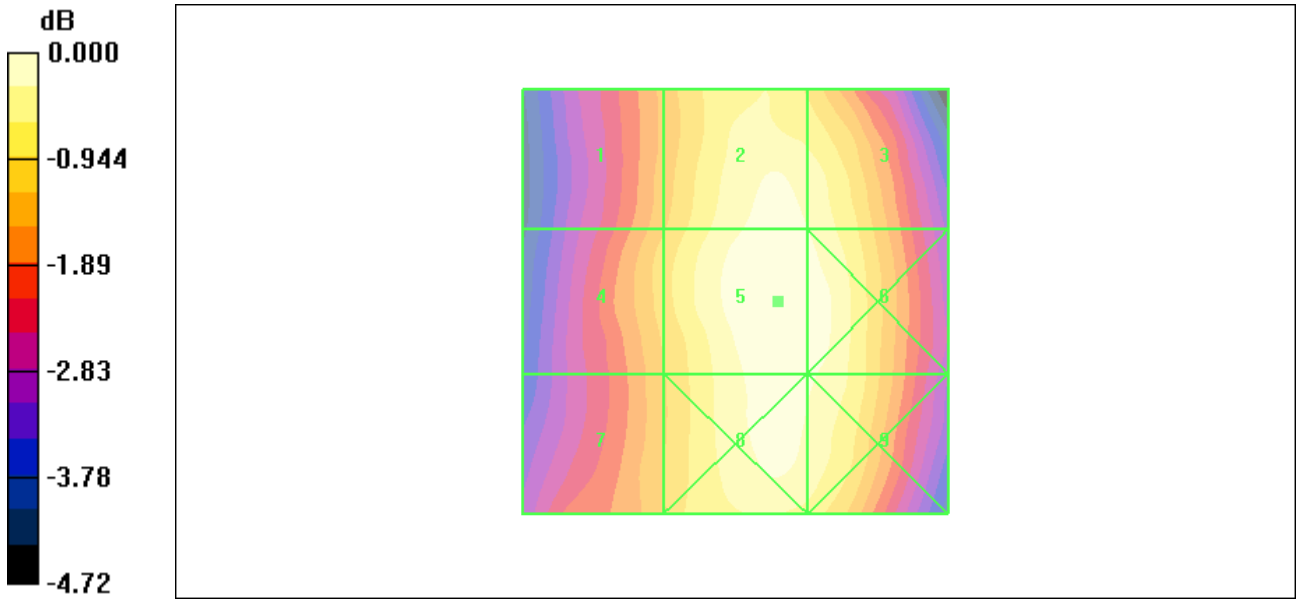

0 dB = 175.3V/m

Figure 12 HAC RF E-Field GSM 850 Channel 251

TA Technology (Shanghai) Co., Ltd.
Test Report

Report No. RXA1204-0069HAC01R1

Page 34 of 134

HAC RF E-Field GSM 850 Middle (Battery 1)

Date/Time: 5/7/2012 6:56:00 PM

Communication System: GSM850; Frequency: 836.6 MHz; Duty Cycle: 1:8.3

Medium parameters used: $\sigma = 0$ mho/m, $\epsilon_r = 1$; $\rho = 1000$ kg/m³

Ambient Temperature: 22.3 °C

Phantom section: RF Section

DASY4 Configuration:

Probe: ER3DV6 - SN2303; ConvF(1, 1, 1); Calibrated: 2/21/2012

Electronics: DAE4 Sn1317; Calibrated: 1/23/2012

Phantom: HAC Test Arch; Type: SD HAC P01 BA;

Measurement SW: DASY4, V4.7 Build 80; Postprocessing SW: SEMCAD, V1.8 Build 186

E Scan - ER3D - 2007: 15 mm from Probe Center to the Device Middle/Hearing Aid

Compatibility Test (101x101x1): Measurement grid: dx=5mm, dy=5mm

Maximum value of peak Total field = 154.3 V/m

Probe Modulation Factor = 2.81

Device Reference Point: 0.000, 0.000, -6.30 mm

Reference Value = 68.7 V/m; Power Drift = 0.122 dB

Hearing Aid Near-Field Category: M3 (AWF -5 dB)

Peak E-field in V/m

Grid 1	Grid 2	Grid 3
133.3 M4	152.0 M3	151.5 M3
Grid 4	Grid 5	Grid 6
137.3 M4	154.3 M3	153.9 M3
Grid 7	Grid 8	Grid 9
133.6 M4	151.2 M3	151.2 M3

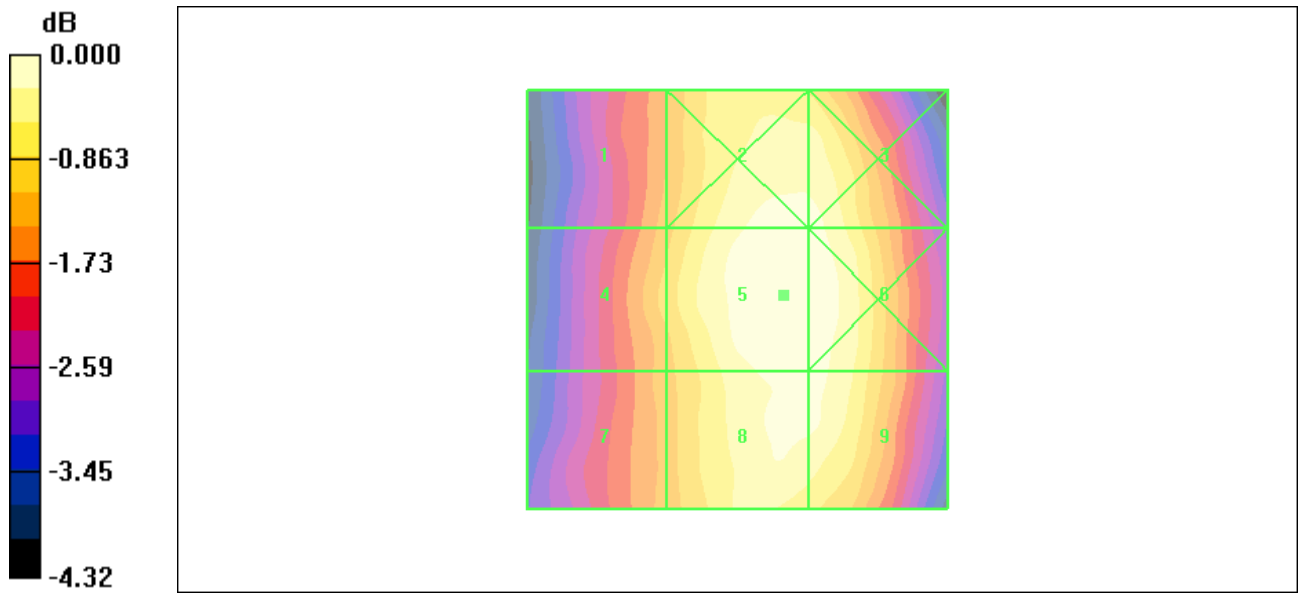

0 dB = 154.3V/m

Figure 13 HAC RF E-Field GSM 850 Channel 190

TA Technology (Shanghai) Co., Ltd.
Test Report

Report No. RXA1204-0069HAC01R1

Page 36 of 134

HAC RF E-Field GSM 850 Low (Battery 1)

Date/Time: 5/7/2012 7:09:26 PM

Communication System: GSM850; Frequency: 824.2 MHz; Duty Cycle: 1:8.3

Medium parameters used: $\sigma = 0$ mho/m, $\epsilon_r = 1$; $\rho = 1000$ kg/m³

Ambient Temperature: 22.3 °C

Phantom section: RF Section

DASY4 Configuration:

Probe: ER3DV6 - SN2303; ConvF(1, 1, 1); Calibrated: 2/21/2012

Electronics: DAE4 Sn1317; Calibrated: 1/23/2012

Phantom: HAC Test Arch; Type: SD HAC P01 BA;

Measurement SW: DASY4, V4.7 Build 80; Postprocessing SW: SEMCAD, V1.8 Build 186

E Scan - ER3D - 2007: 15 mm from Probe Center to the Device Low/Hearing Aid Compatibility

Test (101x101x1): Measurement grid: dx=5mm, dy=5mm

Maximum value of peak Total field = 142.2 V/m

Probe Modulation Factor = 2.81

Device Reference Point: 0.000, 0.000, -6.30 mm

Reference Value = 63.5 V/m; Power Drift = -0.046 dB

Hearing Aid Near-Field Category: M4 (AWF -5 dB)

Peak E-field in V/m

Grid 1	Grid 2	Grid 3
122.2 M4	139.5 M4	137.9 M4
Grid 4	Grid 5	Grid 6
124.8 M4	142.2 M4	140.0 M4
Grid 7	Grid 8	Grid 9
121.4 M4	139.5 M4	138.0 M4

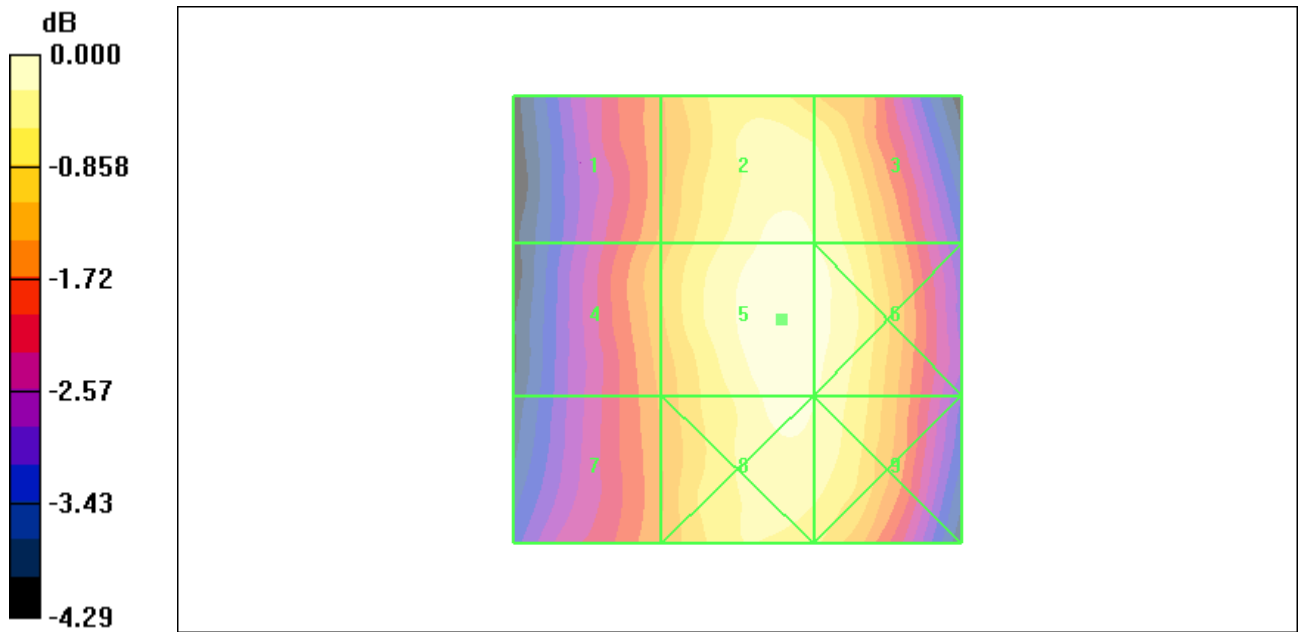

0 dB = 142.2V/m

Figure 14 HAC RF E-Field GSM 850 Channel 128

TA Technology (Shanghai) Co., Ltd.
Test Report

Report No. RXA1204-0069HAC01R1

Page 38 of 134

HAC RF E-Field GSM 850 High (Battery 2)

Date/Time: 5/7/2012 7:38:41 PM

Communication System: GSM850; Frequency: 848.8 MHz; Duty Cycle: 1:8.3

Medium parameters used: $\sigma = 0$ mho/m, $\epsilon_r = 1$; $\rho = 1000$ kg/m³

Ambient Temperature: 22.3 °C

Phantom section: RF Section

DASY4 Configuration:

Probe: ER3DV6 - SN2303; ConvF(1, 1, 1); Calibrated: 2/21/2012

Electronics: DAE4 Sn1317; Calibrated: 1/23/2012

Phantom: HAC Test Arch; Type: SD HAC P01 BA;

Measurement SW: DASY4, V4.7 Build 80; Postprocessing SW: SEMCAD, V1.8 Build 186

E Scan - ER3D - 2007: 15 mm from Probe Center to the Device High/Hearing Aid Compatibility Test (101x101x1): Measurement grid: dx=5mm, dy=5mm

Maximum value of peak Total field = 165.4 V/m

Probe Modulation Factor = 2.81

Device Reference Point: 0.000, 0.000, -6.30 mm

Reference Value = 74.0 V/m; Power Drift = 0.104 dB

Hearing Aid Near-Field Category: M3 (AWF -5 dB)

Peak E-field in V/m

Grid 1 143.1 M4	Grid 2 163.0 M3	Grid 3 160.4 M3
Grid 4 147.0 M4	Grid 5 165.4 M3	Grid 6 163.4 M3
Grid 7 144.5 M4	Grid 8 162.4 M3	Grid 9 161.4 M3

TA Technology (Shanghai) Co., Ltd.
Test Report

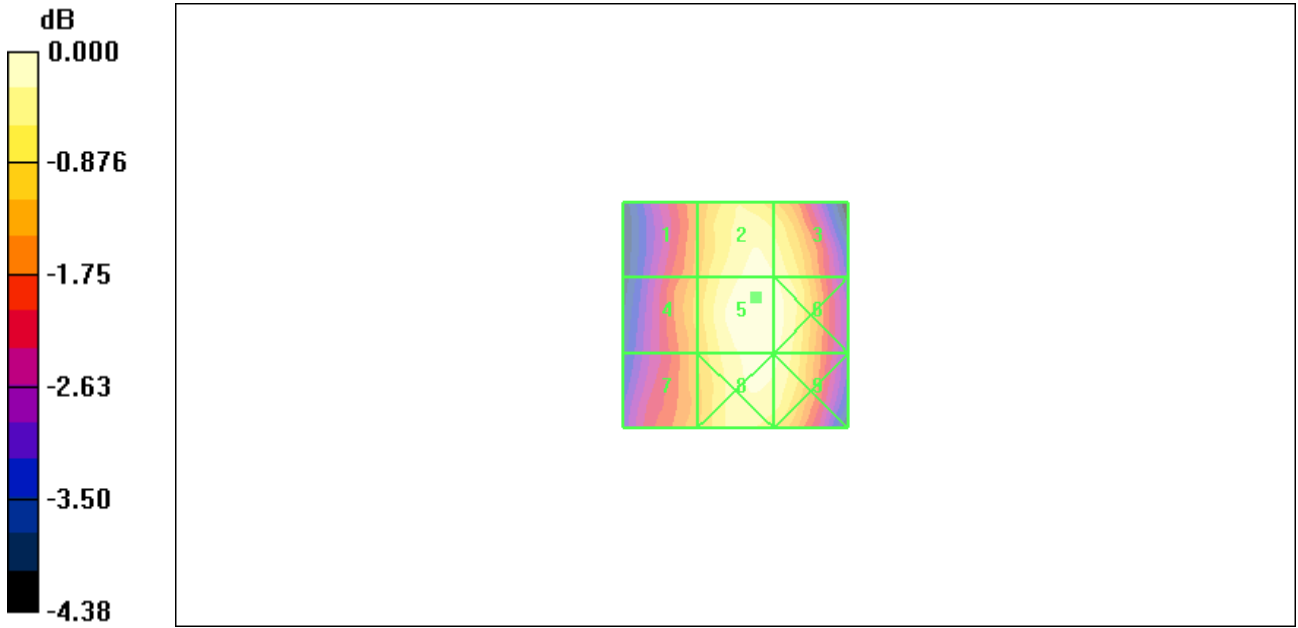

0 dB = 165.4V/m

Figure 15 HAC RF E-Field GSM 850 Channel 251

TA Technology (Shanghai) Co., Ltd.
Test Report

Report No. RXA1204-0069HAC01R1

Page 40 of 134

HAC RF H-Field GSM 850 High (Battery 1)

Date/Time: 5/7/2012 11:54:59 AM

Communication System: GSM850; Frequency: 848.8 MHz; Duty Cycle: 1:8.3

Medium parameters used: $\sigma = 0$ mho/m, $\epsilon_r = 1$; $\rho = 1$ kg/m³

Ambient Temperature: 22.3 °C

Phantom section: RF Section

DASY4 Configuration:

Probe: H3DV6 - SN6138; ; Calibrated: 2/21/2012

Electronics: DAE4 Sn1317; Calibrated: 1/23/2012

Phantom: HAC Test Arch; Type: SD HAC P01 BA;

Measurement SW: DASY4, V4.7 Build 80; Postprocessing SW: SEMCAD, V1.8 Build 186

H Scan - H3DV6 - 2007: 15 mm from Probe Center to the Device High/Hearing Aid

Compatibility Test (101x101x1): Measurement grid: dx=5mm, dy=5mm

Maximum value of peak Total field = 0.253 A/m

Probe Modulation Factor = 2.75

Device Reference Point: 0.000, 0.000, -6.30 mm

Reference Value = 0.067 A/m; Power Drift = -0.011 dB

Hearing Aid Near-Field Category: M4 (AWF -5 dB)

Peak H-field in A/m

Grid 1 0.335 M4	Grid 2 0.238 M4	Grid 3 0.152 M4
Grid 4 0.308 M4	Grid 5 0.229 M4	Grid 6 0.149 M4
Grid 7 0.345 M4	Grid 8 0.253 M4	Grid 9 0.166 M4

TA Technology (Shanghai) Co., Ltd.
Test Report

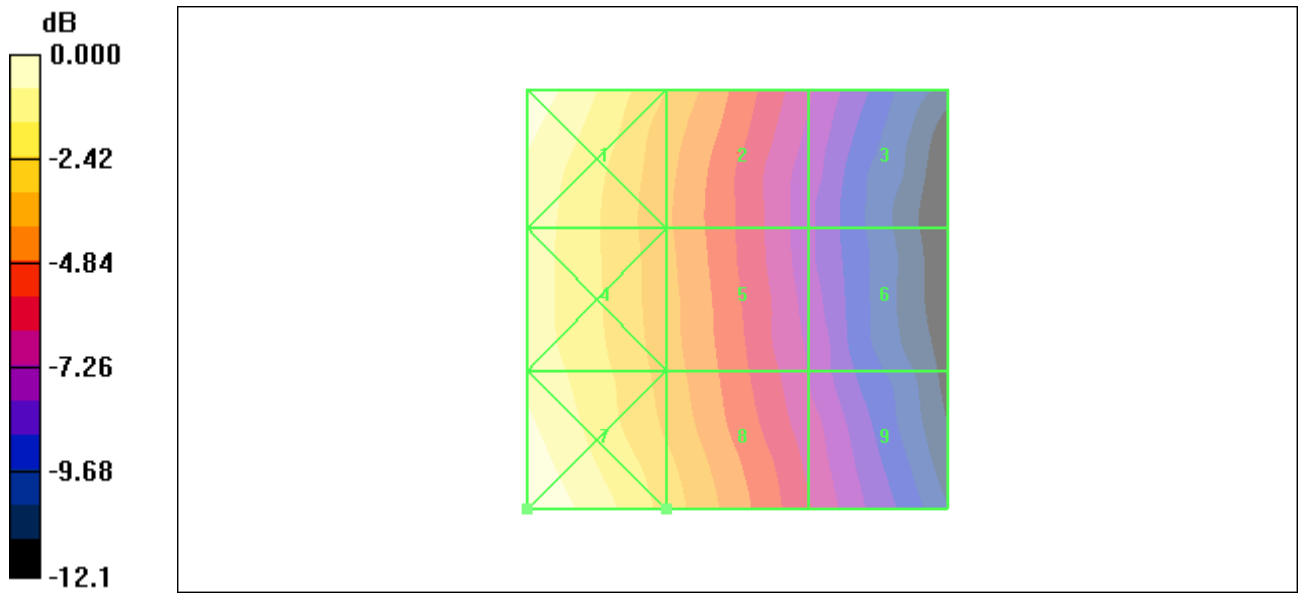

0 dB = 0.345A/m

Figure 16 HAC RF H-Field GSM 850Channel 251

TA Technology (Shanghai) Co., Ltd.
Test Report

Report No. RXA1204-0069HAC01R1

Page 42 of 134

HAC RF H-Field GSM 850 Middle (Battery 1)

Date/Time: 5/7/2012 11:50:04 AM

Communication System: GSM850; Frequency: 836.6 MHz; Duty Cycle: 1:8.3

Medium parameters used: $\sigma = 0$ mho/m, $\epsilon_r = 1$; $\rho = 1$ kg/m³

Ambient Temperature: 22.3 °C

Phantom section: RF Section

DASY4 Configuration:

Probe: H3DV6 - SN6138; ; Calibrated: 2/21/2012

Electronics: DAE4 Sn1317; Calibrated: 1/23/2012

Phantom: HAC Test Arch; Type: SD HAC P01 BA;

Measurement SW: DASY4, V4.7 Build 80; Postprocessing SW: SEMCAD, V1.8 Build 186

H Scan - H3DV6 - 2007: 15 mm from Probe Center to the Device Middle/Hearing Aid

Compatibility Test (101x101x1): Measurement grid: dx=5mm, dy=5mm

Maximum value of peak Total field = 0.218 A/m

Probe Modulation Factor = 2.75

Device Reference Point: 0.000, 0.000, -6.30 mm

Reference Value = 0.058 A/m; Power Drift = -0.079 dB

Hearing Aid Near-Field Category: M4 (AWF -5 dB)

Peak H-field in A/m

Grid 1 0.290 M4	Grid 2 0.205 M4	Grid 3 0.128 M4
Grid 4 0.265 M4	Grid 5 0.196 M4	Grid 6 0.125 M4
Grid 7 0.299 M4	Grid 8 0.218 M4	Grid 9 0.141 M4

TA Technology (Shanghai) Co., Ltd.
Test Report

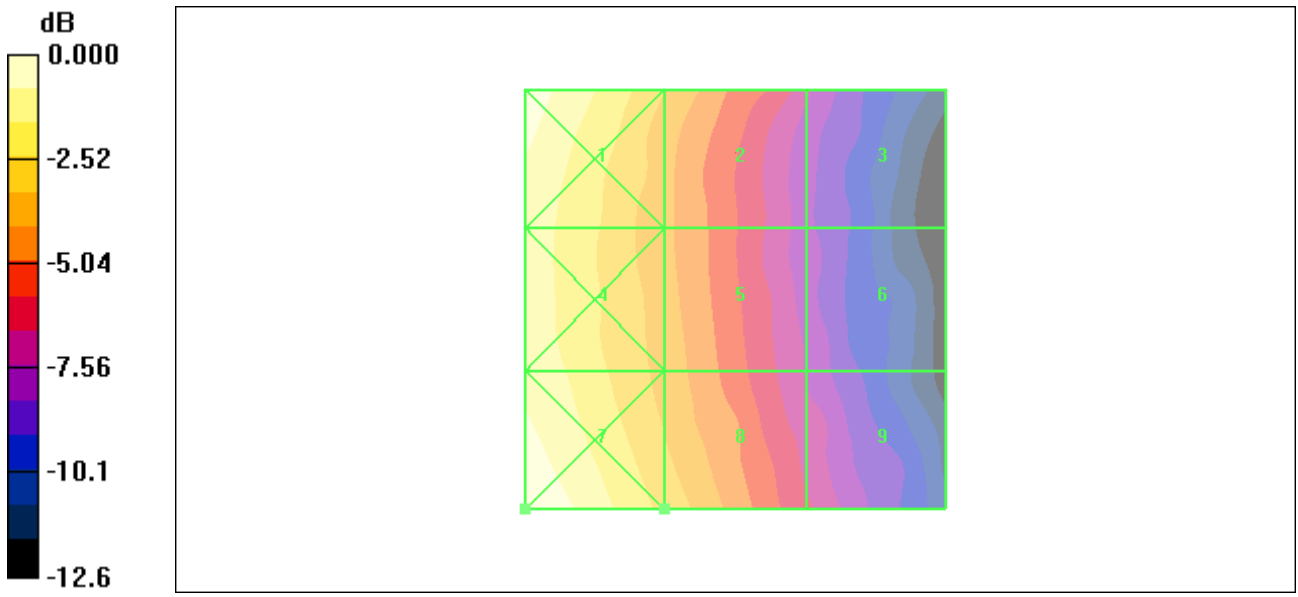

0 dB = 0.299A/m

Figure 17 HAC RF H-Field GSM 850 Channel 190

TA Technology (Shanghai) Co., Ltd.

Test Report

Report No. RXA1204-0069HAC01R1

Page 44 of 134

HAC RF H-Field GSM 850 Low (Battery 1)

Date/Time: 5/7/2012 11:59:47 AM

Communication System: GSM850; Frequency: 824.2 MHz; Duty Cycle: 1:8.3

Medium parameters used: $\sigma = 0$ mho/m, $\epsilon_r = 1$; $\rho = 1$ kg/m³

Ambient Temperature: 22.3 °C

Phantom section: RF Section

DASY4 Configuration:

Probe: H3DV6 - SN6138; ; Calibrated: 2/21/2012

Electronics: DAE4 Sn1317; Calibrated: 1/23/2012

Phantom: HAC Test Arch; Type: SD HAC P01 BA;

Measurement SW: DASY4, V4.7 Build 80; Postprocessing SW: SEMCAD, V1.8 Build 186

H Scan - H3DV6 - 2007: 15 mm from Probe Center to the Device Low/Hearing Aid Compatibility

Test (101x101x1): Measurement grid: dx=5mm, dy=5mm

Maximum value of peak Total field = 0.192 A/m

Probe Modulation Factor = 2.75

Device Reference Point: 0.000, 0.000, -6.30 mm

Reference Value = 0.050 A/m; Power Drift = -0.106 dB

Hearing Aid Near-Field Category: M4 (AWF -5 dB)

Peak H-field in A/m

Grid 1 0.255 M4	Grid 2 0.179 M4	Grid 3 0.113 M4
Grid 4 0.235 M4	Grid 5 0.173 M4	Grid 6 0.109 M4
Grid 7 0.265 M4	Grid 8 0.192 M4	Grid 9 0.125 M4

TA Technology (Shanghai) Co., Ltd.
Test Report

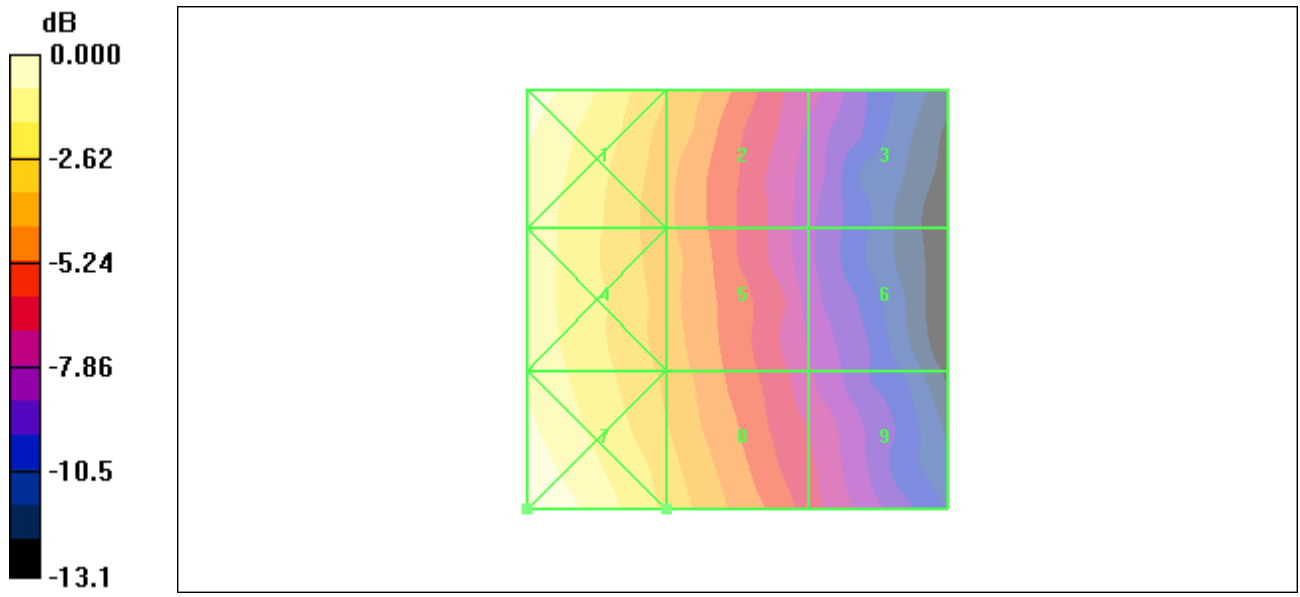

0 dB = 0.265A/m

Figure 18 HAC RF H-Field GSM 850 Channel 128

TA Technology (Shanghai) Co., Ltd.
Test Report

Report No. RXA1204-0069HAC01R1

Page 46 of 134

HAC RF H-Field GSM 850 High (Battery 2)

Date/Time: 5/7/2012 12:05:12 PM

Communication System: GSM850; Frequency: 848.8 MHz; Duty Cycle: 1:8.3

Medium parameters used: $\sigma = 0$ mho/m, $\epsilon_r = 1$; $\rho = 1$ kg/m³

Ambient Temperature: 22.3 °C

Phantom section: RF Section

DASY4 Configuration:

Probe: H3DV6 - SN6138; ; Calibrated: 2/21/2012

Electronics: DAE4 Sn1317; Calibrated: 1/23/2012

Phantom: HAC Test Arch; Type: SD HAC P01 BA;

Measurement SW: DASY4, V4.7 Build 80; Postprocessing SW: SEMCAD, V1.8 Build 186

H Scan - H3DV6 - 2007: 15 mm from Probe Center to the Device High/Hearing Aid

Compatibility Test (101x101x1): Measurement grid: dx=5mm, dy=5mm

Maximum value of peak Total field = 0.256 A/m

Probe Modulation Factor = 2.75

Device Reference Point: 0.000, 0.000, -6.30 mm

Reference Value = 0.067 A/m; Power Drift = 0.054 dB

Hearing Aid Near-Field Category: M4 (AWF -5 dB)

Peak H-field in A/m

Grid 1 0.338 M4	Grid 2 0.241 M4	Grid 3 0.152 M4
Grid 4 0.311 M4	Grid 5 0.230 M4	Grid 6 0.149 M4
Grid 7 0.350 M4	Grid 8 0.256 M4	Grid 9 0.165 M4

TA Technology (Shanghai) Co., Ltd.
Test Report

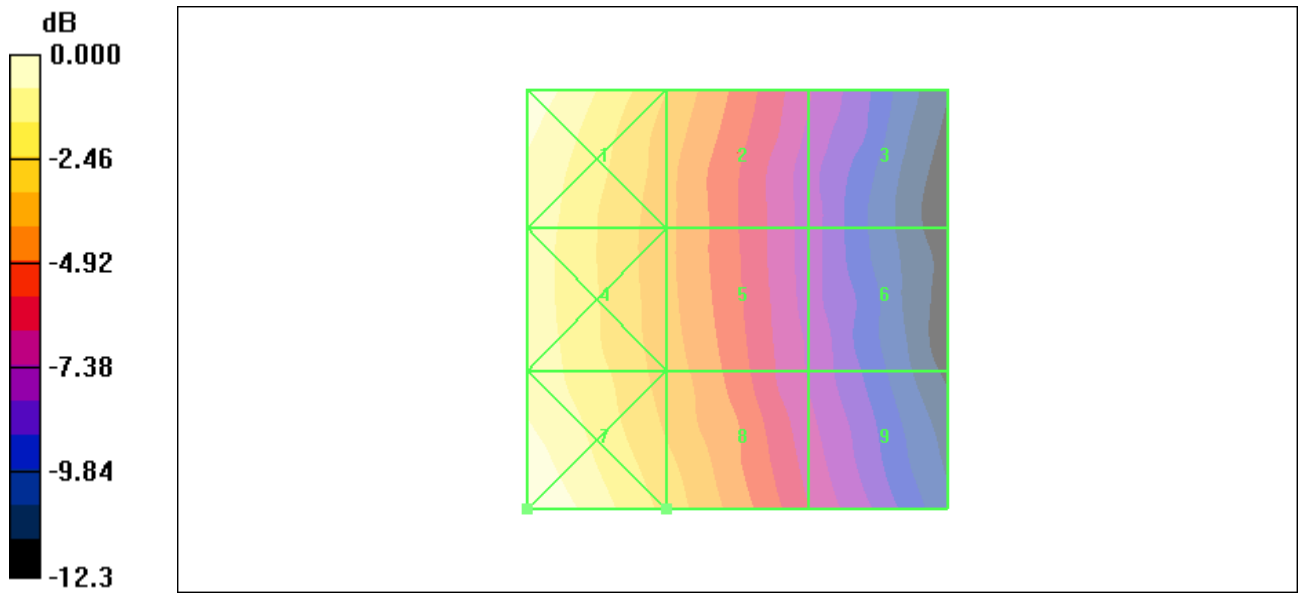

0 dB = 0.350A/m

Figure 19 HAC RF H-Field GSM 850 Channel 251

TA Technology (Shanghai) Co., Ltd.

Test Report

Report No. RXA1204-0069HAC01R1

Page 48 of 134

HAC RF E-Field GSM 1900 High (Battery 1)

Date/Time: 5/7/2012 6:36:00 PM

Communication System: PCS 1900; Frequency: 1909.8 MHz; Duty Cycle: 1:8.3

Medium parameters used: $\sigma = 0$ mho/m, $\epsilon_r = 1$; $\rho = 1000$ kg/m³

Ambient Temperature: 22.3 °C

Phantom section: RF Section

DASY4 Configuration:

Probe: ER3DV6 - SN2303; ConvF(1, 1, 1); Calibrated: 2/21/2012

Electronics: DAE4 Sn1317; Calibrated: 1/23/2012

Phantom: HAC Test Arch; Type: SD HAC P01 BA;

Measurement SW: DASY4, V4.7 Build 80; Postprocessing SW: SEMCAD, V1.8 Build 186

E Scan - ER3D - 2007: 15 mm from Probe Center to the Device High/Hearing Aid Compatibility

Test (101x101x1): Measurement grid: dx=5mm, dy=5mm

Maximum value of peak Total field = 70.4 V/m

Probe Modulation Factor = 2.84

Device Reference Point: 0.000, 0.000, -6.30 mm

Reference Value = 10.6 V/m; Power Drift = 0.028 dB

Hearing Aid Near-Field Category: M3 (AWF -5 dB)

Peak E-field in V/m

Grid 1	Grid 2	Grid 3
64.1 M3	70.4 M3	66.6 M3
Grid 4	Grid 5	Grid 6
37.4 M4	48.0 M3	47.9 M3
Grid 7	Grid 8	Grid 9
63.3 M3	74.5 M3	73.6 M3

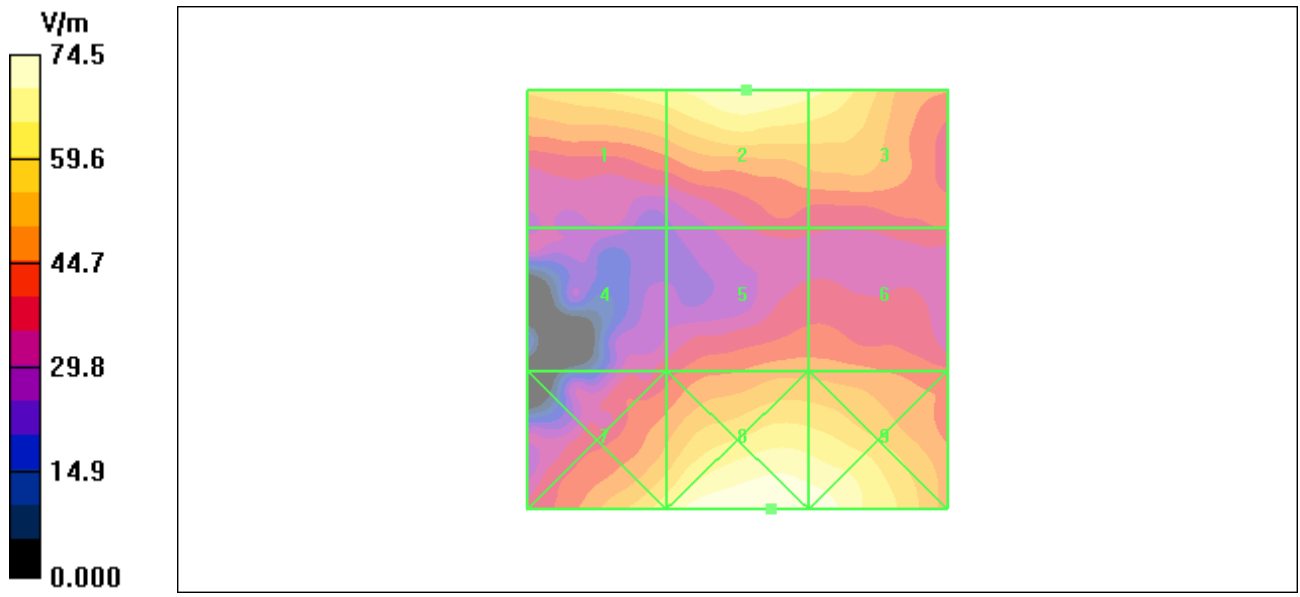

Figure 20 HAC RF E-Field GSM 1900 Channel 810

TA Technology (Shanghai) Co., Ltd.
Test Report

Report No. RXA1204-0069HAC01R1

Page 50 of 134

HAC RF E-Field GSM 1900 Middle (Battery 1)

Date/Time: 5/7/2012 6:29:01 PM

Communication System: PCS 1900; Frequency: 1880 MHz; Duty Cycle: 1:8.3

Medium parameters used: $\sigma = 0$ mho/m, $\epsilon_r = 1$; $\rho = 1000$ kg/m³

Ambient Temperature: 22.3 °C

Phantom section: RF Section

DASY4 Configuration:

Probe: ER3DV6 - SN2303; ConvF(1, 1, 1); Calibrated: 2/21/2012

Electronics: DAE4 Sn1317; Calibrated: 1/23/2012

Phantom: HAC Test Arch; Type: SD HAC P01 BA;

Measurement SW: DASY4, V4.7 Build 80; Postprocessing SW: SEMCAD, V1.8 Build 186

E Scan - ER3D - 2007: 15 mm from Probe Center to the Device Middle/Hearing Aid

Compatibility Test (101x101x1): Measurement grid: dx=5mm, dy=5mm

Maximum value of peak Total field = 67.4 V/m

Probe Modulation Factor = 2.84

Device Reference Point: 0.000, 0.000, -6.30 mm

Reference Value = 10.7 V/m; Power Drift = 0.075 dB

Hearing Aid Near-Field Category: M3 (AWF -5 dB)

Peak E-field in V/m

Grid 1	Grid 2	Grid 3
62.9 M3	67.4 M3	59.4 M3
Grid 4	Grid 5	Grid 6
41.6 M4	47.3 M4	47.5 M3
Grid 7	Grid 8	Grid 9
61.2 M3	73.7 M3	70.7 M3

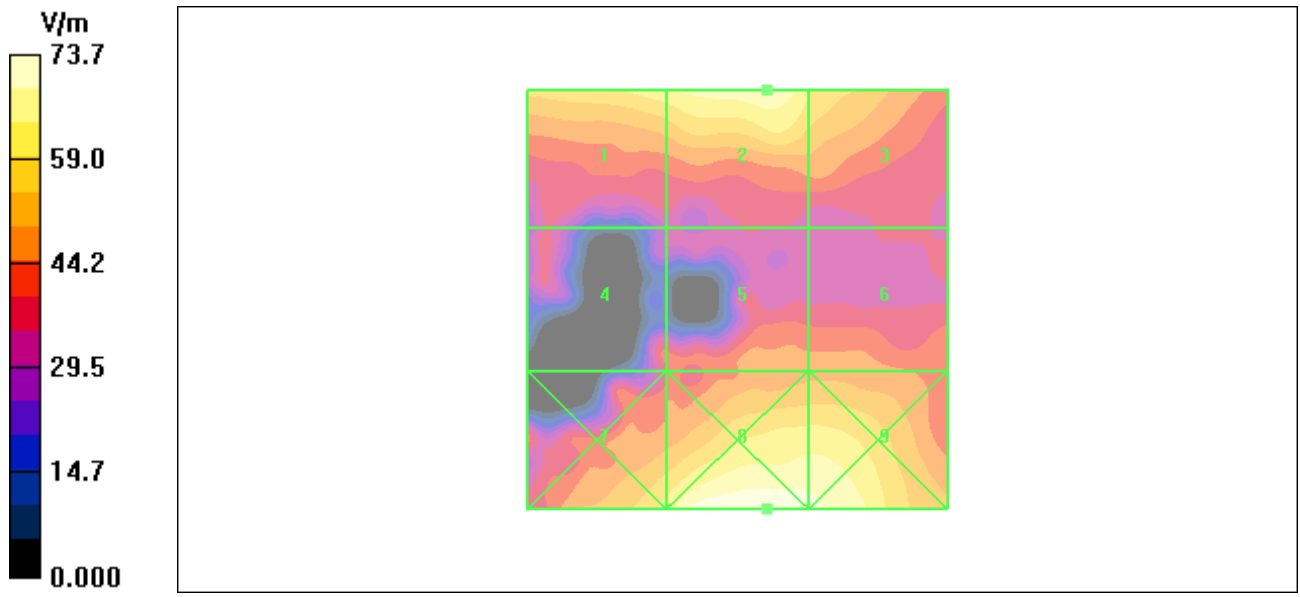

Figure 21 HAC RF E-Field GSM 1900 Channel 661

TA Technology (Shanghai) Co., Ltd.

Test Report

Report No. RXA1204-0069HAC01R1

Page 52 of 134

HAC RF E-Field GSM 1900 Low (Battery 1)

Date/Time: 5/7/2012 6:42:05 PM

Communication System: PCS 1900; Frequency: 1850.2 MHz; Duty Cycle: 1:8.3

Medium parameters used: $\sigma = 0$ mho/m, $\epsilon_r = 1$; $\rho = 1000$ kg/m³

Ambient Temperature: 22.3 °C

Phantom section: RF Section

DASY4 Configuration:

Probe: ER3DV6 - SN2303; ConvF(1, 1, 1); Calibrated: 2/21/2012

Electronics: DAE4 Sn1317; Calibrated: 1/23/2012

Phantom: HAC Test Arch; Type: SD HAC P01 BA;

Measurement SW: DASY4, V4.7 Build 80; Postprocessing SW: SEMCAD, V1.8 Build 186

E Scan - ER3D - 2007: 15 mm from Probe Center to the Device Low/Hearing Aid Compatibility

Test (101x101x1): Measurement grid: dx=5mm, dy=5mm

Maximum value of peak Total field = 61.1 V/m

Probe Modulation Factor = 2.84

Device Reference Point: 0.000, 0.000, -6.30 mm

Reference Value = 11.2 V/m; Power Drift = 0.052 dB

Hearing Aid Near-Field Category: M3 (AWF -5 dB)

Peak E-field in V/m

Grid 1	Grid 2	Grid 3
54.0 M3	61.1 M3	50.0 M3
Grid 4	Grid 5	Grid 6
36.4 M4	51.0 M3	51.8 M3
Grid 7	Grid 8	Grid 9
57.8 M3	70.4 M3	68.4 M3

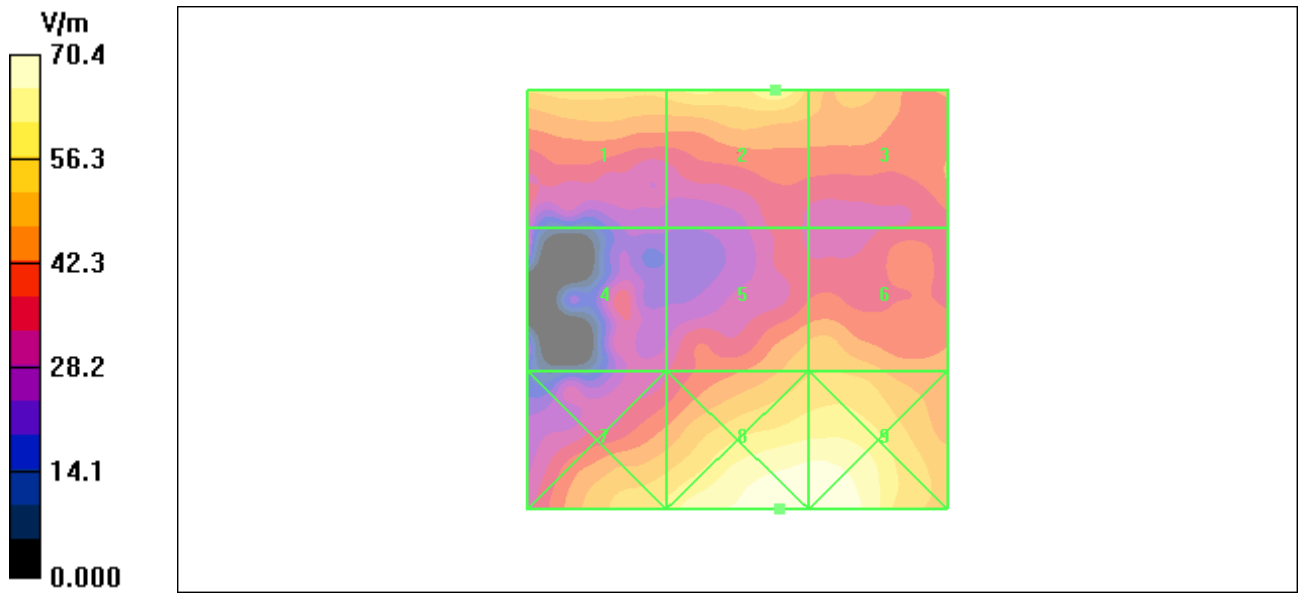

Figure 22 HAC RF E-Field GSM 1900 Channel 512

TA Technology (Shanghai) Co., Ltd.
Test Report

Report No. RXA1204-0069HAC01R1

Page 54 of 134

HAC RF E-Field GSM 1900 High (Battery 2)

Date/Time: 5/7/2012 6:49:32 PM

Communication System: PCS 1900; Frequency: 1909.8 MHz; Duty Cycle: 1:8.3

Medium parameters used: $\sigma = 0$ mho/m, $\epsilon_r = 1$; $\rho = 1000$ kg/m³

Ambient Temperature: 22.3 °C

Phantom section: RF Section

DASY4 Configuration:

Probe: ER3DV6 - SN2303; ConvF(1, 1, 1); Calibrated: 2/21/2012

Electronics: DAE4 Sn1317; Calibrated: 1/23/2012

Phantom: HAC Test Arch; Type: SD HAC P01 BA;

Measurement SW: DASY4, V4.7 Build 80; Postprocessing SW: SEMCAD, V1.8 Build 186

E Scan - ER3D - 2007: 15 mm from Probe Center to the Device High/Hearing Aid Compatibility Test (101x101x1): Measurement grid: dx=5mm, dy=5mm

Maximum value of peak Total field = 69.2 V/m

Probe Modulation Factor = 2.84

Device Reference Point: 0.000, 0.000, -6.30 mm

Reference Value = 10.7 V/m; Power Drift = 0.009 dB

Hearing Aid Near-Field Category: M3 (AWF -5 dB)

Peak E-field in V/m

Grid 1	Grid 2	Grid 3
61.4 M3	69.2 M3	65.1 M3
Grid 4	Grid 5	Grid 6
34.7 M4	46.1 M4	45.6 M4
Grid 7	Grid 8	Grid 9
62.6 M3	75.8 M3	76.0 M3

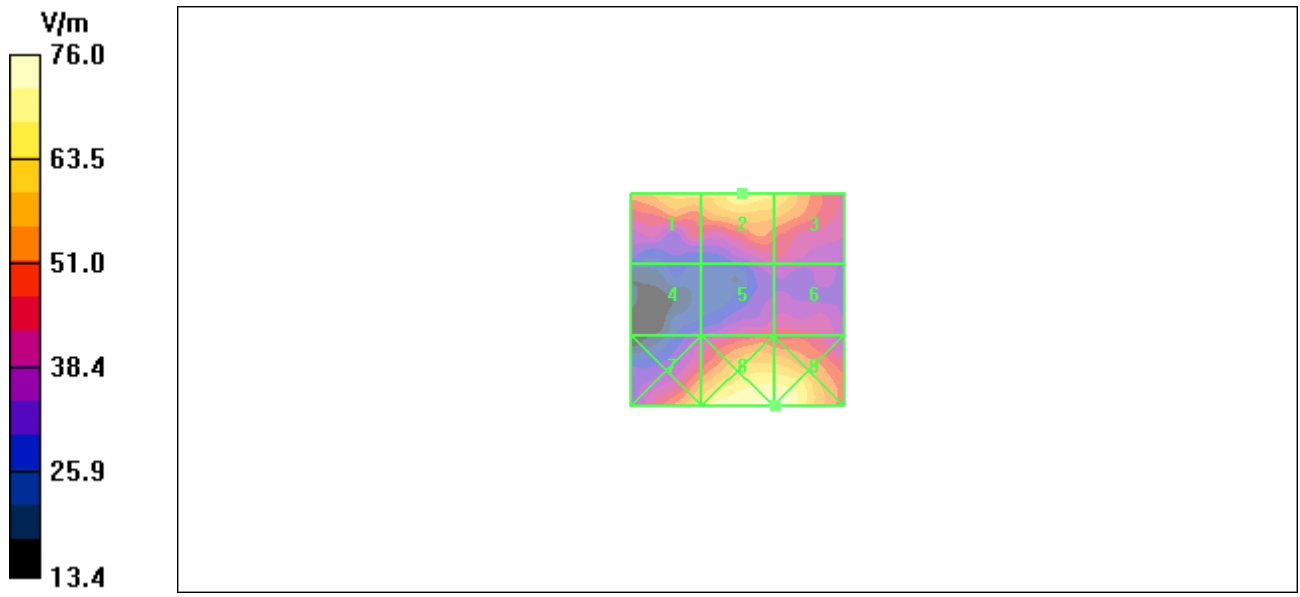

Figure 23 HAC RF E-Field GSM 1900 Channel 810

TA Technology (Shanghai) Co., Ltd.

Test Report

Report No. RXA1204-0069HAC01R1

Page 56 of 134

HAC RF H-Field GSM 1900 High (Battery 1)

Date/Time: 5/7/2012 11:39:22 AM

Communication System: PCS 1900; Frequency: 1909.8 MHz; Duty Cycle: 1:8.3

Medium parameters used: $\sigma = 0$ mho/m, $\epsilon_r = 1$; $\rho = 1$ kg/m³

Ambient Temperature: 22.3 °C

Phantom section: RF Section

DASY4 Configuration:

Probe: H3DV6 - SN6138; ; Calibrated: 2/21/2012

Electronics: DAE4 Sn1317; Calibrated: 1/23/2012

Phantom: HAC Test Arch; Type: SD HAC P01 BA;

Measurement SW: DASY4, V4.7 Build 80; Postprocessing SW: SEMCAD, V1.8 Build 186

H Scan - H3DV6 - 2007: 15 mm from Probe Center to the Device High/Hearing Aid

Compatibility Test (101x101x1): Measurement grid: dx=5mm, dy=5mm

Maximum value of peak Total field = 0.200 A/m

Probe Modulation Factor = 2.84

Device Reference Point: 0.000, 0.000, -6.30 mm

Reference Value = 0.079 A/m; Power Drift = 0.037 dB

Hearing Aid Near-Field Category: M3 (AWF -5 dB)

Peak H-field in A/m

Grid 1	Grid 2	Grid 3
0.189 M3	0.199 M3	0.199 M3
Grid 4	Grid 5	Grid 6
0.169 M3	0.200 M3	0.199 M3
Grid 7	Grid 8	Grid 9
0.166 M3	0.177 M3	0.175 M3

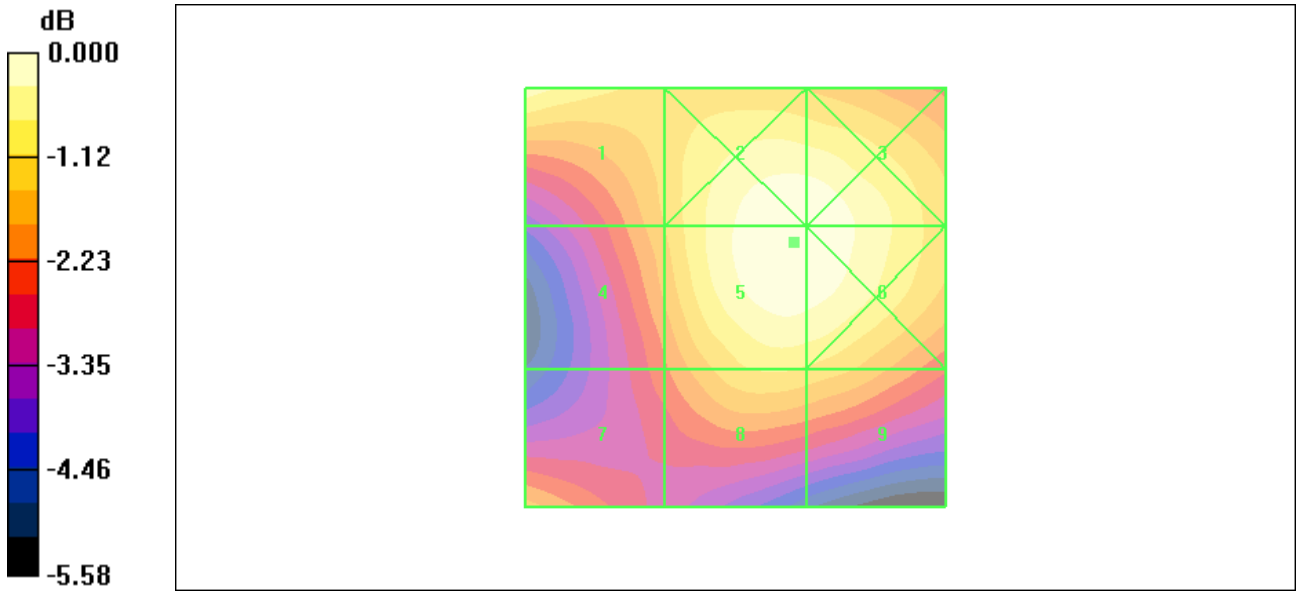

0 dB = 0.200A/m

Figure 24 HAC RF H-Field GSM 1900 Channel 810

TA Technology (Shanghai) Co., Ltd.

Test Report

Report No. RXA1204-0069HAC01R1

Page 58 of 134

HAC RF H-Field GSM 1900 Middle (Battery 1)

Date/Time: 5/7/2012 11:34:28 AM

Communication System: PCS 1900; Frequency: 1880 MHz; Duty Cycle: 1:8.3

Medium parameters used: $\sigma = 0$ mho/m, $\epsilon_r = 1$; $\rho = 1$ kg/m³

Ambient Temperature: 22.3 °C

Phantom section: RF Section

DASY4 Configuration:

Probe: H3DV6 - SN6138; ; Calibrated: 2/21/2012

Electronics: DAE4 Sn1317; Calibrated: 1/23/2012

Phantom: HAC Test Arch; Type: SD HAC P01 BA;

Measurement SW: DASY4, V4.7 Build 80; Postprocessing SW: SEMCAD, V1.8 Build 186

H Scan - H3DV6 - 2007: 15 mm from Probe Center to the Device Middle/Hearing Aid

Compatibility Test (101x101x1): Measurement grid: dx=5mm, dy=5mm

Maximum value of peak Total field = 0.184 A/m

Probe Modulation Factor = 2.84

Device Reference Point: 0.000, 0.000, -6.30 mm

Reference Value = 0.072 A/m; Power Drift = -0.018 dB

Hearing Aid Near-Field Category: M3 (AWF -5 dB)

Peak H-field in A/m

Grid 1	Grid 2	Grid 3
0.180 M3	0.184 M3	0.183 M3
Grid 4	Grid 5	Grid 6
0.152 M3	0.184 M3	0.184 M3
Grid 7	Grid 8	Grid 9
0.164 M3	0.160 M3	0.159 M3

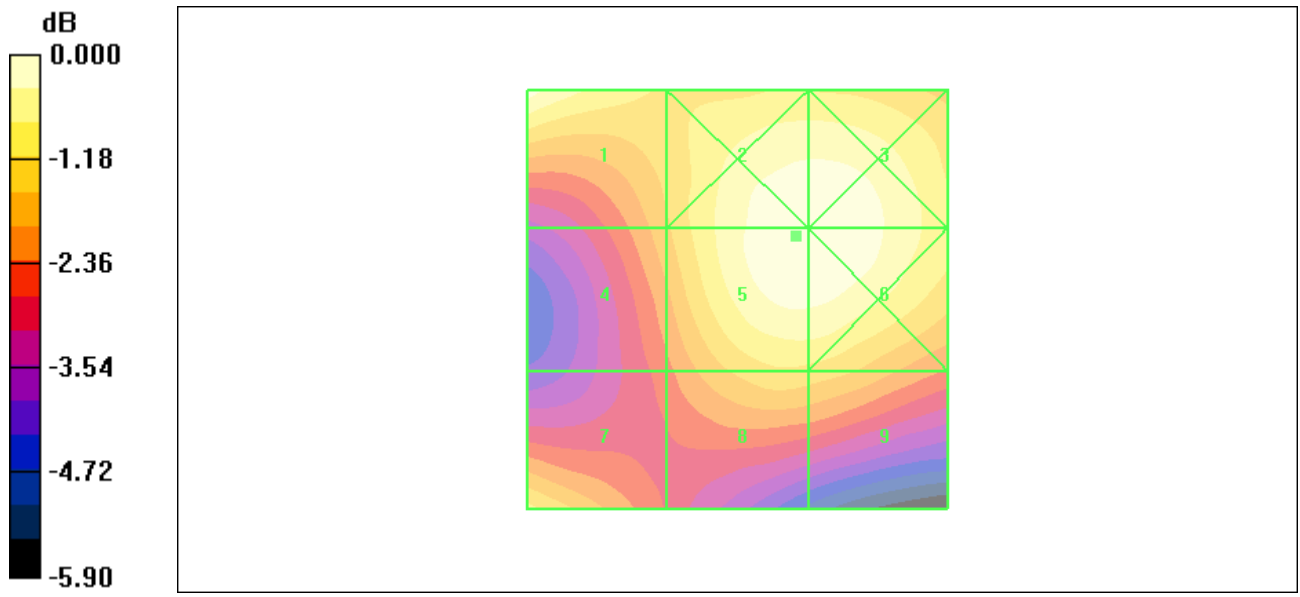

0 dB = 0.184A/m

Figure 25 HAC RF H-Field GSM 1900 Channel 661

TA Technology (Shanghai) Co., Ltd.

Test Report

Report No. RXA1204-0069HAC01R1

Page 60 of 134

HAC RF H-Field GSM 1900 Low (Battery 1)

Date/Time: 5/7/2012 11:44:06 AM

Communication System: PCS 1900; Frequency: 1850.2 MHz; Duty Cycle: 1:8.3

Medium parameters used: $\sigma = 0$ mho/m, $\epsilon_r = 1$; $\rho = 1$ kg/m³

Ambient Temperature: 22.3 °C

Phantom section: RF Section

DASY4 Configuration:

Probe: H3DV6 - SN6138; ; Calibrated: 2/21/2012

Electronics: DAE4 Sn1317; Calibrated: 1/23/2012

Phantom: HAC Test Arch; Type: SD HAC P01 BA;

Measurement SW: DASY4, V4.7 Build 80; Postprocessing SW: SEMCAD, V1.8 Build 186

H Scan - H3DV6 - 2007: 15 mm from Probe Center to the Device Low/Hearing Aid Compatibility Test (101x101x1): Measurement grid: dx=5mm, dy=5mm

Maximum value of peak Total field = 0.182 A/m

Probe Modulation Factor = 2.84

Device Reference Point: 0.000, 0.000, -6.30 mm

Reference Value = 0.071 A/m; Power Drift = 0.040 dB

Hearing Aid Near-Field Category: M3 (AWF -5 dB)

Peak H-field in A/m

Grid 1 0.160 M3	Grid 2 0.182 M3	Grid 3 0.181 M3
Grid 4 0.150 M3	Grid 5 0.182 M3	Grid 6 0.181 M3
Grid 7 0.153 M3	Grid 8 0.156 M3	Grid 9 0.154 M3

TA Technology (Shanghai) Co., Ltd.
Test Report

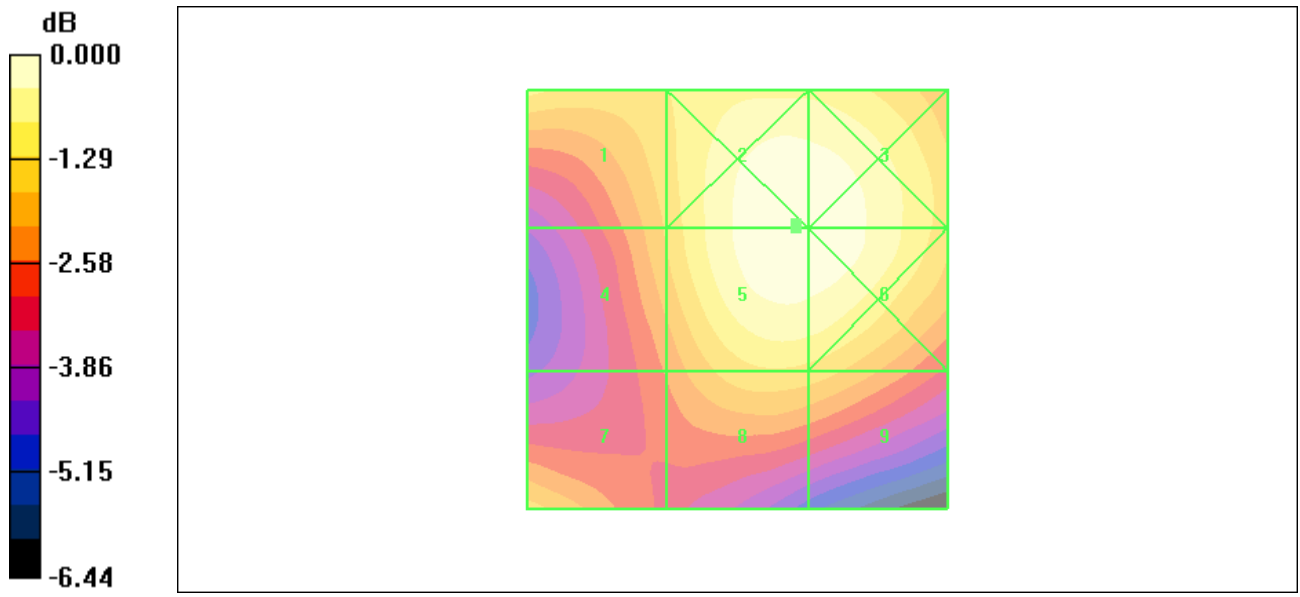

0 dB = 0.182A/m

Figure 26 HAC RF H-Field GSM 1900 Channel 512

TA Technology (Shanghai) Co., Ltd.

Test Report

Report No. RXA1204-0069HAC01R1

Page 62 of 134

HAC RF H-Field GSM 1900 High (Battery 2)

Date/Time: 5/7/2012 12:09:54 PM

Communication System: PCS 1900; Frequency: 1909.8 MHz; Duty Cycle: 1:8.3

Medium parameters used: $\sigma = 0$ mho/m, $\epsilon_r = 1$; $\rho = 1$ kg/m³

Ambient Temperature: 22.3 °C

Phantom section: RF Section

DASY4 Configuration:

Probe: H3DV6 - SN6138; ; Calibrated: 2/21/2012

Electronics: DAE4 Sn1317; Calibrated: 1/23/2012

Phantom: HAC Test Arch; Type: SD HAC P01 BA;

Measurement SW: DASY4, V4.7 Build 80; Postprocessing SW: SEMCAD, V1.8 Build 186

H Scan - H3DV6 - 2007: 15 mm from Probe Center to the Device High/Hearing Aid

Compatibility Test (101x101x1): Measurement grid: dx=5mm, dy=5mm

Maximum value of peak Total field = 0.196 A/m

Probe Modulation Factor = 2.84

Device Reference Point: 0.000, 0.000, -6.30 mm

Reference Value = 0.078 A/m; Power Drift = 0.054 dB

Hearing Aid Near-Field Category: M3 (AWF -5 dB)

Peak H-field in A/m

Grid 1	Grid 2	Grid 3
0.187 M3	0.195 M3	0.195 M3
Grid 4	Grid 5	Grid 6
0.164 M3	0.196 M3	0.195 M3
Grid 7	Grid 8	Grid 9
0.163 M3	0.174 M3	0.172 M3

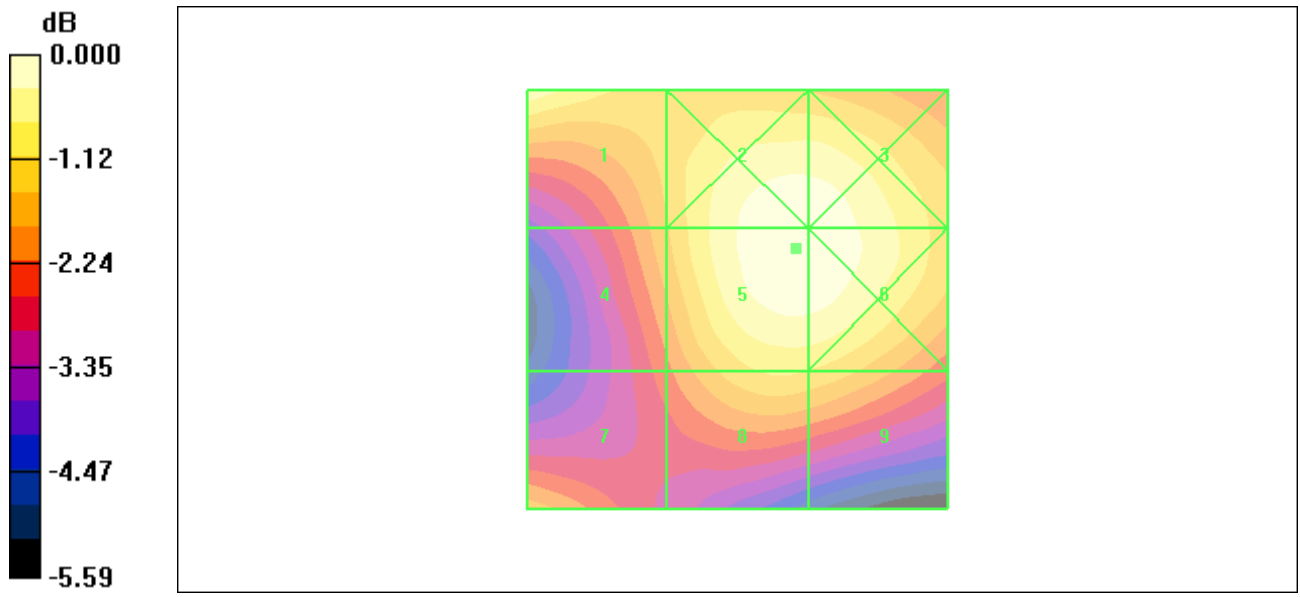

0 dB = 0.196A/m

Figure 27 HAC RF H-Field GSM 1900 Channel 810

TA Technology (Shanghai) Co., Ltd.
Test Report

Report No. RXA1204-0069HAC01R1

Page 64 of 134

HAC RF E-Field WCDMA Band IV High (Battery 1)

Date/Time: 5/7/2012 7:27:41 PM

Communication System: WCDMA Band IV; Frequency: 1752.6 MHz; Duty Cycle: 1:1

Medium parameters used: $\sigma = 0$ mho/m, $\epsilon_r = 1$; $\rho = 1000$ kg/m³

Ambient Temperature: 22.3 °C

Phantom section: RF Section

DASY4 Configuration:

Probe: ER3DV6 - SN2303; ConvF(1, 1, 1); Calibrated: 2/21/2012

Electronics: DAE4 Sn1317; Calibrated: 1/23/2012

Phantom: HAC Test Arch; Type: SD HAC P01 BA;

Measurement SW: DASY4, V4.7 Build 80; Postprocessing SW: SEMCAD, V1.8 Build 186

E Scan - ER3D - 2007: 15 mm from Probe Center to the Device High/Hearing Aid Compatibility

Test (101x101x1): Measurement grid: dx=5mm, dy=5mm

Maximum value of peak Total field = 43.3 V/m

Probe Modulation Factor = 1.02

Device Reference Point: 0.000, 0.000, -6.30 mm

Reference Value = 34.6 V/m; Power Drift = 0.052 dB

Hearing Aid Near-Field Category: M4 (AWF 0 dB)

Peak E-field in V/m

Grid 1	Grid 2	Grid 3
38.0 M4	36.5 M4	34.3 M4
Grid 4	Grid 5	Grid 6
27.9 M4	43.2 M4	43.4 M4
Grid 7	Grid 8	Grid 9
43.3 M4	55.4 M4	54.8 M4

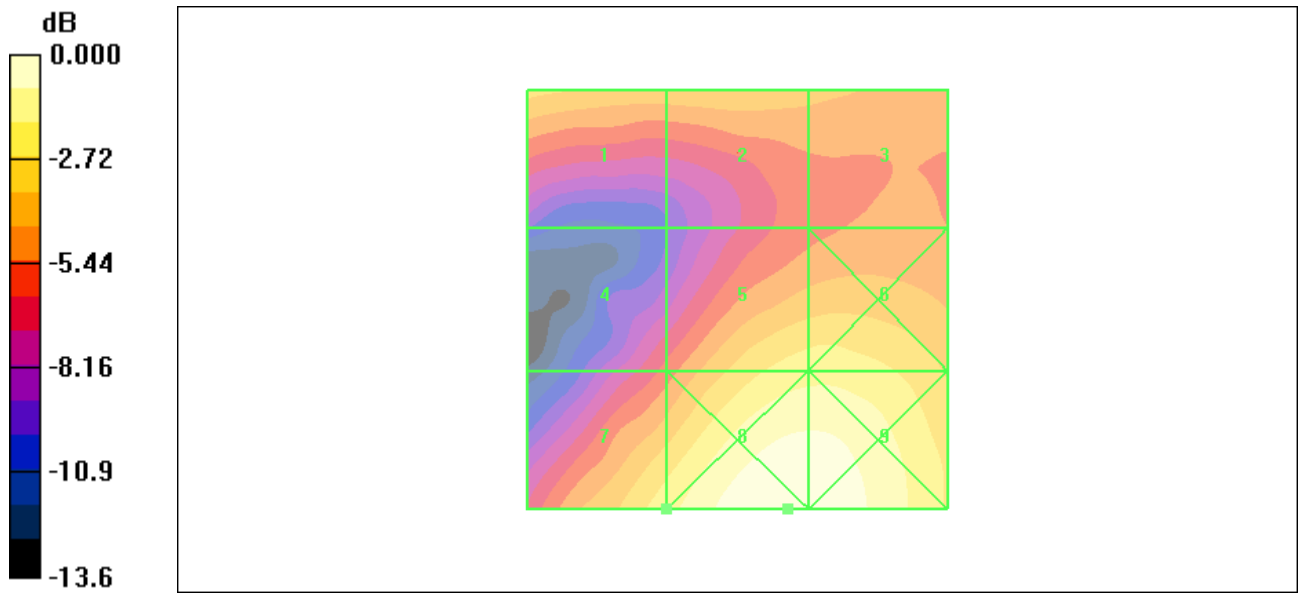

0 dB = 55.4V/m

Figure 28 HAC RF E-Field WCDMA Band IV Channel 1513

TA Technology (Shanghai) Co., Ltd.
Test Report

Report No. RXA1204-0069HAC01R1

Page 66 of 134

HAC RF E-Field WCDMA Band IV Middle (Battery 1)

Date/Time: 5/7/2012 7:22:00 PM

Communication System: WCDMA Band IV; Frequency: 1732.6 MHz; Duty Cycle: 1:1

Medium parameters used: $\sigma = 0$ mho/m, $\epsilon_r = 1$; $\rho = 1000$ kg/m³

Ambient Temperature: 22.3 °C

Phantom section: RF Section

DASY4 Configuration:

Probe: ER3DV6 - SN2303; ConvF(1, 1, 1); Calibrated: 2/21/2012

Electronics: DAE4 Sn1317; Calibrated: 1/23/2012

Phantom: HAC Test Arch; Type: SD HAC P01 BA;

Measurement SW: DASY4, V4.7 Build 80; Postprocessing SW: SEMCAD, V1.8 Build 186

E Scan - ER3D - 2007: 15 mm from Probe Center to the Device Middle/Hearing Aid

Compatibility Test (101x101x1): Measurement grid: dx=5mm, dy=5mm

Maximum value of peak Total field = 39.2 V/m

Probe Modulation Factor = 1.02

Device Reference Point: 0.000, 0.000, -6.30 mm

Reference Value = 31.8 V/m; Power Drift = 0.081 dB

Hearing Aid Near-Field Category: M4 (AWF 0 dB)

Peak E-field in V/m

Grid 1	Grid 2	Grid 3
35.8 M4	33.5 M4	31.3 M4
Grid 4	Grid 5	Grid 6
25.9 M4	39.1 M4	39.2 M4
Grid 7	Grid 8	Grid 9
41.1 M4	50.5 M4	49.9 M4

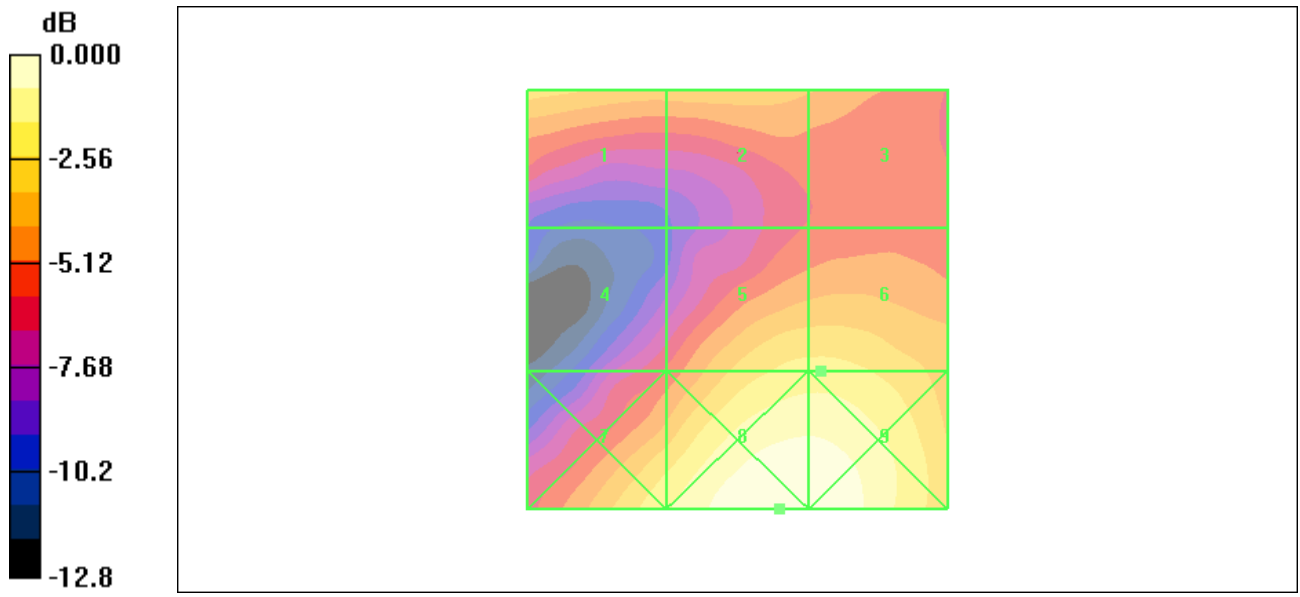

0 dB = 50.5V/m

Figure 29 HAC RF E-Field WCDMA Band IV Channel 1413

TA Technology (Shanghai) Co., Ltd.
Test Report

Report No. RXA1204-0069HAC01R1

Page 68 of 134

HAC RF E-Field WCDMA Band IV Low (Battery 1)

Date/Time: 5/7/2012 7:16:51 PM

Communication System: WCDMA Band IV; Frequency: 1712.4 MHz; Duty Cycle: 1:1

Medium parameters used: $\sigma = 0$ mho/m, $\epsilon_r = 1$; $\rho = 1000$ kg/m³

Ambient Temperature: 22.3 °C

Phantom section: RF Section

DASY4 Configuration:

Probe: ER3DV6 - SN2303; ConvF(1, 1, 1); Calibrated: 2/21/2012

Electronics: DAE4 Sn1317; Calibrated: 1/23/2012

Phantom: HAC Test Arch; Type: SD HAC P01 BA;

Measurement SW: DASY4, V4.7 Build 80; Postprocessing SW: SEMCAD, V1.8 Build 186

E Scan - ER3D - 2007: 15 mm from Probe Center to the Device Low/Hearing Aid Compatibility

Test (101x101x1): Measurement grid: dx=5mm, dy=5mm

Maximum value of peak Total field = 42.8 V/m

Probe Modulation Factor = 1.02

Device Reference Point: 0.000, 0.000, -6.30 mm

Reference Value = 35.4 V/m; Power Drift = 0.086 dB

Hearing Aid Near-Field Category: M4 (AWF 0 dB)

Peak E-field in V/m

Grid 1	Grid 2	Grid 3
37.5 M4	33.6 M4	30.7 M4
Grid 4	Grid 5	Grid 6
29.0 M4	42.8 M4	42.8 M4
Grid 7	Grid 8	Grid 9
45.2 M4	55.8 M4	55.2 M4

TA Technology (Shanghai) Co., Ltd.
Test Report

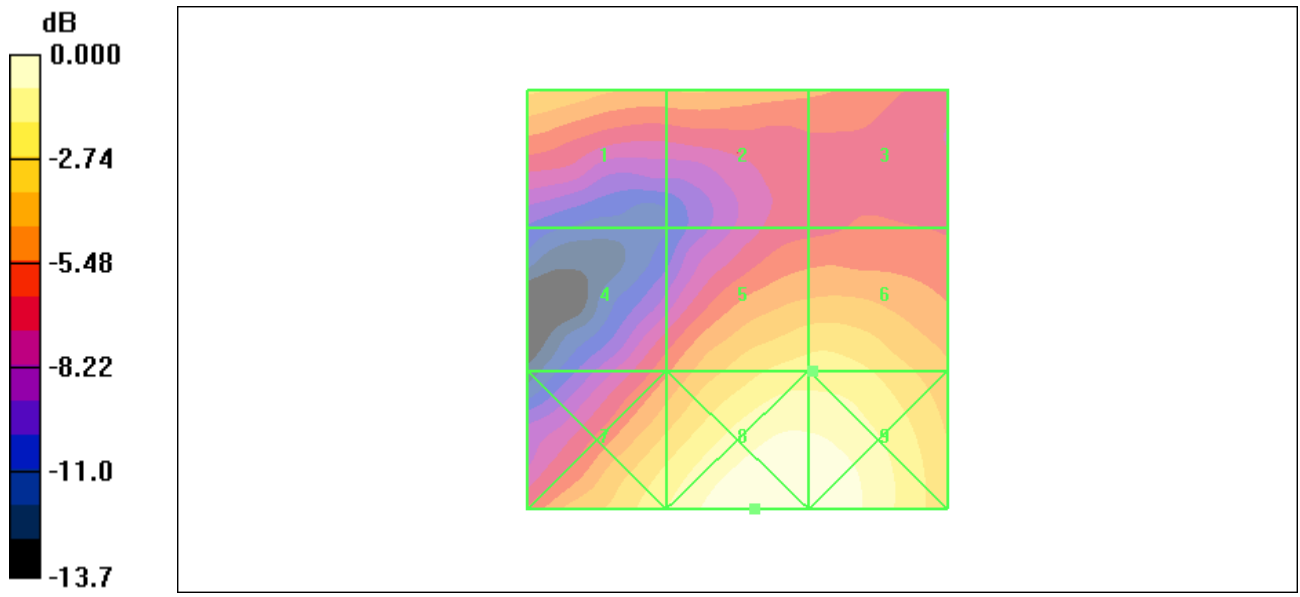

0 dB = 55.8V/m

Figure 30 HAC RF E-Field WCDMA Band IV Channel 1312

HAC RF E-Field WCDMA Band IV High (Battery 2)

Date/Time: 5/7/2012 7:32:40 PM

Communication System: WCDMA Band IV; Frequency: 1752.6 MHz; Duty Cycle: 1:1

Medium parameters used: $\sigma = 0$ mho/m, $\epsilon_r = 1$; $\rho = 1000$ kg/m³

Ambient Temperature: 22.3 °C

Phantom section: RF Section

DASY4 Configuration:

Probe: ER3DV6 - SN2303; ConvF(1, 1, 1); Calibrated: 2/21/2012

Electronics: DAE4 Sn1317; Calibrated: 1/23/2012

Phantom: HAC Test Arch; Type: SD HAC P01 BA;

Measurement SW: DASY4, V4.7 Build 80; Postprocessing SW: SEMCAD, V1.8 Build 186

E Scan - ER3D - 2007: 15 mm from Probe Center to the Device High/Hearing Aid Compatibility Test (101x101x1): Measurement grid: dx=5mm, dy=5mm

Maximum value of peak Total field = 43.5 V/m

Probe Modulation Factor = 1.02

Device Reference Point: 0.000, 0.000, -6.30 mm

Reference Value = 34.8 V/m; Power Drift = 0.119 dB

Hearing Aid Near-Field Category: M4 (AWF 0 dB)

Peak E-field in V/m

Grid 1	Grid 2	Grid 3
37.8 M4	36.9 M4	34.5 M4
Grid 4	Grid 5	Grid 6
28.2 M4	43.3 M4	43.5 M4
Grid 7	Grid 8	Grid 9
43.5 M4	54.8 M4	54.5 M4

TA Technology (Shanghai) Co., Ltd.
Test Report

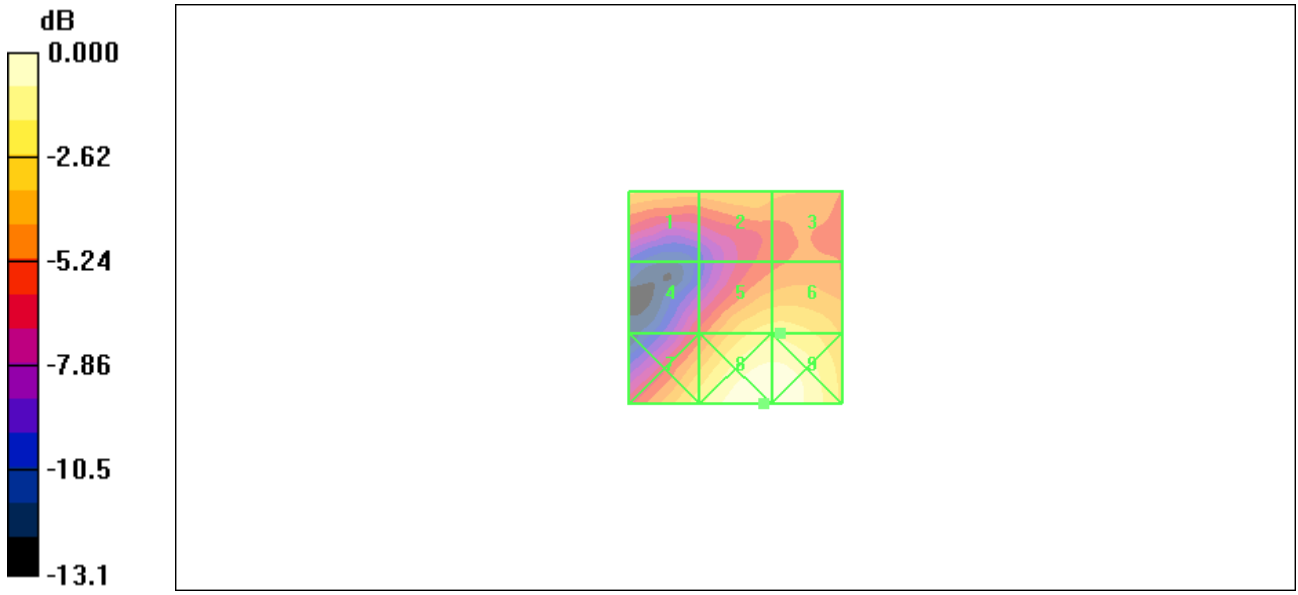

0 dB = 54.8V/m

Figure 31 HAC RF E-Field WCDMA Band IV Channel 1513

TA Technology (Shanghai) Co., Ltd.
Test Report

Report No. RXA1204-0069HAC01R1

Page 72 of 134

HAC RF H-Field WCDMA Band IV High (Battery 1)

Date/Time: 5/7/2012 12:44:52 PM

Communication System: WCDMA Band IV; Frequency: 1752.6 MHz; Duty Cycle: 1:1

Medium parameters used: $\sigma = 0$ mho/m, $\epsilon_r = 1$; $\rho = 1$ kg/m³

Ambient Temperature: 22.3 °C

Phantom section: RF Section

DASY4 Configuration:

Probe: H3DV6 - SN6138; ; Calibrated: 2/21/2012

Electronics: DAE4 Sn1317; Calibrated: 1/23/2012

Phantom: HAC Test Arch; Type: SD HAC P01 BA;

Measurement SW: DASY4, V4.7 Build 80; Postprocessing SW: SEMCAD, V1.8 Build 186

H Scan - H3DV6 - 2007: 15 mm from Probe Center to the Device High/Hearing Aid

Compatibility Test (101x101x1): Measurement grid: dx=5mm, dy=5mm

Maximum value of peak Total field = 0.117 A/m

Probe Modulation Factor = 1.01

Device Reference Point: 0.000, 0.000, -6.30 mm

Reference Value = 0.128 A/m; Power Drift = -0.017 dB

Hearing Aid Near-Field Category: M4 (AWF 0 dB)

Peak H-field in A/m

Grid 1 0.114 M4	Grid 2 0.118 M4	Grid 3 0.114 M4
Grid 4 0.109 M4	Grid 5 0.117 M4	Grid 6 0.113 M4
Grid 7 0.116 M4	Grid 8 0.102 M4	Grid 9 0.095 M4

TA Technology (Shanghai) Co., Ltd.
Test Report

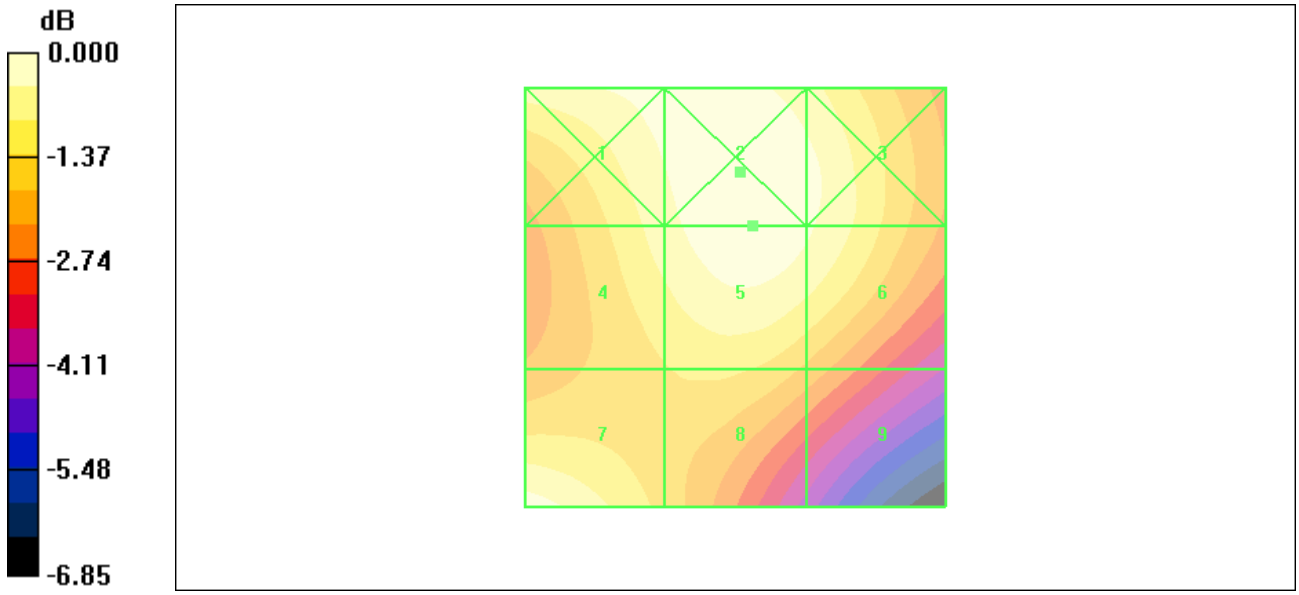

0 dB = 0.118A/m

Figure 32 HAC RF H-Field WCDMA Band IV Channel 1513

TA Technology (Shanghai) Co., Ltd.

Test Report

Report No. RXA1204-0069HAC01R1

Page 74 of 134

HAC RF H-Field WCDMA Band IV Middle (Battery 1)

Date/Time: 5/7/2012 12:40:02 PM

Communication System: WCDMA Band IV; Frequency: 1732.6 MHz; Duty Cycle: 1:1

Medium parameters used: $\sigma = 0$ mho/m, $\epsilon_r = 1$; $\rho = 1$ kg/m³

Ambient Temperature: 22.3 °C

Phantom section: RF Section

DASY4 Configuration:

Probe: H3DV6 - SN6138; ; Calibrated: 2/21/2012

Electronics: DAE4 Sn1317; Calibrated: 1/23/2012

Phantom: HAC Test Arch; Type: SD HAC P01 BA;

Measurement SW: DASY4, V4.7 Build 80; Postprocessing SW: SEMCAD, V1.8 Build 186

H Scan - H3DV6 - 2007: 15 mm from Probe Center to the Device Middle/Hearing Aid

Compatibility Test (101x101x1): Measurement grid: dx=5mm, dy=5mm

Maximum value of peak Total field = 0.106 A/m

Probe Modulation Factor = 1.01

Device Reference Point: 0.000, 0.000, -6.30 mm

Reference Value = 0.116 A/m; Power Drift = 0.032 dB

Hearing Aid Near-Field Category: M4 (AWF 0 dB)

Peak H-field in A/m

Grid 1 0.102 M4	Grid 2 0.106 M4	Grid 3 0.102 M4
Grid 4 0.100 M4	Grid 5 0.106 M4	Grid 6 0.102 M4
Grid 7 0.111 M4	Grid 8 0.094 M4	Grid 9 0.085 M4

TA Technology (Shanghai) Co., Ltd.
Test Report

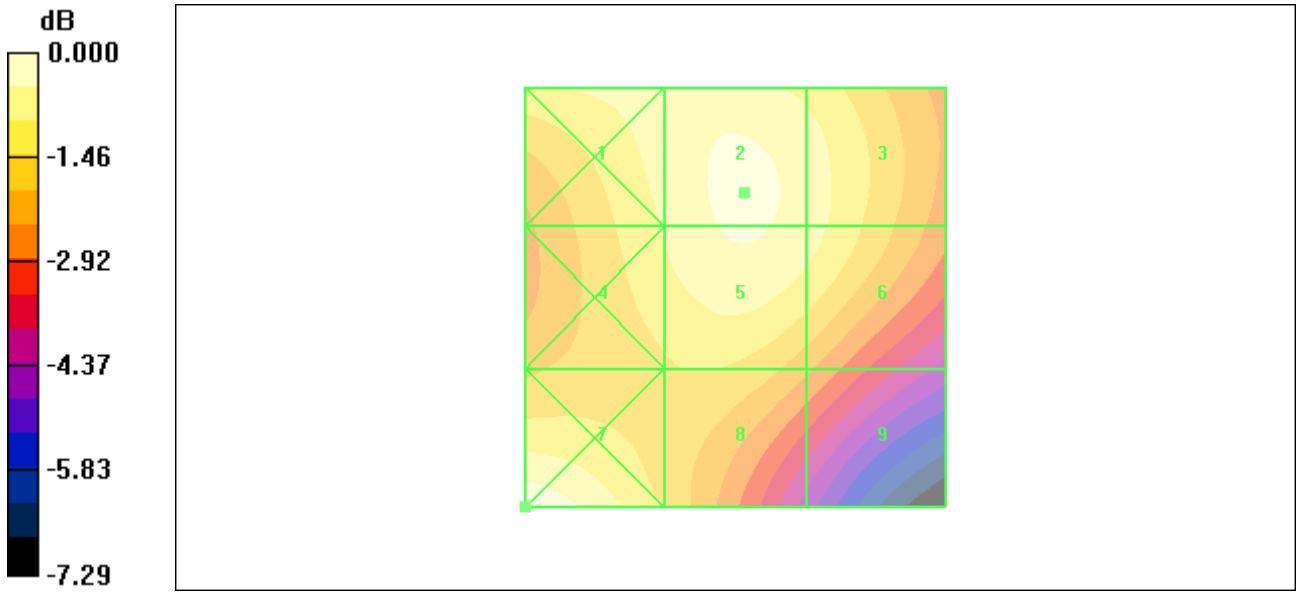

0 dB = 0.111A/m

Figure 33 HAC RF H-Field WCDMA Band IV Channel 1413

TA Technology (Shanghai) Co., Ltd.

Test Report

Report No. RXA1204-0069HAC01R1

Page 76 of 134

HAC RF H-Field WCDMA Band IV Low (Battery 1)

Date/Time: 5/7/2012 12:49:42 PM

Communication System: WCDMA Band IV; Frequency: 1712.4 MHz; Duty Cycle: 1:1

Medium parameters used: $\sigma = 0$ mho/m, $\epsilon_r = 1$; $\rho = 1$ kg/m³

Ambient Temperature: 22.3 °C

Phantom section: RF Section

DASY4 Configuration:

Probe: H3DV6 - SN6138; ; Calibrated: 2/21/2012

Electronics: DAE4 Sn1317; Calibrated: 1/23/2012

Phantom: HAC Test Arch; Type: SD HAC P01 BA;

Measurement SW: DASY4, V4.7 Build 80; Postprocessing SW: SEMCAD, V1.8 Build 186

H Scan - H3DV6 - 2007: 15 mm from Probe Center to the Device Low/Hearing Aid Compatibility

Test (101x101x1): Measurement grid: dx=5mm, dy=5mm

Maximum value of peak Total field = 0.118 A/m

Probe Modulation Factor = 1.01

Device Reference Point: 0.000, 0.000, -6.30 mm

Reference Value = 0.129 A/m; Power Drift = 0.029 dB

Hearing Aid Near-Field Category: M4 (AWF 0 dB)

Peak H-field in A/m

Grid 1 0.113 M4	Grid 2 0.119 M4	Grid 3 0.115 M4
Grid 4 0.111 M4	Grid 5 0.118 M4	Grid 6 0.114 M4
Grid 7 0.118 M4	Grid 8 0.104 M4	Grid 9 0.095 M4

TA Technology (Shanghai) Co., Ltd. Test Report

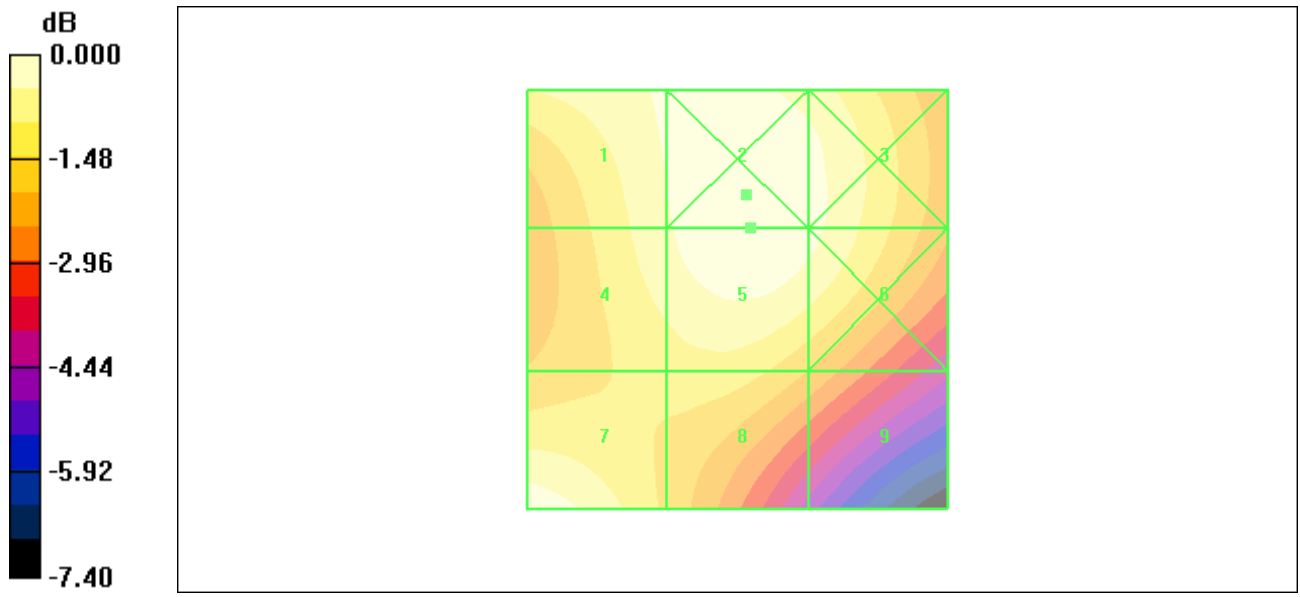

0 dB = 0.119A/m

Figure 34 HAC RF H-Field WCDMA Band IV Channel 1312

TA Technology (Shanghai) Co., Ltd.
Test Report

Report No. RXA1204-0069HAC01R1

Page 78 of 134

HAC RF H-Field WCDMA Band IV Low (Battery 2)

Date/Time: 5/7/2012 12:55:21 PM

Communication System: WCDMA Band IV; Frequency: 1712.4 MHz; Duty Cycle: 1:1

Medium parameters used: $\sigma = 0$ mho/m, $\epsilon_r = 1$; $\rho = 1$ kg/m³

Ambient Temperature: 22.3 °C

Phantom section: RF Section

DASY4 Configuration:

Probe: H3DV6 - SN6138; ; Calibrated: 2/21/2012

Electronics: DAE4 Sn1317; Calibrated: 1/23/2012

Phantom: HAC Test Arch; Type: SD HAC P01 BA;

Measurement SW: DASY4, V4.7 Build 80; Postprocessing SW: SEMCAD, V1.8 Build 186

H Scan - H3DV6 - 2007: 15 mm from Probe Center to the Device Low/Hearing Aid Compatibility

Test (101x101x1): Measurement grid: dx=5mm, dy=5mm

Maximum value of peak Total field = 0.119 A/m

Probe Modulation Factor = 1.01

Device Reference Point: 0.000, 0.000, -6.30 mm

Reference Value = 0.129 A/m; Power Drift = -0.018 dB

Hearing Aid Near-Field Category: M4 (AWF 0 dB)

Peak H-field in A/m

Grid 1	Grid 2	Grid 3
0.114 M4	0.120 M4	0.115 M4
Grid 4	Grid 5	Grid 6
0.112 M4	0.119 M4	0.115 M4
Grid 7	Grid 8	Grid 9
0.118 M4	0.104 M4	0.095 M4

TA Technology (Shanghai) Co., Ltd.
Test Report

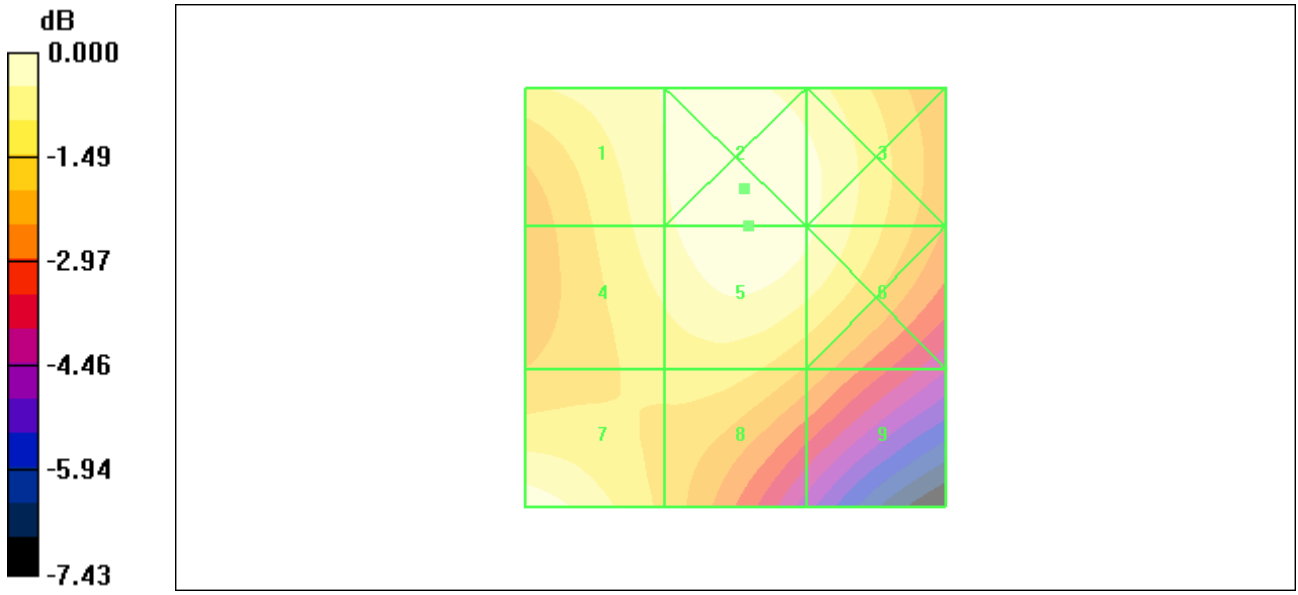

0 dB = 0.120A/m

Figure 35 HAC RF H-Field WCDMA Band IV Channel 1312

TA Technology (Shanghai) Co., Ltd.

Test Report

Report No. RXA1204-0069HAC01R1

Page 80 of 134

HAC RF E-Field WCDMA Band V High (Battery 1)

Date/Time: 5/7/2012 7:53:15 PM

Communication System: WCDMA Band V; Frequency: 846.6 MHz; Duty Cycle: 1:1

Medium parameters used: $\sigma = 0$ mho/m, $\epsilon_r = 1$; $\rho = 1000$ kg/m³

Ambient Temperature: 22.3 °C

Phantom section: RF Section

DASY4 Configuration:

Probe: ER3DV6 - SN2303; ConvF(1, 1, 1); Calibrated: 2/21/2012

Electronics: DAE4 Sn1317; Calibrated: 1/23/2012

Phantom: HAC Test Arch; Type: SD HAC P01 BA;

Measurement SW: DASY4, V4.7 Build 80; Postprocessing SW: SEMCAD, V1.8 Build 186

E Scan - ER3D - 2007: 15 mm from Probe Center to the Device High/Hearing Aid Compatibility

Test (101x101x1): Measurement grid: dx=5mm, dy=5mm

Maximum value of peak Total field = 63.9 V/m

Probe Modulation Factor = 1.03

Device Reference Point: 0.000, 0.000, -6.30 mm

Reference Value = 77.8 V/m; Power Drift = -0.024 dB

Hearing Aid Near-Field Category: M4 (AWF 0 dB)

Peak E-field in V/m

Grid 1	Grid 2	Grid 3
54.4 M4	62.9 M4	62.4 M4
Grid 4	Grid 5	Grid 6
55.7 M4	63.9 M4	63.5 M4
Grid 7	Grid 8	Grid 9
54.0 M4	62.5 M4	62.3 M4

TA Technology (Shanghai) Co., Ltd.
Test Report

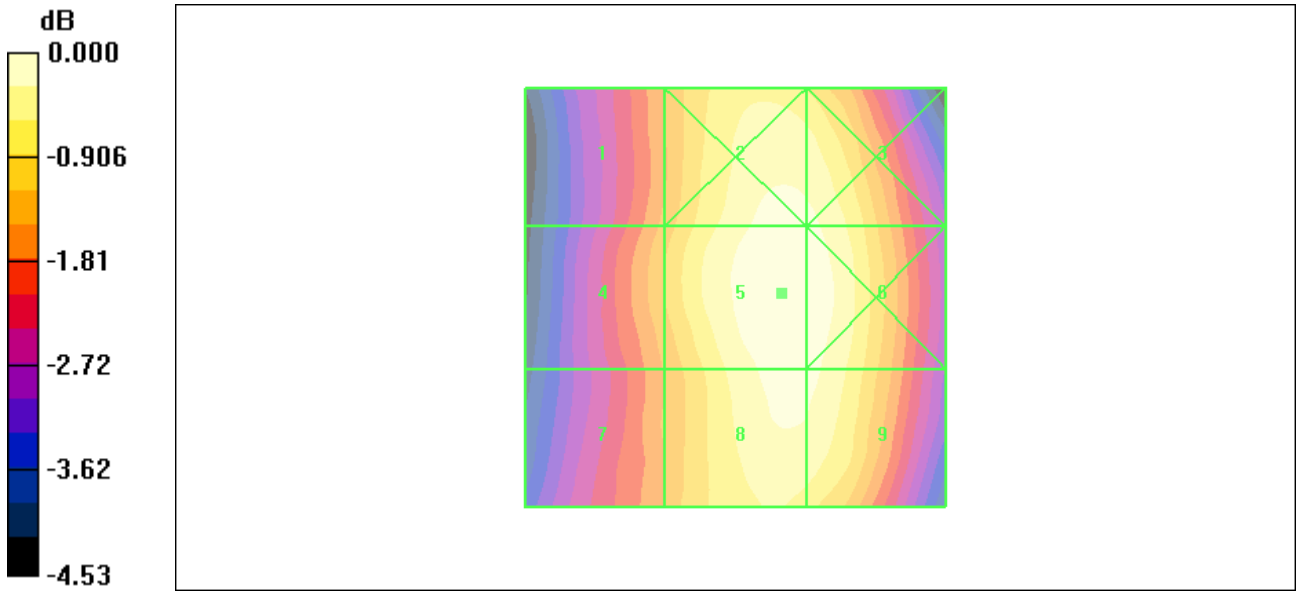

0 dB = 63.9V/m

Figure 36 HAC RF E-Field WCDMA Band V Channel 4233

TA Technology (Shanghai) Co., Ltd.
Test Report

Report No. RXA1204-0069HAC01R1

Page 82 of 134

HAC RF E-Field WCDMA Band V Middle (Battery 1)

Date/Time: 5/7/2012 7:48:24 PM

Communication System: WCDMA Band V; Frequency: 836.6 MHz; Duty Cycle: 1:1

Medium parameters used: $\sigma = 0$ mho/m, $\epsilon_r = 1$; $\rho = 1000$ kg/m³

Ambient Temperature: 22.3 °C

Phantom section: RF Section

DASY4 Configuration:

Probe: ER3DV6 - SN2303; ConvF(1, 1, 1); Calibrated: 2/21/2012

Electronics: DAE4 Sn1317; Calibrated: 1/23/2012

Phantom: HAC Test Arch; Type: SD HAC P01 BA;

Measurement SW: DASY4, V4.7 Build 80; Postprocessing SW: SEMCAD, V1.8 Build 186

E Scan - ER3D - 2007: 15 mm from Probe Center to the Device Middle/Hearing Aid

Compatibility Test (101x101x1): Measurement grid: dx=5mm, dy=5mm

Maximum value of peak Total field = 63.4 V/m

Probe Modulation Factor = 1.03

Device Reference Point: 0.000, 0.000, -6.30 mm

Reference Value = 77.3 V/m; Power Drift = 0.072 dB

Hearing Aid Near-Field Category: M4 (AWF 0 dB)

Peak E-field in V/m

Grid 1	Grid 2	Grid 3
54.3 M4	63.0 M4	62.1 M4
Grid 4	Grid 5	Grid 6
55.5 M4	63.4 M4	63.2 M4
Grid 7	Grid 8	Grid 9
53.7 M4	62.5 M4	62.4 M4

TA Technology (Shanghai) Co., Ltd.
Test Report

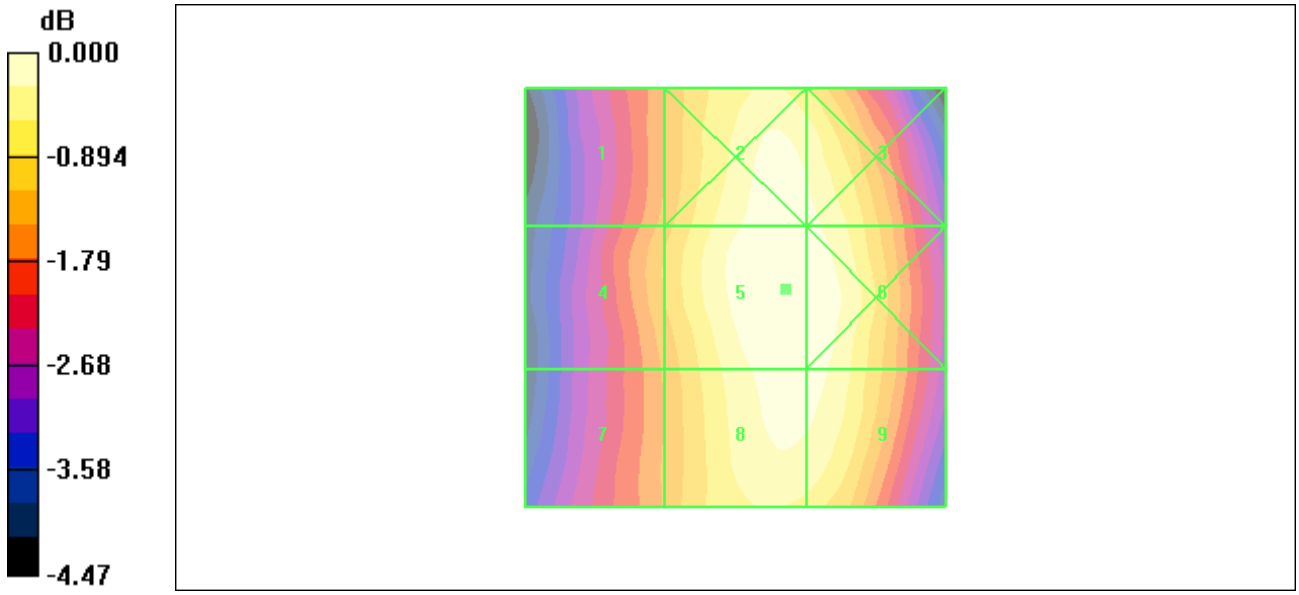

0 dB = 63.4V/m

Figure 37 HAC RF E-Field WCDMA Band V Channel 4183

TA Technology (Shanghai) Co., Ltd.

Test Report

Report No. RXA1204-0069HAC01R1

Page 84 of 134

HAC RF E-Field WCDMA Band V Low (Battery 1)

Date/Time: 5/7/2012 7:58:05 PM

Communication System: WCDMA Band V; Frequency: 826.4 MHz; Duty Cycle: 1:1

Medium parameters used: $\sigma = 0$ mho/m, $\epsilon_r = 1$; $\rho = 1000$ kg/m³

Ambient Temperature: 22.3 °C

Phantom section: RF Section

DASY4 Configuration:

Probe: ER3DV6 - SN2303; ConvF(1, 1, 1); Calibrated: 2/21/2012

Electronics: DAE4 Sn1317; Calibrated: 1/23/2012

Phantom: HAC Test Arch; Type: SD HAC P01 BA;

Measurement SW: DASY4, V4.7 Build 80; Postprocessing SW: SEMCAD, V1.8 Build 186

E Scan - ER3D - 2007: 15 mm from Probe Center to the Device Low/Hearing Aid Compatibility

Test (101x101x1): Measurement grid: dx=5mm, dy=5mm

Maximum value of peak Total field = 55.8 V/m

Probe Modulation Factor = 1.03

Device Reference Point: 0.000, 0.000, -6.30 mm

Reference Value = 68.5 V/m; Power Drift = -0.123 dB

Hearing Aid Near-Field Category: M4 (AWF 0 dB)

Peak E-field in V/m

Grid 1	Grid 2	Grid 3
47.6 M4	55.1 M4	54.7 M4
Grid 4	Grid 5	Grid 6
49.0 M4	55.8 M4	55.4 M4
Grid 7	Grid 8	Grid 9
47.2 M4	54.9 M4	54.4 M4

TA Technology (Shanghai) Co., Ltd.
Test Report

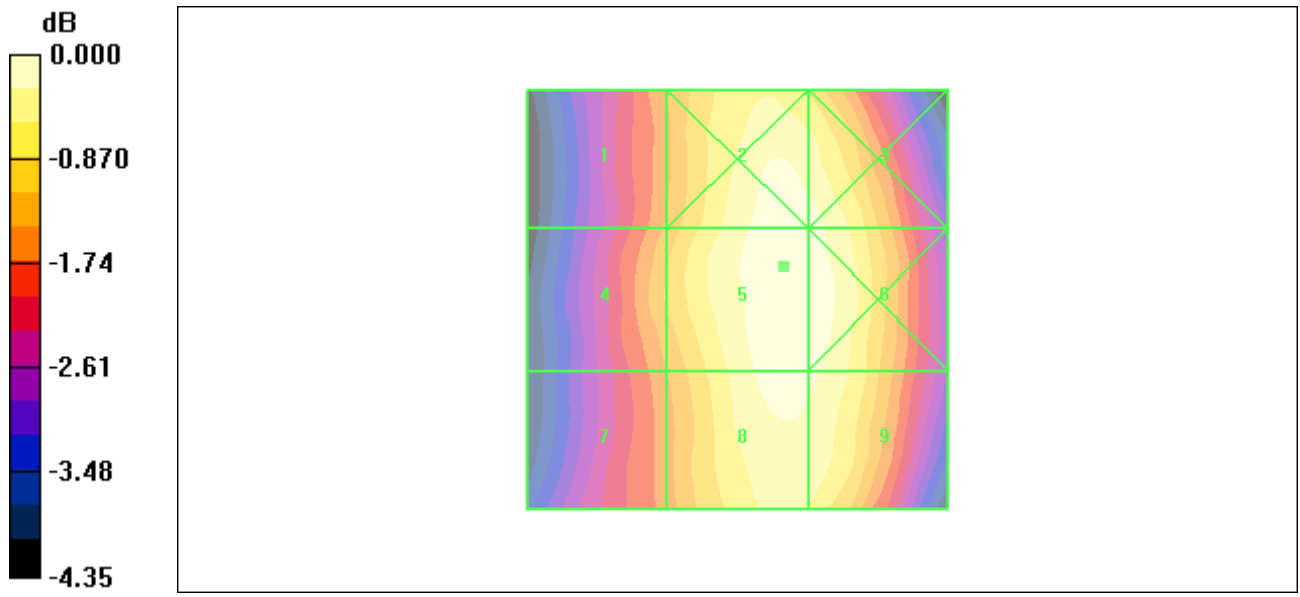

0 dB = 55.8V/m

Figure 38 HAC RF E-Field WCDMA Band V Channel 4132

TA Technology (Shanghai) Co., Ltd.
Test Report

Report No. RXA1204-0069HAC01R1

Page 86 of 134

HAC RF E-Field WCDMA Band V Low (Battery 2)

Date/Time: 5/7/2012 8:03:19 PM

Communication System: WCDMA Band V; Frequency: 846.6 MHz; Duty Cycle: 1:1

Medium parameters used: $\sigma = 0$ mho/m, $\epsilon_r = 1$; $\rho = 1000$ kg/m³

Ambient Temperature: 22.3 °C

Phantom section: RF Section

DASY4 Configuration:

Probe: ER3DV6 - SN2303; ConvF(1, 1, 1); Calibrated: 2/21/2012

Electronics: DAE4 Sn1317; Calibrated: 1/23/2012

Phantom: HAC Test Arch; Type: SD HAC P01 BA;

Measurement SW: DASY4, V4.7 Build 80; Postprocessing SW: SEMCAD, V1.8 Build 186

E Scan - ER3D - 2007: 15 mm from Probe Center to the Device High/Hearing Aid Compatibility Test (101x101x1): Measurement grid: dx=5mm, dy=5mm

Maximum value of peak Total field = 63.3 V/m

Probe Modulation Factor = 1.03

Device Reference Point: 0.000, 0.000, -6.30 mm

Reference Value = 77.1 V/m; Power Drift = 0.013 dB

Hearing Aid Near-Field Category: M4 (AWF 0 dB)

Peak E-field in V/m

Grid 1	Grid 2	Grid 3
54.1 M4	62.5 M4	62.0 M4
Grid 4	Grid 5	Grid 6
55.7 M4	63.3 M4	63.1 M4
Grid 7	Grid 8	Grid 9
53.6 M4	62.0 M4	61.8 M4

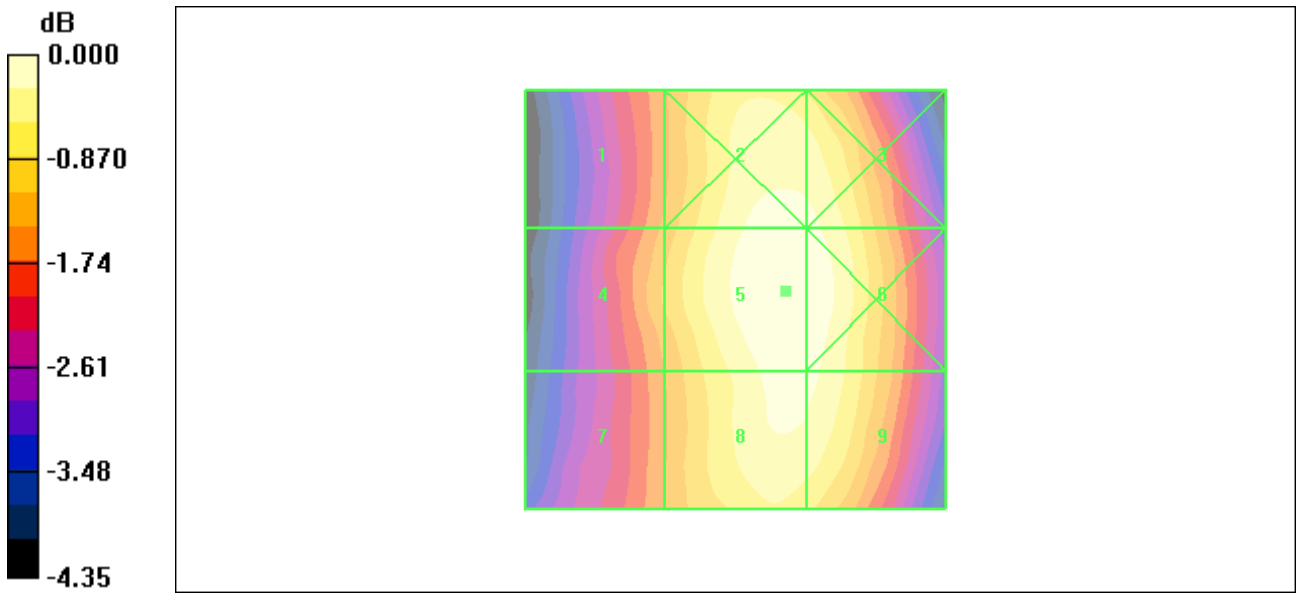

0 dB = 63.3V/m

Figure 39 HAC RF E-Field WCDMA Band V Channel 4132

TA Technology (Shanghai) Co., Ltd.
Test Report

Report No. RXA1204-0069HAC01R1

Page 88 of 134

HAC RF H-Field WCDMA Band V High (Battery 1)

Date/Time: 5/7/2012 12:25:24 PM

Communication System: WCDMA Band V; Frequency: 846.6 MHz; Duty Cycle: 1:1

Medium parameters used: $\sigma = 0$ mho/m, $\epsilon_r = 1$; $\rho = 1$ kg/m³

Ambient Temperature: 22.3 °C

Phantom section: RF Section

DASY4 Configuration:

Probe: H3DV6 - SN6138; ; Calibrated: 2/21/2012

Electronics: DAE4 Sn1317; Calibrated: 1/23/2012

Phantom: HAC Test Arch; Type: SD HAC P01 BA;

Measurement SW: DASY4, V4.7 Build 80; Postprocessing SW: SEMCAD, V1.8 Build 186

H Scan - H3DV6 - 2007: 15 mm from Probe Center to the Device High/Hearing Aid

Compatibility Test (101x101x1): Measurement grid: dx=5mm, dy=5mm

Maximum value of peak Total field = 0.085 A/m

Probe Modulation Factor = 1.01

Device Reference Point: 0.000, 0.000, -6.30 mm

Reference Value = 0.062 A/m; Power Drift = 0.045 dB

Hearing Aid Near-Field Category: M4 (AWF 0 dB)

Peak H-field in A/m

Grid 1 0.113 M4	Grid 2 0.081 M4	Grid 3 0.051 M4
Grid 4 0.103 M4	Grid 5 0.077 M4	Grid 6 0.050 M4
Grid 7 0.116 M4	Grid 8 0.085 M4	Grid 9 0.056 M4

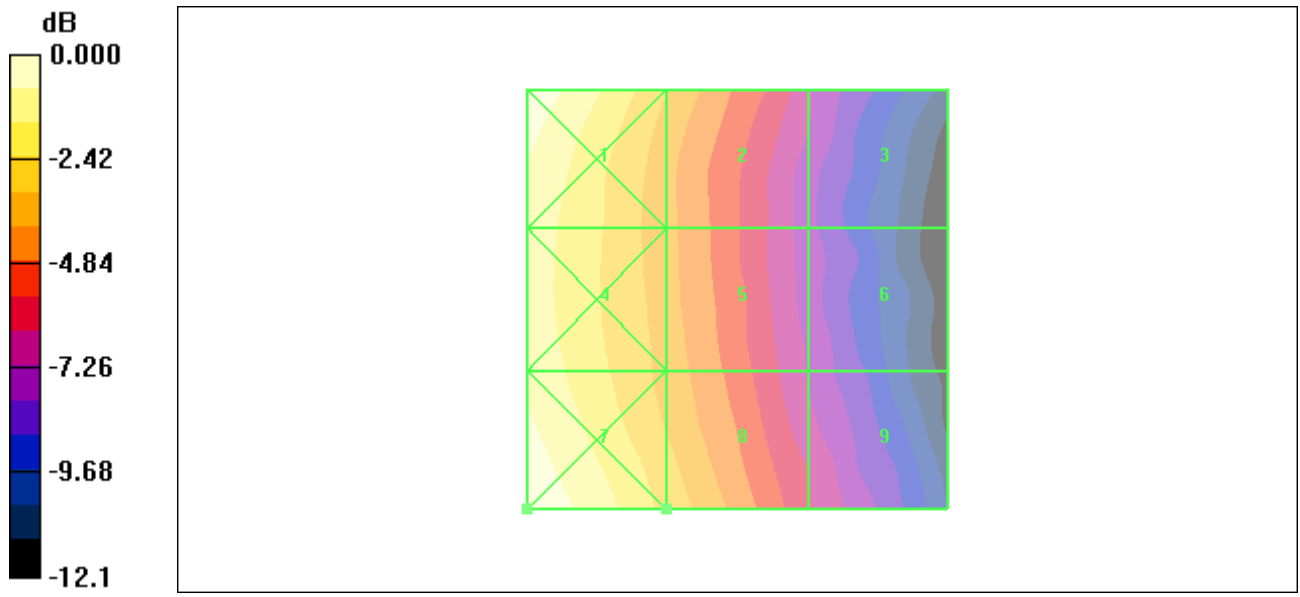

0 dB = 0.116A/m

Figure 40 HAC RF H-Field WCDMA Band V Channel 4233

TA Technology (Shanghai) Co., Ltd.
Test Report

Report No. RXA1204-0069HAC01R1

Page 90 of 134

HAC RF H-Field WCDMA Band V Middle (Battery 1)

Date/Time: 5/7/2012 12:20:40 PM

Communication System: WCDMA Band V; Frequency: 836.6 MHz; Duty Cycle: 1:1

Medium parameters used: $\sigma = 0$ mho/m, $\epsilon_r = 1$; $\rho = 1$ kg/m³

Ambient Temperature: 22.3 °C

Phantom section: RF Section

DASY4 Configuration:

Probe: H3DV6 - SN6138; ; Calibrated: 2/21/2012

Electronics: DAE4 Sn1317; Calibrated: 1/23/2012

Phantom: HAC Test Arch; Type: SD HAC P01 BA;

Measurement SW: DASY4, V4.7 Build 80; Postprocessing SW: SEMCAD, V1.8 Build 186

H Scan - H3DV6 - 2007: 15 mm from Probe Center to the Device Middle/Hearing Aid

Compatibility Test (101x101x1): Measurement grid: dx=5mm, dy=5mm

Maximum value of peak Total field = 0.084 A/m

Probe Modulation Factor = 1.01

Device Reference Point: 0.000, 0.000, -6.30 mm

Reference Value = 0.061 A/m; Power Drift = 0.067 dB

Hearing Aid Near-Field Category: M4 (AWF 0 dB)

Peak H-field in A/m

Grid 1 0.111 M4	Grid 2 0.078 M4	Grid 3 0.050 M4
Grid 4 0.102 M4	Grid 5 0.076 M4	Grid 6 0.049 M4
Grid 7 0.114 M4	Grid 8 0.084 M4	Grid 9 0.055 M4

TA Technology (Shanghai) Co., Ltd.
Test Report

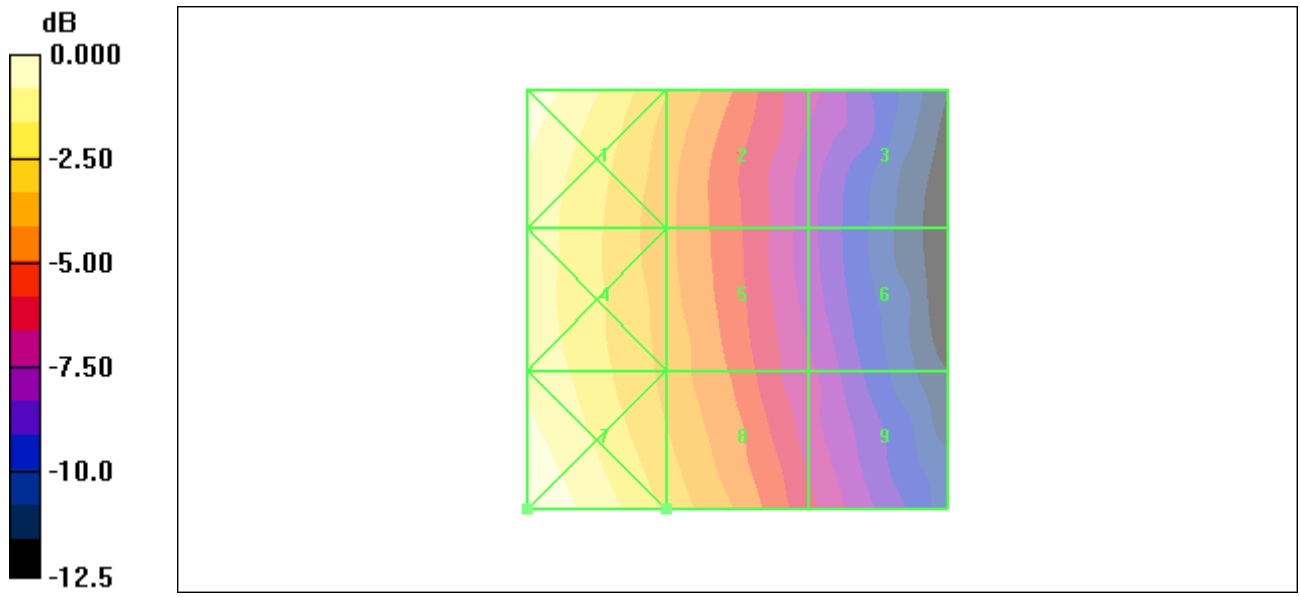

0 dB = 0.114A/m

Figure 41 HAC RF H-Field WCDMA Band V Channel 4183

TA Technology (Shanghai) Co., Ltd.

Test Report

Report No. RXA1204-0069HAC01R1

Page 92 of 134

HAC RF H-Field WCDMA Band V Low (Battery 1)

Date/Time: 5/7/2012 12:30:12 PM

Communication System: WCDMA Band V; Frequency: 826.4 MHz; Duty Cycle: 1:1

Medium parameters used: $\sigma = 0$ mho/m, $\epsilon_r = 1$; $\rho = 1$ kg/m³

Ambient Temperature: 22.3 °C

Phantom section: RF Section

DASY4 Configuration:

Probe: H3DV6 - SN6138; ; Calibrated: 2/21/2012

Electronics: DAE4 Sn1317; Calibrated: 1/23/2012

Phantom: HAC Test Arch; Type: SD HAC P01 BA;

Measurement SW: DASY4, V4.7 Build 80; Postprocessing SW: SEMCAD, V1.8 Build 186

H Scan - H3DV6 - 2007: 15 mm from Probe Center to the Device Low/Hearing Aid Compatibility

Test (101x101x1): Measurement grid: dx=5mm, dy=5mm

Maximum value of peak Total field = 0.072 A/m

Probe Modulation Factor = 1.01

Device Reference Point: 0.000, 0.000, -6.30 mm

Reference Value = 0.051 A/m; Power Drift = 0.199 dB

Hearing Aid Near-Field Category: M4 (AWF 0 dB)

Peak H-field in A/m

Grid 1 0.095 M4	Grid 2 0.067 M4	Grid 3 0.042 M4
Grid 4 0.087 M4	Grid 5 0.065 M4	Grid 6 0.042 M4
Grid 7 0.098 M4	Grid 8 0.072 M4	Grid 9 0.047 M4

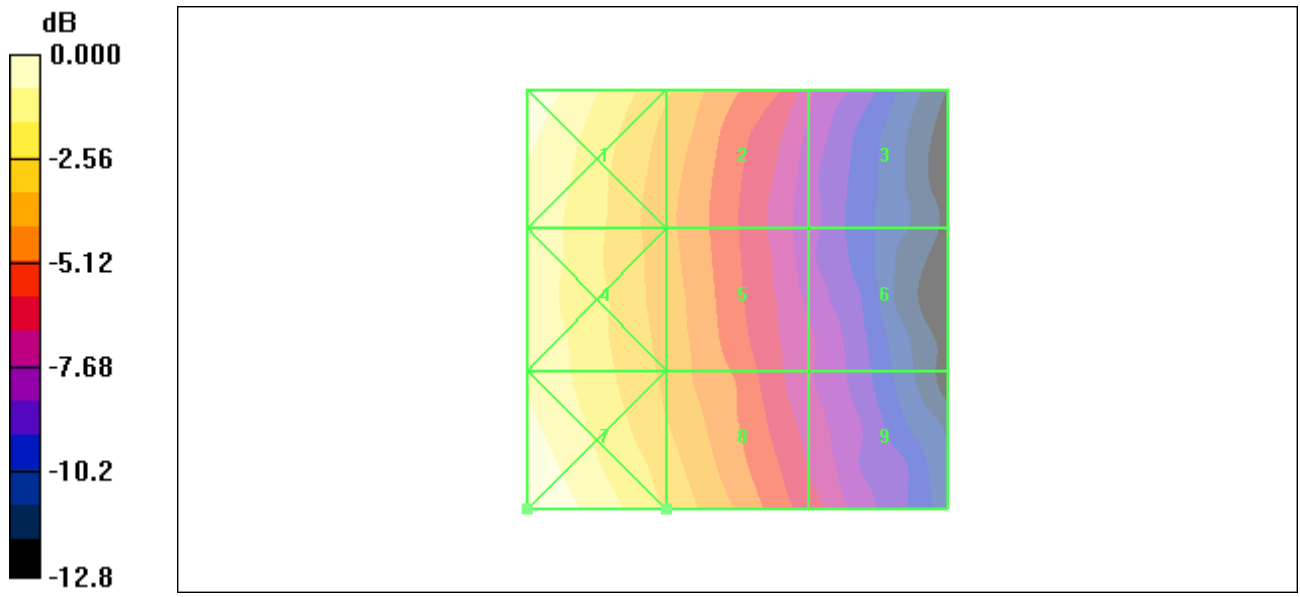

0 dB = 0.098A/m

Figure 42 HAC RF H-Field WCDMA Band V Channel 4132

TA Technology (Shanghai) Co., Ltd.

Test Report

Report No. RXA1204-0069HAC01R1

Page 94 of 134

HAC RF H-Field WCDMA Band V Low (Battery 2)

Date/Time: 5/7/2012 12:35:12 PM

Communication System: WCDMA Band V; Frequency: 846.6 MHz; Duty Cycle: 1:1

Medium parameters used: $\sigma = 0$ mho/m, $\epsilon_r = 1$; $\rho = 1$ kg/m³

Ambient Temperature: 22.3 °C

Phantom section: RF Section

DASY4 Configuration:

Probe: H3DV6 - SN6138; ; Calibrated: 2/21/2012

Electronics: DAE4 Sn1317; Calibrated: 1/23/2012

Phantom: HAC Test Arch; Type: SD HAC P01 BA;

Measurement SW: DASY4, V4.7 Build 80; Postprocessing SW: SEMCAD, V1.8 Build 186

H Scan - H3DV6 - 2007: 15 mm from Probe Center to the Device High/Hearing Aid

Compatibility Test (101x101x1): Measurement grid: dx=5mm, dy=5mm

Maximum value of peak Total field = 0.086 A/m

Probe Modulation Factor = 1.01

Device Reference Point: 0.000, 0.000, -6.30 mm

Reference Value = 0.062 A/m; Power Drift = -0.010 dB

Hearing Aid Near-Field Category: M4 (AWF 0 dB)

Peak H-field in A/m

Grid 1 0.113 M4	Grid 2 0.081 M4	Grid 3 0.052 M4
Grid 4 0.104 M4	Grid 5 0.078 M4	Grid 6 0.050 M4
Grid 7 0.116 M4	Grid 8 0.086 M4	Grid 9 0.056 M4

TA Technology (Shanghai) Co., Ltd. Test Report

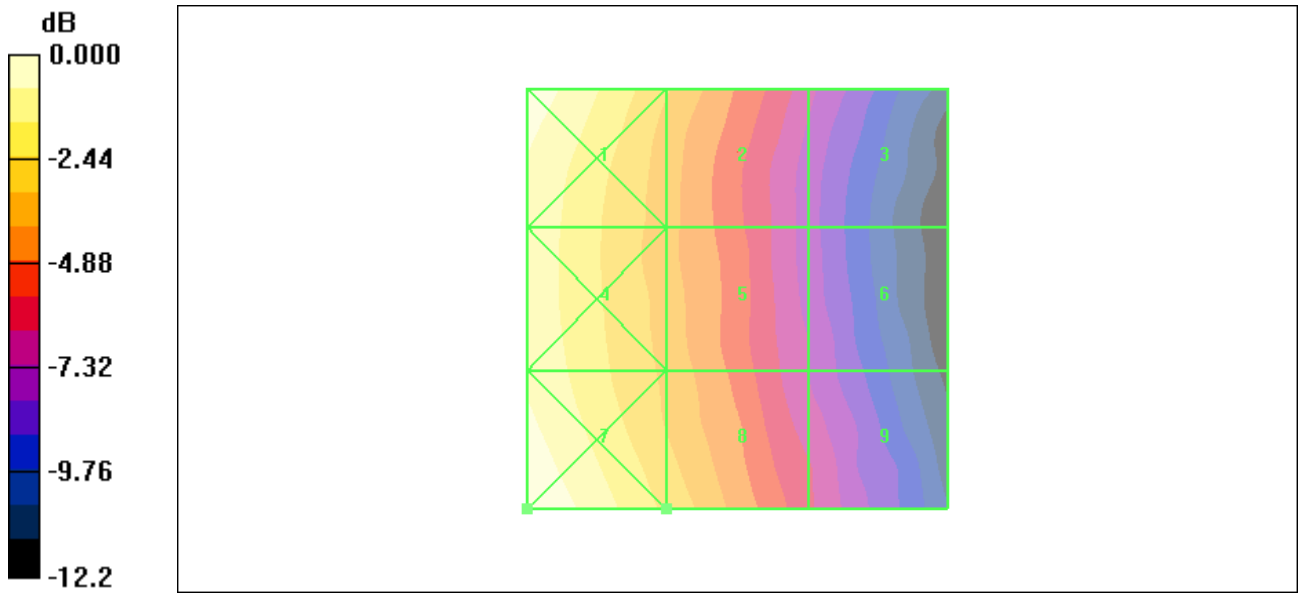

0 dB = 0.116A/m

Figure 43 HAC RF H-Field WCDMA Band V Channel 4132

TA Technology (Shanghai) Co., Ltd. Test Report

Report No. RXA1204-0069HAC01R1

Page 96 of 134

ANNEX C: E-Probe Calibration Certificate

**Calibration Laboratory of
Schmid & Partner
Engineering AG**
Zeughausstrasse 43, 8004 Zurich, Switzerland



S Schweizerischer Kalibrierdienst
C Service suisse d'étalonnage
S Servizio svizzero di taratura
S Swiss Calibration Service

Accredited by the Swiss Accreditation Service (SAS)
The Swiss Accreditation Service is one of the signatories to the EA
Multilateral Agreement for the recognition of calibration certificates

Accreditation No.: **SCS 108**

Client **TA Shanghai (Auden)**

Certificate No: **ER3-2303_Feb12**

CALIBRATION CERTIFICATE

Object: **ER3DV6 - SN:2303**

Calibration procedure(s): **QA CAL-02.v6, QA CAL-25.v4
Calibration procedure for E-field probes optimized for close near field
evaluations in air**

Calibration date: **February 21, 2012**

This calibration certificate documents the traceability to national standards, which realize the physical units of measurements (SI).
The measurements and the uncertainties with confidence probability are given on the following pages and are part of the certificate.

All calibrations have been conducted in the closed laboratory facility: environment temperature (22 ± 3°C and humidity < 75%.

Calibration Equipment used (M&TE critical for calibration)

Primary Standards	ID	Cal Date (Certificate No.)	Scheduled Calibration
Power meter E4419B	GB41293874	31-Mar-11 (No. 217-01372)	Apr-12
Power sensor E4412A	MY41496087	31-Mar-11 (No. 217-01372)	Apr-12
Reference 3 dB Attenuator	SN: S5054 (3c)	29-Mar-11 (No. 217-01369)	Apr-12
Reference 20 dB Attenuator	SN: S5086 (20b)	29-Mar-11 (No. 217-01367)	Apr-12
Reference 30 dB Attenuator	SN: S5129 (30b)	29-Mar-11 (No. 217-01370)	Apr-12
Reference Probe ER3DV6	SN: 2328	11-Oct-11 (No. ER3-2328_Oct11)	Oct-12
DAE4	SN: 789	30-Jan-12 (No. DAE4-789_Jan12)	Jan-13
Secondary Standards	ID	Check Date (in house)	Scheduled Check
RF generator HP 8648C	US3642U01700 *	4-Aug-99 (in house check Apr-11)	In house check: Apr-13
Network Analyzer HP 8753E	US37390565	18-Oct-01 (in house check Oct-11)	In house check: Oct-12

Calibrated by:	Name Claudio Leubler	Function Laboratory Technician	Signature
Approved by:	Name Katja Pokovic	Technical Manager	

Issued: February 22, 2012

This calibration certificate shall not be reproduced except in full without written approval of the laboratory.

TA Technology (Shanghai) Co., Ltd.

Test Report

Report No. RXA1204-0069HAC01R1

Page 97 of 134

**Calibration Laboratory of
Schmid & Partner
Engineering AG**
Zeughausstrasse 43, 8004 Zurich, Switzerland



S Schweizerischer Kalibrierdienst
C Service suisse d'étalonnage
S Servizio svizzero di taratura
S Swiss Calibration Service

Accredited by the Swiss Accreditation Service (SAS)

Accreditation No.: **SCS 108**

The Swiss Accreditation Service is one of the signatories to the EA
Multilateral Agreement for the recognition of calibration certificates

Glossary:

NORM _{x,y,z}	sensitivity in free space
DCP	diode compression point
CF	crest factor (1/duty_cycle) of the RF signal
A, B, C	modulation dependent linearization parameters
Polarization φ	φ rotation around probe axis
Polarization ϑ	ϑ rotation around an axis that is in the plane normal to probe axis (at measurement center), i.e., $\vartheta = 0$ is normal to probe axis
Connector Angle	information used in DASY system to align probe sensor X to the robot coordinate system

Calibration is Performed According to the Following Standards:

- IEEE Std 1309-2005, "IEEE Standard for calibration of electromagnetic field sensors and probes, excluding antennas, from 9 kHz to 40 GHz", December 2005.

Methods Applied and Interpretation of Parameters:

- NORM_{x,y,z}**: Assessed for E-field polarization $\vartheta = 0$ for XY sensors and $\vartheta = 90$ for Z sensor ($f \leq 900$ MHz in TEM-cell; $f > 1800$ MHz: R22 waveguide).
- NORM(f)_{x,y,z}** = NORM_{x,y,z} * frequency_response (see Frequency Response Chart).
- DCP_{x,y,z}**: DCP are numerical linearization parameters assessed based on the data of power sweep with CW signal (no uncertainty required). DCP does not depend on frequency nor media.
- PAR**: PAR is the Peak to Average Ratio that is not calibrated but determined based on the signal characteristics
- A_{x,y,z}; B_{x,y,z}; C_{x,y,z}; VR_{x,y,z}**: A, B, C are numerical linearization parameters assessed based on the data of power sweep for specific modulation signal. The parameters do not depend on frequency nor media. VR is the maximum calibration range expressed in RMS voltage across the diode.
- Spherical isotropy (3D deviation from isotropy)**: in a locally homogeneous field realized using an open waveguide setup.
- Sensor Offset**: The sensor offset corresponds to the offset of virtual measurement center from the probe-tip (on probe axis). No tolerance required.
- Connector Angle**: The angle is assessed using the information gained by determining the NORM_x (no uncertainty required).

ER3DV6 – SN:2303

February 21, 2012

Probe ER3DV6

SN:2303

Manufactured: November 6, 2002
Calibrated: February 21, 2012

Calibrated for DASY/EASY Systems
(Note: non-compatible with DASY2 system!)

TA Technology (Shanghai) Co., Ltd.
Test Report

ER3DV6- SN:2303

February 21, 2012

DASY/EASY - Parameters of Probe: ER3DV6 - SN:2303

Basic Calibration Parameters

	Sensor X	Sensor Y	Sensor Z	Unc (k=2)
Norm ($\mu\text{V}/(\text{V}/\text{m})^2$)	1.40	1.42	1.43	$\pm 10.1\%$
DCP (mV) ^a	100.7	99.2	104.7	

Modulation Calibration Parameters

UID	Communication System Name	PAR		A dB	B dB	C dB	VR mV	Unc ^c (k=2)
10000	CW	0.00	X	0.00	0.00	1.00	111.4	$\pm 3.0\%$
			Y	0.00	0.00	1.00	139.9	
			Z	0.00	0.00	1.00	133.1	

The reported uncertainty of measurement is stated as the standard uncertainty of measurement multiplied by the coverage factor k=2, which for a normal distribution corresponds to a coverage probability of approximately 95%.

^a Numerical linearization parameter; uncertainty not required.

^c Uncertainty is determined using the max. deviation from linear response applying rectangular distribution and is expressed for the square of the field value.

ER3DV6-SN:2303

February 21, 2012

Frequency Response of E-Field
(TEM-Cell: ifi110 EXX, Waveguide: R22)

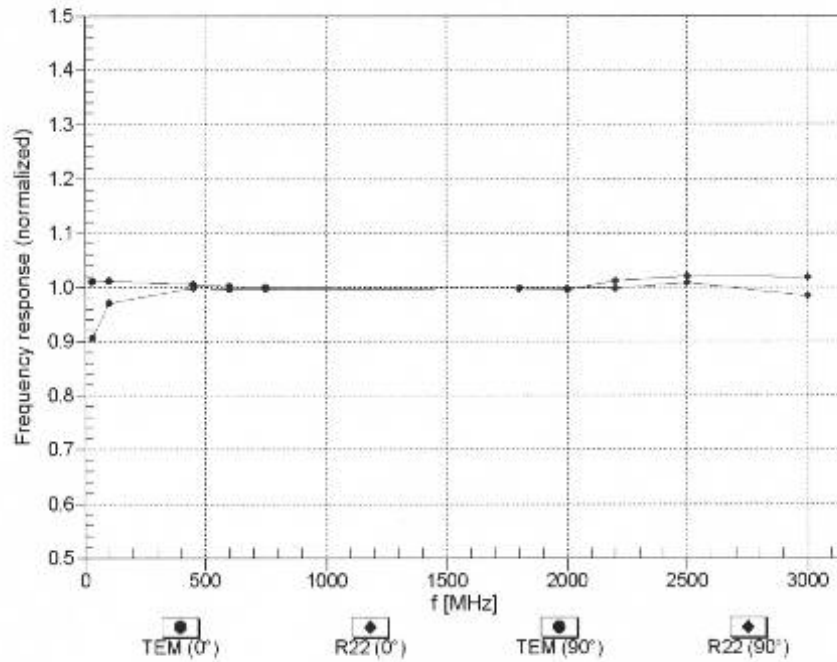

Uncertainty of Frequency Response of E-field: $\pm 6.3\%$ (k=2)

ER3DV6- SN:2303

February 21, 2012

Receiving Pattern (ϕ), $\vartheta = 0^\circ$

f=600 MHz, TEM, 0°

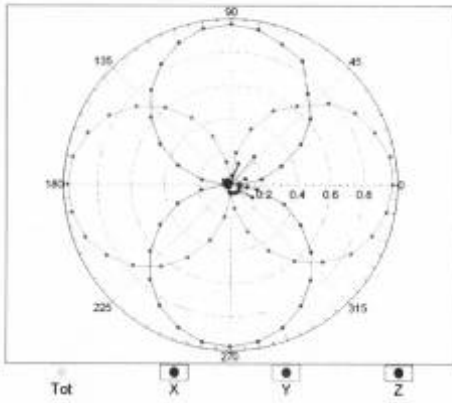

f=2500 MHz, R22, 0°

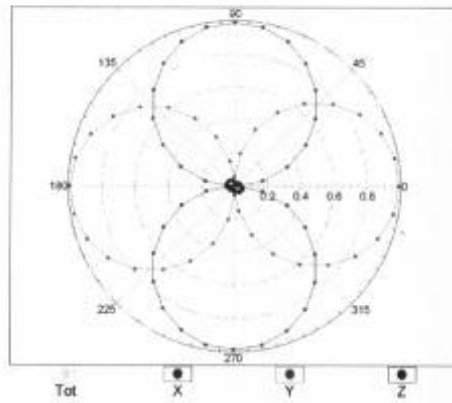

Receiving Pattern (ϕ), $\vartheta = 90^\circ$

f=600 MHz, TEM, 90°

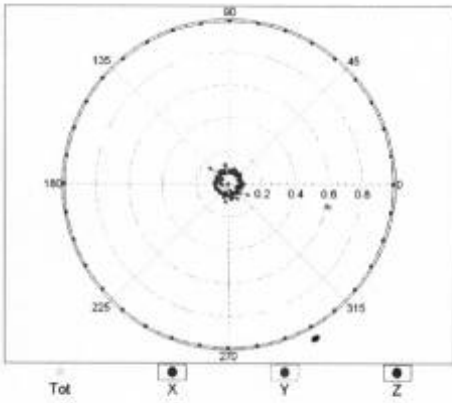

f=2500 MHz, R22, 90°

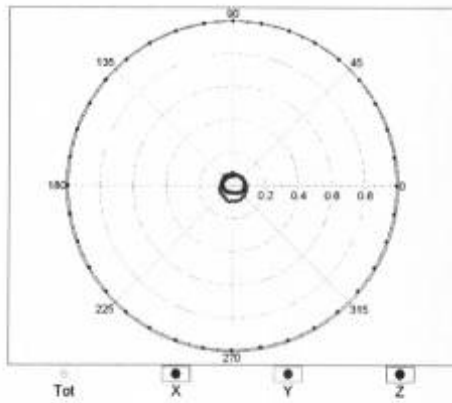

ER3DV6- SN:2303

February 21, 2012

Receiving Pattern (ϕ), $\theta = 0^\circ$

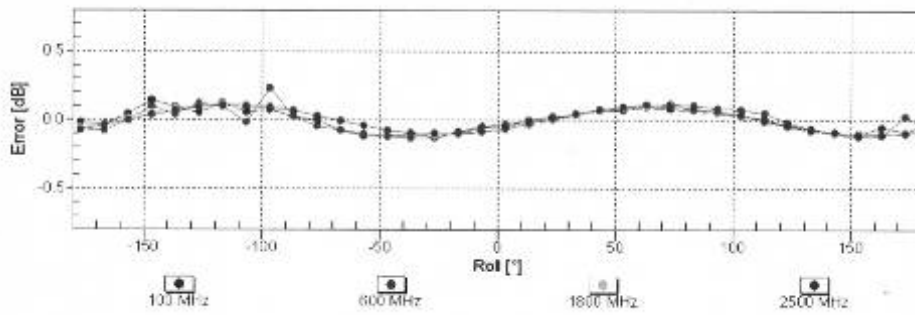

Uncertainty of Axial Isotropy Assessment: $\pm 0.5\%$ ($k=2$)

Receiving Pattern (ϕ), $\theta = 90^\circ$

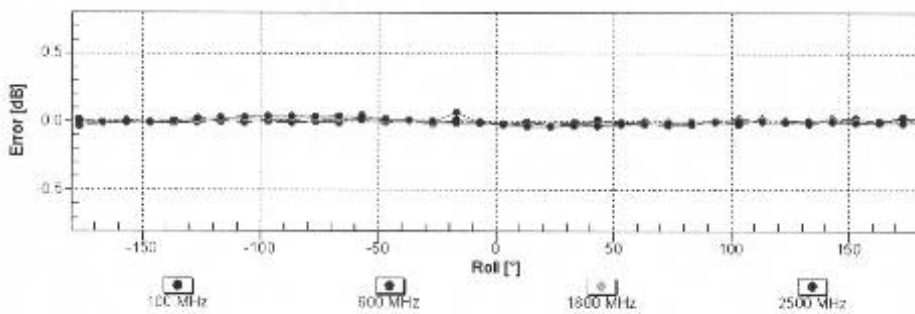

Uncertainty of Axial Isotropy Assessment: $\pm 0.5\%$ ($k=2$)

ER3DV6- SN:2303

February 21, 2012

Dynamic Range f(E-field)
 (TEM cell , f = 900 MHz)

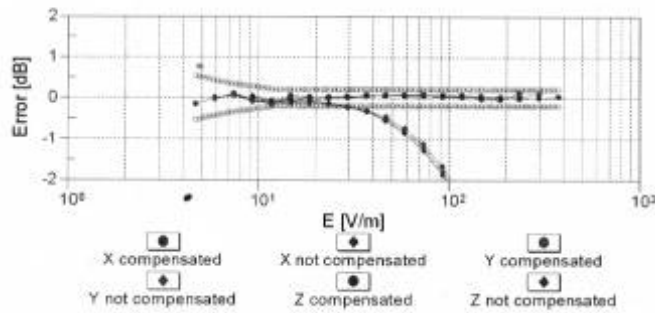
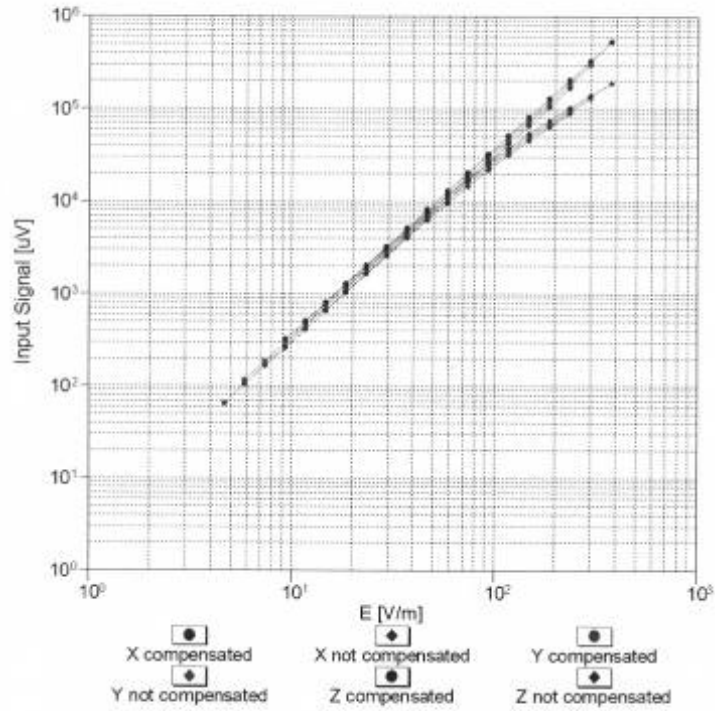

Uncertainty of Linearity Assessment: ± 0.6% (k=2)

ER3DV6- SN:2303

February 21, 2012

Deviation from Isotropy in Air
Error (ϕ, θ), $f = 900$ MHz

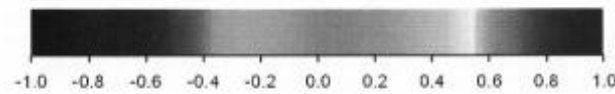
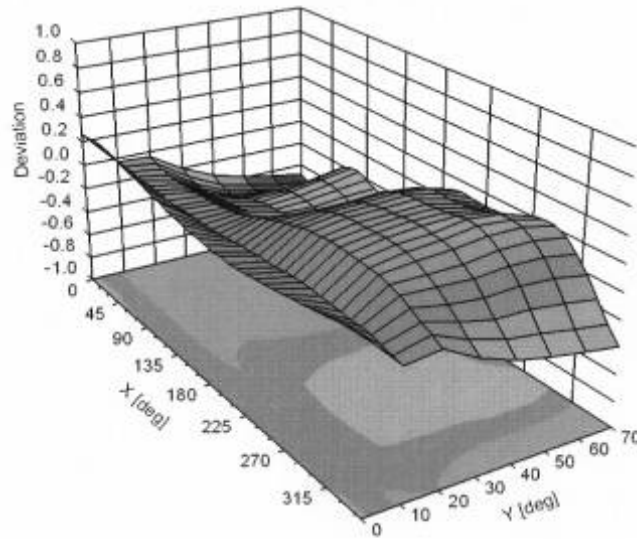

Uncertainty of Spherical Isotropy Assessment: $\pm 2.6\%$ ($k=2$)

ER3DV6- SN:2303

February 21, 2012

DASY/EASY - Parameters of Probe: ER3DV6 - SN:2303

Other Probe Parameters

Sensor Arrangement	Rectangular
Connector Angle (°)	-156.8
Mechanical Surface Detection Mode	enabled
Optical Surface Detection Mode	disabled
Probe Overall Length	337 mm
Probe Body Diameter	10 mm
Tip Length	10 mm
Tip Diameter	8 mm
Probe Tip to Sensor X Calibration Point	2.5 mm
Probe Tip to Sensor Y Calibration Point	2.5 mm
Probe Tip to Sensor Z Calibration Point	2.5 mm

TA Technology (Shanghai) Co., Ltd. Test Report

Report No. RXA1204-0069HAC01R1

Page 106 of 134

ANNEX D: H-Probe Calibration Certificate

**Calibration Laboratory of
Schmid & Partner
Engineering AG**
Zeughausstrasse 43, 8004 Zurich, Switzerland



S Schweizerischer Kalibrierdienst
C Service suisse d'étalonnage
S Servizio svizzero di taratura
S Swiss Calibration Service

Accredited by the Swiss Accreditation Service (SAS)
The Swiss Accreditation Service is one of the signatories to the EA
Multilateral Agreement for the recognition of calibration certificates

Accreditation No.: **SCS 108**

Client **TA Shanghai (Auden)**

Certificate No: **H3-6138_Feb12**

CALIBRATION CERTIFICATE

Object: **H3DV6 - SN:6138**

Calibration procedure(s): **QA CAL-03.v6, QA CAL-25.v4
Calibration procedure for H-field probes optimized for close near field
evaluations in air**

Calibration date: **February 21, 2012**

This calibration certificate documents the traceability to national standards, which realize the physical units of measurements (SI).
The measurements and the uncertainties with confidence probability are given on the following pages and are part of the certificate.

All calibrations have been conducted in the closed laboratory facility: environment temperature (22 ± 3)°C and humidity < 70%.

Calibration Equipment used (M&TE critical for calibration)

Primary Standards	ID	Cal Date (Certificate No.)	Scheduled Calibration
Power meter E4419B	GB41293874	31-Mar-11 (No. 217-01372)	Apr-12
Power sensor E4412A	MY41498087	31-Mar-11 (No. 217-01372)	Apr-12
Reference 3 dB Attenuator	SN: S5054 (3c)	29-Mar-11 (No. 217-01369)	Apr-12
Reference 20 dB Attenuator	SN: S5086 (20b)	29-Mar-11 (No. 217-01367)	Apr-12
Reference 30 dB Attenuator	SN: S5129 (30b)	29-Mar-11 (No. 217-01370)	Apr-12
Reference Probe H3DV6	SN: 6182	11-Oct-11 (No. H3-6182_Oct11)	Oct-12
DAE4	SN: 789	30-Jan-12 (No. DAE4-789_Jan12)	Jan-13
Secondary Standards	ID	Check Date (in house)	Scheduled Check
RF generator HP 8648C	US3642U01700	4-Aug-99 (in house check Apr-11)	In house check: Apr-13
Network Analyzer HP 8753E	US37390585	18-Oct-01 (in house check Oct-11)	In house check: Oct-12

Calibrated by:	Name Claudio Leubler	Function Laboratory Technician	Signature
Approved by:	Name Katja Pokovic	Function Technical Manager	Signature

Issued: February 23, 2012

This calibration certificate shall not be reproduced except in full without written approval of the laboratory.

Calibration Laboratory of
Schmid & Partner
Engineering AG
Zeughausstrasse 43, 8004 Zurich, Switzerland



S Schweizerischer Kalibrierdienst
C Service suisse d'étalonnage
S Servizio svizzero di taratura
S Swiss Calibration Service

Accredited by the Swiss Accreditation Service (SAS)
The Swiss Accreditation Service is one of the signatories to the EA
Multilateral Agreement for the recognition of calibration certificates

Accreditation No.: SCS 108

Glossary:

NORM _{x,y,z}	sensitivity in free space
DCP	diode compression point
CF	crest factor (1/duty_cycle) of the RF signal
A, B, C	modulation dependent linearization parameters
Polarization φ	φ rotation around probe axis
Polarization ϑ	ϑ rotation around an axis that is in the plane normal to probe axis (at measurement center), i.e., $\vartheta = 0$ is normal to probe axis
Connector Angle	information used in DASY system to align probe sensor X to the robot coordinate system

Calibration is Performed According to the Following Standards:

- IEEE Std 1309-2005, "IEEE Standard for calibration of electromagnetic field sensors and probes, excluding antennas, from 9 kHz to 40 GHz", December 2005.

Methods Applied and Interpretation of Parameters:

- NORM_{x,y,z}: Assessed for E-field polarization $\vartheta = 0$ for XY sensors and $\vartheta = 90$ for Z sensor ($f \leq 900$ MHz in TEM-cell; $f > 1800$ MHz: R22 waveguide).
- $X, Y, Z(f)_{a0a1a2} = X, Y, Z_{a0a1a2} \cdot \text{frequency_response}$ (see Frequency Response Chart).
- DCP_{x,y,z}: DCP are numerical linearization parameters assessed based on the data of power sweep with CW signal (no uncertainty required). DCP does not depend on frequency nor media.
- PAR: PAR is the Peak to Average Ratio that is not calibrated but determined based on the signal characteristics
- $A_{x,y,z}; B_{x,y,z}; C_{x,y,z}; VR_{x,y,z}; A, B, C$ are numerical linearization parameters assessed based on the data of power sweep for specific modulation signal. The parameters do not depend on frequency nor media. VR is the maximum calibration range expressed in RMS voltage across the diode.
- Spherical isotropy (3D deviation from isotropy): in a locally homogeneous field realized using an open waveguide setup.
- Sensor Offset: The sensor offset corresponds to the offset of virtual measurement center from the probe tip (on probe axis). No tolerance required.
- Connector Angle: The angle is assessed using the information gained by determining the X_{a0a1a2} (no uncertainty required).

H3DV6 - SN:6138

February 21, 2012

Probe H3DV6

SN:6138

Manufactured: July 3, 2002
Calibrated: February 21, 2012

Calibrated for DASY/EASY Systems
(Note: non-compatible with DASY2 system!)

TA Technology (Shanghai) Co., Ltd.

Test Report

H3DV6- SN:6138

February 21, 2012

DASY/EASY - Parameters of Probe: H3DV6 - SN:6138

Basic Calibration Parameters

		Sensor X	Sensor Y	Sensor Z	Unc (k=2)
Norm (A/m / $\sqrt{\text{mV}}$)	a0	2.73E-003	2.93E-003	3.18E-003	$\pm 5.1 \%$
Norm (A/m / $\sqrt{\text{mV}}$)	a1	-5.89E-005	-2.38E-004	-2.18E-004	$\pm 5.1 \%$
Norm (A/m / $\sqrt{\text{mV}}$)	a2	-5.50E-006	-3.95E-006	-8.28E-007	$\pm 5.1 \%$
DGP (mV) ^b		93.5	92.1	94.8	

Modulation Calibration Parameters

UID	Communication System Name	PAR		A dB	B dB	C dB	VR mV	Unc ^c (k=2)
10000	CW	0.00	X	0.00	0.00	1.00	130.7	$\pm 3.3 \%$
			Y	0.00	0.00	1.00	125.5	
			Z	0.00	0.00	1.00	133.0	

The reported uncertainty of measurement is stated as the standard uncertainty of measurement multiplied by the coverage factor k=2, which for a normal distribution corresponds to a coverage probability of approximately 95%.

^b Numerical linearization parameter: uncertainty not required.

^c Uncertainty is determined using the max. deviation from linear response applying rectangular distribution and is expressed for the square of the field value.

H3DV6-SN:6138

February 21, 2012

Frequency Response of H-Field
(TEM-Cell:ifi110 EXX, Waveguide: R22)

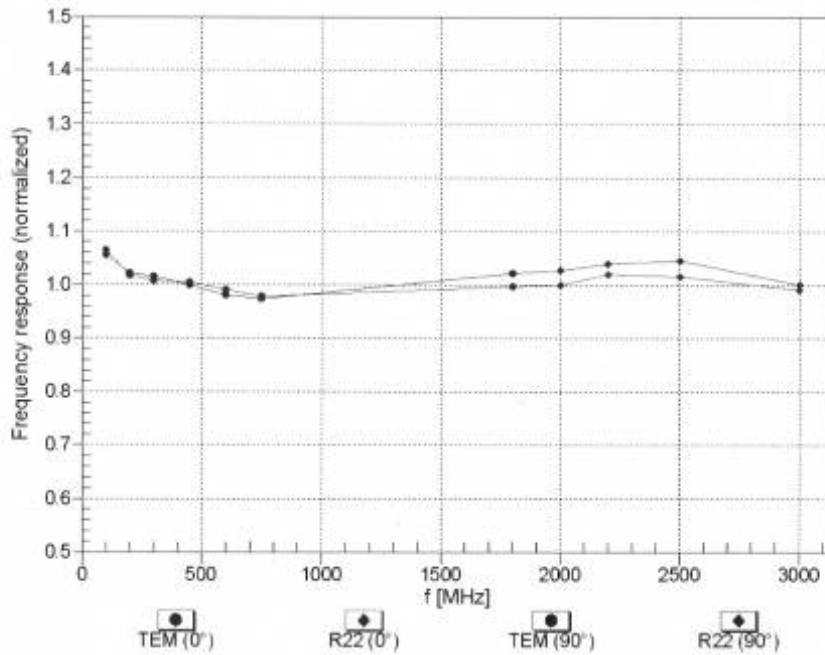

Uncertainty of Frequency Response of H-field: $\pm 6.3\%$ (k=2)

H3DV6-SN:6138

February 21, 2012

Receiving Pattern (ϕ), $\theta = 0^\circ$

f=600 MHz, TEM, 0°

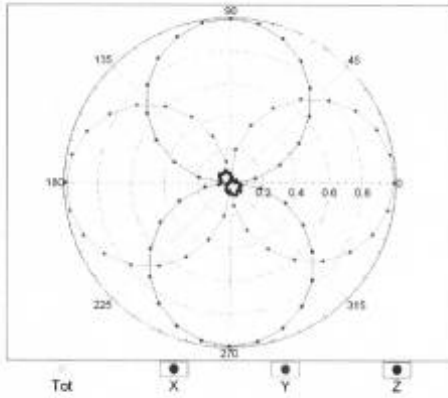

f=2500 MHz, R22, 0°

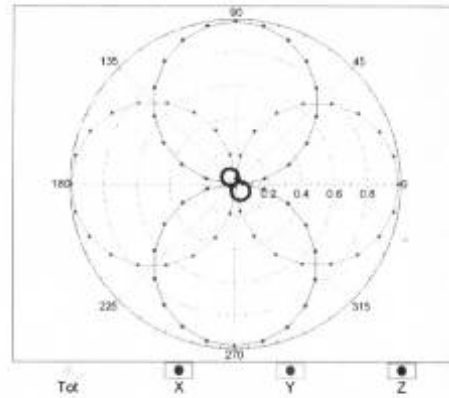

Receiving Pattern (ϕ), $\theta = 90^\circ$

f=600 MHz, TEM, 90°

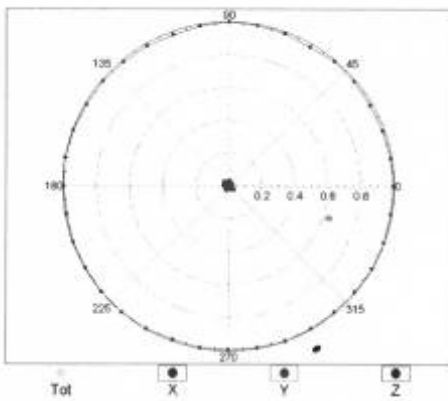

f=2500 MHz, R22, 90°

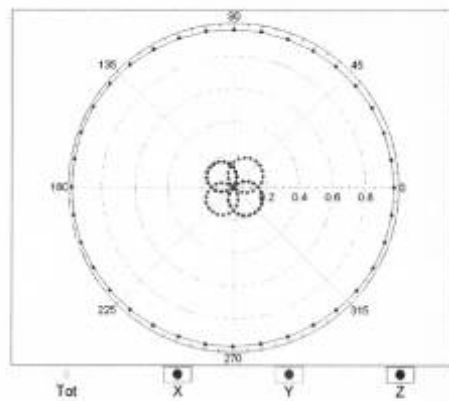

H3DV6- SN:6138

February 21, 2012

Receiving Pattern (ϕ), $\vartheta = 0^\circ$

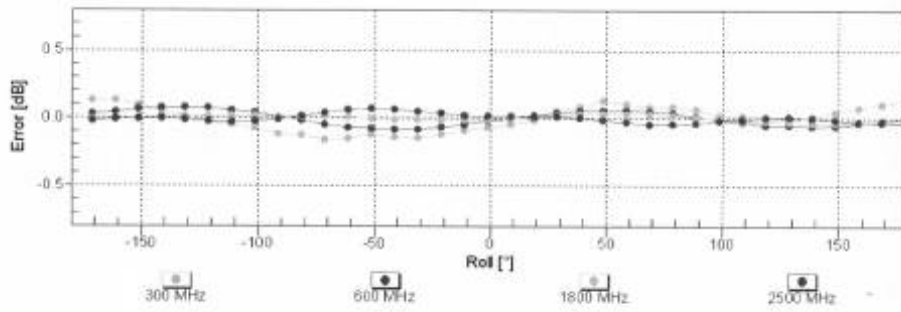

Uncertainty of Axial Isotropy Assessment: $\pm 0.5\%$ ($k=2$)

Receiving Pattern (ϕ), $\vartheta = 90^\circ$

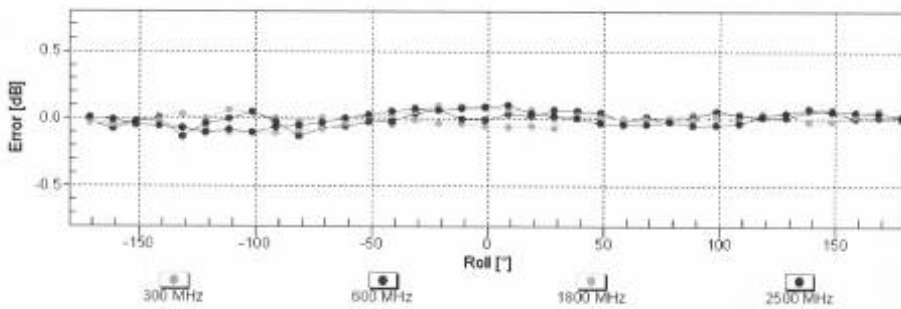

Uncertainty of Axial Isotropy Assessment: $\pm 0.5\%$ ($k=2$)

H3DV6- SN:6138

February 21, 2012

Dynamic Range f(H-field)
 (TEM cell, f = 900 MHz)

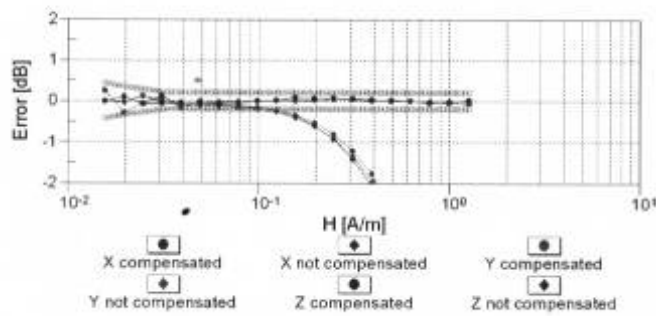
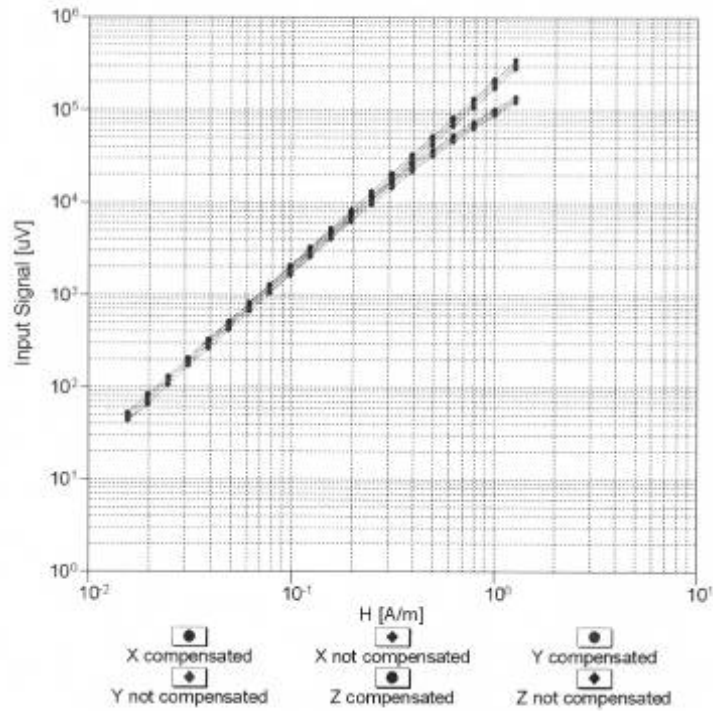

Uncertainty of Linearity Assessment: ± 0.6% (k=2)

H3DV6- SN:6138

February 21, 2012

Deviation from Isotropy in Air
Error (ϕ, θ), $f = 900$ MHz

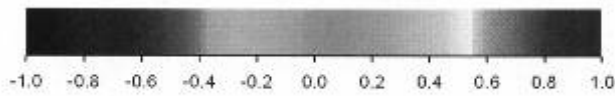
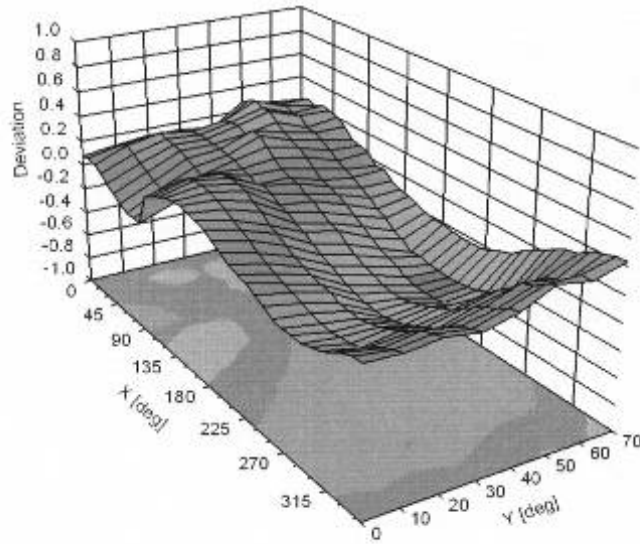

Uncertainty of Spherical Isotropy Assessment: $\pm 2.6\%$ ($k=2$)

H3DV6- SN:6138

February 21, 2012

DASY/EASY - Parameters of Probe: H3DV6 - SN:6138

Other Probe Parameters

Sensor Arrangement	Rectangular
Connector Angle (°)	168.6
Mechanical Surface Detection Mode	enabled
Optical Surface Detection Mode	disabled
Probe Overall Length	337 mm
Probe Body Diameter	10 mm
Tip Length	20 mm
Tip Diameter	6 mm
Probe Tip to Sensor X Calibration Point	3 mm
Probe Tip to Sensor Y Calibration Point	3 mm
Probe Tip to Sensor Z Calibration Point	3 mm

TA Technology (Shanghai) Co., Ltd. Test Report

Report No. RXA1204-0069HAC01R1

Page 116 of 134

ANNEX E: CD835V3 Dipole Calibration Certificate

**Calibration Laboratory of
Schmid & Partner
Engineering AG**
Zeughausstrasse 43, 8004 Zurich, Switzerland



S Schweizerischer Kalibrierdienst
S Service suisse d'étalonnage
C Servizio svizzero di taratura
S Swiss Calibration Service

Accredited by the Swiss Accreditation Service (SAS)
The Swiss Accreditation Service is one of the signatories to the EA
Multilateral Agreement for the recognition of calibration certificates

Accreditation No.: **SCS 108**

Client **TA Shanghai (Auden)**

Certificate No: **CD835V3-1133_Feb12**

CALIBRATION CERTIFICATE																																																			
Object	CD835V3 - SN: 1133																																																		
Calibration procedure(s)	QA CAL-20.v6 Calibration procedure for dipoles in air																																																		
Calibration date:	February 21, 2012																																																		
<p>This calibration certificate documents the traceability to national standards, which realize the physical units of measurements (SI). The measurements and the uncertainties with confidence probability are given on the following pages and are part of the certificate.</p> <p>All calibrations have been conducted in the closed laboratory facility: environment temperature (22 ± 3)°C and humidity < 70%.</p> <p>Calibration Equipment used (M&TE critical for calibration)</p> <table border="1" style="width: 100%; border-collapse: collapse;"> <thead> <tr> <th style="width: 30%;">Primary Standards</th> <th style="width: 15%;">ID #</th> <th style="width: 30%;">Cal Date (Certificate No.)</th> <th style="width: 25%;">Scheduled Calibration</th> </tr> </thead> <tbody> <tr> <td>Power meter EPM-442A</td> <td>GB37480704</td> <td>05-Oct-11 (No. 217-01451)</td> <td>Oct-12</td> </tr> <tr> <td>Power sensor HP 8481A</td> <td>US37292783</td> <td>05-Oct-11 (No. 217-01451)</td> <td>Oct-12</td> </tr> <tr> <td>Probe ER3DV6</td> <td>SN: 2336</td> <td>29-Dec-11 (No. ER3-2336_Dec11)</td> <td>Dec-12</td> </tr> <tr> <td>Probe H3DV6</td> <td>SN: 6065</td> <td>29-Dec-11 (No. H3-6065_Dec11)</td> <td>Dec-12</td> </tr> <tr> <td>DAE4</td> <td>SN: 781</td> <td>20-Apr-11 (No. DAE4-781_Apr11)</td> <td>Apr-12</td> </tr> </tbody> </table> <table border="1" style="width: 100%; border-collapse: collapse;"> <thead> <tr> <th style="width: 30%;">Secondary Standards</th> <th style="width: 15%;">ID #</th> <th style="width: 30%;">Check Date (in house)</th> <th style="width: 25%;">Scheduled Check</th> </tr> </thead> <tbody> <tr> <td>Power meter Agilent 4419B</td> <td>SN: GB42420191</td> <td>09-Oct-09 (in house check Oct-11)</td> <td>In house check: Oct-12</td> </tr> <tr> <td>Power sensor HP 8482H</td> <td>SN: 3318A09450</td> <td>09-Oct-09 (in house check Oct-11)</td> <td>In house check: Oct-12</td> </tr> <tr> <td>Power sensor HP 8482A</td> <td>SN: US37295597</td> <td>09-Oct-09 (in house check Oct-11)</td> <td>In house check: Oct-12</td> </tr> <tr> <td>Network Analyzer HP 8753E</td> <td>US37390585</td> <td>18-Oct-01 (in house check Oct-11)</td> <td>In house check: Oct-12</td> </tr> <tr> <td>RF generator E4433B</td> <td>MY 41000675</td> <td>03-Nov-04 (in house check Oct-11)</td> <td>In house check: Oct-13</td> </tr> </tbody> </table>				Primary Standards	ID #	Cal Date (Certificate No.)	Scheduled Calibration	Power meter EPM-442A	GB37480704	05-Oct-11 (No. 217-01451)	Oct-12	Power sensor HP 8481A	US37292783	05-Oct-11 (No. 217-01451)	Oct-12	Probe ER3DV6	SN: 2336	29-Dec-11 (No. ER3-2336_Dec11)	Dec-12	Probe H3DV6	SN: 6065	29-Dec-11 (No. H3-6065_Dec11)	Dec-12	DAE4	SN: 781	20-Apr-11 (No. DAE4-781_Apr11)	Apr-12	Secondary Standards	ID #	Check Date (in house)	Scheduled Check	Power meter Agilent 4419B	SN: GB42420191	09-Oct-09 (in house check Oct-11)	In house check: Oct-12	Power sensor HP 8482H	SN: 3318A09450	09-Oct-09 (in house check Oct-11)	In house check: Oct-12	Power sensor HP 8482A	SN: US37295597	09-Oct-09 (in house check Oct-11)	In house check: Oct-12	Network Analyzer HP 8753E	US37390585	18-Oct-01 (in house check Oct-11)	In house check: Oct-12	RF generator E4433B	MY 41000675	03-Nov-04 (in house check Oct-11)	In house check: Oct-13
Primary Standards	ID #	Cal Date (Certificate No.)	Scheduled Calibration																																																
Power meter EPM-442A	GB37480704	05-Oct-11 (No. 217-01451)	Oct-12																																																
Power sensor HP 8481A	US37292783	05-Oct-11 (No. 217-01451)	Oct-12																																																
Probe ER3DV6	SN: 2336	29-Dec-11 (No. ER3-2336_Dec11)	Dec-12																																																
Probe H3DV6	SN: 6065	29-Dec-11 (No. H3-6065_Dec11)	Dec-12																																																
DAE4	SN: 781	20-Apr-11 (No. DAE4-781_Apr11)	Apr-12																																																
Secondary Standards	ID #	Check Date (in house)	Scheduled Check																																																
Power meter Agilent 4419B	SN: GB42420191	09-Oct-09 (in house check Oct-11)	In house check: Oct-12																																																
Power sensor HP 8482H	SN: 3318A09450	09-Oct-09 (in house check Oct-11)	In house check: Oct-12																																																
Power sensor HP 8482A	SN: US37295597	09-Oct-09 (in house check Oct-11)	In house check: Oct-12																																																
Network Analyzer HP 8753E	US37390585	18-Oct-01 (in house check Oct-11)	In house check: Oct-12																																																
RF generator E4433B	MY 41000675	03-Nov-04 (in house check Oct-11)	In house check: Oct-13																																																
Calibrated by:	Name Dince Iliev	Function Laboratory Technician	Signature 																																																
Approved by:	Name Fin Bomholt	R&D Director																																																	
Issued: February 22, 2012																																																			
This calibration certificate shall not be reproduced except in full without written approval of the laboratory.																																																			

**Calibration Laboratory of
Schmid & Partner
Engineering AG**
Zeughausstrasse 43, 8004 Zurich, Switzerland



S Schweizerischer Kalibrierdienst
S Service suisse d'étalonnage
S Servizio svizzero di taratura
S Swiss Calibration Service

Accredited by the Swiss Accreditation Service (SAS)

The Swiss Accreditation Service is one of the signatories to the EA
Multilateral Agreement for the recognition of calibration certificates

Accreditation No.: **SCS 108**

References

- [1] ANSI-C63.19-2007
American National Standard for Methods of Measurement of Compatibility between Wireless Communications Devices and Hearing Aids.

Methods Applied and Interpretation of Parameters:

- **Coordinate System:** y-axis is in the direction of the dipole arms. z-axis is from the basis of the antenna (mounted on the table) towards its feed point between the two dipole arms. x-axis is normal to the other axes. In coincidence with the standards [1], the measurement planes (probe sensor center) are selected to be at a distance of 10 mm above the top edge of the dipole arms.
- **Measurement Conditions:** Further details are available from the hardcopies at the end of the certificate. All figures stated in the certificate are valid at the frequency indicated. The forward power to the dipole connector is set with a calibrated power meter connected and monitored with an auxiliary power meter connected to a directional coupler. While the dipole under test is connected, the forward power is adjusted to the same level.
- **Antenna Positioning:** The dipole is mounted on a HAC Test Arch phantom using the matching dipole positioner with the arms horizontal and the feeding cable coming from the floor. The measurements are performed in a shielded room with absorbers around the setup to reduce the reflections. It is verified before the mounting of the dipole under the Test Arch phantom, that its arms are perfectly in a line. It is installed on the HAC dipole positioner with its arms parallel below the dielectric reference wire and able to move elastically in vertical direction without changing its relative position to the top center of the Test Arch phantom. The vertical distance to the probe is adjusted after dipole mounting with a DASY5 Surface Check job. Before the measurement, the distance between phantom surface and probe tip is verified. The proper measurement distance is selected by choosing the matching section of the HAC Test Arch phantom with the proper device reference point (upper surface of the dipole) and the matching grid reference point (tip of the probe) considering the probe sensor offset. The vertical distance to the probe is essential for the accuracy.
- **Feed Point Impedance and Return Loss:** These parameters are measured using a HP 8753E Vector Network Analyzer. The impedance is specified at the SMA connector of the dipole. The influence of reflections was eliminated by applying the averaging function while moving the dipole in the air, at least 70cm away from any obstacles.
- **E-field distribution:** E field is measured in the x-y-plane with an isotropic ER3D-field probe with 100 mW forward power to the antenna feed point. In accordance with [1], the scan area is 20mm wide, its length exceeds the dipole arm length (180 or 90mm). The sensor center is 10 mm (in z) above the top of the dipole arms. Two 3D maxima are available near the end of the dipole arms. Assuming the dipole arms are perfectly in one line, the average of these two maxima (in subgrid 2 and subgrid 8) is determined to compensate for any non-parallelity to the measurement plane as well as the sensor displacement. The E-field value stated as calibration value represents the maximum of the interpolated 3D-E-field, 10mm above the dipole surface.
- **H-field distribution:** H-field is measured with an isotropic H-field probe with 100mW forward power to the antenna feed point, in the x-y-plane. The scan area and sensor distance is equivalent to the E-field scan. The maximum of the field is available at the center (subgrid 5) above the feed point. The H-field value stated as calibration value represents the maximum of the interpolated H-field, 10mm above the dipole surface at the feed point.

TA Technology (Shanghai) Co., Ltd.

Test Report

Measurement Conditions

DASY system configuration, as far as not given on page 1:

DASY Version	DASY5	V52.8.0
Extrapolation	Advanced Extrapolation	
Phantom	HAC Test Arch	
Distance Dipole Top - Probe Center	10mm	
Scan resolution	dx, dy = 5 mm	
Frequency	835MHz ± 1 MHz	
Input power drift	< 0.05 dB	

Maximum Field values

H-field 10 mm above dipole surface	condition	interpolated maximum
Maximum measured	100 mW input power	0.456 A / m ± 8.2 % (k=2)

E-field 10 mm above dipole surface	condition	Interpolated maximum
Maximum measured above high end	100 mW input power	161.4 V / m
Maximum measured above low end	100 mW input power	160.0 V / m
Averaged maximum above arm	100 mW input power	160.7 V / m ± 12.8 % (k=2)

Appendix

Antenna Parameters

Frequency	Return Loss	Impedance
800 MHz	15.7 dB	42.6 Ω - 13.5 jΩ
835 MHz	25.2 dB	47.3 Ω + 4.7 jΩ
900 MHz	17.9 dB	52.9 Ω - 12.8 jΩ
950 MHz	20.7 dB	46.3 Ω + 8.2 jΩ
960 MHz	15.5 dB	52.8 Ω + 17.3 jΩ

3.2 Antenna Design and Handling

The calibration dipole has a symmetric geometry with a built-in two stub matching network, which leads to the enhanced bandwidth.

The dipole is built of standard semirigid coaxial cable. The internal matching line is open ended. The antenna is therefore open for DC signals.

Do not apply force to dipole arms, as they are liable to bend. The soldered connections near the feedpoint may be damaged. After excessive mechanical stress or overheating, check the impedance characteristics to ensure that the internal matching network is not affected.

After long term use with 40W radiated power, only a slight warming of the dipole near the feedpoint can be measured.

TA Technology (Shanghai) Co., Ltd. Test Report

Report No. RXA1204-0069HAC01R1

Page 119 of 134

Impedance Measurement Plot

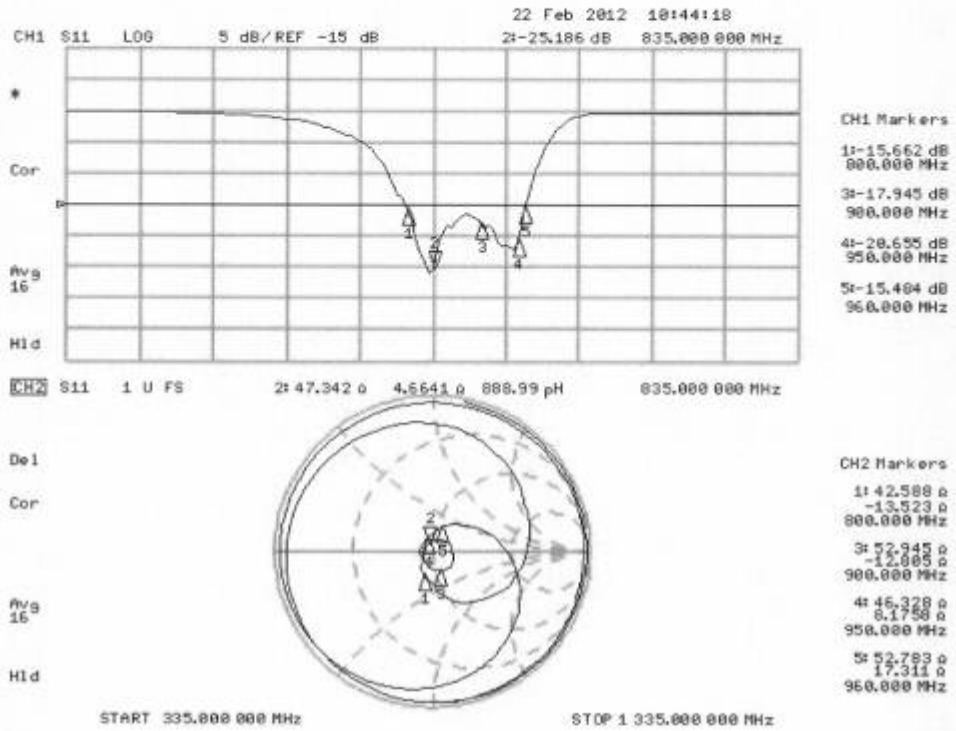

TA Technology (Shanghai) Co., Ltd. Test Report

Report No. RXA1204-0069HAC01R1

Page 120 of 134

DASY5 H-field Result

Date: 21.02.2012

Test Laboratory: SPEAG Lab2

DUT: HAC-Dipole 835 MHz; Type: CD835V3; Serial: CD835V3 - SN: 1133

Communication System: CW; Frequency: 835 MHz
Medium parameters used: $\sigma = 0$ mho/m, $\epsilon_r = 1$; $\rho = 1$ kg/m³
Phantom section: RF Section
Measurement Standard: DASY5 (IEEE/IEC/ANSI C63.19-2007)

DASY52 Configuration:

- Probe: H3DV6 - SN6065; ; Calibrated: 29.12.2011
- Sensor-Surface: (Fix Surface)
- Electronics: DAE4 Sn781; Calibrated: 20.04.2011
- Phantom: HAC Test Arch with AMCC; Type: SD HAC P01 BA; Serial: 1070
- DASY52 52.8.0(692); SEMCAD X 14.6.4(4989)

Dipole H-Field measurement @ 835MHz/H-Scan - 835MHz d=10mm/Hearing Aid Compatibility Test (41x361x1): Measurement grid: dx=5mm, dy=5mm

Device Reference Point: 0, 0, -6.3 mm
Reference Value = 0.49 V/m; Power Drift = 0.00 dB
PMR not calibrated. PMF = 1.000 is applied.
H-field emissions = 0.46 A/m
Near-field category: M4 (AWF 0 dB)

PMF scaled H-field

Grid 1 M4 0.38 A/m	Grid 2 M4 0.40 A/m	Grid 3 M4 0.39 A/m
Grid 4 M4 0.43 A/m	Grid 5 M4 0.46 A/m	Grid 6 M4 0.44 A/m
Grid 7 M4 0.37 A/m	Grid 8 M4 0.40 A/m	Grid 9 M4 0.39 A/m

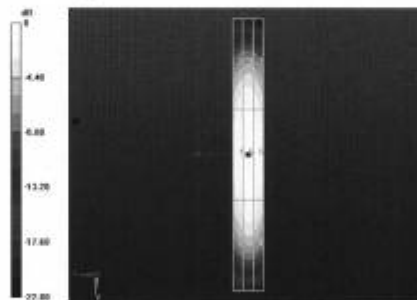

0 dB = 0.46A/m = -6.74 dB A/m

DASY5 E-field Result

Date: 21.02.2012

Test Laboratory: SPEAG Lab2

DUT: HAC-Dipole 835 MHz; Type: CD835V3; Serial: CD835V3 - SN: 1133

Communication System: CW; Frequency: 835 MHz
 Medium parameters used: $\sigma = 0$ mho/m, $\epsilon_r = 1$; $\rho = 1000$ kg/m³
 Phantom section: RF Section
 Measurement Standard: DASY5 (IEEE/IEC/ANSI C63.19-2007)

DASY52 Configuration:

- Probe: ER3DV6 - SN2336; ConvF(1, 1, 1); Calibrated: 29.12.2011
- Sensor-Surface: (Fix Surface)
- Electronics: DAE4 Sn781; Calibrated: 20.04.2011
- Phantom: HAC Test Arch with AMCC; Type: SD HAC P01 BA; Serial: 1070
- DASY52 52.8.0(692); SEMCAD X 14.6.4(4989)

Dipole E-Field measurement @ 835MHz/E-Scan - 835MHz d=10mm/Hearing Aid Compatibility Test (41x361x1): Measurement grid: dx=5mm, dy=5mm

Device Reference Point: 0, 0, -6.3 mm
 Reference Value = 104.5 V/m; Power Drift = 0.00 dB
 PMR not calibrated. PMF = 1.000 is applied.
 E-field emissions = 161.4 V/m
Near-field category: M4 (AWF 0 dB)

PMF scaled E-field

Grid 1 M4 156.3 V/m	Grid 2 M4 161.4 V/m	Grid 3 M4 157.3 V/m
Grid 4 M4 86.05 V/m	Grid 5 M4 88.80 V/m	Grid 6 M4 86.30 V/m
Grid 7 M4 151.4 V/m	Grid 8 M4 160.0 V/m	Grid 9 M4 157.8 V/m

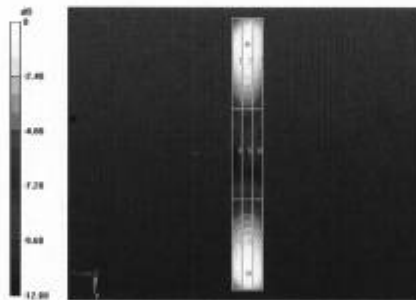

0 dB = 161.4V/m = 44.16 dB V/m

TA Technology (Shanghai) Co., Ltd. Test Report

Report No. RXA1204-0069HAC01R1

Page 122 of 134

ANNEX F: CD1880V3 Dipole Calibration Certificate

**Calibration Laboratory of
Schmid & Partner
Engineering AG**
Zeughausstrasse 43, 8004 Zurich, Switzerland



S Schweizerischer Kalibrierdienst
S Service suisse d'étalonnage
S Servizio svizzero di taratura
S Swiss Calibration Service

Accredited by the Swiss Accreditation Service (SAS)
The Swiss Accreditation Service is one of the signatories to the EA
Multilateral Agreement for the recognition of calibration certificates

Accreditation No.: **SCS 108**

Client **TA Shanghai (Auden)**

Certificate No: **CD1880V3-1115_Feb12**

CALIBRATION CERTIFICATE																																																			
Object	CD1880V3 - SN: 1115																																																		
Calibration procedure(s)	QA CAL-20.v6 Calibration procedure for dipoles in air																																																		
Calibration date:	February 21, 2012																																																		
<p>This calibration certificate documents the traceability to national standards, which realize the physical units of measurements (SI). The measurements and the uncertainties with confidence probability are given on the following pages and are part of the certificate.</p> <p>All calibrations have been conducted in the closed laboratory facility: environment temperature (22 ± 3)°C and humidity < 70%.</p> <p>Calibration Equipment used (M&TE critical for calibration)</p> <table border="1" style="width: 100%; border-collapse: collapse;"> <thead> <tr> <th style="width: 30%;">Primary Standards</th> <th style="width: 15%;">ID #</th> <th style="width: 30%;">Cal Date (Certificate No.)</th> <th style="width: 25%;">Scheduled Calibration</th> </tr> </thead> <tbody> <tr> <td>Power meter EPM-442A</td> <td>GB37480704</td> <td>05-Oct-11 (No. 217-01451)</td> <td>Oct-12</td> </tr> <tr> <td>Power sensor HP 8481A</td> <td>US37292783</td> <td>05-Oct-11 (No. 217-01451)</td> <td>Oct-12</td> </tr> <tr> <td>Probe ER3DV6</td> <td>SN: 2336</td> <td>29-Dec-11 (No. ER3-2336_Dec11)</td> <td>Dec-12</td> </tr> <tr> <td>Probe H3DV6</td> <td>SN: 6065</td> <td>29-Dec-11 (No. H3-6065_Dec11)</td> <td>Dec-12</td> </tr> <tr> <td>DAE4</td> <td>SN: 781</td> <td>20-Apr-11 (No. DAE4-781_Apr11)</td> <td>Apr-12</td> </tr> </tbody> </table> <table border="1" style="width: 100%; border-collapse: collapse;"> <thead> <tr> <th style="width: 30%;">Secondary Standards</th> <th style="width: 15%;">ID #</th> <th style="width: 30%;">Check Date (in house)</th> <th style="width: 25%;">Scheduled Check</th> </tr> </thead> <tbody> <tr> <td>Power meter Agilent 4419B</td> <td>SN: GB42420191</td> <td>09-Oct-09 (in house check Oct-11)</td> <td>In house check: Oct-12</td> </tr> <tr> <td>Power sensor HP 8482H</td> <td>SN: 3318A09450</td> <td>09-Oct-09 (in house check Oct-11)</td> <td>In house check: Oct-12</td> </tr> <tr> <td>Power sensor HP 8482A</td> <td>SN: US37295597</td> <td>09-Oct-09 (in house check Oct-11)</td> <td>In house check: Oct-12</td> </tr> <tr> <td>Network Analyzer HP 8753E</td> <td>US37390585</td> <td>18-Oct-01 (in house check Oct-11)</td> <td>In house check: Oct-12</td> </tr> <tr> <td>RF generator E4433B</td> <td>MY 41000675</td> <td>03-Nov-04 (in house check Oct-11)</td> <td>In house check: Oct-13</td> </tr> </tbody> </table>				Primary Standards	ID #	Cal Date (Certificate No.)	Scheduled Calibration	Power meter EPM-442A	GB37480704	05-Oct-11 (No. 217-01451)	Oct-12	Power sensor HP 8481A	US37292783	05-Oct-11 (No. 217-01451)	Oct-12	Probe ER3DV6	SN: 2336	29-Dec-11 (No. ER3-2336_Dec11)	Dec-12	Probe H3DV6	SN: 6065	29-Dec-11 (No. H3-6065_Dec11)	Dec-12	DAE4	SN: 781	20-Apr-11 (No. DAE4-781_Apr11)	Apr-12	Secondary Standards	ID #	Check Date (in house)	Scheduled Check	Power meter Agilent 4419B	SN: GB42420191	09-Oct-09 (in house check Oct-11)	In house check: Oct-12	Power sensor HP 8482H	SN: 3318A09450	09-Oct-09 (in house check Oct-11)	In house check: Oct-12	Power sensor HP 8482A	SN: US37295597	09-Oct-09 (in house check Oct-11)	In house check: Oct-12	Network Analyzer HP 8753E	US37390585	18-Oct-01 (in house check Oct-11)	In house check: Oct-12	RF generator E4433B	MY 41000675	03-Nov-04 (in house check Oct-11)	In house check: Oct-13
Primary Standards	ID #	Cal Date (Certificate No.)	Scheduled Calibration																																																
Power meter EPM-442A	GB37480704	05-Oct-11 (No. 217-01451)	Oct-12																																																
Power sensor HP 8481A	US37292783	05-Oct-11 (No. 217-01451)	Oct-12																																																
Probe ER3DV6	SN: 2336	29-Dec-11 (No. ER3-2336_Dec11)	Dec-12																																																
Probe H3DV6	SN: 6065	29-Dec-11 (No. H3-6065_Dec11)	Dec-12																																																
DAE4	SN: 781	20-Apr-11 (No. DAE4-781_Apr11)	Apr-12																																																
Secondary Standards	ID #	Check Date (in house)	Scheduled Check																																																
Power meter Agilent 4419B	SN: GB42420191	09-Oct-09 (in house check Oct-11)	In house check: Oct-12																																																
Power sensor HP 8482H	SN: 3318A09450	09-Oct-09 (in house check Oct-11)	In house check: Oct-12																																																
Power sensor HP 8482A	SN: US37295597	09-Oct-09 (in house check Oct-11)	In house check: Oct-12																																																
Network Analyzer HP 8753E	US37390585	18-Oct-01 (in house check Oct-11)	In house check: Oct-12																																																
RF generator E4433B	MY 41000675	03-Nov-04 (in house check Oct-11)	In house check: Oct-13																																																
Calibrated by:	Name Dince Iliev	Function Laboratory Technician	Signature 																																																
Approved by:	Name Fin Bornholt	R&D Director																																																	
Issued: February 22, 2012																																																			
This calibration certificate shall not be reproduced except in full without written approval of the laboratory.																																																			

**Calibration Laboratory of
Schmid & Partner
Engineering AG**
Zeughausstrasse 43, 8004 Zurich, Switzerland



S Schweizerischer Kalibrierdienst
C Service suisse d'étalonnage
S Servizio svizzero di taratura
S Swiss Calibration Service

Accredited by the Swiss Accreditation Service (SAS)
The Swiss Accreditation Service is one of the signatories to the EA
Multilateral Agreement for the recognition of calibration certificates

Accreditation No.: **SCS 108**

References

- [1] ANSI-C63.19-2007
American National Standard for Methods of Measurement of Compatibility between Wireless Communications Devices and Hearing Aids.

Methods Applied and Interpretation of Parameters:

- **Coordinate System:** y-axis is in the direction of the dipole arms. z-axis is from the basis of the antenna (mounted on the table) towards its feed point between the two dipole arms. x-axis is normal to the other axes. In coincidence with the standards [1], the measurement planes (probe sensor center) are selected to be at a distance of 10 mm above the top edge of the dipole arms.
- **Measurement Conditions:** Further details are available from the hardcopies at the end of the certificate. All figures stated in the certificate are valid at the frequency indicated. The forward power to the dipole connector is set with a calibrated power meter connected and monitored with an auxiliary power meter connected to a directional coupler. While the dipole under test is connected, the forward power is adjusted to the same level.
- **Antenna Positioning:** The dipole is mounted on a HAC Test Arch phantom using the matching dipole positioner with the arms horizontal and the feeding cable coming from the floor. The measurements are performed in a shielded room with absorbers around the setup to reduce the reflections. It is verified before the mounting of the dipole under the Test Arch phantom, that its arms are perfectly in a line. It is installed on the HAC dipole positioner with its arms parallel below the dielectric reference wire and able to move elastically in vertical direction without changing its relative position to the top center of the Test Arch phantom. The vertical distance to the probe is adjusted after dipole mounting with a DASY5 Surface Check job. Before the measurement, the distance between phantom surface and probe tip is verified. The proper measurement distance is selected by choosing the matching section of the HAC Test Arch phantom with the proper device reference point (upper surface of the dipole) and the matching grid reference point (tip of the probe) considering the probe sensor offset. The vertical distance to the probe is essential for the accuracy.
- **Feed Point Impedance and Return Loss:** These parameters are measured using a HP 8753E Vector Network Analyzer. The impedance is specified at the SMA connector of the dipole. The influence of reflections was eliminated by applying the averaging function while moving the dipole in the air, at least 70cm away from any obstacles.
- **E-field distribution:** E field is measured in the x-y-plane with an isotropic ER3D-field probe with 100 mW forward power to the antenna feed point. In accordance with [1], the scan area is 20mm wide, its length exceeds the dipole arm length (180 or 90mm). The sensor center is 10 mm (in z) above the top of the dipole arms. Two 3D maxima are available near the end of the dipole arms. Assuming the dipole arms are perfectly in one line, the average of these two maxima (in subgrid 2 and subgrid 8) is determined to compensate for any non-parallelity to the measurement plane as well as the sensor displacement. The E-field value stated as calibration value represents the maximum of the interpolated 3D-E-field, 10mm above the dipole surface.
- **H-field distribution:** H-field is measured with an isotropic H-field probe with 100mW forward power to the antenna feed point, in the x-y-plane. The scan area and sensor distance is equivalent to the E-field scan. The maximum of the field is available at the center (subgrid 5) above the feed point. The H-field value stated as calibration value represents the maximum of the interpolated H-field, 10mm above the dipole surface at the feed point.

TA Technology (Shanghai) Co., Ltd.

Test Report

Measurement Conditions

DASY system configuration, as far as not given on page 1:

DASY Version	DASY5	V52.8.0
Extrapolation	Advanced Extrapolation	
Phantom	HAC Test Arch	
Distance Dipole Top - Probe Center	10mm	
Scan resolution	dx, dy = 5 mm	
Frequency	1880MHz ± 1 MHz	
Input power drift	< 0.05 dB	

Maximum Field values

H-field 10 mm above dipole surface	condition	interpolated maximum
Maximum measured	100 mW input power	0.473 A / m ± 8.2 % (k=2)

E-field 10 mm above dipole surface	condition	Interpolated maximum
Maximum measured above high end	100 mW input power	143.4 V / m
Maximum measured above low end	100 mW input power	139.6 V / m
Averaged maximum above arm	100 mW input power	141.5 V / m ± 12.8 % (k=2)

Appendix

Antenna Parameters

Frequency	Return Loss	Impedance
1730 MHz	30.5 dB	52.6 Ω + 1.5 jΩ
1880 MHz	21.7 dB	46.1 Ω + 6.9 jΩ
1900 MHz	22.0 dB	47.6 Ω + 7.4 jΩ
1950 MHz	29.8 dB	49.9 Ω + 3.2 jΩ
2000 MHz	18.9 dB	41.3 Ω + 5.6 jΩ

3.2 Antenna Design and Handling

The calibration dipole has a symmetric geometry with a built-in two stub matching network, which leads to the enhanced bandwidth.

The dipole is built of standard semirigid coaxial cable. The internal matching line is open ended. The antenna is therefore open for DC signals.

Do not apply force to dipole arms, as they are liable to bend. The soldered connections near the feedpoint may be damaged. After excessive mechanical stress or overheating, check the impedance characteristics to ensure that the internal matching network is not affected.

After long term use with 40W radiated power, only a slight warming of the dipole near the feedpoint can be measured.

TA Technology (Shanghai) Co., Ltd. Test Report

Report No. RXA1204-0069HAC01R1

Page 125 of 134

Impedance Measurement Plot

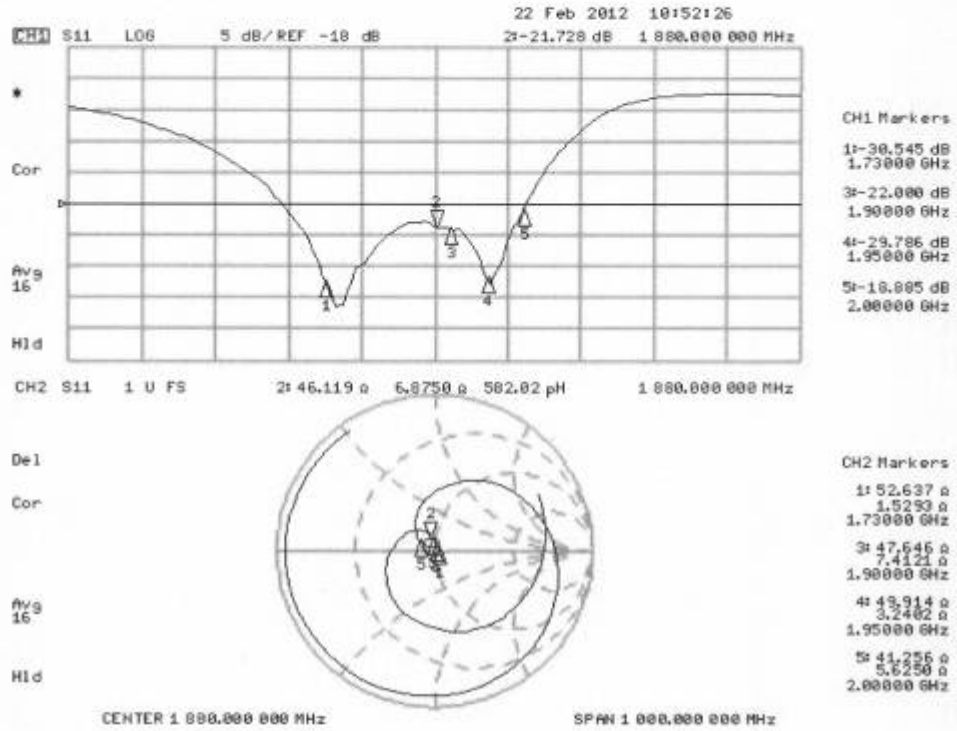

DASY5 H-field Result

Date: 21.02.2012

Test Laboratory: SPEAG Lab2

DUT: HAC Dipole 1880 MHz; Type: CD1880V3; Serial: CD1880V3 - SN: 1115

Communication System: CW; Frequency: 1880 MHz
 Medium parameters used: $\sigma = 0$ mho/m, $\epsilon_r = 1$; $\rho = 1$ kg/m³
 Phantom section: RF Section
 Measurement Standard: DASY5 (IEEE/IEC/ANSI C63.19-2007)

DASY52 Configuration:

- Probe: H3DV6 - SN6065; ; Calibrated: 29.12.2011
- Sensor-Surface: (Fix Surface)
- Electronics: DAE4 Sn781; Calibrated: 20.04.2011
- Phantom: HAC Test Arch with AMCC; Type: SD HAC P01 BA; Serial: 1070
- DASY52 52.8.0(692); SEMCAD X 14.6.4(4989)

Dipole H-Field measurement @ 1880MHz/H-Scan - 1880MHz d=10mm/Hearing Aid Compatibility Test (41x181x1): Measurement grid: dx=5mm, dy=5mm

Device Reference Point: 0, 0, -6.3 mm
 Reference Value = 0.50 V/m; Power Drift = -0.01 dB
 PMR not calibrated. PMF = 1.000 is applied.
 H-field emissions = 0.47 A/m
Near-field category: M2 (AWF 0 dB)

PMF scaled H-field

Grid 1 M2 0.40 A/m	Grid 2 M2 0.43 A/m	Grid 3 M2 0.41 A/m
Grid 4 M2 0.45 A/m	Grid 5 M2 0.47 A/m	Grid 6 M2 0.46 A/m
Grid 7 M2 0.41 A/m	Grid 8 M2 0.44 A/m	Grid 9 M2 0.42 A/m

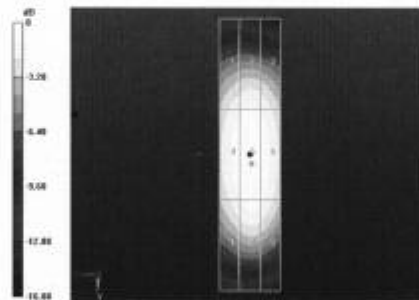

0 dB = 0.47A/m = -6.56 dB A/m

DASY5 E-field Result

Date: 21.02.2012

Test Laboratory: SPEAG Lab2

DUT: HAC Dipole 1880 MHz; Type: CD1880V3; Serial: CD1880V3 - SN: 1115

Communication System: CW; Frequency: 1880 MHz
 Medium parameters used: $\sigma = 0$ mho/m, $\epsilon_r = 1$; $\rho = 1000$ kg/m³
 Phantom section: RF Section
 Measurement Standard: DASY5 (IEEE/IEC/ANSI C63.19-2007)

DASY52 Configuration:

- Probe: ER3DV6 - SN2336; ConvF(1, 1, 1); Calibrated: 29.12.2011
- Sensor-Surface: (Fix Surface)
- Electronics: DAE4 Sn781; Calibrated: 20.04.2011
- Phantom: HAC Test Arch with AMCC; Type: SD HAC P01 BA; Serial: 1070
- DASY52 52.8.0(692); SEMCAD X 14.6.4(4989)

Dipole E-Field measurement @ 1880MHz/E-Scan - 1880MHz d=10mm/Hearing Aid Compatibility Test (41x181x1): Measurement grid: dx=5mm, dy=5mm

Device Reference Point: 0, 0, -6.3 mm
 Reference Value = 161.1 V/m; Power Drift = -0.01 dB
 PMR not calibrated. PMF = 1.000 is applied.
 E-field emissions = 143.4 V/m
Near-field category: M2 (AWF 0 dB)

PMF scaled E-field

Grid 1 M2 134.3 V/m	Grid 2 M2 139.6 V/m	Grid 3 M2 136.5 V/m
Grid 4 M3 90.34 V/m	Grid 5 M3 93.17 V/m	Grid 6 M3 89.93 V/m
Grid 7 M2 134.3 V/m	Grid 8 M2 143.4 V/m	Grid 9 M2 141.8 V/m

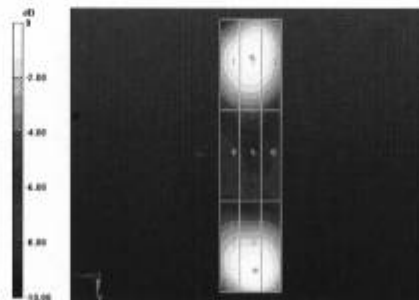

0 dB = 143.4V/m = 43.13 dB V/m

TA Technology (Shanghai) Co., Ltd. Test Report

Report No. RXA1204-0069HAC01R1

Page 128 of 134

ANNEX G: DAE4 Calibration Certificate

**Calibration Laboratory of
Schmid & Partner
Engineering AG**
Zeughausstrasse 43, 8004 Zurich, Switzerland



S Schweizerischer Kalibrierdienst
C Service suisse d'étalonnage
S Servizio svizzero di taratura
S Swiss Calibration Service

Accredited by the Swiss Accreditation Service (SAS)
The Swiss Accreditation Service is one of the signatories to the EA
Multilateral Agreement for the recognition of calibration certificates

Accreditation No.: **SCS 108**

Client **TA Shanghai (Auden)**

Certificate No: **DAE4-1317_Jan12**

CALIBRATION CERTIFICATE

Object: **DAE4 - SD 000 D04 BJ - SN: 1317**

Calibration procedure(s): **QA CAL-06.v24
Calibration procedure for the data acquisition electronics (DAE)**

Calibration date: **January 23, 2012**

This calibration certificate documents the traceability to national standards, which realize the physical units of measurements (SI).
The measurements and the uncertainties with confidence probability are given on the following pages and are part of the certificate.

All calibrations have been conducted in the closed laboratory facility: environment temperature (22 ± 3)°C and humidity < 70%.

Calibration Equipment used (M&TE critical for calibration)

Primary Standards	ID #	Cal Date (Certificate No.)	Scheduled Calibration
Keithley Multimeter Type 2001	SN: 0810278	28-Sep-11 (No:11450)	Sep-12
Secondary Standards	ID #	Check Date (in house)	Scheduled Check
Calibrator Box V2.1	SE UWS 053 AA 1001	05-Jan-12 (in house check)	In house check: Jan-13

	Name	Function	Signature
Calibrated by:	Dominique Steffen	Technician	
Approved by:	Fin Bomholt	R&D Director	

Issued: January 23, 2012

This calibration certificate shall not be reproduced except in full without written approval of the laboratory.

Calibration Laboratory of
Schmid & Partner
Engineering AG
Zeughausstrasse 43, 8004 Zurich, Switzerland



S Schweizerischer Kalibrierdienst
C Service suisse d'étalonnage
S Servizio svizzero di taratura
S Swiss Calibration Service

Accredited by the Swiss Accreditation Service (SAS)
The Swiss Accreditation Service is one of the signatories to the EA
Multilateral Agreement for the recognition of calibration certificates

Accreditation No.: SCS 108

Glossary

DAE data acquisition electronics
Connector angle information used in DASY system to align probe sensor X to the robot coordinate system.

Methods Applied and Interpretation of Parameters

- *DC Voltage Measurement:* Calibration Factor assessed for use in DASY system by comparison with a calibrated instrument traceable to national standards. The figure given corresponds to the full scale range of the voltmeter in the respective range.
- *Connector angle:* The angle of the connector is assessed measuring the angle mechanically by a tool inserted. Uncertainty is not required.
- The following parameters as documented in the Appendix contain technical information as a result from the performance test and require no uncertainty.
 - *DC Voltage Measurement Linearity:* Verification of the Linearity at +10% and -10% of the nominal calibration voltage. Influence of offset voltage is included in this measurement.
 - *Common mode sensitivity:* Influence of a positive or negative common mode voltage on the differential measurement.
 - *Channel separation:* Influence of a voltage on the neighbor channels not subject to an input voltage.
 - *AD Converter Values with inputs shorted:* Values on the internal AD converter corresponding to zero input voltage
 - *Input Offset Measurement:* Output voltage and statistical results over a large number of zero voltage measurements.
 - *Input Offset Current:* Typical value for information; Maximum channel input offset current, not considering the input resistance.
 - *Input resistance:* Typical value for information: DAE input resistance at the connector, during internal auto-zeroing and during measurement.
 - *Low Battery Alarm Voltage:* Typical value for information. Below this voltage, a battery alarm signal is generated.
 - *Power consumption:* Typical value for information. Supply currents in various operating modes.

TA Technology (Shanghai) Co., Ltd.
Test Report

DC Voltage Measurement

A/D - Converter Resolution nominal

High Range: 1LSB = 6.1 μ V , full range = -100...+300 mV

Low Range: 1LSB = 61nV , full range = -1.....+3mV

DASY measurement parameters: Auto Zero Time: 3 sec; Measuring time: 3 sec

Calibration Factors	X	Y	Z
High Range	404.064 \pm 0.1% (k=2)	404.056 \pm 0.1% (k=2)	403.955 \pm 0.1% (k=2)
Low Range	3.98762 \pm 0.7% (k=2)	3.98737 \pm 0.7% (k=2)	3.98343 \pm 0.7% (k=2)

Connector Angle

Connector Angle to be used in DASY system	117.0 $^{\circ}$ \pm 1 $^{\circ}$
---	-------------------------------------

TA Technology (Shanghai) Co., Ltd.

Test Report

Appendix

1. DC Voltage Linearity

High Range	Reading (μV)	Difference (μV)	Error (%)
Channel X + Input	199992.18	-1.75	-0.00
Channel X + Input	20001.35	0.46	0.00
Channel X - Input	-19997.31	1.96	-0.01
Channel Y + Input	199993.18	-1.24	-0.00
Channel Y + Input	20001.40	0.60	0.00
Channel Y - Input	-20000.04	-0.70	0.00
Channel Z + Input	199991.58	-2.43	-0.00
Channel Z + Input	19999.62	-1.14	-0.01
Channel Z - Input	-20001.31	-1.83	0.01

Low Range	Reading (μV)	Difference (μV)	Error (%)
Channel X + Input	2000.74	-0.89	-0.04
Channel X + Input	202.18	-0.01	-0.01
Channel X - Input	-197.58	0.36	-0.18
Channel Y + Input	2000.34	-1.20	-0.06
Channel Y + Input	199.67	-2.39	-1.18
Channel Y - Input	-197.64	0.32	-0.16
Channel Z + Input	2000.69	-0.78	-0.04
Channel Z + Input	200.84	-1.16	-0.57
Channel Z - Input	-198.45	-0.47	0.24

2. Common mode sensitivity

DASY measurement parameters: Auto Zero Time: 3 sec; Measuring time: 3 sec

	Common mode Input Voltage (mV)	High Range Average Reading (μV)	Low Range Average Reading (μV)
Channel X	200	-23.40	-24.98
	-200	28.01	26.12
Channel Y	200	-2.57	-2.75
	-200	1.67	1.31
Channel Z	200	-11.92	-11.43
	-200	9.80	9.45

3. Channel separation

DASY measurement parameters: Auto Zero Time: 3 sec; Measuring time: 3 sec

	Input Voltage (mV)	Channel X (μV)	Channel Y (μV)	Channel Z (μV)
Channel X	200	-	-2.15	-4.41
Channel Y	200	7.18	-	-2.47
Channel Z	200	7.44	5.46	-

TA Technology (Shanghai) Co., Ltd.

Test Report

4. AD-Converter Values with inputs shorted

DASY measurement parameters: Auto Zero Time: 3 sec; Measuring time: 3 sec

	High Range (LSB)	Low Range (LSB)
Channel X	16081	17027
Channel Y	16103	16170
Channel Z	16221	16651

5. Input Offset Measurement

DASY measurement parameters: Auto Zero Time: 3 sec; Measuring time: 3 sec

Input 10MΩ

	Average (μV)	min. Offset (μV)	max. Offset (μV)	Std. Deviation (μV)
Channel X	-0.45	-1.32	0.40	0.32
Channel Y	-2.63	-3.99	-1.68	0.42
Channel Z	-0.67	-3.07	1.36	0.50

6. Input Offset Current

Nominal Input circuitry offset current on all channels: <25fA

7. Input Resistance (Typical values for information)

	Zeroing (kOhm)	Measuring (MOhm)
Channel X	200	200
Channel Y	200	200
Channel Z	200	200

8. Low Battery Alarm Voltage (Typical values for information)

Typical values	Alarm Level (VDC)
Supply (+ Vcc)	+7.9
Supply (- Vcc)	-7.6

9. Power Consumption (Typical values for information)

Typical values	Switched off (mA)	Stand by (mA)	Transmitting (mA)
Supply (+ Vcc)	+0.01	+6	+14
Supply (- Vcc)	-0.01	-8	-9