



TEST REPORT

Report No.: SRTC2012-H024-E0025

Product Name: GSM/GPRS/EDGE/UMTS

Digital Mobile Phone with Bluetooth and WiFi

Product Model: ONE TOUCH 902A

Applicant: TCT Mobile Limited

Manufacturer: TCT Mobile Limited

Specification: FCC Part15B (Certification)

(October 1, 2009 edition)

FCC ID: RAD243

IC: 9238A-0009

The State Radio_monitoring_center Testing Center (SRTC)

No.80 Beilishi Road Xicheng District Beijing, China

Tel: 86-10-68009202 Fax: 86-10-68009205

CONTENTS

1. General information	3
1.1 Notes of the test report	3
1.2 Information about the testing laboratory	3
1.3 Applicant's details	3
1.4 Manufacturer's details	3
1.5 Application details	4
1.6 Reference specification	4
1.7 Information of EUT	4
1.7.1 General information	4
1.7.2 EUT details	5
1.7.3 Auxiliary equipment details	5
2. Test information	8
2.1 Summary of the test results	8
2.2 Test result	9
2.2.1 Conducted Emissions-FCC Part15.107	9
2.2.2 Radiated Emissions-FCC Part15.109	18
2.3 List of test equipments	29
Appendix	30

1. General information

1.1 Notes of the test report

The test report may only be reproduced or published in full. Reproduction or publication of extracts from the report requires the prior written permission of The State Radio_monitoring_center Testing Center (SRTC).

The test results relate only to individual items of the samples which have been tested.

1.2 Information about the testing laboratory

Company: The State Radio_monitoring_center Testing Center (SRTC)
Address: No.80 Beilishi Road, Xicheng District, Beijing China
City: Beijing
Country or Region: China
Contacted person: Wang Junfeng
Tel: +86 10 68009181 +86 10 68009202
Fax: +86 10 68009195 +86 10 68009205
Email: wangjf@srrc.org.cn / wangjunfeng@srtc.org.cn

1.3 Applicant's details

Company: TCT Mobile Limited
Address: 5F, C building, No. 232, Liang Jing Road ZhangJiang High-Tech Park, Pudong Area
City: Shanghai
Country or Region: P.R.China
Grantee Code: RAD
Contacted person: Gong Zhizhou
Tel: +86-21-61460890
Fax: +86-21-61460602
Email: zhizhou.gong@jrdcom.com

1.4 Manufacturer's details

Company: TCT Mobile Limited
Address: 5F, C building, No. 232, Liang Jing Road ZhangJiang High-Tech Park, Pudong Area
City: Shanghai
Country or Region: P.R.China
Contacted person: Gong Zhizhou
Tel: +86-21-61460890
Fax: +86-21-61460602
Email: zhizhou.gong@jrdcom.com

1.5 Application details

Date of reception of test sample: 8th Mar 2012

Date of test: 8th Mar 2012 to 9th Apr 2012

1.6 Reference specification

FCC Part 15B October 1, 2009 (Certification)

1.7 Information of EUT

1.7.1 General information

Name of EUT	GSM/GPRS/EDGE/UMTS Digital Mobile Phone with Bluetooth and WiFi
FCC ID	RAD243
IC	9238A-0009
Frequency range	GSM850/WCDMA Band V: Tx:824~849MHz Rx:869~894MHz PCS1900/WCDMA Band II: Tx:1850~1910MHz Rx:1930~1990MHz
Rated output power	GSM850:33.0dBm PCS1900:30.0dBm WCDMA:24.0dBm
E.R.P. & E.I.R.P.	E.R.P.: 31.7dBm E.I.R.P.: 27.0dBm
Modulation type	GSM/GPRS:GMSK EDGE: GMSK(Uplink direction) 8PSK(Downlink direction) WCDMA:QPSK
Emission Designator	GSM/GPRS/EDGE:300KGXW WCDMA:4M50F9W
Duplex mode	FDD
Equipment Class	Class B
Duplex spacing	GSM850/WCDMA Band V:45MHz PCS1900/WCDMA Band II:80MHz
Antenna type	Fixed Internal
Power Supply	Battery or charger
Rated Power Supply Voltage	3.7V
Extreme Temperature	Lowest: -30°C Highest: +50°C
Extreme Voltage	Minimum: 3.5V Maximum: 4.2V
HW Version	PIO01
SW Version	SW134

1.7.2 EUT details

Product Name	Product Model	IMEI
GSM/GPRS/EDGE/UMTS Digital Mobile Phone with Bluetooth and WiFi	ONE TOUCH 902A	013022000000801

1.7.3 Auxiliary equipment details

AE (Auxiliary Equipment) 1#: Charger

Equipment	Charger
Manufacturer	HUIZHOU BYD ELECTRONIC CO., LTD.
Model Number	CBA3002AG0C1
Input Voltage	100V-240V a.c.
Output Voltage	5.0V d.c.
Frequency	50/60Hz

AE (Auxiliary Equipment) 2#: Charger

Equipment	Charger
Manufacturer	HUIZHOU BYD ELECTRONIC CO., LTD.
Model Number	CBA3001AG0C1
Input Voltage	100V-240V a.c.
Output Voltage	5.0V d.c.
Frequency	50/60Hz

AE (Auxiliary Equipment) 3#: Charger

Equipment	Charger
Manufacturer	HUIZHOU BYD ELECTRONIC CO., LTD.
Model Number	CBA3001AG0C2
Input Voltage	100V-240V a.c.
Output Voltage	5.0V d.c.
Frequency	50/60Hz

AE (Auxiliary Equipment) 4#: Charger

Equipment	Charger
Manufacturer	Ten Pao International Ltd.
Model Number	CBA3000AG0C1
Input Voltage	100V-240V a.c.
Output Voltage	5.0V d.c.
Frequency	50/60Hz

AE (Auxiliary Equipment) 5#: Battery

Equipment	Battery
Manufacturer	SHENZHEN BAK BATTERY CO., LTD
Model Number	CAB31L0000C2
Capacity	1000mAh
Rated Voltage	3.7V d.c.

AE (Auxiliary Equipment) 6#: Headset

Equipment	Headset
Manufacturer	Shen Zhen Ju Wei Electronic Co., LTD
Model Number	CCB3160A11C1

AE (Auxiliary Equipment) 7#: Headset

Equipment	Headset
Manufacturer	SUPERFINE ELECTRONIC CO., LTD
Model Number	CCB3160A11C4

AE (Auxiliary Equipment) 8#: Headset

Equipment	Headset
Manufacturer	Shen Zhen Ju Wei Electronic Co., LTD
Model Number	CCB3160A15C1

AE (Auxiliary Equipment) 9#: Headset

Equipment	Headset
Manufacturer	SUPERFINE ELECTRONIC CO., LTD
Model Number	CCB3160A15C4

AE (Auxiliary Equipment) 10#: Data Cable

Equipment	Data Cable
Manufacturer	Huizhou Shenghua Industry Co., Ltd
Model Number	CDA3122005C2

AE (Auxiliary Equipment) 11#: Data Cable

Equipment	Data Cable
Manufacturer	Shen Zhen Ju Wei Electronic Co., LTD
Model Number	CDA3122002C1

AE (Auxiliary Equipment) 12#: Data Cable

Equipment	Data Cable
Manufacturer	Huizhou Shenghua Industry Co., Ltd
Model Number	CDA3122002C2

AE (Auxiliary Equipment) 13#: Data Cable

Equipment	Data Cable
Manufacturer	Shen Zhen Ju Wei Electronic Co., LTD
Model Number	CDA3122005C1

Note:

All the auxiliary equipments have been labeled with number in order to identify the test sample.



As the information described above, there are four different models of charger manufactured by two different companies, four different models of data cable manufactured by two different companies, and four different models of headset manufactured by two different companies.

The relevant tests have been performed in order to verify in which combination case (EUT exercised by only one model of charger, one model of data cable, and one model of headset) the EUT would have the worst features. So all the tests shown in this test report are performed when the EUT exercised by the charger CBA3000AG0C1, the data cable CDA3122005C2 and the headset CCB3160A15C1.

2. Test information

2.1 Summary of the test results

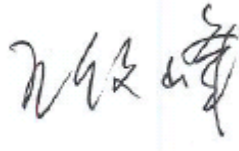
No.	Test case	FCC reference	Verdict
1	Conducted emissions	15.107	Pass
2	Radiated emissions	15.109	Pass

This Test Report Is Issued by: Mr. Song Qizhu Director of the test lab 	Checked by: Mr. Wang Junfeng Deputy director of the test lab 
Tested by: Mr. Wu Chengwang Test engineer 	Issued date: 2012.05.30

2.2 Test result

2.2.1 Conducted Emissions-FCC Part15.107

Ambient condition:

Temperature	Relative humidity	Pressure
17.9°C	36.4%	100.1kPa

Test Setup:

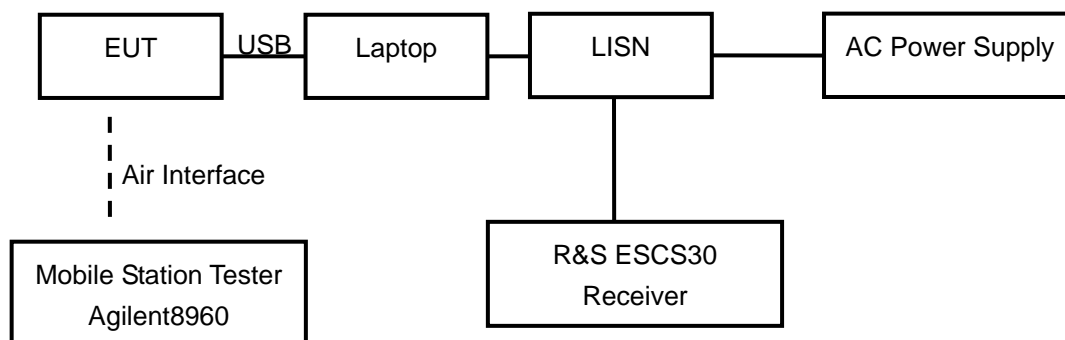

Figure 1

Test Procedure:

The EUT is placed on a non-metallic table 0.4m above the horizontal metal reference ground plane. The EUT connect with a laptop via the USB cable. The accessories of the EUT are connected with the EUT such as headset etc. During the test the data transferring via USB cable between EUT and laptop is maintained.

The AC main power supply of the laptop is connected to LISN and LISN is connected to the reference ground. The test set-up and the test methods are performed according to ANSI C63.4:2009.

Then start the test software ES-K1. Sweep the whole frequency band through the range from 150 KHz to 30 MHz. The measurement should be done for both L line and N line. During pre-test, the receiver uses both peak detector and average detector. And the final test, the receiver uses both average detector and Quasi-peak detector.

The data of cable loss has been calibrated in full testing frequency range before the testing.

Limit:

Frequency of Emission(MHz)	Limits(dBμV)	
	Quasi-peak	Average
0.15~0.5	66 to 56*	56 to 46*
0.5~5	56	46
5~30	60	50

Note: * Decreases with the logarithm of the frequency

Test result:

Noise Level of The Measuring Instrument

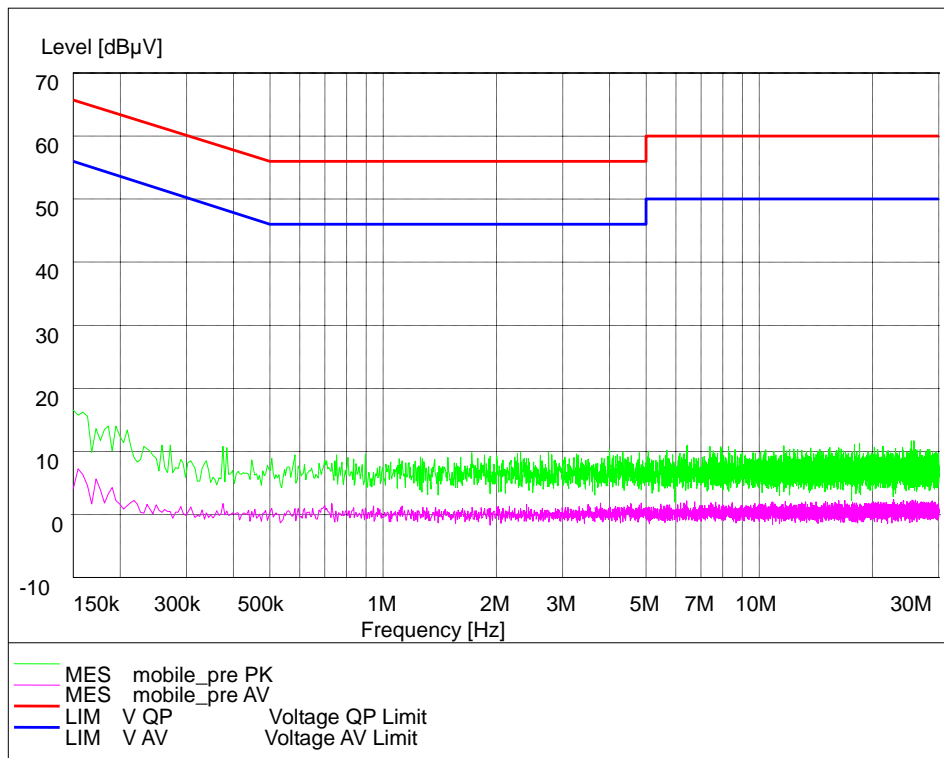

L and N Line

GSM 850 Laptop+AE5#+AE8#+AE10#

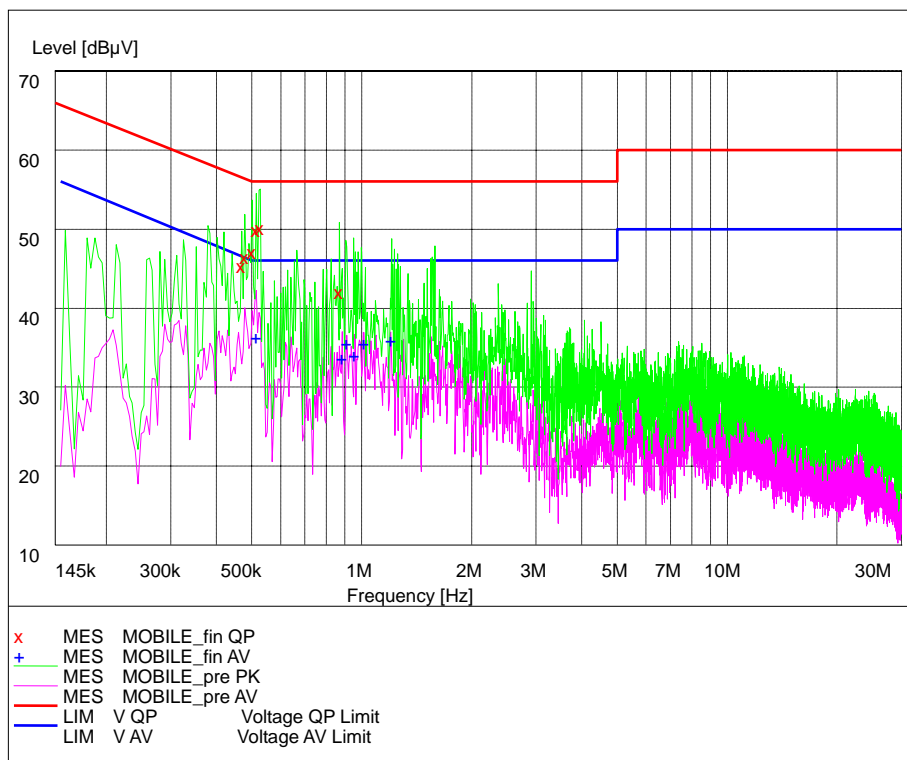

L and N Line

MEASUREMENT RESULT: "MOBILE_fin QP"

Frequency MHz	Level dBµV	Transd	Limit dB	Margin dBµV	Line	PE
0.469500	46.60	20.3	57	9.9	L1	GND
0.478500	47.80	20.3	56	8.6	L1	GND
0.501000	48.40	20.3	56	7.6	L1	GND
0.514500	51.20	20.3	56	4.8	L1	GND
0.528000	51.40	20.3	56	4.6	L1	GND
0.870000	43.30	20.3	56	12.7	N	GND

MEASUREMENT RESULT: "MOBILE_fin AV"

Frequency MHz	Level dBµV	Transd	Limit dB	Margin dBµV	Line	PE
0.514500	37.60	20.3	46	8.4	L1	GND
0.883500	35.00	20.3	46	11.0	L1	GND
0.910500	36.90	20.2	46	9.1	N	GND
0.955500	35.30	20.2	46	10.7	N	GND
1.014000	36.90	20.2	46	9.1	L1	GND
1.203000	37.20	20.2	46	8.8	L1	GND

GSM 1900 Laptop+AE5#+AE8#+AE10#

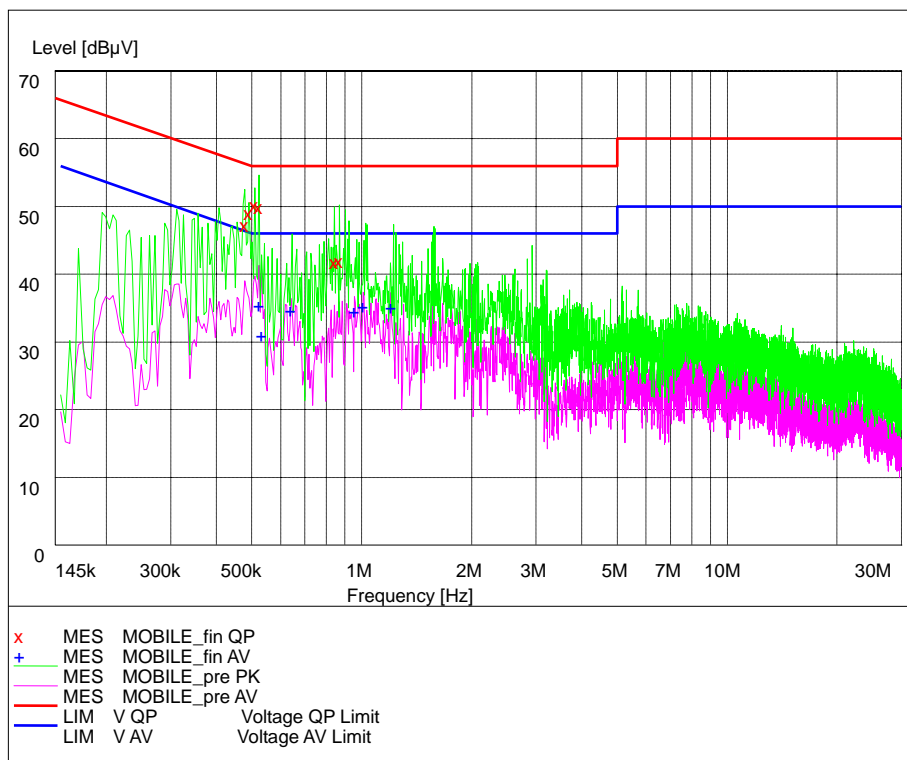

L and N Line

MEASUREMENT RESULT: "MOBILE_fin QP"

Frequency MHz	Level dBμV	Transd	Limit dB	Margin dBμV	Line	PE
0.478500	48.70	20.3	56	7.7	L1	GND
0.492000	50.50	20.3	56	5.6	L1	GND
0.510000	51.80	20.3	56	4.2	L1	GND
0.523500	51.40	20.3	56	4.6	L1	GND
0.843000	43.30	20.3	56	12.7	N	GND
0.870000	43.50	20.3	56	12.5	N	GND

MEASUREMENT RESULT: "MOBILE_fin AV"

Frequency MHz	Level dBμV	Transd	Limit dB	Margin dBμV	Line	PE
0.523500	37.00	20.3	46	9.0	L1	GND
0.532500	32.60	20.3	46	13.4	N	GND
0.640500	36.30	20.3	46	9.7	L1	GND
0.955500	36.10	20.2	46	9.9	L1	GND
1.009500	36.80	20.2	46	9.2	L1	GND
1.203000	36.70	20.2	46	9.3	L1	GND

WCDMA BAND II Laptop+AE5#+AE8#+AE10#

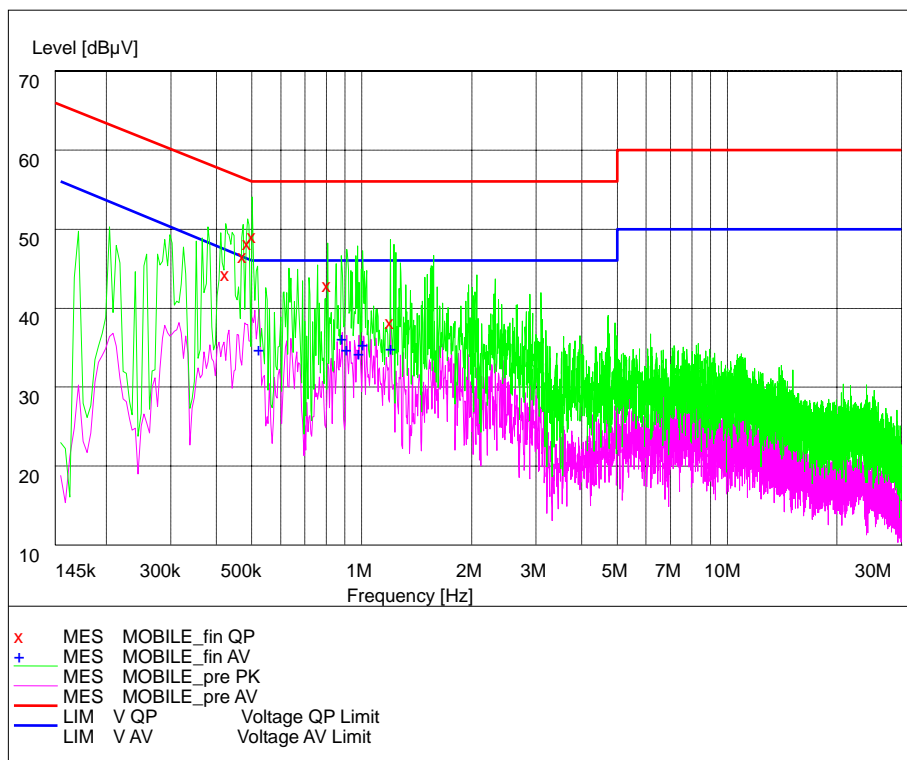

L and N Line

MEASUREMENT RESULT: "MOBILE_fin QP"

Frequency MHz	Level dBμV	Transd	Limit dB	Margin dBμV	Line	PE
0.424500	45.60	20.3	57	11.7	L1	GND
0.474000	47.90	20.3	56	8.5	N	GND
0.487500	49.60	20.3	56	6.6	L1	GND
0.501000	50.40	20.3	56	5.6	L1	GND
0.807000	44.20	20.3	56	11.8	L1	GND
1.198500	39.50	20.2	56	16.5	N	GND

MEASUREMENT RESULT: "MOBILE_fin AV"

Frequency MHz	Level dBμV	Transd	Limit dB	Margin dBμV	Line	PE
0.523500	36.10	20.3	46	9.9	L1	GND
0.883500	37.50	20.3	46	8.5	L1	GND
0.910500	36.10	20.2	46	9.9	L1	GND
0.982500	35.60	20.2	46	10.4	N	GND
1.009500	36.70	20.2	46	9.3	L1	GND
1.203000	36.30	20.2	46	9.7	L1	GND

WCDMA BAND V Laptop+AE5#+AE8#+AE10#

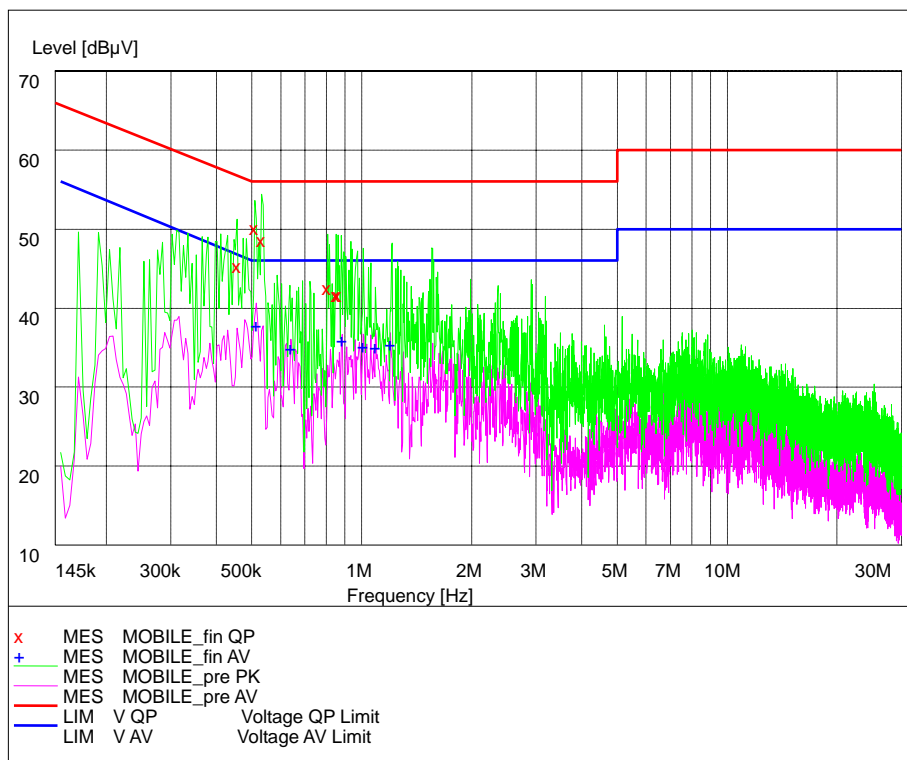

L and N Line

MEASUREMENT RESULT: "MOBILE_fin QP"

Frequency MHz	Level dBμV	Transd	Limit dB	Margin dBμV	Line	PE
0.456000	46.60	20.3	57	10.2	L1	GND
0.510000	51.40	20.3	56	4.6	L1	GND
0.532500	49.90	20.3	56	6.1	L1	GND
0.807000	43.90	20.3	56	12.1	L1	GND
0.852000	42.90	20.3	56	13.1	N	GND
0.861000	43.00	20.3	56	13.0	N	GND

MEASUREMENT RESULT: "MOBILE_fin AV"

Frequency MHz	Level dBμV	Transd	Limit dB	Margin dBμV	Line	PE
0.514500	39.20	20.3	46	6.8	L1	GND
0.640500	36.30	20.3	46	9.7	L1	GND
0.883500	37.20	20.3	46	8.8	L1	GND
1.009500	36.50	20.2	46	9.5	L1	GND
1.090500	36.40	20.2	46	9.6	L1	GND
1.198500	36.80	20.2	46	9.2	L1	GND

FM Radio Laptop+AE5#+AE8#+AE10#

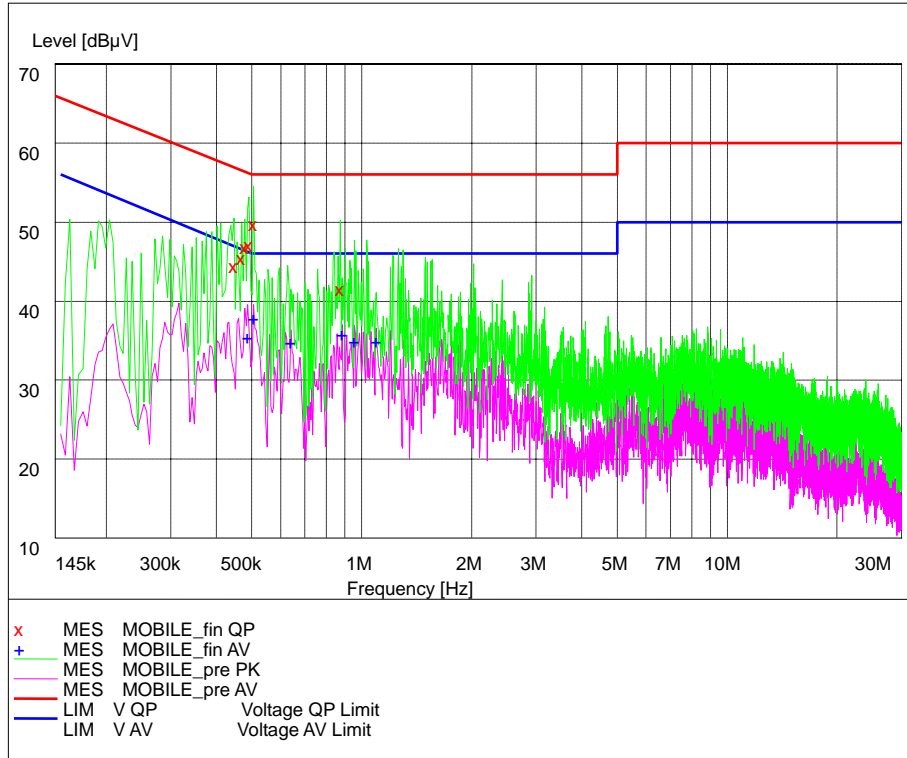

L and N Line

MEASUREMENT RESULT: "MOBILE_fin QP"

Frequency MHz	Level dBμV	Transd	Limit dB	Margin dBμV	Line	PE
0.447000	45.70	20.3	57	11.2	L1	GND
0.469500	46.80	20.3	57	9.7	L1	GND
0.478500	48.10	20.3	56	8.2	L1	GND
0.492000	48.40	20.3	56	7.8	L1	GND
0.505500	51.10	20.3	56	4.9	L1	GND
0.874500	42.80	20.3	56	13.2	N	GND

MEASUREMENT RESULT: "MOBILE_fin AV"

Frequency MHz	Level dBμV	Transd	Limit dB	Margin dBμV	Line	PE
0.487500	36.80	20.3	46	9.4	L1	GND
0.505500	39.10	20.3	46	6.9	L1	GND
0.640500	36.10	20.3	46	9.9	L1	GND
0.883500	37.10	20.3	46	8.9	L1	GND
0.955500	36.20	20.2	46	9.8	L1	GND
1.095000	36.20	20.2	46	9.8	L1	GND

MP3/MP4 Laptop+AE5#+AE8#+AE10#

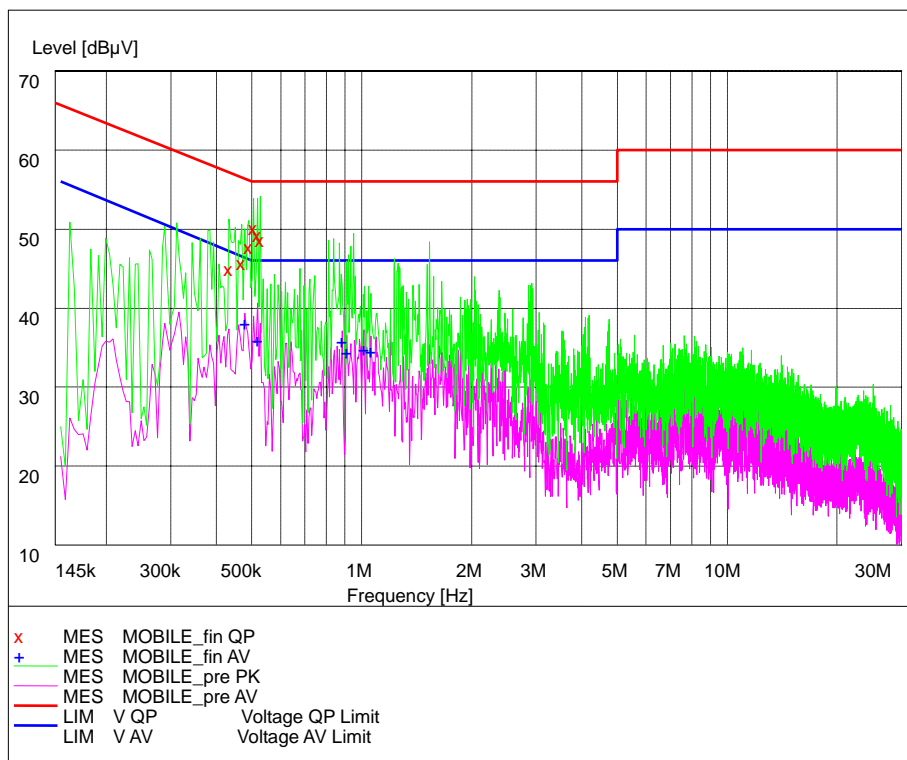

L Line

MEASUREMENT RESULT: "MOBILE_fin QP"

Frequency MHz	Level dBµV	Transd	Limit dB	Margin dBµV	Line	PE
0.433500	46.20	20.3	57	11.0	N	GND
0.469500	47.00	20.3	57	9.5	L1	GND
0.492000	49.00	20.3	56	7.1	L1	GND
0.505500	51.50	20.3	56	4.5	L1	GND
0.519000	50.50	20.3	56	5.5	L1	GND
0.528000	49.90	20.3	56	6.1	L1	GND

MEASUREMENT RESULT: "MOBILE_fin AV"

Frequency MHz	Level dBµV	Transd	Limit dB	Margin dBµV	Line	PE
0.478500	39.40	20.3	46	7.0	L1	GND
0.519000	37.30	20.3	46	8.7	L1	GND
0.883500	37.10	20.3	46	8.9	L1	GND
0.910500	35.70	20.2	46	10.3	N	GND
1.014000	36.10	20.2	46	9.9	L1	GND
1.059000	35.80	20.2	46	10.2	N	GND

Camera Laptop+AE5#+AE8#+AE10#

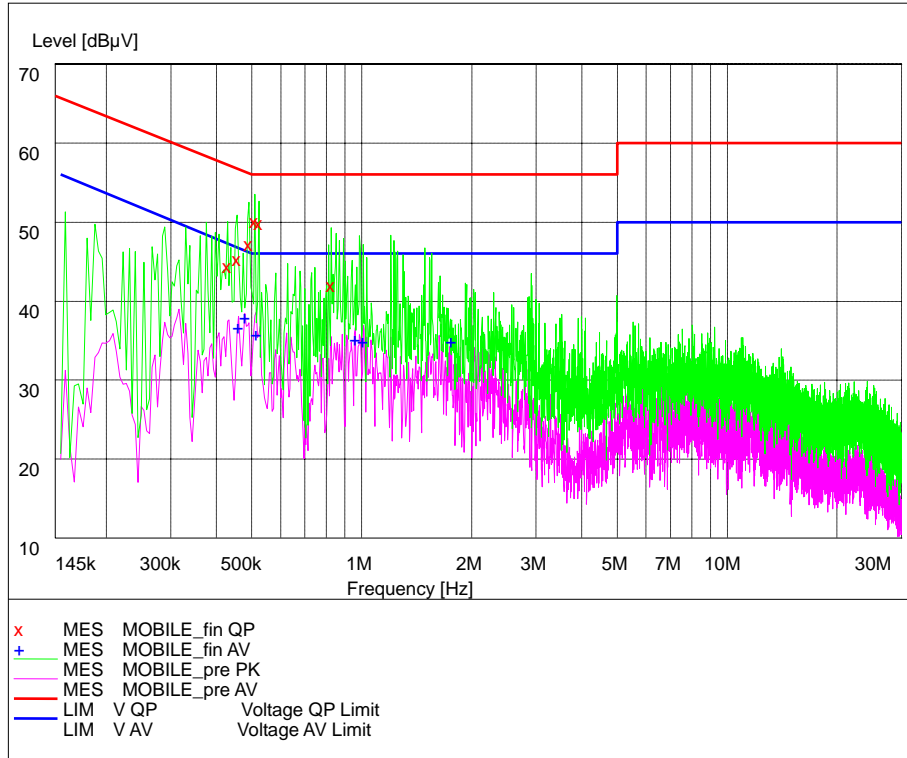

L Line

MEASUREMENT RESULT: "MOBILE_fin QP"

Frequency MHz	Level dBµV	Transd	Limit dB	Margin dBµV	Line	PE
0.429000	45.70	20.3	57	11.5	N	GND
0.456000	46.60	20.3	57	10.1	L1	GND
0.492000	48.60	20.3	56	7.5	L1	GND
0.510000	51.40	20.3	56	4.6	L1	GND
0.523500	51.20	20.3	56	4.8	L1	GND
0.825000	43.30	20.3	56	12.7	N	GND

MEASUREMENT RESULT: "MOBILE_fin AV"

Frequency MHz	Level dBµV	Transd	Limit dB	Margin dBµV	Line	PE
0.460500	38.00	20.3	47	8.7	L1	GND
0.478500	39.30	20.3	46	7.1	L1	GND
0.514500	37.10	20.3	46	8.9	L1	GND
0.960000	36.50	20.2	46	9.5	N	GND
1.009500	36.20	20.2	46	9.8	N	GND
1.761000	36.20	20.2	46	9.8	N	GND

2.2.2 Radiated Emissions-FCC Part15.109

Ambient condition:

Temperature	Relative humidity	Pressure
18.2°C	36.7%	99.7kPa

Test Setup:

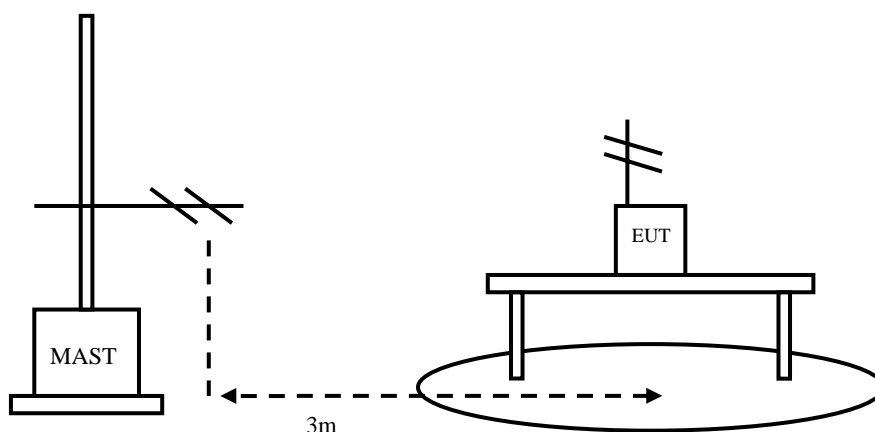

Figure 2

Test Procedure:

The EUT should be placed on a non-metallic table 80cm above the ground plane. The receive antennas shall be moved from 1 to 4 meters. The distance between EUT and receive antenna should be 3 meters.

The EUT should work in idle mode. The accessories of the EUT are connected with the EUT such as headset etc. The test set-up and the test methods are performed according to ANSI C63.4:2009.

Then start the test software ES-K1. Sweep the whole frequency band through the range from 30MHz to 1GHz, using receive log period antenna HL562.

During the test, the height of receive antenna shall be moved from 1 to 4 meters, and the antenna shall be performed under horizontal and vertical polarization. The turn table shall be rotated from 0 to 360 degrees for detecting the maximum of radiated spurious signal level. The measurements shall be repeated with orthogonal polarization of the test antenna. The EUT is laid in two modes as follow: 1. put the EUT in horizontal direction; 2. put the EUT in vertical direction.

The data of cable loss and antenna factor have been calibrated in full testing frequency range before the testing.

A “reference path loss” is established and the A_{Rpl} is the attenuation of “reference path loss”, and including the gain of receive antenna, the gain of the preamplifier, the cable loss.

The measurement results are obtained as described below:

$$\text{Result} = P_{\text{mea}} + A_{Rpl}$$

Limit:

Frequency of Emission(MHz)	Limits	
	Detector	Unit (dB μ V/m)
30~88	Quasi-peak	40
88~216	Quasi-peak	43.5
216~960	Quasi-peak	46
960~1000	Quasi-peak	54
1000~5th harmonic of the highest frequency or 40GHz, whichever is lower	Average	54
	Peak	74

Test result:

GSM 850 Mode

Frequency(MHz)	Result(dBuV/m)	A_{Rpl} (dB)	P_{mea} (dBuV/m)	Polarity
34.91	27.88	15.5	12.38	Vertical
45.43	23.38	11.9	11.48	Vertical
47.39	24.75	10.5	14.25	Vertical
47.96	24.81	10.2	14.61	Vertical
527.05	31.47	18.0	13.47	Vertical
960.32	29.97	24.3	5.67	Horizontal

PCS1900 Mode

Frequency(MHz)	Result(dBuV/m)	A_{Rpl} (dB)	P_{mea} (dBuV/m)	Polarity
34.91	30.44	15.5	14.94	Vertical
47.82	27.64	10.2	17.44	Vertical
54.41	22.84	7.2	15.64	Vertical
85.41	21.36	8.0	13.36	Horizontal
899.40	28.67	23.9	4.77	Vertical
959.45	29.57	24.3	5.27	Vertical

WCDMA Band II Mode

Frequency(MHz)	Result(dBuV/m)	A _{Rpl} (dB)	P _{mea} (dBuV/m)	Polarity
35.05	30.33	15.5	14.83	Vertical
36.73	28.31	15.7	12.61	Vertical
47.82	24.68	10.2	14.48	Vertical
777.56	27.24	22.1	5.14	Vertical
924.25	29.50	24.5	15.0	Vertical
959.67	30.10	24.3	5.80	Vertical

WCDMA Band V Mode

Frequency(MHz)	Result(dBuV/m)	A _{Rpl} (dB)	P _{mea} (dBuV/m)	Polarity
34.91	28.83	15.5	13.33	Vertical
35.07	29.24	15.5	13.74	Vertical
46.69	21.53	10.9	10.63	Vertical
784.57	26.32	22.2	4.12	Horizontal
937.68	27.82	24.3	3.52	Horizontal
939.21	28.54	24.3	4.24	Vertical

FM Radio Mode

Frequency(MHz)	Result(dBuV/m)	A _{Rpl} (dB)	P _{mea} (dBuV/m)	Polarity
34.91	29.66	15.5	14.16	Vertical
48.10	23.19	10.1	13.09	Vertical
717.23	26.60	21.4	15.20	Horizontal
930.26	30.58	24.4	6.18	Horizontal
4418.84	39.90	17.3	22.60	Vertical
5951.90	44.85	17.3	27.55	Horizontal

MP3/MP4 Mode

Frequency(MHz)	Result(dBuV/m)	A _{Rpl} (dB)	P _{mea} (dBuV/m)	Polarity
35.10	30.52	15.5	15.02	Vertical
48.52	23.48	9.8	13.68	Vertical
769.14	26.68	22.0	4.68	Vertical
946.29	29.30	24.4	14.9	Horizontal
4418.84	39.97	12.1	27.87	Vertical
5951.90	44.91	17.3	27.61	Vertical

Camera Mode

Frequency(MHz)	Result(dBuV/m)	A _{Rpl} (dB)	P _{mea} (dBuV/m)	Polarity
33.09	22.09	15.4	6.69	Vertical
35.05	30.83	15.5	15.33	Vertical
48.80	23.95	9.7	14.25	Vertical
791.58	26.72	22.2	4.52	Vertical
933.87	29.48	24.4	5.08	Vertical
4418.84	39.97	12.1	27.87	Vertical

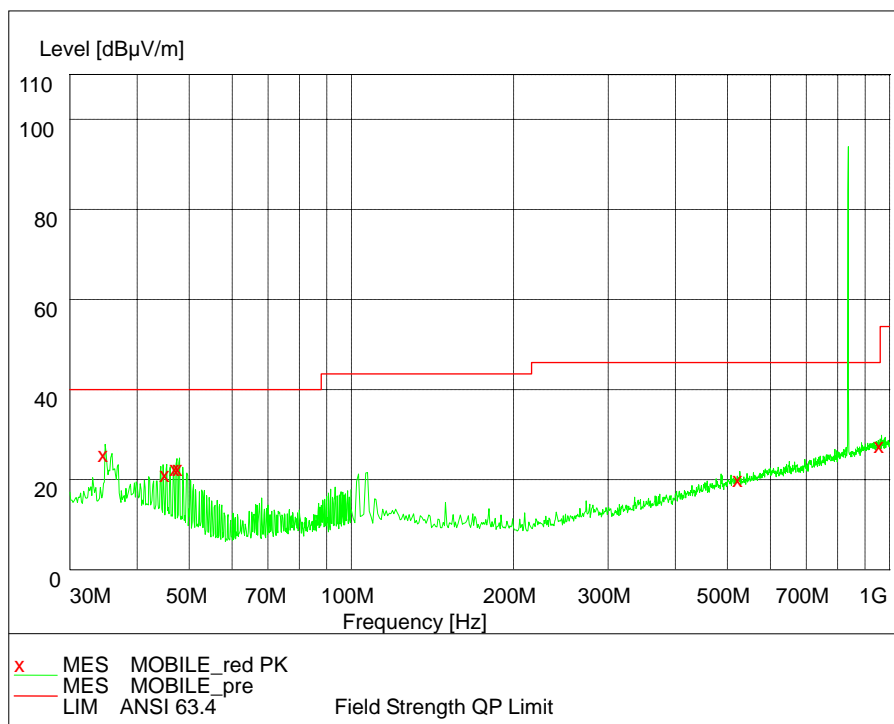

GSM 850(30MHz – 1GHz)

Note: The signal beyond the limit is the base station simulator carrier.

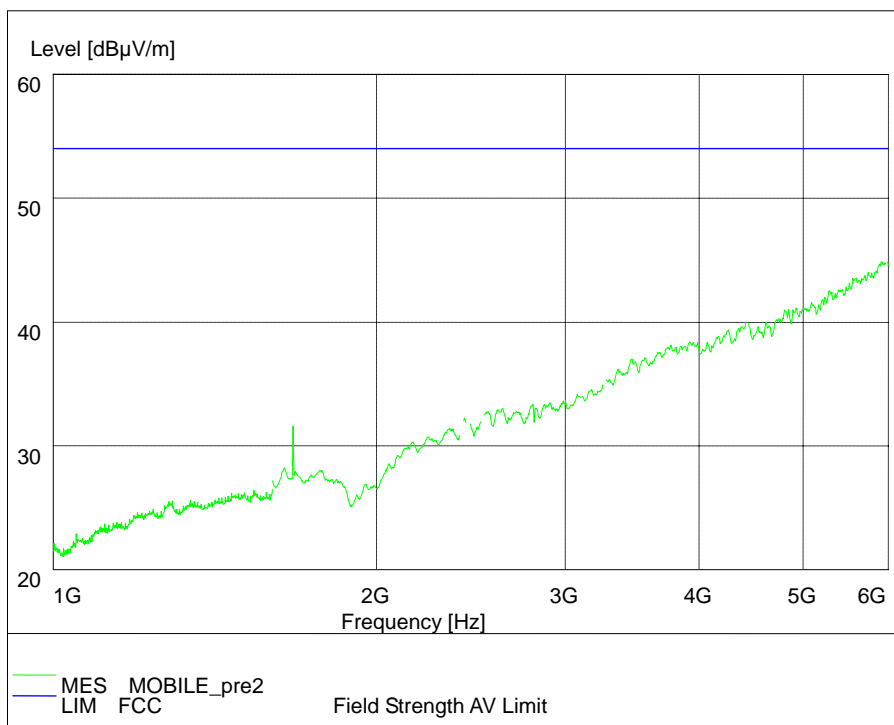

GSM 850(1GHz – 6GHz)

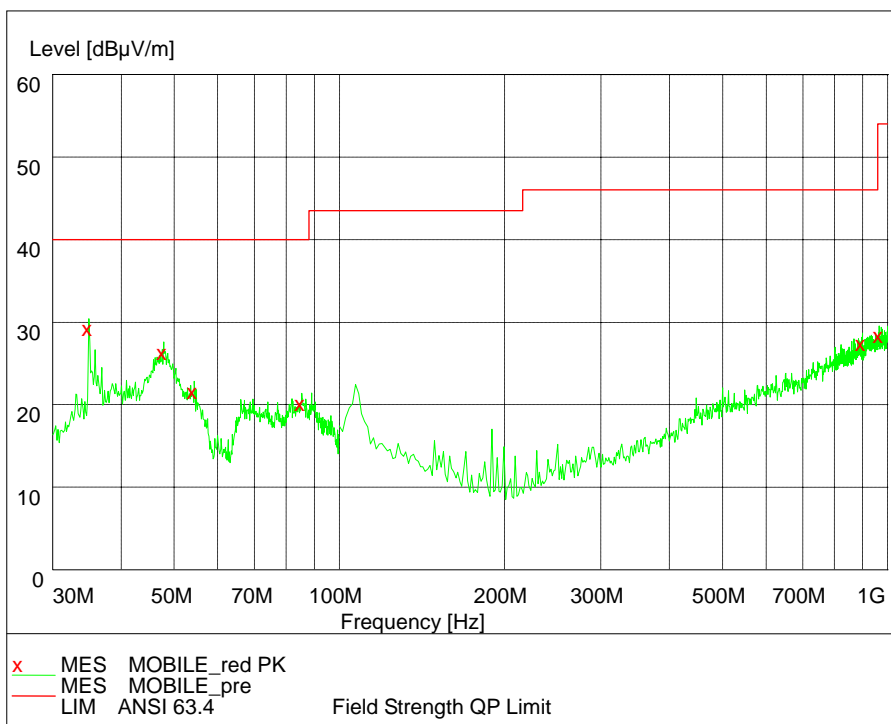

PCS 1900(30MHz – 1GHz)

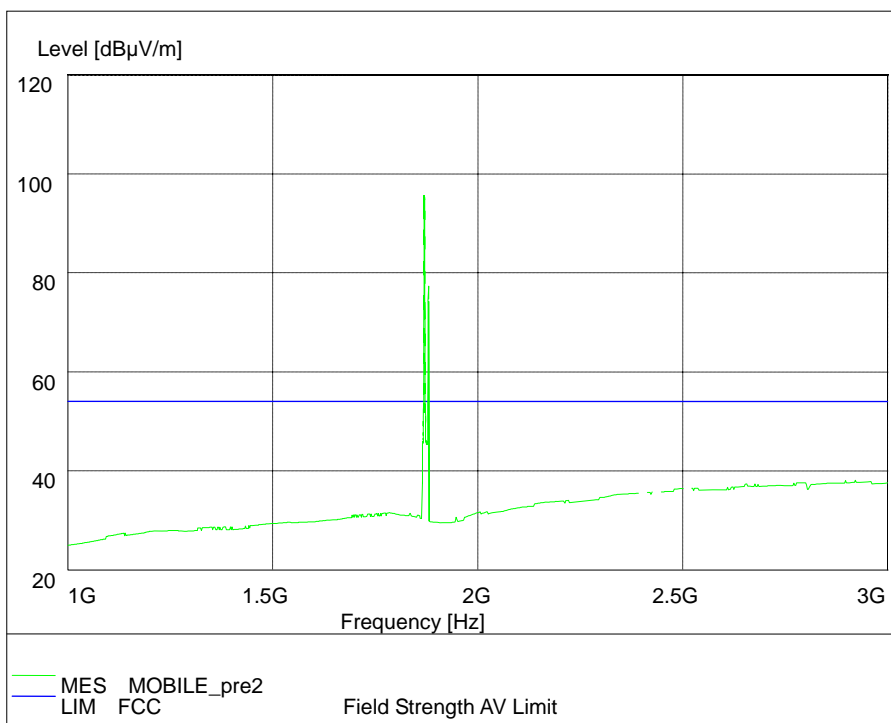

PCS 1900(1GHz – 3GHz)

Note: The signals beyond the limit are the base station and simulator carrier.

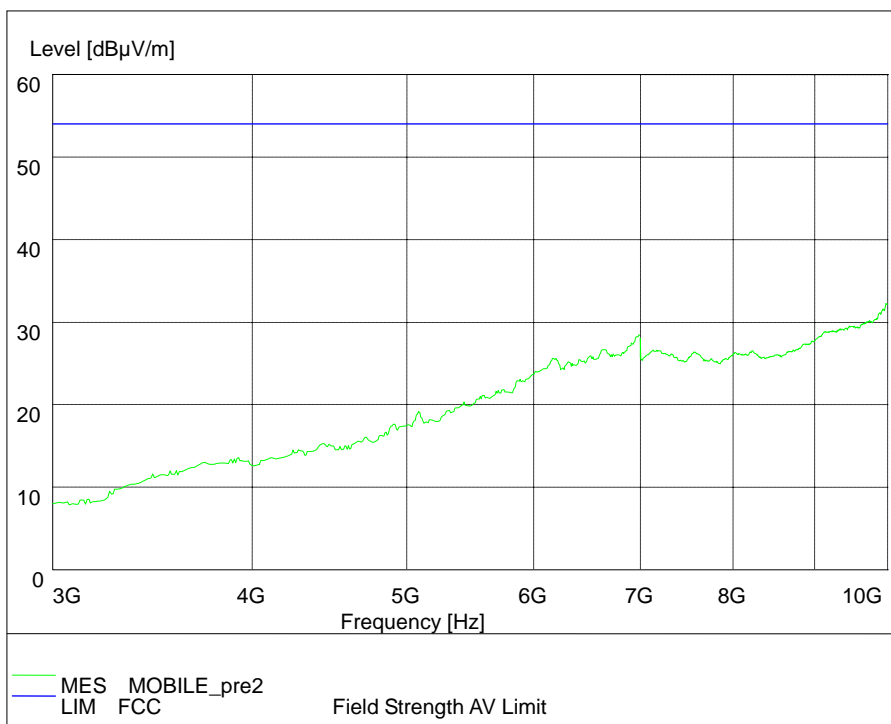

PCS 1900(3GHz – 10GHz)

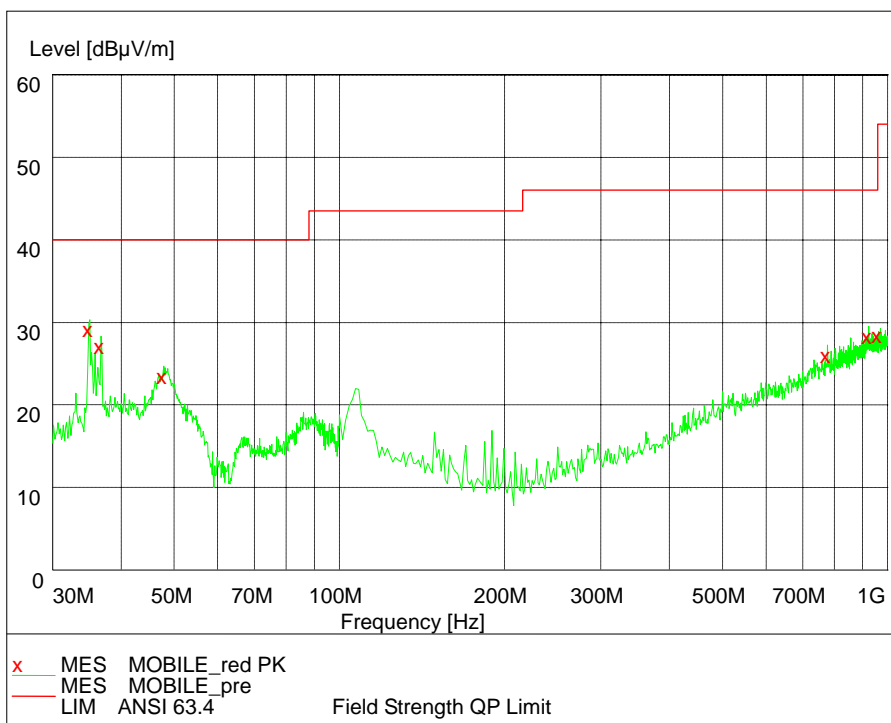

WCDMA BAND II (30MHz – 1GHz)

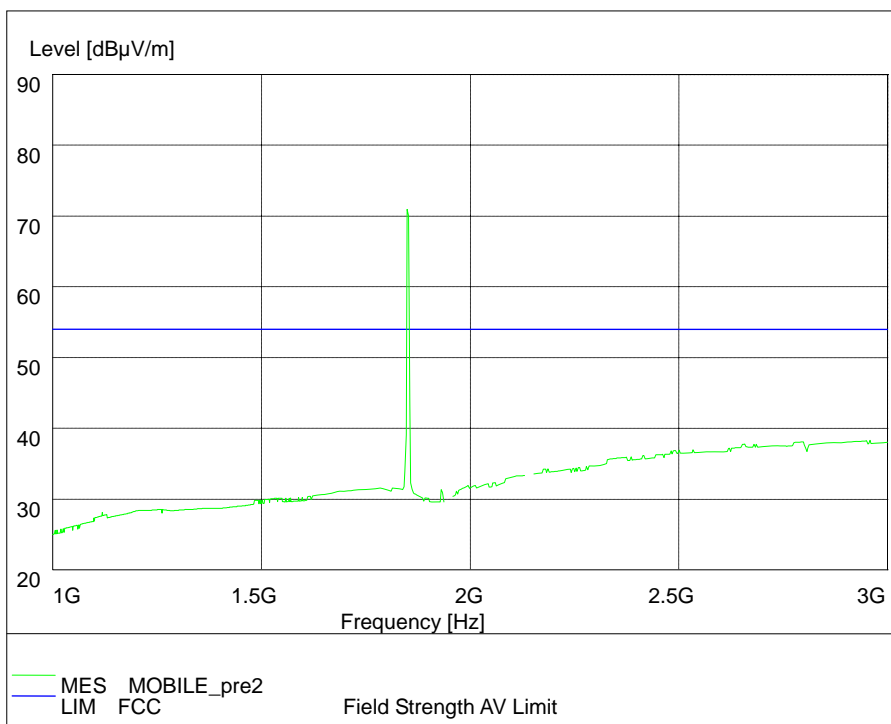

WCDMA BAND II (1GHz – 3GHz)

Note: The signals beyond the limit are the base station and simulator carrier.

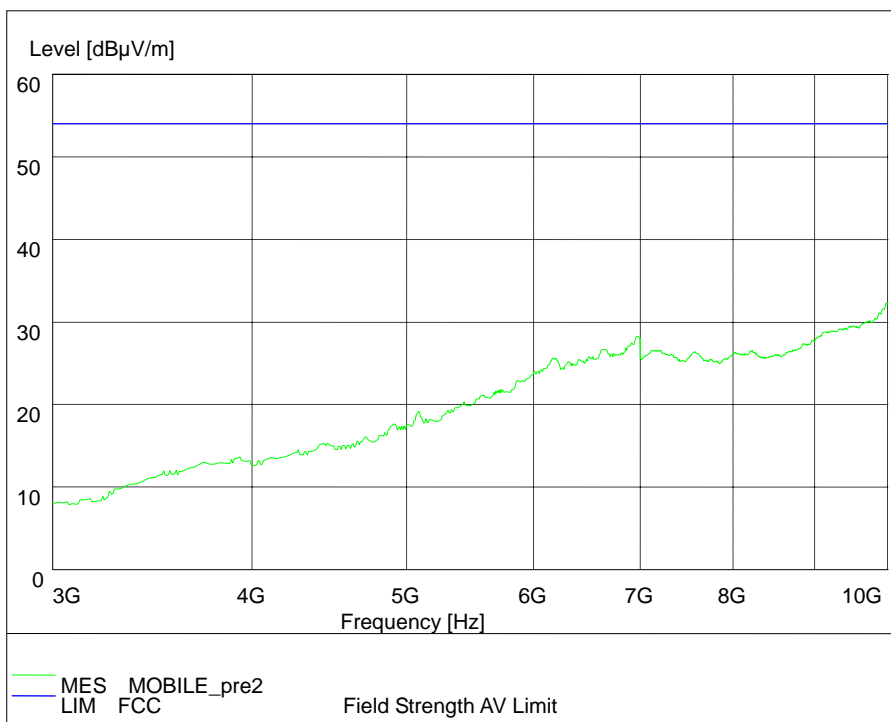

WCDMA BAND II (3GHz – 10GHz)

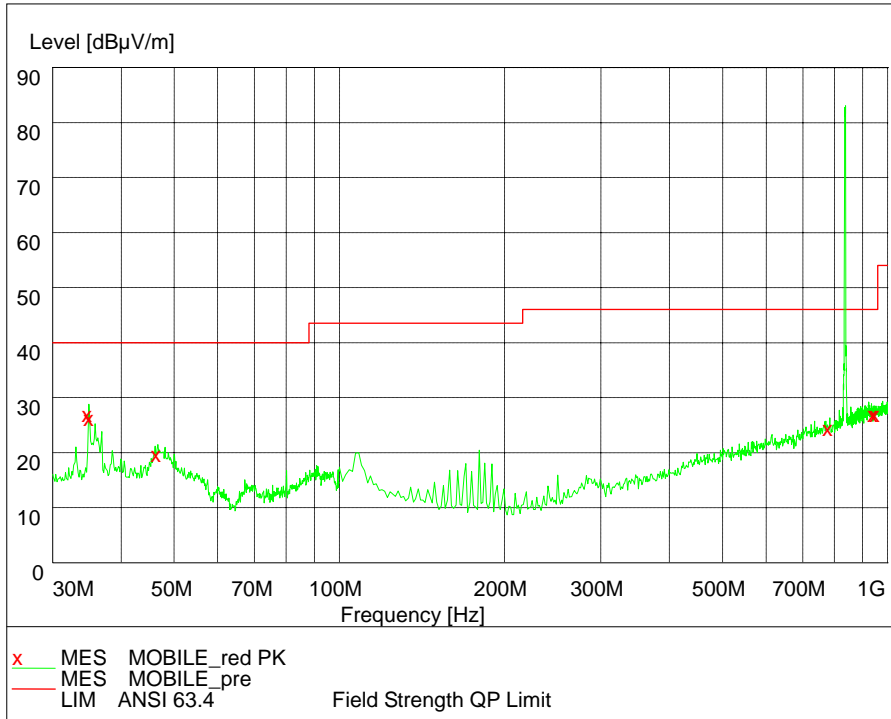

WCDMA BAND V (30MHz – 1GHz)

Note: The signal beyond the limit is the base station simulator carrier.

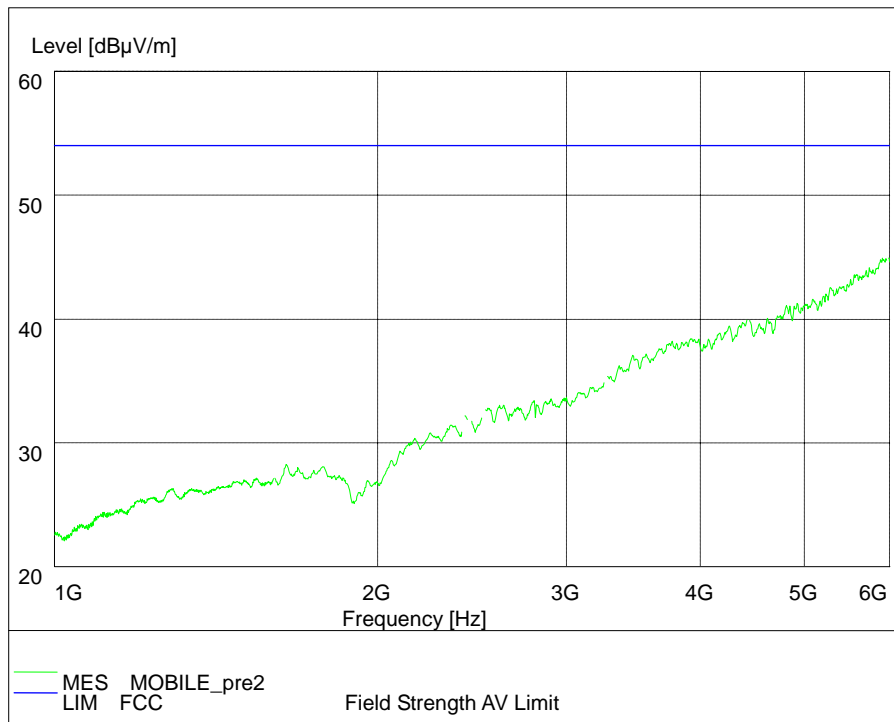

WCDMA BAND V(1GHz – 6GHz)

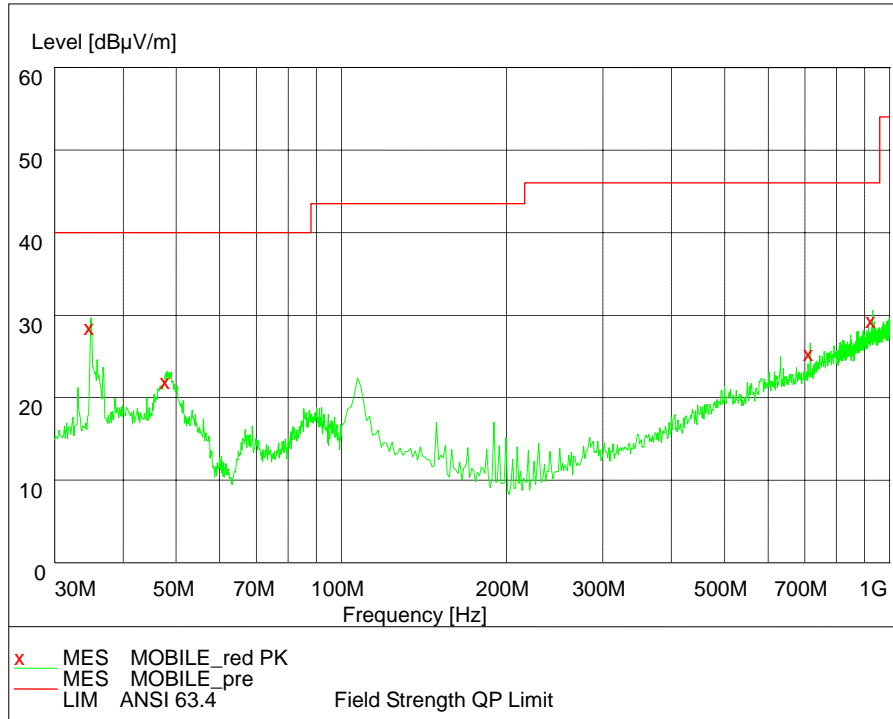

FM Radio (30MHz – 1GHz)

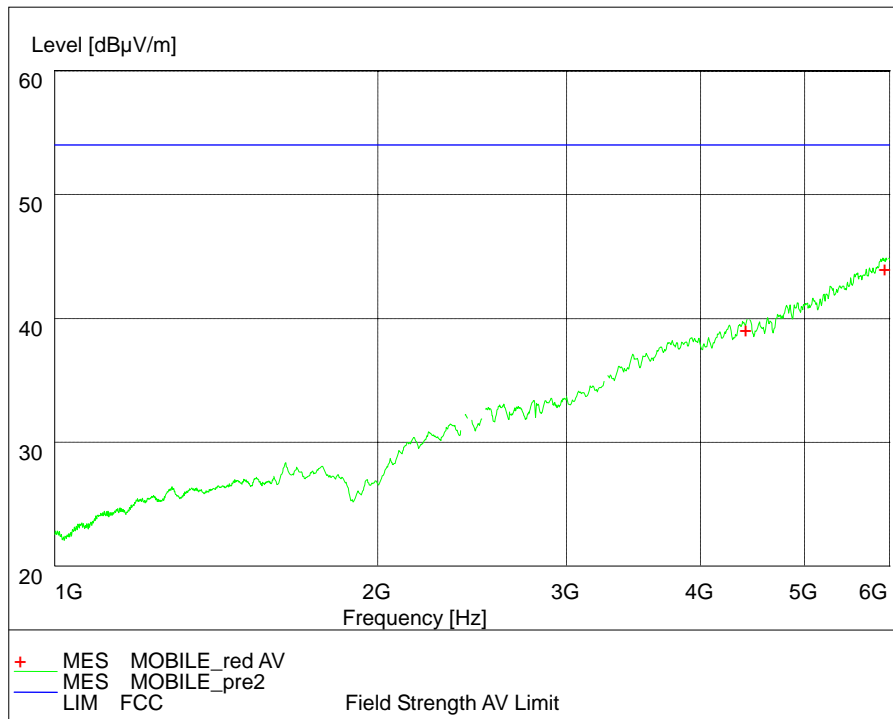

FM Radio (1GHz – 6GHz)

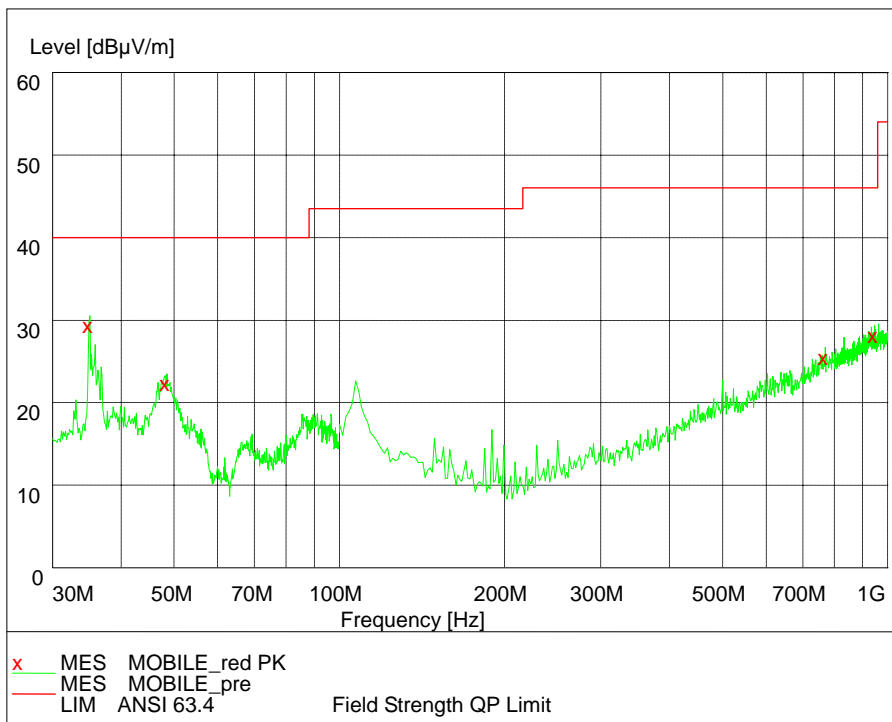

MP3/MP4 (30MHz – 1GHz)

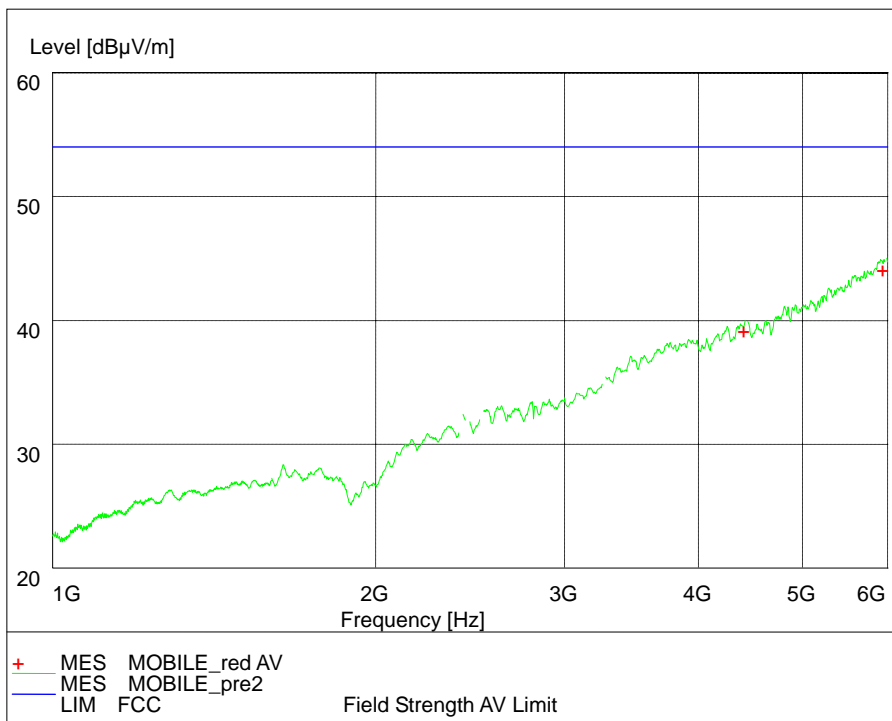

MP3/MP4 (1GHz – 6GHz)

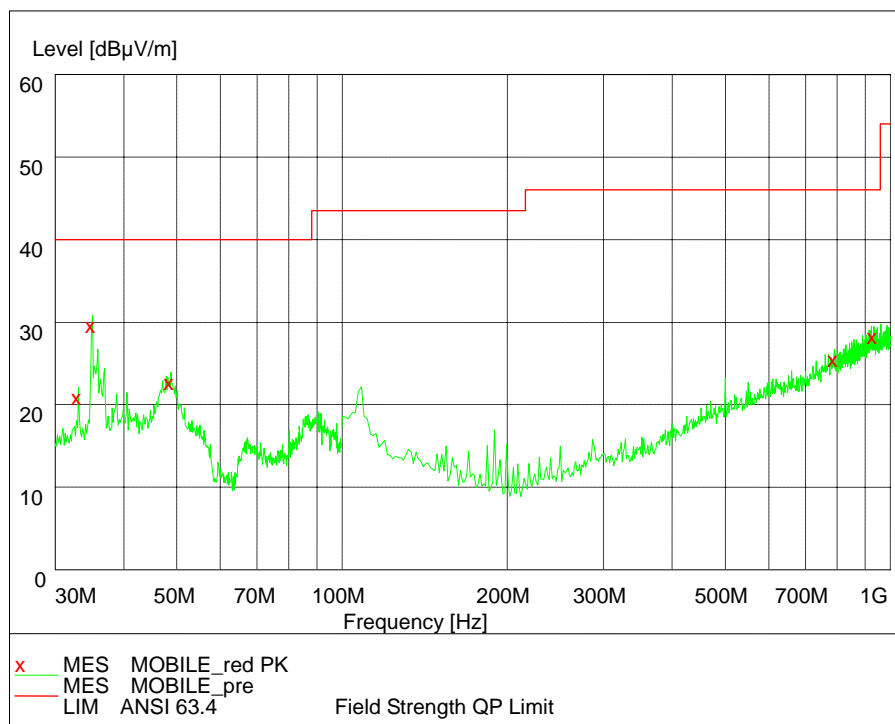

Camera (30MHz – 1GHz)

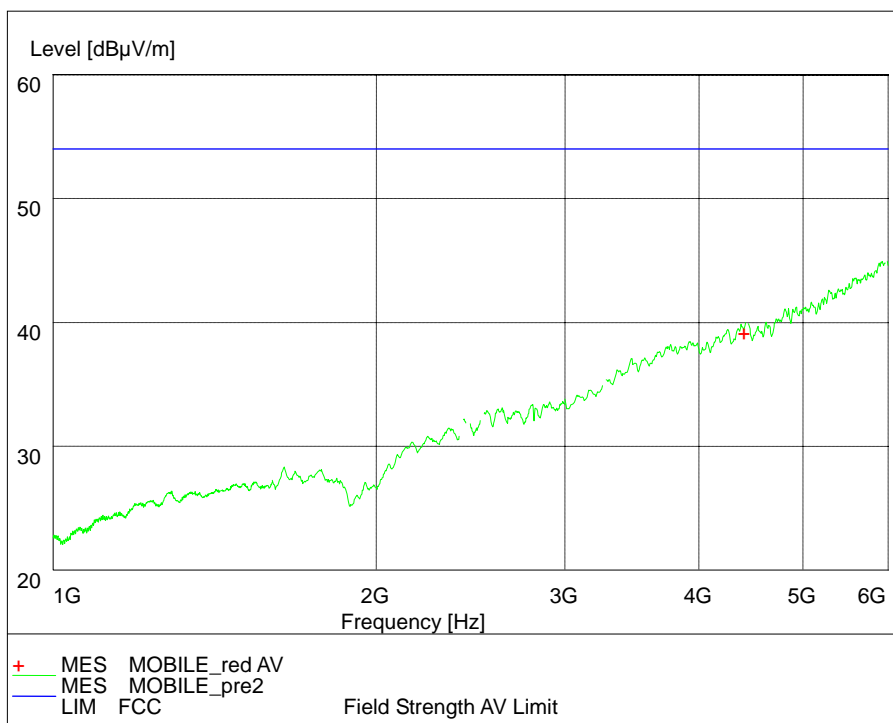

Camera (1GHz – 6GHz)

2.3 List of test equipments

No.	Name/Model	Manufacturer	S/N	Calibration Due Date
1	23.18m×16.88m×9.60m Semi-Anechoic Chamber	FRANKONIA	-----	19 th Aug. 2012
2	ESI 40 EMI test receiver	R&S	100015	19 th Aug. 2012
3	E5515C(8960) Mobile Station Tester	Agilent	GB44050904	19 th Aug. 2012
4	9.080m×5.255m×3.525m Shielding room	FRANKONIA	-----	19 th Aug. 2012
5	ESCS30 EMI test receiver	R&S	100029	19 th Aug. 2012
6	HL562 Ultra log test antenna	R&S	100016	19 th Aug. 2012
7	ESH3-Z2 Pulse limiter	R&S	10002	19 th Aug. 2012
8	ESH3-Z5 Attenuator	R&S	100020	19 th Aug. 2012
9	ESH2Z11 LISN	R&S	50FH-020-10	19 th Aug. 2012
10	HF 906 Double-Ridged Waveguide Horn Antenna	R&S	100030	19 th Aug. 2012
11	HF 906 Double-Ridged Waveguide Horn Antenna	R&S	100029	19 th Aug. 2012
12	PS2000 Turn Table	FRANKONIA	-----	19 th Aug. 2012
13	MA260 Antenna Master	FRANKONIA	-----	19 th Aug. 2012
14	ES-K1EMI test software	R&S	-----	19 th Aug. 2012
15	HL562 Receive antenna	R&S	100167	19 th Aug. 2012

Appendix