



# ANSI C63.19

# TEST REPORT

<b>Product Name</b>	UMTS TriBand / GSM Quadband mobile phone
<b>Model Name</b>	Cocktail S
<b>Marketing Name</b>	one touch 995S
<b>FCC ID</b>	RAD231
<b>Client</b>	TCT Mobile Limited

**TA Technology (Shanghai) Co., Ltd.**

**TA Technology (Shanghai) Co., Ltd.**  
**Test Report**

Report No. RXA1204-0048HAC01R1

Page 2 of 119

**GENERAL SUMMARY**

<b>Product Name</b>	UMTS TriBand / GSM Quadband mobile phone	<b>Model</b>	Cocktail S
<b>Report No.</b>	RXA1204-0048HAC01R1	<b>FCC ID</b>	RAD231
<b>Client</b>	TCT Mobile Limited		
<b>Manufacturer</b>	TCT Mobile Limited		
<b>Reference Standard(s)</b>	<b>ANSI C63.19-2007:</b> American National Standard Methods of Measurement of Compatibility between Wireless Communications Devices and Hearing Aids.		
<b>Conclusion</b>	<p>This portable wireless equipment has been measured in all cases requested by the relevant standards.</p> <p>General Judgment: <b>M3 (RF Emission)</b></p> <div style="text-align: right;">  <p>(Stamp) Date of issue: April 25<sup>th</sup>, 2012</p> </div>		
<b>Comment</b>	The test result only responds to the measured sample.		

Approved by 杨伟中  
Director

Revised by 凌敏宝  
SAR Manager

Performed by 许红梅  
SAR Engineer

## TABLE OF CONTENT

1. General Information .....	4
1.1. Notes of the Test Report.....	4
1.2. Testing Laboratory .....	4
1.3. Applicant Information .....	5
1.4. Manufacturer Information.....	5
1.5. Information of EUT .....	6
1.6. The Ambient Conditions during Test.....	7
1.7. The Total M-rating of each tested band .....	7
1.8. Test Date .....	7
2. Test Information .....	8
2.1. Operational Conditions during Test.....	8
2.1.1. General Description of Test Procedures .....	8
2.1.2. GSM/WCDMA Test Configuration .....	8
2.2. HAC RF Measurements System Configuration.....	9
2.2.1. HAC Measurement Set-up.....	9
2.2.2. Probe System .....	10
2.2.3. Test Arch Phantom & Phone Positioner .....	11
2.3. RF Test Procedures.....	12
2.4. System Check.....	14
2.5. Probe Modulation Factor.....	16
2.6. Conducted Output Power Measurement.....	18
3. Test Results .....	19
3.1. ANSI C63.19-2007 Limits .....	19
3.2. Summary Test Results.....	20
4. Measurement Uncertainty .....	22
5. Main Test Instruments .....	24
ANNEX A: System Check Results.....	25
ANNEX B: Graph Results.....	33
ANNEX C: E-Probe Calibration Certificate.....	81
ANNEX D: H-Probe Calibration Certificate.....	91
ANNEX E: CD835V3 Dipole Calibration Certificate.....	101
ANNEX F: CD1880V3 Dipole Calibration Certificate.....	107
ANNEX G: DAE4 Calibration Certificate.....	113
ANNEX H: The EUT Appearances and Test Configuration.....	118

## 1. General Information

### 1.1. Notes of the Test Report

**TA Technology (Shanghai) Co., Ltd.** guarantees the reliability of the data presented in this test report, which is the results of measurements and tests performed for the items under test on the date and under the conditions stated in this test report and is based on the knowledge and technical facilities available at TA Technology (Shanghai) Co., Ltd. at the time of execution of the test.

**TA Technology (Shanghai) Co., Ltd.** is liable to the client for the maintenance by its personnel of the confidentiality of all information related to the items under test and the results of the test. This report only refers to the item that has undergone the test.

This report standalone dose not constitute or imply by its own an approval of the product by the certification Bodies or competent Authorities. This report cannot be used partially or in full for publicity and/or promotional purposes without previous written approval of **TA Technology (Shanghai) Co., Ltd.** and the Accreditation Bodies, if it applies.

If the electrical report is inconsistent with the printed one, it should be subject to the latter.

### 1.2. Testing Laboratory

Company: TA Technology (Shanghai) Co., Ltd.  
Address: No.145, Jintang Rd, Tangzhen Industry Park, Pudong Shanghai, China  
City: Shanghai  
Post code: 201201  
Country: P. R. China  
Contact: Yang Weizhong  
Telephone: +86-021-50791141/2/3  
Fax: +86-021-50791141/2/3-8000  
Website: <http://www.ta-shanghai.com>  
E-mail: [yangweizhong@ta-shanghai.com](mailto:yangweizhong@ta-shanghai.com)

**TA Technology (Shanghai) Co., Ltd.**  
**Test Report**

Report No. RXA1204-0048HAC01R1

Page 5 of 119

---

**1.3. Applicant Information**

Company: TCT Mobile Limited  
Address: 5F, E building, No. 232, Liang Jing Road ZhangJiang High-Tech Park, Pudong Area  
Shanghai, P.R. China. 201203  
City: Shanghai  
Postal Code: 201203  
Country: P.R. China  
Contact: Gong Zhizhou  
Telephone: 0086-21-61460890  
Fax: 0086-21-61460602

**1.4. Manufacturer Information**

Company: TCT Mobile Limited  
Address: 5F, E building, No. 232, Liang Jing Road ZhangJiang High-Tech Park, Pudong Area  
Shanghai, P.R. China. 201203  
City: Shanghai  
Postal Code: 201203  
Country: P.R. China  
Telephone: 0086-21-61460890  
Fax: 0086-21-61460602

# TA Technology (Shanghai) Co., Ltd.

## Test Report

Report No. RXA1204-0048HAC01R1

Page 6 of 119

### 1.5. Information of EUT

#### General Information

Device Type:	Portable Device		
Product Name:	UMTS TriBand / GSM Quadband mobile phone		
IMEI:	012997000000045		
Hardware Version:	PIO4		
Software Version:	21S		
Antenna Type:	Internal Antenna		
Device Operating Configurations:			
Supporting Mode(s):	GSM 850/ GSM 1900; (tested)		
	GSM 900/ GSM 1800; (untested)		
	WCDMA Band IV/WCDMA Band V; (tested)		
	WCDMA Band I; (untested)		
	WiFi (802.11b/g/n); (untested)		
	Bluetooth; (untested)		
Test Modulation:	(GSM)GMSK; (WCDMA) QPSK		
Device Class:	B		
HSDPA UE Category:	10		
HSUPA UE Category:	6		
GPRS Multislot Class(12):	Max Number of Timeslots in Uplink	4	
	Max Number of Timeslots in Downlink	4	
	Max Total Timeslot	5	
EGPRS Multislot Class(12):	Max Number of Timeslots in Uplink	4	
	Max Number of Timeslots in Downlink	4	
	Max Total Timeslot	5	
Operating Frequency Range(s):	Mode	Tx (MHz)	Rx (MHz)
	GSM 850	824.2 ~ 848.8	869.2 ~ 893.8
	GSM 1900	1850.2 ~ 1909.8	1930.2 ~ 1989.8
	WCDMA Band IV	1712.4 ~ 1752.6	2112.4 ~ 2152.6
	WCDMA Band V	826.4 ~ 846.6	871.4 ~ 891.6
Test Channel: (Low - Middle - High)	128-190-251	(GSM 850) (tested)	
	512-661-810	(GSM 1900) (tested)	
	1312-1413-1513	(WCDMA Band IV) (tested)	
	4132 - 4183 - 4233	(WCDMA Band V) (tested)	
Power Class:	GSM 850: 4, tested with power level 5		
	GSM 1900: 1, tested with power level 0		
	WCDMA Band IV: 3, tested with power control all up bits		
	WCDMA Band V: 3, tested with power control all up bits		

# TA Technology (Shanghai) Co., Ltd.

## Test Report

Report No. RXA1204-0048HAC01R1

Page 7 of 119

### Auxiliary Equipment Details

#### AE:Battery

Model: CAB31Y0002C1  
Manufacturer: BYD  
SN: B284150057A

Equipment Under Test (EUT) is a UMTS TriBand / GSM Quadband mobile phone. The detail about EUT and Lithium Battery is in chapter 1.5 in this report. The device has an internal antenna for GSM/WCDMA Tx/Rx, and the other is BT/WIFI antenna that is used for Tx/Rx. HAC is tested for GSM 850, GSM 1900, WCDMA Band IV and WCDMA Band V. WiFi and Bluetooth modes don't have voice capability, and do not operate in the held to ear mode for providing handset service.

The sample under test was selected by the Client.

Components list please refer to documents of the manufacturer.

### 1.6. The Ambient Conditions during Test

Temperature	Min. = 18°C, Max. = 28 °C
Relative humidity	Min. = 0%, Max. = 80%
Ground system resistance	< 0.5 $\Omega$
Ambient noise is checked and found very low and in compliance with requirement of standards. Reflection of surrounding objects is minimized and in compliance with requirement of standards.	

### 1.7. The Total M-rating of each tested band

Mode	Rating
GSM 850	<b>M3</b>
GSM 1900	<b>M3</b>
WCDMA Band IV	<b>M4</b>
WCDMA Band V	<b>M4</b>

### 1.8. Test Date

The test performed from April 14, 2012 to April 15, 2012.

## **2. Test Information**

### **2.1. Operational Conditions during Test**

#### **2.1.1. General Description of Test Procedures**

The phone was tested in all normal configurations for the ear use. The EUT is mounted in the device holder equivalent as for classic dosimeter measurements. The acoustic output of the EUT shall coincide with the center point of the area formed by the dielectric wire and the middle bar of the arch's top frame. The EUT shall be moved vertically upwards until it touches the frame. The fine adjustment is possible by sliding the complete. The EUT holder is on the yellow base plate of the Test Arch phantom. These test configurations are tested at the high, middle and low frequency channels of each applicable operating mode; for example, GSM, WCDMA (UMTS), CDMA and TDMA.

#### **2.1.2. GSM/WCDMA Test Configuration**

A communication link is set up with a System Simulator (SS) by air link, and a call is established. The Absolute Radiofrequency Channel Number (ARFCN) is allocated to 128, 190 and 251 in the case of GSM 850, to 512, 661 and 810 in the case of GSM 1900, to 1312, 1413 and 1513 in the case of WCDMA Band IV, to 4132, 4183 and 4233 in the case of WCDMA Band V. The EUT is commanded to operate at maximum transmitting power. Using E5515C the power level is set to "5" for GSM 850, set to "0" for GSM 1900. Set to all up bits for WCDMA. The test in the bands of GSM 850/GSM 1900 and WCDMA Band IV /WCDMA Band V are performed in the mode of speech transfer function.



## 2.2. HAC RF Measurements System Configuration

### 2.2.1. HAC Measurement Set-up

These measurements are performed using the DASY5 automated dosimetric assessment system. It is made by Schmid & Partner Engineering AG (SPEAG) in Zurich, Switzerland. It consists of high precision robotics system (Stäubli), robot controller, Intel Core2 computer, near-field probe, probe alignment sensor. The robot is a six-axis industrial robot performing precise movements. Cell controller systems contain the power supply, robot controller, teach pendant (Joystick) and remote control, and are used to drive the robot motors. The Stäubli Robot is connected to the cell controller to allow software manipulation of the robot. A data acquisition electronic (DAE) circuit performs the signal amplification; signal multiplexing, AD-conversion, offset measurements, mechanical surface detection, collision detection, etc. is connected to the Electro-optical coupler (EOC). The EOC performs the conversion from the optical into digital electric signal of the DAE and transfers data to the PC plug-in card.

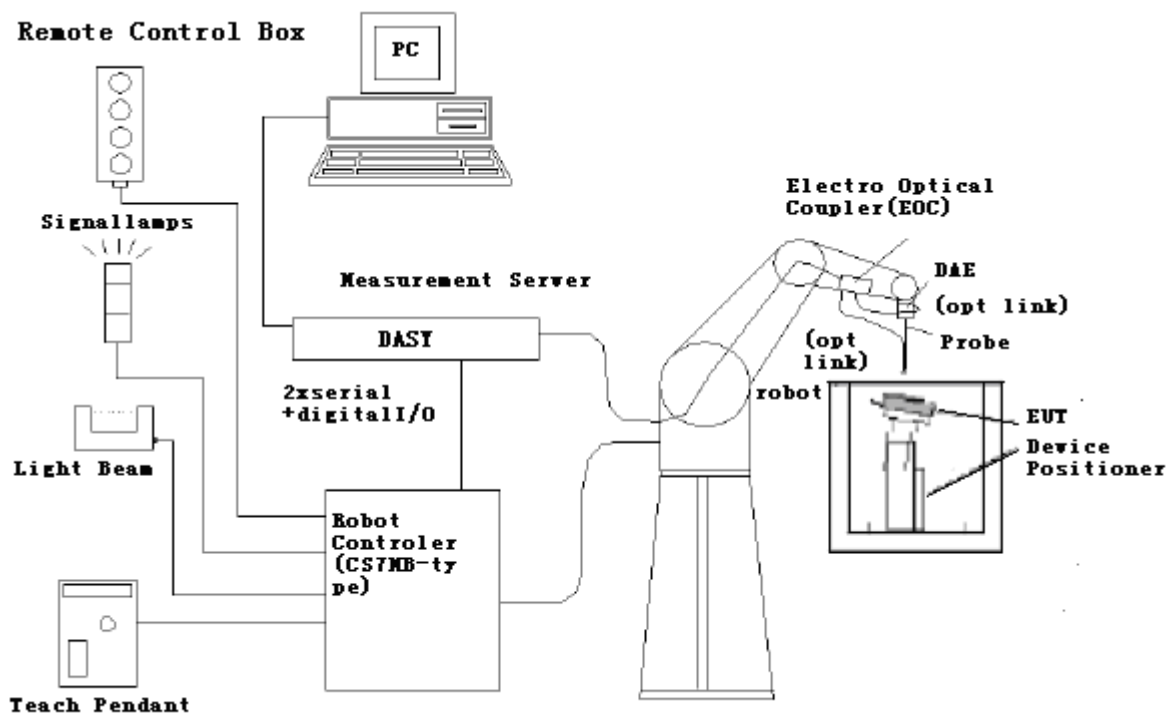

Figure 1 HAC Test Measurement Set-up

The DAE4 consists of a highly sensitive electrometer-grade preamplifier with auto-zeroing, a channel and gain-switching multiplexer, a fast 16 bit AD-converter and a command decoder and control logic unit. Transmission to the PC-card is accomplished through an optical downlink for data and status information and an optical uplink for commands and clock lines. The mechanical probe mounting device includes two different sensor systems for frontal and sidewise probe contacts. They are also used for mechanical surface detection and probe collision detection. The robot uses its own controller with a built in VME-bus computer.

### 2.2.2. Probe System

The HAC measurements were conducted with the E-Field Probe ER3DV6 and the H-Field Probe H3DV6 (manufactured by SPEAG), designed in the classical triangular configuration and optimized for dosimetric evaluation.

#### E-Field Probe Description

Construction	One dipole parallel, two dipoles normal to probe axis Built-in shielding against static charges PEEK enclosure material
Calibration	In air from 100 MHz to 3.0 GHz (absolute accuracy $\pm 6.0\%$ , $k=2$ )
Frequency	40 MHz to > 6 GHz (can be extended to < 20 MHz) Linearity: $\pm 0.2$ dB (100 MHz to 3 GHz)
Directivity	$\pm 0.2$ dB in air (rotation around probe axis) $\pm 0.4$ dB in air (rotation normal to probe axis)
Dynamic Range	2 V/m to > 1000 V/m; Linearity: $\pm 0.2$ dB
Dimensions	Overall length: 330 mm (Tip: 16 mm) Tip diameter: 8 mm (Body: 12 mm) Distance from probe tip to dipole centers: 2.5 mm
Application	General near-field measurements up to 6 GHz Field component measurements Fast automatic scanning in phantoms



**Figure 2 ER3DV6 E-field Probe**

#### H-Field Probe Description

Construction	Three concentric loop sensors with 3.8 mm loop diameters Resistively loaded detector diodes for linear response Built-in shielding against static charges PEEK enclosure material (resistant to organic solvents, e.g., glycolether)
Frequency	200 MHz to 3 GHz (absolute accuracy $\pm 6.0\%$ , $k=2$ ); Output linearized
Directivity	$\pm 0.2$ dB (spherical isotropy error)
Dynamic Range	10 mA/m to 2 A/m at 1 GHz
E-Field Interference	< 10% at 3 GHz (for plane wave)
Dimensions	Overall length: 330 mm (Tip: 40 mm) Tip diameter: 6 mm (Body: 12 mm) Distance from probe tip to dipole centers: 3 mm



**Figure 3 H3DV6 H-field Probe**

Application            General magnetic near-field measurements up to 3  
                              GHz (in air or liquids)  
                              Field component measurements  
                              Surface current measurements  
                              Low interaction with the measured field

**2.2.3. Test Arch Phantom & Phone Positioner**

The Test Arch phantom should be positioned horizontally on a stable surface. Reference markings on the Phantom allow the complete setup of all predefined phantom positions and measurement grids by manually teaching three points in the robot. It enables easy and well defined positioning of the phone and validation dipoles as well as simple teaching of the robot (Dimensions: 370 x 370 x 370 mm).

The Device reference point is set for the EUT at 6.3 mm, the Grid reference point is on the upper surface at the origin of the coordinates, and the “user point \Height Check 0.5 mm” is 0.5mm above the center, allowing verification of the gap of 0.5mm while the probe is positioned there.

The Phone Positioner supports accurate and reliable positioning of any phone with effect on near field  $<\pm 0.5$  dB.

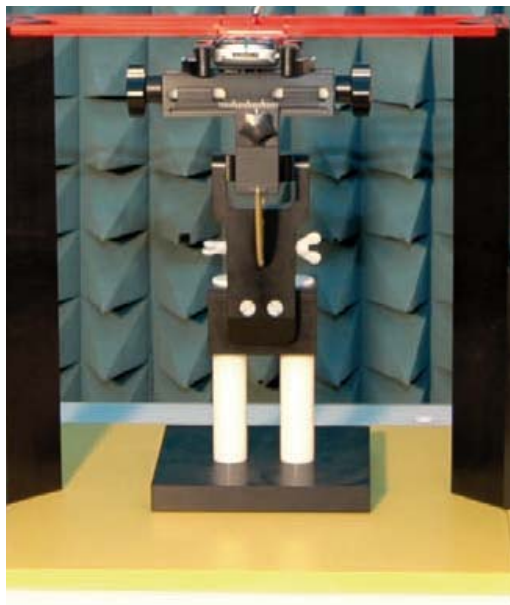

**Figure 4 HAC Phantom & Device Holder**

### **2.3. RF Test Procedures**

**The evaluation was performed with the following procedure:**

1. Confirm proper operation of the field probe, probe measurement system and other instrumentation and the positioning system.
2. Position the WD in its intended test position. The gauge block can simplify this positioning. Note that a separate E-field and H-field gauge block will be needed if the center of the probe sensor elements is at different distances from the tip of the probe.
3. Configure the WD normal operation for maximum rated RF output power, at the desired channel and other operating parameters (e.g., test mode), as intended for the test.
4. The center sub-grid shall center on the center of the axial measurement point or the acoustic output, as appropriate. Locate the field probe at the initial test position in the 50 mm by 50 mm grid, which is contained in the measurement plane. If the field alignment method is used, align the probe for maximum field reception.
5. Record the reading.
6. Scan the entire 50 mm by 50 mm region in equally spaced increments and record the reading at each measurement point. The grid is 5 cm by 5 cm area that is divided into 9 evenly sized blocks or sub-grids. The distance between measurement points shall be sufficient to assure the identification of the maximum reading.
7. Identify the five contiguous sub-grids around the center sub-grid with the lowest maximum field strength readings. Thus the six areas to be used to determine the WD's highest emissions are identified and outlined for the final manual scan. Please note that a maximum of five blocks can be excluded for both E-field and H-field measurements for the WD output being measured. Stated another way, the center sub-grid and three others must be common to both the E-field and H-field measurements.
8. Identify the maximum field reading within the non-excluded sub-grids identified in Step 7.
9. Convert the maximum field strength reading identified in Step 8 to V/m or A/m, as appropriate. For probes which require a probe modulation factor, this conversion shall be done using the appropriate probe modulation factor and the calibration.
10. Repeat Step 1 through Step 10 for both the E-field and H-field measurements.
11. Compare this reading to the categories in ANSI C63.19 Clause 7 and record the resulting category. The lowest category number listed in 7.2, Table 7.4, or Table 7.5 obtained in Step 10 for either E- or H-field determines the M category for the audio coupling mode assessment. Record the WD category rating.



Figure 5 WD reference and plane for RF emission measurements

## 2.4. System Check

### Validation Procedure

Place a dipole antenna meeting the requirements given in ANSI C63.19 D.5 in the position normally occupied by the WD. The dipole antenna serves as a known source for an electrical and magnetic output. Position the E-field and H-field probes so that:

The probes and their cables are parallel to the coaxial feed of the dipole antenna.

The probe cables and the coaxial feed of the dipole antenna approach the measurement area from opposite directions.

The center point of the probe element(s) are 10 mm from the closest surface of the dipole elements. Validation was performed to verify that measured E-field and H-field values are within +/-25% from the target reference values provided by the manufacturer. "Values within +/-25% are acceptable. Of which 12% is deviation and 13% is measurement uncertainty."

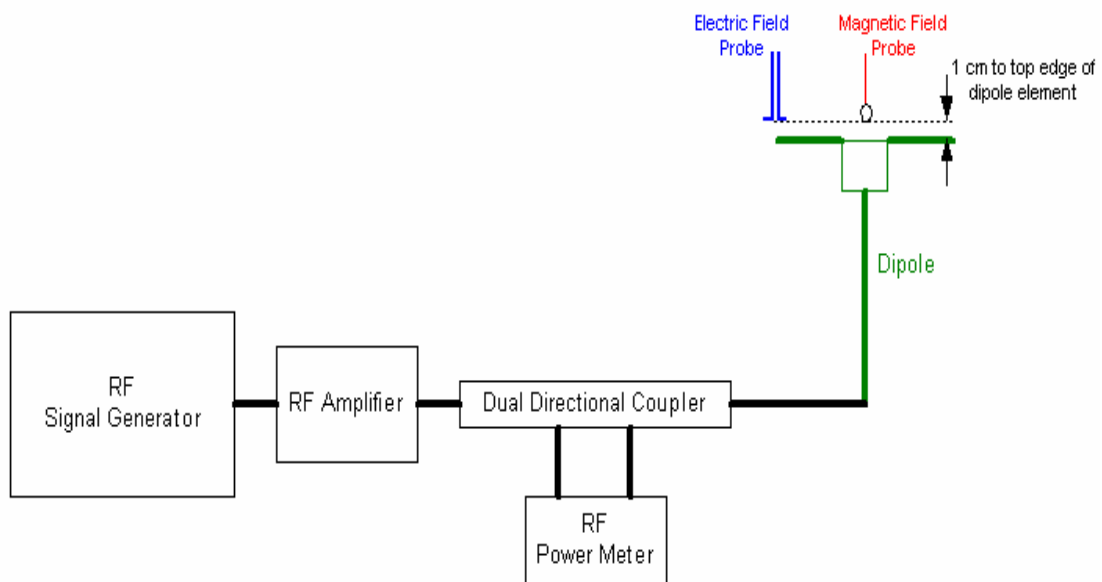

Figure 6 Dipole Validation Setup

**TA Technology (Shanghai) Co., Ltd.**  
**Test Report**

Report No. RXA1204-0048HAC01R1

Page 15 of 119

**Dipole Measurement Summary**

<b>E-Field Scan</b>					
<b>Mode</b>	<b>Frequency (MHz)</b>	<b>Input Power (mW)</b>	<b>Value</b>		<b>Test Date</b>
CW	835	100	Target <sup>1</sup> Value(V/m)	161.4	February 21,2012
			Measured <sup>2</sup> Value(V/m)	169.3	April 14, 2012
			Deviation <sup>3</sup> (%)	-4.89	/
CW	1880	100	Target <sup>1</sup> Value(V/m)	143.4	February 21,2012
			Measured <sup>2</sup> Value(V/m)	141.8	April 14, 2012
			Deviation <sup>3</sup> (%)	1.12	/
<b>H-Field Scan</b>					
<b>Mode</b>	<b>Frequency (MHz)</b>	<b>Input Power (mW)</b>	<b>Value</b>		<b>Test Date</b>
CW	835	100	Target <sup>1</sup> Value(A/m)	0.460	February 21,2012
			Measured <sup>2</sup> Value(A/m)	0.470	April 15, 2012
			Deviation <sup>3</sup> (%)	-2.17	/
CW	1880	100	Target <sup>1</sup> Value(A/m)	0.470	February 21,2012
			Measured <sup>2</sup> Value(A/m)	0.459	April 15, 2012
			Deviation <sup>3</sup> (%)	2.34	/
<p>Notes: 1. Target value is provided by SPEAD in the calibration certificate of specific dipoles.                  2. Please refer to the attachment for detailed measurement data and plot.                  3. Deviation (%) = 100 * (Target value minus Measured value) divided by Target value.</p>					

## 2.5. Probe Modulation Factor

The Probe Modulation Factor (PMF) is defined as the ratio of the field readings for a CW and a modulated signal with the equivalent Field Envelope Peak as defined in ANSI C63.19 (Chapter C.3.1). Calibration shall be made of the modulation response of the probe and its instrumentation chain. This Calibration shall be performed with the field probe, attached to the instrumentation that is to be used with it during the measurement. The response of the probe system to a CW field at the frequency(s) of interest is compared to its response to a modulated signal with equal peak amplitude. The field level of the test signals shall be more than 10dB above the ambient level and the noise floor of the instrumentation being used. The ratio of the CW reading to that taken with a modulated field shall be applied to the readings taken of modulated fields of the specified type.

### Modulation Factor Test Procedure

This may be done using the following procedure:

1. Fix the field probe in a set location relative to a field generating device, such as the reference dipole antenna.
2. Illuminate the probe using the wireless device connected to the reference dipole with a test signal at the intended measurement frequency, Ensure there is sufficient field coupling between the probe and the antenna so the resulting reading is greater than 10 dB above the probe system noise floor but within the systems operating range.
3. Record the amplitude applied to the antenna during transmission and the field strength measured by the E-field probe located near the tip of the dipole antenna
4. Replace the wireless device with an RF signal generator producing an unmodulated CW signal and set to the wireless device operating frequency.
5. Set the amplitude of the unmodulated signal to equal that recorded from the wireless device.
6. Record the reading of the probe measurement system of the unmodulated signal.
7. The ratio, in linear units, of the probe reading in Step 6 to the reading in Step 3 is the E-field modulation factor.  $PMF_E = E_{CW} / E_{mod}$  ( $PMF_H = H_{CW} / H_{mod}$ )
8. Repeat the previous steps using the H-field probe, except locate the probe at the center of the dipole.

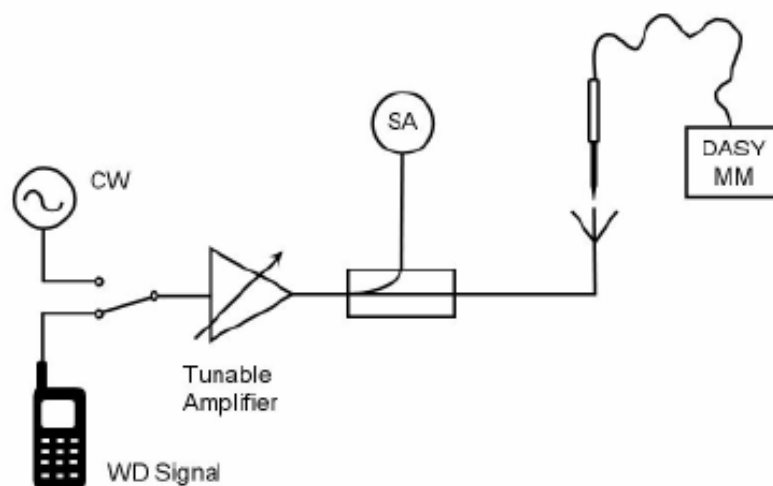

Figure 7 Probe Modulation Factor Test Setup



**TA Technology (Shanghai) Co., Ltd.**  
**Test Report**

Report No. RXA1204-0048HAC01R1

Page 17 of 119

**PMF**

<b>Band</b>	<b>E-Field Probe Modulation Factor</b>	<b>H-Field Probe Modulation Factor</b>
GSM 850	2.81	2.75
GSM 1900	2.84	2.84
WCDMA Band IV	1.03	1.01
WCDMA Band V	1.03	1.01

**TA Technology (Shanghai) Co., Ltd.**  
**Test Report**

**2.6. Conducted Output Power Measurement**

**Summary**

The EUT is tested using an E5515C communications tester as controller unit to set test channels and maximum output power to the DUT, as well as for measuring the conducted power. Conducted output power was measured using an integrated RF connector and attached RF cable. This result contains conducted output power for the EUT.

**Conducted Power Results**

<b>GSM 850</b>	<b>Conducted Power(dBm)</b>		
	Channel 128	Channel 190	Channel 251
Test Results	32.86	32.75	32.61
<b>GSM 1900</b>	<b>Conducted Power(dBm)</b>		
	Channel 512	Channel 661	Channel 810
Test Results	28.75	29.23	29.86
<b>WCDMA Band IV</b>	<b>Conducted Power(dBm)</b>		
	Channel 1312	Channel 1413	Channel 1513
Test Results	23.6	23.56	23.4
<b>WCDMA Band V</b>	<b>Conducted Power(dBm)</b>		
	Channel 4132	Channel 4183	Channel 4233
Test Results	23.35	23.23	23.56

**TA Technology (Shanghai) Co., Ltd.**  
**Test Report**

### 3. Test Results

#### 3.1. ANSI C63.19-2007 Limits

Category		Telephone RF parameters < 960 MHz			
Near field	AWF	E-field emissions		H-field emissions	
Category M1/T1	0	631.0 to 1122.0	V/m	1.91 to 3.39	A/m
	-5	473.2 to 841.4	V/m	1.43 to 2.54	A/m
Category M2/T2	0	354.8 to 631.0	V/m	1.07 to 1.91	A/m
	-5	266.1 to 473.2	V/m	0.80 to 1.43	A/m
Category M3/T3	0	199.5 to 354.8	V/m	0.60 to 1.07	A/m
	-5	149.6 to 266.1	V/m	0.45 to 0.80	A/m
Category M4/T4	0	< 199.5	V/m	< 0.60	A/m
	-5	< 149.6	V/m	< 0.45	A/m
Category		Telephone RF parameters > 960 MHz			
Near field	AWF	E-field emissions		H-field emissions	
Category M1/T1	0	199.5 to 354.8	V/m	0.60 to 1.07	A/m
	-5	149.6 to 266.1	V/m	0.45 to 0.80	A/m
Category M2/T2	0	112.2 to 199.5	V/m	0.34 to 0.60	A/m
	-5	84.1 to 149.6	V/m	0.25 to 0.45	A/m
Category M3/T3	0	63.1 to 112.2	V/m	0.19 to 0.34	A/m
	-5	47.3 to 84.1	V/m	0.14 to 0.25	A/m
Category M4/T4	0	< 63.1	V/m	< 0.19	A/m
	-5	< 47.3	V/m	< 0.14	A/m

**TA Technology (Shanghai) Co., Ltd.**  
**Test Report**

**3.2. Summary Test Results**

**GSM 850 Results**

<b>E-Field</b>					
<b>Channel</b>	<b>Frequency (MHz)</b>	<b>Peak Field (V/m)</b>	<b>Power Drift (dB)</b>	<b>Rating</b>	<b>Graph Results</b>
High/251	848.8	182.0	-0.089	M3	Figure 12
Middle/190	836.6	189.8	-0.063	M3	Figure 13
Low/128	824.2	189.9	-0.044	M3	Figure 14
<b>H-Field</b>					
<b>Channel</b>	<b>Frequency (MHz)</b>	<b>Peak Field (A/m)</b>	<b>Power Drift (dB)</b>	<b>Rating</b>	<b>Graph Results</b>
High/251	848.8	0.265	0.033	M4	Figure 15
Middle/190	836.6	0.267	0.010	M4	Figure 16
Low/128	824.2	0.257	-0.055	M4	Figure 17

**GSM 1900 Results**

<b>E-Field</b>					
<b>Channel</b>	<b>Frequency (MHz)</b>	<b>Peak Field (V/m)</b>	<b>Power Drift (dB)</b>	<b>Rating</b>	<b>Graph Results</b>
High/810	1909.8	56.3	0.111	M3	Figure 18
Middle/661	1880	50.7	0.018	M3	Figure 19
Low/512	1850.2	53.5	0.047	M3	Figure 20
<b>H-Field</b>					
<b>Channel</b>	<b>Frequency (MHz)</b>	<b>Peak Field (A/m)</b>	<b>Power Drift (dB)</b>	<b>Rating</b>	<b>Graph Results</b>
High/810	1909.8	0.176	-0.004	M3	Figure 21
Middle/661	1880	0.141	0.016	M3	Figure 22
Low/512	1850.2	0.16	0.085	M3	Figure 23

**TA Technology (Shanghai) Co., Ltd.**  
**Test Report**

Report No. RXA1204-0048HAC01R1

Page 21 of 119

**WCDMA Band IV Results**

<b>E-Field</b>					
<b>Channel</b>	<b>Frequency (MHz)</b>	<b>Peak Field (V/m)</b>	<b>Power Drift (dB)</b>	<b>Rating</b>	<b>Graph Results</b>
High/1513	1752.6	34.3	-0.173	M4	Figure 24
Middle/1413	1732.6	36.2	-0.080	M4	Figure 25
Low/1312	1712.4	34.7	-0.030	M4	Figure 26
<b>H-Field</b>					
<b>Channel</b>	<b>Frequency (MHz)</b>	<b>Peak Field (A/m)</b>	<b>Power Drift (dB)</b>	<b>Rating</b>	<b>Graph Results</b>
High/1513	1752.6	0.102	0.032	M4	Figure 27
Middle/1413	1732.6	0.107	-0.031	M4	Figure 28
Low/1312	1712.4	0.103	0.000	M4	Figure 29

**WCDMA Band V Results**

<b>E-Field</b>					
<b>Channel</b>	<b>Frequency (MHz)</b>	<b>Peak Field (V/m)</b>	<b>Power Drift (dB)</b>	<b>Rating</b>	<b>Graph Results</b>
High/4233	846.6	66.3	-0.119	M4	Figure 30
Middle/4183	836.6	58.4	0.051	M4	Figure 31
Low/4132	826.4	64.4	0.005	M4	Figure 32
<b>H-Field</b>					
<b>Channel</b>	<b>Frequency (MHz)</b>	<b>Peak Field (A/m)</b>	<b>Power Drift (dB)</b>	<b>Rating</b>	<b>Graph Results</b>
High/4233	846.6	0.093	-0.036	M4	Figure 33
Middle/4183	836.6	0.08	0.020	M4	Figure 34
Low/4132	826.4	0.087	0.077	M4	Figure 35

**TA Technology (Shanghai) Co., Ltd.**  
**Test Report**

Report No. RXA1204-0048HAC01R1

Page 22 of 119

**4. Measurement Uncertainty**

No.	Error source	Type	Uncertainty Value (%)	Prob. Dist.	k	$c_{iE}$	$c_{iH}$	Standard Uncertainty (%) $u_i$ (%) E	Standard Uncertainty (%) $u_i$ (%) H	Degree of freedom $V_{eff}$ or $\nu_i$
<b>Measurement System</b>										
1	Probe Calibration	B	5.1	N	1	1	1	5.1	5.1	$\infty$
2	Axial Isotropy	B	4.7	R	$\sqrt{3}$	1	1	2.7	2.7	$\infty$
3	Sensor Displacement	B	16.5	R	$\sqrt{3}$	1	0.145	9.5	1.4	$\infty$
4	Boundary Effects	B	2.4	R	$\sqrt{3}$	1	1	1.4	1.4	$\infty$
5	Test Arch	B	7.2	R	$\sqrt{3}$	1	0	4.1	0	$\infty$
6	Linearity	B	4.7	R	$\sqrt{3}$	1	1	2.7	2.7	$\infty$
7	Scaling to Peak Envelope Power	B	2.0	R	$\sqrt{3}$	1	1	1.2	1.2	$\infty$
8	System Detection Limit	B	1.0	R	$\sqrt{3}$	1	1	0.6	0.6	$\infty$
9	Readout Electronics	B	0.3	N	1	1	1	0.3	0.3	$\infty$
10	Response Time	B	0.8	R	$\sqrt{3}$	1	1	0.5	0.5	$\infty$
11	Integration Time	B	2.6	R	$\sqrt{3}$	1	1	1.5	1.5	$\infty$
12	RF Ambient Conditions	B	3.0	R	$\sqrt{3}$	1	1	1.7	1.7	$\infty$
13	RF Reflections	B	12.0	R	$\sqrt{3}$	1	1	6.9	6.9	$\infty$
14	Probe Positioner	B	1.2	R	$\sqrt{3}$	1	0.67	0.7	0.5	$\infty$
15	Probe Positioning	A	4.7	R	$\sqrt{3}$	1	0.67	2.7	1.8	$\infty$
16	Extra. And Interpolation	B	1.0	R	$\sqrt{3}$	1	1	0.6	0.6	$\infty$
<b>Test Sample Related</b>										
17	Device Positioning Vertical	B	4.7	R	$\sqrt{3}$	1	0.67	2.7	1.8	$\infty$
18	Device Positioning Lateral	B	1.0	R	$\sqrt{3}$	1	1	0.6	0.6	$\infty$

**TA Technology (Shanghai) Co., Ltd.**  
**Test Report**

Report No. RXA1204-0048HAC01R1

Page 23 of 119

19	Device Holder and Phantom	B	2.4	R	$\sqrt{3}$	1	1	1.4	1.4	$\infty$
20	Power Drift	B	5.0	R	$\sqrt{3}$	1	1	2.9	2.9	$\infty$
<b>Phantom and Setup related</b>										
21	Phantom Thickness	B	2.4	R	$\sqrt{3}$	1	0.67	1.4	0.9	$\infty$
Combined standard uncertainty (%)								15.19	10.82	
Expanded Std. uncertainty on power (K=2)								30.38	21.65	
Expanded Std. uncertainty on field (K=2)								15.19	10.82	

**TA Technology (Shanghai) Co., Ltd.**  
**Test Report**

Report No. RXA1204-0048HAC01R1

Page 24 of 119

**5. Main Test Instruments**

No.	Name	Type	Serial Number	Calibration Date	Valid Period
01	Power meter	Agilent E4417A	GB41291714	March 11, 2012	One year
02	Power sensor	Agilent N8481H	MY50350004	September 25, 2011	One year
03	Signal Generator	HP 8341B	2730A00804	September 12, 2011	One year
04	Amplifier	IXA-020	0401	No Calibration Requested	
05	BTS	E5515C	MY48360988	December 2, 2011	One year
06	E-Field Probe	ER3DV6	2303	February 21, 2012	One year
07	H-Field Probe	H3DV6	6138	February 21, 2012	One year
08	DAE	DAE4	871	November 22, 2011	One year
09	Validation Kit 835MHz	CD835V3	1133	February 21, 2012	One year
10	Validation Kit 1880MHz	CD1880V3	1115	February 21, 2012	One year

\*\*\*\*\*END OF REPORT BODY\*\*\*\*\*



## **ANNEX A: System Check Results**

### **HAC\_System Performance Check at 835MHz\_E**

**DUT: Dipole 835 MHz; Type: CD835V3; SN:1133**

Date/Time: 4/14/2012 9:37:26 PM

Communication System: CW; Frequency: 835 MHz; Duty Cycle: 1:1

Medium parameters used:  $\sigma = 0$  mho/m,  $\epsilon_r = 1$ ;  $\rho = 1000$  kg/m<sup>3</sup>

Ambient Temperature: 22.3 °C

Phantom section: RF Section

DASY5 Configuration:

Probe: ER3DV6 - SN2303; ConvF(1, 1, 1); Calibrated: 2/21/2012

Electronics: DAE4 Sn871; Calibrated: 11/22/2011

Phantom: HAC Test Arch with AMCC; Type: SD HAC P01 BA

Measurement SW: DASY5, V5.2 Build 162; SEMCAD X Version 14.0 Build 59

**Configuration/E Scan - measurement distance from the probe sensor center to CD835 Dipole = 10mm/Hearing Aid Compatibility Test (41x361x1):** Measurement grid: dx=5mm, dy=5mm

Maximum value of peak Total field = 169.3 V/m

Probe Modulation Factor = 1

Device Reference Point: 0, 0, -6.3 mm

Reference Value = 123.4 V/m; Power Drift = -0.033 dB

**Hearing Aid Near-Field Category: M4 (AWF 0 dB)**

Peak E-field in V/m

Grid 1	Grid 2	Grid 3
<b>160.0 M4</b>	<b>169.3 M4</b>	<b>165.9 M4</b>
Grid 4	Grid 5	Grid 6
<b>83.3 M4</b>	<b>89.1 M4</b>	<b>88.1 M4</b>
Grid 7	Grid 8	Grid 9
<b>156.3 M4</b>	<b>164.8 M4</b>	<b>163.6 M4</b>

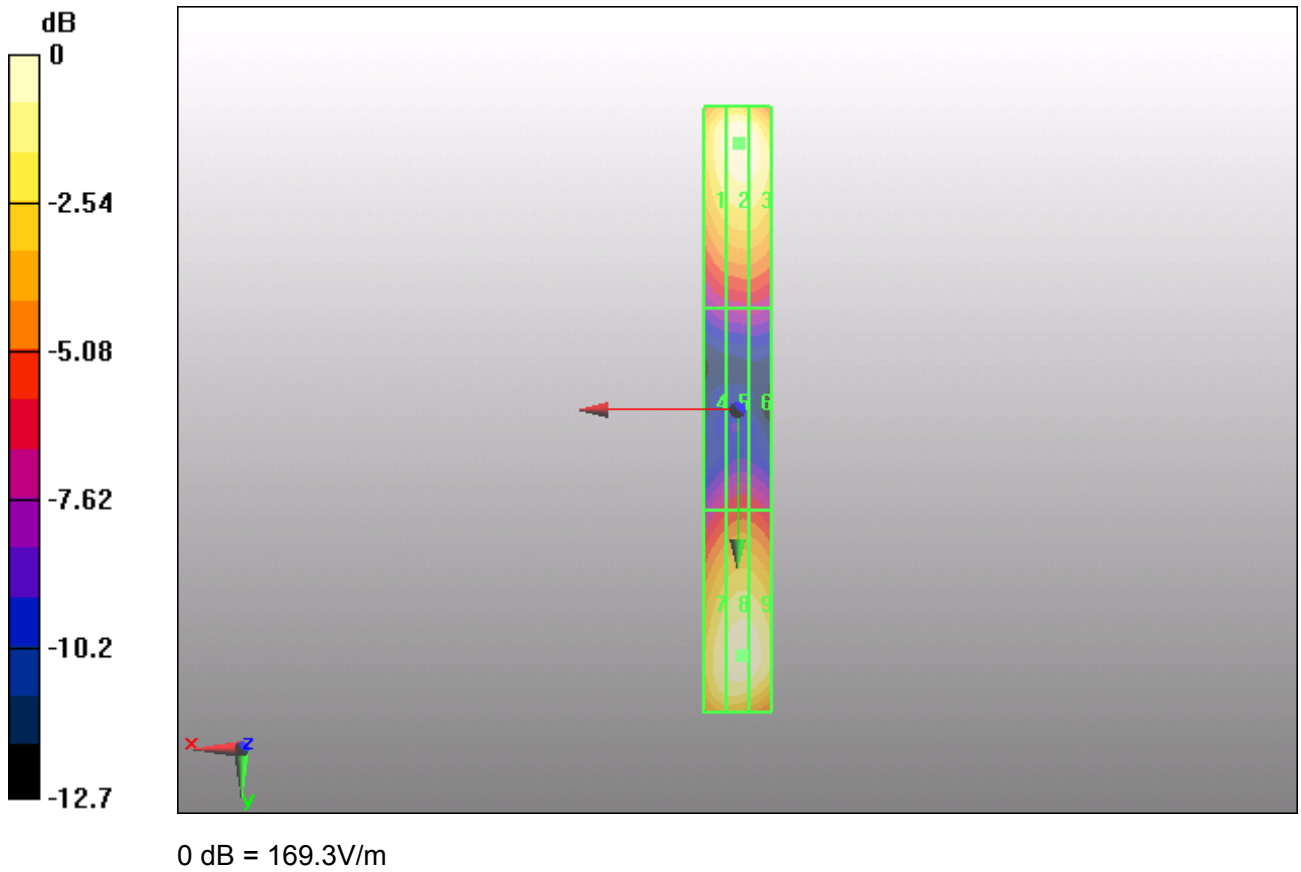

Figure 8 System Performance Check 835MHz\_E

**TA Technology (Shanghai) Co., Ltd.**  
**Test Report**

Report No. RXA1204-0048HAC01R1

Page 27 of 119

**HAC\_System Performance Check at 835MHz\_H**

**DUT: Dipole 835 MHz; Type: CD835V3; SN: 1133**

Date/Time: 4/15/2012 7:00:32 AM

Communication System: CW; Frequency: 835 MHz; Duty Cycle: 1:1

Medium parameters used:  $\sigma = 0$  mho/m,  $\epsilon_r = 1$ ;  $\rho = 1$  kg/m<sup>3</sup>

Ambient Temperature: 22.3 °C

Phantom section: RF Section

DASY5 Configuration:

Probe: H3DV6 - SN6138; ; Calibrated: 2/21/2012

Electronics: DAE4 Sn871; Calibrated: 11/22/2011

Phantom: HAC Test Arch with AMCC; Type: SD HAC P01 BA

Measurement SW: DASY5, V5.2 Build 162; SEMCAD X Version 14.0 Build 59

**Configuration/H Scan - measurement distance from the probe sensor center to CD835 Dipole = 10mm/Hearing Aid Compatibility Test (41x361x1):** Measurement grid: dx=5mm, dy=5mm

Maximum value of peak Total field = 0.470 A/m

Probe Modulation Factor = 1

Device Reference Point: 0, 0, -6.3 mm

Reference Value = 0.501 A/m; Power Drift = -0.021 dB

**Hearing Aid Near-Field Category: M4 (AWF 0 dB)**

Peak H-field in A/m

Grid 1	Grid 2	Grid 3
<b>0.395 M4</b>	<b>0.414 M4</b>	<b>0.391 M4</b>
Grid 4	Grid 5	Grid 6
<b>0.447 M4</b>	<b>0.470 M4</b>	<b>0.443 M4</b>
Grid 7	Grid 8	Grid 9
<b>0.403 M4</b>	<b>0.423 M4</b>	<b>0.397 M4</b>

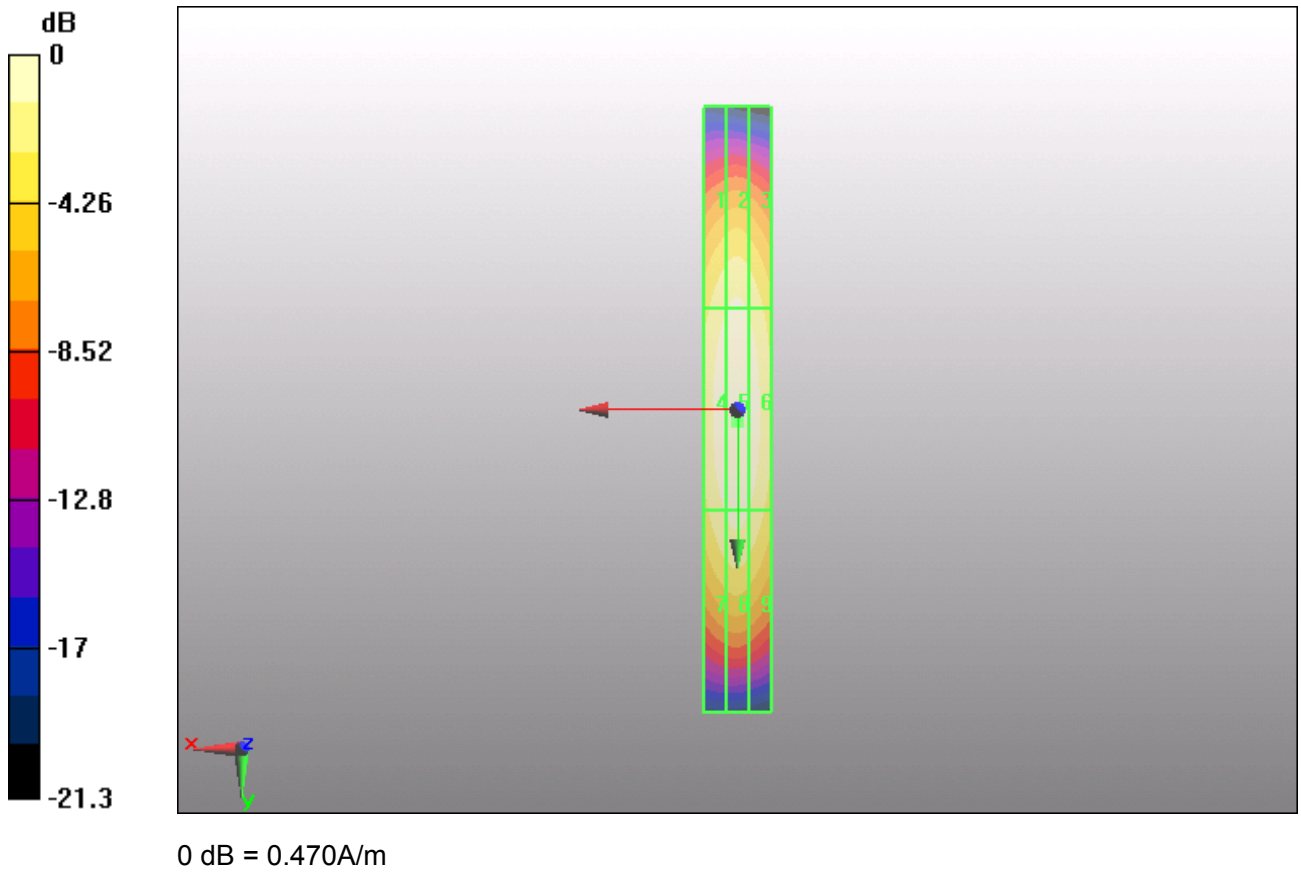

Figure 9 System Performance Check 835MHz\_H

**TA Technology (Shanghai) Co., Ltd.**  
**Test Report**

Report No. RXA1204-0048HAC01R1

Page 29 of 119

**HAC\_System Performance Check at 1880MHz\_E**

**DUT: Dipole 1880 MHz; Type: CD1880V3; SN: 1115**

Date/Time: 4/14/2012 9:57:30 PM

Communication System: CW; Frequency: 1880 MHz; Duty Cycle: 1:1

Medium parameters used:  $\sigma = 0$  mho/m,  $\epsilon_r = 1$ ;  $\rho = 1000$  kg/m<sup>3</sup>

Ambient Temperature: 22.3 °C

Phantom section: RF Section

DASY5 Configuration:

Probe: ER3DV6 - SN2303; ConvF(1, 1, 1); Calibrated: 2/21/2012

Electronics: DAE4 Sn871; Calibrated: 11/22/2011

Phantom: HAC Test Arch with AMCC; Type: SD HAC P01 BA

Measurement SW: DASY5, V5.2 Build 162; SEMCAD X Version 14.0 Build 59

**HAC RF H3DV6 1880 MHz Dipole 20120414/E Scan - measurement distance from the probe sensor center to CD835 Dipole = 10mm/Hearing Aid Compatibility Test (41x241x1):**

Measurement grid: dx=5mm, dy=5mm

Maximum value of peak Total field = 141.8 V/m

Probe Modulation Factor = 1

Device Reference Point: 0, 0, -6.3 mm

Reference Value = 142.7 V/m; Power Drift = -0.019 dB

**Hearing Aid Near-Field Category: M2 (AWF 0 dB)**

Peak E-field in V/m

Grid 1	Grid 2	Grid 3
<b>131.1 M2</b>	<b>137.4 M2</b>	<b>132.2 M2</b>
Grid 4	Grid 5	Grid 6
<b>104.5 M3</b>	<b>112.6 M2</b>	<b>110.7 M3</b>
Grid 7	Grid 8	Grid 9
<b>134.9 M2</b>	<b>141.8 M2</b>	<b>139.5 M2</b>

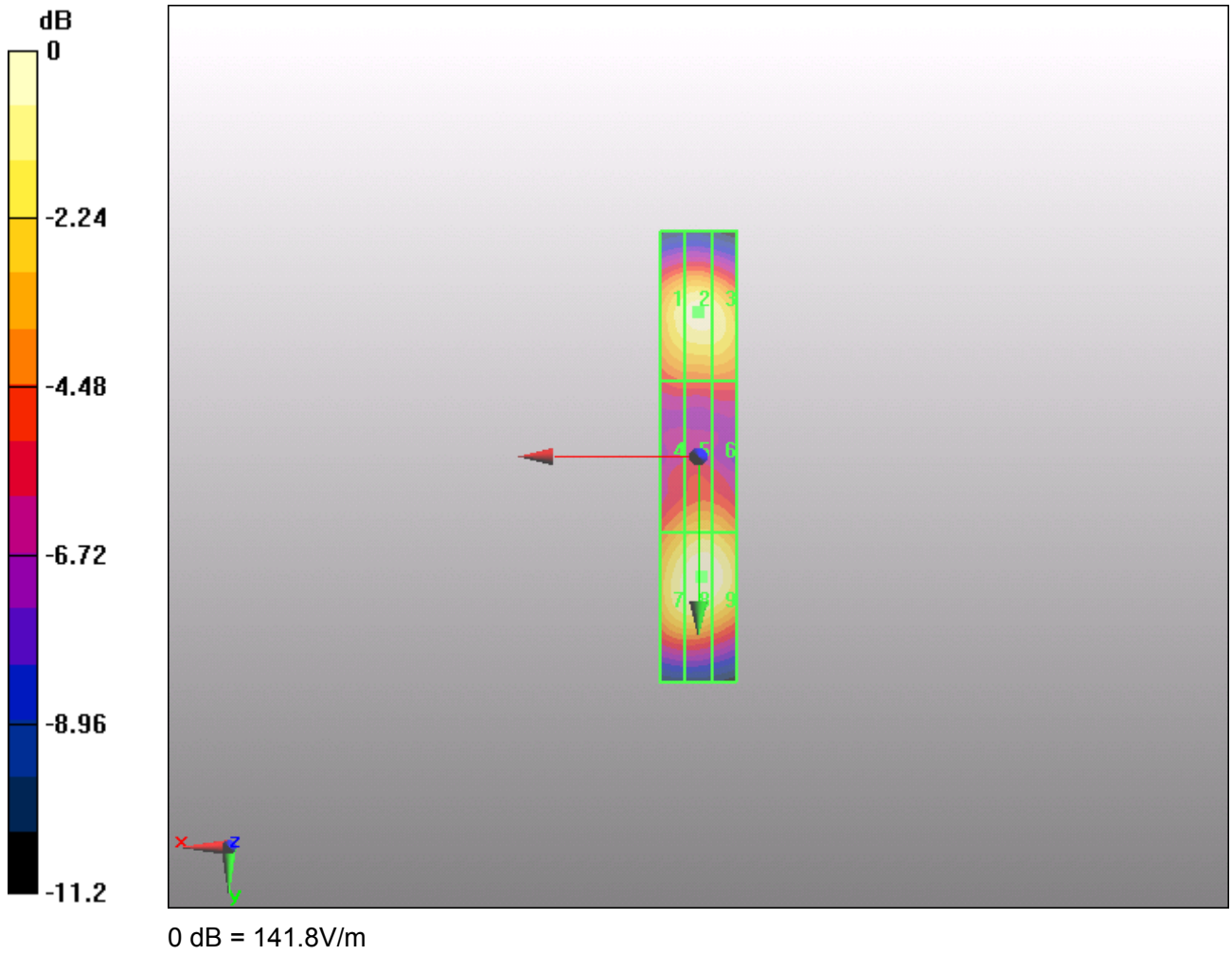

Figure 10 System Performance Check 1880MHz\_E

**TA Technology (Shanghai) Co., Ltd.**  
**Test Report**

Report No. RXA1204-0048HAC01R1

Page 31 of 119

**HAC\_System Performance Check at 1880MHz\_H**

**DUT: Dipole 1880 MHz; Type: CD1880V3; SN: 1115**

Date/Time: 4/15/2012 8:28:54 AM

Communication System: CW; Frequency: 1880 MHz; Duty Cycle: 1:1

Medium parameters used:  $\sigma = 0$  mho/m,  $\epsilon_r = 1$ ;  $\rho = 1$  kg/m<sup>3</sup>

Ambient Temperature: 22.3 °C

Phantom section: RF Section

DASY5 Configuration:

Probe: H3DV6 - SN6138; ; Calibrated: 2/21/2012

Electronics: DAE4 Sn871; Calibrated: 11/22/2011

Phantom: HAC Test Arch with AMCC; Type: SD HAC P01 BA

Measurement SW: DASY5, V5.2 Build 162; SEMCAD X Version 14.0 Build 59

**Configuration/H Scan - measurement distance from the probe sensor center to Dipole = 10mm/Hearing Aid Compatibility Test (41x181x1):** Measurement grid: dx=5mm, dy=5mm

Maximum value of peak Total field = 0.459 A/m

Probe Modulation Factor = 1

Device Reference Point: 0, 0, -6.3 mm

Reference Value = 0.487 A/m; Power Drift = -0.024 dB

**Hearing Aid Near-Field Category: M2 (AWF 0 dB)**

Peak H-field in A/m

Grid 1	Grid 2	Grid 3
<b>0.401 M2</b>	<b>0.418 M2</b>	<b>0.395 M2</b>
Grid 4	Grid 5	Grid 6
<b>0.442 M2</b>	<b>0.459 M2</b>	<b>0.435 M2</b>
Grid 7	Grid 8	Grid 9
<b>0.407 M2</b>	<b>0.424 M2</b>	<b>0.398 M2</b>

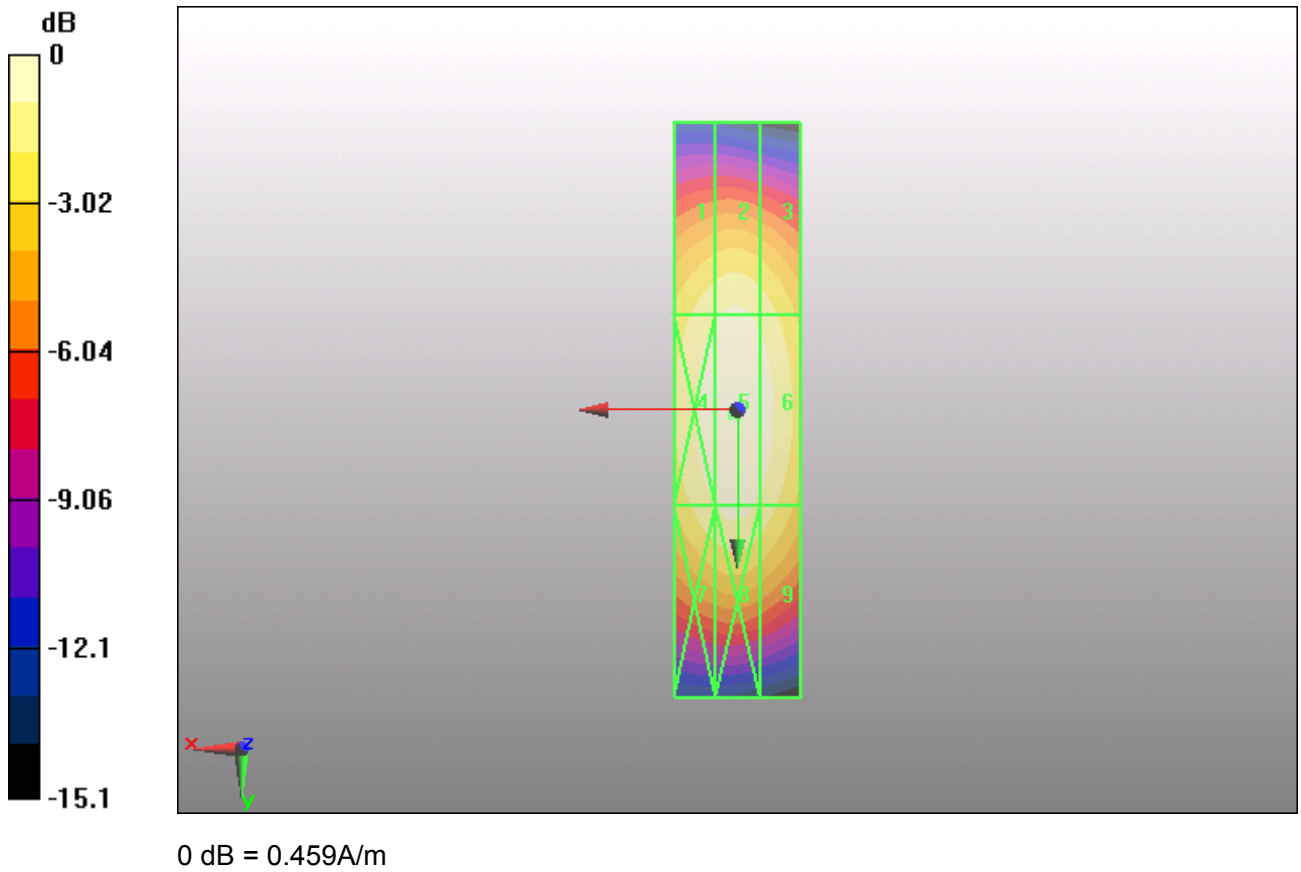

Figure 11 System Performance Check 1880MHz\_H



## **ANNEX B: Graph Results**

### **HAC RF E-Field GSM 850 High**

Date/Time: 4/15/2012 10:10:05 AM

Communication System: GSM; Frequency: 848.8 MHz; Duty Cycle: 1:8.30042

Medium parameters used:  $\sigma = 0$  mho/m,  $\epsilon_r = 1$ ;  $\rho = 1000$  kg/m<sup>3</sup>

Ambient Temperature: 22.3 °C

Phantom section: RF Section

DASY5 Configuration:

Probe: ER3DV6 - SN2303; ConvF(1, 1, 1); Calibrated: 2/21/2012

Electronics: DAE4 Sn871; Calibrated: 11/22/2011

Phantom: HAC Test Arch with AMCC; Type: SD HAC P01 BA;

Measurement SW: DASY5, V5.2 Build 162; SEMCAD X Version 14.0 Build 59

**one touch 995S GSM 850 HAC RF E-Field/E Scan - ER3D - 2007: 15 mm from Probe Center to the Device High/Hearing Aid Compatibility Test (101x101x1):** Measurement grid: dx=5mm, dy=5mm

Maximum value of peak Total field = 182.0 V/m

Probe Modulation Factor = 2.81

Device Reference Point: 0, 0, -6.3 mm

Reference Value = 80.6 V/m; Power Drift = -0.089 dB

**Hearing Aid Near-Field Category: M3 (AWF -5 dB)**

Peak E-field in V/m

Grid 1 <b>162.0 M3</b>	Grid 2 <b>180.7 M3</b>	Grid 3 <b>179.5 M3</b>
Grid 4 <b>157.3 M3</b>	Grid 5 <b>182.0 M3</b>	Grid 6 <b>180.2 M3</b>
Grid 7 <b>147.7 M4</b>	Grid 8 <b>175.7 M3</b>	Grid 9 <b>174.8 M3</b>

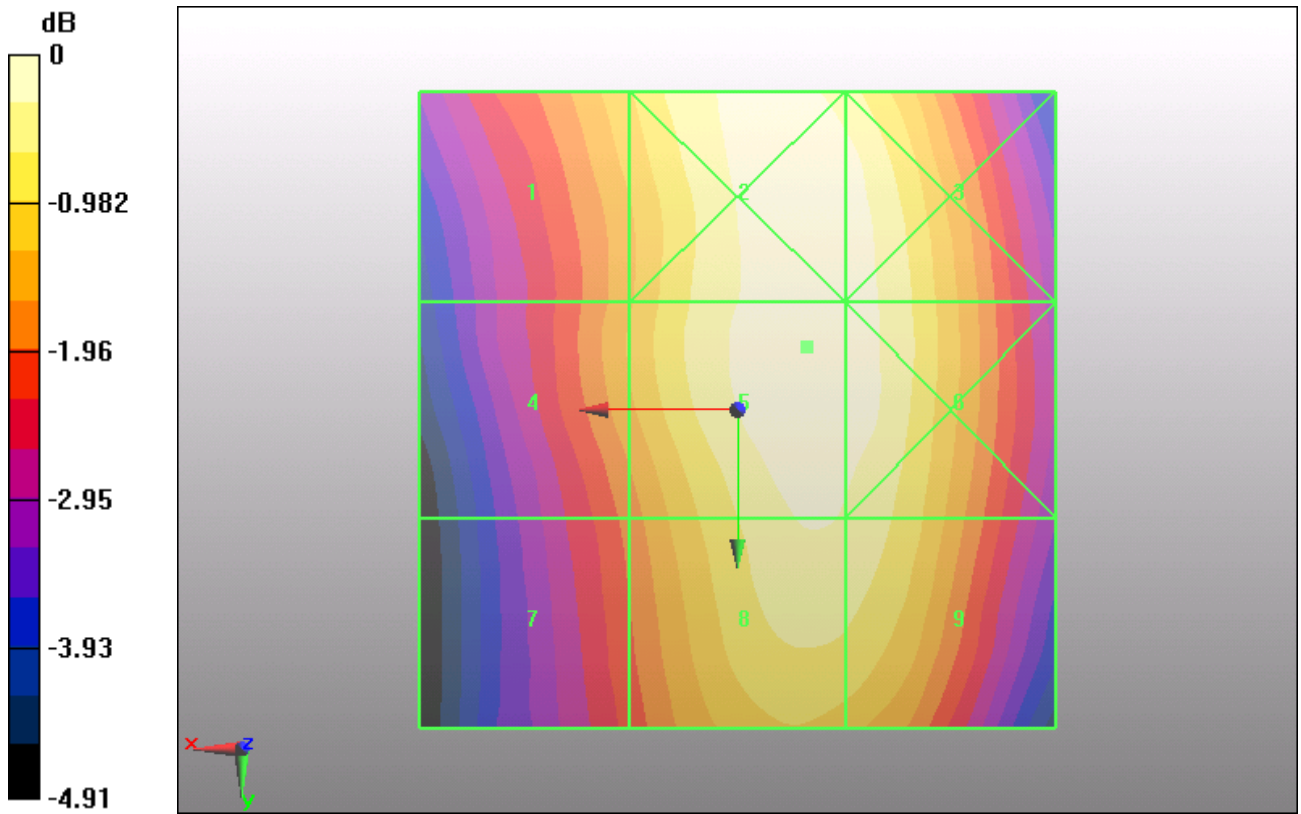

0 dB = 182.0V/m

Figure 12 HAC RF E-Field GSM 850 Channel 251

**TA Technology (Shanghai) Co., Ltd.**  
**Test Report**

Report No. RXA1204-0048HAC01R1

Page 35 of 119

**HAC RF E-Field GSM 850 Middle**

Date/Time: 4/15/2012 9:58:58 AM

Communication System: GSM; Frequency: 836.6 MHz; Duty Cycle: 1:8.30042

Medium parameters used:  $\sigma = 0$  mho/m,  $\epsilon_r = 1$ ;  $\rho = 1000$  kg/m<sup>3</sup>

Ambient Temperature: 22.3 °C

Phantom section: RF Section

DASY5 Configuration:

Probe: ER3DV6 - SN2303; ConvF(1, 1, 1); Calibrated: 2/21/2012

Electronics: DAE4 Sn871; Calibrated: 11/22/2011

Phantom: HAC Test Arch with AMCC; Type: SD HAC P01 BA;

Measurement SW: DASY5, V5.2 Build 162; SEMCAD X Version 14.0 Build 59

**one touch 995S GSM 850 HAC RF E-Field/E Scan - ER3D - 2007: 15 mm from Probe Center to the Device Middle/Hearing Aid Compatibility Test (101x101x1):** Measurement grid: dx=5mm, dy=5mm

Maximum value of peak Total field = 189.8 V/m

Probe Modulation Factor = 2.81

Device Reference Point: 0, 0, -6.3 mm

Reference Value = 84 V/m; Power Drift = -0.063 dB

**Hearing Aid Near-Field Category: M3 (AWF -5 dB)**

Peak E-field in V/m

Grid 1 <b>167.3 M3</b>	Grid 2 <b>188.1 M3</b>	Grid 3 <b>186.5 M3</b>
Grid 4 <b>163.7 M3</b>	Grid 5 <b>189.8 M3</b>	Grid 6 <b>188.0 M3</b>
Grid 7 <b>155.7 M3</b>	Grid 8 <b>184.2 M3</b>	Grid 9 <b>182.9 M3</b>

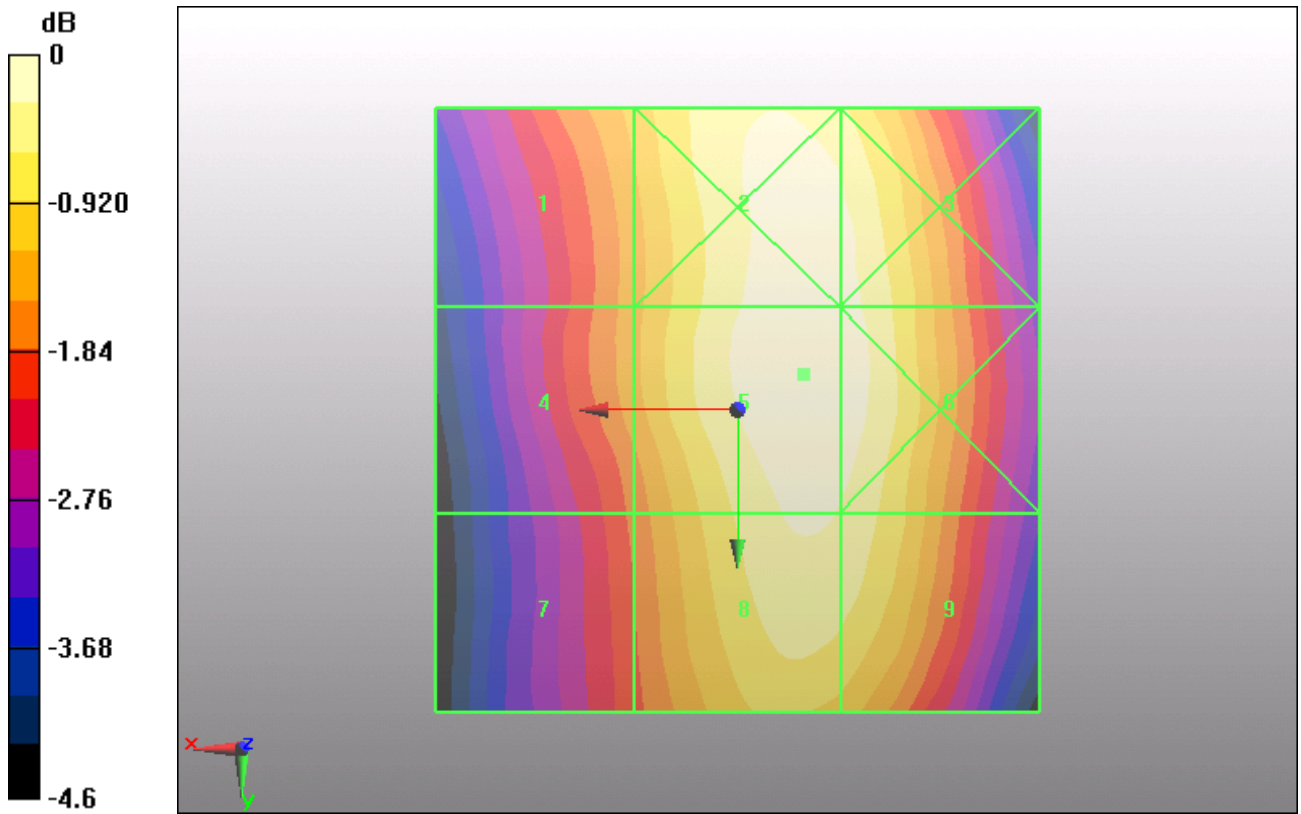

0 dB = 189.8V/m

Figure 13 HAC RF E-Field GSM 850 Channel 190

**TA Technology (Shanghai) Co., Ltd.**  
**Test Report**

Report No. RXA1204-0048HAC01R1

Page 37 of 119

**HAC RF E-Field GSM 850 Low**

Date/Time: 4/15/2012 10:04:36 AM

Communication System: GSM; Frequency: 824.2 MHz; Duty Cycle: 1:8.30042

Medium parameters used:  $\sigma = 0$  mho/m,  $\epsilon_r = 1$ ;  $\rho = 1000$  kg/m<sup>3</sup>

Ambient Temperature: 22.3 °C

Phantom section: RF Section

DASY5 Configuration:

Probe: ER3DV6 - SN2303; ConvF(1, 1, 1); Calibrated: 2/21/2012

Electronics: DAE4 Sn871; Calibrated: 11/22/2011

Phantom: HAC Test Arch with AMCC; Type: SD HAC P01 BA;

Measurement SW: DASY5, V5.2 Build 162; SEMCAD X Version 14.0 Build 59

**one touch 995S GSM 850 HAC RF E-Field/E Scan - ER3D - 2007: 15 mm from Probe Center to the Device Low/Hearing Aid Compatibility Test (101x101x1):** Measurement grid: dx=5mm, dy=5mm

Maximum value of peak Total field = 189.9 V/m

Probe Modulation Factor = 2.81

Device Reference Point: 0, 0, -6.3 mm

Reference Value = 84.2 V/m; Power Drift = -0.044 dB

**Hearing Aid Near-Field Category: M3 (AWF -5 dB)**

Peak E-field in V/m

Grid 1 <b>169.4 M3</b>	Grid 2 <b>188.2 M3</b>	Grid 3 <b>186.8 M3</b>
Grid 4 <b>166.7 M3</b>	Grid 5 <b>189.9 M3</b>	Grid 6 <b>188.2 M3</b>
Grid 7 <b>158.3 M3</b>	Grid 8 <b>185.0 M3</b>	Grid 9 <b>184.4 M3</b>

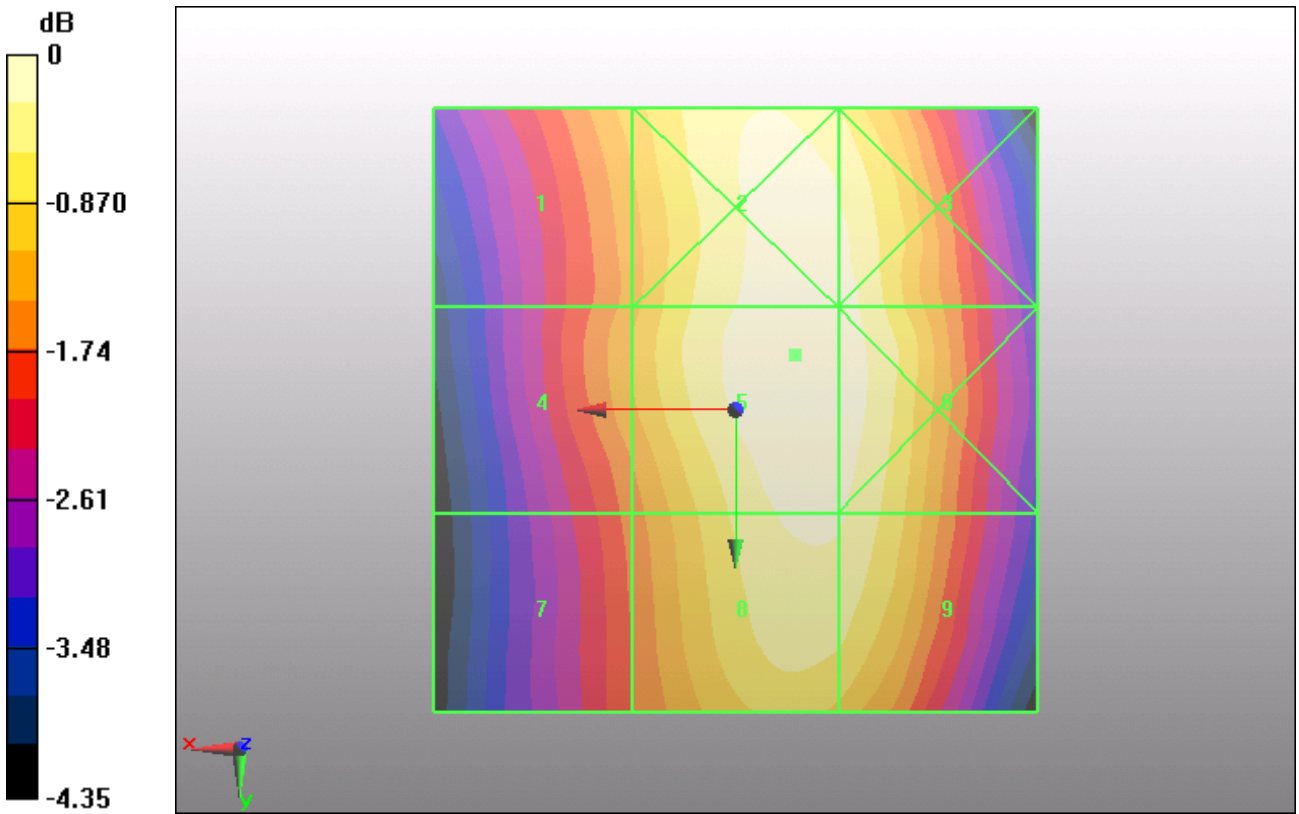

0 dB = 189.9V/m

Figure 14 HAC RF E-Field GSM 850 Channel 128

**TA Technology (Shanghai) Co., Ltd.**  
**Test Report**

Report No. RXA1204-0048HAC01R1

Page 39 of 119

**HAC RF H-Field GSM 850 High**

Date/Time: 4/15/2012 1:16:53 PM

Communication System: GSM; Frequency: 848.8 MHz; Duty Cycle: 1:8.30042

Medium parameters used:  $\sigma = 0$  mho/m,  $\epsilon_r = 1$ ;  $\rho = 1$  kg/m<sup>3</sup>

Ambient Temperature: 22.3 °C

Phantom section: RF Section

DASY5 Configuration:

Probe: H3DV6 - SN6138; ; Calibrated: 2/21/2012

Electronics: DAE4 Sn871; Calibrated: 11/22/2011

Phantom: HAC Test Arch with AMCC; Type: SD HAC P01 BA

Measurement SW: DASY5, V5.2 Build 162; SEMCAD X Version 14.0 Build 59

**One touch 995S GSM 850 HAC RF H-Field/H Scan - H3DV6 - 2007: 15 mm from Probe Center to the Device High/Hearing Aid Compatibility Test (101x101x1):** Measurement grid: dx=5mm, dy=5mm

Maximum value of peak Total field = 0.265 A/m

Probe Modulation Factor = 2.75

Device Reference Point: 0, 0, -6.3 mm

Reference Value = 0.070 A/m; Power Drift = 0.033 dB

**Hearing Aid Near-Field Category: M4 (AWF -5 dB)**

Peak H-field in A/m

Grid 1 <b>0.360 M4</b>	Grid 2 <b>0.256 M4</b>	Grid 3 <b>0.155 M4</b>
Grid 4 <b>0.325 M4</b>	Grid 5 <b>0.239 M4</b>	Grid 6 <b>0.154 M4</b>
Grid 7 <b>0.360 M4</b>	Grid 8 <b>0.265 M4</b>	Grid 9 <b>0.173 M4</b>

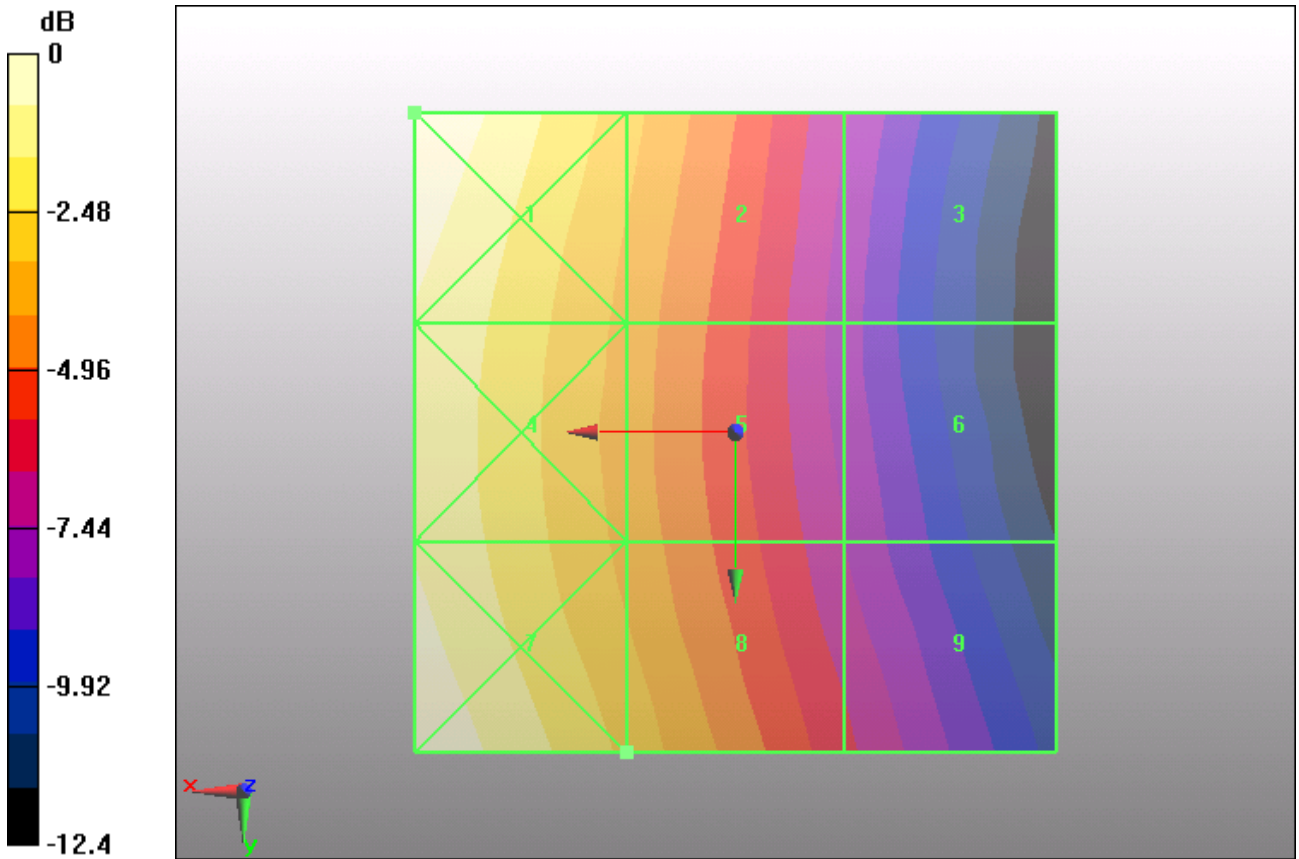

0 dB = 0.360A/m

Figure 15 HAC RF H-Field GSM 850Channel 251



**TA Technology (Shanghai) Co., Ltd.**  
**Test Report**

Report No. RXA1204-0048HAC01R1

Page 41 of 119

**HAC RF H-Field GSM 850 Middle**

Date/Time: 4/15/2012 1:10:51 PM

Communication System: GSM; Frequency: 836.6 MHz; Duty Cycle: 1:8.30042

Medium parameters used:  $\sigma = 0$  mho/m,  $\epsilon_r = 1$ ;  $\rho = 1$  kg/m<sup>3</sup>

Ambient Temperature: 22.3 °C

Phantom section: RF Section

DASY5 Configuration:

Probe: H3DV6 - SN6138; ; Calibrated: 2/21/2012

Electronics: DAE4 Sn871; Calibrated: 11/22/2011

Phantom: HAC Test Arch with AMCC; Type: SD HAC P01 BA

Measurement SW: DASY5, V5.2 Build 162; SEMCAD X Version 14.0 Build 59

**One touch 995S GSM 850 HAC RF H-Field/H Scan - H3DV6 - 2007: 15 mm from Probe Center to the Device Middle/Hearing Aid Compatibility Test (101x101x1):** Measurement grid: dx=5mm, dy=5mm

Maximum value of peak Total field = 0.267 A/m

Probe Modulation Factor = 2.75

Device Reference Point: 0, 0, -6.3 mm

Reference Value = 0.071 A/m; Power Drift = 0.010 dB

**Hearing Aid Near-Field Category: M4 (AWF -5 dB)**

Peak H-field in A/m

Grid 1 <b>0.372 M4</b>	Grid 2 <b>0.266 M4</b>	Grid 3 <b>0.162 M4</b>
Grid 4 <b>0.337 M4</b>	Grid 5 <b>0.245 M4</b>	Grid 6 <b>0.153 M4</b>
Grid 7 <b>0.369 M4</b>	Grid 8 <b>0.267 M4</b>	Grid 9 <b>0.171 M4</b>

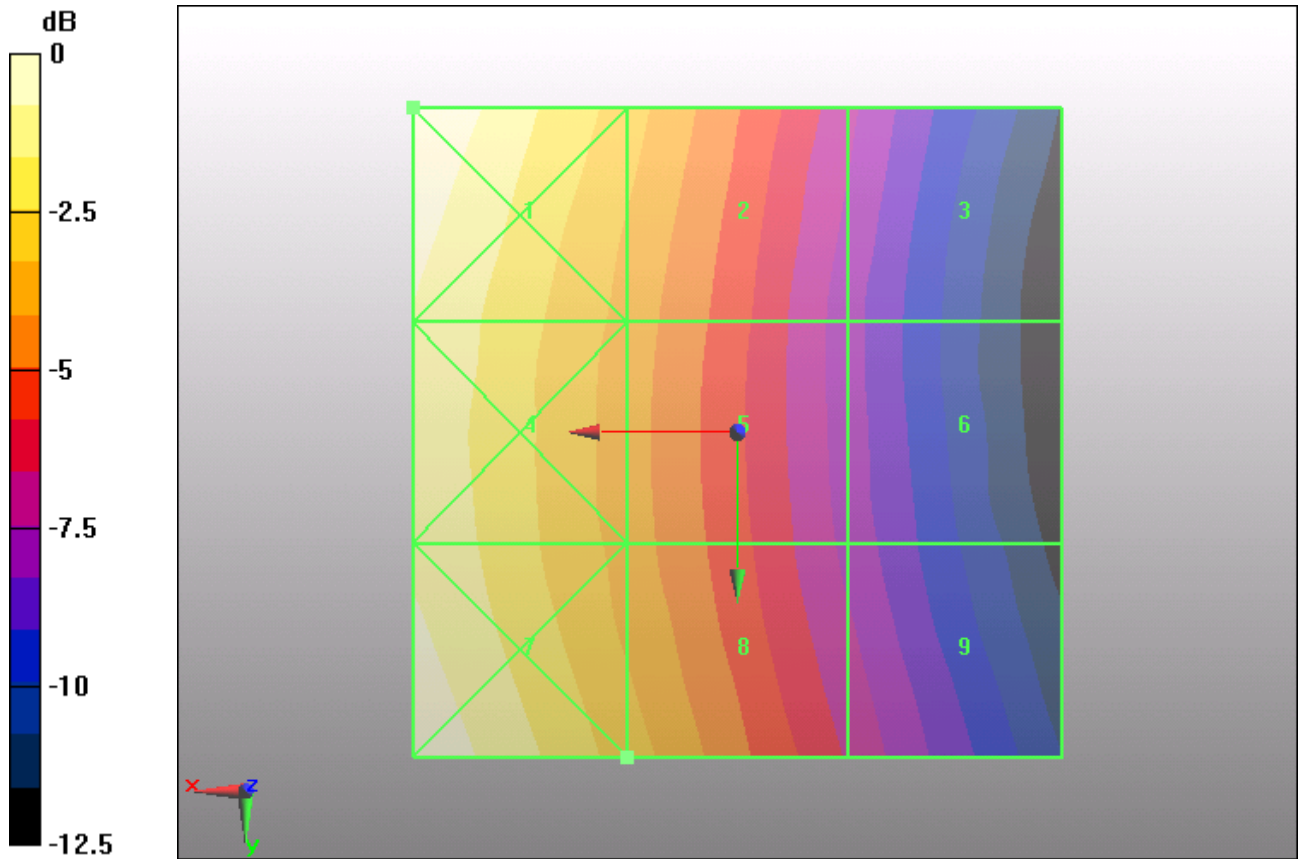

0 dB = 0.372A/m

Figure 16 HAC RF H-Field GSM 850 Channel 190

**TA Technology (Shanghai) Co., Ltd.**  
**Test Report**

Report No. RXA1204-0048HAC01R1

Page 43 of 119

**HAC RF H-Field GSM 850 Low**

Date/Time: 4/15/2012 1:22:24 PM

Communication System: GSM; Frequency: 824.2 MHz; Duty Cycle: 1:8.30042

Medium parameters used:  $\sigma = 0$  mho/m,  $\epsilon_r = 1$ ;  $\rho = 1$  kg/m<sup>3</sup>

Ambient Temperature: 22.3 °C

Phantom section: RF Section

DASY5 Configuration:

Probe: H3DV6 - SN6138; ; Calibrated: 2/21/2012

Electronics: DAE4 Sn871; Calibrated: 11/22/2011

Phantom: HAC Test Arch with AMCC; Type: SD HAC P01 BA

Measurement SW: DASY5, V5.2 Build 162; SEMCAD X Version 14.0 Build 59

**One touch 995S GSM 850 HAC RF H-Field/H Scan - H3DV6 - 2007: 15 mm from Probe Center to the Device Low/Hearing Aid Compatibility Test (101x101x1):** Measurement grid: dx=5mm, dy=5mm

Maximum value of peak Total field = 0.257 A/m

Probe Modulation Factor = 2.75

Device Reference Point: 0, 0, -6.3 mm

Reference Value = 0.067 A/m; Power Drift = -0.055 dB

**Hearing Aid Near-Field Category: M4 (AWF -5 dB)**

Peak H-field in A/m

Grid 1 <b>0.352 M4</b>	Grid 2 <b>0.247 M4</b>	Grid 3 <b>0.148 M4</b>
Grid 4 <b>0.319 M4</b>	Grid 5 <b>0.231 M4</b>	Grid 6 <b>0.144 M4</b>
Grid 7 <b>0.355 M4</b>	Grid 8 <b>0.257 M4</b>	Grid 9 <b>0.166 M4</b>

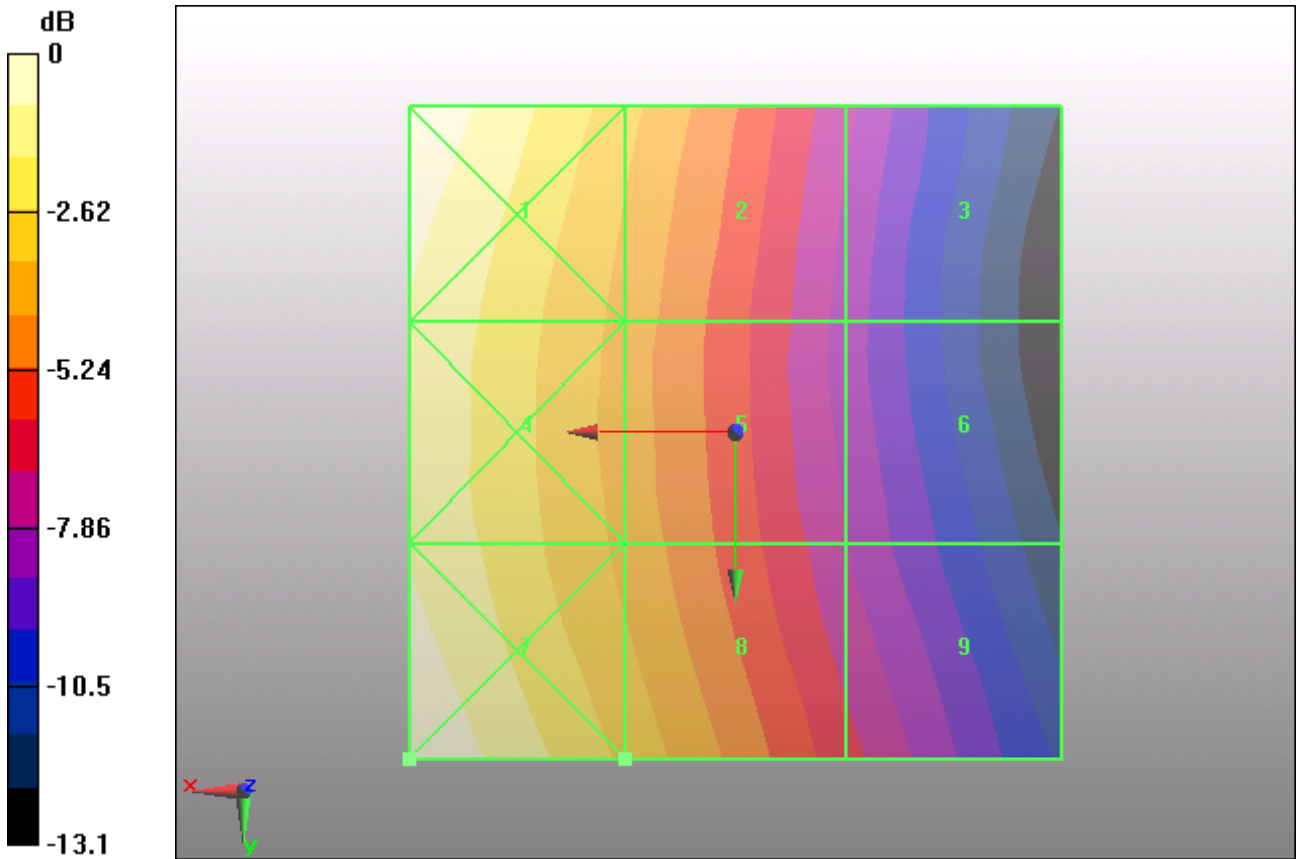

0 dB = 0.355A/m

Figure 17 HAC RF H-Field GSM 850 Channel 128

**TA Technology (Shanghai) Co., Ltd.**  
**Test Report**

Report No. RXA1204-0048HAC01R1

Page 45 of 119

**HAC RF E-Field GSM 1900 High**

Date/Time: 4/15/2012 10:29:36 AM

Communication System: GSM; Frequency: 1909.8 MHz; Duty Cycle: 1:8.30042

Medium parameters used:  $\sigma = 0$  mho/m,  $\epsilon_r = 1$ ;  $\rho = 1000$  kg/m<sup>3</sup>

Ambient Temperature: 22.3 °C

Phantom section: RF Section

DASY5 Configuration:

Probe: ER3DV6 - SN2303; ConvF(1, 1, 1); Calibrated: 2/21/2012

Electronics: DAE4 Sn871; Calibrated: 11/22/2011

Phantom: HAC Test Arch with AMCC; Type: SD HAC P01 BA;

Measurement SW: DASY5, V5.2 Build 162; SEMCAD X Version 14.0 Build 59

**one touch 995S GSM 1900 HAC RF E-Field/E Scan - ER3D - 2007: 15 mm from Probe Center to the Device High/Hearing Aid Compatibility Test (101x101x1):** Measurement grid: dx=5mm, dy=5mm

Maximum value of peak Total field = 56.3 V/m

Probe Modulation Factor = 2.84

Device Reference Point: 0, 0, -6.3 mm

Reference Value = 13.6 V/m; Power Drift = 0.111 dB

**Hearing Aid Near-Field Category: M3 (AWF -5 dB)**

Peak E-field in V/m

Grid 1 <b>44.6 M4</b>	Grid 2 <b>56.3 M3</b>	Grid 3 <b>56.1 M3</b>
Grid 4 <b>34.3 M4</b>	Grid 5 <b>48.6 M3</b>	Grid 6 <b>48.5 M3</b>
Grid 7 <b>65.6 M3</b>	Grid 8 <b>73.6 M3</b>	Grid 9 <b>70.9 M3</b>

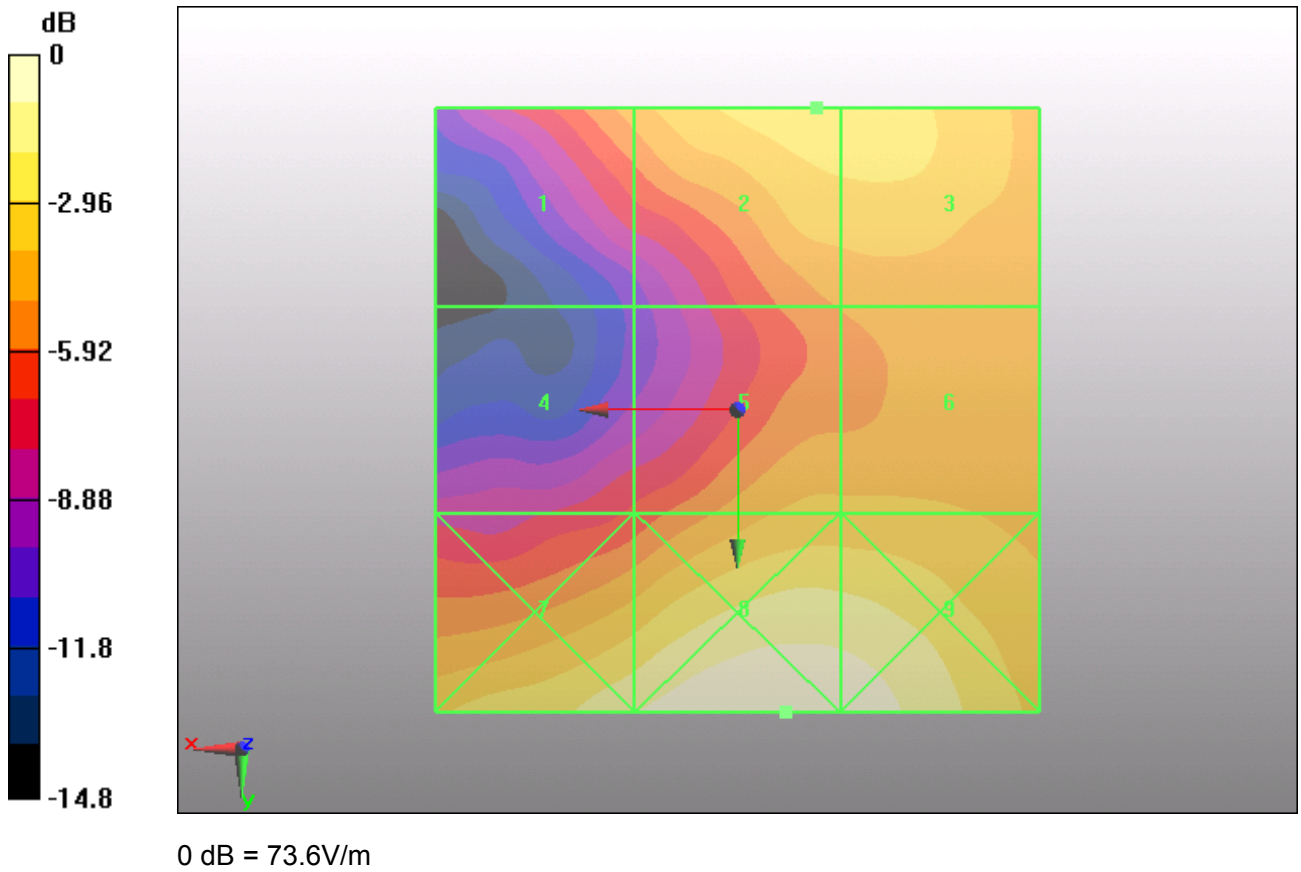

Figure 18 HAC RF E-Field GSM 1900 Channel 810

**TA Technology (Shanghai) Co., Ltd.**  
**Test Report**

Report No. RXA1204-0048HAC01R1

Page 47 of 119

**HAC RF E-Field GSM 1900 Middle**

Date/Time: 4/15/2012 10:17:47 AM

Communication System: GSM; Frequency: 1880 MHz; Duty Cycle: 1:8.30042

Medium parameters used:  $\sigma = 0$  mho/m,  $\epsilon_r = 1$ ;  $\rho = 1000$  kg/m<sup>3</sup>

Ambient Temperature: 22.3 °C

Phantom section: RF Section

DASY5 Configuration:

Probe: ER3DV6 - SN2303; ConvF(1, 1, 1); Calibrated: 2/21/2012

Electronics: DAE4 Sn871; Calibrated: 11/22/2011

Phantom: HAC Test Arch with AMCC; Type: SD HAC P01 BA;

Measurement SW: DASY5, V5.2 Build 162; SEMCAD X Version 14.0 Build 59

**one touch 995S GSM 1900 HAC RF E-Field/E Scan - ER3D - 2007: 15 mm from Probe Center to the Device Middle/Hearing Aid Compatibility Test (101x101x1):** Measurement grid: dx=5mm, dy=5mm

Maximum value of peak Total field = 50.7 V/m

Probe Modulation Factor = 2.84

Device Reference Point: 0, 0, -6.3 mm

Reference Value = 12.5 V/m; Power Drift = 0.018 dB

**Hearing Aid Near-Field Category: M3 (AWF -5 dB)**

Peak E-field in V/m

Grid 1	Grid 2	Grid 3
<b>38.9 M4</b>	<b>50.7 M3</b>	<b>50.7 M3</b>
Grid 4	Grid 5	Grid 6
<b>30.3 M4</b>	<b>43.6 M4</b>	<b>43.6 M4</b>
Grid 7	Grid 8	Grid 9
<b>55.9 M3</b>	<b>63.2 M3</b>	<b>61.4 M3</b>

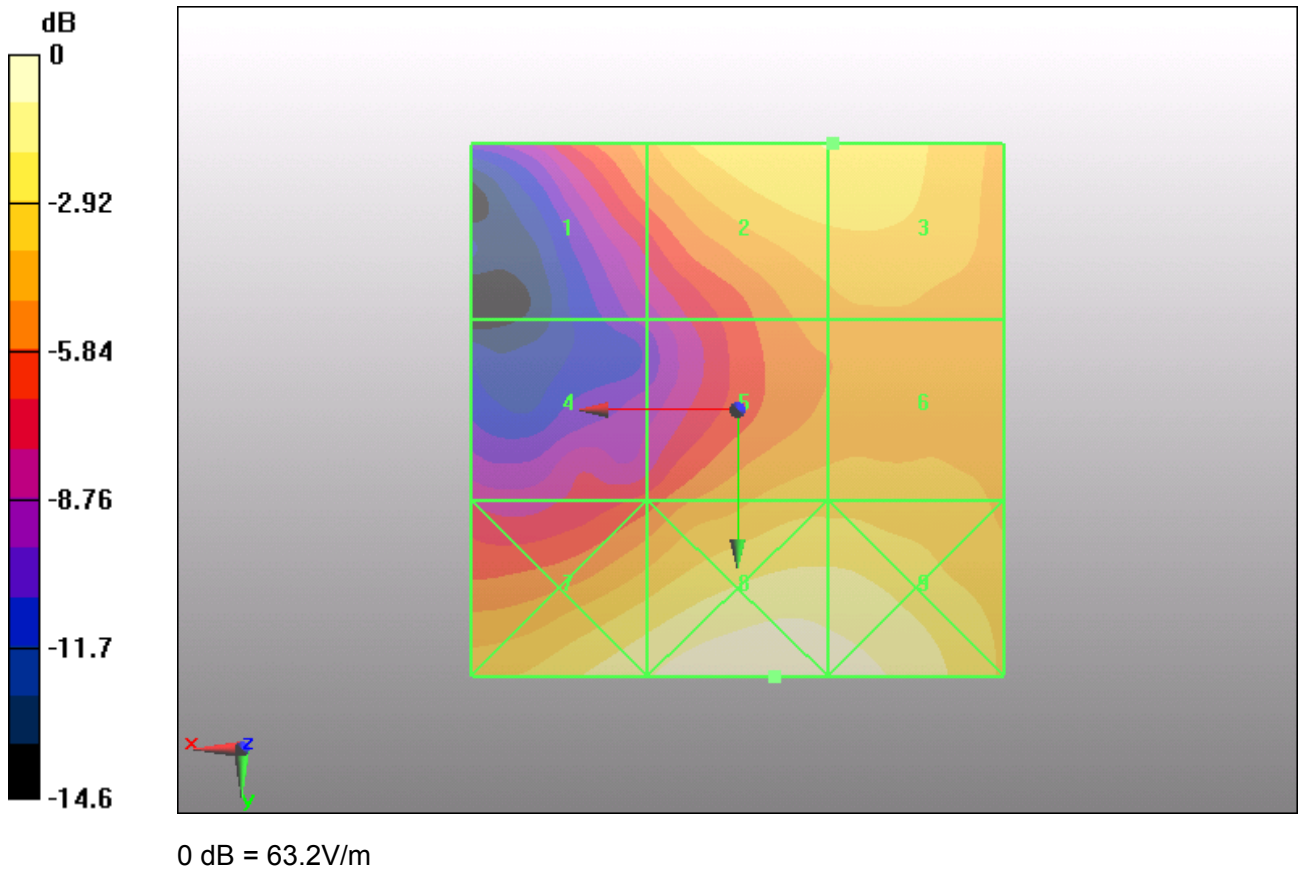

Figure 19 HAC RF E-Field GSM 1900 Channel 661



**TA Technology (Shanghai) Co., Ltd.**  
**Test Report**

Report No. RXA1204-0048HAC01R1

Page 49 of 119

**HAC RF E-Field GSM 1900 Low**

Date/Time: 4/15/2012 10:23:26 AM

Communication System: GSM; Frequency: 1850.2 MHz; Duty Cycle: 1:8.30042

Medium parameters used:  $\sigma = 0$  mho/m,  $\epsilon_r = 1$ ;  $\rho = 1000$  kg/m<sup>3</sup>

Ambient Temperature: 22.3 °C

Phantom section: RF Section

DASY5 Configuration:

Probe: ER3DV6 - SN2303; ConvF(1, 1, 1); Calibrated: 2/21/2012

Electronics: DAE4 Sn871; Calibrated: 11/22/2011

Phantom: HAC Test Arch with AMCC; Type: SD HAC P01 BA;

Measurement SW: DASY5, V5.2 Build 162; SEMCAD X Version 14.0 Build 59

**one touch 995S GSM 1900 HAC RF E-Field/E Scan - ER3D - 2007: 15 mm from Probe Center to the Device Low/Hearing Aid Compatibility Test (101x101x1):** Measurement grid: dx=5mm, dy=5mm

Maximum value of peak Total field = 53.5 V/m

Probe Modulation Factor = 2.84

Device Reference Point: 0, 0, -6.3 mm

Reference Value = 12.1 V/m; Power Drift = 0.047 dB

**Hearing Aid Near-Field Category: M3 (AWF -5 dB)**

Peak E-field in V/m

Grid 1 <b>40.3 M4</b>	Grid 2 <b>53.5 M3</b>	Grid 3 <b>53 M3</b>
Grid 4 <b>31.8 M4</b>	Grid 5 <b>40.8 M4</b>	Grid 6 <b>40.7 M4</b>
Grid 7 <b>57.9 M3</b>	Grid 8 <b>62.3 M3</b>	Grid 9 <b>59.2 M3</b>

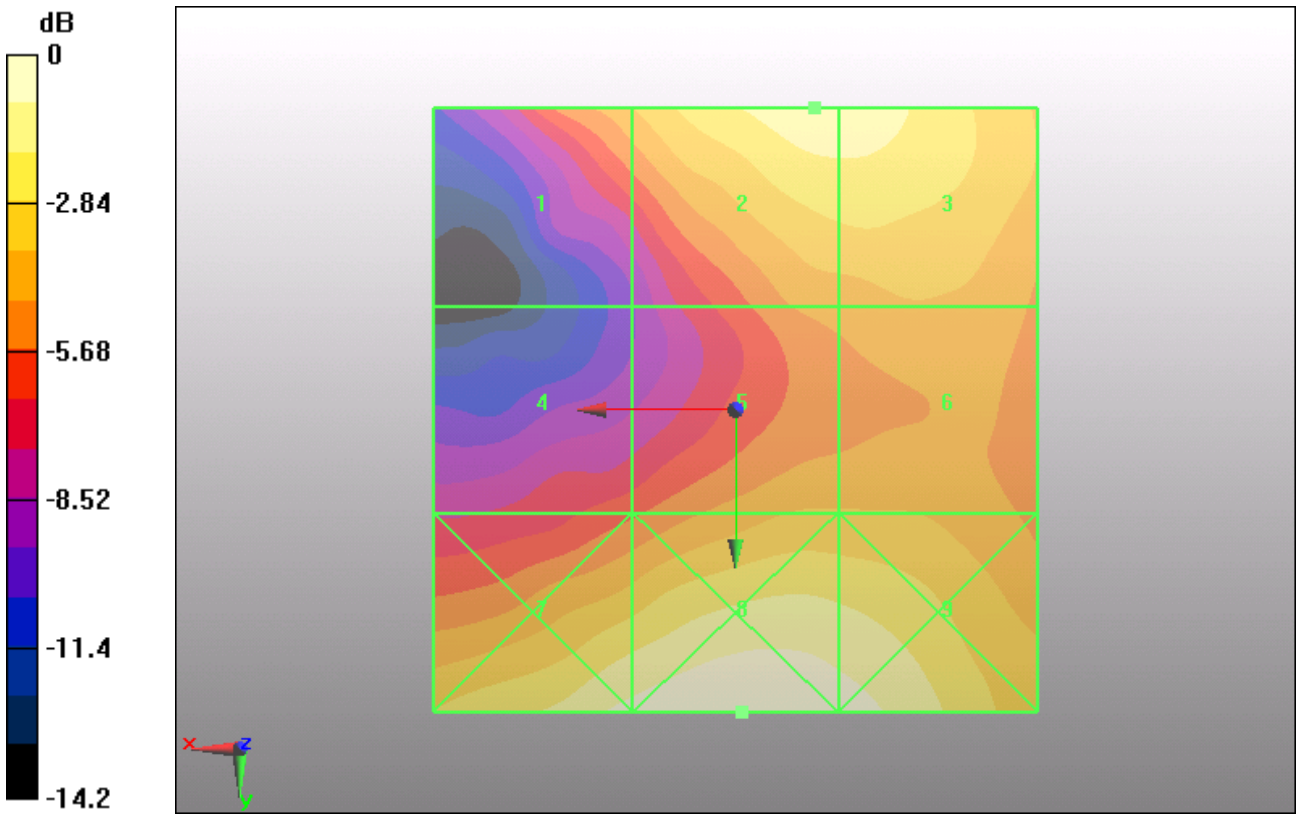

0 dB = 62.3V/m

Figure 20 HAC RF E-Field GSM 1900 Channel 512

**TA Technology (Shanghai) Co., Ltd.**  
**Test Report**

Report No. RXA1204-0048HAC01R1

Page 51 of 119

**HAC RF H-Field GSM 1900 High**

Date/Time: 4/15/2012 12:54:34 PM

Communication System: GSM; Frequency: 1909.8 MHz; Duty Cycle: 1:8.30042

Medium parameters used:  $\sigma = 0$  mho/m,  $\epsilon_r = 1$ ;  $\rho = 1$  kg/m<sup>3</sup>

Ambient Temperature: 22.3 °C

Phantom section: RF Section

DASY5 Configuration:

Probe: H3DV6 - SN6138; ; Calibrated: 2/21/2012

Electronics: DAE4 Sn871; Calibrated: 11/22/2011

Phantom: HAC Test Arch with AMCC; Type: SD HAC P01 BA

Measurement SW: DASY5, V5.2 Build 162; SEMCAD X Version 14.0 Build 59

**One touch 995S GSM 1900 HAC RF H-Field/H Scan - H3DV6 - 2007: 15 mm from Probe Center to the Device High/Hearing Aid Compatibility Test (101x101x1):** Measurement grid: dx=5mm, dy=5mm

Maximum value of peak Total field = 0.176 A/m

Probe Modulation Factor = 2.84

Device Reference Point: 0, 0, -6.3 mm

Reference Value = 0.068 A/m; Power Drift = -0.004 dB

**Hearing Aid Near-Field Category: M3 (AWF -5 dB)**

Peak H-field in A/m

Grid 1	Grid 2	Grid 3
<b>0.119 M4</b>	<b>0.159 M3</b>	<b>0.159 M3</b>
Grid 4	Grid 5	Grid 6
<b>0.145 M3</b>	<b>0.176 M3</b>	<b>0.175 M3</b>
Grid 7	Grid 8	Grid 9
<b>0.179 M3</b>	<b>0.175 M3</b>	<b>0.174 M3</b>

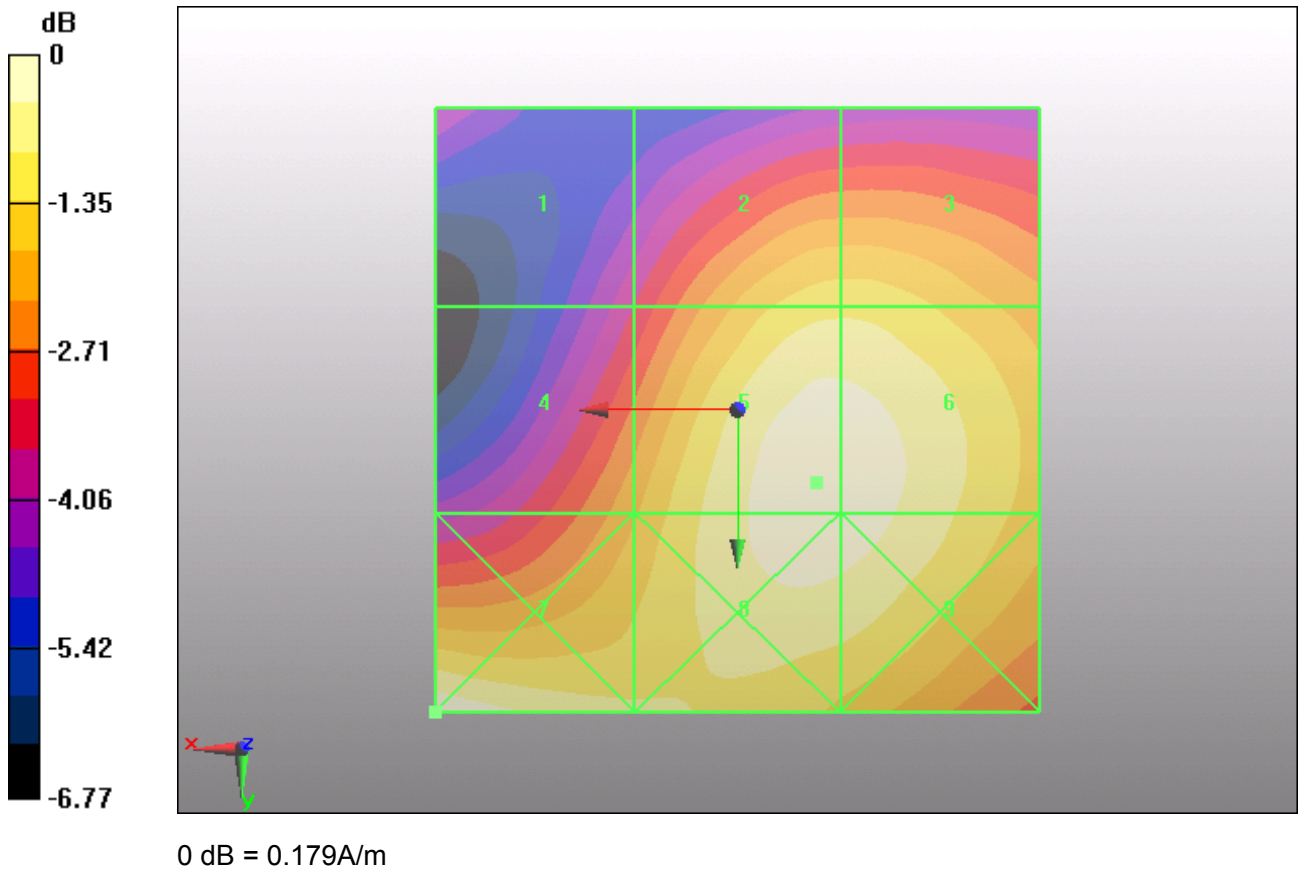

Figure 21 HAC RF H-Field GSM 1900 Channel 810

**TA Technology (Shanghai) Co., Ltd.**  
**Test Report**

Report No. RXA1204-0048HAC01R1

Page 53 of 119

**HAC RF H-Field GSM 1900 Middle**

Date/Time: 4/15/2012 12:48:51 PM

Communication System: GSM; Frequency: 1880 MHz; Duty Cycle: 1:8.30042

Medium parameters used:  $\sigma = 0$  mho/m,  $\epsilon_r = 1$ ;  $\rho = 1$  kg/m<sup>3</sup>

Ambient Temperature: 22.3 °C

Phantom section: RF Section

DASY5 Configuration:

Probe: H3DV6 - SN6138; ; Calibrated: 2/21/2012

Electronics: DAE4 Sn871; Calibrated: 11/22/2011

Phantom: HAC Test Arch with AMCC; Type: SD HAC P01 BA

Measurement SW: DASY5, V5.2 Build 162; SEMCAD X Version 14.0 Build 59

**One touch 995S GSM 1900 HAC RF H-Field/H Scan - H3DV6 - 2007: 15 mm from Probe Center to the Device Middle/Hearing Aid Compatibility Test (101x101x1):** Measurement grid: dx=5mm, dy=5mm

Maximum value of peak Total field = 0.141 A/m

Probe Modulation Factor = 2.84

Device Reference Point: 0, 0, -6.3 mm

Reference Value = 0.056 A/m; Power Drift = 0.016 dB

**Hearing Aid Near-Field Category: M3 (AWF -5 dB)**

Peak H-field in A/m

Grid 1	Grid 2	Grid 3
<b>0.107 M4</b>	<b>0.125 M4</b>	<b>0.125 M4</b>
Grid 4	Grid 5	Grid 6
<b>0.121 M4</b>	<b>0.141 M3</b>	<b>0.139 M4</b>
Grid 7	Grid 8	Grid 9
<b>0.148 M3</b>	<b>0.141 M3</b>	<b>0.139 M4</b>

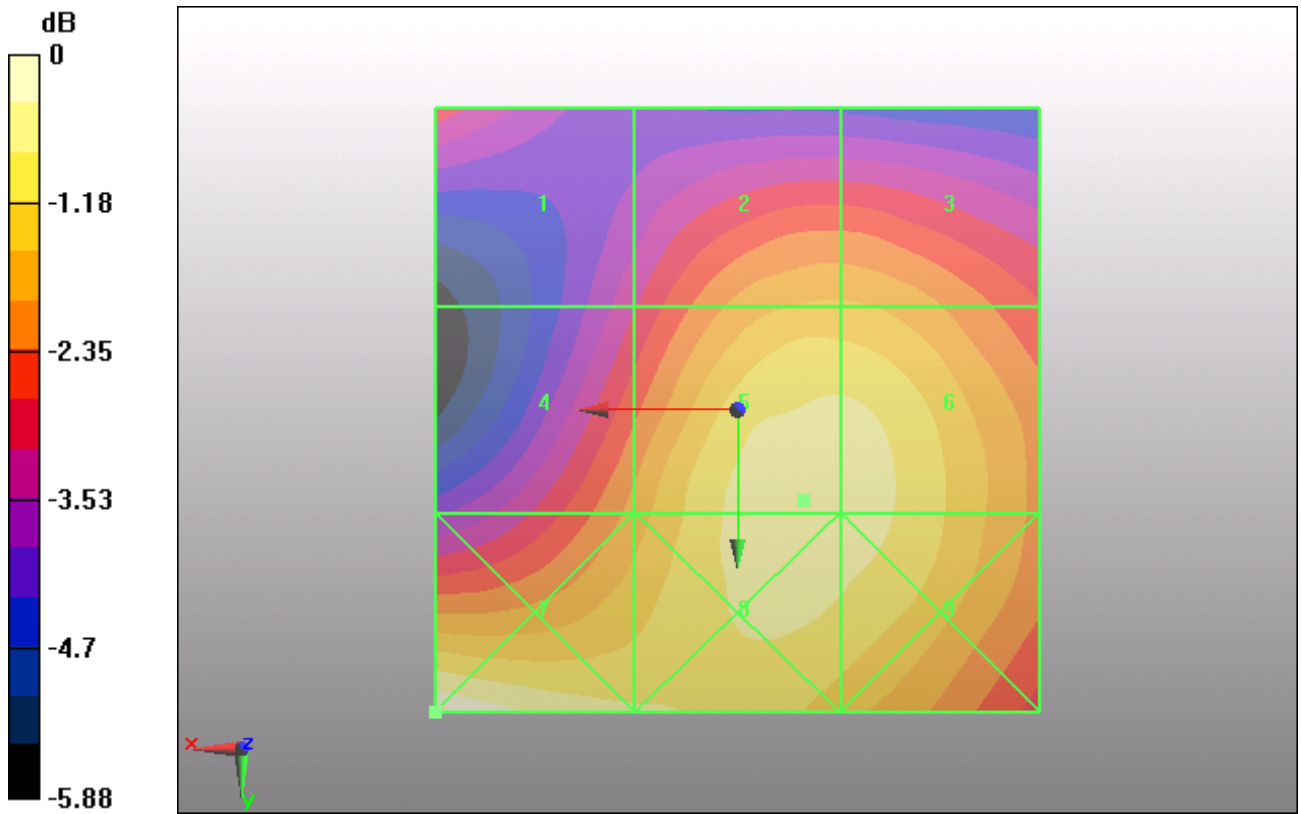

0 dB = 0.148A/m

Figure 22 HAC RF H-Field GSM 1900 Channel 661

**TA Technology (Shanghai) Co., Ltd.**  
**Test Report**

Report No. RXA1204-0048HAC01R1

Page 55 of 119

**HAC RF H-Field GSM 1900 Low**

Date/Time: 4/15/2012 1:30:13 PM

Communication System: GSM; Frequency: 1850.2 MHz; Duty Cycle: 1:8.30042

Medium parameters used:  $\sigma = 0$  mho/m,  $\epsilon_r = 1$ ;  $\rho = 1$  kg/m<sup>3</sup>

Ambient Temperature: 22.3 °C

Phantom section: RF Section

DASY5 Configuration:

Probe: H3DV6 - SN6138; ; Calibrated: 2/21/2012

Electronics: DAE4 Sn871; Calibrated: 11/22/2011

Phantom: HAC Test Arch with AMCC; Type: SD HAC P01 BA

Measurement SW: DASY5, V5.2 Build 162; SEMCAD X Version 14.0 Build 59

**One touch 995S GSM 1900 HAC RF H-Field/H Scan - H3DV6 - 2007: 15 mm from Probe Center to the Device Low 2/Hearing Aid Compatibility Test (101x101x1):** Measurement grid: dx=5mm, dy=5mm

Maximum value of peak Total field = 0.160 A/m

Probe Modulation Factor = 2.84

Device Reference Point: 0, 0, -6.3 mm

Reference Value = 0.065 A/m; Power Drift = 0.085 dB

**Hearing Aid Near-Field Category: M3 (AWF -5 dB)**

Peak H-field in A/m

Grid 1	Grid 2	Grid 3
<b>0.122 M4</b>	<b>0.149 M3</b>	<b>0.148 M3</b>
Grid 4	Grid 5	Grid 6
<b>0.135 M4</b>	<b>0.160 M3</b>	<b>0.159 M3</b>
Grid 7	Grid 8	Grid 9
<b>0.163 M3</b>	<b>0.158 M3</b>	<b>0.157 M3</b>

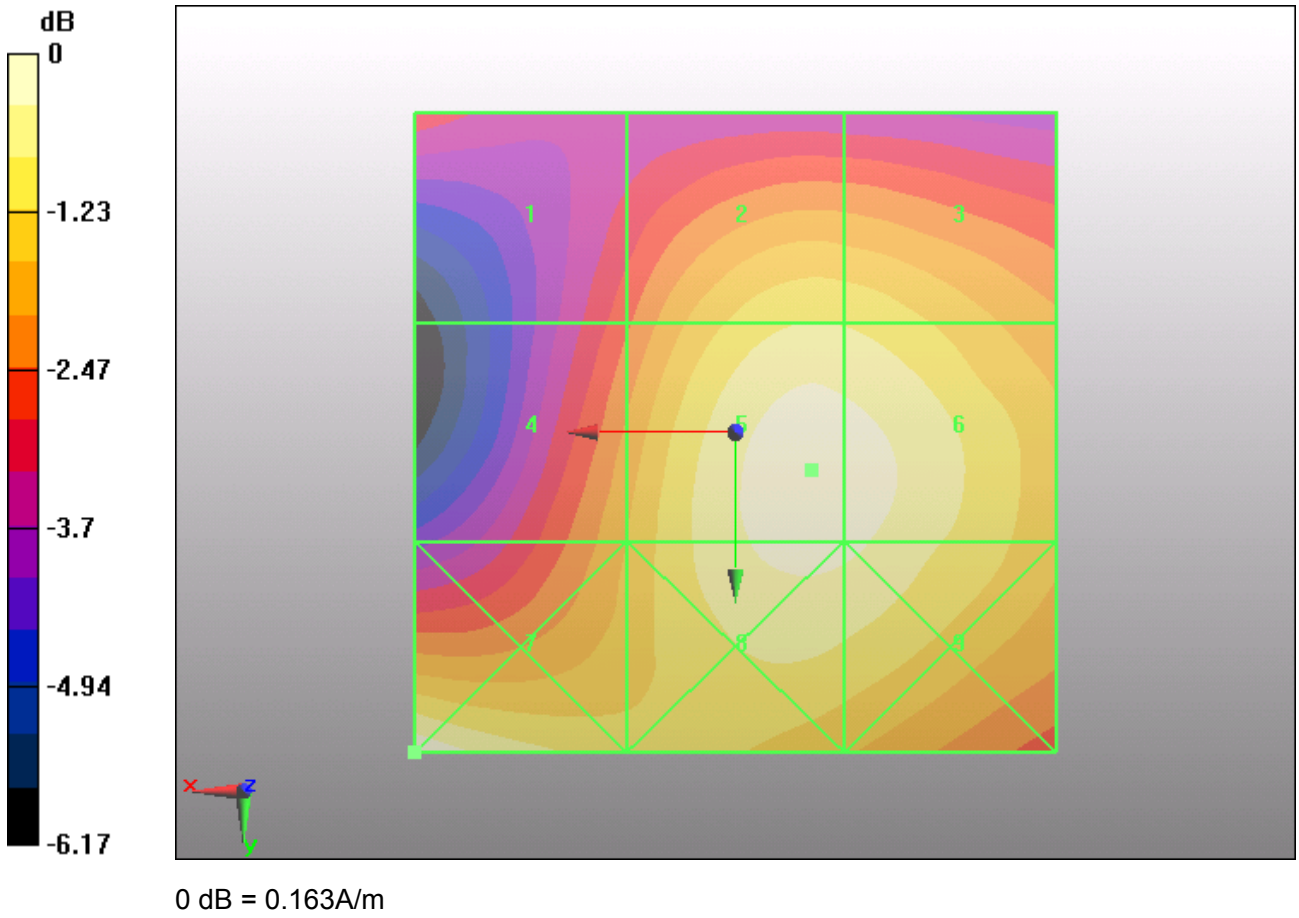

Figure 23 HAC RF H-Field GSM 1900 Channel 512



**TA Technology (Shanghai) Co., Ltd.**  
**Test Report**

Report No. RXA1204-0048HAC01R1

Page 57 of 119

**HAC RF E-Field WCDMA Band IV High**

Date/Time: 4/15/2012 10:55:28 AM

Communication System: WCDMA ; Frequency: 1752.6 MHz;Duty Cycle: 1:1

Medium parameters used:  $\sigma = 0$  mho/m,  $\epsilon_r = 1$ ;  $\rho = 1000$  kg/m<sup>3</sup>

Ambient Temperature:22.3 °C

Phantom section: RF Section

DASY5 Configuration:

Probe: ER3DV6 - SN2303; ConvF(1, 1, 1); Calibrated: 2/21/2012

Electronics: DAE4 Sn871; Calibrated: 11/22/2011

Phantom: HAC Test Arch with AMCC; Type: SD HAC P01 BA;

Measurement SW: DASY5, V5.2 Build 162; SEMCAD X Version 14.0 Build 59

**one touch 870A WCDMA Band II HAC RF E-Field/E Scan - ER3D - 2007: 15 mm from Probe Center to the Device High/Hearing Aid Compatibility Test (101x101x1):** Measurement grid: dx=5mm, dy=5mm

Maximum value of peak Total field = 34.3 V/m

Probe Modulation Factor = 1.03

Device Reference Point: 0, 0, -6.3 mm

Reference Value = 24.5 V/m; Power Drift = -0.173 dB

**Hearing Aid Near-Field Category: M4 (AWF 0 dB)**

Peak E-field in V/m

Grid 1 <b>27.3 M4</b>	Grid 2 <b>34.3 M4</b>	Grid 3 <b>34 M4</b>
Grid 4 <b>19.8 M4</b>	Grid 5 <b>26.6 M4</b>	Grid 6 <b>27.1 M4</b>
Grid 7 <b>34.2 M4</b>	Grid 8 <b>36.4 M4</b>	Grid 9 <b>33.6 M4</b>

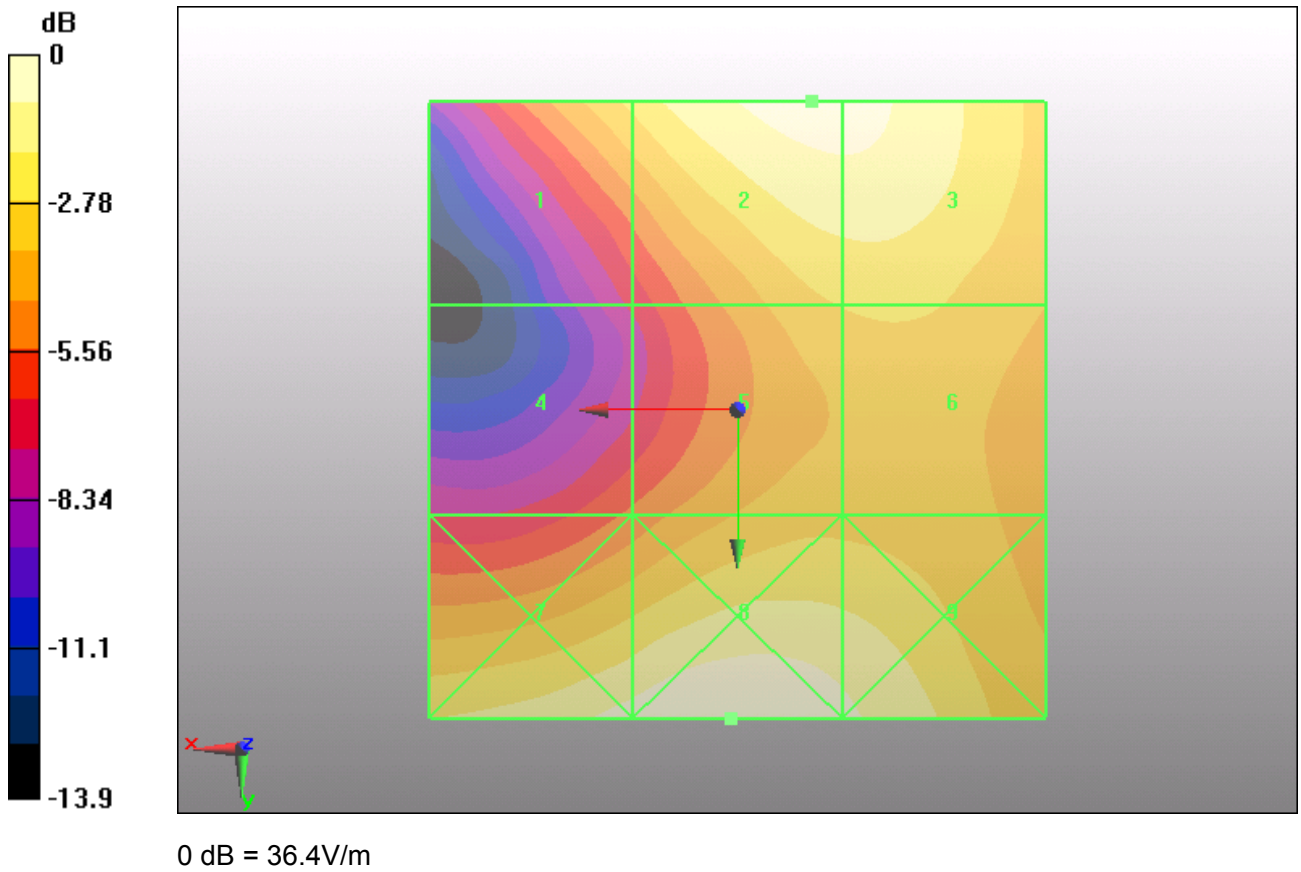

Figure 24 HAC RF E-Field WCDMA Band IV Channel 1513

**TA Technology (Shanghai) Co., Ltd.**  
**Test Report**

Report No. RXA1204-0048HAC01R1

Page 59 of 119

**HAC RF E-Field WCDMA Band IV Middle**

Date/Time: 4/15/2012 10:41:44 AM

Communication System: WCDMA ; Frequency: 1732.6 MHz;Duty Cycle: 1:1

Medium parameters used:  $\sigma = 0$  mho/m,  $\epsilon_r = 1$ ;  $\rho = 1000$  kg/m<sup>3</sup>

Ambient Temperature:22.3 °C

Phantom section: RF Section

DASY5 Configuration:

Probe: ER3DV6 - SN2303; ConvF(1, 1, 1); Calibrated: 2/21/2012

Electronics: DAE4 Sn871; Calibrated: 11/22/2011

Phantom: HAC Test Arch with AMCC; Type: SD HAC P01 BA;

Measurement SW: DASY5, V5.2 Build 162; SEMCAD X Version 14.0 Build 59

**one touch 870A WCDMA Band II HAC RF E-Field/E Scan - ER3D - 2007: 15 mm from Probe Center to the Device Middle/Hearing Aid Compatibility Test (101x101x1):** Measurement grid: dx=5mm, dy=5mm

Maximum value of peak Total field = 36.2 V/m

Probe Modulation Factor = 1.03

Device Reference Point: 0, 0, -6.3 mm

Reference Value = 25.1 V/m; Power Drift = -0.080 dB

**Hearing Aid Near-Field Category: M4 (AWF 0 dB)**

Peak E-field in V/m

Grid 1 <b>29.1 M4</b>	Grid 2 <b>36.2 M4</b>	Grid 3 <b>35.9 M4</b>
Grid 4 <b>22.5 M4</b>	Grid 5 <b>27.5 M4</b>	Grid 6 <b>27.7 M4</b>
Grid 7 <b>38.7 M4</b>	Grid 8 <b>40.6 M4</b>	Grid 9 <b>37.5 M4</b>

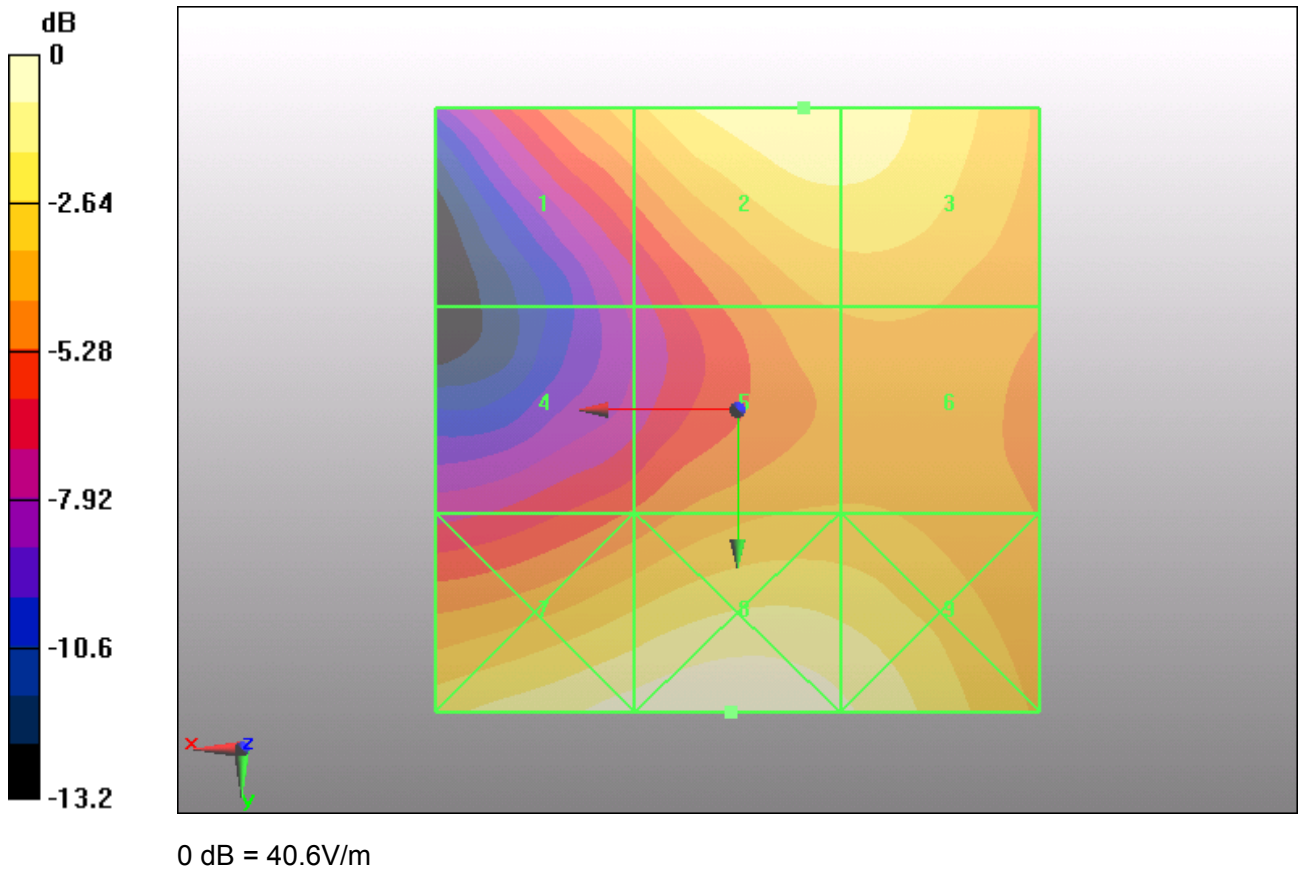

Figure 25 HAC RF E-Field WCDMA Band IV Channel 1413

**TA Technology (Shanghai) Co., Ltd.**  
**Test Report**

Report No. RXA1204-0048HAC01R1

Page 61 of 119

**HAC RF E-Field WCDMA Band IV Low**

Date/Time: 4/15/2012 10:47:46 AM

Communication System: WCDMA ; Frequency: 1712.4 MHz;Duty Cycle: 1:1

Medium parameters used:  $\sigma = 0$  mho/m,  $\epsilon_r = 1$ ;  $\rho = 1000$  kg/m<sup>3</sup>

Ambient Temperature:22.3 °C

Phantom section: RF Section

DASY5 Configuration:

Probe: ER3DV6 - SN2303; ConvF(1, 1, 1); Calibrated: 2/21/2012

Electronics: DAE4 Sn871; Calibrated: 11/22/2011

Phantom: HAC Test Arch with AMCC; Type: SD HAC P01 BA;

Measurement SW: DASY5, V5.2 Build 162; SEMCAD X Version 14.0 Build 59

**one touch 870A WCDMA Band II HAC RF E-Field/E Scan - ER3D - 2007: 15 mm from Probe Center to the Device Low/Hearing Aid Compatibility Test (101x101x1):** Measurement grid: dx=5mm, dy=5mm

Maximum value of peak Total field = 34.7 V/m

Probe Modulation Factor = 1.03

Device Reference Point: 0, 0, -6.3 mm

Reference Value = 21.3 V/m; Power Drift = -0.030 dB

**Hearing Aid Near-Field Category: M4 (AWF 0 dB)**

Peak E-field in V/m

Grid 1 <b>28 M4</b>	Grid 2 <b>34.7 M4</b>	Grid 3 <b>34.3 M4</b>
Grid 4 <b>20 M4</b>	Grid 5 <b>25.2 M4</b>	Grid 6 <b>25.6 M4</b>
Grid 7 <b>34.6 M4</b>	Grid 8 <b>35.3 M4</b>	Grid 9 <b>32.1 M4</b>

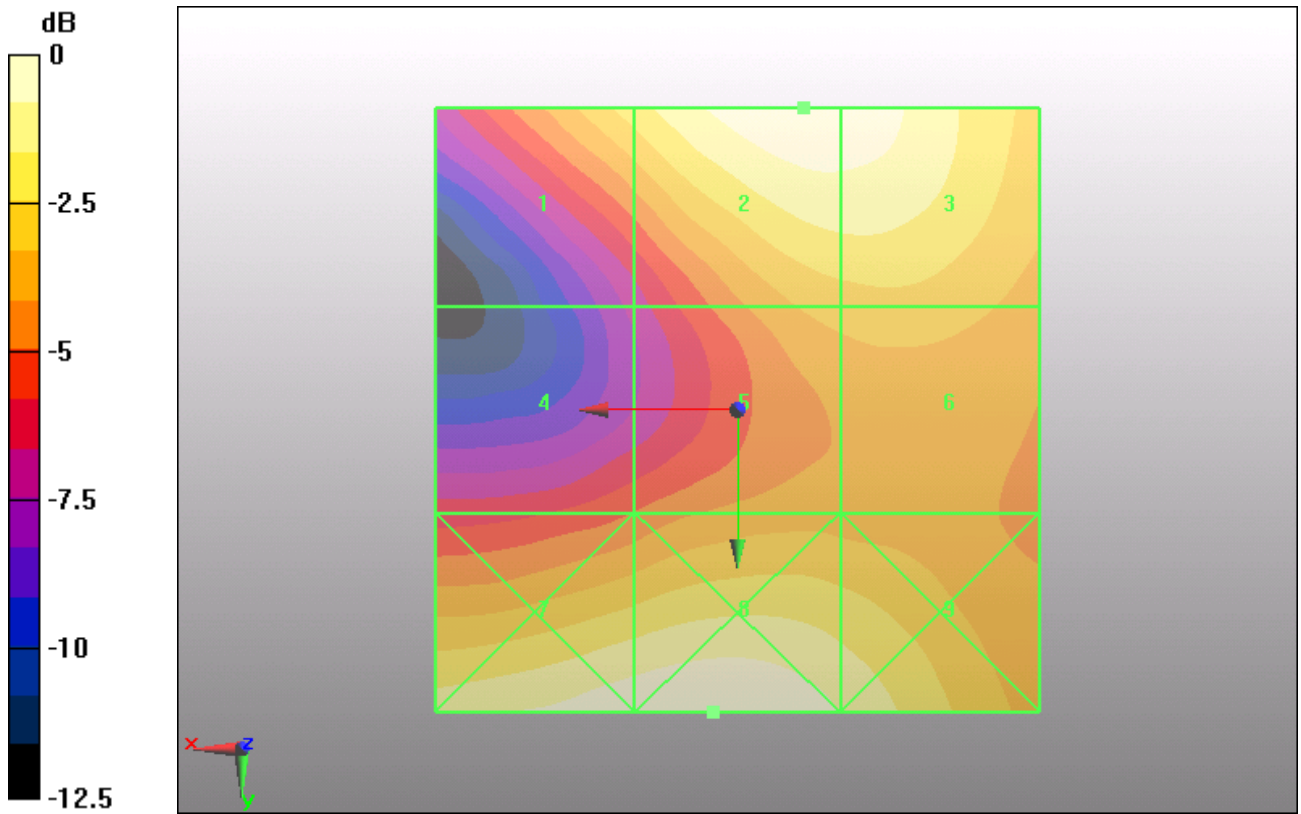

0 dB = 35.3V/m

Figure 26 HAC RF E-Field WCDMA Band IV Channel 1312

**TA Technology (Shanghai) Co., Ltd.**  
**Test Report**

Report No. RXA1204-0048HAC01R1

Page 63 of 119

**HAC RF H-Field WCDMA Band IV High**

Date/Time: 4/15/2012 1:45:01 PM

Communication System: WCDMA ; Frequency: 1752.6 MHz;Duty Cycle: 1:1

Medium parameters used:  $\sigma = 0$  mho/m,  $\epsilon_r = 1$ ;  $\rho = 1$  kg/m<sup>3</sup>

Ambient Temperature:22.3 °C

Phantom section: RF Section

DASY5 Configuration:

Probe: H3DV6 - SN6138; ; Calibrated: 2/21/2012

Electronics: DAE4 Sn871; Calibrated: 11/22/2011

Phantom: HAC Test Arch with AMCC; Type: SD HAC P01 BA

Measurement SW: DASY5, V5.2 Build 162; SEMCAD X Version 14.0 Build 59

**One touch 995S WCDMA IV HAC RF H-Field/H Scan - H3DV6 - 2007: 15 mm from Probe Center to the Device High/Hearing Aid Compatibility Test (101x101x1):** Measurement grid: dx=5mm, dy=5mm

Maximum value of peak Total field = 0.102 A/m

Probe Modulation Factor = 1.01

Device Reference Point: 0, 0, -6.3 mm

Reference Value = 0.115 A/m; Power Drift = 0.032 dB

**Hearing Aid Near-Field Category: M4 (AWF 0 dB)**

Peak H-field in A/m

Grid 1 <b>0.083 M4</b>	Grid 2 <b>0.090 M4</b>	Grid 3 <b>0.089 M4</b>
Grid 4 <b>0.093 M4</b>	Grid 5 <b>0.102 M4</b>	Grid 6 <b>0.100 M4</b>
Grid 7 <b>0.096 M4</b>	Grid 8 <b>0.102 M4</b>	Grid 9 <b>0.100 M4</b>

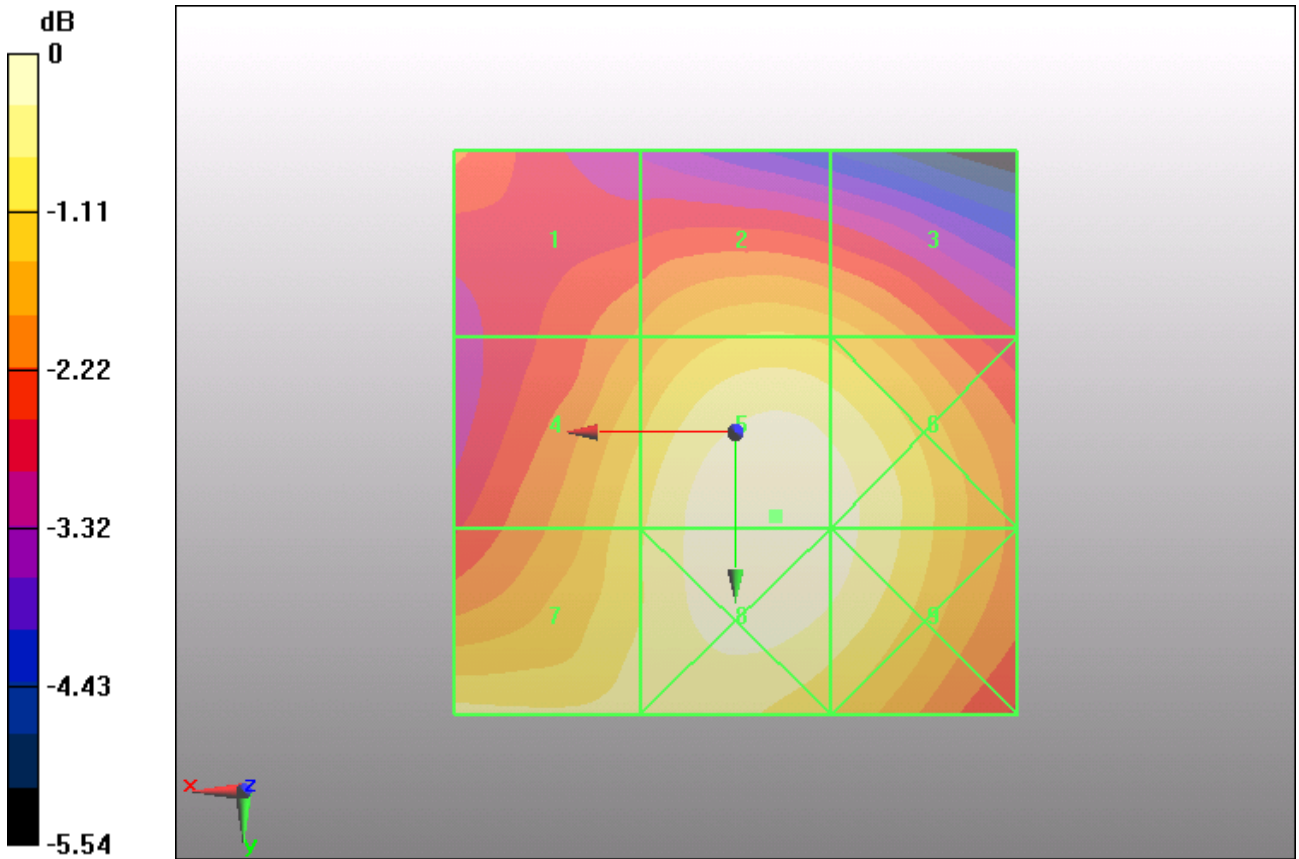

0 dB = 0.102A/m

Figure 27 HAC RF H-Field WCDMA Band IV Channel 1513



**TA Technology (Shanghai) Co., Ltd.**  
**Test Report**

Report No. RXA1204-0048HAC01R1

Page 65 of 119

**HAC RF H-Field WCDMA Band IV Middle**

Date/Time: 4/15/2012 1:39:05 PM

Communication System: WCDMA ; Frequency: 1732.6 MHz;Duty Cycle: 1:1

Medium parameters used:  $\sigma = 0$  mho/m,  $\epsilon_r = 1$ ;  $\rho = 1$  kg/m<sup>3</sup>

Ambient Temperature:22.3 °C

Phantom section: RF Section

DASY5 Configuration:

Probe: H3DV6 - SN6138; ; Calibrated: 2/21/2012

Electronics: DAE4 Sn871; Calibrated: 11/22/2011

Phantom: HAC Test Arch with AMCC; Type: SD HAC P01 BA

Measurement SW: DASY5, V5.2 Build 162; SEMCAD X Version 14.0 Build 59

**One touch 995S WCDMA IV HAC RF H-Field/H Scan - H3DV6 - 2007: 15 mm from Probe Center to the Device Middle/Hearing Aid Compatibility Test (101x101x1):** Measurement grid: dx=5mm, dy=5mm

Maximum value of peak Total field = 0.107 A/m

Probe Modulation Factor = 1.01

Device Reference Point: 0, 0, -6.3 mm

Reference Value = 0.119 A/m; Power Drift = -0.031 dB

**Hearing Aid Near-Field Category: M4 (AWF 0 dB)**

Peak H-field in A/m

Grid 1	Grid 2	Grid 3
<b>0.086 M4</b>	<b>0.094 M4</b>	<b>0.092 M4</b>
Grid 4	Grid 5	Grid 6
<b>0.096 M4</b>	<b>0.107 M4</b>	<b>0.105 M4</b>
Grid 7	Grid 8	Grid 9
<b>0.105 M4</b>	<b>0.107 M4</b>	<b>0.105 M4</b>

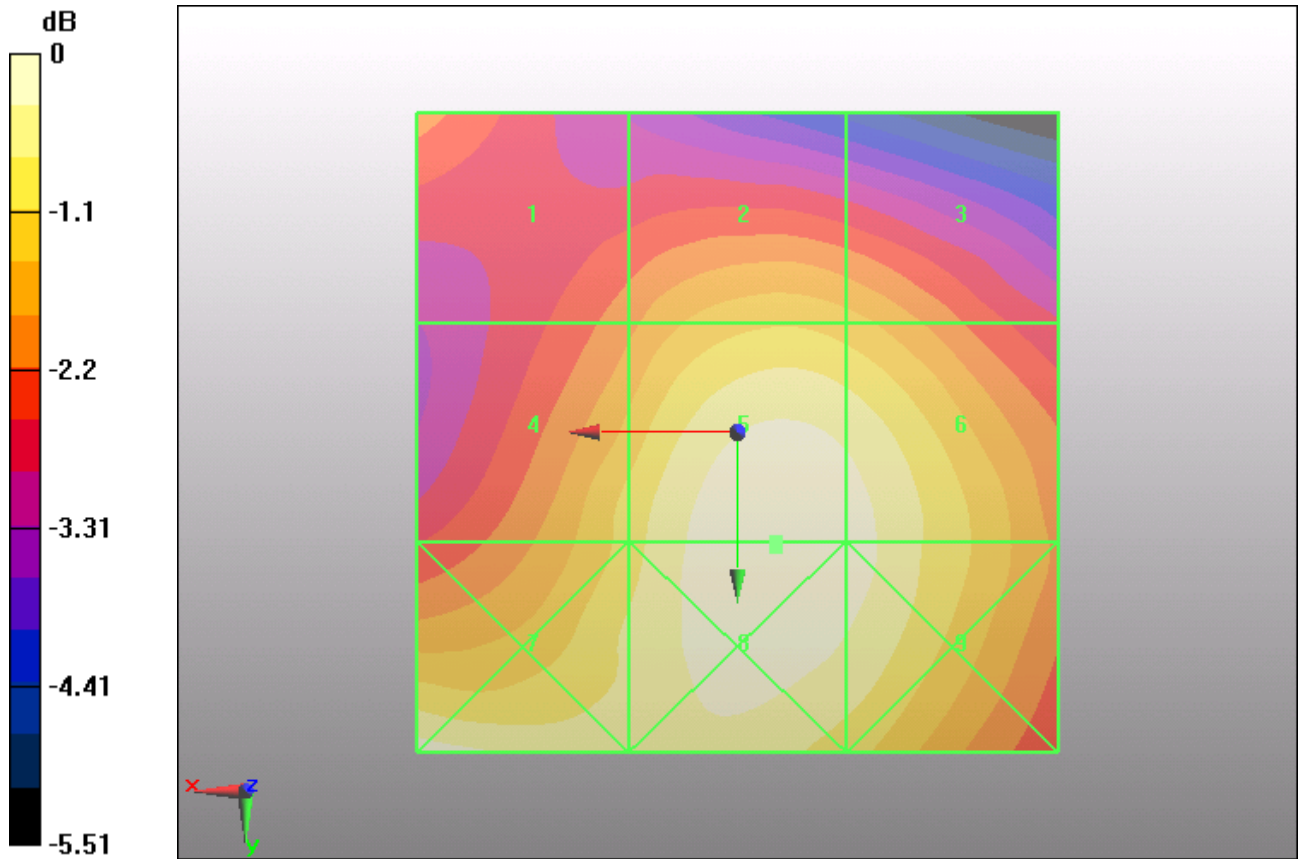

0 dB = 0.107A/m

Figure 28 HAC RF H-Field WCDMA Band IV Channel 1413

**TA Technology (Shanghai) Co., Ltd.**  
**Test Report**

Report No. RXA1204-0048HAC01R1

Page 67 of 119

**HAC RF H-Field WCDMA Band IV Low**

Date/Time: 4/15/2012 1:51:15 PM

Communication System: WCDMA ; Frequency: 1712.4 MHz;Duty Cycle: 1:1

Medium parameters used:  $\sigma = 0$  mho/m,  $\epsilon_r = 1$ ;  $\rho = 1$  kg/m<sup>3</sup>

Ambient Temperature:22.3 °C

Phantom section: RF Section

DASY5 Configuration:

Probe: H3DV6 - SN6138; ; Calibrated: 2/21/2012

Electronics: DAE4 Sn871; Calibrated: 11/22/2011

Phantom: HAC Test Arch with AMCC; Type: SD HAC P01 BA

Measurement SW: DASY5, V5.2 Build 162; SEMCAD X Version 14.0 Build 59

**One touch 995S WCDMA IV HAC RF H-Field/H Scan - H3DV6 - 2007: 15 mm from Probe Center to the Device Low/Hearing Aid Compatibility Test (101x101x1):** Measurement grid: dx=5mm, dy=5mm

Maximum value of peak Total field = 0.103 A/m

Probe Modulation Factor = 1.01

Device Reference Point: 0, 0, -6.3 mm

Reference Value = 0.115 A/m; Power Drift = -0.000 dB

**Hearing Aid Near-Field Category: M4 (AWF 0 dB)**

Peak H-field in A/m

Grid 1 <b>0.085 M4</b>	Grid 2 <b>0.091 M4</b>	Grid 3 <b>0.088 M4</b>
Grid 4 <b>0.095 M4</b>	Grid 5 <b>0.103 M4</b>	Grid 6 <b>0.100 M4</b>
Grid 7 <b>0.097 M4</b>	Grid 8 <b>0.103 M4</b>	Grid 9 <b>0.100 M4</b>

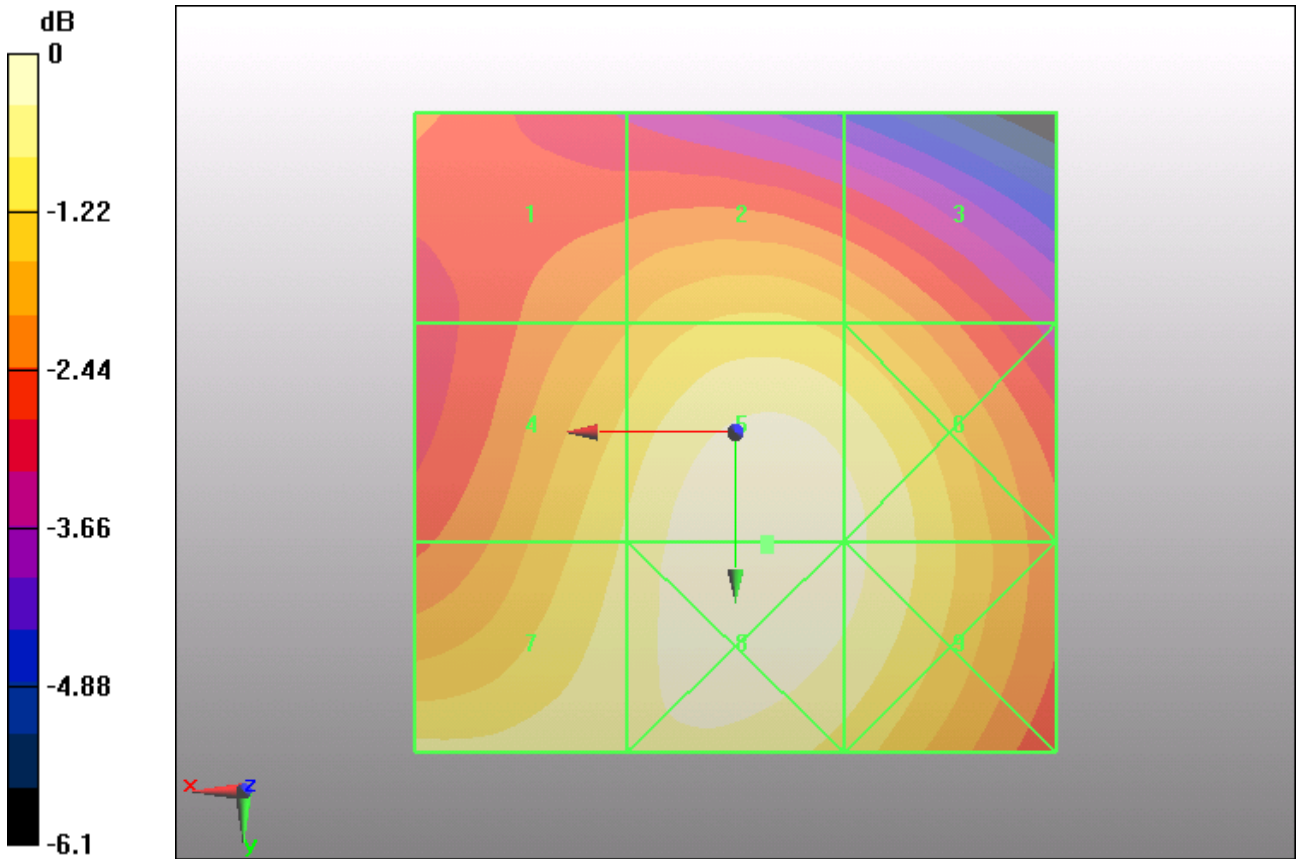

0 dB = 0.103A/m

Figure 29 HAC RF H-Field WCDMA Band IV Channel 1312

**TA Technology (Shanghai) Co., Ltd.**  
**Test Report**

Report No. RXA1204-0048HAC01R1

Page 69 of 119

**HAC RF E-Field WCDMA Band V High**

Date/Time: 4/15/2012 11:24:35 AM

Communication System: WCDMA ; Frequency: 846.6 MHz;Duty Cycle: 1:1

Medium parameters used:  $\sigma = 0$  mho/m,  $\epsilon_r = 1$ ;  $\rho = 1000$  kg/m<sup>3</sup>

Ambient Temperature:22.3 °C

Phantom section: RF Section

DASY5 Configuration:

Probe: ER3DV6 - SN2303; ConvF(1, 1, 1); Calibrated: 2/21/2012

Electronics: DAE4 Sn871; Calibrated: 11/22/2011

Phantom: HAC Test Arch with AMCC; Type: SD HAC P01 BA;

Measurement SW: DASY5, V5.2 Build 162; SEMCAD X Version 14.0 Build 59

**one touch995S WCDMA Band V HAC RF E-Field/E Scan - ER3D - 2007: 15 mm from Probe Center to the Device High/Hearing Aid Compatibility Test (101x101x1):** Measurement grid: dx=5mm, dy=5mm

Maximum value of peak Total field = 66.3 V/m

Probe Modulation Factor = 1.03

Device Reference Point: 0, 0, -6.3 mm

Reference Value = 81.2 V/m; Power Drift = -0.119 dB

**Hearing Aid Near-Field Category: M4 (AWF 0 dB)**

Peak E-field in V/m

Grid 1 <b>58.9 M4</b>	Grid 2 <b>65.8 M4</b>	Grid 3 <b>65 M4</b>
Grid 4 <b>57.2 M4</b>	Grid 5 <b>66.3 M4</b>	Grid 6 <b>65.5 M4</b>
Grid 7 <b>53.9 M4</b>	Grid 8 <b>64.1 M4</b>	Grid 9 <b>63.6 M4</b>

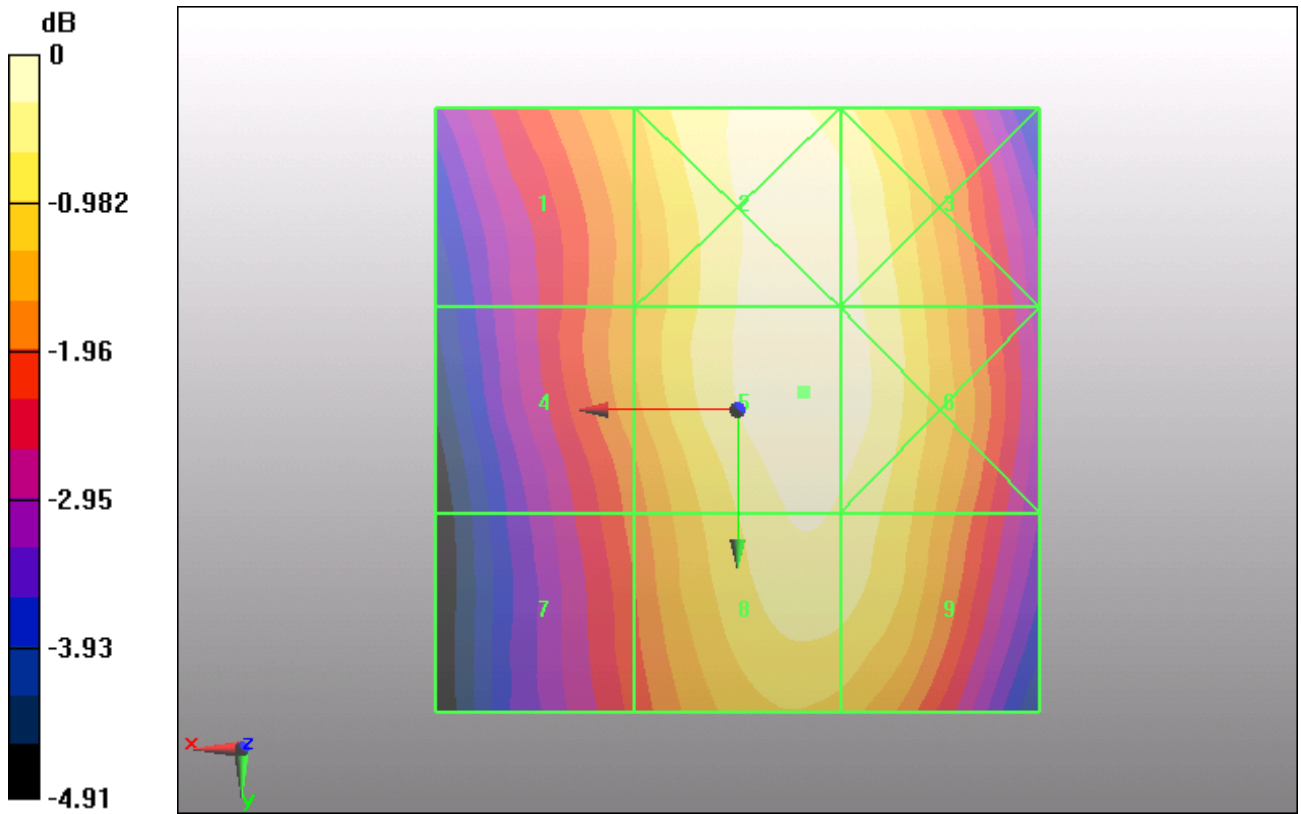

0 dB = 66.3V/m

Figure 30 HAC RF E-Field WCDMA Band V Channel 4233

**TA Technology (Shanghai) Co., Ltd.**  
**Test Report**

Report No. RXA1204-0048HAC01R1

Page 71 of 119

**HAC RF E-Field WCDMA Band V Middle**

Date/Time: 4/15/2012 11:08:51 AM

Communication System: WCDMA ; Frequency: 836.6 MHz;Duty Cycle: 1:1

Medium parameters used:  $\sigma = 0$  mho/m,  $\epsilon_r = 1$ ;  $\rho = 1000$  kg/m<sup>3</sup>

Ambient Temperature:22.3 °C

Phantom section: RF Section

DASY5 Configuration:

Probe: ER3DV6 - SN2303; ConvF(1, 1, 1); Calibrated: 2/21/2012

Electronics: DAE4 Sn871; Calibrated: 11/22/2011

Phantom: HAC Test Arch with AMCC; Type: SD HAC P01 BA;

Measurement SW: DASY5, V5.2 Build 162; SEMCAD X Version 14.0 Build 59

**one touch995S WCDMA Band V HAC RF E-Field/E Scan - ER3D - 2007: 15 mm from Probe Center to the Device Middle/Hearing Aid Compatibility Test (101x101x1):** Measurement grid: dx=5mm, dy=5mm

Maximum value of peak Total field = 58.4 V/m

Probe Modulation Factor = 1.03

Device Reference Point: 0, 0, -6.3 mm

Reference Value = 70.3 V/m; Power Drift = 0.051 dB

**Hearing Aid Near-Field Category: M4 (AWF 0 dB)**

Peak E-field in V/m

Grid 1	Grid 2	Grid 3
<b>51.4 M4</b>	<b>57.7 M4</b>	<b>57.2 M4</b>
Grid 4	Grid 5	Grid 6
<b>50.5 M4</b>	<b>58.4 M4</b>	<b>57.9 M4</b>
Grid 7	Grid 8	Grid 9
<b>47.9 M4</b>	<b>56.5 M4</b>	<b>56.2 M4</b>

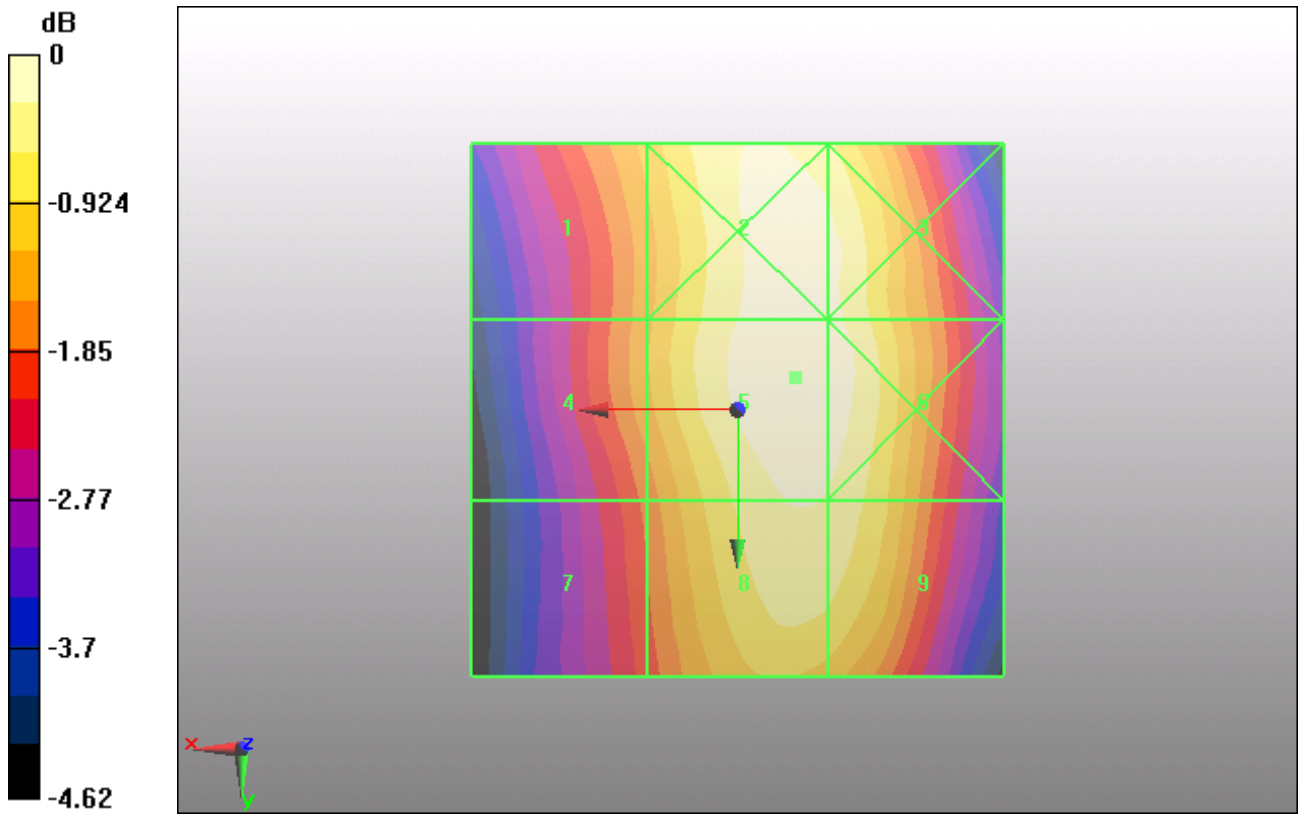

0 dB = 58.4V/m

Figure 31 HAC RF E-Field WCDMA Band V Channel 4183



**TA Technology (Shanghai) Co., Ltd.**  
**Test Report**

Report No. RXA1204-0048HAC01R1

Page 73 of 119

**HAC RF E-Field WCDMA Band V Low**

Date/Time: 4/15/2012 11:18:54 AM

Communication System: WCDMA ; Frequency: 826.4 MHz;Duty Cycle: 1:1

Medium parameters used:  $\sigma = 0$  mho/m,  $\epsilon_r = 1$ ;  $\rho = 1000$  kg/m<sup>3</sup>

Ambient Temperature:22.3 °C

Phantom section: RF Section

DASY5 Configuration:

Probe: ER3DV6 - SN2303; ConvF(1, 1, 1); Calibrated: 2/21/2012

Electronics: DAE4 Sn871; Calibrated: 11/22/2011

Phantom: HAC Test Arch with AMCC; Type: SD HAC P01 BA;

Measurement SW: DASY5, V5.2 Build 162; SEMCAD X Version 14.0 Build 59

**one touch995S WCDMA Band V HAC RF E-Field/E Scan - ER3D - 2007: 15 mm from Probe Center to the Device Low/Hearing Aid Compatibility Test (101x101x1):** Measurement grid: dx=5mm, dy=5mm

Maximum value of peak Total field = 64.4 V/m

Probe Modulation Factor = 1.03

Device Reference Point: 0, 0, -6.3 mm

Reference Value = 77.7 V/m; Power Drift = 0.005 dB

**Hearing Aid Near-Field Category: M4 (AWF 0 dB)**

Peak E-field in V/m

Grid 1 <b>56.9 M4</b>	Grid 2 <b>63.7 M4</b>	Grid 3 <b>63 M4</b>
Grid 4 <b>56.3 M4</b>	Grid 5 <b>64.4 M4</b>	Grid 6 <b>63.6 M4</b>
Grid 7 <b>53.6 M4</b>	Grid 8 <b>62.5 M4</b>	Grid 9 <b>62.1 M4</b>

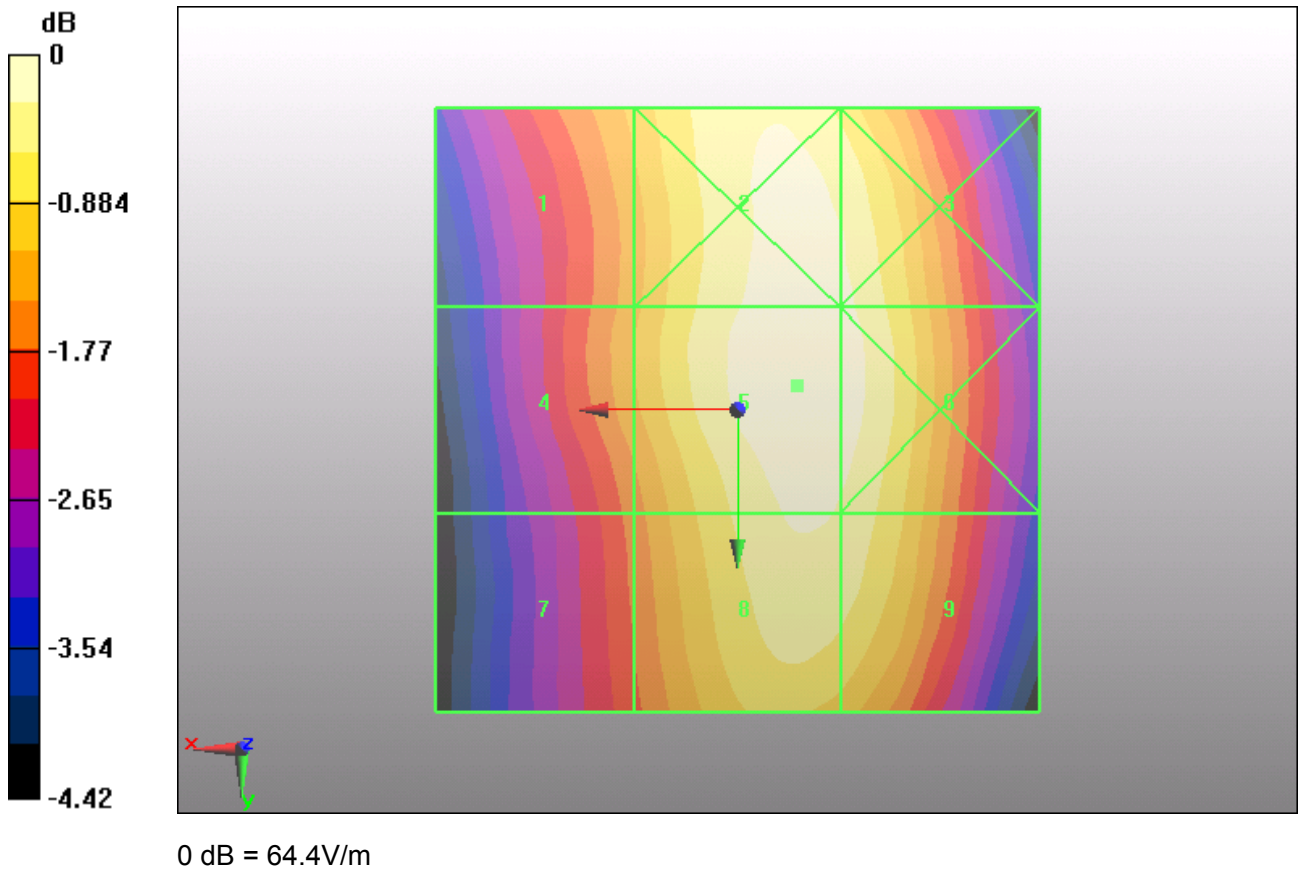

Figure 32 HAC RF E-Field WCDMA Band V Channel 4132

**TA Technology (Shanghai) Co., Ltd.**  
**Test Report**

Report No. RXA1204-0048HAC01R1

Page 75 of 119

**HAC RF H-Field WCDMA Band V High**

Date/Time: 4/15/2012 2:10:56 PM

Communication System: WCDMA ; Frequency: 846.6 MHz; Duty Cycle: 1:1

Medium parameters used:  $\sigma = 0$  mho/m,  $\epsilon_r = 1$ ;  $\rho = 1$  kg/m<sup>3</sup>

Ambient Temperature: 22.3 °C

Phantom section: RF Section

DASY5 Configuration:

Probe: H3DV6 - SN6138; ; Calibrated: 2/21/2012

Electronics: DAE4 Sn871; Calibrated: 11/22/2011

Phantom: HAC Test Arch with AMCC; Type: SD HAC P01 BA

Measurement SW: DASY5, V5.2 Build 162; SEMCAD X Version 14.0 Build 59

**One touch 995S WCDMA Band V HAC RF H-Field/H Scan - H3DV6 - 2007: 15 mm from Probe Center to the Device High/Hearing Aid Compatibility Test (101x101x1):** Measurement grid:

dx=5mm, dy=5mm

Maximum value of peak Total field = 0.093 A/m

Probe Modulation Factor = 1.01

Device Reference Point: 0, 0, -6.3 mm

Reference Value = 0.067 A/m; Power Drift = -0.036 dB

**Hearing Aid Near-Field Category: M4 (AWF 0 dB)**

Peak H-field in A/m

Grid 1 <b>0.126 M4</b>	Grid 2 <b>0.091 M4</b>	Grid 3 <b>0.055 M4</b>
Grid 4 <b>0.113 M4</b>	Grid 5 <b>0.084 M4</b>	Grid 6 <b>0.054 M4</b>
Grid 7 <b>0.126 M4</b>	Grid 8 <b>0.093 M4</b>	Grid 9 <b>0.061 M4</b>

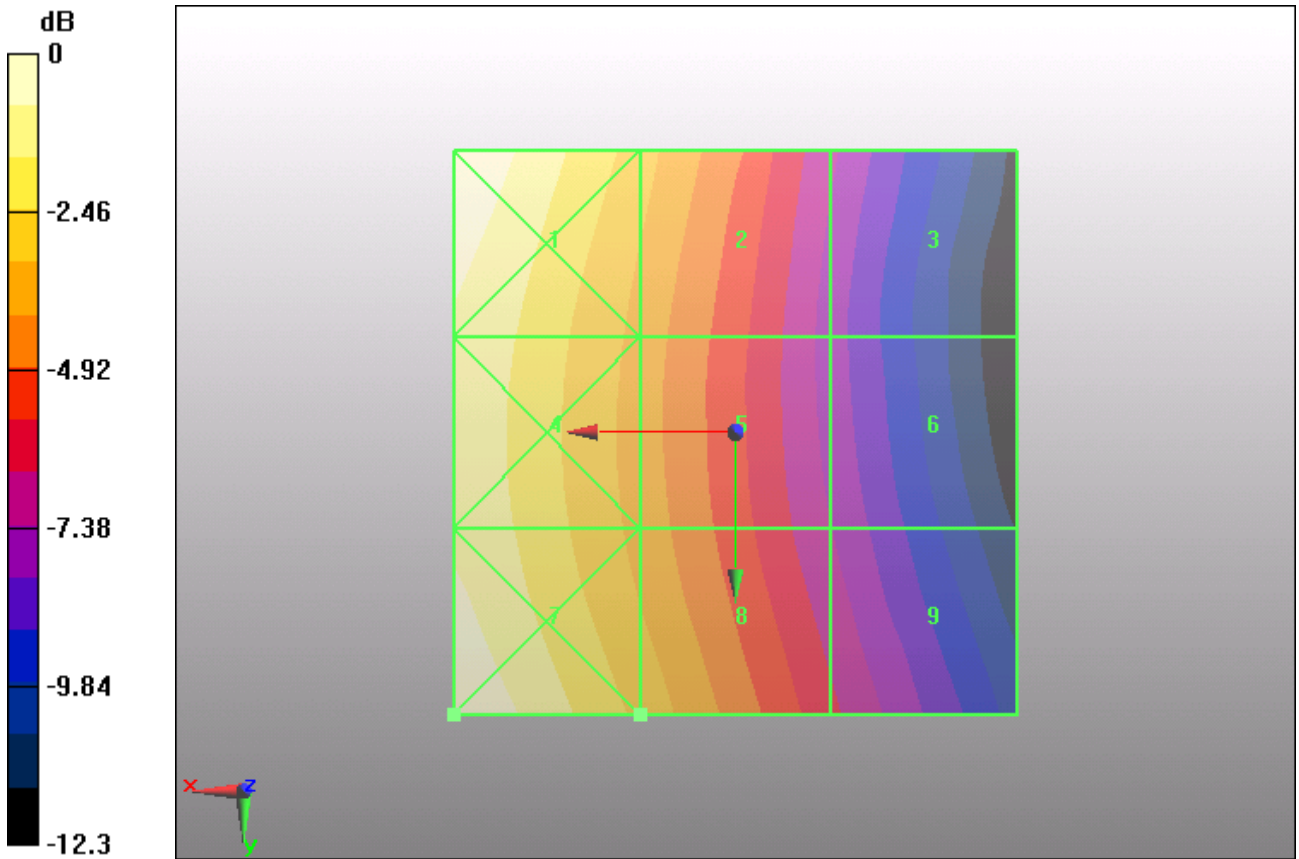

0 dB = 0.126A/m

Figure 33 HAC RF H-Field WCDMA Band V Channel 4233

**TA Technology (Shanghai) Co., Ltd.**  
**Test Report**

Report No. RXA1204-0048HAC01R1

Page 77 of 119

**HAC RF H-Field WCDMA Band V Middle**

Date/Time: 4/15/2012 2:03:27 PM

Communication System: WCDMA ; Frequency: 836.6 MHz; Duty Cycle: 1:1

Medium parameters used:  $\sigma = 0$  mho/m,  $\epsilon_r = 1$ ;  $\rho = 1$  kg/m<sup>3</sup>

Ambient Temperature: 22.3 °C

Phantom section: RF Section

DASY5 Configuration:

Probe: H3DV6 - SN6138; ; Calibrated: 2/21/2012

Electronics: DAE4 Sn871; Calibrated: 11/22/2011

Phantom: HAC Test Arch with AMCC; Type: SD HAC P01 BA

Measurement SW: DASY5, V5.2 Build 162; SEMCAD X Version 14.0 Build 59

**One touch 995S WCDMA Band V HAC RF H-Field/H Scan - H3DV6 - 2007: 15 mm from Probe Center to the Device Middle/Hearing Aid Compatibility Test (101x101x1):** Measurement grid: dx=5mm, dy=5mm

Maximum value of peak Total field = 0.080 A/m

Probe Modulation Factor = 1.01

Device Reference Point: 0, 0, -6.3 mm

Reference Value = 0.058 A/m; Power Drift = 0.020 dB

**Hearing Aid Near-Field Category: M4 (AWF 0 dB)**

Peak H-field in A/m

Grid 1 <b>0.109 M4</b>	Grid 2 <b>0.079 M4</b>	Grid 3 <b>0.049 M4</b>
Grid 4 <b>0.099 M4</b>	Grid 5 <b>0.073 M4</b>	Grid 6 <b>0.046 M4</b>
Grid 7 <b>0.108 M4</b>	Grid 8 <b>0.080 M4</b>	Grid 9 <b>0.051 M4</b>

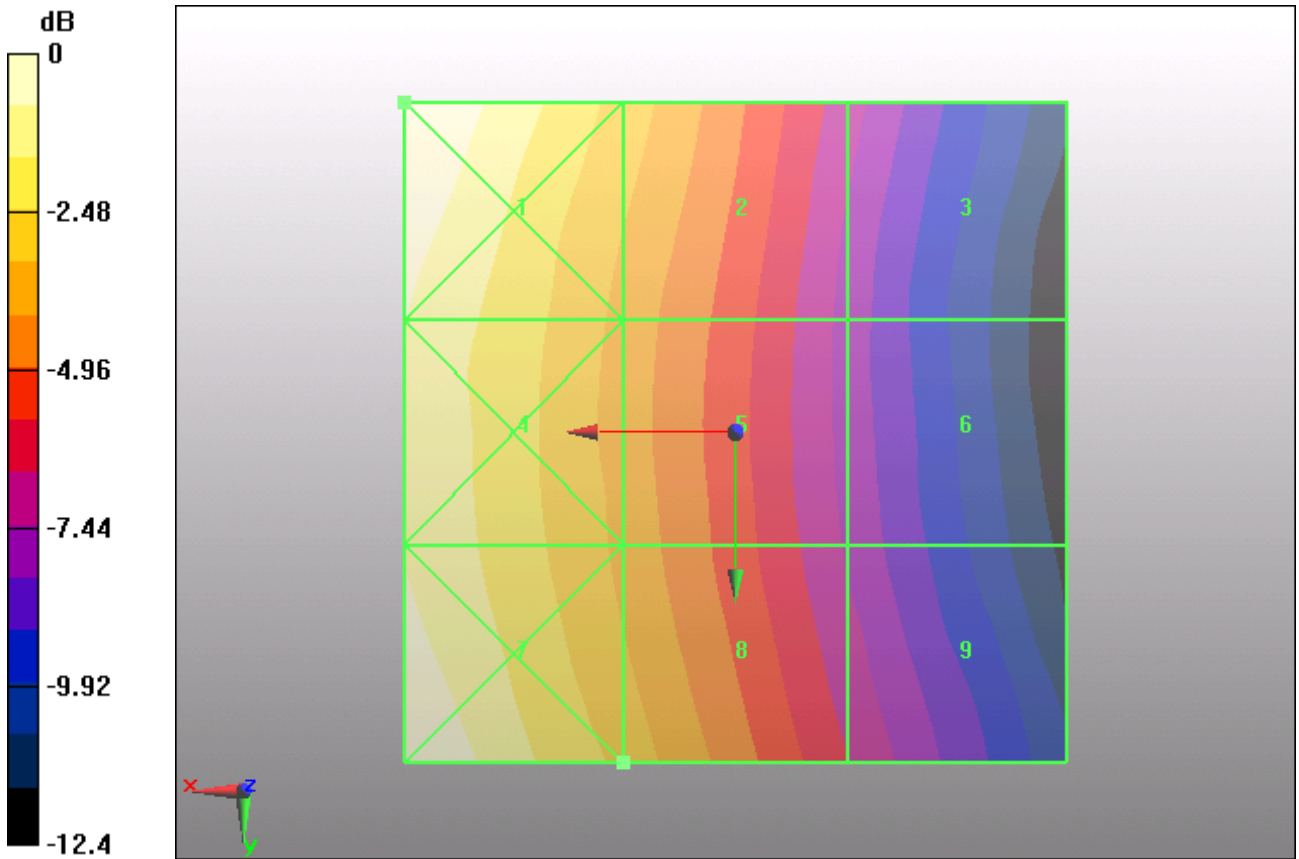

0 dB = 0.109A/m

Figure 34 HAC RF H-Field WCDMA Band V Channel 4183

**TA Technology (Shanghai) Co., Ltd.**  
**Test Report**

Report No. RXA1204-0048HAC01R1

Page 79 of 119

**HAC RF H-Field WCDMA Band V Low**

Date/Time: 4/15/2012 2:16:43 PM

Communication System: WCDMA ; Frequency: 826.4 MHz; Duty Cycle: 1:1

Medium parameters used:  $\sigma = 0$  mho/m,  $\epsilon_r = 1$ ;  $\rho = 1$  kg/m<sup>3</sup>

Ambient Temperature: 22.3 °C

Phantom section: RF Section

DASY5 Configuration:

Probe: H3DV6 - SN6138; ; Calibrated: 2/21/2012

Electronics: DAE4 Sn871; Calibrated: 11/22/2011

Phantom: HAC Test Arch with AMCC; Type: SD HAC P01 BA

Measurement SW: DASY5, V5.2 Build 162; SEMCAD X Version 14.0 Build 59

**One touch 995S WCDMA Band V HAC RF H-Field/H Scan - H3DV6 - 2007: 15 mm from Probe Center to the Device Low/Hearing Aid Compatibility Test (101x101x1):** Measurement grid:

dx=5mm, dy=5mm

Maximum value of peak Total field = 0.087 A/m

Probe Modulation Factor = 1.01

Device Reference Point: 0, 0, -6.3 mm

Reference Value = 0.061 A/m; Power Drift = 0.077 dB

**Hearing Aid Near-Field Category: M4 (AWF 0 dB)**

Peak H-field in A/m

Grid 1 <b>0.118 M4</b>	Grid 2 <b>0.083 M4</b>	Grid 3 <b>0.050 M4</b>
Grid 4 <b>0.107 M4</b>	Grid 5 <b>0.078 M4</b>	Grid 6 <b>0.050 M4</b>
Grid 7 <b>0.119 M4</b>	Grid 8 <b>0.087 M4</b>	Grid 9 <b>0.056 M4</b>

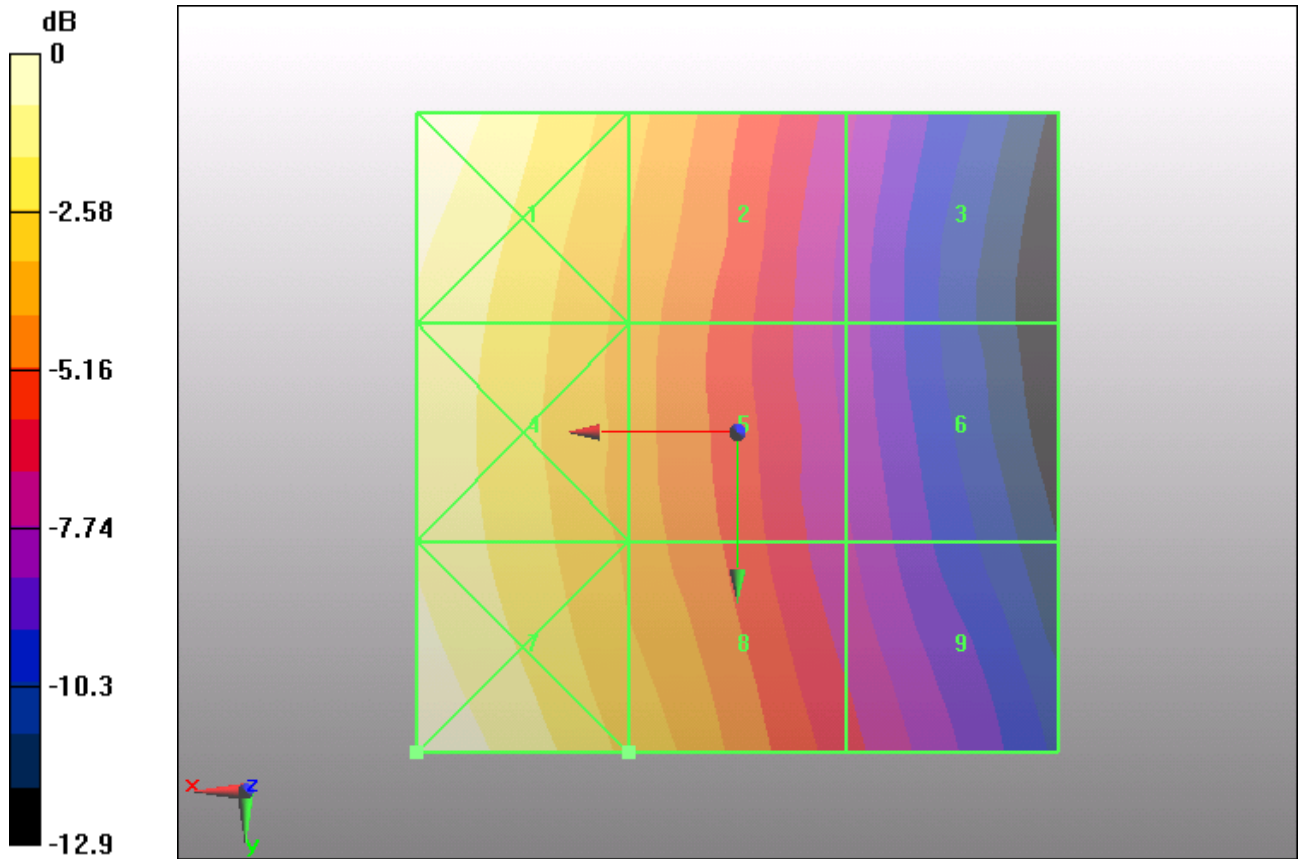

0 dB = 0.119A/m

Figure 35 HAC RF H-Field WCDMA Band V Channel 4132



# TA Technology (Shanghai) Co., Ltd. Test Report

Report No. RXA1204-0048HAC01R1

Page 81 of 119

## ANNEX C: E-Probe Calibration Certificate

**Calibration Laboratory of  
Schmid & Partner  
Engineering AG**  
Zeughausstrasse 43, 8004 Zurich, Switzerland



**S** Schweizerischer Kalibrierdienst  
**C** Service suisse d'étalonnage  
**S** Servizio svizzero di taratura  
**S** Swiss Calibration Service

Accredited by the Swiss Accreditation Service (SAS)  
The Swiss Accreditation Service is one of the signatories to the EA  
Multilateral Agreement for the recognition of calibration certificates

Accreditation No.: **SCS 108**

Client **TA Shanghai (Auden)**

Certificate No: **ER3-2303\_Feb12**

### CALIBRATION CERTIFICATE

Object: **ER3DV6 - SN:2303**

Calibration procedure(s): **QA CAL-02.v6, QA CAL-25.v4  
Calibration procedure for E-field probes optimized for close near field  
evaluations in air**

Calibration date: **February 21, 2012**

This calibration certificate documents the traceability to national standards, which realize the physical units of measurements (SI).  
The measurements and the uncertainties with confidence probability are given on the following pages and are part of the certificate.

All calibrations have been conducted in the closed laboratory facility: environment temperature (22 ± 3°C and humidity < 75%.

Calibration Equipment used (M&TE critical for calibration)

Primary Standards	ID	Cal Date (Certificate No.)	Scheduled Calibration
Power meter E4419B	GB41293874	31-Mar-11 (No. 217-01372)	Apr-12
Power sensor E4412A	MY41496067	31-Mar-11 (No. 217-01372)	Apr-12
Reference 3 dB Attenuator	SN: S5054 (3c)	29-Mar-11 (No. 217-01369)	Apr-12
Reference 20 dB Attenuator	SN: S5086 (20b)	29-Mar-11 (No. 217-01367)	Apr-12
Reference 30 dB Attenuator	SN: S5129 (30b)	29-Mar-11 (No. 217-01370)	Apr-12
Reference Probe ER3DV6	SN: 2328	11-Oct-11 (No. ER3-2328_Oct11)	Oct-12
DAE4	SN: 789	30-Jan-12 (No. DAE4-789_jan12)	Jan-13
Secondary Standards	ID	Check Date (in house)	Scheduled Check
RF generator HP 8648C	US3642U01700 *	4-Aug-99 (in house check Apr-11)	In house check: Apr-13
Network Analyzer HP 8753E	US37390565	18-Oct-01 (in house check Oct-11)	In house check: Oct-12

Calibrated by:	Name <b>Claudio Leubler</b>	Function Laboratory Technician	Signature 
Approved by:	Name <b>Katja Pokovic</b>	Technical Manager	

Issued: February 22, 2012

This calibration certificate shall not be reproduced except in full without written approval of the laboratory.

# TA Technology (Shanghai) Co., Ltd.

## Test Report

Report No. RXA1204-0048HAC01R1

Page 82 of 119

**Calibration Laboratory of  
Schmid & Partner  
Engineering AG**  
Zeughausstrasse 43, 8004 Zurich, Switzerland



**S** Schweizerischer Kalibrierdienst  
**C** Service suisse d'étalonnage  
**S** Servizio svizzero di taratura  
**S** Swiss Calibration Service

Accredited by the Swiss Accreditation Service (SAS)

Accreditation No.: **SCS 108**

The Swiss Accreditation Service is one of the signatories to the EA  
Multilateral Agreement for the recognition of calibration certificates

### Glossary:

NORM <sub>x,y,z</sub>	sensitivity in free space
DCP	diode compression point
CF	crest factor (1/duty_cycle) of the RF signal
A, B, C	modulation dependent linearization parameters
Polarization $\varphi$	$\varphi$ rotation around probe axis
Polarization $\vartheta$	$\vartheta$ rotation around an axis that is in the plane normal to probe axis (at measurement center), i.e., $\vartheta = 0$ is normal to probe axis
Connector Angle	information used in DASY system to align probe sensor X to the robot coordinate system

### Calibration is Performed According to the Following Standards:

- IEEE Std 1309-2005, "IEEE Standard for calibration of electromagnetic field sensors and probes, excluding antennas, from 9 kHz to 40 GHz", December 2005.

### Methods Applied and Interpretation of Parameters:

- NORM<sub>x,y,z</sub>**: Assessed for E-field polarization  $\vartheta = 0$  for XY sensors and  $\vartheta = 90$  for Z sensor ( $f \leq 900$  MHz in TEM-cell;  $f > 1800$  MHz: R22 waveguide).
- NORM(f)<sub>x,y,z</sub>** = NORM<sub>x,y,z</sub> \* frequency\_response (see Frequency Response Chart).
- DCP<sub>x,y,z</sub>**: DCP are numerical linearization parameters assessed based on the data of power sweep with CW signal (no uncertainty required). DCP does not depend on frequency nor media.
- PAR**: PAR is the Peak to Average Ratio that is not calibrated but determined based on the signal characteristics
- A<sub>x,y,z</sub>; B<sub>x,y,z</sub>; C<sub>x,y,z</sub>; VR<sub>x,y,z</sub>**: A, B, C are numerical linearization parameters assessed based on the data of power sweep for specific modulation signal. The parameters do not depend on frequency nor media. VR is the maximum calibration range expressed in RMS voltage across the diode.
- Spherical isotropy (3D deviation from isotropy)**: in a locally homogeneous field realized using an open waveguide setup.
- Sensor Offset**: The sensor offset corresponds to the offset of virtual measurement center from the probe-tip (on probe axis). No tolerance required.
- Connector Angle**: The angle is assessed using the information gained by determining the NORM<sub>x</sub> (no uncertainty required).

ER3DV6 – SN:2303

February 21, 2012

# Probe ER3DV6

## SN:2303

Manufactured: November 6, 2002  
Calibrated: February 21, 2012

Calibrated for DASY/EASY Systems  
(Note: non-compatible with DASY2 system!)

**TA Technology (Shanghai) Co., Ltd.**  
**Test Report**

ER3DV6- SN:2303

February 21, 2012

**DASY/EASY - Parameters of Probe: ER3DV6 - SN:2303**

**Basic Calibration Parameters**

	Sensor X	Sensor Y	Sensor Z	Unc (k=2)
Norm ( $\mu\text{V}/(\text{V}/\text{m})^2$ )	1.40	1.42	1.43	$\pm 10.1\%$
DCP (mV) <sup>a</sup>	100.7	99.2	104.7	

**Modulation Calibration Parameters**

UID	Communication System Name	PAR		A dB	B dB	C dB	VR mV	Unc <sup>c</sup> (k=2)
10000	CW	0.00	X	0.00	0.00	1.00	111.4	$\pm 3.0\%$
			Y	0.00	0.00	1.00	139.9	
			Z	0.00	0.00	1.00	133.1	

The reported uncertainty of measurement is stated as the standard uncertainty of measurement multiplied by the coverage factor k=2, which for a normal distribution corresponds to a coverage probability of approximately 95%.

<sup>a</sup> Numerical linearization parameter; uncertainty not required.

<sup>c</sup> Uncertainty is determined using the max. deviation from linear response applying rectangular distribution and is expressed for the square of the field value.

ER3DV6- SN:2303

February 21, 2012

**Frequency Response of E-Field**  
(TEM-Cell:ifi110 EXX, Waveguide: R22)

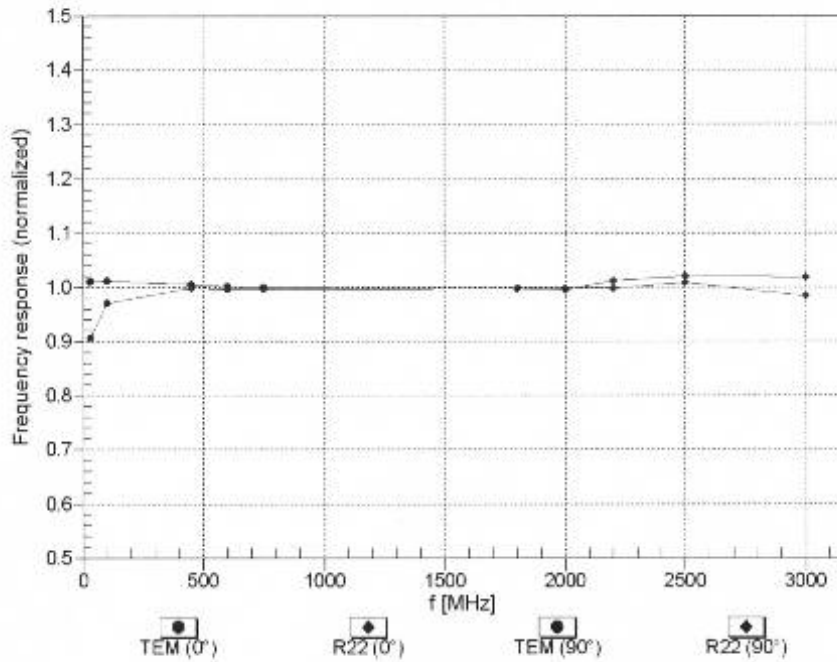

Uncertainty of Frequency Response of E-field:  $\pm 6.3\%$  (k=2)

ER3DV6- SN:2303

February 21, 2012

Receiving Pattern ( $\phi$ ),  $\vartheta = 0^\circ$

f=600 MHz, TEM,  $0^\circ$

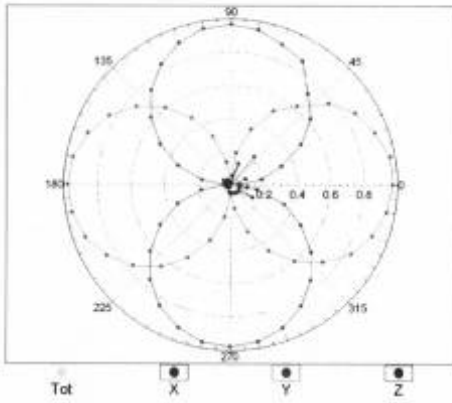

f=2500 MHz, R22,  $0^\circ$

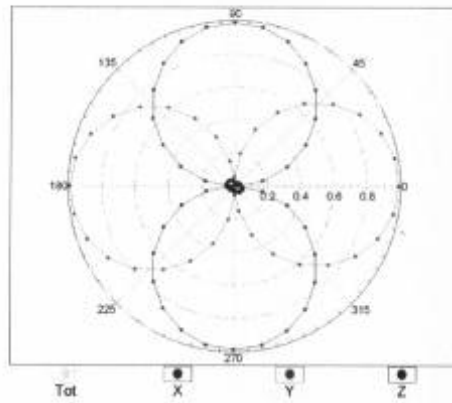

Receiving Pattern ( $\phi$ ),  $\vartheta = 90^\circ$

f=600 MHz, TEM,  $90^\circ$

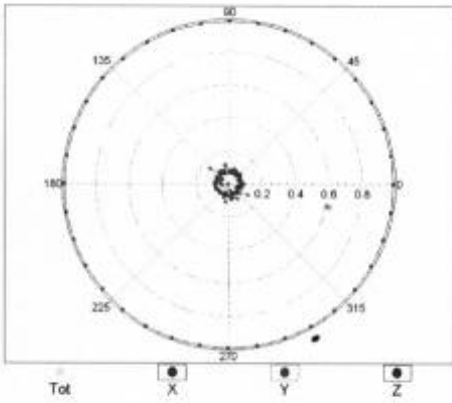

f=2500 MHz, R22,  $90^\circ$

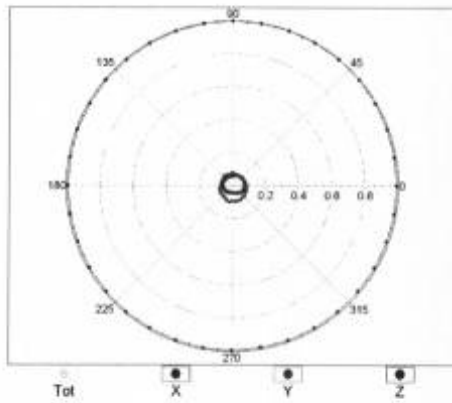

ER3DV6- SN:2303

February 21, 2012

### Receiving Pattern ( $\phi$ ), $\theta = 0^\circ$

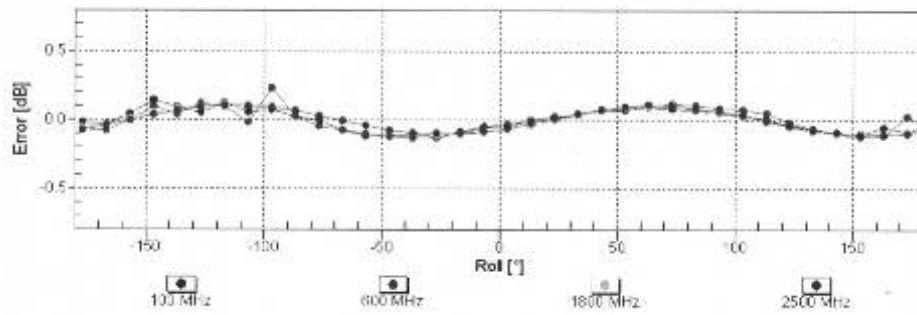

Uncertainty of Axial Isotropy Assessment:  $\pm 0.5\%$  ( $k=2$ )

### Receiving Pattern ( $\phi$ ), $\theta = 90^\circ$

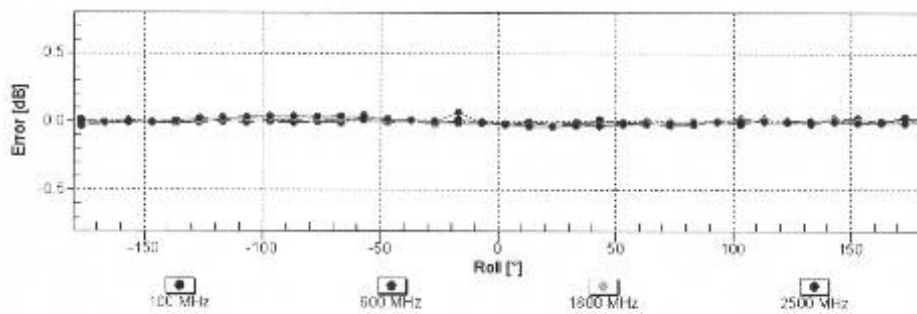

Uncertainty of Axial Isotropy Assessment:  $\pm 0.5\%$  ( $k=2$ )

ER3DV6- SN:2303

February 21, 2012

**Dynamic Range f(E-field)**  
 (TEM cell , f = 900 MHz)

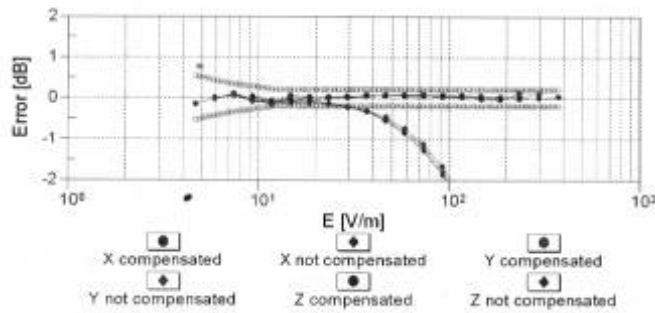
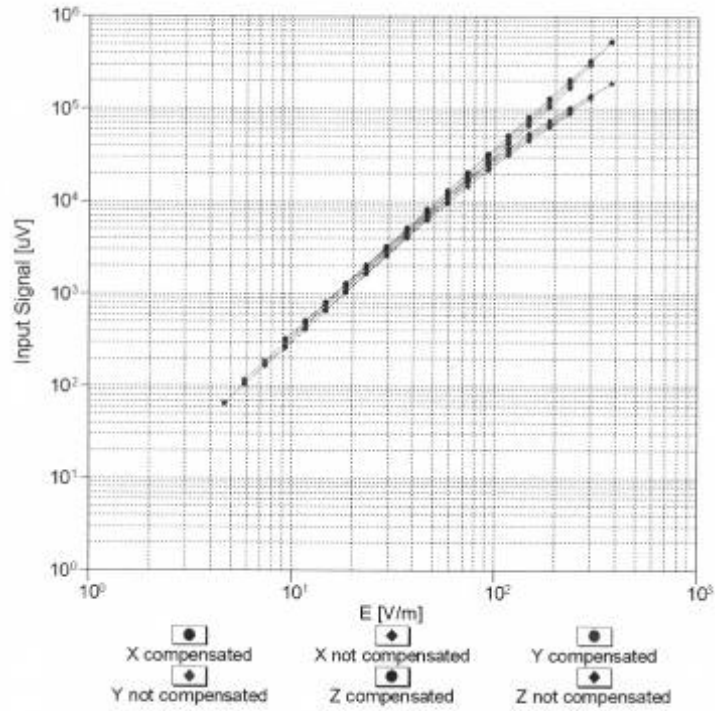

Uncertainty of Linearity Assessment: ± 0.6% (k=2)



ER3DV6- SN:2303

February 21, 2012

**Deviation from Isotropy in Air**  
Error ( $\phi, \theta$ ),  $f = 900$  MHz

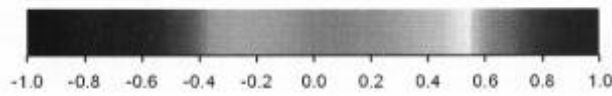
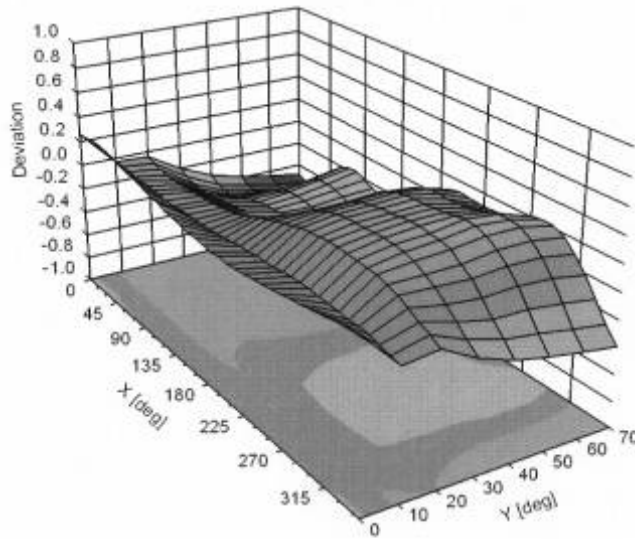

Uncertainty of Spherical Isotropy Assessment:  $\pm 2.6\%$  ( $k=2$ )

ER3DV6- SN:2303

February 21, 2012

### DASY/EASY - Parameters of Probe: ER3DV6 - SN:2303

#### Other Probe Parameters

Sensor Arrangement	Rectangular
Connector Angle (°)	-156.8
Mechanical Surface Detection Mode	enabled
Optical Surface Detection Mode	disabled
Probe Overall Length	337 mm
Probe Body Diameter	10 mm
Tip Length	10 mm
Tip Diameter	8 mm
Probe Tip to Sensor X Calibration Point	2.5 mm
Probe Tip to Sensor Y Calibration Point	2.5 mm
Probe Tip to Sensor Z Calibration Point	2.5 mm

# TA Technology (Shanghai) Co., Ltd.

## Test Report

Report No. RXA1204-0048HAC01R1

Page 91 of 119

### ANNEX D: H-Probe Calibration Certificate

**Calibration Laboratory of  
Schmid & Partner  
Engineering AG**  
Zeughausstrasse 43, 8004 Zurich, Switzerland



**S** Schweizerischer Kalibrierdienst  
**C** Service suisse d'étalonnage  
**S** Servizio svizzero di taratura  
**S** Swiss Calibration Service

Accredited by the Swiss Accreditation Service (SAS)  
The Swiss Accreditation Service is one of the signatories to the EA  
Multilateral Agreement for the recognition of calibration certificates

Accreditation No.: **SCS 108**

Client **TA Shanghai (Auden)**

Certificate No: **H3-6138\_Feb12**

#### CALIBRATION CERTIFICATE

Object: **H3DV6 - SN:6138**

Calibration procedure(s): **QA CAL-03.v6, QA CAL-25.v4  
Calibration procedure for H-field probes optimized for close near field  
evaluations in air**

Calibration date: **February 21, 2012**

This calibration certificate documents the traceability to national standards, which realize the physical units of measurements (SI).  
The measurements and the uncertainties with confidence probability are given on the following pages and are part of the certificate.

All calibrations have been conducted in the closed laboratory facility: environment temperature (22 ± 3)°C and humidity < 70%.

Calibration Equipment used (M&TE critical for calibration)

Primary Standards	ID	Cal Date (Certificate No.)	Scheduled Calibration
Power meter E4419B	GB41293874	31-Mar-11 (No. 217-01372)	Apr-12
Power sensor E4412A	MY41498087	31-Mar-11 (No. 217-01372)	Apr-12
Reference 3 dB Attenuator	SN: S5054 (3c)	29-Mar-11 (No. 217-01369)	Apr-12
Reference 20 dB Attenuator	SN: S5086 (20b)	29-Mar-11 (No. 217-01367)	Apr-12
Reference 30 dB Attenuator	SN: S5129 (30b)	29-Mar-11 (No. 217-01370)	Apr-12
Reference Probe H3DV6	SN: 6182	11-Oct-11 (No. H3-6182_Oct11)	Oct-12
DAE4	SN: 789	30-Jan-12 (No. DAE4-789_Jan12)	Jan-13
Secondary Standards	ID	Check Date (in house)	Scheduled Check
RF generator HP 8648C	US3642U01700	4-Aug-99 (in house check Apr-11)	In house check: Apr-13
Network Analyzer HP 8753E	US37390585	18-Oct-01 (in house check Oct-11)	In house check: Oct-12

Calibrated by:	Name <b>Claudio Leubler</b>	Function Laboratory Technician	Signature 
Approved by:	Name <b>Katja Pokovic</b>	Technical Manager	

Issued: February 23, 2012

This calibration certificate shall not be reproduced except in full without written approval of the laboratory.

Calibration Laboratory of  
Schmid & Partner  
Engineering AG  
Zeughausstrasse 43, 8004 Zurich, Switzerland



S Schweizerischer Kalibrierdienst  
C Service suisse d'étalonnage  
S Servizio svizzero di taratura  
S Swiss Calibration Service

Accredited by the Swiss Accreditation Service (SAS)  
The Swiss Accreditation Service is one of the signatories to the EA  
Multilateral Agreement for the recognition of calibration certificates

Accreditation No.: SCS 108

**Glossary:**

NORM <sub>x,y,z</sub>	sensitivity in free space
DCP	diode compression point
CF	crest factor (1/duty_cycle) of the RF signal
A, B, C	modulation dependent linearization parameters
Polarization $\varphi$	$\varphi$ rotation around probe axis
Polarization $\vartheta$	$\vartheta$ rotation around an axis that is in the plane normal to probe axis (at measurement center), i.e., $\vartheta = 0$ is normal to probe axis
Connector Angle	information used in DASY system to align probe sensor X to the robot coordinate system

**Calibration is Performed According to the Following Standards:**

- IEEE Std 1309-2005, "IEEE Standard for calibration of electromagnetic field sensors and probes, excluding antennas, from 9 kHz to 40 GHz", December 2005.

**Methods Applied and Interpretation of Parameters:**

- NORM<sub>x,y,z</sub>: Assessed for E-field polarization  $\vartheta = 0$  for XY sensors and  $\vartheta = 90$  for Z sensor ( $f \leq 900$  MHz in TEM-cell;  $f > 1800$  MHz: R22 waveguide).
- $X, Y, Z(f)_{a0a1a2} = X, Y, Z_{a0a1a2} \cdot \text{frequency\_response}$  (see Frequency Response Chart).
- DCP<sub>x,y,z</sub>: DCP are numerical linearization parameters assessed based on the data of power sweep with CW signal (no uncertainty required). DCP does not depend on frequency nor media.
- PAR: PAR is the Peak to Average Ratio that is not calibrated but determined based on the signal characteristics
- $A_{x,y,z}; B_{x,y,z}; C_{x,y,z}; VR_{x,y,z}; A, B, C$  are numerical linearization parameters assessed based on the data of power sweep for specific modulation signal. The parameters do not depend on frequency nor media. VR is the maximum calibration range expressed in RMS voltage across the diode.
- Spherical isotropy (3D deviation from isotropy): in a locally homogeneous field realized using an open waveguide setup.
- Sensor Offset: The sensor offset corresponds to the offset of virtual measurement center from the probe tip (on probe axis). No tolerance required.
- Connector Angle: The angle is assessed using the information gained by determining the  $X_{a0a1a2}$  (no uncertainty required).

H3DV6 - SN:6138

February 21, 2012

# Probe H3DV6

## SN:6138

Manufactured: July 3, 2002  
Calibrated: February 21, 2012

Calibrated for DASY/EASY Systems  
(Note: non-compatible with DASY2 system!)

# TA Technology (Shanghai) Co., Ltd.

## Test Report

H3DV6- SN:6138

February 21, 2012

### DASY/EASY - Parameters of Probe: H3DV6 - SN:6138

#### Basic Calibration Parameters

		Sensor X	Sensor Y	Sensor Z	Unc (k=2)
Norm (A/m / $\sqrt{\text{mV}}$ )	a0	2.73E-003	2.93E-003	3.18E-003	$\pm 5.1 \%$
Norm (A/m / $\sqrt{\text{mV}}$ )	a1	-5.89E-005	-2.38E-004	-2.18E-004	$\pm 5.1 \%$
Norm (A/m / $\sqrt{\text{mV}}$ )	a2	-5.50E-006	-3.95E-006	-8.28E-007	$\pm 5.1 \%$
DCP (mV) <sup>b</sup>		93.5	92.1	94.8	

#### Modulation Calibration Parameters

UID	Communication System Name	PAR		A dB	B dB	C dB	VR mV	Unc <sup>c</sup> (k=2)
10000	CW	0.00	X	0.00	0.00	1.00	130.7	$\pm 3.3 \%$
			Y	0.00	0.00	1.00	125.5	
			Z	0.00	0.00	1.00	133.0	

The reported uncertainty of measurement is stated as the standard uncertainty of measurement multiplied by the coverage factor k=2, which for a normal distribution corresponds to a coverage probability of approximately 95%.

<sup>b</sup> Numerical linearization parameter: uncertainty not required.

<sup>c</sup> Uncertainty is determined using the max. deviation from linear response applying rectangular distribution and is expressed for the square of the field value.

H3DV6-SN:6138

February 21, 2012

### Frequency Response of H-Field (TEM-Cell:ifi110 EXX, Waveguide: R22)

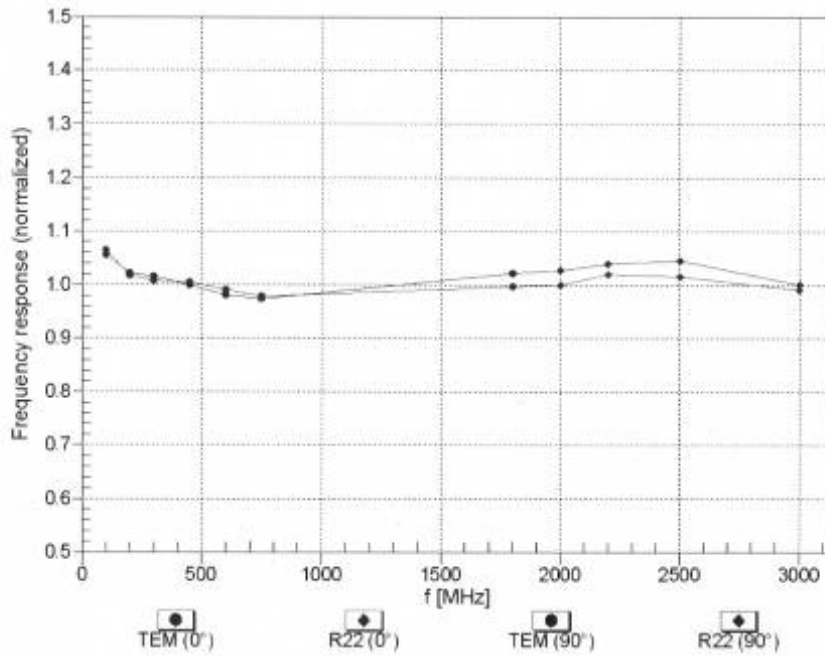

Uncertainty of Frequency Response of H-field:  $\pm 6.3\%$  (k=2)

H3DV6-SN:6138

February 21, 2012

Receiving Pattern ( $\phi$ ),  $\theta = 0^\circ$

f=600 MHz, TEM,  $0^\circ$

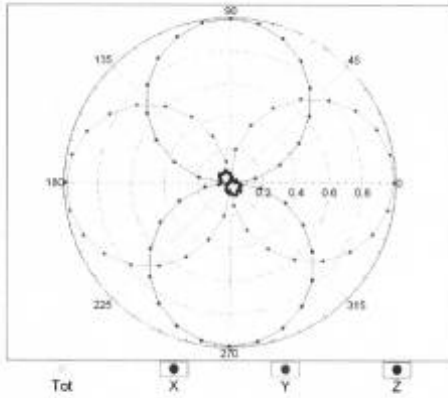

f=2500 MHz, R22,  $0^\circ$

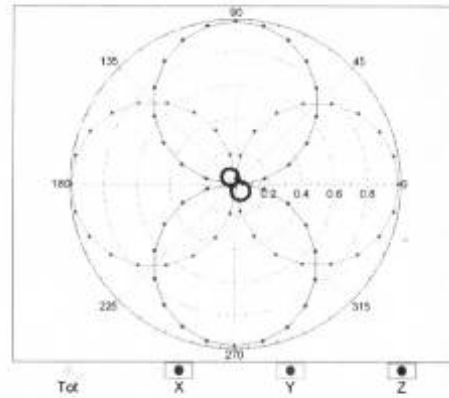

Receiving Pattern ( $\phi$ ),  $\theta = 90^\circ$

f=600 MHz, TEM,  $90^\circ$

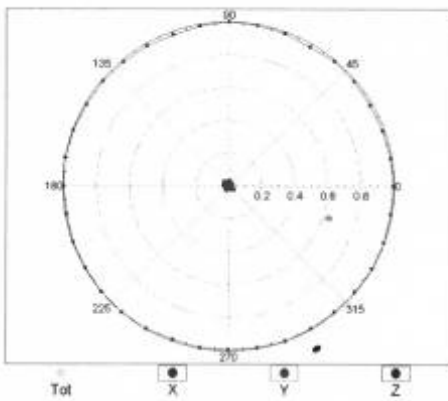

f=2500 MHz, R22,  $90^\circ$

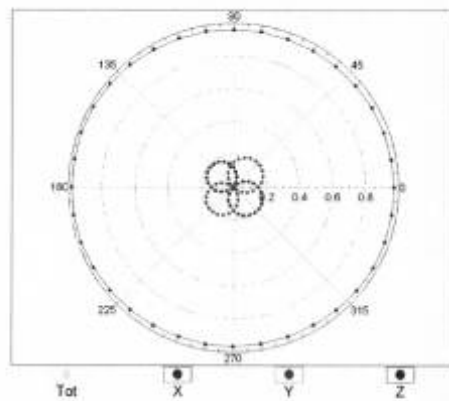



TA Technology (Shanghai) Co., Ltd.  
Test Report

H3DV6- SN:6138

February 21, 2012

Receiving Pattern ( $\phi$ ),  $\vartheta = 0^\circ$

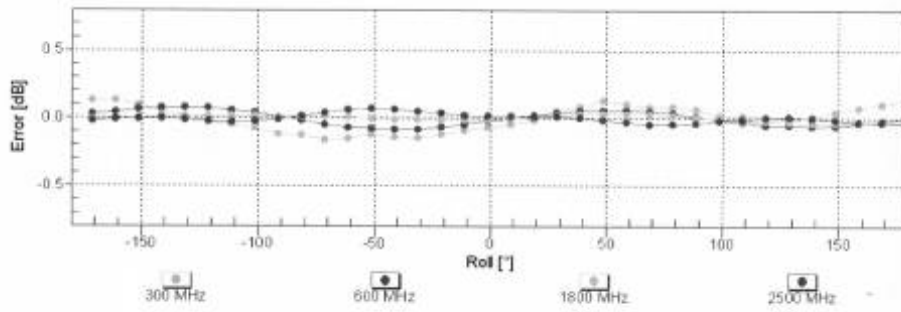

Uncertainty of Axial Isotropy Assessment:  $\pm 0.5\%$  ( $k=2$ )

Receiving Pattern ( $\phi$ ),  $\vartheta = 90^\circ$

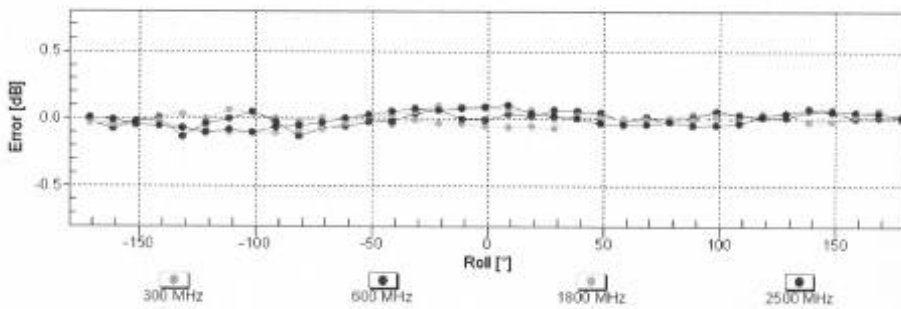

Uncertainty of Axial Isotropy Assessment:  $\pm 0.5\%$  ( $k=2$ )

H3DV6- SN:6138

February 21, 2012

**Dynamic Range f(H-field)**  
 (TEM cell, f = 900 MHz)

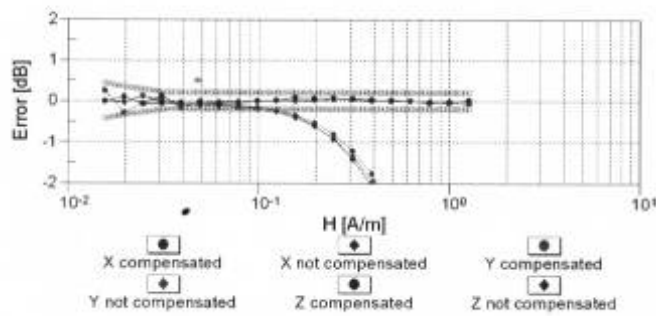
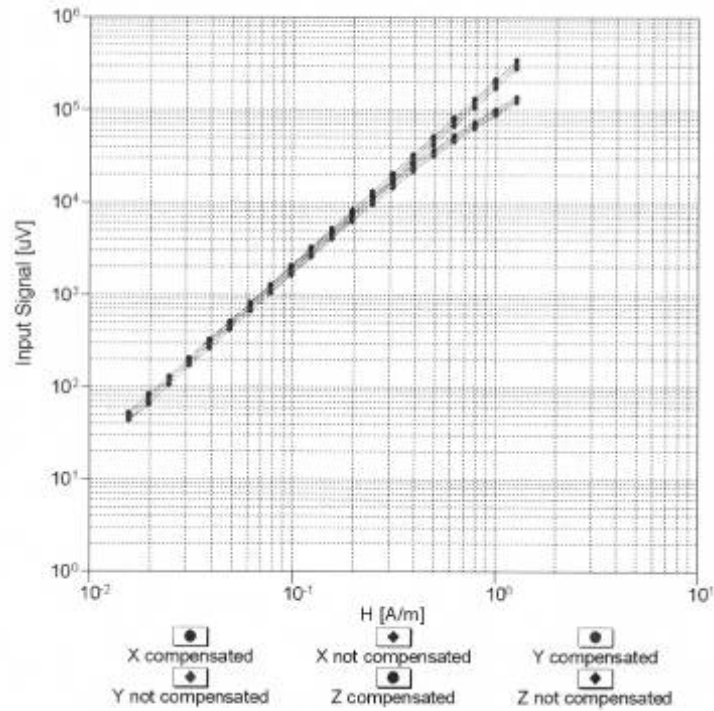

Uncertainty of Linearity Assessment: ± 0.6% (k=2)

H3DV6- SN:6138

February 21, 2012

**Deviation from Isotropy in Air**  
Error ( $\phi$ ,  $\theta$ ),  $f = 900$  MHz

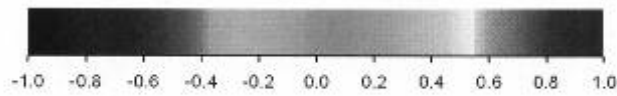
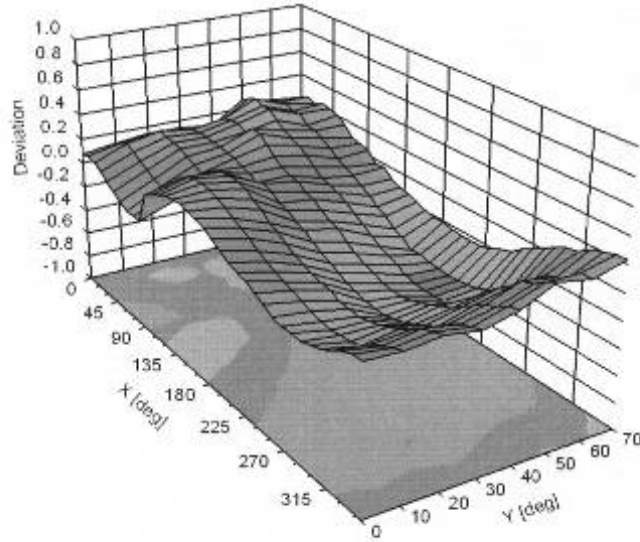

Uncertainty of Spherical Isotropy Assessment:  $\pm 2.6\%$  ( $k=2$ )

**TA Technology (Shanghai) Co., Ltd.**  
**Test Report**

H3DV6- SN:6138

February 21, 2012

**DASY/EASY - Parameters of Probe: H3DV6 - SN:6138**

**Other Probe Parameters**

Sensor Arrangement	Rectangular
Connector Angle (°)	168.6
Mechanical Surface Detection Mode	enabled
Optical Surface Detection Mode	disabled
Probe Overall Length	337 mm
Probe Body Diameter	10 mm
Tip Length	20 mm
Tip Diameter	6 mm
Probe Tip to Sensor X Calibration Point	3 mm
Probe Tip to Sensor Y Calibration Point	3 mm
Probe Tip to Sensor Z Calibration Point	3 mm

# TA Technology (Shanghai) Co., Ltd. Test Report

Report No. RXA1204-0048HAC01R1

Page 101 of 119

## ANNEX E: CD835V3 Dipole Calibration Certificate

**Calibration Laboratory of  
Schmid & Partner  
Engineering AG**  
Zeughausstrasse 43, 8004 Zurich, Switzerland



**S** Schweizerischer Kalibrierdienst  
**S** Service suisse d'étalonnage  
**C** Servizio svizzero di taratura  
**S** Swiss Calibration Service

Accredited by the Swiss Accreditation Service (SAS)  
The Swiss Accreditation Service is one of the signatories to the EA  
Multilateral Agreement for the recognition of calibration certificates

Accreditation No.: **SCS 108**

Client **TA Shanghai (Auden)**

Certificate No: **CD835V3-1133\_Feb12**

CALIBRATION CERTIFICATE																																																			
Object	CD835V3 - SN: 1133																																																		
Calibration procedure(s)	QA CAL-20.v6 Calibration procedure for dipoles in air																																																		
Calibration date:	February 21, 2012																																																		
<p>This calibration certificate documents the traceability to national standards, which realize the physical units of measurements (SI). The measurements and the uncertainties with confidence probability are given on the following pages and are part of the certificate.</p> <p>All calibrations have been conducted in the closed laboratory facility: environment temperature (22 ± 3)°C and humidity &lt; 70%.</p> <p>Calibration Equipment used (M&amp;TE critical for calibration)</p> <table border="1" style="width: 100%; border-collapse: collapse;"> <thead> <tr> <th style="width: 30%;">Primary Standards</th> <th style="width: 15%;">ID #</th> <th style="width: 30%;">Cal Date (Certificate No.)</th> <th style="width: 25%;">Scheduled Calibration</th> </tr> </thead> <tbody> <tr> <td>Power meter EPM-442A</td> <td>GB37480704</td> <td>05-Oct-11 (No. 217-01451)</td> <td>Oct-12</td> </tr> <tr> <td>Power sensor HP 8481A</td> <td>US37292783</td> <td>05-Oct-11 (No. 217-01451)</td> <td>Oct-12</td> </tr> <tr> <td>Probe ER3DV6</td> <td>SN: 2336</td> <td>29-Dec-11 (No. ER3-2336_Dec11)</td> <td>Dec-12</td> </tr> <tr> <td>Probe H3DV6</td> <td>SN: 6065</td> <td>29-Dec-11 (No. H3-6065_Dec11)</td> <td>Dec-12</td> </tr> <tr> <td>DAE4</td> <td>SN: 781</td> <td>20-Apr-11 (No. DAE4-781_Apr11)</td> <td>Apr-12</td> </tr> </tbody> </table> <table border="1" style="width: 100%; border-collapse: collapse;"> <thead> <tr> <th style="width: 30%;">Secondary Standards</th> <th style="width: 15%;">ID #</th> <th style="width: 30%;">Check Date (in house)</th> <th style="width: 25%;">Scheduled Check</th> </tr> </thead> <tbody> <tr> <td>Power meter Agilent 4419B</td> <td>SN: GB42420191</td> <td>09-Oct-09 (in house check Oct-11)</td> <td>In house check: Oct-12</td> </tr> <tr> <td>Power sensor HP 8482H</td> <td>SN: 3318A09450</td> <td>09-Oct-09 (in house check Oct-11)</td> <td>In house check: Oct-12</td> </tr> <tr> <td>Power sensor HP 8482A</td> <td>SN: US37295597</td> <td>09-Oct-09 (in house check Oct-11)</td> <td>In house check: Oct-12</td> </tr> <tr> <td>Network Analyzer HP 8753E</td> <td>US37390585</td> <td>18-Oct-01 (in house check Oct-11)</td> <td>In house check: Oct-12</td> </tr> <tr> <td>RF generator E4433B</td> <td>MY 41000675</td> <td>03-Nov-04 (in house check Oct-11)</td> <td>In house check: Oct-13</td> </tr> </tbody> </table>				Primary Standards	ID #	Cal Date (Certificate No.)	Scheduled Calibration	Power meter EPM-442A	GB37480704	05-Oct-11 (No. 217-01451)	Oct-12	Power sensor HP 8481A	US37292783	05-Oct-11 (No. 217-01451)	Oct-12	Probe ER3DV6	SN: 2336	29-Dec-11 (No. ER3-2336_Dec11)	Dec-12	Probe H3DV6	SN: 6065	29-Dec-11 (No. H3-6065_Dec11)	Dec-12	DAE4	SN: 781	20-Apr-11 (No. DAE4-781_Apr11)	Apr-12	Secondary Standards	ID #	Check Date (in house)	Scheduled Check	Power meter Agilent 4419B	SN: GB42420191	09-Oct-09 (in house check Oct-11)	In house check: Oct-12	Power sensor HP 8482H	SN: 3318A09450	09-Oct-09 (in house check Oct-11)	In house check: Oct-12	Power sensor HP 8482A	SN: US37295597	09-Oct-09 (in house check Oct-11)	In house check: Oct-12	Network Analyzer HP 8753E	US37390585	18-Oct-01 (in house check Oct-11)	In house check: Oct-12	RF generator E4433B	MY 41000675	03-Nov-04 (in house check Oct-11)	In house check: Oct-13
Primary Standards	ID #	Cal Date (Certificate No.)	Scheduled Calibration																																																
Power meter EPM-442A	GB37480704	05-Oct-11 (No. 217-01451)	Oct-12																																																
Power sensor HP 8481A	US37292783	05-Oct-11 (No. 217-01451)	Oct-12																																																
Probe ER3DV6	SN: 2336	29-Dec-11 (No. ER3-2336_Dec11)	Dec-12																																																
Probe H3DV6	SN: 6065	29-Dec-11 (No. H3-6065_Dec11)	Dec-12																																																
DAE4	SN: 781	20-Apr-11 (No. DAE4-781_Apr11)	Apr-12																																																
Secondary Standards	ID #	Check Date (in house)	Scheduled Check																																																
Power meter Agilent 4419B	SN: GB42420191	09-Oct-09 (in house check Oct-11)	In house check: Oct-12																																																
Power sensor HP 8482H	SN: 3318A09450	09-Oct-09 (in house check Oct-11)	In house check: Oct-12																																																
Power sensor HP 8482A	SN: US37295597	09-Oct-09 (in house check Oct-11)	In house check: Oct-12																																																
Network Analyzer HP 8753E	US37390585	18-Oct-01 (in house check Oct-11)	In house check: Oct-12																																																
RF generator E4433B	MY 41000675	03-Nov-04 (in house check Oct-11)	In house check: Oct-13																																																
Calibrated by:	Name Dince Iliev	Function Laboratory Technician	Signature 																																																
Approved by:	Name Fin Bomholt	R&D Director																																																	
Issued: February 22, 2012																																																			
This calibration certificate shall not be reproduced except in full without written approval of the laboratory.																																																			

**Calibration Laboratory of  
Schmid & Partner  
Engineering AG**  
Zeughausstrasse 43, 8004 Zurich, Switzerland



**S** Schweizerischer Kalibrierdienst  
**S** Service suisse d'étalonnage  
**S** Servizio svizzero di taratura  
**S** Swiss Calibration Service

Accredited by the Swiss Accreditation Service (SAS)

The Swiss Accreditation Service is one of the signatories to the EA  
Multilateral Agreement for the recognition of calibration certificates

Accreditation No.: **SCS 108**

#### References

- [1] ANSI-C63.19-2007  
American National Standard for Methods of Measurement of Compatibility between Wireless Communications Devices and Hearing Aids.

#### Methods Applied and Interpretation of Parameters:

- **Coordinate System:** y-axis is in the direction of the dipole arms. z-axis is from the basis of the antenna (mounted on the table) towards its feed point between the two dipole arms. x-axis is normal to the other axes. In coincidence with the standards [1], the measurement planes (probe sensor center) are selected to be at a distance of 10 mm above the top edge of the dipole arms.
- **Measurement Conditions:** Further details are available from the hardcopies at the end of the certificate. All figures stated in the certificate are valid at the frequency indicated. The forward power to the dipole connector is set with a calibrated power meter connected and monitored with an auxiliary power meter connected to a directional coupler. While the dipole under test is connected, the forward power is adjusted to the same level.
- **Antenna Positioning:** The dipole is mounted on a HAC Test Arch phantom using the matching dipole positioner with the arms horizontal and the feeding cable coming from the floor. The measurements are performed in a shielded room with absorbers around the setup to reduce the reflections. It is verified before the mounting of the dipole under the Test Arch phantom, that its arms are perfectly in a line. It is installed on the HAC dipole positioner with its arms parallel below the dielectric reference wire and able to move elastically in vertical direction without changing its relative position to the top center of the Test Arch phantom. The vertical distance to the probe is adjusted after dipole mounting with a DASY5 Surface Check job. Before the measurement, the distance between phantom surface and probe tip is verified. The proper measurement distance is selected by choosing the matching section of the HAC Test Arch phantom with the proper device reference point (upper surface of the dipole) and the matching grid reference point (tip of the probe) considering the probe sensor offset. The vertical distance to the probe is essential for the accuracy.
- **Feed Point Impedance and Return Loss:** These parameters are measured using a HP 8753E Vector Network Analyzer. The impedance is specified at the SMA connector of the dipole. The influence of reflections was eliminating by applying the averaging function while moving the dipole in the air, at least 70cm away from any obstacles.
- **E-field distribution:** E field is measured in the x-y-plane with an isotropic ER3D-field probe with 100 mW forward power to the antenna feed point. In accordance with [1], the scan area is 20mm wide, its length exceeds the dipole arm length (180 or 90mm). The sensor center is 10 mm (in z) above the top of the dipole arms. Two 3D maxima are available near the end of the dipole arms. Assuming the dipole arms are perfectly in one line, the average of these two maxima (in subgrid 2 and subgrid 8) is determined to compensate for any non-parallelity to the measurement plane as well as the sensor displacement. The E-field value stated as calibration value represents the maximum of the interpolated 3D-E-field, 10mm above the dipole surface.
- **H-field distribution:** H-field is measured with an isotropic H-field probe with 100mW forward power to the antenna feed point, in the x-y-plane. The scan area and sensor distance is equivalent to the E-field scan. The maximum of the field is available at the center (subgrid 5) above the feed point. The H-field value stated as calibration value represents the maximum of the interpolated H-field, 10mm above the dipole surface at the feed point.

# TA Technology (Shanghai) Co., Ltd.

## Test Report

### Measurement Conditions

DASY system configuration, as far as not given on page 1:

<b>DASY Version</b>	DASY5	V52.8.0
<b>Extrapolation</b>	Advanced Extrapolation	
<b>Phantom</b>	HAC Test Arch	
<b>Distance Dipole Top - Probe Center</b>	10mm	
<b>Scan resolution</b>	dx, dy = 5 mm	
<b>Frequency</b>	835MHz ± 1 MHz	
<b>Input power drift</b>	< 0.05 dB	

### Maximum Field values

H-field 10 mm above dipole surface	condition	interpolated maximum
Maximum measured	100 mW input power	<b>0.456 A / m ± 8.2 % (k=2)</b>

E-field 10 mm above dipole surface	condition	Interpolated maximum
Maximum measured above high end	100 mW input power	161.4 V / m
Maximum measured above low end	100 mW input power	160.0 V / m
Averaged maximum above arm	100 mW input power	<b>160.7 V / m ± 12.8 % (k=2)</b>

### Appendix

#### Antenna Parameters

Frequency	Return Loss	Impedance
800 MHz	15.7 dB	42.6 Ω - 13.5 jΩ
835 MHz	25.2 dB	47.3 Ω + 4.7 jΩ
900 MHz	17.9 dB	52.9 Ω - 12.8 jΩ
950 MHz	20.7 dB	46.3 Ω + 8.2 jΩ
960 MHz	15.5 dB	52.8 Ω + 17.3 jΩ

#### 3.2 Antenna Design and Handling

The calibration dipole has a symmetric geometry with a built-in two stub matching network, which leads to the enhanced bandwidth.

The dipole is built of standard semirigid coaxial cable. The internal matching line is open ended. The antenna is therefore open for DC signals.

Do not apply force to dipole arms, as they are liable to bend. The soldered connections near the feedpoint may be damaged. After excessive mechanical stress or overheating, check the impedance characteristics to ensure that the internal matching network is not affected.

After long term use with 40W radiated power, only a slight warming of the dipole near the feedpoint can be measured.

# TA Technology (Shanghai) Co., Ltd. Test Report

Report No. RXA1204-0048HAC01R1

Page 104 of 119

## Impedance Measurement Plot

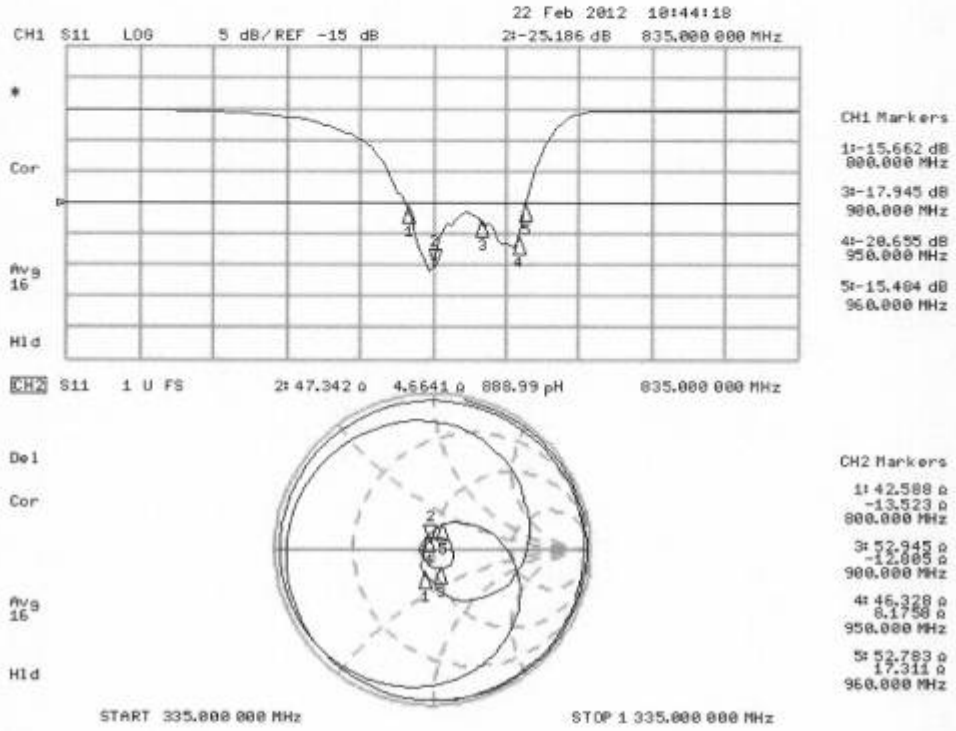



# TA Technology (Shanghai) Co., Ltd. Test Report

**DASY5 H-field Result**

Date: 21.02.2012

Test Laboratory: SPEAG Lab2

**DUT: HAC-Dipole 835 MHz; Type: CD835V3; Serial: CD835V3 - SN: 1133**

Communication System: CW; Frequency: 835 MHz  
 Medium parameters used:  $\sigma = 0$  mho/m,  $\epsilon_r = 1$ ;  $\rho = 1$  kg/m<sup>3</sup>  
 Phantom section: RF Section  
 Measurement Standard: DASY5 (IEEE/IEC/ANSI C63.19-2007)

**DASY52 Configuration:**

- Probe: H3DV6 - SN6065; ; Calibrated: 29.12.2011
- Sensor-Surface: (Fix Surface)
- Electronics: DAE4 Sn781; Calibrated: 20.04.2011
- Phantom: HAC Test Arch with AMCC; Type: SD HAC P01 BA; Serial: 1070
- DASY52 52.8.0(692); SEMCAD X 14.6.4(4989)

**Dipole H-Field measurement @ 835MHz/H-Scan - 835MHz d=10mm/Hearing Aid Compatibility Test (41x361x1):** Measurement grid: dx=5mm, dy=5mm

Device Reference Point: 0, 0, -6.3 mm  
 Reference Value = 0.49 V/m; Power Drift = 0.00 dB  
 PMR not calibrated. PMF = 1.000 is applied.  
 H-field emissions = 0.46 A/m  
**Near-field category: M4 (AWF 0 dB)**

PMF scaled H-field

Grid 1 <b>M4</b> <b>0.38 A/m</b>	Grid 2 <b>M4</b> <b>0.40 A/m</b>	Grid 3 <b>M4</b> <b>0.39 A/m</b>
Grid 4 <b>M4</b> <b>0.43 A/m</b>	Grid 5 <b>M4</b> <b>0.46 A/m</b>	Grid 6 <b>M4</b> <b>0.44 A/m</b>
Grid 7 <b>M4</b> <b>0.37 A/m</b>	Grid 8 <b>M4</b> <b>0.40 A/m</b>	Grid 9 <b>M4</b> <b>0.39 A/m</b>

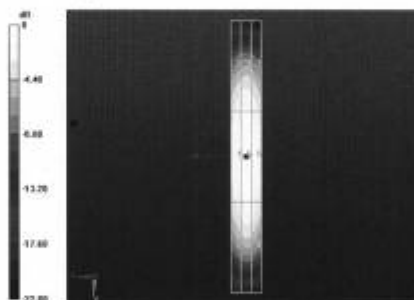

0 dB = 0.46A/m = -6.74 dB A/m

# TA Technology (Shanghai) Co., Ltd.

## Test Report

Report No. RXA1204-0048HAC01R1

Page 106 of 119

### DASY5 E-field Result

Date: 21.02.2012

Test Laboratory: SPEAG Lab2

**DUT: HAC-Dipole 835 MHz; Type: CD835V3; Serial: CD835V3 - SN: 1133**

Communication System: CW; Frequency: 835 MHz

Medium parameters used:  $\sigma = 0$  mho/m,  $\epsilon_r = 1$ ;  $\rho = 1000$  kg/m<sup>3</sup>

Phantom section: RF Section

Measurement Standard: DASY5 (IEEE/IEC/ANSI C63.19-2007)

DASY52 Configuration:

- Probe: ER3DV6 - SN2336; ConvF(1, 1, 1); Calibrated: 29.12.2011
- Sensor-Surface: (Fix Surface)
- Electronics: DAE4 Sn781; Calibrated: 20.04.2011
- Phantom: HAC Test Arch with AMCC; Type: SD HAC P01 BA; Serial: 1070
- DASY52 52.8.0(692); SEMCAD X 14.6.4(4989)

### Dipole E-Field measurement @ 835MHz/E-Scan - 835MHz d=10mm/Hearing Aid Compatibility Test (41x361x1): Measurement grid: dx=5mm, dy=5mm

Device Reference Point: 0, 0, -6.3 mm

Reference Value = 104.5 V/m; Power Drift = 0.00 dB

PMR not calibrated. PMF = 1.000 is applied.

E-field emissions = 161.4 V/m

**Near-field category: M4 (AWF 0 dB)**

PMF scaled E-field

Grid 1 <b>M4</b> <b>156.3 V/m</b>	Grid 2 <b>M4</b> <b>161.4 V/m</b>	Grid 3 <b>M4</b> <b>157.3 V/m</b>
Grid 4 <b>M4</b> <b>86.05 V/m</b>	Grid 5 <b>M4</b> <b>88.80 V/m</b>	Grid 6 <b>M4</b> <b>86.30 V/m</b>
Grid 7 <b>M4</b> <b>151.4 V/m</b>	Grid 8 <b>M4</b> <b>160.0 V/m</b>	Grid 9 <b>M4</b> <b>157.8 V/m</b>

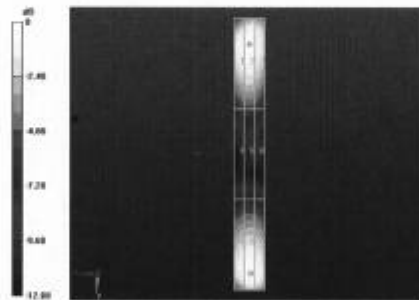

0 dB = 161.4V/m = 44.16 dB V/m

# TA Technology (Shanghai) Co., Ltd.

## Test Report

Report No. RXA1204-0048HAC01R1

Page 107 of 119

### ANNEX F: CD1880V3 Dipole Calibration Certificate

**Calibration Laboratory of  
Schmid & Partner  
Engineering AG**  
Zeughausstrasse 43, 8004 Zurich, Switzerland



**S** Schweizerischer Kalibrierdienst  
**S** Service suisse d'étalonnage  
**S** Servizio svizzero di taratura  
**S** Swiss Calibration Service

Accredited by the Swiss Accreditation Service (SAS)  
The Swiss Accreditation Service is one of the signatories to the EA  
Multilateral Agreement for the recognition of calibration certificates

Accreditation No.: **SCS 108**

Client **TA Shanghai (Auden)**

Certificate No: **CD1880V3-1115\_Feb12**

CALIBRATION CERTIFICATE																																																			
Object	CD1880V3 - SN: 1115																																																		
Calibration procedure(s)	QA CAL-20.v6 Calibration procedure for dipoles in air																																																		
Calibration date:	February 21, 2012																																																		
<p>This calibration certificate documents the traceability to national standards, which realize the physical units of measurements (SI). The measurements and the uncertainties with confidence probability are given on the following pages and are part of the certificate.</p> <p>All calibrations have been conducted in the closed laboratory facility: environment temperature (22 ± 3)°C and humidity &lt; 70%.</p> <p>Calibration Equipment used (M&amp;TE critical for calibration)</p> <table border="1" style="width: 100%; border-collapse: collapse;"> <thead> <tr> <th style="width: 30%;">Primary Standards</th> <th style="width: 15%;">ID #</th> <th style="width: 30%;">Cal Date (Certificate No.)</th> <th style="width: 25%;">Scheduled Calibration</th> </tr> </thead> <tbody> <tr> <td>Power meter EPM-442A</td> <td>GB37480704</td> <td>05-Oct-11 (No. 217-01451)</td> <td>Oct-12</td> </tr> <tr> <td>Power sensor HP 8481A</td> <td>US37292783</td> <td>05-Oct-11 (No. 217-01451)</td> <td>Oct-12</td> </tr> <tr> <td>Probe ER3DV6</td> <td>SN: 2336</td> <td>29-Dec-11 (No. ER3-2336_Dec11)</td> <td>Dec-12</td> </tr> <tr> <td>Probe H3DV6</td> <td>SN: 6065</td> <td>29-Dec-11 (No. H3-6065_Dec11)</td> <td>Dec-12</td> </tr> <tr> <td>DAE4</td> <td>SN: 781</td> <td>20-Apr-11 (No. DAE4-781_Apr11)</td> <td>Apr-12</td> </tr> </tbody> </table> <table border="1" style="width: 100%; border-collapse: collapse;"> <thead> <tr> <th style="width: 30%;">Secondary Standards</th> <th style="width: 15%;">ID #</th> <th style="width: 30%;">Check Date (in house)</th> <th style="width: 25%;">Scheduled Check</th> </tr> </thead> <tbody> <tr> <td>Power meter Agilent 4419B</td> <td>SN: GB42420191</td> <td>09-Oct-09 (in house check Oct-11)</td> <td>In house check: Oct-12</td> </tr> <tr> <td>Power sensor HP 8482H</td> <td>SN: 3318A09450</td> <td>09-Oct-09 (in house check Oct-11)</td> <td>In house check: Oct-12</td> </tr> <tr> <td>Power sensor HP 8482A</td> <td>SN: US37295597</td> <td>09-Oct-09 (in house check Oct-11)</td> <td>In house check: Oct-12</td> </tr> <tr> <td>Network Analyzer HP 8753E</td> <td>US37390585</td> <td>18-Oct-01 (in house check Oct-11)</td> <td>In house check: Oct-12</td> </tr> <tr> <td>RF generator E4433B</td> <td>MY 41000675</td> <td>03-Nov-04 (in house check Oct-11)</td> <td>In house check: Oct-13</td> </tr> </tbody> </table>				Primary Standards	ID #	Cal Date (Certificate No.)	Scheduled Calibration	Power meter EPM-442A	GB37480704	05-Oct-11 (No. 217-01451)	Oct-12	Power sensor HP 8481A	US37292783	05-Oct-11 (No. 217-01451)	Oct-12	Probe ER3DV6	SN: 2336	29-Dec-11 (No. ER3-2336_Dec11)	Dec-12	Probe H3DV6	SN: 6065	29-Dec-11 (No. H3-6065_Dec11)	Dec-12	DAE4	SN: 781	20-Apr-11 (No. DAE4-781_Apr11)	Apr-12	Secondary Standards	ID #	Check Date (in house)	Scheduled Check	Power meter Agilent 4419B	SN: GB42420191	09-Oct-09 (in house check Oct-11)	In house check: Oct-12	Power sensor HP 8482H	SN: 3318A09450	09-Oct-09 (in house check Oct-11)	In house check: Oct-12	Power sensor HP 8482A	SN: US37295597	09-Oct-09 (in house check Oct-11)	In house check: Oct-12	Network Analyzer HP 8753E	US37390585	18-Oct-01 (in house check Oct-11)	In house check: Oct-12	RF generator E4433B	MY 41000675	03-Nov-04 (in house check Oct-11)	In house check: Oct-13
Primary Standards	ID #	Cal Date (Certificate No.)	Scheduled Calibration																																																
Power meter EPM-442A	GB37480704	05-Oct-11 (No. 217-01451)	Oct-12																																																
Power sensor HP 8481A	US37292783	05-Oct-11 (No. 217-01451)	Oct-12																																																
Probe ER3DV6	SN: 2336	29-Dec-11 (No. ER3-2336_Dec11)	Dec-12																																																
Probe H3DV6	SN: 6065	29-Dec-11 (No. H3-6065_Dec11)	Dec-12																																																
DAE4	SN: 781	20-Apr-11 (No. DAE4-781_Apr11)	Apr-12																																																
Secondary Standards	ID #	Check Date (in house)	Scheduled Check																																																
Power meter Agilent 4419B	SN: GB42420191	09-Oct-09 (in house check Oct-11)	In house check: Oct-12																																																
Power sensor HP 8482H	SN: 3318A09450	09-Oct-09 (in house check Oct-11)	In house check: Oct-12																																																
Power sensor HP 8482A	SN: US37295597	09-Oct-09 (in house check Oct-11)	In house check: Oct-12																																																
Network Analyzer HP 8753E	US37390585	18-Oct-01 (in house check Oct-11)	In house check: Oct-12																																																
RF generator E4433B	MY 41000675	03-Nov-04 (in house check Oct-11)	In house check: Oct-13																																																
Calibrated by:	Name Dince Iliev	Function Laboratory Technician	Signature 																																																
Approved by:	Name Fin Bornholt	Function R&D Director	Signature 																																																
Issued: February 22, 2012																																																			
This calibration certificate shall not be reproduced except in full without written approval of the laboratory.																																																			

**Calibration Laboratory of  
Schmid & Partner  
Engineering AG**  
Zeughausstrasse 43, 8004 Zurich, Switzerland



**S** Schweizerischer Kalibrierdienst  
**C** Service suisse d'étalonnage  
**S** Servizio svizzero di taratura  
**S** Swiss Calibration Service

Accredited by the Swiss Accreditation Service (SAS)  
The Swiss Accreditation Service is one of the signatories to the EA  
Multilateral Agreement for the recognition of calibration certificates

Accreditation No.: **SCS 108**

#### References

- [1] ANSI-C63.19-2007  
American National Standard for Methods of Measurement of Compatibility between Wireless Communications Devices and Hearing Aids.

#### Methods Applied and Interpretation of Parameters:

- **Coordinate System:** y-axis is in the direction of the dipole arms. z-axis is from the basis of the antenna (mounted on the table) towards its feed point between the two dipole arms. x-axis is normal to the other axes. In coincidence with the standards [1], the measurement planes (probe sensor center) are selected to be at a distance of 10 mm above the top edge of the dipole arms.
- **Measurement Conditions:** Further details are available from the hardcopies at the end of the certificate. All figures stated in the certificate are valid at the frequency indicated. The forward power to the dipole connector is set with a calibrated power meter connected and monitored with an auxiliary power meter connected to a directional coupler. While the dipole under test is connected, the forward power is adjusted to the same level.
- **Antenna Positioning:** The dipole is mounted on a HAC Test Arch phantom using the matching dipole positioner with the arms horizontal and the feeding cable coming from the floor. The measurements are performed in a shielded room with absorbers around the setup to reduce the reflections. It is verified before the mounting of the dipole under the Test Arch phantom, that its arms are perfectly in a line. It is installed on the HAC dipole positioner with its arms parallel below the dielectric reference wire and able to move elastically in vertical direction without changing its relative position to the top center of the Test Arch phantom. The vertical distance to the probe is adjusted after dipole mounting with a DASY5 Surface Check job. Before the measurement, the distance between phantom surface and probe tip is verified. The proper measurement distance is selected by choosing the matching section of the HAC Test Arch phantom with the proper device reference point (upper surface of the dipole) and the matching grid reference point (tip of the probe) considering the probe sensor offset. The vertical distance to the probe is essential for the accuracy.
- **Feed Point Impedance and Return Loss:** These parameters are measured using a HP 8753E Vector Network Analyzer. The impedance is specified at the SMA connector of the dipole. The influence of reflections was eliminated by applying the averaging function while moving the dipole in the air, at least 70cm away from any obstacles.
- **E-field distribution:** E field is measured in the x-y-plane with an isotropic ER3D-field probe with 100 mW forward power to the antenna feed point. In accordance with [1], the scan area is 20mm wide, its length exceeds the dipole arm length (180 or 90mm). The sensor center is 10 mm (in z) above the top of the dipole arms. Two 3D maxima are available near the end of the dipole arms. Assuming the dipole arms are perfectly in one line, the average of these two maxima (in subgrid 2 and subgrid 8) is determined to compensate for any non-parallelity to the measurement plane as well as the sensor displacement. The E-field value stated as calibration value represents the maximum of the interpolated 3D-E-field, 10mm above the dipole surface.
- **H-field distribution:** H-field is measured with an isotropic H-field probe with 100mW forward power to the antenna feed point, in the x-y-plane. The scan area and sensor distance is equivalent to the E-field scan. The maximum of the field is available at the center (subgrid 5) above the feed point. The H-field value stated as calibration value represents the maximum of the interpolated H-field, 10mm above the dipole surface at the feed point.

# TA Technology (Shanghai) Co., Ltd.

## Test Report

### Measurement Conditions

DASY system configuration, as far as not given on page 1:

<b>DASY Version</b>	DASY5	V52.8.0
<b>Extrapolation</b>	Advanced Extrapolation	
<b>Phantom</b>	HAC Test Arch	
<b>Distance Dipole Top - Probe Center</b>	10mm	
<b>Scan resolution</b>	dx, dy = 5 mm	
<b>Frequency</b>	1880MHz ± 1 MHz	
<b>Input power drift</b>	< 0.05 dB	

### Maximum Field values

<b>H-field 10 mm above dipole surface</b>	<b>condition</b>	<b>interpolated maximum</b>
Maximum measured	100 mW input power	<b>0.473 A / m ± 8.2 % (k=2)</b>

<b>E-field 10 mm above dipole surface</b>	<b>condition</b>	<b>Interpolated maximum</b>
Maximum measured above high end	100 mW input power	143.4 V / m
Maximum measured above low end	100 mW input power	139.6 V / m
Averaged maximum above arm	100 mW input power	<b>141.5 V / m ± 12.8 % (k=2)</b>

### Appendix

#### Antenna Parameters

<b>Frequency</b>	<b>Return Loss</b>	<b>Impedance</b>
1730 MHz	30.5 dB	52.6 Ω + 1.5 jΩ
1880 MHz	21.7 dB	46.1 Ω + 6.9 jΩ
1900 MHz	22.0 dB	47.6 Ω + 7.4 jΩ
1950 MHz	29.8 dB	49.9 Ω + 3.2 jΩ
2000 MHz	18.9 dB	41.3 Ω + 5.6 jΩ

#### 3.2 Antenna Design and Handling

The calibration dipole has a symmetric geometry with a built-in two stub matching network, which leads to the enhanced bandwidth.

The dipole is built of standard semirigid coaxial cable. The internal matching line is open ended. The antenna is therefore open for DC signals.

Do not apply force to dipole arms, as they are liable to bend. The soldered connections near the feedpoint may be damaged. After excessive mechanical stress or overheating, check the impedance characteristics to ensure that the internal matching network is not affected.

After long term use with 40W radiated power, only a slight warming of the dipole near the feedpoint can be measured.

# TA Technology (Shanghai) Co., Ltd. Test Report

Report No. RXA1204-0048HAC01R1

Page 110 of 119

## Impedance Measurement Plot

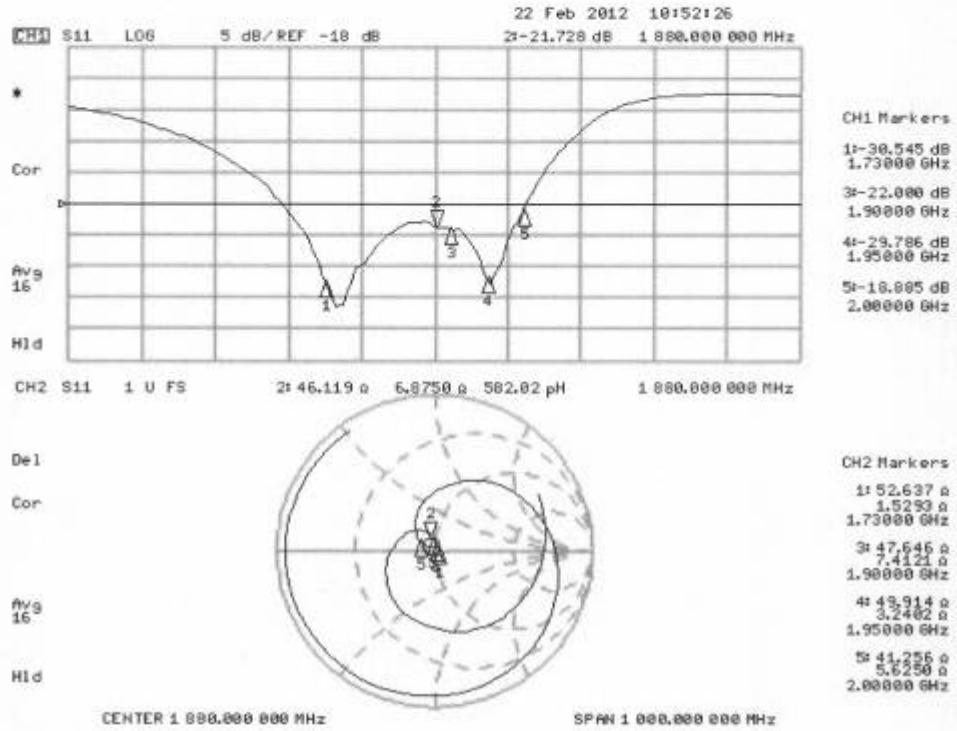

# TA Technology (Shanghai) Co., Ltd. Test Report

Report No. RXA1204-0048HAC01R1

Page 111 of 119

## DASY5 H-field Result

Date: 21.02.2012

Test Laboratory: SPEAG Lab2

**DUT: HAC Dipole 1880 MHz; Type: CD1880V3; Serial: CD1880V3 - SN: 1115**

Communication System: CW; Frequency: 1880 MHz  
 Medium parameters used:  $\sigma = 0$  mho/m,  $\epsilon_r = 1$ ;  $\rho = 1$  kg/m<sup>3</sup>  
 Phantom section: RF Section  
 Measurement Standard: DASY5 (IEEE/IEC/ANSI C63.19-2007)

DASY52 Configuration:

- Probe: H3DV6 - SN6065; ; Calibrated: 29.12.2011
- Sensor-Surface: (Fix Surface)
- Electronics: DAE4 Sn781; Calibrated: 20.04.2011
- Phantom: HAC Test Arch with AMCC; Type: SD HAC P01 BA; Serial: 1070
- DASY52 52.8.0(692); SEMCAD X 14.6.4(4989)

### Dipole H-Field measurement @ 1880MHz/H-Scan - 1880MHz d=10mm/Hearing Aid Compatibility Test (41x181x1): Measurement grid: dx=5mm, dy=5mm

Device Reference Point: 0, 0, -6.3 mm  
 Reference Value = 0.50 V/m; Power Drift = -0.01 dB  
 PMR not calibrated. PMF = 1.000 is applied.  
 H-field emissions = 0.47 A/m  
**Near-field category: M2 (AWF 0 dB)**

PMF scaled H-field

Grid 1 <b>M2</b> <b>0.40 A/m</b>	Grid 2 <b>M2</b> <b>0.43 A/m</b>	Grid 3 <b>M2</b> <b>0.41 A/m</b>
Grid 4 <b>M2</b> <b>0.45 A/m</b>	Grid 5 <b>M2</b> <b>0.47 A/m</b>	Grid 6 <b>M2</b> <b>0.46 A/m</b>
Grid 7 <b>M2</b> <b>0.41 A/m</b>	Grid 8 <b>M2</b> <b>0.44 A/m</b>	Grid 9 <b>M2</b> <b>0.42 A/m</b>

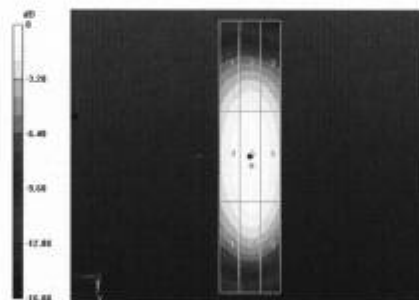

0 dB = 0.47A/m = -6.56 dB A/m

# TA Technology (Shanghai) Co., Ltd. Test Report

Report No. RXA1204-0048HAC01R1

Page 112 of 119

## DASY5 E-field Result

Date: 21.02.2012

Test Laboratory: SPEAG Lab2

**DUT: HAC Dipole 1880 MHz; Type: CD1880V3; Serial: CD1880V3 - SN: 1115**

Communication System: CW; Frequency: 1880 MHz  
 Medium parameters used:  $\sigma = 0$  mho/m,  $\epsilon_r = 1$ ;  $\rho = 1000$  kg/m<sup>3</sup>  
 Phantom section: RF Section  
 Measurement Standard: DASY5 (IEEE/IEC/ANSI C63.19-2007)

DASY52 Configuration:

- Probe: ER3DV6 - SN2336; ConvF(1, 1, 1); Calibrated: 29.12.2011
- Sensor-Surface: (Fix Surface)
- Electronics: DAE4 Sn781; Calibrated: 20.04.2011
- Phantom: HAC Test Arch with AMCC; Type: SD HAC P01 BA; Serial: 1070
- DASY52 52.8.0(692); SEMCAD X 14.6.4(4989)

### Dipole E-Field measurement @ 1880MHz/E-Scan - 1880MHz d=10mm/Hearing Aid Compatibility Test (41x181x1): Measurement grid: dx=5mm, dy=5mm

Device Reference Point: 0, 0, -6.3 mm  
 Reference Value = 161.1 V/m; Power Drift = -0.01 dB  
 PMR not calibrated. PMF = 1.000 is applied.  
 E-field emissions = 143.4 V/m  
**Near-field category: M2 (AWF 0 dB)**

PMF scaled E-field

Grid 1 <b>M2</b> <b>134.3 V/m</b>	Grid 2 <b>M2</b> <b>139.6 V/m</b>	Grid 3 <b>M2</b> <b>136.5 V/m</b>
Grid 4 <b>M3</b> <b>90.34 V/m</b>	Grid 5 <b>M3</b> <b>93.17 V/m</b>	Grid 6 <b>M3</b> <b>89.93 V/m</b>
Grid 7 <b>M2</b> <b>134.3 V/m</b>	Grid 8 <b>M2</b> <b>143.4 V/m</b>	Grid 9 <b>M2</b> <b>141.8 V/m</b>

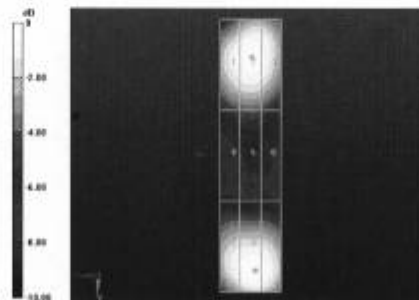

0 dB = 143.4V/m = 43.13 dB V/m



# TA Technology (Shanghai) Co., Ltd.

## Test Report

Report No. RXA1204-0048HAC01R1

Page 113 of 119

### ANNEX G: DAE4 Calibration Certificate

**Calibration Laboratory of  
Schmid & Partner  
Engineering AG**  
Zeughausstrasse 43, 8004 Zurich, Switzerland



**S** Schweizerischer Kalibrierdienst  
**C** Service suisse d'étalonnage  
**S** Servizio svizzero di taratura  
**S** Swiss Calibration Service

Accredited by the Swiss Accreditation Service (SAS)  
The Swiss Accreditation Service is one of the signatories to the EA  
Multilateral Agreement for the recognition of calibration certificates

Accreditation No.: **SCS 108**

Client **TA-SH (Auden)**

Certificate No: **DAE4-871\_Nov11**

CALIBRATION CERTIFICATE																			
Object	DAE4 - SD 000 D04 BJ - SN: 871																		
Calibration procedure(s)	QA CAL-06.v23 Calibration procedure for the data acquisition electronics (DAE)																		
Calibration date:	November 22, 2011																		
<p>This calibration certificate documents the traceability to national standards, which realize the physical units of measurements (SI). The measurements and the uncertainties with confidence probability are given on the following pages and are part of the certificate.</p> <p>All calibrations have been conducted in the closed laboratory facility; environment temperature (22 ± 3)°C and humidity &lt; 70%.</p> <p>Calibration Equipment used (M&amp;TE critical for calibration)</p> <table border="1" style="width: 100%; border-collapse: collapse;"> <thead> <tr> <th style="width: 30%;">Primary Standards</th> <th style="width: 15%;">ID #</th> <th style="width: 30%;">Cal Date (Certificate No.)</th> <th style="width: 25%;">Scheduled Calibration</th> </tr> </thead> <tbody> <tr> <td>Keithley Multimeter Type 2001</td> <td>SN: 0810278</td> <td>28-Sep-11 (No:11450)</td> <td>Sep-12</td> </tr> <tr> <th>Secondary Standards</th> <th>ID #</th> <th>Check Date (in house)</th> <th>Scheduled Check</th> </tr> <tr> <td>Calibrator Box V1.1</td> <td>SE UMS 006 AB 1004</td> <td>08-Jun-11 (in house check)</td> <td>In house check: Jun-12</td> </tr> </tbody> </table>				Primary Standards	ID #	Cal Date (Certificate No.)	Scheduled Calibration	Keithley Multimeter Type 2001	SN: 0810278	28-Sep-11 (No:11450)	Sep-12	Secondary Standards	ID #	Check Date (in house)	Scheduled Check	Calibrator Box V1.1	SE UMS 006 AB 1004	08-Jun-11 (in house check)	In house check: Jun-12
Primary Standards	ID #	Cal Date (Certificate No.)	Scheduled Calibration																
Keithley Multimeter Type 2001	SN: 0810278	28-Sep-11 (No:11450)	Sep-12																
Secondary Standards	ID #	Check Date (in house)	Scheduled Check																
Calibrator Box V1.1	SE UMS 006 AB 1004	08-Jun-11 (in house check)	In house check: Jun-12																
Calibrated by:	Name Andrea Gunti	Function Technician	Signature 																
Approved by:	Fin Bornholt	R&D Director																	
			Issued: November 22, 2011																
This calibration certificate shall not be reproduced except in full without written approval of the laboratory.																			

# TA Technology (Shanghai) Co., Ltd.

## Test Report

Report No. RXA1204-0048HAC01R1

Page 114 of 119

**Calibration Laboratory of  
Schmid & Partner  
Engineering AG**  
Zeughausstrasse 43, 8004 Zurich, Switzerland



**S** Schweizerischer Kalibrierdienst  
**C** Service suisse d'étalonnage  
**S** Servizio svizzero di taratura  
**S** Swiss Calibration Service

Accredited by the Swiss Accreditation Service (SAS)  
The Swiss Accreditation Service is one of the signatories to the EA  
Multilateral Agreement for the recognition of calibration certificates

Accreditation No.: **SCS 108**

### Glossary

DAE data acquisition electronics  
Connector angle information used in DASY system to align probe sensor X to the robot coordinate system.

### Methods Applied and Interpretation of Parameters

- **DC Voltage Measurement:** Calibration Factor assessed for use in DASY system by comparison with a calibrated instrument traceable to national standards. The figure given corresponds to the full scale range of the voltmeter in the respective range.
- **Connector angle:** The angle of the connector is assessed measuring the angle mechanically by a tool inserted. Uncertainty is not required.
- The following parameters as documented in the Appendix contain technical information as a result from the performance test and require no uncertainty.
  - **DC Voltage Measurement Linearity:** Verification of the Linearity at +10% and -10% of the nominal calibration voltage. Influence of offset voltage is included in this measurement.
  - **Common mode sensitivity:** Influence of a positive or negative common mode voltage on the differential measurement.
  - **Channel separation:** Influence of a voltage on the neighbor channels not subject to an input voltage.
  - **AD Converter Values with inputs shorted:** Values on the internal AD converter corresponding to zero input voltage
  - **Input Offset Measurement:** Output voltage and statistical results over a large number of zero voltage measurements.
  - **Input Offset Current:** Typical value for information; Maximum channel input offset current, not considering the input resistance.
  - **Input resistance:** Typical value for information: DAE input resistance at the connector, during internal auto-zeroing and during measurement.
  - **Low Battery Alarm Voltage:** Typical value for information. Below this voltage, a battery alarm signal is generated.
  - **Power consumption:** Typical value for information. Supply currents in various operating modes.

# TA Technology (Shanghai) Co., Ltd.

## Test Report

Report No. RXA1204-0048HAC01R1

Page 115 of 119

### DC Voltage Measurement

A/D - Converter Resolution nominal

High Range: 1LSB = 6.1 $\mu$ V, full range = -100...+300 mV

Low Range: 1LSB = 61nV, full range = -1.....+3mV

DASY measurement parameters: Auto Zero Time: 3 sec; Measuring time: 3 sec

Calibration Factors	X	Y	Z
High Range	404.749 $\pm$ 0.1% (k=2)	404.733 $\pm$ 0.1% (k=2)	405.174 $\pm$ 0.1% (k=2)
Low Range	3.98175 $\pm$ 0.7% (k=2)	3.93601 $\pm$ 0.7% (k=2)	3.96830 $\pm$ 0.7% (k=2)

### Connector Angle

Connector Angle to be used in DASY system	90.0 $\pm$ 1 $^{\circ}$
---	-------------------------

# TA Technology (Shanghai) Co., Ltd.

## Test Report

### Appendix

#### 1. DC Voltage Linearity

High Range	Reading ( $\mu\text{V}$ )	Difference ( $\mu\text{V}$ )	Error (%)
Channel X + Input	199991.9	-0.91	-0.00
Channel X + Input	20000.28	0.48	0.00
Channel X - Input	-19998.51	0.59	-0.00
Channel Y + Input	200003.0	1.24	0.00
Channel Y + Input	19999.67	0.17	0.00
Channel Y - Input	-20000.04	-0.34	0.00
Channel Z + Input	200010.1	-0.11	-0.00
Channel Z + Input	19999.33	-0.07	-0.00
Channel Z - Input	-20001.45	-0.85	0.00

Low Range	Reading ( $\mu\text{V}$ )	Difference ( $\mu\text{V}$ )	Error (%)
Channel X + Input	2000.0	0.05	0.00
Channel X + Input	199.81	-0.09	-0.04
Channel X - Input	-199.63	0.37	-0.19
Channel Y + Input	1999.9	-0.22	-0.01
Channel Y + Input	198.81	-1.19	-0.59
Channel Y - Input	-201.62	-1.72	0.86
Channel Z + Input	2000.4	0.48	0.02
Channel Z + Input	199.30	-0.70	-0.35
Channel Z - Input	-200.86	-1.06	0.53

#### 2. Common mode sensitivity

DASY measurement parameters: Auto Zero Time: 3 sec; Measuring time: 3 sec

	Common mode Input Voltage (mV)	High Range Average Reading ( $\mu\text{V}$ )	Low Range Average Reading ( $\mu\text{V}$ )
Channel X	200	14.43	13.13
	-200	-12.22	-13.72
Channel Y	200	-10.07	-9.78
	-200	9.61	8.66
Channel Z	200	-0.56	-0.83
	-200	-0.01	0.11

#### 3. Channel separation

DASY measurement parameters: Auto Zero Time: 3 sec; Measuring time: 3 sec

	Input Voltage (mV)	Channel X ( $\mu\text{V}$ )	Channel Y ( $\mu\text{V}$ )	Channel Z ( $\mu\text{V}$ )
Channel X	200	-	3.08	0.09
Channel Y	200	3.19	-	4.59
Channel Z	200	0.90	-0.06	-

# TA Technology (Shanghai) Co., Ltd.

## Test Report

#### 4. AD-Converter Values with inputs shorted

DASY measurement parameters: Auto Zero Time: 3 sec; Measuring time: 3 sec

	High Range (LSB)	Low Range (LSB)
Channel X	15920	15519
Channel Y	16179	17567
Channel Z	15791	15270

#### 5. Input Offset Measurement

DASY measurement parameters: Auto Zero Time: 3 sec; Measuring time: 3 sec

Input 10M $\Omega$

	Average ( $\mu$ V)	min. Offset ( $\mu$ V)	max. Offset ( $\mu$ V)	Std. Deviation ( $\mu$ V)
Channel X	0.03	-1.16	2.66	0.46
Channel Y	-0.63	-3.22	0.29	0.46
Channel Z	-0.87	-2.03	0.28	0.46

#### 6. Input Offset Current

Nominal Input circuitry offset current on all channels: <25fA

#### 7. Input Resistance (Typical values for information)

	Zeroing (kOhm)	Measuring (MOhm)
Channel X	200	200
Channel Y	200	200
Channel Z	200	200

#### 8. Low Battery Alarm Voltage (Typical values for information)

Typical values	Alarm Level (VDC)
Supply (+ Vcc)	+7.9
Supply (- Vcc)	-7.6

#### 9. Power Consumption (Typical values for information)

Typical values	Switched off (mA)	Stand by (mA)	Transmitting (mA)
Supply (+ Vcc)	+0.01	+6	+14
Supply (- Vcc)	-0.01	-8	-9

## ANNEX H: The EUT Appearances and Test Configuration



a: EUT

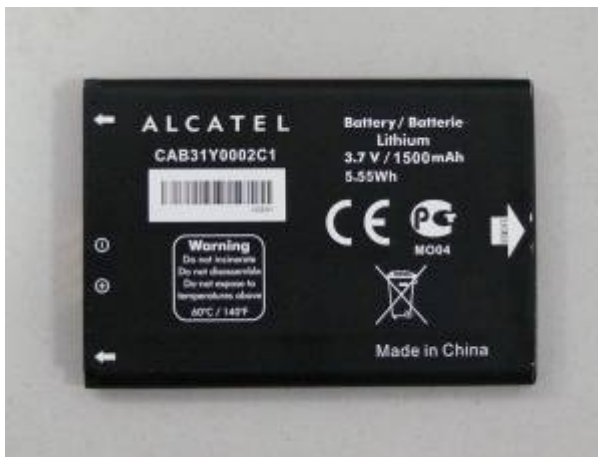

b: Battery

Picture 1: Constituents of EUT

**TA Technology (Shanghai) Co., Ltd.**  
**Test Report**

Report No. RXA1204-0048HAC01R1

Page 119 of 119



**Picture 2: Test Setup**