



HAC RF TEST REPORT

No. 2011HAC00031-1

For

TCT Mobile Limited

GSM/GPRS/EDGE Quad bands mobile phone

Diamond_US

one touch 810A

With

Hardware Version: PIO

Software Version: swC17

FCCID: RAD201

Results Summary: M Category = M3

Issued Date: 2011-09-08



No. DGA-PL-114/01-02

Note:

The test results in this test report relate only to the devices specified in this report. This report shall not be reproduced except in full without the written approval of TMC Beijing.

Test Laboratory:

TMC Beijing, Telecommunication Metrology Center of MIIT

No. 52, Huayuan Bei Road, Haidian District, Beijing, P. R. China 100191.

Tel:+86(0)10-62304633-2079, Fax:+86(0)10-62304793 Email:welcme@emcite.com. www.emcite.com

TABLE OF CONTENT

1 TEST LABORATORY	3
1.1 TESTING LOCATION	3
1.2 TESTING ENVIRONMENT.....	3
1.3 PROJECT DATA	3
1.4 SIGNATURE.....	3
2 CLIENT INFORMATION	4
2.1 APPLICANT INFORMATION	4
2.2 MANUFACTURER INFORMATION	4
3 EQUIPMENT UNDER TEST (EUT) AND ANCILLARY EQUIPMENT (AE)	4
3.1 ABOUT EUT	4
3.2 INTERNAL IDENTIFICATION OF EUT USED DURING THE TEST	4
3.3 INTERNAL IDENTIFICATION OF AE USED DURING THE TEST.....	4
4 CONDUCTED OUTPUT POWER MEASUREMENT	5
4.1 SUMMARY	5
4.2 CONDUCTED POWER	5
5. REFERENCE DOCUMENTS	5
5.1 REFERENCE DOCUMENTS FOR TESTING	5
6 OPERATIONAL CONDITIONS DURING TEST	5
6.1 HAC MEASUREMENT SET-UP	5
6.2 PROBE SPECIFICATION	6
6.3 TEST ARCH PHANTOM & PHONE POSITIONER.....	7
6.4 ROBOTIC SYSTEM SPECIFICATIONS.....	8
7 EUT ARRANGEMENT	8
7.1 WD RF EMISSION MEASUREMENTS REFERENCE AND PLANE	8
8 SYSTEM VALIDATION	9
8.1 VALIDATION PROCEDURE	9
8.2 VALIDATION RESULT	10
9 PROBE MODULATION FACTOR	10
9.1 MODULATION FACTOR TEST PROCEDURE.....	11
9.2 MODULATION FACTOR.....	11
10 RF TEST PROCEDURES	12
11 HAC RF TEST DATA SUMMARY	13
11.1 MEASUREMENT RESULTS (E-FIELD).....	13
11.2 MEASUREMENT RESULTS (H-FIELD)	13
11.3 TOTAL M-RATING	13
12 ANSI C 63.19-2007 LIMITS	14
13 MEASUREMENT UNCERTAINTY	14
14 MAIN TEST INSTRUMENTS	16
15 CONCLUSION	16
ANNEX A TEST LAYOUT	17
ANNEX B TEST PLOTS	18
ANNEX C SYSTEM VALIDATION RESULT	34
ANNEX D PROBE CALIBRATION CERTIFICATE	38

1 Test Laboratory

1.1 Testing Location

Company Name: TMC Beijing, Telecommunication Metrology Center of MIIT
Address: No 52, Huayuan beilu, Haidian District, Beijing,P.R.China
Postal Code: 100191
Telephone: +86-10-62304633
Fax: +86-10-62304793

1.2 Testing Environment

Temperature: 18°C~25 °C,
Relative humidity: 30%~ 70%
Ground system resistance: < 0.5 Ω

Ambient noise is checked and found very low and in compliance with requirement of standards.
Reflection of surrounding objects is minimized and in compliance with requirement of standards.

1.3 Project Data

Project Leader: Qi Dianyuan
Test Engineer: Lin Hao
Testing Start Date: August 23, 2011
Testing End Date: August 23, 2011

1.4 Signature



Lin Hao

(Prepared this test report)

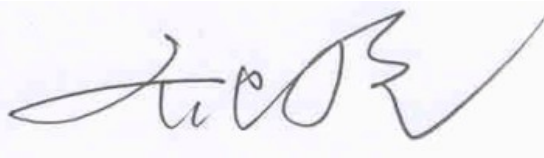

Qi Dianyuan

(Reviewed this test report)



Xiao Li

Deputy Director of the laboratory
(Approved this test report)

2 Client Information

2.1 Applicant Information

Company Name: TCT Mobile Limited
 Address /Post: 5F, E building, No. 232, Liang Jing Road ZhangJiang High-Tech Park,
 Pudong Area Shanghai, P.R. China. 201203
 City: Shanghai
 Postal Code: 201203
 Country: P. R. China
 Telephone: 0086-21-61460890
 Fax: 0086-21-61460602

2.2 Manufacturer Information

Company Name: TCT Mobile Limited
 Address /Post: 5F, E building, No. 232, Liang Jing Road ZhangJiang High-Tech Park,
 Pudong Area Shanghai, P.R. China. 201203
 City: Shanghai
 Postal Code: 201203
 Country: P. R. China
 Telephone: 0086-21-61460890
 Fax: 0086-21-61460602

3 Equipment Under Test (EUT) and Ancillary Equipment (AE)

3.1 About EUT

EUT Description: GSM/GPRS/EDGE Quad bands mobile phone
 Model Name: Diamond_US
 Marketing Name: one touch 810A
 Frequency Band: GSM 850/1900

3.2 Internal Identification of EUT used during the test

EUT ID*	SN or IMEI	HW Version	SW Version
EUT1	012818000020694 / 012818000020678	PIO	swC17

*EUT ID: is used to identify the test sample in the lab internally.

3.3 Internal Identification of AE used during the test

AE ID*	Description	Model	SN	Manufacturer
AE1	Battery	CAB3120000C1	/	BYD

*AE ID: is used to identify the test sample in the lab internally

4 CONDUCTED OUTPUT POWER MEASUREMENT

4.1 Summary

During the process of testing, the EUT was controlled via Rhode & Schwarz Digital Radio Communication tester (CMU-200) to ensure the maximum power transmission and proper modulation. This result contains conducted output power for the EUT. In all cases, the measured output power should be greater and within 5% than EMI measurement.

4.2 Conducted Power

GSM 850MHZ	Conducted Power (dBm)		
	Channel 251(848.8MHz)	Channel 190(836.6MHz)	Channel 128(824.2MHz)
	33.72	33.73	34.07
GSM 1900MHZ	Conducted Power (dBm)		
	Channel 810(1909.8MHz)	Channel 661(1880MHz)	Channel 512(1850.2MHz)
	29.63	29.52	29.46

5. Reference Documents

5.1 Reference Documents for testing

The following document listed in this section is referred for testing.

Reference	Title	Version
ANSI C63.19-2007	American National Standard for Methods of Measurement of Compatibility between Wireless Communication Devices and Hearing Aids	2007 Edition

6 OPERATIONAL CONDITIONS DURING TEST

6.1 HAC MEASUREMENT SET-UP

These measurements are performed using the DASY5 NEO automated dosimetric assessment system. It is made by Schmid & Partner Engineering AG (SPEAG) in Zurich, Switzerland. It consists of high precision robotics system (Stäubli), robot controller, Intel Core2 computer, near-field probe, probe alignment sensor. The robot is a six-axis industrial robot performing precise movements. A cell controller system contains the power supply, robot controller, teach pendant (Joystick), and remote control, is used to drive the robot motors. The PC consists of the HP Intel Core2 1.86 GHz computer with Windows XP system and HAC Measurement Software DASY5 NEO, A/D interface card, monitor, mouse, and keyboard. The Stäubli Robot is connected to the cell controller to allow software manipulation of the robot. A data acquisition electronic (DAE) circuit performs the signal amplification, signal multiplexing, AD-conversion, offset measurements, mechanical surface detection, collision detection, etc. is connected to the Electro-optical coupler (EOC). The EOC performs the conversion from the optical into digital electric signal of the DAE and transfers data to the PC plug-in card.

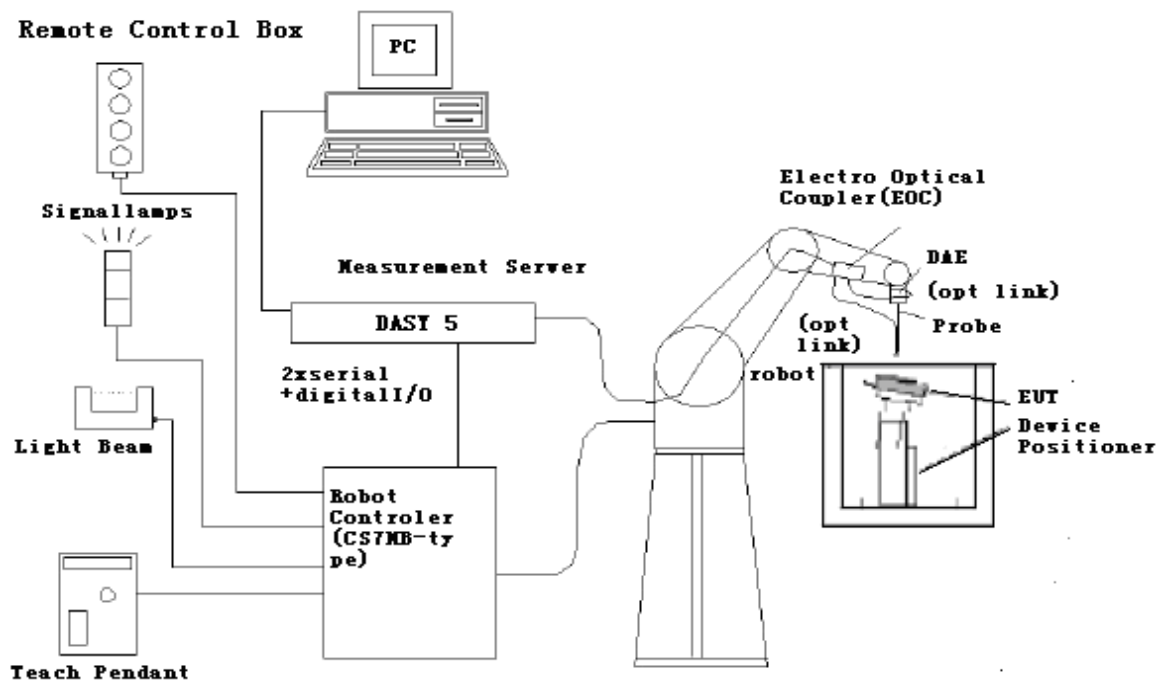

Fig. 1 HAC Test Measurement Set-up

The DAE4 consists of a highly sensitive electrometer-grade preamplifier with auto-zeroing, a channel and gain-switching multiplexer, a fast 16 bit AD-converter and a command decoder and control logic unit. Transmission to the PC-card is accomplished through an optical downlink for data and status information and an optical uplink for commands and clock lines. The mechanical probe mounting device includes two different sensor systems for frontal and sidewise probe contacts. They are also used for mechanical surface detection and probe collision detection. The robot uses its own controller with a built in VME-bus computer.

6.2 Probe Specification

6.2.1 E-Field Probe Description

Construction	One dipole parallel, two dipoles normal to probe axis Built-in shielding against static charges PEEK enclosure material
Calibration	In air from 100 MHz to 3.0 GHz (absolute accuracy $\pm 6.0\%$, $k=2$)
Frequency	40 MHz to > 6 GHz (can be extended to < 20 MHz) Linearity: ± 0.2 dB (100 MHz to 3 GHz)
Directivity	± 0.2 dB in air (rotation around probe axis) ± 0.4 dB in air (rotation normal to probe axis)
Dynamic Range	2 V/m to > 1000 V/m; Linearity: ± 0.2 dB
Dimensions	Overall length: 330 mm (Tip: 16 mm) Tip diameter: 8 mm (Body: 12 mm) Distance from probe tip to dipole centers: 2.5 mm



[ER3DV6]

Application General near-field measurements up to 6 GHz
 Field component measurements
 Fast automatic scanning in phantoms

6.2.2 H-Field Probe Description

Construction Three concentric loop sensors with 3.8 mm loop diameters
 Resistively loaded detector diodes for linear response
 Built-in shielding against static charges
 PEEK enclosure material (resistant to organic solvents,
 e.g., glycoether)



[H3DV6]

Frequency 200 MHz to 3 GHz (absolute accuracy $\pm 6.0\%$, $k=2$); Output
 linearized

Directivity ± 0.2 dB (spherical isotropy error)

Dynamic Range 10 mA/m to 2 A/m at 1 GHz

E-Field Interference < 10% at 3 GHz (for plane wave)

Dimensions Overall length: 330 mm (Tip: 40 mm)
 Tip diameter: 6 mm (Body: 12 mm)
 Distance from probe tip to dipole centers: 3 mm

Application General magnetic near-field measurements up to 3 GHz (in
 air or liquids)
 Field component measurements
 Surface current measurements
 Low interaction with the measured field

6.3 Test Arch Phantom & Phone Positioner

The Test Arch phantom should be positioned horizontally on a stable surface. Reference markings on the Phantom allow the complete setup of all predefined phantom positions and measurement grids by manually teaching three points in the robot. It enables easy and well defined positioning of the phone and validation dipoles as well as simple teaching of the robot (Dimensions: 370 x 370 x 370 mm).

The Phone Positioner supports accurate and reliable positioning of any phone with effect on near field $< \pm 0.5$ dB.

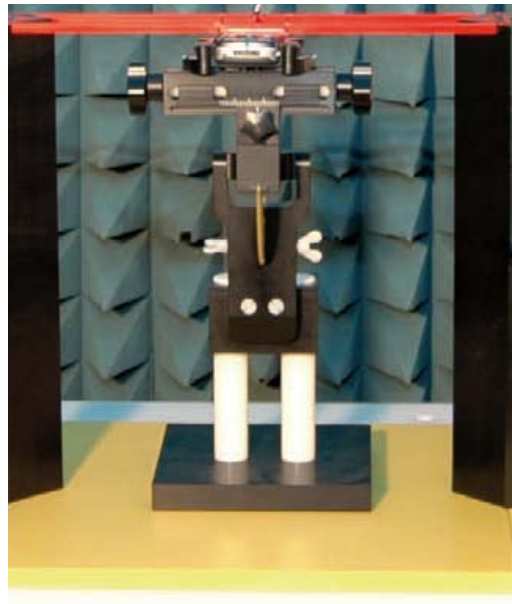

Fig. 2 HAC Phantom & Device Holder

6.4 Robotic System Specifications

Specifications

Positioner: Stäubli Unimation Corp. Robot Model: RX160L

Repeatability: ± 0.02 mm

No. of Axis: 6

Data Acquisition Electronic (DAE) System

Cell Controller

Processor: Intel Core2

Clock Speed: 1.86 GHz

Operating System: Windows XP

Data Converter

Features: Signal Amplifier, multiplexer, A/D converter, and control logic

Software: DASY5 software

Connecting Lines: Optical downlink for data and status info.

Optical uplink for commands and clock

7 EUT ARRANGEMENT

7.1 WD RF Emission Measurements Reference and Plane

Figure 4 illustrates the references and reference plane that shall be used in the WD emissions measurement.

- The grid is 5 cm by 5 cm area that is divided into 9 evenly sized blocks or sub-grids.
- The grid is centered on the audio frequency output transducer of the WD (speaker or T-coil).
- The grid is located by reference to a reference plane. This reference plane is the planar area that contains the highest point in the area of the WD that normally rests against the user's ear
- The measurement plane is located parallel to the reference plane and 15 mm from it, out from

the phone. The grid is located in the measurement plane.

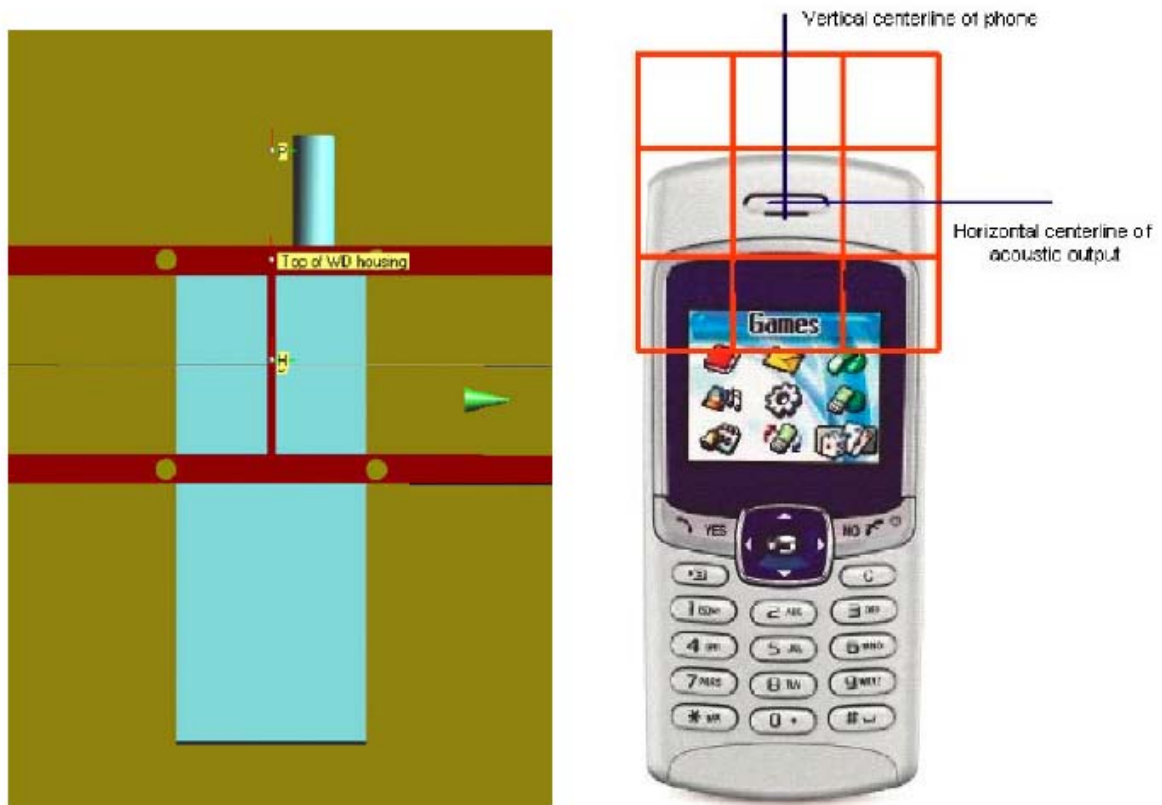

Fig. 3 WD reference and plane for RF emission measurements

8 SYSTEM VALIDATION

8.1 Validation Procedure

Place a dipole antenna meeting the requirements given in ANSI C63.19 D.5 in the position normally occupied by the WD. The dipole antenna serves as a known source for an electrical and magnetic output. Position the E-field and H-field probes so that:

- The probes and their cables are parallel to the coaxial feed of the dipole antenna
- The probe cables and the coaxial feed of the dipole antenna approach the measurement area from opposite directions
- The center point of the probe element(s) are 10 mm from the closest surface of the dipole elements.

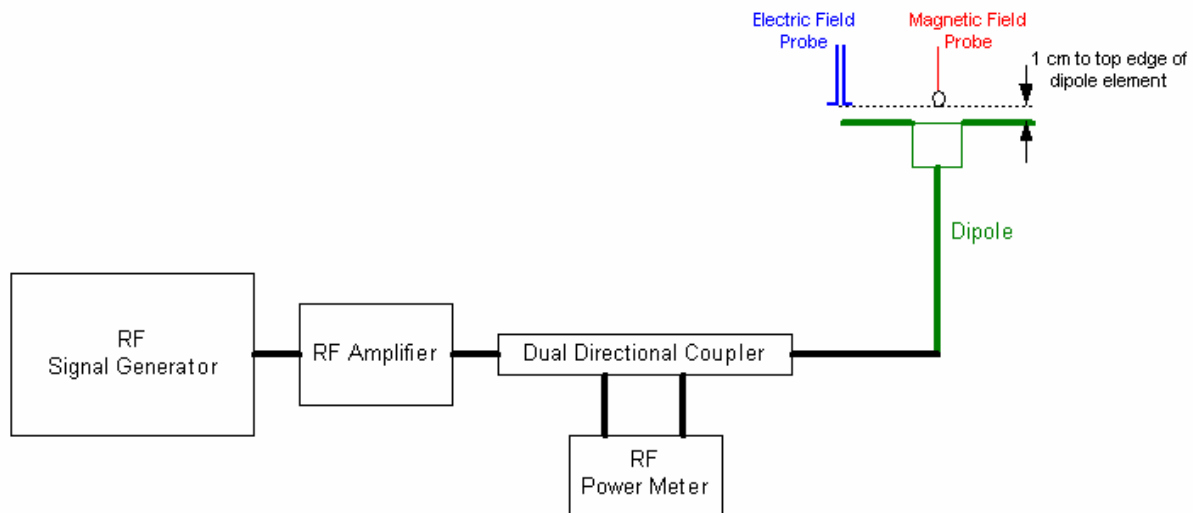

Fig. 4 Dipole Validation Setup

8.2 Validation Result

E-Field Scan							
Mode	Frequency (MHz)	Input Power (mW)	Power	Measured ¹ Value(V/m)	Target ² Value(V/m)	Deviation ³ (%)	Limit ⁴ (%)
CW	835	100		168.4	163.9	+2.75%	± 25
CW	1880	100		134.3	137.7	-2.47%	± 25
H-Field Scan							
Mode	Frequency (MHz)	Input Power (mW)	Power	Measured Value(A/m)	Target Value(A/m)	Deviation (%)	Limit (%)
CW	835	100		0.444	0.458	-3.06%	± 25
CW	1880	100		0.451	0.463	-1.90%	± 25

Notes:

1. Please refer to the attachment for detailed measurement data and plot.
2. Target value is provided by SPEAD in the calibration certificate of specific dipoles.
3. Deviation (%) = 100 * (Measured value minus Target value) divided by Target value.
4. ANSI C63.19 requires values within ± 25% are acceptable, of which 12% is deviation and 13% is measurement uncertainty. Values independently validated for the dipole actually used in the measurements should be used, when available.

9 Probe Modulation Factor

The Probe Modulation Factor (PMF) is defined as the ratio of the field readings for a CW and a modulated signal with the equivalent Field Envelope Peak as defined in ANSI C63.19 (Chapter C.3.1). Calibration shall be made of the modulation response of the probe and its instrumentation chain. This Calibration shall be performed with the field probe, attached to the instrumentation that is to be used with it during the measurement. The response of the probe system to a CW field at the frequency(s) of interest is compared to its response to a modulated signal with equal peak amplitude. The field level of the test signals shall be more than 10dB above the ambient level and

the noise floor of the instrumentation being used. The ratio of the CW reading to that taken with a modulated field shall be applied to the readings taken of modulated fields of the specified type.

9.1 Modulation Factor Test Procedure

This may be done using the following procedure:

1. Fix the field probe in a set location relative to a field generating device, such as the reference dipole antenna, as illustrated in Figure 6.
2. Illuminate the probe using the wireless device connected to the reference dipole with a test signal at the intended measurement frequency, Ensure there is sufficient field coupling between the probe and the antenna so the resulting reading is greater than 10 dB above the probe system noise floor but within the systems operating range.
3. Record the amplitude applied to the antenna during transmission and the field strength measured by the E-field probe located near the tip of the dipole antenna
4. Replace the wireless device with an RF signal generator producing an unmodulated CW signal and set to the wireless device operating frequency.
5. Set the amplitude of the unmodulated signal to equal that recorded from the wireless device.
6. Record the reading of the probe measurement system of the unmodulated signal.
7. The ratio, in linear units, of the probe reading in Step 6) to the reading in Step 3) is the E-field modulation factor. $PMF_E = E_{CW} / E_{mod}$ ($PMF_H = H_{CW} / H_{mod}$)
8. Repeat the previous steps using the H-field probe, except locate the probe at the center of the dipole.

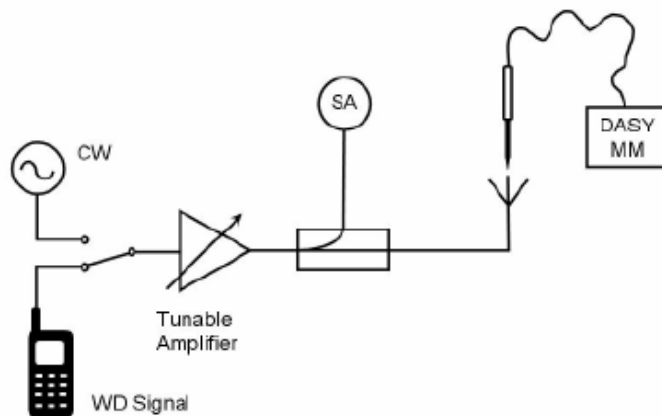

Fig. 5 Probe Modulation Factor Test Setup

9.2 Modulation Factor

9.2.1 E-Field

Frequency (MHz)	Mode	Input Power (mW)	E-Field Measured Value (V/m)	Probe Modulation Factor
835	CW	100	163.9	\
	WCDMA	100	173.9	1.00
	GSM	100	60.2	2.88
1880	CW	100	137.7	\
	WCDMA	100	134.8	1.00
	GSM	100	46.6	2.88

9.2.2 H-Field

Frequency (MHz)	Mode	Input Power (mW)	H-Field Measured Value (A/m)	Probe Modulation Factor
835	CW	100	0.458	\
	WCDMA	100	0.425	1.00
	GSM	100	0.147	2.88
1880	CW	100	0.463	\
	WCDMA	100	0.411	1.00
	GSM	100	0.143	2.88

10 RF TEST PROCEDURES

The evaluation was performed with the following procedure:

- 1) Confirm proper operation of the field probe, probe measurement system and other instrumentation and the positioning system.
- 2) Position the WD in its intended test position. The gauge block can simplify this positioning. Note that a separate E-field and H-field gauge block will be needed if the center of the probe sensor elements are at different distances from the tip of the probe.
- 3) Configure the WD normal operation for maximum rated RF output power, at the desired channel and other operating parameters (e.g., test mode), as intended for the test.
- 4) The center sub-grid shall be centered on the center of the T-Coil mode axial measurement point or the acoustic output, as appropriate. Locate the field probe at the initial test position in the 50 mm by 50 mm grid, which is contained in the measurement plane. If the field alignment method is used, align the probe for maximum field reception.
- 5) Record the reading.
- 6) Scan the entire 50 mm by 50 mm region in equally spaced increments and record the reading at each measurement point. The distance between measurement points shall be sufficient to assure the identification of the maximum reading.
- 7) Identify the five contiguous sub-grids around the center sub-grid with the lowest maximum field strength readings. Thus the six areas to be used to determine the WD's highest emissions are identified and outlined for the final manual scan. Please note that a maximum of five blocks can be excluded for both E-field and H-field measurements for the WD output being measured. Stated another way, the center sub-grid and three others must be common to both the E-field and H-field measurements.
- 8) Identify the maximum field reading within the non-excluded sub-grids identified in Step 7)
- 9) Convert the maximum field strength reading identified in Step 8) to V/m or A/m, as appropriate. For probes which require a probe modulation factor, this conversion shall be done using the appropriate probe modulation factor and the calibration.
- 10) Repeat Step 1) through Step 10) for both the E-field and H-field measurements.
- 11) Compare this reading to the categories in ANSI C63.19 Clause 7 and record the resulting category. The lowest category number listed in 7.2, Table 7.4, or Table 7.5 obtained in Step 10) for either E- or H-field determines the M category for the audio coupling mode assessment. Record the WD category rating.

11 HAC RF TEST DATA SUMMARY

11.1 Measurement Results (E-Field)

Frequency		AWF	Measured Value (V/m)	Power Drift (dB)	Category
MHz	Channel				
GSM 850					
848.8	251	-5	165.6	-0.052	M3 (see Fig B.1)
836.6	190	-5	152.3	0.013	M3 (see Fig B.2)
824.2	128	-5	138.0	-0.021	M4 (see Fig B.3)
GSM 1900					
1909.8	810	-5	24.2	0.194	M4 (see Fig B.4)
1880	661	-5	25.4	0.130	M4 (see Fig B.5)
1850.2	512	-5	27	0.058	M4 (see Fig B.6)

11.2 Measurement Results (H-Field)

Frequency		AWF	Measured Value (A/m)	Power Drift (dB)	Category
MHz	Channel				
GSM 850					
848.8	251	-5	0.316	0.011	M4 (see Fig B.7)
836.6	190	-5	0.296	0.014	M4 (see Fig B.8)
824.2	128	-5	0.272	-0.00946	M4 (see Fig B.9)
GSM 1900					
1909.8	810	-5	0.089	0.043	M4 (see Fig B.10)
1880	661	-5	0.093	-0.044	M4 (see Fig B.11)
1850.2	512	-5	0.096	-0.111	M4 (see Fig B.12)

11.3 Total M-rating

Mode	Maximum value of peak Total E-Field (V/m)	Maximum value of peak Total H-Field (A/m)	E-Field M Rating	H-Field M Rating	Total M Rating
GSM 850	165.6	0.316	M3 (AWF -5 dB)	M4 (AWF -5 dB)	M3 (see Fig B.13)
GSM 1900	27	0.096	M4 (AWF -5 dB)	M4 (AWF -5 dB)	M4 (see Fig B.14)

12 ANSI C 63.19-2007 LIMITS

Table 1: Telephone near-field categories in linear units

Category		Telephone RF parameters < 960 MHz			
Near field	AWF	E-field emissions		H-field emissions	
Category M1/T1	0	631.0 to 1122.0	V/m	1.91 to 3.39	A/m
	-5	473.2 to 841.4	V/m	1.43 to 2.54	A/m
Category M2/T2	0	354.8 to 631.0	V/m	1.07 to 1.91	A/m
	-5	266.1 to 473.2	V/m	0.80 to 1.43	A/m
Category M3/T3	0	199.5 to 354.8	V/m	0.60 to 1.07	A/m
	-5	149.6 to 266.1	V/m	0.45 to 0.80	A/m
Category M4/T4	0	< 199.5	V/m	< 0.60	A/m
	-5	< 149.6	V/m	< 0.45	A/m
Category		Telephone RF parameters > 960 MHz			
Near field	AWF	E-field emissions		H-field emissions	
Category M1/T1	0	199.5 to 354.8	V/m	0.60 to 1.07	A/m
	-5	149.6 to 266.1	V/m	0.45 to 0.80	A/m
Category M2/T2	0	112.2 to 199.5	V/m	0.34 to 0.60	A/m
	-5	84.1 to 149.6	V/m	0.25 to 0.45	A/m
Category M3/T3	0	63.1 to 112.2	V/m	0.19 to 0.34	A/m
	-5	47.3 to 84.1	V/m	0.14 to 0.25	A/m
Category M4/T4	0	< 63.1	V/m	< 0.19	A/m
	-5	< 47.3	V/m	< 0.14	A/m

13 MEASUREMENT UNCERTAINTY

No.	Error source	Type	Uncertainty Value (%)	Prob. Dist.	k	c _i E	c _i H	Standard Uncertainty (%) u _i (%) E	Standard Uncertainty (%) u _i (%) H	Degree of freedom V _{eff} or v _i
Measurement System										
1	Probe Calibration	B	5.	N	1	1	1	5.1	5.1	∞
2	Axial Isotropy	B	4.7	R	$\sqrt{3}$	1	1	2.7	2.7	∞
3	Sensor Displacement	B	16.5	R	$\sqrt{3}$	1	0.145	9.5	1.4	∞
4	Boundary Effects	B	2.4	R	$\sqrt{3}$	1	1	1.4	1.4	∞
5	Linearity	B	4.7	R	$\sqrt{3}$	1	1	2.7	2.7	∞

6	Scaling to Peak Envelope Power	B	2.0	R	$\sqrt{3}$	1	1	1.2	1.2	∞
7	System Detection Limit	B	1.0	R	$\sqrt{3}$	1	1	0.6	0.6	∞
8	Readout Electronics	B	0.3	N	1	1	1	0.3	0.3	∞
9	Response Time	B	0.8	R	$\sqrt{3}$	1	1	0.5	0.5	∞
10	Integration Time	B	2.6	R	$\sqrt{3}$	1	1	1.5	1.5	∞
11	RF Ambient Conditions	B	3.0	R	$\sqrt{3}$	1	1	1.7	1.7	∞
12	RF Reflections	B	12.0	R	$\sqrt{3}$	1	1	6.9	6.9	∞
13	Probe Positioner	B	1.2	R	$\sqrt{3}$	1	0.67	0.7	0.5	∞
14	Probe Positioning	A	4.7	R	$\sqrt{3}$	1	0.67	2.7	1.8	∞
15	Extra. And Interpolation	B	1.0	R	$\sqrt{3}$	1	1	0.6	0.6	∞
Test Sample Related										
16	Device Positioning Vertical	B	4.7	R	$\sqrt{3}$	1	0.67	2.7	1.8	∞
17	Device Positioning Lateral	B	1.0	R	$\sqrt{3}$	1	1	0.6	0.6	∞
18	Device Holder and Phantom	B	2.4	R	$\sqrt{3}$	1	1	1.4	1.4	∞
19	Power Drift	B	5.0	R	$\sqrt{3}$	1	1	2.9	2.9	∞
Phantom and Setup related										
20s	Phantom Thickness	B	2.4	R	$\sqrt{3}$	1	0.67	1.4	0.9	∞
Combined standard uncertainty(%)								14.7	10.9	
Expanded uncertainty (confidence interval of 95 %)		$u_e = 2u_c$		N	k=2			29.4	21.8	

14 MAIN TEST INSTRUMENTS

Table 2: List of Main Instruments

No.	Name	Type	Serial Number	Calibration Date	Valid Period
01	E-Field Probe	ER3DV6	2428	October 20, 2010	One year
02	H-Field Probe	H3DV6	6260	October 20, 2010	One year
03	HAC Dipole	CD835V3	1023	October 21, 2009	Two years
04	HAC Dipole	CD1880V3	1018	October 21, 2009	Two years
05	BTS	8960	MY48365192	November 18, 2010	One year
06	DAE	SPEAG DAE4	777	July 8, 2011	One year

15 CONCLUSION

The HAC measurement indicates that the EUT complies with the HAC limits of the ANSI C63.19-2007. The total M-ratings are **M3** for **GSM 850** and **M4** for **GSM 1900**.

END OF REPORT BODY

ANNEX A TEST LAYOUT



Picture A1: HAC RF System Layout

ANNEX B TEST PLOTS

HAC RF E-Field GSM 850 High

Date/Time: 8/23/2011 10:16:59 AM

Electronics: DAE4 Sn777

Medium: Air

Medium parameters used: $\sigma = 0$ mho/m, $\epsilon_r = 1$; $\rho = 1000$ kg/m³

Ambient Temperature: 23.3°C Liquid Temperature: 22.5°C

Communication System: GSM 850; Frequency: 848.8 MHz; Duty Cycle: 1:8.3

Probe: ER3DV6 - SN2428; ConvF(1, 1, 1)

E Scan - ER3DV6 - 2007: 15 mm from Probe Center to the Device/Hearing Aid

Compatibility Test (101x101x1): Measurement grid: dx=5mm, dy=5mm

Maximum value of peak Total field = 165.6 V/m

Probe Modulation Factor = 2.88

Device Reference Point: 0, 0, -6.3 mm

Reference Value = 71.7 V/m; Power Drift = -0.052 dB

Hearing Aid Near-Field Category: M3 (AWF -5 dB)

Peak E-field in V/m

Grid 1 135.0 M4	Grid 2 148.9 M4	Grid 3 144.1 M4
Grid 4 155.9 M3	Grid 5 165.6 M3	Grid 6 158.5 M3
Grid 7 173.7 M3	Grid 8 174.4 M3	Grid 9 161.0 M3

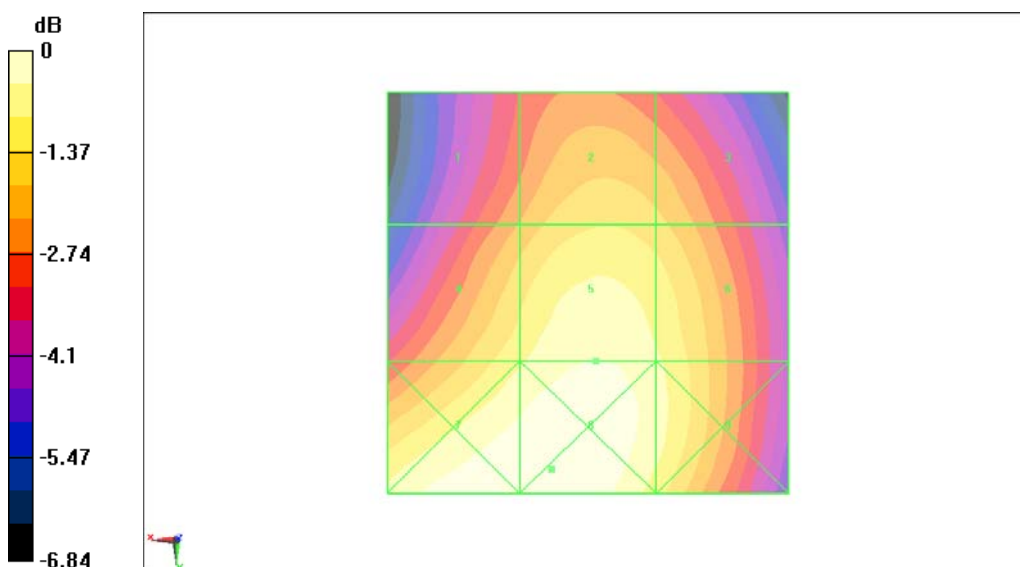

0 dB = 174.4V/m

Fig B.1 HAC RF E-Field GSM 850 High

HAC RF E-Field GSM 850 Middle

Date/Time: 8/23/2011 10:22:34 AM

Electronics: DAE4 Sn777

Medium: Air

Medium parameters used: $\sigma = 0$ mho/m, $\epsilon_r = 1$; $\rho = 1000$ kg/m³

Ambient Temperature: 23.3°C Liquid Temperature: 22.5°C

Communication System: GSM 850; Frequency: 836.6 MHz; Duty Cycle: 1:8.3

Probe: ER3DV6 - SN2428; ConvF(1, 1, 1)

E Scan - ER3DV6 - 2007: 15 mm from Probe Center to the Device/Hearing Aid

Compatibility Test (101x101x1): Measurement grid: dx=5mm, dy=5mm

Maximum value of peak Total field = 152.3 V/m

Probe Modulation Factor = 2.88

Device Reference Point: 0, 0, -6.3 mm

Reference Value = 65.3 V/m; Power Drift = 0.013 dB

Hearing Aid Near-Field Category: M3 (AWF -5 dB)

Peak E-field in V/m

Grid 1 122.6 M4	Grid 2 136.5 M4	Grid 3 132.7 M4
Grid 4 142.5 M4	Grid 5 152.3 M3	Grid 6 145.7 M4
Grid 7 159.2 M3	Grid 8 160.3 M3	Grid 9 148.0 M4

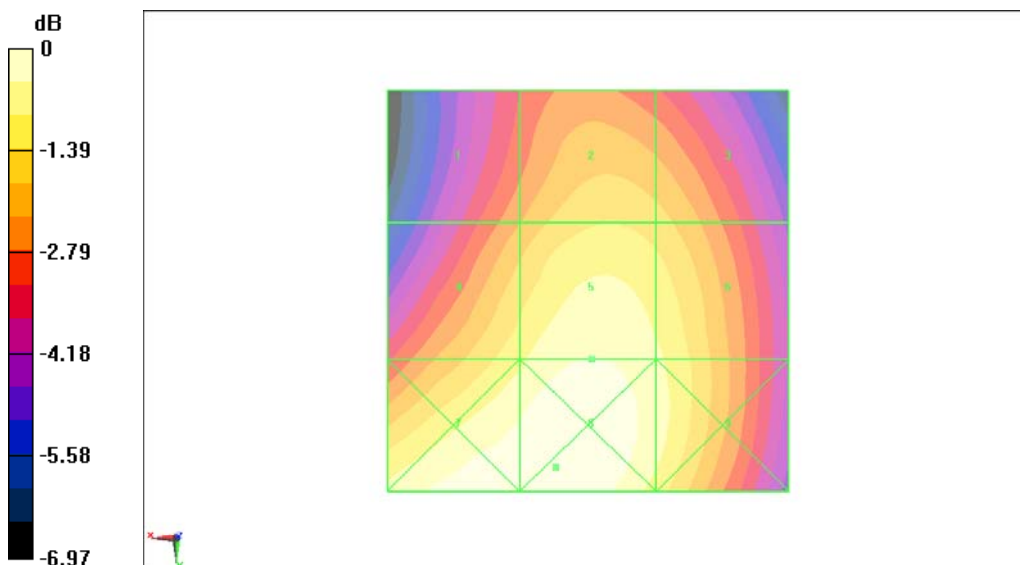

0 dB = 160.3V/m

Fig B.2 HAC RF E-Field GSM 850 Middle

HAC RF E-Field GSM 850 Low

Date/Time: 8/23/2011 10:27:59 AM

Electronics: DAE4 Sn777

Medium: Air

Medium parameters used: $\sigma = 0$ mho/m, $\epsilon_r = 1$; $\rho = 1000$ kg/m³

Ambient Temperature: 23.3°C Liquid Temperature: 22.5°C

Communication System: GSM 850; Frequency: 824.2 MHz; Duty Cycle: 1:8.3

Probe: ER3DV6 - SN2428; ConvF(1, 1, 1)

E Scan - ER3DV6 - 2007: 15 mm from Probe Center to the Device/Hearing Aid

Compatibility Test (101x101x1): Measurement grid: dx=5mm, dy=5mm

Maximum value of peak Total field = 138.0 V/m

Probe Modulation Factor = 2.88

Device Reference Point: 0, 0, -6.3 mm

Reference Value = 59.2 V/m; Power Drift = -0.021 dB

Hearing Aid Near-Field Category: M4 (AWF -5 dB)

Peak E-field in V/m

Grid 1 110.7 M4	Grid 2 123.7 M4	Grid 3 120.8 M4
Grid 4 128.9 M4	Grid 5 138.0 M4	Grid 6 132.2 M4
Grid 7 144.2 M4	Grid 8 145.3 M4	Grid 9 134.9 M4

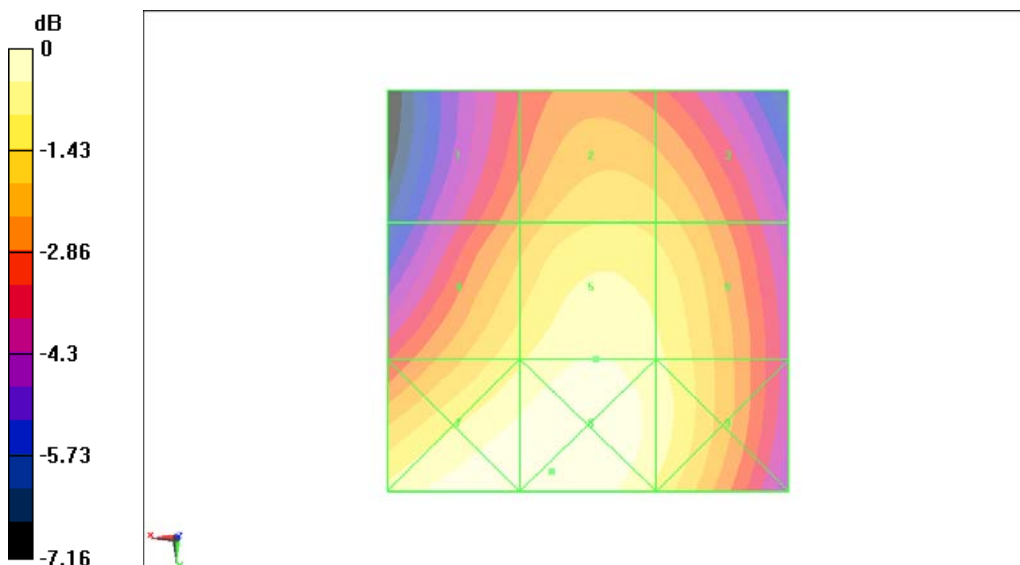

0 dB = 145.3V/m

Fig B.3 HAC RF E-Field GSM 850 Low

HAC RF E-Field GSM 1900 High

Date/Time: 8/23/2011 10:34:55 AM

Electronics: DAE4 Sn777

Medium: Air

Medium parameters used: $\sigma = 0$ mho/m, $\epsilon_r = 1$; $\rho = 1000$ kg/m³

Ambient Temperature: 23.3°C Liquid Temperature: 22.5°C

Communication System: DCS 1900; Frequency: 1909.8 MHz; Duty Cycle: 1:8.3

Probe: ER3DV6 - SN2428; ConvF(1, 1, 1)

E Scan - ER3DV6 - 2007: 15 mm from Probe Center to the Device/Hearing Aid

Compatibility Test (101x101x1): Measurement grid: dx=5mm, dy=5mm

Maximum value of peak Total field = 24.2 V/m

Probe Modulation Factor = 2.88

Device Reference Point: 0, 0, -6.3 mm

Reference Value = 8.01 V/m; Power Drift = 0.194 dB

Hearing Aid Near-Field Category: M4 (AWF -5 dB)

Peak E-field in V/m

Grid 1 21.6 M4	Grid 2 21.7 M4	Grid 3 20.3 M4
Grid 4 22.6 M4	Grid 5 24.2 M4	Grid 6 23.9 M4
Grid 7 29.9 M4	Grid 8 33 M4	Grid 9 31.4 M4

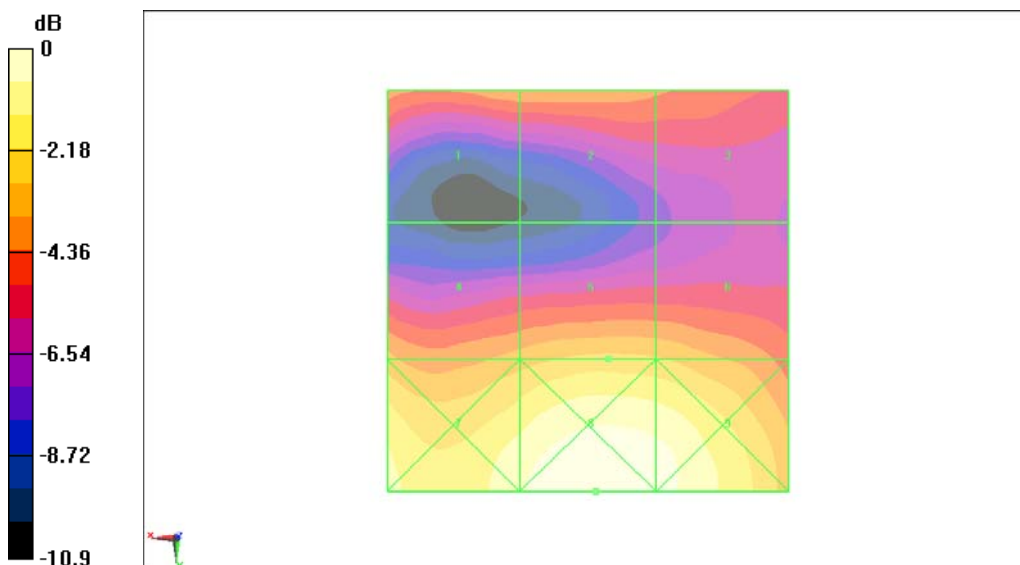

0 dB = 33V/m

Fig B.4 HAC RF E-Field GSM 1900 High

HAC RF E-Field GSM 1900 Middle

Date/Time: 8/23/2011 10:40:15 AM

Electronics: DAE4 Sn777

Medium: Air

Medium parameters used: $\sigma = 0$ mho/m, $\epsilon_r = 1$; $\rho = 1000$ kg/m³

Ambient Temperature: 23.3°C Liquid Temperature: 22.5°C

Communication System: DCS 1900; Frequency: 1880 MHz; Duty Cycle: 1:8.3

Probe: ER3DV6 - SN2428; ConvF(1, 1, 1)

E Scan - ER3DV6 - 2007: 15 mm from Probe Center to the Device/Hearing Aid

Compatibility Test (101x101x1): Measurement grid: dx=5mm, dy=5mm

Maximum value of peak Total field = 25.4 V/m

Probe Modulation Factor = 2.88

Device Reference Point: 0, 0, -6.3 mm

Reference Value = 8.69 V/m; Power Drift = 0.130 dB

Hearing Aid Near-Field Category: M4 (AWF -5 dB)

Peak E-field in V/m

Grid 1	Grid 2	Grid 3
23.8 M4	21.1 M4	17.7 M4
Grid 4	Grid 5	Grid 6
22.3 M4	25.4 M4	25.1 M4
Grid 7	Grid 8	Grid 9
30.1 M4	32.8 M4	31.8 M4

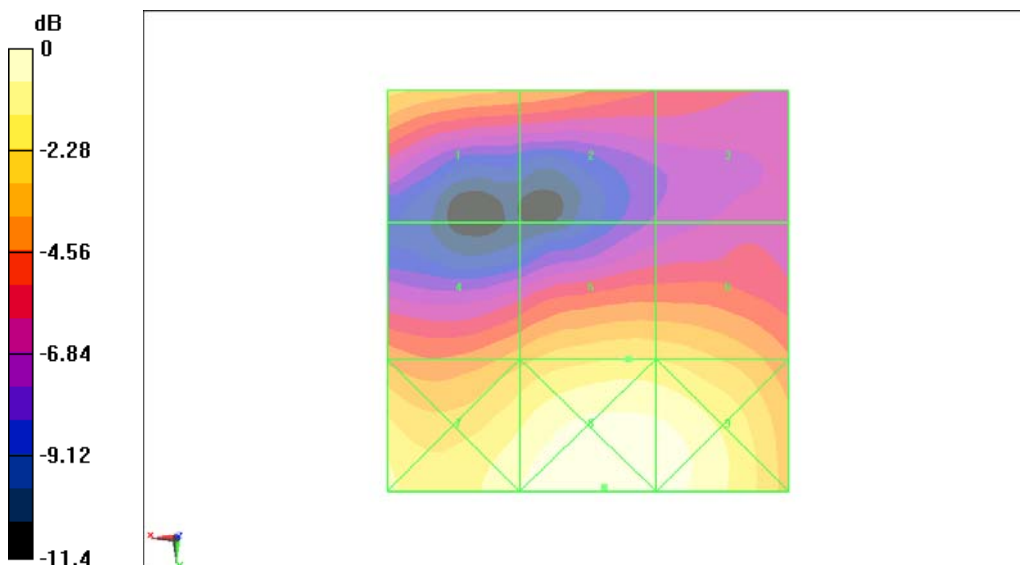

0 dB = 32.8V/m

Fig B.5 HAC RF E-Field GSM 1900 Middle

HAC RF E-Field GSM 1900 Low

Date/Time: 8/23/2011 10:45:37 AM

Electronics: DAE4 Sn777

Medium: Air

Medium parameters used: $\sigma = 0$ mho/m, $\epsilon_r = 1$; $\rho = 1000$ kg/m³

Ambient Temperature: 23.3°C Liquid Temperature: 22.5°C

Communication System: DCS 1900; Frequency: 1850.2 MHz; Duty Cycle: 1:8.3

Probe: ER3DV6 - SN2428; ConvF(1, 1, 1)

E Scan - ER3DV6 - 2007: 15 mm from Probe Center to the Device/Hearing Aid

Compatibility Test (101x101x1): Measurement grid: dx=5mm, dy=5mm

Maximum value of peak Total field = 27 V/m

Probe Modulation Factor = 2.88

Device Reference Point: 0, 0, -6.3 mm

Reference Value = 8.91 V/m; Power Drift = 0.058 dB

Hearing Aid Near-Field Category: M4 (AWF -5 dB)

Peak E-field in V/m

Grid 1 25.6 M4	Grid 2 25 M4	Grid 3 22.2 M4
Grid 4 23.2 M4	Grid 5 27 M4	Grid 6 26.8 M4
Grid 7 32.6 M4	Grid 8 35.9 M4	Grid 9 35 M4

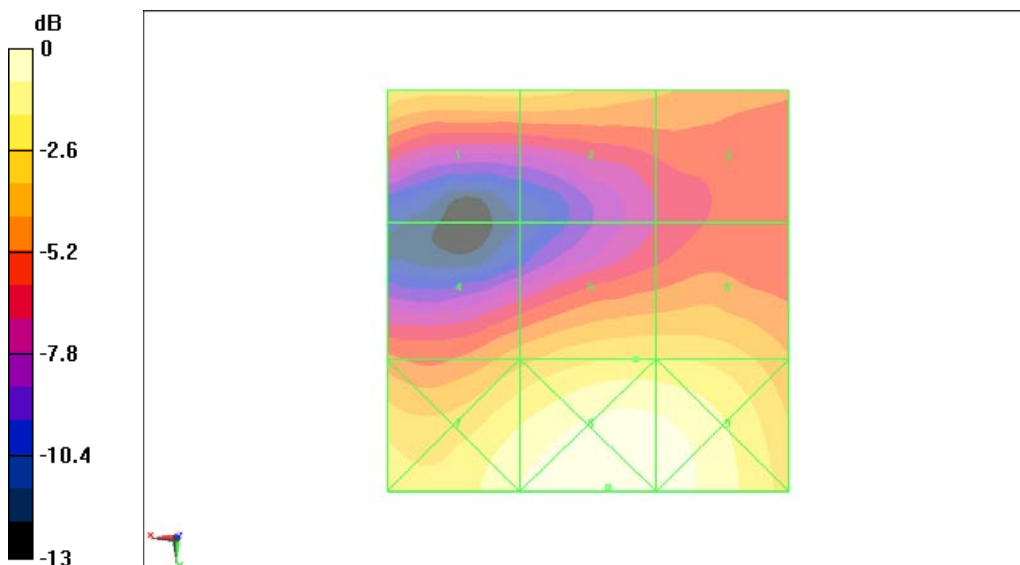

0 dB = 35.9V/m

Fig B.6 HAC RF E-Field GSM 1900 Low

HAC RF H-Field GSM 850 High

Date/Time: 8/23/2011 8:35:04 AM

Electronics: DAE4 Sn777

Medium: Air

Medium parameters used: $\sigma = 0$ mho/m, $\epsilon_r = 1$; $\rho = 1$ kg/m³

Ambient Temperature: 23.3°C Liquid Temperature: 22.5°C

Communication System: GSM 850; Frequency: 848.8 MHz; Duty Cycle: 1:8.3

Probe: H3DV6 - SN6260;

H Scan - H3DV6 - 2007: 15 mm from Probe Center to the Device/Hearing Aid

Compatibility Test (101x101x1): Measurement grid: dx=5mm, dy=5mm

Maximum value of peak Total field = 0.316 A/m

Probe Modulation Factor = 2.88

Device Reference Point: 0, 0, -6.3 mm

Reference Value = 0.087 A/m; Power Drift = 0.011 dB

Hearing Aid Near-Field Category: M4 (AWF -5 dB)

Peak H-field in A/m

Grid 1 0.490 M3	Grid 2 0.314 M4	Grid 3 0.194 M4
Grid 4 0.489 M3	Grid 5 0.316 M4	Grid 6 0.194 M4
Grid 7 0.483 M3	Grid 8 0.314 M4	Grid 9 0.191 M4

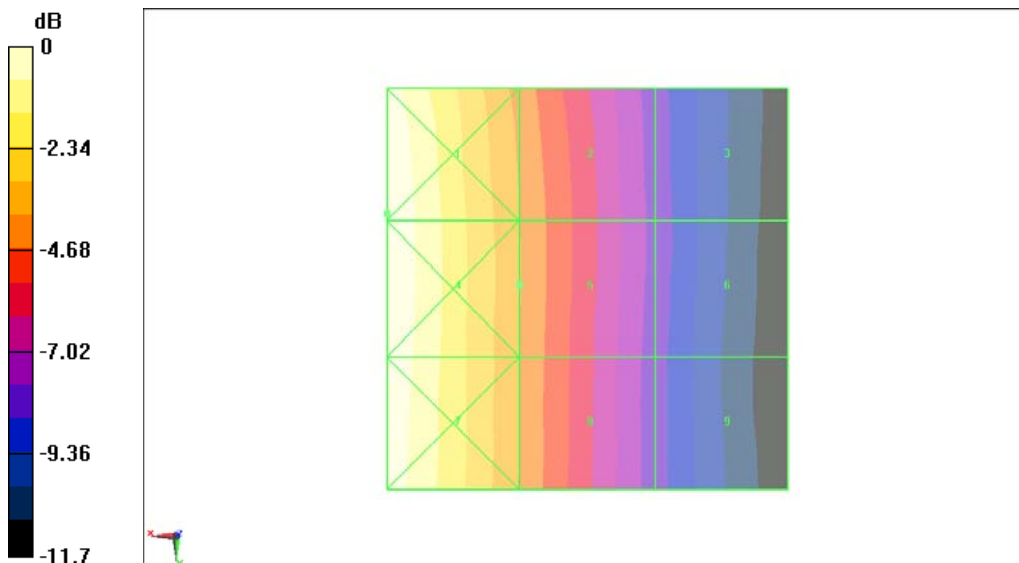

0 dB = 0.490A/m

Fig B.7 HAC RF H-Field GSM 850 High

HAC RF H-Field GSM 850 Middle

Date/Time: 8/23/2011 8:40:29 AM

Electronics: DAE4 Sn777

Medium: Air

Medium parameters used: $\sigma = 0$ mho/m, $\epsilon_r = 1$; $\rho = 1$ kg/m³

Ambient Temperature: 23.3°C Liquid Temperature: 22.5°C

Communication System: GSM 850; Frequency: 836.6 MHz; Duty Cycle: 1:8.3

Probe: H3DV6 - SN6260;

H Scan - H3DV6 - 2007: 15 mm from Probe Center to the Device/Hearing Aid

Compatibility Test (101x101x1): Measurement grid: dx=5mm, dy=5mm

Maximum value of peak Total field = 0.296 A/m

Probe Modulation Factor = 2.88

Device Reference Point: 0, 0, -6.3 mm

Reference Value = 0.082 A/m; Power Drift = 0.014 dB

Hearing Aid Near-Field Category: M4 (AWF -5 dB)

Peak H-field in A/m

Grid 1 0.454 M3	Grid 2 0.295 M4	Grid 3 0.184 M4
Grid 4 0.455 M3	Grid 5 0.296 M4	Grid 6 0.184 M4
Grid 7 0.445 M4	Grid 8 0.293 M4	Grid 9 0.181 M4

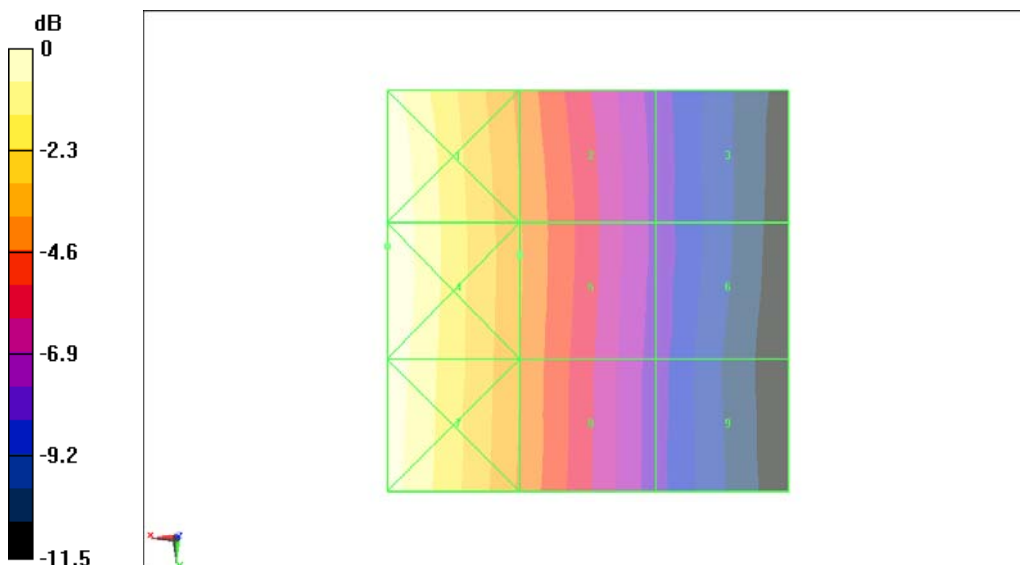

0 dB = 0.455 A/m

Fig B.8 HAC RF H-Field GSM 850 Middle

HAC RF H-Field GSM 850 Low

Date/Time: 8/23/2011 8:46:02 AM

Electronics: DAE4 Sn777

Medium: Air

Medium parameters used: $\sigma = 0$ mho/m, $\epsilon_r = 1$; $\rho = 1$ kg/m³

Ambient Temperature: 23.3°C Liquid Temperature: 22.5°C

Communication System: GSM 850; Frequency: 824.2 MHz; Duty Cycle: 1:8.3

Probe: H3DV6 - SN6260;

H Scan - H3DV6 - 2007: 15 mm from Probe Center to the Device/Hearing Aid

Compatibility Test (101x101x1): Measurement grid: dx=5mm, dy=5mm

Maximum value of peak Total field = 0.272 A/m

Probe Modulation Factor = 2.88

Device Reference Point: 0, 0, -6.3 mm

Reference Value = 0.076 A/m; Power Drift = -0.00946 dB

Hearing Aid Near-Field Category: M4 (AWF -5 dB)

Peak H-field in A/m

Grid 1 0.411 M4	Grid 2 0.272 M4	Grid 3 0.174 M4
Grid 4 0.411 M4	Grid 5 0.272 M4	Grid 6 0.173 M4
Grid 7 0.399 M4	Grid 8 0.267 M4	Grid 9 0.167 M4

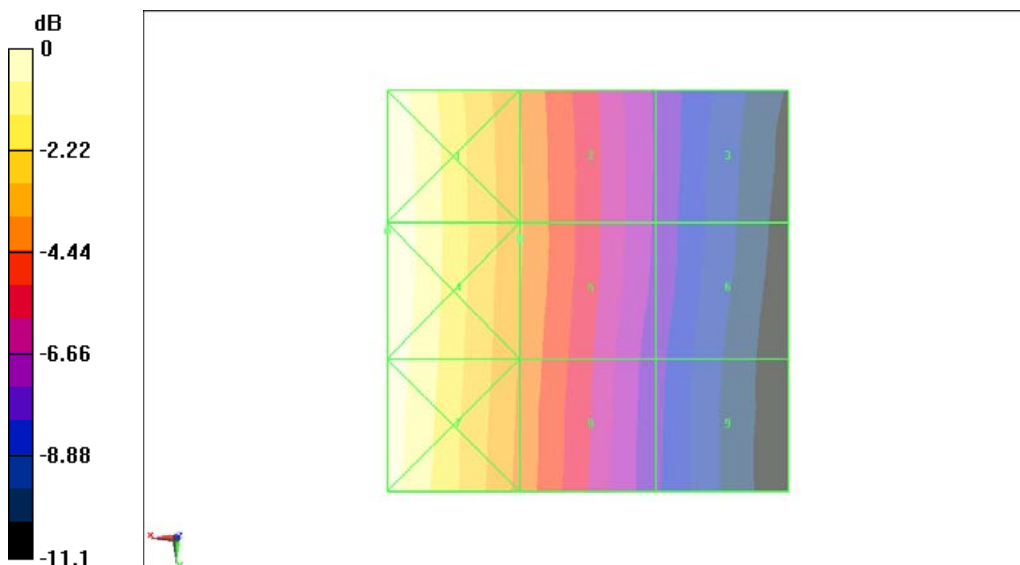

0 dB = 0.411A/m

Fig B.9 HAC RF H-Field GSM 850 Low

HAC RF H-Field GSM 1900 High

Date/Time: 8/23/2011 8:54:26 AM

Electronics: DAE4 Sn777

Medium: Air

Medium parameters used: $\sigma = 0$ mho/m, $\epsilon_r = 1$; $\rho = 1$ kg/m³

Ambient Temperature: 23.3°C Liquid Temperature: 22.5°C

Communication System: DCS 1900; Frequency: 1909.8 MHz; Duty Cycle: 1:8.3

Probe: H3DV6 - SN6260;

H Scan - H3DV6 - 2007: 15 mm from Probe Center to the Device/Hearing Aid

Compatibility Test (101x101x1): Measurement grid: dx=5mm, dy=5mm

Maximum value of peak Total field = 0.089 A/m

Probe Modulation Factor = 2.88

Device Reference Point: 0, 0, -6.3 mm

Reference Value = 0.023 A/m; Power Drift = 0.043 dB

Hearing Aid Near-Field Category: M4 (AWF -5 dB)

Peak H-field in A/m

Grid 1 0.119 M4	Grid 2 0.076 M4	Grid 3 0.060 M4
Grid 4 0.115 M4	Grid 5 0.070 M4	Grid 6 0.059 M4
Grid 7 0.140 M4	Grid 8 0.089 M4	Grid 9 0.048 M4

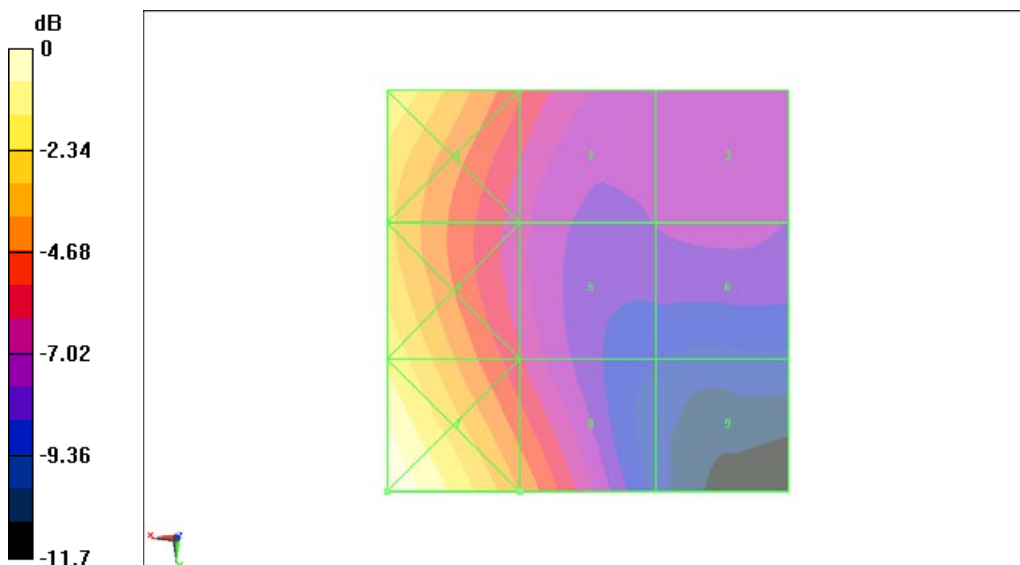

0 dB = 0.140A/m

Fig B.10 HAC RF H-Field GSM 1900 High

HAC RF H-Field GSM 1900 Middle

Date/Time: 8/23/2011 8:59:53 AM

Electronics: DAE4 Sn777

Medium: Air

Medium parameters used: $\sigma = 0$ mho/m, $\epsilon_r = 1$; $\rho = 1$ kg/m³

Ambient Temperature: 23.3°C Liquid Temperature: 22.5°C

Communication System: DCS 1900; Frequency: 1880 MHz; Duty Cycle: 1:8.3

Probe: H3DV6 - SN6260;

H Scan - H3DV6 - 2007: 15 mm from Probe Center to the Device/Hearing Aid

Compatibility Test (101x101x1): Measurement grid: dx=5mm, dy=5mm

Maximum value of peak Total field = 0.093 A/m

Probe Modulation Factor = 2.88

Device Reference Point: 0, 0, -6.3 mm

Reference Value = 0.027 A/m; Power Drift = -0.044 dB

Hearing Aid Near-Field Category: M4 (AWF -5 dB)

Peak H-field in A/m

Grid 1 0.116 M4	Grid 2 0.076 M4	Grid 3 0.065 M4
Grid 4 0.121 M4	Grid 5 0.077 M4	Grid 6 0.062 M4
Grid 7 0.143 M3	Grid 8 0.093 M4	Grid 9 0.050 M4

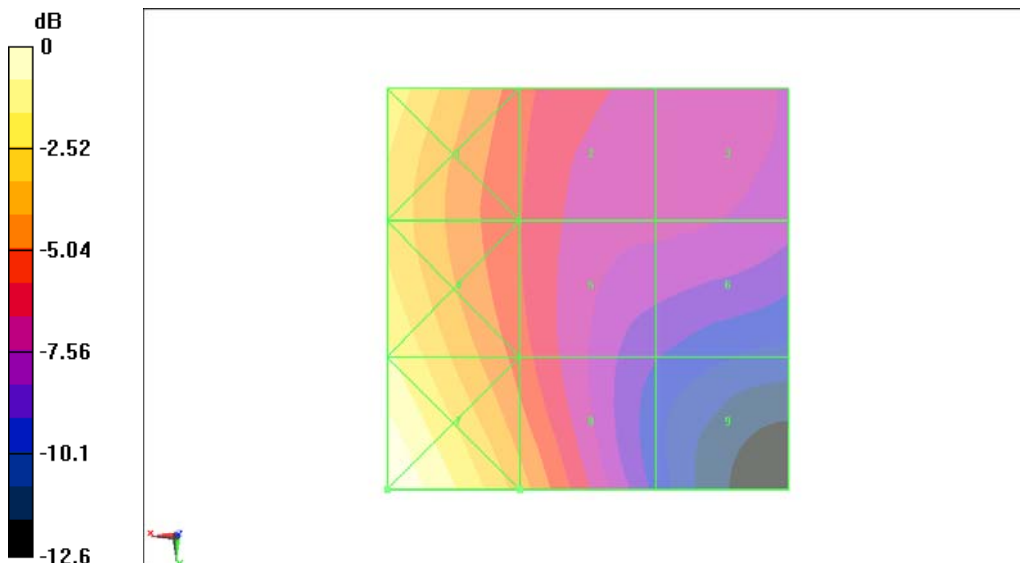

0 dB = 0.143A/m

Fig B.11 HAC RF H-Field GSM 1900 Middle

HAC RF H-Field GSM 1900 Low

Date/Time: 8/23/2011 9:07:04 AM

Electronics: DAE4 Sn777

Medium: Air

Medium parameters used: $\sigma = 0$ mho/m, $\epsilon_r = 1$; $\rho = 1$ kg/m³

Ambient Temperature: 23.3°C Liquid Temperature: 22.5°C

Communication System: DCS 1900; Frequency: 1850.2 MHz; Duty Cycle: 1:8.3

Probe: H3DV6 - SN6260;

H Scan - H3DV6 - 2007: 15 mm from Probe Center to the Device/Hearing Aid

Compatibility Test (101x101x1): Measurement grid: dx=5mm, dy=5mm

Maximum value of peak Total field = 0.096 A/m

Probe Modulation Factor = 2.88

Device Reference Point: 0, 0, -6.3 mm

Reference Value = 0.031 A/m; Power Drift = -0.111 dB

Hearing Aid Near-Field Category: M4 (AWF -5 dB)

Peak H-field in A/m

Grid 1 0.124 M4	Grid 2 0.084 M4	Grid 3 0.073 M4
Grid 4 0.124 M4	Grid 5 0.083 M4	Grid 6 0.071 M4
Grid 7 0.149 M3	Grid 8 0.096 M4	Grid 9 0.058 M4

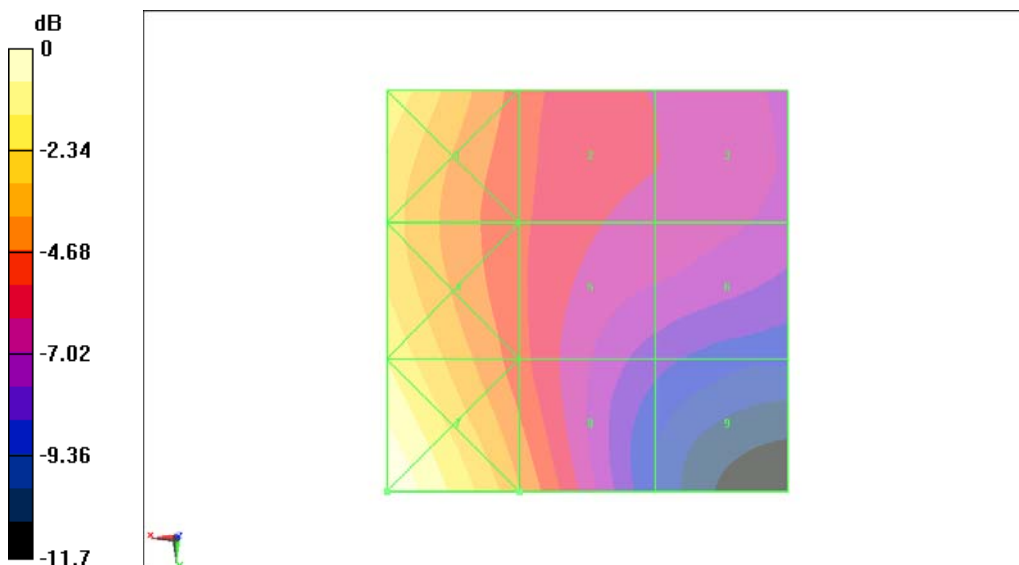

0 dB = 0.149A/m

Fig B.12 HAC RF H-Field GSM 1900 Low

Total M-rating of GSM 850 MHz Band

Date/Time: 8/23/2011 10:16:59 AM, Date/Time: 8/23/2011 8:35:04 AM

Electronics: DAE4 Sn777

Medium: Air

Medium parameters used: $\sigma = 0$ mho/m, $\epsilon_r = 1$; $\rho = 1000$ kg/m³ Medium parameters used: $\sigma = 0$ mho/m, $\epsilon_r = 1$; $\rho = 1$ kg/m³

Ambient Temperature:23.3°C Liquid Temperature: 22.5°C

Communication System: GSM 850; Frequency: 848.8 MHz; Duty Cycle: 1:8.3

Probe: ER3DV6 - SN2428Probe: H3DV6 - SN6260;ConvF(1, 1, 1)

E Scan - ER3DV6 - 2007: 15 mm from Probe Center to the Device/Hearing Aid

Compatibility Test (101x101x1): Measurement grid: dx=5mm, dy=5mm

Maximum value of peak Total field = 165.6 V/m

Probe Modulation Factor = 2.88

Device Reference Point: 0, 0, -6.3 mm

Reference Value = 71.7 V/m; Power Drift = -0.052 dB

Hearing Aid Near-Field Category: M3 (AWF -5 dB)

Peak E-field in V/m

Grid 1	Grid 2	Grid 3
135.0 M4	148.9 M4	144.1 M4
Grid 4	Grid 5	Grid 6
155.9 M3	165.6 M3	158.5 M3
Grid 7	Grid 8	Grid 9
173.7 M3	174.4 M3	161.0 M3

H Scan - H3DV6 - 2007: 15 mm from Probe Center to the Device/Hearing Aid

Compatibility Test (101x101x1): Measurement grid: dx=5mm, dy=5mm

Maximum value of peak Total field = 0.316 A/m

Probe Modulation Factor = 2.88

Device Reference Point: 0, 0, -6.3 mm

Reference Value = 0.087 A/m; Power Drift = 0.011 dB

Hearing Aid Near-Field Category: M4 (AWF -5 dB)

Peak H-field in A/m

Grid 1	Grid 2	Grid 3
0.490 M3	0.314 M4	0.194 M4
Grid 4	Grid 5	Grid 6
0.489 M3	0.316 M4	0.194 M4
Grid 7	Grid 8	Grid 9
0.483 M3	0.314 M4	0.191 M4

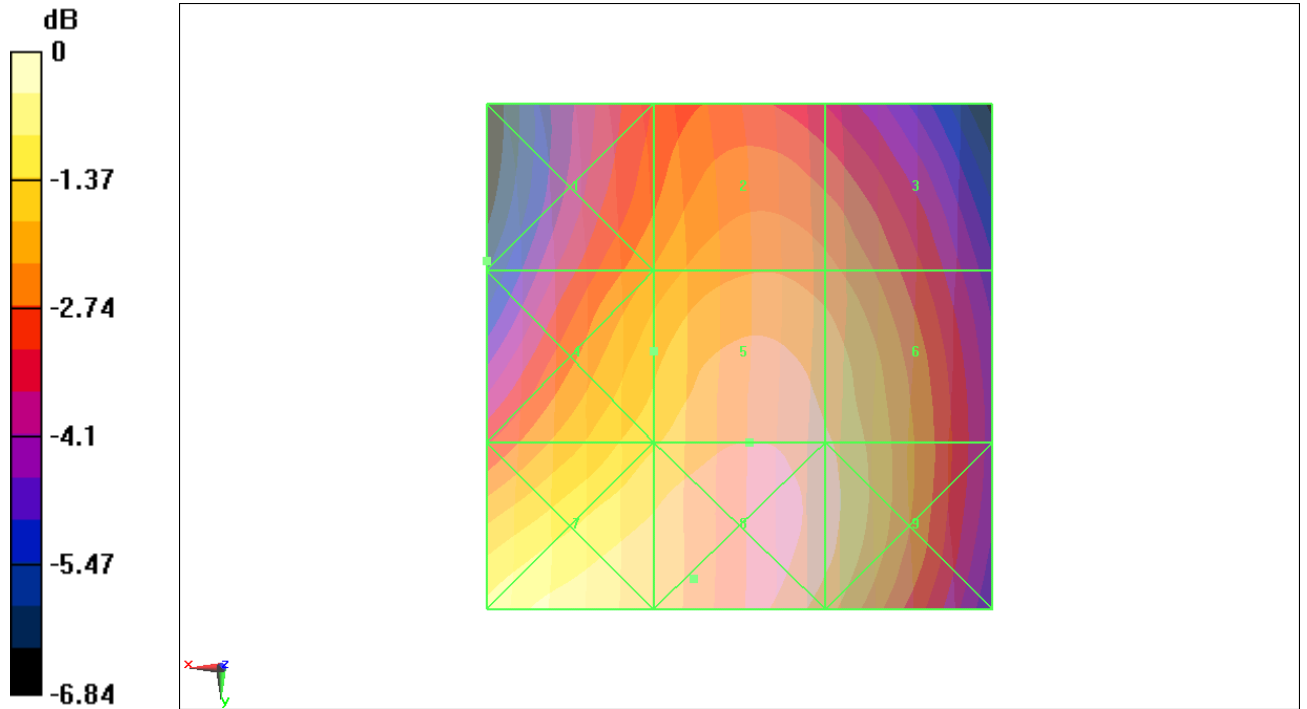

0 dB = 174.4V/m

RF RESULTS AND M-RATING	E-Field M Rating	M3 (AWF -5 dB)
	H-Field M Rating	M4 (AWF -5 dB)
	Total M Rating	M3

Fig B.13 Total M-rating of GSM 850

Total M-rating of GSM 1900 MHz Band

Date/Time: 8/23/2011 10:45:37 AM, Date/Time: 8/23/2011 9:07:04 AM

Electronics: DAE4 Sn777

Medium: Air

Medium parameters used: $\sigma = 0$ mho/m, $\epsilon_r = 1$; $\rho = 1000$ kg/m³ Medium parameters used: $\sigma = 0$ mho/m, $\epsilon_r = 1$; $\rho = 1$ kg/m³

Ambient Temperature:23.3°C Liquid Temperature: 22.5°C

Communication System: PCS 1900; Frequency: 1850.2 MHz; Duty Cycle: 1:8.3

Probe: ER3DV6 - SN2428Probe: H3DV6 - SN6260;ConvF(1, 1, 1)

E Scan - ER3DV6 - 2007: 15 mm from Probe Center to the Device/Hearing Aid Compatibility Test (101x101x1): Measurement grid: dx=5mm, dy=5mm

Maximum value of peak Total field = 27 V/m

Probe Modulation Factor = 2.88

Device Reference Point: 0, 0, -6.3 mm

Reference Value = 8.91 V/m; Power Drift = 0.058 dB

Hearing Aid Near-Field Category: M4 (AWF -5 dB)

Peak E-field in V/m

Grid 1	Grid 2	Grid 3
25.6 M4	25 M4	22.2 M4
Grid 4	Grid 5	Grid 6
23.2 M4	27 M4	26.8 M4
Grid 7	Grid 8	Grid 9
32.6 M4	35.9 M4	35 M4

H Scan - H3DV6 - 2007: 15 mm from Probe Center to the Device/Hearing Aid Compatibility Test (101x101x1): Measurement grid: dx=5mm, dy=5mm

Maximum value of peak Total field = 0.096 A/m

Probe Modulation Factor = 2.88

Device Reference Point: 0, 0, -6.3 mm

Reference Value = 0.031 A/m; Power Drift = -0.111 dB

Hearing Aid Near-Field Category: M4 (AWF -5 dB)

Peak H-field in A/m

Grid 1	Grid 2	Grid 3
0.124 M4	0.084 M4	0.073 M4
Grid 4	Grid 5	Grid 6
0.124 M4	0.083 M4	0.071 M4
Grid 7	Grid 8	Grid 9
0.149 M3	0.096 M4	0.058 M4

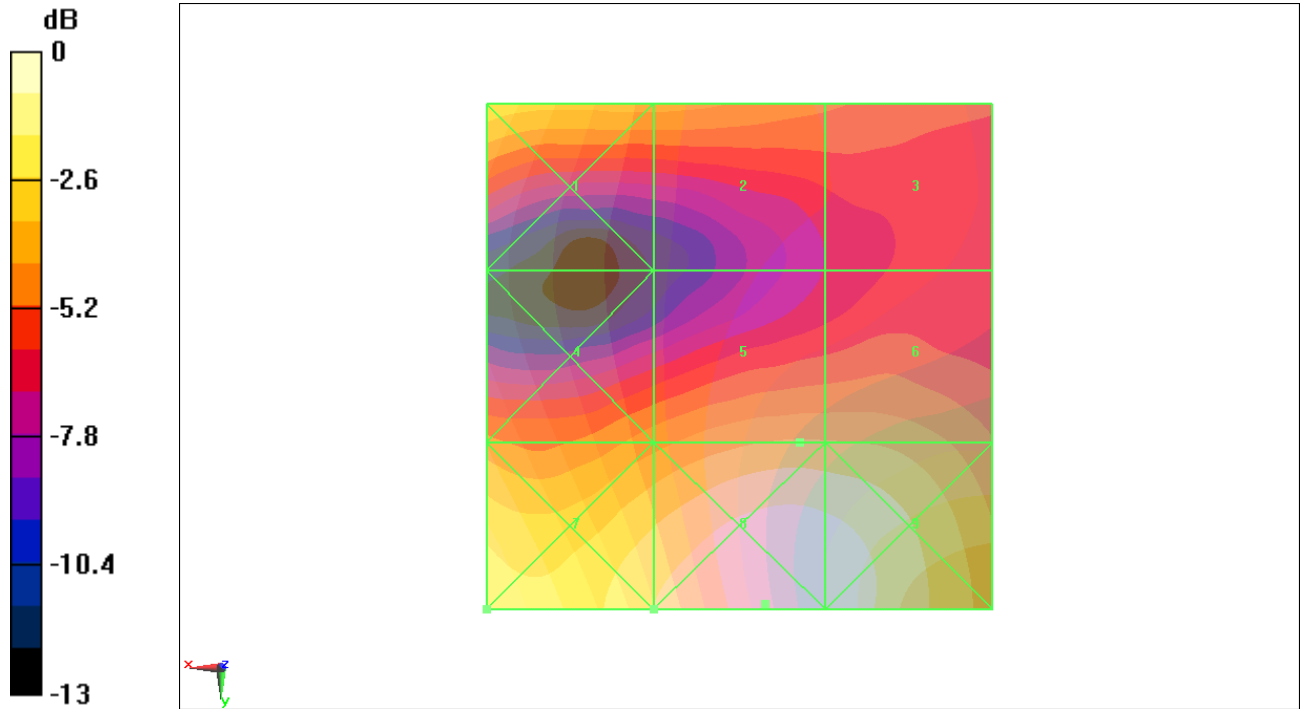

0 dB = 35.9V/m

RF RESULTS AND M-RATING	E-Field M Rating	M4 (AWF -5 dB)
	H-Field M Rating	M4 (AWF -5 dB)
	Total M Rating	M4

Fig B.14 Total M-rating of GSM 1900

ANNEX C SYSTEM VALIDATION RESULT

E SCAN of Dipole 835 MHz

Date/Time: 8/23/2011 6:42:49 AM

Electronics: DAE4 Sn777

Medium: Air

Medium parameters used: $\sigma = 0$ mho/m, $\epsilon_r = 1$; $\rho = 1000$ kg/m³

Communication System: CW; Frequency: 835 MHz; Duty Cycle: 1:1

Probe: ER3DV6 - SN2428;ConvF(1, 1, 1)

E Scan - measurement distance from the probe sensor center to CD835 Dipole = 10mm/Hearing Aid Compatibility Test (41x361x1): Measurement grid: dx=5mm, dy=5mm

Maximum value of peak Total field = 168.4 V/m

Probe Modulation Factor = 1

Device Reference Point: 0, 0, -6.3 mm

Reference Value = 118.4 V/m; Power Drift = 0.116 dB

Hearing Aid Near-Field Category: M4 (AWF 0 dB)

Peak E-field in V/m

Grid 1	Grid 2	Grid 3
143.2 M4	145.7 M4	138.1 M4
Grid 4	Grid 5	Grid 6
80.0 M4	82.2 M4	79.0 M4
Grid 7	Grid 8	Grid 9
160.1 M4	168.4 M4	160.1M4

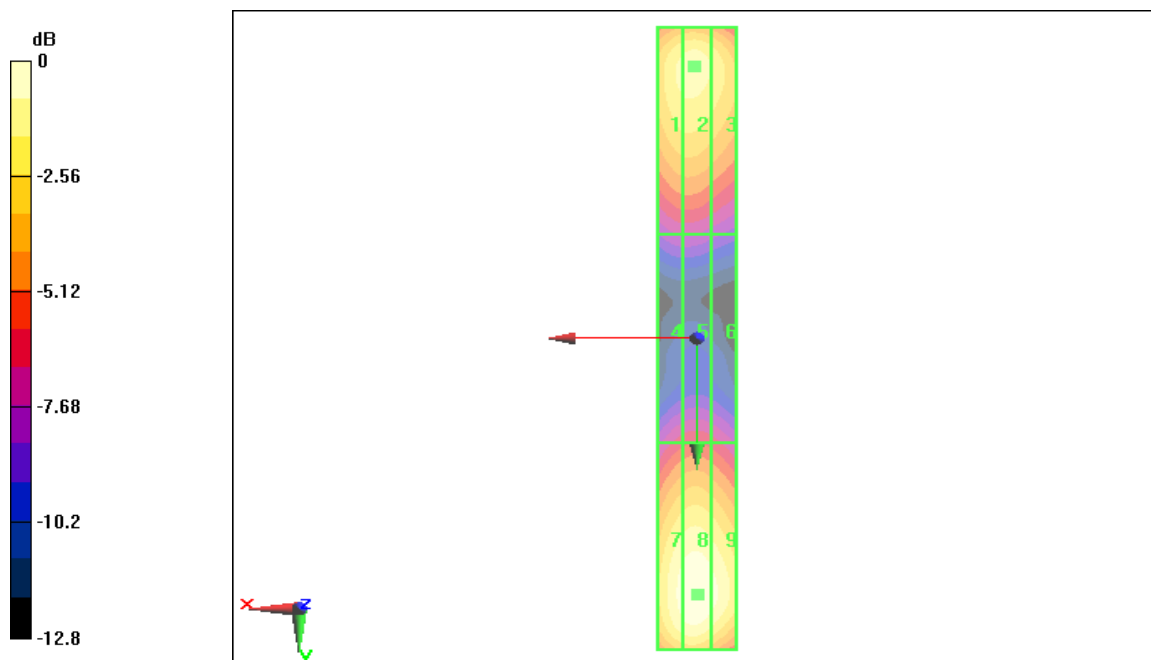

0 dB = 168.4V/m

H SCAN of Dipole 835 MHz

Date/Time: 8/23/2011 7:03:10 AM

Electronics: DAE4 Sn777

Medium: Air

Medium parameters used: $\sigma = 0$ mho/m, $\epsilon_r = 1$; $\rho = 1$ kg/m³

Communication System: CW; Frequency: 835 MHz; Duty Cycle: 1:1

Probe: H3DV6 - SN6260;

H Scan - measurement distance from the probe sensor center to CD835 Dipole = 10mm/Hearing Aid Compatibility Test (41x361x1): Measurement grid: dx=5mm, dy=5mm

Maximum value of peak Total field = 0.444 A/m

Probe Modulation Factor = 1

Device Reference Point: 0, 0, -6.3 mm

Reference Value = 0.465 A/m; Power Drift = -0.001 dB

Hearing Aid Near-Field Category: M4 (AWF 0 dB)

Peak H-field in A/m

Grid 1	Grid 2	Grid 3
0.359 M4	0.384 M4	0.368 M4
Grid 4	Grid 5	Grid 6
0.417 M4	0.444 M4	0.431 M4
Grid 7	Grid 8	Grid 9
0.369 M4	0.398 M4	0.388 M4

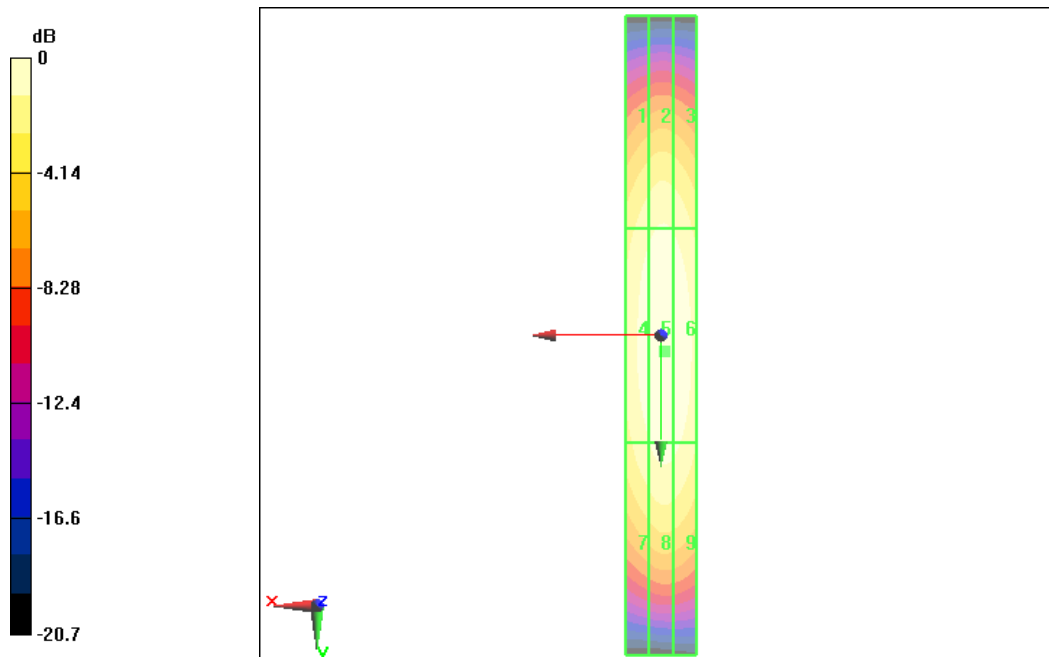

0 dB = 0.444A/m

E SCAN of Dipole 1880 MHz

Date/Time: 8/23/2011 7:26:43 AM

Electronics: DAE4 Sn777

Medium: Air

Medium parameters used: $\sigma = 0$ mho/m, $\epsilon_r = 1$; $\rho = 1000$ kg/m³

Communication System: CW; Frequency: 1900 MHz; Duty Cycle: 1:1

Probe: ER3DV6 - SN2428;ConvF(1, 1, 1)

E Scan - measurement distance from the probe sensor center to CD1880 Dipole = 10mm/Hearing Aid Compatibility Test (41x181x1): Measurement grid: dx=5mm, dy=5mm

Maximum value of peak Total field = 134.3 V/m

Probe Modulation Factor = 1

Device Reference Point: 0, 0, -6.3 mm

Reference Value = 140.1 V/m; Power Drift = -0.060 dB

Hearing Aid Near-Field Category: M2 (AWF 0 dB)

Peak E-field in V/m

Grid 1	Grid 2	Grid 3
126.4 M2	128.5 M2	120.8 M2
Grid 4	Grid 5	Grid 6
84.5 M3	87.5 M3	85.1 M3
Grid 7	Grid 8	Grid 9
131.6 M2	134.3 M2	125.9 M2

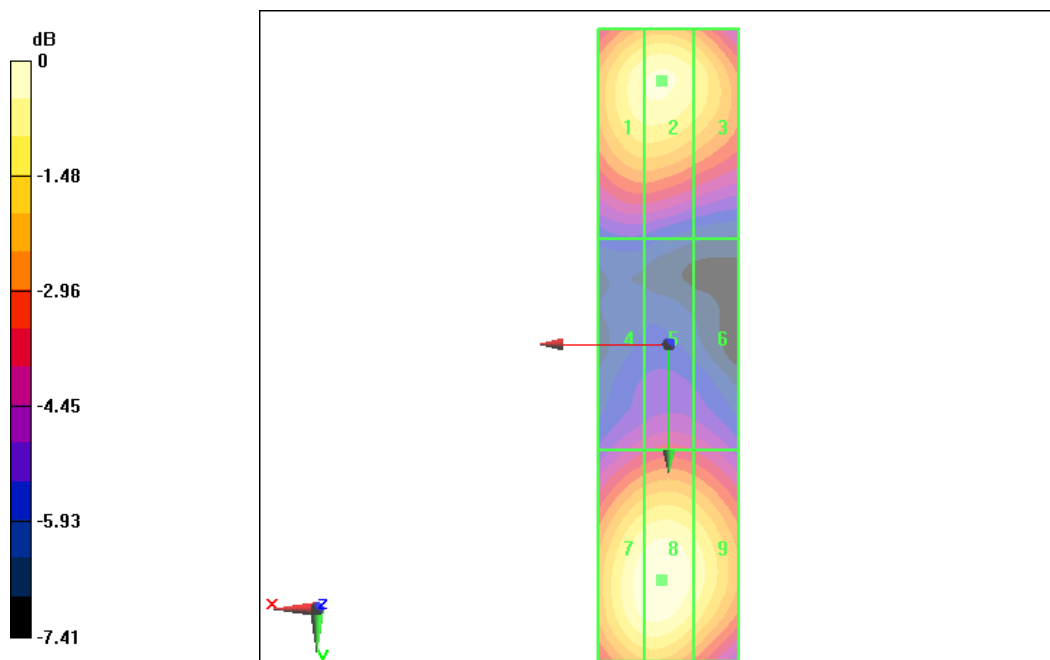

0 dB = 134.3V/m

H SCAN of Dipole 1880 MHz

Date/Time: 8/23/2011 7:50:31 AM

Electronics: DAE4 Sn777

Medium: Air

Medium parameters used: $\sigma = 0$ mho/m, $\epsilon_r = 1$; $\rho = 1$ kg/m³

Communication System: CW; Frequency: 1900 MHz; Duty Cycle: 1:1

Probe: H3DV6 - SN6260;

H Scan - measurement distance from the probe sensor center to CD1880 Dipole = 10mm/Hearing Aid Compatibility Test (41x181x1): Measurement grid: dx=5mm, dy=5mm

Maximum value of peak Total field = 0.451 A/m

Probe Modulation Factor = 1

Device Reference Point: 0, 0, -6.3 mm

Reference Value = 0.470 A/m; Power Drift = 0.128 dB

Hearing Aid Near-Field Category: M2 (AWF 0 dB)

Peak H-field in A/m

Grid 1	Grid 2	Grid 3
0.380 M2	0.401 M2	0.396 M2
Grid 4	Grid 5	Grid 6
0.420 M2	0.451 M2	0.431 M2
Grid 7	Grid 8	Grid 9
0.381 M2	0.409 M2	0.400 M2

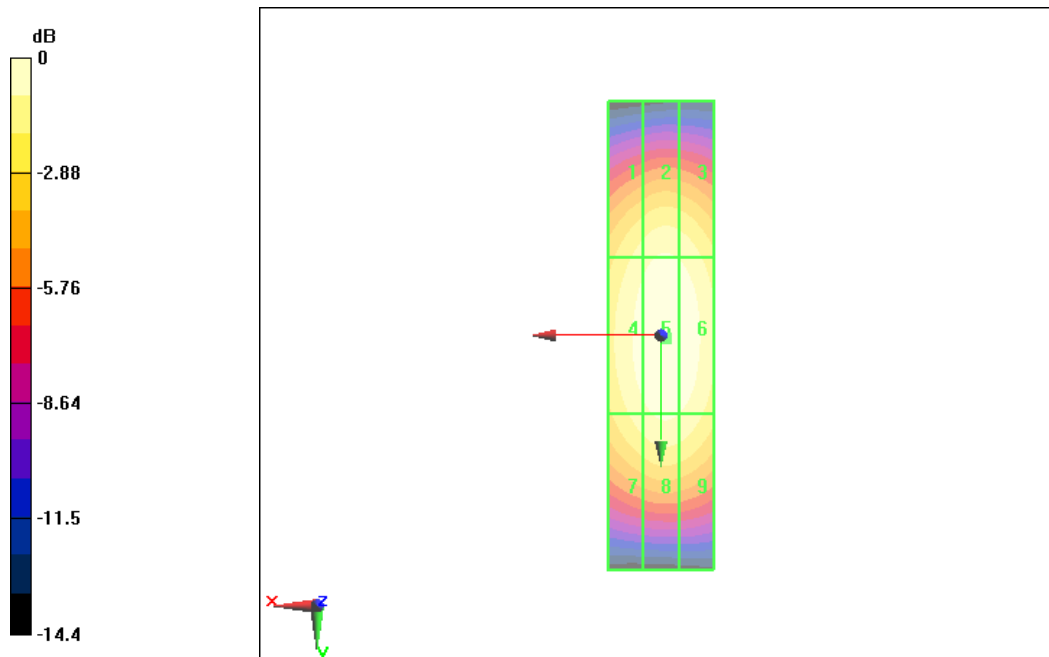

0 dB = 0.451A/m

ANNEX D PROBE CALIBRATION CERTIFICATE

E_Probe ER3DV6

Calibration Laboratory of
Schmid & Partner
Engineering AG
Zeughausstrasse 43, 8004 Zurich, Switzerland



S Schweizerischer Kalibrierdienst
C Service suisse d'étalonnage
S Servizio svizzero di taratura
S Swiss Calibration Service

Accredited by the Swiss Accreditation Service (SAS)
The Swiss Accreditation Service is one of the signatories to the EA
Multilateral Agreement for the recognition of calibration certificates

Accreditation No.: SCS 108

Client **TMC**

Certificate No: ER3-2428_Oct10

CALIBRATION CERTIFICATE

Object: ER3DV6 - SN:2428

Calibration procedure(s): QA CAL-02.v5 and QA CAL-25.v2
Calibration procedure for E-field probes optimized for close near field evaluations in air



Calibration date: October 20, 2010

This calibration certificate documents the traceability to national standards, which realize the physical units of measurements (SI).
The measurements and the uncertainties with confidence probability are given on the following pages and are part of the certificate.

All calibrations have been conducted in the closed laboratory facility: environment temperature (22 ± 3)°C and humidity < 70%.

Calibration Equipment used (M&TE critical for calibration)

Primary Standards	ID #	Cal Date (Certificate No.)	Scheduled Calibration
Power meter E4419B	GB41293874	1-Apr-10 (No. 217-01030)	Apr-11
Power sensor E4412A	MY41495277	1-Apr-10 (No. 217-01030)	Apr-11
Power sensor E4412A	MY41498087	1-Apr-10 (No. 217-01030)	Apr-11
Reference 3 dB Attenuator	SN: S5054 (3c)	31-Mar-10 (No. 217-01026)	Mar-11
Reference 20 dB Attenuator	SN: S5086 (20b)	31-Mar-10 (No. 217-01028)	Mar-11
Reference 30 dB Attenuator	SN: S5129 (30b)	31-Mar-10 (No. 217-01027)	Mar-11
Reference Probe ER3DV6	SN: 2328	3-Oct-10 (No. ER3-2328_Oct10)	Oct-11
DAE4	SN: 789	19-Dec-09 (No. DAE4-789_Dec09)	Dec-10
Secondary Standards	ID #	Check Date (in house)	Scheduled Check
RF generator HP 8648C	US3642U01700	4-Aug-99 (in house check Oct-09)	In house check: Oct-11
Network Analyzer HP 8753E	US37390585	18-Oct-01 (in house check Oct-10)	In house check: Oct-11

	Name	Function	Signature
Calibrated by:	Marcel Fehr	Laboratory Technician	
Approved by:	Katja Pokovic	Technical Manager	

Issued: October 21, 2010

This calibration certificate shall not be reproduced except in full without written approval of the laboratory.

**Calibration Laboratory of
Schmid & Partner
Engineering AG**
Zeughausstrasse 43, 8004 Zurich, Switzerland



S Schweizerischer Kalibrierdienst
C Service suisse d'étalonnage
S Servizio svizzero di taratura
S Swiss Calibration Service

Accredited by the Swiss Accreditation Service (SAS)
The Swiss Accreditation Service is one of the signatories to the EA
Multilateral Agreement for the recognition of calibration certificates

Accreditation No.: **SCS 108**

Glossary:

NORM _{x,y,z}	sensitivity in free space
DCP	diode compression point
CF	crest factor (1/duty_cycle) of the RF signal
A, B, C	modulation dependent linearization parameters
Polarization φ	φ rotation around probe axis
Polarization ϑ	ϑ rotation around an axis that is in the plane normal to probe axis (at measurement center), i.e., $\vartheta = 0$ is normal to probe axis
Connector Angle	information used in DASY system to align probe sensor X to the robot coordinate system

Calibration is Performed According to the Following Standards:

- a) IEEE Std 1309-2005, "IEEE Standard for calibration of electromagnetic field sensors and probes, excluding antennas, from 9 kHz to 40 GHz", December 2005.

Methods Applied and Interpretation of Parameters:

- *NORM_{x,y,z}*: Assessed for E-field polarization $\vartheta = 0$ for XY sensors and $\vartheta = 90$ for Z sensor ($f \leq 900$ MHz in TEM-cell; $f > 1800$ MHz: R22 waveguide).
- *NORM(f)_{x,y,z}* = *NORM_{x,y,z}* * *frequency_response* (see Frequency Response Chart).
- *DCP_{x,y,z}*: DCP are numerical linearization parameters assessed based on the data of power sweep with CW signal (no uncertainty required). DCP does not depend on frequency nor media.
- *A_{x,y,z}; B_{x,y,z}; C_{x,y,z}* are numerical linearization parameters assessed based on the data of power sweep for specific modulation signal. The parameters do not depend on frequency nor media.
- *Spherical isotropy (3D deviation from isotropy)*: in a locally homogeneous field realized using an open waveguide setup.
- *Sensor Offset*: The sensor offset corresponds to the offset of virtual measurement center from the probe tip (on probe axis). No tolerance required.
- *Connector Angle*: The angle is assessed using the information gained by determining the *NORM_x* (no uncertainty required).

ER3DV6 SN:2428

October 20, 2010

Probe ER3DV6

SN:2428

Manufactured:	September 11, 2007
Last calibrated:	October 20, 2009
Recalibrated:	October 20, 2010

Calibrated for DASYS Systems

(Note: non-compatible with DASYS2 system!)

ER3DV6 SN:2428

October 20, 2010

DASY - Parameters of Probe: ER3DV6 SN:2428

Basic Calibration Parameters

	Sensor X	Sensor Y	Sensor Z	Unc (k=2)
Norm ($\mu\text{V}/(\text{V}/\text{m})^2$)	1.52	1.59	1.86	$\pm 10.1\%$
DCP (mV) [^]	91.5	93.0	98.9	

Modulation Calibration Parameters

UID	Communication System Name	PAR		A dB	B dBuV	C	VR mV	Unc (k=2)
10000	CW		X	0.00	0.00	1.00	300	$\pm 1.5\%$
			Y	0.00	0.00	1.00	300	
			Z	0.00	0.00	1.00	300	

The reported uncertainty of measurement is stated as the standard uncertainty of measurement multiplied by the coverage factor k=2, which for a normal distribution corresponds to a coverage probability of approximately 95%.

[^] numerical linearization parameter: uncertainty not required

ER3DV6 SN:2428

October 20, 2010

Frequency Response of E-Field

(TEM-Cell:ifi110 EXX, Waveguide R22)

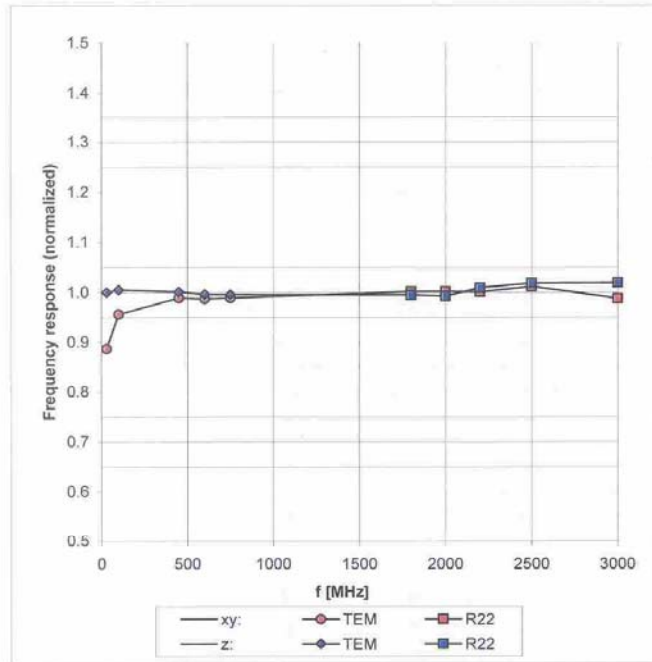

Uncertainty of Frequency Response of E-field: $\pm 6.3\%$ (k=2)

ER3DV6 SN:2428

October 20, 2010

Receiving Pattern (ϕ), $\vartheta = 0^\circ$

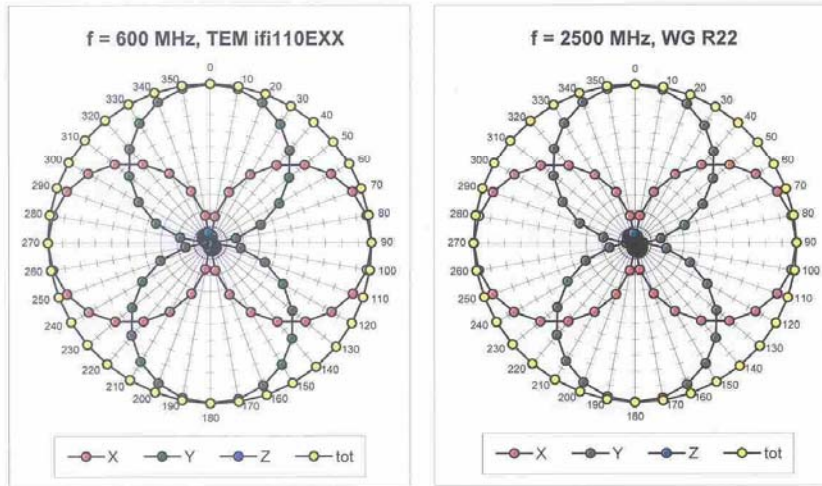

Receiving Pattern (ϕ), $\vartheta = 90^\circ$

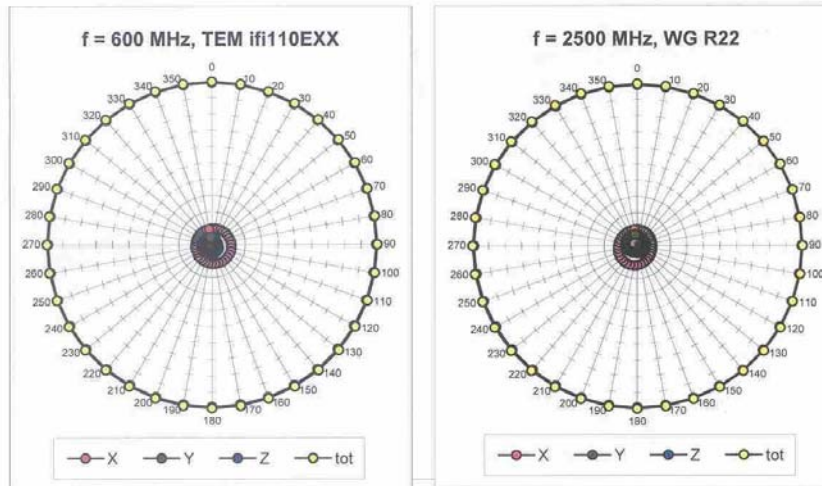

ER3DV6 SN:2428

October 20, 2010

Receiving Pattern (ϕ), $\vartheta = 0^\circ$

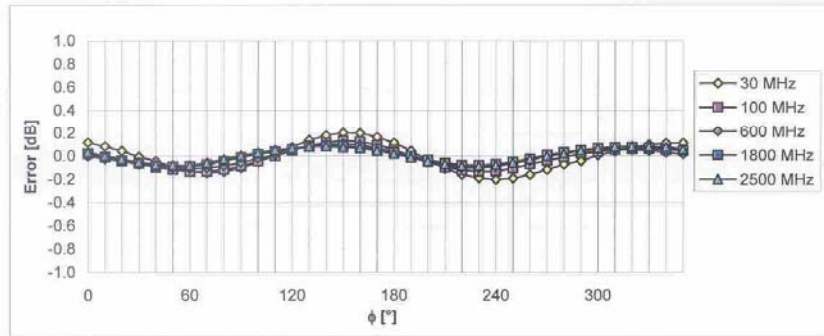

Uncertainty of Axial Isotropy Assessment: $\pm 0.5\%$ ($k=2$)

Receiving Pattern (ϕ), $\vartheta = 90^\circ$

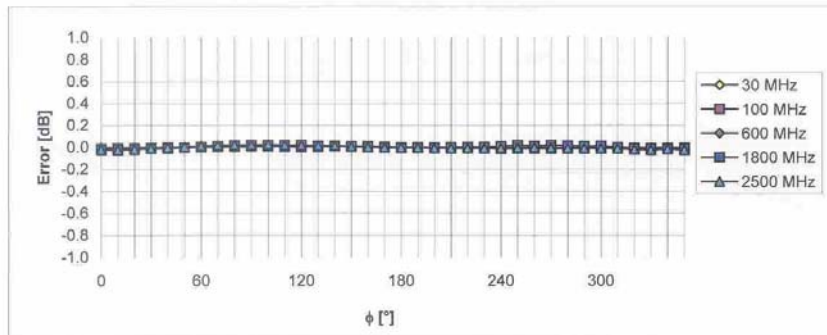

Uncertainty of Axial Isotropy Assessment: $\pm 0.5\%$ ($k=2$)

ER3DV6 SN:2428

October 20, 2010

Dynamic Range f(E-field) (Waveguide R22, f = 1800 MHz)

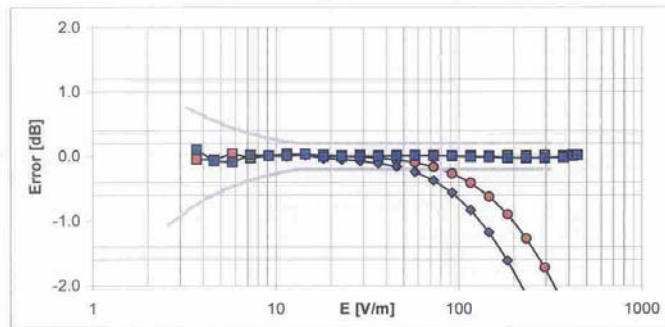
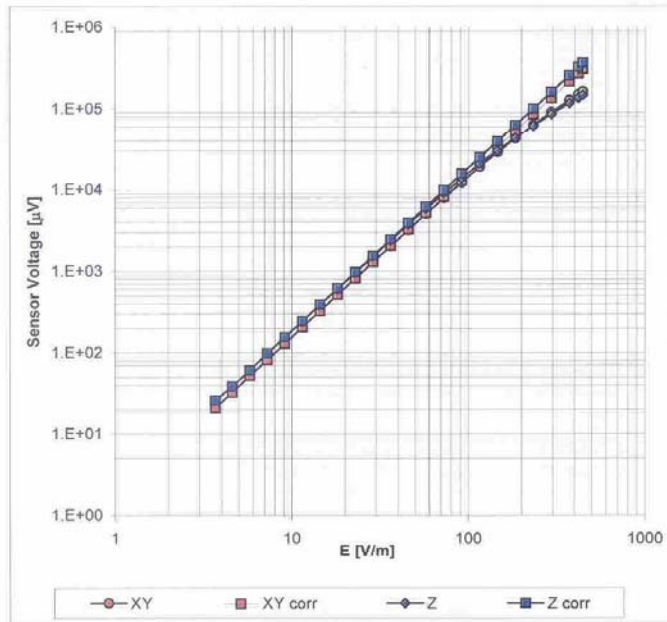

Uncertainty of Linearity Assessment: $\pm 0.6\%$ ($k=2$)

ER3DV6 SN:2428

October 20, 2010

Deviation from Isotropy in Air
Error (ϕ, ϑ), $f = 900$ MHz

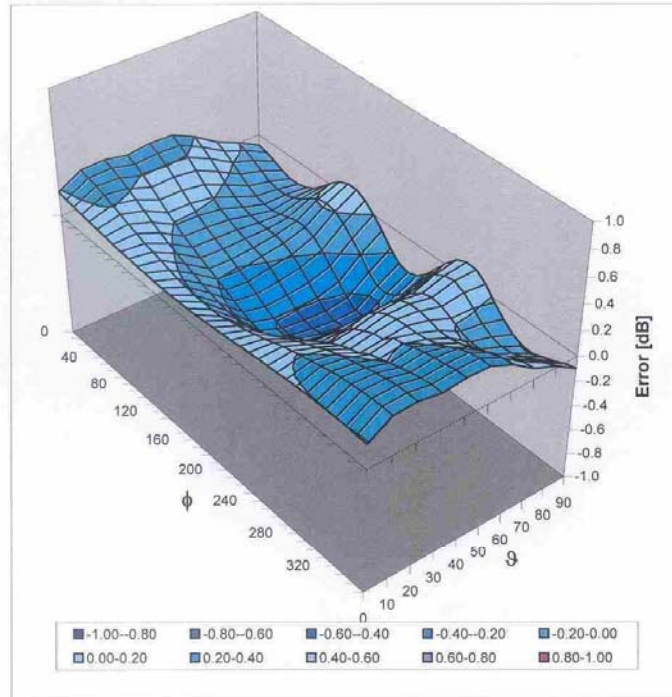

Uncertainty of Spherical Isotropy Assessment: $\pm 2.6\%$ ($k=2$)

ER3DV6 SN:2428

October 20, 2010

Other Probe Parameters

Sensor Arrangement	Rectangular
Connector Angle (°)	-218.7
Mechanical Surface Detection Mode	enabled
Optical Surface Detection Mode	disabled
Probe Overall Length	337 mm
Probe Body Diameter	10 mm
Tip Length	10 mm
Tip Diameter	8.0 mm
Probe Tip to Sensor X Calibration Point	2.5 mm
Probe Tip to Sensor Y Calibration Point	2.5 mm
Probe Tip to Sensor Z Calibration Point	2.5 mm

H_Probe H3DV6

Calibration Laboratory of
Schmid & Partner
Engineering AG
Zeughausstrasse 43, 8004 Zurich, Switzerland



S Schweizerischer Kalibrierdienst
C Service suisse d'étalonnage
S Servizio svizzero di taratura
S Swiss Calibration Service

Accredited by the Swiss Accreditation Service (SAS)
The Swiss Accreditation Service is one of the signatories to the EA
Multilateral Agreement for the recognition of calibration certificates

Accreditation No.: SCS 108

Client TMC

Certificate No: H3-6260_Oct10

CALIBRATION CERTIFICATE

Object H3DV6 - SN:6260

Calibration procedure(s) QA CAL-03.v5 and QA CAL-25.v2
Calibration procedure for H-field probes optimized for close near field
evaluations in air

Calibration date: October 20, 2010



This calibration certificate documents the traceability to national standards, which realize the physical units of measurements (SI).
The measurements and the uncertainties with confidence probability are given on the following pages and are part of the certificate.

All calibrations have been conducted in the closed laboratory facility: environment temperature (22 ± 3)°C and humidity < 70%.

Calibration Equipment used (M&TE critical for calibration)

Primary Standards	ID #	Cal Date (Certificate No.)	Scheduled Calibration
Power meter E4419B	GB41293874	1-Apr-10 (No. 217-01030)	Apr-11
Power sensor E4412A	MY41495277	1-Apr-10 (No. 217-01030)	Apr-11
Power sensor E4412A	MY41498087	1-Apr-10 (No. 217-01030)	Apr-11
Reference 3 dB Attenuator	SN: S5054 (3c)	31-Mar-10 (No. 217-01026)	Mar-11
Reference 20 dB Attenuator	SN: S5086 (20b)	31-Mar-10 (No. 217-01028)	Mar-11
Reference 30 dB Attenuator	SN: S5129 (30b)	31-Mar-10 (No. 217-01027)	Mar-11
Reference Probe H3DV6	SN: 6182	3-Oct-10 (No. H3-6182_Oct10)	Oct-11
DAE4	SN: 789	19-Dec-09 (No. DAE4-789_Dec09)	Dec-10

Secondary Standards	ID #	Check Date (in house)	Scheduled Check
RF generator HP 8648C	US3642U01700	4-Aug-99 (in house check Oct-09)	In house check: Oct-11
Network Analyzer HP 8753E	US37390585	18-Oct-01 (in house check Oct-10)	In house check: Oct-11

Calibrated by:	Name	Function	Signature
	Marcel Fehr	Laboratory Technician	
Approved by:	Katja Pokovic	Technical Manager	

Issued: October 21, 2010

This calibration certificate shall not be reproduced except in full without written approval of the laboratory.

**Calibration Laboratory of
Schmid & Partner
Engineering AG**
Zeughausstrasse 43, 8004 Zurich, Switzerland



S Schweizerischer Kalibrierdienst
S Service suisse d'étalonnage
C Servizio svizzero di taratura
S Swiss Calibration Service

Accredited by the Swiss Accreditation Service (SAS)
The Swiss Accreditation Service is one of the signatories to the EA
Multilateral Agreement for the recognition of calibration certificates

Accreditation No.: **SCS 108**

Glossary:

NORM _{x,y,z}	sensitivity in free space
DCP	diode compression point
CF	crest factor (1/duty_cycle) of the RF signal
A, B, C	modulation dependent linearization parameters
Polarization φ	φ rotation around probe axis
Polarization ϑ	ϑ rotation around an axis that is in the plane normal to probe axis (at measurement center), i.e., $\vartheta = 0$ is normal to probe axis
Connector Angle	information used in DASY system to align probe sensor X to the robot coordinate system

Calibration is Performed According to the Following Standards:

- a) IEEE Std 1309-2005, "IEEE Standard for calibration of electromagnetic field sensors and probes, excluding antennas, from 9 kHz to 40 GHz", December 2005.

Methods Applied and Interpretation of Parameters:

- *NORM_{x,y,z}*: Assessed for E-field polarization $\vartheta = 0$ for XY sensors and $\vartheta = 90$ for Z sensor ($f \leq 900$ MHz in TEM-cell; $f > 1800$ MHz: R22 waveguide).
- $X, Y, Z(f)_{a0a1a2} = X, Y, Z_{a0a1a2} * frequency_response$ (see Frequency Response Chart).
- *DCP_{x,y,z}*: DCP are numerical linearization parameters assessed based on the data of power sweep with CW signal (no uncertainty required). DCP does not depend on frequency nor media.
- *A_{x,y,z}; B_{x,y,z}; C_{x,y,z}* are numerical linearization parameters assessed based on the data of power sweep for specific modulation signal. The parameters do not depend on frequency nor media.
- *Spherical isotropy (3D deviation from isotropy)*: in a locally homogeneous field realized using an open waveguide setup.
- *Sensor Offset*: The sensor offset corresponds to the offset of virtual measurement center from the probe tip (on probe axis). No tolerance required.
- *Connector Angle*: The angle is assessed using the information gained by determining the X_{a0a1a2} (no uncertainty required).

H3DV6 SN:6260

October 20, 2010

Probe H3DV6

SN:6260

Manufactured:	September 7, 2007
Last calibrated:	October 20, 2009
Recalibrated:	October 20, 2010

Calibrated for DASY Systems

(Note: non-compatible with DASY2 system!)

H3DV6 SN:6260

October 20, 2010

DASY - Parameters of Probe: H3DV6 SN:6260

Basic Calibration Parameters

		Sensor X	Sensor Y	Sensor Z	Unc (k=2)
Norm (A/m / $\sqrt{\mu V}$)	a0	2.47E-3	2.49E-3	2.95E-3	$\pm 10.1\%$
Norm (A/m / $\sqrt{\mu V}$)	a1	-2.97E-5	5.62E-6	-4.47E-5	$\pm 10.1\%$
Norm (A/m / $\sqrt{\mu V}$)	a2	4.84E-5	4.36E-5	6.01E-5	$\pm 10.1\%$
DCP (mV) ^A		84.5	90.3	83.9	

Modulation Calibration Parameters

UID	Communication System Name	PAR		A dB	B dBuV	C	VR mV	Unc (k=2)
10000	CW	0.00	X	0.00	0.00	1.00	300	$\pm 1.5\%$
			Y	0.00	0.00	1.00	300	
			Z	0.00	0.00	1.00	300	

The reported uncertainty of measurement is stated as the standard uncertainty of measurement multiplied by the coverage factor k=2, which for a normal distribution corresponds to a coverage probability of approximately 95%.

¹ numerical linearization parameter: uncertainty not required

H3DV6 SN:6260

October 20, 2010

Frequency Response of H-Field (TEM-Cell:ifi110 EXX, Waveguide R22)

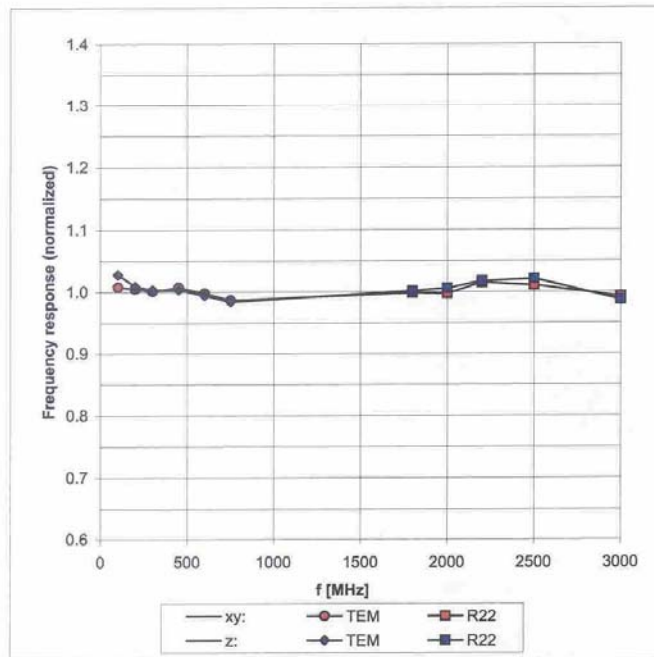

Uncertainty of Frequency Response of H-field: $\pm 6.3\%$ ($k=2$)

H3DV6 SN:6260

October 20, 2010

Receiving Pattern (ϕ), $\vartheta = 90^\circ$

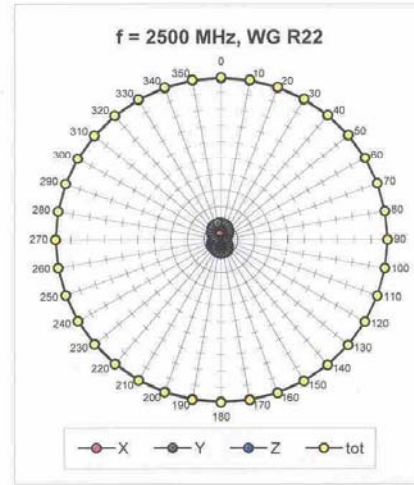
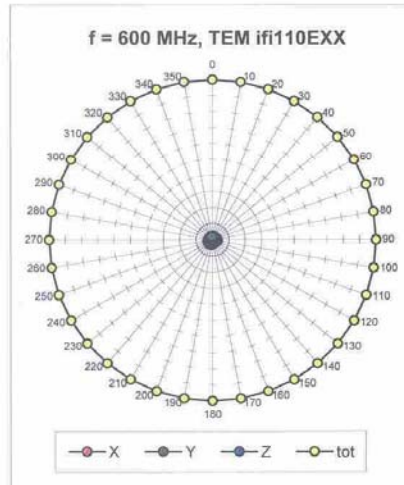

Receiving Pattern (ϕ), $\vartheta = 0^\circ$

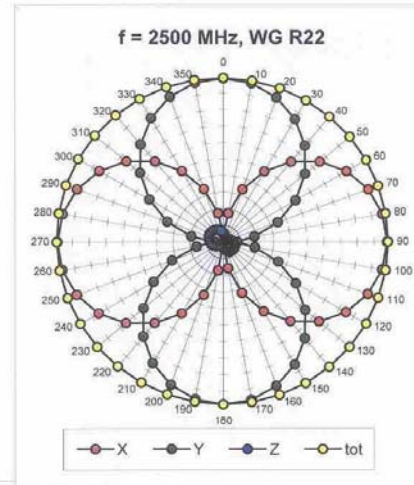
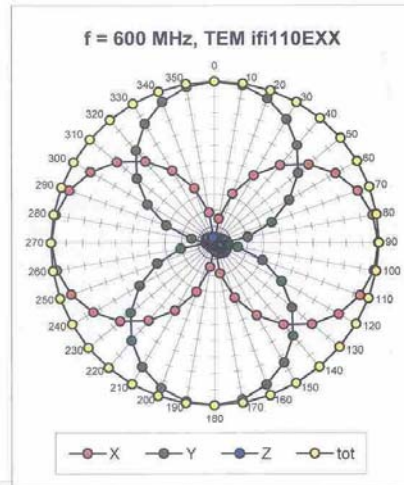

H3DV6 SN:6260

October 20, 2010

Receiving Pattern (ϕ), $\vartheta = 90^\circ$

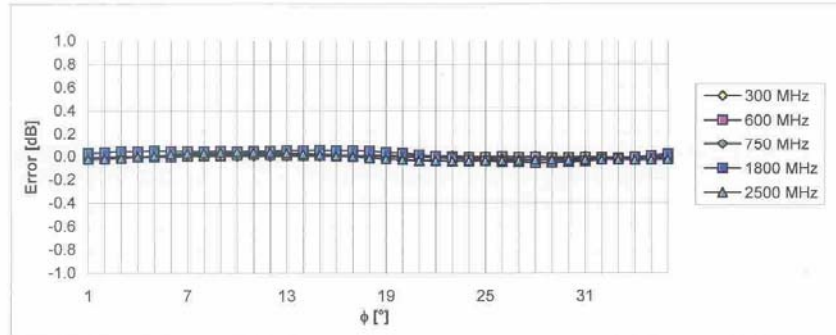

Uncertainty of Axial Isotropy Assessment: $\pm 0.5\%$ (k=2)

Receiving Pattern (ϕ), $\vartheta = 0^\circ$

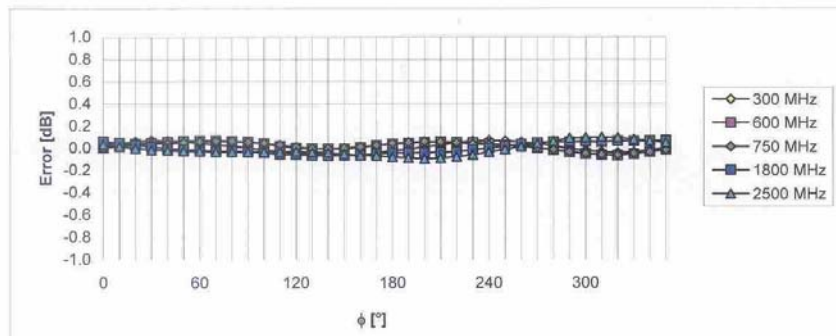

Uncertainty of Axial Isotropy Assessment: $\pm 0.5\%$ (k=2)

H3DV6 SN:6260

October 20, 2010

Dynamic Range f(H-field) (Waveguide R22, f = 1800 MHz)

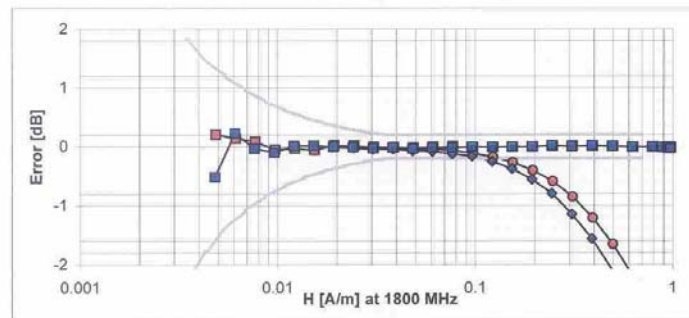
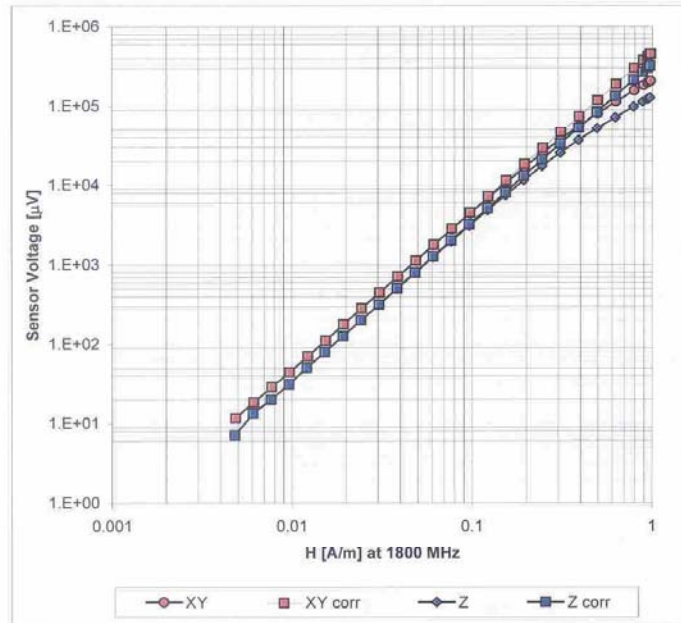

Uncertainty of Linearity Assessment: $\pm 0.6\%$ ($k=2$)

H3DV6 SN:6260

October 20, 2010

Deviation from Isotropy in Air
Error (ϕ, ϑ), $f = 900$ MHz

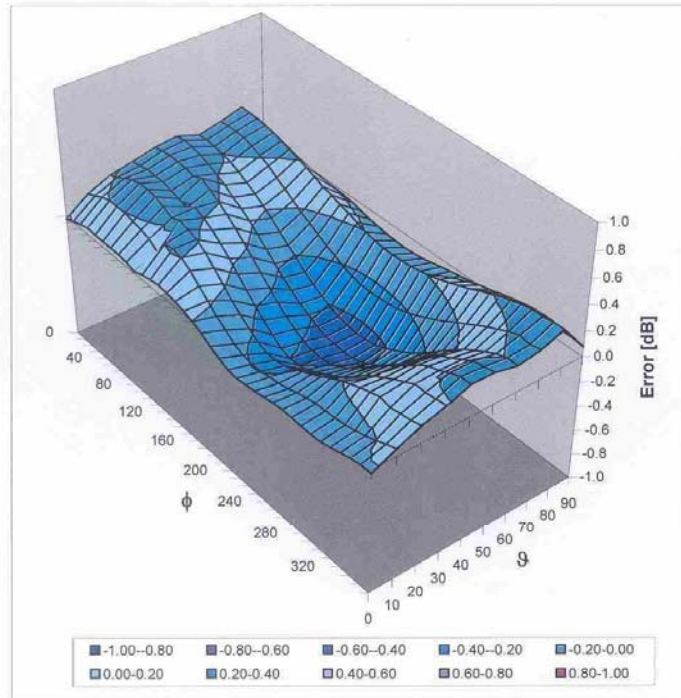

Uncertainty of Spherical Isotropy Assessment: $\pm 2.6\%$ ($k=2$)

H3DV6 SN:6260

October 20, 2010

Other Probe Parameters

Sensor Arrangement	Rectangular
Connector Angle (°)	-154.1
Mechanical Surface Detection Mode	enabled
Optical Surface Detection Mode	disabled
Probe Overall Length	337 mm
Probe Body Diameter	10 mm
Tip Length	20 mm
Tip Diameter	6.0 mm
Probe Tip to Sensor X Calibration Point	3 mm
Probe Tip to Sensor Y Calibration Point	3 mm
Probe Tip to Sensor Z Calibration Point	3 mm