



---

# TEST REPORT

---

Report No.: SRTC2011-H024-E0038

Product Name: GSM/GPRS/EDGE/WCDMA

Digital Mobile Phone with Bluetooth

Marketing Name: one touch 900A

Product Model: yippee 3G\_A2

Applicant: TCT Mobile Limited

Manufacturer: TCT Mobile Limited

Specification: FCC Part15B (Certification)

(October 1, 2009 edition)

FCC ID: RAD197

The State Radio\_monitoring\_center Testing Center (SRTC)

No.80 Beilishi Road Xicheng District Beijing, China

Tel: 86-10-68009202 Fax: 86-10-68009205

## CONTENTS

1. General information .....	3
1.1 Notes of the test report .....	3
1.2 Information about the testing laboratory.....	3
1.3 Applicant's details .....	3
1.4 Manufacturer's details.....	3
1.5 Application details .....	4
1.6 Reference specification.....	4
1.7 Information of EUT .....	4
1.7.1 General information.....	4
1.7.2 EUT details .....	5
1.7.3 Auxiliary equipment details.....	5
2. Test information .....	7
2.1 Summary of the test results.....	7
2.2 Test result.....	8
2.2.1 Conducted Emissions-FCC Part15.107 .....	8
2.2.2 Radiated Emissions-FCC Part15.109 .....	22
2.3. List of test equipments .....	32
Appendix .....	33

## 1. General information

### 1.1 Notes of the test report

The test report may only be reproduced or published in full. Reproduction or publication of extracts from the report requires the prior written permission of The State Radio\_monitoring\_center Testing Center (SRTC).

The test results relate only to individual items of the samples which have been tested.

### 1.2 Information about the testing laboratory

Company: The State Radio\_monitoring\_center Testing Center (SRTC)  
Address: No.80 Beilishi Road, Xicheng District, Beijing China  
City: Beijing  
Country or Region: China  
Contacted person: Wang Junfeng  
Tel: +86 10 68009181 +86 10 68009202  
Fax: +86 10 68009195 +86 10 68009205  
Email: wangjf@srrc.org.cn / wangjunfeng@srtc.org.cn

### 1.3 Applicant's details

Company: TCT Mobile Limited  
Address: 5F, E building, No. 232, Liang Jing Road ZhangJiang High-Tech Park, Pudong Area  
City: Shanghai  
Country or Region: P.R.China  
Grantee Code: RAD  
Contacted Person: Gong Zhizhou  
Tel: +86-21-61460890  
Fax: +86-21-61460602  
Email: zhizhou.gong@jrdcom.com

### 1.4 Manufacturer's details

Company: TCT Mobile Limited  
Address: 5F, E building, No. 232, Liang Jing Road ZhangJiang High-Tech Park, Pudong Area  
City: Shanghai  
Country or Region: P.R.China  
Contacted Person: Gong Zhizhou  
Tel: +86-21-61460890  
Fax: +86-21-61460602  
Email: zhizhou.gong@jrdcom.com

## 1.5 Application details

Date of reception of test sample: 8<sup>th</sup> Mar 2011

Date of test: 9<sup>th</sup> Mar 2011 to 12<sup>th</sup> Apr 2011

## 1.6 Reference specification

FCC Part 15B October 1, 2009 (Certification)

## 1.7 Information of EUT

### 1.7.1 General information

Name of EUT	GSM/GPRS/EDGE/WCDMA Digital Mobile Phone with Bluetooth
FCC ID	RAD197
Frequency range	GSM850/WCDMA Band V: Tx:824~849MHz Rx:869~894MHz PCS1900/WCDMA Band II: Tx:1850~1910MHz Rx:1930~1990MHz
Rated output power	GSM850:33.0dBm PCS1900:30.0dBm WCDMA:24.0dBm
E.R.P. & E.I.R.P.	E.R.P.: 31.7dBm E.I.R.P.: 26.2dBm
Modulation type	GSM/GPRS:GMSK EDGE: GMSK(Uplink direction) 8PSK(Downlink direction) WCDMA:QPSK
Emission Designator	GSM/GPRS/EDGE(GMSK):300KGXW WCDMA:4M50F9W
Duplex mode	FDD
Equipment Class	Class B
Duplex spacing	GSM850/WCDMA Band V:45MHz PCS1900/WCDMA Band II:80MHz
Antenna type	Integral
Power Supply	Battery or charger
Rated Power Supply Voltage	3.8V
Extreme Temperature	Lowest: -30°C Highest: +50°C
Extreme Voltage	Minimum: 3.5V Maximum: 4.2V
HW Version	LOT1
SW Version	sw53K

### 1.7.2 EUT details

Product Name	Marketing Name	Product Model	IMEI
GSM/GPRS/EDGE/WCDMA Digital Mobile Phone with Bluetooth	one touch 900A	yippee 3G_A2	012787000001080

### 1.7.3 Auxiliary equipment details

#### AE (Auxiliary Equipment) 1#: Charger

Equipment	Charger
Manufacturer	HUIZHOU BYD ELECTRONIC CO., LTD.
Model Number	CBA3001AG0C1
Input Voltage	100V-240V a.c.
Output Voltage	5.0V d.c.
Frequency	50/60Hz

#### AE (Auxiliary Equipment) 2#: Battery

Equipment	Battery
Manufacturer	BYD LITHIUM BATTERY CO., LTD
Model Number	CAB31L0000C1
Capacity	1000mAh
Rated Voltage	3.7V d.c.

#### AE (Auxiliary Equipment) 3#: Headset

Equipment	Headset
Manufacturer	HuiZhou Lianyun Electronic Technology Co.,Ltd
Model Number	CCB3160A10C2

#### AE (Auxiliary Equipment) 4#: Charger

Equipment	Charger
Manufacturer	Ten Pao International Ltd.
Model Number	CBA3120AG0C2
Input Voltage	100V-240V a.c.
Output Voltage	5.0V d.c.
Frequency	50/60Hz

AE (Auxiliary Equipment) 5#: Battery

Equipment	Battery
Manufacturer	SHENZHEN BAK BATTERY CO., LTD
Model Number	CAB31L0000C2
Capacity	1000mAh
Rated Voltage	3.7V d.c.

AE (Auxiliary Equipment) 6#: Headset

Equipment	Headset
Manufacturer	Shen Zhen Ju Wei Electronic Co.,LTD
Model Number	CCB3160A10C0

AE (Auxiliary Equipment) 7#: Data Cable

Equipment	Data Cable
Manufacturer	Shen Zhen Ju Wei Electronic Co.,LTD
Model Number	CDA3122001C1

AE (Auxiliary Equipment) 8#: Data Cable

Equipment	Data Cable
Manufacturer	Huizhou Shenghua Industry Co.,Ltd
Model Number	CDA3122001C2

Note:

All the auxiliary equipments have been labeled with number in order to identify the test sample.



As the information described above, there are two different models of battery manufactured by two different companies, and two different models of headset manufactured by two different companies.

The relevant tests have been performed in order to verify in which combination case (EUT exercised by only one model of battery and one model of headset) the EUT would have the worst features. So all the tests except conducted emissions (please refer to the section 2.2.1 for details) shown in this test report are performed when the EUT exercised by the the battery CAB31L0000C1 and the headset CCB3160A10C2.

## 2. Test information

### 2.1 Summary of the test results

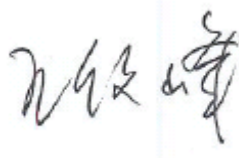
No.	Test case	FCC reference	Verdict
1	Conducted emissions	15.107	Pass
2	Radiated emissions	15.109	Pass

This Test Report Is Issued by: Mr. Song Qizhu Director of the test lab 	Checked by: Mr. Wang Junfeng Deputy director of the test lab 
Tested by: Mr. Wang Zheng Test engineer 	Issued date:  <p style="text-align: center;"><b>2011.06.08</b></p>

## 2.2 Test result

### 2.2.1 Conducted Emissions-FCC Part15.107

Ambient condition:

Temperature	Relative humidity	Pressure
21°C	47.9%	100.2kPa

Test Setup:

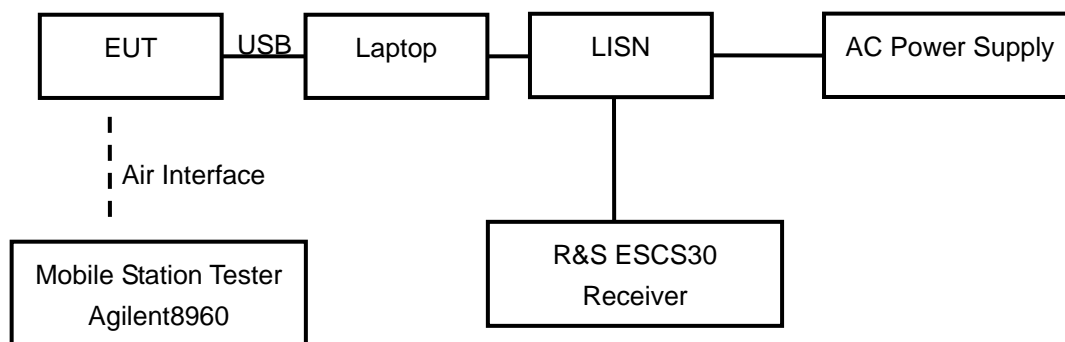

Figure 1

Test Procedure:

The EUT is placed on a non-metallic table 0.4m above the horizontal metal reference ground plane. The EUT connect with a laptop via the USB cable. The accessories of the EUT are connected with the EUT such as headset etc. During the test the data transferring via USB cable between EUT and laptop is maintained.

The AC main power supply of the laptop is connected to LISN and LISN is connected to the reference ground. The test set-up and the test methods are performed according to ANSI C63.4:2009.

Then start the test software ES-K1. Sweep the whole frequency band through the range from 150 KHz to 30 MHz. The measurement should be done for both L line and N line. During pre-test, the receiver uses both peak detector and average detector. And the final test, the receiver uses both average detector and Quasi-peak detector.

The data of cable loss has been calibrated in full testing frequency range before the testing.



Limit:

Frequency of Emission(MHz)	Limits(dBμV)	
	Quasi-peak	Average
0.15~0.5	66 to 56*	56 to 46*
0.5~5	56	46
5~30	60	50

Note: \* Decreases with the logarithm of the frequency

Test result:

Refer to the following figures.

Noise Level of The Measuring Instrument

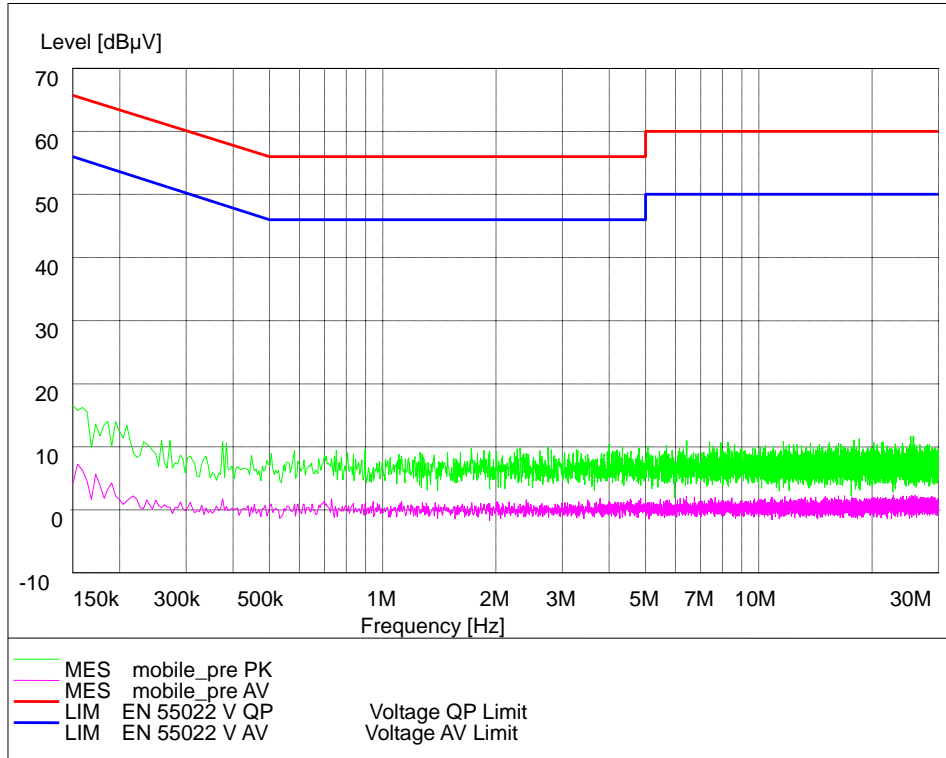

L and N Line

GSM 850 Laptop+AE2#+AE3#+AE7

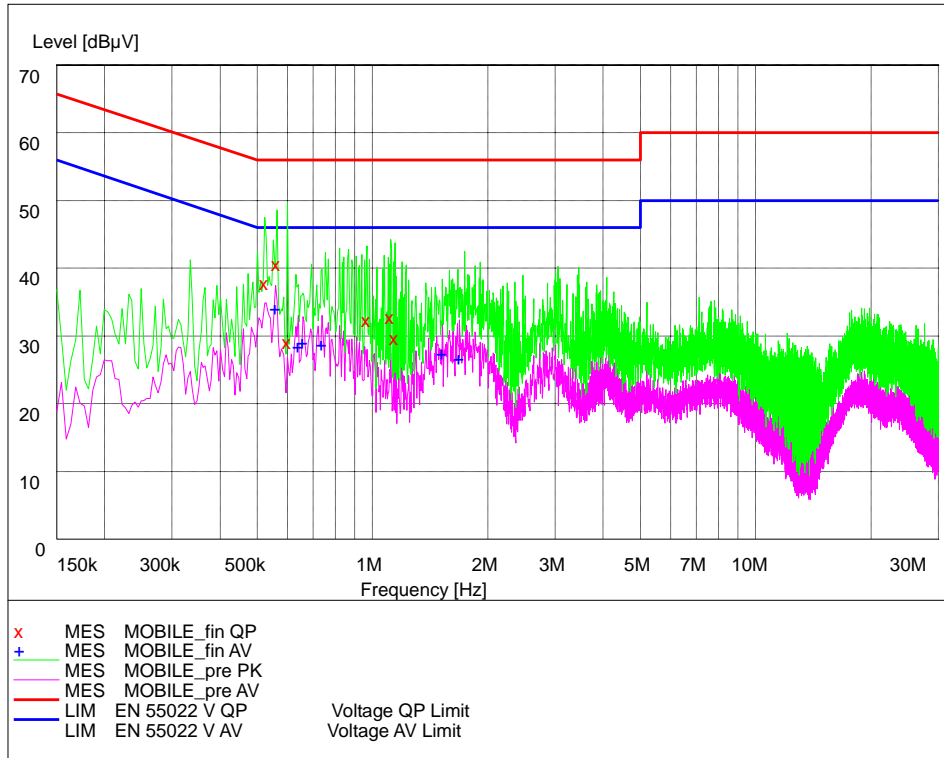

L and N Line

**MEASUREMENT RESULT: "MOBILE\_fin QP"**

Frequency	Level	Transd	Limit	Margin	Line	PE
MHz	dBµV	dB	dBµV	dB		
0.523500	39.30	20.3	56	16.7	N	GND
0.564000	42.10	20.3	56	13.9	L1	GND
0.600000	30.70	20.3	56	25.3	L1	GND
0.969000	34.00	20.2	56	22.0	L1	GND
1.117500	34.30	20.2	56	21.7	N	GND
1.144500	31.30	20.2	56	24.7	L1	GND

**MEASUREMENT RESULT: "MOBILE\_fin AV"**

Frequency	Level	Transd	Limit	Margin	Line	PE
MHz	dBµV	dB	dBµV	dB		
0.559500	35.60	20.3	46	10.4	N	GND
0.640500	30.00	20.3	46	16.0	L1	GND
0.658500	30.70	20.3	46	15.3	N	GND
0.739500	30.30	20.3	46	15.7	L1	GND
1.522500	29.00	20.2	46	17.0	L1	GND
1.689000	28.30	20.2	46	17.7	L1	GND

GSM 850 Laptop+AE2#+AE3#+AE8

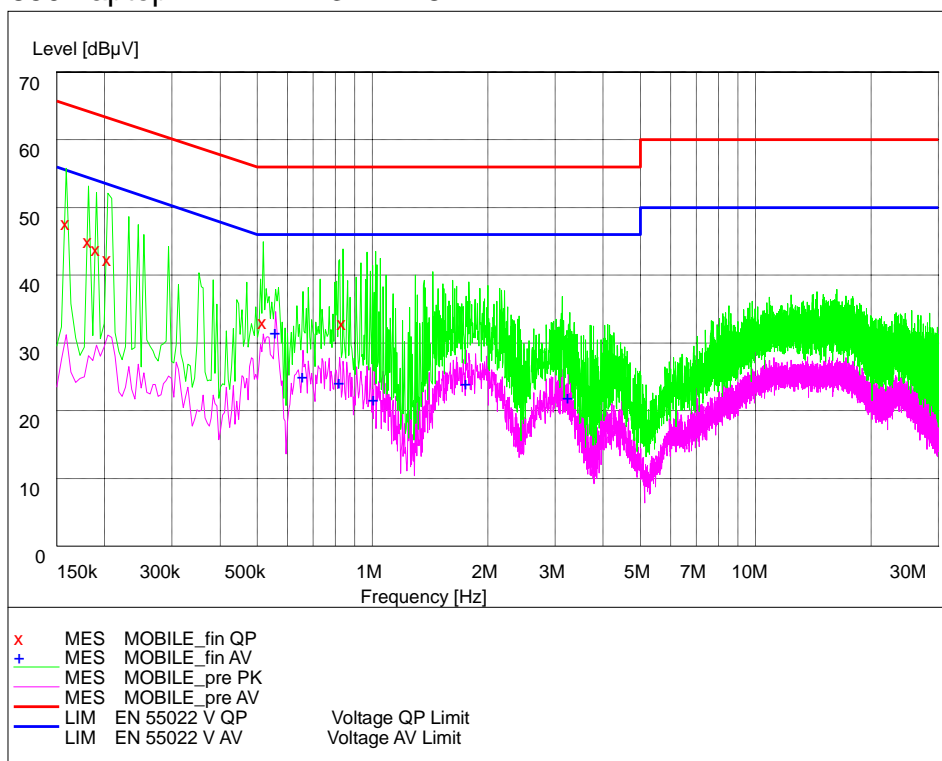

L and N Line

**MEASUREMENT RESULT: "MOBILE\_fin QP"**

Frequency	Level	Transd	Limit	Margin	Line	PE
MHz	dBµV	dB	dBµV	dB		
0.159000	49.30	20.1	65	16.0	L1	GND
0.181500	46.60	20.2	64	17.6	L1	GND
0.190500	45.50	20.1	64	18.3	L1	GND
0.204000	43.90	20.2	63	19.3	N	GND
0.519000	34.60	20.3	56	21.4	L1	GND
0.838500	34.50	20.3	56	21.5	N	GND

**MEASUREMENT RESULT: "MOBILE\_fin AV"**

Frequency	Level	Transd	Limit	Margin	Line	PE
MHz	dBµV	dB	dBµV	dB		
0.559500	33.20	20.3	46	12.8	L1	GND
0.658500	26.60	20.3	46	19.4	L1	GND
0.820500	25.80	20.3	46	20.2	L1	GND
1.009500	23.20	20.2	46	22.8	L1	GND
1.756500	25.60	20.2	46	20.4	L1	GND
3.246000	23.50	20.3	46	22.5	N	GND

GSM 1900 Laptop+AE2#+AE3#+AE7

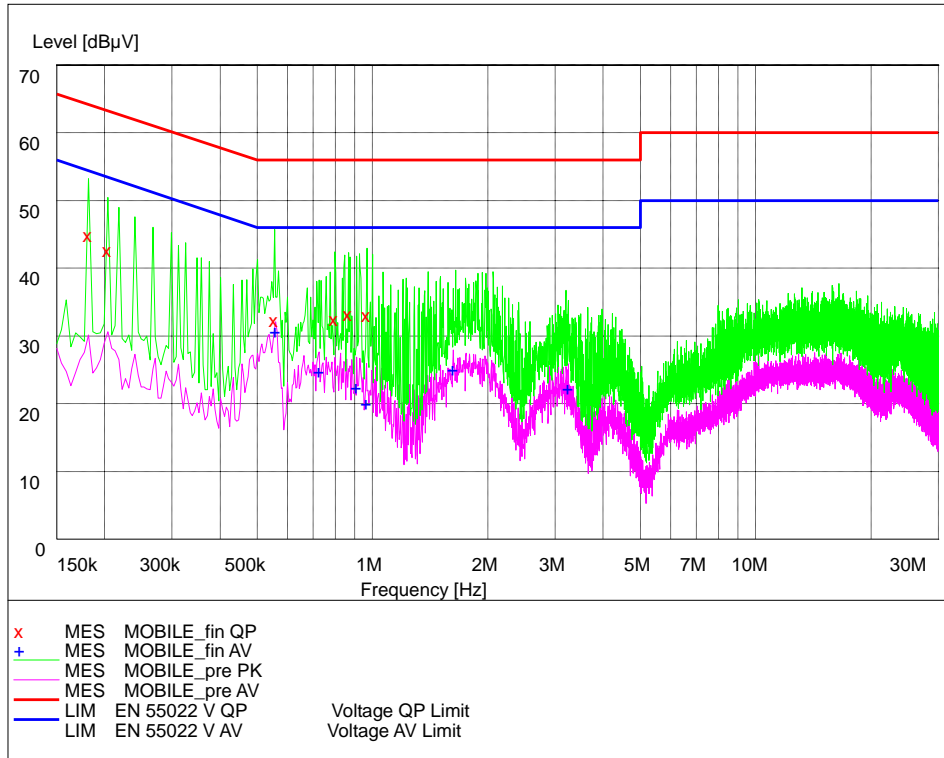

L and N Line

**MEASUREMENT RESULT: "MOBILE\_fin QP"**

Frequency	Level	Transd	Limit	Margin	Line	PE
MHz	dBμV	dB	dBμV	dB		
0.181500	46.40	20.2	64	17.8	L1	GND
0.204000	44.10	20.2	63	19.2	L1	GND
0.555000	33.90	20.3	56	22.1	L1	GND
0.798000	34.10	20.3	56	21.9	L1	GND
0.865500	34.80	20.3	56	21.2	N	GND
0.969000	34.60	20.2	56	21.4	N	GND

**MEASUREMENT RESULT: "MOBILE\_fin AV"**

Frequency	Level	Transd	Limit	Margin	Line	PE
MHz	dBμV	dB	dBμV	dB		
0.559500	32.30	20.3	46	13.7	N	GND
0.726000	26.40	20.3	46	19.6	L1	GND
0.910500	24.00	20.2	46	22.0	L1	GND
0.964500	21.60	20.2	46	24.4	N	GND
1.626000	26.60	20.2	46	19.4	L1	GND
3.250500	23.80	20.3	46	22.2	L1	GND

GSM 1900 Laptop+AE2#+AE3#+AE8

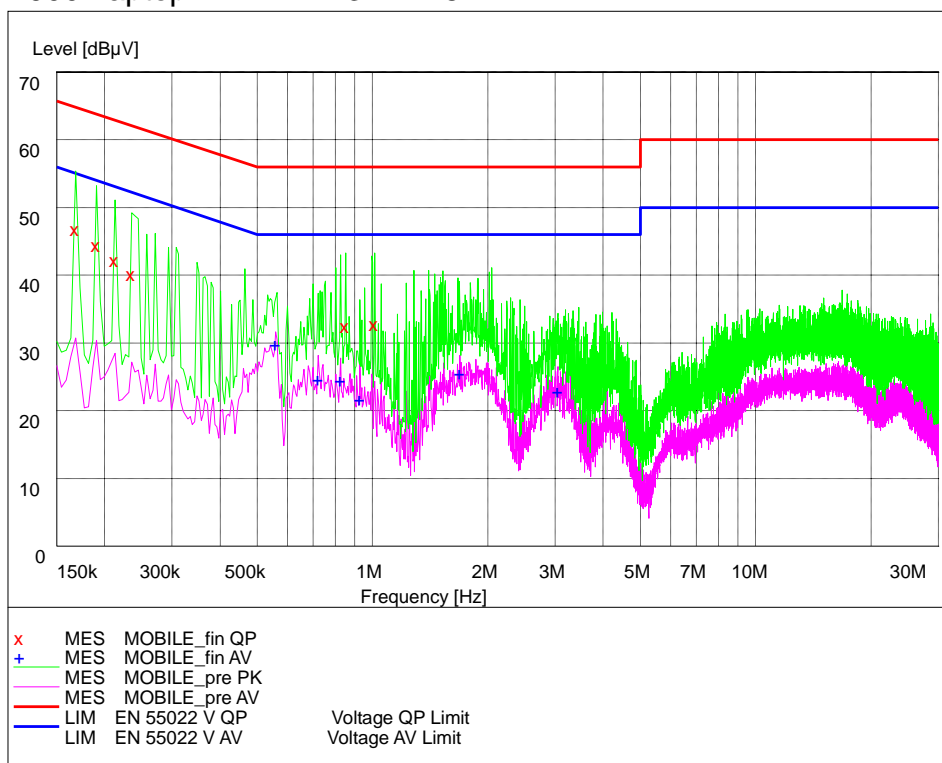

L and N Line

**MEASUREMENT RESULT: "MOBILE\_fin QP"**

Frequency	Level	Transd	Limit	Margin	Line	PE
MHz	dBμV	dB	dBμV	dB		
0.168000	48.40	20.2	65	16.4	L1	GND
0.190500	46.00	20.1	64	17.8	L1	GND
0.213000	43.70	20.2	63	19.2	N	GND
0.235500	41.70	20.2	62	20.4	L1	GND
0.852000	34.10	20.3	56	21.9	L1	GND
1.014000	34.30	20.2	56	21.7	N	GND

**MEASUREMENT RESULT: "MOBILE\_fin AV"**

Frequency	Level	Transd	Limit	Margin	Line	PE
MHz	dBμV	dB	dBμV	dB		
0.559500	31.40	20.3	46	14.6	L1	GND
0.721500	26.30	20.3	46	19.7	L1	GND
0.825000	26.10	20.3	46	19.9	L1	GND
0.928500	23.30	20.3	46	22.7	N	GND
1.693500	27.10	20.2	46	18.9	L1	GND
3.048000	24.40	20.3	46	21.6	N	GND

WCDMA BAND II Laptop+AE2#+AE3#+AE7

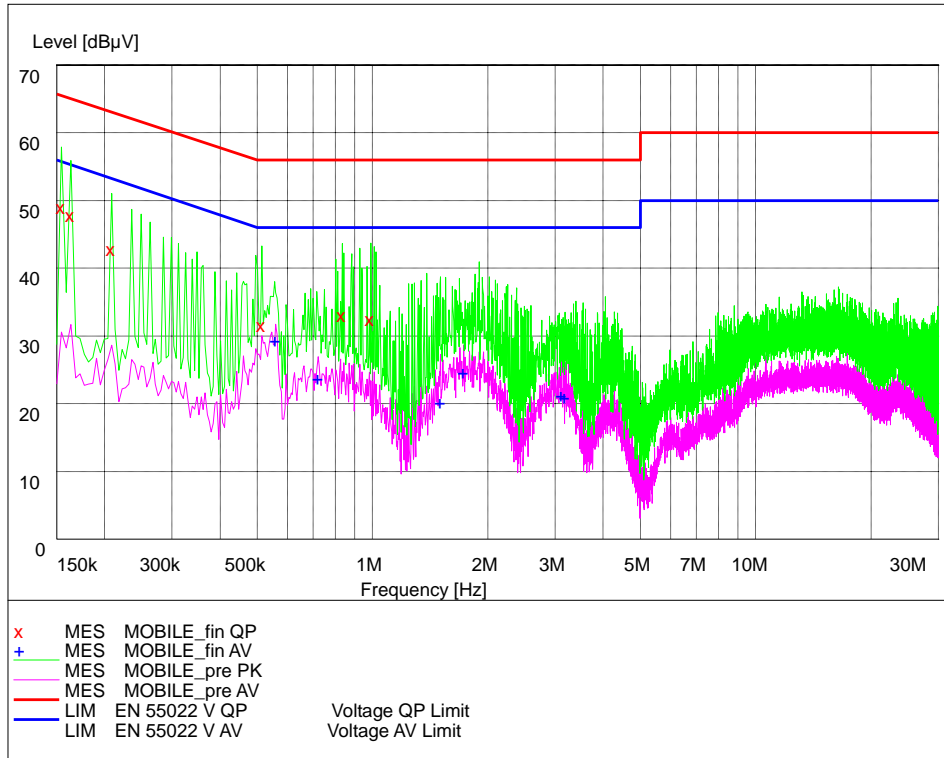

L and N Line

**MEASUREMENT RESULT: "MOBILE\_fin QP"**

Frequency	Level	Transd	Limit	Margin	Line	PE
MHz	dBμV	dB	dBμV	dB		
0.154500	50.60	20.1	66	14.9	L1	GND
0.163500	49.40	20.2	65	15.6	L1	GND
0.208500	44.40	20.1	63	18.7	N	GND
0.514500	33.20	20.3	56	22.8	L1	GND
0.834000	34.60	20.3	56	21.4	L1	GND
0.991500	34.10	20.2	56	21.9	L1	GND

**MEASUREMENT RESULT: "MOBILE\_fin AV"**

Frequency	Level	Transd	Limit	Margin	Line	PE
MHz	dBμV	dB	dBμV	dB		
0.559500	30.90	20.3	46	15.1	L1	GND
0.721500	25.30	20.3	46	20.7	L1	GND
1.504500	21.80	20.2	46	24.2	L1	GND
1.729500	26.20	20.2	46	19.8	L1	GND
3.115500	22.90	20.3	46	23.1	N	GND
3.183000	22.50	20.3	46	23.5	L1	GND

WCDMA BAND II Laptop+AE2#+AE3#+AE8

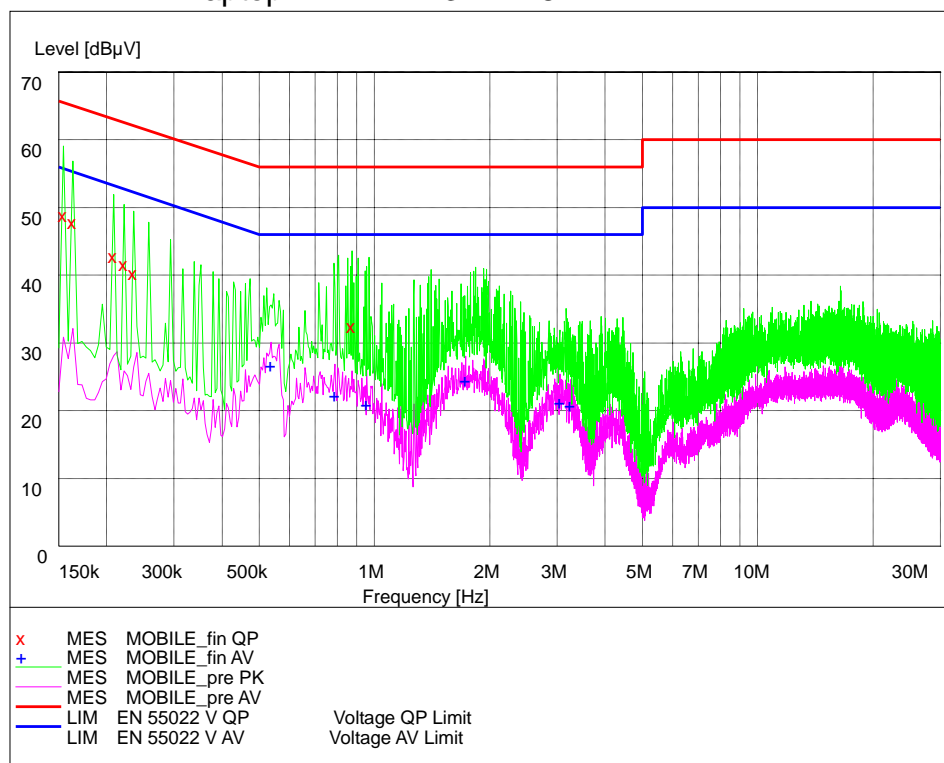

L and N Line

**MEASUREMENT RESULT: "MOBILE\_fin QP"**

Frequency	Level	Transd	Limit	Margin	Line	PE
MHz	dBμV	dB	dBμV	dB		
0.154500	50.50	20.1	66	15.0	L1	GND
0.163500	49.40	20.2	65	15.6	L1	GND
0.208500	44.30	20.1	63	18.8	L1	GND
0.222000	43.10	20.2	63	19.5	L1	GND
0.235500	41.90	20.2	62	20.2	L1	GND
0.874500	34.10	20.3	56	21.9	N	GND

**MEASUREMENT RESULT: "MOBILE\_fin AV"**

Frequency	Level	Transd	Limit	Margin	Line	PE
MHz	dBμV	dB	dBμV	dB		
0.537000	28.30	20.3	46	17.7	N	GND
0.789000	23.90	20.3	46	22.1	L1	GND
0.955500	22.50	20.2	46	23.5	N	GND
1.729500	26.00	20.2	46	20.0	L1	GND
3.048000	22.90	20.3	46	23.1	L1	GND
3.250500	22.40	20.3	46	23.6	L1	GND



WCDMA BAND V Laptop+AE2#+AE3#+AE7

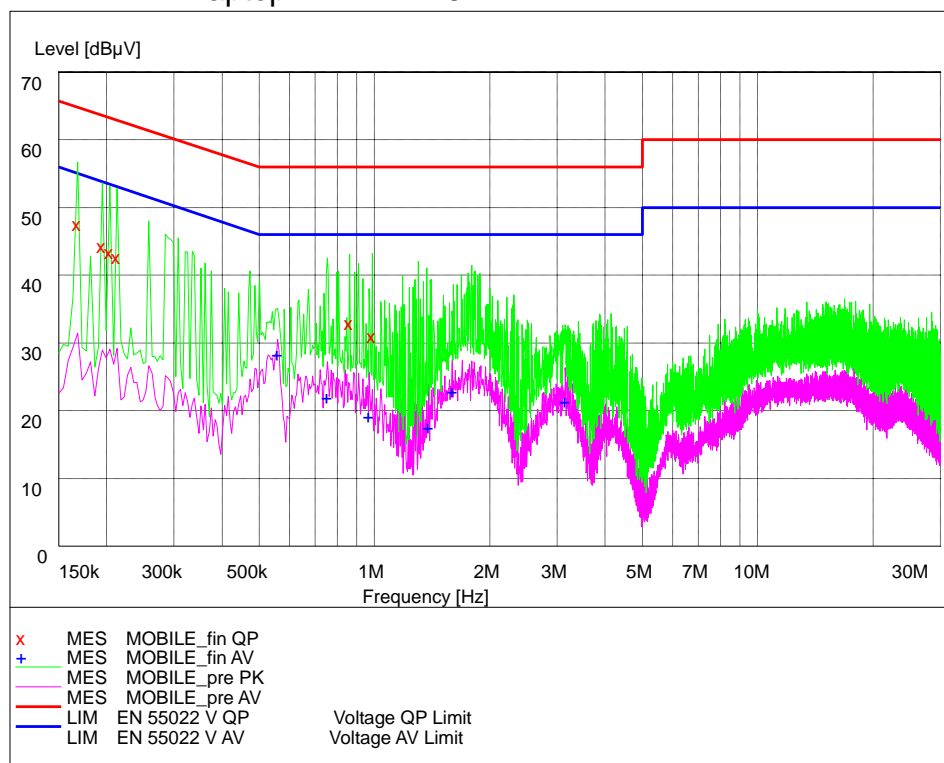

L and N Line

**MEASUREMENT RESULT: "MOBILE\_fin QP"**

Frequency	Level	Transd	Limit	Margin	Line	PE
MHz	dBµV	dB	dBµV	dB		
0.168000	49.10	20.2	65	15.8	L1	GND
0.195000	45.90	20.2	64	17.7	N	GND
0.204000	45.00	20.2	63	18.2	L1	GND
0.213000	44.20	20.2	63	18.7	L1	GND
0.861000	34.50	20.3	56	21.5	L1	GND
0.987000	32.50	20.2	56	23.5	N	GND

**MEASUREMENT RESULT: "MOBILE\_fin AV"**

Frequency	Level	Transd	Limit	Margin	Line	PE
MHz	dBµV	dB	dBµV	dB		
0.559500	29.80	20.3	46	16.2	N	GND
0.753000	23.60	20.3	46	22.4	L1	GND
0.969000	20.70	20.2	46	25.3	N	GND
1.387500	19.10	20.2	46	26.9	L1	GND
1.599000	24.40	20.2	46	21.6	N	GND
3.147000	23.00	20.3	46	23.0	L1	GND

WCDMA BAND V Laptop+AE2#+AE3#+AE8

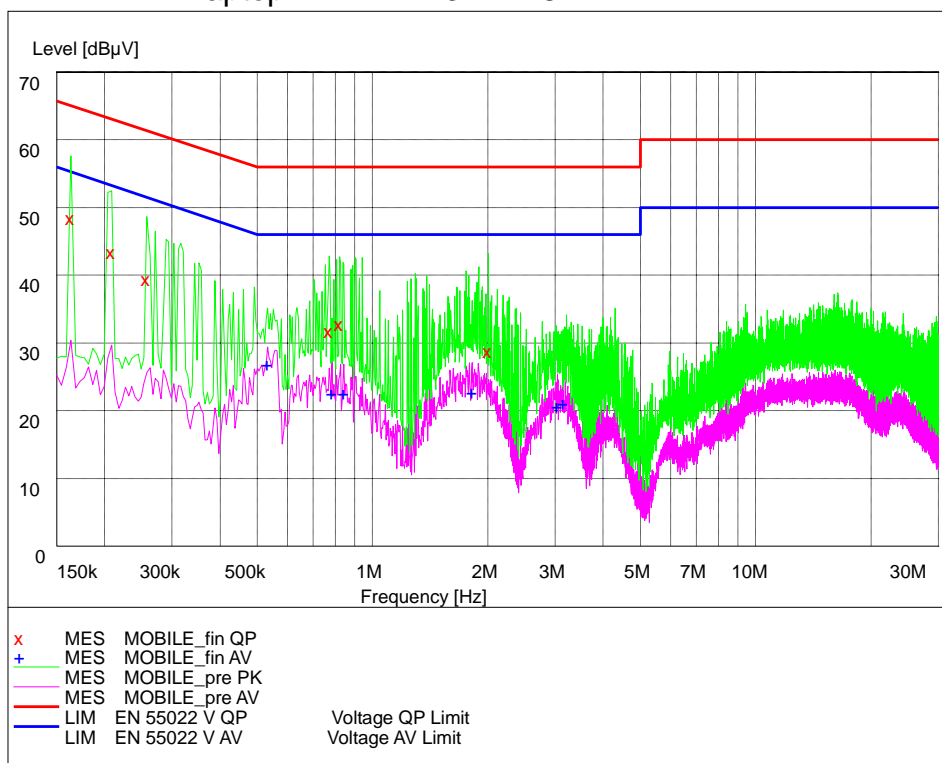

L and N Line

**MEASUREMENT RESULT: "MOBILE\_fin QP"**

Frequency MHz	Level dBμV	Transd dB	Limit dBμV	Margin dB	Line	PE
0.163500	50.00	20.2	65	15.0	L1	GND
0.208500	45.00	20.1	63	18.1	N	GND
0.258000	40.90	20.2	61	20.4	L1	GND
0.771000	33.40	20.2	56	22.6	L1	GND
0.820500	34.40	20.3	56	21.6	L1	GND
2.008500	30.40	20.3	56	25.6	L1	GND

**MEASUREMENT RESULT: "MOBILE\_fin AV"**

Frequency MHz	Level dBμV	Transd dB	Limit dBμV	Margin dB	Line	PE
0.532500	28.40	20.3	46	17.6	L1	GND
0.784500	24.20	20.3	46	21.8	L1	GND
0.843000	24.20	20.3	46	21.8	L1	GND
1.819500	24.30	20.2	46	21.7	L1	GND
3.039000	22.20	20.3	46	23.8	N	GND
3.147000	22.70	20.3	46	23.3	L1	GND

FM Radio Laptop+AE2#+AE3#+AE7

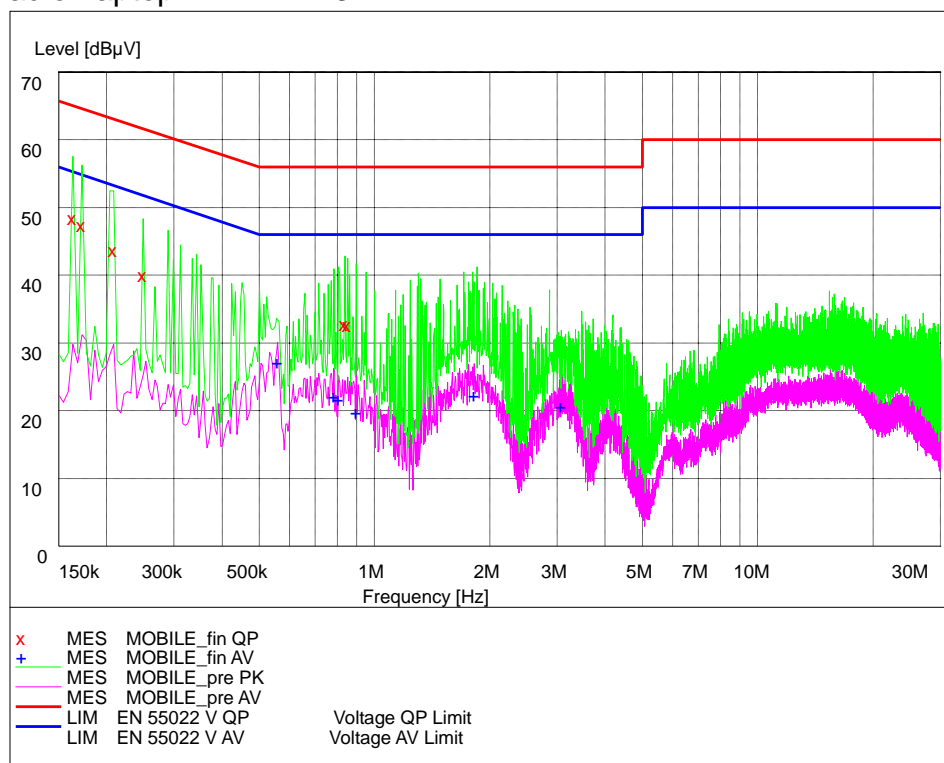

L and N Line

**MEASUREMENT RESULT: "MOBILE\_fin QP"**

Frequency	Level	Transd	Limit	Margin	Line	PE
MHz	dBμV	dB	dBμV	dB		
0.163500	50.00	20.2	65	15.0	L1	GND
0.172500	48.90	20.2	65	15.7	L1	GND
0.208500	45.20	20.1	63	17.9	L1	GND
0.249000	41.50	20.2	62	20.1	N	GND
0.838500	34.40	20.3	56	21.6	L1	GND
0.852000	34.20	20.3	56	21.8	L1	GND

**MEASUREMENT RESULT: "MOBILE\_fin AV"**

Frequency	Level	Transd	Limit	Margin	Line	PE
MHz	dBμV	dB	dBμV	dB		
0.559500	28.70	20.3	46	17.3	N	GND
0.784500	23.70	20.3	46	22.3	L1	GND
0.807000	23.20	20.3	46	22.8	L1	GND
0.897000	21.30	20.2	46	24.7	N	GND
1.824000	23.80	20.2	46	22.2	L1	GND
3.079500	22.30	20.3	46	23.7	L1	GND

MP3/MP4 Laptop+AE2#+AE3#+AE7

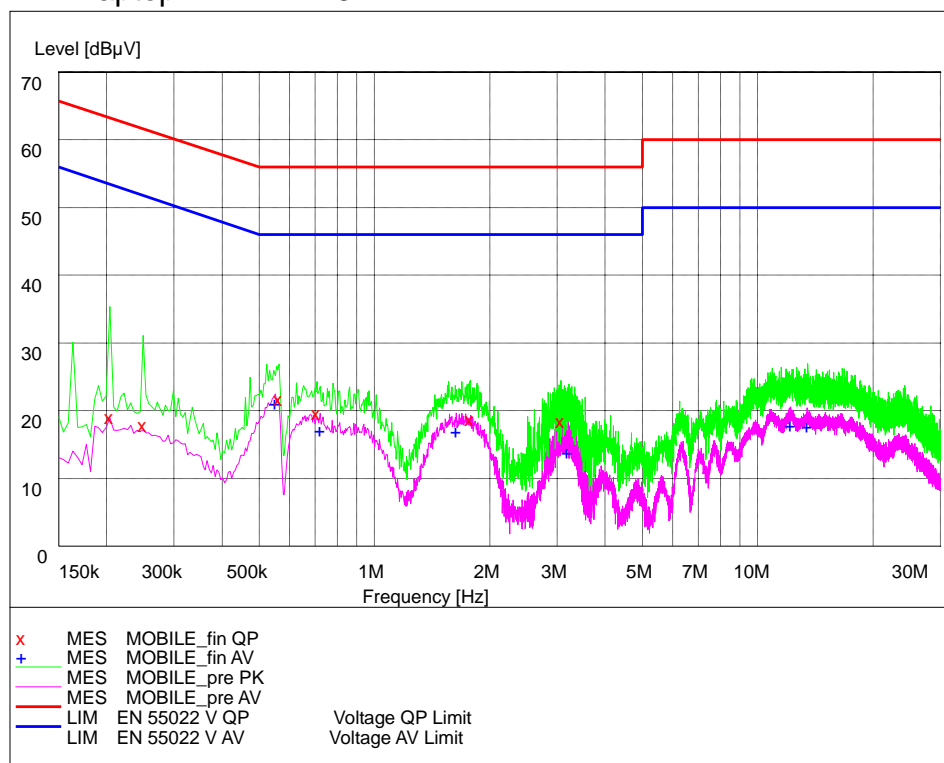

L Line

**MEASUREMENT RESULT: "MOBILE\_fin QP"**

Frequency	Level	Transd	Limit	Margin	Line	PE
MHz	dBμV	dB	dBμV	dB		
0.204000	20.60	20.2	63	42.7	L1	GND
0.249000	19.40	20.2	62	42.3	L1	GND
0.564000	23.30	20.3	56	32.7	N	GND
0.708000	21.10	20.3	56	34.9	L1	GND
1.779000	20.30	20.2	56	35.7	L1	GND
3.070500	20.00	20.3	56	36.0	L1	GND

**MEASUREMENT RESULT: "MOBILE\_fin AV"**

Frequency	Level	Transd	Limit	Margin	Line	PE
MHz	dBμV	dB	dBμV	dB		
0.550500	22.70	20.3	46	23.3	N	GND
0.721500	18.70	20.3	46	27.3	L1	GND
1.635000	18.50	20.2	46	27.5	L1	GND
3.192000	15.40	20.3	46	30.6	L1	GND
12.205500	19.50	20.7	50	30.5	L1	GND
13.461000	19.30	20.8	50	30.7	N	GND

Camera Laptop+AE2#+AE3#+AE7

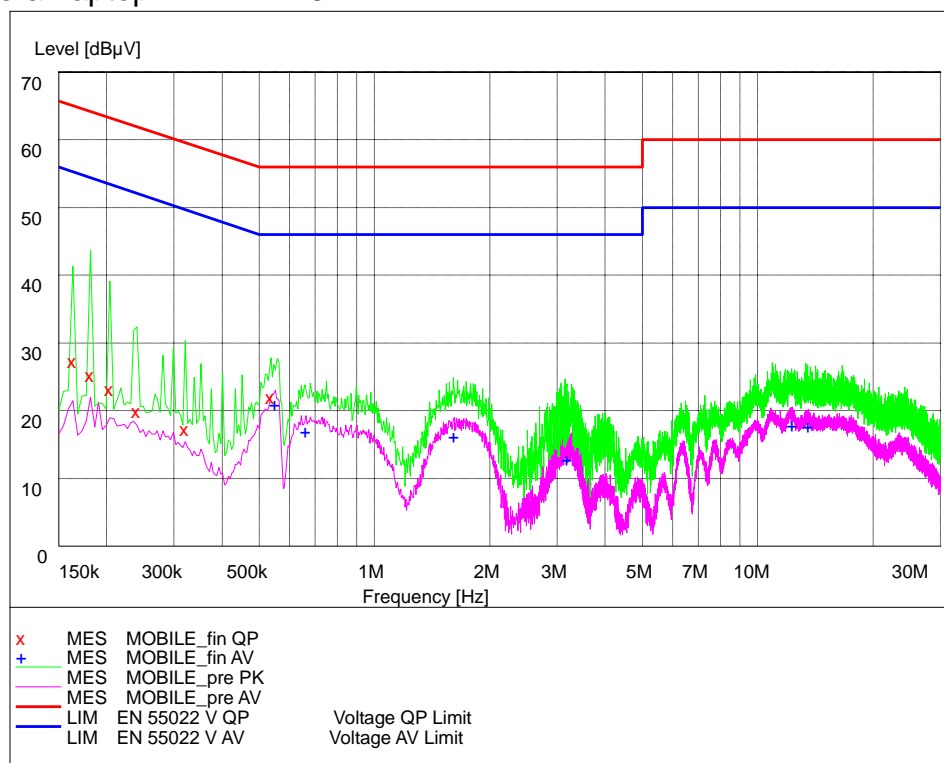

L Line

**MEASUREMENT RESULT: "MOBILE\_fin QP"**

Frequency	Level	Transd	Limit	Margin	Line	PE
MHz	dBμV	dB	dBμV	dB		
0.163500	28.80	20.2	65	36.2	L1	GND
0.181500	26.90	20.2	64	37.3	L1	GND
0.204000	24.70	20.2	63	38.5	N	GND
0.240000	21.50	20.2	62	40.4	L1	GND
0.321000	18.90	20.2	60	40.7	L1	GND
0.537000	23.50	20.3	56	32.5	N	GND

**MEASUREMENT RESULT: "MOBILE\_fin AV"**

Frequency	Level	Transd	Limit	Margin	Line	PE
MHz	dBμV	dB	dBμV	dB		
0.550500	22.50	20.3	46	23.5	N	GND
0.663000	18.60	20.3	46	27.4	L1	GND
1.617000	17.80	20.2	46	28.2	L1	GND
3.187500	14.30	20.3	46	31.7	L1	GND
12.336000	19.40	20.7	50	30.6	L1	GND
13.600500	19.30	20.8	50	30.7	L1	GND

## 2.2.2 Radiated Emissions-FCC Part15.109

Ambient condition:

Temperature	Relative humidity	Pressure
21.3°C	49.5%	101.6kPa

Test Setup:

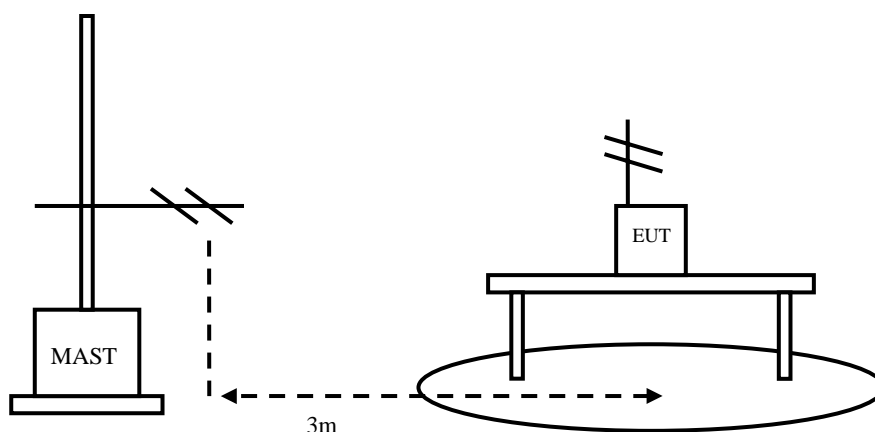

Figure 2

Test Procedure:

The EUT should be placed on a non-metallic table 80cm above the ground plane. The receive antennas shall be moved from 1 to 4 meters. The distance between EUT and receive antenna should be 3 meters.

The EUT should work in idle mode. The accessories of the EUT are connected with the EUT such as headset etc. The test set-up and the test methods are performed according to ANSI C63.4:2009.

Then start the test software ES-K1. Sweep the whole frequency band through the range from 30MHz to 1GHz, using receive log period antenna HL562.

During the test, the height of receive antenna shall be moved from 1 to 4 meters, and the antenna shall be performed under horizontal and vertical polarization. The turn table shall be rotated from 0 to 360 degrees for detecting the maximum of radiated spurious signal level. The measurements shall be repeated with orthogonal polarization of the test antenna. The EUT is laid in two modes as follow: 1. put the EUT in horizontal direction; 2. put the EUT in vertical direction.

The data of cable loss and antenna factor have been calibrated in full testing frequency range before the testing.

A “reference path loss” is established and the  $A_{Rpl}$  is the attenuation of “reference path loss”, and including the gain of receive antenna, the gain of the preamplifier, the cable loss.

The measurement results are obtained as described below:

$$\text{Result} = P_{\text{mea}} + A_{Rpl}$$

Limit:

Frequency of Emission(MHz)	Limits	
	Detector	Unit (dB $\mu$ V/m)
30~88	Quasi-peak	40
88~216	Quasi-peak	43.5
216~960	Quasi-peak	46
960~1000	Quasi-peak	54
1000~5th harmonic of the highest frequency or 40GHz, whichever is lower	Average	54
	Peak	74

Test result:

#### GSM 850 Mode

Frequency(MHz)	Result(dBuV/m)	$A_{Rpl}$ (dB)	$P_{\text{mea}}$ (dBuV/m)	Polarity
32.63	20.01	8.1	11.91	Vertical
53.43	20.34	7.6	12.74	Vertical
86.26	21.62	8.9	12.72	Vertical
101.79	21.26	9.1	12.16	Horizontal
183.32	21.40	10.2	11.20	Vertical
960.32	29.97	24.3	5.67	Vertical

#### PCS1900 Mode

Frequency(MHz)	Result(dBuV/m)	$A_{Rpl}$ (dB)	$P_{\text{mea}}$ (dBuV/m)	Polarity
32.09	19.48	8.1	11.38	Vertical
52.87	19.84	7.6	12.24	Vertical
86.53	21.58	8.9	12.68	Vertical
101.87	21.08	9.1	11.98	Horizontal
183.66	20.95	10.2	10.75	Vertical
959.45	29.57	24.3	5.27	Vertical

### WCDMA Band II Mode

Frequency(MHz)	Result(dBuV/m)	A <sub>Rpl</sub> (dB)	P <sub>mea</sub> (dBuV/m)	Polarity
32.77	20.16	8.1	12.06	Vertical
53.65	20.06	7.6	12.46	Horizontal
86.45	21.49	8.9	12.59	Vertical
102.07	21.00	9.1	11.90	Vertical
183.35	20.56	10.2	10.36	Vertical
959.96	30.10	24.3	5.80	Vertical

### WCDMA Band V Mode

Frequency(MHz)	Result(dBuV/m)	A <sub>Rpl</sub> (dB)	P <sub>mea</sub> (dBuV/m)	Polarity
32.45	19.80	8.1	11.70	Vertical
53.16	19.92	7.6	12.32	Vertical
86.14	21.80	8.9	12.90	Vertical
102.71	21.25	9.1	12.15	Horizontal
183.33	21.38	10.2	11.18	Vertical
960.09	29.18	24.3	4.88	Vertical

### FM Radio Mode

Frequency(MHz)	Result(dBuV/m)	A <sub>Rpl</sub> (dB)	P <sub>mea</sub> (dBuV/m)	Polarity
32.29	20.03	8.1	11.93	Vertical
52.90	19.83	7.6	12.23	Vertical
86.75	21.70	8.9	12.80	Horizontal
101.92	20.71	9.1	11.61	Vertical
184.16	20.98	10.2	10.78	Vertical
959.62	29.76	24.3	5.46	Vertical

### MP3/MP4 Mode

Frequency(MHz)	Result(dBuV/m)	A <sub>Rpl</sub> (dB)	P <sub>mea</sub> (dBuV/m)	Polarity
32.65	19.65	8.1	11.55	Vertical
52.85	20.04	7.6	12.44	Vertical
86.74	21.97	8.9	13.07	Vertical
102.19	20.68	9.1	11.58	Horizontal
183.65	20.92	10.2	10.72	Vertical
959.51	29.29	24.3	4.99	Vertical

### Camera Mode

Frequency(MHz)	Result(dBuV/m)	A <sub>Rpl</sub> (dB)	P <sub>mea</sub> (dBuV/m)	Polarity
32.58	19.33	8.1	11.23	Vertical
53.08	20.43	7.6	12.83	Horizontal
86.59	21.55	8.9	12.65	Vertical
102.57	21.10	9.1	12.00	Vertical
183.76	20.78	10.2	10.58	Vertical
960.25	29.64	24.3	5.34	Vertical



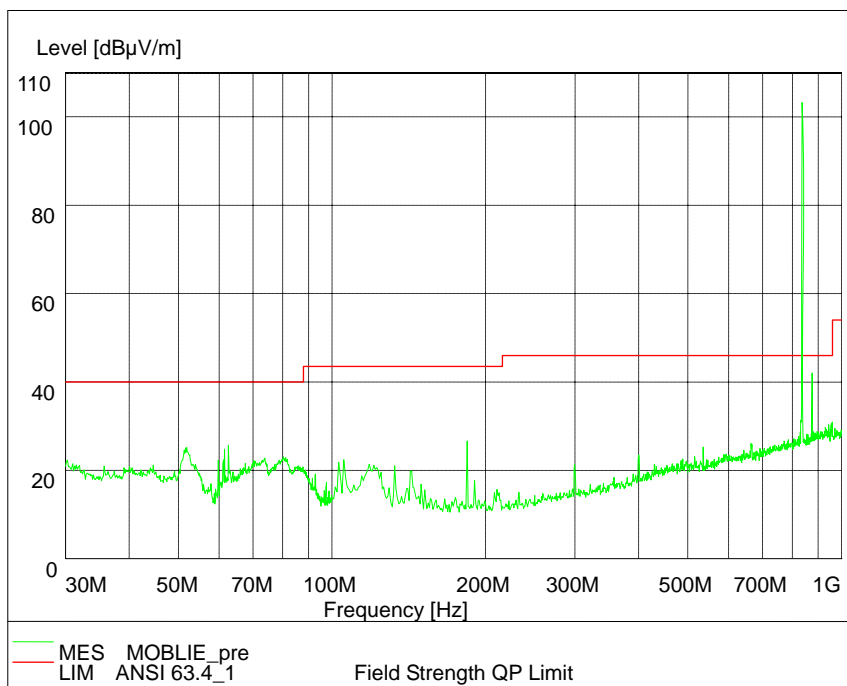

### GSM 850(30MHz – 1GHz)

Note: The signal beyond the limit is the base station simulator carrier.

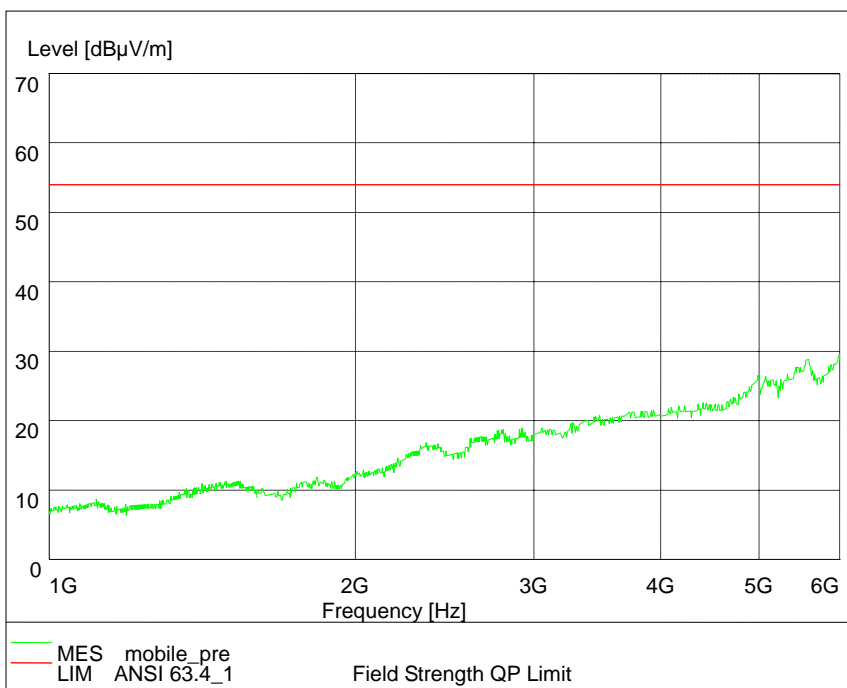

### GSM 850(1GHz – 6GHz)

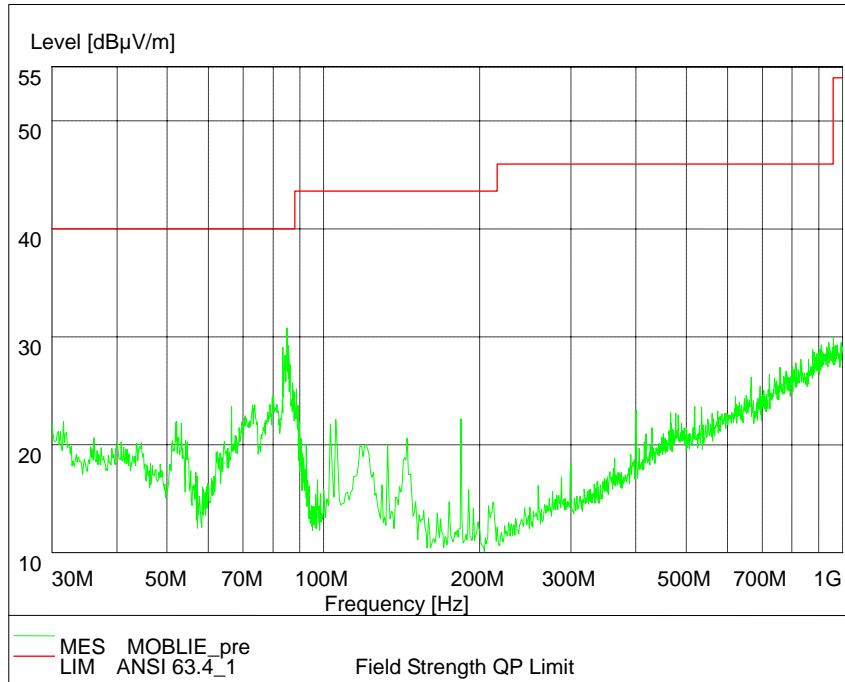

PCS 1900(30MHz – 1GHz)

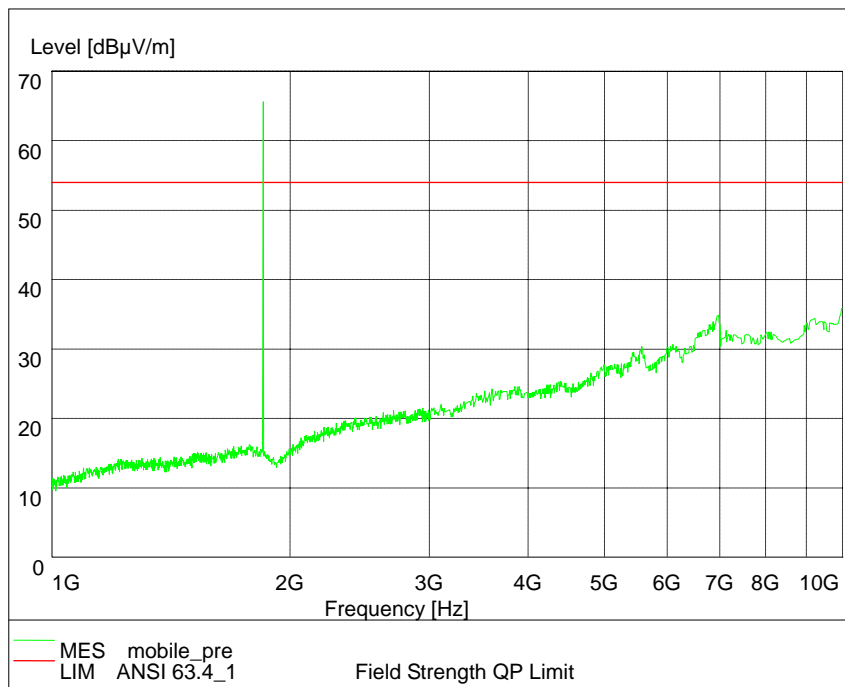

PCS 1900(1GHz – 10GHz)

Note: The signals beyond the limit are the base station and simulator carrier.

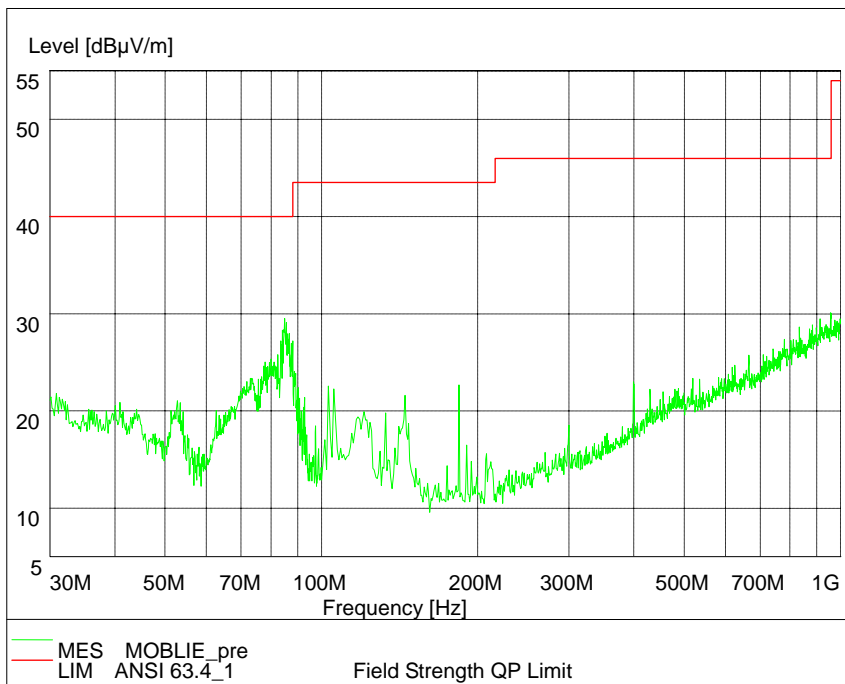

WCDMA BAND II(30MHz – 1GHz)

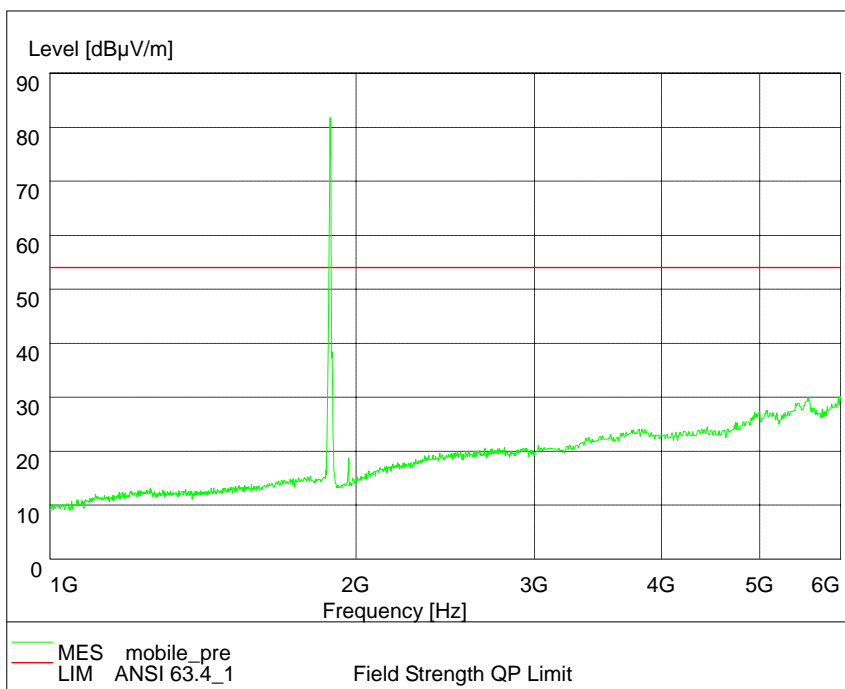

WCDMA BAND II(1GHz – 10GHz )

Note: The signals beyond the limit are the base station and simulator carrier.

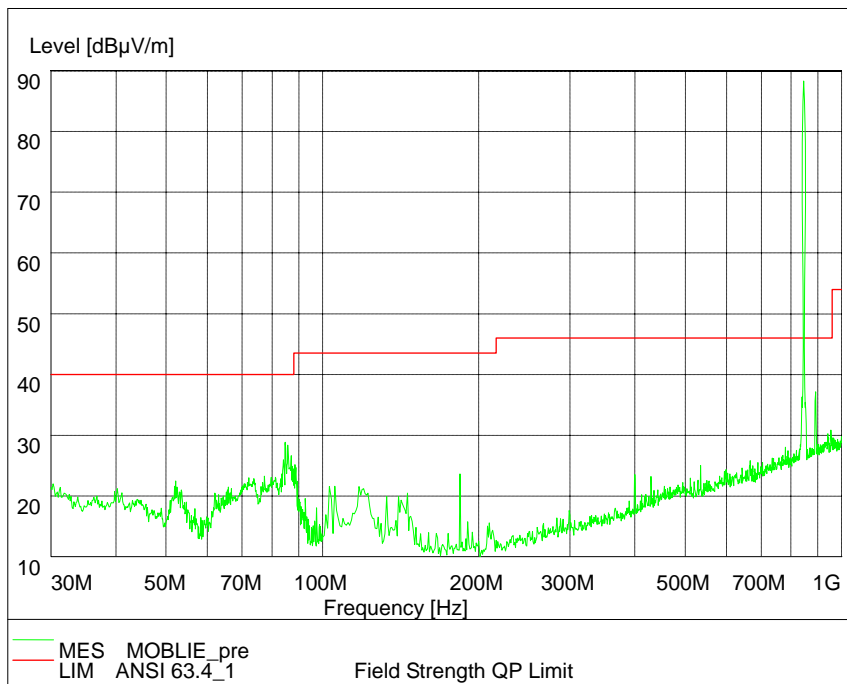

WCDMA BAND V (30MHz – 1GHz)

Note: The signal beyond the limit is the base station simulator carrier.

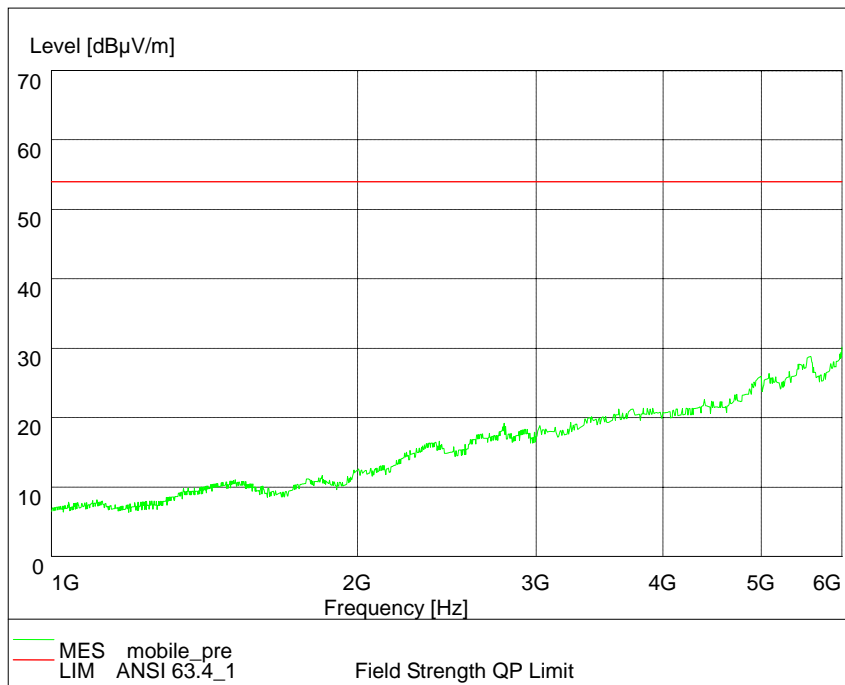

WCDMA BAND V(1GHz – 6GHz)

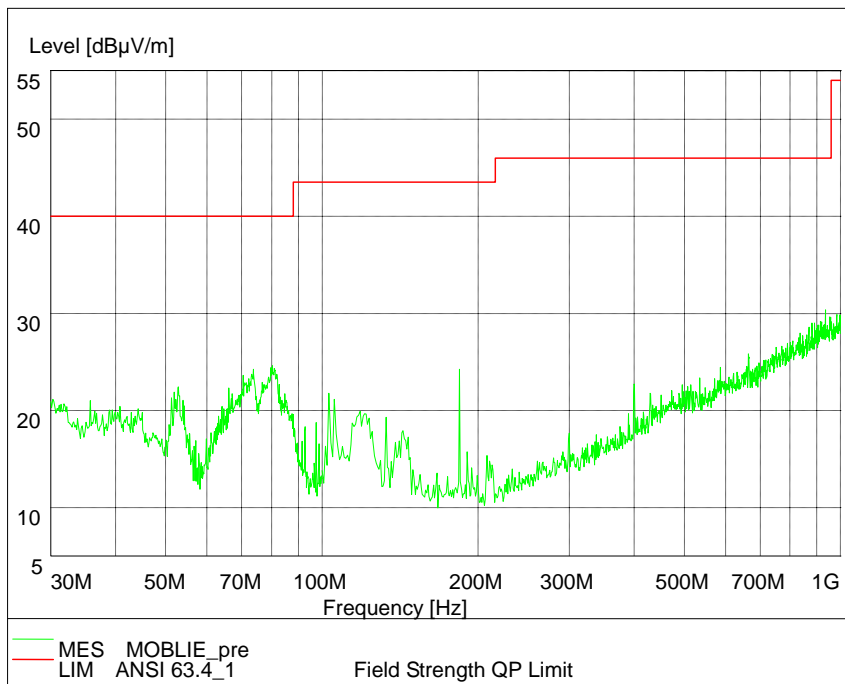

### FM Radio (30MHz – 1GHz )

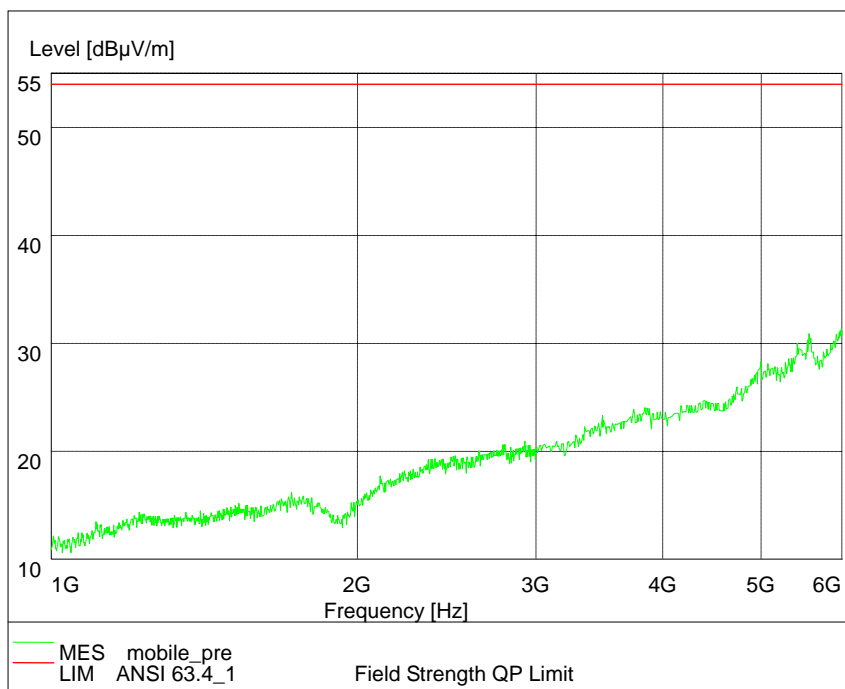

### FM Radio (1GHz – 6GHz)

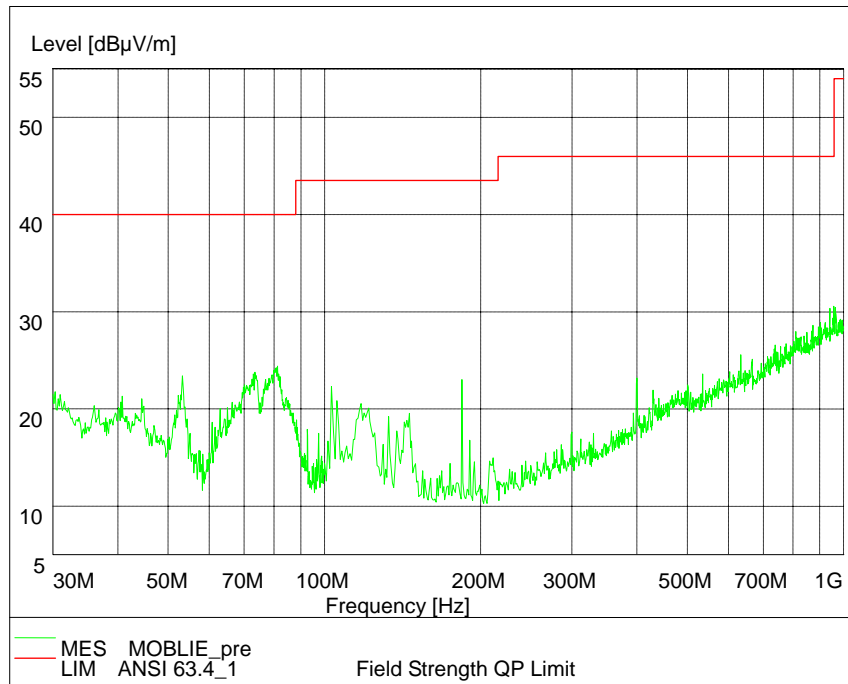

MP3/MP4 (30MHz – 1GHz)

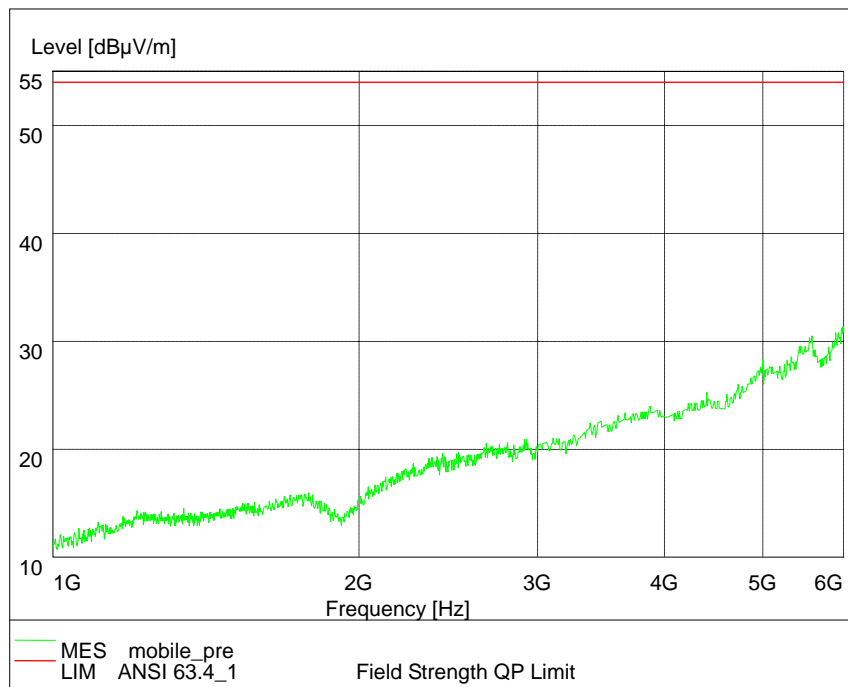

MP3/MP4 (1GHz – 6GHz)

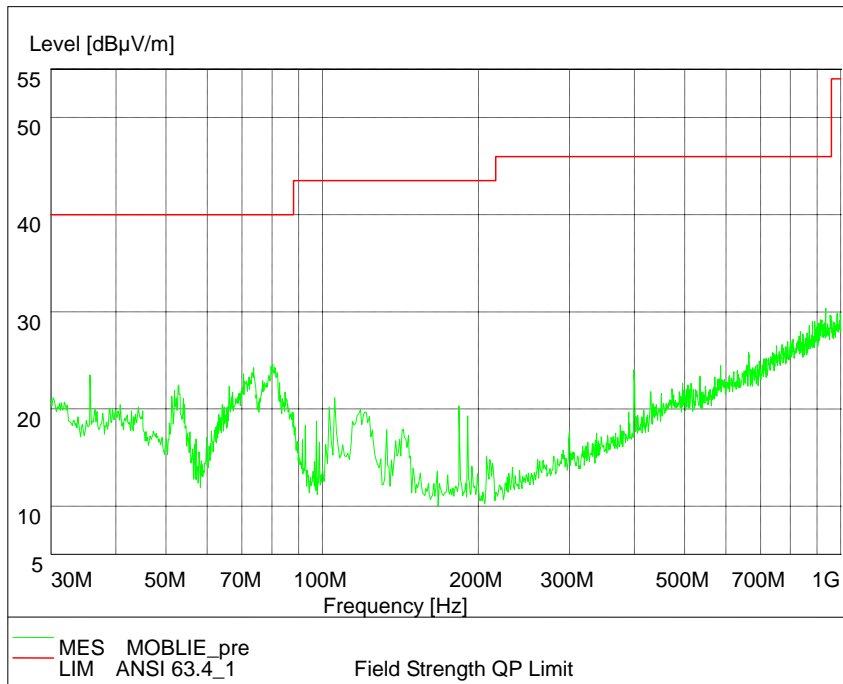

Camera (30MHz – 1GHz)

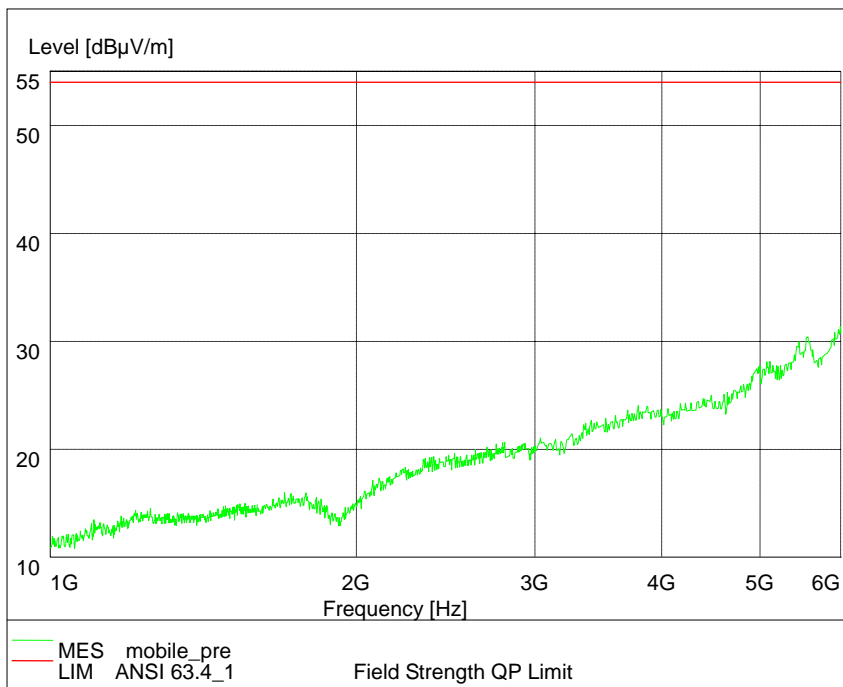

Camera (1GHz – 6GHz)

### 2.3. List of test equipments

No.	Name/Model	Manufacturer	S/N	Calibration Due Date
1	23.18m×16.88m×9.60m Semi-Anechoic Chamber	FRANKONIA	-----	19 <sup>th</sup> Aug. 2011
2	ESI 40 EMI test receiver	R&S	100015	19 <sup>th</sup> Aug. 2011
3	E5515C(8960) Mobile Station Tester	Agilent	GB44050904	19 <sup>th</sup> Aug. 2011
4	9.080m×5.255m×3.525m Shielding room	FRANKONIA	-----	19 <sup>th</sup> Aug. 2011
5	ESCS30 EMI test receiver	R&S	100029	19 <sup>th</sup> Aug. 2011
6	HL562 Ultra log test antenna	R&S	100016	19 <sup>th</sup> Aug. 2011
7	ESH3-Z2 Pulse limiter	R&S	10002	19 <sup>th</sup> Aug. 2011
8	ESH3-Z5 Attenuator	R&S	100020	19 <sup>th</sup> Aug. 2011
9	ESH2Z11 LISN	R&S	50FH-020-10	19 <sup>th</sup> Aug. 2011
10	HF 906 Double-Ridged Waveguide Horn Antenna	R&S	100030	19 <sup>th</sup> Aug. 2011
11	HF 906 Double-Ridged Waveguide Horn Antenna	R&S	100029	19 <sup>th</sup> Aug. 2011
12	PS2000 Turn Table	FRANKONIA	-----	19 <sup>th</sup> Aug. 2011
13	MA260 Antenna Master	FRANKONIA	-----	19 <sup>th</sup> Aug. 2011
14	ES-K1EMI test software	R&S	-----	19 <sup>th</sup> Aug. 2011
15	HL562 Receive antenna	R&S	100167	19 <sup>th</sup> Aug. 2011



## Appendix