



ANSI C63.19 TEST REPORT

Product Name	HSDPA/UMTS dual band / GSM four bands mobile phone
Model Name	Brandy Lite S
Marketing Name	one touch 908S
FCC ID	RAD170
IC	9238A-0002
Client	TCT Mobile Limited

TA Technology (Shanghai) Co., Ltd.



TA Technology (Shanghai) Co., Ltd.
Test Report

Report No. RZA1105-0804HAC01

Page 2 of 84

GENERAL SUMMARY

Product Name	HSDPA/UMTS dual band / GSM four bands mobile phone	Model	Brandy Lite S
FCC ID	RAD170	IC	9238A-0002
Report No.	RZA1105-0804HAC01		
Client	TCT Mobile Limited		
Manufacturer	TCT Mobile Limited		
Reference Standard(s)	ANSI C63.19-2007: American National Standard Methods of Measurement of Compatibility between Wireless Communications Devices and Hearing Aids.		
Conclusion	<p>This portable wireless equipment has been measured in all cases requested by the relevant standards.</p> <p>General Judgment: M3 (RF Emission)</p> <p style="text-align: right;">(Stamp) Date of issue: June 1st, 2011</p> 		
Comment	The test result only responds to the measured sample.		

Approved by 杨伟中
Yang Weizhong

Revised by 凌敏宝
Ling Minbao

Performed by 杜如蔚
Du Ruwei

TABLE OF CONTENT

1. General Information	4
1.1. Notes of the Test Report.....	4
1.2. Testing Laboratory	4
1.3. Applicant Information	5
1.4. Manufacturer Information.....	5
1.5. Information of EUT	6
1.6. The Ambient Conditions during Test.....	7
1.7. The Total M-rating of each tested band	7
1.8. Test Date	7
2. Test Information	8
2.1. Operational Conditions during Test.....	8
2.1.1. General Description of Test Procedures	8
2.1.2. GSM/WCDMA Test Configuration	8
2.2. HAC RF Measurements System Configuration.....	9
2.2.1. HAC Measurement Set-up.....	9
2.2.2. Probe System	10
2.2.3. Test Arch Phantom & Phone Positioner	11
2.3. RF Test Procedures.....	12
2.4. System Check.....	14
2.5. Probe Modulation Factor.....	15
2.6. Conducted Output Power Measurement.....	17
3. Test Results	18
3.1. ANSI C63.19-2007 Limits	18
3.2. Summary Test Results.....	19
4. Measurement Uncertainty	21
5. Main Test Instruments	23
ANNEX A: System Check Results.....	24
ANNEX B: Graph Results.....	28
ANNEX C: E-Probe Calibration Certificate.....	46
ANNEX D: H-Probe Calibration Certificate.....	56
ANNEX E: CD835V3 Dipole Calibration Certificate.....	66
ANNEX F: CD1880V3 Dipole Calibration Certificate.....	72
ANNEX G: DAE4 Calibration Certificate.....	78
ANNEX H: The EUT Appearances and Test Configuration.....	83

1. General Information

1.1. Notes of the Test Report

TA Technology (Shanghai) Co., Ltd. guarantees the reliability of the data presented in this test report, which is the results of measurements and tests performed for the items under test on the date and under the conditions stated in this test report and is based on the knowledge and technical facilities available at TA Technology (Shanghai) Co., Ltd. at the time of execution of the test.

TA Technology (Shanghai) Co., Ltd. is liable to the client for the maintenance by its personnel of the confidentiality of all information related to the items under test and the results of the test. This report only refers to the item that has undergone the test.

This report standalone dose not constitute or imply by its own an approval of the product by the certification Bodies or competent Authorities. This report cannot be used partially or in full for publicity and/or promotional purposes without previous written approval of **TA Technology (Shanghai) Co., Ltd.** and the Accreditation Bodies, if it applies.

If the electrical report is inconsistent with the printed one, it should be subject to the latter.

1.2. Testing Laboratory

Company: TA Technology (Shanghai) Co., Ltd.
Address: No.145, Jintang Rd, Tangzhen Industry Park, Pudong Shanghai, China
City: Shanghai
Post code: 201201
Country: P. R. China
Contact: Yang Weizhong
Telephone: +86-021-50791141/2/3
Fax: +86-021-50791141/2/3-8000
Website: <http://www.ta-shanghai.com>
E-mail: yangweizhong@ta-shanghai.com

1.3. Applicant Information

Company: TCT Mobile Limited
Address: 5F, E building, No. 232, Liang Jing Road ZhangJiang High-Tech Park, Pudong Area
Shanghai, P.R. China. 201203
City: Shanghai
Postal Code: 201203
Country: P.R. China
Contact: Gong Zhizhou
Telephone: 0086-21-6146089
Fax: 0086-21-61460602

1.4. Manufacturer Information

Company: TCT Mobile Limited
Address: 5F, E building, No. 232, Liang Jing Road ZhangJiang High-Tech Park, Pudong Area
Shanghai, P.R. China. 201203
City: Shanghai
Postal Code: 201203
Country: P.R. China
Telephone: 0086-21-6146089
Fax: 0086-21-61460602

TA Technology (Shanghai) Co., Ltd.

Test Report

Report No. RZA1105-0804HAC01

Page 6 of 84

1.5. Information of EUT

General Information

Device Type:	Portable Device		
Product Name:	HSDPA/UMTS dual band / GSM four bands mobile phone		
Brand:	ALCATEL		
IMEI:	012636000020328		
Hardware Version:	PIO		
Software Version:	V61I		
Antenna Type:	Internal Antenna		
Device Operating Configurations:			
Supporting Mode(s):	GSM 850/ GSM 1900; (tested)		
	WCDMA Band IV; (tested)		
	GSM900/GSM1800/WCDMA Band I		
	WiFi		
	Bluetooth		
Test Modulation:	(GSM)GMSK; (WCDMA) QPSK		
Device Class:	B		
HSDPA UE Category:	8		
GPRS Multislot Class(12):	Max Number of Timeslots in Uplink	4	
	Max Number of Timeslots in Downlink	4	
	Max Total Timeslot	5	
EGPRS Multislot Class(12):	Max Number of Timeslots in Uplink	4	
	Max Number of Timeslots in Downlink	4	
	Max Total Timeslot	5	
Operating Frequency Range(s):	Mode	Tx (MHz)	Rx (MHz)
	GSM 850	824.2 ~ 848.8	869.2 ~ 893.8
	GSM 1900	1850.2 ~ 1909.8	1930.2 ~ 1989.8
	WCDMA Band IV	1712.4 ~ 1752.6	2112.4 ~ 2152.2
Test Channel: (Low - Middle - High)	128-190-251	(GSM 850) (tested)	
	512-661-810	(GSM 1900) (tested)	
	1312-1413-1513	(WCDMA Band IV) (tested)	
Power Class:	GSM 850: 4, tested with power level 5		
	GSM 1900: 1, tested with power level 0		
	WCDMA Band IV: 3, tested with power control all up bits		

TA Technology (Shanghai) Co., Ltd.

Test Report

Report No. RZA1105-0804HAC01

Page 7 of 84

Auxiliary Equipment Details

AE1:Battery

Model: /
Manufacturer: BYD
S/N: CAB31P0000C1

Equipment Under Test (EUT) is a model of HSDPA/UMTS dual band / GSM four bands mobile phone. The detail about Mobile phone and Lithium Battery is in chapter 1.5 in this report. It has Personal Wireless Routers (hot spots) function. HAC is tested for GSM 850, GSM 1900 and WCDMA Band IV. The device has an internal antenna for GSM/WCDMA Tx/Rx, and the other is BT/WIFI antenna that is used for Tx/Rx.

The sample under test was selected by the Client.

Components list please refer to documents of the manufacturer.

1.6. The Ambient Conditions during Test

Temperature	Min. = 18°C, Max. = 28 °C
Relative humidity	Min. = 0%, Max. = 80%
Ground system resistance	< 0.5 Ω
Ambient noise is checked and found very low and in compliance with requirement of standards. Reflection of surrounding objects is minimized and in compliance with requirement of standards.	

1.7. The Total M-rating of each tested band

Mode	Rating
GSM 850	M3
GSM 1900	M3
WCDMA Band IV	M4

1.8. Test Date

The test is performed on May 31, 2011.

2. Test Information

2.1. Operational Conditions during Test

2.1.1. General Description of Test Procedures

The phone was tested in all normal configurations for the ear use. The EUT is mounted in the device holder equivalent as for classic dosimeter measurements. The acoustic output of the EUT shall coincide with the center point of the area formed by the dielectric wire and the middle bar of the arch's top frame. The EUT shall be moved vertically upwards until it touches the frame. The fine adjustment is possible by sliding the complete. The EUT holder is on the yellow base plate of the Test Arch phantom. These test configurations are tested at the high, middle and low frequency channels of each applicable operating mode; for example, GSM, WCDMA (UMTS), CDMA and TDMA.

2.1.2. GSM/WCDMA Test Configuration

A communication link is set up with a System Simulator (SS) by air link, and a call is established. The Absolute Radiofrequency Channel Number (ARFCN) is allocated to 128, 190 and 251 in the case of GSM 850, to 512, 661 and 810 in the case of GSM 1900, to 1312, 1413 and 1513 in the case of WCDMA Band IV. The EUT is commanded to operate at maximum transmitting power. Using E5515C the power level is set to "5" in SAR of GSM 850, set to "0" in SAR of GSM 1900. Set to all "1's" for WCDMA. The test in the band of GSM 850/1900 and WCDMA Band IV are performed in the mode of speech transfer function.

2.2. HAC RF Measurements System Configuration

2.2.1. HAC Measurement Set-up

These measurements are performed using the DASY4 automated dosimetric assessment system. It is made by Schmid & Partner Engineering AG (SPEAG) in Zurich, Switzerland. It consists of high precision robotics system (Stäubli), robot controller, Intel Core2 computer, near-field probe, probe alignment sensor. The robot is a six-axis industrial robot performing precise movements. Cell controller systems contain the power supply, robot controller, teach pendant (Joystick) and remote control, and are used to drive the robot motors. The Stäubli Robot is connected to the cell controller to allow software manipulation of the robot. A data acquisition electronic (DAE) circuit performs the signal amplification; signal multiplexing, AD-conversion, offset measurements, mechanical surface detection, collision detection, etc. is connected to the Electro-optical coupler (EOC). The EOC performs the conversion from the optical into digital electric signal of the DAE and transfers data to the PC plug-in card.

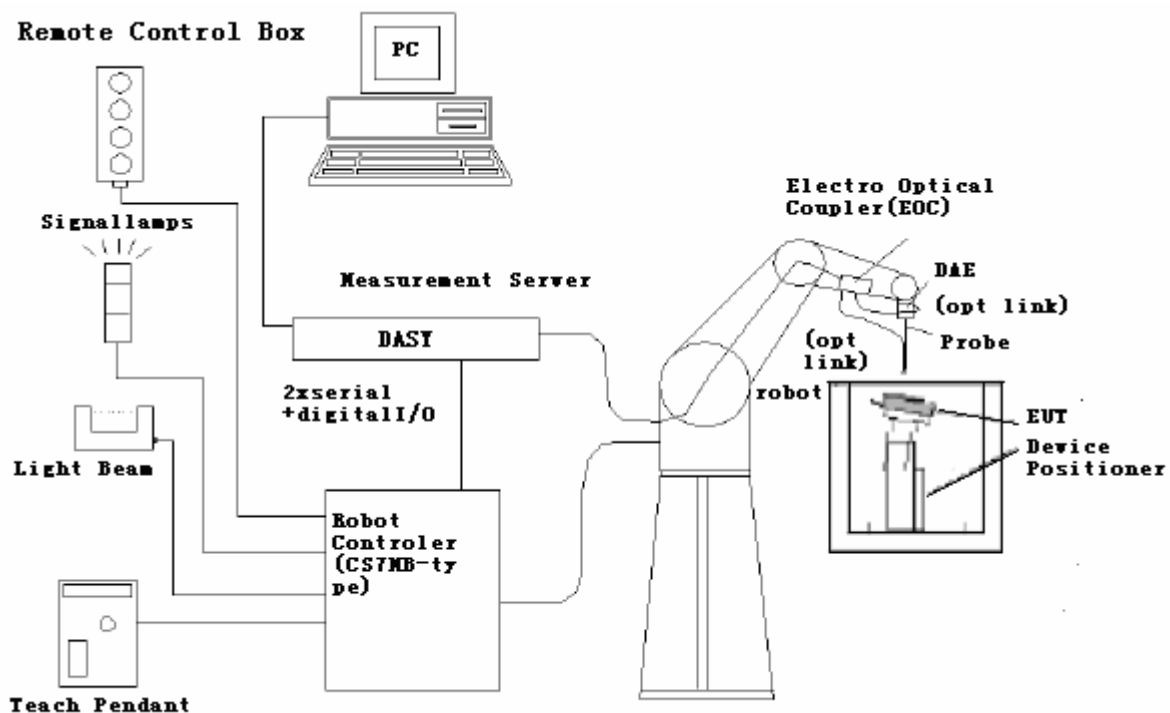

Figure 1 HAC Test Measurement Set-up

The DAE4 consists of a highly sensitive electrometer-grade preamplifier with auto-zeroing, a channel and gain-switching multiplexer, a fast 16 bit AD-converter and a command decoder and control logic unit. Transmission to the PC-card is accomplished through an optical downlink for data and status information and an optical uplink for commands and clock lines. The mechanical probe mounting device includes two different sensor systems for frontal and sidewise probe contacts. They are also used for mechanical surface detection and probe collision detection. The robot uses its own controller with a built in VME-bus computer.

2.2.2. Probe System

The HAC measurements were conducted with the E-Field Probe ER3DV6 and the H-Field Probe H3DV6 (manufactured by SPEAG), designed in the classical triangular configuration and optimized for dosimetric evaluation.

E-Field Probe Description

Construction	One dipole parallel, two dipoles normal to probe axis Built-in shielding against static charges PEEK enclosure material
Calibration	In air from 100 MHz to 3.0 GHz (absolute accuracy $\pm 6.0\%$, $k=2$)
Frequency	40 MHz to > 6 GHz (can be extended to < 20 MHz) Linearity: ± 0.2 dB (100 MHz to 3 GHz)
Directivity	± 0.2 dB in air (rotation around probe axis) ± 0.4 dB in air (rotation normal to probe axis)
Dynamic Range	2 V/m to > 1000 V/m; Linearity: ± 0.2 dB
Dimensions	Overall length: 330 mm (Tip: 16 mm) Tip diameter: 8 mm (Body: 12 mm) Distance from probe tip to dipole centers: 2.5 mm
Application	General near-field measurements up to 6 GHz Field component measurements Fast automatic scanning in phantoms



Figure 2 ER3DV6 E-field Probe

H-Field Probe Description

Construction	Three concentric loop sensors with 3.8 mm loop diameters Resistively loaded detector diodes for linear response Built-in shielding against static charges PEEK enclosure material (resistant to organic solvents, e.g., glycolether)
Frequency	200 MHz to 3 GHz (absolute accuracy $\pm 6.0\%$, $k=2$); Output linearized
Directivity	± 0.2 dB (spherical isotropy error)
Dynamic Range	10 mA/m to 2 A/m at 1 GHz
E-Field Interference	< 10% at 3 GHz (for plane wave)
Dimensions	Overall length: 330 mm (Tip: 40 mm) Tip diameter: 6 mm (Body: 12 mm) Distance from probe tip to dipole centers: 3 mm



Figure 3 H3DV6 H-field Probe

Application General magnetic near-field measurements up to 3 GHz (in air or liquids)
Field component measurements
Surface current measurements
Low interaction with the measured field

2.2.3. Test Arch Phantom & Phone Positioner

The Test Arch phantom should be positioned horizontally on a stable surface. Reference markings on the Phantom allow the complete setup of all predefined phantom positions and measurement grids by manually teaching three points in the robot. It enables easy and well defined positioning of the phone and validation dipoles as well as simple teaching of the robot (Dimensions: 370 x 370 x 370 mm).

The Device reference point is set for the EUT at 6.3 mm, the Grid reference point is on the upper surface at the origin of the coordinates, and the “user point \Height Check 0.5 mm” is 0.5mm above the center, allowing verification of the gap of 0.5mm while the probe is positioned there.

The Phone Positioner supports accurate and reliable positioning of any phone with effect on near field $<\pm 0.5$ dB.

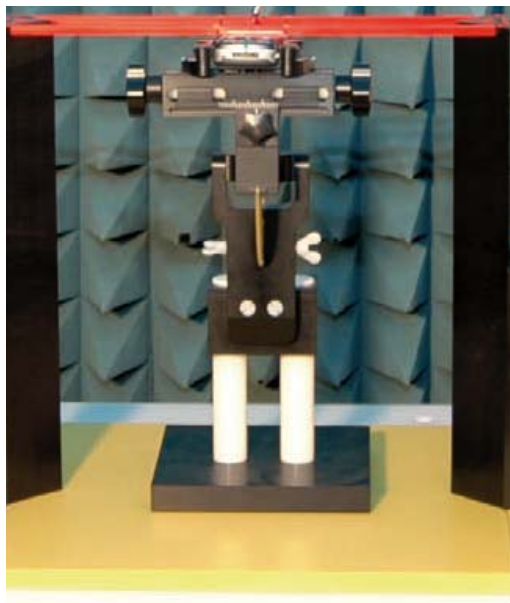

Figure 4 HAC Phantom & Device Holder

2.3. RF Test Procedures

The evaluation was performed with the following procedure:

1. Confirm proper operation of the field probe, probe measurement system and other instrumentation and the positioning system.
2. Position the WD in its intended test position. The gauge block can simplify this positioning. Note that a separate E-field and H-field gauge block will be needed if the center of the probe sensor elements is at different distances from the tip of the probe.
3. Configure the WD normal operation for maximum rated RF output power, at the desired channel and other operating parameters (e.g., test mode), as intended for the test.
4. The center sub-grid shall center on the center of the axial measurement point or the acoustic output, as appropriate. Locate the field probe at the initial test position in the 50 mm by 50 mm grid, which is contained in the measurement plane. If the field alignment method is used, align the probe for maximum field reception.
5. Record the reading.
6. Scan the entire 50 mm by 50 mm region in equally spaced increments and record the reading at each measurement point. The grid is 5 cm by 5 cm area that is divided into 9 evenly sized blocks or sub-grids. The distance between measurement points shall be sufficient to assure the identification of the maximum reading.
7. Identify the five contiguous sub-grids around the center sub-grid with the lowest maximum field strength readings. Thus the six areas to be used to determine the WD's highest emissions are identified and outlined for the final manual scan. Please note that a maximum of five blocks can be excluded for both E-field and H-field measurements for the WD output being measured. Stated another way, the center sub-grid and three others must be common to both the E-field and H-field measurements.
8. Identify the maximum field reading within the non-excluded sub-grids identified in Step 7.
9. Convert the maximum field strength reading identified in Step 8 to V/m or A/m, as appropriate. For probes which require a probe modulation factor, this conversion shall be done using the appropriate probe modulation factor and the calibration.
10. Repeat Step 1 through Step 10 for both the E-field and H-field measurements.
11. Compare this reading to the categories in ANSI C63.19 Clause 7 and record the resulting category. The lowest category number listed in 7.2, Table 7.4, or Table 7.5 obtained in Step 10 for either E- or H-field determines the M category for the audio coupling mode assessment. Record the WD category rating.



Figure 5 WD reference and plane for RF emission measurements

2.4. System Check

Validation Procedure

Place a dipole antenna meeting the requirements given in ANSI C63.19 D.5 in the position normally occupied by the WD. The dipole antenna serves as a known source for an electrical and magnetic output. Position the E-field and H-field probes so that:

The probes and their cables are parallel to the coaxial feed of the dipole antenna.

The probe cables and the coaxial feed of the dipole antenna approach the measurement area from opposite directions.

The center point of the probe element(s) are 10 mm from the closest surface of the dipole elements. Validation was performed to verify that measured E-field and H-field values are within +/-25% from the target reference values provided by the manufacturer. "Values within +/-25% are acceptable. Of which 12% is deviation and 13% is measurement uncertainty."

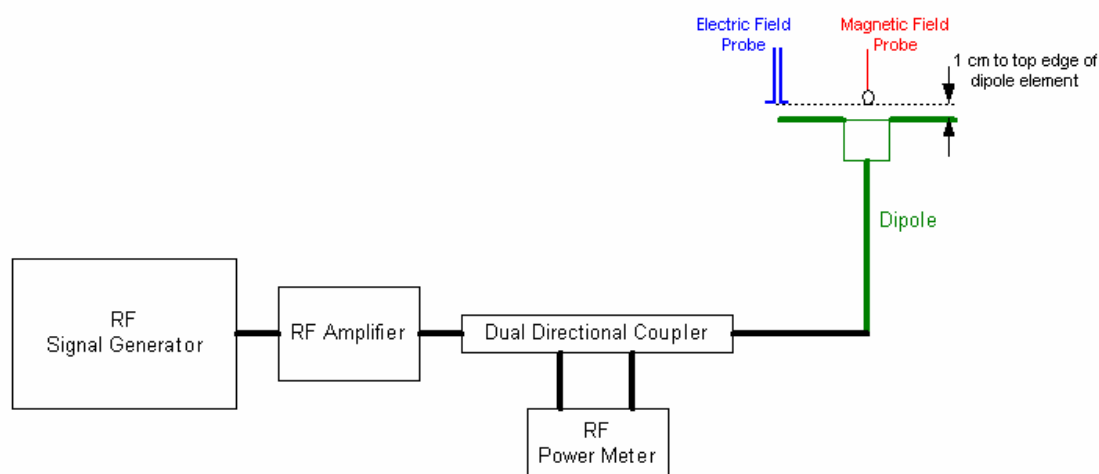

Figure 6 Dipole Validation Setup

Dipole Measurement Summary

E-Field Scan						
Mode	Frequency (MHz)	Input Power (mW)	Measured ¹ Value(V/m)	Target ² Value(V/m)	Deviation ³ (%)	Test Date
CW	835	100	149.2	158.2	5.69	May 31, 2011
CW	1880	100	131.4	142.9	8.05	May 31, 2011
H-Field Scan						
Mode	Frequency (MHz)	Input Power (mW)	Measured ¹ Value(V/m)	Target ² Value(V/m)	Deviation ³ (%)	Test Date
CW	835	100	0.443	0.446	0.67	May 31, 2011
CW	1880	100	0.449	0.475	5.47	May 31, 2011

Notes: 1. please refer to the attachment for detailed measurement data and plot.

2. Target value is provided by SPEAD in the calibration certificate of specific dipoles.

3. Deviation (%) = 100 * (Target value minus Measured value) divided by Target value.

2.5. Probe Modulation Factor

The Probe Modulation Factor (PMF) is defined as the ratio of the field readings for a CW and a modulated signal with the equivalent Field Envelope Peak as defined in ANSI C63.19 (Chapter C.3.1). Calibration shall be made of the modulation response of the probe and its instrumentation chain. This Calibration shall be performed with the field probe, attached to the instrumentation that is to be used with it during the measurement. The response of the probe system to a CW field at the frequency(s) of interest is compared to its response to a modulated signal with equal peak amplitude. The field level of the test signals shall be more than 10dB above the ambient level and the noise floor of the instrumentation being used. The ratio of the CW reading to that taken with a modulated field shall be applied to the readings taken of modulated fields of the specified type.

Modulation Factor Test Procedure

This may be done using the following procedure:

1. Fix the field probe in a set location relative to a field generating device, such as the reference dipole antenna.
2. Illuminate the probe using the wireless device connected to the reference dipole with a test signal at the intended measurement frequency, Ensure there is sufficient field coupling between the probe and the antenna so the resulting reading is greater than 10 dB above the probe system noise floor but within the systems operating range.
3. Record the amplitude applied to the antenna during transmission and the field strength measured by the E-field probe located near the tip of the dipole antenna
4. Replace the wireless device with an RF signal generator producing an unmodulated CW signal and set to the wireless device operating frequency.
5. Set the amplitude of the unmodulated signal to equal that recorded from the wireless device.
6. Record the reading of the probe measurement system of the unmodulated signal.
7. The ratio, in linear units, of the probe reading in Step 6 to the reading in Step 3 is the E-field modulation factor. $PMF_E = E_{CW} / E_{mod}$ ($PMF_H = H_{CW} / H_{mod}$)
8. Repeat the previous steps using the H-field probe, except locate the probe at the center of the dipole.

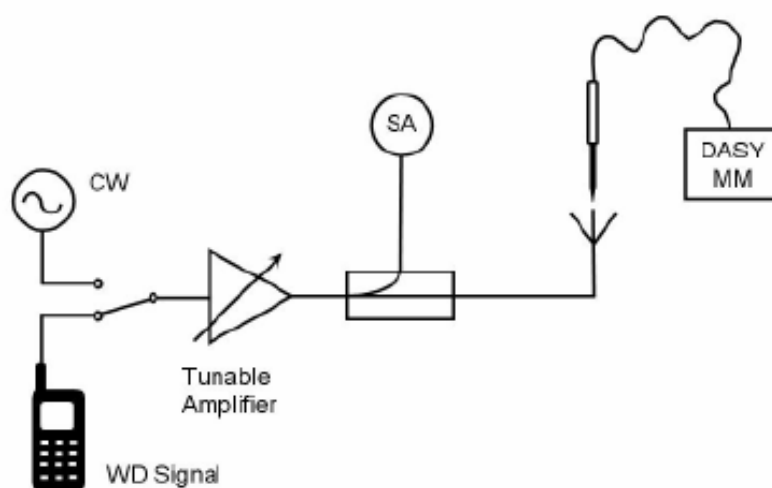

Figure 7 Probe Modulation Factor Test Setup

TA Technology (Shanghai) Co., Ltd.
Test Report

Report No. RZA1105-0804HAC01

Page 16 of 84

PMF

Band	E-Field Probe Modulation Factor	H-Field Probe Modulation Factor
GSM 850	2.81	2.75
GSM 1900	2.84	2.84
WCDMA Band IV	1.02	1.01

2.6. Conducted Output Power Measurement

Summary

The DUT is tested using an E5515C communications tester as controller unit to set test channels and maximum output power to the DUT, as well as for measuring the conducted power. Conducted output power was measured using an integrated RF connector and attached RF cable. This result contains conducted output power for the EUT.

Conducted Power Results

GSM 850	Conducted Power(dBm)		
	Channel 128	Channel 190	Channel 251
Test Results	31.69	31.63	31.55
GSM 1900	Conducted Power(dBm)		
	Channel 512	Channel 661	Channel 810
Test Results	28.62	28.71	28.58
WCDMA Band IV	Conducted Power(dBm)		
	Channel 1312	Channel 1413	Channel 1513
Test Results	22.78	22.55	22.88

TA Technology (Shanghai) Co., Ltd.
Test Report

3. Test Results

3.1. ANSI C63.19-2007 Limits

Category		Telephone RF parameters < 960 MHz			
Near field	AWF	E-field emissions		H-field emissions	
Category M1/T1	0	631.0 to 1122.0	V/m	1.91 to 3.39	A/m
	-5	473.2 to 841.4	V/m	1.43 to 2.54	A/m
Category M2/T2	0	354.8 to 631.0	V/m	1.07 to 1.91	A/m
	-5	266.1 to 473.2	V/m	0.80 to 1.43	A/m
Category M3/T3	0	199.5 to 354.8	V/m	0.60 to 1.07	A/m
	-5	149.6 to 266.1	V/m	0.45 to 0.80	A/m
Category M4/T4	0	< 199.5	V/m	< 0.60	A/m
	-5	< 149.6	V/m	< 0.45	A/m
Category		Telephone RF parameters > 960 MHz			
Near field	AWF	E-field emissions		H-field emissions	
Category M1/T1	0	199.5 to 354.8	V/m	0.60 to 1.07	A/m
	-5	149.6 to 266.1	V/m	0.45 to 0.80	A/m
Category M2/T2	0	112.2 to 199.5	V/m	0.34 to 0.60	A/m
	-5	84.1 to 149.6	V/m	0.25 to 0.45	A/m
Category M3/T3	0	63.1 to 112.2	V/m	0.19 to 0.34	A/m
	-5	47.3 to 84.1	V/m	0.14 to 0.25	A/m
Category M4/T4	0	< 63.1	V/m	< 0.19	A/m
	-5	< 47.3	V/m	< 0.14	A/m

TA Technology (Shanghai) Co., Ltd.
Test Report

3.2. Summary Test Results

GSM 850 Results

E-Field					
Channel	Frequency (MHz)	Peak Field (V/m)	Power Drift (dB)	Rating	Graph Results
High/251	848.8	158.600	-0.039	M3	Figure 12
Middle/190	836.6	160.100	0.024	M3	Figure 13
Low/128	824.2	166.700	0.056	M3	Figure 14
H-Field					
Channel	Frequency (MHz)	Peak Field (A/m)	Power Drift (dB)	Rating	Graph Results
High/251	848.8	0.235	0.076	M4	Figure 15
Middle/190	836.6	0.231	-0.045	M4	Figure 16
Low/128	824.2	0.232	0.002	M4	Figure 17

GSM 1900 Results

E-Field					
Channel	Frequency (MHz)	Peak Field (V/m)	Power Drift (dB)	Rating	Graph Results
High/810	1909.8	73.700	0.017	M3	Figure 18
Middle/661	1880	73.800	-0.005	M3	Figure 19
Low/512	1850.2	78.500	0.163	M3	Figure 20
H-Field					
Channel	Frequency (MHz)	Peak Field (A/m)	Power Drift (dB)	Rating	Graph Results
High/810	1909.8	0.205	0.020	M3	Figure 21
Middle/661	1880	0.203	-0.001	M3	Figure 22
Low/512	1850.2	0.201	0.022	M3	Figure 23

TA Technology (Shanghai) Co., Ltd.
Test Report

Report No. RZA1105-0804HAC01

Page 20 of 84

WCDMA Band IV Results

WCDMA Band V E-Field					
Channel	Frequency (MHz)	Peak Field (V/m)	Power Drift (dB)	Rating	Graph Results
High/1513	1752.6	42.900	-0.003	M4	Figure 24
Middle/1413	1732.6	50.600	0.092	M4	Figure 25
Low/1312	1712.4	44.800	-0.003	M4	Figure 26
WCDMA Band V H-Field					
Channel	Frequency (MHz)	Peak Field (A/m)	Power Drift (dB)	Rating	Graph Results
High/1513	1752.6	0.109	0.085	M4	Figure 27
Middle/1413	1732.6	0.129	-0.028	M4	Figure 28
Low/1312	1712.4	0.112	0.173	M4	Figure 29

TA Technology (Shanghai) Co., Ltd.
Test Report

Report No. RZA1105-0804HAC01

Page 21 of 84

4. Measurement Uncertainty

No.	Error source	Type	Uncertainty Value (%)	Prob. Dist.	k	c_{iE}	c_{iH}	Standard Uncertainty (%) u_i (%) E	Standard Uncertainty (%) u_i (%) H	Degree of freedom V_{eff} or v_i
Measurement System										
1	Probe Calibration	B	5.	N	1	1	1	5.1	5.1	∞
2	Axial Isotropy	B	4.7	R	$\sqrt{3}$	1	1	2.7	2.7	∞
3	Sensor Displacement	B	16.5	R	$\sqrt{3}$	1	0.145	9.5	1.4	∞
4	Boundary Effects	B	2.4	R	$\sqrt{3}$	1	1	1.4	1.4	∞
5	Linearity	B	4.7	R	$\sqrt{3}$	1	1	2.7	2.7	∞
6	Scaling to Peak Envelope Power	B	2.0	R	$\sqrt{3}$	1	1	1.2	1.2	∞
7	System Detection Limit	B	1.0	R	$\sqrt{3}$	1	1	0.6	0.6	∞
8	Readout Electronics	B	0.3	N	1	1	1	0.3	0.3	∞
9	Response Time	B	0.8	R	$\sqrt{3}$	1	1	0.5	0.5	∞
10	Integration Time	B	2.6	R	$\sqrt{3}$	1	1	1.5	1.5	∞
11	RF Ambient Conditions	B	3.0	R	$\sqrt{3}$	1	1	1.7	1.7	∞
12	RF Reflections	B	12.0	R	$\sqrt{3}$	1	1	6.9	6.9	∞
13	Probe Positioner	B	1.2	R	$\sqrt{3}$	1	0.67	0.7	0.5	∞
14	Probe Positioning	A	4.7	R	$\sqrt{3}$	1	0.67	2.7	1.8	∞
15	Extra. And Interpolation	B	1.0	R	$\sqrt{3}$	1	1	0.6	0.6	∞
Test Sample Related										
16	Device Positioning Vertical	B	4.7	R	$\sqrt{3}$	1	0.67	2.7	1.8	∞
17	Device Positioning Lateral	B	1.0	R	$\sqrt{3}$	1	1	0.6	0.6	∞
18	Device Holder and Phantom	B	2.4	R	$\sqrt{3}$	1	1	1.4	1.4	∞

TA Technology (Shanghai) Co., Ltd.
Test Report

Report No. RZA1105-0804HAC01

Page 22 of 84

19	Power Drift	B	5.0	R	$\sqrt{3}$	1	1	2.9	2.9	∞
Phantom and Setup related										
20s	Phantom Thickness	B	2.4	R	$\sqrt{3}$	1	0.67	1.4	0.9	∞
Combined standard uncertainty(%)								14.7	10.9	
Expanded uncertainty (confidence interval of 95 %)		$u_e = 2u_c$		N	k=2			29.4	21.8	

TA Technology (Shanghai) Co., Ltd.
Test Report

Report No. RZA1105-0804HAC01

Page 23 of 84

5. Main Test Instruments

No.	Name	Type	Serial Number	Calibration Date	Valid Period
01	Power meter	Agilent E4417A	GB41291714	March 12, 2011	One year
02	Power sensor	Agilent N8481H	MY50350004	September 26, 2010	One year
03	Signal Generator	HP 8341B	2730A00804	September 13, 2010	One year
04	Amplifier	IXA-020	0401	No Calibration Requested	
05	BTS	E5515C	MY48360988	December 3, 2010	One year
06	E-Field Probe	ER3DV6	2428	October 20, 2009	Two years
07	H-Field Probe	H3DV6	6260	October 20, 2009	Two years
08	DAE	DAE4	871	November 18, 2010	One year
09	Validation Kit 835MHz	CD835V3	1133	April 22, 2009	Three years
10	Validation Kit 1880MHz	CD1880V3	1135	January 13, 2010	Three years

*****END OF REPORT BODY*****

TA Technology (Shanghai) Co., Ltd. Test Report

ANNEX A: System Check Results

HAC_System Performance Check at 835MHz_E

DUT: Dipole 835 MHz; Type: CD835V3; SN:1133

Date/Time: 5/31/2011 11:45:32 AM

Communication System: CW; Frequency: 835 MHz; Duty Cycle: 1:1

Medium parameters used: $\sigma = 0$ mho/m, $\epsilon_r = 1$; $\rho = 1000$ kg/m³

Ambient Temperature: 22.3 °C Liquid Temperature: 21.5 °C

Phantom section: RF Section

DASY4 Configuration:

Probe: ER3DV6 - SN2428; ConvF(1, 1, 1); Calibrated: 10/20/2009

Electronics: DAE4 Sn871; Calibrated: 11/18/2010

Phantom: HAC Test Arch; Type: SD HAC P01 BA;

Measurement SW: DASY4, V4.7 Build 80; Postprocessing SW: SEMCAD, V1.8 Build 186

E Scan - measurement distance from the probe sensor center to CD835 Dipole = 10mm/Hearing Aid Compatibility Test (41x361x1): Measurement grid: dx=5mm, dy=5mm

Maximum value of peak Total field = 149.2 V/m

Probe Modulation Factor = 1.00

Device Reference Point: 0.000, 0.000, -6.30 mm

Reference Value = 100.7 V/m; Power Drift = -0.066 dB

Hearing Aid Near-Field Category: M4 (AWF 0 dB)

Peak E-field in V/m

Grid 1 147.0 M4	Grid 2 149.2 M4	Grid 3 143.9 M4
Grid 4 83.4 M4	Grid 5 85.0 M4	Grid 6 81.1 M4
Grid 7 148.8 M4	Grid 8 154.0 M4	Grid 9 148.9 M4

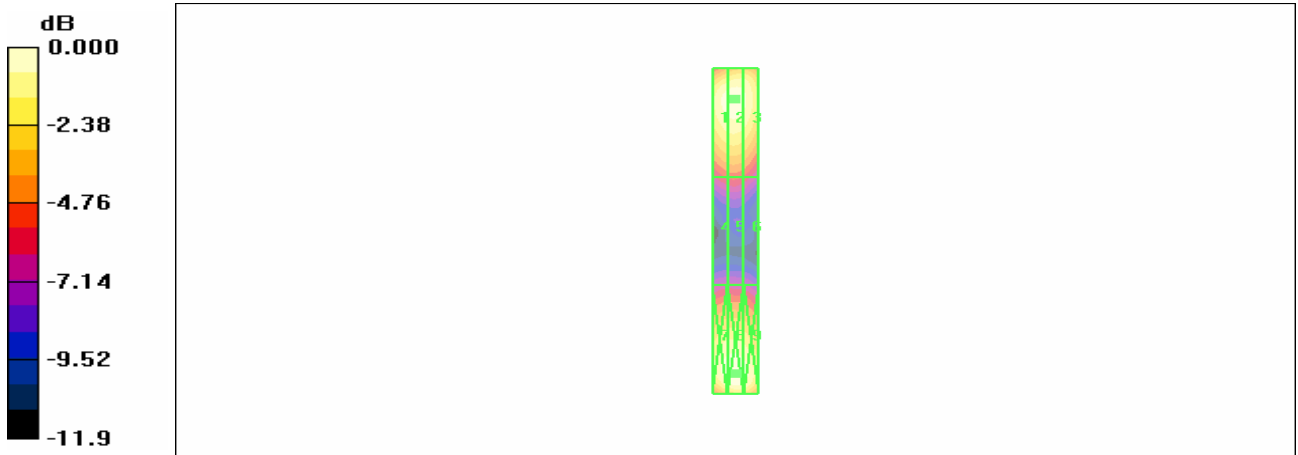

0 dB = 154.0V/m

Figure 8 System Performance Check 835MHz_E

TA Technology (Shanghai) Co., Ltd.

Test Report

HAC_System Performance Check at 835MHz_H

DUT: Dipole 835 MHz; Type: CD835V3; SN: 1133

Date/Time: 5/31/2011 10:30:58 AM

Communication System: CW; Frequency: 835 MHz; Duty Cycle: 1:1

Medium parameters used: $\sigma = 0$ mho/m, $\epsilon_r = 1$; $\rho = 1$ kg/m³

Ambient Temperature: 22.3 °C Liquid Temperature: 21.5 °C

Phantom section: RF Section

DASY4 Configuration:

Probe: H3DV6 - SN6260; Calibrated: 10/20/2009

Electronics: DAE4 Sn871; Calibrated: 11/18/2010

Phantom: HAC Test Arch; Type: SD HAC P01 BA;

Measurement SW: DASY4, V4.7 Build 80; Postprocessing SW: SEMCAD, V1.8 Build 186

H Scan - measurement distance from the probe sensor center to CD835 Dipole = 10mm/Hearing Aid Compatibility Test (41x361x1): Measurement grid: dx=5mm, dy=5mm

Maximum value of peak Total field = 0.443 A/m

Probe Modulation Factor = 1.00

Device Reference Point: 0.000, 0.000, -6.30 mm

Reference Value = 0.464 A/m; Power Drift = 0.019 dB

Hearing Aid Near-Field Category: M4 (AWF 0 dB)

Peak H-field in A/m

Grid 1 0.391 M4	Grid 2 0.408 M4	Grid 3 0.384 M4
Grid 4 0.427 M4	Grid 5 0.443 M4	Grid 6 0.414 M4
Grid 7 0.397 M4	Grid 8 0.410 M4	Grid 9 0.381 M4

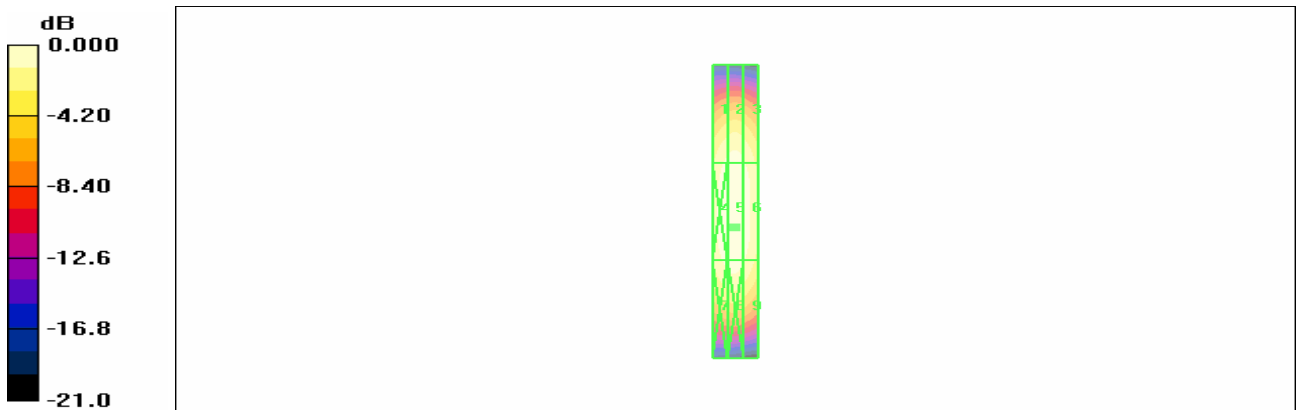

0 dB = 0.443A/m

Figure 9 System Performance Check 835MHz_H

TA Technology (Shanghai) Co., Ltd. Test Report

HAC_System Performance Check at 1880MHz_E

DUT: Dipole 1880 MHz; Type: CD1880V3; SN:1135

Date/Time: 5/31/2011 9:15:34 AM

Communication System: CW; Frequency: 1880 MHz; Duty Cycle: 1:1

Medium parameters used: $\sigma = 0$ mho/m, $\epsilon_r = 1$; $\rho = 1000$ kg/m³

Ambient Temperature: 22.3 °C Liquid Temperature: 21.5 °C

Phantom section: RF Section

DASY4 Configuration:

Probe: ER3DV6 - SN2428; ConvF(1, 1, 1); Calibrated: 10/20/2009

Electronics: DAE4 Sn871; Calibrated: 11/18/2010

Phantom: HAC Test Arch; Type: SD HAC P01 BA;

Measurement SW: DASY4, V4.7 Build 80; Postprocessing SW: SEMCAD, V1.8 Build 186

E Scan - measurement distance from the probe sensor center to CD1880 Dipole = 10mm/Hearing Aid Compatibility Test (41x181x1): Measurement grid: dx=5mm, dy=5mm

Maximum value of peak Total field = 131.4 V/m

Probe Modulation Factor = 1.00

Device Reference Point: 0.000, 0.000, -6.30 mm

Reference Value = 151.0 V/m; Power Drift = -0.047 dB

Hearing Aid Near-Field Category: M2 (AWF 0 dB)

Peak E-field in V/m

Grid 1 128.5 M2	Grid 2 131.4 M2	Grid 3 128.5 M2
Grid 4 87.5 M3	Grid 5 89.7 M3	Grid 6 86.2 M3
Grid 7 128.7 M2	Grid 8 134.0 M2	Grid 9 130.3 M2

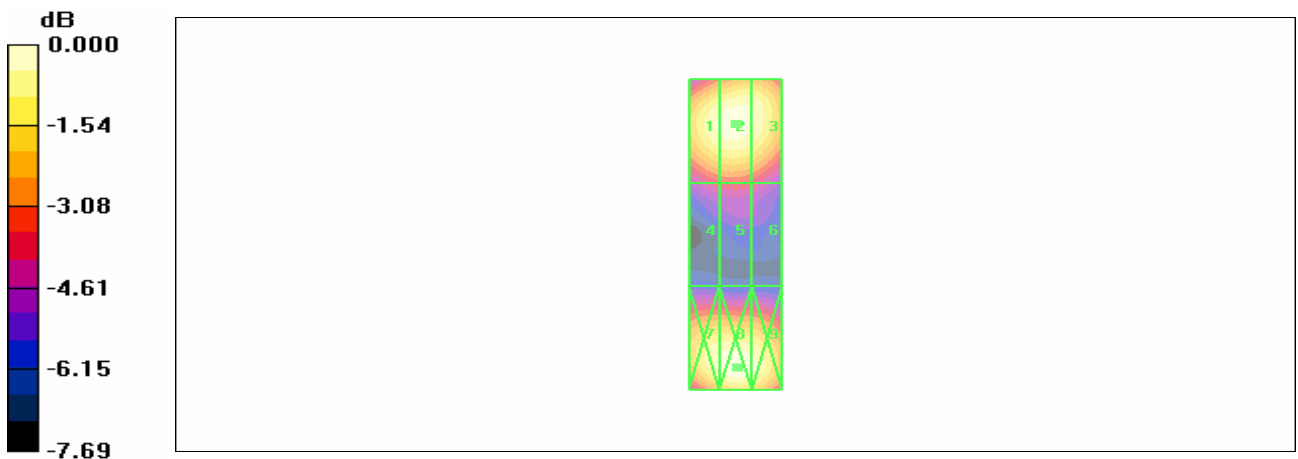

0 dB = 134.0V/m

Figure 10 System Performance Check 1880MHz_E

TA Technology (Shanghai) Co., Ltd. Test Report

HAC_System Performance Check at 1880MHz_H

DUT: Dipole 1880 MHz; Type: CD1880V3; SN:1135

Date/Time: 5/31/2011 7:55:22 AM

Communication System: CW; Frequency: 1880 MHz; Duty Cycle: 1:1

Medium parameters used: $\sigma = 0$ mho/m, $\epsilon_r = 1$; $\rho = 1$ kg/m³

Ambient Temperature: 22.3 °C Liquid Temperature: 21.5 °C

Phantom section: RF Section

DASY4 Configuration:

Probe: H3DV6 - SN6260; Calibrated: 10/20/2009

Electronics: DAE4 Sn871; Calibrated: 11/18/2010

Phantom: HAC Test Arch; Type: SD HAC P01 BA;

Measurement SW: DASY4, V4.7 Build 80; Postprocessing SW: SEMCAD, V1.8 Build 186

H Scan - measurement distance from the probe sensor center to Dipole = 10mm/Hearing Aid

Compatibility Test (41x181x1): Measurement grid: dx=5mm, dy=5mm

Maximum value of peak Total field = 0.449 A/m

Probe Modulation Factor = 1.00

Device Reference Point: 0.000, 0.000, -6.30 mm

Reference Value = 0.472 A/m; Power Drift = -0.005 dB

Hearing Aid Near-Field Category: M2 (AWF 0 dB)

Peak H-field in A/m

Grid 1	Grid 2	Grid 3
0.400 M2	0.413 M2	0.387 M2
Grid 4	Grid 5	Grid 6
0.435 M2	0.449 M2	0.422 M2
Grid 7	Grid 8	Grid 9
0.397 M2	0.410 M2	0.384 M2

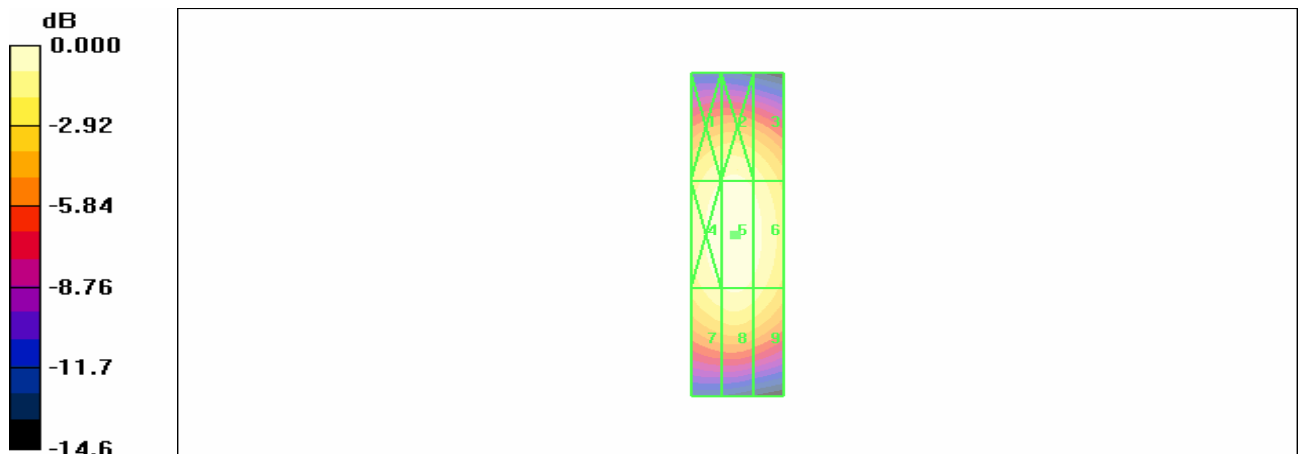

0 dB = 0.449A/m

Figure 11 System Performance Check 1880MHz_H

ANNEX B: Graph Results

HAC RF E-Field GSM 850 High

Date/Time: 5/31/2011 2:31:41 PM

Communication System: GSM 850; Frequency: 848.8 MHz; Duty Cycle: 1:8.3

Medium parameters used: $\sigma = 0$ mho/m, $\epsilon_r = 1$; $\rho = 1000$ kg/m³

Ambient Temperature: 22.3 °C Liquid Temperature: 21.5 °C

Phantom section: RF Section

DASY4 Configuration:

Probe: ER3DV6 - SN2428; ConvF(1, 1, 1); Calibrated: 10/20/2009

Electronics: DAE4 Sn871; Calibrated: 11/18/2010

Phantom: HAC Test Arch; Type: SD HAC P01 BA;

Measurement SW: DASY4, V4.7 Build 80; Postprocessing SW: SEMCAD, V1.8 Build 186

E Scan - ER3D - 2007: 15 mm from Probe Center to the Device High/Hearing Aid Compatibility Test (101x101x1): Measurement grid: dx=5mm, dy=5mm

Maximum value of peak Total field = 158.6 V/m

Probe Modulation Factor = 2.81

Device Reference Point: 0.000, 0.000, -6.30 mm

Reference Value = 73.7 V/m; Power Drift = -0.039 dB

Hearing Aid Near-Field Category: M3 (AWF -5 dB)

Peak E-field in V/m

Grid 1 140.5 M4	Grid 2 149.8 M3	Grid 3 143.5 M4
Grid 4 147.5 M4	Grid 5 158.6 M3	Grid 6 152.5 M3
Grid 7 145.7 M4	Grid 8 156.8 M3	Grid 9 150.8 M3

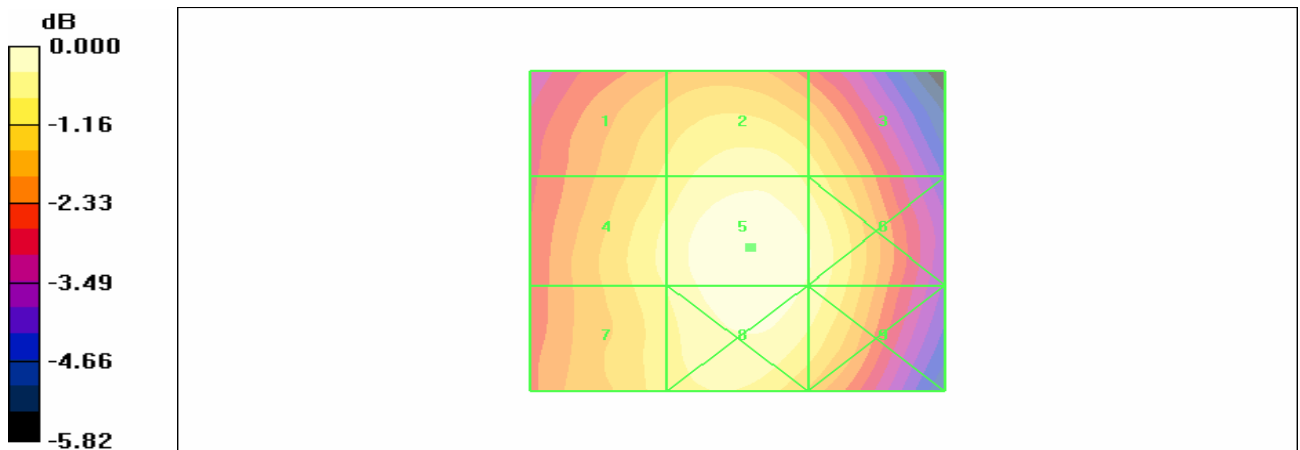

0 dB = 158.6V/m

Figure 12 HAC RF E-Field GSM 850 Channel 251

HAC RF E-Field GSM 850 Middle

Date/Time: 5/31/2011 2:36:40 PM

Communication System: GSM 850; Frequency: 836.6 MHz; Duty Cycle: 1:8.3

Medium parameters used: $\sigma = 0$ mho/m, $\epsilon_r = 1$; $\rho = 1000$ kg/m³

Ambient Temperature: 22.3 °C Liquid Temperature: 21.5 °C

Phantom section: RF Section

DASY4 Configuration:

Probe: ER3DV6 - SN2428; ConvF(1, 1, 1); Calibrated: 10/20/2009

Electronics: DAE4 Sn871; Calibrated: 11/18/2010

Phantom: HAC Test Arch; Type: SD HAC P01 BA;

Measurement SW: DASY4, V4.7 Build 80; Postprocessing SW: SEMCAD, V1.8 Build 186

E Scan - ER3D - 2007: 15 mm from Probe Center to the Device Middle/Hearing Aid

Compatibility Test (101x101x1): Measurement grid: dx=5mm, dy=5mm

Maximum value of peak Total field = 160.1 V/m

Probe Modulation Factor = 2.81

Device Reference Point: 0.000, 0.000, -6.30 mm

Reference Value = 74.1 V/m; Power Drift = 0.024 dB

Hearing Aid Near-Field Category: M3 (AWF -5 dB)

Peak E-field in V/m

Grid 1 141.4 M4	Grid 2 150.6 M3	Grid 3 144.8 M4
Grid 4 148.8 M4	Grid 5 160.1 M3	Grid 6 153.2 M3
Grid 7 146.6 M4	Grid 8 158.3 M3	Grid 9 151.6 M3

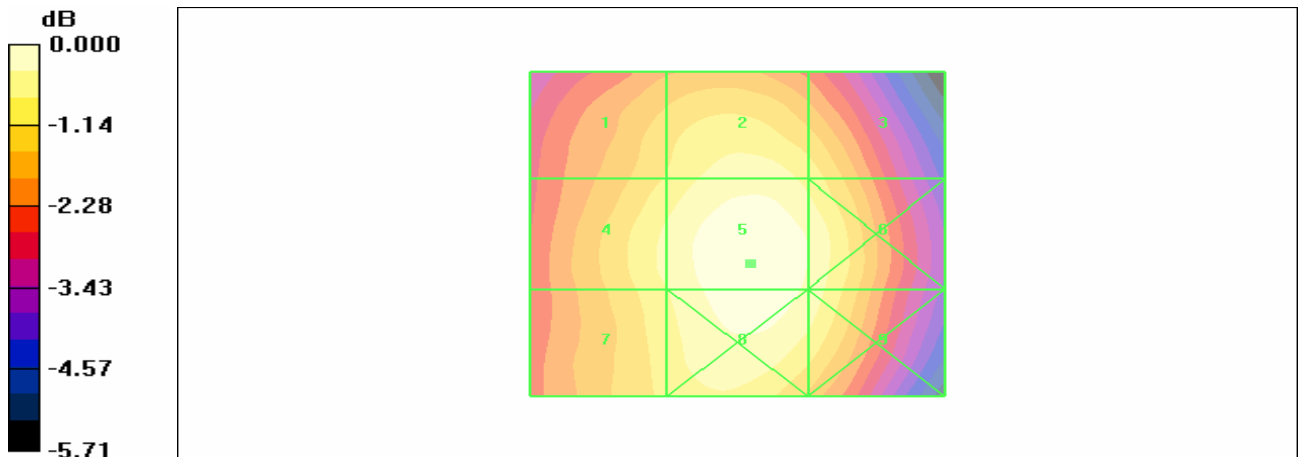

0 dB = 160.1V/m

Figure 13 HAC RF E-Field GSM 850 Channel 190

TA Technology (Shanghai) Co., Ltd. Test Report

HAC RF E-Field GSM 850 Low

Date/Time: 5/31/2011 2:49:41 PM

Communication System: GSM 850; Frequency: 824.2 MHz; Duty Cycle: 1:8.3

Medium parameters used: $\sigma = 0$ mho/m, $\epsilon_r = 1$; $\rho = 1000$ kg/m³

Ambient Temperature: 22.3 °C Liquid Temperature: 21.5 °C

Phantom section: RF Section

DASY4 Configuration:

Probe: ER3DV6 - SN2428; ConvF(1, 1, 1); Calibrated: 10/20/2009

Electronics: DAE4 Sn871; Calibrated: 11/18/2010

Phantom: HAC Test Arch; Type: SD HAC P01 BA;

Measurement SW: DASY4, V4.7 Build 80; Postprocessing SW: SEMCAD, V1.8 Build 186

E Scan - ER3D - 2007: 15 mm from Probe Center to the Device Low/Hearing Aid Compatibility Test (101x101x1): Measurement grid: dx=5mm, dy=5mm

Maximum value of peak Total field = 166.7 V/m

Probe Modulation Factor = 2.81

Device Reference Point: 0.000, 0.000, -6.30 mm

Reference Value = 76.9 V/m; Power Drift = 0.056 dB

Hearing Aid Near-Field Category: M3 (AWF -5 dB)

Peak E-field in V/m

Grid 1 147.7 M4	Grid 2 156.9 M3	Grid 3 150.8 M3
Grid 4 154.9 M3	Grid 5 166.7 M3	Grid 6 159.4 M3
Grid 7 153.2 M3	Grid 8 164.7 M3	Grid 9 158.0 M3

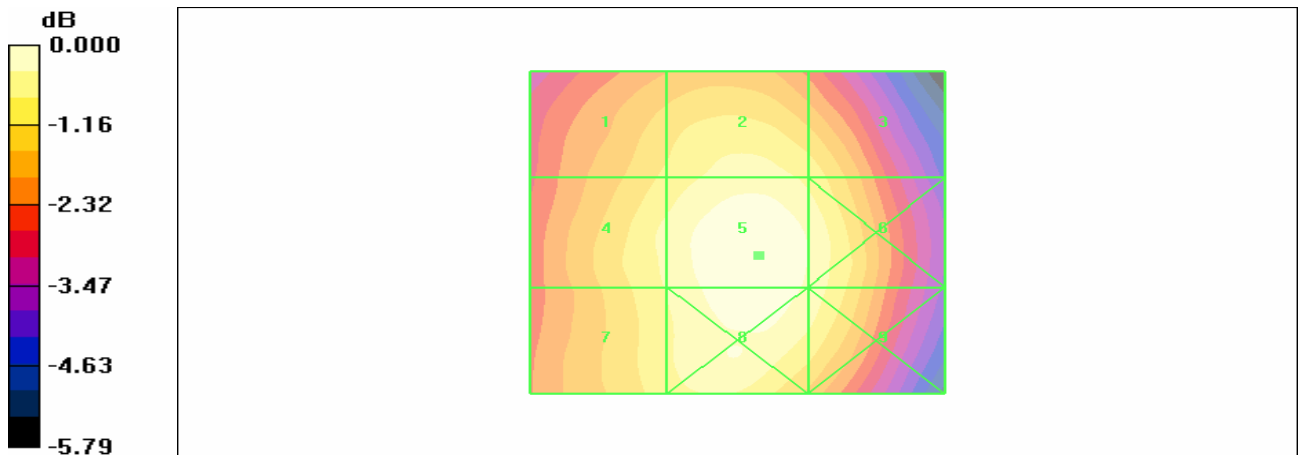

0 dB = 166.7V/m

Figure 14 HAC RF E-Field GSM 850 Channel 128

HAC RF H-Field GSM 850 High

Date/Time: 5/31/2011 1:01:54 PM

Communication System: GSM 850; Frequency: 848.8 MHz; Duty Cycle: 1:8.3

Medium parameters used: $\sigma = 0$ mho/m, $\epsilon_r = 1$; $\rho = 1$ kg/m³

Ambient Temperature: 22.3 °C Liquid Temperature: 21.5 °C

Phantom section: RF Section

DASY4 Configuration:

Probe: H3DV6 - SN6260; Calibrated: 10/20/2009

Electronics: DAE4 Sn871; Calibrated: 11/18/2010

Phantom: HAC Test Arch; Type: SD HAC P01 BA;

Measurement SW: DASY4, V4.7 Build 80; Postprocessing SW: SEMCAD, V1.8 Build 186

H Scan - H3DV6 - 2007: 15 mm from Probe Center to the Device High/Hearing Aid

Compatibility Test (101x101x1): Measurement grid: dx=5mm, dy=5mm

Maximum value of peak Total field = 0.235 A/m

Probe Modulation Factor = 2.75

Device Reference Point: 0.000, 0.000, -6.30 mm

Reference Value = 0.070 A/m; Power Drift = 0.076 dB

Hearing Aid Near-Field Category: M4 (AWF -5 dB)

Peak H-field in A/m

Grid 1 0.328 M4	Grid 2 0.235 M4	Grid 3 0.149 M4
Grid 4 0.320 M4	Grid 5 0.231 M4	Grid 6 0.142 M4
Grid 7 0.329 M4	Grid 8 0.234 M4	Grid 9 0.143 M4

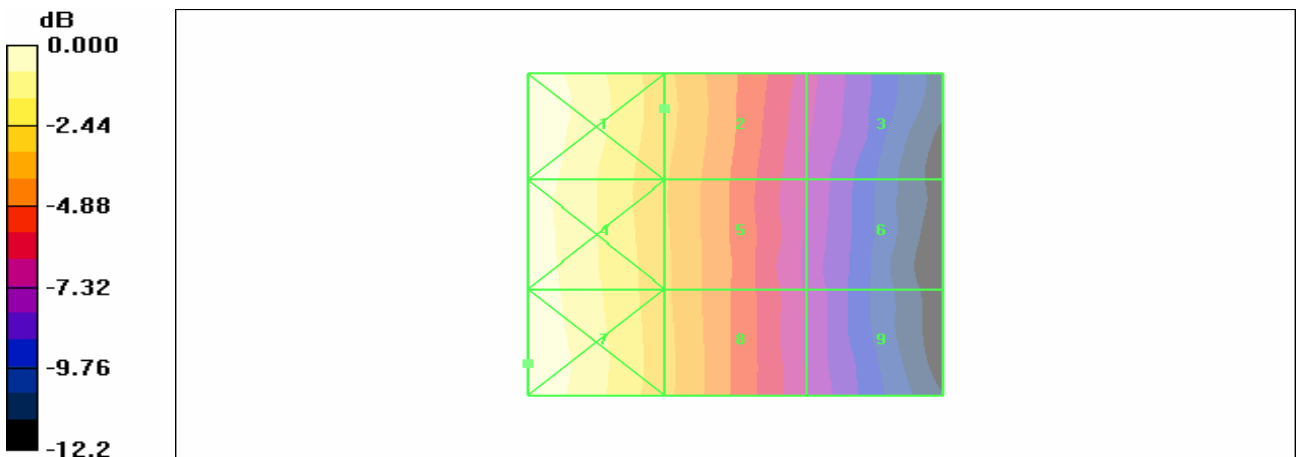

0 dB = 0.329 A/m

Figure 15 HAC RF H-Field GSM 850 Channel 251

TA Technology (Shanghai) Co., Ltd. Test Report

HAC RF H-Field GSM 850 Middle

Date/Time: 5/31/2011 1:06:46 PM

Communication System: GSM 850; Frequency: 836.6 MHz; Duty Cycle: 1:8.3

Medium parameters used: $\sigma = 0$ mho/m, $\epsilon_r = 1$; $\rho = 1$ kg/m³

Ambient Temperature: 22.3 °C Liquid Temperature: 21.5 °C

Phantom section: RF Section

DASY4 Configuration:

Probe: H3DV6 - SN6260; Calibrated: 10/20/2009

Electronics: DAE4 Sn871; Calibrated: 11/18/2010

Phantom: HAC Test Arch; Type: SD HAC P01 BA;

Measurement SW: DASY4, V4.7 Build 80; Postprocessing SW: SEMCAD, V1.8 Build 186

H Scan - H3DV6 - 2007: 15 mm from Probe Center to the Device Middle/Hearing Aid

Compatibility Test (101x101x1): Measurement grid: dx=5mm, dy=5mm

Maximum value of peak Total field = 0.231 A/m

Probe Modulation Factor = 2.75

Device Reference Point: 0.000, 0.000, -6.30 mm

Reference Value = 0.068 A/m; Power Drift = -0.045 dB

Hearing Aid Near-Field Category: M4 (AWF -5 dB)

Peak H-field in A/m

Grid 1 0.321 M4	Grid 2 0.229 M4	Grid 3 0.143 M4
Grid 4 0.312 M4	Grid 5 0.227 M4	Grid 6 0.138 M4
Grid 7 0.324 M4	Grid 8 0.231 M4	Grid 9 0.141 M4

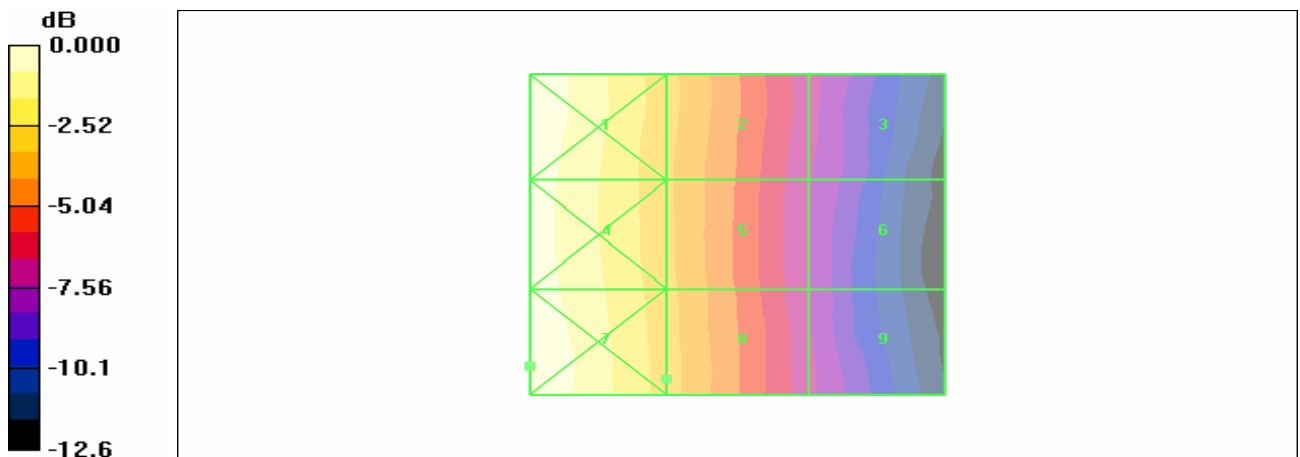

0 dB = 0.324A/m

Figure 16 HAC RF H-Field GSM 850 Channel 190

HAC RF H-Field GSM 850 Low

Date/Time: 5/31/2011 1:13:23 PM

Communication System: GSM 850; Frequency: 824.2 MHz; Duty Cycle: 1:8.3

Medium parameters used: $\sigma = 0$ mho/m, $\epsilon_r = 1$; $\rho = 1$ kg/m³

Ambient Temperature: 22.3 °C Liquid Temperature: 21.5 °C

Phantom section: RF Section

DASY4 Configuration:

Probe: H3DV6 - SN6260; Calibrated: 10/20/2009

Electronics: DAE4 Sn871; Calibrated: 11/18/2010

Phantom: HAC Test Arch; Type: SD HAC P01 BA;

Measurement SW: DASY4, V4.7 Build 80; Postprocessing SW: SEMCAD, V1.8 Build 186

H Scan - H3DV6 - 2007: 15 mm from Probe Center to the Device Low/Hearing Aid Compatibility Test (101x101x1): Measurement grid: dx=5mm, dy=5mm

Maximum value of peak Total field = 0.232 A/m

Probe Modulation Factor = 2.75

Device Reference Point: 0.000, 0.000, -6.30 mm

Reference Value = 0.068 A/m; Power Drift = 0.002 dB

Hearing Aid Near-Field Category: M4 (AWF -5 dB)

Peak H-field in A/m

Grid 1 0.325 M4	Grid 2 0.230 M4	Grid 3 0.142 M4
Grid 4 0.319 M4	Grid 5 0.227 M4	Grid 6 0.135 M4
Grid 7 0.329 M4	Grid 8 0.232 M4	Grid 9 0.140 M4

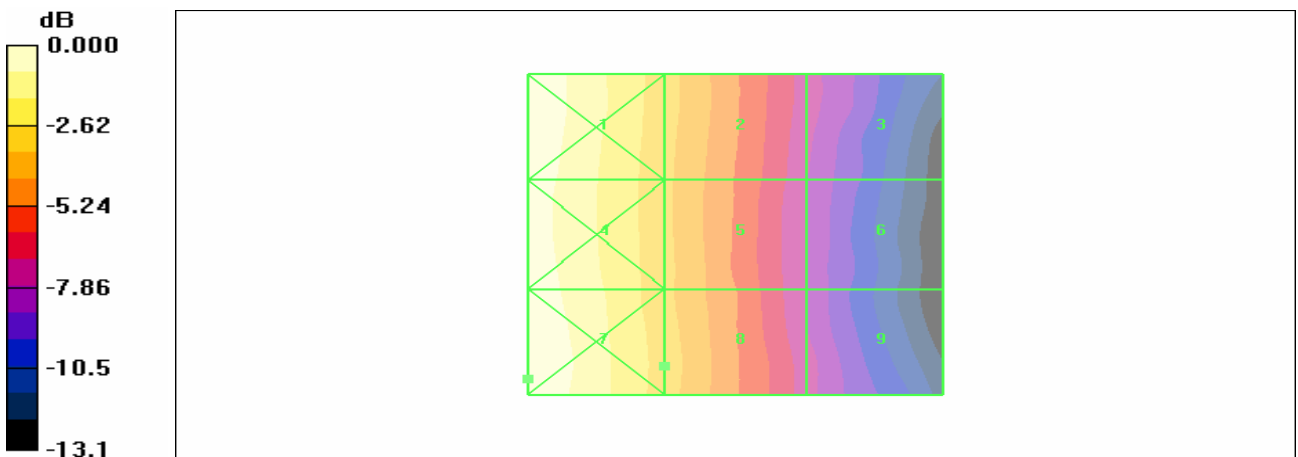

0 dB = 0.329A/m

Figure 17 HAC RF H-Field GSM 850 Channel 128

HAC RF E-Field GSM 1900 High

Date/Time: 5/31/2011 2:57:28 PM

Communication System: PCS 1900; Frequency: 1909.8 MHz; Duty Cycle: 1:8.3

Medium parameters used: $\sigma = 0$ mho/m, $\epsilon_r = 1$; $\rho = 1000$ kg/m³

Ambient Temperature: 22.3 °C Liquid Temperature: 21.5 °C

Phantom section: RF Section

DASY4 Configuration:

Probe: ER3DV6 - SN2428; ConvF(1, 1, 1); Calibrated: 10/20/2009

Electronics: DAE4 Sn871; Calibrated: 11/18/2010

Phantom: HAC Test Arch; Type: SD HAC P01 BA;

Measurement SW: DASY4, V4.7 Build 80; Postprocessing SW: SEMCAD, V1.8 Build 186

E Scan - ER3D - 2007: 15 mm from Probe Center to the Device High/Hearing Aid Compatibility Test (101x101x1): Measurement grid: dx=5mm, dy=5mm

Maximum value of peak Total field = 73.7 V/m

Probe Modulation Factor = 2.84

Device Reference Point: 0.000, 0.000, -6.30 mm

Reference Value = 27.1 V/m; Power Drift = 0.017 dB

Hearing Aid Near-Field Category: M3 (AWF -5 dB)

Peak E-field in V/m

Grid 1	Grid 2	Grid 3
57.1 M3	55.5 M3	55.5 M3
Grid 4	Grid 5	Grid 6
49.0 M3	73.7 M3	73.2 M3
Grid 7	Grid 8	Grid 9
59.6 M3	76.2 M3	74.9 M3

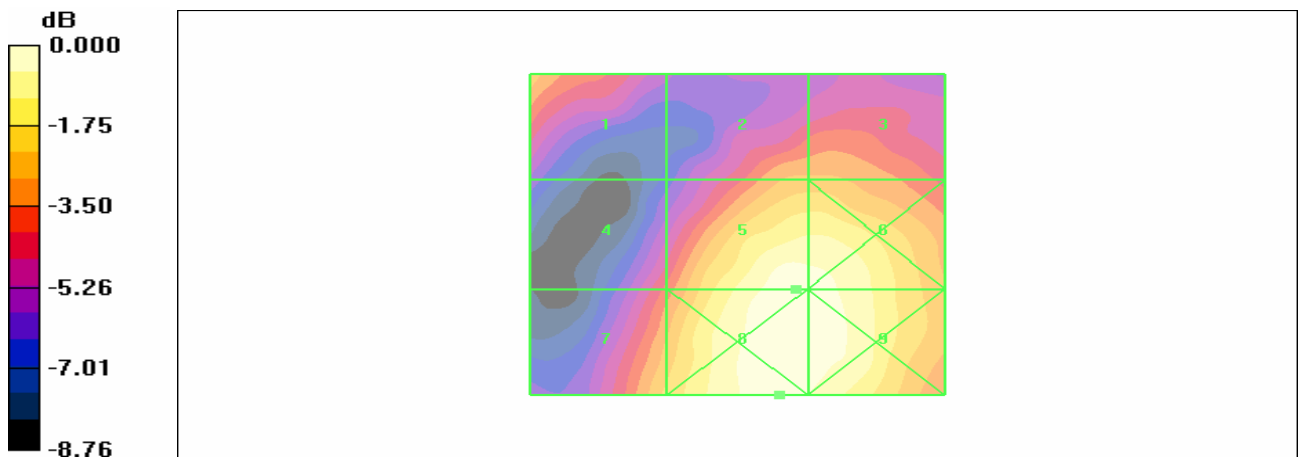

0 dB = 76.2V/m

Figure 18 HAC RF E-Field GSM 1900 Channel 810

TA Technology (Shanghai) Co., Ltd. Test Report

HAC RF E-Field GSM 1900 Middle

Date/Time: 5/31/2011 3:02:16 PM

Communication System: PCS 1900; Frequency: 1880 MHz; Duty Cycle: 1:8.3

Medium parameters used: $\sigma = 0$ mho/m, $\epsilon_r = 1$; $\rho = 1000$ kg/m³

Ambient Temperature: 22.3 °C Liquid Temperature: 21.5 °C

Phantom section: RF Section

DASY4 Configuration:

Probe: ER3DV6 - SN2428; ConvF(1, 1, 1); Calibrated: 10/20/2009

Electronics: DAE4 Sn871; Calibrated: 11/18/2010

Phantom: HAC Test Arch; Type: SD HAC P01 BA;

Measurement SW: DASY4, V4.7 Build 80; Postprocessing SW: SEMCAD, V1.8 Build 186

E Scan - ER3D - 2007: 15 mm from Probe Center to the Device Middle/Hearing Aid

Compatibility Test (101x101x1): Measurement grid: dx=5mm, dy=5mm

Maximum value of peak Total field = 73.8 V/m

Probe Modulation Factor = 2.84

Device Reference Point: 0.000, 0.000, -6.30 mm

Reference Value = 27.4 V/m; Power Drift = -0.005 dB

Hearing Aid Near-Field Category: M3 (AWF -5 dB)

Peak E-field in V/m

Grid 1	Grid 2	Grid 3
50.5 M3	53.9 M3	54.9 M3
Grid 4	Grid 5	Grid 6
51.2 M3	73.8 M3	73.2 M3
Grid 7	Grid 8	Grid 9
61.9 M3	75.1 M3	74.5 M3

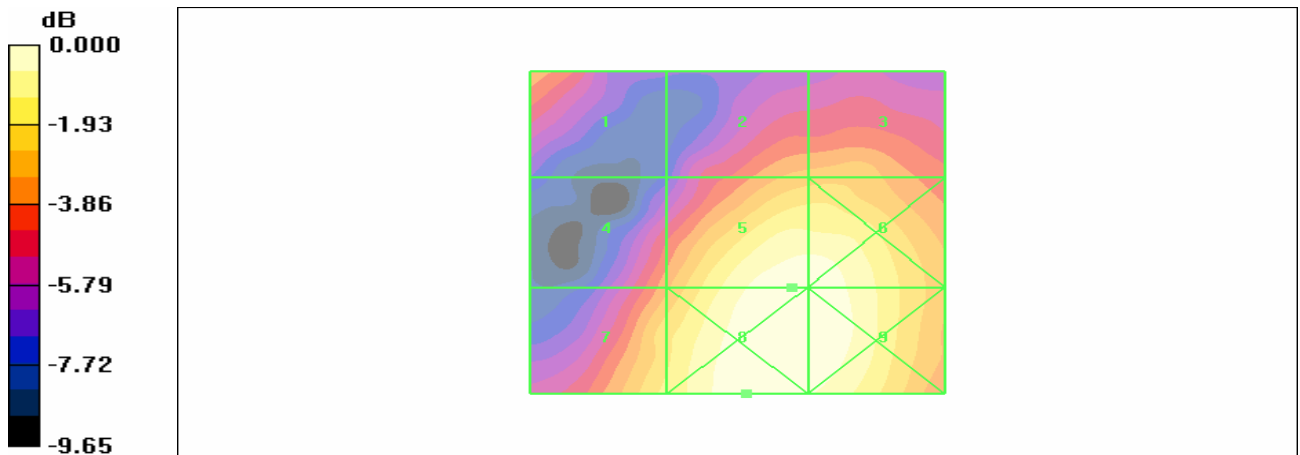

0 dB = 75.1V/m

Figure 19 HAC RF E-Field GSM 1900 Channel 661

TA Technology (Shanghai) Co., Ltd. Test Report

HAC RF E-Field GSM 1900 Low

Date/Time: 5/31/2011 3:07:07 PM

Communication System: PCS 1900; Frequency: 1850.2 MHz; Duty Cycle: 1:8.3

Medium parameters used: $\sigma = 0$ mho/m, $\epsilon_r = 1$; $\rho = 1000$ kg/m³

Ambient Temperature: 22.3 °C Liquid Temperature: 21.5 °C

Phantom section: RF Section

DASY4 Configuration:

Probe: ER3DV6 - SN2428; ConvF(1, 1, 1); Calibrated: 10/20/2009

Electronics: DAE4 Sn871; Calibrated: 11/18/2010

Phantom: HAC Test Arch; Type: SD HAC P01 BA;

Measurement SW: DASY4, V4.7 Build 80; Postprocessing SW: SEMCAD, V1.8 Build 186

E Scan - ER3D - 2007: 15 mm from Probe Center to the Device Low/Hearing Aid Compatibility Test (101x101x1): Measurement grid: dx=5mm, dy=5mm

Maximum value of peak Total field = 78.5 V/m

Probe Modulation Factor = 2.84

Device Reference Point: 0.000, 0.000, -6.30 mm

Reference Value = 29.3 V/m; Power Drift = 0.163 dB

Hearing Aid Near-Field Category: M3 (AWF -5 dB)

Peak E-field in V/m

Grid 1	Grid 2	Grid 3
50.0 M3	57.5 M3	59.1 M3
Grid 4	Grid 5	Grid 6
56.8 M3	78.5 M3	78.0 M3
Grid 7	Grid 8	Grid 9
64.9 M3	80.4 M3	78.8 M3

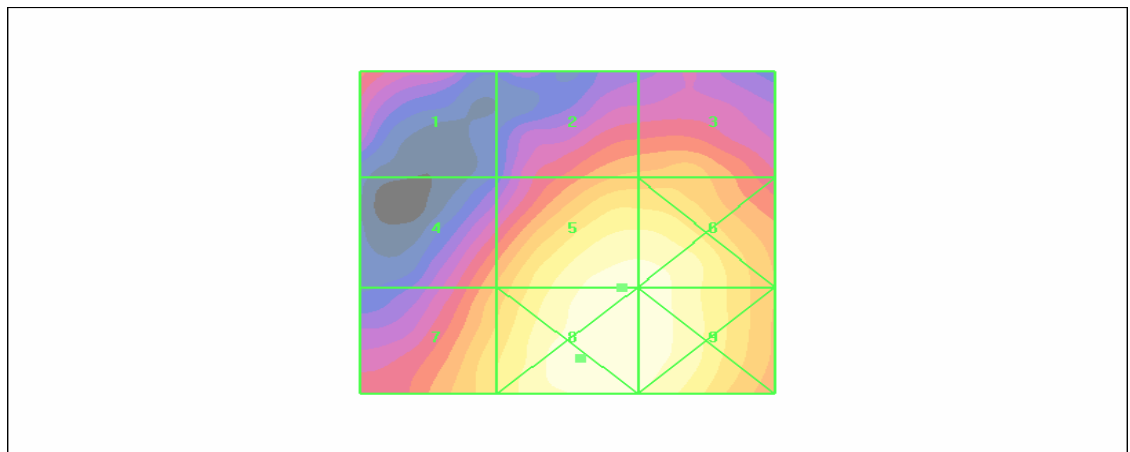
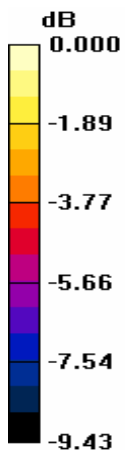

0 dB = 80.4V/m

Figure 20 HAC RF E-Field GSM 1900 Channel 512

TA Technology (Shanghai) Co., Ltd. Test Report

HAC RF H-Field GSM 1900 High

Date/Time: 5/31/2011 1:20:17 PM

Communication System: PCS 1900; Frequency: 1909.8 MHz; Duty Cycle: 1:8.3

Medium parameters used: $\sigma = 0$ mho/m, $\epsilon_r = 1$; $\rho = 1$ kg/m³

Ambient Temperature: 22.3 °C Liquid Temperature: 21.5 °C

Phantom section: RF Section

DASY4 Configuration:

Probe: H3DV6 - SN6260; Calibrated: 10/20/2009

Electronics: DAE4 Sn871; Calibrated: 11/18/2010

Phantom: HAC Test Arch; Type: SD HAC P01 BA;

Measurement SW: DASY4, V4.7 Build 80; Postprocessing SW: SEMCAD, V1.8 Build 186

H Scan - H3DV6 - 2007: 15 mm from Probe Center to the Device High/Hearing Aid

Compatibility Test (101x101x1): Measurement grid: dx=5mm, dy=5mm

Maximum value of peak Total field = 0.205 A/m

Probe Modulation Factor = 2.84

Device Reference Point: 0.000, 0.000, -6.30 mm

Reference Value = 0.074 A/m; Power Drift = 0.020 dB

Hearing Aid Near-Field Category: M3 (AWF -5 dB)

Peak H-field in A/m

Grid 1 0.205 M3	Grid 2 0.205 M3	Grid 3 0.178 M3
Grid 4 0.205 M3	Grid 5 0.205 M3	Grid 6 0.175 M3
Grid 7 0.220 M3	Grid 8 0.198 M3	Grid 9 0.146 M3

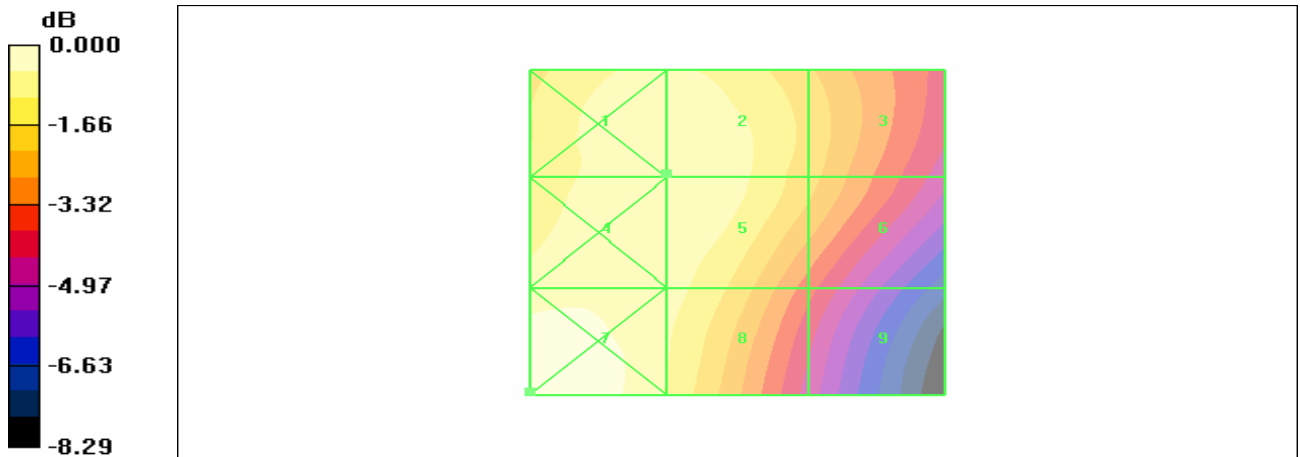

0 dB = 0.220A/m

Figure 21 HAC RF H-Field GSM 1900 Channel 810

TA Technology (Shanghai) Co., Ltd. Test Report

HAC RF H-Field GSM 1900 Middle

Date/Time: 5/31/2011 1:25:04 PM

Communication System: PCS 1900; Frequency: 1880 MHz; Duty Cycle: 1:8.3

Medium parameters used: $\sigma = 0$ mho/m, $\epsilon_r = 1$; $\rho = 1$ kg/m³

Ambient Temperature: 22.3 °C Liquid Temperature: 21.5 °C

Phantom section: RF Section

DASY4 Configuration:

Probe: H3DV6 - SN6260; Calibrated: 10/20/2009

Electronics: DAE4 Sn871; Calibrated: 11/18/2010

Phantom: HAC Test Arch; Type: SD HAC P01 BA;

Measurement SW: DASY4, V4.7 Build 80; Postprocessing SW: SEMCAD, V1.8 Build 186

H Scan - H3DV6 - 2007: 15 mm from Probe Center to the Device Middle/Hearing Aid

Compatibility Test (101x101x1): Measurement grid: dx=5mm, dy=5mm

Maximum value of peak Total field = 0.203 A/m

Probe Modulation Factor = 2.84

Device Reference Point: 0.000, 0.000, -6.30 mm

Reference Value = 0.073 A/m; Power Drift = -0.001 dB

Hearing Aid Near-Field Category: M3 (AWF -5 dB)

Peak H-field in A/m

Grid 1 0.202 M3	Grid 2 0.202 M3	Grid 3 0.172 M3
Grid 4 0.205 M3	Grid 5 0.203 M3	Grid 6 0.170 M3
Grid 7 0.223 M3	Grid 8 0.197 M3	Grid 9 0.142 M3

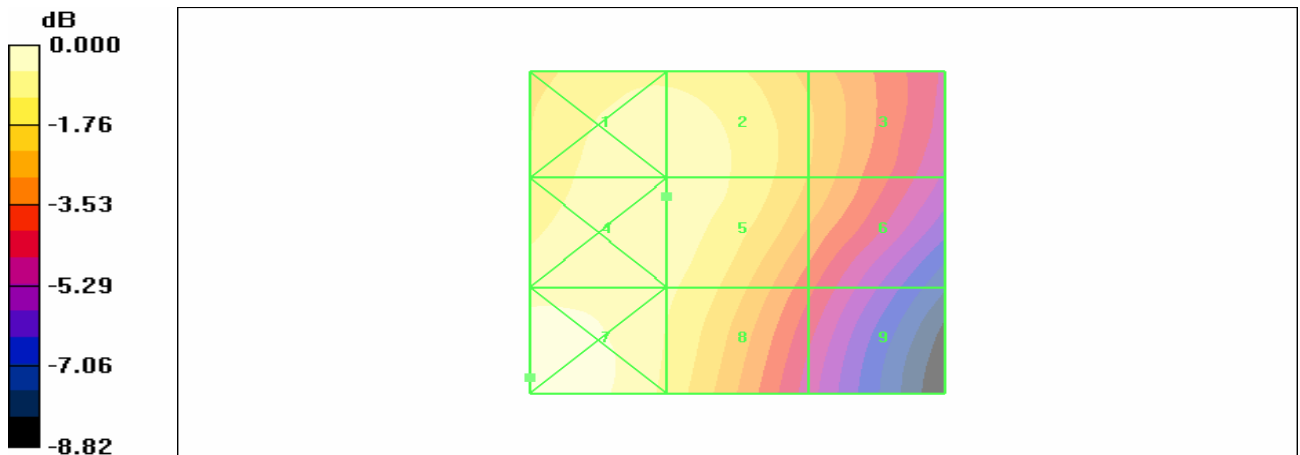

0 dB = 0.223A/m

Figure 22 HAC RF H-Field GSM 1900 Channel 661

TA Technology (Shanghai) Co., Ltd.

Test Report

HAC RF H-Field GSM 1900 Low

Date/Time: 5/31/2011 1:30:20 PM

Communication System: PCS 1900; Frequency: 1850.2 MHz; Duty Cycle: 1:8.3

Medium parameters used: $\sigma = 0$ mho/m, $\epsilon_r = 1$; $\rho = 1$ kg/m³

Ambient Temperature: 22.3 °C Liquid Temperature: 21.5 °C

Phantom section: RF Section

DASY4 Configuration:

Probe: H3DV6 - SN6260; Calibrated: 10/20/2009

Electronics: DAE4 Sn871; Calibrated: 11/18/2010

Phantom: HAC Test Arch; Type: SD HAC P01 BA;

Measurement SW: DASY4, V4.7 Build 80; Postprocessing SW: SEMCAD, V1.8 Build 186

H Scan - H3DV6 - 2007: 15 mm from Probe Center to the Device Low/Hearing Aid Compatibility Test (101x101x1): Measurement grid: dx=5mm, dy=5mm

Maximum value of peak Total field = 0.201 A/m

Probe Modulation Factor = 2.84

Device Reference Point: 0.000, 0.000, -6.30 mm

Reference Value = 0.072 A/m; Power Drift = 0.022 dB

Hearing Aid Near-Field Category: M3 (AWF -5 dB)

Peak H-field in A/m

Grid 1 0.201 M3	Grid 2 0.200 M3	Grid 3 0.169 M3
Grid 4 0.208 M3	Grid 5 0.201 M3	Grid 6 0.166 M3
Grid 7 0.230 M3	Grid 8 0.198 M3	Grid 9 0.141 M3

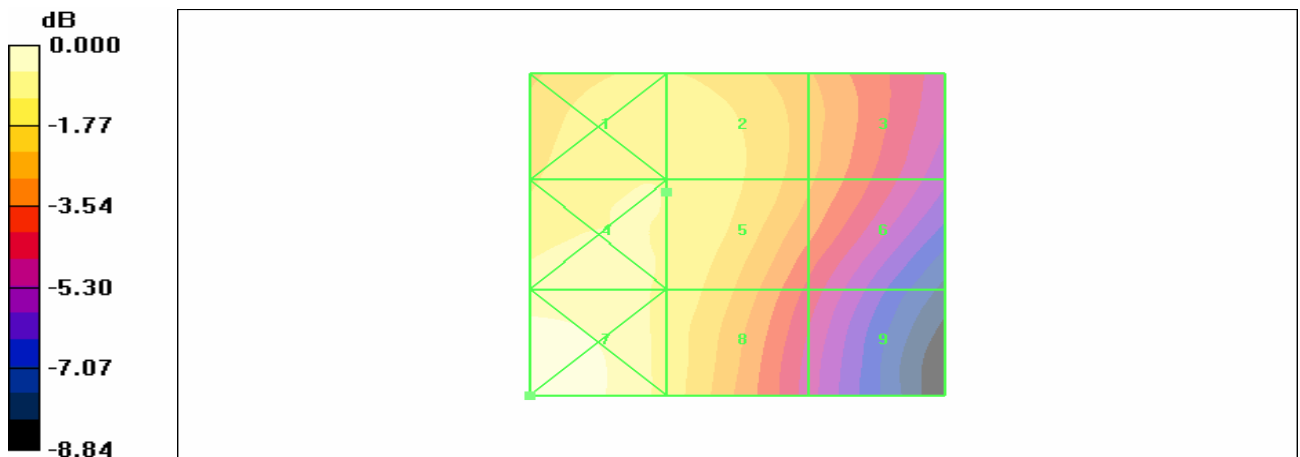

0 dB = 0.230A/m

Figure 23 HAC RF H-Field GSM 1900 Channel 512

HAC RF E-Field WCDMA Band IV High

Date/Time: 5/31/2011 2:18:21 PM

Communication System: WCDMA Band IV; Frequency: 1752.6 MHz; Duty Cycle: 1:1

Medium parameters used: $\sigma = 0$ mho/m, $\epsilon_r = 1$; $\rho = 1000$ kg/m³

Ambient Temperature: 22.3 °C Liquid Temperature: 21.5 °C

Phantom section: RF Section

DASY4 Configuration:

Probe: ER3DV6 - SN2428; ConvF(1, 1, 1); Calibrated: 10/20/2009

Electronics: DAE4 Sn871; Calibrated: 11/18/2010

Phantom: HAC Test Arch; Type: SD HAC P01 BA;

Measurement SW: DASY4, V4.7 Build 80; Postprocessing SW: SEMCAD, V1.8 Build 186

E Scan - ER3D - 2007: 15 mm from Probe Center to the Device High/Hearing Aid Compatibility Test (101x101x1): Measurement grid: dx=5mm, dy=5mm

Maximum value of peak Total field = 42.9 V/m

Probe Modulation Factor = 1.02

Device Reference Point: 0.000, 0.000, -6.30 mm

Reference Value = 48.3 V/m; Power Drift = -0.003 dB

Hearing Aid Near-Field Category: M4 (AWF 0 dB)

Peak E-field in V/m

Grid 1 24.1 M4	Grid 2 33.6 M4	Grid 3 33.6 M4
Grid 4 32.9 M4	Grid 5 42.9 M4	Grid 6 42.6 M4
Grid 7 36.0 M4	Grid 8 43.4 M4	Grid 9 42.9 M4

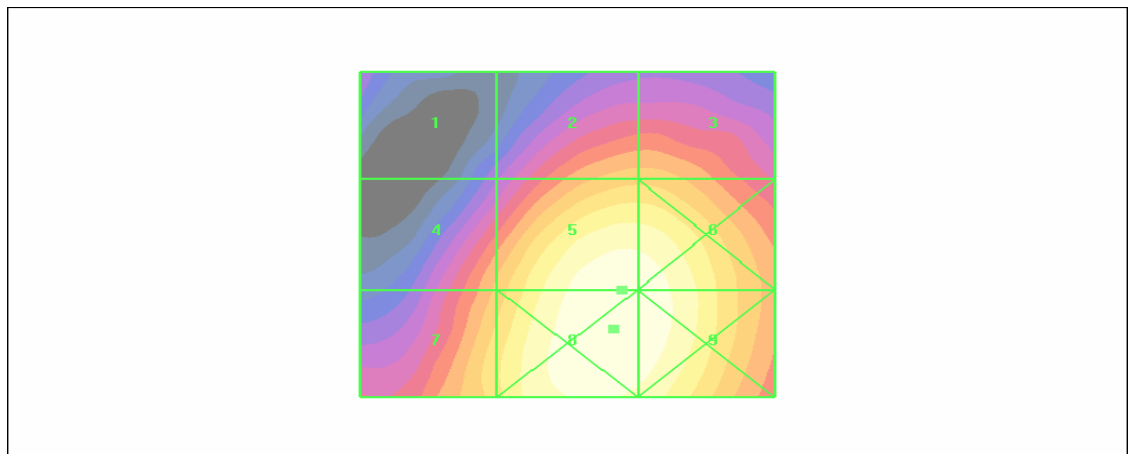
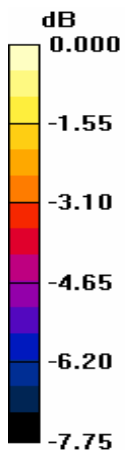

0 dB = 43.4V/m

Figure 24 HAC RF E-Field WCDMA Band IV Channel 1513

HAC RF E-Field WCDMA Band IV Middle

Date/Time: 5/31/2011 2:13:12 PM

Communication System: WCDMA Band IV; Frequency: 1732.6 MHz; Duty Cycle: 1:1

Medium parameters used: $\sigma = 0$ mho/m, $\epsilon_r = 1$; $\rho = 1000$ kg/m³

Ambient Temperature: 22.3 °C Liquid Temperature: 21.5 °C

Phantom section: RF Section

DASY4 Configuration:

Probe: ER3DV6 - SN2428; ConvF(1, 1, 1); Calibrated: 10/20/2009

Electronics: DAE4 Sn871; Calibrated: 11/18/2010

Phantom: HAC Test Arch; Type: SD HAC P01 BA;

Measurement SW: DASY4, V4.7 Build 80; Postprocessing SW: SEMCAD, V1.8 Build 186

E Scan - ER3D - 2007: 15 mm from Probe Center to the Device Middle/Hearing Aid

Compatibility Test (101x101x1): Measurement grid: dx=5mm, dy=5mm

Maximum value of peak Total field = 50.6 V/m

Probe Modulation Factor = 1.02

Device Reference Point: 0.000, 0.000, -6.30 mm

Reference Value = 56.2 V/m; Power Drift = 0.092 dB

Hearing Aid Near-Field Category: M4 (AWF 0 dB)

Peak E-field in V/m

Grid 1 28.2 M4	Grid 2 39.1 M4	Grid 3 39.1 M4
Grid 4 39.5 M4	Grid 5 50.6 M4	Grid 6 50.2 M4
Grid 7 43.8 M4	Grid 8 51.6 M4	Grid 9 51.0 M4

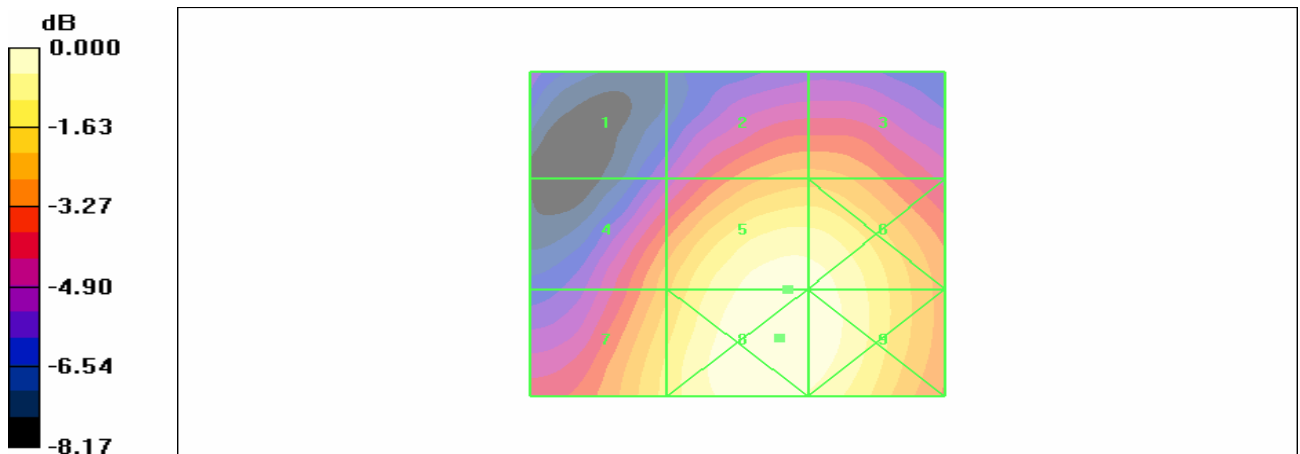

0 dB = 51.6V/m

Figure 25 HAC RF E-Field WCDMA Band IV Channel 1413

HAC RF E-Field WCDMA Band IV Low

Date/Time: 5/31/2011 2:08:20 PM

Communication System: WCDMA Band IV; Frequency: 1712.4 MHz; Duty Cycle: 1:1

Medium parameters used: $\sigma = 0$ mho/m, $\epsilon_r = 1$; $\rho = 1000$ kg/m³

Ambient Temperature: 22.3 °C Liquid Temperature: 21.5 °C

Phantom section: RF Section

DASY4 Configuration:

Probe: ER3DV6 - SN2428; ConvF(1, 1, 1); Calibrated: 10/20/2009

Electronics: DAE4 Sn871; Calibrated: 11/18/2010

Phantom: HAC Test Arch; Type: SD HAC P01 BA;

Measurement SW: DASY4, V4.7 Build 80; Postprocessing SW: SEMCAD, V1.8 Build 186

E Scan - ER3D - 2007: 15 mm from Probe Center to the Device Low/Hearing Aid Compatibility Test (101x101x1): Measurement grid: dx=5mm, dy=5mm

Maximum value of peak Total field = 44.8 V/m

Probe Modulation Factor = 1.02

Device Reference Point: 0.000, 0.000, -6.30 mm

Reference Value = 49.3 V/m; Power Drift = -0.003 dB

Hearing Aid Near-Field Category: M4 (AWF 0 dB)

Peak E-field in V/m

Grid 1	Grid 2	Grid 3
25.1 M4	34.0 M4	34.0 M4
Grid 4	Grid 5	Grid 6
35.2 M4	44.8 M4	44.5 M4
Grid 7	Grid 8	Grid 9
39.7 M4	46.2 M4	45.5 M4

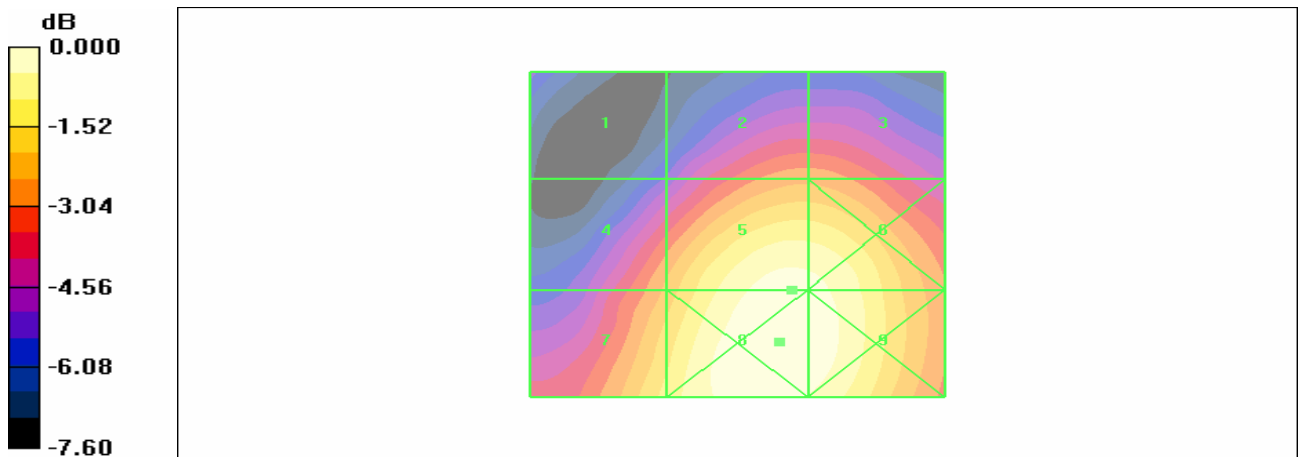

0 dB = 46.2V/m

Figure 26 HAC RF E-Field WCDMA Band IV Channel 1312

HAC RF H-Field WCDMA Band IV High

Date/Time: 5/31/2011 1:41:04 PM

Communication System: WCDMA Band IV; Frequency: 1752.6 MHz; Duty Cycle: 1:1

Medium parameters used: $\sigma = 0$ mho/m, $\epsilon_r = 1$; $\rho = 1$ kg/m³

Ambient Temperature: 22.3 °C Liquid Temperature: 21.5 °C

Phantom section: RF Section

DASY4 Configuration:

Probe: H3DV6 - SN6260; Calibrated: 10/20/2009

Electronics: DAE4 Sn871; Calibrated: 11/18/2010

Phantom: HAC Test Arch; Type: SD HAC P01 BA;

Measurement SW: DASY4, V4.7 Build 80; Postprocessing SW: SEMCAD, V1.8 Build 186

H Scan - H3DV6 - 2007: 15 mm from Probe Center to the Device High/Hearing Aid

Compatibility Test (101x101x1): Measurement grid: dx=5mm, dy=5mm

Maximum value of peak Total field = 0.109 A/m

Probe Modulation Factor = 1.01

Device Reference Point: 0.000, 0.000, -6.30 mm

Reference Value = 0.103 A/m; Power Drift = 0.085 dB

Hearing Aid Near-Field Category: M4 (AWF 0 dB)

Peak H-field in A/m

Grid 1 0.109 M4	Grid 2 0.106 M4	Grid 3 0.085 M4
Grid 4 0.117 M4	Grid 5 0.106 M4	Grid 6 0.084 M4
Grid 7 0.130 M4	Grid 8 0.109 M4	Grid 9 0.073 M4

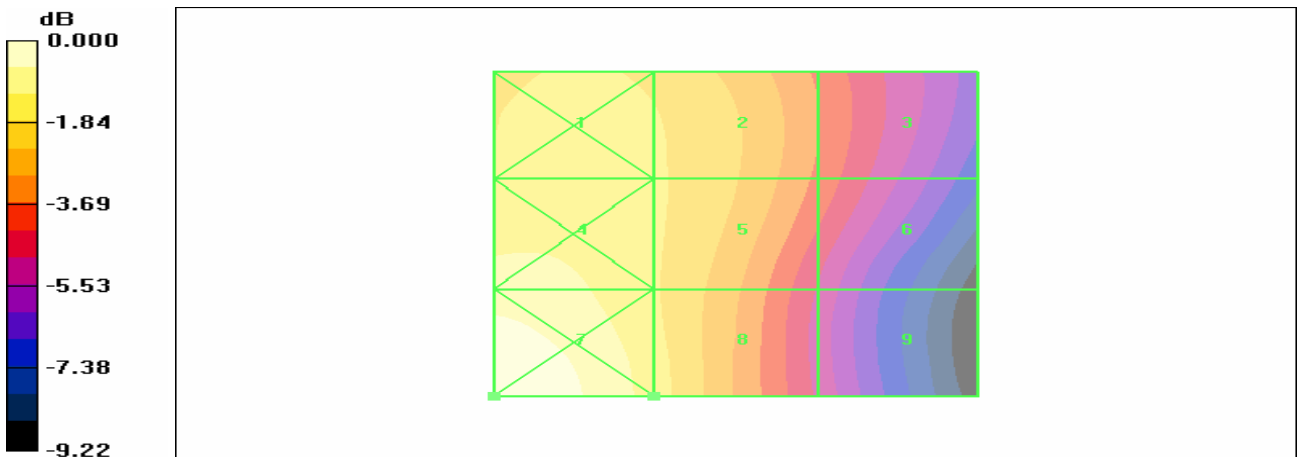

0 dB = 0.130A/m

Figure 27 HAC RF H-Field WCDMA Band IV Channel 1513

HAC RF H-Field WCDMA Band IV Middle

Date/Time: 5/31/2011 1:46:03 PM

Communication System: WCDMA Band IV; Frequency: 1732.6 MHz; Duty Cycle: 1:1

Medium parameters used: $\sigma = 0$ mho/m, $\epsilon_r = 1$; $\rho = 1$ kg/m³

Ambient Temperature: 22.3 °C Liquid Temperature: 21.5 °C

Phantom section: RF Section

DASY4 Configuration:

Probe: H3DV6 - SN6260; Calibrated: 10/20/2009

Electronics: DAE4 Sn871; Calibrated: 11/18/2010

Phantom: HAC Test Arch; Type: SD HAC P01 BA;

Measurement SW: DASY4, V4.7 Build 80; Postprocessing SW: SEMCAD, V1.8 Build 186

H Scan - H3DV6 - 2007: 15 mm from Probe Center to the Device Middle/Hearing Aid

Compatibility Test (101x101x1): Measurement grid: dx=5mm, dy=5mm

Maximum value of peak Total field = 0.129 A/m

Probe Modulation Factor = 1.01

Device Reference Point: 0.000, 0.000, -6.30 mm

Reference Value = 0.122 A/m; Power Drift = -0.028 dB

Hearing Aid Near-Field Category: M4 (AWF 0 dB)

Peak H-field in A/m

Grid 1 0.129 M4	Grid 2 0.126 M4	Grid 3 0.100 M4
Grid 4 0.140 M4	Grid 5 0.127 M4	Grid 6 0.098 M4
Grid 7 0.158 M4	Grid 8 0.133 M4	Grid 9 0.088 M4

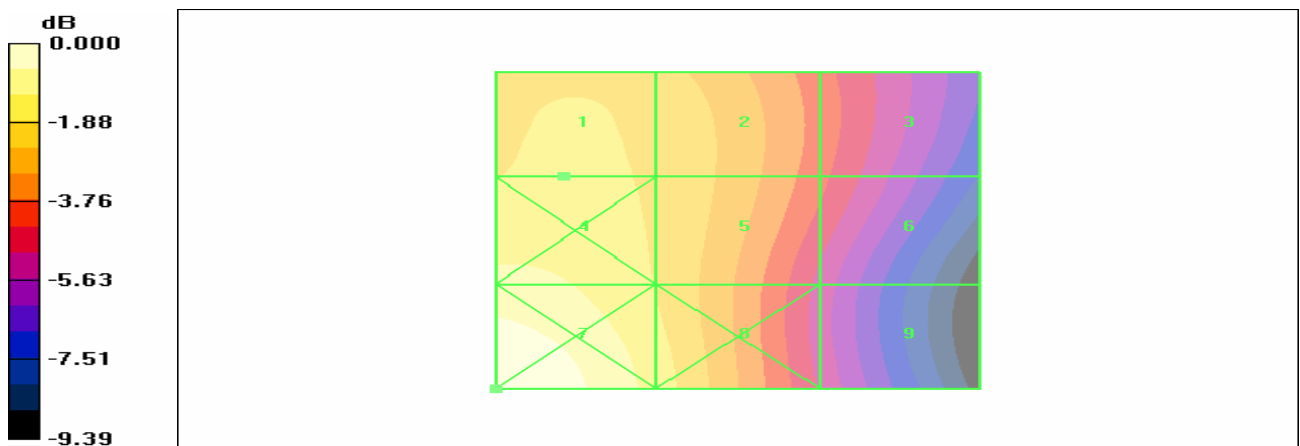

0 dB = 0.158A/m

Figure 28 HAC RF H-Field WCDMA Band IV Channel 1413

HAC RF H-Field WCDMA Band IV Low

Date/Time: 5/31/2011 1:51:10 PM

Communication System: WCDMA Band IV; Frequency: 1712.4 MHz; Duty Cycle: 1:1

Medium parameters used: $\sigma = 0$ mho/m, $\epsilon_r = 1$; $\rho = 1$ kg/m³

Ambient Temperature: 22.3 °C Liquid Temperature: 21.5 °C

Phantom section: RF Section

DASY4 Configuration:

Probe: H3DV6 - SN6260; Calibrated: 10/20/2009

Electronics: DAE4 Sn871; Calibrated: 11/18/2010

Phantom: HAC Test Arch; Type: SD HAC P01 BA;

Measurement SW: DASY4, V4.7 Build 80; Postprocessing SW: SEMCAD, V1.8 Build 186

H Scan - H3DV6 - 2007: 15 mm from Probe Center to the Device Low/Hearing Aid Compatibility Test (101x101x1): Measurement grid: dx=5mm, dy=5mm

Maximum value of peak Total field = 0.112 A/m

Probe Modulation Factor = 1.01

Device Reference Point: 0.000, 0.000, -6.30 mm

Reference Value = 0.105 A/m; Power Drift = 0.173 dB

Hearing Aid Near-Field Category: M4 (AWF 0 dB)

Peak H-field in A/m

Grid 1 0.108 M4	Grid 2 0.108 M4	Grid 3 0.086 M4
Grid 4 0.119 M4	Grid 5 0.112 M4	Grid 6 0.085 M4
Grid 7 0.136 M4	Grid 8 0.120 M4	Grid 9 0.081 M4

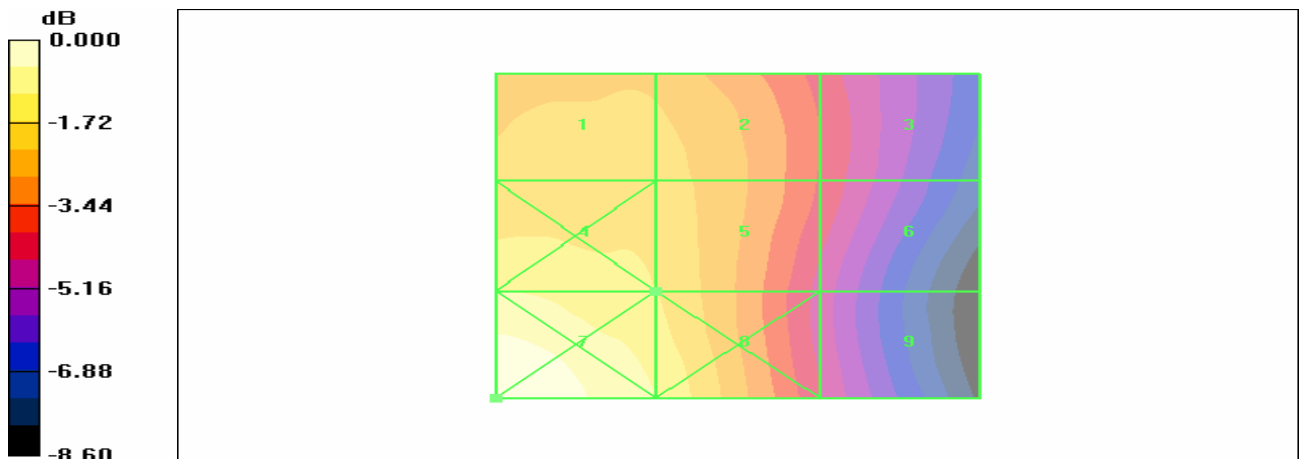

0 dB = 0.136A/m

Figure 29 HAC RF H-Field WCDMA Band IV Channel 1312

TA Technology (Shanghai) Co., Ltd. Test Report

Report No. RZA1105-0804HAC01

Page 46 of 84

ANNEX C: E-Probe Calibration Certificate

**Calibration Laboratory of
Schmid & Partner
Engineering AG**
Zeughausstrasse 43, 8004 Zurich, Switzerland



S Schweizerischer Kalibrierdienst
C Service suisse d'étalonnage
S Servizio svizzero di taratura
S Swiss Calibration Service

Accredited by the Swiss Accreditation Service (SAS)
The Swiss Accreditation Service is one of the signatories to the EA
Multilateral Agreement for the recognition of calibration certificates

Accreditation No.: **SCS 108**

Client **TMC**

Certificate No: **ER3-2428_Oct09**

CALIBRATION CERTIFICATE

Object **ER3DV6 - SN:2428**

Calibration procedure(s) **QA CAL-02.v5 and QA CAL-25.v2
Calibration procedure for E-field probes optimized for close near field
evaluations in air**

Calibration date: **October 20, 2009**

This calibration certificate documents the traceability to national standards, which realize the physical units of measurements (SI).
The measurements and the uncertainties with confidence probability are given on the following pages and are part of the certificate.

All calibrations have been conducted in the closed laboratory facility: environment temperature (22 ± 3)°C and humidity < 70%.

Calibration Equipment used (M&TE critical for calibration):

Primary Standards	ID #	Cal Date (Certificate No.)	Scheduled Calibration
Power meter E4418B	GB41283874	1-Apr-09 (No. 217-01030)	Apr-10
Power sensor E4412A	MY41495277	1-Apr-09 (No. 217-01030)	Apr-10
Power sensor E4412A	MY41498087	1-Apr-09 (No. 217-01030)	Apr-10
Reference 3 dB Attenuator	SN: S5054 (3c)	31-Mar-09 (No. 217-01026)	Mar-10
Reference 20 dB Attenuator	SN: S5086 (20b)	31-Mar-09 (No. 217-01026)	Mar-10
Reference 30 dB Attenuator	SN: S5129 (30b)	31-Mar-09 (No. 217-01027)	Mar-10
Reference Probe ER3DV6	SN: 2328	3-Oct-09 (No. ER3-2328_Oct09)	Oct-10
DAE4	SN: 789	19-Dec-08 (No. DAE4-789_Dec08)	Dec-09

Secondary Standards	ID #	Check Date (in house)	Scheduled Check
RF generator HP 8648C	US3642U01700	4-Aug-99 (in house check Oct-09)	In house check: Oct-11
Network Analyzer HP 8753E	US37390585	18-Oct-01 (in house check Oct-09)	In house check: Oct-10

Calibrated by:	Name	Function	Signature
	Marcel Fehr	Laboratory Technician	
Approved by:	Katja Pokovic	Technical Manager	

Issued: October 22, 2009

This calibration certificate shall not be reproduced except in full without written approval of the laboratory.

TA Technology (Shanghai) Co., Ltd.

Test Report

Report No. RZA1105-0804HAC01

Page 47 of 84

Calibration Laboratory of
Schmid & Partner
Engineering AG
Zughausstrasse 43, 8004 Zurich, Switzerland



S Schweizerischer Kalibrierdienst
C Service suisse d'étalonnage
S Servizio svizzero di taratura
S Swiss Calibration Service

Accredited by the Swiss Accreditation Service (SAS)
The Swiss Accreditation Service is one of the signatories to the EA
Multilateral Agreement for the recognition of calibration certificates

Accreditation No.: **SCS 108**

Glossary:

NORM _{x,y,z}	sensitivity in free space
DCP	diode compression point
CF	crest factor (1/duty_cycle) of the RF signal
A, B, C	modulation dependent linearization parameters
Polarization φ	φ rotation around probe axis
Polarization ϑ	ϑ rotation around an axis that is in the plane normal to probe axis (at measurement center), i.e., $\vartheta = 0$ is normal to probe axis
Connector Angle	information used in DASY system to align probe sensor X to the robot coordinate system

Calibration is Performed According to the Following Standards:

- IEEE Std 1309-2005, "IEEE Standard for calibration of electromagnetic field sensors and probes, excluding antennas, from 9 kHz to 40 GHz", December 2005.

Methods Applied and Interpretation of Parameters:

- NORM_{x,y,z}*: Assessed for E-field polarization $\vartheta = 0$ for XY sensors and $\vartheta = 90$ for Z sensor ($f \leq 900$ MHz in TEM-cell; $f > 1800$ MHz: R22 waveguide).
- NORM(f)_{x,y,z}* = *NORM_{x,y,z}* * *frequency_response* (see Frequency Response Chart).
- DCP_{x,y,z}*: DCP are numerical linearization parameters assessed based on the data of power sweep with CW signal (no uncertainty required). DCP does not depend on frequency nor media.
- A_{x,y,z}*; *B_{x,y,z}*; *C_{x,y,z}* are numerical linearization parameters assessed based on the data of power sweep for specific modulation signal. The parameters do not depend on frequency nor media.
- Spherical isotropy (3D deviation from isotropy)*: in a locally homogeneous field realized using an open waveguide setup.
- Sensor Offset*: The sensor offset corresponds to the offset of virtual measurement center from the probe tip (on probe axis). No tolerance required.
- Connector Angle*: The angle is assessed using the information gained by determining the *NORM_x* (no uncertainty required).

ER3DV6 SN:2428

October 20, 2009

Probe ER3DV6

SN:2428

Manufactured:	September 11, 2007
Last calibrated:	December 13, 2007
Recalibrated:	October 20, 2009

Calibrated for DASY Systems

(Note: non-compatible with DASY2 system!)

TA Technology (Shanghai) Co., Ltd.

Test Report

ER3DV6 SN:2428

October 20, 2009

DASY - Parameters of Probe: ER3DV6 SN:2428

Basic Calibration Parameters

	Sensor X	Sensor Y	Sensor Z	Unc (k=2)
Norm ($\mu\text{V}/(\text{V}/\text{m})^2$)	1.52	1.59	1.86	$\pm 10.1\%$
DCP (mV) [^]	91.5	93.0	98.9	

Modulation Calibration Parameters

UID	Communication System Name	PAR		A dB	B dBuV	C	VR mV	Unc (k=2)
10000	CW		X	0.00	0.00	1.00	300	$\pm 1.5\%$
			Y	0.00	0.00	1.00	300	
			Z	0.00	0.00	1.00	300	

The reported uncertainty of measurement is stated as the standard uncertainty of measurement multiplied by the coverage factor k=2, which for a normal distribution corresponds to a coverage probability of approximately 95%.

[^] numerical linearization parameter: uncertainty not required

ER3DV6 SN:2428

October 20, 2009

Frequency Response of E-Field

(TEM-Cell:ifi110 EXX, Waveguide R22)

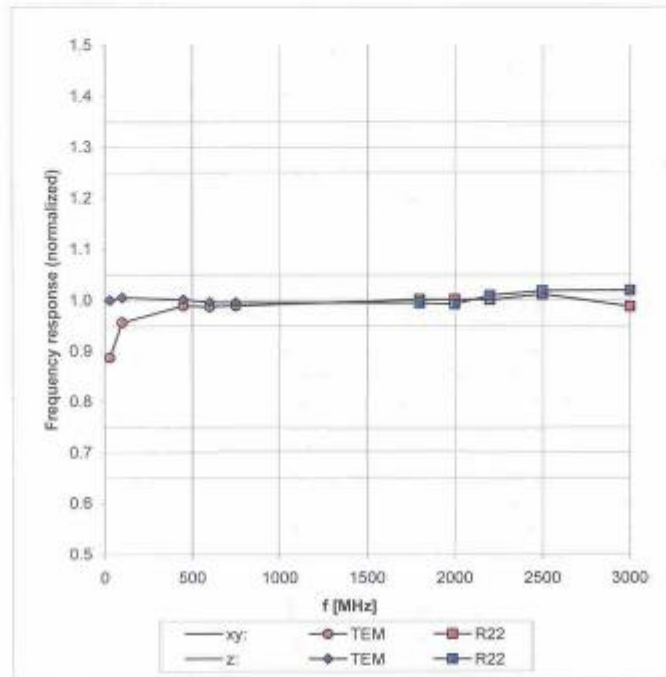

Uncertainty of Frequency Response of E-field: $\pm 6.3\%$ (k=2)

ER3DV6 SN:2428

October 20, 2009

Receiving Pattern (ϕ), $\vartheta = 0^\circ$

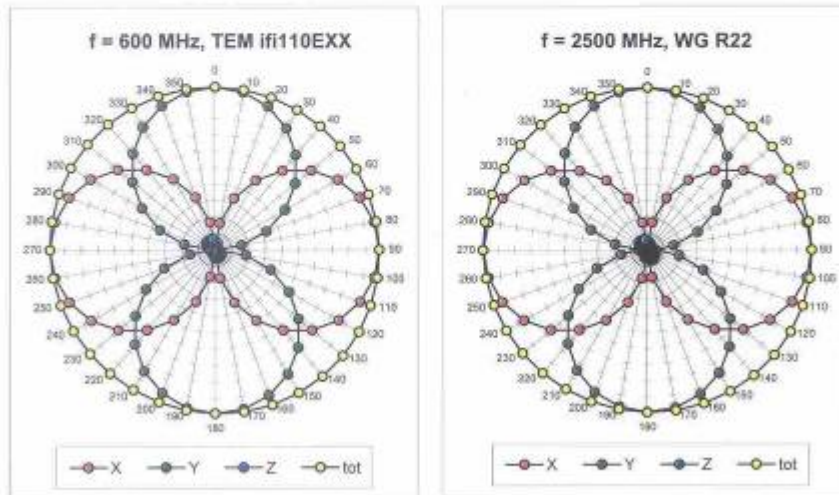

Receiving Pattern (ϕ), $\vartheta = 90^\circ$

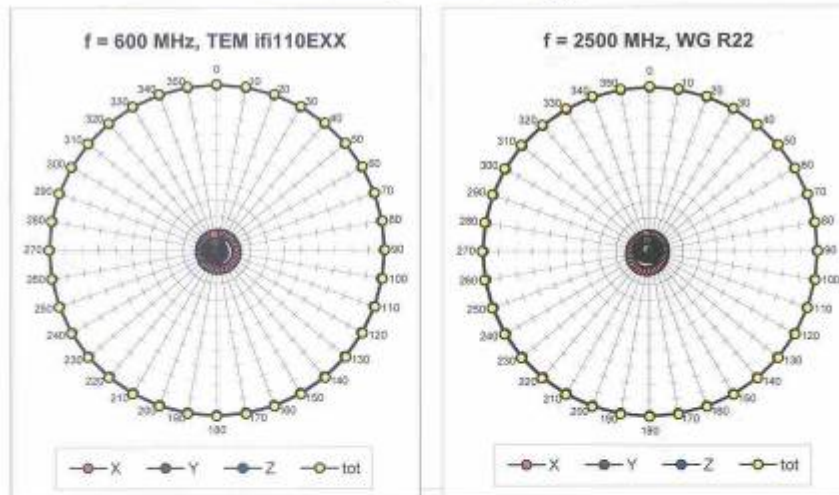

ER3DV6 SN:2428

October 20, 2009

Receiving Pattern (ϕ), $\vartheta = 0^\circ$

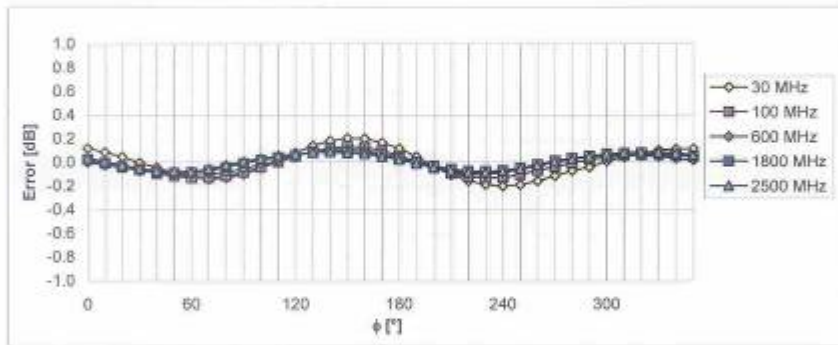

Uncertainty of Axial Isotropy Assessment: $\pm 0.5\%$ (k=2)

Receiving Pattern (ϕ), $\vartheta = 90^\circ$

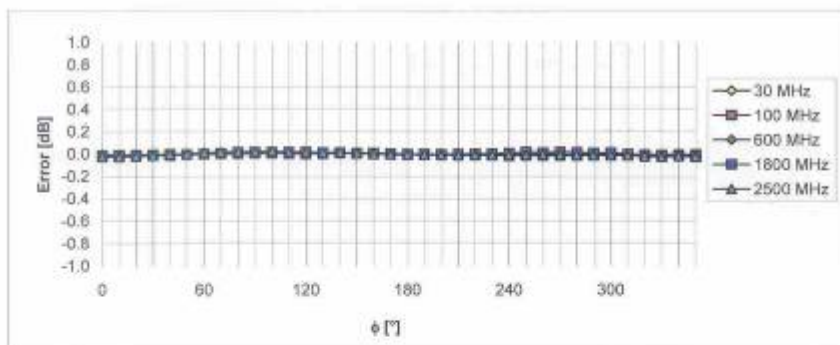

Uncertainty of Axial Isotropy Assessment: $\pm 0.5\%$ (k=2)

ER3DV6 SN:2428

October 20, 2009

Dynamic Range f(E-field)
(Waveguide R22, f = 1800 MHz)

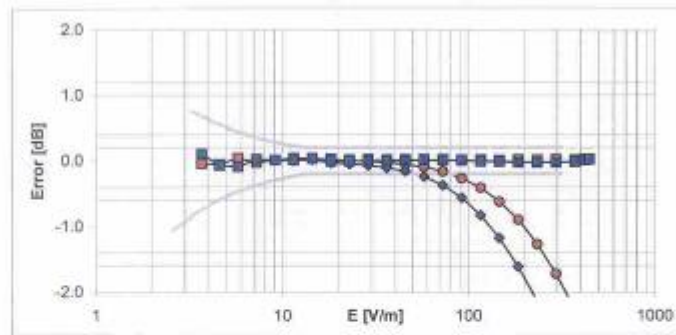
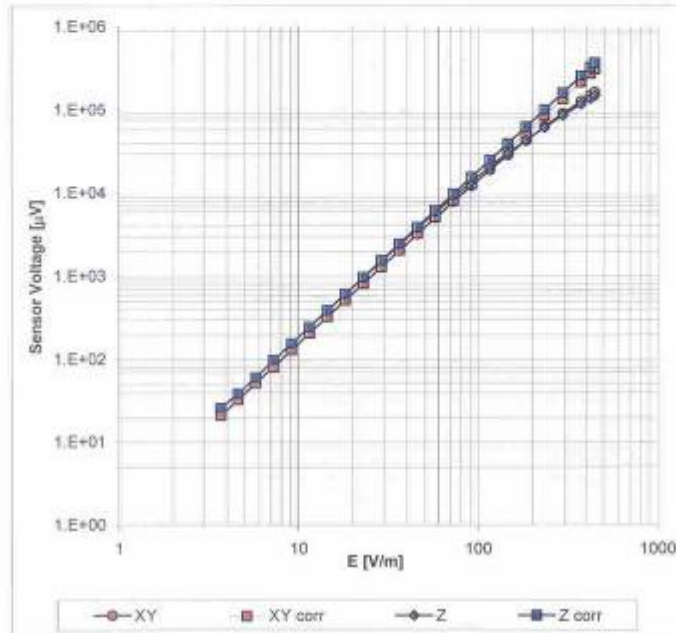

Uncertainty of Linearity Assessment: $\pm 0.6\%$ (k=2)

TA Technology (Shanghai) Co., Ltd. Test Report

Report No. RZA1105-0804HAC01

Page 54 of 84

ER3DV6 SN:2428

October 20, 2009

Deviation from Isotropy in Air Error (ϕ, ϑ), $f = 900$ MHz

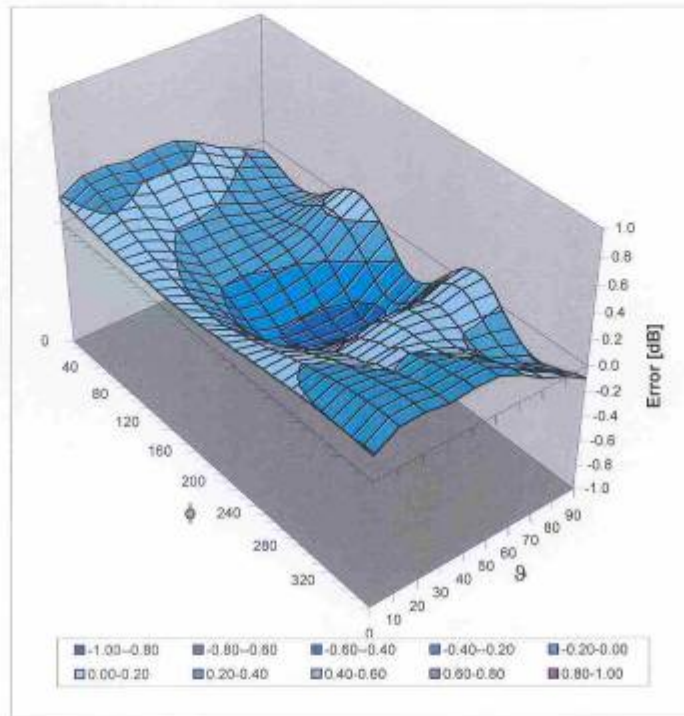

Uncertainty of Spherical Isotropy Assessment: $\pm 2.6\%$ ($k=2$)

ER3DV6 SN:2428

October 20, 2009

Other Probe Parameters

Sensor Arrangement	Rectangular
Connector Angle (°)	-218.7
Mechanical Surface Detection Mode	enabled
Optical Surface Detection Mode	disabled
Probe Overall Length	337 mm
Probe Body Diameter	10 mm
Tip Length	10 mm
Tip Diameter	8.0 mm
Probe Tip to Sensor X Calibration Point	2.5 mm
Probe Tip to Sensor Y Calibration Point	2.5 mm
Probe Tip to Sensor Z Calibration Point	2.5 mm

TA Technology (Shanghai) Co., Ltd. Test Report

Report No. RZA1105-0804HAC01

Page 56 of 84

ANNEX D: H-Probe Calibration Certificate

**Calibration Laboratory of
Schmid & Partner
Engineering AG**
Zeughausstrasse 43, 8004 Zurich, Switzerland



S Schweizerischer Kalibrierdienst
S Service suisse d'étalonnage
C Servizio svizzero di taratura
S Swiss Calibration Service

Accredited by the Swiss Accreditation Service (SAS)
The Swiss Accreditation Service is one of the signatories to the EA
Multilateral Agreement for the recognition of calibration certificates

Accreditation No.: **SCS 108**

Client **TMC**

Certificate No: **H3-6260_Oct09**

CALIBRATION CERTIFICATE

Object: **H3DV6 - SN:6260**

Calibration procedure(s): **QA CAL-03.v5 and QA CAL-25.v2
Calibration procedure for H-field probes optimized for close near field
evaluations in air**

Calibration date: **October 20, 2009**

This calibration certificate documents the traceability to national standards, which realize the physical units of measurements (SI).
The measurements and the uncertainties with confidence probability are given on the following pages and are part of the certificate.

All calibrations have been conducted in the closed laboratory facility: environment temperature (22 ± 3)°C and humidity < 70%.

Calibration Equipment used (M&TE critical for calibration)

Primary Standards	ID #	Cal Date (Certificate No.)	Scheduled Calibration
Power meter E4419B	GB41293874	1-Apr-09 (No. 217-01030)	Apr-10
Power sensor E4412A	MY41495277	1-Apr-09 (No. 217-01030)	Apr-10
Power sensor E4412A	MY41498087	1-Apr-09 (No. 217-01030)	Apr-10
Reference 3 dB Attenuator	SN: S5054 (3c)	31-Mar-09 (No. 217-01025)	Mar-10
Reference 20 dB Attenuator	SN: S5095 (20b)	31-Mar-09 (No. 217-01025)	Mar-10
Reference 30 dB Attenuator	SN: S5129 (30b)	31-Mar-09 (No. 217-01027)	Mar-10
Reference Probe H3DV6	SN: 6182	3-Oct-09 (No. H3-6182_Oct09)	Oct-10
DAE4	SN: 789	19-Dec-08 (No. DAE4-789_Dec08)	Dec-09

Secondary Standards	ID #	Check Date (in house)	Scheduled Check
RF generator HP 8648C	US3642U01700	4-Aug-09 (in house check Oct-09)	In house check: Oct-11
Network Analyzer HP 8753E	US37390585	18-Oct-01 (in house check Oct-09)	In house check: Oct10

Calibrated by:	Name	Function	Signature
	Marcel Fehr	Laboratory Technician	
Approved by:	Katja Pokovic	Technical Manager	

Issued: October 22, 2009

This calibration certificate shall not be reproduced except in full without written approval of the laboratory.

TA Technology (Shanghai) Co., Ltd.

Test Report

Report No. RZA1105-0804HAC01

Page 57 of 84

Calibration Laboratory of
Schmid & Partner
Engineering AG
Zeughausstrasse 43, 8004 Zurich, Switzerland



S Schweizerischer Kalibrierdienst
C Service suisse d'étalonnage
S Servizio svizzero di taratura
S Swiss Calibration Service

Accredited by the Swiss Accreditation Service (SAS)
The Swiss Accreditation Service is one of the signatories to the EA
Multilateral Agreement for the recognition of calibration certificates

Accreditation No.: SCS 108

Glossary:

NORM _{x,y,z}	sensitivity in free space
DCP	diode compression point
CF	crest factor (1/duty_cycle) of the RF signal
A, B, C	modulation dependent linearization parameters
Polarization φ	φ rotation around probe axis
Polarization ϑ	ϑ rotation around an axis that is in the plane normal to probe axis (at measurement center), I.e., $\vartheta = 0$ is normal to probe axis
Connector Angle	information used in DASY system to align probe sensor X to the robot coordinate system

Calibration is Performed According to the Following Standards:

- IEEE Std 1309-2005, "IEEE Standard for calibration of electromagnetic field sensors and probes, excluding antennas, from 9 kHz to 40 GHz", December 2005.

Methods Applied and Interpretation of Parameters:

- NORM_{x,y,z}*: Assessed for E-field polarization $\vartheta = 0$ for XY sensors and $\vartheta = 90$ for Z sensor ($f \leq 900$ MHz in TEM-cell; $f > 1800$ MHz: R22 waveguide).
- X, Y, Z(f)*: $a_0 a_1 a_2 = X, Y, Z$ * frequency_response (see Frequency Response Chart).
- DCP_{x,y,z}*: DCP are numerical linearization parameters assessed based on the data of power sweep with CW signal (no uncertainty required). DCP does not depend on frequency nor media.
- A_{x,y,z}; B_{x,y,z}; C_{x,y,z}* are numerical linearization parameters assessed based on the data of power sweep for specific modulation signal. The parameters do not depend on frequency nor media.
- Spherical isotropy (3D deviation from isotropy)*: in a locally homogeneous field realized using an open waveguide setup.
- Sensor Offset*: The sensor offset corresponds to the offset of virtual measurement center from the probe tip (on probe axis). No tolerance required.
- Connector Angle*: The angle is assessed using the information gained by determining the *X_{a0a1a2}* (no uncertainty required).

H3DV6 SN:6260

October 20, 2009

Probe H3DV6

SN:6260

Manufactured:	September 7, 2007
Last calibrated:	December 13, 2007
Recalibrated:	October 20, 2009

Calibrated for DASY Systems

(Note: non-compatible with DASY2 system!)

TA Technology (Shanghai) Co., Ltd.

Test Report

H3DV6 SN:6260

October 20, 2009

DASY - Parameters of Probe: H3DV6 SN:6260

Basic Calibration Parameters

		Sensor X	Sensor Y	Sensor Z	Unc (k=2)
Norm (A/m / $\sqrt{\mu V}$)	a0	2.47E-3	2.49E-3	2.95E-3	$\pm 10.1\%$
Norm (A/m / $\sqrt{\mu V}$)	a1	-2.97E-5	5.62E-6	-4.47E-5	$\pm 10.1\%$
Norm (A/m / $\sqrt{\mu V}$)	a2	4.84E-5	4.36E-5	6.01E-5	$\pm 10.1\%$
DCP (mV) ¹		84.5	90.3	83.9	

Modulation Calibration Parameters

UID	Communication System Name	PAR		A dB	B dBuV	C	VR mV	Unc (k=2)
10000	CW	0.00	X	0.00	0.00	1.00	300	$\pm 1.5\%$
			Y	0.00	0.00	1.00	300	
			Z	0.00	0.00	1.00	300	

The reported uncertainty of measurement is stated as the standard uncertainty of measurement multiplied by the coverage factor k=2, which for a normal distribution corresponds to a coverage probability of approximately 95%.

¹ numerical linearization parameter: uncertainty not required

H3DV6 SN:6260

October 20, 2009

Frequency Response of H-Field (TEM-Cell:ifi110 EXX, Waveguide R22)

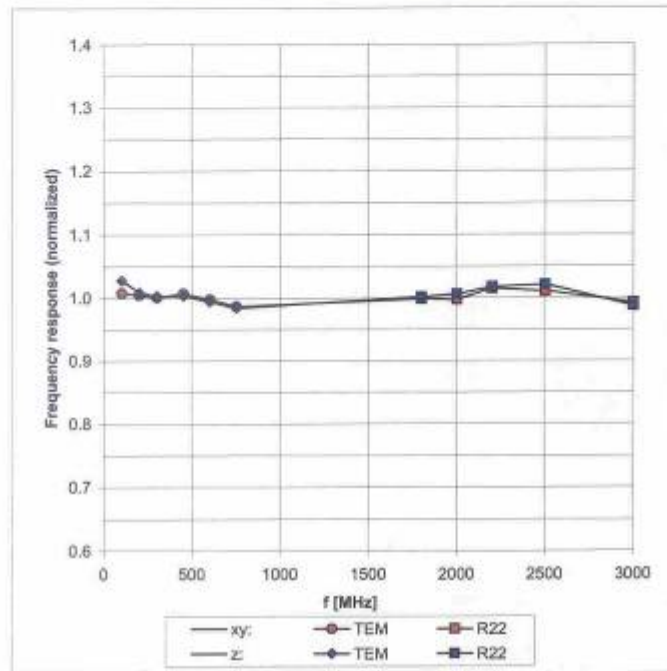

Uncertainty of Frequency Response of H-field: $\pm 6.3\%$ (k=2)

H3DV6 SN:6260

October 20, 2009

Receiving Pattern (ϕ), $\vartheta = 90^\circ$

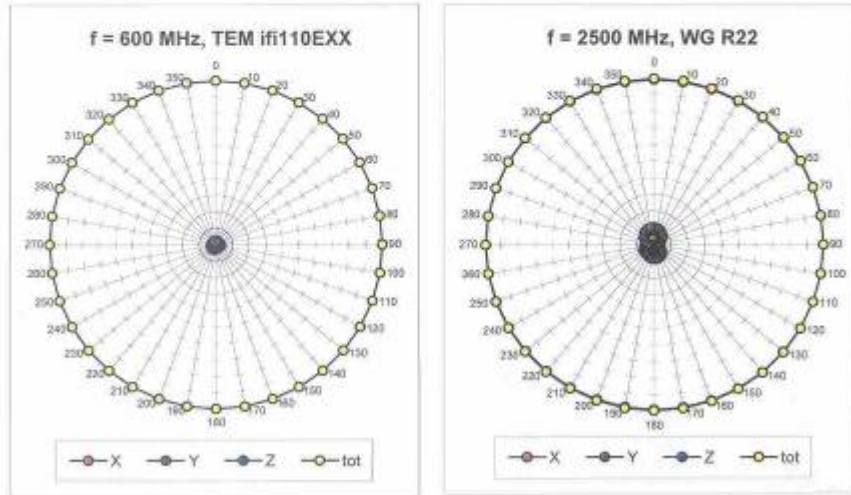

Receiving Pattern (ϕ), $\vartheta = 0^\circ$

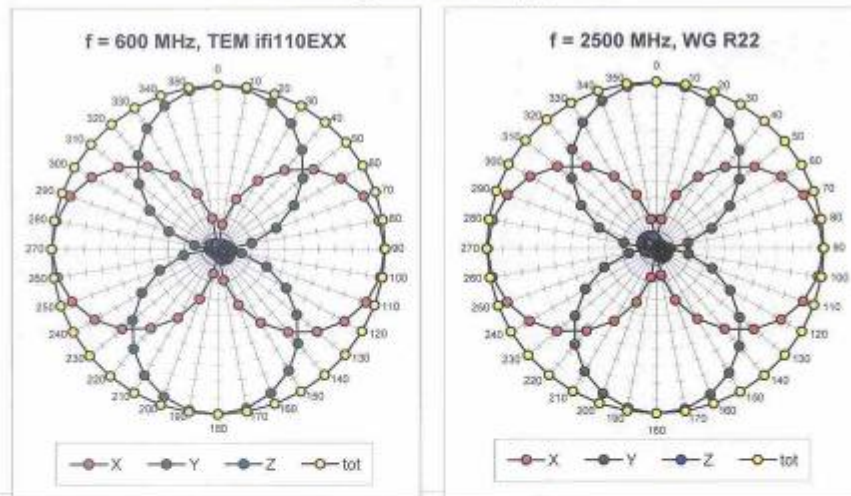

TA Technology (Shanghai) Co., Ltd. Test Report

H3DV6 SN:6260

October 20, 2009

Receiving Pattern (ϕ), $\vartheta = 90^\circ$

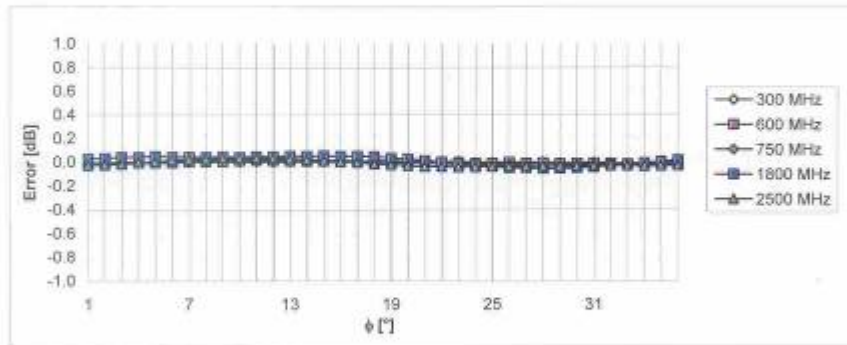

Uncertainty of Axial Isotropy Assessment: $\pm 0.5\%$ (k=2)

Receiving Pattern (ϕ), $\vartheta = 0^\circ$

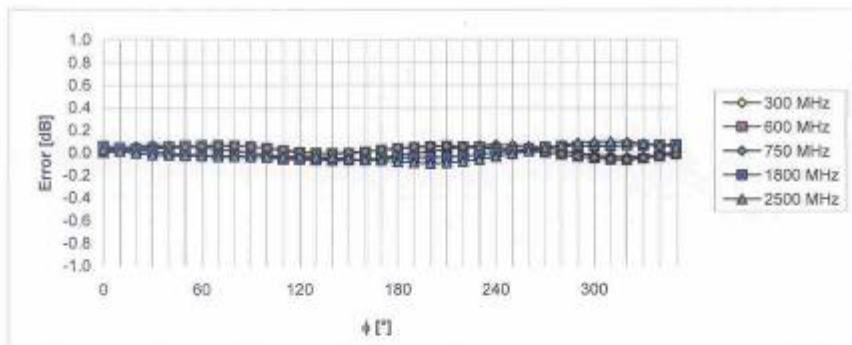

Uncertainty of Axial Isotropy Assessment: $\pm 0.5\%$ (k=2)

H3DV6 SN:6260

October 20, 2009

Dynamic Range f(H-field)
(Waveguide R22, f = 1800 MHz)

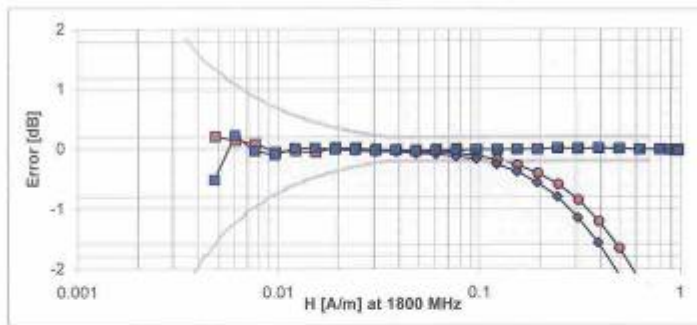
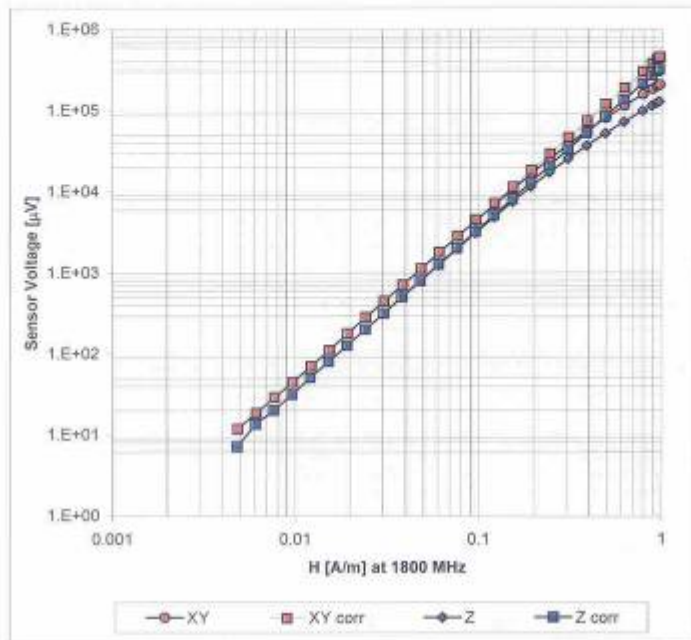

Uncertainty of Linearity Assessment: $\pm 0.6\%$ (k=2)

H3DV6 SN:6260

October 20, 2009

Deviation from Isotropy in Air
Error (ϕ , θ), $f = 900$ MHz

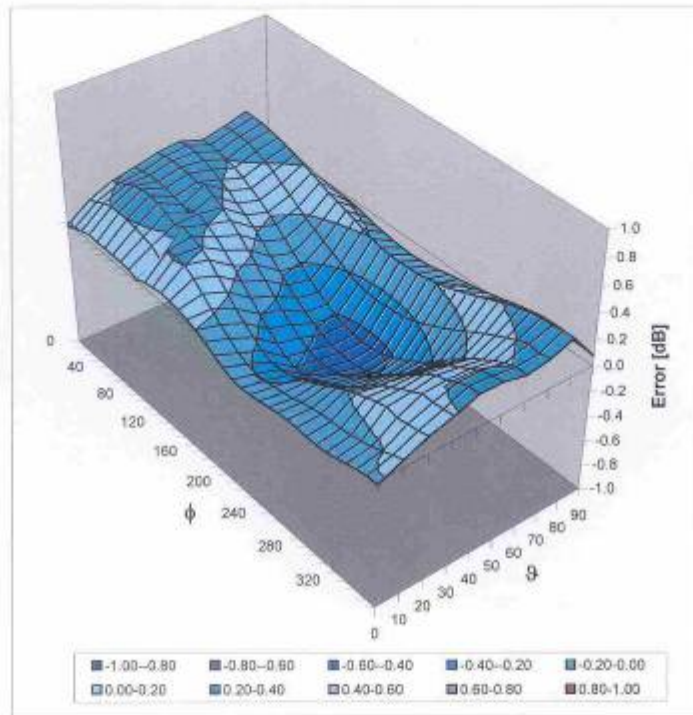

Uncertainty of Spherical Isotropy Assessment: $\pm 2.6\%$ ($k=2$)

TA Technology (Shanghai) Co., Ltd.
Test Report

H3DV6 SN:6260

October 20, 2009

Other Probe Parameters

Sensor Arrangement	Rectangular
Connector Angle (°)	-154.1
Mechanical Surface Detection Mode	enabled
Optical Surface Detection Mode	disabled
Probe Overall Length	337 mm
Probe Body Diameter	10 mm
Tip Length	20 mm
Tip Diameter	6.0 mm
Probe Tip to Sensor X Calibration Point	3 mm
Probe Tip to Sensor Y Calibration Point	3 mm
Probe Tip to Sensor Z Calibration Point	3 mm

TA Technology (Shanghai) Co., Ltd. Test Report

Report No. RZA1105-0804HAC01

Page 66 of 84

ANNEX E: CD835V3 Dipole Calibration Certificate

**Calibration Laboratory of
Schmid & Partner
Engineering AG**
Zeughausstrasse 43, 8004 Zurich, Switzerland



S Schweizerischer Kalibrierdienst
C Service suisse d'étalonnage
S Servizio svizzero di taratura
S Swiss Calibration Service

Accredited by the Swiss Accreditation Service (SAS)
The Swiss Accreditation Service is one of the signatories to the EA
Multilateral Agreement for the recognition of calibration certificates

Accreditation No.: **SCS 108**

Client **TA Technology (Auden)**

Certificate No: **CD835V3-1133_Apr09**

CALIBRATION CERTIFICATE

Object: **CD835V3 - SN: 1133**

Calibration procedure(s): **QA CAL-20.v4
Calibration procedure for dipoles in air**

Calibration date: **April 22, 2009**

Condition of the calibrated item: **In Tolerance**

This calibration certificate documents the traceability to national standards, which realize the physical units of measurements (SI).
All calibrations have been conducted in the closed laboratory facility; environment temperature (22 ± 3)°C and humidity < 70%.

Calibration Equipment used (M&TE critical for calibration)

Primary Standards	ID #	Cal Date (Certificate No.)	Scheduled Calibration
Power meter EPM-442A	GB37480704	08-Oct-08 (No. 217-00898)	Oct-09
Power sensor HP 8461A	US37292783	08-Oct-08 (No. 217-00898)	Oct-09
Probe ER3DV6	SN: 2336	22-Dec-08 (No. ER3-2336_Dec08)	Dec-09
Probe H3DV6	SN: 6065	22-Dec-08 (No. H3-6065_Dec08)	Dec-09
DAE4	SN: 781	20-Feb-09 (No. DAE4-781_Feb09)	Feb-10
Secondary Standards	ID #	Check Date (in house)	Scheduled Check
Power meter R&S NRP	SN: 101748	23-Sep-08 (in house check Dec-08)	In house check: Dec-10
Power sensor R&S NRP-Z91	SN: 100711	25-Aug-08 (in house check Dec-08)	In house check: Dec-10
Power sensor R&S NRP-Z91	SN: 100712	25-Aug-08 (in house check Dec-08)	In house check: Dec-10
Network Analyzer HP 8753E	US37390585	18-Oct-01 (in house check Oct-08)	In house check: Oct-09
RF generator E4433B	MY 41310391	03-Nov-04 (in house check Oct-07)	In house check: Oct-09

	Name	Function	Signature
Calibrated by:	Mike Mell	Laboratory Technician	
Approved by:	Fin Bombolt	Technical Director	

Issued: April 24, 2009

This calibration certificate shall not be reproduced except in full without written approval of the laboratory.

**Calibration Laboratory of
Schmid & Partner
Engineering AG**
Zeughausstrasse 43, 8004 Zurich, Switzerland



S Schweizerischer Kalibrierdienst
C Service suisse d'étalonnage
S Servizio svizzero di taratura
S Swiss Calibration Service

Accredited by the Swiss Accreditation Service (SAS)
The Swiss Accreditation Service is one of the signatories to the EA
Multilateral Agreement for the recognition of calibration certificates

Accreditation No.: **SCS 108**

References

- [1] ANSI-C63.19-2006
American National Standard for Methods of Measurement of Compatibility between Wireless Communications Devices and Hearing Aids.
- [2] ANSI-C63.19-2007
American National Standard for Methods of Measurement of Compatibility between Wireless Communications Devices and Hearing Aids.

Methods Applied and Interpretation of Parameters:

- **Coordinate System:** y-axis is in the direction of the dipole arms. z-axis is from the basis of the antenna (mounted on the table) towards its feed point between the two dipole arms. x-axis is normal to the other axes. In coincidence with the standards [1, 2], the measurement planes (probe sensor center) are selected to be at a distance of 10 mm above the top edge of the dipole arms.
- **Measurement Conditions:** Further details are available from the hardcopies at the end of the certificate. All figures stated in the certificate are valid at the frequency indicated. The forward power to the dipole connector is set with a calibrated power meter connected and monitored with an auxiliary power meter connected to a directional coupler. While the dipole under test is connected, the forward power is adjusted to the same level.
- **Antenna Positioning:** The dipole is mounted on a HAC Test Arch phantom using the matching dipole positioner with the arms horizontal and the feeding cable coming from the floor. The measurements are performed in a shielded room with absorbers around the setup to reduce the reflections. It is verified before the mounting of the dipole under the Test Arch phantom, that its arms are perfectly in a line. It is installed on the HAC dipole positioner with its arms parallel below the dielectric reference wire and able to move elastically in vertical direction without changing its relative position to the top center of the Test Arch phantom. The vertical distance to the probe is adjusted after dipole mounting with a DASY4 Surface Check job. Before the measurement, the distance between phantom surface and probe tip is verified. The proper measurement distance is selected by choosing the matching section of the HAC Test Arch phantom with the proper device reference point (upper surface of the dipole) and the matching grid reference point (tip of the probe) considering the probe sensor offset. The vertical distance to the probe is essential for the accuracy.
- **Feed Point Impedance and Return Loss:** These parameters are measured using a HP 8753E Vector Network Analyzer. The impedance is specified at the SMA connector of the dipole. The influence of reflections was eliminated by applying the averaging function while moving the dipole in the air, at least 70cm away from any obstacles.
- **E-field distribution:** E field is measured in the x-y-plane with an isotropic ER3D-field probe with 100 mW forward power to the antenna feed point. In accordance with [1, 2], the scan area is 20mm wide, its length exceeds the dipole arm length (180 or 90mm). The sensor center is 10 mm (in z) above the top of the dipole arms. Two 3D maxima are available near the end of the dipole arms. Assuming the dipole arms are perfectly in one line, the average of these two maxima (in subgrid 2 and subgrid 8) is determined to compensate for any non-parallelity to the measurement plane as well as the sensor displacement. The E-field value stated as calibration value represents the maximum of the interpolated 3D-E-field, 10mm above the dipole surface.
- **H-field distribution:** H-field is measured with an isotropic H-field probe with 100mW forward power to the antenna feed point, in the x-y-plane. The scan area and sensor distance is equivalent to the E-field scan. The maximum of the field is available at the center (subgrid 5) above the feed point. The H-field value stated as calibration value represents the maximum of the interpolated H-field, 10mm above the dipole surface at the feed point.

TA Technology (Shanghai) Co., Ltd.

Test Report

1 Measurement Conditions

DASY system configuration, as far as not given on page 1.

DASY Version	DASY4	V4.7 B80
DASY PP Version	SEMCAD	V1.8 B186
Phantom	HAC Test Arch	SD HAC P01 BA, #1070
Distance Dipole Top - Probe Center	10 mm	
Scan resolution	dx, dy = 5 mm	area = 20 x 180 mm
Frequency	835 MHz ± 1 MHz	
Forward power at dipole connector	20.0 dBm = 100mW	
Input power drift	< 0.05 dB	

2 Maximum Field values

H-field 10 mm above dipole surface	condition	interpolated maximum
Maximum measured	100 mW forward power	0.446 A/m

Uncertainty for H-field measurement: 8.2% (k=2)

E-field 10 mm above dipole surface	condition	Interpolated maximum
Maximum measured above high end-	100 mW forward power	158.2 V/m
Maximum measured above low end	100 mW forward power	157.3 V/m
Averaged maximum above arm	100 mW forward power	157.8 V/m

Uncertainty for E-field measurement: 12.8% (k=2)

3 Appendix

3.1 Antenna Parameters

Frequency	Return Loss	Impedance
800 MHz	18.2 dB	(43.3 – j12.9) Ohm
835 MHz	33.2 dB	(49.3 + j2.1) Ohm
900 MHz	17.4 dB	(53.5 – j13.6) Ohm
950 MHz	20.0 dB	(44.3 + j7.5) Ohm
960 MHz	14.8 dB	(53.2 + j18.8) Ohm

3.2 Antenna Design and Handling

The calibration dipole has a symmetric geometry with a built-in two stub matching network, which leads to the enhanced bandwidth.

The dipole is built of standard semirigid coaxial cable. The internal matching line is open ended. The antenna is therefore open for DC signals.

Do not apply force to dipole arms, as they are liable to bend. The soldered connections near the feedpoint may be damaged. After excessive mechanical stress or overheating, check the impedance characteristics to ensure that the internal matching network is not affected.

After long term use with 40W radiated power, only a slight warming of the dipole near the feedpoint can be measured.

3.3 Measurement Sheets

3.3.1 Return Loss and Smith Chart

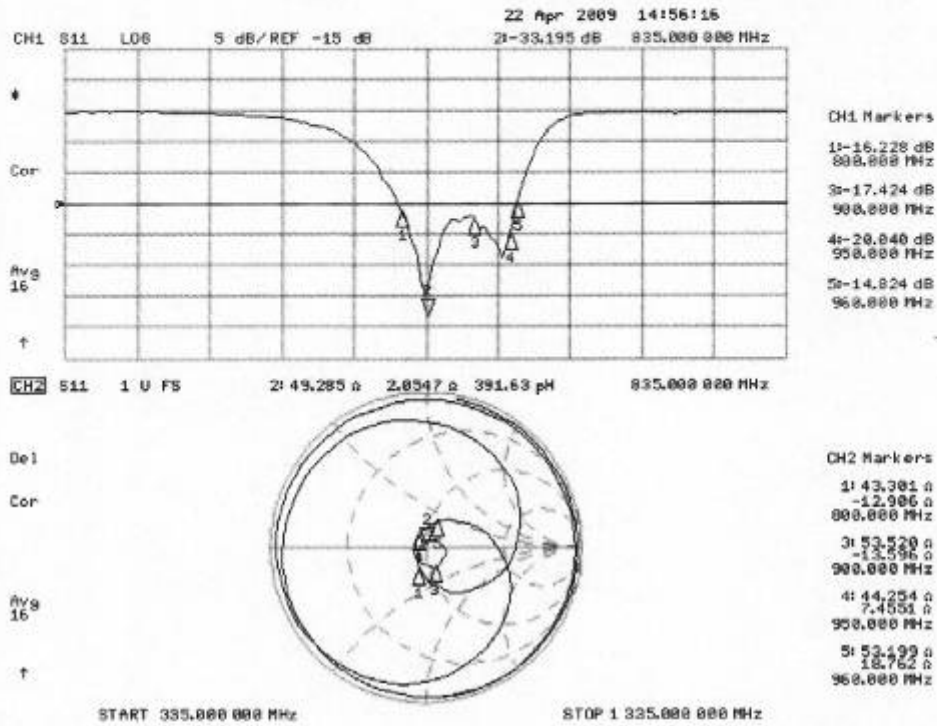

3.3.2 DASY4 H-field Result

Date/Time: 21.04.2009 13:38:21

Test Laboratory: SPEAG Lab 2

DUT: HAC-Dipole 835 MHz; Type: D835V3; Serial: 1133
 Communication System: CW; Frequency: 835 MHz; Duty Cycle: 1:1
 Medium parameters used: $\sigma = 0$ mho/m, $\epsilon_r = 1$; $\rho = 1$ kg/m³
 Phantom section: RF Section
 Measurement Standard: DASY4 (High Precision Assessment)

DASY4 Configuration:

- Probe: H3DV6 - SN6065; ; Calibrated: 22.12.2008
- Sensor-Surface: (Fix Surface)
- Electronics: DAE4 Sn781; Calibrated: 20.02.2009
- Phantom: HAC Test Arch with AMCC; Type: SD HAC P01 BA; Serial: 1070
- Measurement SW: DASY4, V4.7 Build 80; Postprocessing SW: SEMCAD, V1.8 Build 186

H Scan - measurement distance from the probe sensor center to CD835 Dipole = 10mm/Hearing Aid Compatibility Test (41x361x1):

Measurement grid: dx=5mm, dy=5mm
 Maximum value of peak Total field = 0.446 A/m
 Probe Modulation Factor = 1.00
 Device Reference Point: 0.000, 0.000, -6.30 mm
 Reference Value = 0.472 A/m; Power Drift = -0.006 dB
Hearing Aid Near-Field Category: M4 (AWF 0 dB)

Peak H-field in A/m

Grid 1	Grid 2	Grid 3
0.364 M4	0.385 M4	0.368 M4
Grid 4	Grid 5	Grid 6
0.417 M4	0.446 M4	0.426 M4
Grid 7	Grid 8	Grid 9
0.365 M4	0.393 M4	0.376 M4

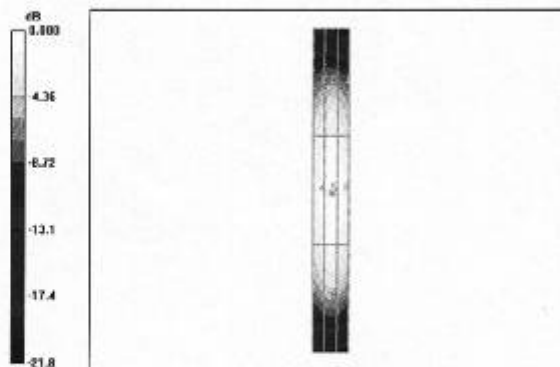

0 dB = 0.446 A/m

TA Technology (Shanghai) Co., Ltd.

Test Report

3.3.3 DASY4 E-field Result

Date/Time: 22.04.2009 12:51:53

Test Laboratory: SPEAG Lab 2

DUT: HAC-Dipole 835 MHz; Type: D835V3; Serial: 1133
 Communication System: CW; Frequency: 835 MHz; Duty Cycle: 1:1
 Medium parameters used: $\sigma = 0$ mho/m, $\epsilon_r = 1$; $\rho = 1000$ kg/m³
 Phantom section: RF Section
 Measurement Standard: DASY4 (High Precision Assessment)

DASY4 Configuration:

- Probe: ER3DV6 - SN2336; ConvF(1, 1, 1); Calibrated: 22.12.2008
- Sensor-Surface: (Fix Surface)
- Electronics: DA4 Sn781; Calibrated: 20.02.2009
- Phantom: HAC Test Arch with AMCC; Type: SD HAC P01 BA; Serial: 1070
- Measurement SW: DASY4, V4.7 Build 80; Postprocessing SW: SEMCAD, V1.8 Build 186

E Scan - measurement distance from the probe sensor center to CD835 Dipole = 10mm/Hearing Aid Compatibility Test (41x361x1):
 Measurement grid: dx=5mm, dy=5mm
 Maximum value of peak Total field = 158.2 V/m
 Probe Modulation Factor = 1.00
 Device Reference Point: 0.000, 0.000, -6.30 mm
 Reference Value = 105.8 V/m; Power Drift = -0.013 dB
Hearing Aid Near-Field Category: M4 (AWF 0 dB)

Peak E-field in V/m

Grid 1	Grid 2	Grid 3
152.4 M4	158.2 M4	154.6 M4
Grid 4	Grid 5	Grid 6
84.6 M4	86.9 M4	84.2 M4
Grid 7	Grid 8	Grid 9
151.7 M4	157.3 M4	152.4 M4

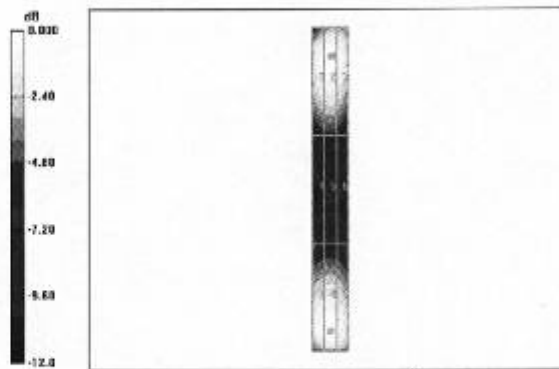

0 dB = 158.2V/m

TA Technology (Shanghai) Co., Ltd. Test Report

Report No. RZA1105-0804HAC01

Page 72 of 84

ANNEX F: CD1880V3 Dipole Calibration Certificate

**Calibration Laboratory of
Schmid & Partner
Engineering AG**
Zaughausstrasse 43, 8004 Zurich, Switzerland



S Schweizerischer Kalibrierdienst
C Service suisse d'étalonnage
S Servizio svizzero di taratura
S Swiss Calibration Service

Accredited by the Swiss Accreditation Service (SAS)
The Swiss Accreditation Service is one of the signatories to the EA
Multilateral Agreement for the recognition of calibration certificates

Accreditation No.: **SCS 108**

Client **Auden**

Certificate No: **CD1880V3-1135_Jan10**

CALIBRATION CERTIFICATE

Object **CD1880V3 - SN: 1135**

Calibration procedure(s) **QA CAL-20.v5
Calibration procedure for dipoles in air**

Calibration date: **January 13, 2010**

This calibration certificate documents the traceability to national standards, which realize the physical units of measurements (SI).
All calibrations have been conducted in the closed laboratory facility: environment temperature (22 ± 3)°C and humidity < 70%.

Calibration Equipment used (M&TE critical for calibration)

Primary Standards	ID #	Cal Date (Certificate No.)	Scheduled Calibration
Power meter EPM-442A	GB37480704	06-Oct-09 (No. 217-01086)	Oct-10
Power sensor HP 8481A	US37292783	06-Oct-09 (No. 217-01086)	Oct-10
Probe ER3DV6	SN: 2336	30-Dec-09 (No. ER3-2336_Dec09)	Dec-10
Probe H3DV6	SN: 6065	30-Dec-09 (No. H3-6065_Dec09)	Dec-10
DAE4	SN: 781	30-Nov-09 (No. DAE4-781_Nov09)	Nov-10

Secondary Standards	ID #	Check Date (in house)	Scheduled Check
Power meter Agilent 4419B	SN: GB42420181	09-Oct-09 (in house check Oct-09)	In house check: Oct-10
Power sensor HP 8482H	SN: 3318A09450	09-Oct-09 (in house check Oct-09)	In house check: Oct-10
Power sensor HP 8482A	SN: US37295597	09-Oct-09 (in house check Oct-09)	In house check: Oct-10
Network Analyzer HP 8753E	US37390585	18-Oct-01 (in house check Oct-09)	In house check: Oct-10
RF generator E4433B	MY 41000675	03-Nov-04 (in house check Oct-09)	In house check: Oct-11

Calibrated by: **Claudio Leubler** Name
Function: **Laboratory Technician**

Approved by: **Katja Pokovic** Name
Function: **Technical Manager**

Signature

Issued: January 19, 2010

This calibration certificate shall not be reproduced except in full without written approval of the laboratory.

Calibration Laboratory of
Schmid & Partner
Engineering AG
Zeughausstrasse 43, 8004 Zurich, Switzerland



S Schweizerischer Kalibrierdienst
C Service suisse d'étalonnage
S Servizio svizzero di taratura
S Swiss Calibration Service

Accredited by the Swiss Accreditation Service (SAS)
The Swiss Accreditation Service is one of the signatories to the EA
Multilateral Agreement for the recognition of calibration certificates

Accreditation No.: SCS 108

References

- [1] ANSI-C63.19-2006
American National Standard for Methods of Measurement of Compatibility between Wireless Communications Devices and Hearing Aids.
- [2] ANSI-C63.19-2007
American National Standard for Methods of Measurement of Compatibility between Wireless Communications Devices and Hearing Aids.

Methods Applied and Interpretation of Parameters:

- **Coordinate System:** y-axis is in the direction of the dipole arms. z-axis is from the basis of the antenna (mounted on the table) towards its feed point between the two dipole arms. x-axis is normal to the other axes. In coincidence with the standards [1, 2], the measurement planes (probe sensor center) are selected to be at a distance of 10 mm above the top edge of the dipole arms.
- **Measurement Conditions:** Further details are available from the hardcopies at the end of the certificate. All figures stated in the certificate are valid at the frequency indicated. The forward power to the dipole connector is set with a calibrated power meter connected and monitored with an auxiliary power meter connected to a directional coupler. While the dipole under test is connected, the forward power is adjusted to the same level.
- **Antenna Positioning:** The dipole is mounted on a HAC Test Arch phantom using the matching dipole positioner with the arms horizontal and the feeding cable coming from the floor. The measurements are performed in a shielded room with absorbers around the setup to reduce the reflections. It is verified before the mounting of the dipole under the Test Arch phantom, that its arms are perfectly in a line. It is installed on the HAC dipole positioner with its arms parallel below the dielectric reference wire and able to move elastically in vertical direction without changing its relative position to the top center of the Test Arch phantom. The vertical distance to the probe is adjusted after dipole mounting with a DASY5 Surface Check job. Before the measurement, the distance between phantom surface and probe tip is verified. The proper measurement distance is selected by choosing the matching section of the HAC Test Arch phantom with the proper device reference point (upper surface of the dipole) and the matching grid reference point (tip of the probe) considering the probe sensor offset. The vertical distance to the probe is essential for the accuracy.
- **Feed Point Impedance and Return Loss:** These parameters are measured using a HP 8753E Vector Network Analyzer. The impedance is specified at the SMA connector of the dipole. The influence of reflections was eliminated by applying the averaging function while moving the dipole in the air, at least 70cm away from any obstacles.
- **E-field distribution:** E field is measured in the x-y-plane with an isotropic ER3D-field probe with 100 mW forward power to the antenna feed point. In accordance with [1, 2], the scan area is 20mm wide, its length exceeds the dipole arm length (180 or 90mm). The sensor center is 10 mm (in z) above the top of the dipole arms. Two 3D maxima are available near the end of the dipole arms. Assuming the dipole arms are perfectly in one line, the average of these two maxima (in subgrid 2 and subgrid 8) is determined to compensate for any non-parallelity to the measurement plane as well as the sensor displacement. The E-field value stated as calibration value represents the maximum of the interpolated 3D-E-field, 10mm above the dipole surface.
- **H-field distribution:** H-field is measured with an isotropic H-field probe with 100mW forward power to the antenna feed point, in the x-y-plane. The scan area and sensor distance is equivalent to the E-field scan. The maximum of the field is available at the center (subgrid 5) above the feed point. The H-field value stated as calibration value represents the maximum of the interpolated H-field, 10mm above the dipole surface at the feed point.

TA Technology (Shanghai) Co., Ltd.

Test Report

1. Measurement Conditions

DASY system configuration, as far as not given on page 1.

DASY Version	DASY5	V5.2 B157
DASY PP Version	SEMCAD X	V14.0 B57
Phantom	HAC Test Arch	SD HAC P01 BA, #1070
Distance Dipole Top - Probe Center	10 mm	
Scan resolution	dx, dy = 5 mm	area = 20 x 90 mm
Frequency	1880 MHz ± 1 MHz	
Forward power at dipole connector	20.0 dBm = 100mW	
Input power drift	< 0.05 dB	

2. Maximum Field values

H-field 10 mm above dipole surface	condition	Interpolated maximum
Maximum measured	100 mW forward power	0.475 A/m

Uncertainty for H-field measurement: 8.2% (k=2)

E-field 10 mm above dipole surface	condition	Interpolated maximum
Maximum measured above high end	100 mW forward power	142.9 V/m
Maximum measured above low end	100 mW forward power	139.7 V/m
Averaged maximum above arm	100 mW forward power	141.3 V/m

Uncertainty for E-field measurement: 12.8% (k=2)

3. Appendix

3.1 Antenna Parameters

Frequency	Return Loss	Impedance
1710 MHz	18.8 dB	(47.5 + j10.9) Ohm
1880 MHz	21.2 dB	(51.5 + j8.7) Ohm
1900 MHz	21.8 dB	(54.4 + j7.3) Ohm
1950 MHz	26.4 dB	(54.9 - j1.1) Ohm
2000 MHz	20.0 dB	(41.0 - j0.8) Ohm

3.2 Antenna Design and Handling

The calibration dipole has a symmetric geometry with a built-in two stub matching network, which leads to the enhanced bandwidth.

The dipole is built of standard semirigid coaxial cable. The internal matching line is open ended. The antenna is therefore open for DC signals.

Do not apply force to dipole arms, as they are liable to bend. The soldered connections near the feedpoint may be damaged. After excessive mechanical stress or overheating, check the impedance characteristics to ensure that the internal matching network is not affected.

After long term use with 40W radiated power, only a slight warming of the dipole near the feedpoint can be measured.

TA Technology (Shanghai) Co., Ltd. Test Report

3.3 Measurement Sheets

3.3.1 Return Loss and Smith Chart

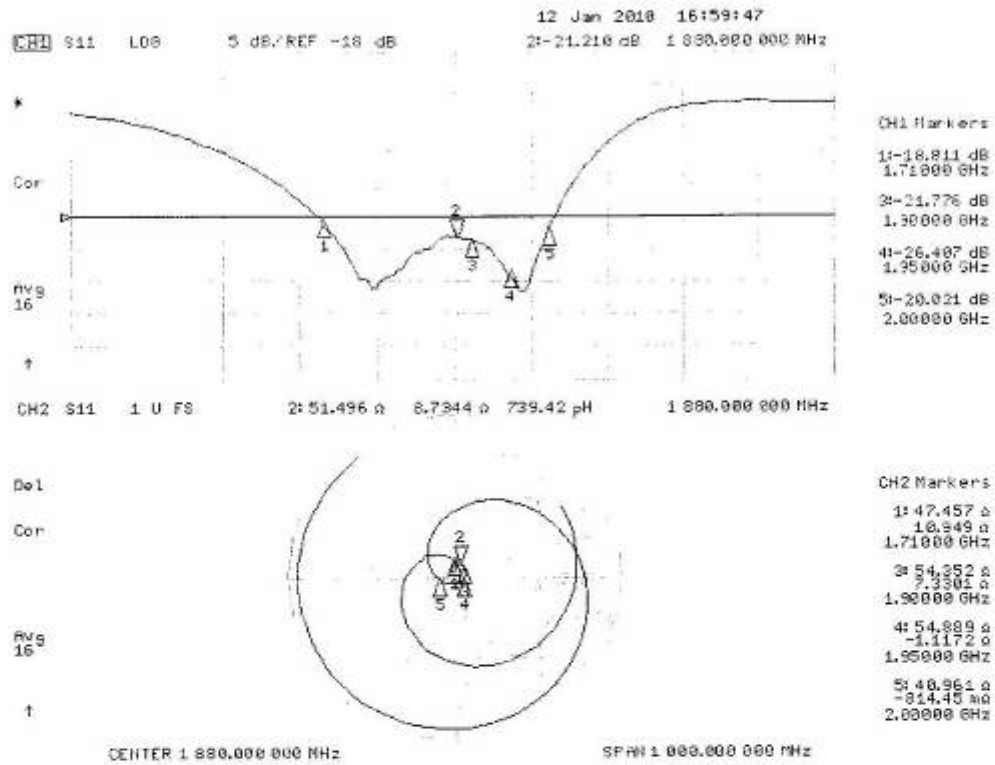

3.3.2 DASY4 H-Field Result

Date/Time: 13.01.2010 12:17:00

Test Laboratory: SPEAG Lab2

HAC_RF_CD1880_1135_100113_H_CL

DUT: HAC Dipole 1880 MHz; Type: CD1880V3; Serial: 1135

Communication System: CW; Frequency: 1880 MHz

Medium parameters used: $\sigma = 0$ mho/m, $\epsilon_r = 1$; $\rho = 1$ kg/m³

Phantom section: RF Section

Measurement Standard: DASY5 (IEEE/IEC/ANSI C63.19-2007)

DASY5 Configuration:

- Probe: H3DV6 - SN6065; ; Calibrated: 30.12.2009
- Sensor-Surface: (Fix Surface)
- Electronics: DAE4 Sn781; Calibrated: 30.11.2009
- Phantom: HAC Test Arch with AMCC; Type: SD HAC P01 BA; Serial: 1070
- Measurement SW: DASY5, V5.2 Build 157; SEMCAD X Version 14.0 Build 57

Dipole H-Field measurement @ 1880MHz/H Scan - measurement distance from the probe sensor center to CD1880 Dipole = 10mm/Hearing Aid Compatibility Test (41x181x1):

Measurement grid: dx=5mm, dy=5mm

Maximum value of peak Total field = 0.475 A/m

Probe Modulation Factor = 1

Device Reference Point: 0, 0, -6.3 mm

Reference Value = 0.503 A/m; Power Drift = -0.017 dB

Hearing Aid Near-Field Category: M2 (AWF 0 dB)

Peak H-field in A/m

Grid 1 0.421 M2	Grid 2 0.436 M2	Grid 3 0.410 M2
Grid 4 0.458 M2	Grid 5 0.475 M2	Grid 6 0.447 M2
Grid 7 0.412 M2	Grid 8 0.431 M2	Grid 9 0.407 M2

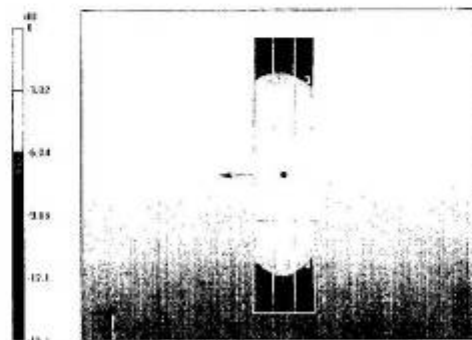

0 dB = 0.475A/m

3.3.3 DASY4 E-Field Result

Date/Time: 13.01.2010 13:42:51

Test Laboratory: SPEAG Lab2

HAC_RF_CD1880_1135_100113_E_CL

DUT: HAC Dipole 1880 MHz; Type: CD1880V3; Serial: 1135

Communication System: CW; Frequency: 1880 MHz

Medium parameters used: $\sigma = 0$ mho/m, $\epsilon_r = 1$; $\rho = 1000$ kg/m³

Phantom section: RF Section

Measurement Standard: DASY5 (IEEE/IEC/ANSI C63.19-2007)

DASY5 Configuration:

- Probe: ER3DV6 - SN2336; ConvF(1, 1, 1); Calibrated: 30.12.2009
- Sensor-Surface: (Fix Surface)
- Electronics: DAE4 Sn781; Calibrated: 30.11.2009
- Phantom: HAC Test Arch with AMCC; Type: SD HAC P01 BA; Serial: 1070
- Measurement SW: DASY5, V5.2 Build 157; SEMCAD X Version 14.0 Build 57

Dipole E-Field measurement @ 1880MHz/E Scan - measurement distance from the probe sensor center to CD1880 Dipole = 10mm/Hearing Aid Compatibility Test (41x181x1):

Measurement grid: dx=5mm, dy=5mm

Maximum value of peak Total field = 142.9 V/m

Probe Modulation Factor = 1

Device Reference Point: 0, 0, -6.3 mm

Reference Value = 162.1 V/m; Power Drift = -0.010 dB

Hearing Aid Near-Field Category: M2 (AWF 0 dB)

Peak E-field in V/m

Grid 1 136.2 M2	Grid 2 139.7 M2	Grid 3 135.5 M2
Grid 4 93.1 M3	Grid 5 95.1 M3	Grid 6 90.7 M3
Grid 7 135.2 M2	Grid 8 142.9 M2	Grid 9 140.6 M2

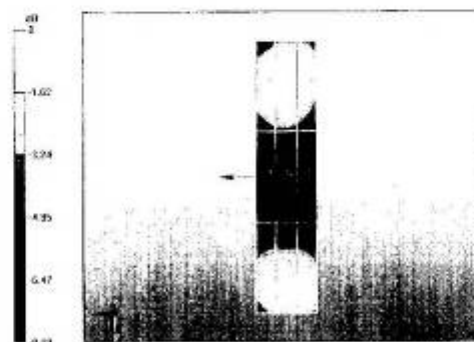

0 dB = 142.9V/m

TA Technology (Shanghai) Co., Ltd. Test Report

Report No. RZA1105-0804HAC01

Page 78 of 84

ANNEX G: DAE4 Calibration Certificate

**Calibration Laboratory of
Schmid & Partner
Engineering AG**
Zeughausstrasse 43, 8004 Zurich, Switzerland



S Schweizerischer Kalibrierdienst
C Service suisse d'étalonnage
S Servizio svizzero di taratura
S Swiss Calibration Service

Accredited by the Swiss Accreditation Service (SAS)
The Swiss Accreditation Service is one of the signatories to the EA
Multilateral Agreement for the recognition of calibration certificates

Accreditation No.: **SCS 108**

Client **TA - SH (Auden)**

Certificate No: **DAE4-871_Nov10**

CALIBRATION CERTIFICATE

Object **DAE4 - SD 000 D04 BJ - SN: 871**

Calibration procedure(s) **QA CAL-06.v22
Calibration procedure for the data acquisition electronics (DAE)**

Calibration date: **November 18, 2010**

This calibration certificate documents the traceability to national standards, which realize the physical units of measurements (SI).
The measurements and the uncertainties with confidence probability are given on the following pages and are part of the certificate.

All calibrations have been conducted in the closed laboratory facility: environment temperature (22 ± 3)°C and humidity < 70%.

Calibration Equipment used (M&TE critical for calibration)

Primary Standards	ID #	Cal Date (Certificate No.)	Scheduled Calibration
Keithley Multimeter Type 2001	SN: 0810278	28-Sep-10 (No:10376)	Sep-11
Secondary Standards	ID #	Check Date (in house)	Scheduled Check
Calibrator Box V1.1	SE UMS 006 AB 1004	07-Jun-10 (in house check)	In house check: Jun-11

Calibrated by:	Name Andrea Guntli	Function Technician	Signature
Approved by:	Name Fin Bornholt	Function R&D Director	Signature

Issued: November 18, 2010

This calibration certificate shall not be reproduced except in full without written approval of the laboratory.

**Calibration Laboratory of
Schmid & Partner
Engineering AG**
Zeughausstrasse 43, 8004 Zurich, Switzerland



S Schweizerischer Kalibrierdienst
C Service suisse d'étalonnage
S Servizio svizzero di taratura
S Swiss Calibration Service

Accredited by the Swiss Accreditation Service (SAS)
The Swiss Accreditation Service is one of the signatories to the EA
Multilateral Agreement for the recognition of calibration certificates

Accreditation No.: **SCS 108**

Glossary

DAE data acquisition electronics
Connector angle information used in DASY system to align probe sensor X to the robot coordinate system.

Methods Applied and Interpretation of Parameters

- *DC Voltage Measurement*: Calibration Factor assessed for use in DASY system by comparison with a calibrated instrument traceable to national standards. The figure given corresponds to the full scale range of the voltmeter in the respective range.
- *Connector angle*: The angle of the connector is assessed measuring the angle mechanically by a tool inserted. Uncertainty is not required.
- The following parameters as documented in the Appendix contain technical information as a result from the performance test and require no uncertainty.
 - *DC Voltage Measurement Linearity*: Verification of the Linearity at +10% and -10% of the nominal calibration voltage. Influence of offset voltage is included in this measurement.
 - *Common mode sensitivity*: Influence of a positive or negative common mode voltage on the differential measurement.
 - *Channel separation*: Influence of a voltage on the neighbor channels not subject to an input voltage.
 - *AD Converter Values with inputs shorted*: Values on the internal AD converter corresponding to zero input voltage
 - *Input Offset Measurement*: Output voltage and statistical results over a large number of zero voltage measurements.
 - *Input Offset Current*: Typical value for information; Maximum channel input offset current, not considering the input resistance.
 - *Input resistance*: Typical value for information: DAE input resistance at the connector, during internal auto-zeroing and during measurement.
 - *Low Battery Alarm Voltage*: Typical value for information. Below this voltage, a battery alarm signal is generated.
 - *Power consumption*: Typical value for information. Supply currents in various operating modes.

TA Technology (Shanghai) Co., Ltd.
Test Report

DC Voltage Measurement

A/D - Converter Resolution nominal

High Range: 1LSB = 6.1 μ V, full range = -100...+300 mV
Low Range: 1LSB = 61nV, full range = -1.....+3mV

DASY measurement parameters: Auto Zero Time: 3 sec; Measuring time: 3 sec

Calibration Factors	X	Y	Z
High Range	404.757 \pm 0.1% (k=2)	404.740 \pm 0.1% (k=2)	405.181 \pm 0.1% (k=2)
Low Range	3.98219 \pm 0.7% (k=2)	3.93489 \pm 0.7% (k=2)	3.96831 \pm 0.7% (k=2)

Connector Angle

Connector Angle to be used in DASY system	90.0 $^{\circ}$ \pm 1 $^{\circ}$
-------------------------------------------	------------------------------------

TA Technology (Shanghai) Co., Ltd.

Test Report

Appendix

1. DC Voltage Linearity

High Range	Reading (μV)	Difference (μV)	Error (%)
Channel X + Input	200001.2	-1.56	-0.00
Channel X + Input	20000.71	0.71	0.00
Channel X - Input	-19997.87	1.63	-0.01
Channel Y + Input	199994.3	1.99	0.00
Channel Y + Input	19998.92	-1.08	-0.01
Channel Y - Input	-20000.26	-0.76	0.00
Channel Z + Input	200009.2	-1.04	-0.00
Channel Z + Input	19998.70	-1.10	-0.01
Channel Z - Input	-20000.16	-0.76	0.00

Low Range	Reading (μV)	Difference (μV)	Error (%)
Channel X + Input	2000.1	0.16	0.01
Channel X + Input	199.58	-0.52	-0.26
Channel X - Input	-200.79	-0.89	0.45
Channel Y + Input	1999.9	-0.03	-0.00
Channel Y + Input	199.45	-0.55	-0.27
Channel Y - Input	-200.31	-0.41	0.21
Channel Z + Input	2000.1	0.33	0.02
Channel Z + Input	199.13	-0.77	-0.38
Channel Z - Input	-201.47	-1.37	0.69

2. Common mode sensitivity

DASY measurement parameters: Auto Zero Time: 3 sec; Measuring time: 3 sec

	Common mode Input Voltage (mV)	High Range Average Reading (μV)	Low Range Average Reading (μV)
Channel X	200	14.25	12.86
	-200	-12.68	-14.21
Channel Y	200	-10.04	-10.39
	-200	9.20	9.17
Channel Z	200	-0.85	-1.40
	-200	-0.34	-0.31

3. Channel separation

DASY measurement parameters: Auto Zero Time: 3 sec; Measuring time: 3 sec

	Input Voltage (mV)	Channel X (μV)	Channel Y (μV)	Channel Z (μV)
Channel X	200	-	2.85	0.69
Channel Y	200	2.41	-	2.73
Channel Z	200	2.54	0.73	-

TA Technology (Shanghai) Co., Ltd.

Test Report

4. AD-Converter Values with inputs shorted

DASY measurement parameters: Auto Zero Time: 3 sec; Measuring time: 3 sec

	High Range (LSB)	Low Range (LSB)
Channel X	15920	15517
Channel Y	16171	16732
Channel Z	15803	16474

5. Input Offset Measurement

DASY measurement parameters: Auto Zero Time: 3 sec; Measuring time: 3 sec

Input 10M Ω

	Average (μ V)	min. Offset (μ V)	max. Offset (μ V)	Std. Deviation (μ V)
Channel X	0.03	-2.35	0.86	0.43
Channel Y	-0.50	-1.49	-0.49	0.38
Channel Z	-0.92	-2.21	0.14	0.44

6. Input Offset Current

Nominal Input circuitry offset current on all channels: <25fA

7. Input Resistance (Typical values for information)

	Zeroing (k Ω)	Measuring (M Ω)
Channel X	200	200
Channel Y	200	200
Channel Z	200	200

8. Low Battery Alarm Voltage (Typical values for information)

Typical values	Alarm Level (VDC)
Supply (+ Vcc)	+7.9
Supply (- Vcc)	-7.6

9. Power Consumption (Typical values for information)

Typical values	Switched off (mA)	Stand by (mA)	Transmitting (mA)
Supply (+ Vcc)	+0.01	+6	+14
Supply (- Vcc)	-0.01	-8	-9

ANNEX H: The EUT Appearances and Test Configuration



a: EUT



b: Battery

Picture 1: Constituents of EUT



Picture 2: Test Setup