

MK701

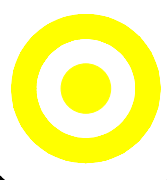

R703
R704
R705

TP707 TP708 TP710 TP705 TP706

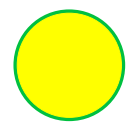

TP901 TP709 TP704 TP703 TP601

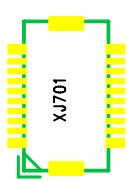

LQAD02 Rev.B1

XXXX 4-X

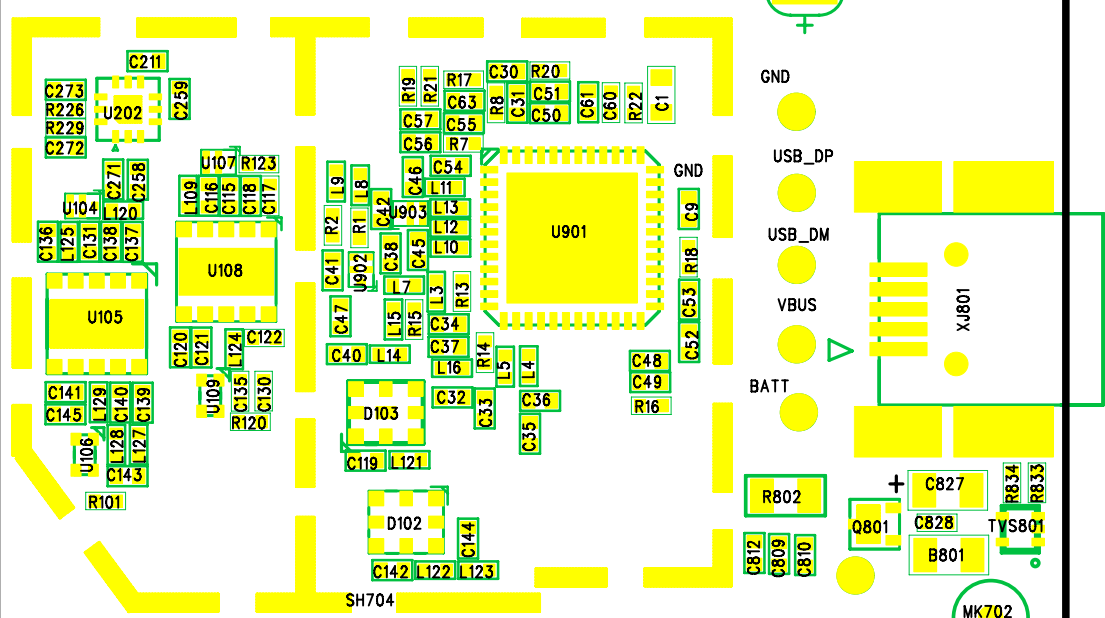
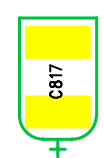
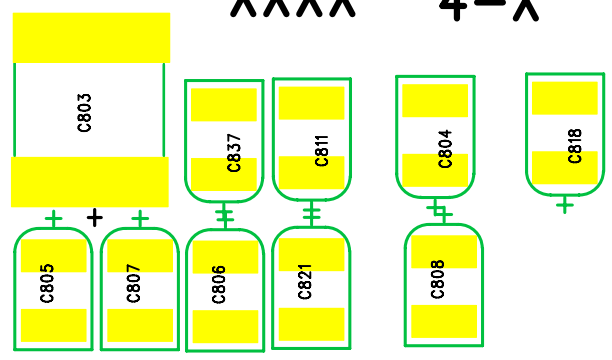

GND
USB_DP
USB_DM
VBUS
BATT

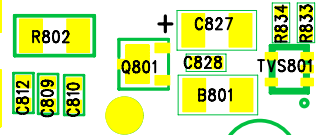
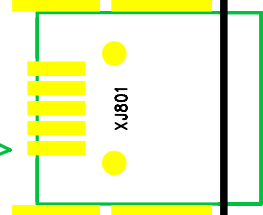

MK702

SH704

