

ELECTROMAGNETIC EMISSIONS COMPLIANCE REPORT

INTENTIONAL RADIATOR CERTIFICATION TO FCC PART 22 SUBPART H and PART 24 SUBPART E REQUIREMENT

OF

Product Name: GSM 850/1900 mobile phone

Brand Name: Alcatel

Model Name: CVLE6 Crystal

Market Name: OT-E230a

FCC ID: RAD048

Report No.: ER/2006/B0008

Issue Date: Dec. 05, 2006

FCC Rule Part: 2 , 22H & 24E

Prepared for T&A mobile phones
3/F,B2 Block,Digital Technology Yard,Gaoxin
Nan Qi Road,Nan Shan District,
Shenzhen,Guangdong,P.R.China

Prepared by SGS Taiwan Ltd.
No. 134, Wu Kung Rd., Wuku Industrial Zone,
Taipei County, Taiwan.

Note: This report shall not be reproduced except in full, without the written approval of SGS Taiwan Ltd. This document may be altered or revised by SGS Taiwan Ltd. personnel only, and shall be noted in the revision section of the document.

This document is issued by the Company subject to its General Conditions of Service printed overleaf or available on request and accessible at www.sgs.com. Attention is drawn to the limitations of liability, indemnification, and Jurisdictional issued defined therein. Unless otherwise stated, the results shown in this test report refer only to the sample(s) tested. This document cannot be reproduced except in full, without prior approval of Company. Any unauthorized alteration, forgery or falsification of the content or appearance of this report is unlawful and offenders may be prosecuted to the fullest extent of the law. 此報告是遵循本公司訂定之通用服務條款所製作發放，請注意此條款列印於背面，亦可在www.sgs.com中查閱。將本公司之義務，免責，管轄權皆明確規範之。除非另有說明，此報告結果僅對檢驗之樣品負責。本報告未經本公司書面許可，不可部份複製。對本報告內容或外觀之任何未經授權之變更、偽造、竄改皆屬非法，違犯者將會被依法追訴。

VERIFICATION OF COMPLIANCE

Applicant: T&A mobile phones
 3/F,B2 Block,Digital Technology Yard,Gaoxin Nan Qi Road,Nan Shan District, Shenzhen,Guangdong,P.R.China

Equipment Under Test: GSM 850/1900 mobile phone

FCC ID Number: RAD048

Brand Name: Alcatel

Model No.: CVLE6 Crystal

Market Name: OT-E230a

Model Difference: N/A

File Number: ER/2006/B0008



Date of test: Nov. 15, 2006 ~ Nov. 17, 2006

Date of EUT Received: Nov. 15, 2006

We hereby certify that:

The above equipment was tested by SGS Taiwan Ltd. The test data, data evaluation, test procedures, and equipment configurations shown in this report were made in accordance with the procedures given in TIA/EIA-603-1-1998 and the energy emitted by the sample EUT tested as described in this report is in compliance with conducted and radiated emission limits of FCC Rule FCC PART 22 subpart H and FCC PART 24 subpart E.

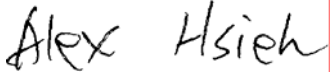
The test results of this report relate only to the tested sample identified in this report.

Test By:		Date	Dec. 05, 2006
	_____ <i>Alex Hsieh/Sr. Engineer</i>		
Prepared By:		Date	Dec. 05, 2006
	_____ <i>Eva Kao/ Sr. Engineer</i>		
Approved By:		Date	Dec. 05, 2006
	_____ <i>Vincent Su/Manager</i>		

This document is issued by the Company subject to its General Conditions of Service printed overleaf or available on request and accessible at www.sgs.com. Attention is drawn to the limitations of liability, indemnification, and Jurisdictional issued defined therein. Unless otherwise stated, the results shown in this test report refer only to the sample(s) tested. This document cannot be reproduced except in full, without prior approval of Company. Any unauthorized alteration, forgery or falsification of the content or appearance of this report is unlawful and offenders may be prosecuted to the fullest extent of the law. 此報告是遵循本公司訂定之通用服務條款所製作發放，請注意此條款列印於背面，亦可在www.sgs.com中查閱。將本公司之義務，免責，管轄權皆明確規範之。除非另有說明，此報告結果僅對檢驗之樣品負責。本報告未經本公司書面許可，不可部份複製。對本報告內容或外觀之任何未經授權之變更、偽造、竄改皆屬非法，違犯者將會被依法追訴。

Version

Version No.	Date
00	Dec. 05, 2006

This document is issued by the Company subject to its General Conditions of Service printed overleaf or available on request and accessible at www.sgs.com. Attention is drawn to the limitations of liability, indemnification, and Jurisdictional issued defined therein. Unless otherwise stated, the results shown in this test report refer only to the sample(s) tested. This document cannot be reproduced except in full, without prior approval of Company. Any unauthorized alteration, forgery or falsification of the content or appearance of this report is unlawful and offenders may be prosecuted to the fullest extent of the law. 此報告是遵循本公司訂定之通用服務條款所製作發放，請注意此條款列印於背面，亦可在www.sgs.com中查閱。將本公司之義務，免責，管轄權皆明確規範之。除非另有說明，此報告結果僅對檢驗之樣品負責。本報告未經本公司書面許可，不可部份複製。對本報告內容或外觀之任何未經授權之變更、偽造、竄改皆屬非法，違犯者將會被依法追訴。

Table of Contents

1. GENERAL INFORMATION	6
1.1 Product Description	6
1.2 Related Submittal(s) / Grant (s)	6
1.3 Test Methodology	6
1.4 Test Facility	7
1.5 Special Accessories	7
1.6 Equipment Modifications	7
2. SYSTEM TEST CONFIGURATION	8
2.1 EUT Configuration	8
2.2 EUT Exercise	8
2.3 Test Procedure	8
2.4 Configuration of Tested System	9
3. SUMMARY OF TEST RESULTS	10
4. DESCRIPTION OF TEST MODES	10
5. RF POWER OUTPUT MEASUREMENT	11
5.1 Standard Applicable	11
5.2 Test Set-up:	11
5.3 Measurement Procedure	11
5.4 Measurement Equipment Used:	12
5.5 Measurement Result	12
6. ERP, EIRP MEASUREMENT	13
6.1 Standard Applicable	13
6.2 Test SET-UP (Block Diagram of Configuration)	13
6.3 Measurement Procedure	15
6.4 Measurement Equipment Used:	16
6.5 Measurement Result	17
7. OCCUPIED BANDWIDTH MEASUREMENT	19
7.1 Standard Applicable	19
7.2 Test Set-up:	19
7.3 Measurement Procedure	19
7.4 Measurement Equipment Used:	20
7.5 Measurement Result:	20

This document is issued by the Company subject to its General Conditions of Service printed overleaf or available on request and accessible at www.sgs.com. Attention is drawn to the limitations of liability, indemnification, and Jurisdictional issued defined therein. Unless otherwise stated, the results shown in this test report refer only to the sample(s) tested. This document cannot be reproduced except in full, without prior approval of Company. Any unauthorized alteration, forgery or falsification of the content or appearance of this report is unlawful and offenders may be prosecuted to the fullest extent of the law. 此報告是遵循本公司訂定之通用服務條款所製作發放，請注意此條款列印於背面，亦可在www.sgs.com中查閱。將本公司之義務，免責，管轄權皆明確規範之。除非另有說明，此報告結果僅對檢驗之樣品負責。本報告未經本公司書面許可，不可部份複製。對本報告內容或外觀之任何未經授權之變更、偽造、竄改皆屬非法，違犯者將會被依法追訴。

8. OUT OF BAND EMISSION AT ANTENNA TERMINALS 25

8.1 Standard Applicable 25

8.2 Test SET-UP..... 25

8.3 Measurement Procedure..... 25

8.4 Measurement Equipment Used: 26

8.5 Measurement Result..... 27

9. FIELD STRENGTH OF SPURIOUS RADIATION MEASUREMENT 35

9.1 Standard Applicable 35

9.2 EUT Setup (Block Diagram of Configuration) 35

9.3 Measurement Procedure..... 37

9.4 Measurement Equipment Used: 38

9.5 Measurement Result..... 38

10. FREQUENCY STABILITY V.S. TEMPERATURE MEASUREMENT 51

10.1 Standard Applicable 51

10.2 Test Set-up: 51

10.3 Measurement Procedure..... 51

10.4 Measurement Equipment Used: 52

10.5 Measurement Result..... 53

11. FREQUENCY STABILITY V.S. VOLTAGE MEASUREMENT 54

11.1 Standard Applicable 54

11.2 Test Set-up: 54

11.3 Measurement Procedure..... 54

11.4 Measurement Equipment Used: 55

11.5 Measurement Result..... 56

12. AC POWER LINE CONDUCTED EMISSION TEST 57

12.1 Standard Applicable 57

12.2 EUT Setup..... 57

12.3 Measurement Procedure..... 57

12.4 Measurement Equipment Used: 58

12.5 Measurement Result..... 58

APPENDIX 1 PHOTOGRPHS OF SET UP 67

APPENDIX 2 PHOTOGRPHS OF EUT 70

This document is issued by the Company subject to its General Conditions of Service printed overleaf or available on request and accessible at www.sgs.com. Attention is drawn to the limitations of liability, indemnification, and Jurisdictional issued defined therein. Unless otherwise stated, the results shown in this test report refer only to the sample(s) tested. This document cannot be reproduced except in full, without prior approval of Company. Any unauthorized alteration, forgery or falsification of the content or appearance of this report is unlawful and offenders may be prosecuted to the fullest extent of the law. 此報告是遵循本公司訂定之通用服務條款所製作發放，請注意此條款列印於背面，亦可在www.sgs.com中查閱。將本公司之義務，免責，管轄權皆明確規範之。除非另有說明，此報告結果僅對檢驗之樣品負責。本報告未經本公司書面許可，不可部份複製。對本報告內容或外觀之任何未經授權之變更、偽造、竄改皆屬非法，違犯者將會被依法追訴。

1. GENERAL INFORMATION

1.1 Product Description

Product	GSM 850/1900 mobile phone	
Model Name	CVLE6 Crystal	
Market Name	OT-E230a	
Model Difference:	N/A	
Trade Name	Alcatel	
Frequency Range and Power	TX: 824.2 MHz – 848.8 MHz	33 dBm
	TX: 1850.2MHz –1909.8MHz	30 dBm
Type of Emission	300KGXW	
Power Supply	3.7 Vdc re-chargeable battery or 4.5Vdc by AC/DC power adapters	
	Model:	Two 4.5V, 350mA AC/DC Adapters S002EU0450035 (supplier: ALCATEL) 3DS09371AGAA (supplier: ALCATEL)

1.2 Related Submittal(s) / Grant (s)

This submittal(s) (test report) is intended for FCC ID: **RAD048** filing to comply with Section Part 22 subpart H and Part 24 subpart E of the FCC CFR 47 Rules.

1.3 Test Methodology

Both conducted and radiated testing were performed according to the procedures document on chapter 13 of ANSI C63.4 (2003) and FCC CFR 47.1046, 2.1047, 2.1049, 2.1051, 2.1053, 2.1055 and 2.1057.

1.4 Test Facility

The open area test site and conducted measurement facility used to collect the radiated data is located on the address of SGS Taiwan Ltd. No. 134, Wu Kung Rd., Wuku Industrial Zone, Taipei Country, Taiwan. The Open Area Test Sites and the Line Conducted labs are constructed and calibrated to meet the FCC requirements in documents ANSI C63.4: 2003 and CISPR 22/EN 55022 requirements. Site No. 1(3 & 10 meters) Registration Number: 94644, Both OATS and Anechoic chamber (3 meters) was accredited by TAF (0513). Canada Registration Number: 4620A-1

1.5 Special Accessories

Not available for this EUT intended for grant.

1.6 Equipment Modifications

Not available for this EUT intended for grant.

2. SYSTEM TEST CONFIGURATION

2.1 EUT Configuration

The EUT configuration for testing is installed on RF field strength measurement to meet the Commissions requirement and operating in a manner which intends to maximize its emission characteristics in a continuous normal application.

2.2 EUT Exercise

The EUT (Transmitter) was operated in the engineering mode to fix the Tx frequency which was for the purpose of the measurements.

2.3 Test Procedure

2.3.1 Conducted Emissions

The EUT is placed on a turn table which is 0.8 m above ground plane. According to the requirements in Section 7 and 13 of ANSI C63.4-2003. Conducted emissions from the EUT measured in the frequency range between 0.15 MHz and 30MHz using CISPR Quasi-Peak and Average detector mode.

2.3.2 Radiated Emissions

The EUT is placed on a turn table which is 1.0 m above ground plane. The turn table shall rotate 360 degrees to determine the position of maximum emission level. EUT is set 3m away from the receiving antenna which varied from 1m to 4m to find out the highest emission. And also, each emission was to be maximized by changing the polarization of receiving antenna both horizontal and vertical. In order to find out the max. emission, the relative positions of this hand-held transmitter(EUT) was rotated through three orthogonal axes according to the requirements in Section 8 and 13 of ANSI C63.4-2003.

2.4 Configuration of Tested System

Fig. 2-1 ConFig. 2-1 Configuration of Tested System

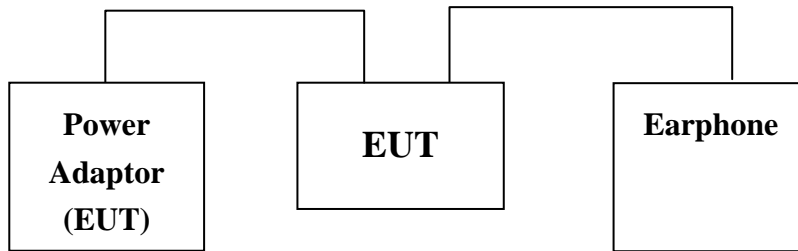

Table 2-1 Equipment Used in Tested System

Item	Equipment	Mfr/Brand	Model/ Type No.	FCC ID	Series No.	Data Cable	Power Cord
1.	Ear phone	N/A	N/A	N/A	N/A	Shielded, 1.2 m	N/A

3. SUMMARY OF TEST RESULTS

FCC Rules	Description Of Test	Result
§2.1046(a) §22.913(a) §24.232(a)	RF Power Output	Compliant
§2.1046(a) §22.913(a) §24.232(a)	ERP/ EIRP measurement	Compliant
§2.1049(h)	99% Occupied Bandwidth	Compliant
§2.1051 §22.917(a) §24.238(a)	Out of Band Emissions at Antenna Terminals and Band Edge	Compliant
§2.1053 §22.917(a) §24.238(a)	Field Strength of Spurious Radiation	Compliant
§2.1055(a)(1)(b)	Frequency Stability vs. Temperature	Compliant
§2.1055(d)(1)(2)	Frequency Stability vs. Voltage	Compliant
§15.107;§15.207	AC Power Line Conducted Emission	Compliant

4. DESCRIPTION OF TEST MODES

The EUT has been tested under operating condition.

EUT staying in continuous transmitting mode. Channel Low, Mid and High for each type and band with rated data rate are chosen for full testing.

The field strength of spurious radiation emission was measured as EUT stand-up position (H mode) and lie down position (E1, E2 mode) for both GSM and GPRS with all power adaptors . The worst-case E1 mode for GSM 850 band and E2 mode for GSM 1900 band with power adaptor model number: S002EU0450035 for channel Low, Mid and High at GSM/PCS mode was reported.

5. RF POWER OUTPUT MEASUREMENT

5.1 Standard Applicable

According to FCC §2.1046.

FCC 22.913(a) Mobile station are limited to 7W.

FCC 24.232(b) Mobile station are limited to 2W.

5.2 Test Set-up:

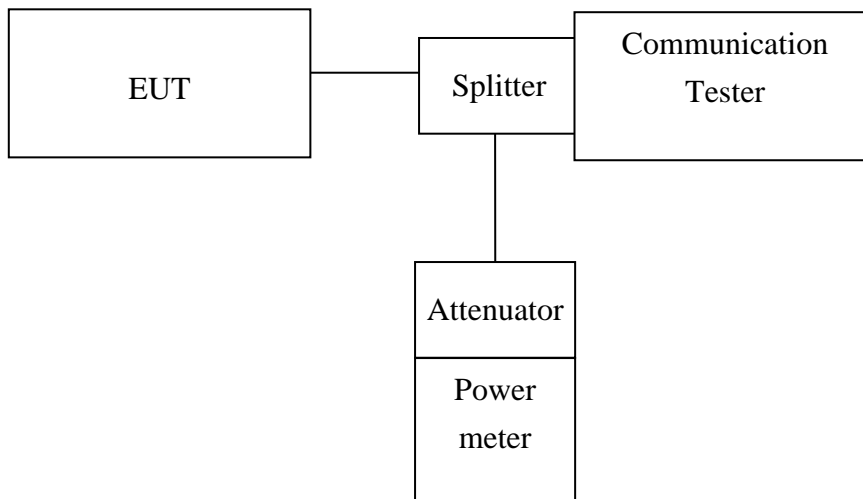

Note: Measurement setup for testing on Antenna connector

5.3 Measurement Procedure

The transmitter output was connected to a calibrated attenuator, the other end of which was connected to a power meter. Transmitter output was read off the power meter in dBm. The power output at the transmitter antenna port was determined by adding the value of the attenuator to the power meter reading.

5.4 Measurement Equipment Used:

Conducted Emission Test Site					
EQUIPMENT TYPE	MFR	MODEL NUMBER	SERIAL NUMBER	LAST CAL.	CAL DUE.
Communication Test	R&S	SMU200	N/A	N/A	N/A
Power Sensor	Anritsu	MA2490A	31431	06/28/2006	06/29/2007
Power Meter	Anritsu	ML2487A	6K00002070	06/28/2006	06/29/2007
Temperature Chamber	TERCHY	MHG-120LF	911009	10/14/2006	10/13/2007
Low Loss Cable	HUBER+SUHNER	SUCOFLEX 104PEA	N/A	N/A	N/A
Attenuator	Mini-Circuit	BW-S10W5	N/A	09/23/2006	09/22/2007
Attenuator	Mini-Circuit	BW-S6W5	N/A	09/23/2006	09/22/2007
Splitter	Agilent	11636B	51728	09/23/2006	09/22/2007

5.5 Measurement Result

EUT Mode	Frequency (MHz)	CH	Power meter Reading (dBm)	Path Loss (dB)	Peak Power (dBm)
GSM 850	824.20	128	4.42	27.20	31.62
	836.60	190	4.60	27.20	31.80
	848.80	251	4.69	27.20	31.89

EUT Mode	Frequency (MHz)	CH	Power Meter Reading (dBm)	Path Loss (dB)	Peak Power (dBm)
PCS 1900	1850.20	512	2.66	27.20	29.86
	1880.00	661	2.85	27.20	30.05
	1909.80	810	2.70	27.20	29.90

This document is issued by the Company subject to its General Conditions of Service printed overleaf or available on request and accessible at www.sgs.com. Attention is drawn to the limitations of liability, indemnification, and Jurisdictional issued defined therein. Unless otherwise stated, the results shown in this test report refer only to the sample(s) tested. This document cannot be reproduced except in full, without prior approval of Company. Any unauthorized alteration, forgery or falsification of the content or appearance of this report is unlawful and offenders may be prosecuted to the fullest extent of the law. 此報告是遵循本公司訂定之通用服務條款所製作發放，請注意此條款列印於背面，亦可在www.sgs.com中查閱。將本公司之義務，免責，管轄權皆明確規範之。除非另有說明，此報告結果僅對檢驗之樣品負責。本報告未經本公司書面許可，不可部份複製。對本報告內容或外觀之任何未經授權之變更、偽造、竄改皆屬非法，違犯者將會被依法追訴。

6. ERP, EIRP MEASUREMENT

6.1 Standard Applicable

According to FCC §2.1046

FCC 22.913(a) Mobile station are limited to 7W ERP.

FCC 24.232(b) Mobile station are limited to 2W EIRP.

6.2 Test SET-UP (Block Diagram of Configuration)

(A) Radiated Emission Test Set-Up, Frequency Below 1000MHz

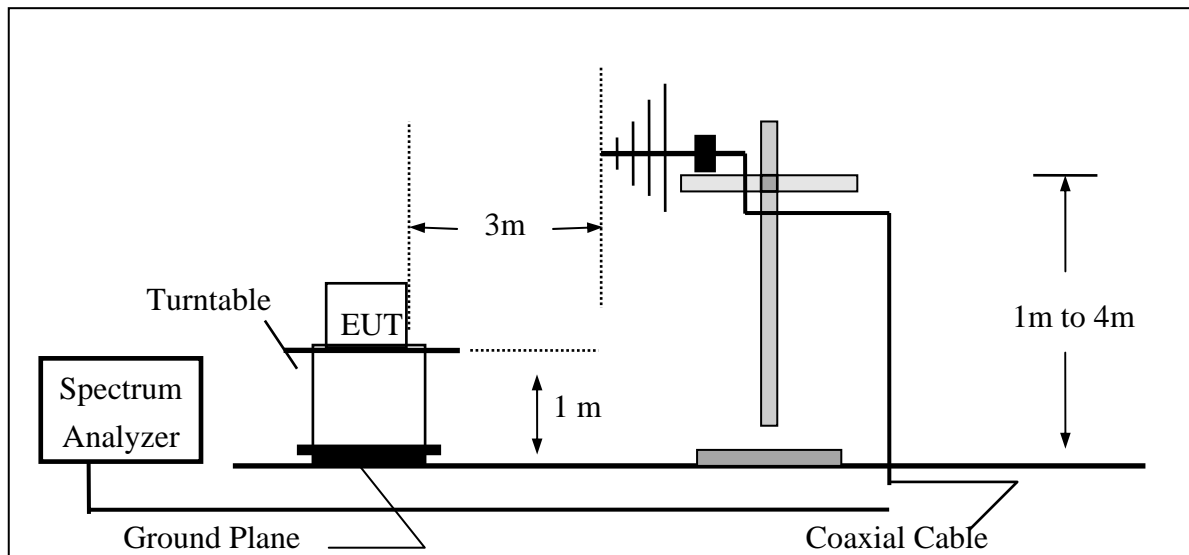

This document is issued by the Company subject to its General Conditions of Service printed overleaf or available on request and accessible at www.sgs.com. Attention is drawn to the limitations of liability, indemnification, and Jurisdictional issued defined therein. Unless otherwise stated, the results shown in this test report refer only to the sample(s) tested. This document cannot be reproduced except in full, without prior approval of Company. Any unauthorized alteration, forgery or falsification of the content or appearance of this report is unlawful and offenders may be prosecuted to the fullest extent of the law. 此報告是遵循本公司訂定之通用服務條款所製作發放，請注意此條款列印於背面，亦可在www.sgs.com中查閱。將本公司之義務，免責，管轄權皆明確規範之。除非另有說明，此報告結果僅對檢驗之樣品負責。本報告未經本公司書面許可，不可部份複製。對本報告內容或外觀之任何未經授權之變更、偽造、竄改皆屬非法，違犯者將會被依法追訴。

(B) Radiated Emission Test Set-UP Frequency Over 1 GHz

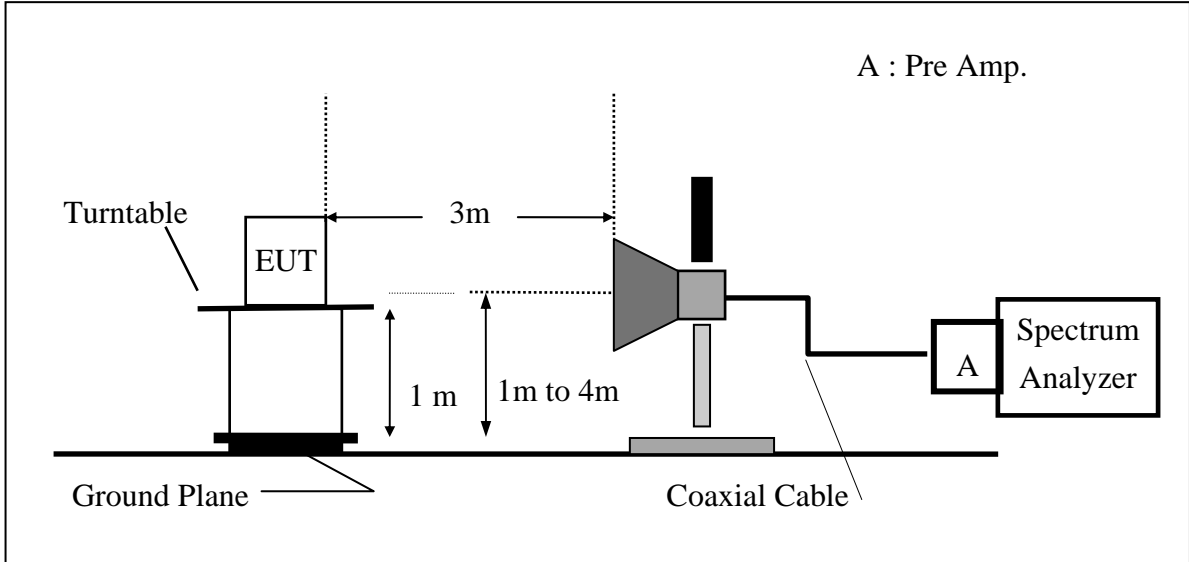

(C) Substituted Method Test Set-UP

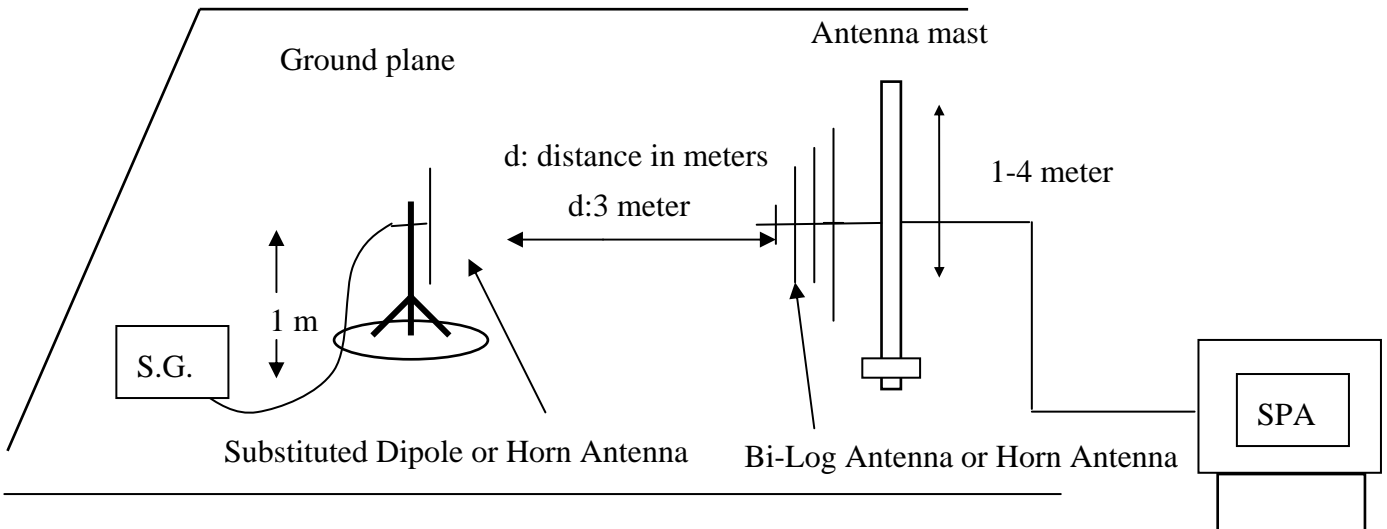

This document is issued by the Company subject to its General Conditions of Service printed overleaf or available on request and accessible at www.sgs.com. Attention is drawn to the limitations of liability, indemnification, and Jurisdictional issued defined therein. Unless otherwise stated, the results shown in this test report refer only to the sample(s) tested. This document cannot be reproduced except in full, without prior approval of Company. Any unauthorized alteration, forgery or falsification of the content or appearance of this report is unlawful and offenders may be prosecuted to the fullest extent of the law. 此報告是遵循本公司訂定之通用服務條款所製作發放，請注意此條款列印於背面，亦可在www.sgs.com中查閱。將本公司之義務，免責，管轄權皆明確規範之。除非另有說明，此報告結果僅對檢驗之樣品負責。本報告未經本公司書面許可，不可部份複製。對本報告內容或外觀之任何未經授權之變更、偽造、竄改皆屬非法，違犯者將會被依法追訴。

6.3 Measurement Procedure

The EUT was placed on a non-conductive turntable using a non-conductive support. The radiated emission at the fundamental frequency was measured at 3 m with a test antenna and EMI spectrum analyzer.

During the measurement, the EUT was in communication with the station. The highest emission was recorded with the rotation of the turntable and the lowering of the test antenna from 4m to 1m. The reading was recorded and the field strength (E in dBuV/m) was calculated.

ERP in frequency band 824.2 – 848.80.8MHz were measured using a substitution method. The EUT was replaced by a dipole antenna connected, the S.G. output was recorded and ERP was calculated as follows:

EIRP in frequency band 1850.2 – 1909.8MHz were measured using a substitution method. The EUT was replaced by a horn antenna connected, the S.G. output was recorded and EIRP was calculated as follows:

$$\text{ERP} = \text{S.G. output (dBm)} + \text{Antenna Gain (dBd)} - \text{Cable Loss (dB)}$$

$$\text{EIRP} = \text{S.G. output (dBm)} + \text{Antenna Gain (dBi)} - \text{Cable Loss (dB)}$$

6.4 Measurement Equipment Used:

EQUIPMENT TYPE	MFR	MODEL NUMBER	SERIAL NUMBER	LAST CAL.	CAL DUE.
Spectrum Analyzer	Agilent	E4446A	MY43360126	03/29/2006	03/28/2007
Spectrum Analyzer	Agilent	7405A	US41160416	06/28/2006	06/29/2007
Communication Test	R&S	SMU200	N/A	N/A	N/A
Bilog Antenna	SCHWAZBECK	VULB9163	152	06/03/2006	06/02/2007
Horn antenna	Schwarzbeck	BBHA 9120D	309/320	08/16/2006	08/15/2007
Pre-Amplifier	HP	8447D	2944A09469	07/19/2006	07/18/2007
Pre-Amplifier	HP	8494B	3008A00578	02/26/2006	02/25/2007
Signal Generator	R&S	SMR40	100210	02/09/2006	02/10/2007
Turn Table	HD	DT420	N/A	N.C.R	N.C.R
Antenna Tower	HD	MA240-N	240/657	N.C.R	N.C.R
Controller	HD	HD100	N/A	N.C.R	N.C.R
Low Loss Cable	HUBER+SUHNER	SUCOFLEX 104PEA-10M	10m	10/09/2006	10/08/2007
Low Loss Cable	HUBER+SUHNER	SUCOFLEX 104PEA-3M	3m	10/09/2006	10/08/2007
Low Loss Cable	HUBER+SUHNER	SUCOFLEX 104PEA-0.5M	0.5m	10/09/2006	10/08/2007
Site NSA	SGS	966 chamber	N/A	11/17/2005	11/16/2006
Attenuator	Mini-Circuit	BW-S10W5	N/A	09/23/2006	09/22/2007
Dipole Antenna	Schwarzbeck	VHAP	908/909	06/10/2006	06/11/2007
Dipole Antenna	Schwarzbeck	UHAP	891/892	06/10/2006	06/11/2007
Horn antenna	Schwarzbeck	BBHA 9120D	N/A	08/16/2006	08/15/2007

This document is issued by the Company subject to its General Conditions of Service printed overleaf or available on request and accessible at www.sgs.com. Attention is drawn to the limitations of liability, indemnification, and Jurisdictional issued defined therein. Unless otherwise stated, the results shown in this test report refer only to the sample(s) tested. This document cannot be reproduced except in full, without prior approval of Company. Any unauthorized alteration, forgery or falsification of the content or appearance of this report is unlawful and offenders may be prosecuted to the fullest extent of the law. 此報告是遵循本公司訂定之通用服務條款所製作發放，請注意此條款列印於背面，亦可在www.sgs.com中查閱。將本公司之義務，免責，管轄權皆明確規範之。除非另有說明，此報告結果僅對檢驗之樣品負責。本報告未經本公司書面許可，不可部份複製。對本報告內容或外觀之任何未經授權之變更、偽造、竄改皆屬非法，違犯者將會被依法追訴。

6.5 Measurement Result

EUT Mode	Frequency (MHz)	CH	EUT Pol.	Antenna Pol.	SPA Reading (dBuV)	S.G. Output (dBm)	Antenna Gain (dBd)	Cable Loss (dB)	ERP (dBm)	Limit (dBm)
GSM 850	824.20	128	H	V	129.31	42.92	-7.87	3.62	29.95	38.45
				H	130.72	44.45	-7.87	3.62	31.42	38.45
			E1	V	131.17	44.78	-7.87	3.62	31.82	38.45
				H	129.47	43.20	-7.87	3.62	30.22	38.45
			E2	V	124.45	38.06	-7.87	3.62	25.08	38.45
				H	132.07	45.80	-7.87	3.62	32.52	38.45
	836.60	190	H	V	125.96	39.71	-7.88	3.65	26.77	38.45
				H	129.37	43.14	-7.88	3.65	30.25	38.45
			E1	V	131.89	45.64	-7.88	3.65	32.66	38.45
				H	130.73	44.50	-7.88	3.65	31.52	38.45
			E2	V	125.22	38.97	-7.88	3.65	26.65	38.45
				H	130.72	44.49	-7.88	3.65	31.55	38.45
	848.80	251	H	V	125.76	39.64	-7.88	3.68	26.62	38.45
				H	129.92	43.73	-7.88	3.68	30.82	38.45
			E1	V	131.53	45.41	-7.88	3.68	31.56	38.45
				H	129.24	43.05	-7.88	3.68	30.11	38.45
			E2	V	124.86	38.74	-7.88	3.68	25.78	38.45
				H	130.69	44.50	-7.88	3.68	31.53	38.45

Remark :

- (1) The RBW,VBW of SPA for frequency
 Below 1GHz was RBW=100 KHz, VBW=300KHz,
 Above 1GHz was RBW= 1MHz , VBW= 3MHz

EUT Mode	Frequency (MHz)	CH	EUT Pol.	Antenna Pol.	SPA Reading (dBUV)	S.G. Output (dBm)	Antenna Gain (dBi)	Cable Loss (dB)	EIRP (dBm)	Limit (dBm)
PCS 1900	1850.20	512	H	V	118.81	14.42	9.90	5.56	18.76	33.00
				H	128.63	24.45	9.90	5.56	28.79	33.00
			E1	V	127.82	23.43	9.90	5.56	27.77	33.00
				H	126.97	22.79	9.90	5.56	27.13	33.00
			E2	V	125.49	21.10	9.90	5.56	25.44	33.00
				H	128.57	24.39	9.90	5.84	28.45	33.00
	1880.00	661	H	V	119.17	14.81	9.99	5.61	19.19	33.00
				H	128.80	24.66	9.99	5.61	29.03	33.00
			E1	V	127.69	23.33	9.99	5.61	27.71	33.00
				H	127.32	23.18	9.99	5.61	27.55	33.00
			E2	V	126.03	21.67	9.99	5.61	26.05	33.00
				H	129.24	25.10	9.99	5.61	29.47	33.00
	1909.80	810	H	V	119.97	15.64	10.08	5.66	20.06	33.00
				H	128.37	24.26	10.08	5.66	28.68	33.00
			E1	V	126.64	22.31	10.08	5.66	26.73	33.00
				H	125.95	21.84	10.08	5.66	26.26	33.00
			E2	V	125.84	21.51	10.08	5.66	25.93	33.00
				H	128.92	24.81	10.08	5.66	29.23	33.00

Remark :

- (1) The RBW,VBW of SPA for frequency
 Below 1GHz was RBW=100 KHz, VBW=300KHz,
 Above 1GHz was RBW= 1MHz , VBW= 3MHz

This document is issued by the Company subject to its General Conditions of Service printed overleaf or available on request and accessible at www.sgs.com. Attention is drawn to the limitations of liability, indemnification, and Jurisdictional issued defined therein. Unless otherwise stated, the results shown in this test report refer only to the sample(s) tested. This document cannot be reproduced except in full, without prior approval of Company. Any unauthorized alteration, forgery or falsification of the content or appearance of this report is unlawful and offenders may be prosecuted to the fullest extent of the law. 此報告是遵循本公司訂定之通用服務條款所製作發放，請注意此條款列印於背面，亦可在www.sgs.com中查閱。將本公司之義務，免責，管轄權皆明確規範之。除非另有說明，此報告結果僅對檢驗之樣品負責。本報告未經本公司書面許可，不可部份複製。對本報告內容或外觀之任何未經授權之變更、偽造、竄改皆屬非法，違犯者將會被依法追訴。

7. OCCUPIED BANDWIDTH MEASUREMENT

7.1 Standard Applicable

According to §FCC 2.1049.

7.2 Test Set-up:

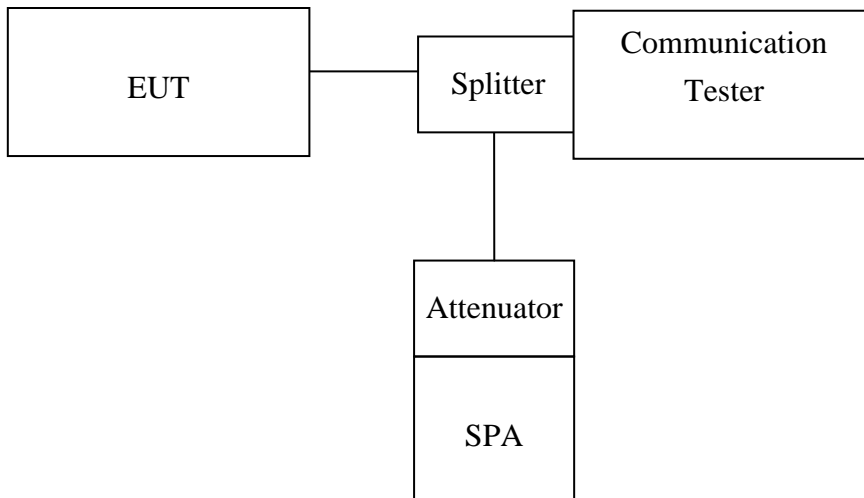

Note: Measurement setup for testing on Antenna connector

7.3 Measurement Procedure

The EUT's output RF connector was connected with a short cable to the spectrum analyzer, RBW (10/30KHz) was set to about 1% of emission BW, VBW= 3 times RBW(30/100KHz), -26dBc display line was placed on the screen (or 99% bandwidth), the occupied bandwidth is the delta frequency between the two points where the display line intersects the signal trace.

7.4 Measurement Equipment Used:

Conducted Emission Test Site					
EQUIPMENT TYPE	MFR	MODEL NUMBER	SERIAL NUMBER	LAST CAL.	CAL DUE.
Spectrum Analyzer	Agilent	E4446A	MY43360126	03/29/2006	03/28/2007
Spectrum Analyzer	Agilent	E7405A	US41160416	06/28/2006	06/29/2007
Communication Test	R&S	SMU200	N/A	N/A	N/A
Temperature Chamber	TERCHY	MHG-120LF	911009	10/14/2006	10/13/2007
Low Loss Cable	HUBER+SUHNER	SUCOFLEX 104PEA	N/A	N/A	N/A
Attenuator	Mini-Circuit	BW-S10W5	N/A	09/23/2006	09/22/2007
Attenuator	Mini-Circuit	BW-S6W5	N/A	09/23/2006	09/22/2007
Splitter	Agilent	11636B	51728	09/23/2006	09/22/2007
AC Power Supply	APW-105N	887592	All Power	N/A	N/A

7.5 Measurement Result:.

EUT Mode	Frequency (MHz)	CH	99% Bandwidth (MHz)
GSM 850	824.20	128	0.2406
	836.60	190	0.2413
	848.80	251	0.2433

EUT Mode	Frequency (MHz)	CH	99% Bandwidth (MHz)
PCS 1900	1850.20	512	0.2408
	1880.00	661	0.2398
	1909.80	810	0.2384

This document is issued by the Company subject to its General Conditions of Service printed overleaf or available on request and accessible at www.sgs.com. Attention is drawn to the limitations of liability, indemnification, and Jurisdictional issued defined therein. Unless otherwise stated, the results shown in this test report refer only to the sample(s) tested. This document cannot be reproduced except in full, without prior approval of Company. Any unauthorized alteration, forgery or falsification of the content or appearance of this report is unlawful and offenders may be prosecuted to the fullest extent of the law. 此報告是遵循本公司訂定之通用服務條款所製作發放，請注意此條款列印於背面，亦可在www.sgs.com中查閱。將本公司之義務，免責，管轄權皆明確規範之。除非另有說明，此報告結果僅對檢驗之樣品負責。本報告未經本公司書面許可，不可部份複製。對本報告內容或外觀之任何未經授權之變更、偽造、竄改皆屬非法，違犯者將會被依法追訴。

Figure 7-1: GSM Channel Low

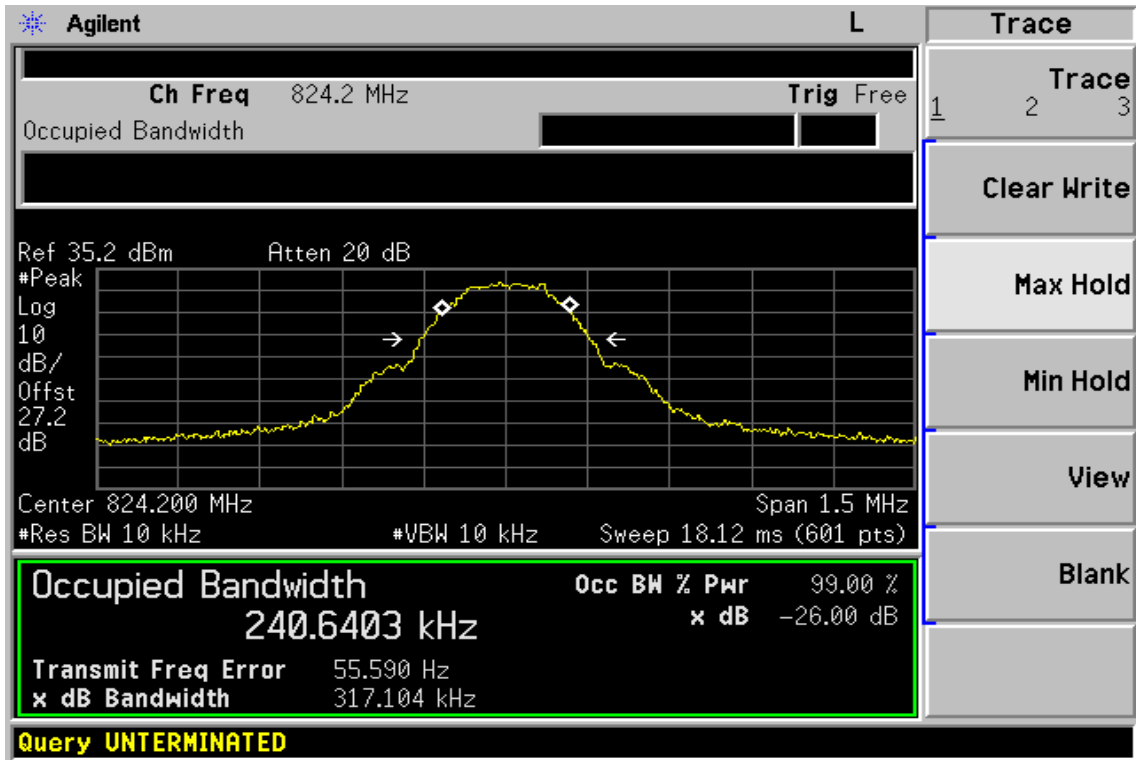
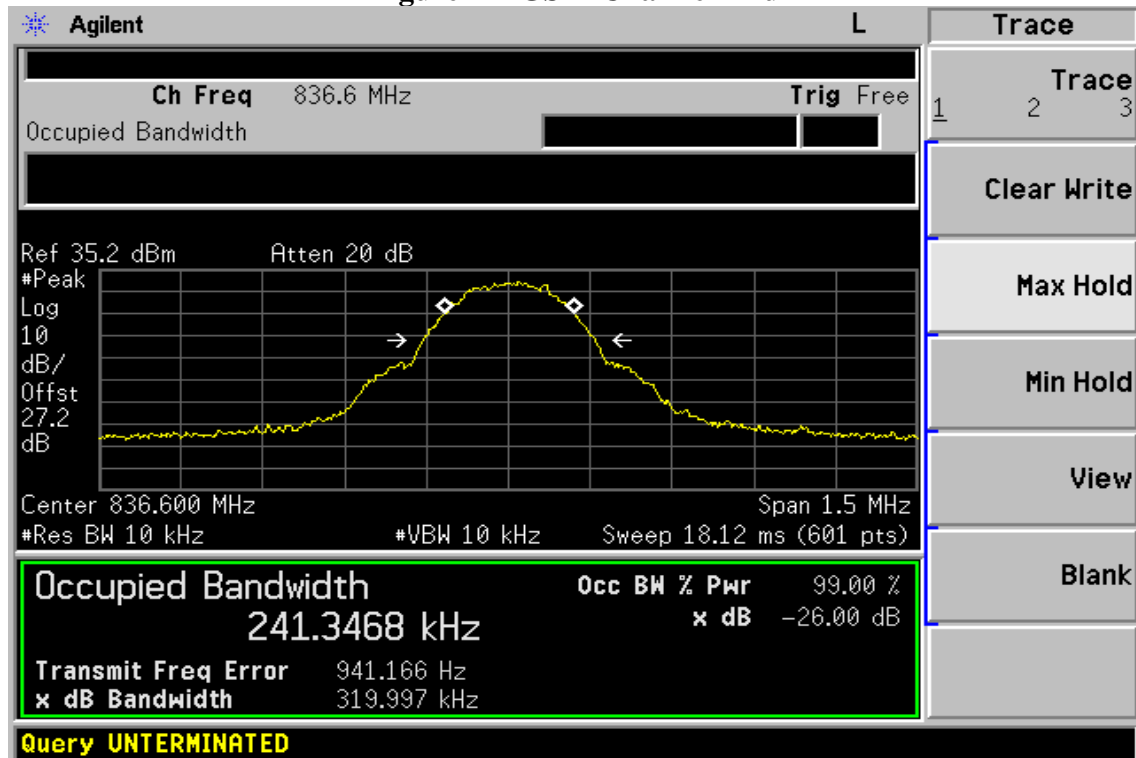

Figure 7-2 GSM Channel Mid



This document is issued by the Company subject to its General Conditions of Service printed overleaf or available on request and accessible at www.sgs.com. Attention is drawn to the limitations of liability, indemnification, and Jurisdictional issued defined therein. Unless otherwise stated, the results shown in this test report refer only to the sample(s) tested. This document cannot be reproduced except in full, without prior approval of Company. Any unauthorized alteration, forgery or falsification of the content or appearance of this report is unlawful and offenders may be prosecuted to the fullest extent of the law. 此報告是遵循本公司訂定之通用服務條款所製作發放，請注意此條款列印於背面，亦可在www.sgs.com中查閱。將本公司之義務，免責，管轄權皆明確規範之。除非另有說明，此報告結果僅對檢驗之樣品負責。本報告未經本公司書面許可，不可部份複製。對本報告內容或外觀之任何未經授權之變更、偽造、竄改皆屬非法，違犯者將會被依法追訴。

Figure 7-4: PCS Channel Low

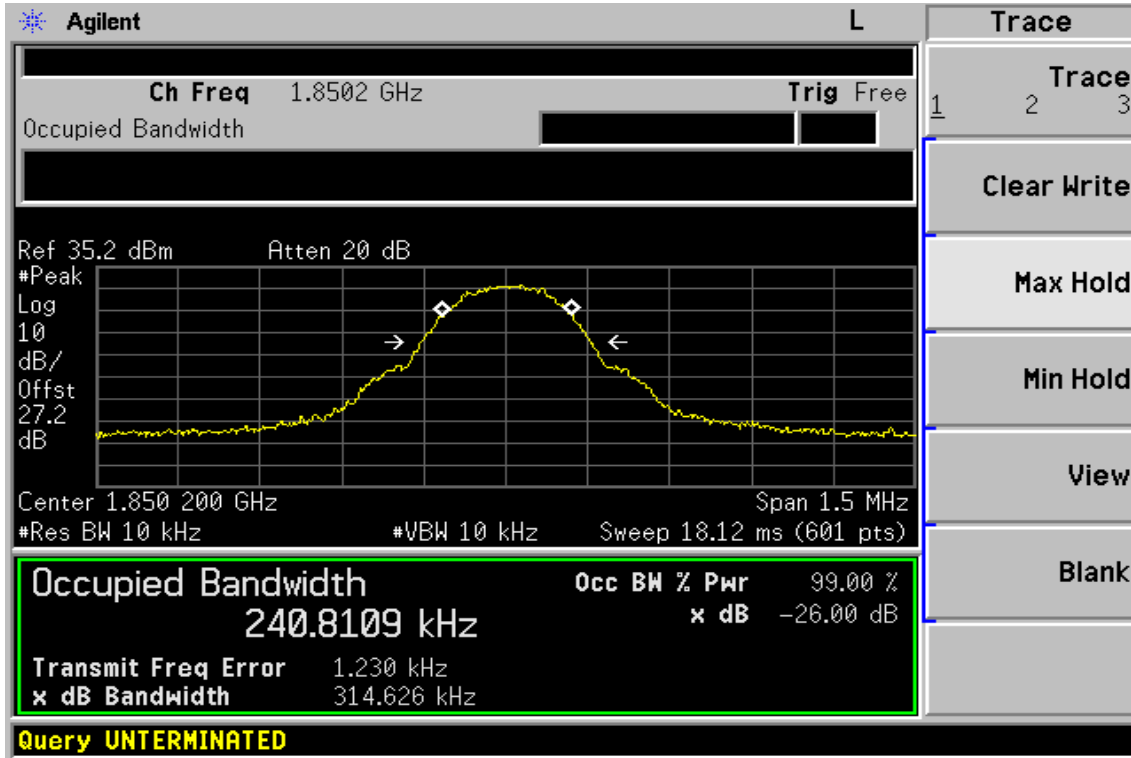
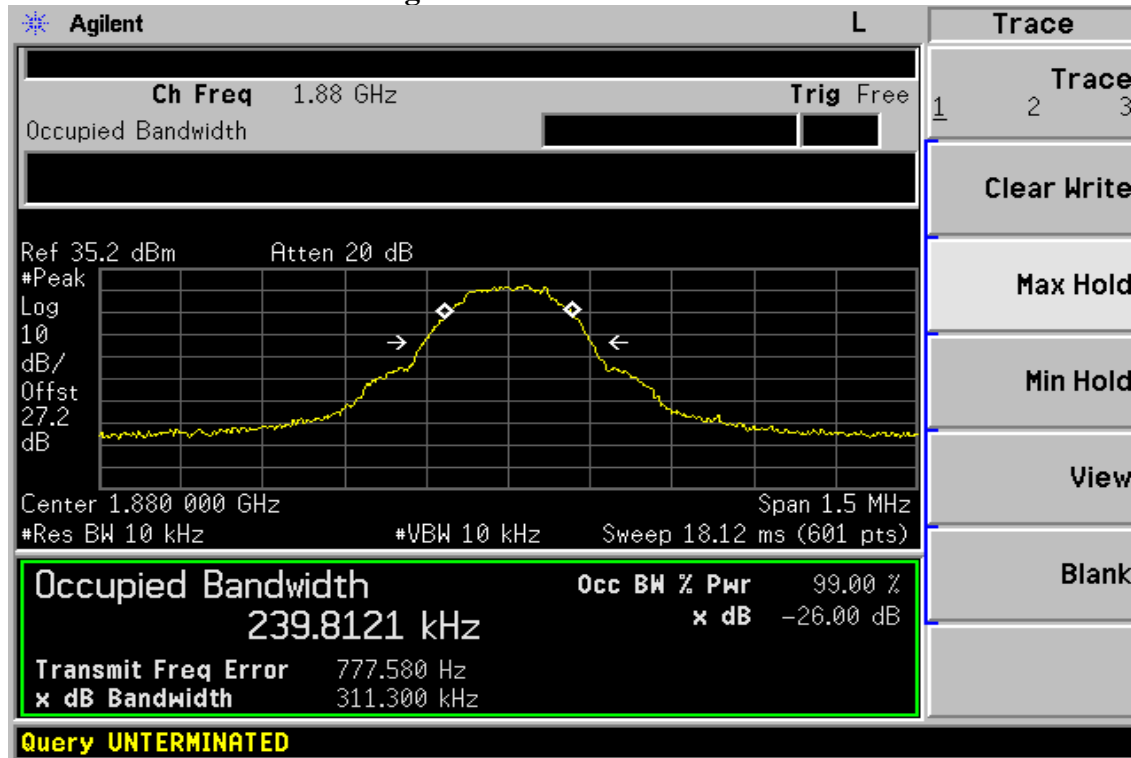
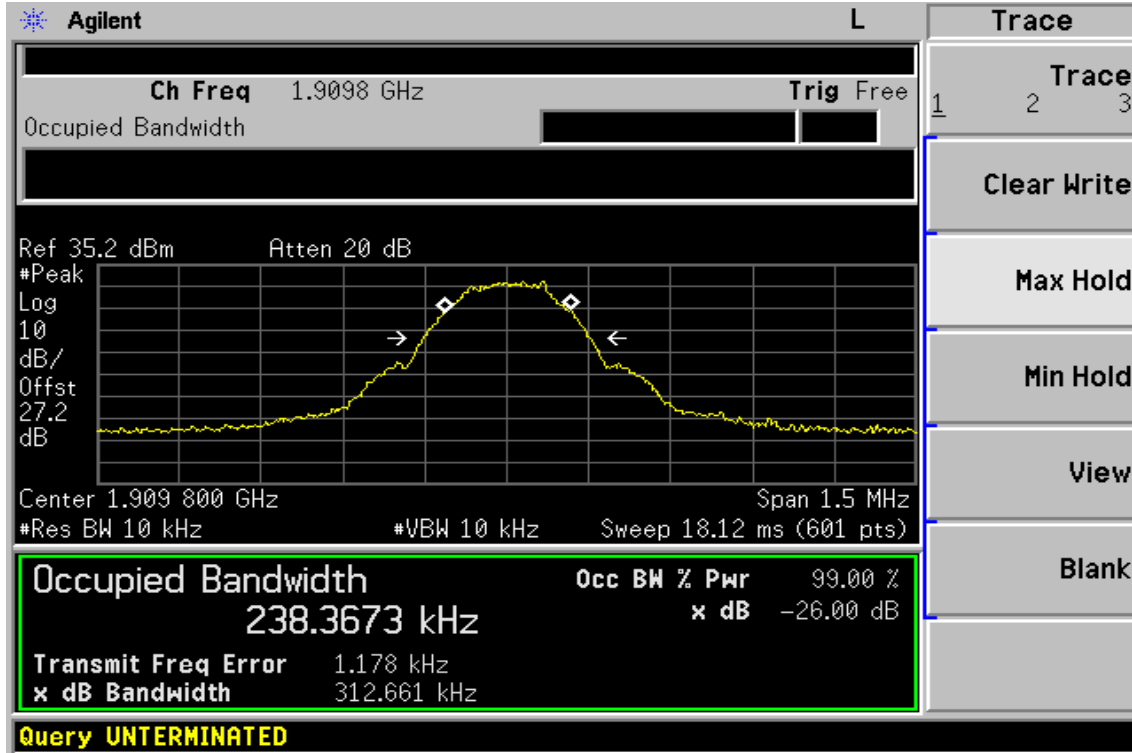

Figure 7-5 PCS Channel Mid



This document is issued by the Company subject to its General Conditions of Service printed overleaf or available on request and accessible at www.sgs.com. Attention is drawn to the limitations of liability, indemnification, and Jurisdictional issued defined therein. Unless otherwise stated, the results shown in this test report refer only to the sample(s) tested. This document cannot be reproduced except in full, without prior approval of Company. Any unauthorized alteration, forgery or falsification of the content or appearance of this report is unlawful and offenders may be prosecuted to the fullest extent of the law. 此報告是遵循本公司訂定之通用服務條款所製作發放，請注意此條款列印於背面，亦可在www.sgs.com中查閱。將本公司之義務，免責，管轄權皆明確規範之。除非另有說明，此報告結果僅對檢驗之樣品負責。本報告未經本公司書面許可，不可部份複製。對本報告內容或外觀之任何未經授權之變更、偽造、竄改皆屬非法，違犯者將會被依法追訴。

Figure 7-6: PCS Channel High



This document is issued by the Company subject to its General Conditions of Service printed overleaf or available on request and accessible at www.sgs.com. Attention is drawn to the limitations of liability, indemnification, and Jurisdictional issued defined therein. Unless otherwise stated, the results shown in this test report refer only to the sample(s) tested. This document cannot be reproduced except in full, without prior approval of Company. Any unauthorized alteration, forgery or falsification of the content or appearance of this report is unlawful and offenders may be prosecuted to the fullest extent of the law. 此報告是遵循本公司訂定之通用服務條款所製作發放，請注意此條款列印於背面，亦可在www.sgs.com中查閱。將本公司之義務，免責，管轄權皆明確規範之。除非另有說明，此報告結果僅對檢驗之樣品負責。本報告未經本公司書面許可，不可部份複製。對本報告內容或外觀之任何未經授權之變更、偽造、竄改皆屬非法，違犯者將會被依法追訴。

8. OUT OF BAND EMISSION AT ANTENNA TERMINALS

8.1 Standard Applicable

According to FCC §2.1051.

FCC §22.917(a),§24.238(a), the magnitude of each spurious and harmonic emission that can be detected when the equipment is operated under the conditions specified in the instruction manual and/ or alignment procedure, shall not be less than $43 + 10 \log$ (mean output power in watts) dBc below the mean power output outside a license's frequency block (-13dBm)

8.2 Test SET-UP

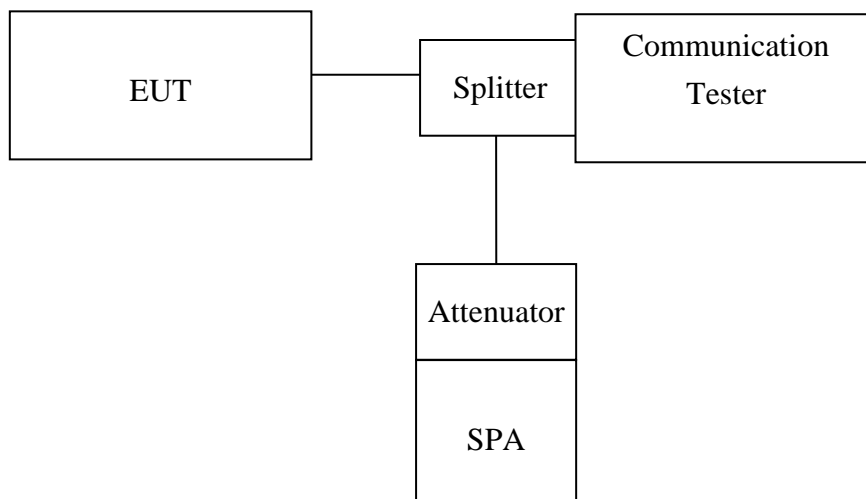

Note: Measurement setup for testing on Antenna connector

8.3 Measurement Procedure

The RF output of the transceiver was connected to a spectrum analyzer through appropriate attenuation. The resolution bandwidth of the spectrum analyzer was set at 1MHz, sufficient scans were taken to show the out of band Emissions if any up to 10th harmonic.

For the out of band: Set the RBW, VBW = 1MHz, Start=30MHz, Stop= 10 th harmonic.
Limit = -13dBm

Band Edge Requirements: In the 1 MHz bands immediately outside and adjacent to the frequency block, a resolution bandwidth of at least 1 percent of the emission bandwidth of the fundamental emission of the transmitter may be employed to measure the out of band Emissions. Limit, -13dBm.

This document is issued by the Company subject to its General Conditions of Service printed overleaf or available on request and accessible at www.sgs.com. Attention is drawn to the limitations of liability, indemnification, and Jurisdictional issued defined therein. Unless otherwise stated, the results shown in this test report refer only to the sample(s) tested. This document cannot be reproduced except in full, without prior approval of Company. Any unauthorized alteration, forgery or falsification of the content or appearance of this report is unlawful and offenders may be prosecuted to the fullest extent of the law. 此報告是遵循本公司訂定之通用服務條款所製作發放，請注意此條款列印於背面，亦可在www.sgs.com中查閱。將本公司之義務，免責，管轄權皆明確規範之。除非另有說明，此報告結果僅對檢驗之樣品負責。本報告未經本公司書面許可，不可部份複製。對本報告內容或外觀之任何未經授權之變更、偽造、竄改皆屬非法，違犯者將會被依法追訴。

8.4 Measurement Equipment Used:

Conducted Emission Test Site					
EQUIPMENT TYPE	MFR	MODEL NUMBER	SERIAL NUMBER	LAST CAL.	CAL DUE.
Spectrum Analyzer	Agilent	E4446A	MY43360126	03/29/2006	03/28/2007
Spectrum Analyzer	Agilent	E7405A	US41160416	06/28/2006	06/29/2007
Communication Test	R&S	SMU200	N/A	N/A	N/A
Temperature Chamber	TERCHY	MHG-120LF	911009	10/14/2006	10/13/2007
Low Loss Cable	HUBER+SUHNER	SUCOFLEX 104PEA	N/A	N/A	N/A
Attenuator	Mini-Circuit	BW-S10W5	N/A	09/23/2006	09/22/2007
Attenuator	Mini-Circuit	BW-S6W5	N/A	09/23/2006	09/22/2007
Splitter	Agilent	11636B	51728	09/23/2006	09/22/2007
AC Power Supply	APW-105N	887592	All Power	N/A	N/A

This document is issued by the Company subject to its General Conditions of Service printed overleaf or available on request and accessible at www.sgs.com. Attention is drawn to the limitations of liability, indemnification, and Jurisdictional issued defined therein. Unless otherwise stated, the results shown in this test report refer only to the sample(s) tested. This document cannot be reproduced except in full, without prior approval of Company. Any unauthorized alteration, forgery or falsification of the content or appearance of this report is unlawful and offenders may be prosecuted to the fullest extent of the law. 此報告是遵循本公司訂定之通用服務條款所製作發放，請注意此條款列印於背面，亦可在www.sgs.com中查閱。將本公司之義務，免責，管轄權皆明確規範之。除非另有說明，此報告結果僅對檢驗之樣品負責。本報告未經本公司書面許可，不可部份複製。對本報告內容或外觀之任何未經授權之變更、偽造、竄改皆屬非法，違犯者將會被依法追訴。

8.5 Measurement Result

Figure 8-1: Out of Band emission at antenna terminals– GSM Channel Lowest

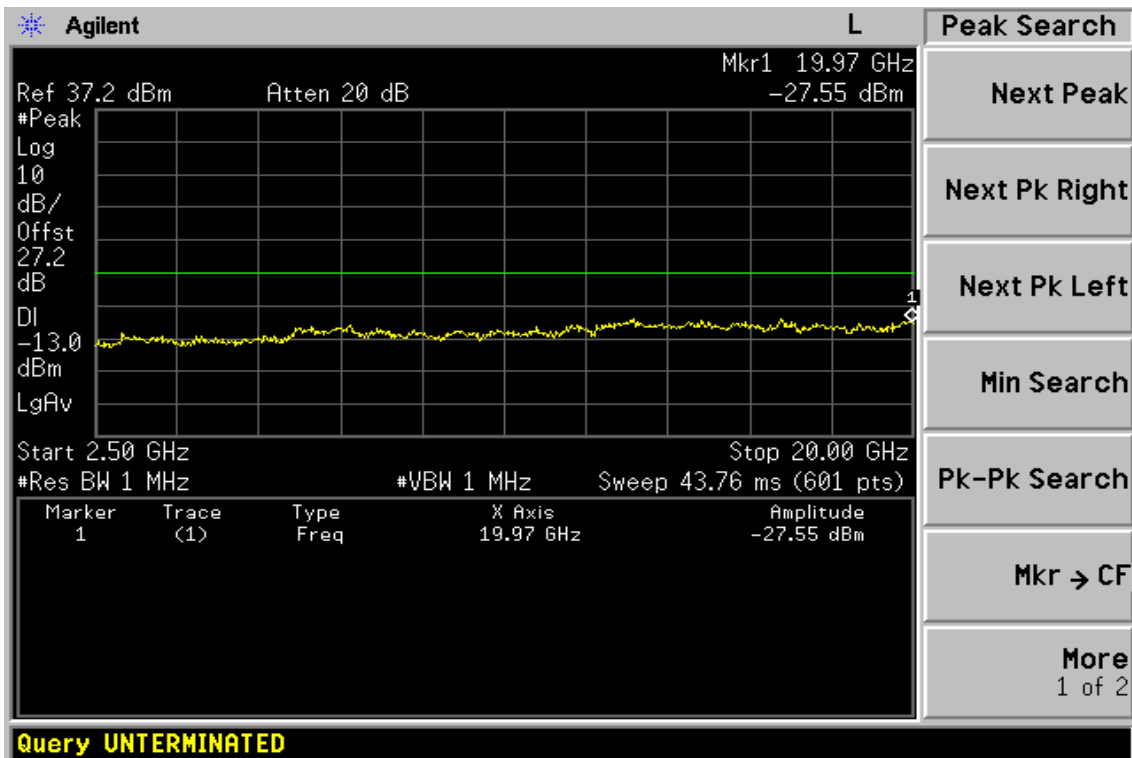
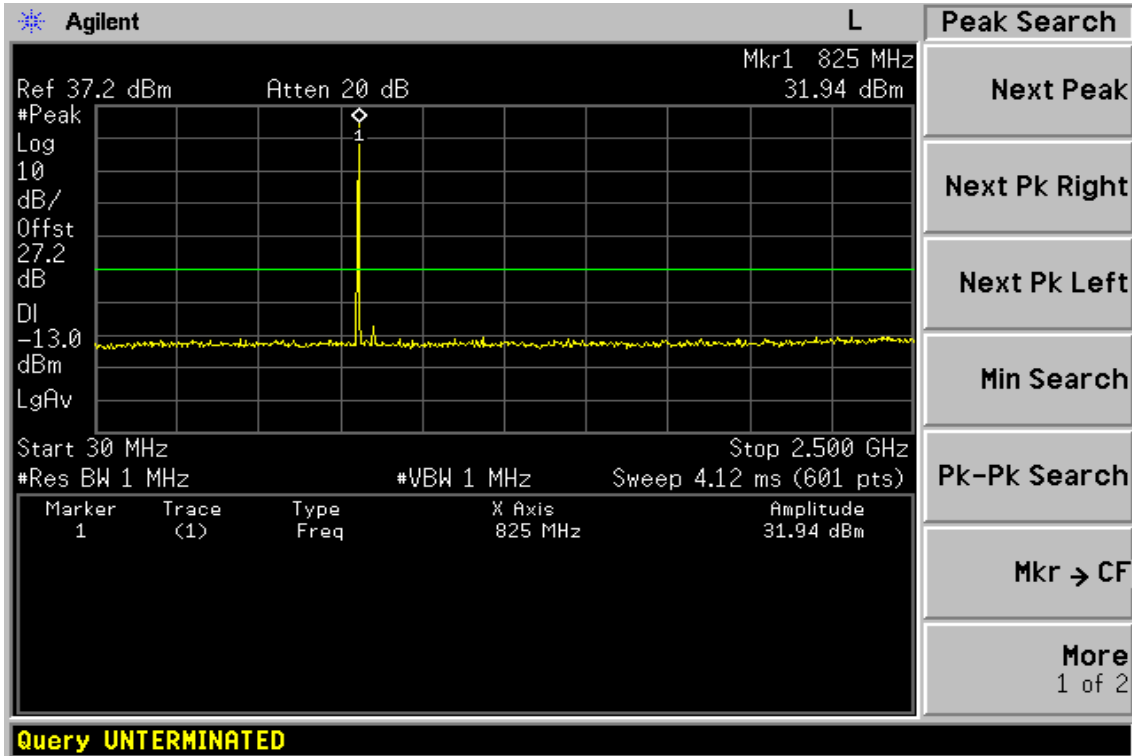

This document is issued by the Company subject to its General Conditions of Service printed overleaf or available on request and accessible at www.sgs.com. Attention is drawn to the limitations of liability, indemnification, and Jurisdictional issued defined therein. Unless otherwise stated, the results shown in this test report refer only to the sample(s) tested. This document cannot be reproduced except in full, without prior approval of Company. Any unauthorized alteration, forgery or falsification of the content or appearance of this report is unlawful and offenders may be prosecuted to the fullest extent of the law. 此報告是遵循本公司訂定之通用服務條款所製作發放，請注意此條款列印於背面，亦可在www.sgs.com中查閱。將本公司之義務，免責，管轄權皆明確規範之。除非另有說明，此報告結果僅對檢驗之樣品負責。本報告未經本公司書面許可，不可部份複製。對本報告內容或外觀之任何未經授權之變更、偽造、竄改皆屬非法，違犯者將會被依法追訴。

Figure 8-2: Out of Band emission at antenna terminals –GSM Channel Mid

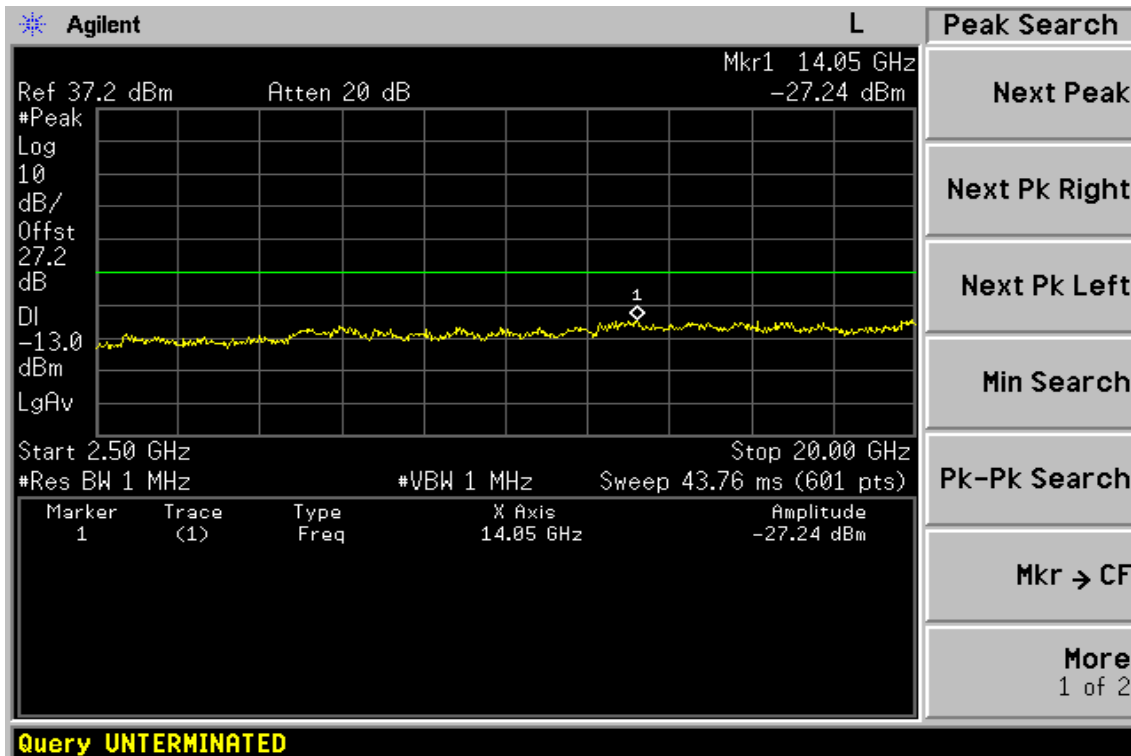
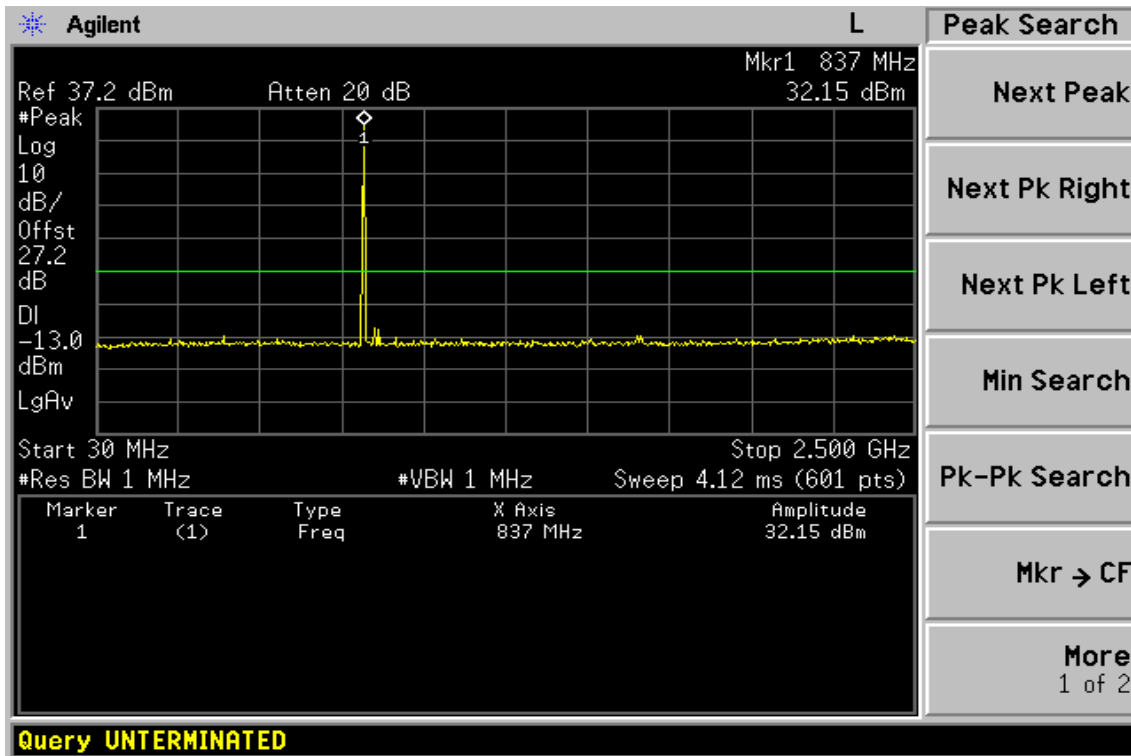

This document is issued by the Company subject to its General Conditions of Service printed overleaf or available on request and accessible at www.sgs.com. Attention is drawn to the limitations of liability, indemnification, and Jurisdictional issued defined therein. Unless otherwise stated, the results shown in this test report refer only to the sample(s) tested. This document cannot be reproduced except in full, without prior approval of Company. Any unauthorized alteration, forgery or falsification of the content or appearance of this report is unlawful and offenders may be prosecuted to the fullest extent of the law. 此報告是遵循本公司訂定之通用服務條款所製作發放，請注意此條款列印於背面，亦可在www.sgs.com中查閱。將本公司之義務，免責，管轄權皆明確規範之。除非另有說明，此報告結果僅對檢驗之樣品負責。本報告未經本公司書面許可，不可部份複製。對本報告內容或外觀之任何未經授權之變更、偽造、竄改皆屬非法，違犯者將會被依法追訴。

Figure 8-3: Out of Band emission at antenna terminals–GSM Channel Highest

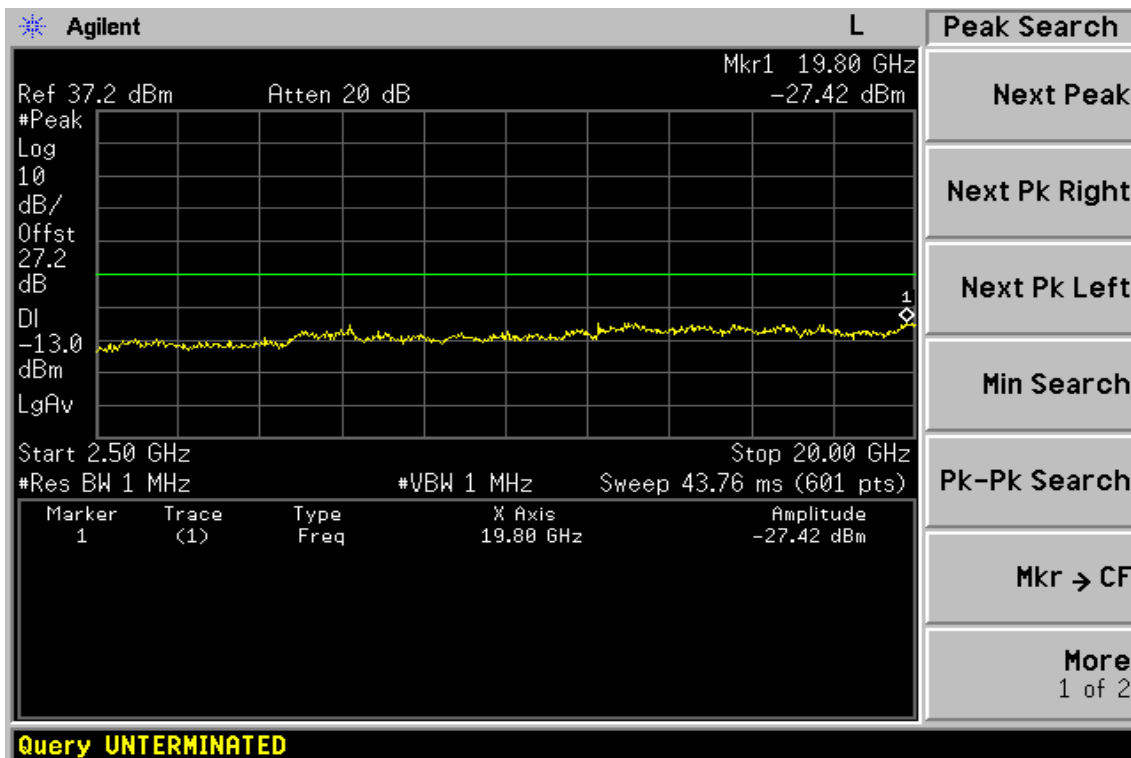
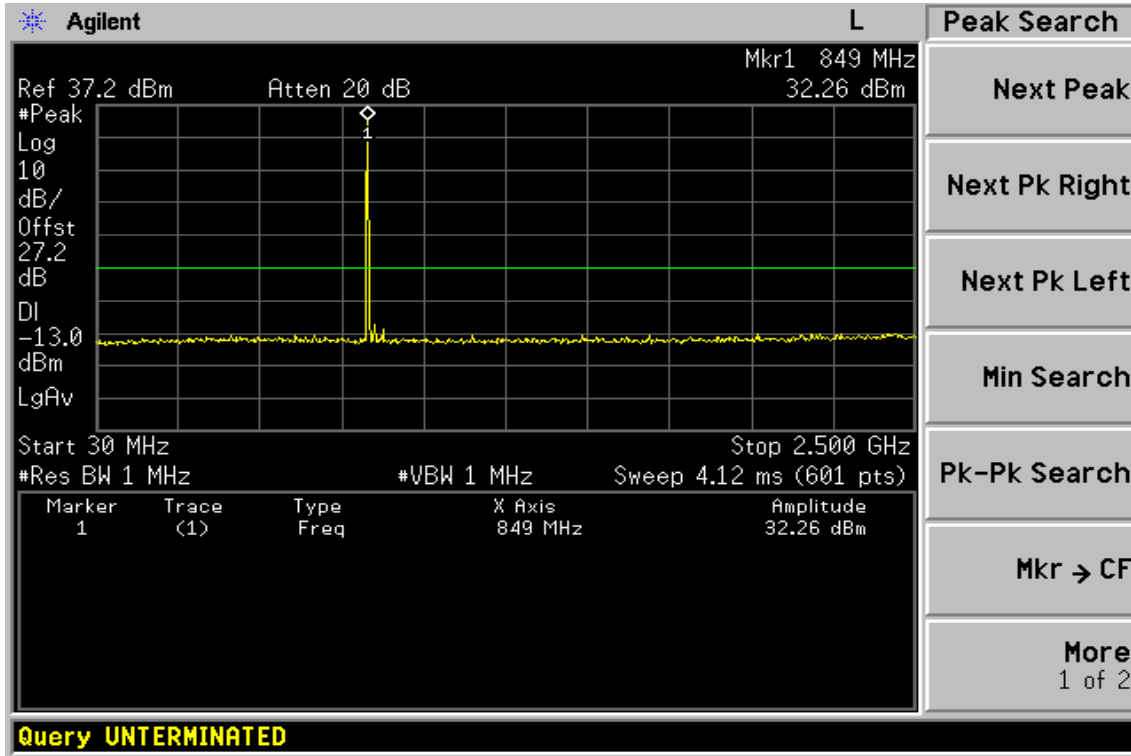

This document is issued by the Company subject to its General Conditions of Service printed overleaf or available on request and accessible at www.sgs.com. Attention is drawn to the limitations of liability, indemnification, and Jurisdictional issued defined therein. Unless otherwise stated, the results shown in this test report refer only to the sample(s) tested. This document cannot be reproduced except in full, without prior approval of Company. Any unauthorized alteration, forgery or falsification of the content or appearance of this report is unlawful and offenders may be prosecuted to the fullest extent of the law. 此報告是遵循本公司訂定之通用服務條款所製作發放，請注意此條款列印於背面，亦可在www.sgs.com中查閱。將本公司之義務，免責，管轄權皆明確規範之。除非另有說明，此報告結果僅對檢驗之樣品負責。本報告未經本公司書面許可，不可部份複製。對本報告內容或外觀之任何未經授權之變更、偽造、竄改皆屬非法，違犯者將會被依法追訴。

Figure 8-4: Bad edge emission at antenna terminals – GSM Channel Lowest

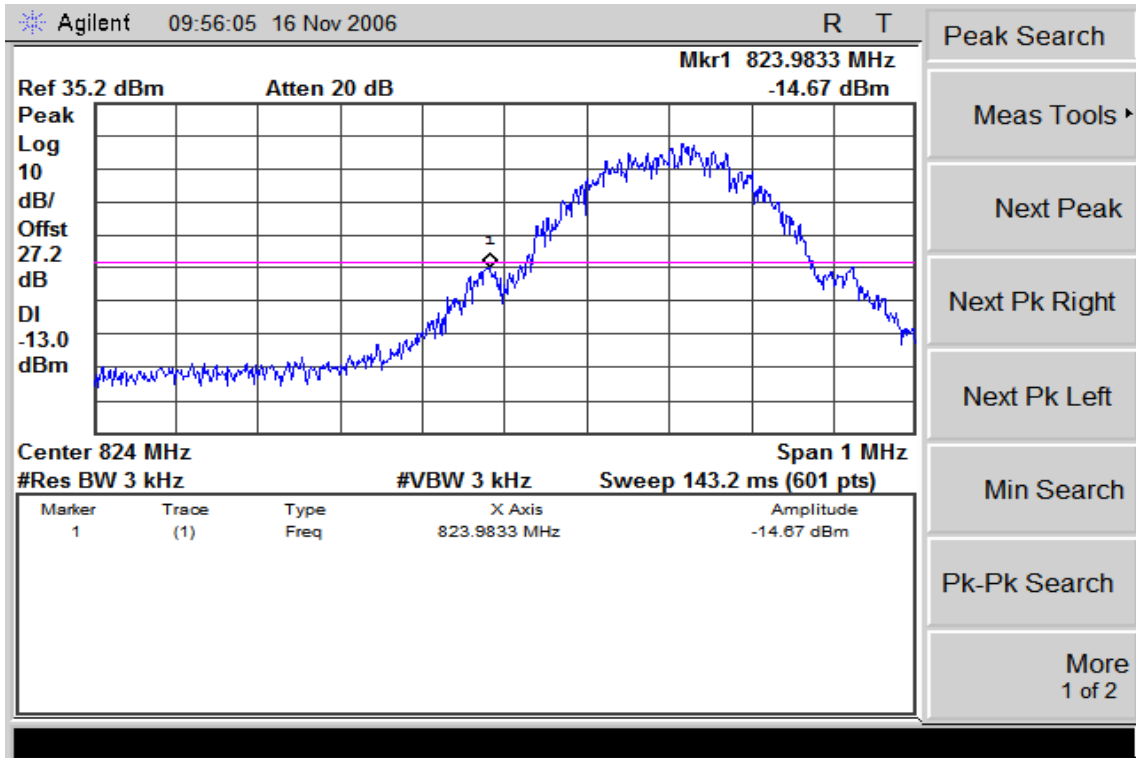
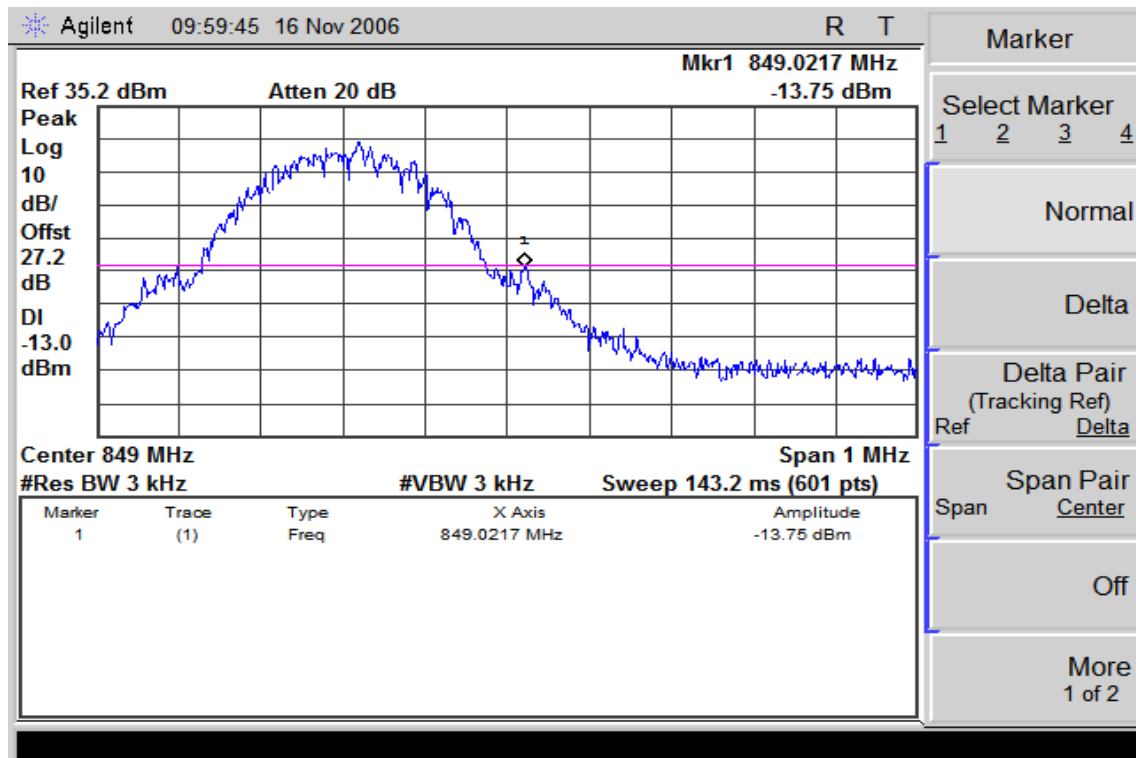
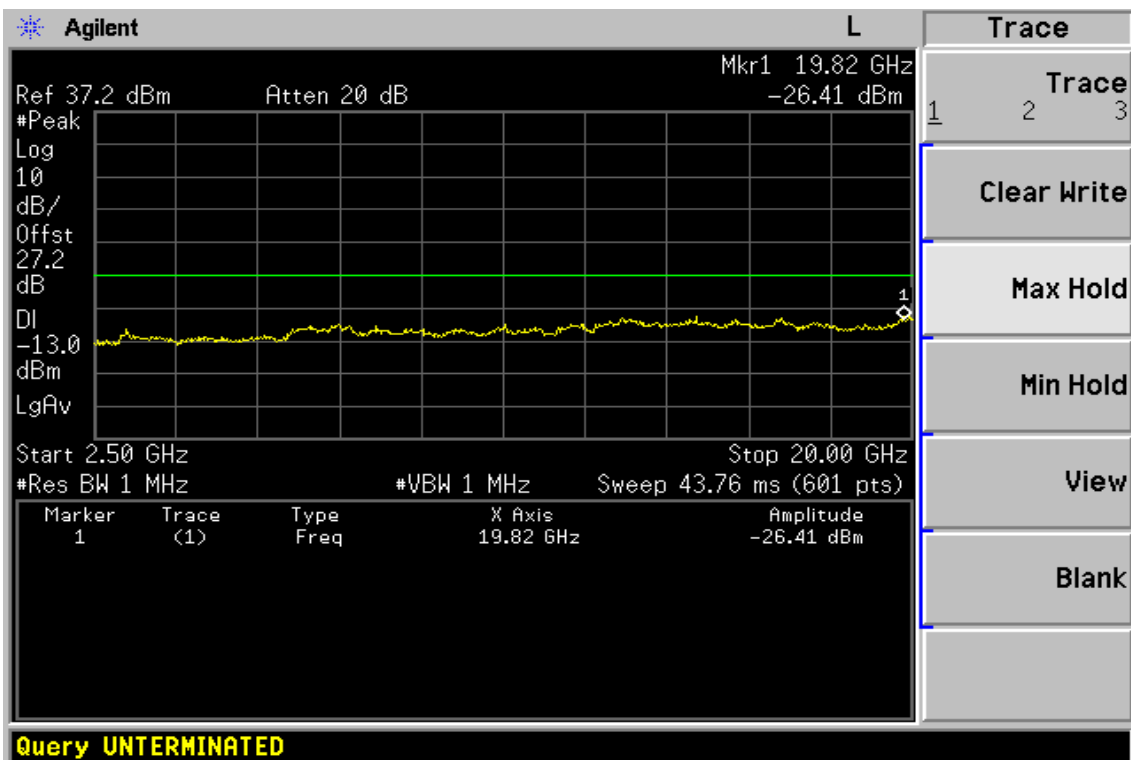
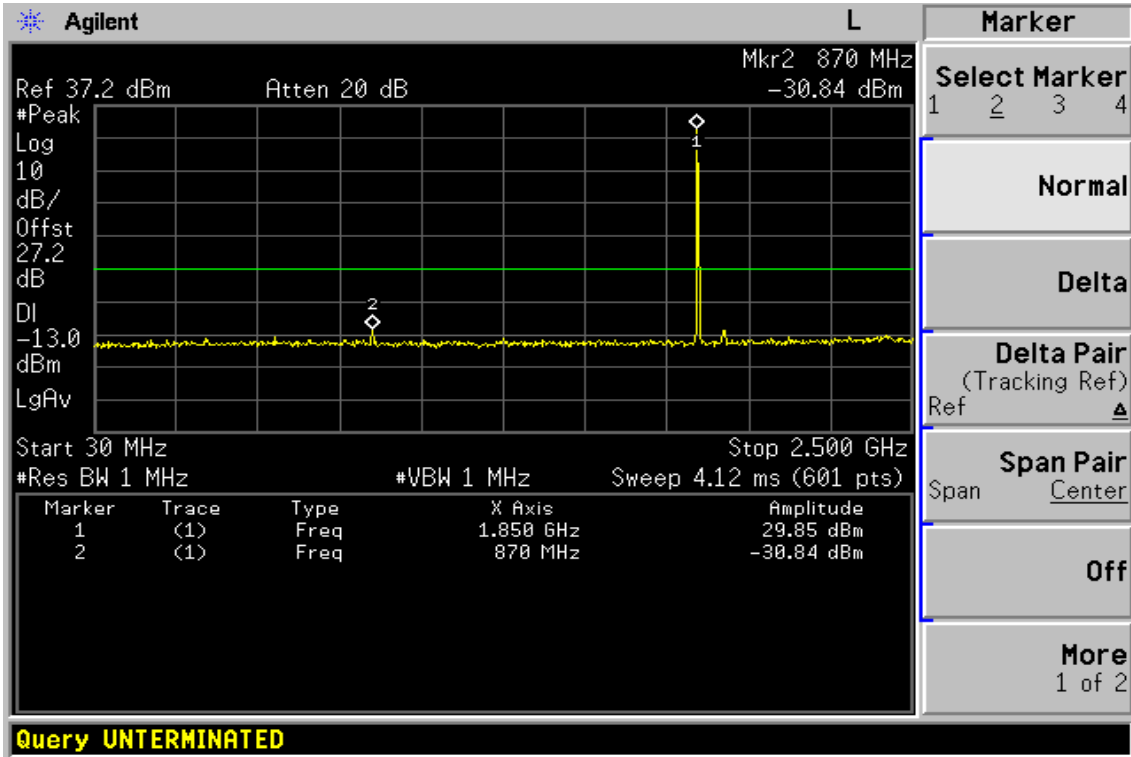

Figure 8-5: Band edge emission at antenna terminals – GSM Channel Highest



This document is issued by the Company subject to its General Conditions of Service printed overleaf or available on request and accessible at www.sgs.com. Attention is drawn to the limitations of liability, indemnification, and Jurisdictional issued defined therein. Unless otherwise stated, the results shown in this test report refer only to the sample(s) tested. This document cannot be reproduced except in full, without prior approval of Company. Any unauthorized alteration, forgery or falsification of the content or appearance of this report is unlawful and offenders may be prosecuted to the fullest extent of the law. 此報告是遵循本公司訂定之通用服務條款所製作發放，請注意此條款列印於背面，亦可在www.sgs.com中查閱。將本公司之義務，免責，管轄權皆明確規範之。除非另有說明，此報告結果僅對檢驗之樣品負責。本報告未經本公司書面許可，不可部份複製。對本報告內容或外觀之任何未經授權之變更、偽造、竄改皆屬非法，違犯者將會被依法追訴。

Figure 8-6: Out of Band emission at antenna terminals– PCS Channel Lowest



This document is issued by the Company subject to its General Conditions of Service printed overleaf or available on request and accessible at www.sgs.com. Attention is drawn to the limitations of liability, indemnification, and Jurisdictional issued defined therein. Unless otherwise stated, the results shown in this test report refer only to the sample(s) tested. This document cannot be reproduced except in full, without prior approval of Company. Any unauthorized alteration, forgery or falsification of the content or appearance of this report is unlawful and offenders may be prosecuted to the fullest extent of the law. 此報告是遵循本公司訂定之通用服務條款所製作發放，請注意此條款列印於背面，亦可在www.sgs.com中查閱。將本公司之義務，免責，管轄權皆明確規範之。除非另有說明，此報告結果僅對檢驗之樣品負責。本報告未經本公司書面許可，不可部份複製。對本報告內容或外觀之任何未經授權之變更、偽造、竄改皆屬非法，違犯者將會被依法追訴。

Figure 8-7: Out of Band emission at antenna terminals –PCS Channel Mid

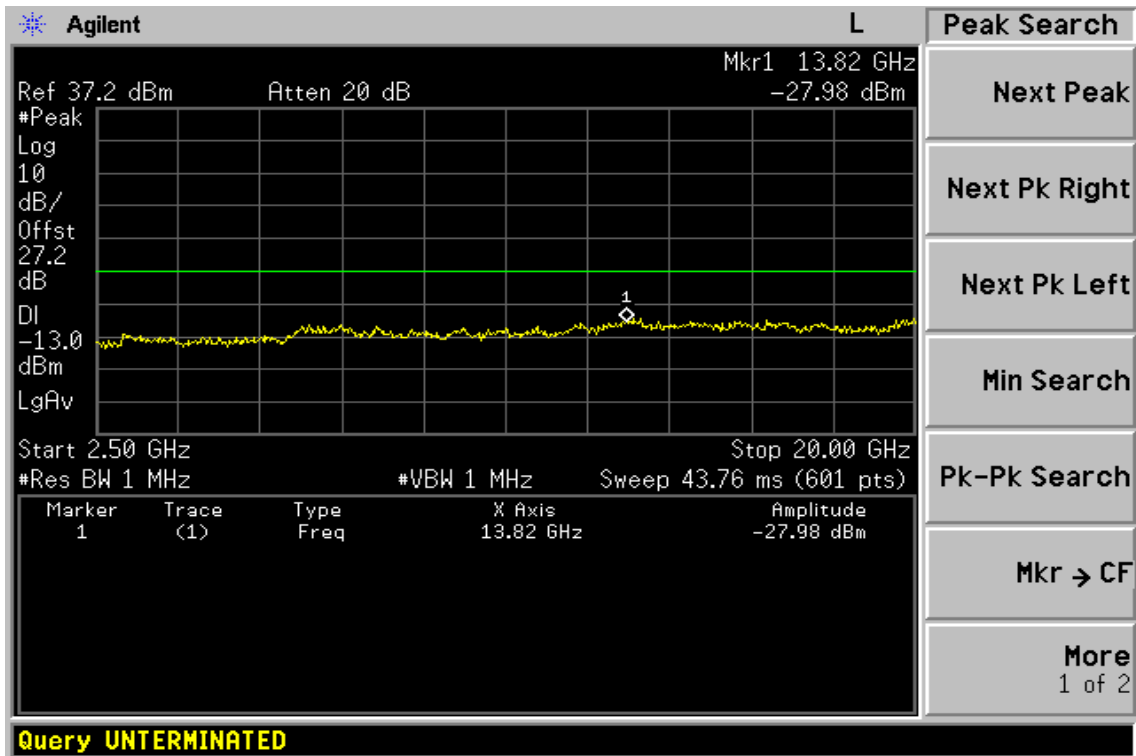
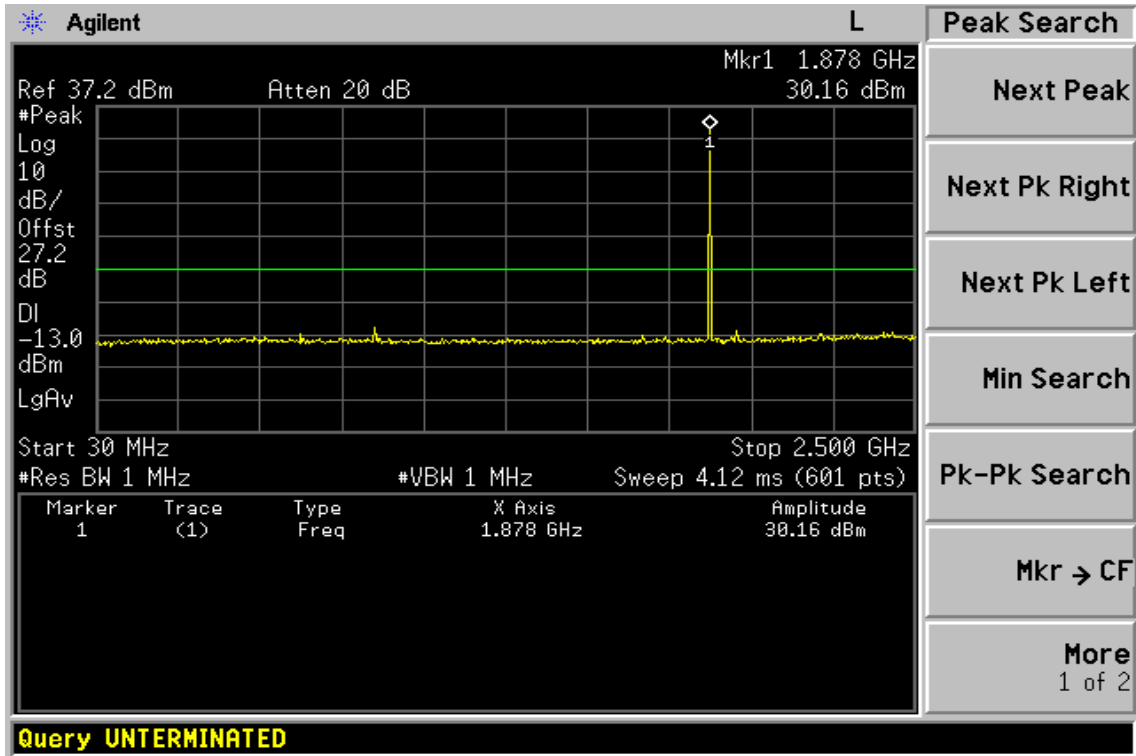

This document is issued by the Company subject to its General Conditions of Service printed overleaf or available on request and accessible at www.sgs.com. Attention is drawn to the limitations of liability, indemnification, and Jurisdictional issued defined therein. Unless otherwise stated, the results shown in this test report refer only to the sample(s) tested. This document cannot be reproduced except in full, without prior approval of Company. Any unauthorized alteration, forgery or falsification of the content or appearance of this report is unlawful and offenders may be prosecuted to the fullest extent of the law. 此報告是遵循本公司訂定之通用服務條款所製作發放，請注意此條款列印於背面，亦可在www.sgs.com中查閱。將本公司之義務，免責，管轄權皆明確規範之。除非另有說明，此報告結果僅對檢驗之樣品負責。本報告未經本公司書面許可，不可部份複製。對本報告內容或外觀之任何未經授權之變更、偽造、竄改皆屬非法，違犯者將會被依法追訴。

Figure 8-8: Out of Band emission at antenna terminals–PCS Channel Highest

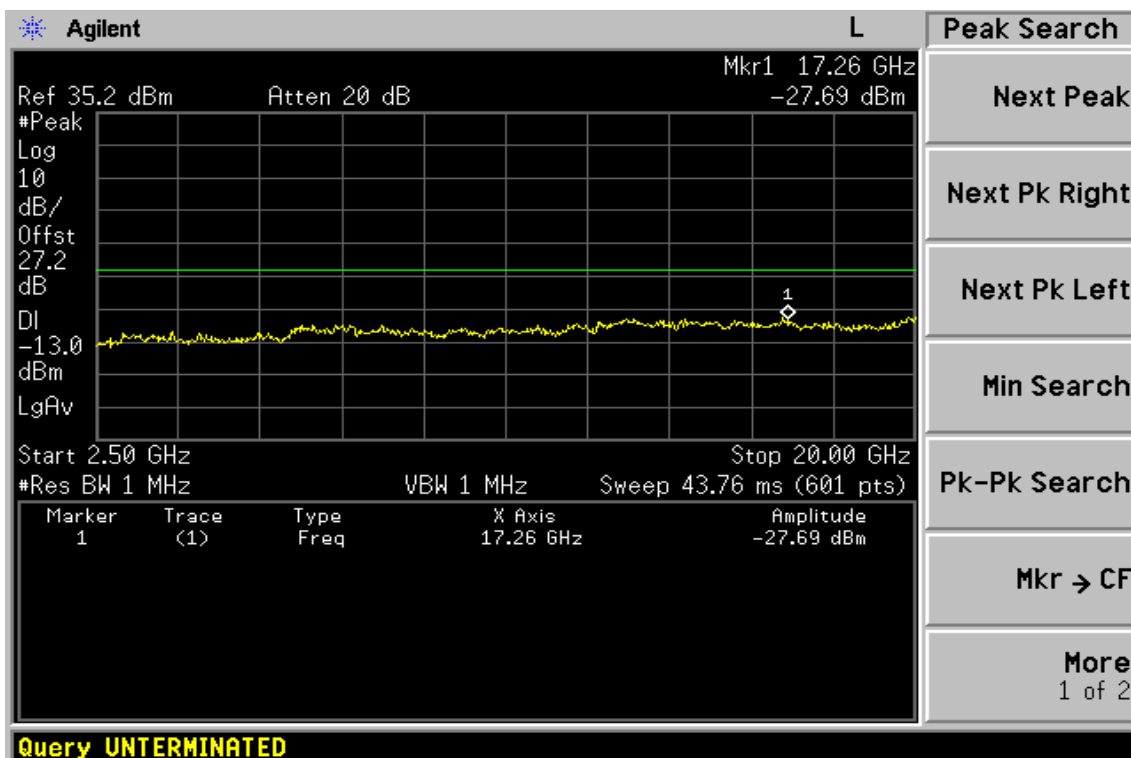
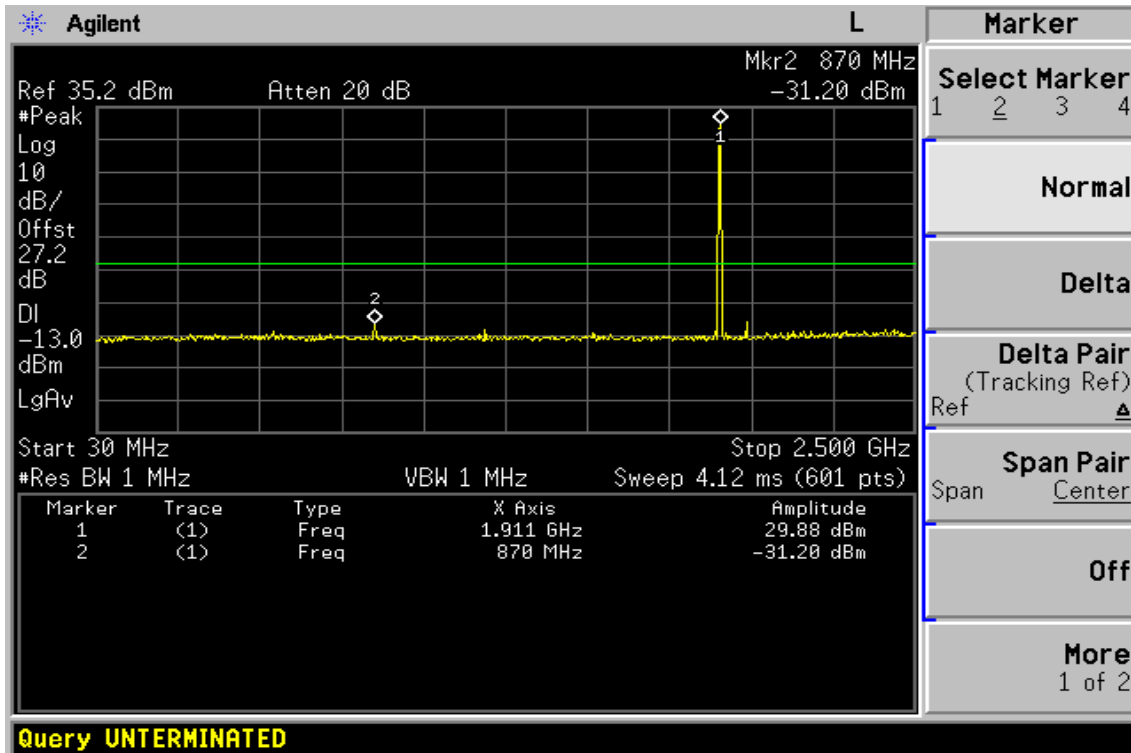

This document is issued by the Company subject to its General Conditions of Service printed overleaf or available on request and accessible at www.sgs.com. Attention is drawn to the limitations of liability, indemnification, and Jurisdictional issued defined therein. Unless otherwise stated, the results shown in this test report refer only to the sample(s) tested. This document cannot be reproduced except in full, without prior approval of Company. Any unauthorized alteration, forgery or falsification of the content or appearance of this report is unlawful and offenders may be prosecuted to the fullest extent of the law. 此報告是遵循本公司訂定之通用服務條款所製作發放，請注意此條款列印於背面，亦可在www.sgs.com中查閱。將本公司之義務，免責，管轄權皆明確規範之。除非另有說明，此報告結果僅對檢驗之樣品負責。本報告未經本公司書面許可，不可部份複製。對本報告內容或外觀之任何未經授權之變更、偽造、竄改皆屬非法，違犯者將會被依法追訴。

Figure 8-9: Bad edge emission at antenna terminals – PCS Channel Lowest

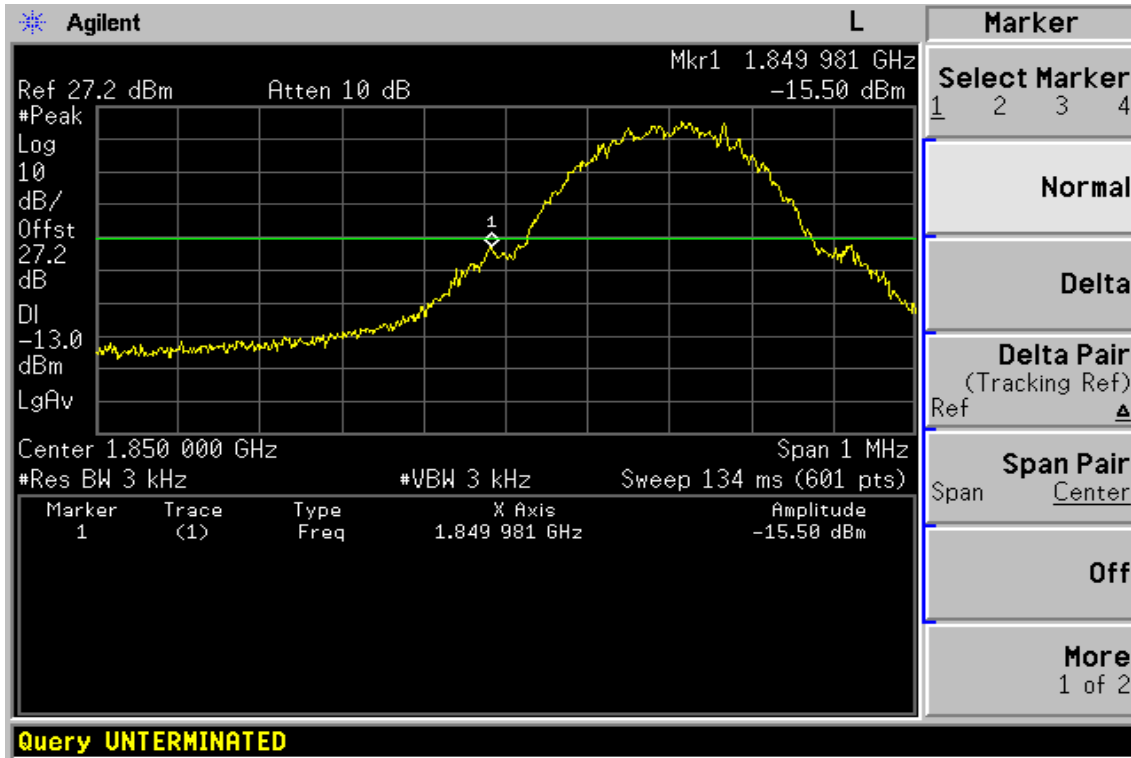
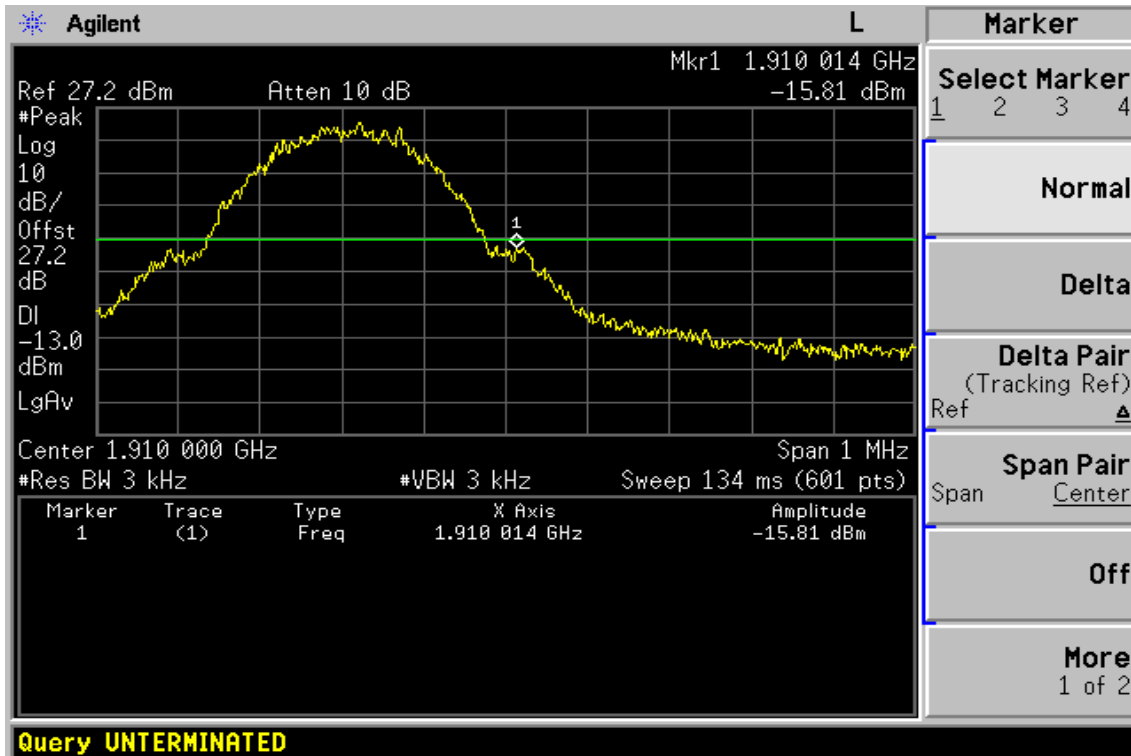

Figure 8-10: Band edge emission at antenna terminals – PCS Channel Highest



This document is issued by the Company subject to its General Conditions of Service printed overleaf or available on request and accessible at www.sgs.com. Attention is drawn to the limitations of liability, indemnification, and Jurisdictional issued defined therein. Unless otherwise stated, the results shown in this test report refer only to the sample(s) tested. This document cannot be reproduced except in full, without prior approval of Company. Any unauthorized alteration, forgery or falsification of the content or appearance of this report is unlawful and offenders may be prosecuted to the fullest extent of the law. 此報告是遵循本公司訂定之通用服務條款所製作發放，請注意此條款列印於背面，亦可在www.sgs.com中查閱。將本公司之義務，免責，管轄權皆明確規範之。除非另有說明，此報告結果僅對檢驗之樣品負責。本報告未經本公司書面許可，不可部份複製。對本報告內容或外觀之任何未經授權之變更、偽造、竄改皆屬非法，違犯者將會被依法追訴。

9. FIELD STRENGTH OF SPURIOUS RADIATION MEASUREMENT

9.1 Standard Applicable

According to FCC §2.1053,

FCC §22.917(a),§24.238(a), the magnitude of each spurious and harmonic emission that can be detected when the equipment is operated under the conditions specified in the instruction manual and/ or alignment procedure, shall not be less than $43 + 10 \log$ (mean output power in watts) dBc below the mean power output outside a license's frequency block (-13dBm)

9.2 EUT Setup (Block Diagram of Configuration)

(A) Radiated Emission Test Set-Up, Frequency Below 1000MHz

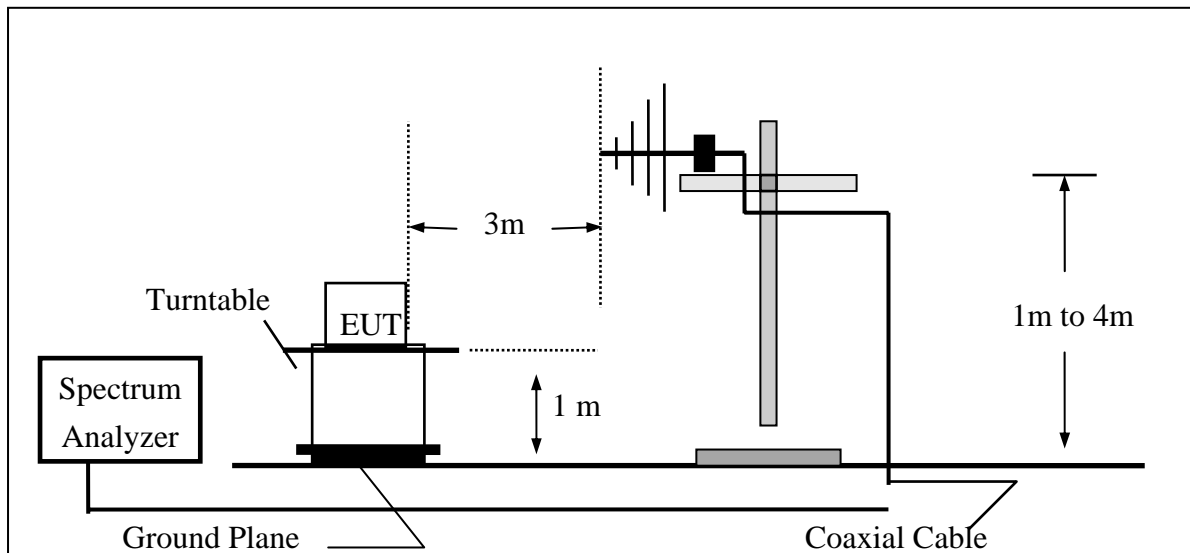

(B) Radiated Emission Test Set-UP Frequency Over 1 GHz

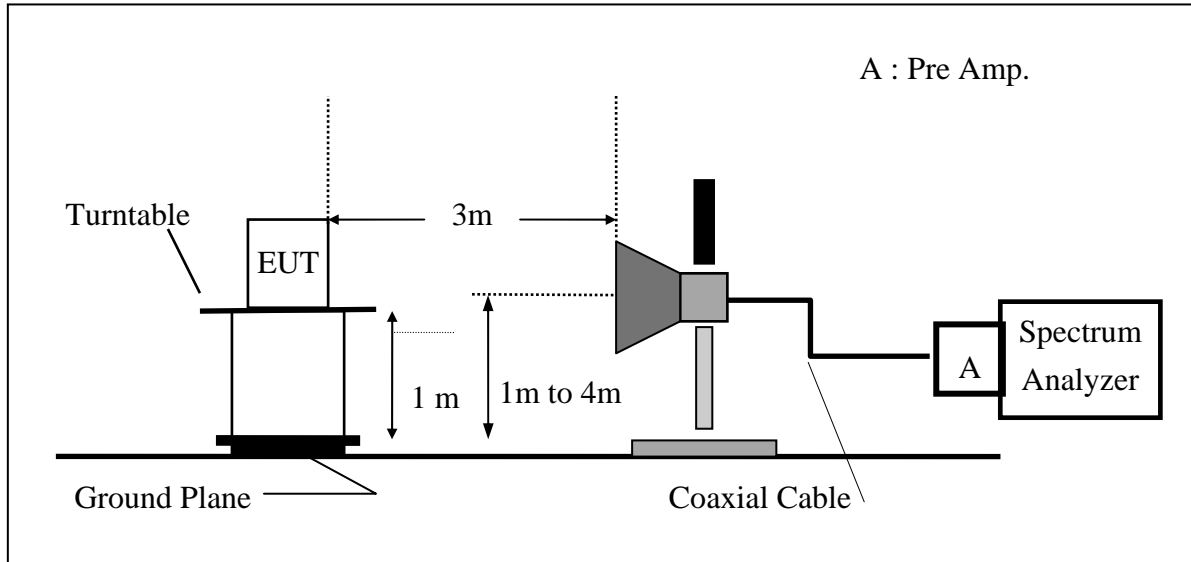

(C) Substituted Method Test Set-UP

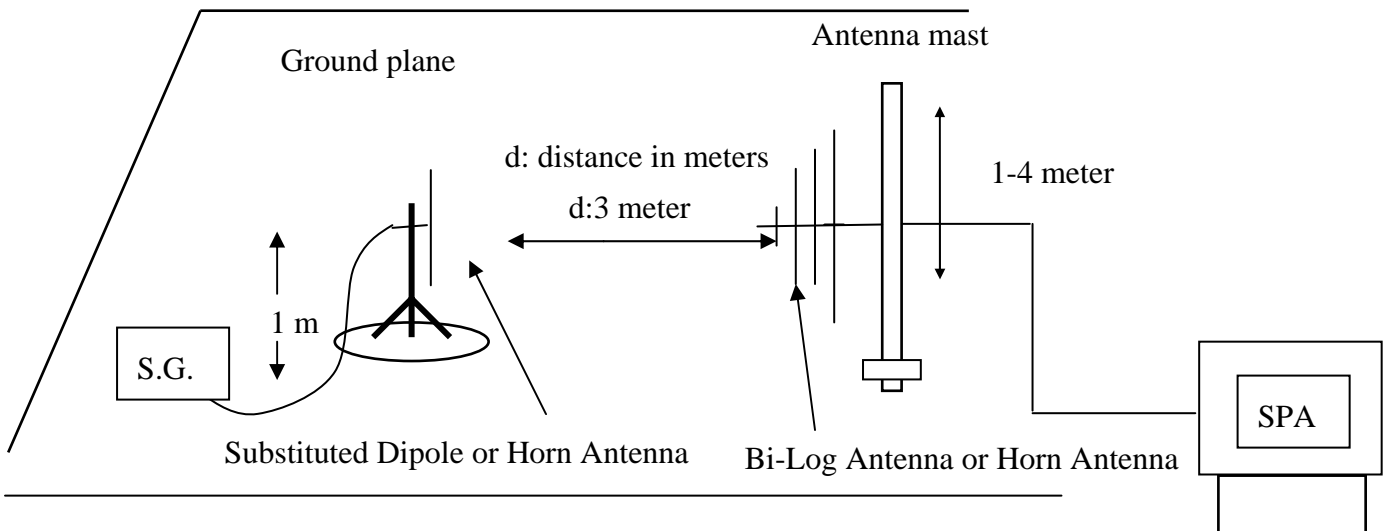

This document is issued by the Company subject to its General Conditions of Service printed overleaf or available on request and accessible at www.sgs.com. Attention is drawn to the limitations of liability, indemnification, and Jurisdictional issued defined therein. Unless otherwise stated, the results shown in this test report refer only to the sample(s) tested. This document cannot be reproduced except in full, without prior approval of Company. Any unauthorized alteration, forgery or falsification of the content or appearance of this report is unlawful and offenders may be prosecuted to the fullest extent of the law. 此報告是遵循本公司訂定之通用服務條款所製作發放，請注意此條款列印於背面，亦可在www.sgs.com中查閱。將本公司之義務，免責，管轄權皆明確規範之。除非另有說明，此報告結果僅對檢驗之樣品負責。本報告未經本公司書面許可，不可部份複製。對本報告內容或外觀之任何未經授權之變更、偽造、竄改皆屬非法，違犯者將會被依法追訴。

9.3 Measurement Procedure

The EUT was placed on a non-conductive, The measurement antenna was placed at a distance of 3 meters from the EUT. During the tests, the antenna height and the EUT azimuth were varied in order to identify the maximum level of emissions from the EUT. This maximization process was repeated with the EUT positioned in each of its three orthogonal orientations.

The frequency range up to tenth harmonic was investigated for each of three fundamental frequency (low, middle and high channels). Once spurious emission were identified, the power of the emission was determined using the substitution method.

The spurious emissions attenuation was calculated as the difference between radiated power at the fundamental frequency and the spurious emissions frequency.

$$\text{ERP} = \text{S.G. output (dBm)} + \text{Antenna Gain(dBd)} - \text{Cable Loss (dB)}$$

$$\text{EIRP} = \text{S.G. output (dBm)} + \text{Antenna Gain(dBi)} - \text{Cable Loss (dB)}$$

9.4 Measurement Equipment Used:

EQUIPMENT TYPE	MFR	MODEL NUMBER	SERIAL NUMBER	LAST CAL.	CAL DUE.
Spectrum Analyzer	Agilent	E4446A	MY43360126	03/29/2006	03/28/2007
Spectrum Analyzer	Agilent	7405A	US41160416	06/28/2006	06/29/2007
Spectrum Analyzer	R&S	FSP 40	100034	11/09/2006	11/10/2007
Communication Test	R&S	SMU200	N/A	N/A	N/A
Bilog Antenna	SCHWAZBECK	VULB9163	152	06/03/2006	06/02/2007
Horn antenna	Schwarzbeck	BBHA 9120D	309/320	08/16/2006	08/15/2007
Pre-Amplifier	HP	8447D	2944A09469	07/19/2006	07/18/2007
Pre-Amplifier	HP	8494B	3008A00578	02/26/2006	02/25/2007
Signal Generator	R&S	SMR40	100210	02/09/2006	02/10/2007
Turn Table	HD	DT420	N/A	N.C.R	N.C.R
Antenna Tower	HD	MA240-N	240/657	N.C.R	N.C.R
Controller	HD	HD100	N/A	N.C.R	N.C.R
Low Loss Cable	HUBER+SUHNER	SUCOFLEX 104PEA-10M	10m	10/09/2006	10/08/2007
Low Loss Cable	HUBER+SUHNER	SUCOFLEX 104PEA-3M	3m	10/09/2006	10/08/2007
Low Loss Cable	HUBER+SUHNER	SUCOFLEX 104PEA-0.5M	0.5m	10/09/2006	10/08/2007
Site NSA	SGS	966 chamber	N/A	11/17/2005	11/16/2006
Attenuator	Mini-Circuit	BW-S10W5	N/A	09/23/2006	09/22/2007
Dipole Antenna	Schwarzbeck	VHAP	908/909	06/10/2006	06/11/2007
Dipole Antenna	Schwarzbeck	UHAP	891/892	06/10/2006	06/11/2007
Horn antenna	Schwarzbeck	BBHA 9120D	N/A	08/16/2006	08/15/2007

9.5 Measurement Result

Refer to attach tabular data sheets.

Radiated Spurious Emission Measurement Result: GSM 850 Mode

Operation Mode	: TX CH Low E1 Mode	Test Date	: Nov. 17, 2005
Fundamental Frequency	: 824.20 MHz	Test By	: Eric
Temperature	: 25°C	Pol.	: Ver.
Humidity	: 65%	Adaptor Model	: S002EU0450035

Freq. (MHz)	SPA. Reading (dBuV)	Ant.Pol. H/V	S.G Out-put (dBm)	Antenna Gain (dB/dBi)	Cable Loss (dB)	ERP/EIRP (dBm)	Limit (dBm)	Safe Margin (dBm)
59.10	43.10	V	-67.81	-0.47	1.08	-69.36	-13.00	-56.36
89.17	40.41	V	-62.81	-7.75	1.16	-71.73	-13.00	-58.73
351.07	30.67	V	-66.91	-7.64	2.36	-76.92	-13.00	-63.92
823.98	82.07	V	-4.32	-7.87	3.62	-15.82	-13.00	-2.82
1648.40	43.59	V	-60.99	9.29	5.23	-56.93	-13.00	-43.93
2472.60	39.83	V	-61.18	10.08	6.53	-57.63	-13.00	-44.63
3296.80	---	V		12.17	7.71		-13.00	
4121.00	---	V		12.61	8.86		-13.00	
4945.20	---	V		12.65	9.74		-13.00	
5769.40	---	V		13.55	10.54		-13.00	
6593.60	---	V		12.05	11.30		-13.00	
7417.80	---	V		11.49	12.10		-13.00	
8242.00	---	V		11.48	12.71		-13.00	

Measurement uncertainty	30MHz - 80MHz: 5.04dB
	80MHz - 1000MHz: 3.76dB
	1GHz - 13GHz: 4.45dB

Remark :

- 1 The emission behaviors belongs to narrowband spurious emission.
- 2 Remark"---" means that the emission level is too low to be measured
- 3 The result basic equation calculation is as follows:
- 4 $ERP/EIRP (dBm) = SG \text{ Setting}(dBm) + Antenna \text{ Gain} (dB/dBi) - Cable \text{ loss} (dB)$

This document is issued by the Company subject to its General Conditions of Service printed overleaf or available on request and accessible at www.sgs.com. Attention is drawn to the limitations of liability, indemnification, and Jurisdictional issued defined therein. Unless otherwise stated, the results shown in this test report refer only to the sample(s) tested. This document cannot be reproduced except in full, without prior approval of Company. Any unauthorized alteration, forgery or falsification of the content or appearance of this report is unlawful and offenders may be prosecuted to the fullest extent of the law. 此報告是遵循本公司訂定之通用服務條款所製作發放，請注意此條款列印於背面，亦可在www.sgs.com中查閱。將本公司之義務，免責，管轄權皆明確規範之。除非另有說明，此報告結果僅對檢驗之樣品負責。本報告未經本公司書面許可，不可部份複製。對本報告內容或外觀之任何未經授權之變更、偽造、竄改皆屬非法，違犯者將會被依法追訴。

Radiated Spurious Emission Measurement Result: GSM 850 Mode

Operation Mode	: TX CH Low E1 Mode	Test Date	: Nov. 17, 2005
Fundamental Frequency	: 824.20 MHz	Test By	: Eric
Temperature	: 25°C	Pol.	: Hor.
Humidity	: 65%	Adaptor Model	: S002EU0450035

Freq. (MHz)	SPA. Reading (dBuV)	Ant.Pol. H/V	S.G Out-put (dBm)	Antenna Gain (dB/dBi)	Cable Loss (dB)	ERP/EIRP (dBm)	Limit (dBm)	Safe Margin (dBm)
55.22	41.20	H	-68.04	-0.53	1.10	-69.67	-13.00	-56.67
103.72	35.24	H	-67.37	-7.76	1.38	-76.51	-13.00	-63.51
351.07	29.77	H	-67.41	-7.64	2.36	-77.42	-13.00	-64.42
824.00	81.62	H	-4.65	-7.87	3.62	-16.15	-13.00	-3.15
1648.40	47.39	H	-57.01	9.29	5.23	-52.95	-13.00	-39.95
2472.60	45.08	H	-55.83	10.08	6.53	-52.28	-13.00	-39.28
3296.80	---	H		12.17	7.71		-13.00	
4121.00	---	H		12.61	8.86		-13.00	
4945.20	---	H		12.65	9.74		-13.00	
5769.40	---	H		13.55	10.54		-13.00	
6593.60	---	H		12.05	11.30		-13.00	
7417.80	---	H		11.49	12.10		-13.00	
8242.00	---	H		11.48	12.71		-13.00	

Measurement uncertainty	30MHz - 80MHz: 5.04dB
	80MHz - 1000MHz: 3.76dB
	1GHz - 13GHz: 4.45dB

Remark :

- 1 The emission behaviors belongs to narrowband spurious emission.
- 2 Remark”---“ means that the emission level is too low to be measured
- 3 The result basic equation calculation is as follows:
- 4 $ERP/EIRP (dBm) = SG \text{ Setting}(dBm) + Antenna \text{ Gain} (dB/dBi) - Cable \text{ loss} (dB)$

This document is issued by the Company subject to its General Conditions of Service printed overleaf or available on request and accessible at www.sgs.com. Attention is drawn to the limitations of liability, indemnification, and Jurisdictional issued defined therein. Unless otherwise stated, the results shown in this test report refer only to the sample(s) tested. This document cannot be reproduced except in full, without prior approval of Company. Any unauthorized alteration, forgery or falsification of the content or appearance of this report is unlawful and offenders may be prosecuted to the fullest extent of the law. 此報告是遵循本公司訂定之通用服務條款所製作發放，請注意此條款列印於背面，亦可在www.sgs.com中查閱。將本公司之義務，免責，管轄權皆明確規範之。除非另有說明，此報告結果僅對檢驗之樣品負責。本報告未經本公司書面許可，不可部份複製。對本報告內容或外觀之任何未經授權之變更、偽造、竄改皆屬非法，違犯者將會被依法追訴。

Radiated Spurious Emission Measurement Result: GSM 850 Mode

Operation Mode	: TX CH Mid E1 Mode	Test Date	: Nov. 17, 2005
Fundamental Frequency	: 836.60 MHz	Test By	: Eric
Temperature	: 25°C	Pol.	: Ver.
Humidity	: 65%	Adaptor Model	: S002EU0450035

Freq. (MHz)	SPA. Reading (dBuV)	Ant.Pol. H/V	S.G Out-put (dBm)	Antenna Gain (dB/dBi)	Cable Loss (dB)	ERP/EIRP (dBm)	Limit (dBm)	Safe Margin (dBm)
59.10	42.49	V	-68.42	-0.47	1.08	-69.97	-13.00	-56.97
89.17	40.10	V	-63.12	-7.75	1.16	-72.04	-13.00	-59.04
297.72	30.30	V	-68.02	-7.92	2.16	-78.11	-13.00	-65.11
351.07	31.67	V	-65.91	-7.64	2.36	-75.92	-13.00	-62.92
1673.20	46.99	V	-57.57	9.36	5.27	-53.47	-13.00	-40.47
2509.80	---	V		10.09	6.58		-13.00	
3346.40	---	V		12.28	7.79		-13.00	
4183.00	---	V		12.62	8.93		-13.00	
5019.60	---	V		12.67	9.81		-13.00	
5856.20	---	V		13.68	10.62		-13.00	
6692.80	---	V		11.95	11.39		-13.00	
7529.40	---	V		11.45	12.20		-13.00	
8366.00	---	V		11.59	12.81		-13.00	

Measurement uncertainty	30MHz - 80MHz: 5.04dB
	80MHz -1000MHz: 3.76dB
	1GHz - 13GHz: 4.45dB

Remark :

- 1 The emission behaviors belongs to narrowband spurious emission.
- 2 Remark”---“ means that the emission level is too low to be measured
- 3 The result basic equation calculation is as follows:
- 4 $ERP/EIRP (dBm) = SG \text{ Setting}(dBm) + Antenna \text{ Gain} (dB/dBi) - Cable \text{ loss} (dB)$

This document is issued by the Company subject to its General Conditions of Service printed overleaf or available on request and accessible at www.sgs.com. Attention is drawn to the limitations of liability, indemnification, and Jurisdictional issued defined therein. Unless otherwise stated, the results shown in this test report refer only to the sample(s) tested. This document cannot be reproduced except in full, without prior approval of Company. Any unauthorized alteration, forgery or falsification of the content or appearance of this report is unlawful and offenders may be prosecuted to the fullest extent of the law. 此報告是遵循本公司訂定之通用服務條款所製作發放，請注意此條款列印於背面，亦可在www.sgs.com中查閱。將本公司之義務，免責，管轄權皆明確規範之。除非另有說明，此報告結果僅對檢驗之樣品負責。本報告未經本公司書面許可，不可部份複製。對本報告內容或外觀之任何未經授權之變更、偽造、竄改皆屬非法，違犯者將會被依法追訴。

Radiated Spurious Emission Measurement Result: GSM 850 Mode

Operation Mode	: TX CH Mid E1 Mode	Test Date	: Nov. 17, 2005
Fundamental Frequency	: 836.60 MHz	Test By	: Eric
Temperature	: 25°C	Pol.	: Hor.
Humidity	: 65%	Adaptor Model	: S002EU0450035

Freq. (MHz)	SPA. Reading (dBuV)	Ant.Pol. H/V	S.G Out-put (dBm)	Antenna Gain (dB/dBi)	Cable Loss (dB)	ERP/EIRP (dBm)	Limit (dBm)	Safe Margin (dBm)
57.16	39.81	H	-70.23	-0.50	1.09	-71.81	-13.00	-58.81
105.66	35.23	H	-67.18	-7.76	1.39	-76.33	-13.00	-63.33
1673.20	39.49	H	-64.89	9.36	5.27	-60.79	-13.00	-47.79
2509.80	---	H		10.09	6.58		-13.00	
3346.40	---	H		12.28	7.79		-13.00	
4183.00	---	H		12.62	8.93		-13.00	
5019.60	---	H		12.67	9.81		-13.00	
5856.20	---	H		13.68	10.62		-13.00	
6692.80	---	H		11.95	11.39		-13.00	
7529.40	---	H		11.45	12.20		-13.00	
8366.00	---	H		11.59	12.81		-13.00	

Measurement uncertainty	30MHz - 80MHz: 5.04dB
	80MHz -1000MHz: 3.76dB
	1GHz - 13GHz: 4.45dB

Remark :

- 1 The emission behaviors belongs to narrowband spurious emission.
- 2 Remark"---" means that the emission level is too low to be measured
- 3 The result basic equation calculation is as follows:
- 4 $ERP/EIRP (dBm) = SG \text{ Setting}(dBm) + Antenna \text{ Gain} (dB/dBi) - Cable \text{ loss} (dB)$

Radiated Spurious Emission Measurement Result: GSM 850 Mode

Operation Mode	: TX CH High E1 Mode	Test Date	: Nov. 17, 2005
Fundamental Frequency	: 848.80 MHz	Test By	: Eric
Temperature	: 25°C	Pol.	: Ver.
Humidity	: 65%	Adaptor Model	: S002EU0450035

Freq. (MHz)	SPA. Reading (dBuV)	Ant.Pol. H/V	S.G Out-put (dBm)	Antenna Gain (dB/dBi)	Cable Loss (dB)	ERP/EIRP (dBm)	Limit (dBm)	Safe Margin (dBm)
59.10	43.22	V	-67.69	-0.47	1.08	-69.24	-13.00	-56.24
89.17	40.47	V	-62.75	-7.75	1.16	-71.67	-13.00	-58.67
297.72	31.64	V	-66.68	-7.92	2.16	-76.77	-13.00	-63.77
351.07	31.54	V	-66.04	-7.64	2.36	-76.05	-13.00	-63.05
849.02	81.85	V	-4.27	-7.88	3.68	-15.83	-13.00	-2.83
1697.60	50.49	V	-54.05	9.44	5.31	-49.92	-13.00	-36.92
2546.40	---	V		10.20	6.63		-13.00	
3395.20	---	V		12.38	7.87		-13.00	
4244.00	---	V		12.63	9.00		-13.00	
5092.80	---	V		12.74	9.88		-13.00	
5941.60	---	V		13.81	10.70		-13.00	
6790.40	---	V		11.86	11.48		-13.00	
7639.20	---	V		11.40	12.27		-13.00	
8488.00	---	V		11.70	12.91		-13.00	

Measurement uncertainty	30MHz - 80MHz: 5.04dB
	80MHz - 1000MHz: 3.76dB
	1GHz - 13GHz: 4.45dB

Remark :

- 1 The emission behaviors belongs to narrowband spurious emission.
- 2 Remark"---" means that the emission level is too low to be measured
- 3 The result basic equation calculation is as follows:
- 4 $ERP/EIRP (dBm) = SG \text{ Setting}(dBm) + Antenna \text{ Gain} (dB/dBi) - Cable \text{ loss} (dB)$

This document is issued by the Company subject to its General Conditions of Service printed overleaf or available on request and accessible at www.sgs.com. Attention is drawn to the limitations of liability, indemnification, and Jurisdictional issued defined therein. Unless otherwise stated, the results shown in this test report refer only to the sample(s) tested. This document cannot be reproduced except in full, without prior approval of Company. Any unauthorized alteration, forgery or falsification of the content or appearance of this report is unlawful and offenders may be prosecuted to the fullest extent of the law. 此報告是遵循本公司訂定之通用服務條款所製作發放，請注意此條款列印於背面，亦可在www.sgs.com中查閱。將本公司之義務，免責，管轄權皆明確規範之。除非另有說明，此報告結果僅對檢驗之樣品負責。本報告未經本公司書面許可，不可部份複製。對本報告內容或外觀之任何未經授權之變更、偽造、竄改皆屬非法，違犯者將會被依法追訴。

Radiated Spurious Emission Measurement Result: GSM 850 Mode

Operation Mode	: TX CH High E1 Mode	Test Date	: Nov. 17, 2005
Fundamental Frequency	: 848.80 MHz	Test By	: Eric
Temperature	: 25°C	Pol.	: Hor.
Humidity	: 65%	Adaptor Model	: S002EU0450035

Freq. (MHz)	SPA Reading (dBuV)	Ant.Pol. H/V	S.G Output (dBm)	Antenna Gain (dB/dBi)	Cable Loss (dB)	ERP/EIRP (dBm)	Limit (dBm)	Safe Margin (dBm)
57.16	40.83	H	-69.21	-0.50	1.09	-70.79	-13.00	-57.79
103.72	35.06	H	-67.55	-7.76	1.38	-76.69	-13.00	-63.69
849.02	74.89	H	-11.30	-7.88	3.68	-22.86	-13.00	-9.86
1697.60	43.98	H	-60.37	9.44	5.31	-56.24	-13.00	-43.24
2546.40	40.74	H	-59.86	10.20	6.63	-56.30	-13.00	-43.30
3395.20	---	H		12.38	7.87		-13.00	
4244.00	---	H		12.63	9.00		-13.00	
5092.80	---	H		12.74	9.88		-13.00	
5941.60	---	H		13.81	10.70		-13.00	
6790.40	---	H		11.86	11.48		-13.00	
7639.20	---	H		11.40	12.27		-13.00	
8488.00	---	H		11.70	12.91		-13.00	

Measurement uncertainty	30MHz - 80MHz: 5.04dB
	80MHz - 1000MHz: 3.76dB
	1GHz - 13GHz: 4.45dB

Remark :

- 1 The emission behaviors belongs to narrowband spurious emission.
- 2 Remark"---" means that the emission level is too low to be measured
- 3 The result basic equation calculation is as follows:
- 4 $ERP/EIRP (dBm) = SG \text{ Setting}(dBm) + Antenna \text{ Gain} (dB/dBi) - Cable \text{ loss} (dB)$

This document is issued by the Company subject to its General Conditions of Service printed overleaf or available on request and accessible at www.sgs.com. Attention is drawn to the limitations of liability, indemnification, and Jurisdictional issued defined therein. Unless otherwise stated, the results shown in this test report refer only to the sample(s) tested. This document cannot be reproduced except in full, without prior approval of Company. Any unauthorized alteration, forgery or falsification of the content or appearance of this report is unlawful and offenders may be prosecuted to the fullest extent of the law. 此報告是遵循本公司訂定之通用服務條款所製作發放，請注意此條款列印於背面，亦可在www.sgs.com中查閱。將本公司之義務，免責，管轄權皆明確規範之。除非另有說明，此報告結果僅對檢驗之樣品負責。本報告未經本公司書面許可，不可部份複製。對本報告內容或外觀之任何未經授權之變更、偽造、竄改皆屬非法，違犯者將會被依法追訴。

Radiated Spurious Emission Measurement Result: PCS 1900 Mode

Operation Mode	: TX CH Low E2 Mode	Test Date	: Nov. 17, 2005
Fundamental Frequency	: 1850.20MHz	Test By	: Eric
Temperature	: 25°C	Pol.	: Ver.
Humidity	: 65%	Adaptor Model	: 3DS07848AAAA

Freq. (MHz)	SPA. Reading (dBuV)	Ant.Pol. H/V	S.G Out-put (dBm)	Antenna Gain (dB/dBi)	Cable Loss (dB)	ERP/EIRP (dBm)	Limit (dBm)	Safe Margin (dBm)
57.16	41.90	V	-68.18	-0.50	1.09	-69.77	-13.00	-56.77
103.72	40.17	V	-61.41	-7.76	1.38	-70.55	-13.00	-57.55
1850.00	82.81	V	-21.58	9.90	5.56	-17.24	-13.00	-4.24
3700.40	42.99	V	-54.94	12.61	8.31	-50.64	-13.00	-37.64
5550.60	42.24	V	-48.60	13.23	10.33	-45.70	-13.00	-32.70
7400.80	---	V		11.50	12.08		-13.00	
9251.00	---	V		11.92	13.50		-13.00	
11101.20	---	V		11.66	15.11		-13.00	
12951.40	---	V		13.63	16.60		-13.00	
14801.60	---	V		12.76	17.95		-13.00	
16651.80	---	V		15.92	19.14		-13.00	
18502.00	---	V		18.75	10.40		-13.00	

Measurement uncertainty	30MHz - 80MHz: 5.04dB
	80MHz -1000MHz: 3.76dB
	1GHz - 13GHz: 4.45dB

Remark :

- 1 The emission behaviors belongs to narrowband spurious emission.
- 2 Remark"---" means that the emission level is too low to be measured
- 3 The result basic equation calculation is as follows:
- 4 $ERP/EIRP (dBm) = SG \text{ Setting}(dBm) + Antenna \text{ Gain} (dB/dBi) - Cable \text{ loss} (dB)$

This document is issued by the Company subject to its General Conditions of Service printed overleaf or available on request and accessible at www.sgs.com. Attention is drawn to the limitations of liability, indemnification, and Jurisdictional issued defined therein. Unless otherwise stated, the results shown in this test report refer only to the sample(s) tested. This document cannot be reproduced except in full, without prior approval of Company. Any unauthorized alteration, forgery or falsification of the content or appearance of this report is unlawful and offenders may be prosecuted to the fullest extent of the law. 此報告是遵循本公司訂定之通用服務條款所製作發放，請注意此條款列印於背面，亦可在www.sgs.com中查閱。將本公司之義務，免責，管轄權皆明確規範之。除非另有說明，此報告結果僅對檢驗之樣品負責。本報告未經本公司書面許可，不可部份複製。對本報告內容或外觀之任何未經授權之變更、偽造、竄改皆屬非法，違犯者將會被依法追訴。

Radiated Spurious Emission Measurement Result: PCS 1900 Mode

Operation Mode	: TX CH Low E2 Mode	Test Date	: Nov. 17, 2005
Fundamental Frequency	: 1850.20MHz	Test By	: Eric
Temperature	: 25°C	Pol.	: Hor.
Humidity	: 65%	Adaptor Model	: S002EU0450035

Freq. (MHz)	SPA. Reading (dBuV)	Ant.Pol. H/V	S.G Out-put (dBm)	Antenna Gain (dB/dBi)	Cable Loss (dB)	ERP/EIRP (dBm)	Limit (dBm)	Safe Margin (dBm)
60.07	40.35	H	-70.86	-0.46	1.07	-72.39	-13.00	-59.39
95.96	37.82	H	-65.48	-7.76	1.32	-74.56	-13.00	-61.56
1850.00	78.27	H	-25.91	9.90	5.56	-21.57	-13.00	-8.57
3700.40	40.04	H	-58.00	12.61	8.31	-53.70	-13.00	-40.70
5550.60	41.73	H	-49.32	13.23	10.33	-46.42	-13.00	-33.42
7400.80	---	H		11.50	12.08		-13.00	
9251.00	---	H		11.92	13.50		-13.00	
11101.20	---	H		11.66	15.11		-13.00	
12951.40	---	H		13.63	16.60		-13.00	
14801.60	---	H		12.76	17.95		-13.00	
16651.80	---	H		15.92	19.14		-13.00	
18502.00	---	H		18.75	10.40		-13.00	

Measurement uncertainty	30MHz - 80MHz: 5.04dB
	80MHz -1000MHz: 3.76dB
	1GHz - 13GHz: 4.45dB

Remark :

- 1 The emission behaviors belongs to narrowband spurious emission.
- 2 Remark"---" means that the emission level is too low to be measured
- 3 The result basic equation calculation is as follows:
- 4 $ERP/EIRP (dBm) = SG \text{ Setting}(dBm) + Antenna \text{ Gain} (dB/dBi) - Cable \text{ loss} (dB)$

Radiated Spurious Emission Measurement Result: PCS 1900 Mode

Operation Mode	: TX CH Mid E2 Mode	Test Date	: Nov. 17, 2005
Fundamental Frequency	: 1880MHz	Test By	: Eric
Temperature	: 25°C	Pol.	: Ver.
Humidity	: 65%	Adaptor Model	: S002EU0450035

Freq. (MHz)	SPA Reading (dBuV)	Ant.Pol. H/V	S.G Output (dBm)	Antenna Gain (dB/dBi)	Cable Loss (dB)	ERP/EIRP (dBm)	Limit (dBm)	Safe Margin (dBm)
57.16	42.70	V	-67.38	-0.50	1.09	-68.97	-13.00	-55.97
102.75	40.31	V	-61.36	-7.76	1.37	-70.49	-13.00	-57.49
3760.00	43.89	V	-53.77	12.60	8.39	-49.55	-13.00	-36.55
5640.00	36.63	V	-53.95	13.36	10.41	-51.00	-13.00	-38.00
7520.00	---	V		11.45	12.19		-13.00	
9400.00	---	V		11.93	13.61		-13.00	
11280.00	---	V		11.92	15.27		-13.00	
13160.00	---	V		13.33	16.71		-13.00	
15040.00	---	V		13.76	18.15		-13.00	
16920.00	---	V		15.27	19.32		-13.00	
18800.00	---	V		18.68	16.58		-13.00	

Measurement uncertainty	30MHz - 80MHz: 5.04dB
	80MHz - 1000MHz: 3.76dB
	1GHz - 13GHz: 4.45dB

Remark :

- 1 The emission behaviors belongs to narrowband spurious emission.
- 2 Remark"---" means that the emission level is too low to be measured
- 3 The result basic equation calculation is as follows:
- 4 $ERP/EIRP (dBm) = SG \text{ Setting}(dBm) + \text{Antenna Gain} (dB/dBi) - \text{Cable loss} (dB)$

This document is issued by the Company subject to its General Conditions of Service printed overleaf or available on request and accessible at www.sgs.com. Attention is drawn to the limitations of liability, indemnification, and Jurisdictional issued defined therein. Unless otherwise stated, the results shown in this test report refer only to the sample(s) tested. This document cannot be reproduced except in full, without prior approval of Company. Any unauthorized alteration, forgery or falsification of the content or appearance of this report is unlawful and offenders may be prosecuted to the fullest extent of the law. 此報告是遵循本公司訂定之通用服務條款所製作發放，請注意此條款列印於背面，亦可在www.sgs.com中查閱。將本公司之義務，免責，管轄權皆明確規範之。除非另有說明，此報告結果僅對檢驗之樣品負責。本報告未經本公司書面許可，不可部份複製。對本報告內容或外觀之任何未經授權之變更、偽造、竄改皆屬非法，違犯者將會被依法追訴。

Radiated Spurious Emission Measurement Result: PCS 1900 Mode

Operation Mode	: TX CH Mid E2 Mode	Test Date	: Nov. 17, 2005
Fundamental Frequency	: 1880MHz	Test By	: Eric
Temperature	: 25°C	Pol.	: Hor.
Humidity	: 65%	Adaptor Model	: S002EU0450035

Freq. (MHz)	SPA Reading (dBuV)	Ant.Pol. H/V	S.G Output (dBm)	Antenna Gain (dB/dBi)	Cable Loss (dB)	ERP/EIRP (dBm)	Limit (dBm)	Safe Margin (dBm)
73.65	50.58	H	-61.76	-1.58	1.18	-64.52	-13.00	-51.52
103.72	37.76	H	-64.85	-7.76	1.38	-73.99	-13.00	-60.99
3760.00	43.67	H	-54.10	12.60	8.39	-49.89	-13.00	-36.89
5640.00	35.67	H	-55.08	13.36	10.41	-52.13	-13.00	-39.13
7520.00	---	H		11.45	12.19		-13.00	
9400.00	---	H		11.93	13.61		-13.00	
11280.00	---	H		11.92	15.27		-13.00	
13160.00	---	H		13.33	16.71		-13.00	
15040.00	---	H		13.76	18.15		-13.00	
16920.00	---	H		15.27	19.32		-13.00	
18800.00	---	H		18.68	16.58		-13.00	

Measurement uncertainty	30MHz - 80MHz: 5.04dB
	80MHz - 1000MHz: 3.76dB
	1GHz - 13GHz: 4.45dB

Remark :

- 1 The emission behaviors belongs to narrowband spurious emission.
- 2 Remark"---" means that the emission level is too low to be measured
- 3 The result basic equation calculation is as follows:
- 4 $ERP/EIRP (dBm) = SG \text{ Setting}(dBm) + Antenna \text{ Gain} (dB/dBi) - Cable \text{ loss} (dB)$

This document is issued by the Company subject to its General Conditions of Service printed overleaf or available on request and accessible at www.sgs.com. Attention is drawn to the limitations of liability, indemnification, and Jurisdictional issued defined therein. Unless otherwise stated, the results shown in this test report refer only to the sample(s) tested. This document cannot be reproduced except in full, without prior approval of Company. Any unauthorized alteration, forgery or falsification of the content or appearance of this report is unlawful and offenders may be prosecuted to the fullest extent of the law. 此報告是遵循本公司訂定之通用服務條款所製作發放，請注意此條款列印於背面，亦可在www.sgs.com中查閱。將本公司之義務，免責，管轄權皆明確規範之。除非另有說明，此報告結果僅對檢驗之樣品負責。本報告未經本公司書面許可，不可部份複製。對本報告內容或外觀之任何未經授權之變更、偽造、竄改皆屬非法，違犯者將會被依法追訴。

Radiated Spurious Emission Measurement Result: PCS 1900 Mode

Operation Mode	: TX CH High E2 Mode	Test Date	: Nov. 17, 2005
Fundamental Frequency	: 1909.8 MHz	Test By	: Eric
Temperature	: 25°C	Pol.	: Ver.
Humidity	: 65%	Adaptor Model	: S002EU0450035

Freq. (MHz)	SPA. Reading (dBuV)	Ant.Pol. H/V	S.G Out-put (dBm)	Antenna Gain (dB/dBi)	Cable Loss (dB)	ERP/EIRP (dBm)	Limit (dBm)	Safe Margin (dBm)
60.07	40.08	V	-71.22	-0.46	1.07	-72.76	-13.00	-59.76
103.72	37.37	V	-64.21	-7.76	1.38	-73.35	-13.00	-60.35
1910.00	83.94	V	-20.39	10.08	5.66	-15.97	-13.00	-2.97
3981.60	44.02	V	-52.64	12.60	8.69	-48.74	-13.00	-35.74
5972.40	46.60	V	-43.00	13.86	10.73	-39.88	-13.00	-26.88
7963.20	---	V		11.27	12.49		-13.00	
9954.00	---	V		12.08	14.24		-13.00	
11944.80	---	V		13.08	15.87		-13.00	
13935.60	---	V		11.82	17.21		-13.00	
15926.40	---	V		17.08	18.70		-13.00	
17917.20	---	V		9.63	19.97		-13.00	
19908.00	---	V		18.88	21.24		-13.00	

Measurement uncertainty	30MHz - 80MHz: 5.04dB
	80MHz -1000MHz: 3.76dB
	1GHz - 13GHz: 4.45dB

Remark :

- 1 The emission behaviors belongs to narrowband spurious emission.
- 2 Remark"---" means that the emission level is too low to be measured
- 3 The result basic equation calculation is as follows:
- 4 $ERP/EIRP (dBm) = SG \text{ Setting}(dBm) + Antenna \text{ Gain} (dB/dBi) - Cable \text{ loss} (dB)$

Radiated Spurious Emission Measurement Result: PCS 1900 Mode

Operation Mode	: TX CH High E2 Mode	Test Date	: Nov. 17, 2005
Fundamental Frequency	: 1909.8 MHz	Test By	: Eric
Temperature	: 25°C	Pol.	: Hor.
Humidity	: 65%	Adaptor Model	: S002EU0450035

Freq. (MHz)	SPA. Reading (dBuV)	Ant.Pol. H/V	S.G Out-put (dBm)	Antenna Gain (dB/dBi)	Cable Loss (dB)	ERP/EIRP (dBm)	Limit (dBm)	Safe Margin (dBm)
57.16	44.14	H	-65.90	-0.50	1.09	-67.48	-13.00	-54.48
100.81	42.42	H	-60.50	-7.76	1.36	-69.62	-13.00	-56.62
1910.00	78.06	H	-26.05	10.08	5.66	-21.63	-13.00	-8.63
3981.60	40.29	H	-56.48	12.60	8.69	-52.58	-13.00	-39.58
5972.40	37.74	H	-51.89	13.86	10.73	-48.77	-13.00	-35.77
7963.20	---	H		11.27	12.49		-13.00	
9954.00	---	H		12.08	14.24		-13.00	
11944.80	---	H		13.08	15.87		-13.00	
13935.60	---	H		11.82	17.21		-13.00	
15926.40	---	H		17.08	18.70		-13.00	
17917.20	---	H		9.63	19.97		-13.00	
17188.20	---	H		14.47	19.52		-13.00	

Measurement uncertainty	30MHz - 80MHz: 5.04dB
	80MHz -1000MHz: 3.76dB
	1GHz - 13GHz: 4.45dB

Remark :

- 1 The emission behaviors belongs to narrowband spurious emission.
- 2 Remark"---" means that the emission level is too low to be measured
- 3 The result basic equation calculation is as follows:
- 4 ERP/EIRP (dBm) = SG Setting(dBm) + Antenna Gain (dB/dBi) – Cable loss (dB)

10. FREQUENCY STABILITY V.S. TEMPERATURE MEASUREMENT

10.1 Standard Applicable

According to FCC §2.1055(a)(1)(b).

Frequency Tolerance: 2.5 ppm

10.2 Test Set-up:

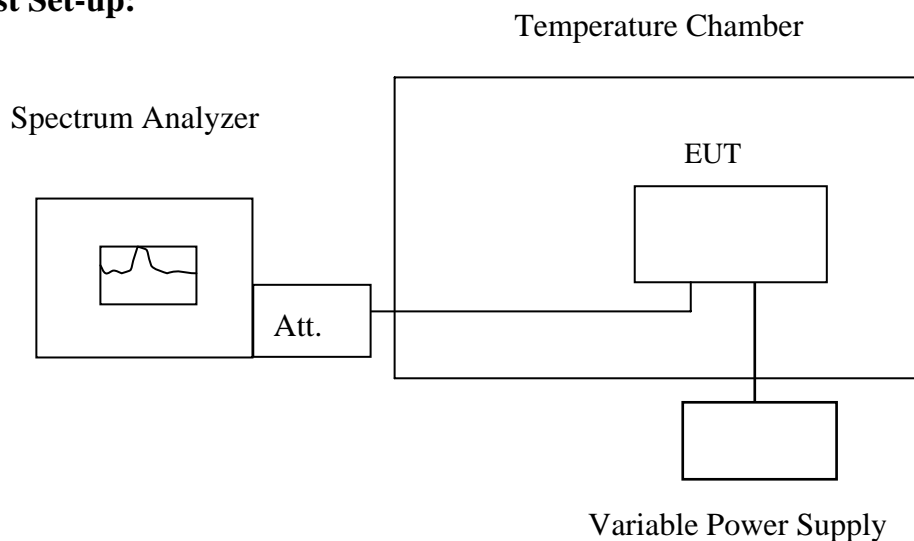

Note : Measurement setup for testing on Antenna connector

10.3 Measurement Procedure

The equipment under test was connected to an external AC or DC power supply and input rated voltage. RF output was connected to a frequency counter or spectrum analyzer via feed through attenuators. The EUT was placed inside the temperature chamber. Set the spectrum analyzer RBW low enough to obtain the desired frequency resolution and measure EUT 25°C operating frequency as reference frequency. Turn EUT off and set the chamber temperature to -30°C. After the temperature stabilized for approximately 30 minutes recorded the frequency. Repeat step measure with 10°C increased per stage until the highest temperature of +50°C reached.

10.4 Measurement Equipment Used:

Conducted Emission Test Site					
EQUIPMENT TYPE	MFR	MODEL NUMBER	SERIAL NUMBER	LAST CAL.	CAL DUE.
Spectrum Analyzer	Agilent	E4446A	MY43360126	03/29/2006	03/28/2007
Spectrum Analyzer	Agilent	E7405A	US41160416	06/28/2006	06/29/2007
Spectrum Analyzer	R&S	FSP 40	100034	11/09/2006	11/10/2007
Communication Test	R&S	SMU200	N/A	N/A	N/A
Temperature Chamber	TERCHY	MHG-120LF	911009	10/14/2006	10/13/2007
Low Loss Cable	HUBER+SUHNER	SUCOFLEX 104PEA	N/A	N/A	N/A
Attenuator	Mini-Circuit	BW-S10W5	N/A	09/23/2006	09/22/2007
Attenuator	Mini-Circuit	BW-S6W5	N/A	09/23/2006	09/22/2007
Splitter	Agilent	11636B	51728	09/23/2006	09/22/2007
DC Power Supply	Topward	3303A	715856	N/A	N/A

This document is issued by the Company subject to its General Conditions of Service printed overleaf or available on request and accessible at www.sgs.com. Attention is drawn to the limitations of liability, indemnification, and Jurisdictional issued defined therein. Unless otherwise stated, the results shown in this test report refer only to the sample(s) tested. This document cannot be reproduced except in full, without prior approval of Company. Any unauthorized alteration, forgery or falsification of the content or appearance of this report is unlawful and offenders may be prosecuted to the fullest extent of the law. 此報告是遵循本公司訂定之通用服務條款所製作發放，請注意此條款列印於背面，亦可在www.sgs.com中查閱。將本公司之義務，免責，管轄權皆明確規範之。除非另有說明，此報告結果僅對檢驗之樣品負責。本報告未經本公司書面許可，不可部份複製。對本報告內容或外觀之任何未經授權之變更、偽造、竄改皆屬非法，違犯者將會被依法追訴。

10.5 Measurement Result

Reference Frequency: GSM Mid Channel 836.6 MHz @ 25°C				
Limit: +/- 2.5 ppm = 2091 Hz				
Power Supply	Environment	Frequency	Delta (Hz)	Limit (Hz)
Vdc	Temperature (°C)	(MHz)		
3.7	-30	836.599964	34.00	2091
3.7	-20	836.599972	26.00	2091
3.7	-10	836.599985	13.00	2091
3.7	0	836.599992	6.00	2091
3.7	10	836.599996	2.00	2091
3.7	20	836.599998	0.00	2091
3.7	30	836.600052	-54.00	2091
3.7	40	836.600057	-59.00	2091
3.7	50	836.600069	-71.00	2091

Reference Frequency: PCS Mid Channel 1880 MHz @ 25°C				
Limit: +/- 2.5 ppm = 4700 Hz				
Power Supply	Environment	Frequency	Delta (Hz)	Limit (Hz)
Vdc	Temperature (°C)	(MHz)		
3.7	-30	1879.999937	40.00	4700
3.7	-20	1879.999940	37.00	4700
3.7	-10	1879.999947	30.00	4700
3.7	0	1879.999957	20.00	4700
3.7	10	1879.999968	9.00	4700
3.7	20	1879.999977	0.00	4700
3.7	30	1879.999985	-8.00	4700
3.7	40	1879.999990	-13.00	4700
3.7	50	1880.000020	-43.00	4700

Note: The battery is rated 3.7V dc.

11. FREQUENCY STABILITY V.S. VOLTAGE MEASUREMENT

11.1 Standard Applicable

According to FCC §2.1055(d)(1)(2)

Frequency Tolerance: 2.5 ppm

11.2 Test Set-up:

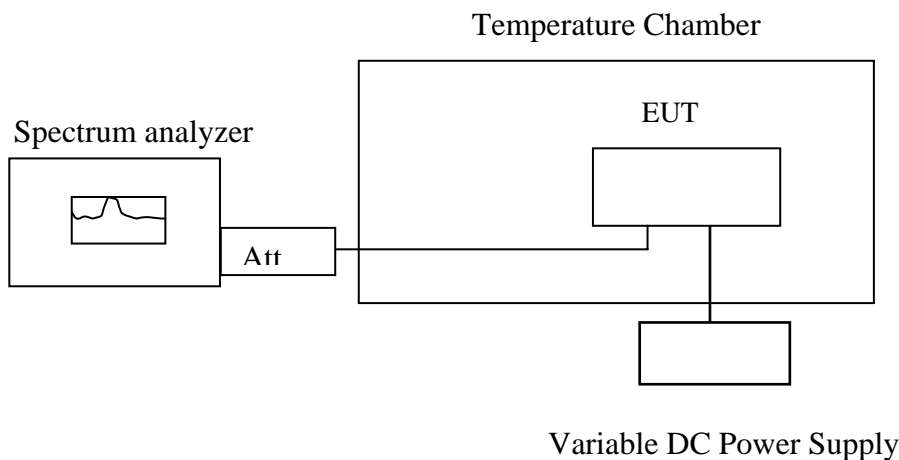

Note: Measurement setup for testing on Antenna connector

11.3 Measurement Procedure

Set chamber temperature to 25°C. Use a variable AC power supply / DC power source to power the EUT and set the voltage to rated voltage. Set the spectrum analyzer RBW low enough to obtain the desired frequency resolution and recorded the frequency.

Reduce the input voltage to specified extreme voltage variation (+/- 15%) and endpoint, record the maximum frequency change.

11.4 Measurement Equipment Used:

Conducted Emission Test Site					
EQUIPMENT TYPE	MFR	MODEL NUMBER	SERIAL NUMBER	LAST CAL.	CAL DUE.
Spectrum Analyzer	Agilent	E4446A	MY43360126	03/29/2006	03/28/2007
Spectrum Analyzer	Agilent	E7405A	US41160416	06/28/2006	06/29/2007
Spectrum Analyzer	R&S	FSP 40	100034	11/09/2006	11/10/2007
Communication Test	R&S	SMU200	N/A	N/A	N/A
Temperature Chamber	TERCHY	MHG-120LF	911009	10/14/2006	10/13/2007
Low Loss Cable	HUBER+SUHNER	SUCOFLEX 104PEA	N/A	N/A	N/A
Attenuator	Mini-Circuit	BW-S10W5	N/A	09/23/2006	09/22/2007
Attenuator	Mini-Circuit	BW-S6W5	N/A	09/23/2006	09/22/2007
Splitter	Agilent	11636B	51728	09/23/2006	09/22/2007
DC Power Supply	Topward	3303A	715856	N/A	N/A

This document is issued by the Company subject to its General Conditions of Service printed overleaf or available on request and accessible at www.sgs.com. Attention is drawn to the limitations of liability, indemnification, and Jurisdictional issued defined therein. Unless otherwise stated, the results shown in this test report refer only to the sample(s) tested. This document cannot be reproduced except in full, without prior approval of Company. Any unauthorized alteration, forgery or falsification of the content or appearance of this report is unlawful and offenders may be prosecuted to the fullest extent of the law. 此報告是遵循本公司訂定之通用服務條款所製作發放，請注意此條款列印於背面，亦可在www.sgs.com中查閱。將本公司之義務，免責，管轄權皆明確規範之。除非另有說明，此報告結果僅對檢驗之樣品負責。本報告未經本公司書面許可，不可部份複製。對本報告內容或外觀之任何未經授權之變更、偽造、竄改皆屬非法，違犯者將會被依法追訴。

11.5 Measurement Result

Reference Frequency: GSM Mid Channel 836.6 MHz @ 25°C				
Limit: +/- 2.5 ppm = 2091 Hz				
Power Supply	Environment	Frequency	Delta (Hz)	Limit (Hz)
Vdc	Temperature (°C)	(MHz)		
3.70	25.00	836.599998	0.00	2091.00
3.15	25.00	836.600000	-2.20	2091.00
4.26	25.00	836.600014	-16.00	2091.00
(End Point)	25.00	836.599977	21.00	2091.00

Reference Frequency: PCS Mid Channel 1880 MHz @ 25°C				
Limit: +/- 2.5 ppm = 4700 Hz				
Power Supply	Environment	Frequency	Delta (Hz)	Limit (Hz)
Vdc	Temperature (°C)	(MHz)		
3.7	25	1879.999977	0.00	4700
3.145	25	1879.999955	22.00	4700
4.255	25	1879.999990	-13.00	4700
(Endpoint)	25	1880.000020	-43.00	4700

Note: The battery is rated 3.7V dc.

12. AC POWER LINE CONDUCTED EMISSION TEST

12.1 Standard Applicable

According to §15.207. The emission value for frequency within 150KHz to 30MHz shall not exceed criteria of below chart.

Frequency range MHz	Limits dB(uV)	
	Quasi-peak	Average
0.15 to 0.50	66 to 56	56 to 46
0.50 to 5	56	46
5 to 30	60	50

Note

- 1.The lower limit shall apply at the transition frequencies
- 2.The limit decreases linearly with the logarithm of the frequency in the range 0.15 MHz to 0.50 MHz.

12.2 EUT Setup

1. The conducted emission tests were performed in the test site, using the setup in accordance with the ANSI C63.4-2001.
2. The EUT was plug-in DC power adaptor and was placed on the center of the back edge on the test table. The peripherals like earphone was placed on the side of the EUT. The rear of the EUT and peripherals were placed flushed with the rear of the tabletop.
3. The Power adaptor was connected with 110Vac/60Hz power source.

12.3 Measurement Procedure

1. The EUT was placed on a table which is 0.8m above ground plane.
2. Maximum procedure was performed on the six highest emissions to ensure EUT compliance.
3. Repeat above procedures until all frequency measured were complete.

12.4 Measurement Equipment Used:

Conducted Emission Test Site					
EQUIPMENT TYPE	MFR	MODEL NUMBER	SERIAL NUMBER	LAST CAL.	CAL DUE.
EMC Analyzer	HP	8594EM	3624A00203	09/02/2006	09/03/2007
EMI Test Receiver	R&S	ESCS30	828985/004	06/09/2006	06/10/2007
Transient Limiter	HP	11947A	3107A02062	09/02/2006	09/03/2007
LISN	Rolf-Heine	NNB-2/16Z	99012	12/31/2005	12/30/2006
LISN	Rolf-Heine	NNB-2/16Z	99013	12/24/2005	12/23/2006
Coaxial Cables	N/A	No. 3, 4	N/A	12/24/2005	12/23/2006

12.5 Measurement Result

The initial step in collecting conducted data is a spectrum analyzer peak scan of the measurement range. Significant peaks are then marked as shown on the following data page, and these signals are then quasi-peaked.

AC POWER LINE CONDUCTED EMISSION TEST DATA

Operation Mode	: GSM850 Link Mode	Test Date	: Nov. 16, 2005
Fundamental Frequency	: N/A	Test By	: Eric
Temperature	: 25°C	Adaptor Model	: 3DS09371AGAA
Humidity	: 62%		

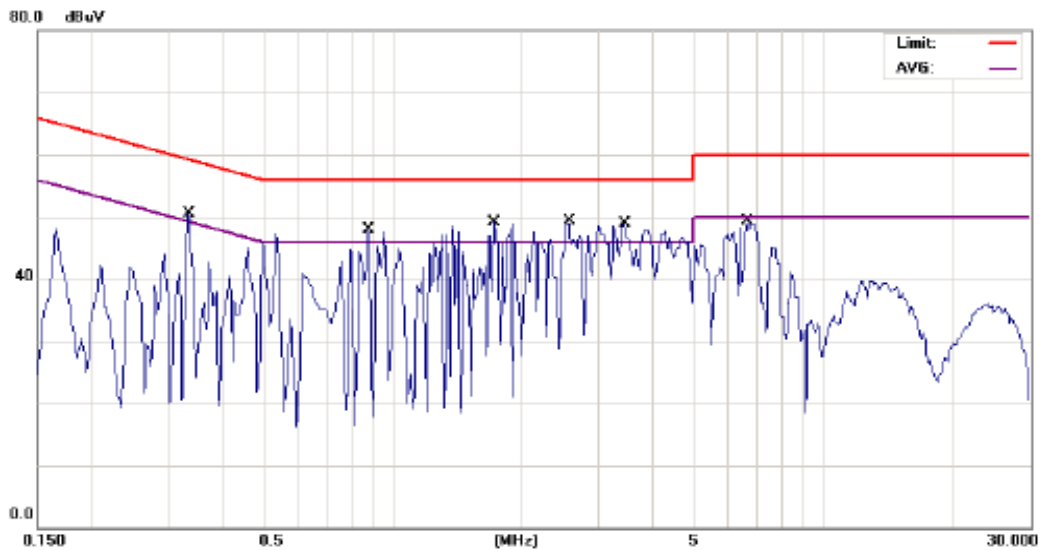

Site	SGS CONDUCTED #1	Phase:	L1	Temperature:	25 °C
Limit:	CISPR22 Class B Conduction(QP)	Power:	AC 120V/60Hz	Humidity:	62 %
EUT:	GSM850/1900 mobile phone	Distance:		Air Pressure:	hpa
M/N:	cvie6 crystal				
Note:	GSM850 3DS09371AGAA				

No.	Mk.	Freq.	Reading Level	Factor	Measurement	Limit	Over	Detector	Comment
		MHz	dBuV	dB	dBuV	dBuV	dB		
1		0.3350	43.70	0.81	44.51	59.33	-14.82	QP	
2		0.3350	41.00	0.81	41.81	49.33	-7.52	AVG	
3		0.8800	45.10	0.65	45.75	56.00	-10.25	QP	
4		0.8800	40.70	0.65	41.35	46.00	-4.65	AVG	
5		1.7200	48.20	0.63	48.83	56.00	-7.17	QP	
6		1.7200	43.70	0.63	44.33	46.00	-1.67	AVG	
7		2.5600	47.70	0.68	48.38	56.00	-7.62	QP	
8	*	2.5600	43.80	0.68	44.48	46.00	-1.52	AVG	
9		3.4400	46.50	0.74	47.24	56.00	-8.76	QP	
10		3.4400	41.50	0.74	42.24	46.00	-3.76	AVG	
11		6.6800	47.20	0.79	47.99	60.00	-12.01	QP	
12		6.6800	38.10	0.79	38.89	50.00	-11.11	AVG	

This document is issued by the Company subject to its General Conditions of Service printed overleaf or available on request and accessible at www.sgs.com. Attention is drawn to the limitations of liability, indemnification, and Jurisdictional issued defined therein. Unless otherwise stated, the results shown in this test report refer only to the sample(s) tested. This document cannot be reproduced except in full, without prior approval of Company. Any unauthorized alteration, forgery or falsification of the content or appearance of this report is unlawful and offenders may be prosecuted to the fullest extent of the law. 此報告是遵循本公司訂定之通用服務條款所製作發放，請注意此條款列印於背面，亦可在www.sgs.com中查閱。將本公司之義務，免責，管轄權皆明確規範之。除非另有說明，此報告結果僅對檢驗之樣品負責。本報告未經本公司書面許可，不可部份複製。對本報告內容或外觀之任何未經授權之變更、偽造、竄改皆屬非法，違犯者將會被依法追訴。

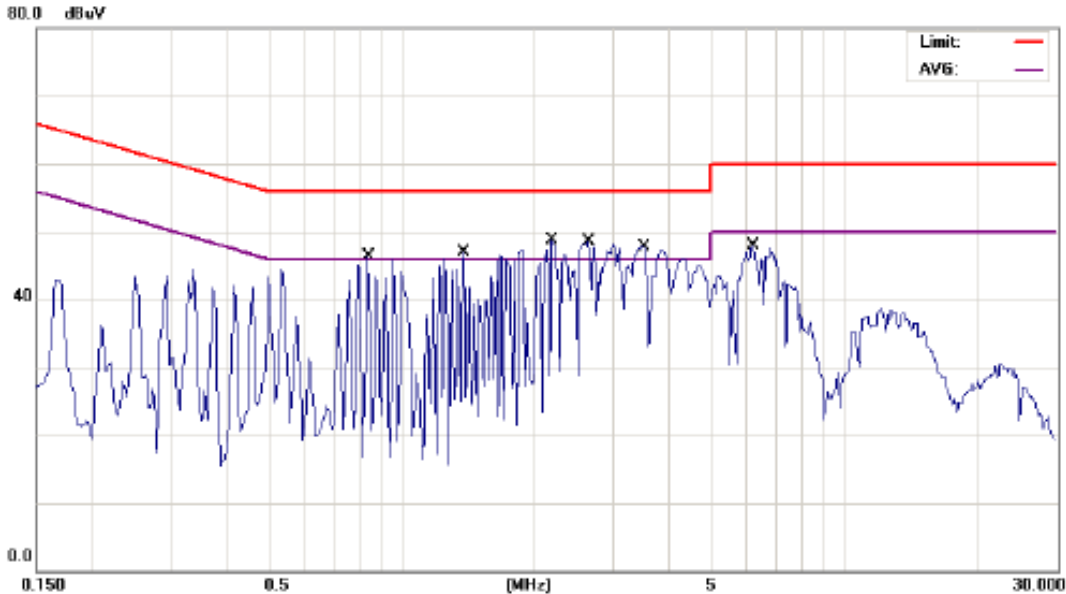

Site: SGS CONDUCTED #1
 Limit: CISPR22 Class B Conduction(QP)
 EUT: GSM850/1900 mobile phone
 M/N: cvle6 crystal
 Note: GSM850 3DS09371AGAA

Phase: N
 Power: AC 120V/60Hz
 Distance:

Temperature: 25 °C
 Humidity: 62 %
 Air Pressure: hpa

No. Mk.	Freq. MHz	Reading Level dBuV	Factor dB	Measurement dBuV	Limit dBuV	Over dB	Detector	Comment
1	0.8400	44.50	0.68	45.18	56.00	-10.82	QP	
2	0.8400	41.30	0.68	41.98	46.00	-4.02	AVG	
3	1.3800	47.10	0.61	47.71	56.00	-8.29	QP	
4 *	1.3800	44.10	0.61	44.71	46.00	-1.29	AVG	
5	2.1800	47.00	0.66	47.66	56.00	-8.34	QP	
6	2.1800	42.80	0.66	43.46	46.00	-2.54	AVG	
7	2.6400	47.20	0.69	47.89	56.00	-8.11	QP	
8	2.6400	43.60	0.69	44.29	46.00	-1.71	AVG	
9	3.5200	45.00	0.74	45.74	56.00	-10.26	QP	
10	3.5200	41.30	0.74	42.04	46.00	-3.96	AVG	
11	6.2000	46.70	0.79	47.49	60.00	-12.51	QP	
12	6.2000	37.50	0.79	38.29	50.00	-11.71	AVG	

This document is issued by the Company subject to its General Conditions of Service printed overleaf or available on request and accessible at www.sgs.com. Attention is drawn to the limitations of liability, indemnification, and Jurisdictional issued defined therein. Unless otherwise stated, the results shown in this test report refer only to the sample(s) tested. This document cannot be reproduced except in full, without prior approval of Company. Any unauthorized alteration, forgery or falsification of the content or appearance of this report is unlawful and offenders may be prosecuted to the fullest extent of the law. 此報告是遵循本公司訂定之通用服務條款所製作發放，請注意此條款列印於背面，亦可在www.sgs.com中查閱。將本公司之義務，免責，管轄權皆明確規範之。除非另有說明，此報告結果僅對檢驗之樣品負責。本報告未經本公司書面許可，不可部份複製。對本報告內容或外觀之任何未經授權之變更、偽造、竄改皆屬非法，違犯者將會被依法追訴。

AC POWER LINE CONDUCTED EMISSION TEST DATA

Operation Mode : GSM1900 Link Mode Test Date : Nov. 16, 2005
 Fundamental Frequency : N/A Test By : Eric
 Temperature : 25°C Adaptor Model : 3DS09371AGAA
 Humidity : 62%

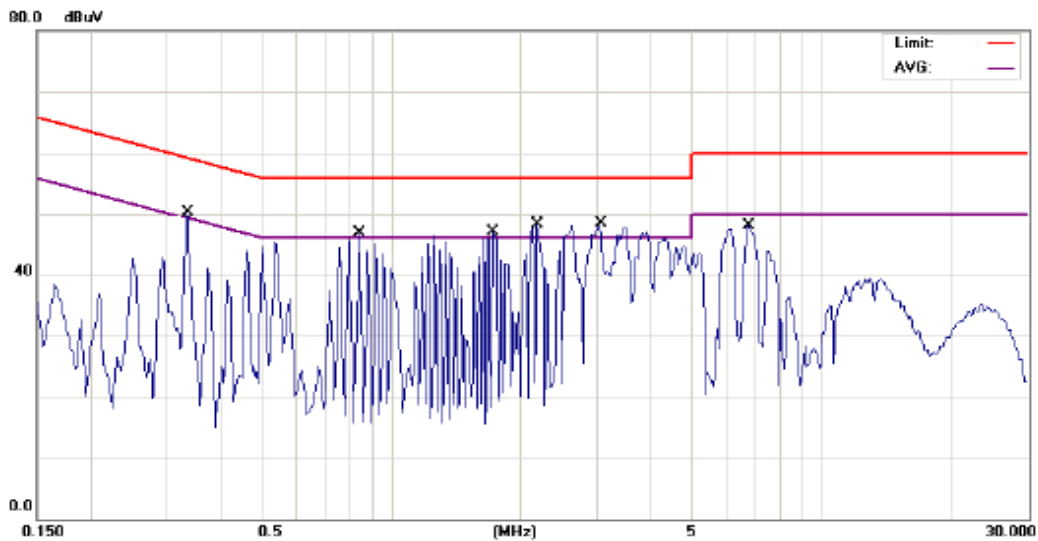

Site: SGS CONDUCTED #1 Phase: L1 Temperature: 25 °C
 Limit: CISPR22 Class B Conduction(QP) Power: AC 120V/60Hz Humidity: 62 %
 EUT: GSM850/1900 mobile phone Distance: Air Pressure: hpa
 M/N: cvle6 crystal
 Note: GSM1900 3DS09371AGAA

No.	Mk.	Freq. MHz	Reading Level dBµV	Factor dB	Measure- ment dBµV	Limit dBµV	Over dB	Detector	Comment
1		0.3350	47.50	0.81	48.31	59.33	-11.02	QP	
2		0.3350	43.80	0.81	44.61	49.33	-4.72	AVG	
3		0.8400	44.00	0.68	44.68	56.00	-11.32	QP	
4		0.8400	40.70	0.68	41.38	46.00	-4.62	AVG	
5		1.7200	46.90	0.63	47.53	56.00	-8.47	QP	
6	*	1.7200	43.10	0.63	43.73	46.00	-2.27	AVG	
7		2.1800	47.30	0.66	47.96	56.00	-8.04	QP	
8		2.1800	43.00	0.66	43.66	46.00	-2.34	AVG	
9		3.0600	46.70	0.71	47.41	56.00	-8.59	QP	
10		3.0600	42.10	0.71	42.81	46.00	-3.19	AVG	
11		6.7600	46.30	0.78	47.08	60.00	-12.92	QP	
12		6.7600	38.40	0.78	39.18	50.00	-10.82	AVG	

This document is issued by the Company subject to its General Conditions of Service printed overleaf or available on request and accessible at www.sgs.com. Attention is drawn to the limitations of liability, indemnification, and Jurisdictional issued defined therein. Unless otherwise stated, the results shown in this test report refer only to the sample(s) tested. This document cannot be reproduced except in full, without prior approval of Company. Any unauthorized alteration, forgery or falsification of the content or appearance of this report is unlawful and offenders may be prosecuted to the fullest extent of the law. 此報告是遵循本公司訂定之通用服務條款所製作發放，請注意此條款列印於背面，亦可在www.sgs.com中查閱。將本公司之義務，免責，管轄權皆明確規範之。除非另有說明，此報告結果僅對檢驗之樣品負責。本報告未經本公司書面許可，不可部份複製。對本報告內容或外觀之任何未經授權之變更、偽造、竄改皆屬非法，違犯者將會被依法追訴。

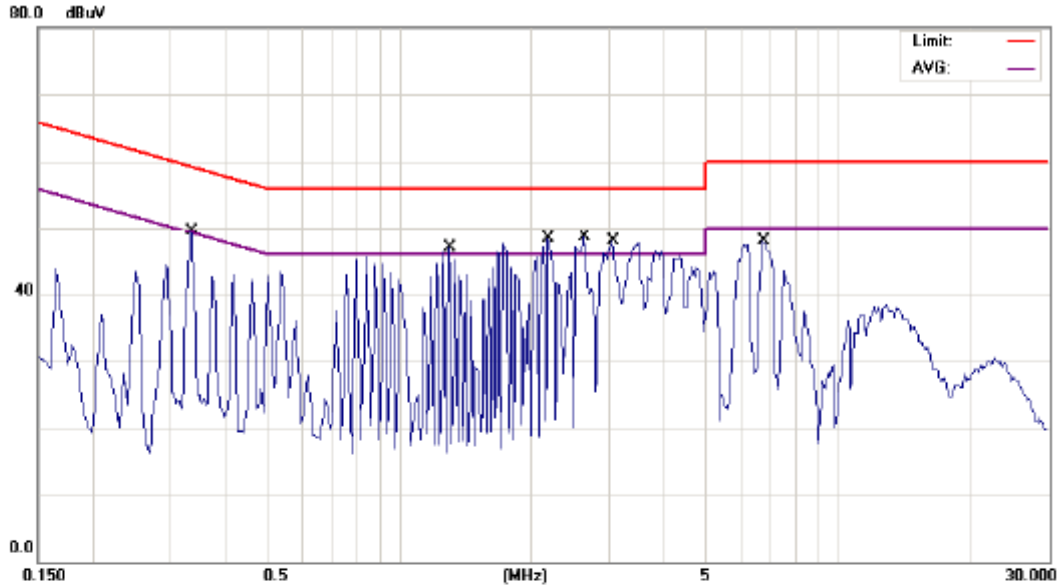

Site: SGS CONDUCTED #1
 Limit: CISPR22 Class B Conduction(QP)
 EUT: GSM850/1900 mobile phone
 M/N: cvle6 crystal
 Note: GSM1900 3DS09371AGAA

Phase: N
 Power: AC 120V/60Hz
 Distance:

Temperature: 25 °C
 Humidity: 62 %
 Air Pressure: hpa

No.	Mk.	Freq. MHz	Reading Level dBuV	Factor dB	Measure- ment dBuV	Limit dBuV	Over dB	Detector	Comment
1		0.3350	47.90	0.81	48.71	59.33	-10.62	QP	
2		0.3350	41.30	0.81	42.11	49.33	-7.22	AVG	
3		1.3000	45.70	0.60	46.30	56.00	-9.70	QP	
4		1.3000	41.00	0.60	41.60	46.00	-4.40	AVG	
5		2.1800	46.90	0.66	47.56	56.00	-8.44	QP	
6	*	2.1800	43.60	0.66	44.26	46.00	-1.74	AVG	
7		2.6400	46.10	0.69	46.79	56.00	-9.21	QP	
8		2.6400	43.50	0.69	44.19	46.00	-1.81	AVG	
9		3.0600	46.40	0.71	47.11	56.00	-8.89	QP	
10		3.0600	43.10	0.71	43.81	46.00	-2.19	AVG	
11		6.7600	46.20	0.78	46.98	60.00	-13.02	QP	
12		6.7600	38.10	0.78	38.88	50.00	-11.12	AVG	

This document is issued by the Company subject to its General Conditions of Service printed overleaf or available on request and accessible at www.sgs.com. Attention is drawn to the limitations of liability, indemnification, and Jurisdictional issued defined therein. Unless otherwise stated, the results shown in this test report refer only to the sample(s) tested. This document cannot be reproduced except in full, without prior approval of Company. Any unauthorized alteration, forgery or falsification of the content or appearance of this report is unlawful and offenders may be prosecuted to the fullest extent of the law. 此報告是遵循本公司訂定之通用服務條款所製作發放，請注意此條款列印於背面，亦可在www.sgs.com中查閱。將本公司之義務，免責，管轄權皆明確規範之。除非另有說明，此報告結果僅對檢驗之樣品負責。本報告未經本公司書面許可，不可部份複製。對本報告內容或外觀之任何未經授權之變更、偽造、竄改皆屬非法，違犯者將會被依法追訴。

AC POWER LINE CONDUCTED EMISSION TEST DATA

Operation Mode : GSM850 Link Mode Test Date : Nov. 16, 2005
 Fundamental Frequency : N/A Test By : Eric
 Temperature : 25°C Adaptor Model : S002EU0450035
 Humidity : 62%

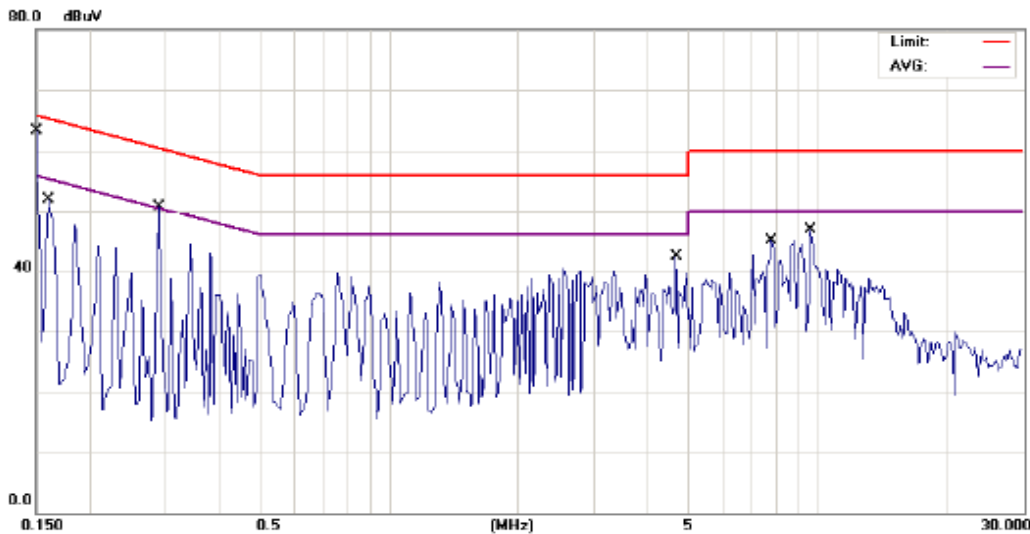

Site: SGS CONDUCTED #1 Phase: L1 Temperature: 25 °C
 Limit: CISPR22 Class B Conduction(QP) Power: AC 120V/60Hz Humidity: 62 %
 EUT: GSM850/1900 mobile phone Distance: Air Pressure: hpa
 M/N: cvle6 crystal
 Note: GSM850 S002EU0450035

No.	Mk.	Freq. MHz	Reading Level dBuV	Factor dB	Measure- ment dBuV	Limit dBuV	Over dB	Detector	Comment
1	*	0.1500	52.20	0.68	52.88	66.00	-13.12	QP	
2		0.1500	21.20	0.68	21.88	56.00	-34.12	AVG	
3		0.1615	45.00	0.70	45.70	65.39	-19.69	QP	
4		0.1615	21.10	0.70	21.80	55.39	-33.59	AVG	
5		0.2900	45.40	0.79	46.19	60.52	-14.33	QP	
6		0.2900	26.20	0.79	26.99	50.52	-23.53	AVG	
7		4.6800	32.70	0.79	33.49	56.00	-22.51	QP	
8		4.6800	24.10	0.79	24.89	46.00	-21.11	AVG	
9		7.8000	36.40	0.78	37.18	60.00	-22.82	QP	
10		7.8000	23.20	0.78	23.98	50.00	-26.02	AVG	
11		9.6400	37.20	0.89	38.09	60.00	-21.91	QP	
12		9.6400	24.30	0.89	25.19	50.00	-24.81	AVG	

This document is issued by the Company subject to its General Conditions of Service printed overleaf or available on request and accessible at www.sgs.com. Attention is drawn to the limitations of liability, indemnification, and Jurisdictional issued defined therein. Unless otherwise stated, the results shown in this test report refer only to the sample(s) tested. This document cannot be reproduced except in full, without prior approval of Company. Any unauthorized alteration, forgery or falsification of the content or appearance of this report is unlawful and offenders may be prosecuted to the fullest extent of the law. 此報告是遵循本公司訂定之通用服務條款所製作發放，請注意此條款列印於背面，亦可在www.sgs.com中查閱。將本公司之義務，免責，管轄權皆明確規範之。除非另有說明，此報告結果僅對檢驗之樣品負責。本報告未經本公司書面許可，不可部份複製。對本報告內容或外觀之任何未經授權之變更、偽造、竄改皆屬非法，違犯者將會被依法追訴。

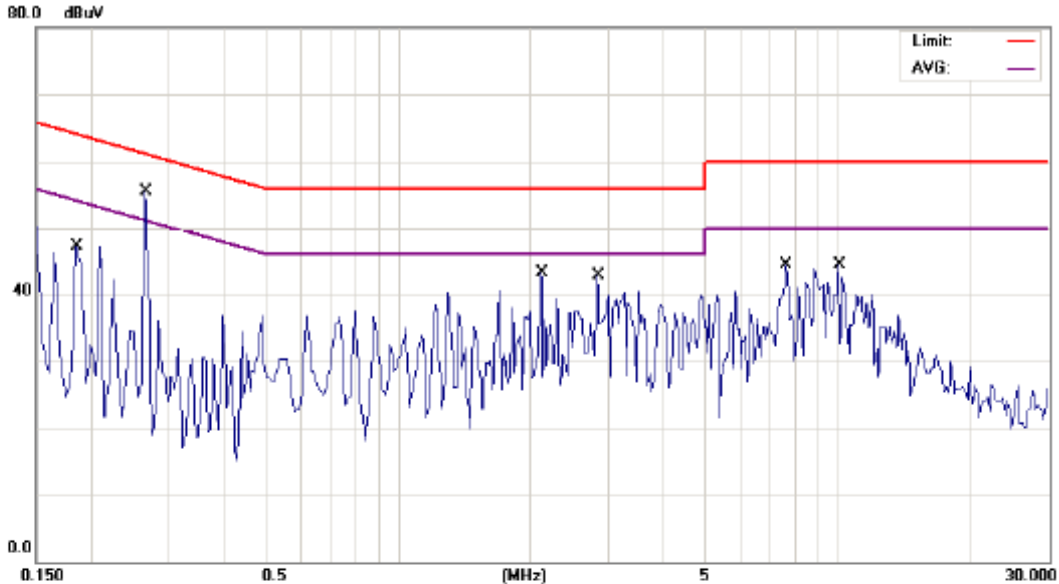

Site: SGS CONDUCTED #1
 Limit: CISPR22 Class B Conduction(QP)
 EUT: GSM850/1900 mobile phone
 M/N: cvle6 crystal
 Note: GSM850 S002EU0450035

Phase: N
 Power: AC 120V/60Hz
 Distance:

Temperature: 25 °C
 Humidity: 62 %
 Air Pressure: hpa

No.	Mk.	Freq. MHz	Reading Level dBuV	Factor dB	Measure- ment dBuV	Limit dBuV	Over dB	Detector	Comment
1		0.1850	47.40	0.73	48.13	64.26	-16.13	QP	
2		0.1850	21.20	0.73	21.93	54.26	-32.33	AVG	
3	*	0.2650	49.40	0.78	50.18	61.27	-11.09	QP	
4		0.2650	22.50	0.78	23.28	51.27	-27.99	AVG	
5		2.1200	32.70	0.66	33.36	56.00	-22.64	QP	
6		2.1200	22.60	0.66	23.26	46.00	-22.74	AVG	
7		2.8400	34.40	0.70	35.10	56.00	-20.90	QP	
8		2.8400	24.00	0.70	24.70	46.00	-21.30	AVG	
9		7.6400	39.00	0.78	39.78	60.00	-20.22	QP	
10		7.6400	28.00	0.78	28.78	50.00	-21.22	AVG	
11		10.0800	36.40	0.91	37.31	60.00	-22.69	QP	
12		10.0800	25.20	0.91	26.11	50.00	-23.89	AVG	

This document is issued by the Company subject to its General Conditions of Service printed overleaf or available on request and accessible at www.sgs.com. Attention is drawn to the limitations of liability, indemnification, and Jurisdictional issued defined therein. Unless otherwise stated, the results shown in this test report refer only to the sample(s) tested. This document cannot be reproduced except in full, without prior approval of Company. Any unauthorized alteration, forgery or falsification of the content or appearance of this report is unlawful and offenders may be prosecuted to the fullest extent of the law. 此報告是遵循本公司訂定之通用服務條款所製作發放，請注意此條款列印於背面，亦可在www.sgs.com中查閱。將本公司之義務，免責，管轄權皆明確規範之。除非另有說明，此報告結果僅對檢驗之樣品負責。本報告未經本公司書面許可，不可部份複製。對本報告內容或外觀之任何未經授權之變更、偽造、竄改皆屬非法，違犯者將會被依法追訴。

AC POWER LINE CONDUCTED EMISSION TEST DATA

Operation Mode : GSM1900 Link Mode Test Date : Nov. 16, 2005
 Fundamental Frequency : N/A Test By : Eric
 Temperature : 25°C Adaptor Model : S002EU0450035
 Humidity : 62%

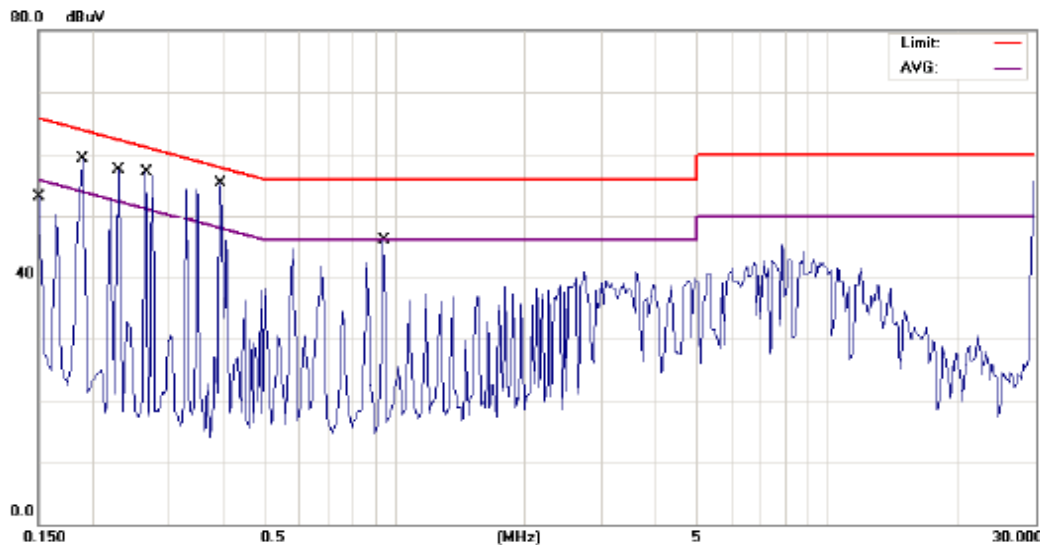

Site: SGS CONDUCTED #1 Phase: L1 Temperature: 25 °C
 Limit: CISPR22 Class B Conduction(QP) Power: AC 120V/60Hz Humidity: 62 %
 EUT: GSM850/1900 mobile phone Distance: Air Pressure: hpa
 M/N: cvle6 crystal
 Note: GSM 1900 S002EU0450035

No.	Mk.	Freq.	Reading Level	Factor	Measurement	Limit	Over	Detector	Comment
		MHz	dBuV	dB	dBuV	dBuV	dB		
1		0.1500	54.00	0.68	54.68	66.00	-11.32	QP	
2		0.1500	25.20	0.68	25.88	56.00	-30.12	AVG	
3	*	0.1900	56.10	0.74	56.84	64.04	-7.20	QP	
4		0.1900	28.20	0.74	28.94	54.04	-25.10	AVG	
5		0.2300	47.70	0.76	48.46	62.45	-13.99	QP	
6		0.2300	22.00	0.76	22.76	52.45	-29.69	AVG	
7		0.2650	46.90	0.78	47.68	61.27	-13.59	QP	
8		0.2650	20.00	0.78	20.78	51.27	-30.49	AVG	
9		0.3950	40.40	0.83	41.23	57.96	-16.73	QP	
10		0.3950	20.20	0.83	21.03	47.96	-26.93	AVG	
11		0.9400	37.40	0.62	38.02	56.00	-17.98	QP	
12		0.9400	25.20	0.62	25.82	46.00	-20.18	AVG	

This document is issued by the Company subject to its General Conditions of Service printed overleaf or available on request and accessible at www.sgs.com. Attention is drawn to the limitations of liability, indemnification, and Jurisdictional issued defined therein. Unless otherwise stated, the results shown in this test report refer only to the sample(s) tested. This document cannot be reproduced except in full, without prior approval of Company. Any unauthorized alteration, forgery or falsification of the content or appearance of this report is unlawful and offenders may be prosecuted to the fullest extent of the law. 此報告是遵循本公司訂定之通用服務條款所製作發放，請注意此條款列印於背面，亦可在www.sgs.com中查閱。將本公司之義務，免責，管轄權皆明確規範之。除非另有說明，此報告結果僅對檢驗之樣品負責。本報告未經本公司書面許可，不可部份複製。對本報告內容或外觀之任何未經授權之變更、偽造、竄改皆屬非法，違犯者將會被依法追訴。

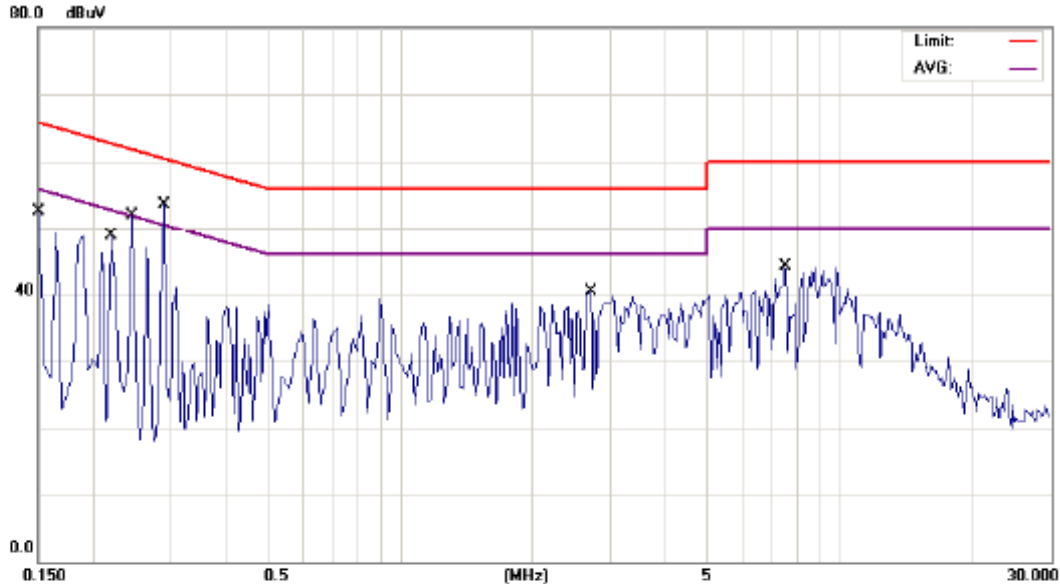

Site: SGS CONDUCTED #1
 Limit: CISPR22 Class B Conduction(QP)
 EUT: GSM850/1900 mobile phone
 M/N: cvle6 crystal
 Note: GSM1900 S002EU0450035

Phase: N
 Power: AC 120V/60Hz
 Distance:

Temperature: 25 °C
 Humidity: 62 %
 Air Pressure: hpa

No.	Mk.	Freq. MHz	Reading Level dBuV	Factor dB	Measure- ment dBuV	Limit dBuV	Over dB	Detector	Comment
1		0.1500	49.40	0.68	50.08	66.00	-15.92	QP	
2		0.1500	28.50	0.68	29.18	56.00	-26.82	AVG	
3		0.2200	41.20	0.76	41.96	62.82	-20.86	QP	
4		0.2200	20.00	0.76	20.76	52.82	-32.06	AVG	
5		0.2450	45.00	0.77	45.77	61.92	-16.15	QP	
6		0.2450	23.50	0.77	24.27	51.92	-27.65	AVG	
7	*	0.2900	46.00	0.79	46.79	60.52	-13.73	QP	
8		0.2900	25.00	0.79	25.79	50.52	-24.73	AVG	
9		2.7200	35.00	0.69	35.69	56.00	-20.31	QP	
10		2.7200	23.50	0.69	24.19	46.00	-21.81	AVG	
11		7.5200	39.00	0.78	39.78	60.00	-20.22	QP	
12		7.5200	30.70	0.78	31.48	50.00	-18.52	AVG	

This document is issued by the Company subject to its General Conditions of Service printed overleaf or available on request and accessible at www.sgs.com. Attention is drawn to the limitations of liability, indemnification, and Jurisdiction issued defined therein. Unless otherwise stated, the results shown in this test report refer only to the sample(s) tested. This document cannot be reproduced except in full, without prior approval of Company. Any unauthorized alteration, forgery or falsification of the content or appearance of this report is unlawful and offenders may be prosecuted to the fullest extent of the law. 此報告是遵循本公司訂定之通用服務條款所製作發放，請注意此條款列印於背面，亦可在www.sgs.com中查閱。將本公司之義務，免責，管轄權皆明確規範之。除非另有說明，此報告結果僅對檢驗之樣品負責。本報告未經本公司書面許可，不可部份複製。對本報告內容或外觀之任何未經授權之變更、偽造、竄改皆屬非法，違犯者將會被依法追訴。