



FCC 47 CFR PART 22 SUBPART H AND PART 24 SUBPART E

TEST REPORT

For

Mobile

Model: C61Ba

Market name: OT-E100a

Trade Name: Alcatel

Issued to

**TCL&Alcatel Mobile Phones
3/F, B2 Block, Digital Technology Yard, Gaoxin Nan Qi Road,
Nan Shan District, Shenzhen, Guangdong, P.R.China**

Issued by

COMPLIANCE CERTIFICATION SERVICES (KUNSHAN) INC.

10#Weiye Rd, Innovation Park Eco. & Tec. Development Zone

Kunshan city JiangSu, (215300) CHINA

TEL: 86-512-57355888

FAX: 86-512-57370818



Lab. Code: 200581-0

Note: This report shall not be reproduced except in full, without the written approval of Compliance Certification Services Inc. This document may be altered or revised by Compliance Certification Services Inc. personnel only, and shall be noted in the revision section of the document.



TABLE OF CONTENTS

1. TEST RESULT CERTIFICATION.....	3
2. EUT DESCRIPTION	4
3. TEST METHODOLOGY	6
3.1 EUT CONFIGURATION	6
3.2 EUT EXERCISE	6
3.3 GENERAL TEST PROCEDURES	6
3.4 DESCRIPTION OF TEST MODES	6
4. INSTRUMENT CALIBRATION.....	7
5. FACILITIES AND ACCREDITATIONS	8
5.1 FACILITIES	8
5.2 EQUIPMENT	8
5.3 LABORATORY ACCREDITATIONS AND LISTING	8
5.4 TABLE OF ACCREDITATIONS AND LISTINGS	9
6. SETUP OF EQUIPMENT UNDER TEST	10
6.1 SETUP CONFIGURATION OF EUT	10
6.2 SUPPORT EQUIPMENT	10
7. FCC PART 22 & 24 REQUIREMENTS	11
7.1 PEAK POWER	11
7.2 ERP & EIRP MEASUREMENT	13
7.3 OCCUPIED BANDWIDTH MEASUREMENT	16
7.4 OUT OF BAND EMISSION AT ANTENNA TERMINALS	21
7.5 FIELD STRENGTH OF SPURIOUS RADIATION MEASUREMENT	31
7.6 FREQUENCY STABILITY V.S. TEMPERATURE MEASUREMENT	38
7.7 FREQUENCY STABILITY V.S. VOLTAGE MEASUREMENT	40
7.8 POWERLINE CONDUCTED EMISSIONS	42



1. TEST RESULT CERTIFICATION

Applicant: TCL & Alcatel Mobile Phones
 3/F, B2 Block, Digital Technology Yard, Gaoxin Nan Qi Road,
 Nan Shan District, Shenzhen, Guangdong, P.R.China

Equipment Under Test: Mobile

Trade Name: Alcatel

Model Number: C61Ba

Market name: OT-E100a

Date of Test: April 6~13, 2006

APPLICABLE STANDARDS	
STANDARD	TEST RESULT
FCC 47 CFR PART 22 SUBPART H AND PART 24 SUBPART E	No non-compliance noted

We hereby certify that:

The above equipment was tested by Compliance Certification Services Inc. The test data, data evaluation, test procedures, and equipment configurations shown in this report were made in accordance with the procedures given in ANSI/TIA/EIA-603-A-2001 and the energy emitted by the sample EUT tested as described in this report is in compliance with conducted and radiated emission limits of FCC Rule FCC PART 22 Subpart H and PART 24 Subpart E.

The test results of this report relate only to the tested sample identified in this report.

Approved by:

Reviewed by:



 Tony Houng
 General Manager of Kunshan Laboratory
 Compliance Certification Services Inc.



 Miró Chueh
 Section Manager of Kunshan Laboratory
 Compliance Certification Services Inc.



2. EUT DESCRIPTION

Product	Mobile
Trade Name	Alcatel
Model Number	C61Ba
Market name	OT-E100a
Model Discrepancy	N/A
Power Supply	<ol style="list-style-type: none"> 1. AC to DC charger Trade Name :Alcatel Model Number :3DS09371AGAA Input: AC100-127V, 50/60Hz, 0.15 A Output: DC4.5V,350mA DC Power Cord: DC Power Cable 2m Non-shielding, Non-detachable, without Core Manufactures: Astec 2. AC to DC charger Trade Name :Alcatel Model Number :3DS09371AGAA Input: AC100-127V, 50/60Hz, 0.3 A Output: DC4.5V,350mA DC Power Cord: DC Power Cable 2.05m Non-shielding, Non-detachable, without Core Manufactures: Leader 3. AC to DC charger Trade Name :Alcatel Model Number :3DS09371AAAA Input: AC200-240V, 50/60Hz, 0.3 A Output: DC4.5V,350mA DC Power Cord: DC Power Cable 2m Non-shielding, Non-detachable, without Core Manufactures: Astec 4. AC to DC charger Trade Name :Alcatel Model Number : 3DS09371AAAA Input: AC200-240V, 50/60Hz, 0.15 A Output: DC4.5V,350mA DC Power Cord: DC Power Cable 2.06m Non-shielding, Non-detachable, without Core Manufactures: Leader 5. AC to DC charger Trade Name :Alcatel Model Number : 3DS10628AHAA Input: AC100-240V, 50/60Hz, 0.10 A Output: DC4.5V,350mA DC Power Cord: DC Power Cable 2.06m Non-shielding,



	<p>Non-detachable, without Core Manufactures: TENPAO</p> <p>6. AC to DC charger Trade Name :Alcatel Model Number : 3DS10628AGAA Input: AC100-240V, 50/60Hz, 0.10 A Output: DC4.5V,350mA DC Power Cord: DC Power Cable 2.06m Non-shielding, Non-detachable, without Core Manufactures: TENPAO</p> <p>7. DC to DC charger Trade Name :Alcatel Model Number :3DS07848AAAA Input: DC12/24V, Output: DC4.5V DC Power Cord: DC Power Cable 2.64m Non-shielding, Non-detachable, without Core Manufactures: Primax</p> <p>8. Battery: Alcatel / 3DS11080AAAA Lithium-Ion 3.7V/ 600mAh</p>
Frequency Range	TX: 824 ~ 849 MHz / 1850 ~ 1910 MHz RX: 869 ~ 894 MHz / 1930 ~ 1990 MHz
Transmit Power	31.09 dBm
Cellular Phone Protocol	GSM (PCS)
Type of Emission	241KGXW
Antenna Type	Inner Antenna

Remark: This submittal(s) (test report) is intended for FCC ID: RAD036 filing to comply with Part 22 and Part 24 of the FCC 47 CFR Rules.



3. TEST METHODOLOGY

Both conducted and radiated testing were performed according to the procedures document on chapter 13 of ANSI C63.4 and FCC CFR 47, 2.1046, 2.1047, 2.1049, 2.1051, 2.1053, 2.1055 and 2.1057.

3.1 EUT CONFIGURATION

The EUT configuration for testing is installed on RF field strength measurement to meet the Commissions requirement and operating in a manner that intends to maximize its emission characteristics in a continuous normal application.

3.2 EUT EXERCISE

The EUT was operated in the engineering mode to fix the TX frequency that was for the purpose of the measurements.

3.3 GENERAL TEST PROCEDURES

Conducted Emissions

The EUT is placed on the turntable, which is 0.8 m above ground plane. According to the requirements in Section 13.1.4.1 of ANSI C63.4. Conducted emissions from the EUT measured in the frequency range between 0.15 MHz and 30MHz using CISPR Quasi-peak and average detector modes.

Radiated Emissions

The EUT is placed on a turn table, which is 0.8 m above ground plane. The turntable shall rotate 360 degrees to determine the position of maximum emission level. EUT is set 3m away from the receiving antenna, which varied from 1m to 4m to find out the highest emission. And also, each emission was to be maximized by changing the polarization of receiving antenna both horizontal and vertical. In order to find out the maximum emissions, exploratory radiated emission measurements were made according to the requirements in Section 13.1.4.1 of ANSI C63.4.

3.4 DESCRIPTION OF TEST MODES

The EUT (model: C61Ba) had been tested under operating condition.

EUT staying in continuous transmitting mode was programmed. Channel Low, Mid and High were chosen for full testing.

After verification, all tests were carried out with the worst case test modes as shown below except radiated spurious emission below 1GHz, which worst case was in normal link mode only.

The field strength of spurious emission was measured in the following position: EUT stand-up position (Z axis), lie-down position (X, Y axis). The worst emission was found in stand-up position (Z axis) and the worst case was recorded.



4. INSTRUMENT CALIBRATION

The measuring equipment, which was utilized in performing the tests documented herein, has been calibrated in accordance with the manufacturer's recommendations for utilizing calibration equipment, which is traceable to recognized national standards.



5. FACILITIES AND ACCREDITATIONS

5.1 FACILITIES

All measurement facilities used to collect the measurement data are located at CCS China Kunshan Lab at 10#, Weiye Rd, Innovation Park Eco. & Tec. Development Zone Kunshan city JiangSu, (215300)CHINA.

The sites are constructed in conformance with the requirements of ANSI C63.7, ANSI C63.4 and CISPR Publication 22.

5.2 EQUIPMENT

Radiated emissions are measured with one or more of the following types of linearly polarized antennas: tuned dipole, biconical, log periodic, bi-log, and/or ridged waveguide, horn. Spectrum analyzers with pre-selectors and quasi-peak detectors are used to perform radiated measurements.

Conducted emissions are measured with Line Impedance Stabilization Networks and EMI Test Receivers.





Calibrated wideband preamplifiers, coaxial cables, and coaxial attenuators are also used for making measurements.

All receiving equipment conforms to CISPR Publication 16-1, "Radio Interference Measuring Apparatus and Measurement Methods."

5.3 LABORATORY ACCREDITATIONS AND LISTING

The test facilities used to perform radiated and conducted emissions tests are accredited by National Voluntary Laboratory Accreditation Program for the specific scope of accreditation under Lab Code: 200581-0 to perform Electromagnetic Interference tests according to FCC PART 15 AND CISPR 22 requirements. No part of this report may be used to claim or imply product endorsement by NVLAP or any agency of the US Government. In addition, the test facilities are listed with Federal Communications Commission (Registration no: 93105 and 90471).

5.4 TABLE OF ACCREDITATIONS AND LISTINGS

Country	Agency	Scope of Accreditation	Logo
USA	NVLAP	EN 55022, EN 61000-3-2, EN 61000-3-3, EN550024, EN 61000-4-2, EN 61000-4-3, EN61000-4-4, EN 61000-4-5, EN 61000-4-6, IEC 61000-4-8, EN 61000-4-11 ANSI C63.4, CISPR16-1, IEC61000-3-2, IEC61000-3-3, IEC 61000-4-2, IEC 61000-4-3, IEC 61000-4-4, IEC 61000-4-5, IEC 61000-4-6, IEC 61000-4-8, IEC 61000-4-11	 Lab. Code: 200581-0
USA	FCC	3/10 meter Sites to perform FCC Part 15/18 measurements	 93105, 90471
Japan	VCCI	3/10 meter Sites and conducted test sites to perform radiated/conducted measurements	 R-1600 C-1707
Norway	NEMKO	EN61000-6-1/2/3/4, EN 50082-1/2, IEC 61000-6-1/2/3/4, EN 50091-2, EN 55011, EN 55022, EN 55024, EN 61000-3-2/3, EN 61000-11, IEC 61000-4-2/3/4/5/6/8/11, CISPR16-1/2/3/4	 ELA 105

** No part of this report may be used to claim or imply product endorsement by NVLAP or any agency of the US Government.*



6. SETUP OF EQUIPMENT UNDER TEST

6.1 SETUP CONFIGURATION OF EUT

See test photographs attached in Appendix 1 for the actual connections between EUT and support equipment.

6.2 SUPPORT EQUIPMENT

No.	Device Type	Brand	Model	FCC ID	Series No.	Data Cable	Power Cord
1	N/A						

Remark:

1. All the equipment/cables were placed in the worst-case configuration to maximize the emission during the test.
2. Grounding was established in accordance with the manufacturer's requirements and conditions for the intended use.



7. FCC PART 22 & 24 REQUIREMENTS

7.1 PEAK POWER

LIMIT

According to FCC §2.1046.

MEASUREMENT EQUIPMENT USED

Name of Equipment	Manufacturer	Model	Serial Number	Calibration Due
Peak and Avg Power Sensor	Agilent	E9327A	US40441788	09/05/2007
EPM-P Series Power Meter	Agilent	E4416A	QB41292714	09/05/2007
Spectrum Analyzer	Agilent	E4446A	MY44020154	08/27/2007
Wireless communication test set	Agilent	E5515C	GB44051695	10/06/2007

Remark: Each piece of equipment is scheduled for calibration once a year.

Test Configuration

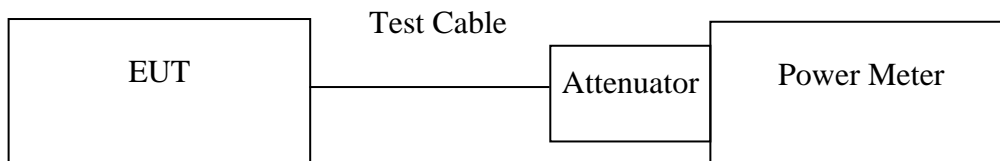

Remark: Measurement setup for testing on Antenna connector

TEST PROCEDURE

The transmitter output was connected to a calibrated attenuator, the other end of which was connected to a power meter. Transmitter output was read off the power meter in dBm. The power output at the transmitter antenna port was determined by adding the value of the attenuator to the power meter reading.



TEST RESULTS

No non-compliance noted.

Test Data

Test Mode	CH	Frequency (MHz)	Power Meter Reading (dBm)	Factor (dB)	Peak Power (dBm)
GSM 850	128	824.20	5.28	26.50	31.78
	190	836.60	5.24		31.74
	251	848.80	5.09		31.59

Remark: The value of factor includes both the loss of cable and external attenuator

Test Mode	CH	Frequency (MHz)	Power Meter Reading (dBm)	Factor (dB)	Peak Power (dBm)
GSM 1900	512	1850.20	4.64	24.50	29.14
	661	1880.00	5.34		29.84
	810	1910.00	5.25		29.75

Remark: The value of factor includes both the loss of cable and external attenuator

7.2 ERP & EIRP MEASUREMENT

LIMIT

According to FCC §2.1046

FCC 22.913(a): The Effective Radiated Power (ERP) of mobile transmitters must not exceed 7 Watts.

FCC 24.232(b): The equivalent Isotropic Radiated Power (EIRP) must not exceed 2 Watts.

MEASUREMENT EQUIPMENT USED

977 Chamber (3m)				
Name of Equipment	Manufacturer	Model	Serial Number	Calibration Due
Spectrum Analyzer	Agilent	E4446A	MY44020154	08/27/2007
EMI Test Receiver	R&S	ESPI3	101026	11/10/2006
Pre-Amplifier	MINI	ZFL-1000VH2	d041703	12/13/2006
Pre-Amplifier	Miteq	NSP4000-NF	870731	01/28/2007
Bilog Antenna	Sunol	JB1	A110204-2	11/10/2006
Horn-antenna	SCHWARZBECK	BBHA9120D	D:266	02/01/2007
PSG Analog Signal Generator	Agilent	E8257C	MY43321570	12/11/2006
Wireless communication test set	Agilent	E5515C	QB44051695	10/06/2007
Turn Table	CT	CT123	4165	N.C.R
Antenna Tower	CT	CTERG23	3256	N.C.R
Controller	CT	CT100	95637	N.C.R
Site NSA	CCS	N/A	N/A	04/06/2007

Remark: Each piece of equipment is scheduled for calibration once a year.

TEST CONFIGURATION

Below 1 GHz

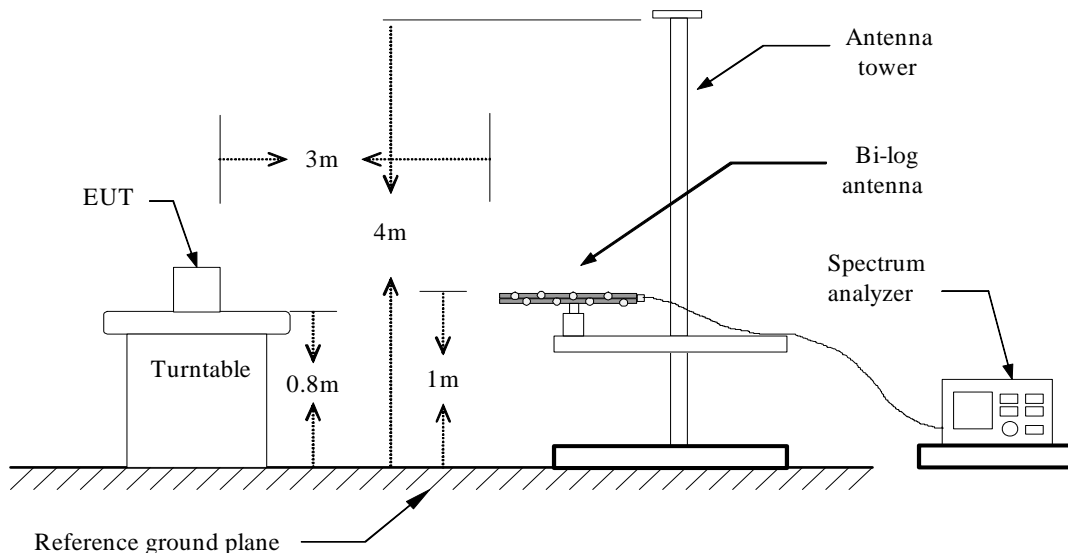

Above 1 GHz

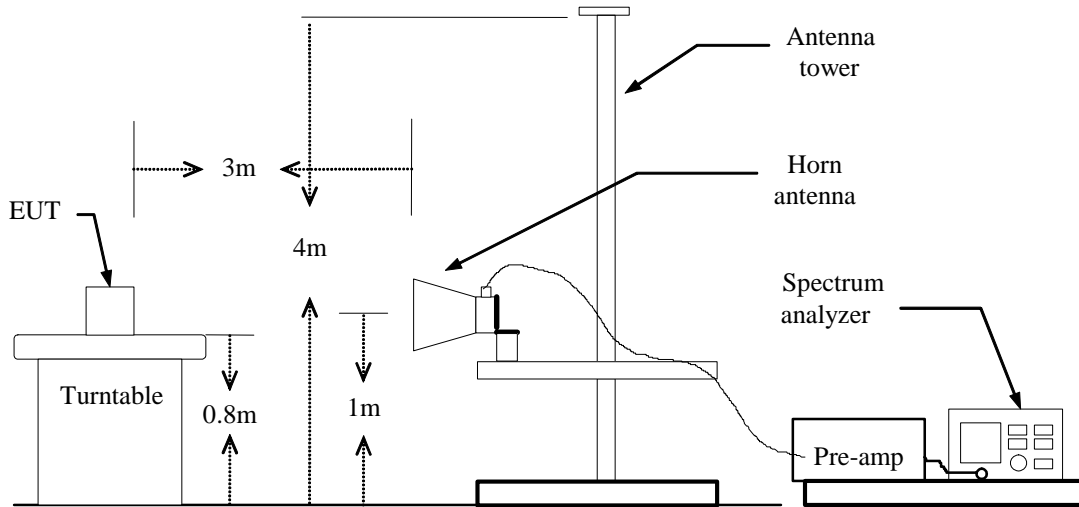

For Substituted Method Test Set-UP

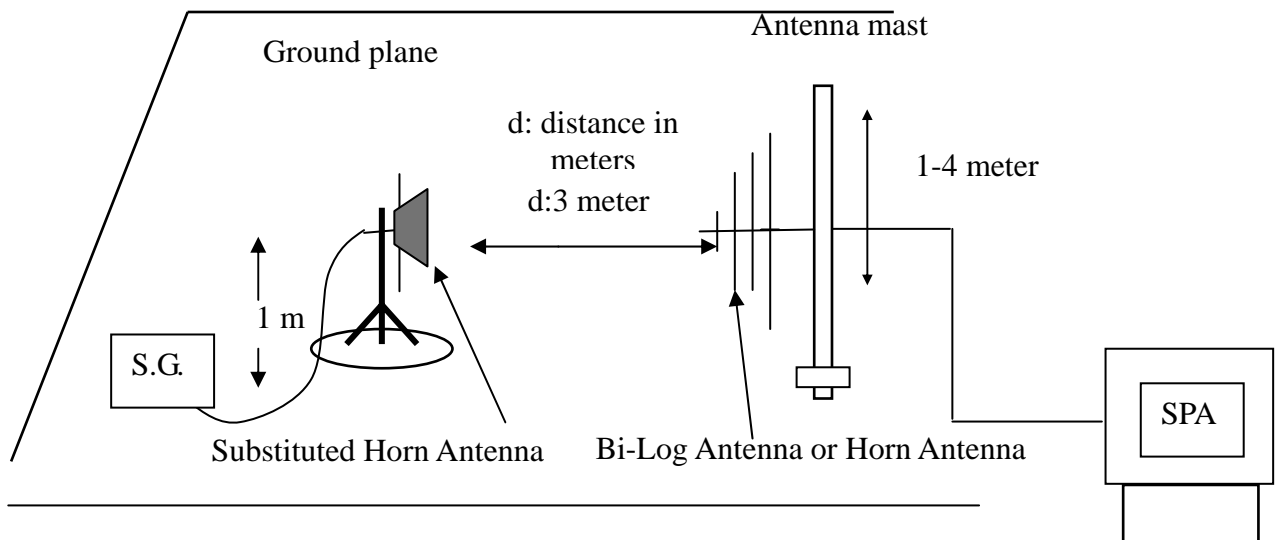

TEST PROCEDURE

The EUT was placed on an non-conductive turntable using a non-conductive support. The radiated emission at the fundamental frequency was measured at 3 m with a test antenna and EMI spectrum analyzer.

During the measurement of the EUT, the resolution bandwidth was set to 3MHz and the average bandwidth was set to 3MHz. The highest emission was recorded with the rotation of the turntable and the lowering of the test antenna. The reading was recorded and the field strength (E in dBuV/m) was calculated.

ERP in frequency band 824-849MHz, and EIRP in frequency band 1851.25 –1910MHz were measured using a substitution method. The EUT was replaced by half-wave dipole (824-849MHz) or horn antenna (1851.25-1910MHz) connected to a signal generator. The spectrum analyzer reading was recorded and ERP/EIRP was calculated as follows:

$$ERP = \text{S.G. output (dBm)} + \text{Antenna Gain (dBd)} - \text{Cable (dB)}$$

$$EIRP = \text{S.G. output (dBm)} + \text{Antenna Gain (dBi)} - \text{Cable (dB)}$$



TEST RESULTS

No non-compliance noted.

GSM 850 Test Data

EUT Pol.	Channel	Frequency (MHz)	Reading level (dBUV)	Antenna Pol.	S.G. (dBm)	Cable loss (dB)	Ant.Gain (dBi)	Emission level (dBm)	Limit (dBm)	Margin (dB)
Z	128	824.20	129.83	V	27.76	2.87	6.20	31.09	38.5	-7.41
		824.20	118.67	H	22.10	2.87	6.20	25.43	38.5	-13.07
	190	836.60	128.17	V	27.51	2.88	6.40	31.03	38.5	-7.47
		836.60	120.00	H	23.89	2.88	6.40	27.41	38.5	-11.09
	251	848.80	127.33	V	26.90	2.94	6.50	30.46	38.5	-8.04
		848.80	119.17	H	23.01	2.94	6.50	26.57	38.5	-11.93

GSM 1900 Test Data

EUT Pol.	Channel	Frequency (MHz)	Reading level (dBUV)	Antenna Pol.	S.G. (dBm)	Cable loss (dB)	Ant.Gain (dBi)	Emission level (dBm)	Limit (dBm)	Margin (dB)
Z	512	1850.20	123.67	V	24.11	4.31	8.45	28.25	33	-4.75
		1850.20	120.17	H	20.22	4.31	8.45	24.36	33	-8.64
	661	1880.00	124.83	V	25.53	4.53	8.48	29.48	33	-3.52
		1880.00	122.33	H	21.46	4.53	8.48	25.41	33	-7.59
	810	1909.80	125.10	V	25.54	4.55	8.52	29.51	33	-3.49
		1909.80	121.17	H	21.84	4.55	8.52	25.81	33	-7.19



7.3 OCCUPIED BANDWIDTH MEASUREMENT

LIMIT

According to §FCC 2.1049.

MEASUREMENT EQUIPMENT USED

Name of Equipment	Manufacturer	Model	Serial Number	Calibration Due
Spectrum Analyzer	Agilent	E4446A	MY44020154	08/27/2007
Wireless communication test set	Agilent	E5515C	QB44051695	10/06/2007

Remark: Each piece of equipment is scheduled for calibration once a year.

Test Configuration

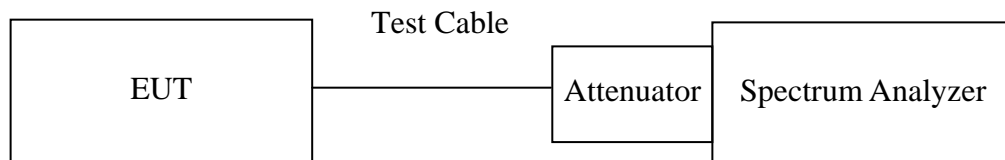

Remark: Measurement setup for testing on Antenna connector

TEST PROCEDURE

The EUT's output RF connector was connected with a short cable to the spectrum analyzer, RBW was set to about 1% of emission BW, VBW is set to 3 times the RBW, -26dBc display line was placed on the screen (or 99% bandwidth), the occupied bandwidth is the delta frequency between the two points where the display line intersects the signal trace.



TEST RESULTS

No non-compliance noted

Test Data

Test Mode	CH	Frequency (MHz)	Bandwidth (kHz)
GSM 850	128	824.20	241.31
	190	836.60	240.24
	251	848.80	240.54

Test Mode	CH	Frequency (MHz)	Bandwidth (kHz)
GSM 1900	512	1850.20	238.75
	661	1880.00	239.36
	810	1909.80	239.88



Test Plot

GSM 850 (CH Low)

Agilent 15:28:20 Apr 7, 2006

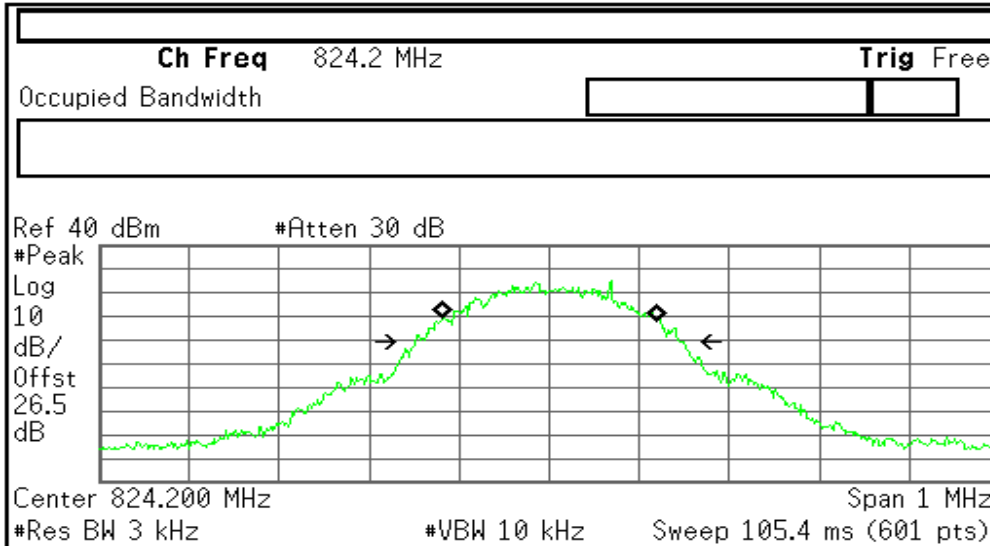

Occupied Bandwidth	Occ BW % Pwr	99.00 %
241.3100 kHz	x dB	-26.00 dB
Transmit Freq Error		-232.799 Hz
x dB Bandwidth		298.202 kHz

Copyright 2000-2004 Agilent Technologies

Measure
Meas Off
Channel Power
Occupied BW
ACP
Multi Carrier Power
Power Stat CCDF
More 1 of 2

GSM 850 (CH Mid)

Agilent 15:29:22 Apr 7, 2006

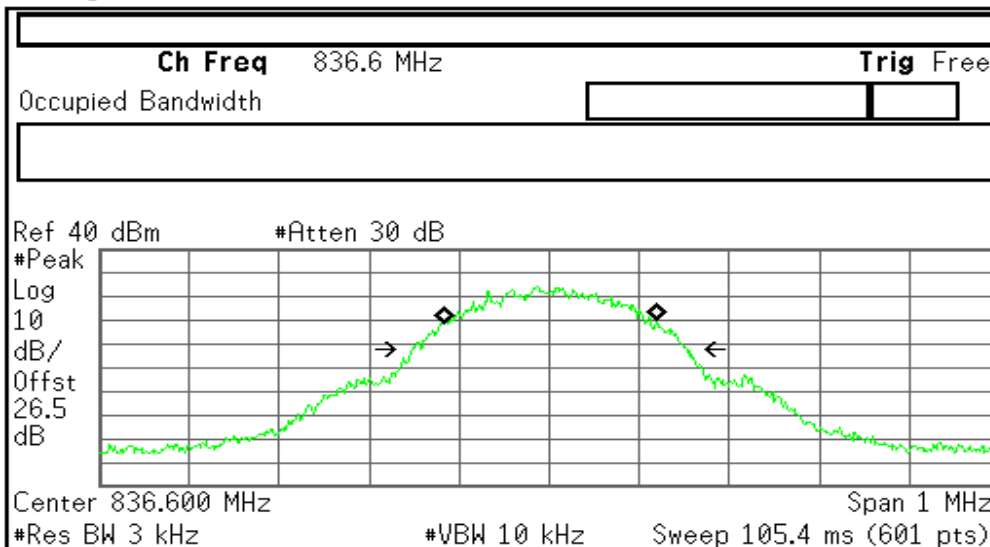

Occupied Bandwidth	Occ BW % Pwr	99.00 %
240.2370 kHz	x dB	-26.00 dB
Transmit Freq Error		1.304 kHz
x dB Bandwidth		304.817 kHz

Copyright 2000-2004 Agilent Technologies

Measure
Meas Off
Channel Power
Occupied BW
ACP
Multi Carrier Power
Power Stat CCDF
More 1 of 2



GSM 850 (CH High)

Agilent 15:27:01 Apr 7, 2006

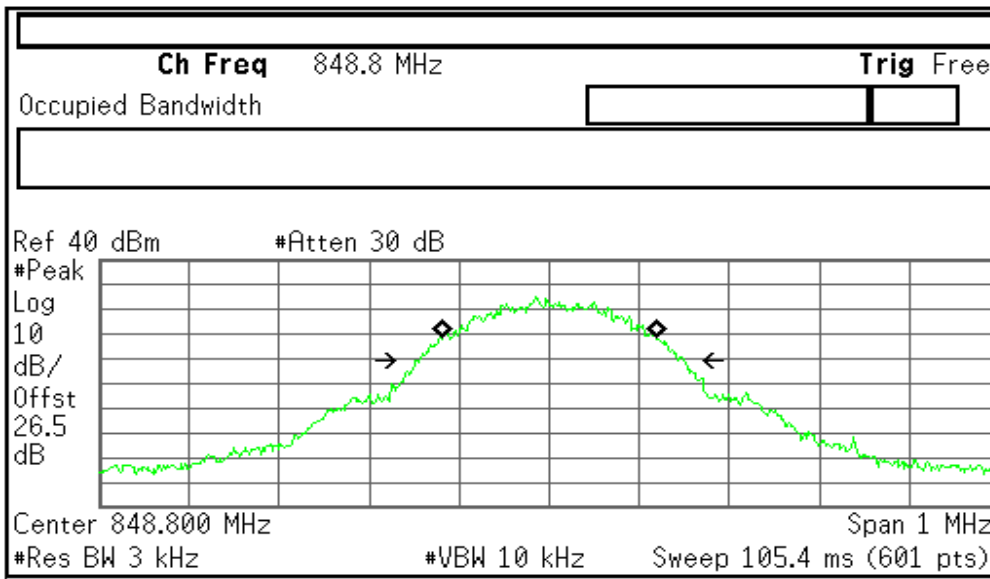

Occupied Bandwidth	Occ BW % Pwr	99.00 %
240.5355 kHz	x dB	-26.00 dB
Transmit Freq Error	222.706 Hz	
x dB Bandwidth	303.278 kHz	

Copyright 2000-2004 Agilent Technologies

Measure
Meas Off
Channel Power
Occupied BW
ACP
Multi Carrier Power
Power Stat CCDF
More 1 of 2

GSM 1900 (CH Low)

Agilent 15:03:40 Apr 7, 2006

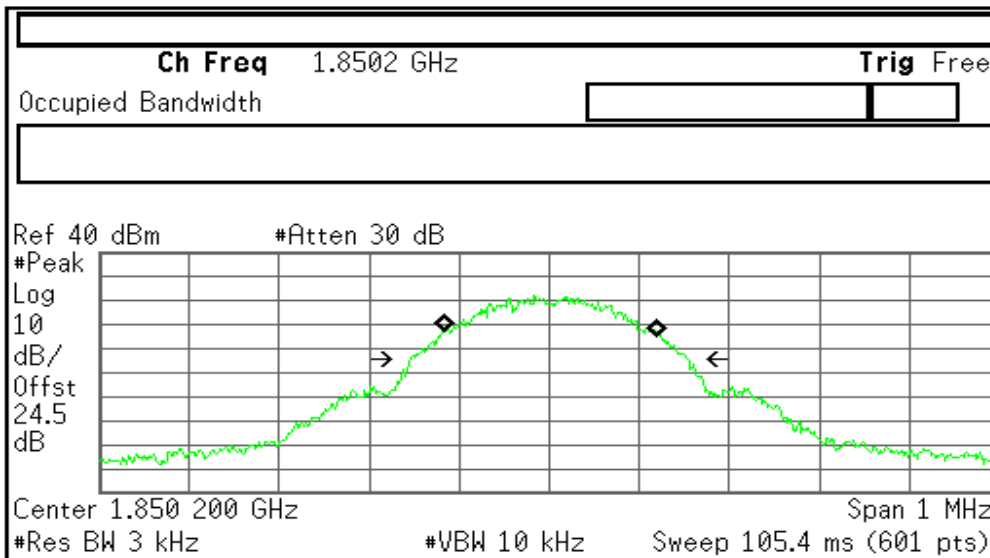

Occupied Bandwidth	Occ BW % Pwr	99.00 %
238.7529 kHz	x dB	-26.00 dB
Transmit Freq Error	435.876 Hz	
x dB Bandwidth	311.081 kHz	

Copyright 2000-2004 Agilent Technologies

Measure
Meas Off
Channel Power
Occupied BW
ACP
Multi Carrier Power
Power Stat CCDF
More 1 of 2



GSM 1900 (CH Mid)

Agilent 15:04:45 Apr 7, 2006

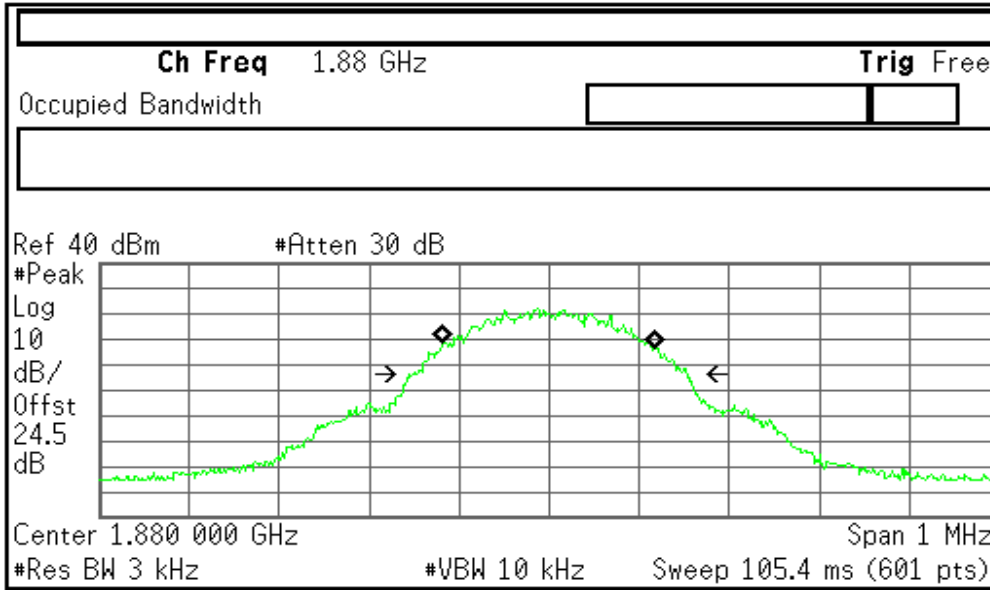

Occupied Bandwidth	Occ BW % Pwr	99.00 %
239.3592 kHz	x dB	-26.00 dB
Transmit Freq Error		-1.326 kHz
x dB Bandwidth		306.111 kHz

Copyright 2000-2004 Agilent Technologies

Measure
Meas Off
Channel Power
Occupied BW
ACP
Multi Carrier Power
Power Stat CCDF
More 1 of 2

GSM 1900 (CH High)

Agilent 15:06:14 Apr 7, 2006

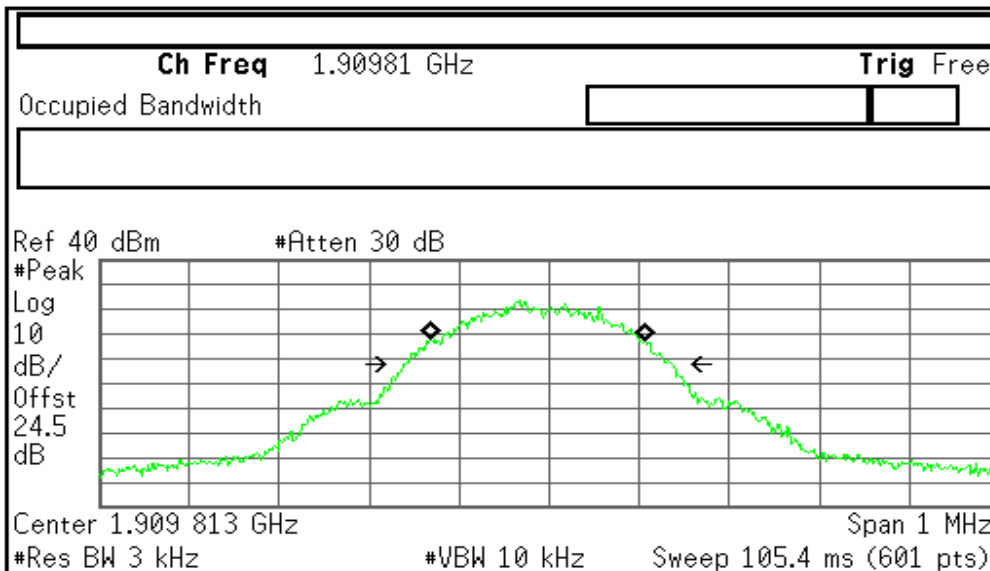

Occupied Bandwidth	Occ BW % Pwr	99.00 %
239.8840 kHz	x dB	-26.00 dB
Transmit Freq Error		-14.113 kHz
x dB Bandwidth		300.368 kHz

Copyright 2000-2004 Agilent Technologies

Measure
Meas Off
Channel Power
Occupied BW
ACP
Multi Carrier Power
Power Stat CCDF
More 1 of 2



7.4 OUT OF BAND EMISSION AT ANTENNA TERMINALS

LIMIT

According to FCC §2.1051, FCC §22.917(e), FCC §22.917(f), FCC §24.238(a).

Out of Band Emissions: The mean power of emission must be attenuated below the mean power of the non-modulated carrier (P) on any frequency twice or more than twice the fundamental frequency by at least $43 + 10 \log P$ dB.

Mobile Emissions in Base Frequency Range: The mean power of any emissions appearing in the base station frequency range from cellular mobile transmitters operated must be attenuated to a level not exceed -80 dBm at the transmit antenna connector.

Band Edge Requirements: In the 1MHz bands immediately outside and adjacent to the frequency block, a resolution bandwidth of at least 1% of the emission bandwidth of the fundamental emission of the transmitter may be employed to measure the Out of band Emission

MEASUREMENT EQUIPMENT USED

Name of Equipment	Manufacturer	Model	Serial Number	Calibration Due
Spectrum Analyzer	Agilent	E4446A	MY44020154	08/27/2007
Wireless communication test set	Agilent	E5515C	QB44051695	10/06/2007

Remark: Each piece of equipment is scheduled for calibration once a year.

TEST CONFIGURATION

Out of band emission at antenna terminals:

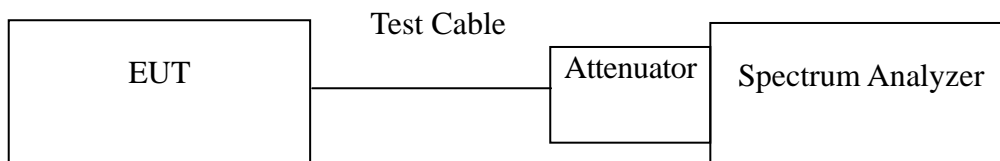

TEST PROCEDURE

The RF output of the transceiver was connected to a spectrum analyzer through appropriate attenuation. The resolution bandwidth of the spectrum analyzer was set at 1MHz, sufficient scans were taken to show the out of band Emissions if any up to 10th harmonic.

For the out of band: Set the RBW, VBW = 1MHz, Start=30MHz, Stop= 10 th harmonic. Limit = -13 dBm

Band Edge Requirements (824 MHz and 849 MHz /1850MHz and 1910MHz): In the 1 MHz bands immediately outside and adjacent to the frequency block, a resolution bandwidth of at least 1 percent of the emission bandwidth of the fundamental emission of the transmitter may be employed to measure the out of band Emissions. Limit, -13 dBm.



TEST RESULTS

No non-compliance noted.

Test Data

Mode	CH	Location	Description
GSM 850	128	Figure 7-1	Conducted spurious emissions, 30MHz - 2.5GHz
		Figure 7-2	Conducted spurious emissions, 2.5GHz - 20GHz
	190	Figure 7-3	Conducted spurious emissions, 30MHz - 2.5GHz
		Figure 7-4	Conducted spurious emissions, 2.5GHz - 20GHz
	251	Figure 7-5	Conducted spurious emissions, 30MHz - 2.5GHz
		Figure 7-6	Conducted spurious emissions, 2.5GHz - 20GHz

Mode	CH	Location	Description
GSM 1900	512	Figure 8-1	Conducted spurious emissions, 30MHz - 2.5GHz
		Figure 8-2	Conducted spurious emissions, 2.5GHz - 20GHz
	661	Figure 8-3	Conducted spurious emissions, 30MHz - 2.5GHz
		Figure 8-4	Conducted spurious emissions, 2.5GHz - 20GHz
	810	Figure 8-5	Conducted spurious emissions, 30MHz - 2.5GHz
		Figure 8-6	Conducted spurious emissions, 2.5GHz - 20GHz

Mode	CH	Location	Description
GSM 850	128	Figure 9-1	Band Edge emissions
	251	Figure 9-2	Band Edge emissions

Mode	CH	Location	Description
GSM 1900	512	Figure 10-1	Band Edge emissions
	810	Figure 10-2	Band Edge emissions



Test Plot

GSM 850

Figure 7-1: Out of Band emission at antenna terminals – GSM CH Low

Agilent 15:32:45 Apr 7, 2006

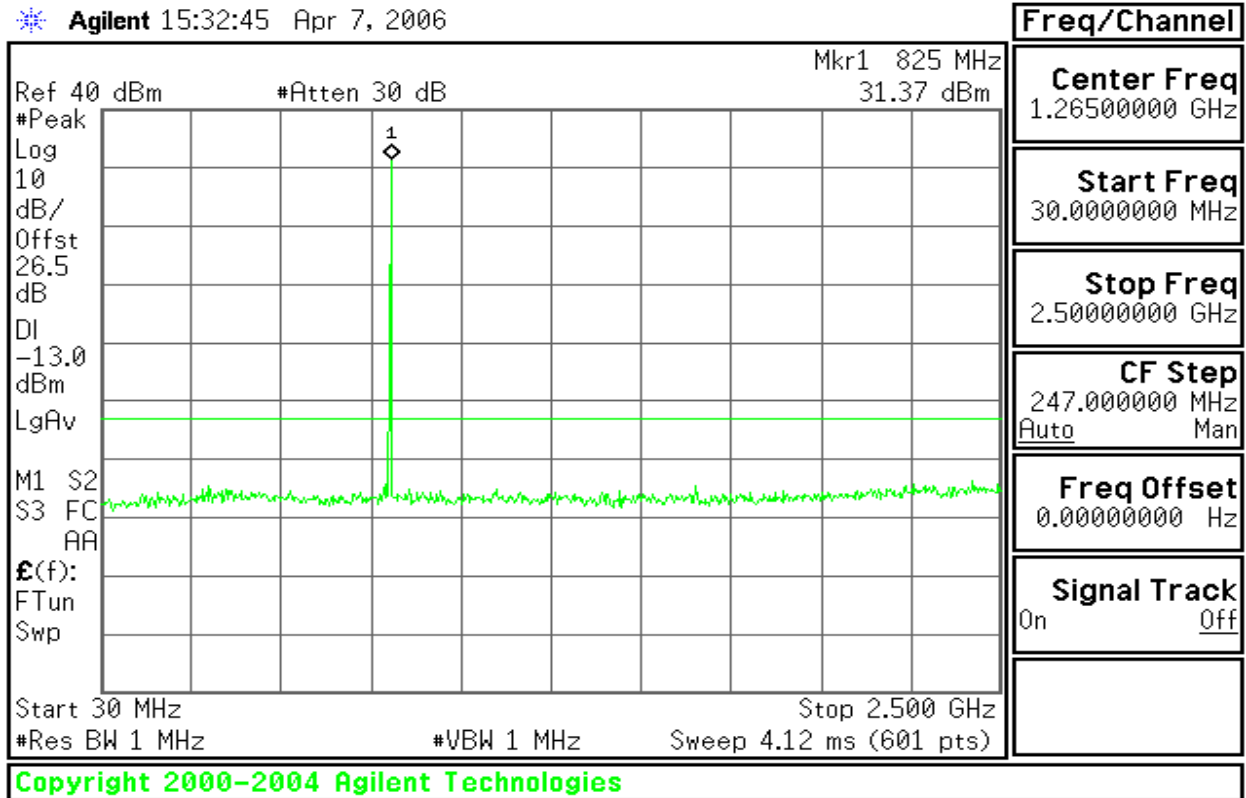

Figure 7-2: Out of Band emission at antenna terminals – GSM CH Low

Agilent 15:31:15 Apr 7, 2006

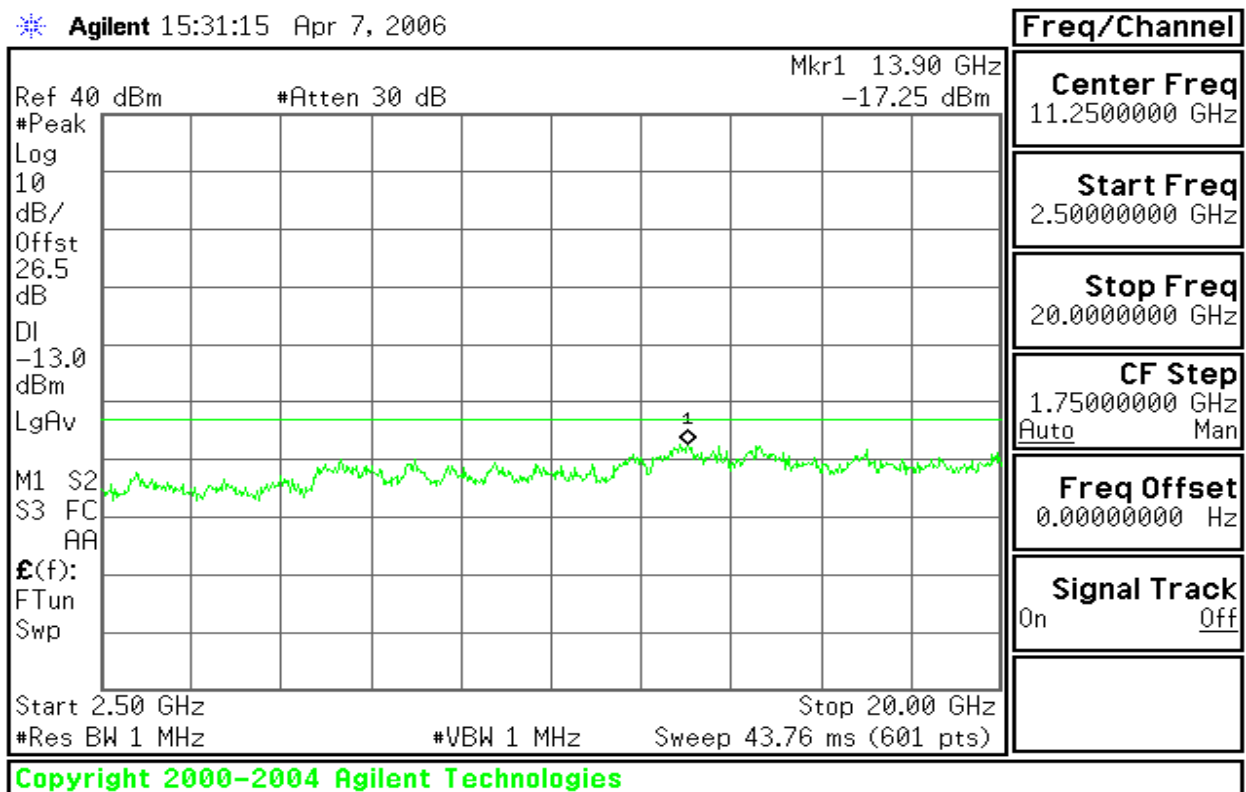



Figure 7-3: Out of Band emission at antenna terminals – GSM CH Mid

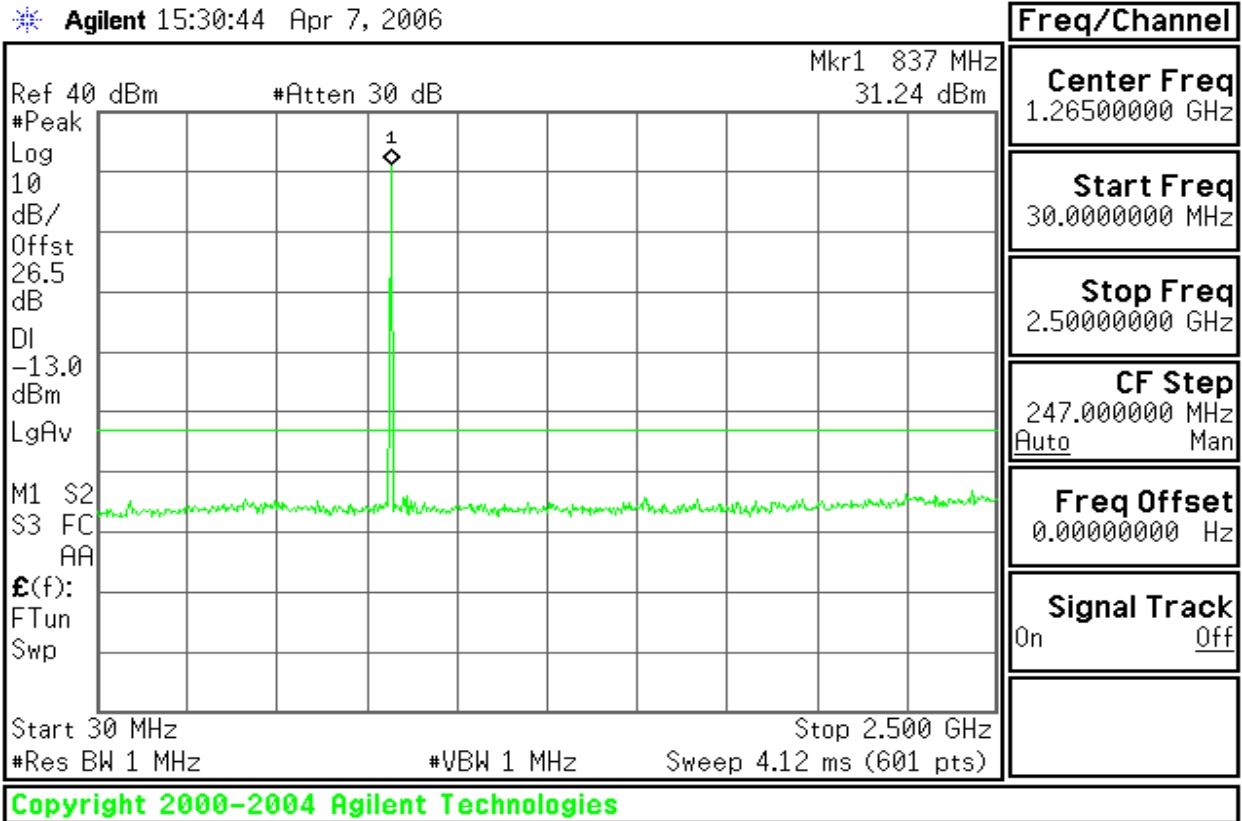

Figure 7-4: Out of Band emission at antenna terminals – GSM CH Mid

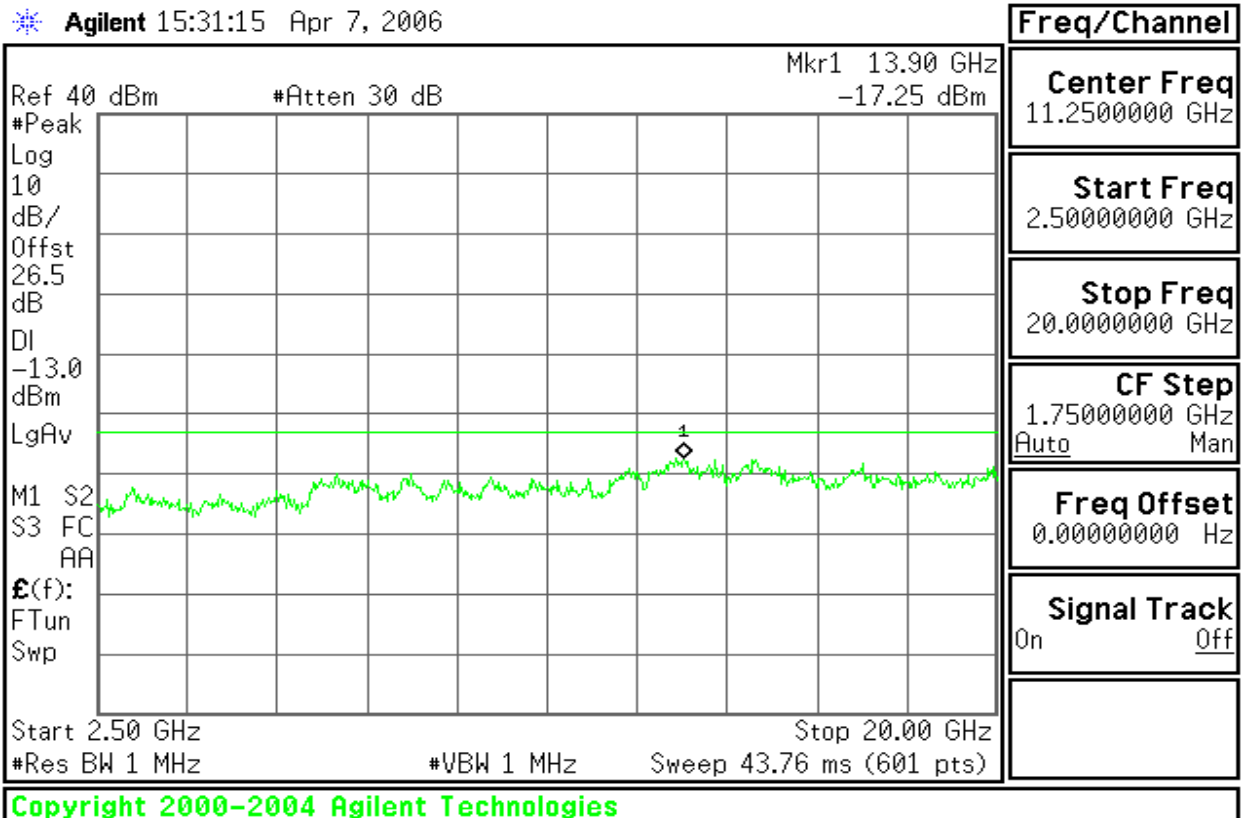



Figure 7-5: Out of Band emission at antenna terminals – GSM CH High

Agilent 15:32:15 Apr 7, 2006

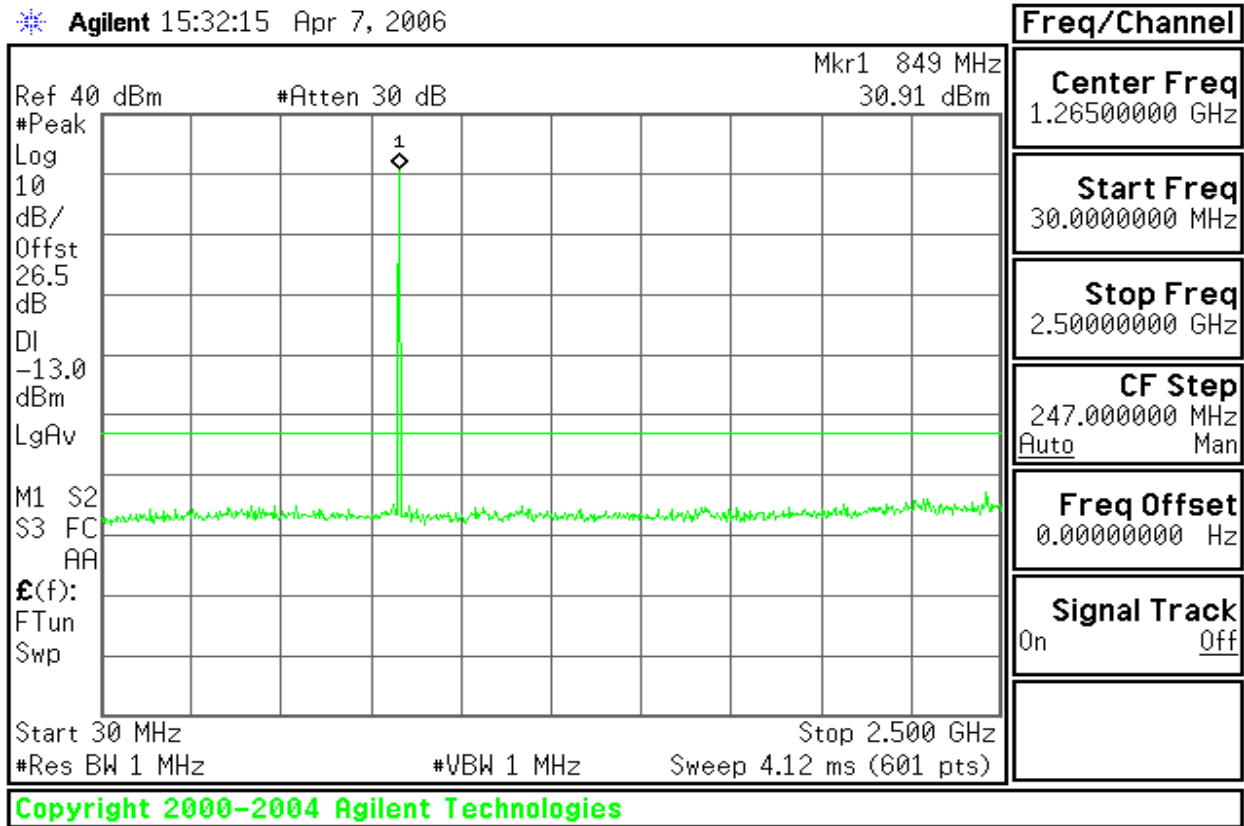
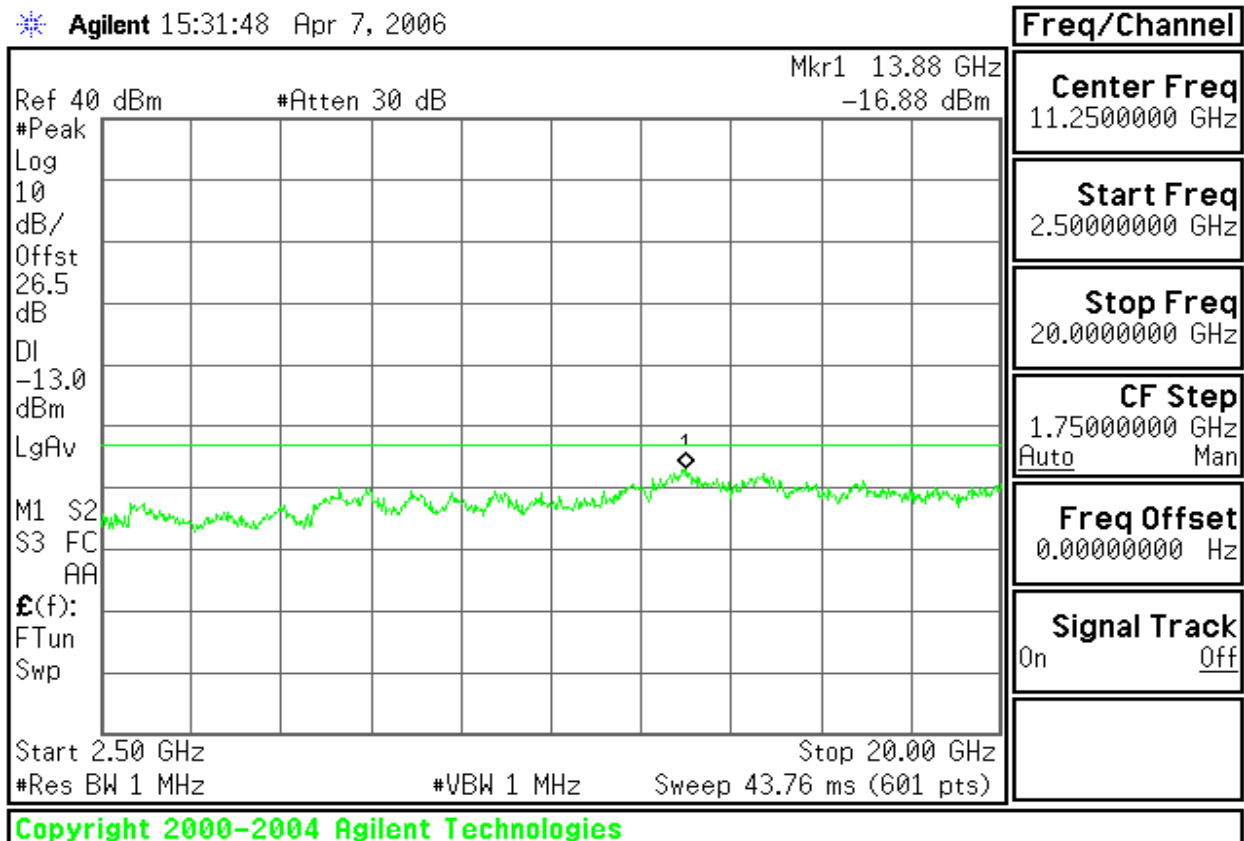

Figure 7-6: Out of Band emission at antenna terminals – GSM CH High

Agilent 15:31:48 Apr 7, 2006





GSM 1900

Figure 8-1: Out of Band emission at antenna terminals – GSM CH Low

Agilent 15:01:02 Apr 7, 2006

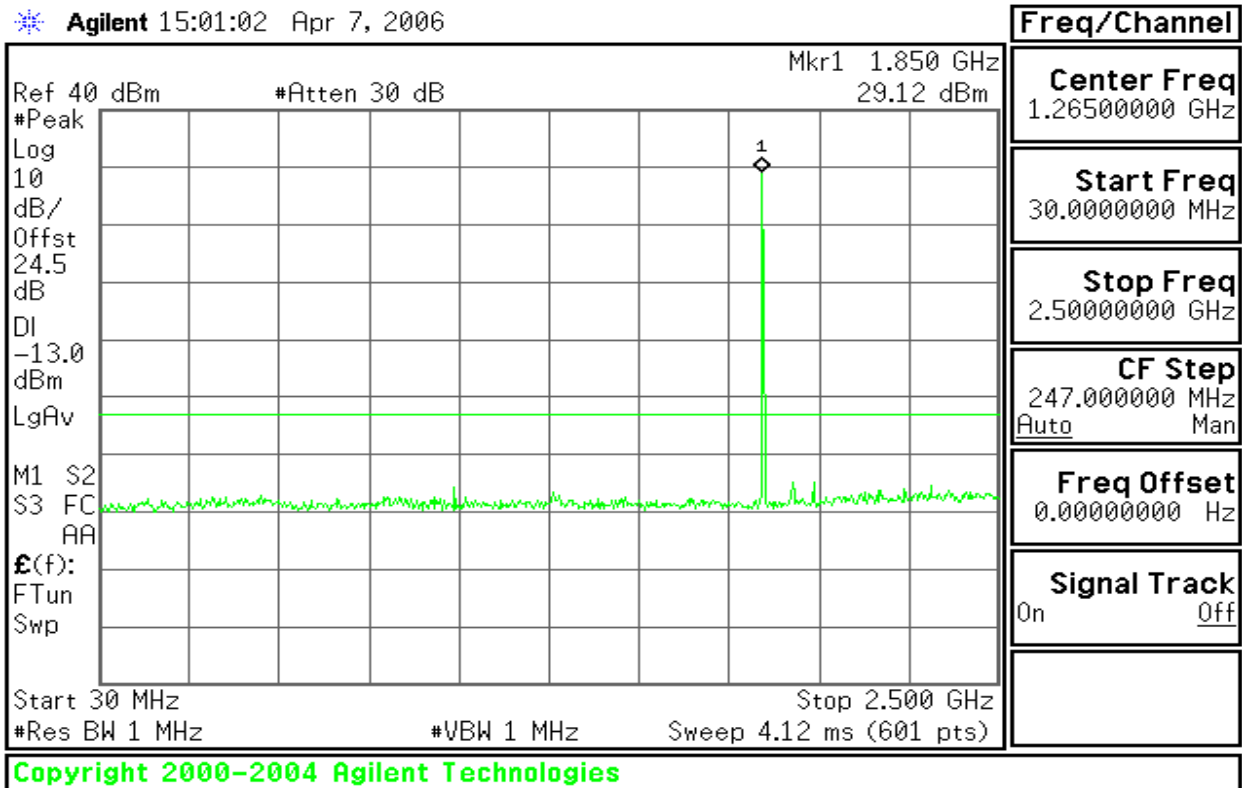

Figure 8-2: Out of Band emission at antenna terminals – GSM CH Low

Agilent 15:00:23 Apr 7, 2006

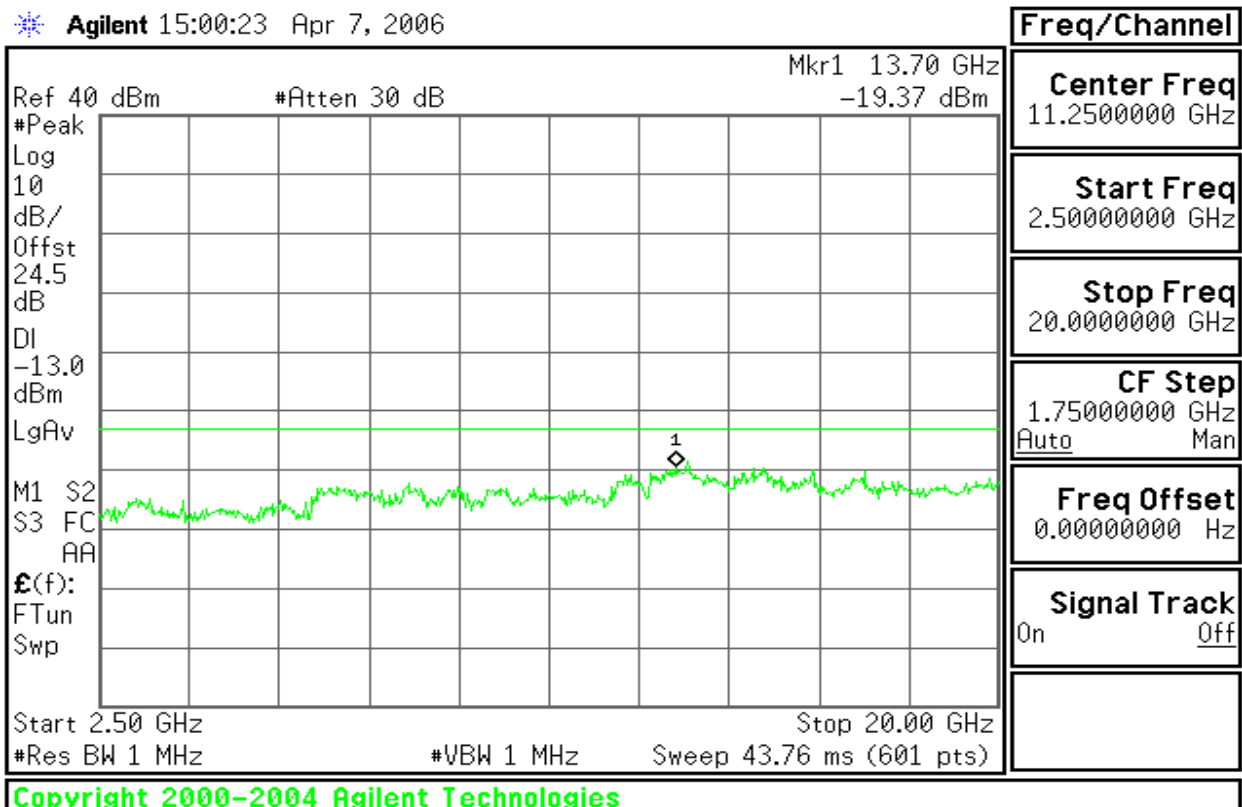



Figure 8-3: Out of Band emission at antenna terminals – GSM CH Mid

Agilent 14:59:29 Apr 7, 2006

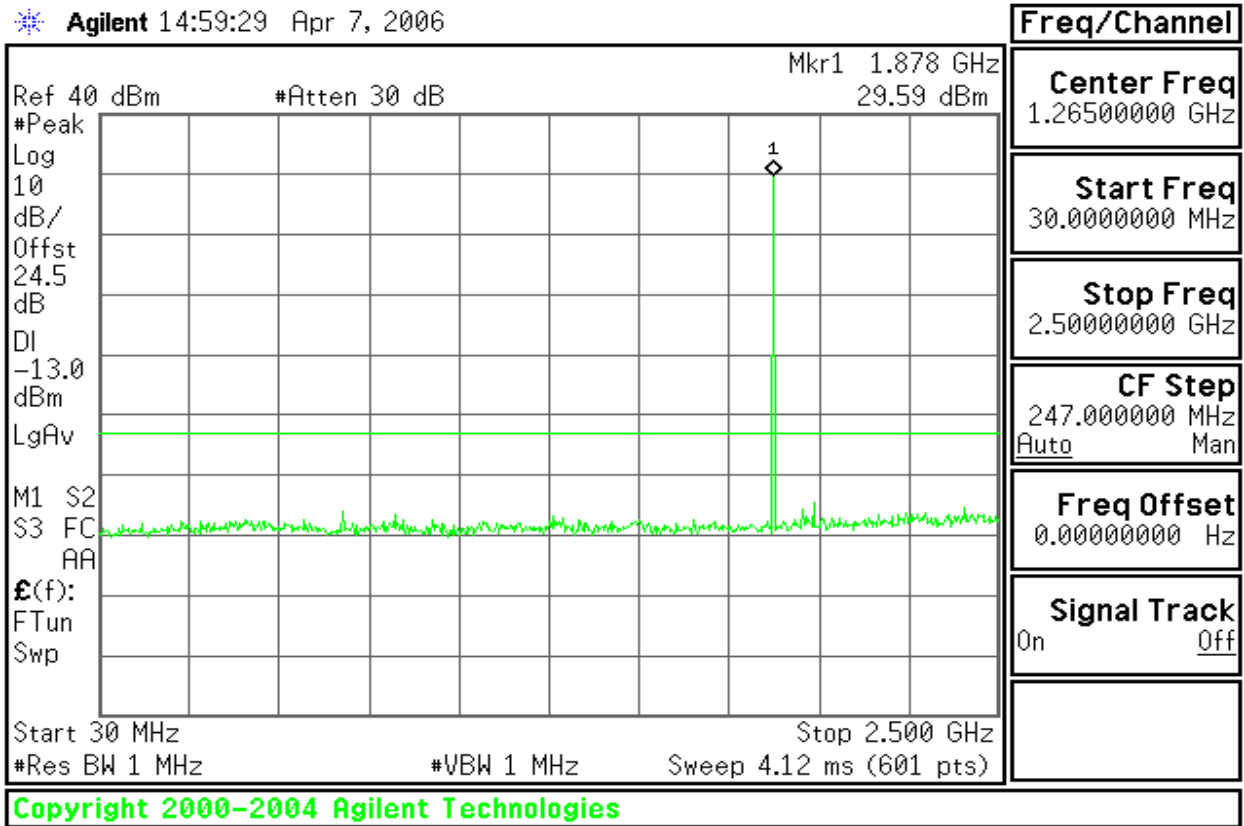

Figure 8-4: Out of Band emission at antenna terminals – GSM CH Mid

Agilent 14:59:59 Apr 7, 2006

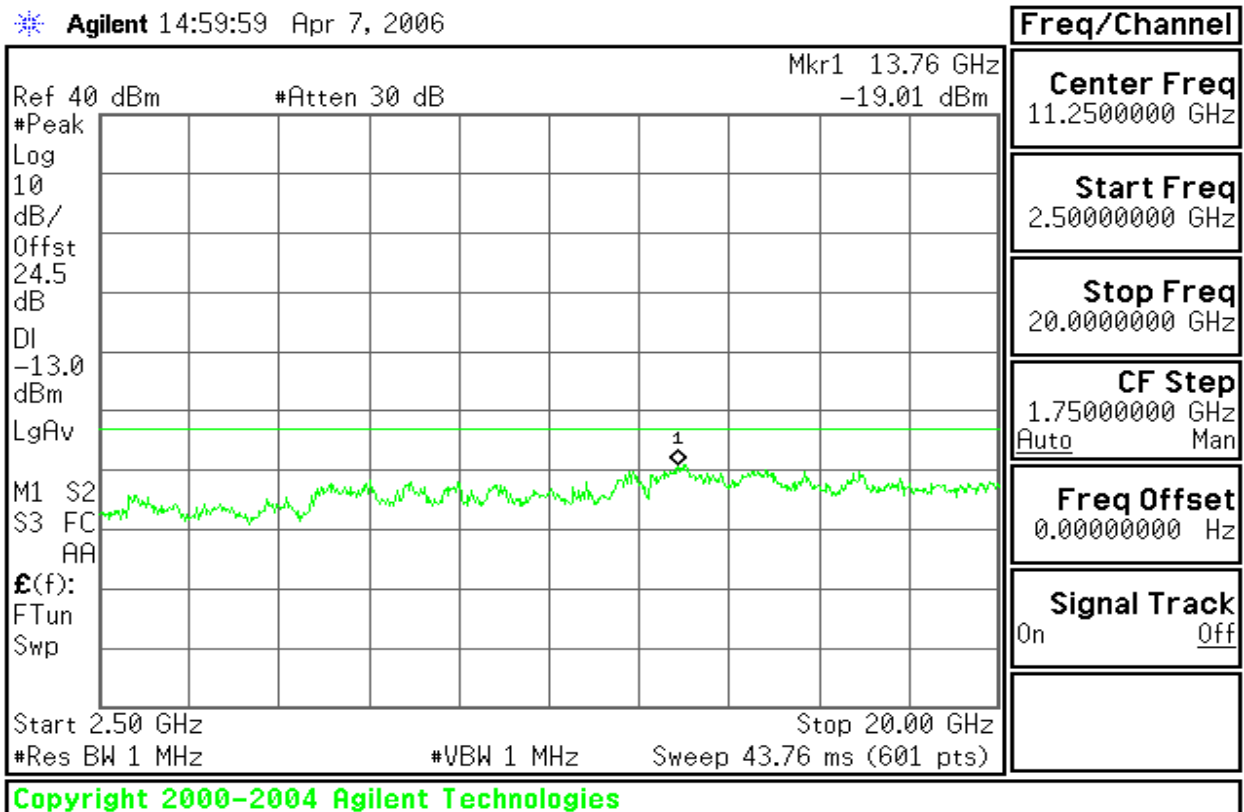

Figure 8-5: Out of Band emission at antenna terminals – GSM CH High

Agilent 14:58:05 Apr 7, 2006

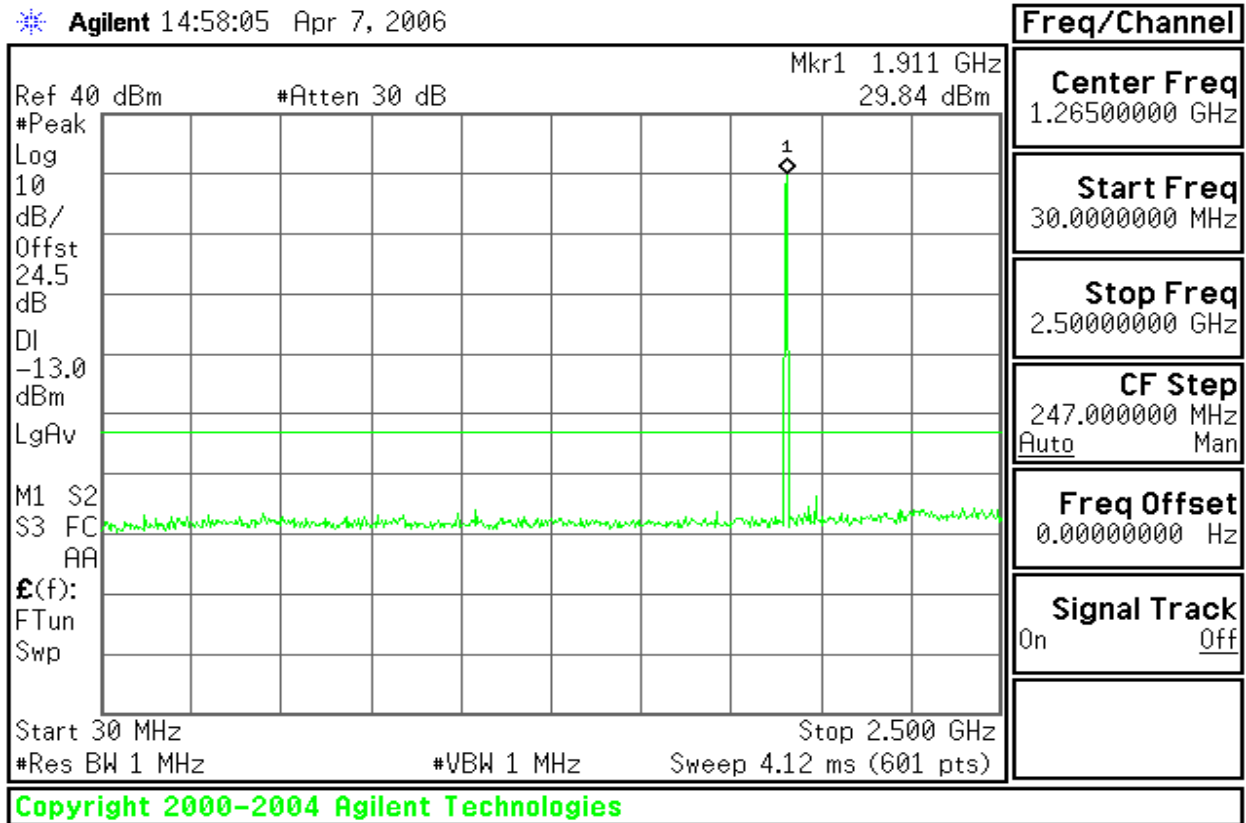
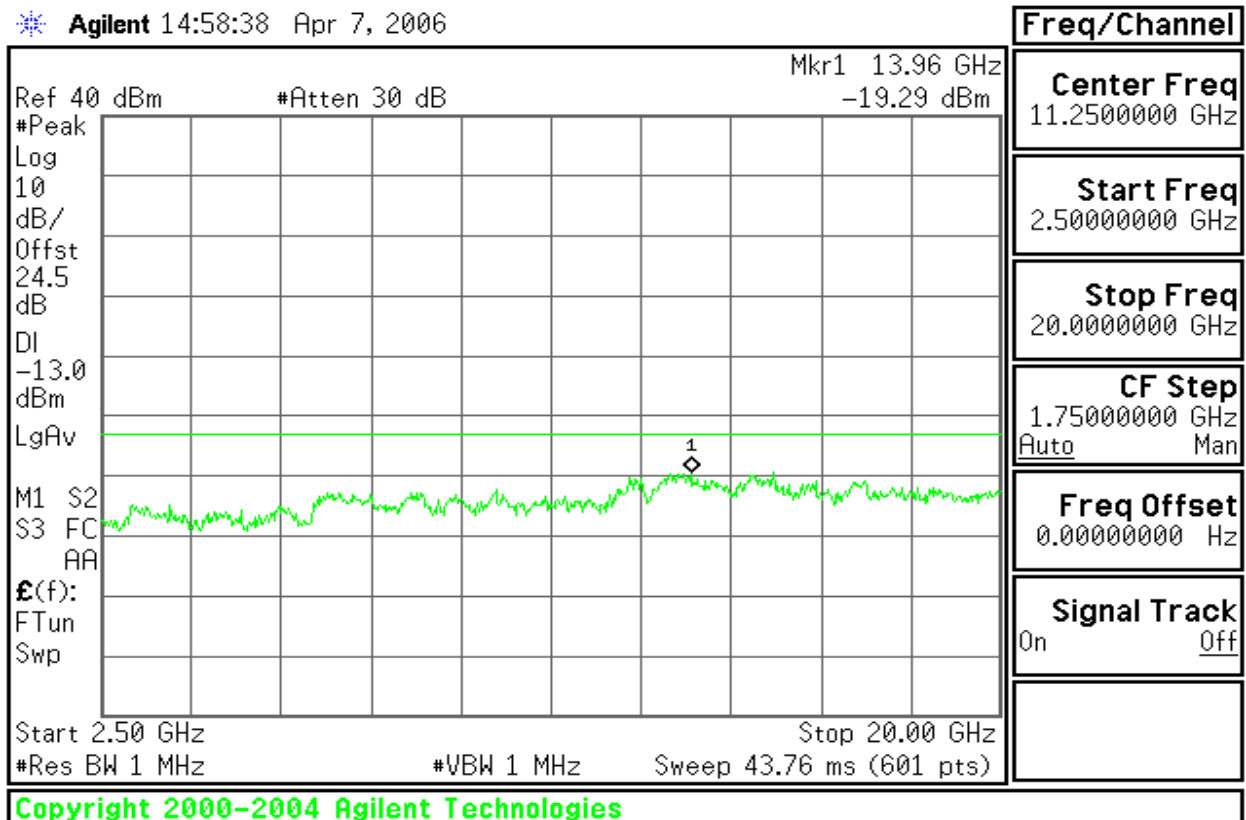

Figure 8-6: Out of Band emission at antenna terminals – GSM CH High

Agilent 14:58:38 Apr 7, 2006





GSM 850

Figure 9-1: Band Edge emissions – GSM CH Low

Agilent 15:37:40 Apr 7, 2006

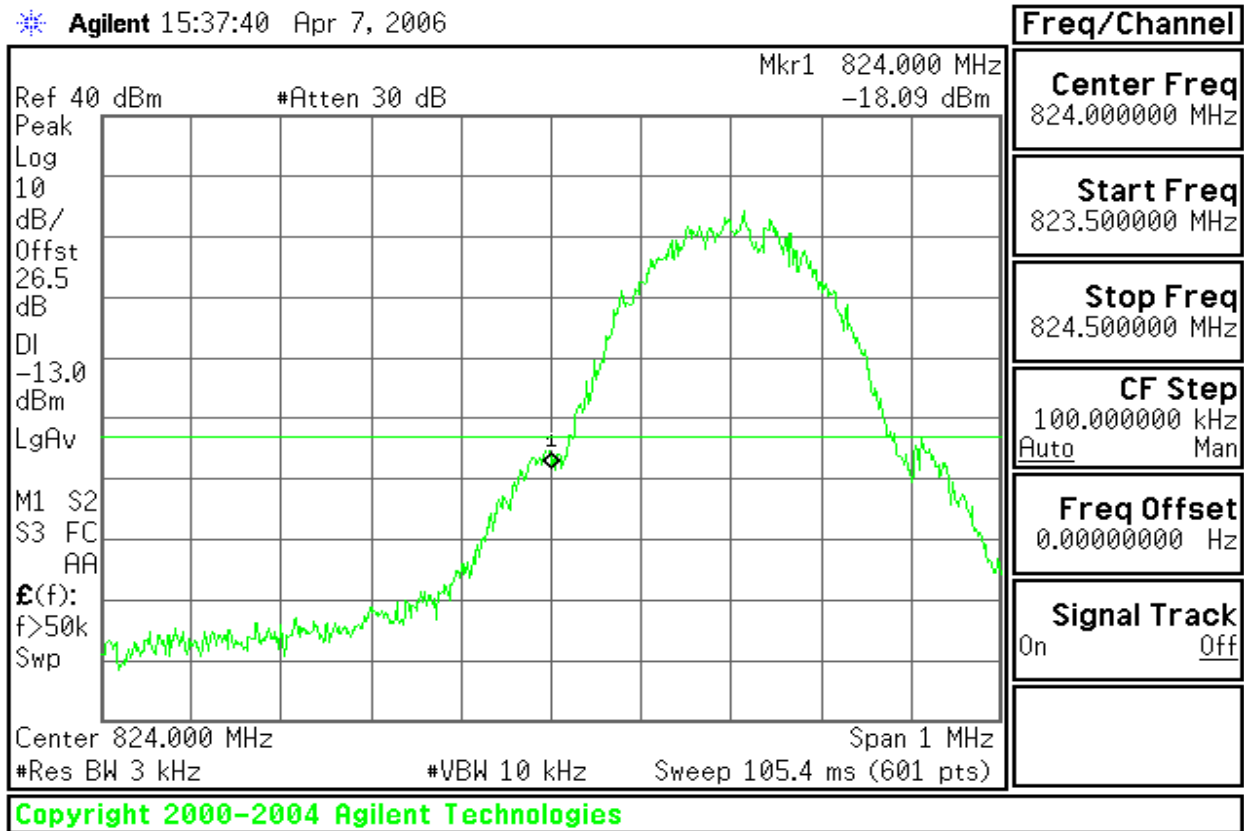
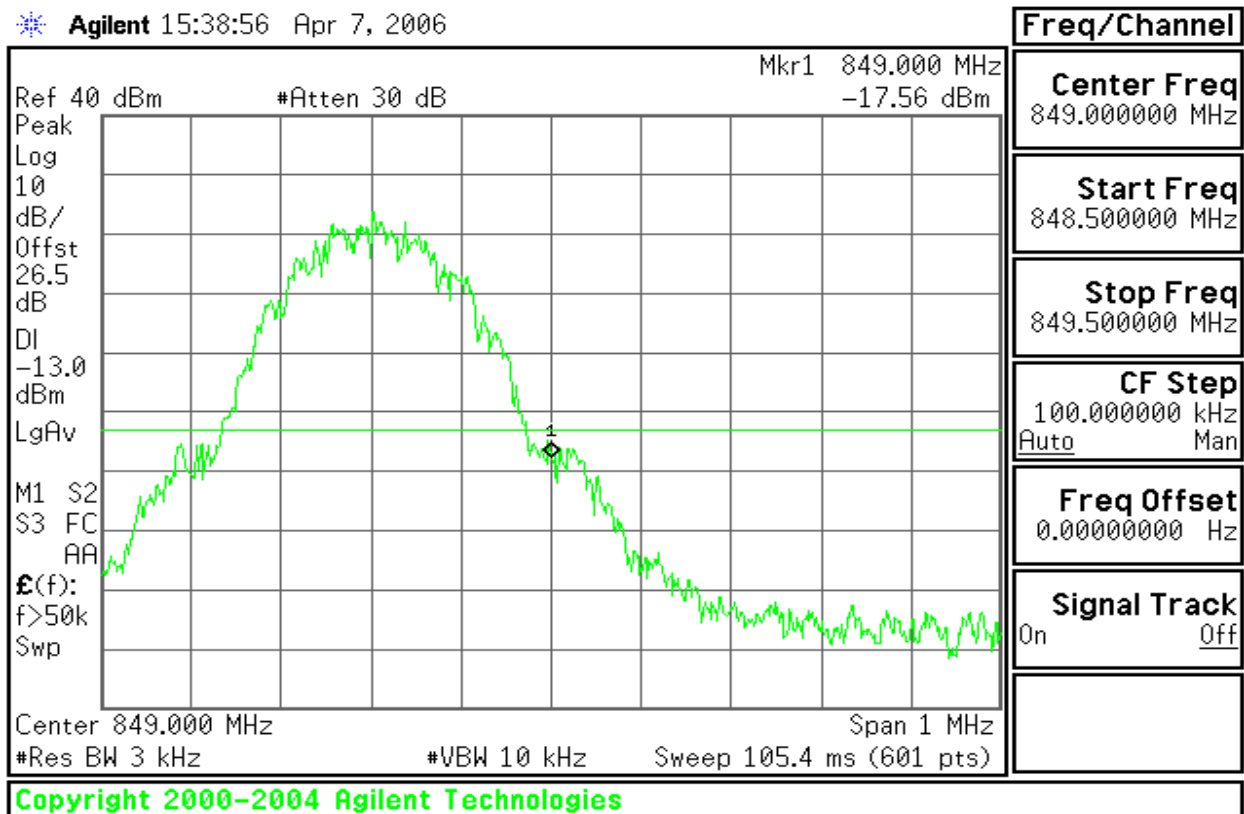

Figure 9-2: Band Edge emissions – GSM CH High

Agilent 15:38:56 Apr 7, 2006





GSM 1900

Figure 10-1: Band Edge emissions – GSM CH Low

Agilent 14:55:47 Apr 7, 2006

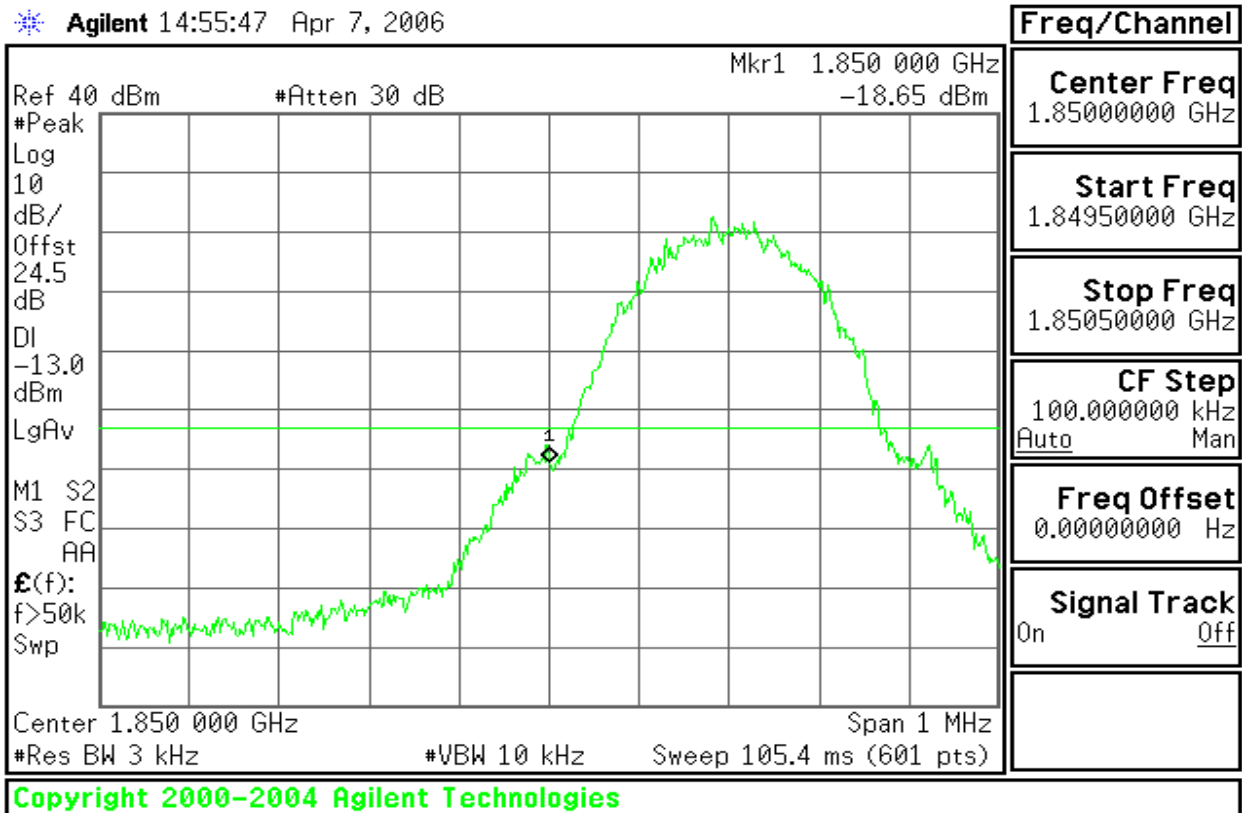
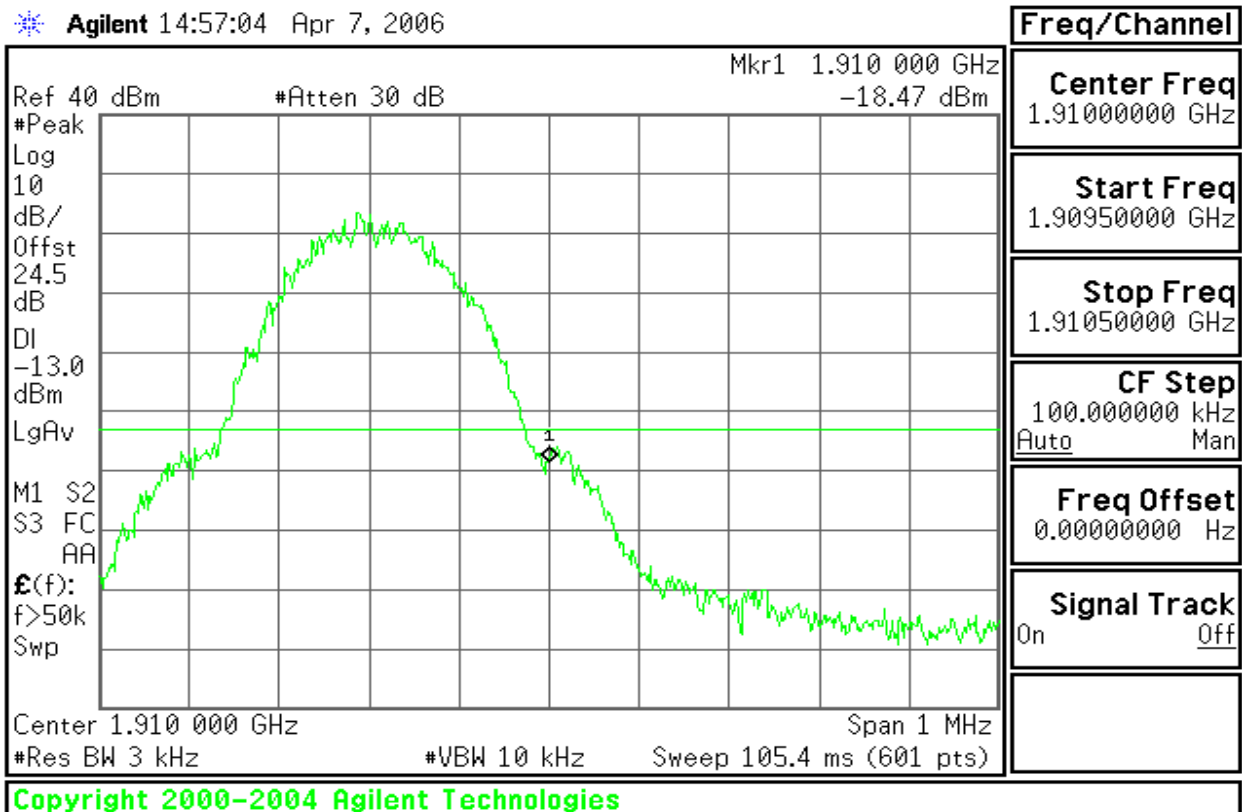

Figure 10-2: Band Edge emissions – GSM CH High

Agilent 14:57:04 Apr 7, 2006





7.5 FIELD STRENGTH OF SPURIOUS RADIATION MEASUREMENT

LIMIT

According to FCC §2.1053

MEASUREMENT EQUIPMENT USED

977 Chamber (3m)				
Name of Equipment	Manufacturer	Model	Serial Number	Calibration Due
Spectrum Analyzer	Agilent	E4446A	MY44020154	08/27/2007
EMI Test Receiver	R&S	ESPI3	101026	11/10/2006
Pre-Amplifier	MINI	ZFL-1000VH2	d041703	12/13/2006
Pre-Amplifier	Miteq	NSP4000-NF	870731	01/28/2007
Bilog Antenna	Sunol	JB1	A110204-2	11/10/2006
Horn-antenna	SCHWARZBECK	BBHA9120D	D:266	02/01/2007
PSG Analog Signal Generator	Agilent	E8257C	MY43321570	12/11/2006
Wireless communication test set	Agilent	E5515C	QB44051695	10/06/2007
Turn Table	CT	CT123	4165	N.C.R
Antenna Tower	CT	CTERG23	3256	N.C.R
Controller	CT	CT100	95637	N.C.R
Site NSA	CCS	N/A	N/A	04/06/2007

Remark: Each piece of equipment is scheduled for calibration once a year.

Test Configuration

Below 1 GHz

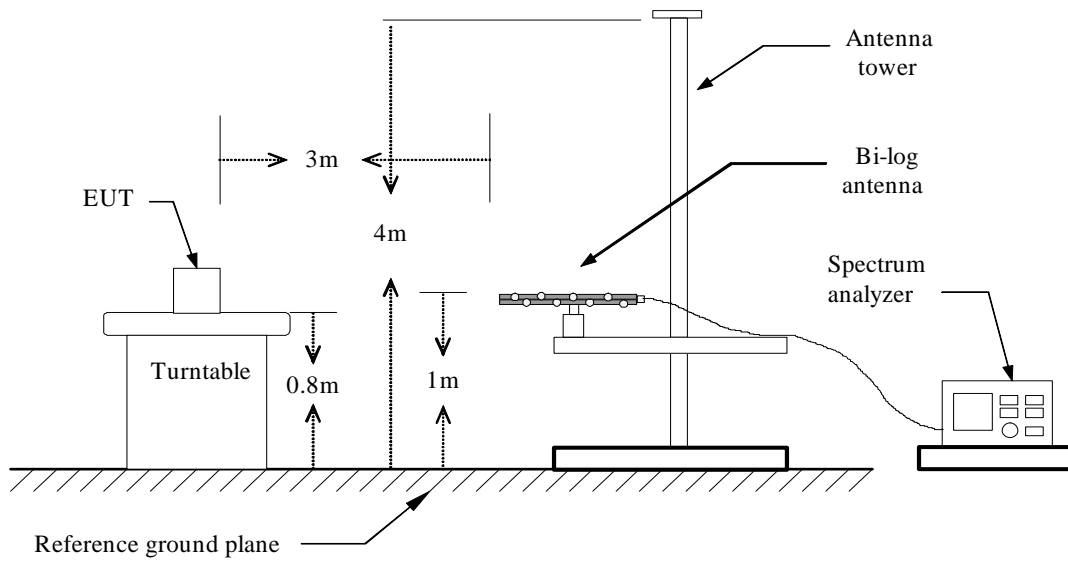

Above 1 GHz

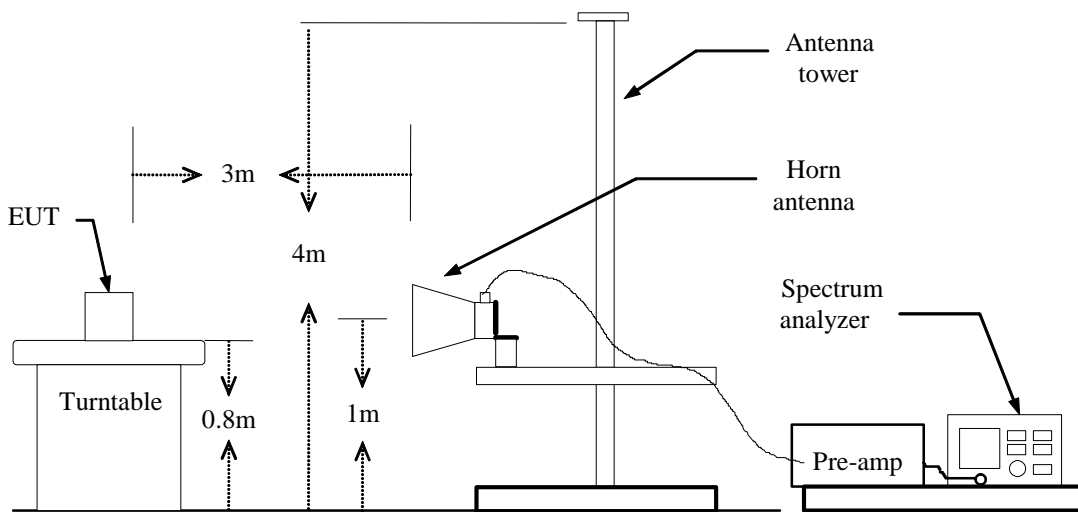

Substituted Method Test Set-up

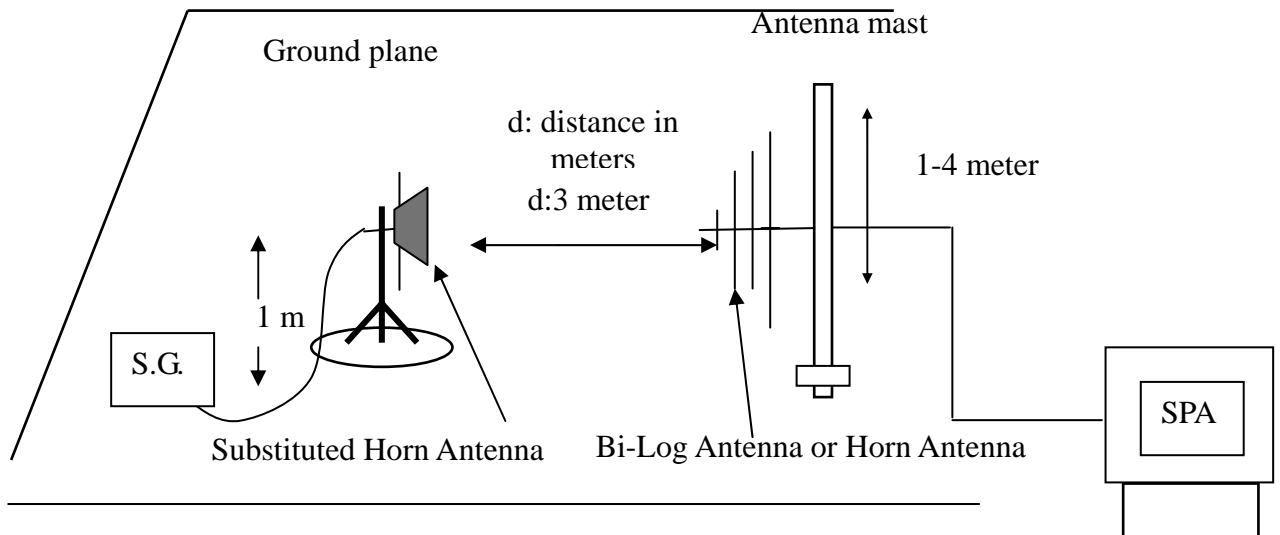



TEST PROCEDURE

The EUT was placed on a non-conductive, the measurement antenna was placed at a distance of 3 meters from the EUT. During the tests, the antenna height and the EUT azimuth were varied in order to identify the maximum level of emissions from the EUT. This maximization process was repeated with the EUT positioned in each of its three orthogonal orientations.

The frequency range up to tenth harmonic was investigated for each of three fundamental frequency (low, middle and high channels). Once spurious emission were identified, the power of the emission was determined using the substitution method.

The spurious emissions attenuation was calculated as the difference between radiated power at the fundamental frequency and the spurious emissions frequency.

ERP = S.G. output (dBm) + Antenna Gain (dBd) – Cable (dB)

EIRP = S.G. output (dBm) + Antenna Gain (dBi) – Cable (dB)

TEST RESULTS

Refer to the attached tabular data sheets.

**Radiated Spurious Emission Measurement Result****Below 1GHz**

No emissions to be recorded.

(Since no specific emission noted beyond the background noise floor)

Above 1GHz**Operation Mode:** GSM 850 / TX / CH 128**Test Date:** April 13, 2006**Temperature:** 25°C**Tested by:** Spring Zhou**Humidity:** 55 % RH**Polarity:** Ver. / Hor.

Frequency (MHz)	Reading level (dBuV)	Antenna Polarization	S.G. (dBm)	Cable loss (dB)	Ant.Gain (dBd)	Emission level (dBm)	Limit (dBm)	Margin (dB)
1648.47	34.78	V	-76.28	4.01	7.86	-72.43	-13.00	-59.43
1648.55	37.692	H	-78.21	4.01	7.86	-74.36	-13.00	-61.36

Operation Mode: GSM 850 / TX / CH 190**Test Date:** April 13, 2006**Temperature:** 25°C**Tested by:** Spring Zhou**Humidity:** 55 % RH**Polarity:** Ver. / Hor.

Frequency (MHz)	Reading level (dBuV)	Antenna Polarization	S.G. (dBm)	Cable loss (dB)	Ant.Gain (dBd)	Emission level (dBm)	Limit (dBm)	Margin (dB)
1673.24	34.78	V	-73.18	4.21	7.95	-69.44	-13.00	-56.44
1673.51	36.48	H	-75.44	4.21	7.95	-71.70	-13.00	-58.70

Operation Mode: GSM 850 / TX / CH 251**Test Date:** April 13, 2006**Temperature:** 25°C**Tested by:** Spring Zhou**Humidity:** 55 % RH**Polarity:** Ver. / Hor.

Frequency (MHz)	Reading level (dBuV)	Antenna Polarization	S.G. (dBm)	Cable loss (dB)	Ant.Gain (dBd)	Emission level (dBm)	Limit (dBm)	Margin (dB)
1697.53	36.21	V	-75.73	4.53	8.12	-72.14	-13.00	-59.14
1697.45	35.65	H	-74.57	4.53	8.12	-70.98	-13.00	-57.98

Remark:

- 1. Measuring frequencies from 1 GHz to the 10th harmonic of highest fundamental frequency.*
- 2. Measurements above show only up to 6 maximum emissions noted, or would be lesser, with " N/A " remark, if no specific emissions from the EUT are recorded (ie: margin>20dB from the applicable limit) and considered that's already beyond the background noise floor.*



3. *Data of measurement within this frequency range shown “ --- ” in the table above means the reading of emissions are attenuated more than 20dB below the permissible limits or the field strength is too small to be measured.*
4. *Radiated emissions measured in frequency above 1000MHz were made with an instrument using Peak detector mode and average detector mode of the emission shown in Actual FS column.*
5. *Spectrum setting:*
 - a. *Peak Setting 1GHz to 10th harmonics of fundamental, RBW = 1MHz, VBW = 1MHz, Sweep time = Auto.*
 - b. *AV Setting 1GHz to 10th harmonics of fundamental, RBW = 1MHz, VBW = 10Hz, Sweep time = Auto.*

**Below 1GHz**

No emissions to be recorded.

(Since no specific emission noted beyond the background noise floor)

Above 1GHz**Operation Mode:** GSM 1900 / TX / CH 512**Test Date:** April 13, 2006**Temperature:** 25°C**Tested by:** Spring Zhou**Humidity:** 55 % RH**Polarity:** Ver. / Hor.

Frequency (MHz)	Reading level (dBuV)	Antenna Polarization	S.G. (dBm)	Cable loss (dB)	Ant.Gain (dBi)	Emission level (dBm)	Limit (dBm)	Margin (dB)
3700.53	28.12	V	-73.23	6.65	13.40	-66.48	-13.00	-53.48
3700.49	27.68	H	-72.73	6.65	13.40	-65.98	-13.00	-52.98

Operation Mode: GSM 1900 / TX / CH 661**Test Date:** April 13, 2006**Temperature:** 25°C**Tested by:** Spring Zhou**Humidity:** 55 % RH**Polarity:** Ver. / Hor.

Frequency (MHz)	Reading level (dBuV)	Antenna Polarization	S.G. (dBm)	Cable loss (dB)	Ant.Gain (dBi)	Emission level (dBm)	Limit (dBm)	Margin (dB)
3760.15	27.43	V	-72.15	6.75	13.56	-65.34	-13.00	-52.34
3759.93	28.22	H	-73.37	6.75	13.56	-66.56	-13.00	-53.56

Operation Mode: GSM 1900 / TX / CH 810**Test Date:** April 13, 2006**Temperature:** 25°C**Tested by:** Spring Zhou**Humidity:** 55 % RH**Polarity:** Ver. / Hor.

Frequency (MHz)	Reading level (dBuV)	Antenna Polarization	S.G. (dBm)	Cable loss (dB)	Ant.Gain (dBi)	Emission level (dBm)	Limit (dBm)	Margin (dB)
3819.74	29.88	V	-75.86	6.84	14.25	-68.45	-13.00	-55.45
3819.76	28.54	H	-73.95	6.84	14.25	-66.54	-13.00	-53.54

Remark:

- 1. Measuring frequencies from 1 GHz to the 10th harmonic of highest fundamental frequency.*
- 2. Measurements above show only up to 6 maximum emissions noted, or would be lesser, with " N/A " remark, if no specific emissions from the EUT are recorded (ie: margin>20dB from the applicable limit) and considered that's already beyond the background noise floor.*
- 3. Data of measurement within this frequency range shown " --- " in the table above means the reading of emissions are attenuated more than 20dB below the permissible*



limits or the field strength is too small to be measured.

4. Radiated emissions measured in frequency above 1000MHz were made with an instrument using Peak detector mode and average detector mode of the emission shown in Actual FS column.

5. Spectrum setting:

a. Peak Setting 1GHz to 10th harmonics of fundamental, RBW = 1MHz, VBW = 1MHz, Sweep time = Auto.

b. AV Setting 1GHz to 10th harmonics of fundamental, RBW = 1MHz, VBW = 10Hz, Sweep time = Auto.

7.6 FREQUENCY STABILITY V.S. TEMPERATURE MEASUREMENT

LIMIT

According to FCC §2.1055, FCC §24.235.

Frequency Tolerance: 2.5 ppm

MEASUREMENT EQUIPMENT USED

Name of Equipment	Manufacturer	Model	Serial Number	Calibration Due
DC POWER SUPPLY	GW instek	GPS-3303C	E903131	10/18/2007
Spectrum Analyzer	Agilent	E4446A	MY44020154	08/27/2007
Wireless communication test set	Agilent	E5515C	QB44051695	10/06/2007
Temp. / Humidity Chamber	Kingson	THS-M1	242	05/26/2007

Remark: Each piece of equipment is scheduled for calibration once a year.

Test Configuration

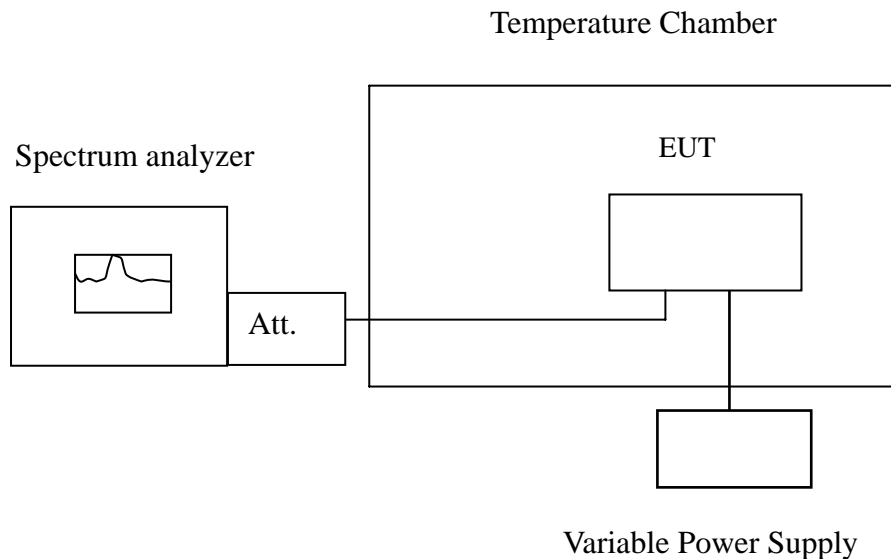

Remark: Measurement setup for testing on Antenna connector



TEST PROCEDURE

The equipment under test was connected to an external AC or DC power supply and input rated voltage. RF output was connected to a frequency counter or spectrum analyzer via feed through attenuators. The EUT was placed inside the temperature chamber. Set the spectrum analyzer RBW low enough to obtain the desired frequency resolution and measure EUT 20°C operating frequency as reference frequency. Turn EUT off and set the chamber temperature to -30°C. After the temperature stabilized for approximately 30 minutes recorded the frequency. Repeat step measure with 10°C increased per stage until the highest temperature of +50°C reached.

TEST RESULTS

No non-compliance noted.

Reference Frequency: GSM Mid Channel 836.6 MHz @ 20°C				
Limit: ± 2.5 ppm = 2091.5 Hz				
Power Supply Vdc	Environment Temperature (°C)	Frequency (Hz)	Delta (Hz)	Limit (Hz)
3.7	50	836600019	45.00	2091.5
	40	836600022	48.00	
	30	836600017	40.00	
	20	836599974	0.00	
	10	836600027	53.00	
	0	836600022	46.00	
	-10	836600033	57.00	
	-20	836600026	51.00	
	-30	836600036	62.00	

Reference Frequency: GSM Mid Channel 1880 MHz @ 20°C				
Limit: ± 2.5 ppm = 4700 Hz				
Power Supply Vdc	Environment Temperature (°C)	Frequency (Hz)	Delta (Hz)	Limit (Hz)
3.7	50	1879999971	-49	4700
	40	1879999976	-45	
	30	1879999973	-48	
	20	1880000018	0	
	10	1879999972	-56	
	0	1879999973	-49	
	-10	1879999971	-47	
	-20	1879999965	-51	
	-30	1879999967	-48	

7.7 FREQUENCY STABILITY V.S. VOLTAGE MEASUREMENT

LIMIT

According to FCC §2.1055, FCC §24.235,

Frequency Tolerance: 2.5 ppm.

MEASUREMENT EQUIPMENT USED

Name of Equipment	Manufacturer	Model	Serial Number	Calibration Due
DC POWER SUPPLY	GW instek	GPS-3303C	E903131	10/18/2007
Spectrum Analyzer	Agilent	E4446A	MY44020154	08/27/2007
Wireless communication test set	Agilent	E5515C	QB44051695	10/06/2007
Temp. / Humidity Chamber	Kingson	THS-M1	242	05/26/2007

Remark: Each piece of equipment is scheduled for calibration once a year.

Test Configuration

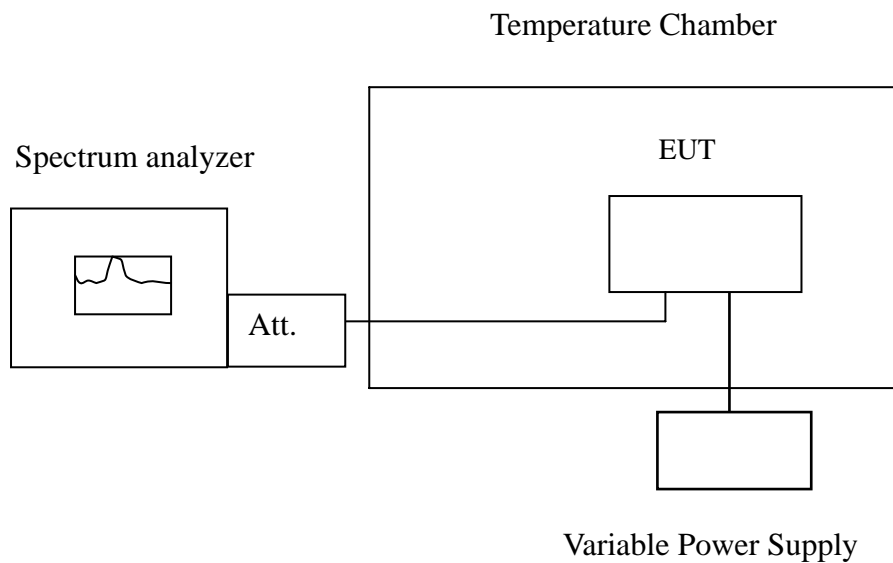

Remark: Measurement setup for testing on Antenna connector.



TEST PROCEDURE

Set chamber temperature to 20°C. Use a variable AC power supply / DC power source to power the EUT and set the voltage to rated voltage. Set the spectrum analyzer RBW low enough to obtain the desired frequency resolution and recorded the frequency.

Reduce the input voltage to specify extreme voltage variation (± 15%) and endpoint, record the maximum frequency change.

TEST RESULTS

No non-compliance noted.

Reference Frequency: GSM Mid Channel 836.6 MHz @ 20°C				
Limit: ± 2.5 ppm = 2091.5Hz				
Power Supply Vdc	Environment Temperature (°C)	Frequency (Hz)	Delta (Hz)	Limit (Hz)
4.3	20	836599973	-3	2091.5
3.7		836599976	0	
3.2 (End Point)		836599969	-7	

Reference Frequency: GSM Mid Channel 1880 MHz @ 20°C				
Limit: ± 2.5 ppm = 4700 Hz				
Power Supply Vdc	Environment Temperature (°C)	Frequency (Hz)	Delta (Hz)	Limit (Hz)
4.3	20	1880000027	8	4700
3.7		1880000019	0	
3.2 (End Point)		1880000018	-1	



7.8 POWERLINE CONDUCTED EMISSIONS

LIMIT

For an intentional radiator which is designed to be connected to the public utility (AC) power line, the radio frequency voltage that is conducted back onto the AC power line on any frequency or frequencies within the band 150 kHz to 30 MHz shall not exceed 250 microvolts (The limit decreases linearly with the logarithm of the frequency in the range 0.15 MHz to 0.50 MHz). The limits at specific frequency range is listed as follows:

Frequency Range (MHz)	Limits (dB μ V)	
	Quasi-peak	Average
0.15 to 0.50	66 to 56	56 to 46
0.50 to 5	56	46
5 to 30	60	50

Compliance with this provision shall be based on the measurement of the radio frequency voltage between each power line (LINE and NEUTRAL) and ground at the power terminals.

MEASUREMENT EQUIPMENT USED

Name of Equipment	Manufacturer	Model	Serial Number	Calibration Due
EMI Test Receiver	R&S	ESI26	100068	01/21/2007
EMC Analyzer	Agilent	E7402A	US41160329	01/21/2007
LISN	FCC	FCC-LISN-50-50-2-M	01067	02/02/2007
LISN (EUT)	FCC	FCC-LISN-50-50-2-M	01068	02/02/2007
TRANSIENT LIMITER	SCHAFFNER	CFL9206	1710	05/19/2007
EMI Monitor control box	FCC	0-SVDC	N/A	N.C.R

Remark: Each piece of equipment is scheduled for calibration once a year.

Test Configuration

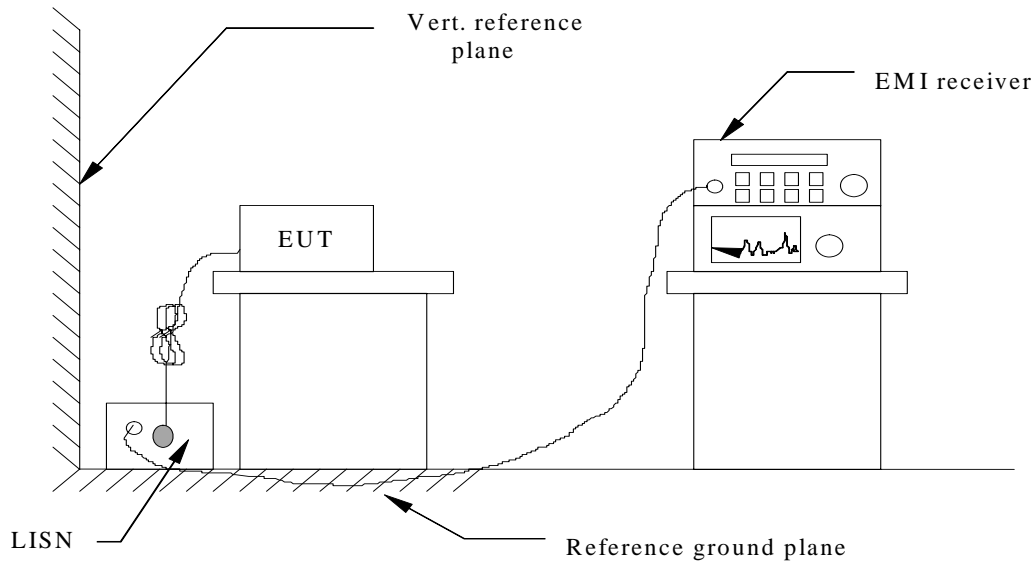

See test photographs attached in Appendix 1 for the actual connections between EUT and support equipment.

TEST PROCEDURE

1. The EUT was placed on a table, which is 0.8m above ground plane.
2. Maximum procedure was performed on the six highest emissions to ensure EUT compliance.
3. Repeat above procedures until all frequency measured were complete.

DECISION OF FINAL TEST MODE

1. The following test mode(s) were scanned during the preliminary test:
 1. AC to DC charger :Trade Name :Alcatel ; Model Number :3DS09371AGAA
Manufactures: Astec
 2. AC to DC charger:Trade Name :Alcatel; Model Number :3DS09371AGAA
Manufactures: Leader
 3. AC to DC charger: Trade Name :Alcatel; Model Number :3DS09371AAAA
Manufactures: Astec
 4. AC to DC charger: Trade Name :Alcatel; Model Number : 3DS09371AAAA
Manufactures: Leader
 5. AC to DC charger: Trade Name :Alcatel; Model Number : 3DS10628AGAA
Manufactures: Tenpao
 6. AC to DC charger: Trade Name :Alcatel; Model Number :3DS10628AHAA
Manufactures: Tenpao
 7. DC to DC charger: Trade Name :Alcatel; Model Number :3DS07848AAAA
Manufactures: Primax
2. After the preliminary scan, the following test mode was found to produce the highest emission level.
 1. AC to DC charger :Trade Name :Alcatel ; Model Number :3DS09371AGAA
Manufactures: Astec
 7. DC to DC charger: Trade Name :Alcatel; Model Number :3DS07848AAAA
Manufactures: Primax



TEST RESULTS

The initial step in collecting conducted data is a spectrum analyzer peak scan of the measurement range. Significant peaks are then marked as shown on the following data page, and these signals are then quasi-peaked.

Link mode

Operation Mode: (AC to DC charger) **Test Date:** April 07, 2006

Temperature: 25°C **Tested by:** Spring Zhou

Humidity: 68% RH

Freq. (MHz)	PEAK. Raw (dBuV)	Q.P. Raw (dBuV)	AVG Raw (dBuV)	Q.P. Limit (dBuV)	AVG Limit (dBuV)	Margin (dB)	Factor (dB)	Remark
0.165	39.12	50.14	43.90	65.58	55.58	-11.68	10.32	L1
0.209	37.35	48.48	41.98	64.31	54.31	-12.33	10.30	L1
0.246	36.96	46.70	40.44	63.25	53.25	-12.81	10.30	L1
0.332	40.12	45.44	39.09	60.81	50.81	-11.72	10.30	L1
0.372	36.38	44.38	37.85	59.64	49.64	-11.79	10.30	L1
0.906	31.47	35.58	29.70	56.00	46.00	-16.30	10.46	L1
0.165	38.80	50.41	44.06	65.58	55.58	-11.52	10.40	L2
0.206	37.61	48.37	41.96	64.41	54.41	-12.45	40.39	L2
0.250	35.87	46.68	40.48	63.14	53.14	-12.66	10.38	L2
0.328	39.52	45.00	38.81	60.92	50.92	-12.11	10.38	L2
0.906	29.13	34.11	28.00	56.00	46.00	-18.00	10.55	L2
5.335	29.54	27.44	24.97	60.00	50.00	-25.03	11.14	L2



Link mode

Operation Mode: (DC to DC charger) **Test Date:** April 07, 2006**Temperature:** 25°C **Tested by:** Spring Zhou**Humidity:** 68% RH

Freq. (MHz)	PEAK. Raw (dBuV)	Q.P. Raw (dBuV)	AVG Raw (dBuV)	Q.P. Limit (dBuV)	AVG Limit (dBuV)	Margin (dB)	Factor (dB)	Remark
0.405	38.59	18.24	17.65	58.71	48.71	-31.06	10.41	L1
0.780	50.99	18.01	16.60	56.00	46.00	-29.40	10.42	L1
0.965	47.84	13.00	11.91	56.00	46.00	-34.09	10.43	L1
1.025	49.09	19.87	17.79	56.00	46.00	-28.21	10.43	L1
1.130	48.26	20.08	20.11	56.00	46.00	-25.89	10.44	L1
1.240	38.83	16.17	16.17	56.00	46.00	-29.83	10.45	L1
0.685	38.41	17.76	16.85	56.00	46.00	-29.15	10.40	L2
0.780	49.27	24.14	23.46	56.00	46.00	-22.54	10.41	L2
0.950	46.59	21.08	20.16	56.00	46.00	-25.84	10.42	L2
1.035	44.94	17.26	16.51	56.00	46.00	-29.49	10.42	L2
1.165	44.62	14.01	14.81	56.00	46.00	-31.19	10.43	L2
1.250	34.30	16.16	17.29	56.00	46.00	-28.71	10.44	L2

Remark:

1. The measuring frequencies range between 0.15 MHz and 30 MHz.
2. The emissions measured in the frequency range between 0.15 MHz and 30MHz were made with an instrument using Quasi-peak detector and Average detector.
3. "---" denotes the emission level was or more than 2dB below the Average limit, and no re-check was made.
4. The IF bandwidth of SPA between 0.15MHz and 30MHz was 10KHz. The IF bandwidth of Test Receiver between 0.15MHz and 30MHz was 9kHz
5. L1 = Line One (Live Line) / L2 = Line Two (Neutral Line)

Note:

Freq. = Emission frequency in KHz

Factor (dB) = cable loss + Insertion loss of LISN+ Insertion loss of TRANSIENT LIMITER (The TRANSIENT LIMITER included 10 dB ATTENUATION)

Amptd dBuV = Uncorrected Analyzer/Receiver reading + cable loss + Insertion loss of LISN+ Insertion loss of TRANSIENT LIMITER, if it > 0.5 dB

Limit dBuV = Limit stated in standard



Margin dB = Reading in reference to limit

Calculation Formula

$$\text{Margin (dB)} = \text{Amptd (dBuV)} - \text{Limit (dBuV)}$$

Test Plots

AC to DC charger

Conducted emissions (Line 1)

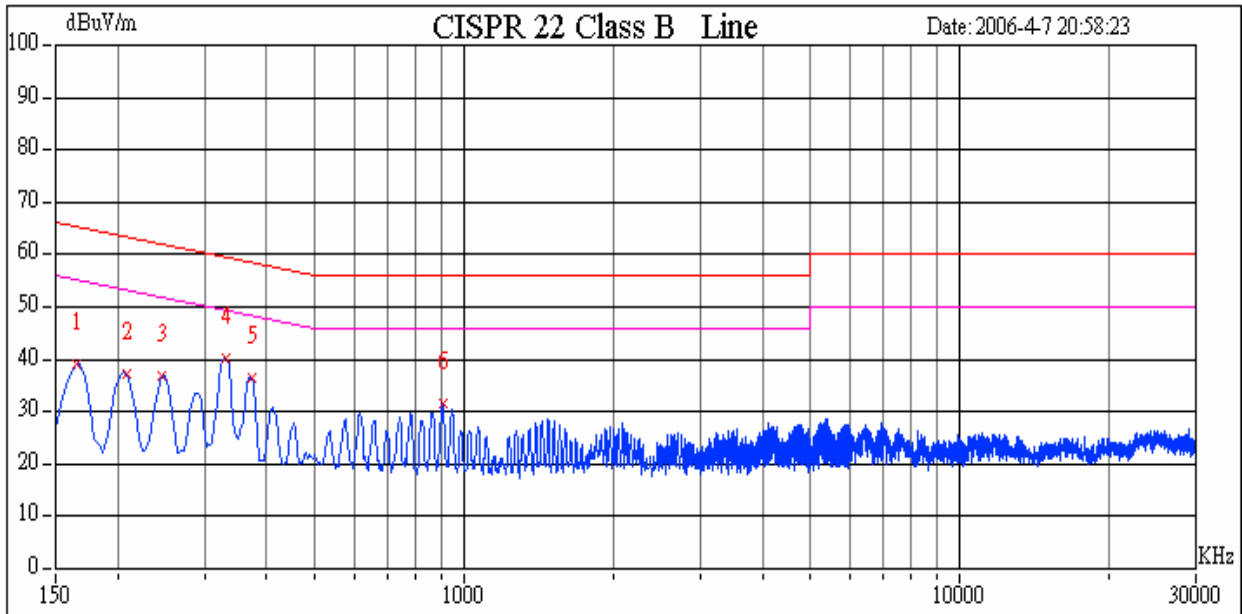

Conducted emissions (Line 2)

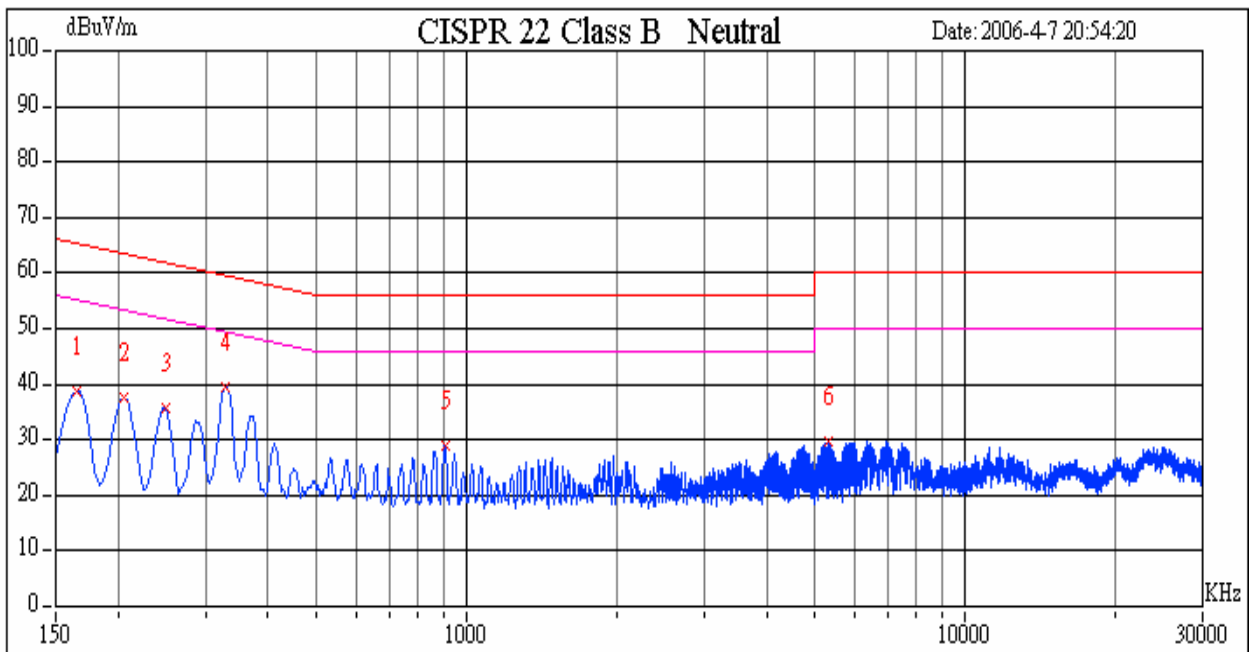



Test Plots

DC to DC charger

Conducted emissions (Line 1)

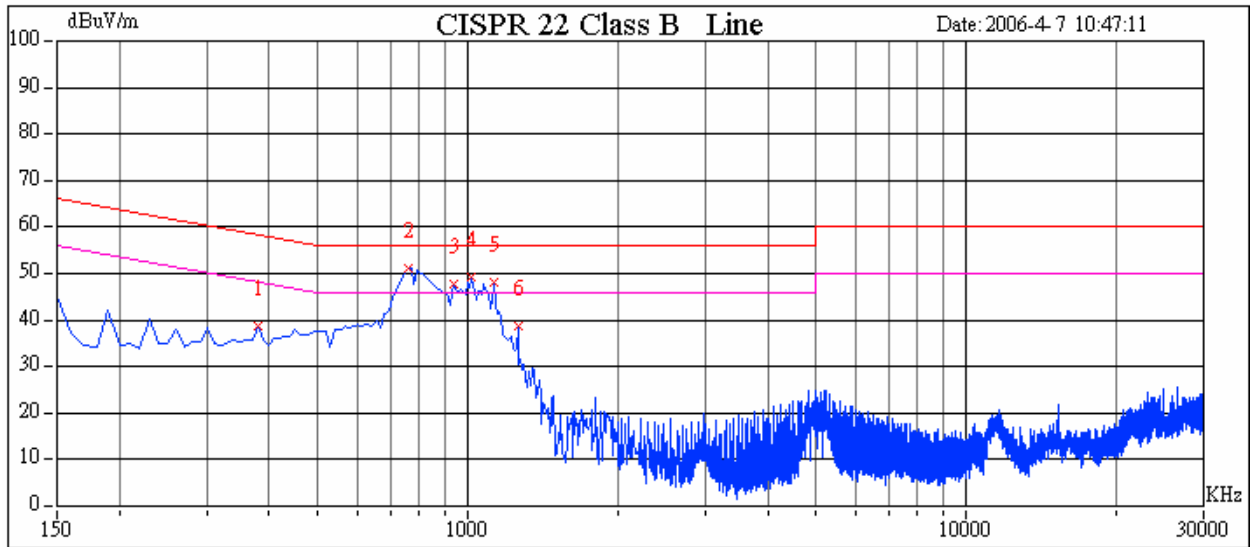

Conducted emissions (Line 2)

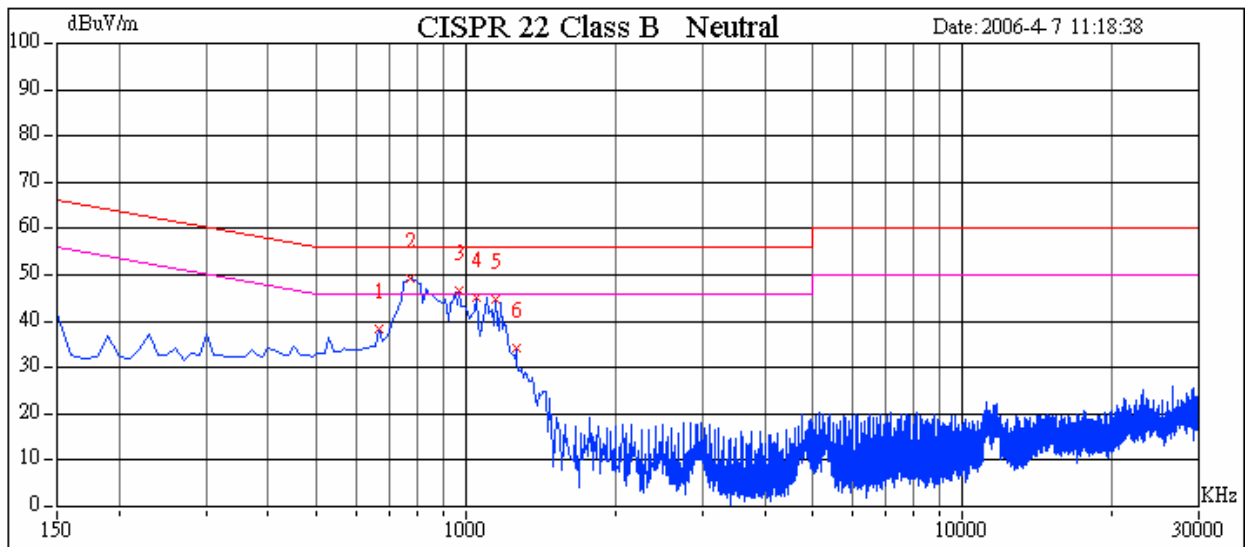

APPENDIX 1 PHOTOGRAPHS OF TEST SETUP

Radiated Emission Set up Photos

Front of view

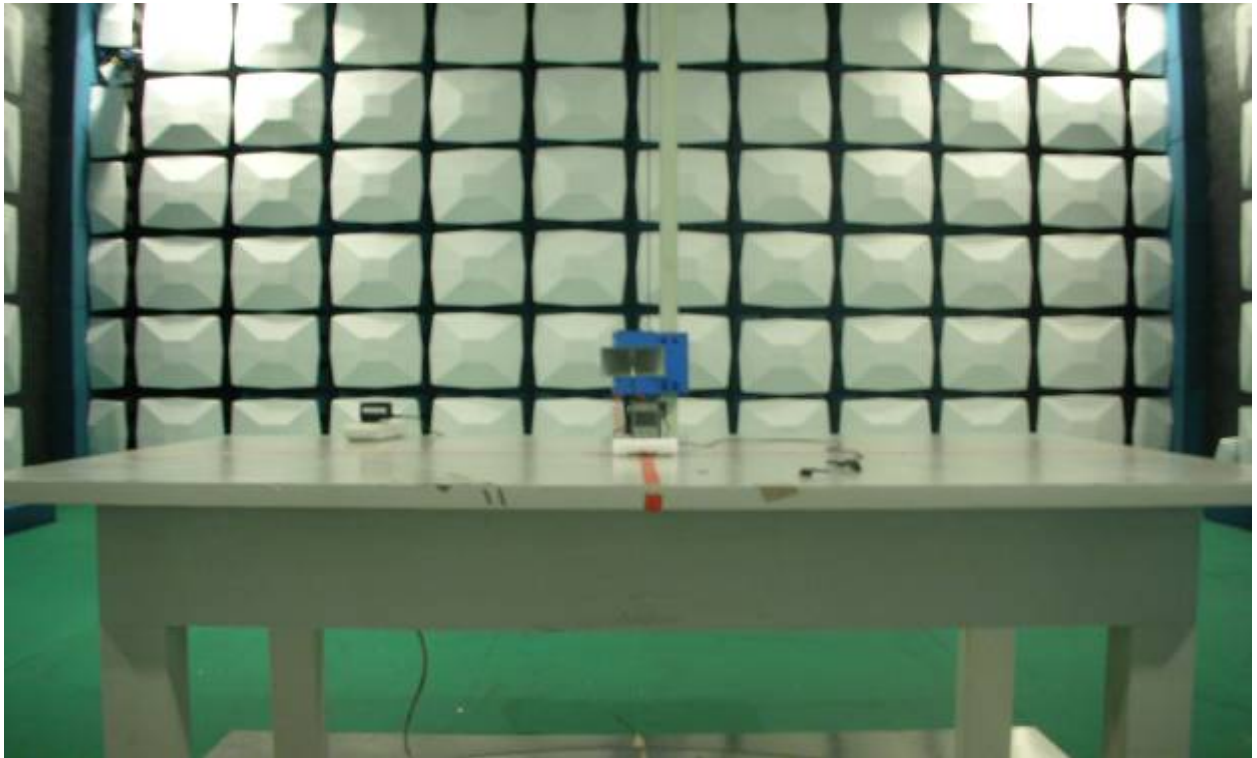

Back of view

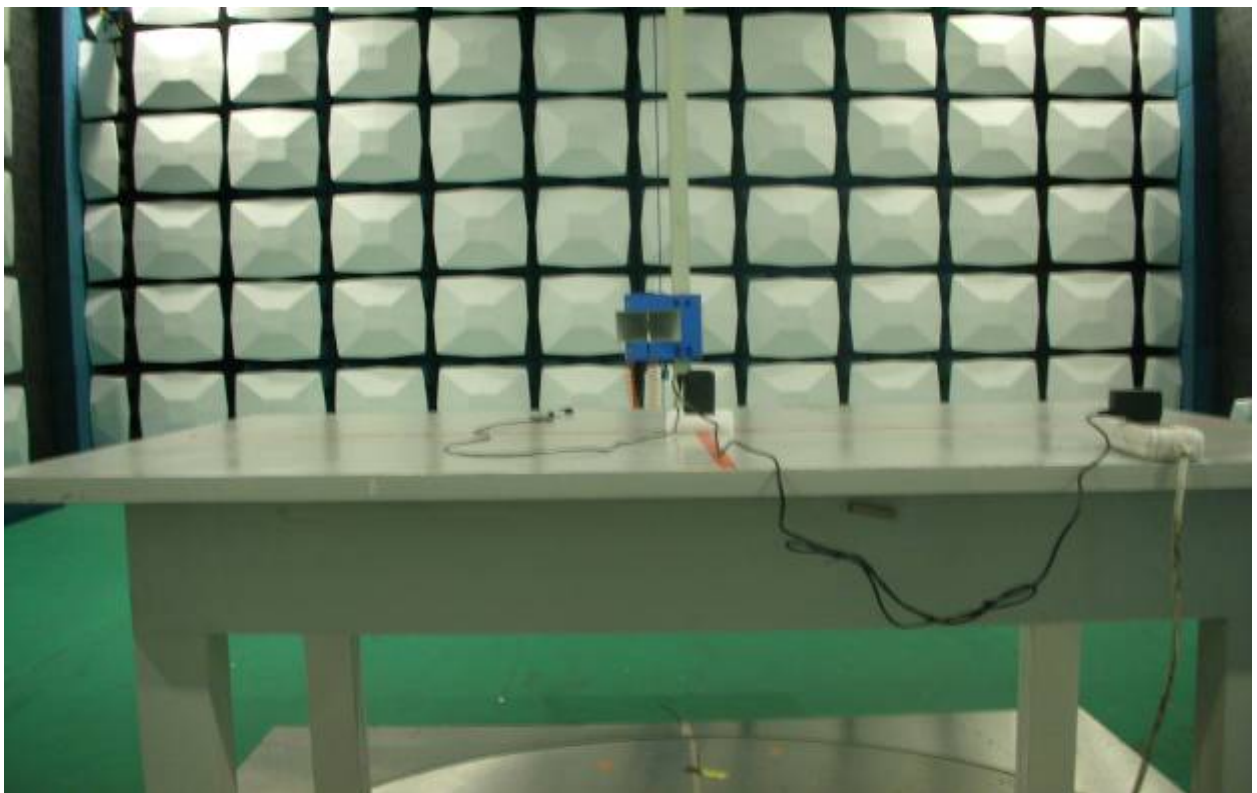

Conducted Emission Set Up Photos

AC to DC charger

