

ELECTROMAGNETIC EMISSIONS COMPLIANCE REPORT

INTENTIONAL RADIATOR CERTIFICATION TO FCC PART 22 SUBPART H and PART 24 SUBPART E REQUIREMENT

OF

Product Name: GSM 850/1900 mobile phone

Brand Name: Alcatel

Model Name: VLE5

Market Name: OT-E252a

FCC ID: RAD020

Report No.: ER/2005/50021-02

Issue Date: Aug 26, 2005

FCC Rule Part: 2 & 24E& 22H

Prepared for TCL & Alcatel Mobile Phones
30/F, Times Square, 500 Zhangyang Rd.,
Shanghai 200122, P.R. China

Prepared by SGS Taiwan Ltd.
No. 134, Wu Kung Rd., Wuku Industrial Zone,
Taipei County, Taiwan.

Note: This report shall not be reproduced except in full, without the written approval of SGS Taiwan Ltd. This document may be altered or revised by SGS Taiwan Ltd. personnel only, and shall be noted in the revision section of the document.

The results shown in this test report refer only to the sample(s) tested unless otherwise stated. This test report cannot be reproduced, except in full, without prior written permission of the Company.

VERIFICATION OF COMPLIANCE

Applicant: TCL & Alcatel Mobile Phones
 30/F, Times Square, 500 Zhangyang Rd., Shanghai 200122, P.R. China

Equipment Under Test: GSM 850/1900 mobile phone

FCC ID Number: RAD020

Brand Name: Alcatel

Model No.: VLE5

Market Name: OT-E252a

Model Difference: N/A

File Number: ER/2005/50021-02



Date of test: Jul 05, 2005 ~ Aug 22, 2005

Date of EUT Received: Jul 05, 2005

We hereby certify that:

The above equipment was tested by SGS Taiwan Ltd. The test data, data evaluation, test procedures, and equipment configurations shown in this report were made in accordance with the procedures given in TIA/EIA-603-1-1998 and the energy emitted by the sample EUT tested as described in this report is in compliance with conducted and radiated emission limits of FCC Rule FCC PART 22 subpart H and FCC PART 24 subpart E.

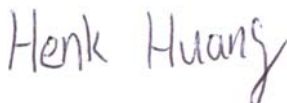
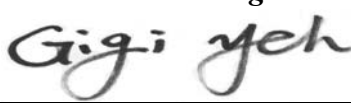
The test results of this report relate only to the tested sample identified in this report.

Test By:	 <hr style="border: 0.5px solid black;"/> Henk Huang	Date	<hr style="border: 0.5px solid black;"/> Aug. 26, 2005
Prepared By:	 <hr style="border: 0.5px solid black;"/> Gigi Yeh	Date	<hr style="border: 0.5px solid black;"/> Aug. 26, 2005
Approved By	 <hr style="border: 0.5px solid black;"/> Vincent Su	Date	<hr style="border: 0.5px solid black;"/> Aug. 26, 2005

The results shown in this test report refer only to the sample(s) tested unless otherwise stated. This test report cannot be reproduced, except in full, without prior written permission of the Company.

Version

Version No.	Date
00	Aug. 24, 2005
01	Aug. 26, 2005
02	Aug 30, 2005

The results shown in this test report refer only to the sample(s) tested unless otherwise stated. This test report cannot be reproduced, except in full, without prior written permission of the Company.

Table of Contents

1. GENERAL INFORMATION 6

1.1 Product Description 6

1.2 Related Submittal(s) / Grant (s) 6

1.3 Test Methodology 6

1.4 Test Facility 7

1.5 Special Accessories 7

1.6 Equipment Modifications 7

2. SYSTEM TEST CONFIGURATION 8

2.1 EUT Configuration 8

2.2 EUT Exercise 8

2.3 Test Procedure 8

2.4 Configuration of Tested System 9

3. SUMMARY OF TEST RESULTS 10

4. DESCRIPTION OF TEST MODES 10

5. RF POWER OUTPUT MEASUREMENT 11

5.1 Standard Applicable 11

5.2 Test Set-up: 11

5.3 Measurement Procedure 11

5.4 Measurement Equipment Used: 11

5.5 Measurement Result 13

6. ERP, EIRP MEASUREMENT 14

6.1 Standard Applicable 14

6.2 Test SET-UP (Block Diagram of Configuration) 14

6.3 Measurement Procedure 16

6.4 Measurement Equipment Used: 17

6.5 Measurement Result 18

7. OCCUPIED BANDWIDTH MEASUREMENT 20

7.1 Standard Applicable 20

7.2 Test Set-up: 20

7.3 Measurement Procedure 20

7.4 Measurement Equipment Used: 20

7.5 Measurement Result: 22

8. OUT OF BAND EMISSION AT ANTENNA TERMINALS 27

8.1 Standard Applicable 27

8.2 Test SET-UP 27

The results shown in this test report refer only to the sample(s) tested unless otherwise stated. This test report cannot be reproduced, except in full, without prior written permission of the Company.

8.3	Measurement Procedure.....	27
8.4	Measurement Equipment Used:.....	28
8.5	Measurement Result.....	29
9.	FIELD STRENGTH OF SPURIOUS RADIATION MEASUREMENT	35
9.1	Standard Applicable	35
9.2	EUT Setup (Block Diagram of Configuration).....	35
9.3	Measurement Procedure.....	37
9.4	Measurement Equipment Used:.....	38
9.5	Measurement Result.....	38
10.	FREQUENCY STABILITY V.S. TEMPERATURE MEASUREMENT	45
10.1	Standard Applicable	45
10.2	Test Set-up:	45
10.3	Measurement Procedure.....	45
10.4	Measurement Equipment Used:.....	46
10.5	Measurement Result.....	47
11.	FREQUENCY STABILITY V.S. VOLTAGE MEASUREMENT	48
11.1	Standard Applicable	48
11.2	Test Set-up:	48
11.3	Measurement Procedure.....	48
11.4	Measurement Equipment Used:.....	48
11.5	Measurement Result.....	50
12.	AC POWER LINE CONDUCTED EMISSION TEST	51
12.1	Standard Applicable	51
12.2	EUT Setup.....	51
12.3	Measurement Procedure.....	51
12.4	Measurement Equipment Used:.....	52
12.5	Measurement Result.....	52
	PHOTOGRPHS OF SET UP.....	63
	PHOTOGRPHS OF EUT.....	66

The results shown in this test report refer only to the sample(s) tested unless otherwise stated. This test report cannot be reproduced, except in full, without prior written permission of the Company.

1. GENERAL INFORMATION

1.1 Product Description

Product	GSM 850/1900 mobile phone	
Model Name	VLE5	
Market Name	OT-E252a	
Model Difference:	N/A	
Trade Name	Alcatel	
Frequency Range and Power	TX: 824.2 MHz – 848.8 MHz	33 dBm
	TX: 1850.2MHz –1909.8MHz	30 dBm
Type of Emission	300KGXW	
Power Supply	Four 5V DC by AC/DC Adapters model number: 3DS09371AGAA,(supplier: Astec and Leader Electronics) model number: 3DS 09371AAA (supplier: Astec and Leader Electronics) One 5Vdc Car Charge Model number: 3DS 07848AAAA (supplier: Primax)	

1.2 Related Submittal(s) / Grant (s)

This submittal(s) (test report) is intended for FCC ID: **RAD020** filing to comply with Section Part 22 subpart H and Part 24 subpart E of the FCC CFR 47 Rules.

1.3 Test Methodology

Both conducted and radiated testing were performed according to the procedures document on chapter 13 of ANSI C63.4 (2003) and FCC CFR 47.1046, 2.1047, 2.1049, 2.1051, 2.1053, 2.1055 and 2.1057.

The results shown in this test report refer only to the sample(s) tested unless otherwise stated. This test report cannot be reproduced, except in full, without prior written permission of the Company.

1.4 Test Facility

The open area test site and conducted measurement facility used to collect the radiated data is located on the address of SGS Taiwan Ltd. No. 134, Wu Kung Rd., Wuku Industrial Zone, Taipei Country, Taiwan. The Open Area Test Sites and the Line Conducted labs are constructed and calibrated to meet the FCC requirements in documents ANSI C63.4: 1993 and CISPR 22/EN 55022 requirements. Site No. 1(3 &10 meters) Registration Number: 94644, Anechoic chamber (3 meters) Registration Number: 573967

1.5 Special Accessories

Not available for this EUT intended for grant.

1.6 Equipment Modifications

Not available for this EUT intended for grant.

The results shown in this test report refer only to the sample(s) tested unless otherwise stated. This test report cannot be reproduced, except in full, without prior written permission of the Company.

2. SYSTEM TEST CONFIGURATION

2.1 EUT Configuration

The EUT configuration for testing is installed on RF field strength measurement to meet the Commissions requirement and operating in a manner which intends to maximize its emission characteristics in a continuous normal application.

2.2 EUT Exercise

The EUT (Transmitter) was operated in the engineering mode to fix the Tx frequency which was for the purpose of the measurements.

2.3 Test Procedure

2.3.1 Conducted Emissions

The EUT is placed on a turn table which is 0.8 m above ground plane. According to the requirements in Section 7 and 13 of ANSI C63.4-2003. Conducted emissions from the EUT measured in the frequency range between 0.15 MHz and 30MHz using CISPR Quasi-Peak and Average detector mode.

2.3.2 Radiated Emissions

The EUT is placed on a turn table which is 1.0 m above ground plane. The turn table shall rotate 360 degrees to determine the position of maximum emission level. EUT is set 3m away from the receiving antenna which varied from 1m to 4m to find out the highest emission. And also, each emission was to be maximized by changing the polarization of receiving antenna both horizontal and vertical. In order to find out the max. emission, the relative positions of this hand-held transmitter(EUT) was rotated through three orthogonal axes according to the requirements in Section 8 and 13 of ANSI C63.4-2003.

The results shown in this test report refer only to the sample(s) tested unless otherwise stated. This test report cannot be reproduced, except in full, without prior written permission of the Company.

2.4 Configuration of Tested System

Fig. 2-1 ConFig. 2-1 Configuration of Tested System

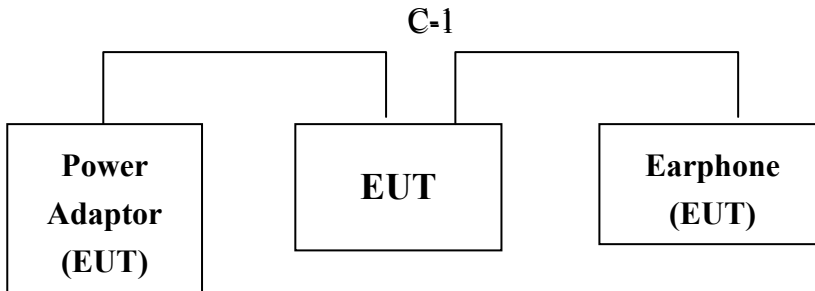

Table 2-1 Equipment Used in Tested System

Item	Equipment	Mfr/Brand	Model/ Type No.	FCC ID	Series No.	Data Cable	Power Cord
1.	N/A						

The results shown in this test report refer only to the sample(s) tested unless otherwise stated. This test report cannot be reproduced, except in full, without prior written permission of the Company.

3. SUMMARY OF TEST RESULTS

FCC Rules	Description Of Test	Result
§2.1046(a) §22.913(a) §24.232(a)	RF Power Output	Compliant
§2.1046(a) §22.913(a) §24.232(a)	ERP/ EIRP measurement	Compliant
§2.1049(h)	99% Occupied Bandwidth	Compliant
§2.1051 §22.917(a) §24.238(a)	Out of Band Emissions at Antenna Terminals and Band Edge	Compliant
§2.1053 §22.917(a) §24.238(a)	Field Strength of Spurious Radiation	Compliant
§2.1055(a)(1)(b)	Frequency Stability vs. Temperature	Compliant
§2.1055(d)(1)(2)	Frequency Stability vs. Voltage	Compliant
§15.107;§15.207	AC Power Line Conducted Emission	Compliant

4. DESCRIPTION OF TEST MODES

The EUT has been tested under operating condition.

EUT staying in continuous transmitting mode. Channel Low, Mid and High for each type and band with rated data rate are chosen for full testing.

The field strength of spurious radiation emission was measured as EUT stand-up position (H mode) and lie down position (E1, E2 mode) for both GSM and GPRS with all power adaptors. The worst-case E1 mode with power adaptor model number: 3DS09371AGAA, Supplier : Leader for channel Low, Mid and High at GSM mode was reported.

The results shown in this test report refer only to the sample(s) tested unless otherwise stated. This test report cannot be reproduced, except in full, without prior written permission of the Company.

5. RF POWER OUTPUT MEASUREMENT

5.1 Standard Applicable

According to FCC §2.1046.

FCC 22.913(a) Mobile station are limited to 7W.

FCC 24.232(b) Mobile station are limited to 2W.

5.2 Test Set-up:

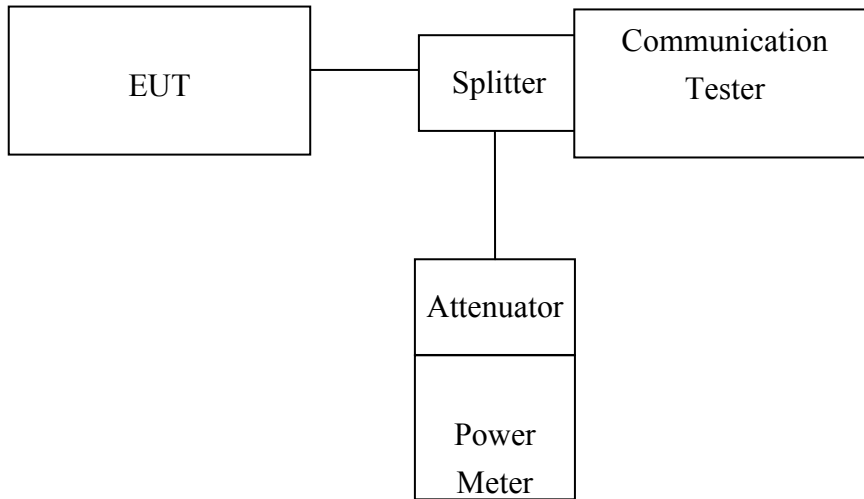

Note: Measurement setup for testing on Antenna connector

5.3 Measurement Procedure

The transmitter output was connected to a calibrated attenuator, the other end of which was connected to a power meter. Transmitter output was read off the power meter in dBm. The power output at the transmitter antenna port was determined by adding the value of the attenuator to the power meter reading.

5.4 Measurement Equipment Used:

Conducted Emission Test Site					
EQUIPMENT TYPE	MFR	MODEL NUMBER	SERIAL NUMBER	LAST CAL.	CAL DUE.
Spectrum Analyzer	Agilent	E4446A	MY43360126	03/29/2005	03/28/2006
Spectrum Analyzer	Agilent	7405A	US41160416	06/28/2005	06/29/2006

The results shown in this test report refer only to the sample(s) tested unless otherwise stated. This test report cannot be reproduced, except in full, without prior written permission of the Company.

Spectrum Analyzer	R&S	FSP 40	100034	11/09/2004	11/10/2005
Power Sensor	Anritsu	MA2490A	31431	06/28/2005	06/29/2006
Power Meter	Anritsu	ML2487A	6K00002070	06/28/2005	06/29/2006
Temperature Chamber	TERCHY	MHG-120LF	911009	11/11/2004	11/12/2005
Low Loss Cable	HUBER+SUHNER	SUCOFLEX 104PEA	N/A	N/A	N/A
Attenuator	Mini-Circuit	BW-S10W5	N/A	10/07/2004	10/06/2005
Attenuator	Mini-Circuit	BW-S6W5	N/A	10/07/2004	10/06/2005
Splitter	Mini-Circuit	ZFSC-2-10G	N/A	10/07/2004	10/06/2005
Signal Generator	R&S	SMR40	100210	11/09/2004	11/10/2005
Diode Detector	Agilent	8471E	MY4224	N/A	N/A
AC Power Supply	APW-105N	887592	All Power	N/A	N/A

The results shown in this test report refer only to the sample(s) tested unless otherwise stated. This test report cannot be reproduced, except in full, without prior written permission of the Company.

5.5 Measurement Result

EUT Mode	Frequency (MHz)	CH	CMU200 Reading (dBm)	Offset (dB)	Average Power (dBm)
GSM 850	824.20	128	9.22	23.30	32.52
	836.60	190	9.12	23.30	32.42
	848.80	251	8.67	23.30	31.97

EUT Mode	Frequency (MHz)	CH	CMU200 Reading (dBm)	Offset (dB)	Average Power (dBm)
PCS 1900	1850.20	512	5.16	24.82	29.98
	1880.00	661	5.14	24.82	29.96
	1909.80	810	5.10	24.82	29.92

The results shown in this test report refer only to the sample(s) tested unless otherwise stated. This test report cannot be reproduced, except in full, without prior written permission of the Company.

6. ERP, EIRP MEASUREMENT

6.1 Standard Applicable

According to FCC §2.1046

FCC 22.913(a) Mobile station are limited to 7W ERP.

FCC 24.232(b) Mobile station are limited to 2W EIRP.

6.2 Test SET-UP (Block Diagram of Configuration)

(A) Radiated Emission Test Set-Up, Frequency Below 1000MHz

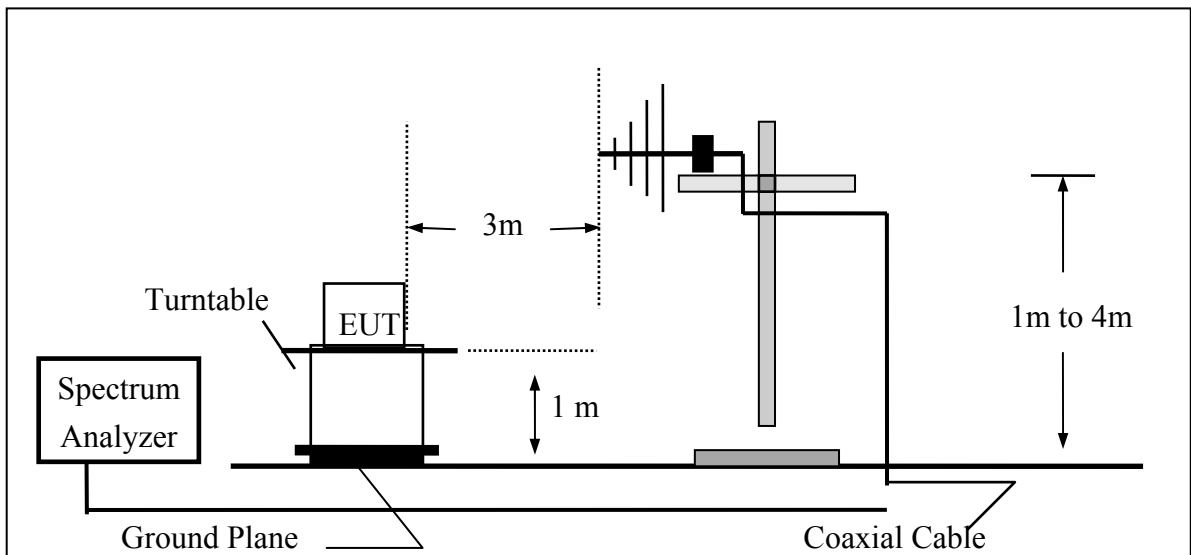

The results shown in this test report refer only to the sample(s) tested unless otherwise stated. This test report cannot be reproduced, except in full, without prior written permission of the Company.

(B) Radiated Emission Test Set-UP Frequency Over 1 GHz

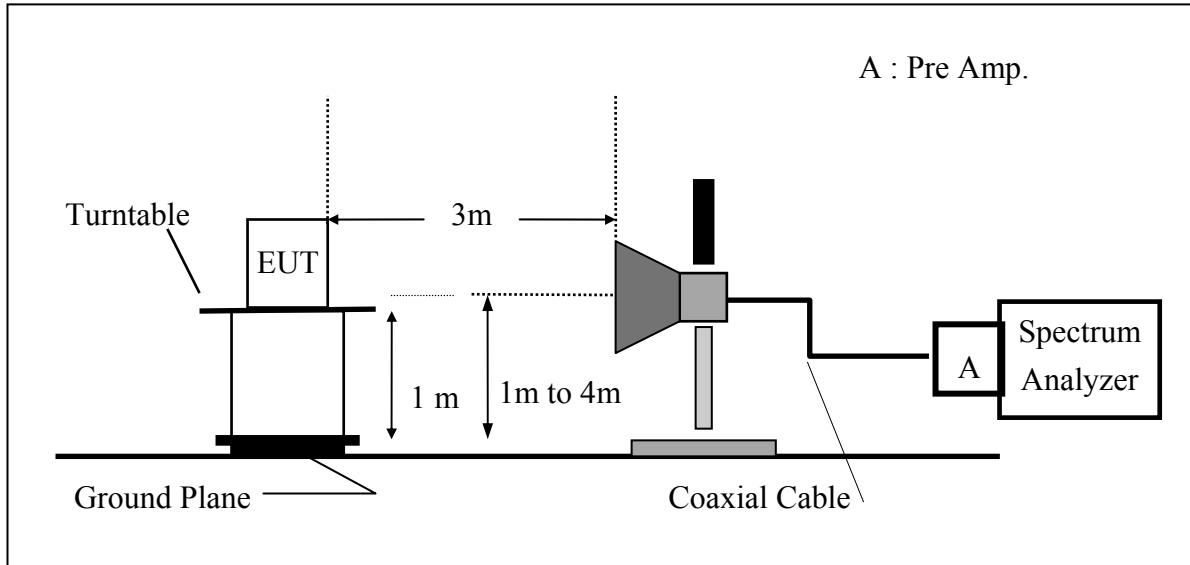

(C) Substituted Method Test Set-UP

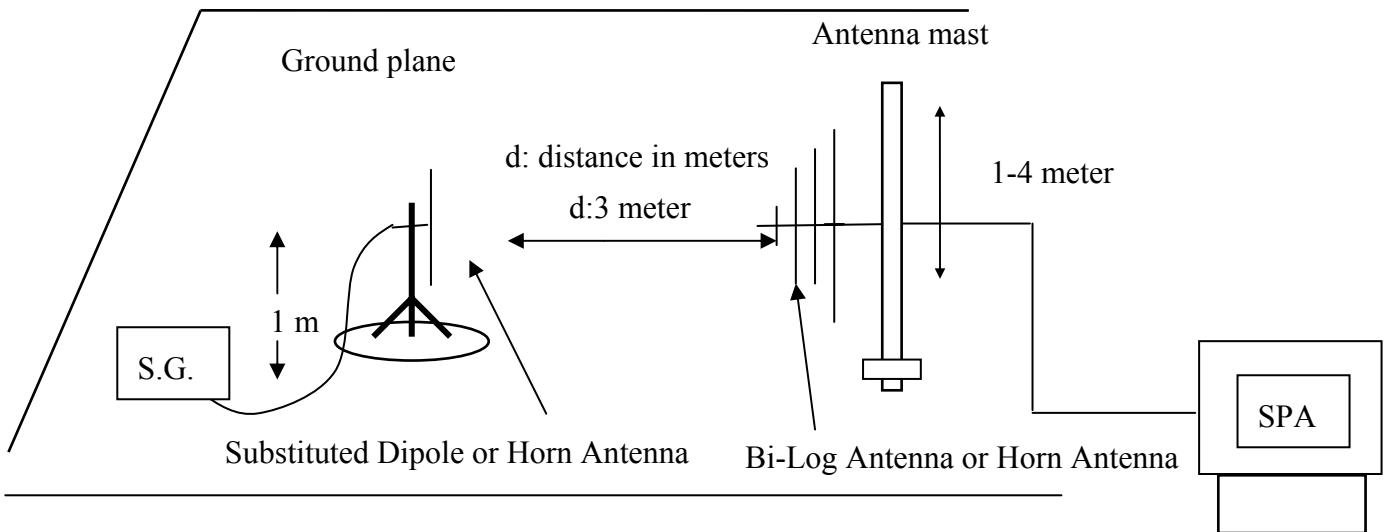

The results shown in this test report refer only to the sample(s) tested unless otherwise stated. This test report cannot be reproduced, except in full, without prior written permission of the Company.

6.3 Measurement Procedure

The EUT was placed on an non-conductive turntable using a non-conductive support. The radiated emission at the fundamental frequency was measured at 3 m with a test antenna and EMI spectrum analyzer.

During the measurement, the EUT was communication with the station. The highest emission was recorded with the rotation of the turntable and the lowering of the test antenna from 4m to 1m. The reading was recorded and the field strength (E in dBuV/m) was calculated.

ERP in frequency band 824.2 –848.80.8MHz were measured using a substitution method. The EUT was replaced by dipole antenna connected, the S.G. output was recorded and ERP was calculated as follows:

EIRP in frequency band 1850.2 –1909.8MHz were measured using a substitution method. The EUT was replaced by or horn antenna connected, the S.G. output was recorded and EIRP was calculated as follows:

$$\text{ERP} = \text{S.G. output (dBm)} + \text{Antenna Gain (dBd)} - \text{Cable Loss (dB)}$$

$$\text{EIRP} = \text{S.G. output (dBm)} + \text{Antenna Gain (dBi)} - \text{Cable Loss (dB)}$$

The results shown in this test report refer only to the sample(s) tested unless otherwise stated. This test report cannot be reproduced, except in full, without prior written permission of the Company.

6.4 Measurement Equipment Used:

EQUIPMENT TYPE	MFR	MODEL NUMBER	SERIAL NUMBER	LAST CAL.	CAL DUE.
Spectrum Analyzer	R&S	FSP 40	100034	05/27/2005	05/26/2006
Spectrum Analyzer	Agilent	E7405A	US41160416	08/27/2004	08/26/2005
Bilog Antenna	SCHWAZBECK	VULB9163	152	06/03/2005	06/02/2006
Horn antenna	Schwarzbeck	BBHA 9120D	309/320	08/16/2004	08/15/2005
Pre-Amplifier	HP	8447D	2944A09469	07/19/2005	07/18/2006
Pre-Amplifier	HP	8494B	3008A00578	02/26/2005	02/25/2006
Signal Generator	R&S	SMR40	100210	02/09/2005	02/10/2006
Turn Table	HD	DT420	N/A	N.C.R	N.C.R
Antenna Tower	HD	MA240-N	240/657	N.C.R	N.C.R
Controller	HD	HD100	N/A	N.C.R	N.C.R
Low Loss Cable	HUBER+SUHNER	SUCOFLEX 104PEA-10M	10m	10/09/2004	10/08/2005
Low Loss Cable	HUBER+SUHNER	SUCOFLEX 104PEA-3M	3m	10/09/2004	10/08/2005
Low Loss Cable	HUBER+SUHNER	SUCOFLEX 104PEA-0.5M	0.5m	10/09/2004	10/08/2005
Site NSA	SGS	966 chamber	N/A	11/17/2004	11/16/2005
Site NSA	SGS	10m Open-Site	N/A	10/02/2004	10/01/2005
Attenuator	Mini-Circuit	BW-S10W5	N/A	10/07/2004	10/06/2005
Temperature Chamber	TERCHY	MHG-120LF	911009	10/14/2004	10/13/2005
Dipole Antenna	Schwarzbeck	VHAP	908/909	06/10/2005	06/11/2006
Dipole Antenna	Schwarzbeck	UHAP	891/892	06/10/2005	06/11/2006
Horn antenna	Schwarzbeck	BBHA 9120D	N/A	08/16/2004	08/15/2005

The results shown in this test report refer only to the sample(s) tested unless otherwise stated. This test report cannot be reproduced, except in full, without prior written permission of the Company.

6.5 Measurement Result

EUT Mode	Frequency (MHz)	CH	EUT Pol.	Antenna Pol.	SPA Reading (dBuV)	S.G. Output (dBm)	Antenna Gain (dBd)	Cable Loss (dB)	ERP (dBm)	Limit (dBm)
GSM 850	824.20	128	H	V	123.27	35.95	-7.87	3.64	24.43	38.45
				H	126.63	40.98	-7.87	3.64	27.46	38.45
			E1	V	127.07	39.75	-7.87	3.64	28.23	38.45
				H	125.43	37.78	-7.87	3.64	26.26	38.45
			E2	V	118.34	31.01	-7.87	3.64	19.50	38.45
				H	126.87	26.77	-7.87	5.84	13.06	38.45
	836.50	190	H	V	122.96	35.93	-7.88	3.70	24.36	38.45
				H	126.72	41.39	-7.88	3.70	26.81	38.45
			E1	V	126.93	39.90	-7.88	3.70	28.33	38.45
				H	125.77	38.43	-7.88	3.70	26.86	38.45
			E2	V	117.46	30.43	-7.88	3.70	18.86	38.45
				H	126.72	39.38	-7.88	3.70	27.81	38.45
	848.80	251	H	V	123.54	36.80	-7.88	3.75	25.18	38.45
				H	126.29	41.27	-7.88	3.75	27.64	38.45
			E1	V	127.47	40.73	-7.88	3.75	29.10	38.45
				H	126.51	39.49	-7.88	3.75	27.86	38.45
			E2	V	117.28	30.54	-7.88	3.75	18.91	38.45
				H	126.94	39.92	-7.88	3.75	28.29	38.45

Remark :

- (1) The RBW,VBW of SPA for frequency
 Below 1GHz was RBW=100 KHz, VBW=300KHz,
 Above 1GHz was RBW= 1MHz , VBW= 3MHz

The results shown in this test report refer only to the sample(s) tested unless otherwise stated. This test report cannot be reproduced, except in full, without prior written permission of the Company.

EUT Mode	Frequency (MHz)	CH	EUT Pol.	Antenna Pol.	SPA Reading (dBuV)	S.G. Output (dBm)	Antenna Gain (dBi)	Cable Loss (dB)	EIRP (dBm)	Limit (dBm)
PCS 1900	1850.20	512	H	V	123.19	16.23	9.90	5.41	20.72	33.00
				H	127.55	20.66	9.90	5.41	25.15	33.00
			E1	V	129.90	22.94	9.90	5.41	27.43	33.00
				H	124.96	18.07	9.90	5.41	22.56	33.00
			E2	V	126.12	19.16	9.90	5.41	23.65	33.00
				H	129.15	22.26	9.90	5.84	26.32	33.00
	1880.00	661	H	V	124.60	17.65	9.99	5.46	22.18	33.00
				H	127.88	21.01	9.99	5.46	25.54	33.00
			E1	V	130.26	23.31	9.99	5.46	27.84	33.00
				H	125.76	18.89	9.99	5.46	23.42	33.00
			E2	V	127.44	20.49	9.99	5.46	25.02	33.00
				H	129.76	23.39	9.99	5.46	27.42	33.00
	1909.80	810	H	V	123.25	16.31	10.08	5.51	20.88	33.00
				H	128.29	21.44	10.08	5.51	26.00	33.00
			E1	V	129.73	22.79	10.08	5.51	27.36	33.00
				H	126.86	20.01	10.08	5.51	24.57	33.00
			E2	V	126.16	19.22	10.08	5.51	23.79	33.00
				H	128.39	24.54	10.08	5.51	26.10	33.00

Remark :

- The RBW,VBW of SPA for frequency
Below 1GHz was RBW=100 KHz, VBW=300KHz,
Above 1GHz was RBW= 1MHz , VBW= 3MHz

The results shown in this test report refer only to the sample(s) tested unless otherwise stated. This test report cannot be reproduced, except in full, without prior written permission of the Company.

7. OCCUPIED BANDWIDTH MEASUREMENT

7.1 Standard Applicable

According to §FCC 2.1049.

7.2 Test Set-up:

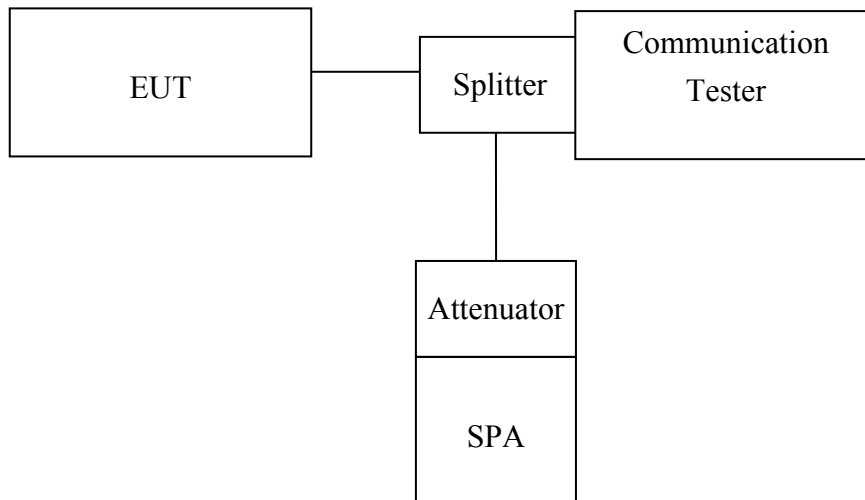

Note: Measurement setup for testing on Antenna connector

7.3 Measurement Procedure

The EUT's output RF connector was connected with a short cable to the spectrum analyzer, RBW (10/30KHz) was set to about 1% of emission BW, VBW= 3 times RBW(30/100KHz), -26dBc display line was placed on the screen (or 99% bandwidth), the occupied bandwidth is the delta frequency between the two points where the display line intersects the signal trace.

7.4 Measurement Equipment Used:

Conducted Emission Test Site					
EQUIPMENT TYPE	MFR	MODEL NUMBER	SERIAL NUMBER	LAST CAL.	CAL DUE.
Spectrum Analyzer	Agilent	E4446A	MY43360126	03/29/2005	03/28/2006
Spectrum Analyzer	Agilent	7405A	US41160416	06/28/2005	06/29/2006
Spectrum Analyzer	R&S	FSP 40	100034	11/09/2004	11/10/2005

The results shown in this test report refer only to the sample(s) tested unless otherwise stated. This test report cannot be reproduced, except in full, without prior written permission of the Company.

Power Sensor	Anritsu	MA2490A	31431	06/28/2005	06/29/2006
Power Meter	Anritsu	ML2487A	6K00002070	06/28/2005	06/29/2006
Temperature Chamber	TERCHY	MHG-120LF	911009	11/11/2004	11/12/2005
Low Loss Cable	HUBER+SUHNE R	SUCOFLEX 104PEA	N/A	N/A	N/A
Attenuator	Mini-Circuit	BW-S10W5	N/A	10/07/2004	10/06/2005
Attenuator	Mini-Circuit	BW-S6W5	N/A	10/07/2004	10/06/2005
Splitter	Mini-Circuit	ZFSC-2-10G	N/A	10/07/2004	10/06/2005
Signal Generator	R&S	SMR40	100210	11/09/2004	11/10/2005
Diode Detector	Agilent	8471E	MY4224	N/A	N/A
AC Power Supply	APW-105N	887592	All Power	N/A	N/A

The results shown in this test report refer only to the sample(s) tested unless otherwise stated. This test report cannot be reproduced, except in full, without prior written permission of the Company.

7.5 Measurement Result:

EUT Mode	Frequency (MHz)	CH	Bandwidth (MHz)
GSM 850	824.20	128	0.2430
	836.60	190	0.23855
	848.80	251	0.23822

EUT Mode	Frequency (MHz)	CH	Bandwidth (MHz)
PCS 1900	1850.20	512	0.23643
	1880.00	661	0.23690
	1909.80	810	0.23854

The results shown in this test report refer only to the sample(s) tested unless otherwise stated. This test report cannot be reproduced, except in full, without prior written permission of the Company.

Figure 7-1: GSM Channel Low

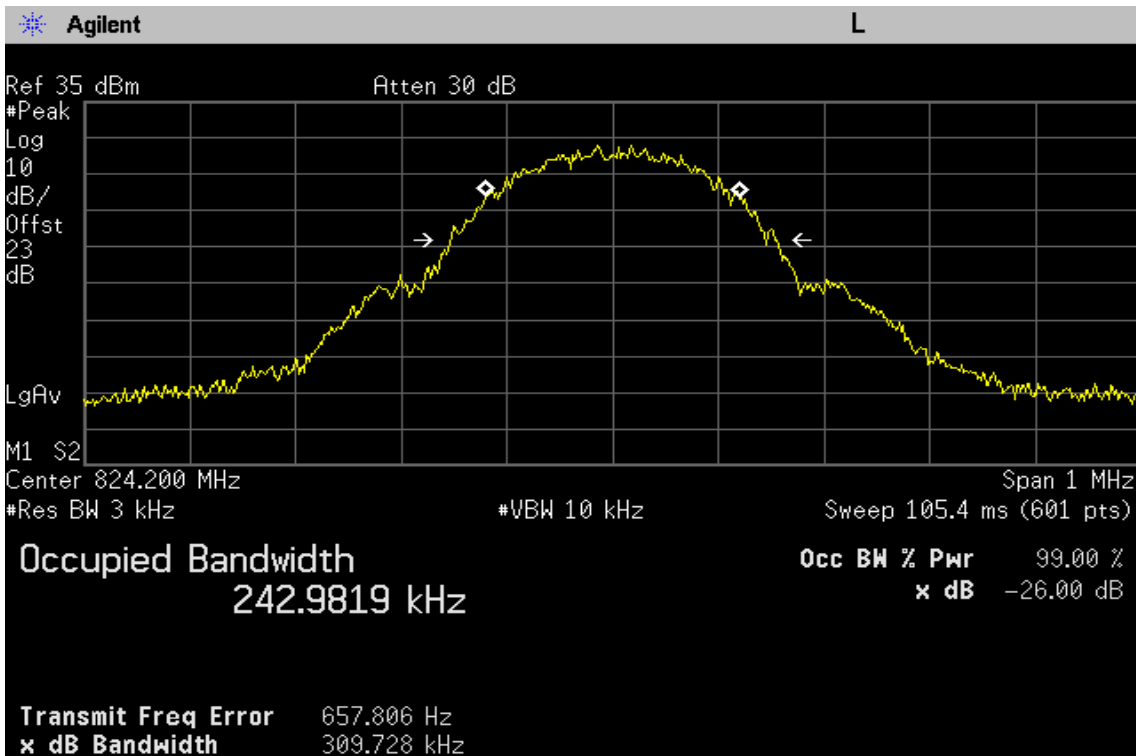
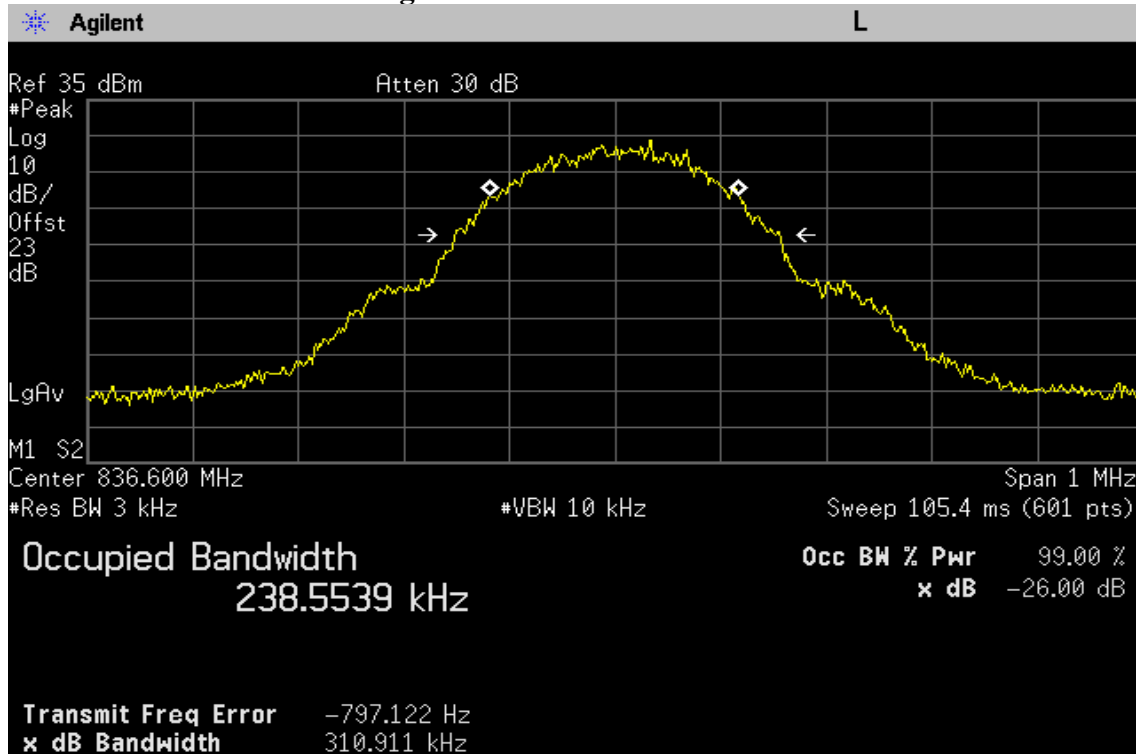
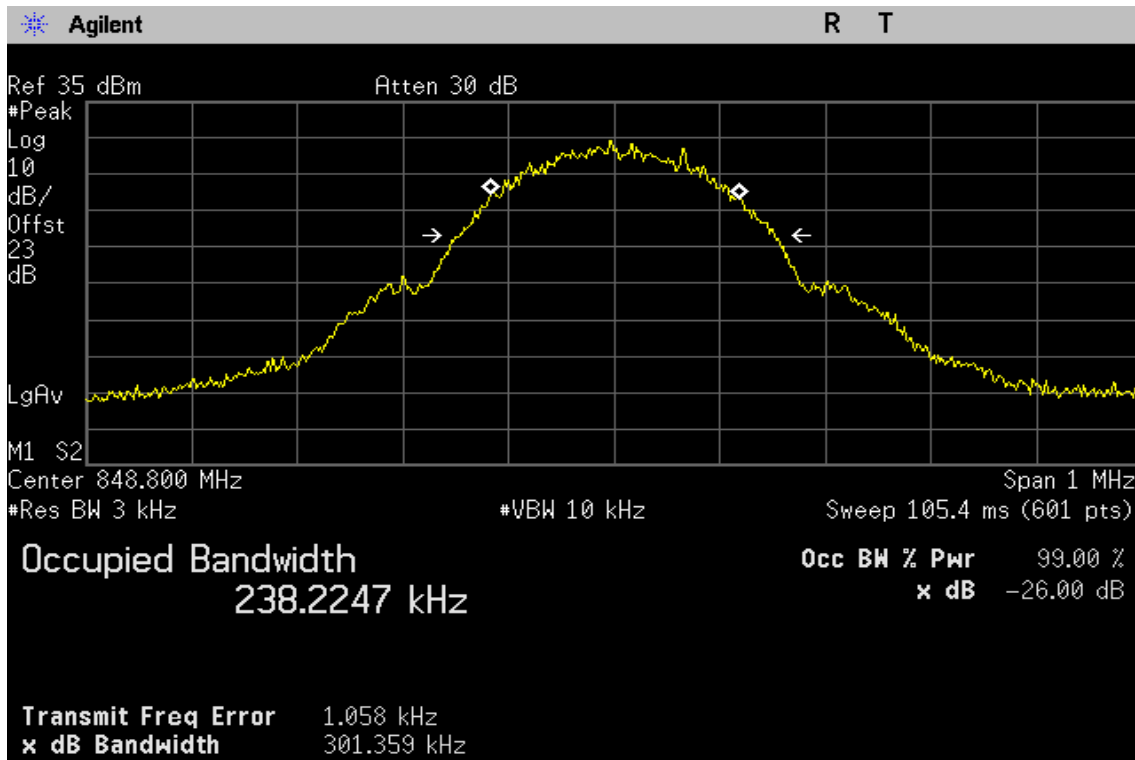

Figure 7-2 GSM Channel Mid



The results shown in this test report refer only to the sample(s) tested unless otherwise stated. This test report cannot be reproduced, except in full, without prior written permission of the Company.

Figure 7-3: GSM Channel High



The results shown in this test report refer only to the sample(s) tested unless otherwise stated. This test report cannot be reproduced, except in full, without prior written permission of the Company.

Figure 7-4: PCS Channel Low

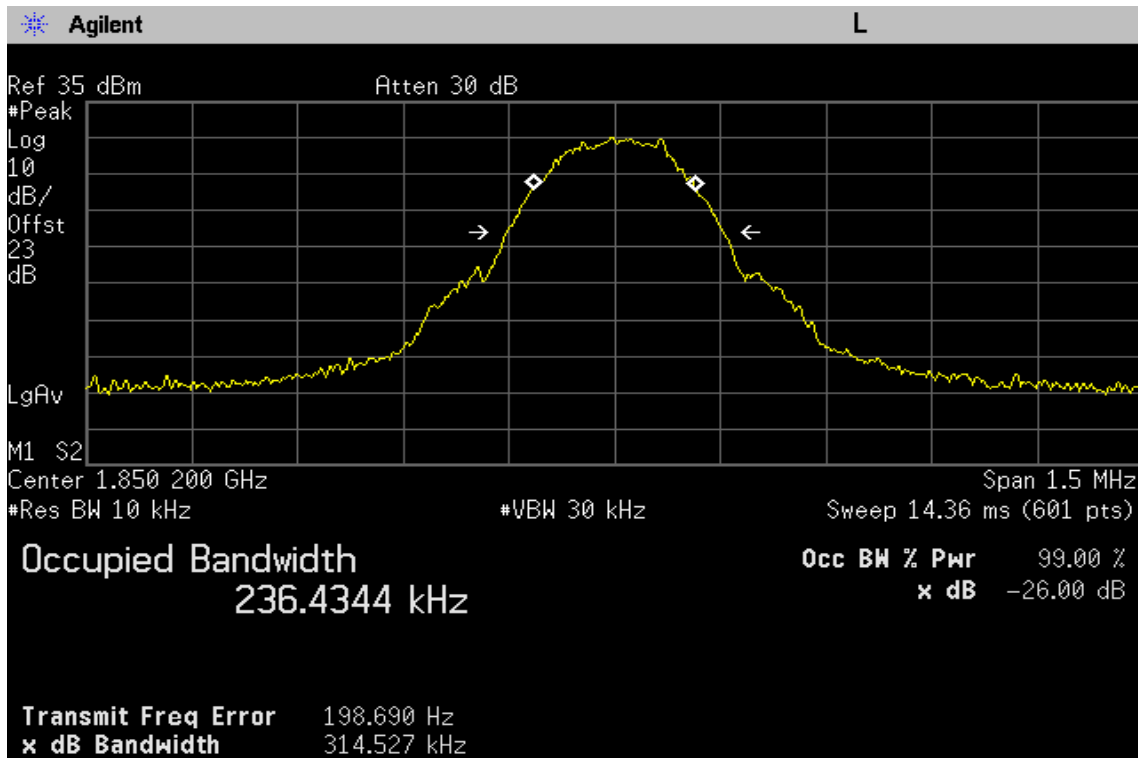
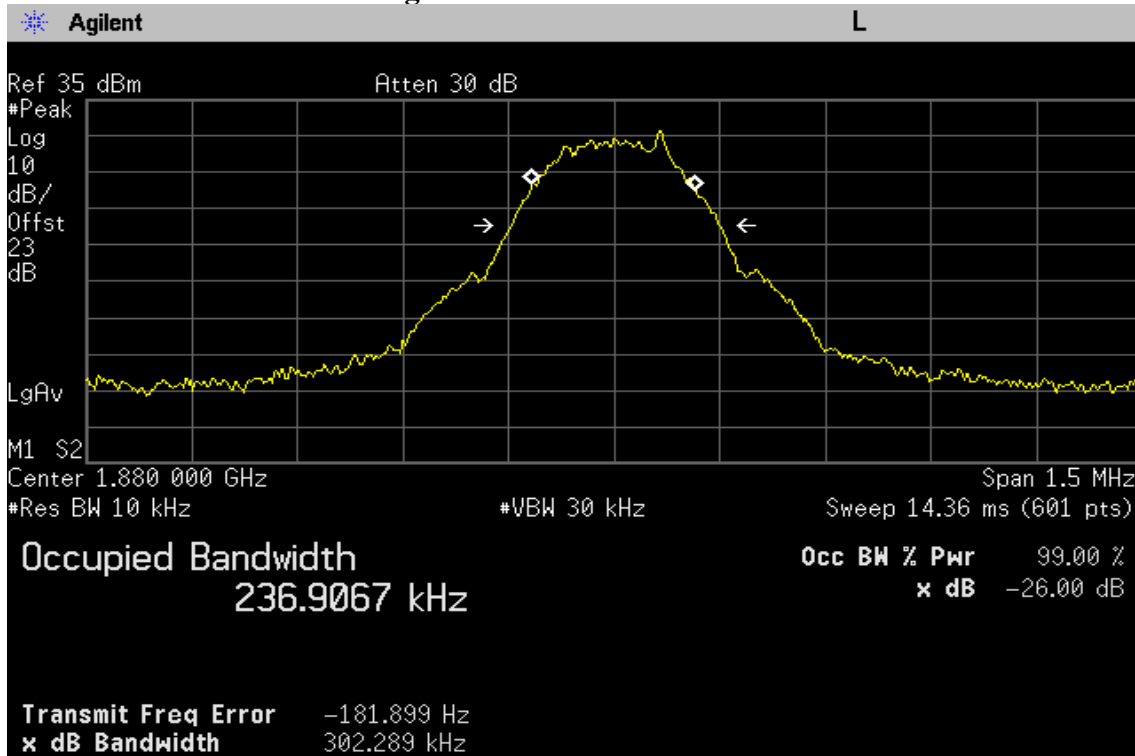
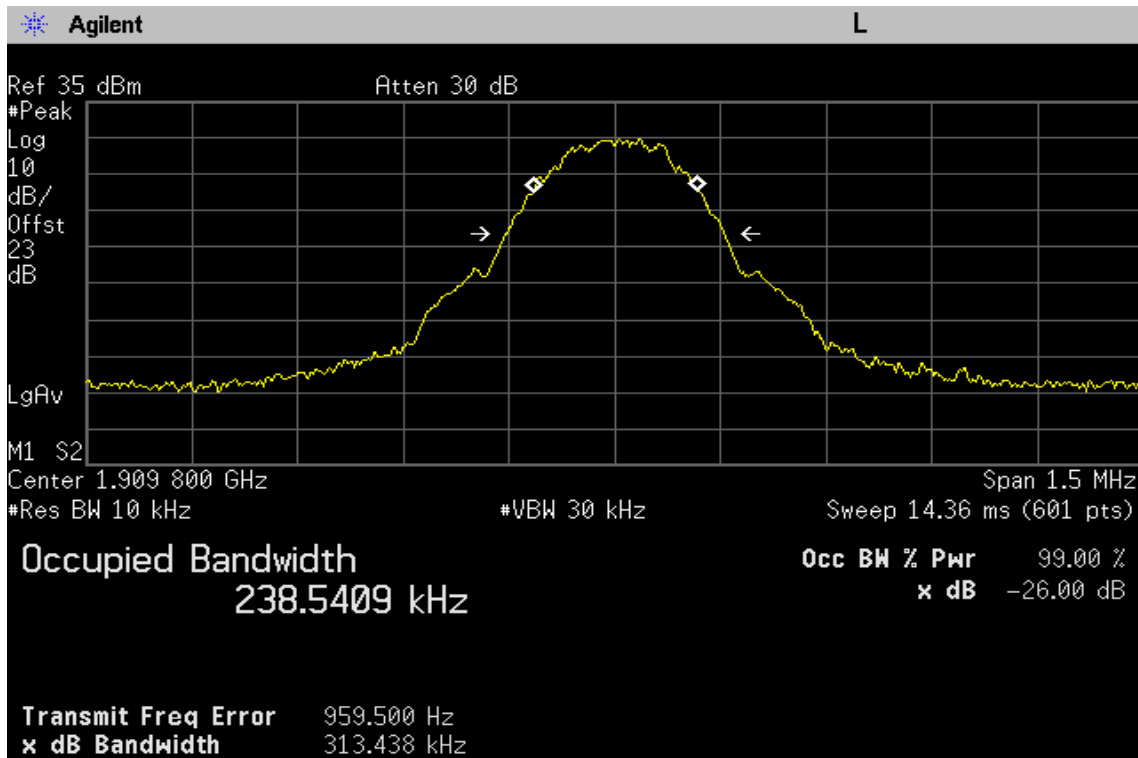

Figure 7-5 PCS Channel Mid



The results shown in this test report refer only to the sample(s) tested unless otherwise stated. This test report cannot be reproduced, except in full, without prior written permission of the Company.

Figure 7-6: PCS Channel High



The results shown in this test report refer only to the sample(s) tested unless otherwise stated. This test report cannot be reproduced, except in full, without prior written permission of the Company.

8. OUT OF BAND EMISSION AT ANTENNA TERMINALS

8.1 Standard Applicable

According to FCC §2.1051.

FCC §22.917(a),§24.238(a), the magnitude of each spurious and harmonic emission that can be detected when the equipment is operated under the conditions specified in the instruction manual and/ or alignment procedure, shall not be less than $43 + 10 \log$ (mean output power in watts) dBc below the mean power output outside a license's frequency block (-13dBm)

8.2 Test SET-UP

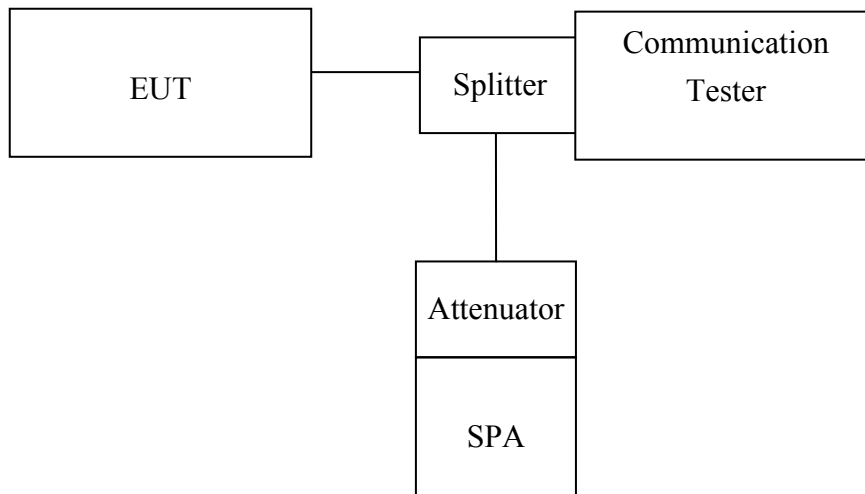

Note: Measurement setup for testing on Antenna connector

8.3 Measurement Procedure

The RF output of the transceiver was connected to a spectrum analyzer through appropriate attenuation. The resolution bandwidth of the spectrum analyzer was set at 1MHz, sufficient scans were taken to show the out of band Emissions if any up to 10th harmonic.

For the out of band: Set the RBW, VBW = 1MHz, Start=30MHz, Stop= 10th harmonic.
Limit = -13dBm

Band Edge Requirements: In the 1 MHz bands immediately outside and adjacent to the frequency block, a resolution bandwidth of at least 1 percent of the emission bandwidth of the fundamental emission of the transmitter may be employed to measure the out of band Emissions. Limit, -13dBm.

The results shown in this test report refer only to the sample(s) tested unless otherwise stated. This test report cannot be reproduced, except in full, without prior written permission of the Company.

8.4 Measurement Equipment Used:

Conducted Emission Test Site					
EQUIPMENT TYPE	MFR	MODEL NUMBER	SERIAL NUMBER	LAST CAL.	CAL DUE.
Spectrum Analyzer	Agilent	E4446A	MY43360126	03/29/2005	03/28/2006
Spectrum Analyzer	Agilent	7405A	US41160416	06/28/2005	06/29/2006
Spectrum Analyzer	R&S	FSP 40	100034	11/09/2004	11/10/2005
Power Sensor	Anritsu	MA2490A	31431	06/28/2005	06/29/2006
Power Meter	Anritsu	ML2487A	6K00002070	06/28/2005	06/29/2006
Temperature Chamber	TERCHY	MHG-120LF	911009	11/11/2004	11/12/2005
Low Loss Cable	HUBER+SUHNER	SUCOFLEX 104PEA	N/A	N/A	N/A
Attenuator	Mini-Circuit	BW-S10W5	N/A	10/07/2004	10/06/2005
Attenuator	Mini-Circuit	BW-S6W5	N/A	10/07/2004	10/06/2005
Splitter	Mini-Circuit	ZFSC-2-10G	N/A	10/07/2004	10/06/2005
Signal Generator	R&S	SMR40	100210	11/09/2004	11/10/2005
Diode Detector	Agilent	8471E	MY4224	N/A	N/A
AC Power Supply	APW-105N	887592	All Power	N/A	N/A

The results shown in this test report refer only to the sample(s) tested unless otherwise stated. This test report cannot be reproduced, except in full, without prior written permission of the Company.

8.5 Measurement Result

Figure 8-1: Out of Band emission at antenna terminals– GSM Channel Lowest

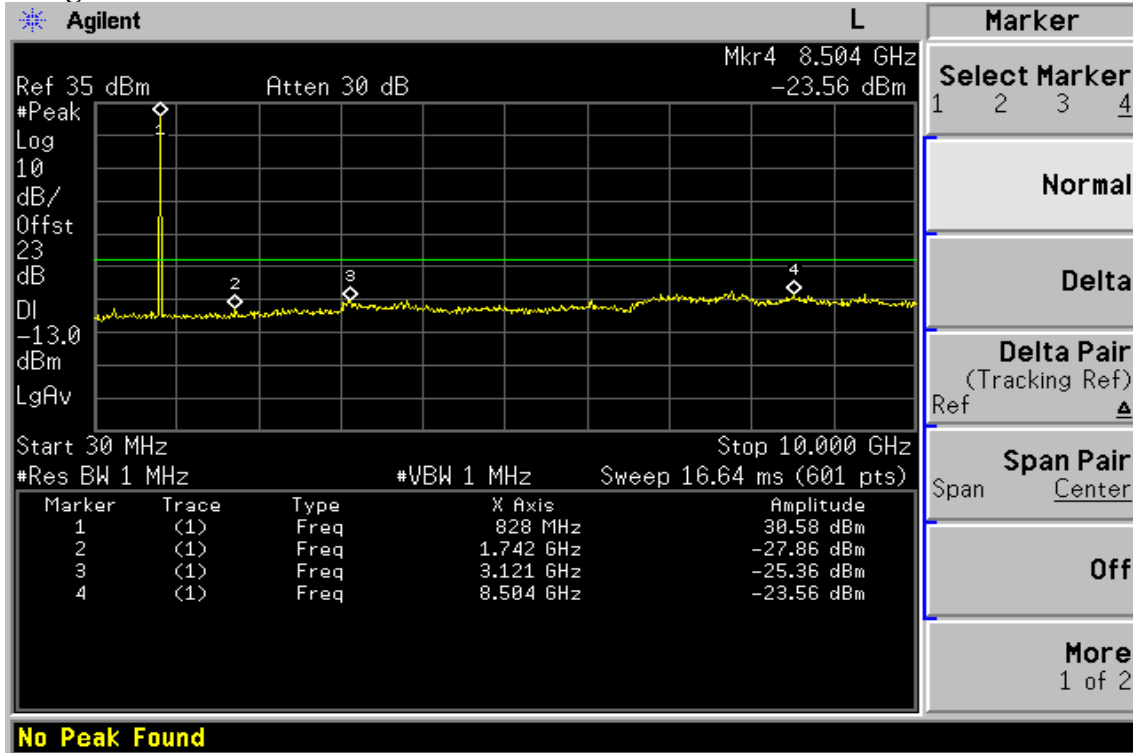
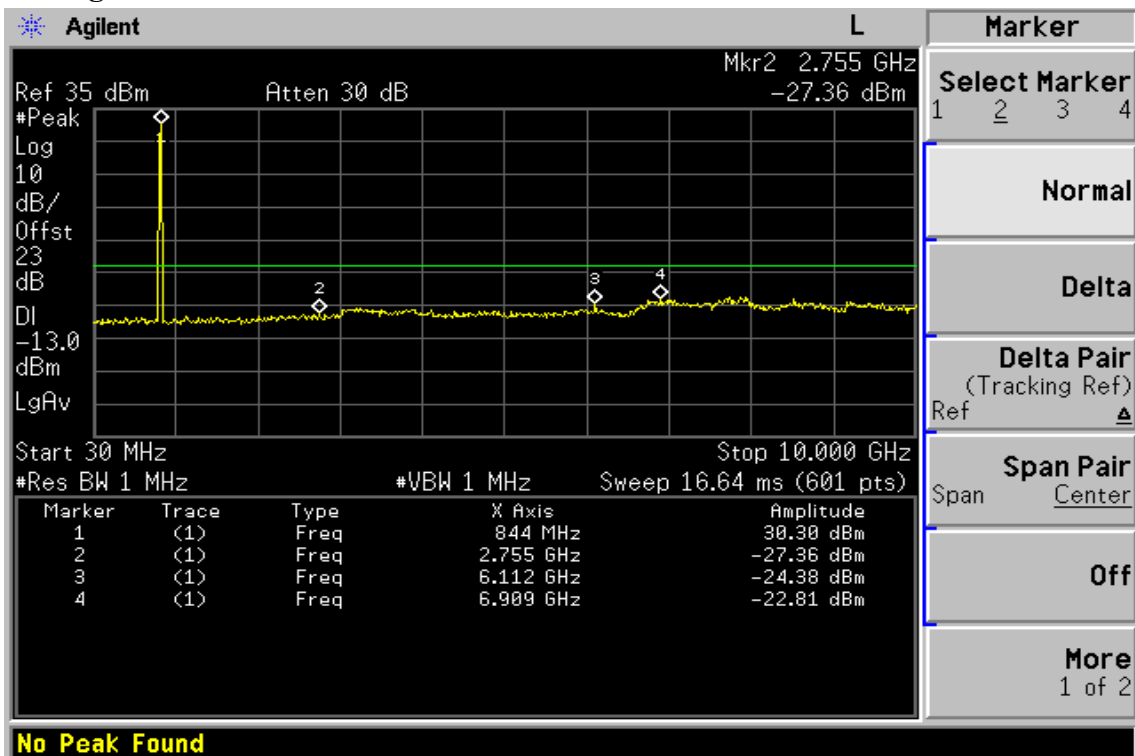
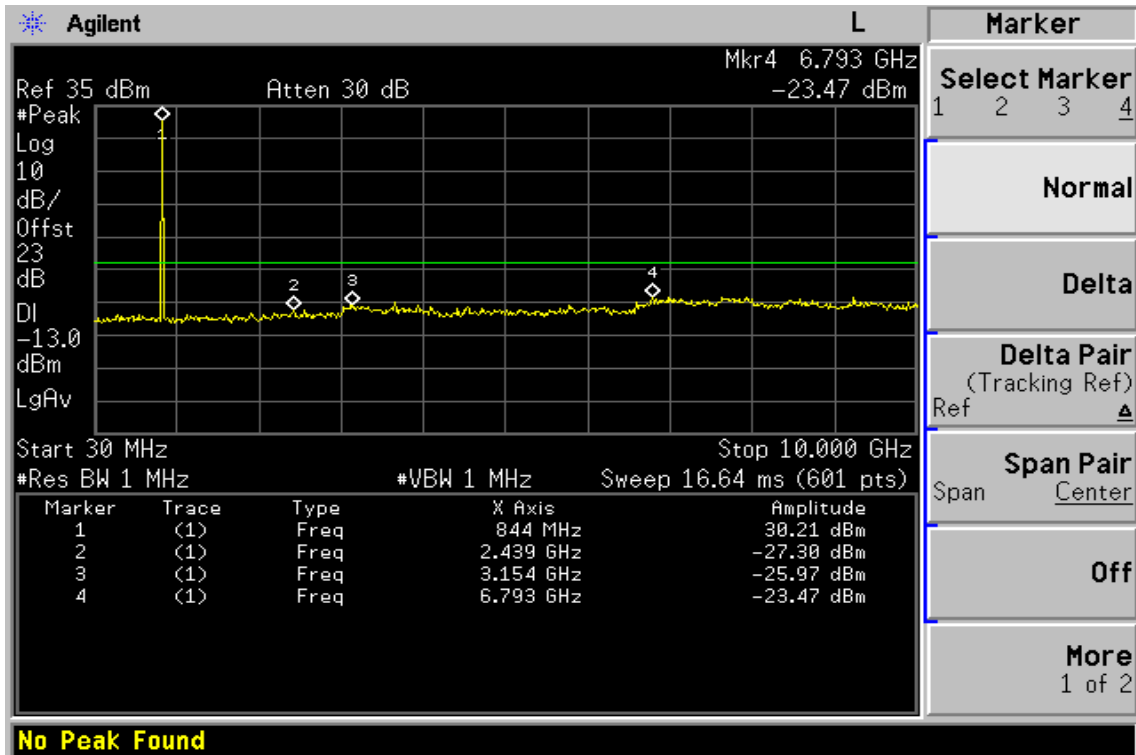

Figure 8-2: Out of Band emission at antenna terminals –GSM Channel Mid



The results shown in this test report refer only to the sample(s) tested unless otherwise stated. This test report cannot be reproduced, except in full, without prior written permission of the Company.

Figure 8-3: Out of Band emission at antenna terminals–GSM Channel Highest



The results shown in this test report refer only to the sample(s) tested unless otherwise stated. This test report cannot be reproduced, except in full, without prior written permission of the Company.

Figure 8-4: Bad edge emission at antenna terminals – GSM Channel Lowest

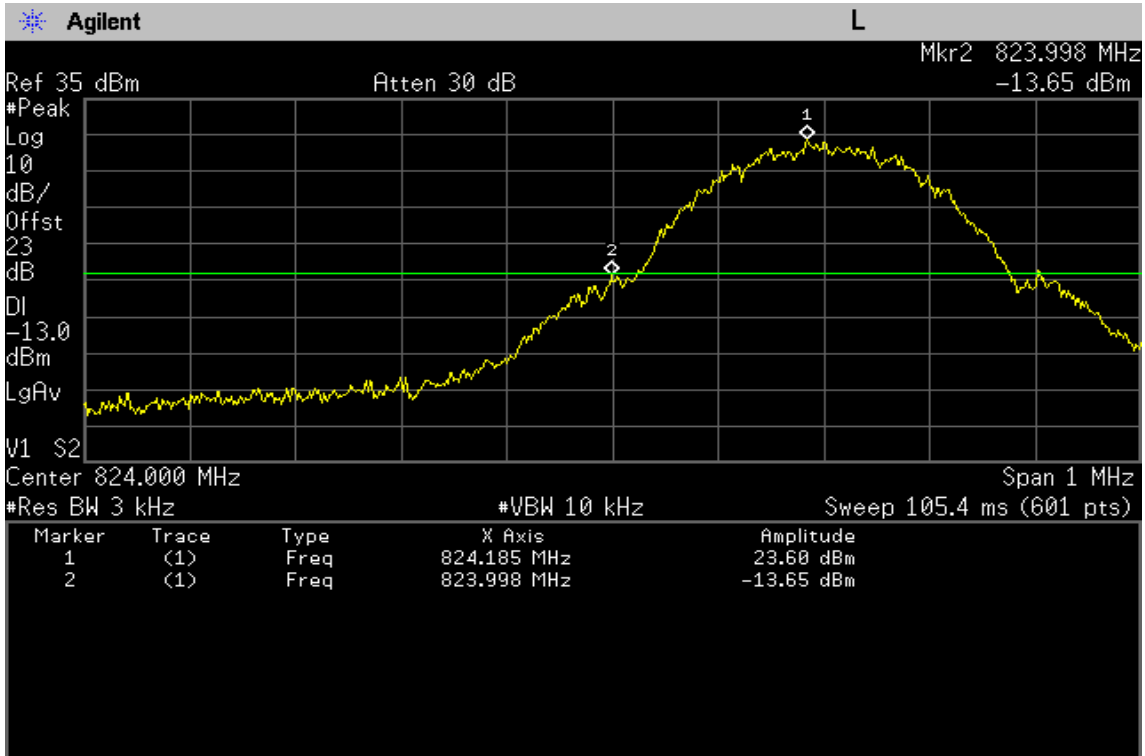
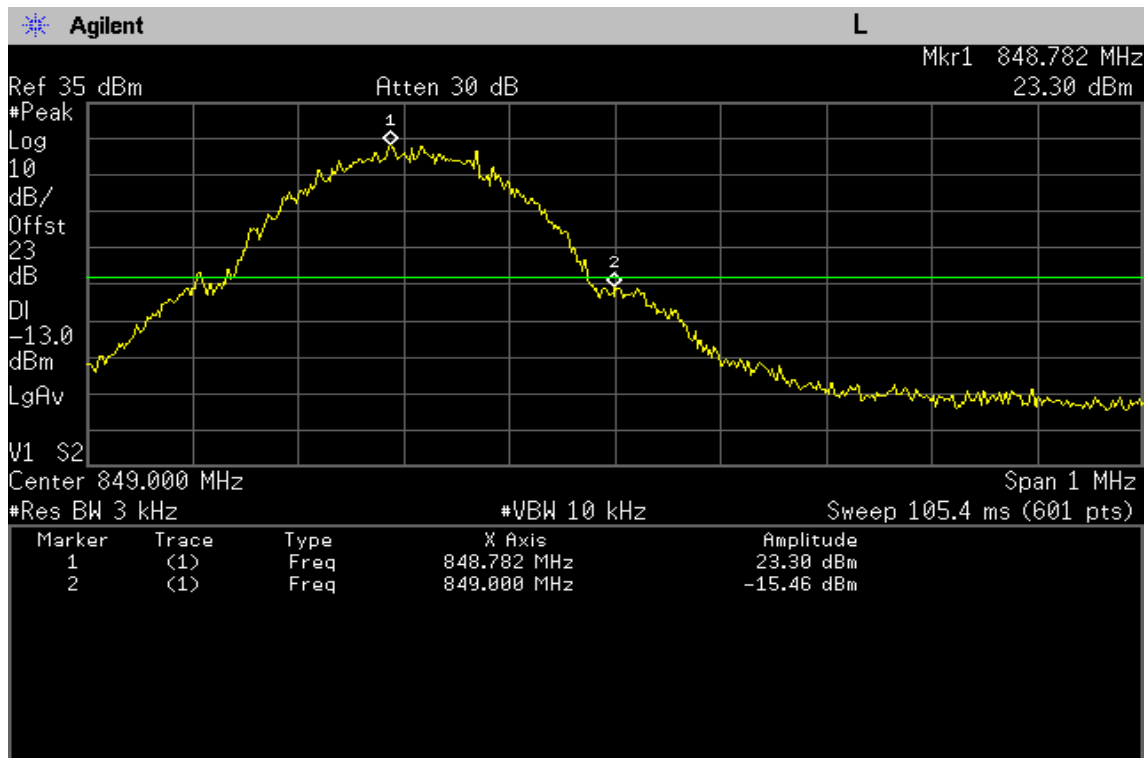

Figure 8-5: Band edge emission at antenna terminals – GSM Channel Highest



The results shown in this test report refer only to the sample(s) tested unless otherwise stated. This test report cannot be reproduced, except in full, without prior written permission of the Company.

Figure 8-6: Out of Band emission at antenna terminals– PCS Channel Lowest

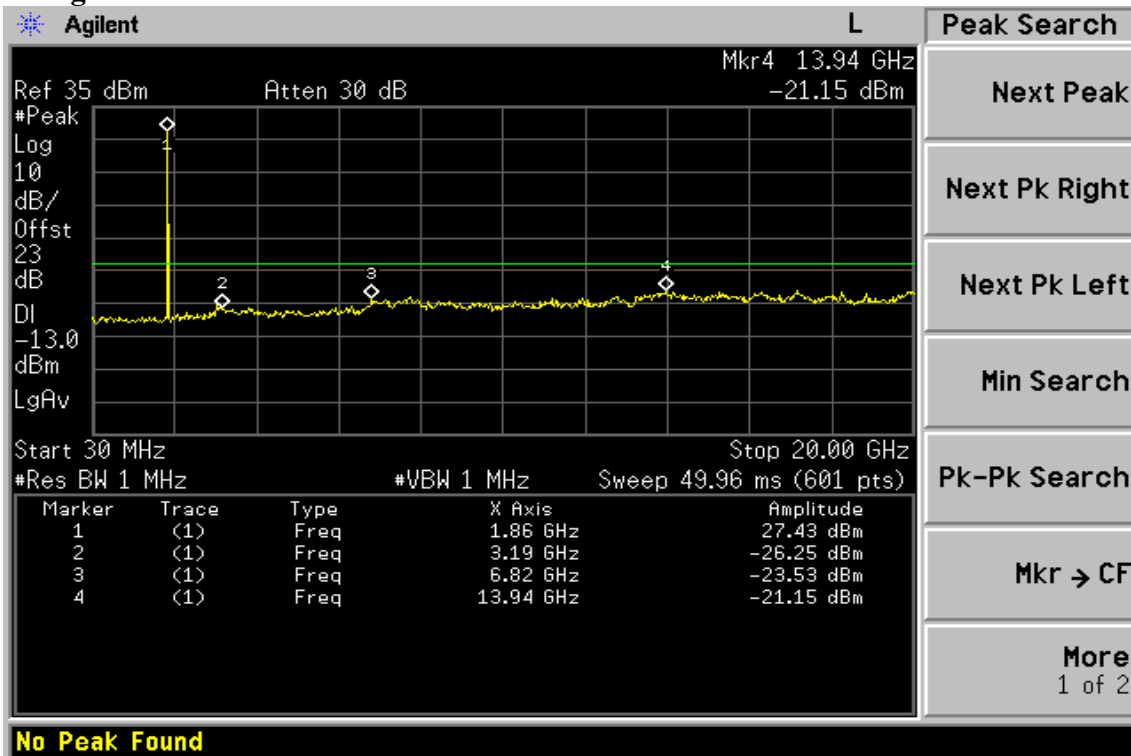
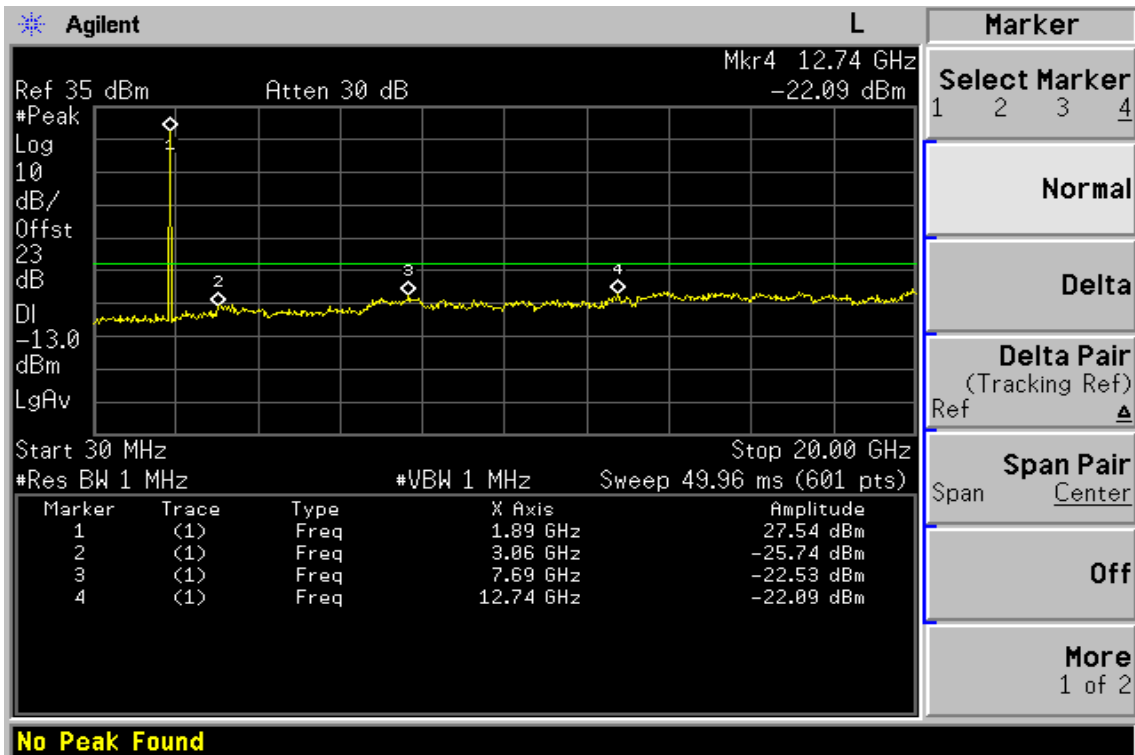
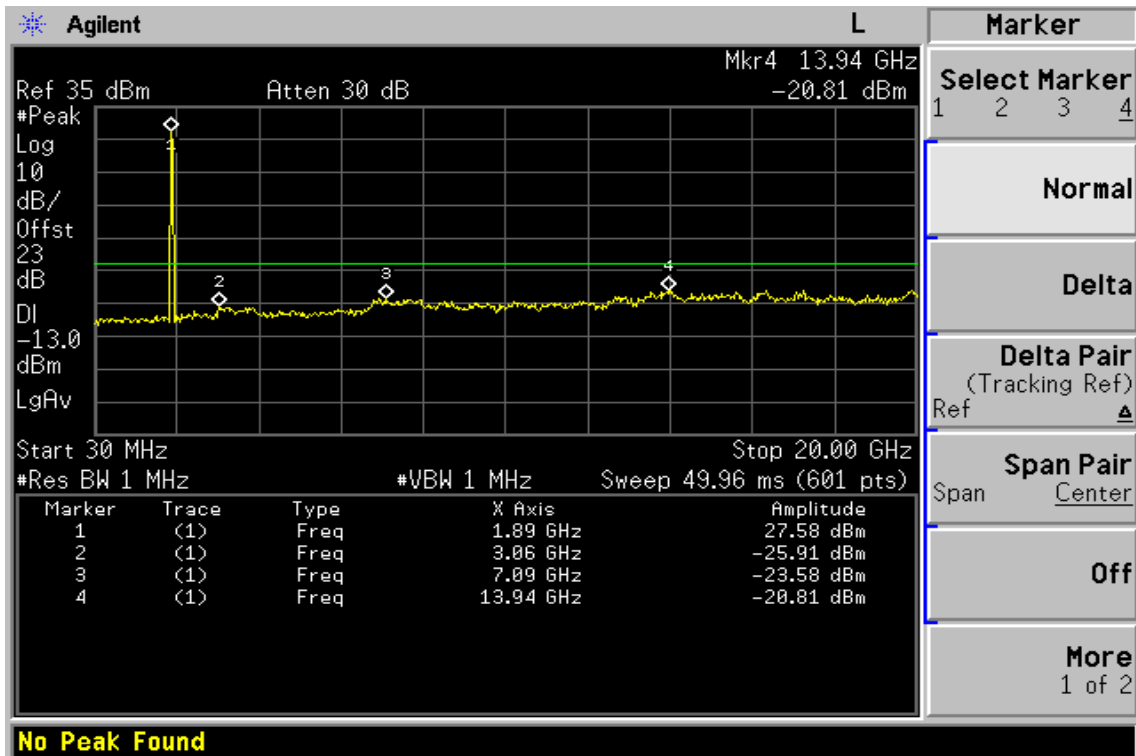

Figure 8-7: Out of Band emission at antenna terminals –PCS Channel Mid



The results shown in this test report refer only to the sample(s) tested unless otherwise stated. This test report cannot be reproduced, except in full, without prior written permission of the Company.

Figure 8-8: Out of Band emission at antenna terminals–PCS Channel Highest



The results shown in this test report refer only to the sample(s) tested unless otherwise stated. This test report cannot be reproduced, except in full, without prior written permission of the Company.

Figure 8-9: Bad edge emission at antenna terminals – PCS Channel Lowest

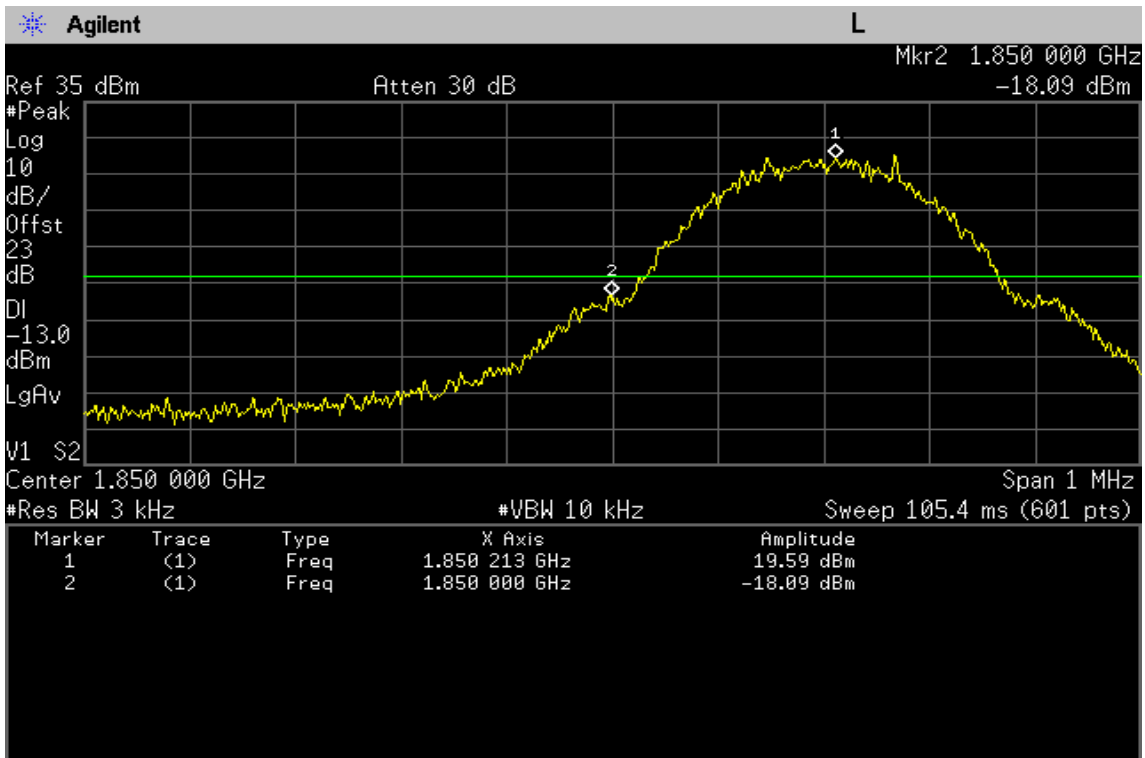
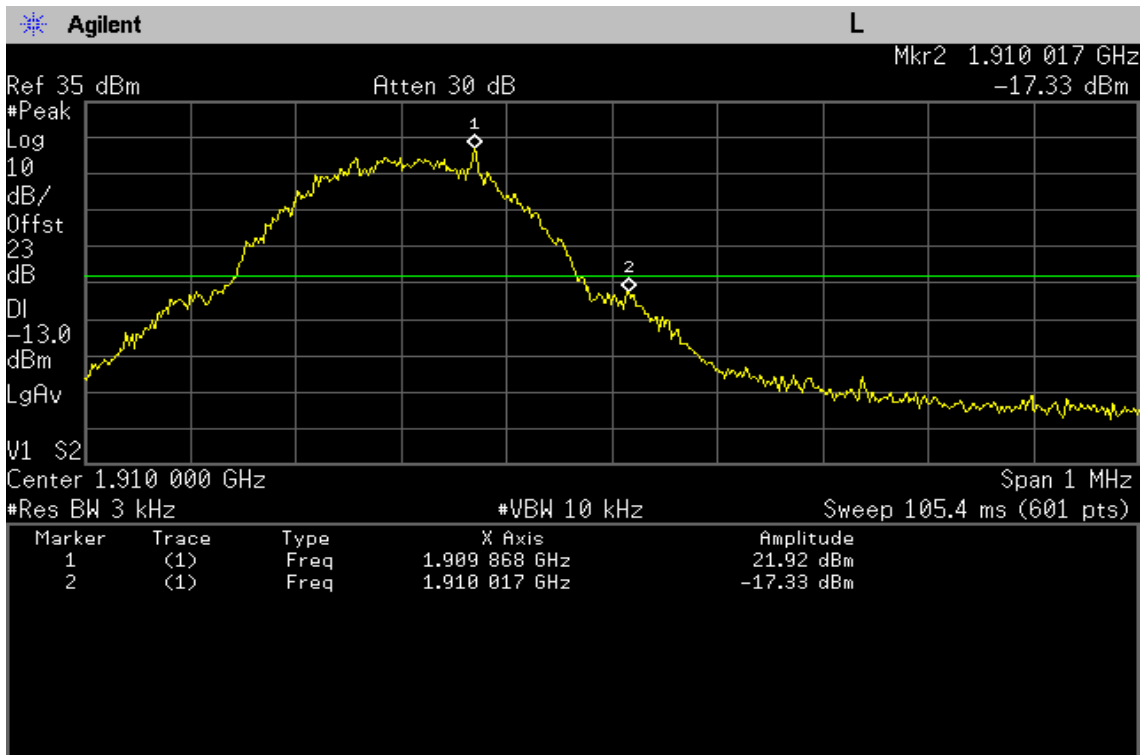

Figure 8-10: Band edge emission at antenna terminals – PCS Channel Highest



The results shown in this test report refer only to the sample(s) tested unless otherwise stated. This test report cannot be reproduced, except in full, without prior written permission of the Company.

9. FIELD STRENGTH OF SPURIOUS RADIATION MEASUREMENT

9.1 Standard Applicable

According to FCC §2.1053,

FCC §22.917(a),§24.238(a), the magnitude of each spurious and harmonic emission that can be detected when the equipment is operated under the conditions specified in the instruction manual and/ or alignment procedure, shall not be less than $43 + 10 \log$ (mean output power in watts) dBc below the mean power output outside a license's frequency block (-13dBm)

9.2 EUT Setup (Block Diagram of Configuration)

(A) Radiated Emission Test Set-Up, Frequency Below 1000MHz

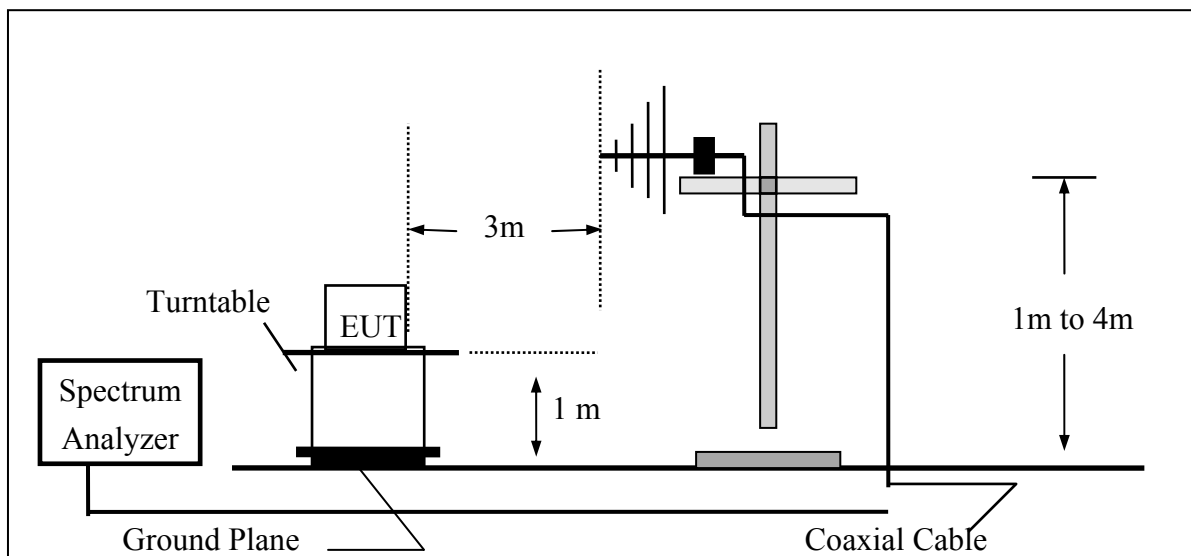

The results shown in this test report refer only to the sample(s) tested unless otherwise stated. This test report cannot be reproduced, except in full, without prior written permission of the Company.

(B) Radiated Emission Test Set-UP Frequency Over 1 GHz

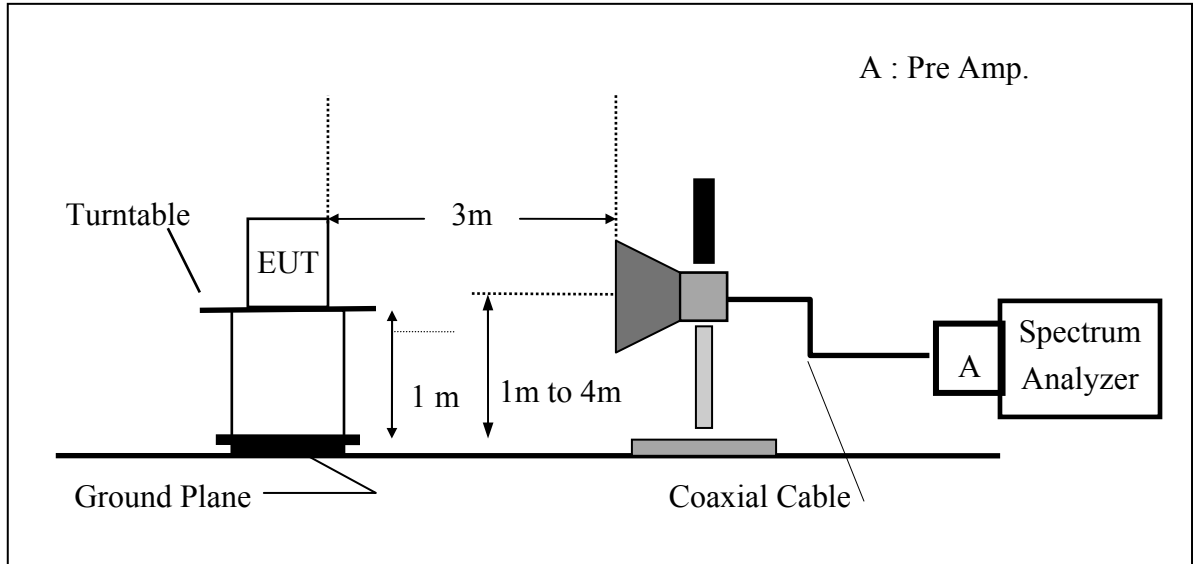

(C) Substituted Method Test Set-UP

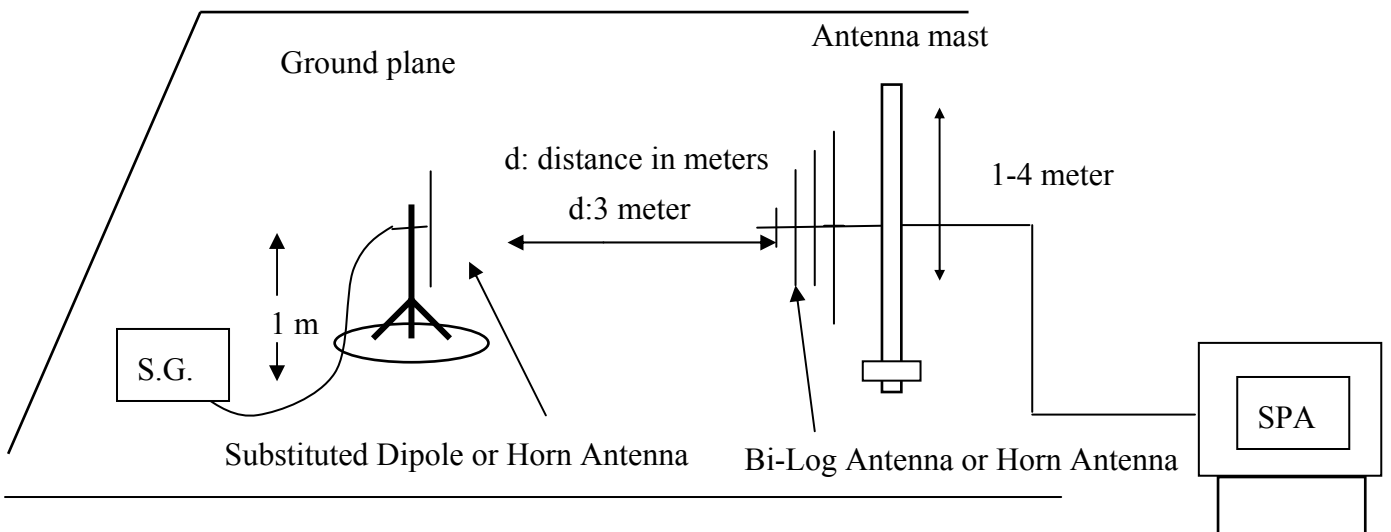

The results shown in this test report refer only to the sample(s) tested unless otherwise stated. This test report cannot be reproduced, except in full, without prior written permission of the Company.

9.3 Measurement Procedure

The EUT was placed on a non-conductive, The measurement antenna was placed at a distance of 3 meters from the EUT. During the tests, the antenna height and the EUT azimuth were varied in order to identify the maximum level of emissions from the EUT. This maximization process was repeated with the EUT positioned in each of its three orthogonal orientations.

The frequency range up to tenth harmonic was investigated for each of three fundamental frequency (low, middle and high channels). Once spurious emission were identified, the power of the emission was determined using the substitution method.

The spurious emissions attenuation was calculated as the difference between radiated power at the fundamental frequency and the spurious emissions frequency.

$$\text{ERP} = \text{S.G. output (dBm)} + \text{Antenna Gain(dBd)} - \text{Cable Loss (dB)}$$

$$\text{EIRP} = \text{S.G. output (dBm)} + \text{Antenna Gain(dBi)} - \text{Cable Loss (dB)}$$

The results shown in this test report refer only to the sample(s) tested unless otherwise stated. This test report cannot be reproduced, except in full, without prior written permission of the Company.

9.4 Measurement Equipment Used:

EQUIPMENT TYPE	MFR	MODEL NUMBER	SERIAL NUMBER	LAST CAL.	CAL DUE.
Spectrum Analyzer	R&S	FSP 40	100034	05/27/2005	05/26/2006
Spectrum Analyzer	Agilent	E7405A	US41160416	08/27/2004	08/26/2005
Bilog Antenna	SCHWAZBECK	VULB9163	152	06/03/2005	06/02/2006
Horn antenna	Schwarzbeck	BBHA 9120D	309/320	08/16/2004	08/15/2005
Pre-Amplifier	HP	8447D	2944A09469	07/19/2005	07/18/2006
Pre-Amplifier	HP	8494B	3008A00578	02/26/2005	02/25/2006
Signal Generator	R&S	SMR40	100210	02/09/2005	02/10/2006
Turn Table	HD	DT420	N/A	N.C.R	N.C.R
Antenna Tower	HD	MA240-N	240/657	N.C.R	N.C.R
Controller	HD	HD100	N/A	N.C.R	N.C.R
Low Loss Cable	HUBER+SUHNER	SUCOFLEX 104PEA-10M	10m	10/09/2004	10/08/2005
Low Loss Cable	HUBER+SUHNER	SUCOFLEX 104PEA-3M	3m	10/09/2004	10/08/2005
Low Loss Cable	HUBER+SUHNER	SUCOFLEX 104PEA-0.5M	0.5m	10/09/2004	10/08/2005
Site NSA	SGS	966 chamber	N/A	11/17/2004	11/16/2005
Site NSA	SGS	10m Open-Site	N/A	10/02/2004	10/01/2005
Attenuator	Mini-Circuit	BW-S10W5	N/A	10/07/2004	10/06/2005
Temperature Chamber	TERCHY	MHG-120LF	911009	10/14/2004	10/13/2005
Dipole Antenna	Schwarzbeck	VHAP	908/909	06/10/2005	06/11/2006
Dipole Antenna	Schwarzbeck	UHAP	891/892	06/10/2005	06/11/2006
Horn antenna	Schwarzbeck	BBHA 9120D	N/A	08/16/2004	08/15/2005

9.5 Measurement Result

Refer to attach tabular data sheets.

The results shown in this test report refer only to the sample(s) tested unless otherwise stated. This test report cannot be reproduced, except in full, without prior written permission of the Company.

Radiated Spurious Emission Measurement Result: GSM 850 Mode

Operation Mode	: TX CH Low E1 Mode	Test Date:	Jul.20, 2005
Fundamental Frequency	: 824.20 MHz	Test By:	Henk
Temperature	: 25°C	Pol:	Ver / Hor
Humidity	: 65%	Adaptor Model:	3DS09371AGAA
		Supplier:	Leader

Freq.	SPA. Reading	Ant.Pol.	S.G Output	Antenna Gain	Cable Loss	ERP/EIRP	Limit	Safe Margin
(MHz)	(dBuV)	H/V	(dBm)	(dB/dBi)	(dB)	(dBm)	(dBm)	(dBm)
75.59	49.78	V	-61.74	-1.85	1.05	-64.65	-13.00	-51.65
824.00	81.29	V	-6.04	-7.87	3.64	-17.56	-13.00	-4.56
1645.00	58.11	V	-48.93	9.28	5.05	-44.70	-13.00	-31.70
2462.50	54.03	V	-50.10	10.08	6.28	-46.30	-13.00	-33.30
3295.00	37.74	V	-64.84	12.16	7.25	-59.93	-13.00	-46.93
4945.62	---	V	---	---	---	---	-13.00	---
5769.89	---	V	---	---	---	---	-13.00	---
6594.16	---	V	---	---	---	---	-13.00	---
7418.43	---	V	---	---	---	---	-13.00	---
8242.70	---	V	---	---	---	---	-13.00	---
32.91	45.67	H	-59.33	-5.98	0.71	-66.02	-13.00	-53.02
824.00	84.10	H	-3.56	-7.87	3.64	-15.08	-13.00	-2.08
1645.00	58.53	H	-48.48	9.28	5.05	-44.25	-13.00	-31.25
2462.00	48.02	H	-56.10	10.08	6.28	-52.30	-13.00	-39.30
4945.62	---	H	---	---	---	---	-13.00	---
5769.89	---	H	---	---	---	---	-13.00	---
6594.16	---	H	---	---	---	---	-13.00	---
7418.43	---	H	---	---	---	---	-13.00	---
8242.70	---	H	---	---	---	---	-13.00	---

Remark :

- 1 The emission behaviour belongs to narrowband spurious emission.
- 2 Remark"---" means that the emission level is too low to be measured
- 3 The result basic equation calculation is as follows:
- 4 $ERP/EIRP (dBm) = SG \text{ Setting}(dBm) + Antenna \text{ Gain} (dBd/dBi) - Cable \text{ loss} (dB)$

The results shown in this test report refer only to the sample(s) tested unless otherwise stated. This test report cannot be reproduced, except in full, without prior written permission of the Company.

Radiated Spurious Emission Measurement Result: GSM 850 Mode

Operation Mode : TX CH Mid E1 Mode
 Fundamental Frequency : 836.60 MHz
 Temperature : 25°C
 Humidity : 65%

Test Date: Jul.20, 2005
 Test By: Henk
 Pol: Ver / Hor
 Adaptor Model: 3DS09371AGAA
 Supplier: Leader

Freq.	SPA Reading	Ant.Pol.	S.G Output	Antenna Gain	Cable Loss	ERP/EIRP	Limit	Safe Margin
(MHz)	(dBuV)	H/V	(dBm)	(dBd/dBi)	(dB)	(dBm)	(dBm)	(dBm)
39.70	44.62	V	-57.27	-2.79	0.78	-60.84	-13.00	-47.84
1652.50	64.17	V	-42.87	9.30	5.06	-38.63	-13.00	-25.63
2492.50	51.55	V	-52.40	10.06	6.32	-48.65	-13.00	-35.65
3332.50	37.73	V	-64.84	12.24	7.28	-59.87	-13.00	-46.87
5019.12	---	V	---	---	---	---	-13.00	---
5855.64	---	V	---	---	---	---	-13.00	---
6692.16	---	V	---	---	---	---	-13.00	---
7528.68	---	V	---	---	---	---	-13.00	---
8365.20	---	V	---	---	---	---	-13.00	---
39.70	45.53	H	-57.36	-2.79	0.78	-60.94	-13.00	-47.94
1652.50	63.42	H	-43.59	9.30	5.06	-39.35	-13.00	-26.35
2492.50	45.38	H	-58.56	10.06	6.32	-54.82	-13.00	-41.82
3331.50	39.19	H	-63.14	12.24	7.28	-58.18	-13.00	-45.18
5855.64	---	H	---	---	---	---	-13.00	---
6692.16	---	H	---	---	---	---	-13.00	---
7528.68	---	H	---	---	---	---	-13.00	---
8365.20	---	H	---	---	---	---	-13.00	---

Remark :

- 1 The emission behaviour belongs to narrowband spurious emission.
- 2 Remark"---" means that the emission level is too low to be measured
- 3 The result basic equation calculation is as follows:
- 4 $ERP/EIRP (dBm) = SG \text{ Setting}(dBm) + Antenna \text{ Gain} (dBd/dBi) - Cable \text{ loss} (dB)$

The results shown in this test report refer only to the sample(s) tested unless otherwise stated. This test report cannot be reproduced, except in full, without prior written permission of the Company.

Radiated Spurious Emission Measurement Result: GSM 850 Mode

Operation Mode	: TX CH High E1 Mode	Test Date:	Jul.20, 2005
Fundamental Frequency	: 848.80 MHz	Test By:	Henk
Temperature	: 25°C	Pol:	Ver / Hor
Humidity	: 65%	Adaptor Model:	3DS09371AGAA
		Supplier:	Leader

Freq.	SPA. Reading	Ant.Pol.	S.G Output	Antenna Gain	Cable Loss	ERP/EIRP	Limit	Safe Margin
(MHz)	(dBuV)	H/V	(dBm)	(dB/dBi)	(dB)	(dBm)	(dBm)	(dBm)
39.70	44.87	V	-57.02	-2.79	0.78	-60.59	-13.00	-47.59
849.00	82.34	V	-4.39	-7.88	3.75	-16.02	-13.00	-3.02
1982.50	70.24	V	-36.67	10.30	5.64	-32.01	-13.00	-19.01
2545.00	54.28	V	-49.51	10.19	6.40	-45.72	-13.00	-32.72
3392.50	39.11	V	-63.43	12.38	7.33	-58.39	-13.00	-45.39
5942.09	---	V	---	---	---	---	-13.00	---
6790.96	---	V	---	---	---	---	-13.00	---
7639.83	---	V	---	---	---	---	-13.00	---
8488.70	---	V	---	---	---	---	-13.00	---
31.94	45.86	H	-59.44	-6.43	0.70	-66.57	-13.00	-53.57
849.00	79.86	H	-7.16	-7.88	3.75	-18.78	-13.00	-5.78
1682.50	63.58	H	-43.41	9.39	5.11	-39.13	-13.00	-26.13
2545.00	46.73	H	-57.05	10.19	6.40	-53.26	-13.00	-40.26
3392.50	39.19	H	-63.10	12.38	7.33	-58.05	-13.00	-45.05
5942.09	---	H	---	---	---	---	-13.00	---
6790.96	---	H	---	---	---	---	-13.00	---
7639.83	---	H	---	---	---	---	-13.00	---
8488.70	---	H	---	---	---	---	-13.00	---

Remark :

- 1 The emission behaviour belongs to narrowband spurious emission.
- 2 Remark"---" means that the emission level is too low to be measured
- 3 The result basic equation calculation is as follows:
- 4 $ERP/EIRP (dBm) = SG \text{ Setting}(dBm) + Antenna \text{ Gain} (dBd/dBi) - Cable \text{ loss} (dB)$

The results shown in this test report refer only to the sample(s) tested unless otherwise stated. This test report cannot be reproduced, except in full, without prior written permission of the Company.

Radiated Spurious Emission Measurement Result: PCS 1900 Mode

Operation Mode	: TX CH Low E1 Mode	Test Date	Jul.20, 2005
Fundamental Frequency	: 1850.20MHz	Test By:	Henk
Temperature	: 25°C	Pol:	Ver / Hor
Humidity	: 65%	Adaptor Model:	3DS09371AGAA
		Supplier:	Leader

Freq.	SPA Reading	Ant.Pol.	S.G Output	Antenna Gain	Cable Loss	ERP/EIRP	Limit	Safe Margin
(MHz)	(dBuV)	H/V	(dBm)	(dB/dBi)	(dB)	(dBm)	(dBm)	(dBm)
31.94	51.37	V	-52.77	-6.43	0.70	-59.90	-13.00	-46.90
1850.00	80.72	V	-26.24	9.90	5.41	-21.75	-13.00	-8.75
3695.50	47.61	V	-53.99	12.61	7.72	-49.10	-13.00	-36.10
5550.60	---	V	---	---	---	---	-13.00	---
7400.80	---	V	---	---	---	---	-13.00	---
9251.00	---	V	---	---	---	---	-13.00	---
11101.20	---	V	---	---	---	---	-13.00	---
12951.40	---	V	---	---	---	---	-13.00	---
14801.60	---	V	---	---	---	---	-13.00	---
16651.80	---	V	---	---	---	---	-13.00	---
18502.00	---	V	---	---	---	---	-13.00	---
31.94	47.00	H	-58.30	-6.43	0.70	-65.43	-13.00	-52.43
1645.00	58.53	H	-48.48	9.28	5.05	-44.25	-13.00	-31.25
3692.50	47.61	H	-53.78	12.61	7.71	-48.89	-13.00	-35.89
5550.60	---	H	---	---	---	---	-13.00	---
7400.80	---	H	---	---	---	---	-13.00	---
9251.00	---	H	---	---	---	---	-13.00	---
11101.20	---	H	---	---	---	---	-13.00	---
12951.40	---	H	---	---	---	---	-13.00	---
14801.60	---	H	---	---	---	---	-13.00	---
16651.80	---	H	---	---	---	---	-13.00	---
18502.00	---	H	---	---	---	---	-13.00	---

Remark :

- 1 The emission behaviour belongs to narrowband spurious emission.
- 2 Remark"---" means that the emission level is too low to be measured
- 3 The result basic equation calculation is as follows:
- 4 $ERP/EIRP (dBm) = SG \text{ Setting}(dBm) + Antenna \text{ Gain} (dBd/dBi) - Cable \text{ loss} (dB)$

The results shown in this test report refer only to the sample(s) tested unless otherwise stated. This test report cannot be reproduced, except in full, without prior written permission of the Company.

Radiated Spurious Emission Measurement Result : PCS 1900 Mode

Operation Mode : TX CH Mid E1 Mode
 Fundamental Frequency : 1880MHz
 Temperature : 25°C
 Humidity : 65%

Test Date Jul.20, 2005
 Test By Henk
 Pol Ver / Hor
 Adaptor Model: 3DS09371AGAA
 Supplier: Leader

Freq.	SPA. Reading	Ant.Pol.	S.G Output	Antenna Gain	Cable Loss	ERP/EIRP	Limit	Safe Margin
(MHz)	(dBuV)	H/V	(dBm)	(dB/dBi)	(dB)	(dBm)	(dBm)	(dBm)
39.70	44.84	V	-57.05	-2.79	0.78	-60.62	-13.00	-47.62
3692.50	47.61	V	-54.00	12.61	7.71	-49.11	-13.00	-36.11
5640.00	---	V	---	---	---	---	-13.00	---
7520.00	---	V	---	---	---	---	-13.00	---
9400.00	---	V	---	---	---	---	-13.00	---
11280.00	---	V	---	---	---	---	-13.00	---
13160.00	---	V	---	---	---	---	-13.00	---
15040.00	---	V	---	---	---	---	-13.00	---
16920.00	---	V	---	---	---	---	-13.00	---
18800.00	---	V	---	---	---	---	-13.00	---
31.94	47.39	H	-57.91	-6.43	0.70	-65.04	-13.00	-52.04
3692.50	42.49	H	-58.90	12.61	7.71	-54.01	-13.00	-41.01
7520.00	---	H	---	---	---	---	-13.00	---
9400.00	---	H	---	---	---	---	-13.00	---
11280.00	---	H	---	---	---	---	-13.00	---
13160.00	---	H	---	---	---	---	-13.00	---
15040.00	---	H	---	---	---	---	-13.00	---
16920.00	---	H	---	---	---	---	-13.00	---
18800.00	---	H	---	---	---	---	-13.00	---

Remark :

- 1 The emission behaviour belongs to narrowband spurious emission.
- 2 Remark"---" means that the emission level is too low to be measured
- 3 The result basic equation calculation is as follows:
- 4 $ERP/EIRP (dBm) = SG \text{ Setting}(dBm) + Antenna \text{ Gain} (dBd/dBi) - Cable \text{ loss} (dB)$

The results shown in this test report refer only to the sample(s) tested unless otherwise stated. This test report cannot be reproduced, except in full, without prior written permission of the Company.

Radiated Spurious Emission Measurement Result : PCS 1900 Mode

Operation Mode	: TX CH High E1 Mode	Test Date	Jul.20, 2005
Fundamental Frequency	: 1909.8 MHz	Test By	Henk
Temperature	: 25°C	Pol	Ver / Hor
Humidity	: 65%	Adaptor Model:	3DS09371AGAA
		Supplier:	Leader

Freq.	SPA. Reading	Ant.Pol.	S.G Output	Antenna Gain	Cable Loss	ERP/EIRP	Limit	Safe Margin
(MHz)	(dBuV)	H/V	(dBm)	(dB/dBi)	(dB)	(dBm)	(dBm)	(dBm)
30.00	46.95	V	-57.75	-7.34	0.69	-65.78	-13.00	-52.78
1910.00	83.49	V	-23.45	10.08	5.51	-18.88	-13.00	-5.88
3812.50	46.33	V	-54.73	12.60	7.90	-50.03	-13.00	-37.03
5725.00	35.85	V	-58.87	13.49	9.78	-55.15	-13.00	-42.15
7639.20	---	V	---	---	---	---	-13.00	---
9549.00	---	V	---	---	---	---	-13.00	---
11458.80	---	V	---	---	---	---	-13.00	---
13368.60	---	V	---	---	---	---	-13.00	---
15278.40	---	V	---	---	---	---	-13.00	---
17188.20	---	V	---	---	---	---	-13.00	---
19098.00	---	V	---	---	---	---	-13.00	---
31.94	46.63	H	-58.67	-6.43	0.70	-65.80	-13.00	-52.80
1910.00	77.88	H	-28.97	10.08	5.51	-24.41	-13.00	-11.41
3812.50	47.02	H	-53.87	12.60	7.90	-49.17	-13.00	-36.17
7639.20	---	H	---	---	---	---	-13.00	---
9549.00	---	H	---	---	---	---	-13.00	---
11458.80	---	H	---	---	---	---	-13.00	---
13368.60	---	H	---	---	---	---	-13.00	---
15278.40	---	H	---	---	---	---	-13.00	---
17188.20	---	H	---	---	---	---	-13.00	---
19098.00	---	H	---	---	---	---	-13.00	---

Remark :

- 1 The emission behaviour belongs to narrowband spurious emission.
- 2 Remark"---" means that the emission level is too low to be measured
- 3 The result basic equation calculation is as follows:
- 4 $ERP/EIRP (dBm) = SG \text{ Setting}(dBm) + Antenna \text{ Gain} (dBd/dBi) - Cable \text{ loss} (dB)$

The results shown in this test report refer only to the sample(s) tested unless otherwise stated. This test report cannot be reproduced, except in full, without prior written permission of the Company.

10. FREQUENCY STABILITY V.S. TEMPERATURE MEASUREMENT

10.1 Standard Applicable

According to FCC §2.1055(a)(1)(b).

Frequency Tolerance: 2.5 ppm

10.2 Test Set-up:

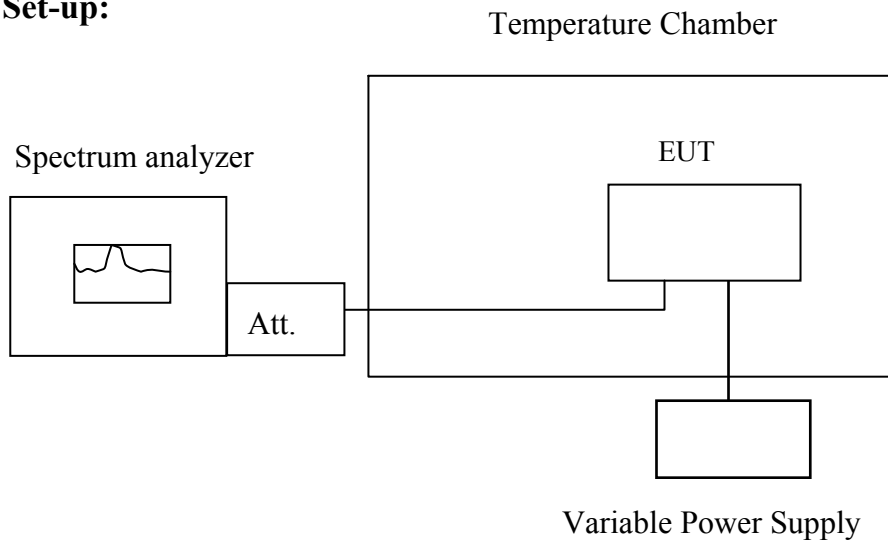

Note : Measurement setup for testing on Antenna connector

10.3 Measurement Procedure

The equipment under test was connected to an external AC or DC power supply and input rated voltage. RF output was connected to a frequency counter or spectrum analyzer via feed through attenuators. The EUT was placed inside the temperature chamber. Set the spectrum analyzer RBW low enough to obtain the desired frequency resolution and measure EUT 25°C operating frequency as reference frequency. Turn EUT off and set the chamber temperature to -30°C. After the temperature stabilized for approximately 30 minutes recorded the frequency. Repeat step measure with 10°C increased per stage until the highest temperature of +50°C reached.

The results shown in this test report refer only to the sample(s) tested unless otherwise stated. This test report cannot be reproduced, except in full, without prior written permission of the Company.

10.4 Measurement Equipment Used:

Conducted Emission Test Site					
EQUIPMENT TYPE	MFR	MODEL NUMBER	SERIAL NUMBER	LAST CAL.	CAL DUE.
Spectrum Analyzer	Agilent	E4446A	MY43360126	03/29/2005	03/28/2006
Spectrum Analyzer	Agilent	7405A	US41160416	06/28/2005	06/29/2006
Spectrum Analyzer	R&S	FSP 40	100034	11/09/2004	11/10/2005
Power Sensor	Anritsu	MA2490A	31431	06/28/2005	06/29/2006
Power Meter	Anritsu	ML2487A	6K00002070	06/28/2005	06/29/2006
Temperature Chamber	TERCHY	MHG-120LF	911009	11/11/2004	11/12/2005
Low Loss Cable	HUBER+SUHNER	SUCOFLEX 104PEA	N/A	N/A	N/A
Attenuator	Mini-Circuit	BW-S10W5	N/A	10/07/2004	10/06/2005
Attenuator	Mini-Circuit	BW-S6W5	N/A	10/07/2004	10/06/2005
Splitter	Mini-Circuit	ZFSC-2-10G	N/A	10/07/2004	10/06/2005
Signal Generator	R&S	SMR40	100210	11/09/2004	11/10/2005
Diode Detector	Agilent	8471E	MY4224	N/A	N/A
AC Power Supply	APW-105N	887592	All Power	N/A	N/A

The results shown in this test report refer only to the sample(s) tested unless otherwise stated. This test report cannot be reproduced, except in full, without prior written permission of the Company.

10.5 Measurement Result

Reference Frequency: GSM Mid Channel 836.6 MHz @ 25°C				
Limit: +/- 2.5 ppm = 2091 Hz				
Power Supply	Environment	Frequency	Delta (Hz)	Limit (Hz)
Vdc	Temperature (°C)	(MHz)		
3.7	-30	836.59946	110.00	2091
3.7	-20	836.59973	-160.00	2091
3.7	-10	836.59950	70.00	2091
3.7	0	836.59965	-80.00	2091
3.7	10	836.59958	-10.00	2091
3.7	20	836.59957	0.00	2091
3.7	30	836.59983	-260.00	2091
3.7	40	836.59978	-210.00	2091
3.7	50	836.59981	-240.00	2091

Reference Frequency: PCS Mid Channel 1880 MHz @ 25°C				
Limit: +/- 2.5 ppm = 4700 Hz				
Power Supply	Environment	Frequency	Delta (Hz)	Limit (Hz)
Vdc	Temperature (°C)	(MHz)		
3.7	-30	1879.99854	-170.00	4700
3.7	-20	1879.99847	-100.00	4700
3.7	-10	1879.99863	-260.00	4700
3.7	0	1879.99856	-190.00	4700
3.7	10	1879.99830	70.00	4700
3.7	20	1879.99837	0.00	4700
3.7	30	1879.99820	170.00	4700
3.7	40	1879.99842	-50.00	4700
3.7	50	1879.99793	440.00	4700

Note: The battery is rated 3.7V dc.

The results shown in this test report refer only to the sample(s) tested unless otherwise stated. This test report cannot be reproduced, except in full, without prior written permission of the Company.

11. FREQUENCY STABILITY V.S. VOLTAGE MEASUREMENT

11.1 Standard Applicable

According to FCC §2.1055(d)(1)(2)

Frequency Tolerance: 2.5 ppm

11.2 Test Set-up:

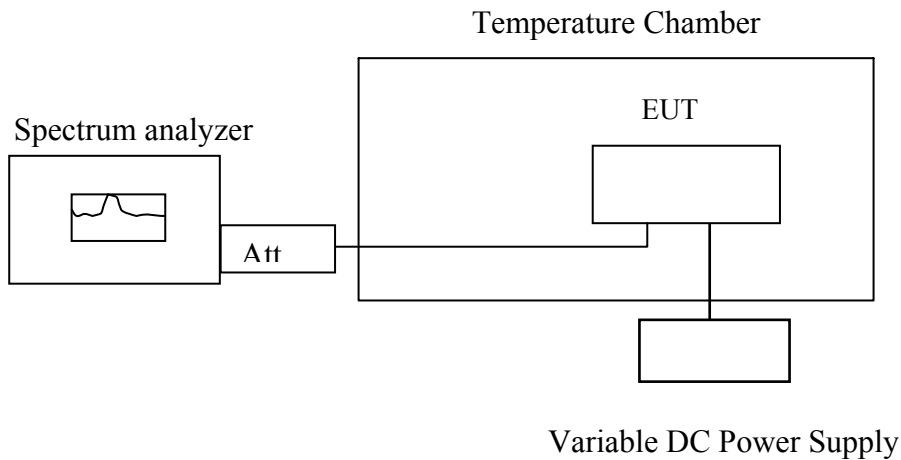

Note: Measurement setup for testing on Antenna connector

11.3 Measurement Procedure

Set chamber temperature to 25°C. Use a variable AC power supply / DC power source to power the EUT and set the voltage to rated voltage. Set the spectrum analyzer RBW low enough to obtain the desired frequency resolution and recorded the frequency.

Reduce the input voltage to specified extreme voltage variation (+/- 15%) and endpoint, record the maximum frequency change.

11.4 Measurement Equipment Used:

Conducted Emission Test Site					
EQUIPMENT TYPE	MFR	MODEL NUMBER	SERIAL NUMBER	LAST CAL.	CAL DUE.
Spectrum Analyzer	Agilent	E4446A	MY43360126	03/29/2005	03/28/2006
Spectrum Analyzer	Agilent	7405A	US41160416	06/28/2005	06/29/2006
Spectrum Analyzer	R&S	FSP 40	100034	11/09/2004	11/10/2005

The results shown in this test report refer only to the sample(s) tested unless otherwise stated. This test report cannot be reproduced, except in full, without prior written permission of the Company.

Power Sensor	Anritsu	MA2490A	31431	06/28/2005	06/29/2006
Power Meter	Anritsu	ML2487A	6K00002070	06/28/2005	06/29/2006
Temperature Chamber	TERCHY	MHG-120LF	911009	11/11/2004	11/12/2005
Low Loss Cable	HUBER+SUHNE R	SUCOFLEX 104PEA	N/A	N/A	N/A
Attenuator	Mini-Circuit	BW-S10W5	N/A	10/07/2004	10/06/2005
Attenuator	Mini-Circuit	BW-S6W5	N/A	10/07/2004	10/06/2005
Splitter	Mini-Circuit	ZFSC-2-10G	N/A	10/07/2004	10/06/2005
Signal Generator	R&S	SMR40	100210	11/09/2004	11/10/2005
Diode Detector	Agilent	8471E	MY4224	N/A	N/A
AC Power Supply	APW-105N	887592	All Power	N/A	N/A

The results shown in this test report refer only to the sample(s) tested unless otherwise stated. This test report cannot be reproduced, except in full, without prior written permission of the Company.

11.5 Measurement Result

Reference Frequency: GSM Mid Channel 836.6 MHz @ 25°C				
Limit: +/- 2.5 ppm = 2091 Hz				
Power Supply	Environment	Frequency	Delta (Hz)	Limit (Hz)
Vdc	Temperature (°C)	(MHz)		
3.70	25.00	836.5998	0.00	2091.00
3.15	25.00	836.59946	340.00	2091.00
4.26	25.00	836.59973	70.00	2091.00
2.9 (End Point)	25.00	836.59950	300.00	2091.00

Reference Frequency: PCS Mid Channel 1880 MHz @ 25°C				
Limit: +/- 2.5 ppm = 4700 Hz				
Power Supply	Environment	Frequency	Delta (Hz)	Limit (Hz)
Vdc	Temperature (°C)	(MHz)		
3.7	25	1879.99837	0.00	4700
3.145	25	1879.99854	-170.00	4700
4.255	25	1879.99847	-100.00	4700
2.9 (Endpoint)	25	1879.99863	-260.00	4700

Note: The battery is rated 3.7V dc.

The results shown in this test report refer only to the sample(s) tested unless otherwise stated. This test report cannot be reproduced, except in full, without prior written permission of the Company.

12. AC POWER LINE CONDUCTED EMISSION TEST

12.1 Standard Applicable

According to §15.207. The emission value for frequency within 150KHz to 30MHz shall not exceed criteria of below chart.

Frequency range MHz	Limits dB(uV)	
	Quasi-peak	Average
0.15 to 0.50	66 to 56	56 to 46
0.50 to 5	56	46
5 to 30	60	50

Note

- 1.The lower limit shall apply at the transition frequencies
- 2.The limit decreases linearly with the logarithm of the frequency in the range 0.15 MHz to 0.50 MHz.

12.2 EUT Setup

1. The conducted emission tests were performed in the test site, using the setup in accordance with the ANSI C63.4-2001.
2. The EUT was plug-in DC power adaptor and was placed on the center of the back edge on the test table. The peripherals like earphone was placed on the side of the EUT. The rear of the EUT and peripherals were placed flushed with the rear of the tabletop.
3. The Power adaptor was connected with 110Vac/60Hz power source.

12.3 Measurement Procedure

1. The EUT was placed on a table which is 0.8m above ground plane.
2. Maximum procedure was performed on the six highest emissions to ensure EUT compliance.
3. Repeat above procedures until all frequency measured were complete.

The results shown in this test report refer only to the sample(s) tested unless otherwise stated. This test report cannot be reproduced, except in full, without prior written permission of the Company.

12.4 Measurement Equipment Used:

Conducted Emission Test Site					
EQUIPMENT TYPE	MFR	MODEL NUMBER	SERIAL NUMBER	LAST CAL.	CAL DUE.
EMC Analyzer	HP	8594EM	3624A00203	09/02/2004	09/03/2005
EMI Test Receiver	R&S	ESCS30	828985/004	06/09/2005	06/10/2006
Transient Limiter	HP	11947A	3107A02062	09/02/2005	09/03/2006
LISN	Rolf-Heine	NNB-2/16Z	99012	12/31/2004	12/30/2005
LISN	Rolf-Heine	NNB-2/16Z	99013	12/24/2004	12/23/2005
Coaxial Cables	N/A	No. 3, 4	N/A	12/24/2004	12/23/2005

12.5 Measurement Result

The initial step in collecting conducted data is a spectrum analyzer peak scan of the measurement range. Significant peaks are then marked as shown on the following data page, and these signals are then quasi-peaked.

The results shown in this test report refer only to the sample(s) tested unless otherwise stated. This test report cannot be reproduced, except in full, without prior written permission of the Company.

AC POWER LINE CONDUCTED EMISSION TEST DATA

Operation Mode	: Normal Operating(GSM 850)	Test Date	May 26, 2005
Fundamental Frequency	: N/A	Test By	Willis
Temperature	: 25°C	Pol	Line/Neutral
Humidity	: 65%	Adaptor Model	3DS09371AGAA
Test Voltage	: 110Vac	Supplier:	Leader

FREQ MHz	Q.P. Raw dBuV	AVG Raw dBuV	Q.P. Limit dBuV	AVG Limit dBuV	Q.P. Margin dB	AVG Margin dB	NOTE
0.33	49.59	43.11	59.45	49.45	-9.86	-6.34	L1
0.37	48.74	43.70	58.50	48.50	-9.76	-4.80	L1
0.41	50.65	46.06	57.65	47.65	-7.00	-1.59	L1
0.60	45.01	36.21	56.00	46.00	-10.99	-9.79	L1
3.72	46.42	43.23	56.00	46.00	-9.58	-2.77	L1
5.87	48.99	42.38	60.00	50.00	-11.01	-7.62	L1
0.16	54.77	50.32	65.46	55.46	-10.69	-5.14	L2
0.29	48.04	---	60.52	50.52	-12.48	---	L2
0.33	47.97	42.19	59.45	49.45	-11.48	-7.26	L2
0.42	52.89	43.76	57.45	47.45	-4.56	-3.69	L2
3.22	46.31	42.28	56.00	46.00	-9.69	-3.72	L2
5.87	49.09	42.87	60.00	50.00	-10.91	-7.13	L2

Remark :

- (1) Measuring frequencies from 0.15 MHz to 30MHz °
- (2) The emissions measured in frequency range from 0.15 MHz to 30MHz were made with an instrument using Qusia-Peak detector and Average detector.
- (3) “---” denotes the emission level was or more than 2dB below the Average limit, so no re-check anymore.
- (4) The IF bandwidth of SPA between 0.15MHz to 30MHz was 10KHz;
The IF bandwidth of Test Receiver between 0.15MHz to 30MHz was 9KHz;
- (5) L1 = Line One (Hot side) / L2 = Line Two (Neutral side)

The results shown in this test report refer only to the sample(s) tested unless otherwise stated. This test report cannot be reproduced, except in full, without prior written permission of the Company.

Conducted Emission Test Plot (3DS 09371AGAA supplier: Leader)

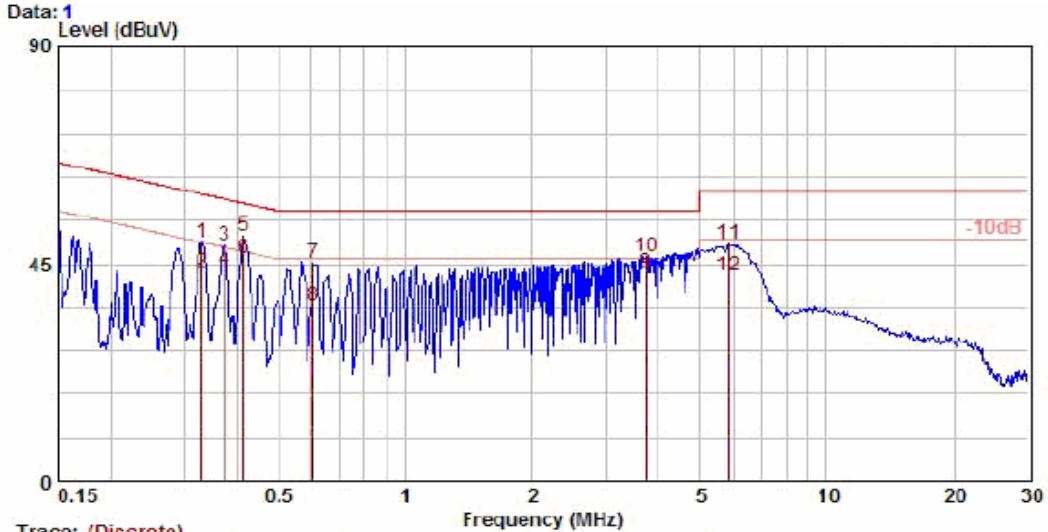

Condition : FCC 15.207-COND-QP NNB-2/16Z (99012) LINE
 Applicant: :Alcatel
 Project No.: :ER/2005/50012
 EUT Description::GSM 850/1900 mobile phone
 EUT Model: : OT-E252a
 Test Mode: :Operation GSM850
 Temp./Humid. :25/65
 Operator: :willis

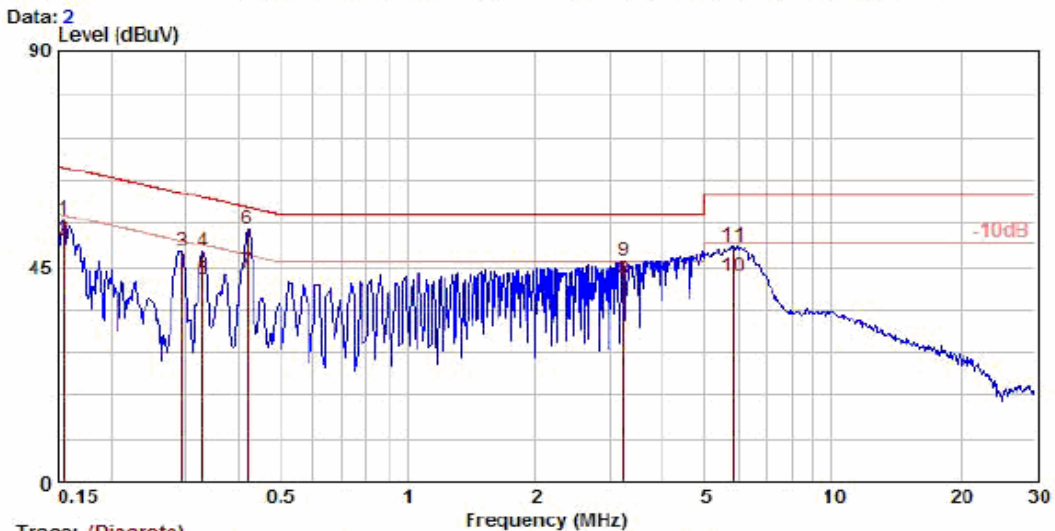

Condition : FCC 15.207-COND-QP NNB-2/16Z (99012) NEUTRAL
 Applicant: :Alcatel
 Project No.: :ER/2005/50012
 EUT Description::GSM 850/1900 mobile phone
 EUT Model: : OT-E252a
 Test Mode: :Operation GSM850
 Temp./Humid. :25/65
 Operator: :willis

The results shown in this test report refer only to the sample(s) tested unless otherwise stated. This test report cannot be reproduced, except in full, without prior written permission of the Company.

AC POWER LINE CONDUCTED EMISSION TEST DATA

Operation Mode	: Normal Operating(GSM 1900)	Test Date	May 26, 2005
Fundamental Frequency	: N/A	Test By	Willis
Temperature	: 25°C	Pol	Line/Neutral
Humidity	: 65%	Adaptor Model	3DS09371AGAA
Test Voltage	: 110Vac	Supplier:	Leader

FREQ MHz	Q.P. Raw dBuV	AVG Raw dBuV	Q.P. Limit dBuV	AVG Limit dBuV	Q.P. Margin dB	AVG Margin dB	NOTE
0.29	47.73	42.10	60.52	50.52	-12.79	-8.42	L1
0.33	45.93	40.35	59.45	49.45	-13.52	-9.10	L1
0.42	47.56	41.42	57.45	47.45	-9.89	-6.03	L1
2.07	45.29	39.30	56.00	46.00	-10.71	-6.70	L1
3.22	46.47	41.57	56.00	46.00	-9.53	-4.43	L1
5.99	48.95	44.14	60.00	50.00	-11.05	-5.86	L1
0.29	48.74	46.14	60.52	50.52	-11.78	-4.38	L2
0.33	50.15	38.68	59.45	49.45	-9.30	-10.77	L2
0.37	48.74	41.64	58.50	48.50	-9.76	-6.86	L2
0.41	51.34	38.58	57.65	47.65	-6.31	-9.07	L2
0.60	45.24	40.12	56.00	46.00	-10.76	-5.88	L2
3.22	45.40	41.40	56.00	46.00	-10.60	-4.60	L2

Remark :

- (1) Measuring frequencies from 0.15 MHz to 30MHz ◦
- (2) The emissions measured in frequency range from 0.15 MHz to 30MHz were made with an instrument using Qusia-Peak detector and Average detector.
- (3) “---” denotes the emission level was or more than 2dB below the Average limit, so no re-check anymore.
- (4) The IF bandwidth of SPA between 0.15MHz to 30MHz was 10KHz;
The IF bandwidth of Test Receiver between 0.15MHz to 30MHz was 9KHz;
- (5) L1 = Line One (Hot side) / L2 = Line Two (Neutral side)

The results shown in this test report refer only to the sample(s) tested unless otherwise stated. This test report cannot be reproduced, except in full, without prior written permission of the Company.

Conducted Emission Test Plot (3DS09371AGAA supplier: Leader)

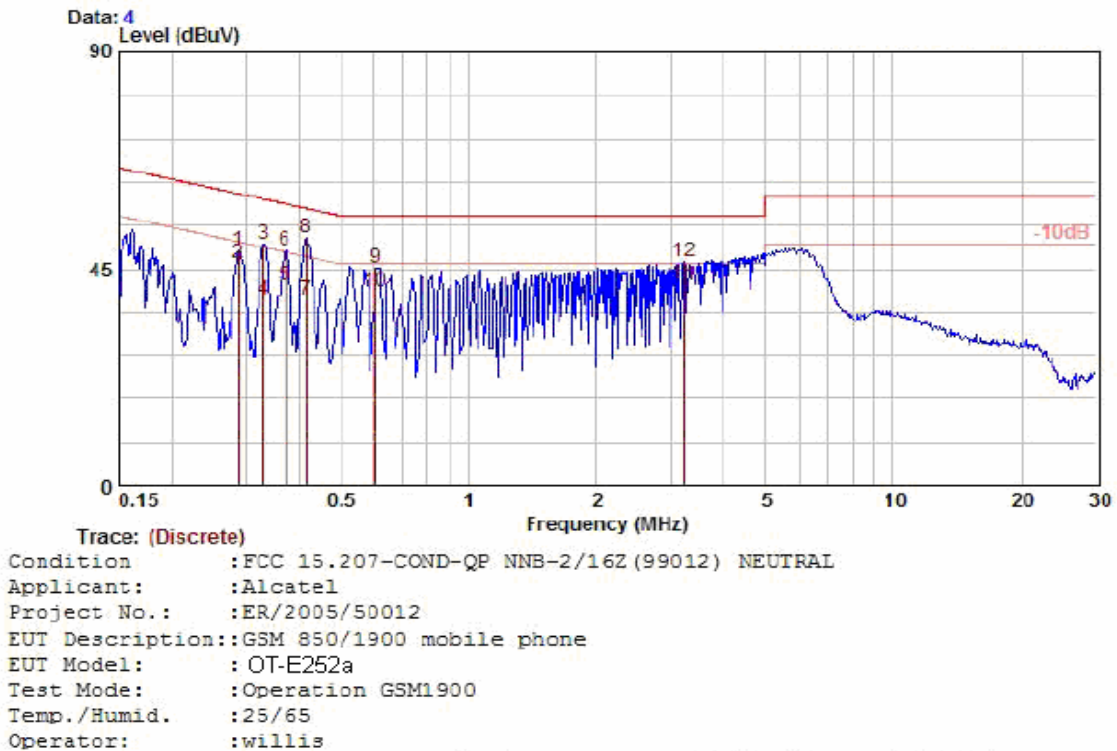
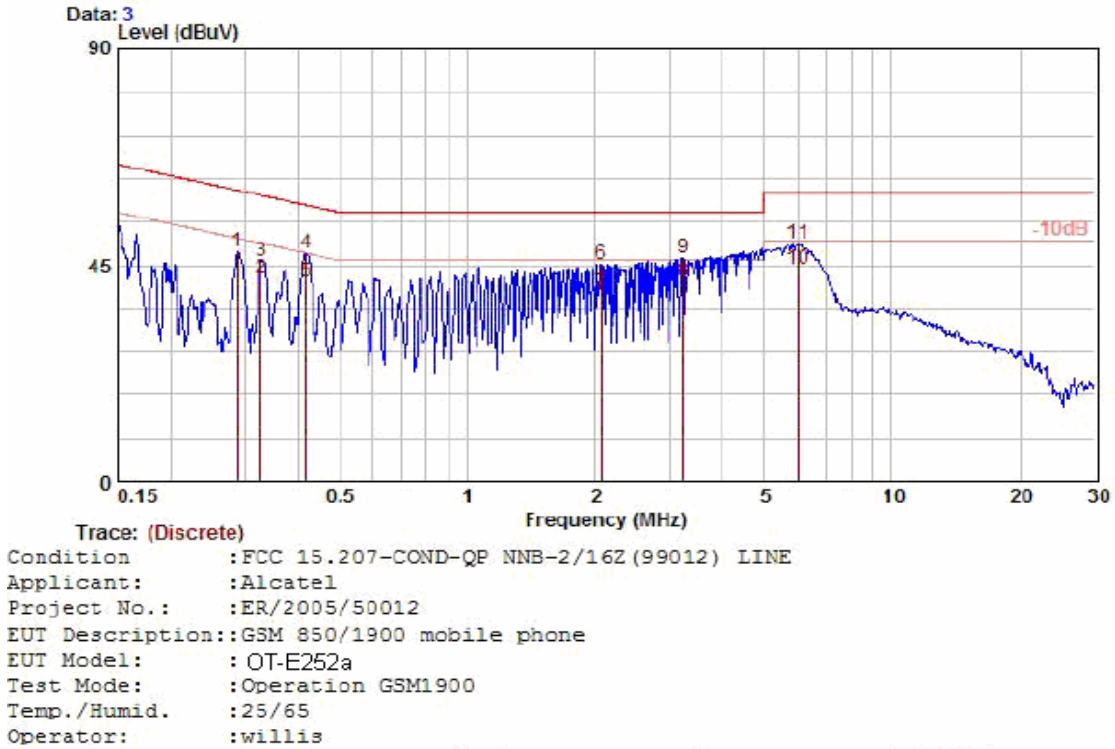

The results shown in this test report refer only to the sample(s) tested unless otherwise stated. This test report cannot be reproduced, except in full, without prior written permission of the Company.

AC POWER LINE CONDUCTED EMISSION TEST DATA

Operation Mode	: Normal Operating	Test Date	Jul 20, 2005
Fundamental Frequency	: N/A	Test By	Henk
Temperature	: 25°C	Pol	Line/Neutral
Humidity	: 65%	Adaptor Model	3DS09371AGAA
Test Voltage	: 110Vac	Supplier:	Astec

FREQ MHz	Q.P. Raw dBuV	AVG Raw dBuV	Q.P. Limit dBuV	AVG Limit dBuV	Q.P. Margin dB	AVG Margin dB	NOTE
0.33	43.70	---	59.46	49.46	-15.76	---	L1
0.41	46.00	42.00	57.61	47.61	-11.61	-5.61	L1
0.62	39.10	---	56.00	46.00	-16.90	---	L1
2.52	39.00	---	56.00	46.00	-17.00	---	L1
3.01	41.20	---	56.00	46.00	-14.80	---	L1
6.20	42.20	---	60.00	50.00	-17.80	---	L1
0.29	40.70	---	60.62	50.62	-19.92	---	L2
2.30	40.10	---	56.00	46.00	-15.90	---	L2
2.95	40.60	---	56.00	46.00	-15.40	---	L2
3.49	41.00	---	56.00	46.00	-15.00	---	L2
4.93	41.90	---	56.00	46.00	-14.10	---	L2
5.99	43.80	---	60.00	50.00	-16.20	---	L2

Remark :

- (1) Measuring frequencies from 0.15 MHz to 30MHz °
- (2) The emissions measured in frequency range from 0.15 MHz to 30MHz were made with an instrument using Qusia-Peak detector and Average detector.
- (3) “---” denotes the emission level was or more than 2dB below the Average limit, so no re-check anymore.
- (4) The IF bandwidth of SPA between 0.15MHz to 30MHz was 10KHz;
 The IF bandwidth of Test Receiver between 0.15MHz to 30MHz was 9KHz;
- (5) L1 = Line One (Hot side) / L2 = Line Two (Neutral side)

The results shown in this test report refer only to the sample(s) tested unless otherwise stated. This test report cannot be reproduced, except in full, without prior written permission of the Company.

Conducted Emission Test Plot (3DS09371AGAA supplier: Astec)

Conducted Emission Measurement

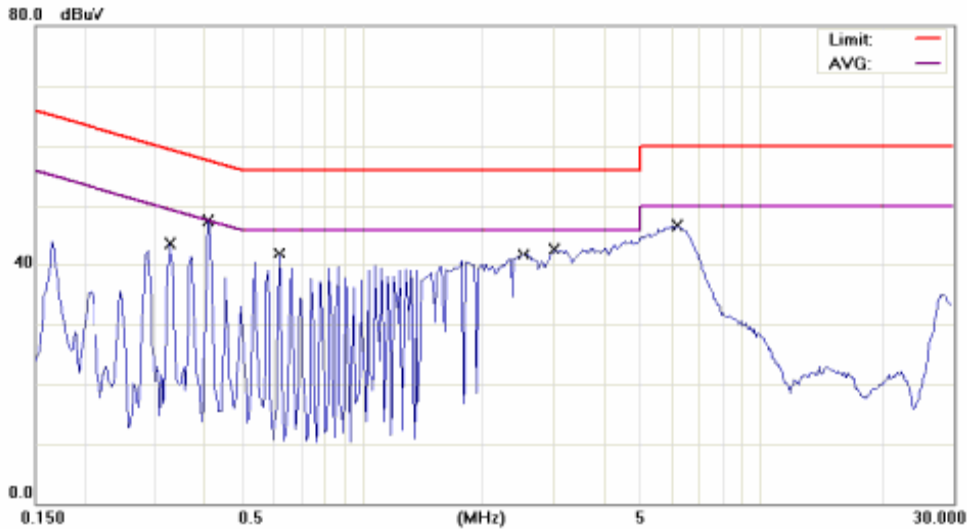

Site SGS CONDUCTED #1	Phase: L1	Temperature: 24 °C
Limit: CISPR22 Class B Conduction(QP)	Power: AC 110V/60Hz	Humidity: 61 %
EUT: Mobile phone	Distance:	Air Pressure: hpa
M/N: OT-252a		
Note: 3DS09371AG AA (CHARGE & LINK)		

Conducted Emission Measurement

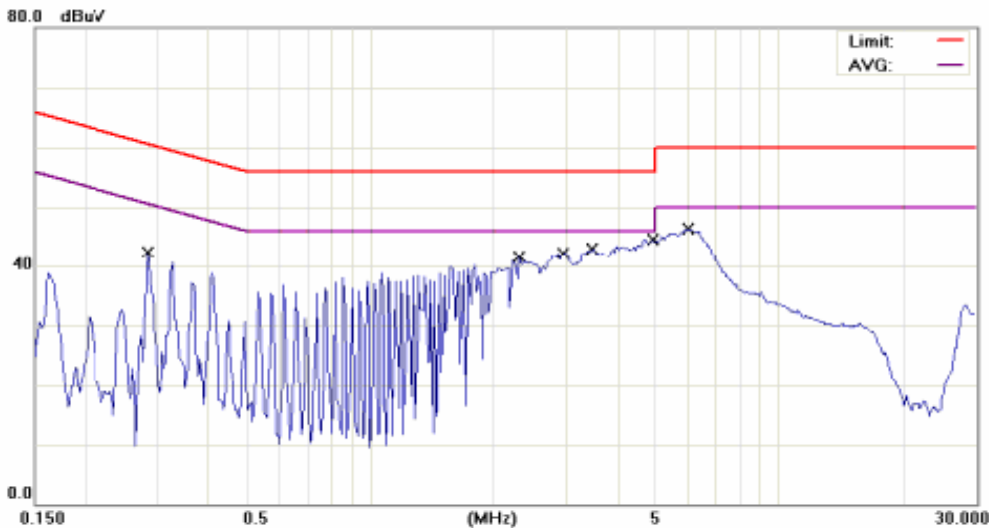

Site SGS CONDUCTED #1	Phase: N	Temperature: 24 °C
Limit: CISPR22 Class B Conduction(QP)	Power: AC 110V/60Hz	Humidity: 61 %
EUT: Mobile phone	Distance:	Air Pressure: hpa
M/N: OT-252a		
Note: 3DS09371AG AA (CHARGE & LINK)		

The results shown in this test report refer only to the sample(s) tested unless otherwise stated. This test report cannot be reproduced, except in full, without prior written permission of the Company.

AC POWER LINE CONDUCTED EMISSION TEST DATA

Operation Mode : Normal Operating
 Fundamental Frequency : N/A
 Temperature : 25°C
 Humidity : 65%
 Test Voltage : 230Vac

Test Date Jul 20, 2005
 Test By Henk
 Pol Line/Neutral
 Adaptor Model 3DS09371AAAA
 Supplier: Astec

FREQ MHz	Q.P. Raw dBuV	AVG Raw dBuV	Q.P. Limit dBuV	AVG Limit dBuV	Q.P. Margin dB	AVG Margin dB	NOTE
0.24	49.20	---	62.10	52.10	-12.90	---	L1
0.29	48.20	---	60.62	50.62	-12.42	---	L1
0.44	48.90	33.70	57.15	47.15	-8.25	-13.45	L1
0.58	48.90	32.30	56.00	46.00	-7.10	-13.70	L1
0.73	49.30	31.60	56.00	46.00	-6.70	-14.40	L1
0.99	53.20	41.20	56.00	46.00	-2.80	-4.80	L1
0.38	49.60	32.10	58.18	48.18	-8.58	-16.08	L2
0.45	49.80	37.80	56.93	46.93	-7.13	-9.13	L2
0.52	42.30	---	56.00	46.00	-13.70	---	L2
0.60	35.60	---	56.00	46.00	-20.40	---	L2
0.74	48.80	31.20	56.00	46.00	-7.20	-14.80	L2
0.94	54.20	37.20	56.00	46.00	-1.80	-8.80	L2

Remark :

- (1) Measuring frequencies from 0.15 MHz to 30MHz °
- (2) The emissions measured in frequency range from 0.15 MHz to 30MHz were made with an instrument using Qusia-Peak detector and Average detector.
- (3) “---” denotes the emission level was or more than 2dB below the Average limit, so no re-check anymore.
- (4) The IF bandwidth of SPA between 0.15MHz to 30MHz was 10KHz;
 The IF bandwidth of Test Receiver between 0.15MHz to 30MHz was 9KHz;
- (5) L1 = Line One (Hot side) / L2 = Line Two (Neutral side)

The results shown in this test report refer only to the sample(s) tested unless otherwise stated. This test report cannot be reproduced, except in full, without prior written permission of the Company.

Conducted Emission Test Plot (3DS09371AAAA Supplier: Astec)

Conducted Emission Measurement

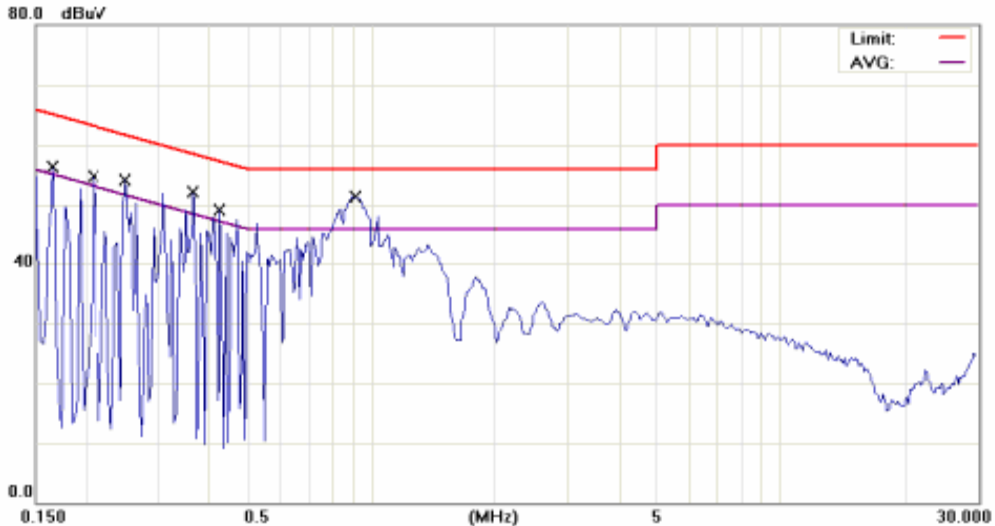

Site SGS CONDUCTED #1	Phase: L1	Temperature: 24 °C
Limit: CISPR22 Class B Conduction(QP)	Power: AC 230V/50Hz	Humidity: 61 %
EUT: Mobile phone	Distance:	Air Pressure: hpa
M/N: OT-252a		
Note: 3DS09371AAAA	(CHARGE & LINK)	

Conducted Emission Measurement

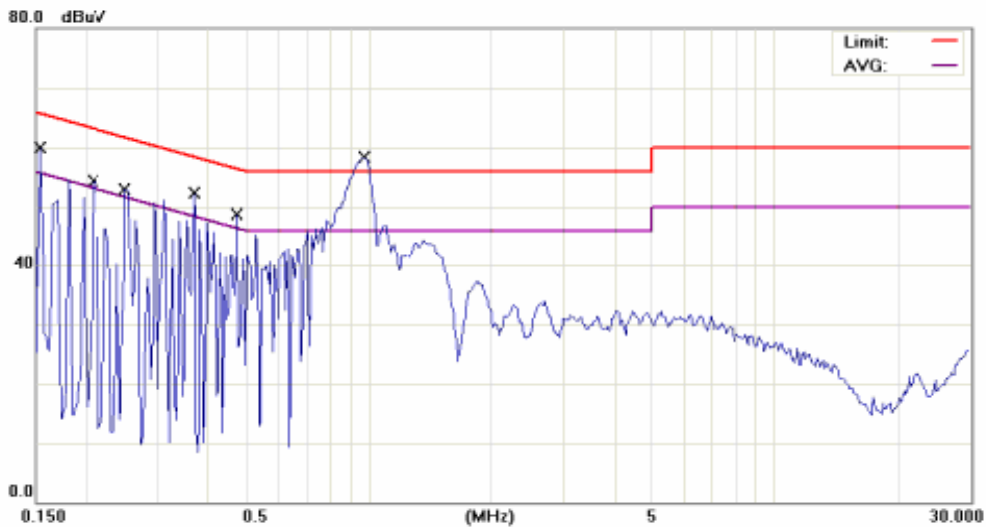

Site SGS CONDUCTED #1	Phase: N	Temperature: 24 °C
Limit: CISPR22 Class B Conduction(QP)	Power: AC 230V/50Hz	Humidity: 61 %
EUT: Mobile phone	Distance:	Air Pressure: hpa
M/N: OT-252a		
Note: 3DS09371AAAA	(CHARGE & LINK)	

The results shown in this test report refer only to the sample(s) tested unless otherwise stated. This test report cannot be reproduced, except in full, without prior written permission of the Company.

AC POWER LINE CONDUCTED EMISSION TEST DATA

Operation Mode	: Normal Operating	Test Date	Jul 20, 2005
Fundamental Frequency	: N/A	Test By	Henk
Temperature	: 25°C	Pol	Line/Neutral
Humidity	: 65%	Adaptor Model	3DS09371AAAA
Test Voltage	: 230Vac	Supplier:	Leader

FREQ MHz	Q.P. Raw dBuV	AVG Raw dBuV	Q.P. Limit dBuV	AVG Limit dBuV	Q.P. Margin dB	AVG Margin dB	NOTE
0.16	46.80	40.15	65.58	55.58	-18.78	-15.43	L1
0.20	41.70	45.70	63.58	53.58	-21.88	-7.88	L1
0.37	45.50	---	58.44	48.44	-12.94	---	L1
0.62	41.30	---	56.00	46.00	-14.70	---	L1
2.94	44.40	42.70	56.00	46.00	-11.60	-3.30	L1
4.77	44.10	40.30	56.00	46.00	-11.90	-5.70	L1
0.15	48.10	---	65.79	55.79	-17.69	---	L2
0.18	46.30	---	64.43	54.43	-18.13	---	L2
0.36	43.60	---	58.62	48.62	-15.02	---	L2
2.79	43.70	---	56.00	46.00	-12.30	---	L2
3.74	42.90	---	56.00	46.00	-13.10	---	L2
4.15	43.70	---	56.00	46.00	-12.30	---	L2

Remark :

- (1) Measuring frequencies from 0.15 MHz to 30MHz ◦
- (2) The emissions measured in frequency range from 0.15 MHz to 30MHz were made with an instrument using Qusia-Peak detector and Average detector.
- (3) “---” denotes the emission level was or more than 2dB below the Average limit, so no re-check anymore.
- (4) The IF bandwidth of SPA between 0.15MHz to 30MHz was 10KHz;
The IF bandwidth of Test Receiver between 0.15MHz to 30MHz was 9KHz;
- (5) L1 = Line One (Hot side) / L2 = Line Two (Neutral side)

The results shown in this test report refer only to the sample(s) tested unless otherwise stated. This test report cannot be reproduced, except in full, without prior written permission of the Company.

Conducted Emission Test Plot (3DS09371AAAA Supplier : Leader)

Conducted Emission Measurement

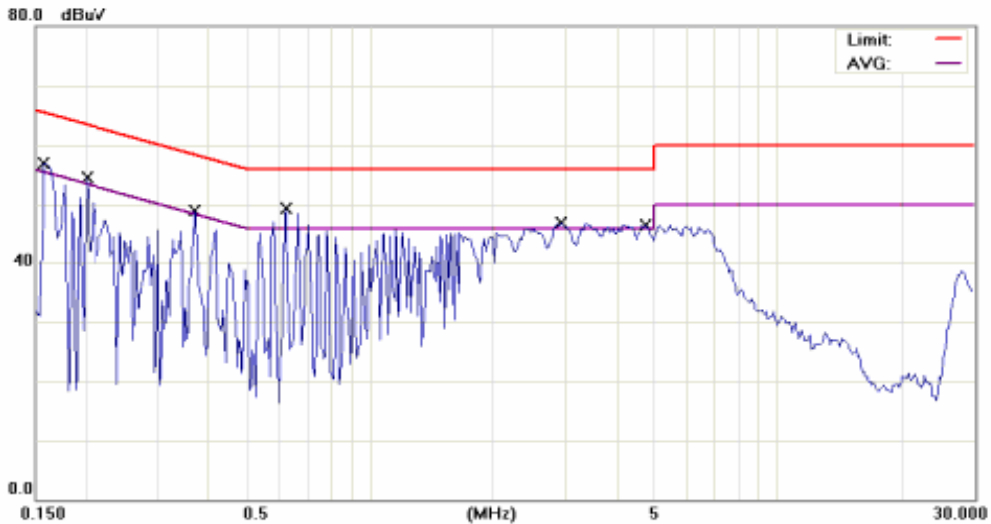

Site SGS CONDUCTED #1	Phase: L1	Temperature: 24 °C
Limit: CISPR22 Class B Conduction(QP)	Power: AC 230V/50Hz	Humidity: 61 %
EUT: Mobile phone	Distance:	Air Pressure: hpa
M/N: OT-252a		
Note: 3DS09371 AAAA	(CHARGE & LINK)	

Conducted Emission Measurement

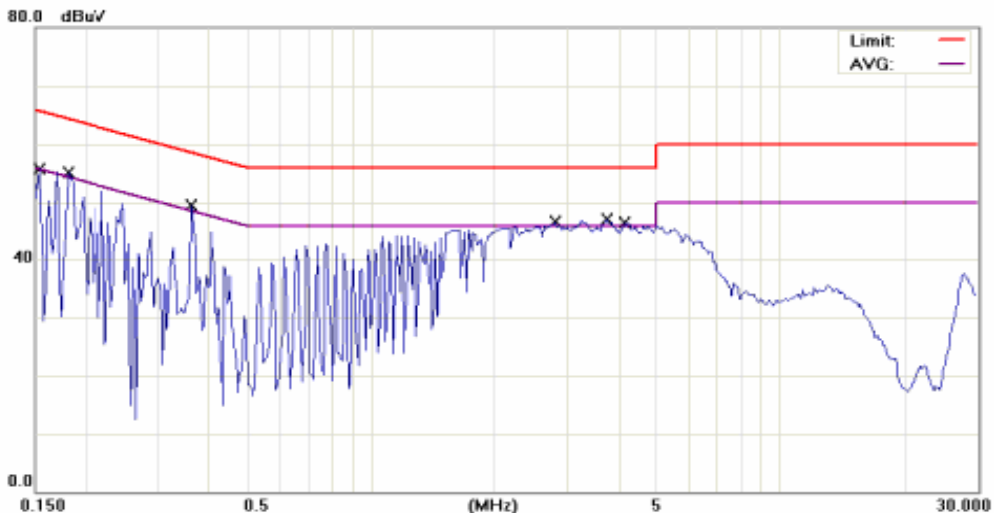

Site SGS CONDUCTED #1	Phase: N	Temperature: 24 °C
Limit: CISPR22 Class B Conduction(QP)	Power: AC 230V/50Hz	Humidity: 61 %
EUT: Mobile phone	Distance:	Air Pressure: hpa
M/N: OT-252a		
Note: 3DS09371 AAAA	(CHARGE & LINK)	

The results shown in this test report refer only to the sample(s) tested unless otherwise stated. This test report cannot be reproduced, except in full, without prior written permission of the Company.

APPENDIX 1

PHOTOGRPHS OF SET UP

The results shown in this test report refer only to the sample(s) tested unless otherwise stated. This test report cannot be reproduced, except in full, without prior written permission of the Company.

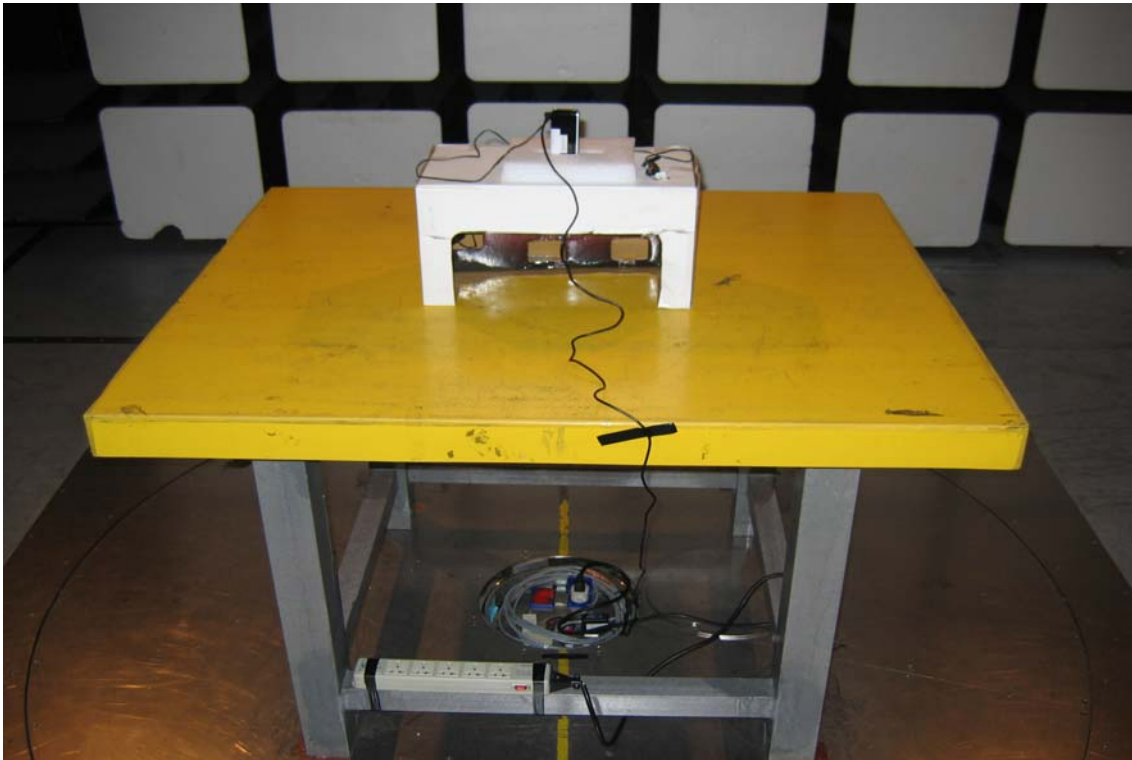
Radiated Emission Set up Photos

The results shown in this test report refer only to the sample(s) tested unless otherwise stated. This test report cannot be reproduced, except in full, without prior written permission of the Company.

Conducted Emission Set Up Photos

The results shown in this test report refer only to the sample(s) tested unless otherwise stated. This test report cannot be reproduced, except in full, without prior written permission of the Company.

APPENDIX 2

PHOTOGRPHS OF EUT

The results shown in this test report refer only to the sample(s) tested unless otherwise stated. This test report cannot be reproduced, except in full, without prior written permission of the Company.

All of EUT



Front View of EUT



The results shown in this test report refer only to the sample(s) tested unless otherwise stated. This test report cannot be reproduced, except in full, without prior written permission of the Company.

Back View of EUT*Left View of EUT*

The results shown in this test report refer only to the sample(s) tested unless otherwise stated. This test report cannot be reproduced, except in full, without prior written permission of the Company.

Top View of EUT*Bottom View of EUT*

The results shown in this test report refer only to the sample(s) tested unless otherwise stated. This test report cannot be reproduced, except in full, without prior written permission of the Company.

Battery



Adaptor-3DS09371AGAA Supplier: Leader Electronics



The results shown in this test report refer only to the sample(s) tested unless otherwise stated. This test report cannot be reproduced, except in full, without prior written permission of the Company.

Adaptor-3DS09371AGAA Supplier: Astec



Adaptor-3DS09371AAAA Supplier: Astec



The results shown in this test report refer only to the sample(s) tested unless otherwise stated. This test report cannot be reproduced, except in full, without prior written permission of the Company.

Adaptor-3DS09371AAAA Supplier: Leader Electronics



Adaptor-3DS07848AAAA Supplier :Primax



The results shown in this test report refer only to the sample(s) tested unless otherwise stated. This test report cannot be reproduced, except in full, without prior written permission of the Company.

Open View of EUT



Internal of EUT --- 1



The results shown in this test report refer only to the sample(s) tested unless otherwise stated. This test report cannot be reproduced, except in full, without prior written permission of the Company.

Internal of EUT --- 2

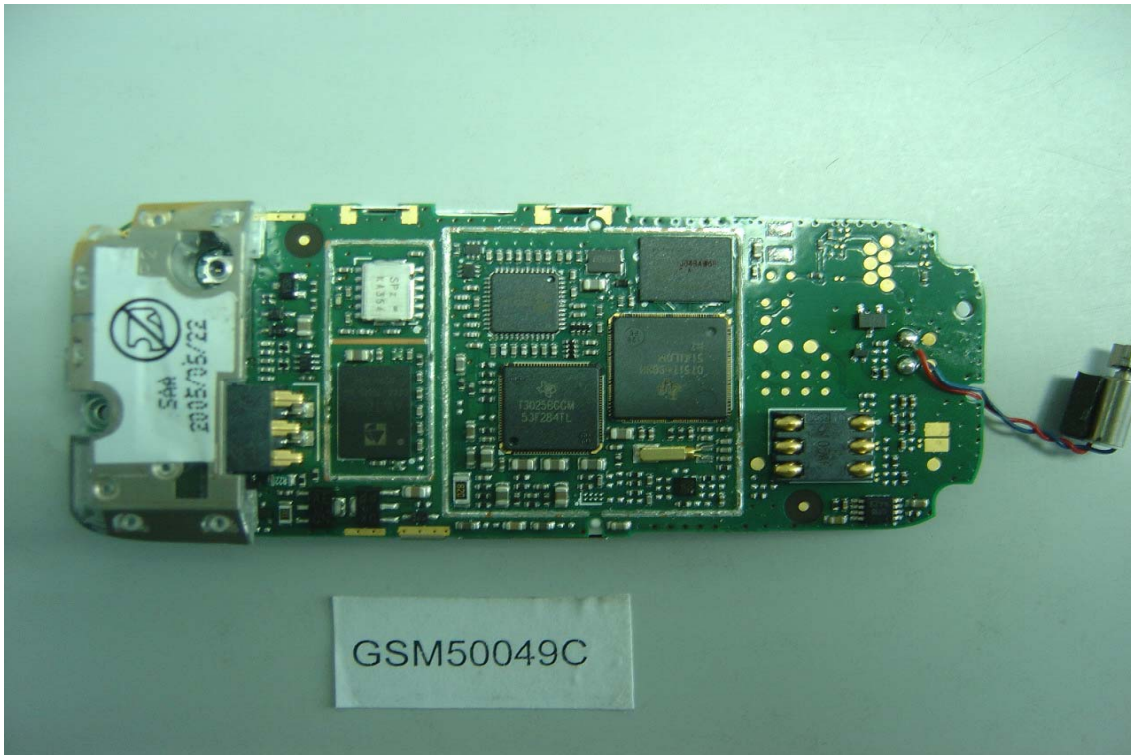

The results shown in this test report refer only to the sample(s) tested unless otherwise stated. This test report cannot be reproduced, except in full, without prior written permission of the Company.