

SAR TEST REPORT

Equipment Under Test :	GSM 850&PCS1900MHz MOBILE PHONE
FCC ID :	RAD017
Model No. :	VLE5
Market Name :	OT-E158a
Applicant :	TCL&Alcatel Mobile Phones
Address of Applicant :	30/F, Times Square, 500 Zhangyang RD. Shanghai 200122, P.R.China
Date of Receipt :	2005.06.27
Date of Test :	2005.07.06 – 2005.07.14
Date of Issue :	2005.07.19

Standards:

FCC OET Bulletin 65 supplement C, ANSI/IEEE C95.1, C95.3, IEEE 1528-2002

In the configuration tested, the EUT complied with the standards specified above.

Remarks:

This report details the results of the testing carried out on one sample, the results contained in this test report do not relate to other samples of the same product. The manufacturer should ensure that all products in series production are in conformity with the product sample detailed in this report.

This report may only be reproduced and distributed in full. If the product in this report is used in any configuration other than that detailed in the report, the manufacturer must ensure the new system complies with all relevant standards. Any mention of SGS-CSTC Shanghai GSM Lab or testing done by SGS-CSTC Shanghai GSM Lab must approve SGS Shanghai GSM Lab in connection with distribution or use of the product described in this report in writing.

Tested by :



Date :

2005.07.19

Approved by :

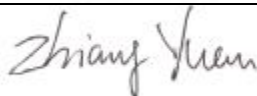

Date :

2005.07.19

Contents

1. General Information	5
1.1 Test Laboratory.....	5
1.2 Details of Applicant	5
1.3 Description of EUT(s).....	5
1.4 Test Environment	6
1.5 Operation Configuration	6
1.6 The SAR Measurement System.....	6
1.7 SAR System Verification.....	8
1.8 Tissue Simulant Fluid for the Frequency Band 850MHz and 1900MHZ	9
1.9 Test Standards and Limits	10
2. Summary of Results.....	11
3. Instruments List	13
4. Measurements	14
4.1 FCC-OET65-LeftHandSide-Touch-GSM850-Low	14
FCC-OET65-LeftHandSide-Touch-GSM850-Low	14
4.2 FCC-OET65-LeftHandSide-Touch-GSM850-Mid	15
FCC-OET65-LeftHandSide-Touch-GSM850-Mid.....	15
4.3 FCC-OET65-LeftHandSide-Touch-GSM850-High	17
FCC-OET65-LeftHandSide-Touch-GSM850-High	17
4.4 FCC-OET65-LeftHandSide-Tilt-GSM850-Low	19
FCC-OET65-LeftHandSide-Tilt-GSM850-Low	19
4.5 FCC-OET65-LeftHandSide-Tilt-GSM850-Mid	21
FCC-OET65-LeftHandSide-Tilt-GSM850-Mid.....	21
4.6 FCC-OET65-LeftHandSide-Tilt-GSM850-High	23
FCC-OET65-LeftHandSide-Tilt-GSM850-High.....	23
4.7 FCC-OET65-RightHandSide-Touch-GSM850-Low	25
FCC-OET65-RightHandSide-Touch-GSM850-Low	25
4.8 FCC-OET65-RightHandSide-Touch-GSM850-Mid	27
FCC-OET65-RightHandSide-Touch-GSM850-Mid.....	27
4.9 FCC-OET65-RightHandSide-Touch-GSM850-High.....	29
FCC-OET65-RightHandSide-Touch-GSM850-High	29
4.10 FCC-OET65-RightHandSide-Tilt-GSM850-Low.....	31

FCC-OET65-RightHandSide-Tilt-GSM850-Low 31

4.11 FCC-OET65-RightHandSide-Tilt-GSM850-Mid 33

FCC-OET65-RightHandSide-Tilt-GSM850-Mid..... 33

4.12 FCC-OET65-RightHandSide-Tilt-GSM850-High 35

FCC-OET65-RightHandSide-Tilt-GSM850-High 35

4.13 FCC-OET65-Body-Worn-GSM850-Low 37

FCC-OET65-Body-Worn-GSM850-Low 37

4.14 FCC-OET65-Body-Worn-GSM850-Mid 39

FCC-OET65-Body-Worn-GSM850-Mid 39

4.15 FCC-OET65-Body-Worn-GSM850-High..... 41

FCC-OET65-Body-Worn-GSM850-High..... 41

4.16 FCC-OET65-LeftHandSide-Touch-GSM1900-Low 43

FCC-OET65-LeftHandSide-Touch-GSM1900-Low 43

4.17 FCC-OET65-LeftHandSide-Touch-GSM1900-Mid 45

FCC-OET65-LeftHandSide-Touch-GSM1900-Mid..... 45

4.18 FCC-OET65-LeftHandSide-Touch-GSM1900-High 47

FCC-OET65-LeftHandSide-Touch-GSM1900-High 47

4.19 FCC-OET65-LeftHandSide-Tilt-GSM1900-Low 49

FCC-OET65-LeftHandSide-Tilt-GSM1900-Low 49

4.20 FCC-OET65-LeftHandSide-Tilt-GSM1900-Mid 51

FCC-OET65-LeftHandSide-Tilt-GSM1900-Mid..... 51

4.21 FCC-OET65-LeftHandSide-Tilt-GSM1900-High 53

FCC-OET65-LeftHandSide-Tilt-GSM1900-High..... 53

4.22 FCC-OET65-RightHandSide-Touch-GSM1900-Low 55

FCC-OET65-RightHandSide-Touch-GSM1900-Low 55

4.23 FCC-OET65-RightHandSide-Touch-GSM1900-Mid 57

FCC-OET65-RightHandSide-Touch-GSM1900-Mid..... 57

4.24 FCC-OET65-RightHandSide-Touch-GSM1900-High..... 59

FCC-OET65-RightHandSide-Touch-GSM1900-High 59

4.25 FCC-OET65-RightHandSide-Tilt-GSM1900-Low..... 61

FCC-OET65-RightHandSide-Tilt-GSM1900-Low 61

4.26 FCC-OET65-RightHandSide-Tilt-GSM1900-Mid..... 63

FCC-OET65-RightHandSide-Tilt-GSM1900-Mid..... 63

4.27 FCC-OET65-RightHandSide-Tilt-GSM1900-High..... 65

FCC-OET65-RightHandSide-Tilt-GSM1900-High	65
4.28 FCC-OET65-Body-Worn-GSM1900-Low	67
FCC-OET65-Body-Worn-GSM1900-Low	67
4.29 FCC-OET65-Body-Worn-GSM1900-Mid	69
FCC-OET65-Body-Worn-GSM1900-Mid	69
4.30 FCC-OET65-Body-Worn-GSM1900-High.....	71
FCC-OET65-Body-Worn-GSM1900-High.....	71
Appendix.....	74
1. Photographs of Test Setup.....	74
2. Photographs of the EUT	77
3. Photographs of the battery	77
4. Photograph of the charger	78
5. Probe Calibration certificate.....	79
6. Uncertainty analysis	87
7. Phantom description	88

1. General Information

1.1 Test Laboratory

GSM Lab
 SGS-CSTC Standards Technical Services Co.Ltd Shanghai Branch
 9F,the 3rd Building, No.899, Yishan Rd, Xuhui District, Shanghai, China
 Zip code: 200233
 Telephone: +86 (0) 21 6495 1616
 Fax: +86 (0) 21 6495 3679
 Internet: <http://www.cn.sgs.com>

1.2 Details of Applicant

Name: TCL&Alcatel Mobile Phones
 Address: 30/F, Times Square, 500 Zhangyang RD. Shanghai
 200122, P.R.China

1.3 Description of EUT(s)

Brand name	Alcatel	
Model No.	VLE5	
Market Name	OT-E158a	
Serial No.	IMEI: 0010160002705704100	
Battery Type	Lithium-Ion, 4.2Volt	
Provider of Battery	BYD	
Antenna Type	Internal Antenna	
Operation Mode	GSM850/PCS1900	
Modulation Mode	GMSK	
Frequency range	GSM850	Tx: 824~849 MHz
		Rx: 869~894 MHz
	GSM1900	Tx: 1850~1910 MHz
		Rx: 1930~1990 MHz
Maximum RF Conducted Power	GSM850: 33dBm, GSM1900: 30dBm	

1.4 Test Environment

Ambient temperature: 22.0° C

Tissue Simulating Liquid: 22° C

Relative Humidity: 32%

1.5 Operation Configuration

Configuration 1: GSM 850, LeftHandSide Touch & 15° Tilt Position

Configuration 2: GSM 850, RightHandSide Touch & 15° Tilt Position

Configuration 3: GSM 850, BodyWorn (1.5cm between EUT and phantom)

Configuration 4: GSM 1900, LeftHandSide Touch & 15° Tilt Position

Configuration 5: GSM 1900, RightHandSide Touch & 15° Tilt Position

Configuration 6: GSM 1900, BodyWorn (1.5cm between EUT and phantom)

1.6 The SAR Measurement System

A photograph of the SAR measurement System is given in Fig.a.

This SAR Measurement System uses a Computer-controlled 3-D stepper motor system (Speag Dasy 4 professional system). A Model ET3DV6 1774 E-field probe is used to determine the internal electric fields. The SAR can be obtained from the equation $SAR = \sigma (|E_i|^2) / \rho$ where σ and ρ are the conductivity and mass density of the tissue-simulant.

The DASY4 system for performing compliance tests consists of the following items:

- ÿ A standard high precision 6-axis robot (Stabile RX family) with controller, teach pendant and software. An arm extension for accommodation the data acquisition electronics (DAE).
- ÿ A dosimetric probe, i.e., an isotropic E-field probe optimized and calibrated for usage in tissue simulating liquid. The probe is equipped with an optical surface detector system.
- ÿ A data acquisition electronics (DAE) which performs the signal amplification, signal

multiplexing, AD-conversion, offset measurements, mechanical surface detection, collision detection, etc. The unit is battery powered with standard or rechargeable batteries. The signal is optically transmitted to the EOC.

- ÿ The Electro-optical converter (EOC) performs the conversion between optical and electrical of the signals for the digital communication to DAE and for the analog signal from the optical surface detection. The EOC is connected to the measurement server.

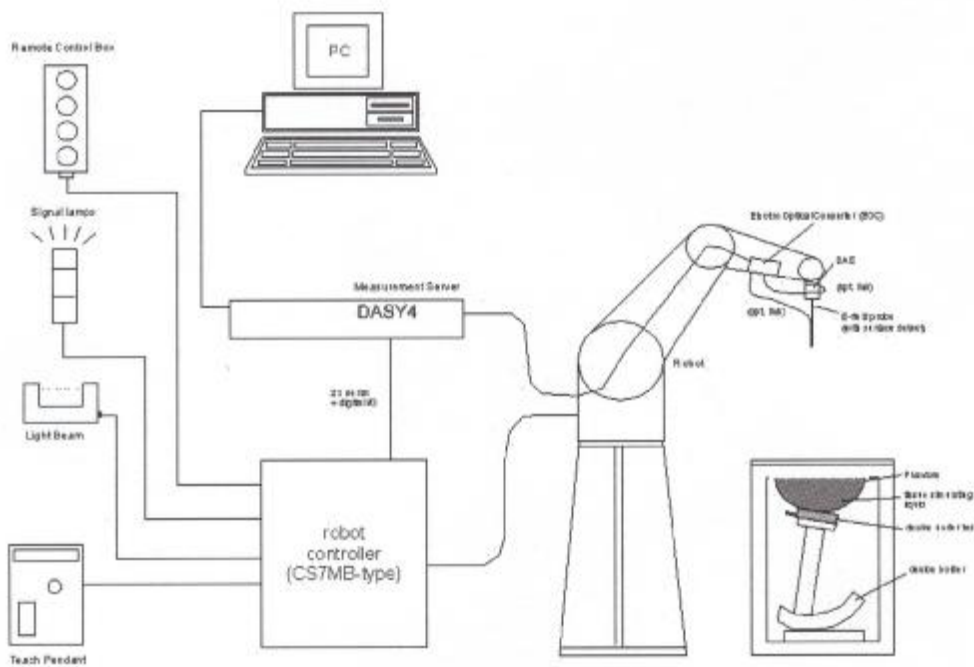

Fig. a SAR System Configuration

- ÿ The function of the measurement server is to perform the time critical tasks such as signal filtering, control of the robot operation and fast movement interrupts.
- ÿ A probe alignment unit which improves the (absolute) accuracy of the probe positioning.
- ÿ A computer operating Windows 2000 or Windows XP.
- ÿ DASY4 software.
- ÿ Remote control with teach pendant and additional circuitry for robot safety such as warning lamps, etc.

- ÿ The SAM twin phantom enabling testing left-hand, right-hand and body-worn usage.
- ÿ The device holder for handheld mobile phones.
- ÿ Tissue simulating liquid mixed according to the given recipes.
- ÿ Validation dipole kits allowing to validate the proper functioning of the system.

1.7 SAR System Verification

The microwave circuit arrangement for system verification is sketched in Fig. b. The daily system accuracy verification occurs within the flat section of the SAM phantom. A SAR measurement was performed to see if the measured SAR was within +/- 10% from the target SAR values. These tests were done at 850MHz and 1900MHz. The tests were conducted on the same days as the measurement of the DUT. The obtained results from the system accuracy verification are displayed in the table 1 (SAR values are normalized to 1W forward power delivered to the dipole). During the tests, the ambient temperature of the laboratory was in the range 22°C, the relative humidity was in the range 60% and the liquid depth above the ear reference points was above 15 cm in all the cases. It is seen that the system is operating within its specification, as the results are within acceptable tolerance of the reference values.

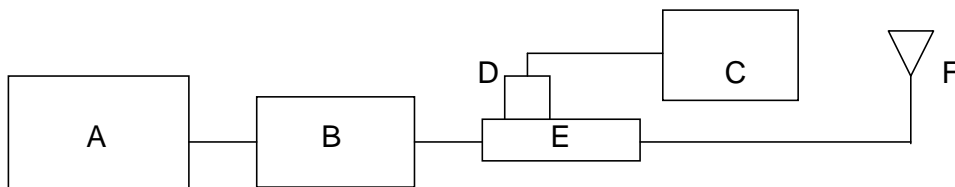

Fig. b the microwave circuit arrangement used for SAR system verification

- A. Agilent Model E4438C Signal Generator
- B. Agilent Model 8449B Preamplifier
- C. Agilent Model E4416A Power Meter
- D. Agilent Model 8481H Power Sensor
- E. HT CP6100 20N Dual directional coupler
- F. Reference dipole antenna

Validation Kit	Frequency	Target SAR 1g (250mW)	Target SAR 10g (250mW)	Measured SAR 1g	Measured SAR 10g	Measured Date
ET3DV6 SN1774	900M Head	2.69	1.73	2.62	1.66	2005-07-11
ET3DV6 SN1774	900M Body	2.75	1.77	2.69	1.71	2005-07-06
ET3DV6 SN1774	1900M Head	10.4	5.35	10.12	5.21	2005-07-14
ET3DV6 SN1774	1900M Body	10.52	5.53	10.37	5.26	2005-07-13

Table 1. Result System Validation

1.8 Tissue Simulant Fluid for the Frequency Band 850MHz and 1900MHZ

The dielectric properties for this body-simulant fluid were measured by using the HP Model 85070D Dielectric Probe (rates frequency band 200 MHz to 20 GHz) in conjunction with Agilent E5071B Network Analyzer (300 KHz-8500 MHz). The Conductivity (σ) and Permittivity (ρ) are listed in Table 2. For the SAR measurement given in this report. The temperature variation of the Tissue Simulant Fluid was 22°C.

Frequency (MHz)	Tissue Type	Limit/Measured	Permittivity (ρ)	Conductivity (σ)	Simulated Tissue Temp ($^{\circ}$ C)
850	Head	Measured, 2005-07-11	41.69	0.877	22
		Recommended Limit	41.5 \pm 5%	0.90 \pm 10%	20-24
850	Body	Measured, 2005-07-06	52.52	0.99	22
		Recommended Limit	55.2 \pm 5%	0.97 \pm 10%	20-24
1900	Head	Measured, 2005-07-14	40.32	1.44	22
		Recommended Limit	40.0 \pm 5%	1.40 \pm 10%	20-24
1900	Body	Measured, 2005-07-13	51.52	1.52	22
		Recommended Limit	53.3 \pm 5%	1.52 \pm 10%	20-24

Table 2. Dielectric parameters for the Frequency Band 850MHz&1900MHZ

1.9 Test Standards and Limits

According to FCC 47 CFR §2.1093(d) the limits to be used for evaluation are based generally on criteria published by the American National Standards Institute (ANSI) for localized specific absorption rate (SAR) in Section 4.2 of "IEEE Standard for Safty Levels with Respect to Human Exposure to Radio Frequency Electromagnetic Fields, 3KHz to 300GHz," ANSI/IEEE C95.1-1992, Conpyright 1992 by the Institute of Electrical & Electronics Engineers, Inc., New York, New York 10071.

Human Exposure	Uncontrolled Environment General Population
Spatial Peak SAR (Brain)	1.60 mW/g (averaged over a mass of 1g)

Table 3. RF Exposure Limits

Notes:

1. Uncontrolled environments are defined as locations where there is potential exposure of individuals who have no knowledge or control of their potential exposure.

2. Summary of Results

Frequency Band	EUT position	Conducted Output Power (Average)	1g Average (mW/g)	Power Drift (dB)	Amb. Temp (°C)	Verdict
850 MHz	LeftHandSide Touch, Low Channel	32.9	0.84	0.05	22	PASS
	LeftHandSide Touch, Mid Channel	32.8	0.949	-0.01	22	PASS
	LeftHandSide Touch, High Channel	32.9	0.968	0.05	22	PASS
	LeftHandSide Tilt, Low Channel	32.9	0.606	-0.03	22	PASS
	LeftHandSide Tilt, Mid Channel	32.8	0.587	-0.08	22	PASS
	LeftHandSide Tilt, High Channel	32.9	0.621	0.04	22	PASS
	RightHandSide Touch, Low Channel	32.9	0.929	-0.3	22	PASS
	RightHandSide Touch, Mid Channel	32.8	0.958	0.09	22	PASS
	RightHandSide Touch, High Channel	32.9	0.962	0.04	22	PASS
	RightHandSide Tilt, Low Channel	32.9	0.589	-0.1	22	PASS
	RightHandSide Tilt, Mid Channel	32.8	0.594	-0.01	22	PASS
	RightHandSide Tilt, High Channel	32.9	0.59	0.1	22	PASS
	BodyWorn, Low Channel	32.9	0.963	-0.04	22	PASS
	BodyWorn, Mid Channel	32.8	0.888	0.02	22	PASS
	BodyWorn, High Channel	32.9	1.23	-0.1	22	PASS
1900 MHz	LeftHandSide Touch, Low Channel	29.3	0.293	-0.1	22	PASS
	LeftHandSide Touch, Mid Channel	29.4	0.369	-0.2	22	PASS
	LeftHandSide Touch, High Channel	29.3	0.35	-0.06	22	PASS
	LeftHandSide Tilt, Low Channel	29.3	0.422	-0.08	22	PASS
	LeftHandSide Tilt, Mid Channel	29.4	0.55	-0.04	22	PASS
	LeftHandSide Tilt, High Channel	29.3	0.502	0.002	22	PASS
	RightHandSide Touch, Low Channel	29.3	0.425	0.008	22	PASS

RightHandSide Touch, Mid Channel	29.4	0.528	0.005	22	PASS
RightHandSide Touch, High Channel	29.3	0.474	0.02	22	PASS
RightHandSide Tilt, Low Channel	29.3	0.501	0.03	22	PASS
RightHandSide Tilt, Mid Channel	29.4	0.68	-0.05	22	PASS
RightHandSide Tilt, High Channel	29.3	0.648	0.02	22	PASS
BodyWorn, Low Channel	29.3	0.192	-0.008	22	PASS
BodyWorn, Mid Channel	29.4	0.32	-0.06	22	PASS
BodyWorn, High Channel	29.3	0.398	0.02	22	PASS

Note:

1. In GSM850 band, the low, middle and high channels are CH128/824.2MHz, CH189/836.4MHz and CH251/848.8MHz separately.
2. In GSM1900 band, the low, middle and high channels are CH512/1805.2MHz, CH661/1880.0MHz and CH810/1909.8MHz separately.
3. For the Bodyworn measurements the sample was only placed with the antenna toward the phantom since this position delivers the highest SAR values.

3. Instruments List

Instrument	Model	Serial number	No.	Date of last Calibration
Desktop PC	COMPAQ EVO	N/A	GSM-SAR-025	N/A
Dasy 4 software	V 4.1 build 47	N/A	GSM-SAR-001	N/A
Probe	ET3DV6	1774	GSM-SAR-021	2004.10.26
DAE	DAE3	569	GSM-SAR-023	2005.3.20
Phantom	SAM	N/A	GSM-SAR-005	N/A
Robot	RX90L	N/A	GSM-SAR-008	N/A
900MHz system validation dipole	D900V2	184	GSM-SAR-013	2005.3.20
1900MHz system validation dipole	D1900V2	5d028	GSM-SAR-020	2005.3.20
Dielectric probe kit	85070D	US01440168	GSM-SAR-016	2004.12.20
Agilent network analyzer	E5071B	MY42100549	GSM-SAR-007	2004.12.20
Agilent signal generator	E4438	14438CATO-19719	GSM-SAR-008	2004.12.20
Agilent preamplifier	8449B	3008A01921	GSM-SAR-009	2004.12.20
Agilent power meter	E4416A	GB41292095	GSM-SAR-010	2004.12.20
Agilent power sensor	8481h	MY41091234	GSM-SAR-011	2004.12.20
HT CP6100 20N Coupling	6100	SCP301480120	GSM-SAR-012	2004.12.20
R&S Universal radio communication tester	CMU200	103633	GSM-AUD-002	2004.12.20

4. Measurements

4.1 FCC-OET65-LeftHandSide-Touch-GSM850-Low

Date/Time: 07/12/05 11:00:25

Test Laboratory: SGS-GSM

File Name: [FCC-OET65-LeftHandSide-Touch-GSM850-confirm.da4](#)

FCC-OET65-LeftHandSide-Touch-GSM850-Low

DUT: GSM50058; Type: Head; Serial: 20050705

Program: Compliance Testing: EN 50361 Protocol Left-Hand Side)

Communication System: GSM850; Frequency: 824.2 MHz; Duty Cycle: 1:8.3

Medium: HSL850 ($\sigma = 0.865816$ mho/m, $\epsilon_r = 41.8373$, $\rho = 1000$ kg/m³)

Phantom section: Left Section

Measurement Standard: DASY4 (High Precision Assessment)

DASY4 Configuration:

- Probe: ET3DV6 - SN1774; ConvF(6.96, 6.96, 6.96); Calibrated: 2004-10-26
- Sensor-Surface: 4mm (Mechanical Surface Detection)
- Electronics: DAE3 Sn569; Calibrated: 2003-6-4
- Phantom: SAM 12; Type: SAM V4.0; Serial: TP-1283
- Measurement SW: DASY4, V4.1 Build 47; Postprocessing SW: SEMCAD, V1.6 Build 115

Touch position - Low/Area Scan (71x111x1): Measurement grid: dx=15mm, dy=15mm

Reference Value = 28.2 V/m

Power Drift = 0.05 dB

Maximum value of SAR = 0.883 mW/g

Touch position - Low/Zoom Scan (7x7x7) (7x7x7)/Cube 0: Measurement grid: dx=5mm, dy=5mm, dz=5mm

Peak SAR (extrapolated) = 1.18 W/kg
SAR(1 g) = 0.84 mW/g; SAR(10 g) = 0.566 mW/g
Reference Value = 28.2 V/m
Power Drift = 0.05 dB
Maximum value of SAR = 0.893 mW/g

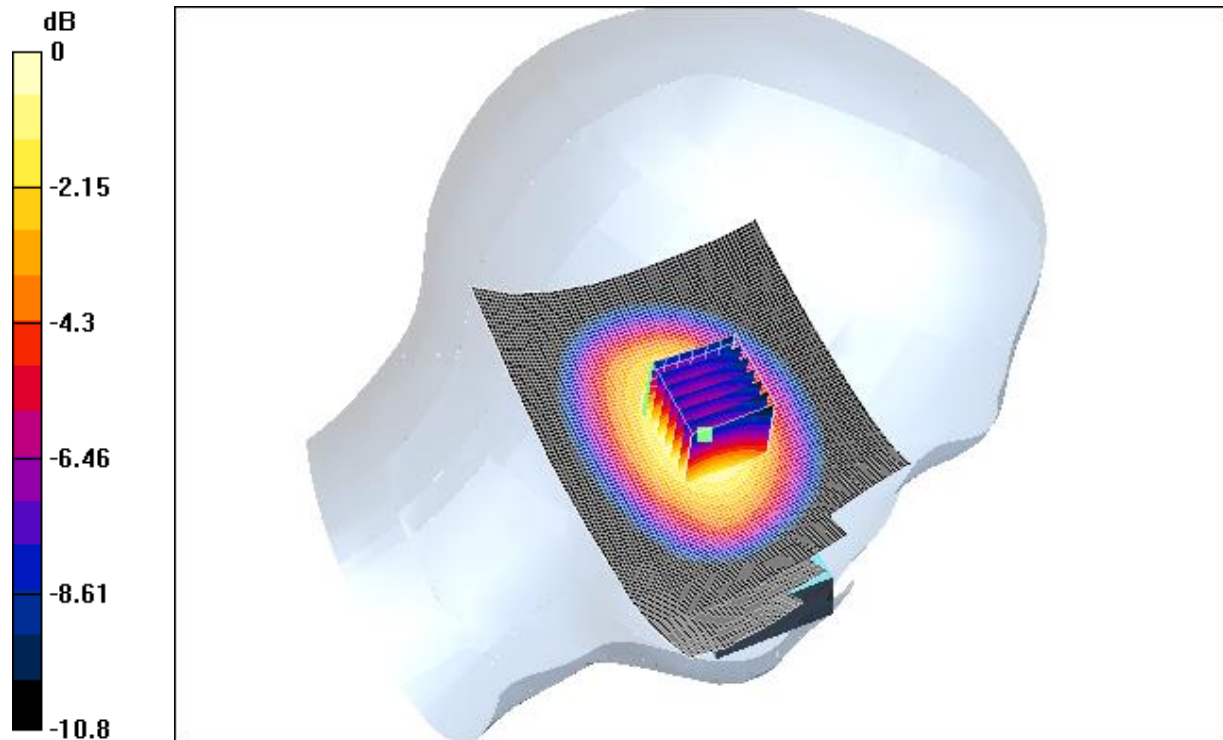

0 dB = 0.893mW/g

4.2 FCC-OET65-LeftHandSide-Touch-GSM850-Mid

Date/Time: 07/12/05 11:00:25

Test Laboratory: SGS-GSM

File Name: [FCC-OET65-LeftHandSide-Touch-GSM850-confirm.da4](#)

FCC-OET65-LeftHandSide-Touch-GSM850-Mid

DUT: GSM50058; Type: Head; Serial: 20050705

Program: Compliance Testing: EN 50361 Protocol Left-Hand Side)

Communication System: GSM850; Frequency: 836.4 MHz; Duty Cycle: 1:8.3

Medium: HSL850 ($\sigma = 0.8773$ mho/m, $\epsilon_r = 41.699$, $\rho = 1000$ kg/m³)

Phantom section: Left Section

Measurement Standard: DASYS4 (High Precision Assessment)

DASY4 Configuration:

- Probe: ET3DV6 - SN1774; ConvF(6.96, 6.96, 6.96); Calibrated: 2004-10-26
- Sensor-Surface: 4mm (Mechanical Surface Detection)
- Electronics: DAE3 Sn569; Calibrated: 2003-6-4
- Phantom: SAM 12; Type: SAM V4.0; Serial: TP-1283
- Measurement SW: DASYS4, V4.1 Build 47; Postprocessing SW: SEMCAD, V1.6 Build 115

Touch position - Middle/Area Scan (71x111x1): Measurement grid: dx=15mm, dy=15mm

Reference Value = 32 V/m

Power Drift = -0.01 dB

Maximum value of SAR = 0.991 mW/g

Touch position - Middle/Zoom Scan (7x7x7)/Cube 0: Measurement grid: dx=5mm, dy=5mm, dz=5mm

Peak SAR (extrapolated) = 1.34 W/kg

SAR(1 g) = 0.949 mW/g; SAR(10 g) = 0.636 mW/g

Reference Value = 32 V/m

Power Drift = -0.01 dB

Maximum value of SAR = 1.01 mW/g

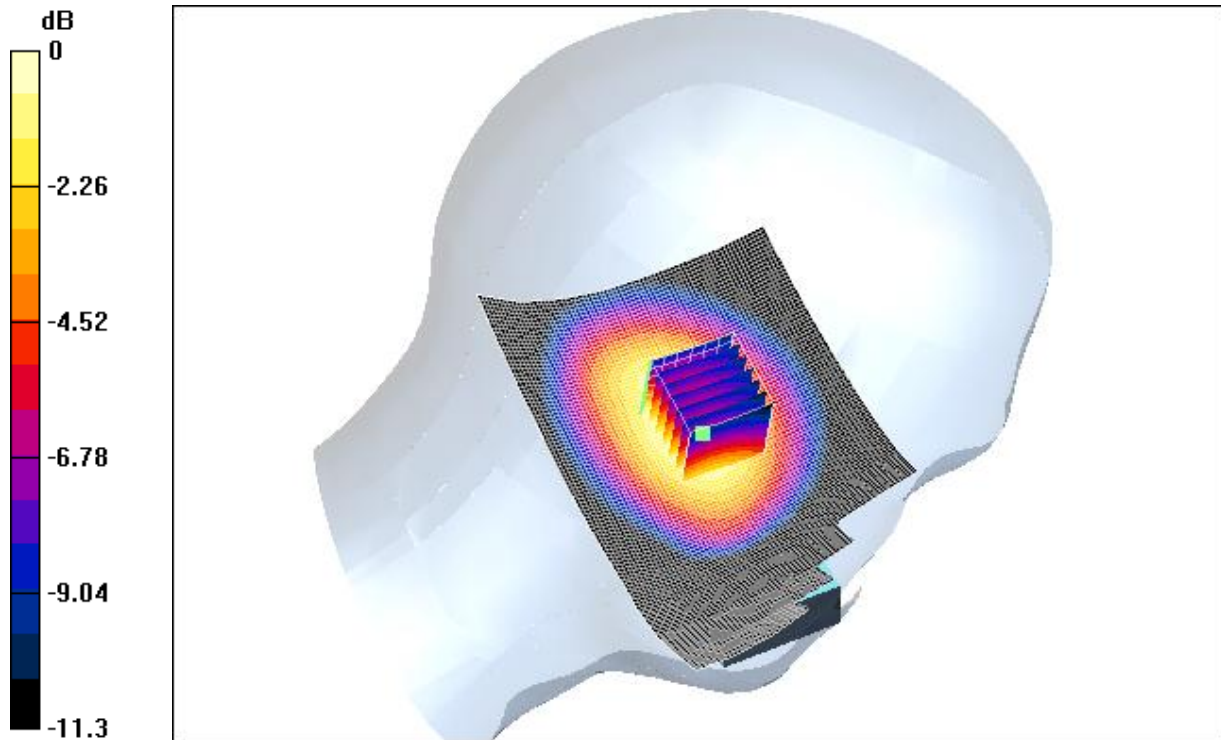

0 dB = 1.01mW/g

4.3 FCC-OET65-LeftHandSide-Touch-GSM850-High

Date/Time: 07/12/05 11:00:25

Test Laboratory: SGS-GSM

File Name: [FCC-OET65-LeftHandSide-Touch-GSM850-confirm.da4](#)

FCC-OET65-LeftHandSide-Touch-GSM850-High

DUT: GSM50058; Type: Head; Serial: 20050705

Program: Compliance Testing: EN 50361 Protocol Left-Hand Side)

Communication System: GSM850; Frequency: 848.8 MHz;Duty Cycle: 1:8.3

Medium: HSL850 ($\sigma = 0.889355$ mho/m, $\epsilon_r = 41.5624$, $\rho = 1000$ kg/m³)

Phantom section: Left Section

Measurement Standard: DASY4 (High Precision Assessment)

DASY4 Configuration:

- Probe: ET3DV6 - SN1774; ConvF(6.96, 6.96, 6.96); Calibrated: 2004-10-26
- Sensor-Surface: 4mm (Mechanical Surface Detection)
- Electronics: DAE3 Sn569; Calibrated: 2003-6-4
- Phantom: SAM 12; Type: SAM V4.0; Serial: TP-1283
- Measurement SW: DASY4, V4.1 Build 47; Postprocessing SW: SEMCAD, V1.6 Build 115

Touch position - High/Area Scan (71x111x1): Measurement grid: dx=15mm, dy=15mm

Reference Value = 29.9 V/m

Power Drift = 0.05 dB

Maximum value of SAR = 1.02 mW/g

Touch position - High/Zoom Scan (7x7x7) (7x7x7)/Cube 0: Measurement grid: dx=5mm, dy=5mm,
dz=5mm

Peak SAR (extrapolated) = 1.37 W/kg

SAR(1 g) = 0.968 mW/g; SAR(10 g) = 0.646 mW/g

Reference Value = 29.9 V/m

Power Drift = 0.05 dB

Maximum value of SAR = 1.02 mW/g

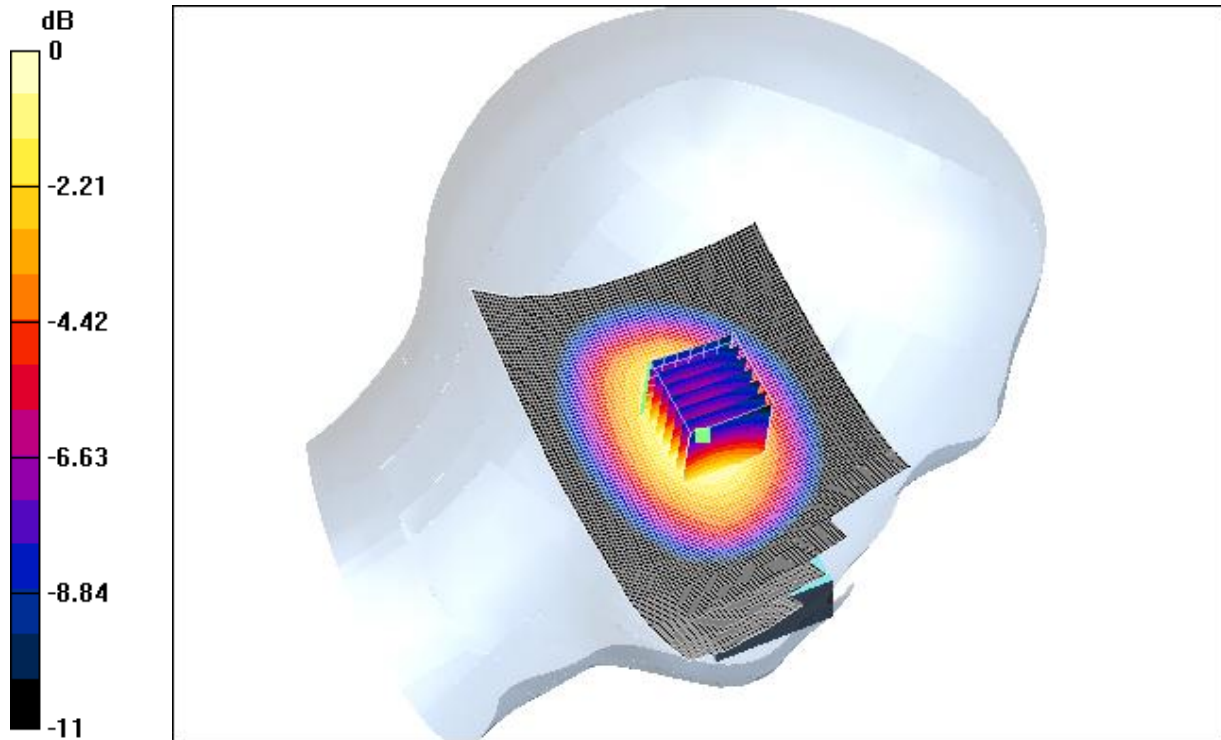

0 dB = 1.02mW/g

4.4 FCC-OET65-LeftHandSide-Tilt-GSM850-Low

Date/Time: 07/12/05 12:57:58

Test Laboratory: SGS-GSM

File Name: [FCC-OET65-LeftHandSide-Tilt-GSM850.da4](#)

FCC-OET65-LeftHandSide-Tilt-GSM850-Low

DUT: GSM50058; Type: Head; Serial: 20050705

Program: Compliance Testing: EN 50361 Protocol Left-Hand Side)

Communication System: GSM850; Frequency: 824.2 MHz;Duty Cycle: 1:8.3

Medium: HSL850 ($\sigma = 0.865816$ mho/m, $\epsilon_r = 41.8373$, $\rho = 1000$ kg/m³)

Phantom section: Left Section

Measurement Standard: DASY4 (High Precision Assessment)

DASY4 Configuration:

- Probe: ET3DV6 - SN1774; ConvF(6.96, 6.96, 6.96); Calibrated: 2004-10-26
- Sensor-Surface: 4mm (Mechanical Surface Detection)
- Electronics: DAE3 Sn569; Calibrated: 2003-6-4
- Phantom: SAM 12; Type: SAM V4.0; Serial: TP-1283
- Measurement SW: DASY4, V4.1 Build 47; Postprocessing SW: SEMCAD, V1.6 Build 115

Tilt position - Low/Area Scan (71x111x1): Measurement grid: dx=15mm, dy=15mm

Reference Value = 27.3 V/m

Power Drift = -0.03 dB

Maximum value of SAR = 0.65 mW/g

Tilt position - Low/Zoom Scan (7x7x7)/Cube 0: Measurement grid: dx=5mm, dy=5mm, dz=5mm

Peak SAR (extrapolated) = 0.811 W/kg

SAR(1 g) = 0.606 mW/g; SAR(10 g) = 0.425 mW/g

Reference Value = 27.3 V/m

Power Drift = -0.03 dB

Maximum value of SAR = 0.637 mW/g

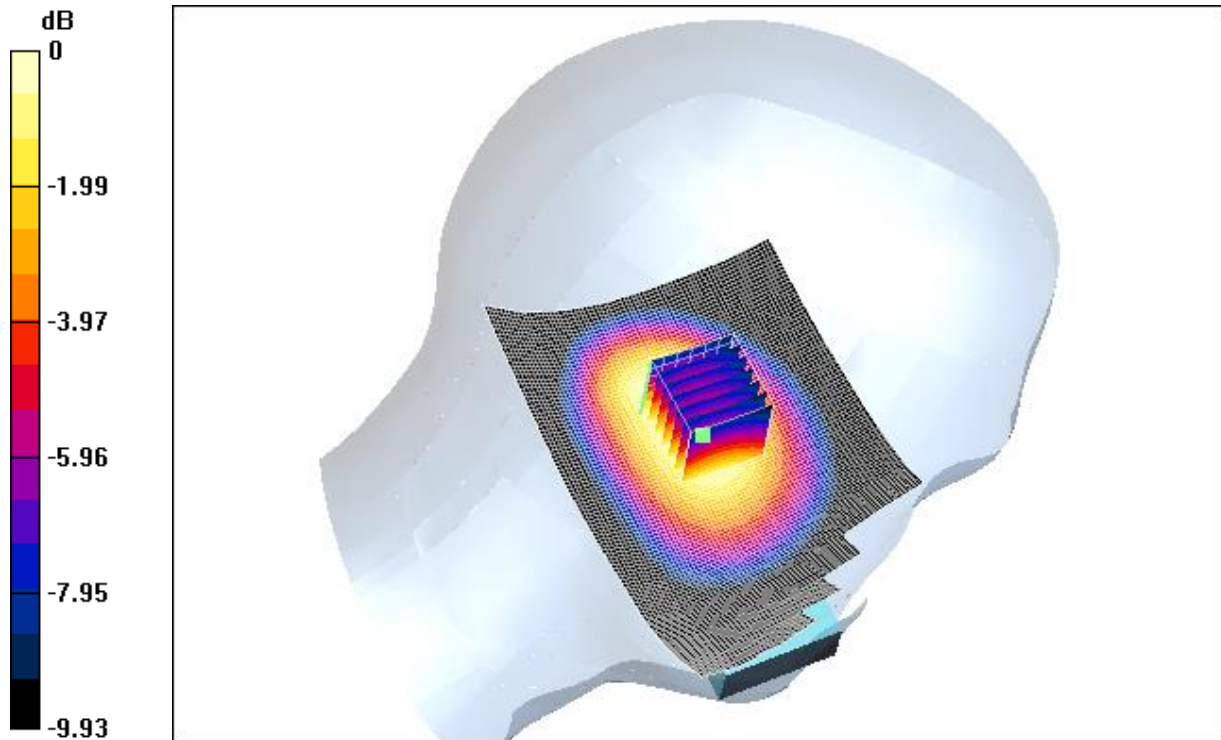

0 dB = 0.637mW/g

4.5 FCC-OET65-LeftHandSide-Tilt-GSM850-Mid

Date/Time: 07/12/05 12:57:58

Test Laboratory: SGS-GSM

File Name: [FCC-OET65-LeftHandSide-Tilt-GSM850.da4](#)

FCC-OET65-LeftHandSide-Tilt-GSM850-Mid

DUT: GSM50058; Type: Head; Serial: 20050705

Program: Compliance Testing: EN 50361 Protocol Left-Hand Side)

Communication System: GSM850; Frequency: 836.4 MHz;Duty Cycle: 1:8.3

Medium: HSL850 ($\sigma = 0.8773$ mho/m, $\epsilon_r = 41.699$, $\rho = 1000$ kg/m³)

Phantom section: Left Section

Measurement Standard: DASY4 (High Precision Assessment)

DASY4 Configuration:

- Probe: ET3DV6 - SN1774; ConvF(6.96, 6.96, 6.96); Calibrated: 2004-10-26
- Sensor-Surface: 4mm (Mechanical Surface Detection)
- Electronics: DAE3 Sn569; Calibrated: 2003-6-4
- Phantom: SAM 12; Type: SAM V4.0; Serial: TP-1283
- Measurement SW: DASY4, V4.1 Build 47; Postprocessing SW: SEMCAD, V1.6 Build 115

Tilt position - Middle/Area Scan (71x111x1): Measurement grid: dx=15mm, dy=15mm

Reference Value = 27.1 V/m

Power Drift = -0.08 dB

Maximum value of SAR = 0.672 mW/g

Tilt position - Middle/Zoom Scan (7x7x7) (7x7x7)/Cube 0: Measurement grid: dx=5mm, dy=5mm,
dz=5mm

Peak SAR (extrapolated) = 0.896 W/kg

SAR(1 g) = 0.587 mW/g; SAR(10 g) = 0.399 mW/g

Reference Value = 27.1 V/m

Power Drift = -0.08 dB

Maximum value of SAR = 0.623 mW/g

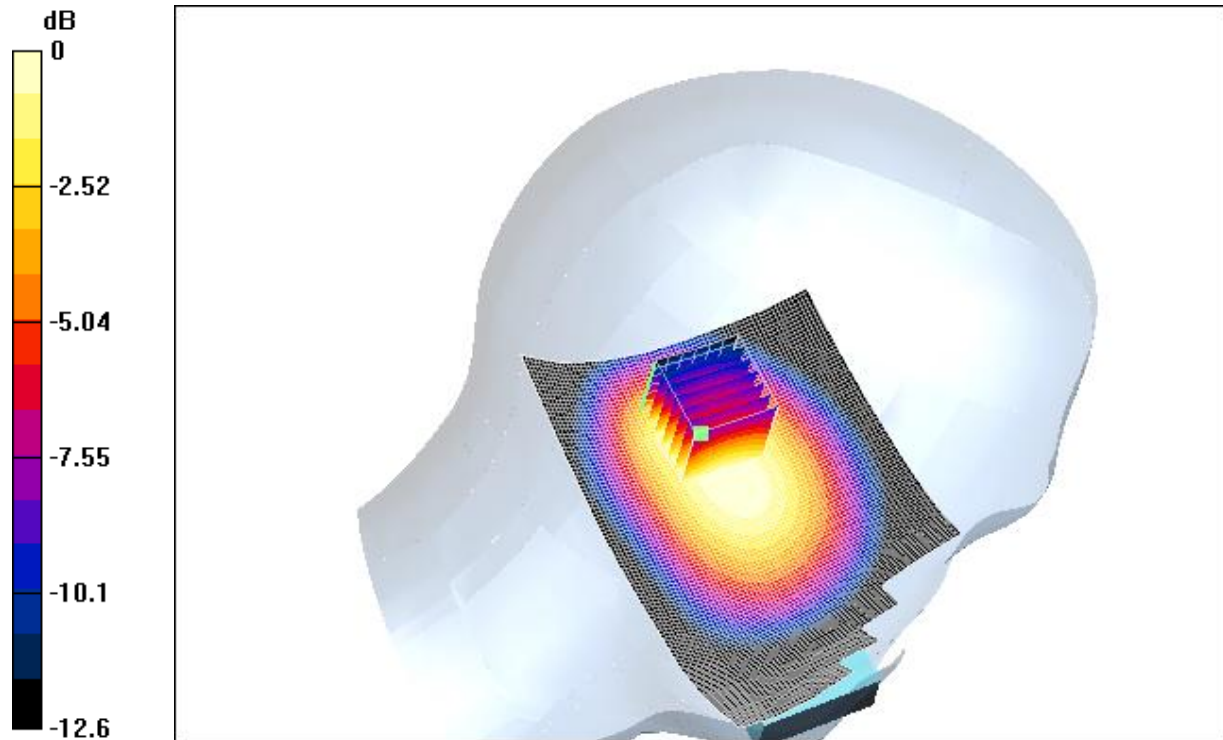

0 dB = 0.623mW/g

4.6 FCC-OET65-LeftHandSide-Tilt-GSM850-High

Date/Time: 07/12/05 12:57:58

Test Laboratory: SGS-GSM

File Name: [FCC-OET65-LeftHandSide-Tilt-GSM850.da4](#)

FCC-OET65-LeftHandSide-Tilt-GSM850-High

DUT: GSM50058; Type: Head; Serial: 20050705

Program: Compliance Testing: EN 50361 Protocol Left-Hand Side)

Communication System: GSM850; Frequency: 848.8 MHz;Duty Cycle: 1:8.3

Medium: HSL850 ($\sigma = 0.889355$ mho/m, $\epsilon_r = 41.5624$, $\rho = 1000$ kg/m³)

Phantom section: Left Section

Measurement Standard: DASY4 (High Precision Assessment)

DASY4 Configuration:

- Probe: ET3DV6 - SN1774; ConvF(6.96, 6.96, 6.96); Calibrated: 2004-10-26
- Sensor-Surface: 4mm (Mechanical Surface Detection)
- Electronics: DAE3 Sn569; Calibrated: 2003-6-4
- Phantom: SAM 12; Type: SAM V4.0; Serial: TP-1283
- Measurement SW: DASY4, V4.1 Build 47; Postprocessing SW: SEMCAD, V1.6 Build 115

Tilt position - High/Area Scan (71x111x1): Measurement grid: dx=15mm, dy=15mm

Reference Value = 27.5 V/m

Power Drift = 0.04 dB

Maximum value of SAR = 0.706 mW/g

Tilt position - High/Zoom Scan (7x7x7) (7x7x7)/Cube 0: Measurement grid: dx=5mm, dy=5mm, dz=5mm

Peak SAR (extrapolated) = 0.988 W/kg

SAR(1 g) = 0.621 mW/g; SAR(10 g) = 0.419 mW/g

Reference Value = 27.5 V/m

Power Drift = 0.04 dB

Maximum value of SAR = 0.652 mW/g

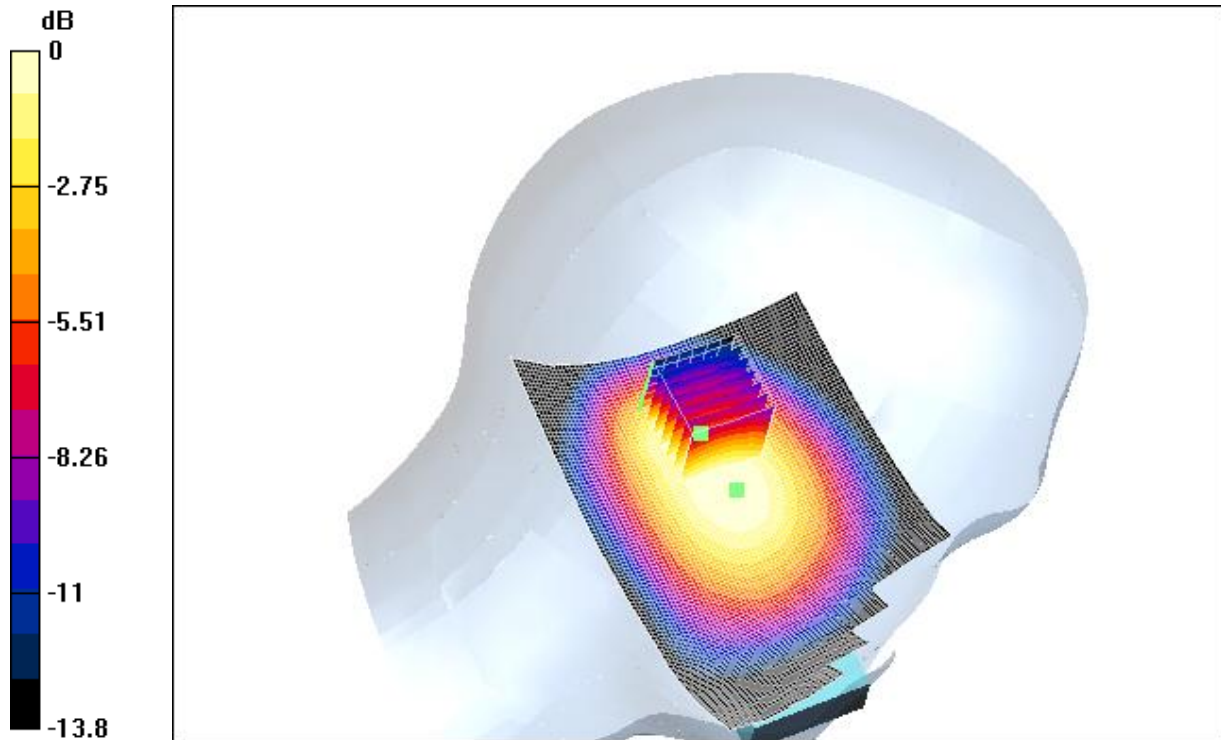

0 dB = 0.652mW/g

4.7 FCC-OET65-RightHandSide-Touch-GSM850-Low

Date/Time: 07/11/05 19:08:30

Test Laboratory: SGS-GSM

File Name: [FCC-OET65-RightHandSide-Touch-GSM850.da4](#)

FCC-OET65-RightHandSide-Touch-GSM850-Low

DUT: GSM50058; Type: Head; Serial: 20050705

Program: Compliance Testing: EN 50361 Protocol Right-Hand Side)

Communication System: GSM850; Frequency: 824.2 MHz;Duty Cycle: 1:8.3

Medium: HSL850 ($\sigma = 0.865816$ mho/m, $\epsilon_r = 41.8373$, $\rho = 1000$ kg/m³)

Phantom section: Right Section

Measurement Standard: DASY4 (High Precision Assessment)

DASY4 Configuration:

- Probe: ET3DV6 - SN1774; ConvF(6.96, 6.96, 6.96); Calibrated: 2004-10-26
- Sensor-Surface: 4mm (Mechanical Surface Detection)
- Electronics: DAE3 Sn569; Calibrated: 2003-6-4
- Phantom: SAM 12; Type: SAM V4.0; Serial: TP-1283
- Measurement SW: DASY4, V4.1 Build 47; Postprocessing SW: SEMCAD, V1.6 Build 115

Touch position - Low/Area Scan (71x111x1): Measurement grid: dx=15mm, dy=15mm

Reference Value = 31.5 V/m

Power Drift = -0.3 dB

Maximum value of SAR = 1.02 mW/g

Touch position - Low/Zoom Scan (7x7x7) (7x7x7)/Cube 0: Measurement grid: dx=5mm, dy=5mm,
dz=5mm

Peak SAR (extrapolated) = 1.3 W/kg

SAR(1 g) = 0.929 mW/g; SAR(10 g) = 0.642 mW/g

Reference Value = 31.5 V/m

Power Drift = -0.3 dB

Maximum value of SAR = 0.978 mW/g

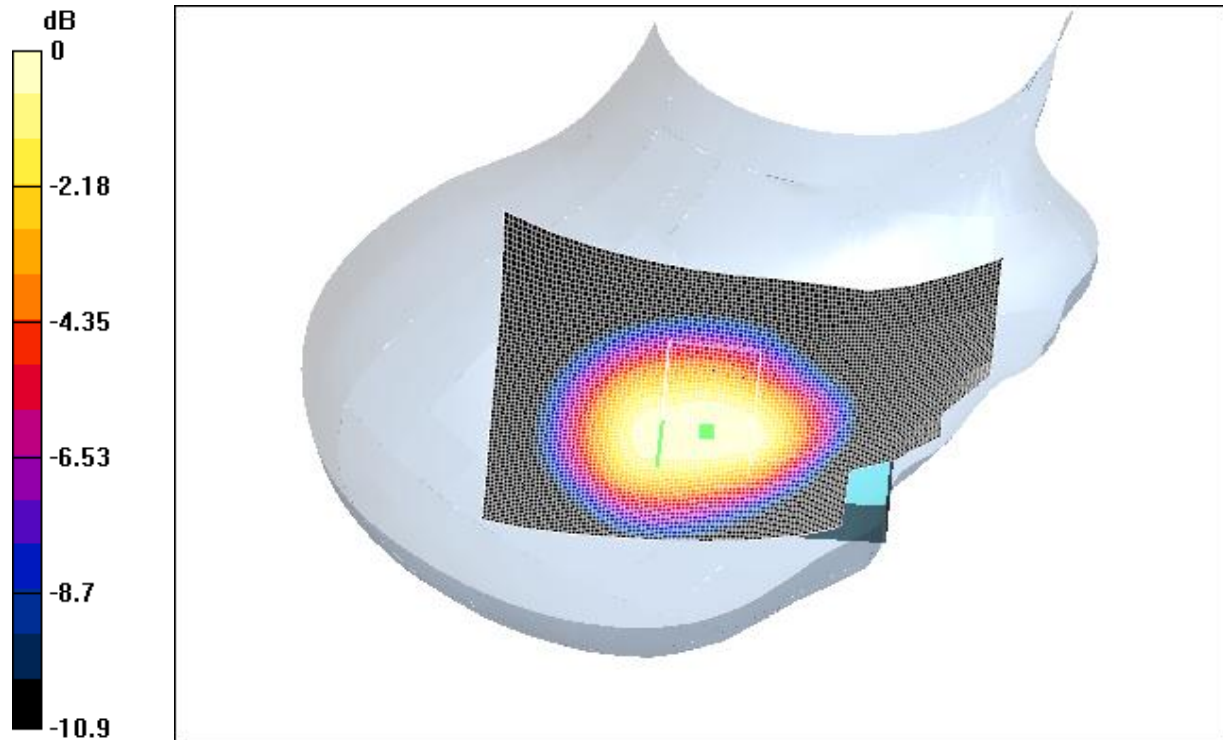

0 dB = 0.978mW/g

4.8 FCC-OET65-RightHandSide-Touch-GSM850-Mid

Date/Time: 07/11/05 19:35:21

Test Laboratory: SGS-GSM

File Name: [FCC-OET65-RightHandSide-Touch-GSM850.da4](#)

FCC-OET65-RightHandSide-Touch-GSM850-Mid

DUT: GSM50058; Type: Head; Serial: 20050705

Program: Compliance Testing: EN 50361 Protocol Right-Hand Side)

Communication System: GSM850; Frequency: 836.4 MHz;Duty Cycle: 1:8.3

Medium: HSL850 ($\sigma = 0.8773$ mho/m, $\epsilon_r = 41.699$, $\rho = 1000$ kg/m³)

Phantom section: Right Section

Measurement Standard: DASY4 (High Precision Assessment)

DASY4 Configuration:

- Probe: ET3DV6 - SN1774; ConvF(6.96, 6.96, 6.96); Calibrated: 2004-10-26
- Sensor-Surface: 4mm (Mechanical Surface Detection)
- Electronics: DAE3 Sn569; Calibrated: 2003-6-4
- Phantom: SAM 12; Type: SAM V4.0; Serial: TP-1283
- Measurement SW: DASY4, V4.1 Build 47; Postprocessing SW: SEMCAD, V1.6 Build 115

Touch position - Middle/Area Scan (71x111x1): Measurement grid: dx=15mm, dy=15mm

Reference Value = 31.7 V/m

Power Drift = 0.09 dB

Maximum value of SAR = 1.01 mW/g

Touch position - Middle/Zoom Scan (7x7x7)/Cube 0: Measurement grid: dx=5mm, dy=5mm, dz=5mm

Peak SAR (extrapolated) = 1.31 W/kg

SAR(1 g) = 0.958 mW/g; SAR(10 g) = 0.647 mW/g

Reference Value = 31.7 V/m

Power Drift = 0.09 dB

Maximum value of SAR = 1.01 mW/g

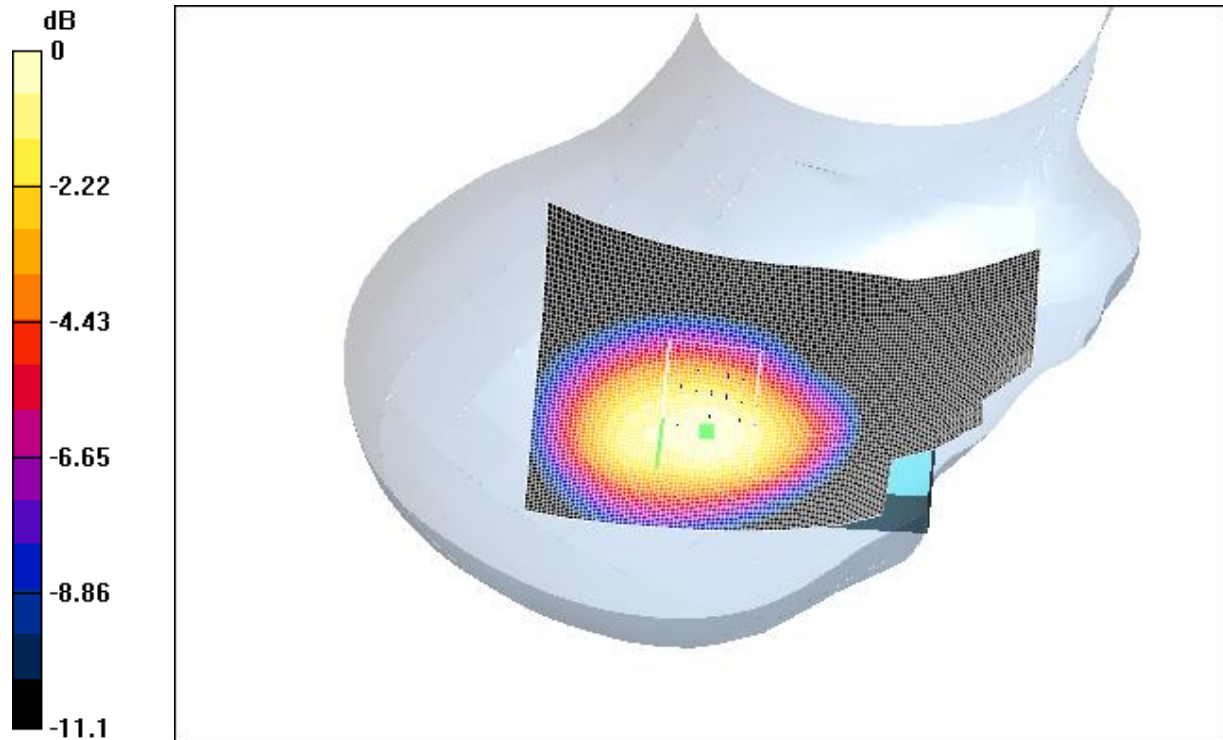

0 dB = 1.01mW/g

4.9 FCC-OET65-RightHandSide-Touch-GSM850-High

Date/Time: 07/11/05 19:35:21

Test Laboratory: SGS-GSM

File Name: [FCC-OET65-RightHandSide-Touch-GSM850.da4](#)

FCC-OET65-RightHandSide-Touch-GSM850-High

DUT: GSM50058; Type: Head; Serial: 20050705

Program: Compliance Testing: EN 50361 Protocol Right-Hand Side)

Communication System: GSM850; Frequency: 848.8 MHz;Duty Cycle: 1:8.3

Medium: HSL850 ($\sigma = 0.889355$ mho/m, $\epsilon_r = 41.5624$, $\rho = 1000$ kg/m³)

Phantom section: Right Section

Measurement Standard: DASYS4 (High Precision Assessment)

DASY4 Configuration:

- Probe: ET3DV6 - SN1774; ConvF(6.96, 6.96, 6.96); Calibrated: 2004-10-26
- Sensor-Surface: 4mm (Mechanical Surface Detection)
- Electronics: DAE3 Sn569; Calibrated: 2003-6-4
- Phantom: SAM 12; Type: SAM V4.0; Serial: TP-1283
- Measurement SW: DASYS4, V4.1 Build 47; Postprocessing SW: SEMCAD, V1.6 Build 115

Touch position - High/Area Scan (71x111x1): Measurement grid: dx=15mm, dy=15mm

Reference Value = 30.4 V/m

Power Drift = 0.04 dB

Maximum value of SAR = 1.04 mW/g

Touch position - High/Zoom Scan (7x7x7) (7x7x7)/Cube 0: Measurement grid: dx=5mm, dy=5mm,
dz=5mm

Peak SAR (extrapolated) = 1.34 W/kg

SAR(1 g) = 0.962 mW/g; SAR(10 g) = 0.664 mW/g

Reference Value = 30.4 V/m

Power Drift = 0.04 dB

Maximum value of SAR = 1.03 mW/g

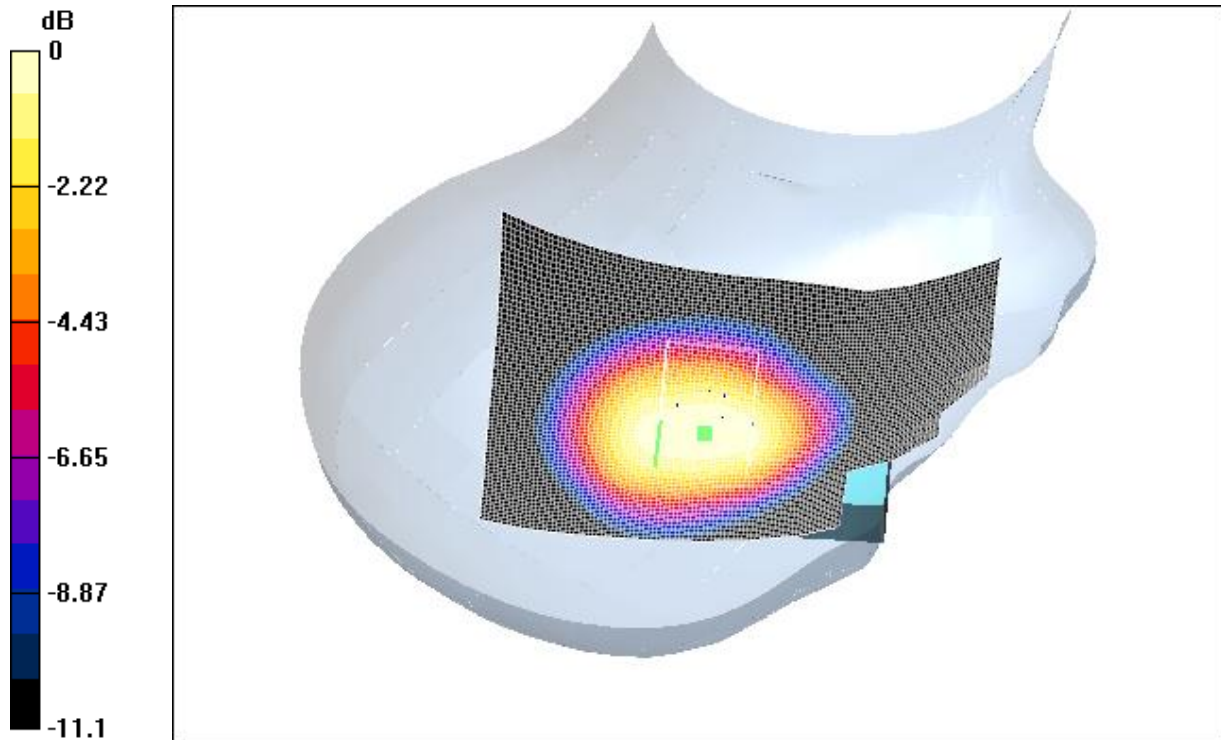

0 dB = 1.03mW/g

4.10 FCC-OET65-RightHandSide-Tilt-GSM850-Low

Date/Time: 07/11/05 21:09:18

Test Laboratory: SGS-GSM

File Name: [FCC-OET65-RightHandSide-Tilt-GSM850.da4](#)

FCC-OET65-RightHandSide-Tilt-GSM850-Low

DUT: GSM50058; Type: Head; Serial: 20050705

Program: Compliance Testing: EN 50361 Protocol Right-Hand Side)

Communication System: GSM850; Frequency: 824.2 MHz; Duty Cycle: 1:8.3

Medium: HSL850 ($\sigma = 0.865816$ mho/m, $\epsilon_r = 41.8373$, $\rho = 1000$ kg/m³)

Phantom section: Right Section

Measurement Standard: DASY4 (High Precision Assessment)

DASY4 Configuration:

- Probe: ET3DV6 - SN1774; ConvF(6.96, 6.96, 6.96); Calibrated: 2004-10-26
- Sensor-Surface: 4mm (Mechanical Surface Detection)
- Electronics: DAE3 Sn569; Calibrated: 2003-6-4
- Phantom: SAM 12; Type: SAM V4.0; Serial: TP-1283
- Measurement SW: DASY4, V4.1 Build 47; Postprocessing SW: SEMCAD, V1.6 Build 115

Tilt position - Low/Area Scan (71x111x1): Measurement grid: dx=15mm, dy=15mm

Reference Value = 26.1 V/m

Power Drift = -0.1 dB

Maximum value of SAR = 0.642 mW/g

Tilt position - Low/Zoom Scan (7x7x7) (7x7x7)/Cube 0: Measurement grid: dx=5mm, dy=5mm, dz=5mm

Peak SAR (extrapolated) = 0.872 W/kg

SAR(1 g) = 0.589 mW/g; SAR(10 g) = 0.395 mW/g

Reference Value = 26.1 V/m

Power Drift = -0.1 dB

Maximum value of SAR = 0.625 mW/g

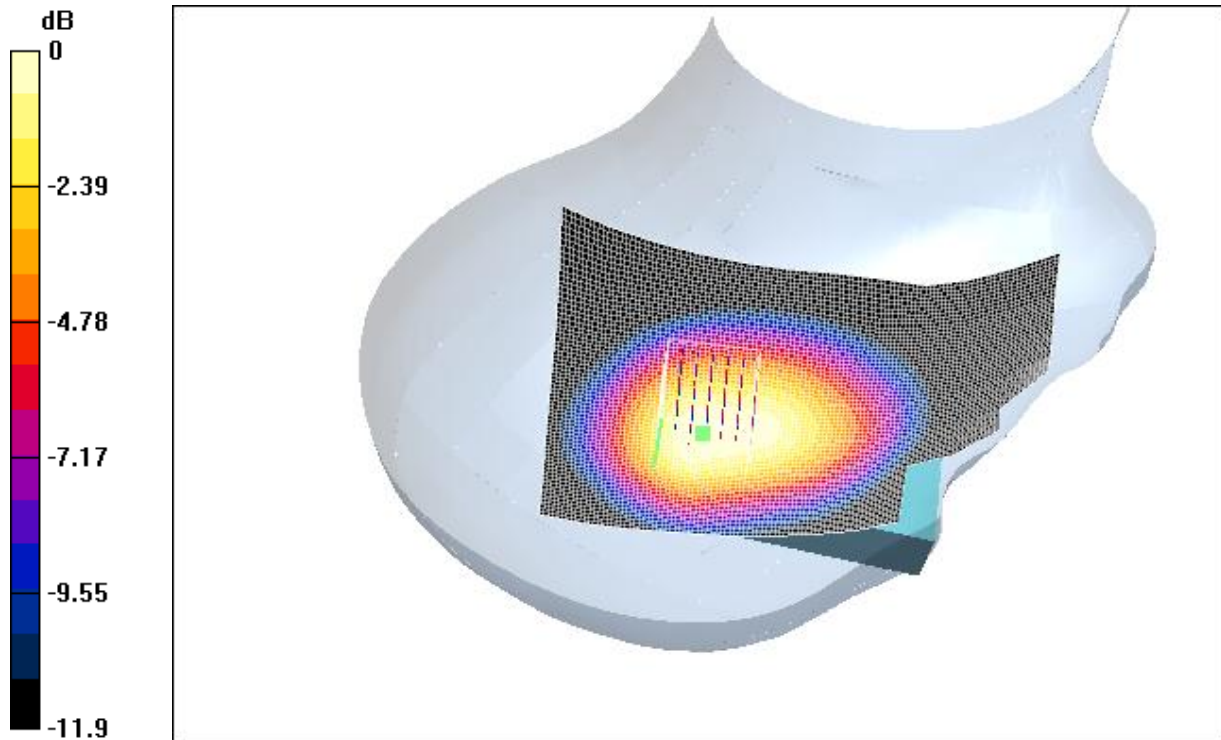

0 dB = 0.625mW/g

4.11 FCC-OET65-RightHandSide-Tilt-GSM850-Mid

Date/Time: 07/11/05 20:40:25

Test Laboratory: SGS-GSM

File Name: [FCC-OET65-RightHandSide-Tilt-GSM850.da4](#)

FCC-OET65-RightHandSide-Tilt-GSM850-Mid

DUT: GSM50058; Type: Head; Serial: 20050705

Program: Compliance Testing: EN 50361 Protocol Right-Hand Side)

Communication System: GSM850; Frequency: 836.4 MHz; Duty Cycle: 1:8.3

Medium: HSL850 ($\sigma = 0.8773$ mho/m, $\epsilon_r = 41.699$, $\rho = 1000$ kg/m³)

Phantom section: Right Section

Measurement Standard: DASY4 (High Precision Assessment)

DASY4 Configuration:

- Probe: ET3DV6 - SN1774; ConvF(6.96, 6.96, 6.96); Calibrated: 2004-10-26
- Sensor-Surface: 4mm (Mechanical Surface Detection)
- Electronics: DAE3 Sn569; Calibrated: 2003-6-4
- Phantom: SAM 12; Type: SAM V4.0; Serial: TP-1283
- Measurement SW: DASY4, V4.1 Build 47; Postprocessing SW: SEMCAD, V1.6 Build 115

Tilt position - Middle/Area Scan (71x111x1): Measurement grid: dx=15mm, dy=15mm

Reference Value = 26 V/m

Power Drift = -0.01 dB

Maximum value of SAR = 0.653 mW/g

Tilt position - Middle/Zoom Scan (7x7x7)/Cube 0: Measurement grid: dx=5mm, dy=5mm, dz=5mm

Peak SAR (extrapolated) = 0.887 W/kg

SAR(1 g) = 0.594 mW/g; SAR(10 g) = 0.4 mW/g

Reference Value = 26 V/m

Power Drift = -0.01 dB

Maximum value of SAR = 0.63 mW/g

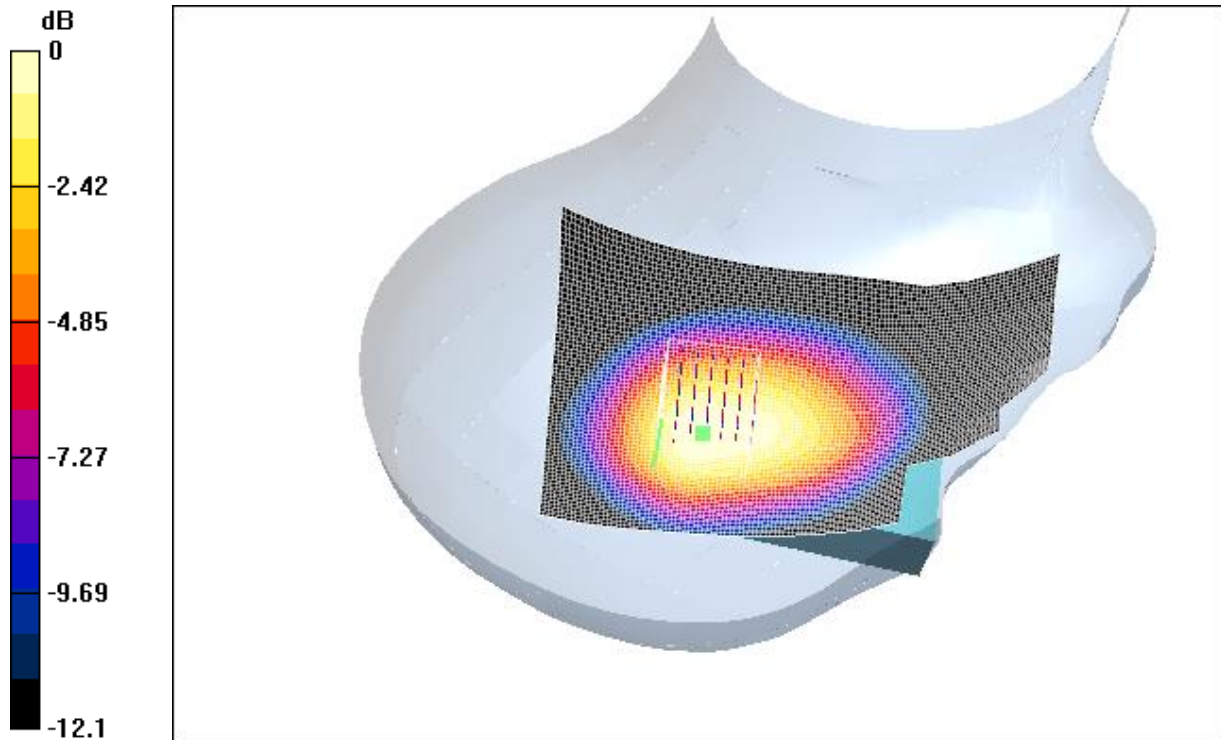

0 dB = 0.63mW/g

4.12 FCC-OET65-RightHandSide-Tilt-GSM850-High

Date/Time: 07/11/05 20:07:19

Test Laboratory: SGS-GSM

File Name: [FCC-OET65-RightHandSide-Tilt-GSM850.da4](#)

FCC-OET65-RightHandSide-Tilt-GSM850-High

DUT: GSM50058; Type: Head; Serial: 20050705

Program: Compliance Testing: EN 50361 Protocol Right-Hand Side)

Communication System: GSM850; Frequency: 848.8 MHz; Duty Cycle: 1:8.3

Medium: HSL850 ($\sigma = 0.889355$ mho/m, $\epsilon_r = 41.5624$, $\rho = 1000$ kg/m³)

Phantom section: Right Section

Measurement Standard: DASY4 (High Precision Assessment)

DASY4 Configuration:

- Probe: ET3DV6 - SN1774; ConvF(6.96, 6.96, 6.96); Calibrated: 2004-10-26
- Sensor-Surface: 4mm (Mechanical Surface Detection)
- Electronics: DAE3 Sn569; Calibrated: 2003-6-4
- Phantom: SAM 12; Type: SAM V4.0; Serial: TP-1283
- Measurement SW: DASY4, V4.1 Build 47; Postprocessing SW: SEMCAD, V1.6 Build 115

Tilt position - High/Area Scan (71x111x1): Measurement grid: dx=15mm, dy=15mm

Reference Value = 25.5 V/m

Power Drift = 0.1 dB

Maximum value of SAR = 0.65 mW/g

Tilt position - High/Zoom Scan (7x7x7) (7x7x7)/Cube 0: Measurement grid: dx=5mm, dy=5mm, dz=5mm

Peak SAR (extrapolated) = 0.891 W/kg

SAR(1 g) = 0.59 mW/g; SAR(10 g) = 0.396 mW/g

Reference Value = 25.5 V/m

Power Drift = 0.1 dB

Maximum value of SAR = 0.628 mW/g

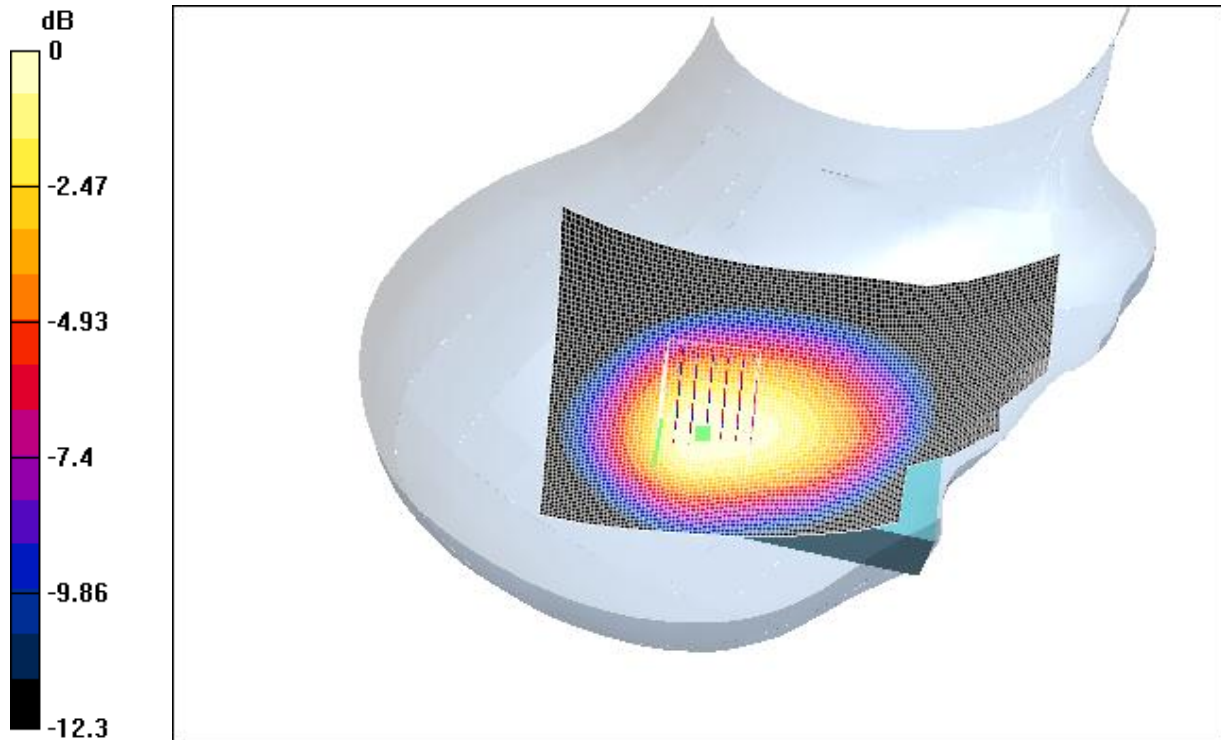

0 dB = 0.628mW/g

4.13 FCC-OET65-Body-Worn-GSM850-Low

Date/Time: 07/07/05 13:52:44

Test Laboratory: SGS-GSM

File Name: [FCC-OET65-Body-Worn-GSM850-01.da4](#)

FCC-OET65-Body-Worn-GSM850-Low

DUT: GSM50058; Type: Head; Serial: 20050705

Program: Compliance Testing: FCC OET65 Protocol (Body Worn)

Communication System: GSM850; Frequency: 824.2 MHz; Duty Cycle: 1:8.3

Medium: HSL850-Body ($\sigma = 0.982648$ mho/m, $\epsilon_r = 52.6441$, $\rho = 1000$ kg/m³)

Phantom section: Flat Section

Measurement Standard: DASY4 (High Precision Assessment)

DASY4 Configuration:

- Probe: ET3DV6 - SN1774; ConvF(6.65, 6.65, 6.65); Calibrated: 2004-10-26
- Sensor-Surface: 4mm (Mechanical Surface Detection)
- Electronics: DAE3 Sn569; Calibrated: 2003-6-4
- Phantom: SAM 12; Type: SAM V4.0; Serial: TP-1283
- Measurement SW: DASY4, V4.1 Build 47; Postprocessing SW: SEMCAD, V1.6 Build 115

Body Worn - Low/Area Scan (51x91x1): Measurement grid: dx=15mm, dy=15mm

Reference Value = 24.3 V/m

Power Drift = -0.04 dB

Maximum value of SAR = 1.07 mW/g

Body Worn - Low/Zoom Scan (7x7x7) (7x7x7)/Cube 0: Measurement grid: dx=5mm, dy=5mm, dz=5mm

Peak SAR (extrapolated) = 1.45 W/kg

SAR(1 g) = 0.963 mW/g; SAR(10 g) = 0.638 mW/g

Reference Value = 24.3 V/m

Power Drift = -0.04 dB

Maximum value of SAR = 1.02 mW/g

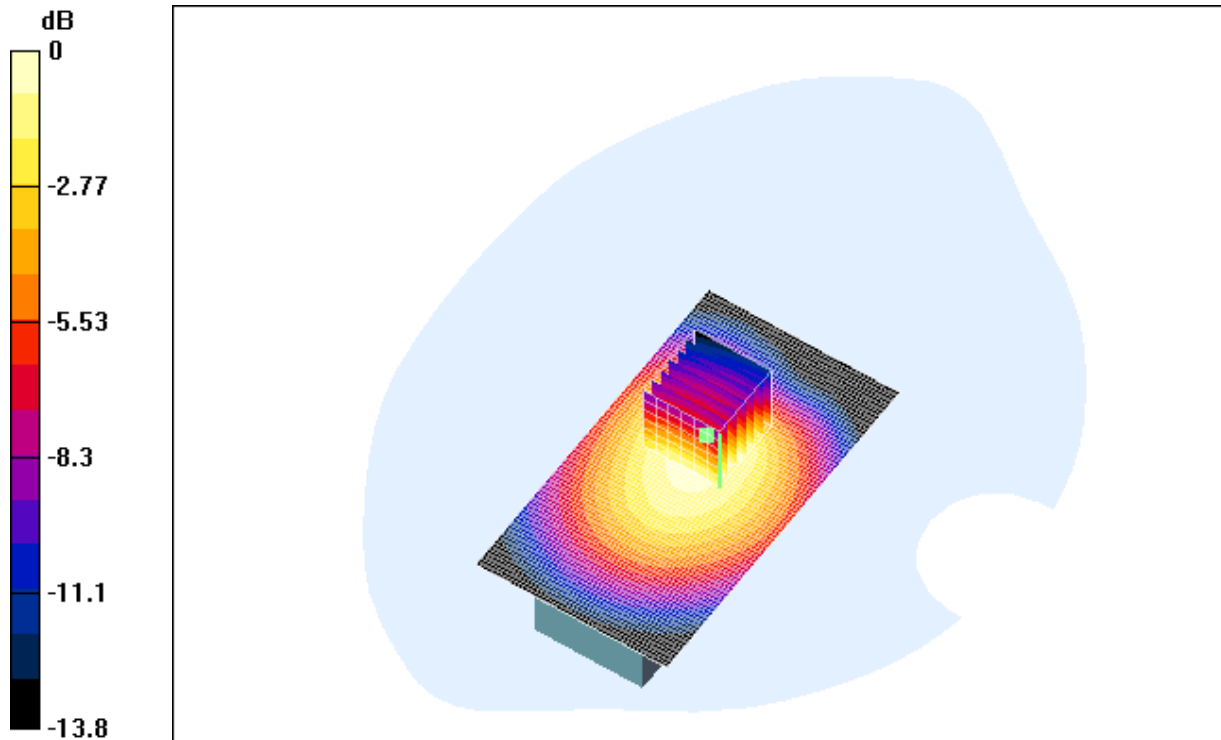

0 dB = 1.02mW/g

4.14 FCC-OET65-Body-Worn-GSM850-Mid

Date/Time: 07/06/05 16:12:48

Test Laboratory: SGS-GSM

File Name: [FCC-OET65-Body-Worn-GSM850-01.da4](#)

FCC-OET65-Body-Worn-GSM850-Mid

DUT: GSM50058; Type: Head; Serial: 20050705

Program: Compliance Testing: FCC OET65 Protocol (Body Worn)

Communication System: GSM850; Frequency: 836.4 MHz; Duty Cycle: 1:8.3

Medium: HSL850-Body ($\sigma = 0.99717$ mho/m, $\epsilon_r = 52.5261$, $\rho = 1000$ kg/m³)

Phantom section: Flat Section

Measurement Standard: DASY4 (High Precision Assessment)

DASY4 Configuration:

- Probe: ET3DV6 - SN1774; ConvF(6.65, 6.65, 6.65); Calibrated: 2004-10-26
- Sensor-Surface: 4mm (Mechanical Surface Detection)
- Electronics: DAE3 Sn569; Calibrated: 2003-6-4
- Phantom: SAM 12; Type: SAM V4.0; Serial: TP-1283
- Measurement SW: DASY4, V4.1 Build 47; Postprocessing SW: SEMCAD, V1.6 Build 115

Body Worn - Middle/Area Scan (51x91x1): Measurement grid: dx=15mm, dy=15mm

Reference Value = 16.8 V/m

Power Drift = 0.02 dB

Maximum value of SAR = 0.951 mW/g

Body Worn - Middle/Zoom Scan (7x7x7)/Cube 0: Measurement grid: dx=5mm, dy=5mm, dz=5mm

Peak SAR (extrapolated) = 1.31 W/kg

SAR(1 g) = 0.888 mW/g; SAR(10 g) = 0.592 mW/g

Reference Value = 16.8 V/m

Power Drift = 0.02 dB

Maximum value of SAR = 0.947 mW/g

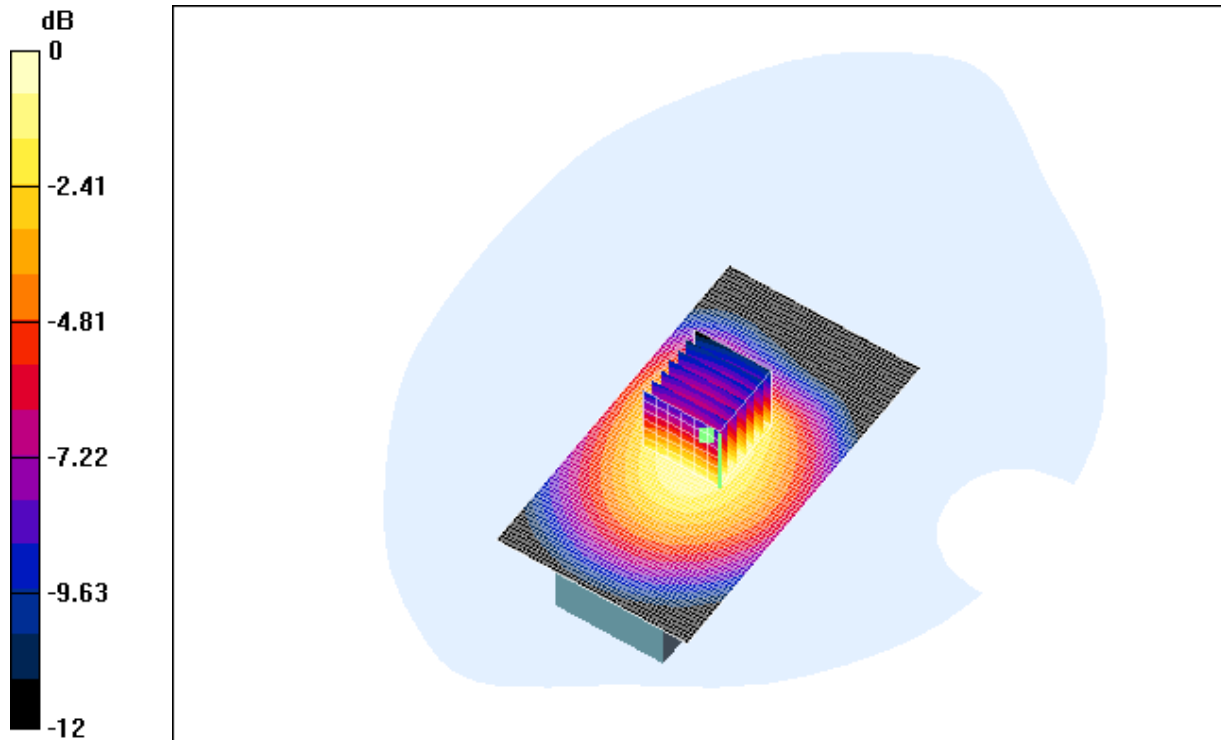

0 dB = 0.947mW/g

4.15 FCC-OET65-Body-Worn-GSM850-High

Date/Time: 07/07/05 13:52:44

Test Laboratory: SGS-GSM

File Name: [FCC-OET65-Body-Worn-GSM850-01.da4](#)

FCC-OET65-Body-Worn-GSM850-High

DUT: GSM50058; Type: Head; Serial: 20050705

Program: Compliance Testing: FCC OET65 Protocol (Body Worn)

Communication System: GSM850; Frequency: 848.8 MHz; Duty Cycle: 1:8.3

Medium: HSL850-Body ($\sigma = 1.01257$ mho/m, $\epsilon_r = 52.4876$, $\rho = 1000$ kg/m³)

Phantom section: Flat Section

Measurement Standard: DASY4 (High Precision Assessment)

DASY4 Configuration:

- Probe: ET3DV6 - SN1774; ConvF(6.65, 6.65, 6.65); Calibrated: 2004-10-26
- Sensor-Surface: 4mm (Mechanical Surface Detection)
- Electronics: DAE3 Sn569; Calibrated: 2003-6-4
- Phantom: SAM 12; Type: SAM V4.0; Serial: TP-1283
- Measurement SW: DASY4, V4.1 Build 47; Postprocessing SW: SEMCAD, V1.6 Build 115

Body Worn - High/Area Scan (51x91x1): Measurement grid: dx=15mm, dy=15mm

Reference Value = 25 V/m

Power Drift = -0.1 dB

Maximum value of SAR = 1.36 mW/g

Body Worn - High/Zoom Scan (7x7x7) (7x7x7)/Cube 0: Measurement grid: dx=5mm, dy=5mm, dz=5mm

Peak SAR (extrapolated) = 1.87 W/kg

SAR(1 g) = 1.23 mW/g; SAR(10 g) = 0.806 mW/g

Reference Value = 25 V/m

Power Drift = -0.1 dB

Maximum value of SAR = 1.31 mW/g

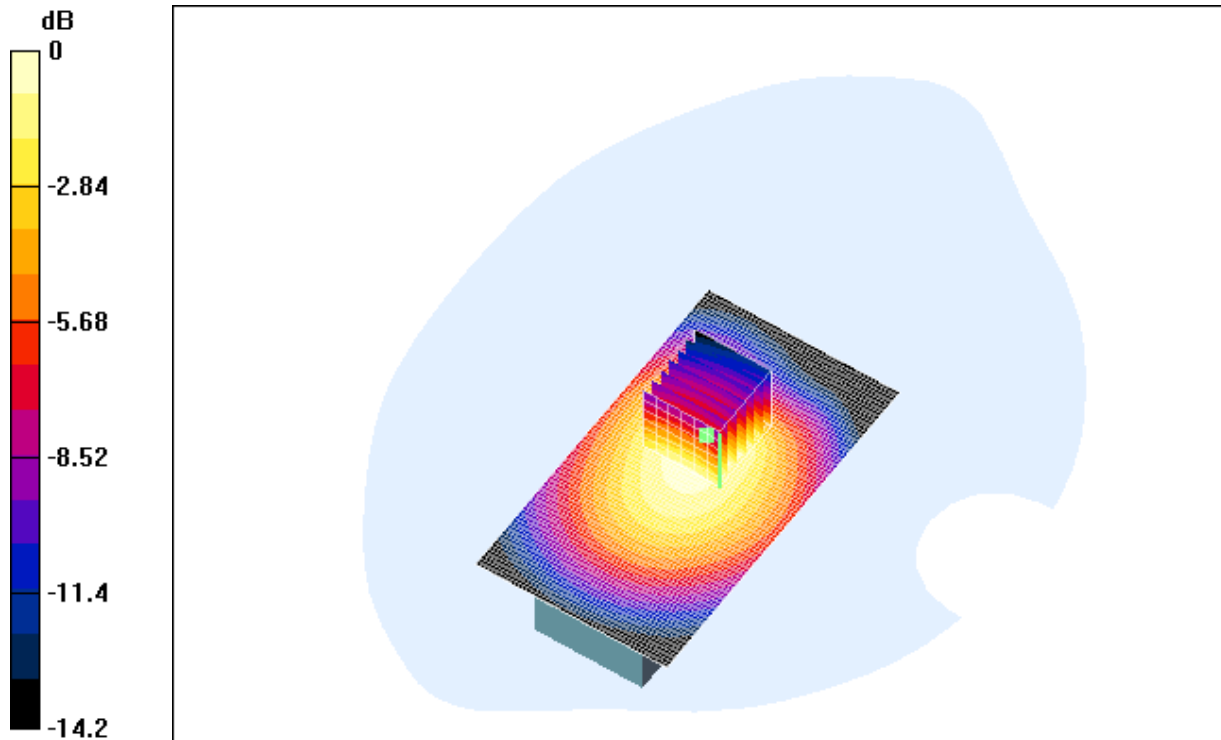

0 dB = 1.31mW/g

4.16 FCC-OET65-LeftHandSide-Touch-GSM1900-Low

Date/Time: 07/14/05 10:05:47

Test Laboratory: SGS-GSM

File Name: [FCC-OET65-LeftHandSide-Touch-GSM1900.da4](#)

FCC-OET65-LeftHandSide-Touch-GSM1900-Low

DUT: GSM50058; Type: Head; Serial: 20050714

Program: Compliance Testing: EN 50361 Protocol Left-Hand Side)

Communication System: DCS 1900; Frequency: 1850.2 MHz;Duty Cycle: 1:8.3

Medium: HSL1900 ($\sigma = 1.41808$ mho/m, $\epsilon_r = 40.5312$, $\rho = 1000$ kg/m³)

Phantom section: Left Section

Measurement Standard: DASY4 (High Precision Assessment)

DASY4 Configuration:

- Probe: ET3DV6 - SN1774; ConvF(5.25, 5.25, 5.25); Calibrated: 2004-10-26
- Sensor-Surface: 4mm (Mechanical Surface Detection)
- Electronics: DAE3 Sn569; Calibrated: 2003-6-4
- Phantom: SAM 12; Type: SAM V4.0; Serial: TP-1283
- Measurement SW: DASY4, V4.1 Build 47; Postprocessing SW: SEMCAD, V1.6 Build 115

Touch position - Low/Area Scan (71x111x1): Measurement grid: dx=15mm, dy=15mm

Reference Value = 10.9 V/m

Power Drift = -0.1 dB

Maximum value of SAR = 0.33 mW/g

Touch position - Low/Zoom Scan (7x7x7) (7x7x7)/Cube 0: Measurement grid: dx=5mm, dy=5mm,
dz=5mm

Peak SAR (extrapolated) = 0.473 W/kg

SAR(1 g) = 0.293 mW/g; SAR(10 g) = 0.157 mW/g

Reference Value = 10.9 V/m

Power Drift = -0.1 dB

Maximum value of SAR = 0.325 mW/g

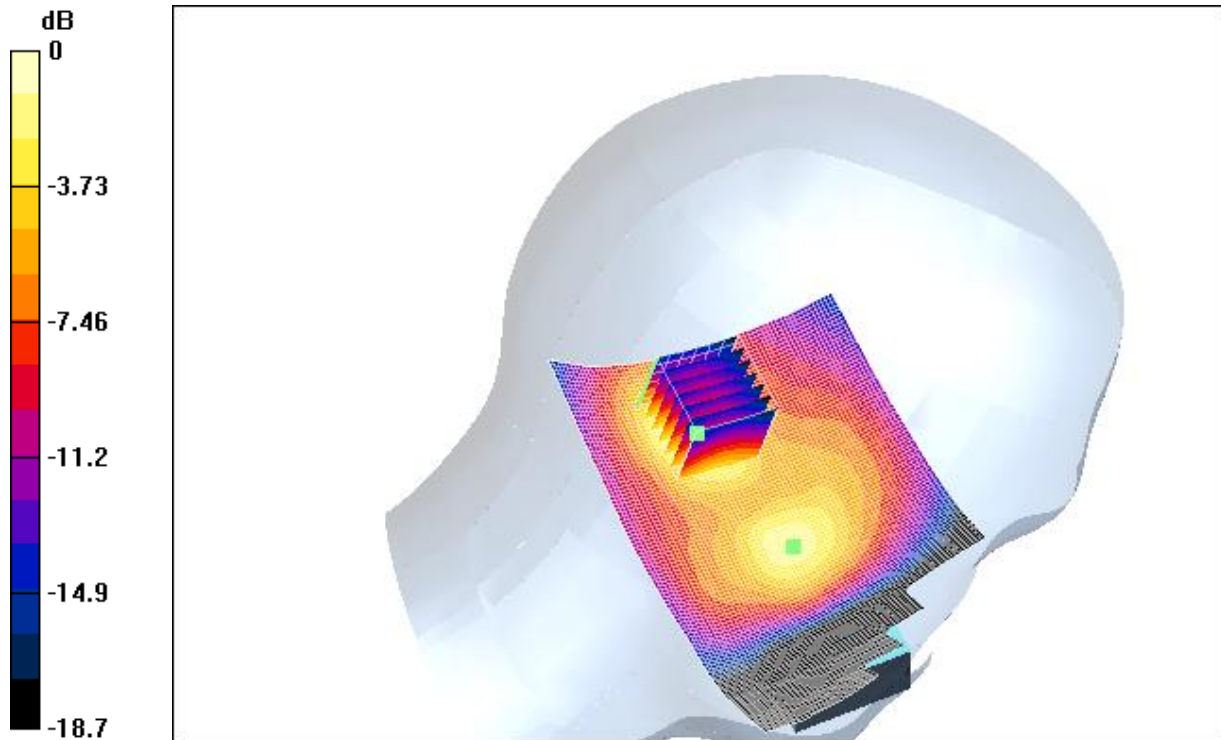

0 dB = 0.325mW/g

4.17 FCC-OET65-LeftHandSide-Touch-GSM1900-Mid

Date/Time: 07/14/05 09:31:18

Test Laboratory: SGS-GSM

File Name: [FCC-OET65-LeftHandSide-Touch-GSM1900.da4](#)

FCC-OET65-LeftHandSide-Touch-GSM1900-Mid

DUT: GSM50058; Type: Head; Serial: 20050714

Program: Compliance Testing: EN 50361 Protocol Left-Hand Side)

Communication System: DCS 1900; Frequency: 1880 MHz; Duty Cycle: 1:8.3

Medium: HSL1900 ($\sigma = 1.44443$ mho/m, $\epsilon_r = 40.3239$, $\rho = 1000$ kg/m³)

Phantom section: Left Section

Measurement Standard: DASY4 (High Precision Assessment)

DASY4 Configuration:

- Probe: ET3DV6 - SN1774; ConvF(5.25, 5.25, 5.25); Calibrated: 2004-10-26
- Sensor-Surface: 4mm (Mechanical Surface Detection)
- Electronics: DAE3 Sn569; Calibrated: 2003-6-4
- Phantom: SAM 12; Type: SAM V4.0; Serial: TP-1283
- Measurement SW: DASY4, V4.1 Build 47; Postprocessing SW: SEMCAD, V1.6 Build 115

Touch position - Middle/Area Scan (71x111x1): Measurement grid: dx=15mm, dy=15mm

Reference Value = 11.9 V/m

Power Drift = -0.2 dB

Maximum value of SAR = 0.42 mW/g

Touch position - Middle/Zoom Scan (7x7x7)/Cube 0: Measurement grid: dx=5mm, dy=5mm, dz=5mm

Peak SAR (extrapolated) = 0.601 W/kg

SAR(1 g) = 0.369 mW/g; SAR(10 g) = 0.197 mW/g

Reference Value = 11.9 V/m

Power Drift = -0.2 dB

Maximum value of SAR = 0.405 mW/g

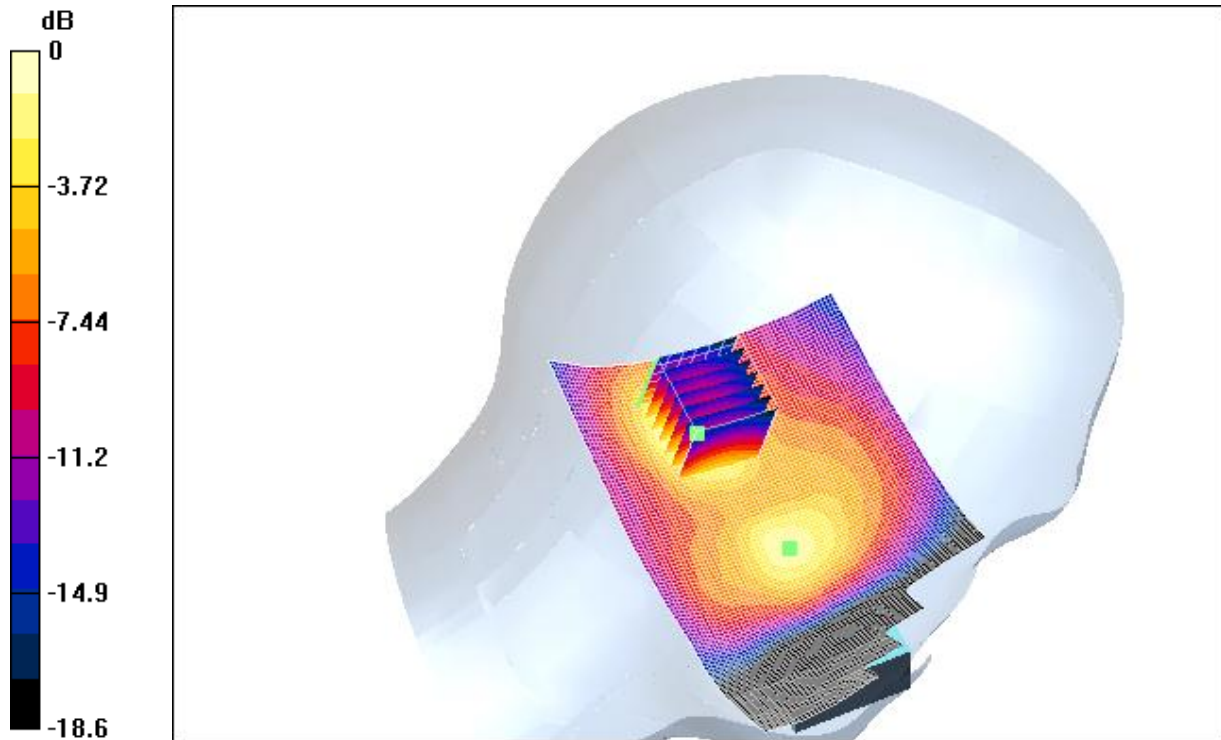

0 dB = 0.405mW/g

4.18 FCC-OET65-LeftHandSide-Touch-GSM1900-High

Date/Time: 07/14/05 10:39:43

Test Laboratory: SGS-GSM

File Name: [FCC-OET65-LeftHandSide-Touch-GSM1900.da4](#)

FCC-OET65-LeftHandSide-Touch-GSM1900-High

DUT: GSM50058; Type: Head; Serial: 20050714

Program: Compliance Testing: EN 50361 Protocol Left-Hand Side)

Communication System: DCS 1900; Frequency: 1909.8 MHz;Duty Cycle: 1:8.3

Medium: HSL1900 ($\sigma = 1.46824$ mho/m, $\epsilon_r = 39.9929$, $\rho = 1000$ kg/m³)

Phantom section: Left Section

Measurement Standard: DASYS4 (High Precision Assessment)

DASY4 Configuration:

- Probe: ET3DV6 - SN1774; ConvF(5.25, 5.25, 5.25); Calibrated: 2004-10-26
- Sensor-Surface: 4mm (Mechanical Surface Detection)
- Electronics: DAE3 Sn569; Calibrated: 2003-6-4
- Phantom: SAM 12; Type: SAM V4.0; Serial: TP-1283
- Measurement SW: DASYS4, V4.1 Build 47; Postprocessing SW: SEMCAD, V1.6 Build 115

Touch position - High/Area Scan (71x111x1): Measurement grid: dx=15mm, dy=15mm

Reference Value = 11.3 V/m

Power Drift = -0.06 dB

Maximum value of SAR = 0.391 mW/g

Touch position - High/Zoom Scan (7x7x7) (7x7x7)/Cube 0: Measurement grid: dx=5mm, dy=5mm,
dz=5mm

Peak SAR (extrapolated) = 0.58 W/kg

SAR(1 g) = 0.35 mW/g; SAR(10 g) = 0.183 mW/g

Reference Value = 11.3 V/m

Power Drift = -0.06 dB

Maximum value of SAR = 0.39 mW/g

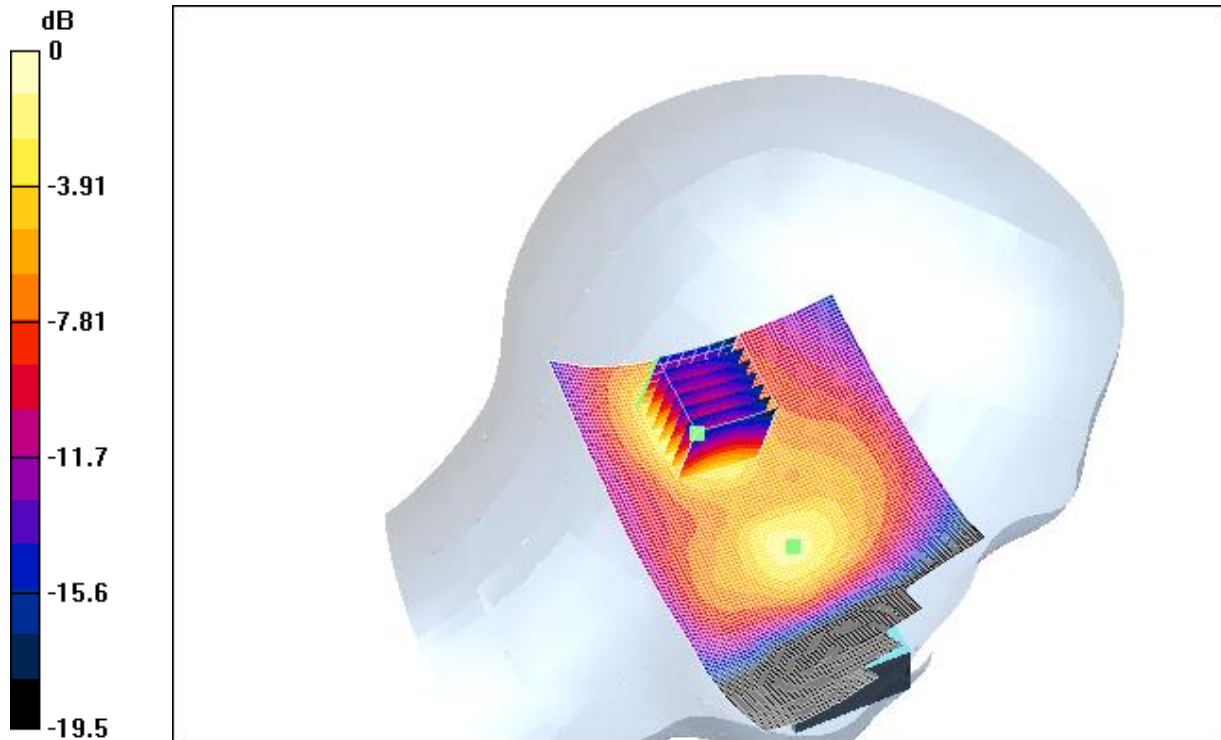

0 dB = 0.39mW/g

4.19 FCC-OET65-LeftHandSide-Tilt-GSM1900-Low

Date/Time: 07/14/05 13:10:52

Test Laboratory: SGS-GSM

File Name: [FCC-OET65-LeftHandSide-Tilt-GSM1900.da4](#)

FCC-OET65-LeftHandSide-Tilt-GSM1900-Low

DUT: GSM50058; Type: Head; Serial: 20050714

Program: Compliance Testing: EN 50361 Protocol Left-Hand Side)

Communication System: DCS 1900; Frequency: 1850.2 MHz;Duty Cycle: 1:8.3

Medium: HSL1900 ($\sigma = 1.41808$ mho/m, $\epsilon_r = 40.5312$, $\rho = 1000$ kg/m³)

Phantom section: Left Section

Measurement Standard: DASY4 (High Precision Assessment)

DASY4 Configuration:

- Probe: ET3DV6 - SN1774; ConvF(5.25, 5.25, 5.25); Calibrated: 2004-10-26
- Sensor-Surface: 4mm (Mechanical Surface Detection)
- Electronics: DAE3 Sn569; Calibrated: 2003-6-4
- Phantom: SAM 12; Type: SAM V4.0; Serial: TP-1283
- Measurement SW: DASY4, V4.1 Build 47; Postprocessing SW: SEMCAD, V1.6 Build 115

Tilt position - Low/Area Scan (71x111x1): Measurement grid: dx=15mm, dy=15mm

Reference Value = 11.8 V/m

Power Drift = -0.08 dB

Maximum value of SAR = 0.47 mW/g

Tilt position - Low/Zoom Scan (7x7x7) (7x7x7)/Cube 0: Measurement grid: dx=5mm, dy=5mm, dz=5mm

Peak SAR (extrapolated) = 0.71 W/kg

SAR(1 g) = 0.422 mW/g; SAR(10 g) = 0.221 mW/g

Reference Value = 11.8 V/m

Power Drift = -0.08 dB

Maximum value of SAR = 0.469 mW/g

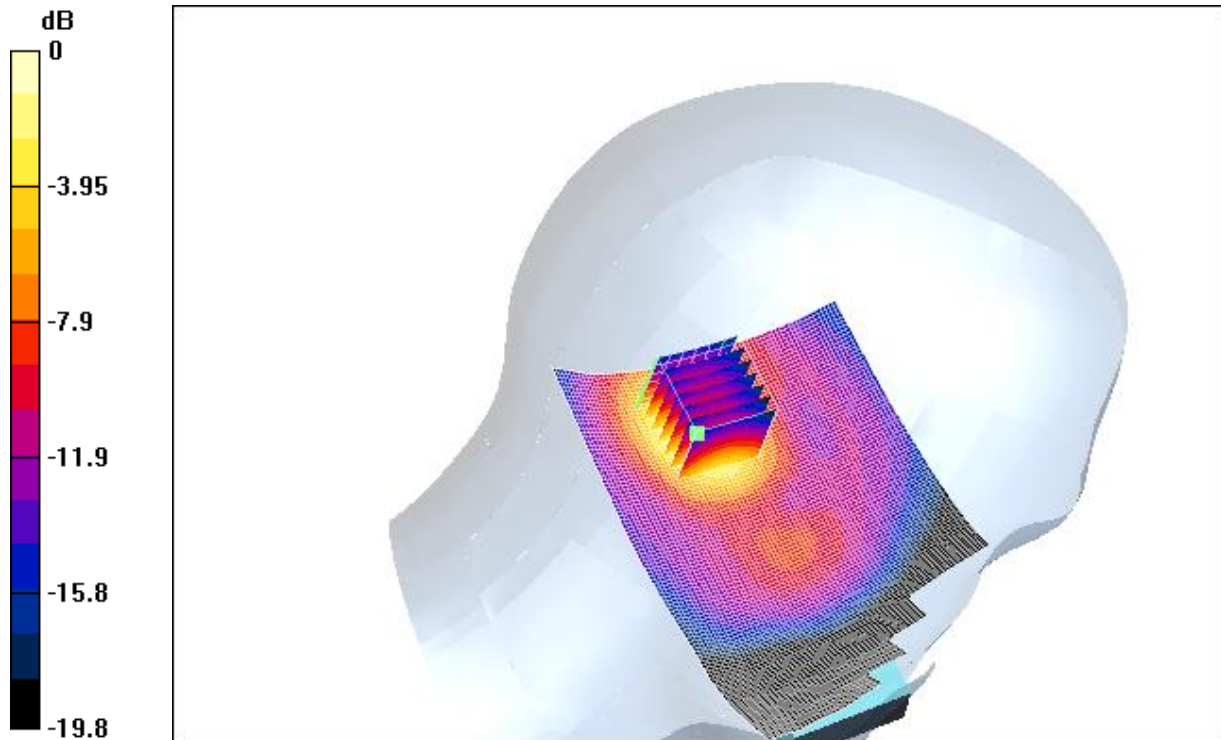

0 dB = 0.469mW/g

4.20 FCC-OET65-LeftHandSide-Tilt-GSM1900-Mid

Date/Time: 07/14/05 13:10:52

Test Laboratory: SGS-GSM

File Name: [FCC-OET65-LeftHandSide-Tilt-GSM1900.da4](#)

FCC-OET65-LeftHandSide-Tilt-GSM1900-Mid

DUT: GSM50058; Type: Head; Serial: 20050714

Program: Compliance Testing: EN 50361 Protocol Left-Hand Side)

Communication System: DCS 1900; Frequency: 1880 MHz;Duty Cycle: 1:8.3

Medium: HSL1900 ($\sigma = 1.44443$ mho/m, $\epsilon_r = 40.3239$, $\rho = 1000$ kg/m³)

Phantom section: Left Section

Measurement Standard: DASYS4 (High Precision Assessment)

DASY4 Configuration:

- Probe: ET3DV6 - SN1774; ConvF(5.25, 5.25, 5.25); Calibrated: 2004-10-26
- Sensor-Surface: 4mm (Mechanical Surface Detection)
- Electronics: DAE3 Sn569; Calibrated: 2003-6-4
- Phantom: SAM 12; Type: SAM V4.0; Serial: TP-1283
- Measurement SW: DASYS4, V4.1 Build 47; Postprocessing SW: SEMCAD, V1.6 Build 115

Tilt position - Middle/Area Scan (71x111x1): Measurement grid: dx=15mm, dy=15mm

Reference Value = 12.7 V/m

Power Drift = -0.04 dB

Maximum value of SAR = 0.609 mW/g

Tilt position - Middle/Zoom Scan (7x7x7)/Cube 0: Measurement grid: dx=5mm, dy=5mm, dz=5mm

Peak SAR (extrapolated) = 0.955 W/kg

SAR(1 g) = 0.55 mW/g; SAR(10 g) = 0.281 mW/g

Reference Value = 12.7 V/m

Power Drift = -0.04 dB

Maximum value of SAR = 0.619 mW/g

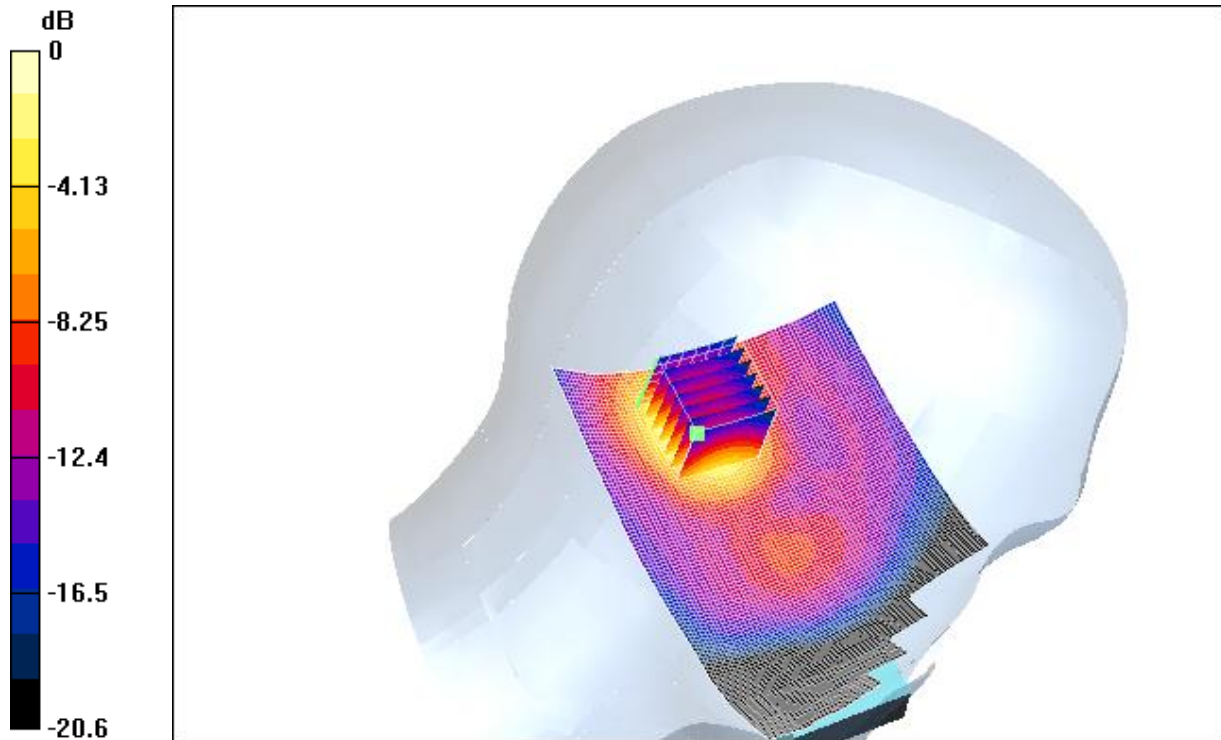

0 dB = 0.619mW/g

4.21 FCC-OET65-LeftHandSide-Tilt-GSM1900-High

Date/Time: 07/14/05 13:10:52

Test Laboratory: SGS-GSM

File Name: [FCC-OET65-LeftHandSide-Tilt-GSM1900.da4](#)

FCC-OET65-LeftHandSide-Tilt-GSM1900-High

DUT: GSM50058; Type: Head; Serial: 20050714

Program: Compliance Testing: EN 50361 Protocol Left-Hand Side)

Communication System: DCS 1900; Frequency: 1909.8 MHz;Duty Cycle: 1:8.3

Medium: HSL1900 ($\sigma = 1.46824$ mho/m, $\epsilon_r = 39.9929$, $\rho = 1000$ kg/m³)

Phantom section: Left Section

Measurement Standard: DASY4 (High Precision Assessment)

DASY4 Configuration:

- Probe: ET3DV6 - SN1774; ConvF(5.25, 5.25, 5.25); Calibrated: 2004-10-26
- Sensor-Surface: 4mm (Mechanical Surface Detection)
- Electronics: DAE3 Sn569; Calibrated: 2003-6-4
- Phantom: SAM 12; Type: SAM V4.0; Serial: TP-1283
- Measurement SW: DASY4, V4.1 Build 47; Postprocessing SW: SEMCAD, V1.6 Build 115

Tilt position - High/Area Scan (71x111x1): Measurement grid: dx=15mm, dy=15mm

Reference Value = 11.8 V/m

Power Drift = 0.002 dB

Maximum value of SAR = 0.559 mW/g

Tilt position - High/Zoom Scan (7x7x7) (7x7x7)/Cube 0: Measurement grid: dx=5mm, dy=5mm, dz=5mm

Peak SAR (extrapolated) = 0.883 W/kg

SAR(1 g) = 0.502 mW/g; SAR(10 g) = 0.253 mW/g

Reference Value = 11.8 V/m

Power Drift = 0.002 dB

Maximum value of SAR = 0.561 mW/g

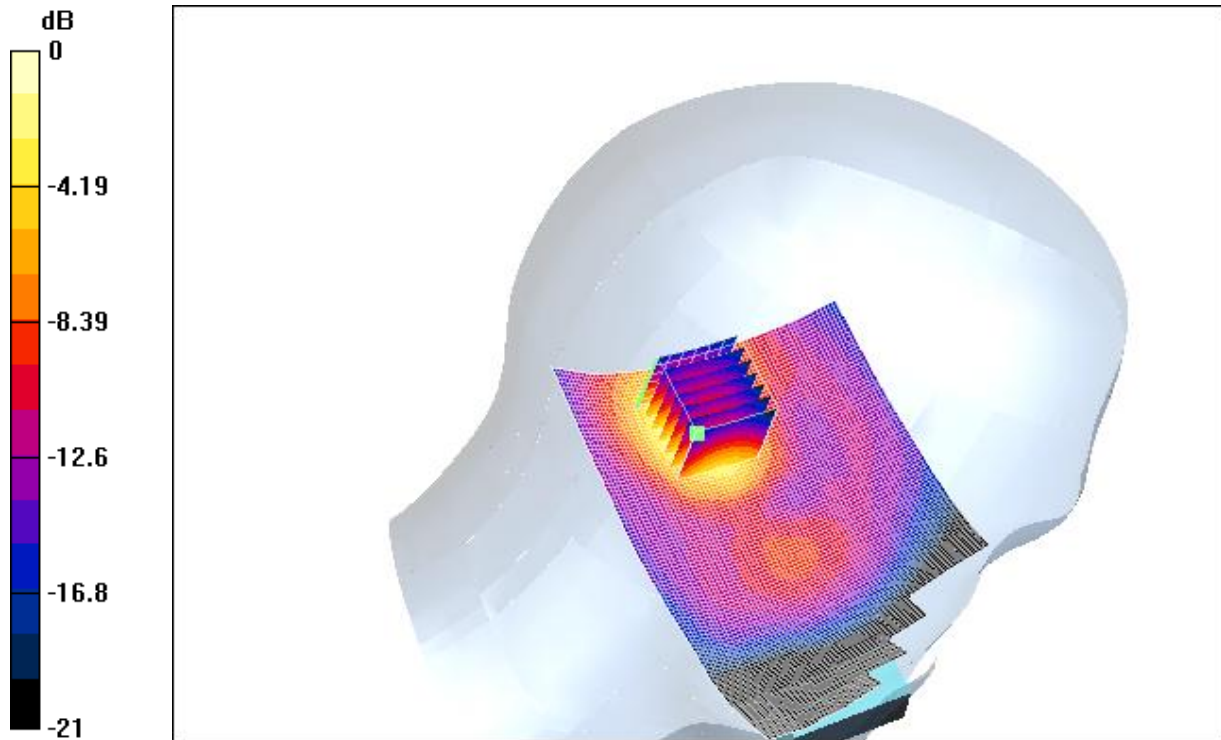

0 dB = 0.561mW/g

4.22 FCC-OET65-RightHandSide-Touch-GSM1900-Low

Date/Time: 07/14/05 15:33:12

Test Laboratory: SGS-GSM

File Name: [FCC-OET65-RightHandSide-Touch-GSM1900.da4](#)

FCC-OET65-RightHandSide-Touch-GSM1900-Low

DUT: GSM50058; Type: Head; Serial: 20050714

Program: Compliance Testing: EN 50361 Protocol Right-Hand Side)

Communication System: DCS 1900; Frequency: 1850.2 MHz; Duty Cycle: 1:8.3

Medium: HSL1900 ($\sigma = 1.41808$ mho/m, $\epsilon_r = 40.5312$, $\rho = 1000$ kg/m³)

Phantom section: Right Section

Measurement Standard: DASY4 (High Precision Assessment)

DASY4 Configuration:

- Probe: ET3DV6 - SN1774; ConvF(5.25, 5.25, 5.25); Calibrated: 2004-10-26
- Sensor-Surface: 4mm (Mechanical Surface Detection)
- Electronics: DAE3 Sn569; Calibrated: 2003-6-4
- Phantom: SAM 12; Type: SAM V4.0; Serial: TP-1283
- Measurement SW: DASY4, V4.1 Build 47; Postprocessing SW: SEMCAD, V1.6 Build 115

Touch position - Low/Area Scan (71x111x1): Measurement grid: dx=15mm, dy=15mm

Reference Value = 13.2 V/m

Power Drift = 0.008 dB

Maximum value of SAR = 0.47 mW/g

Touch position - Low/Zoom Scan (7x7x7) (7x7x7)/Cube 0: Measurement grid: dx=5mm, dy=5mm,
dz=5mm

Peak SAR (extrapolated) = 0.716 W/kg

SAR(1 g) = 0.425 mW/g; SAR(10 g) = 0.223 mW/g

Reference Value = 13.2 V/m

Power Drift = 0.008 dB

Maximum value of SAR = 0.476 mW/g

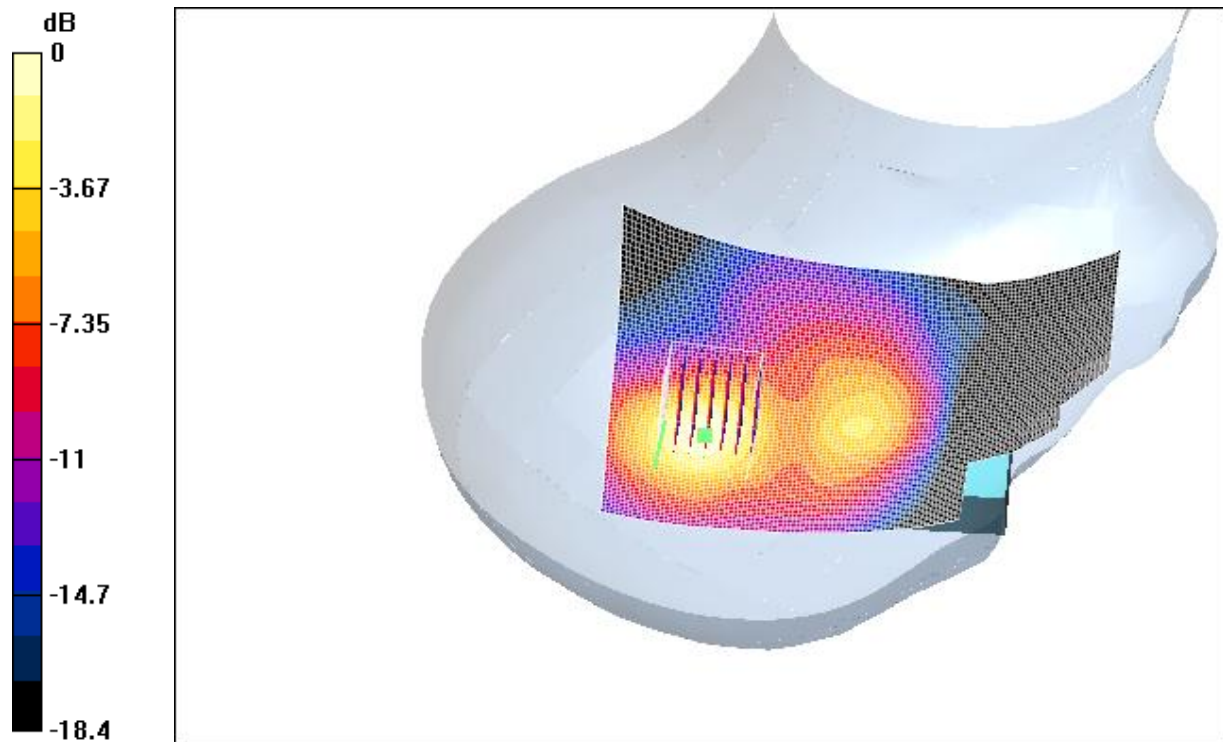

0 dB = 0.476mW/g

4.23 FCC-OET65-RightHandSide-Touch-GSM1900-Mid

Date/Time: 07/14/05 15:33:12

Test Laboratory: SGS-GSM

File Name: [FCC-OET65-RightHandSide-Touch-GSM1900.da4](#)

FCC-OET65-RightHandSide-Touch-GSM1900-Mid

DUT: GSM50058; Type: Head; Serial: 20050714

Program: Compliance Testing: EN 50361 Protocol Right-Hand Side)

Communication System: DCS 1900; Frequency: 1880 MHz;Duty Cycle: 1:8.3

Medium: HSL1900 ($\sigma = 1.44443$ mho/m, $\epsilon_r = 40.3239$, $\rho = 1000$ kg/m³)

Phantom section: Right Section

Measurement Standard: DASY4 (High Precision Assessment)

DASY4 Configuration:

- Probe: ET3DV6 - SN1774; ConvF(5.25, 5.25, 5.25); Calibrated: 2004-10-26
- Sensor-Surface: 4mm (Mechanical Surface Detection)
- Electronics: DAE3 Sn569; Calibrated: 2003-6-4
- Phantom: SAM 12; Type: SAM V4.0; Serial: TP-1283
- Measurement SW: DASY4, V4.1 Build 47; Postprocessing SW: SEMCAD, V1.6 Build 115

Touch position - Middle/Area Scan (71x111x1): Measurement grid: dx=15mm, dy=15mm

Reference Value = 14.8 V/m

Power Drift = 0.005 dB

Maximum value of SAR = 0.574 mW/g

Touch position - Middle/Zoom Scan (7x7x7)/Cube 0: Measurement grid: dx=5mm, dy=5mm, dz=5mm

Peak SAR (extrapolated) = 0.901 W/kg

SAR(1 g) = 0.528 mW/g; SAR(10 g) = 0.272 mW/g

Reference Value = 14.8 V/m

Power Drift = 0.005 dB

Maximum value of SAR = 0.586 mW/g

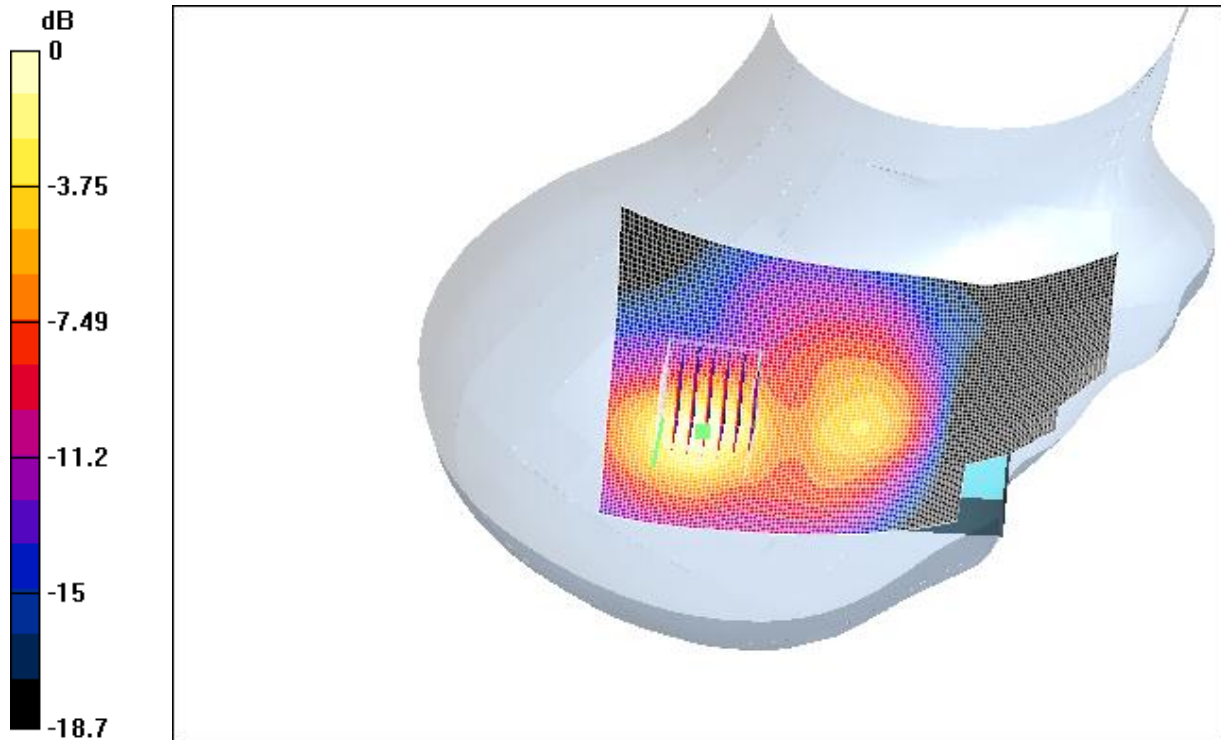

0 dB = 0.586mW/g

4.24 FCC-OET65-RightHandSide-Touch-GSM1900-High

Date/Time: 07/14/05 15:33:12

Test Laboratory: SGS-GSM

File Name: [FCC-OET65-RightHandSide-Touch-GSM1900.da4](#)

FCC-OET65-RightHandSide-Touch-GSM1900-High

DUT: GSM50058; Type: Head; Serial: 20050714

Program: Compliance Testing: EN 50361 Protocol Right-Hand Side)

Communication System: DCS 1900; Frequency: 1909.8 MHz;Duty Cycle: 1:8.3

Medium: HSL1900 ($\sigma = 1.46824$ mho/m, $\epsilon_r = 39.9929$, $\rho = 1000$ kg/m³)

Phantom section: Right Section

Measurement Standard: DASYS4 (High Precision Assessment)

DASY4 Configuration:

- Probe: ET3DV6 - SN1774; ConvF(5.25, 5.25, 5.25); Calibrated: 2004-10-26
- Sensor-Surface: 4mm (Mechanical Surface Detection)
- Electronics: DAE3 Sn569; Calibrated: 2003-6-4
- Phantom: SAM 12; Type: SAM V4.0; Serial: TP-1283
- Measurement SW: DASYS4, V4.1 Build 47; Postprocessing SW: SEMCAD, V1.6 Build 115

Touch position - High/Area Scan (71x111x1): Measurement grid: dx=15mm, dy=15mm

Reference Value = 14 V/m

Power Drift = 0.02 dB

Maximum value of SAR = 0.506 mW/g

Touch position - High/Zoom Scan (7x7x7) (7x7x7)/Cube 0: Measurement grid: dx=5mm, dy=5mm,
dz=5mm

Peak SAR (extrapolated) = 0.816 W/kg

SAR(1 g) = 0.474 mW/g; SAR(10 g) = 0.244 mW/g

Reference Value = 14 V/m

Power Drift = 0.02 dB

Maximum value of SAR = 0.53 mW/g

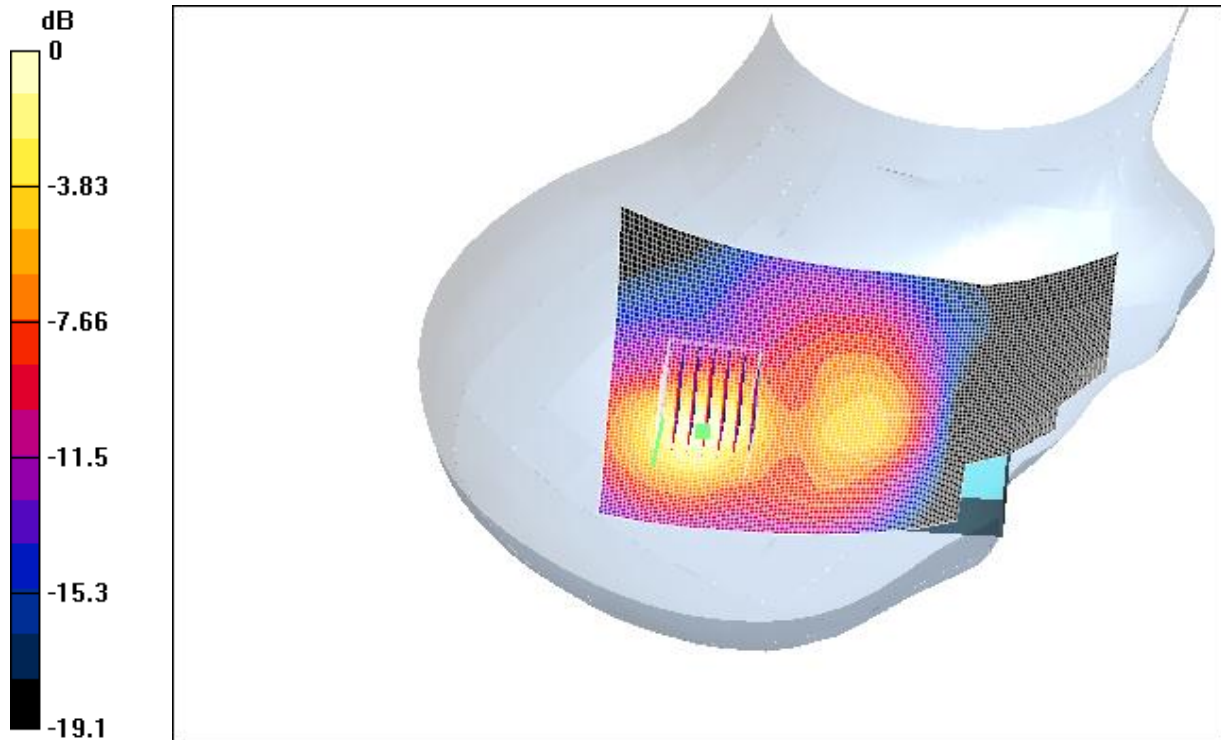

0 dB = 0.53mW/g

4.25 FCC-OET65-RightHandSide-Tilt-GSM1900-Low

Date/Time: 07/14/05 18:08:18

Test Laboratory: SGS-GSM

File Name: [FCC-OET65-RightHandSide-Tilt-GSM1900.da4](#)

FCC-OET65-RightHandSide-Tilt-GSM1900-Low

DUT: GSM50058; Type: Head; Serial: 20050714

Program: Compliance Testing: EN 50361 Protocol Right-Hand Side)

Communication System: DCS 1900; Frequency: 1850.2 MHz;Duty Cycle: 1:8.3

Medium: HSL1900 ($\sigma = 1.41808$ mho/m, $\epsilon_r = 40.5312$, $\rho = 1000$ kg/m³)

Phantom section: Right Section

Measurement Standard: DASY4 (High Precision Assessment)

DASY4 Configuration:

- Probe: ET3DV6 - SN1774; ConvF(5.25, 5.25, 5.25); Calibrated: 2004-10-26
- Sensor-Surface: 4mm (Mechanical Surface Detection)
- Electronics: DAE3 Sn569; Calibrated: 2003-6-4
- Phantom: SAM 12; Type: SAM V4.0; Serial: TP-1283
- Measurement SW: DASY4, V4.1 Build 47; Postprocessing SW: SEMCAD, V1.6 Build 115

Tilt position - Low/Area Scan (71x111x1): Measurement grid: dx=15mm, dy=15mm

Reference Value = 13 V/m

Power Drift = 0.03 dB

Maximum value of SAR = 0.527 mW/g

Tilt position - Low/Zoom Scan (7x7x7) (7x7x7)/Cube 0: Measurement grid: dx=5mm, dy=5mm, dz=5mm

Peak SAR (extrapolated) = 0.889 W/kg

SAR(1 g) = 0.501 mW/g; SAR(10 g) = 0.254 mW/g

Reference Value = 13 V/m

Power Drift = 0.03 dB

Maximum value of SAR = 0.559 mW/g

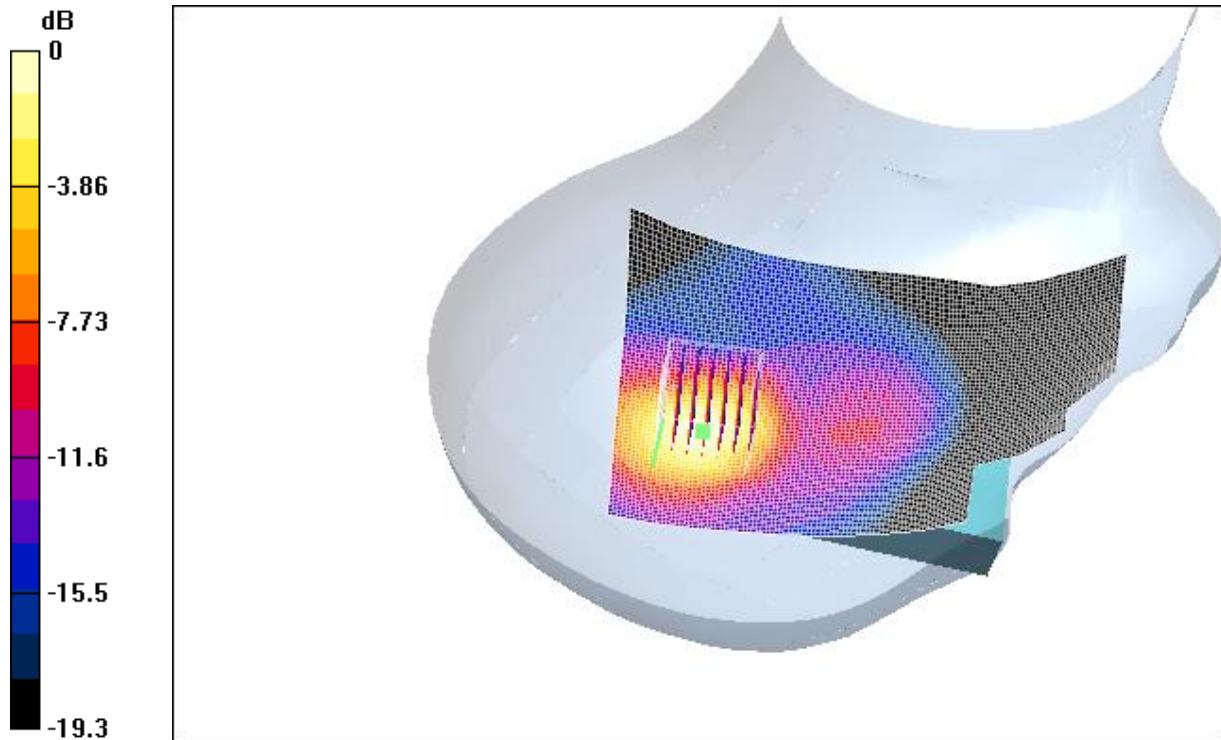

0 dB = 0.559mW/g

4.26 FCC-OET65-RightHandSide-Tilt-GSM1900-Mid

Date/Time: 07/14/05 18:08:18

Test Laboratory: SGS-GSM

File Name: [FCC-OET65-RightHandSide-Tilt-GSM1900.da4](#)

FCC-OET65-RightHandSide-Tilt-GSM1900-Mid

DUT: GSM50058; Type: Head; Serial: 20050714

Program: Compliance Testing: EN 50361 Protocol Right-Hand Side)

Communication System: DCS 1900; Frequency: 1880 MHz;Duty Cycle: 1:8.3

Medium: HSL1900 ($\sigma = 1.44443$ mho/m, $\epsilon_r = 40.3239$, $\rho = 1000$ kg/m³)

Phantom section: Right Section

Measurement Standard: DASYS4 (High Precision Assessment)

DASY4 Configuration:

- Probe: ET3DV6 - SN1774; ConvF(5.25, 5.25, 5.25); Calibrated: 2004-10-26
- Sensor-Surface: 4mm (Mechanical Surface Detection)
- Electronics: DAE3 Sn569; Calibrated: 2003-6-4
- Phantom: SAM 12; Type: SAM V4.0; Serial: TP-1283
- Measurement SW: DASYS4, V4.1 Build 47; Postprocessing SW: SEMCAD, V1.6 Build 115

Tilt position - Middle/Area Scan (71x111x1): Measurement grid: dx=15mm, dy=15mm

Reference Value = 14.6 V/m

Power Drift = -0.05 dB

Maximum value of SAR = 0.715 mW/g

Tilt position - Middle/Zoom Scan (7x7x7)/Cube 0: Measurement grid: dx=5mm, dy=5mm, dz=5mm

Peak SAR (extrapolated) = 1.25 W/kg

SAR(1 g) = 0.68 mW/g; SAR(10 g) = 0.341 mW/g

Reference Value = 14.6 V/m

Power Drift = -0.05 dB

Maximum value of SAR = 0.752 mW/g

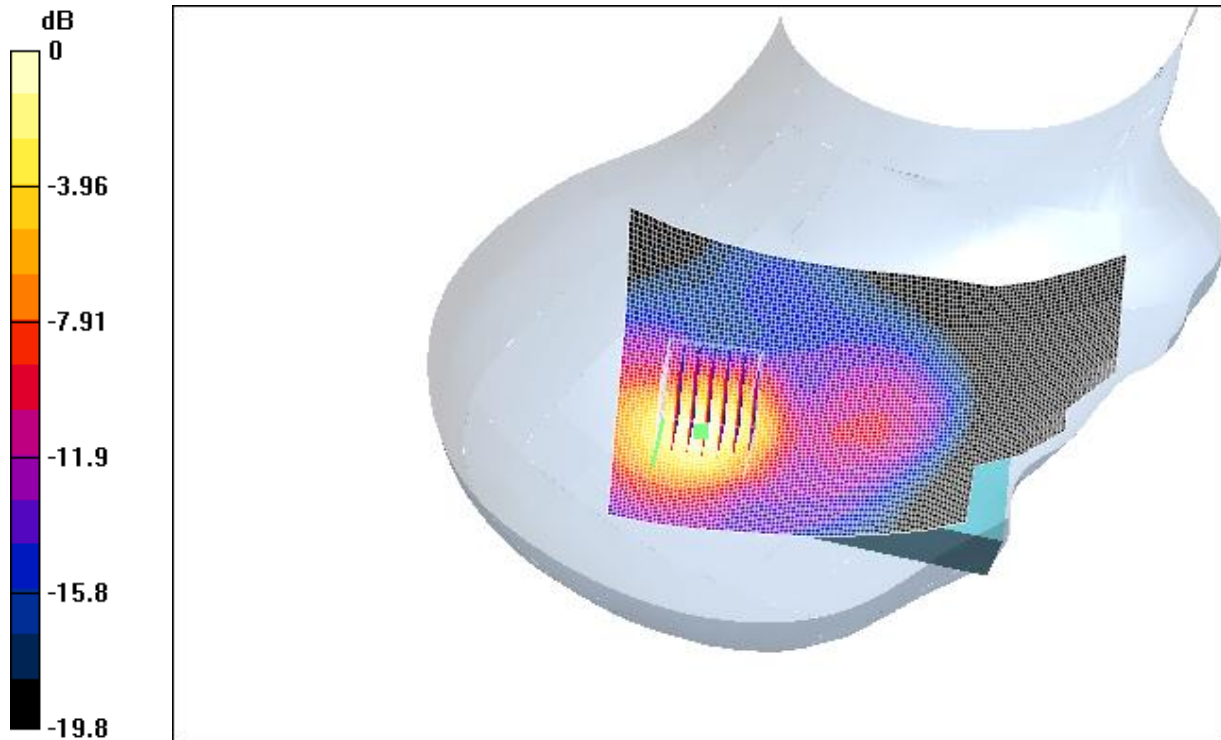

0 dB = 0.752mW/g

4.27 FCC-OET65-RightHandSide-Tilt-GSM1900-High

Date/Time: 07/14/05 18:08:18

Test Laboratory: SGS-GSM

File Name: [FCC-OET65-RightHandSide-Tilt-GSM1900.da4](#)

FCC-OET65-RightHandSide-Tilt-GSM1900-High

DUT: GSM50058; Type: Head; Serial: 20050714

Program: Compliance Testing: EN 50361 Protocol Right-Hand Side)

Communication System: DCS 1900; Frequency: 1909.8 MHz;Duty Cycle: 1:8.3

Medium: HSL1900 ($\sigma = 1.46824$ mho/m, $\epsilon_r = 39.9929$, $\rho = 1000$ kg/m³)

Phantom section: Right Section

Measurement Standard: DASY4 (High Precision Assessment)

DASY4 Configuration:

- Probe: ET3DV6 - SN1774; ConvF(5.25, 5.25, 5.25); Calibrated: 2004-10-26
- Sensor-Surface: 4mm (Mechanical Surface Detection)
- Electronics: DAE3 Sn569; Calibrated: 2003-6-4
- Phantom: SAM 12; Type: SAM V4.0; Serial: TP-1283
- Measurement SW: DASY4, V4.1 Build 47; Postprocessing SW: SEMCAD, V1.6 Build 115

Tilt position - High/Area Scan (71x111x1): Measurement grid: dx=15mm, dy=15mm

Reference Value = 14.1 V/m

Power Drift = 0.02 dB

Maximum value of SAR = 0.683 mW/g

Tilt position - High/Zoom Scan (7x7x7) (7x7x7)/Cube 0: Measurement grid: dx=5mm, dy=5mm, dz=5mm

Peak SAR (extrapolated) = 1.21 W/kg

SAR(1 g) = 0.648 mW/g; SAR(10 g) = 0.319 mW/g

Reference Value = 14.1 V/m

Power Drift = 0.02 dB

Maximum value of SAR = 0.727 mW/g

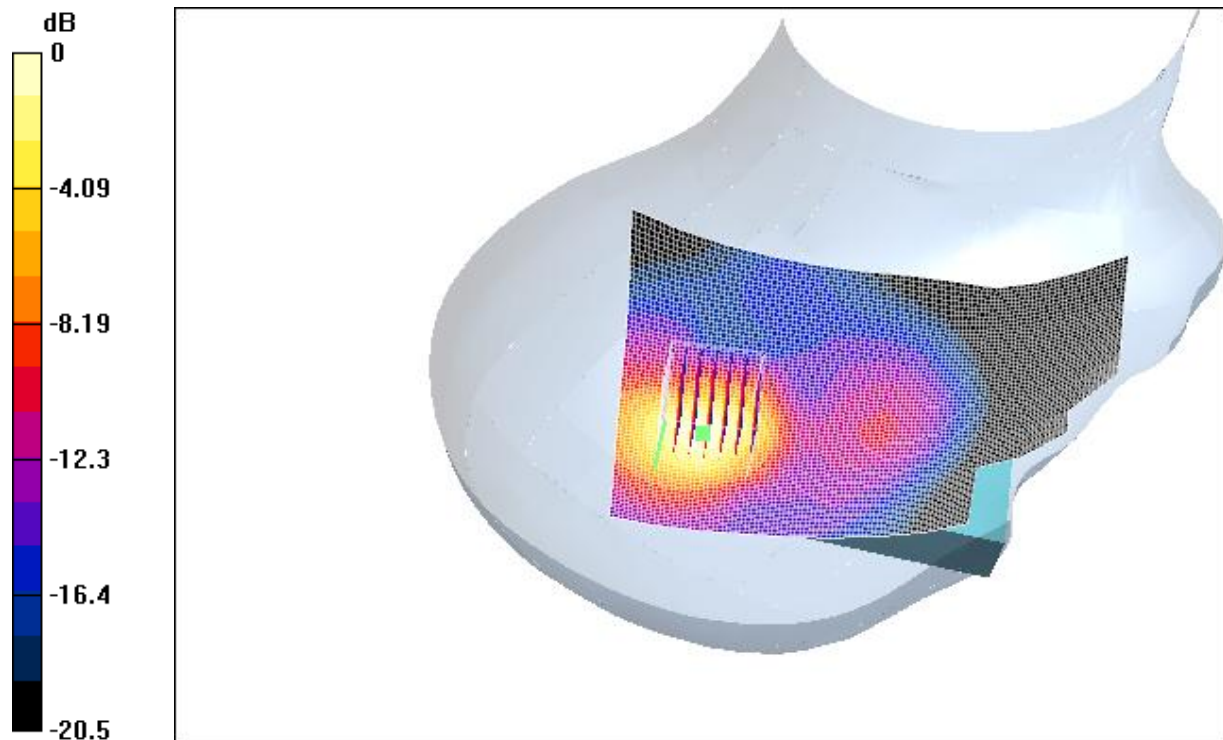

0 dB = 0.727mW/g

4.28 FCC-OET65-Body-Worn-GSM1900-Low

Date/Time: 07/13/05 22:46:26

Test Laboratory: SGS-GSM

File Name: [FCC-OET65-Body-Worn-GSM1900.da4](#)

FCC-OET65-Body-Worn-GSM1900-Low

DUT: GSM50058; Type: Head; Serial: 20050713

Program: Compliance Testing: FCC OET65 Protocol (Body Worn)

Communication System: DCS 1900; Frequency: 1850.2 MHz; Duty Cycle: 1:8.3

Medium: HSL1900 ($\sigma = 1.48803$ mho/m, $\epsilon_r = 51.6495$, $\rho = 1000$ kg/m³)

Phantom section: Flat Section

Measurement Standard: DASY4 (High Precision Assessment)

DASY4 Configuration:

- Probe: ET3DV6 - SN1774; ConvF(4.66, 4.66, 4.66); Calibrated: 2004-10-26
- Sensor-Surface: 4mm (Mechanical Surface Detection)
- Electronics: DAE3 Sn569; Calibrated: 2003-6-4
- Phantom: SAM 12; Type: SAM V4.0; Serial: TP-1283
- Measurement SW: DASY4, V4.1 Build 47; Postprocessing SW: SEMCAD, V1.6 Build 115

Body Worn - Low/Area Scan (51x91x1): Measurement grid: dx=15mm, dy=15mm

Reference Value = 11.8 V/m

Power Drift = -0.008 dB

Maximum value of SAR = 0.206 mW/g

Body Worn - Low/Zoom Scan (7x7x7) (7x7x7)/Cube 0: Measurement grid: dx=5mm, dy=5mm, dz=5mm

Peak SAR (extrapolated) = 0.28 W/kg

SAR(1 g) = 0.192 mW/g; SAR(10 g) = 0.12 mW/g

Reference Value = 11.8 V/m

Power Drift = -0.008 dB

Maximum value of SAR = 0.206 mW/g

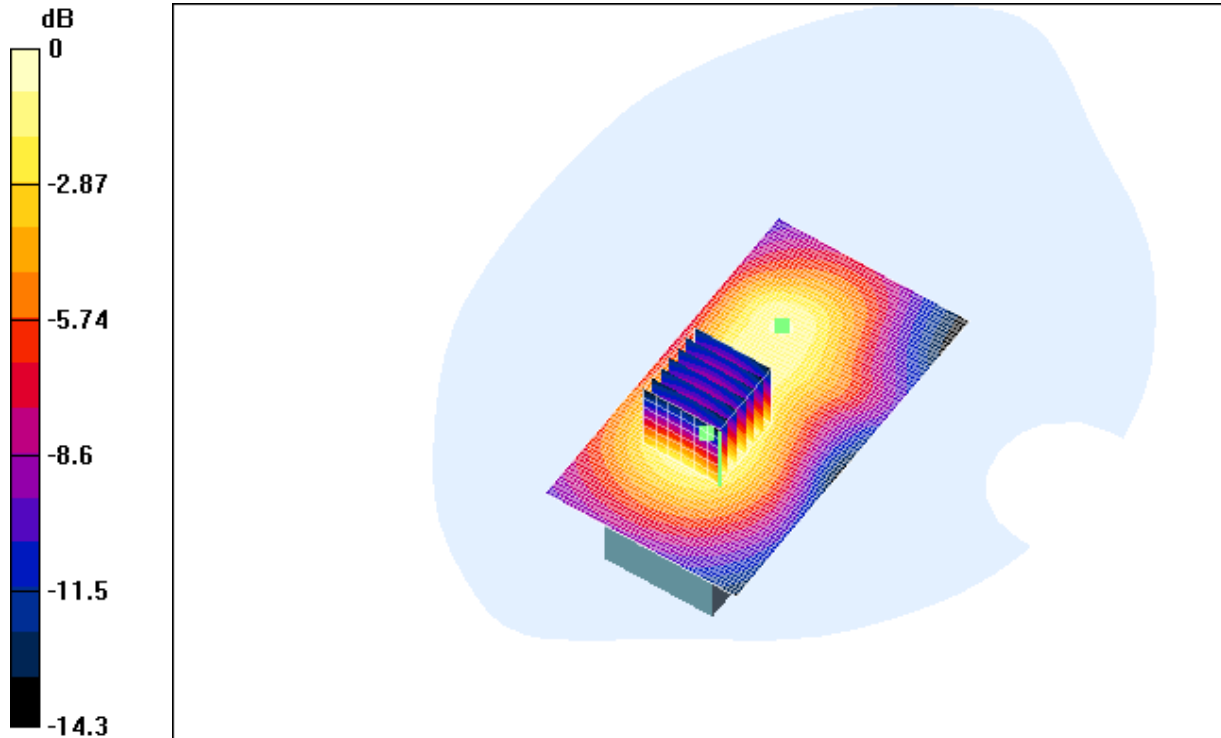

0 dB = 0.206mW/g

4.29 FCC-OET65-Body-Worn-GSM1900-Mid

Date/Time: 07/13/05 22:46:26

Test Laboratory: SGS-GSM

File Name: [FCC-OET65-Body-Worn-GSM1900.da4](#)

FCC-OET65-Body-Worn-GSM1900-Mid

DUT: GSM50058; Type: Head; Serial: 20050713

Program: Compliance Testing: FCC OET65 Protocol (Body Worn)

Communication System: DCS 1900; Frequency: 1880 MHz; Duty Cycle: 1:8.3

Medium: HSL1900 ($\sigma = 1.52127$ mho/m, $\epsilon_r = 51.5237$, $\rho = 1000$ kg/m³)

Phantom section: Flat Section

Measurement Standard: DASY4 (High Precision Assessment)

DASY4 Configuration:

- Probe: ET3DV6 - SN1774; ConvF(4.66, 4.66, 4.66); Calibrated: 2004-10-26
- Sensor-Surface: 4mm (Mechanical Surface Detection)
- Electronics: DAE3 Sn569; Calibrated: 2003-6-4
- Phantom: SAM 12; Type: SAM V4.0; Serial: TP-1283
- Measurement SW: DASY4, V4.1 Build 47; Postprocessing SW: SEMCAD, V1.6 Build 115

Body Worn - Middle/Area Scan (51x91x1): Measurement grid: dx=15mm, dy=15mm

Reference Value = 13.6 V/m

Power Drift = -0.06 dB

Maximum value of SAR = 0.347 mW/g

Body Worn - Middle/Zoom Scan (7x7x7)/Cube 0: Measurement grid: dx=5mm, dy=5mm, dz=5mm

Peak SAR (extrapolated) = 0.474 W/kg

SAR(1 g) = 0.32 mW/g; SAR(10 g) = 0.2 mW/g

Reference Value = 13.6 V/m

Power Drift = -0.06 dB

Maximum value of SAR = 0.342 mW/g

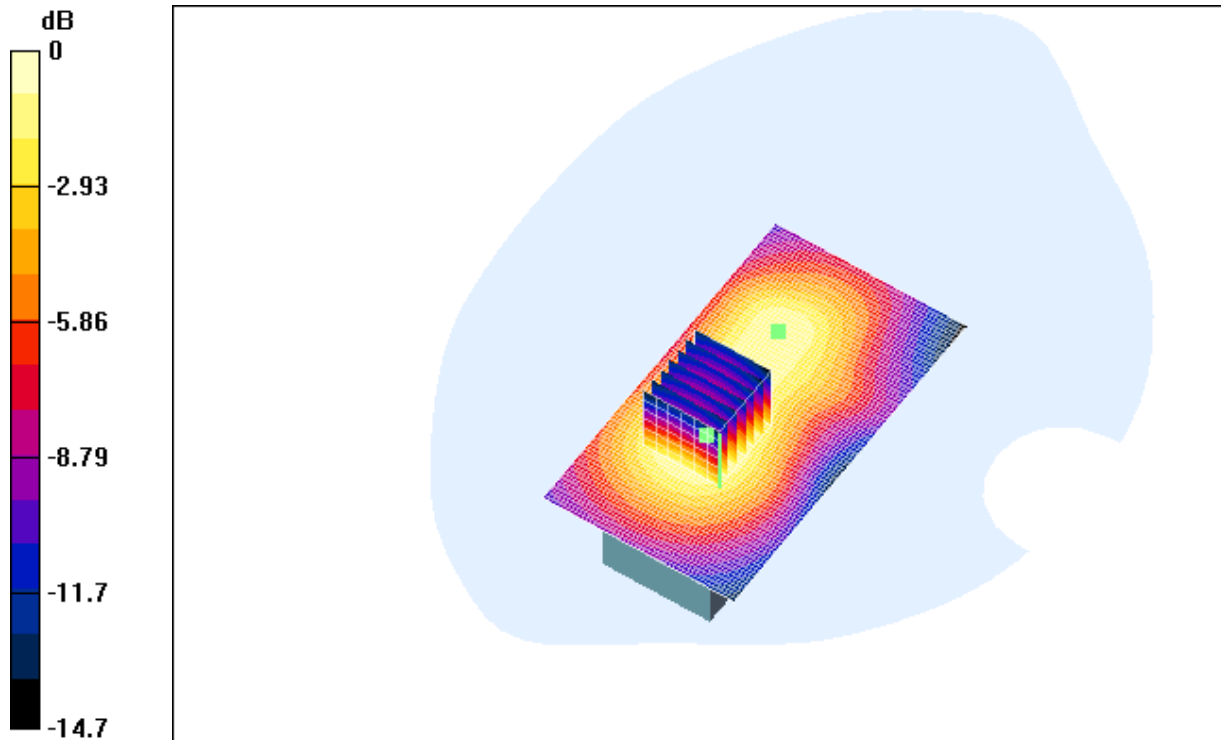

0 dB = 0.342mW/g

4.30 FCC-OET65-Body-Worn-GSM1900-High

Date/Time: 07/13/05 22:46:26

Test Laboratory: SGS-GSM

File Name: [FCC-OET65-Body-Worn-GSM1900.da4](#)

FCC-OET65-Body-Worn-GSM1900-High

DUT: GSM50058; Type: Head; Serial: 20050713

Program: Compliance Testing: FCC OET65 Protocol (Body Worn)

Communication System: DCS 1900; Frequency: 1909.8 MHz; Duty Cycle: 1:8.3

Medium: HSL1900 ($\sigma = 1.55344$ mho/m, $\epsilon_r = 51.4693$, $\rho = 1000$ kg/m³)

Phantom section: Flat Section

Measurement Standard: DASY4 (High Precision Assessment)

DASY4 Configuration:

- Probe: ET3DV6 - SN1774; ConvF(4.66, 4.66, 4.66); Calibrated: 2004-10-26
- Sensor-Surface: 4mm (Mechanical Surface Detection)
- Electronics: DAE3 Sn569; Calibrated: 2003-6-4
- Phantom: SAM 12; Type: SAM V4.0; Serial: TP-1283
- Measurement SW: DASY4, V4.1 Build 47; Postprocessing SW: SEMCAD, V1.6 Build 115

Body Worn - High/Area Scan (51x91x1): Measurement grid: dx=15mm, dy=15mm

Reference Value = 13.2 V/m

Power Drift = 0.02 dB

Maximum value of SAR = 0.428 mW/g

Body Worn - High/Zoom Scan (7x7x7) (7x7x7)/Cube 0: Measurement grid: dx=5mm, dy=5mm, dz=5mm

Peak SAR (extrapolated) = 0.604 W/kg

SAR(1 g) = 0.398 mW/g; SAR(10 g) = 0.244 mW/g

Reference Value = 13.2 V/m

Power Drift = 0.02 dB

Maximum value of SAR = 0.43 mW/g

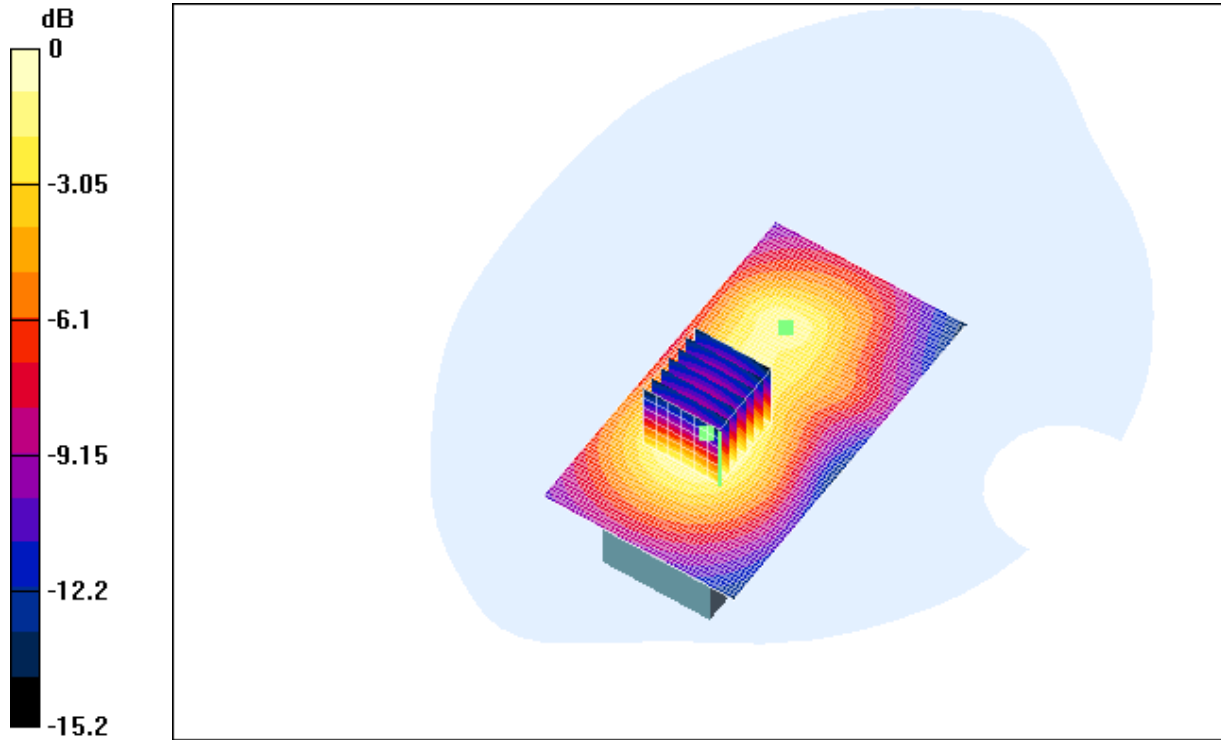

0 dB = 0.43mW/g

Appendix

1. Photographs of Test Setup

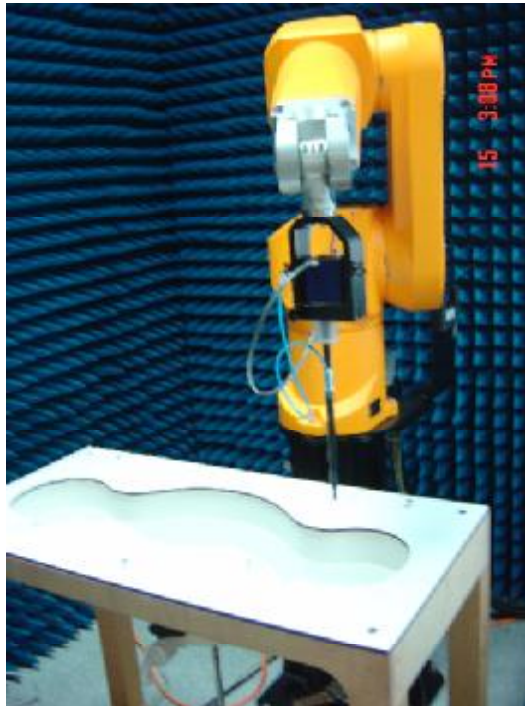

Fig.1 Photograph of the SAR measurement System

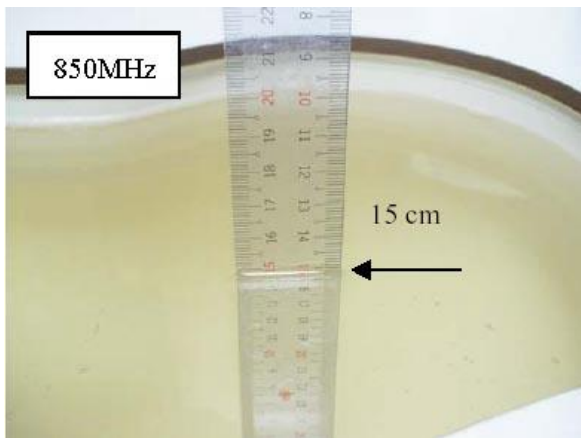

Fig.2 Photograph of the Tissue Simulant Fluid Liquid depth 15cm for Left-Head Side

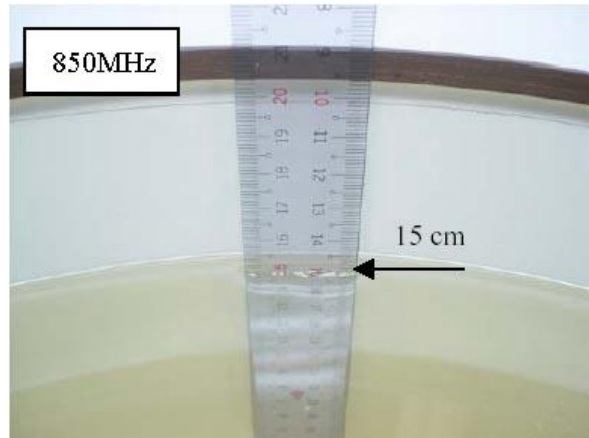

Fig.3 Photograph of the Tissue Simulant Liquid depth 15cm for Body-Worn

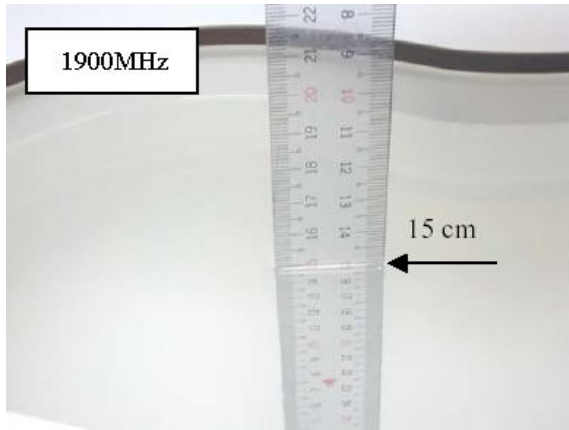

Fig.4 Photograph of the Tissue Simulant Fluid Liquid depth 15cm for Right-Head Side

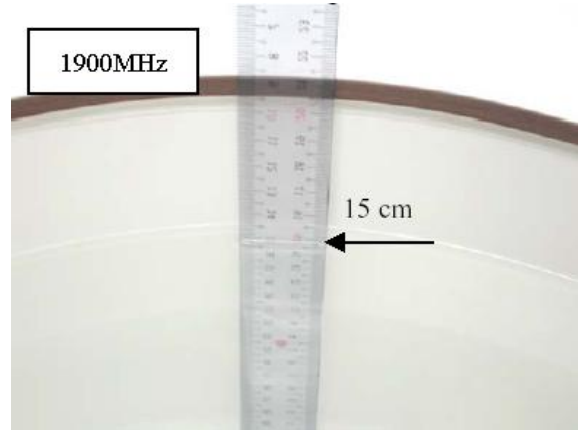

Fig.5 Photograph of the Tissue Simulant Liquid depth 15cm for Body-Worn

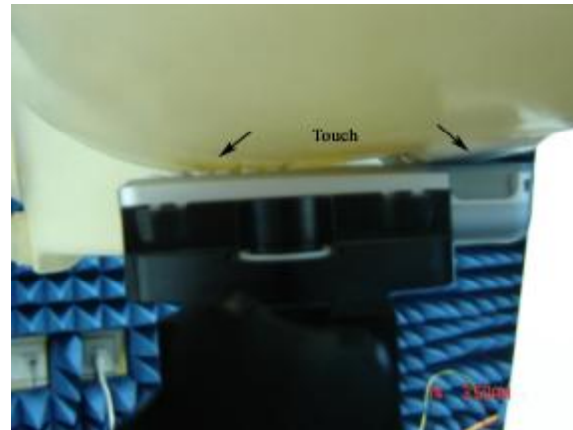
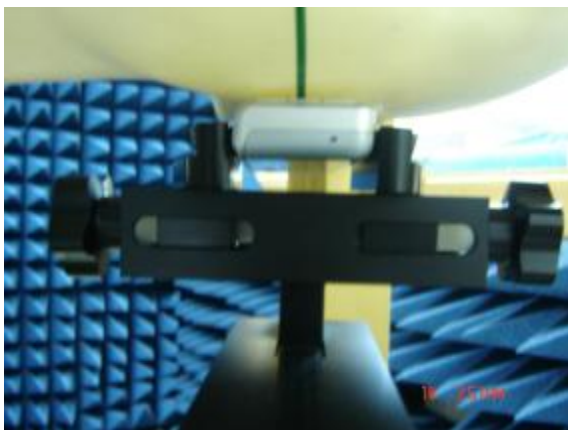

Fig.6 Photograph of the Left Hand Side Touch status

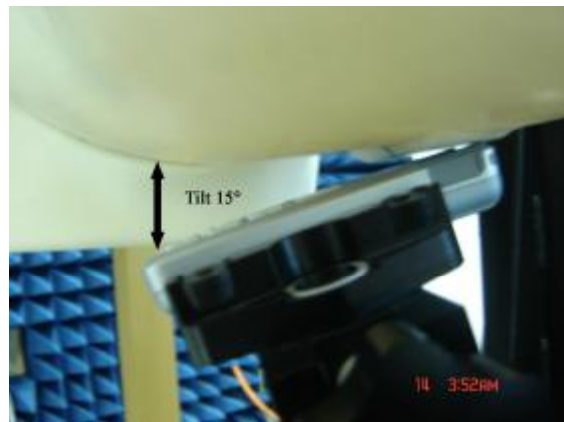

Fig.7 Photograph of the Left Hand Side Tilt status

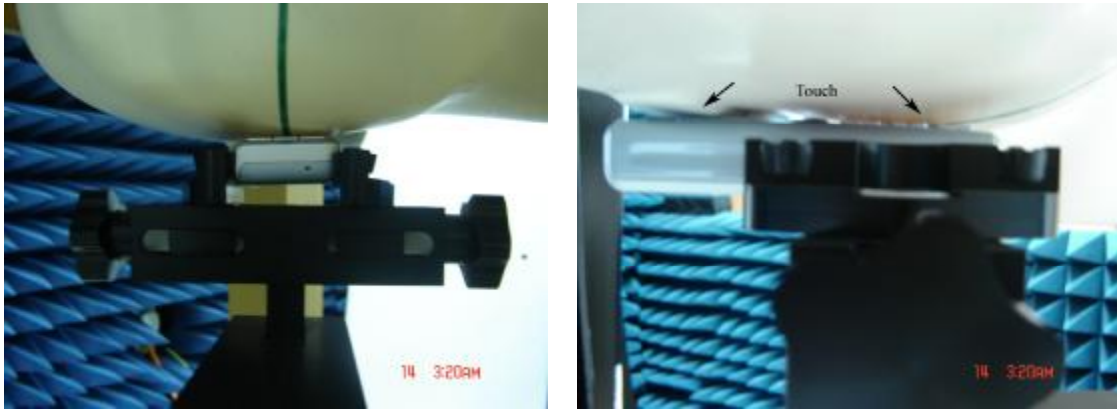

Fig.8 Photograph of the Right Hand Side Touch status

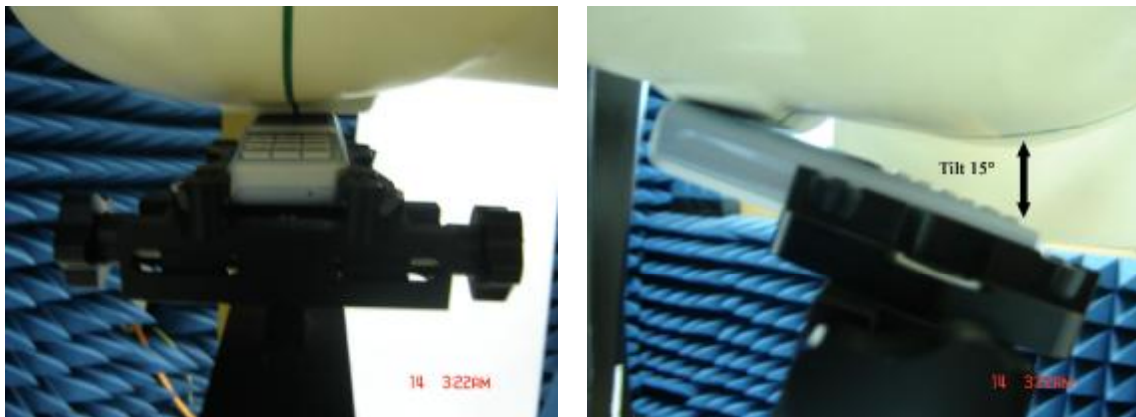

Fig.9 Photograph of the Right Hand Side Tilt status



Fig.10 Photograph of the BodyWorn status

2. Photographs of the EUT



Fig.11 Front View

Fig.12 Back View

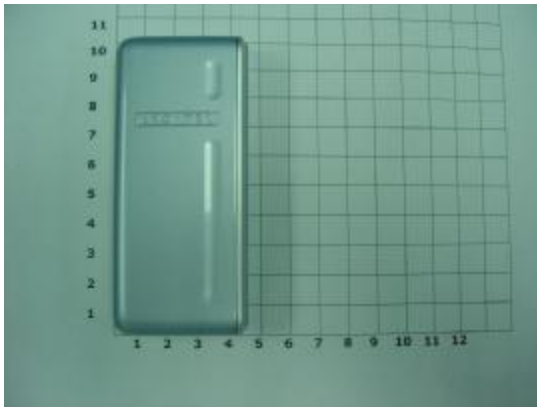

3. Photographs of the battery



Fig.13 Front view of battery



Fig.14 Back view of battery

4. Photograph of the charger



Fig.15 Charger

5. Probe Calibration certificate

Calibration Laboratory of
 Schmid & Partner
 Engineering AG
 Zeughausstrasse 43, 8004 Zurich, Switzerland



S Schweizerischer Kalibrierdienst
 S Service suisse d'étalonnage
 C Servizio svizzero di taratura
 S Swiss Calibration Service

Accredited by the Swiss Federal Office of Metrology and Accreditation
 The Swiss Accreditation Service is one of the signatories to the EA
 Multilateral Agreement for the recognition of calibration certificates

Accreditation No.: SCS 108

Client **SGS China (Auden)**

Certificate No: ET3-1774_Oct04

CALIBRATION CERTIFICATE

Object: ET3DV6 - SN:1774

Calibration procedure(s): QA CAL-01.v5
 Calibration procedure for dosimetric E-field probes

Calibration date: October 26, 2004

Condition of the calibrated item: In Tolerance

This calibration certificate documents the traceability to national standards, which realize the physical units of measurements (SI).
 The measurements and the uncertainties with confidence probability are given on the following pages and are part of the certificate.

All calibrations have been conducted in the closed laboratory facility: environment temperature (22 ± 3)°C and humidity < 70%.

Calibration Equipment used (M&TE critical for calibration)

Primary Standards	ID #	Cal Date (Calibrated by, Certificate No.)	Scheduled Calibration
Power meter E4419B	GB41293874	5-May-04 (METAS, No. 251-00388)	May-05
Power sensor E4412A	MY41495277	5-May-04 (METAS, No. 251-00388)	May-05
Reference 3 dB Attenuator	SN: S5054 (3c)	3-Apr-03 (METAS, No. 251-00403)	Aug-05
Reference 20 dB Attenuator	SN: S5096 (20b)	3-May-04 (METAS, No. 251-00389)	May-05
Reference 30 dB Attenuator	SN: S5129 (30b)	3-Apr-03 (METAS, No. 251-00404)	Aug-05
Reference Probe ES3DV2	SN:3013	8-Jan-04 (SPEAG, No. ES3-3013_Jan04)	Jan-05
D4E4	SN: 617	26-May-04 (SPEAG, No. D4E4-617_May04)	May-05
Secondary Standards	ID #	Check Date (in house)	Scheduled Check
Power sensor HP 8481A	MY41092180	18-Sep-02 (SPEAG, in house check Oct-03)	in house check: Oct 05
RF generator HP 8648C	US3642U01700	4-Aug-99 (SPEAG, in house check Dec-03)	in house check: Dec-05
Network Analyzer HP 8753E	US37390585	18-Oct-01 (SPEAG, in house check Nov-03)	in house check: Nov 04

Calibrated by: Nico Vetterli, Laboratory Technician, Signature: *N. Vetterli*

Approved by: Katja Pokovic, Technical Manager, Signature: *Katja Pokovic*

Issued: October 28, 2004

This calibration certificate shall not be reproduced except in full without written approval of the laboratory.

ET3DV6 SN:1774

October 26, 2004

Probe ET3DV6

SN:1774

Manufactured:	April 15, 2003
Last calibrated:	May 23, 2003
Repaired:	October 18, 2004
Recalibrated:	October 26, 2004

Calibrated for DASY Systems

(Note: non-compatible with DASY2 system!)

ET3DV6 SN:1774

October 26, 2004

Frequency Response of E-Field

(TEM-Cell:if1110 EXX, Waveguide: R22)

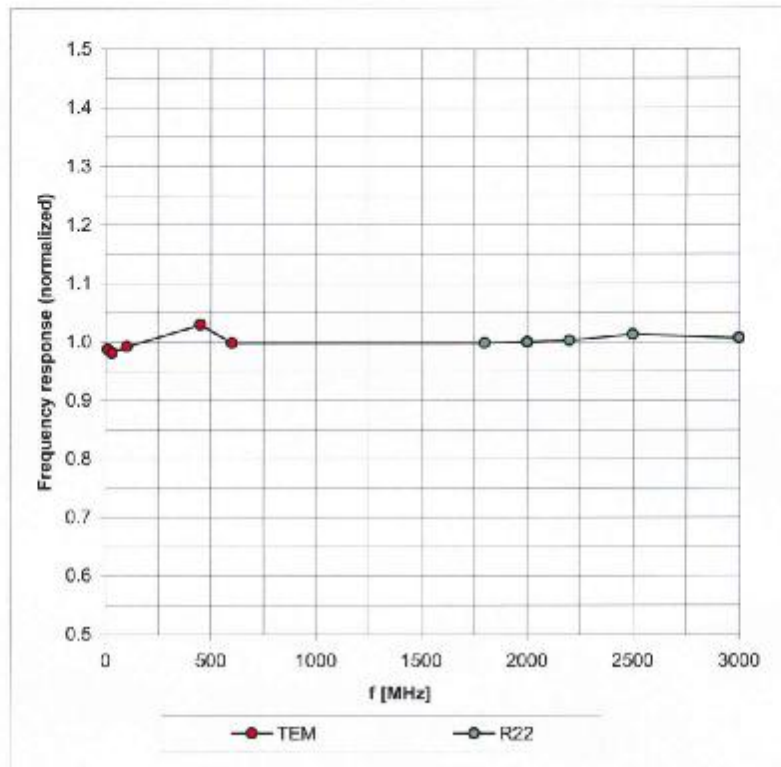

Uncertainty of Frequency Response of E-field: $\pm 6.3\%$ (k=2)

ET3DV6 SN:1774

October 26, 2004

Dynamic Range $f(\text{SAR}_{\text{head}})$ (Waveguide R22, $f = 1800 \text{ MHz}$)

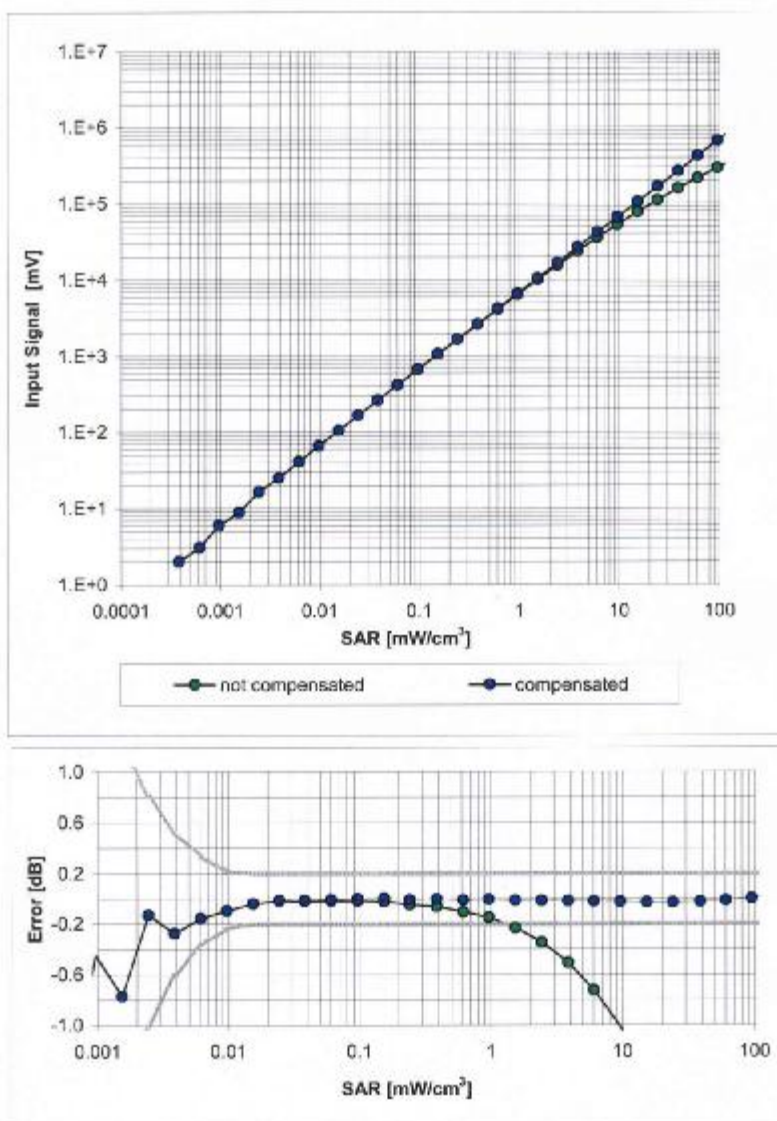

Uncertainty of Linearity Assessment: $\pm 0.6\%$ ($k=2$)

ET3DV6 SN:1774

October 26, 2004

Conversion Factor Assessment

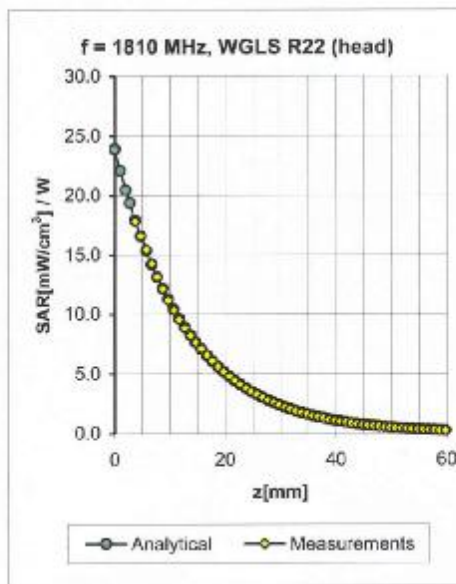
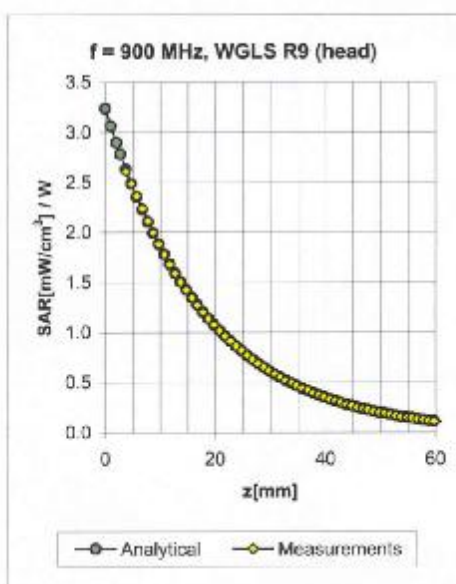

f [MHz]	Validity [MHz] ^c	TSL	Permittivity	Conductivity	Alpha	Depth	ConvF	Uncertainty
835	± 50 / ± 100	Head	41.5 ± 5%	0.90 ± 5%	1.13	1.42	6.96 ± 11.0%	(k=2)
900	± 50 / ± 100	Head	41.5 ± 5%	0.97 ± 5%	1.09	1.46	6.61 ± 11.0%	(k=2)
1750	± 50 / ± 100	Head	40.0 ± 5%	1.40 ± 5%	0.58	2.31	5.48 ± 11.0%	(k=2)
1900	± 50 / ± 100	Head	40.0 ± 5%	1.40 ± 5%	0.54	2.52	5.25 ± 11.0%	(k=2)
2450	± 50 / ± 100	Head	39.2 ± 5%	1.80 ± 5%	0.63	2.30	4.70 ± 11.8%	(k=2)
835	± 50 / ± 100	Body	55.2 ± 5%	0.97 ± 5%	0.96	1.58	6.65 ± 11.0%	(k=2)
900	± 50 / ± 100	Body	55.0 ± 5%	1.05 ± 5%	1.00	1.57	6.36 ± 11.0%	(k=2)
1750	± 50 / ± 100	Body	53.3 ± 5%	1.52 ± 5%	0.52	2.81	4.79 ± 11.0%	(k=2)
1900	± 50 / ± 100	Body	53.3 ± 5%	1.52 ± 5%	0.52	2.98	4.66 ± 11.0%	(k=2)
2450	± 50 / ± 100	Body	52.7 ± 5%	1.95 ± 5%	0.62	2.18	4.35 ± 11.8%	(k=2)

^c The validity of ± 100 MHz only applies for DASY 4.3 B17 and higher (see Page 2). The uncertainty is the RSS of the ConvF uncertainty at calibration frequency and the uncertainty for the indicated frequency band.

ET3DV6 SN:1774

October 26, 2004

Deviation from Isotropy in HSL

Error (ϕ , θ), $f = 900$ MHz

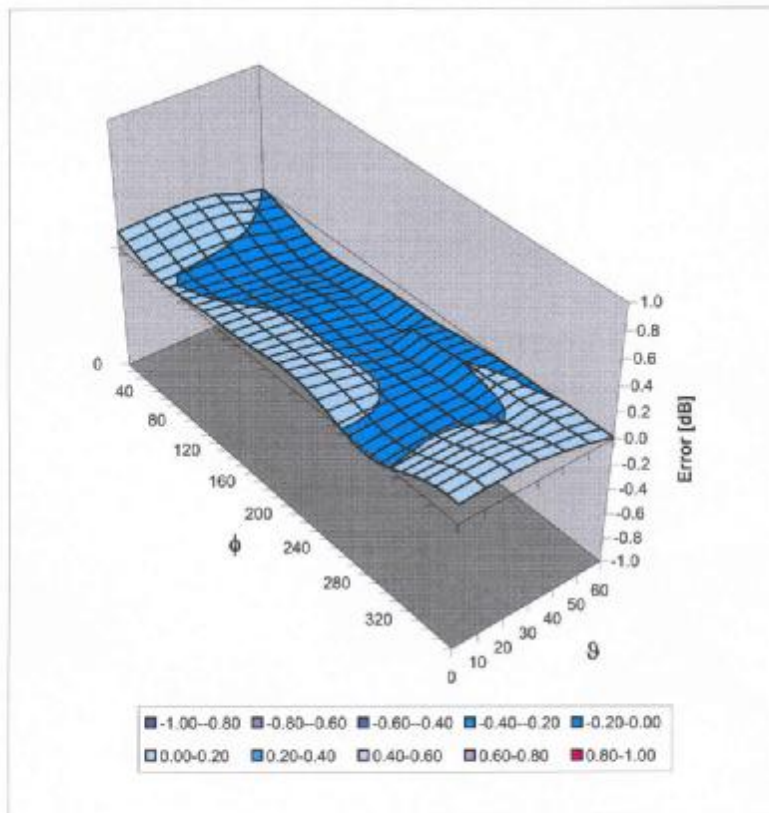

Uncertainty of Spherical Isotropy Assessment: $\pm 2.6\%$ ($k=2$)

ET3DV6 SN:1774

October 26, 2004

Receiving Pattern (ϕ), $\vartheta = 0^\circ$

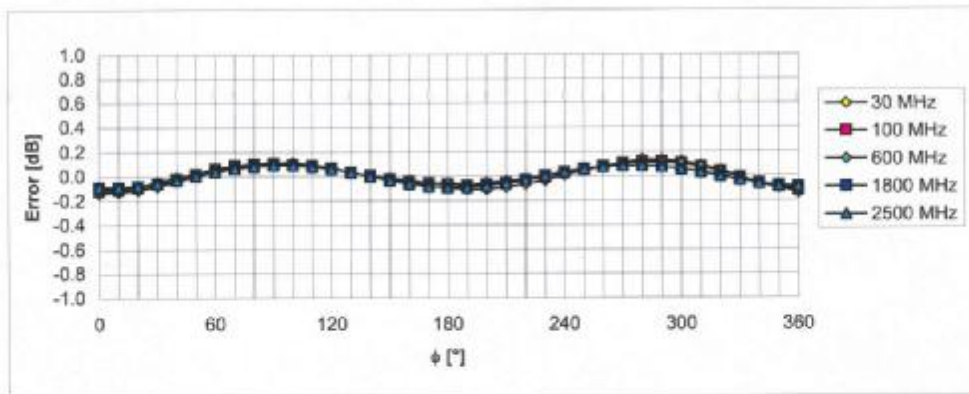
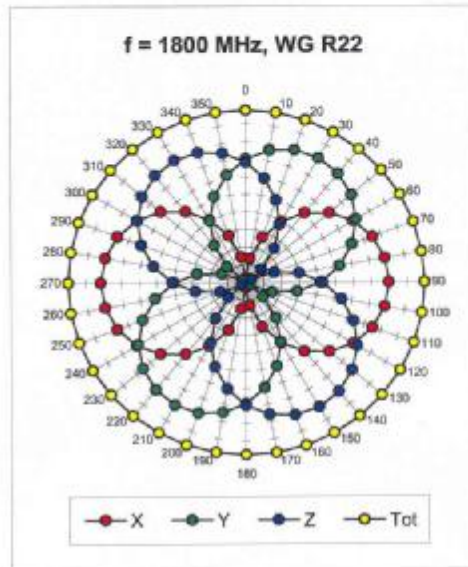
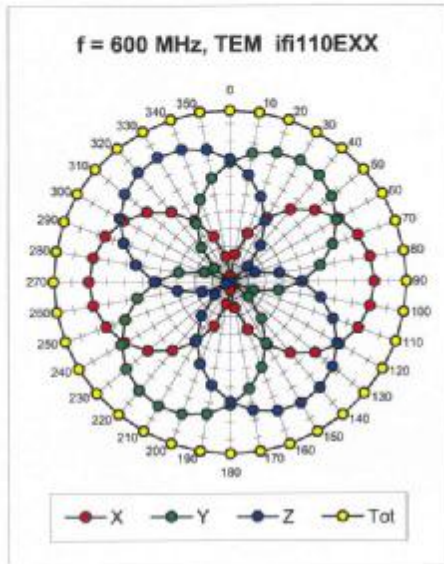

Uncertainty of Axial Isotropy Assessment: $\pm 0.5\%$ (k=2)

6. Uncertainty analysis

Error Description	Tol. (± %)	Prob. dist.	Div.	(c_1) (1g)	(c_2) (10g)	Std. unc. (± %)		(v_i)
Measurement System								
Probe Calibration	4.8	N	1	1	1	4.8	4.8	∞
Axial Isotropy	4.7	R	$\sqrt{3}$	1	1	2.7	2.7	∞
Hemispherical Isotropy	0	R	$\sqrt{3}$	1	1	0	0	∞
Boundary Effects	1.0	R	$\sqrt{3}$	1	1	0.6	0.6	∞
Linearity	4.7	R	$\sqrt{3}$	1	1	2.7	2.7	∞
System Detection Limit	1.0	R	$\sqrt{3}$	1	1	0.6	0.6	∞
Readout Electronics	1.0	N	1	1	1	1.0	1.0	∞
Response Time	0	R	$\sqrt{3}$	1	1	0	0	∞
Integration Time	0	R	$\sqrt{3}$	1	1	0	0	∞
RF Ambient Conditions	3.0	R	$\sqrt{3}$	1	1	1.7	1.7	∞
Probe Positioner	0.4	R	$\sqrt{3}$	1	1	0.2	0.2	∞
Probe Positioning	2.9	R	$\sqrt{3}$	1	1	1.7	1.7	∞
Algorithms for Max. SAR Eval.	1.0	R	$\sqrt{3}$	1	1	0.6	0.6	∞
Dipole								
Dipole Axis to Liquid Distance	2.0	R	$\sqrt{3}$	1	1	1.2	1.2	∞
Input power and SAR drift meas.	4.7	R	$\sqrt{3}$	1	1	2.7	2.7	∞
Phantom and Tissue Param.								
Phantom Uncertainty	4.0	R	$\sqrt{3}$	1	1	2.3	2.3	∞
Liquid Conductivity (target)	5.0	R.	$\sqrt{3}$	0.64	0.43	1.8	1.2	∞
Liquid Conductivity (meas.)	2.5	N	1	0.64	0.43	1.6	1.1	∞
Liquid Permittivity (target)	5.0	R	$\sqrt{3}$	0.6	0.49	1.7	1.4	∞
Liquid Permittivity (meas.)	2.5	N	1	0.6	0.49	1.5	1.2	∞
Combined Standard Uncertainty						8.4	8.1	∞
Coverage Factor for 95%		kp=2						
Expanded Uncertainty						16.8	16.2	

Dasy4 Uncertainty Budget

7. Phantom description

**Schmid & Partner
Engineering AG**

Zeughausstrasse 43, 8004 Zurich, Switzerland, Phone +41 1 245 97 00, Fax +41 1 245 97 79

Certificate of conformity / First Article Inspection

Item	SAM Twin Phantom V4.0
Type No	QD 000 P40 CA
Series No	TP-1150 and higher
Manufacturer / Origin	Untersee Composites Hauptstr. 69 CH-8559 Fruttwilen Switzerland

Tests

The series production process used allows the limitation to test of first articles. Complete tests were made on the pre-series Type No. QD 000 P40 AA, Serial No. TP-1001 and on the series first article Type No. QD 000 P40 BA, Serial No. TP-1006. Certain parameters have been retested using further series units (called samples).

Test	Requirement	Details	Units tested
Shape	Compliance with the geometry according to the CAD model.	ITIS CAD File (*)	First article, Samples
Material thickness	Compliant with the requirements according to the standards	2mm +/- 0.2mm in specific areas	First article, Samples
Material parameters	Dielectric parameters for required frequencies	200 MHz - 3 GHz Relative permittivity < 5 Loss tangent < 0.05.	Material sample TP 104-S
Material resistivity	The material has been tested to be compatible with the liquids defined in the standards	Liquid type HSL 1800 and others according to the standard.	Pre-series, First article

Standards

- [1] CENELEC EN 50361
- [2] IEEE P1528-200x draft 6.5
- [3] IEC PT 62209 draft 0.9
- (*) The ITIS CAD file is derived from [2] and is also within the tolerance requirements of the shapes of [1] and [3].

Conformity

Based on the sample tests above, we certify that this item is in compliance with the uncertainty requirements of SAR measurements specified in standard [1] and draft standards [2] and [3].

Date 28.02.2002

Signature / Stamp

*F. Bernhult***Schmid & Partner
Engineering AG**Zeughausstrasse 43, CH-8004 Zurich
Tel. +41 1 245 97 00, Fax +41 1 245 97 79*Volker Kopp***The end**