



FCC 47 CFR PART 15 SUBPART C

TEST REPORT

For

Bluetooth Speaker

Model: BS552

Brand: N/A

Test Report Number:

C131230Z04-RP1

Prepared for

Sunitec Enterprise Co., Ltd

10F.-1, No.200, Jingping Rd., Jhonghe City, Taipei County 23581, Taiwan

Prepared by

COMPLIANCE CERTIFICATION SERVICES (SHENZHEN) INC.

**No.10-1, Mingkeda Logistics Park, No.18, Huanguan South Rd.,
Guan Lan Town, Baoan District, Shenzhen China**

TEL: 86-755-28055000

FAX: 86-755-28055221

Issued Date: January 4, 2014



TESTING CERT #2861.01



检测
CNAS L4818

Note: This report shall not be reproduced except in full, without the written approval of Compliance Certification Services Inc. This document may be altered or revised by Compliance Certification Services Inc. personnel only, and shall be noted in the revision section of the document. The client should not use it to claim product endorsement by TAF, A2LA, NVLAP, NIST or any government agencies. The test result of this report relate only to the tested sample identified in this report.



Revision History

Rev.	Issue No.	Revisions	Effect Page	Revised By
00	C131230Z04-RP1	Initial Issue	ALL	Nancy Fu



TABLE OF CONTENTS

1. TEST RESULT CERTIFICATION4

2. EUT DESCRIPTION.....5

3. TEST METHODOLOGY.....6

 3.1 DESCRIPTION OF TEST MODES.....6

4. FACILITIES AND ACCREDITATIONS7

 4.1 FACILITIES.....7

 4.2 ACCREDITATIONS7

 4.3 MEASUREMENT UNCERTAINTY7

5. SETUP OF EQUIPMENT UNDER TEST8

 5.1 SETUP CONFIGURATION OF EUT8

 5.2 SUPPORT EQUIPMENT8

6. FCC PART 15.247 REQUIREMENTS9

 6.1 20dB BANDWIDTH.....9

 6.2 PEAK POWER.....13

 6.3 PEAK POWER SPECTRAL DENSITY15

 6.4 BAND EDGES MEASUREMENT16

 6.5 FREQUENCY SEPARATION.....26

 6.6 NUMBER OF HOPPING FREQUENCY29

 6.7 TIME OF OCCUPANCY (DWELL TIME).....32

 6.8 SPURIOUS EMISSIONS39

 6.9 POWERLINE CONDUCTED EMISSIONS57



1. TEST RESULT CERTIFICATION

Product	Bluetooth Speaker
Model	BS552
Brand	N/A
Tested	December 30, 2013~January 4, 2014
Applicant	Sunitec Enterprise Co., Ltd 10F.-1, No.200, Jingping Rd., Jhonghe City, Taipei County 23581, Taiwan
Manufacturer	Sunitec Enterprise Co., Ltd No.2, Qilin Road 2, RunTang Ind, Dan-Keng Village Fu Min Community, Guan-Lan Town, BaoAn District, Shenzhen Guangdong China

APPLICABLE STANDARDS	
STANDARD	TEST RESULT
FCC 47 CFR Part 15 Subpart C	No non-compliance noted

We hereby certify that:

The above equipment was tested by Compliance Certification Services Inc. The test data, data evaluation, test procedures, and equipment configurations shown in this report were made in accordance with the procedures given in ANSI C63.4:2009 and the energy emitted by the sample EUT tested as described in this report is in compliance with conducted and radiated emission limits of FCC Rules Part 15.207, 15.209 and 15.247.

The test results of this report relate only to the tested sample EUT identified in this report.

Approved by:

Reviewed by:

Tom Gan
Supervisor of EMC Dept.
Compliance Certification Service Inc.

Ruby Zhang
Supervisor of Report Dept.
Compliance Certification Service Inc.



2. EUT DESCRIPTION

Product	Bluetooth Speaker
Model Number	BS552
Brand	N/A
Model Discrepancy	N/A
Identify Number	C131230Z04-RP1
Power Supply	DC5V supplied by the notebook or DC3.7V supplied by the battery
Received Date	December 30, 2013
USB In Cable	Unshielded, 1.0m
Frequency Range	2402 ~ 2480 MHz
Transmit Power	GFSK : 3.27dBm 8DPSK : 1.89dBm
Modulation Technique	FHSS (GFSK for 1Mbps, $\pi/4$ -DQPSK for 2Mbps, 8DPSK for 3Mbps)
Number of Channels	79 Channels
Antenna Specification	Built-in antenna with 0dBi gain(Max)
Temperature Range	-20°C ~ +45°C

Note: This submittal(s) (test report) is intended for FCC ID: RA8-BS006 filing to comply with Section 15.207, 15.209 and 15.247 of the FCC Part 15, Subpart C Rules.



3. TEST METHODOLOGY

3.1 DESCRIPTION OF TEST MODES

The EUT has been tested under operating condition.

Test program used to control the EUT for staying in continuous transmitting and receiving mode is programmed.

The following test mode(s) were scanned during the preliminary test below 1G:

Test Item	Test mode	Worse mode
Conducted Emission	Mode 1: Charging + Play music	<input checked="" type="checkbox"/>
	Mode 2: Line in	<input type="checkbox"/>
Radiated Emission	Mode 1: TX	<input checked="" type="checkbox"/>

Above 1G, Channel Low (2402MHz) · Mid (2441MHz) and High (2480MHz) were chosen for full testing for GFSK and 8DPSK.



4. FACILITIES AND ACCREDITATIONS

4.1 FACILITIES

All measurement facilities used to collect the measurement data are located at

- No.10-1, Mingkeda Logistics Park, No.18, Huanguan South Rd., Guan Lan Town, Baoan District, Shenzhen, China**

The sites are constructed in conformance with the requirements of ANSI C63.4:2009, ANSI C63.7 and CISPR Publication 22. All receiving equipment conforms to CISPR Publication 16-1, "Radio Interference Measuring Apparatus and Measurement Methods."

4.2 ACCREDITATIONS

Our laboratories are accredited and approved by the following accreditation body according to ISO/IEC 17025.

USA	A2LA
China	CNAS

The measuring facility of laboratories has been authorized or registered by the following approval agencies.

USA	FCC
Japan	VCCI(C-3478, R-3135, T-652, G-624)
Canada	INDUSTRY CANADA
Taiwan	BSMI
Norway	Nemko

Copies of granted accreditation certificates are available for downloading from our web site, <http://www.ccsrf.com>

4.3 MEASUREMENT UNCERTAINTY

Where relevant, the following measurement uncertainty levels have been estimated for tests performed on the EUT as specified in CISPR 16-4-2:

Parameter	Uncertainty
Radiated Emission, 30 to 200 MHz Test Site : 966(2)	+/-3.6880dB
Radiated Emission, 200 to 1000 MHz Test Site : 966(2)	+/-3.6695dB
Radiated Emission, 1 to 8 GHz	+/-5.1782dB
Radiated Emission, 8 to 18 GHz	+/-5.2173dB
Conducted Emissions	+/-3.6836dB
Band Width	178kHz
Peak Output Power MU	+/-1.906dB
Band Edge MU	+/-0.182dB
Channel Separation MU	416.178Hz
Duty Cycle MU	0.054ms
Frequency Stability MU	226Hz

This uncertainty represents an expanded uncertainty expressed at approximately the 95% confidence level using a coverage factor of k=2.

The measured result is above (below) the specification limit by a margin less than the measurement uncertainty; it is therefore not possible to state compliance based on the 95% level of confidence. However, the result indicates that compliance (non-compliance) is more probable than non-compliance) with the specification limit.



5. SETUP OF EQUIPMENT UNDER TEST

5.1 SETUP CONFIGURATION OF EUT

See test photographs attached in Appendix 1 for the actual connections between EUT and support equipment.

5.2 SUPPORT EQUIPMENT

No.	Equipment	Model No.	Serial No.	FCC ID	Brand	Data Cable	Power Cord
1	Notebook	992F2VG	62P7043	N/A	IBM	N/A	Unshielded 1.80m

Notes:

Grounding was established in accordance with the manufacturer's requirements and conditions for the intended use.



6. FCC PART 15.247 REQUIREMENTS

6.1 20dB BANDWIDTH

None; for reporting purpose only.

MEASUREMENT EQUIPMENT USED

Name of Equipment	Manufacturer	Model	Serial Number	Last Calibration	Due Calibration
Spectrum Analyzer	Agilent	N9010A	MY52221469	10/25/2013	10/24/2014

Remark: Each piece of equipment is scheduled for calibration once a year.

TEST CONFIGURATION

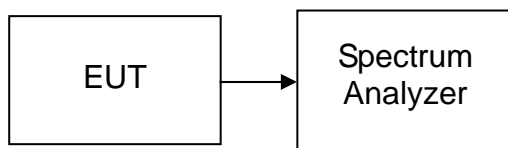

TEST PROCEDURE

1. Place the EUT on the table and set it in the transmitting mode.
2. Remove the antenna from the EUT, then connect a low loss RF cable from antenna port to the spectrum analyzer.
3. Set the spectrum analyzer as RBW=30kHz, VBW=100kHz, Span=3MHz, Sweep = auto.
4. Mark the peak frequency and 20dB (upper and lower) frequency.
5. Repeat until all the test channels are investigated.

TEST RESULTS

No non-compliance noted



Test plot
GFSK

20dB Bandwidth(CH Low)

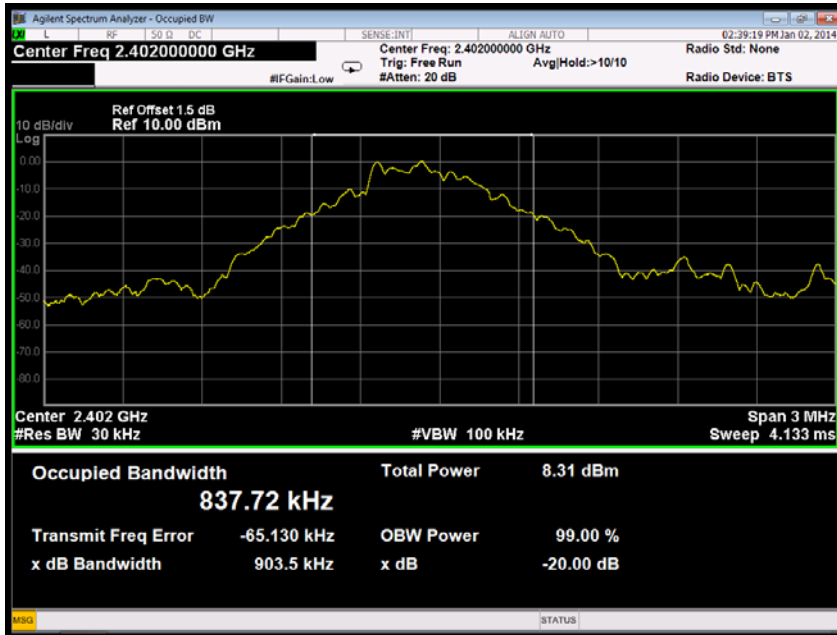

20dB Bandwidth (CH Mid)

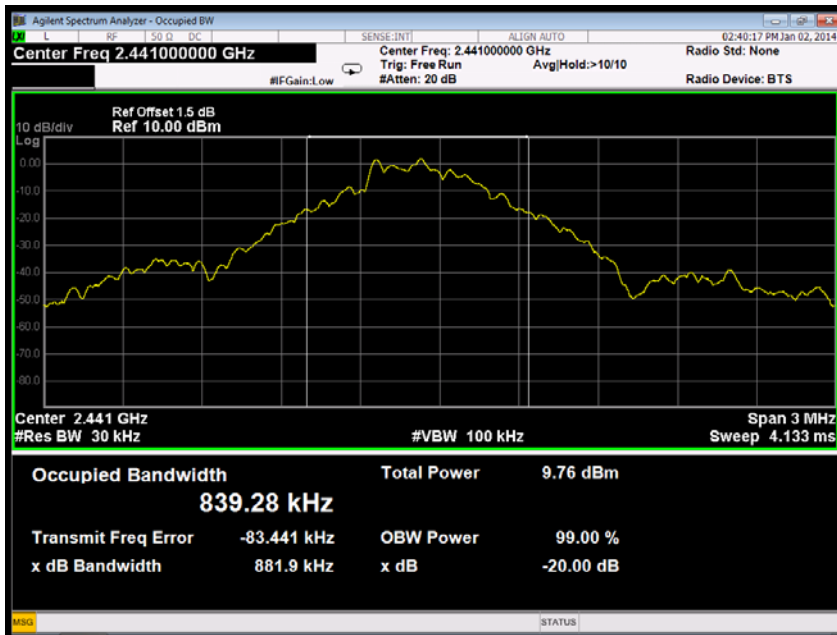



20dB Bandwidth (CH High)

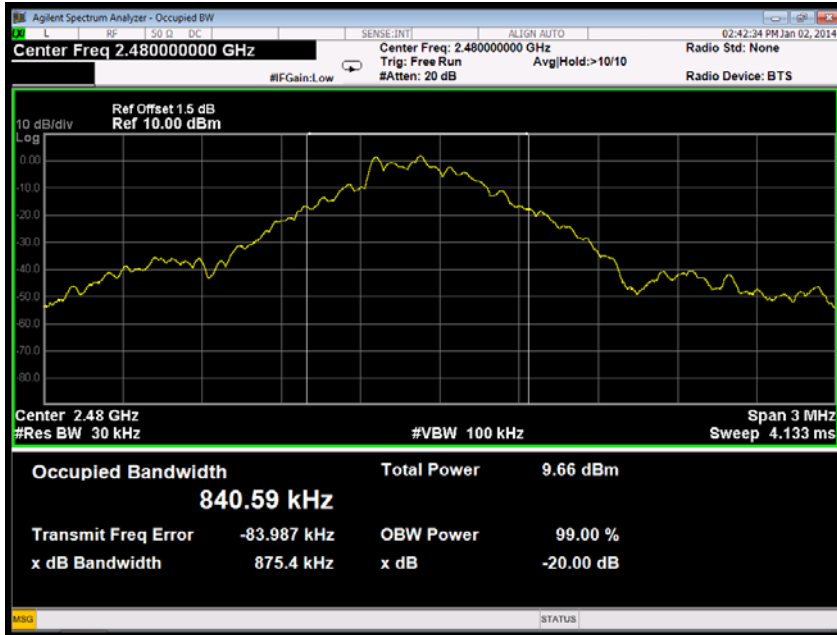

8DPSK

20dB Bandwidth (CH Low)

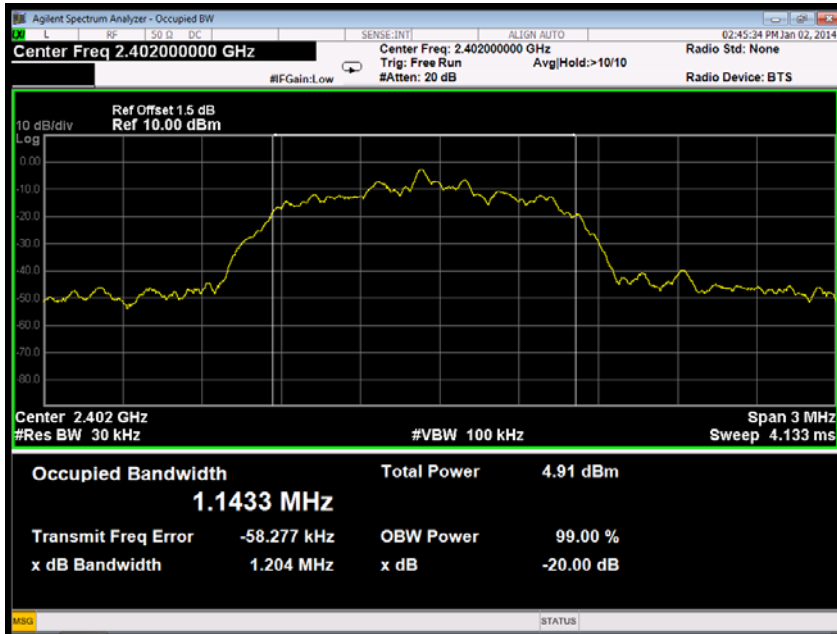



20dB Bandwidth (CH Mid)

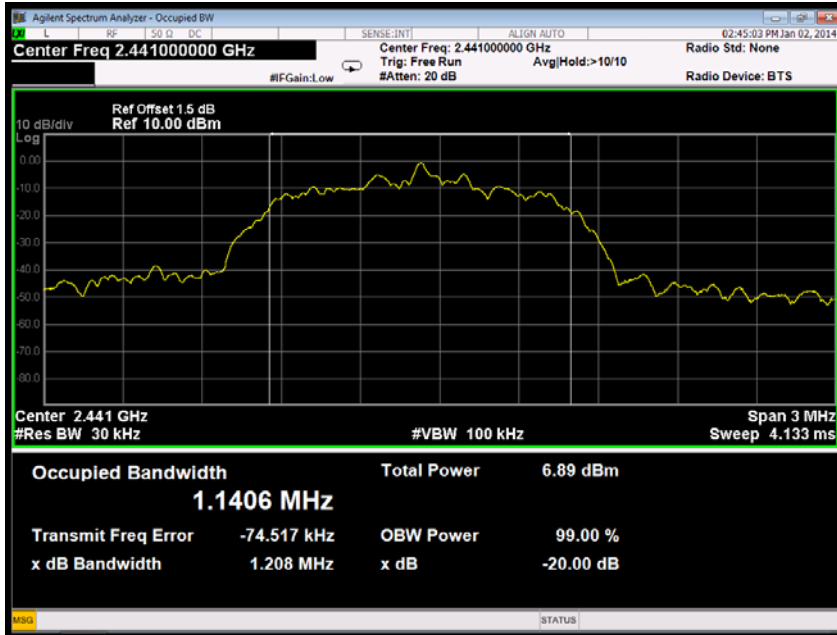

20dB Bandwidth (CH High)

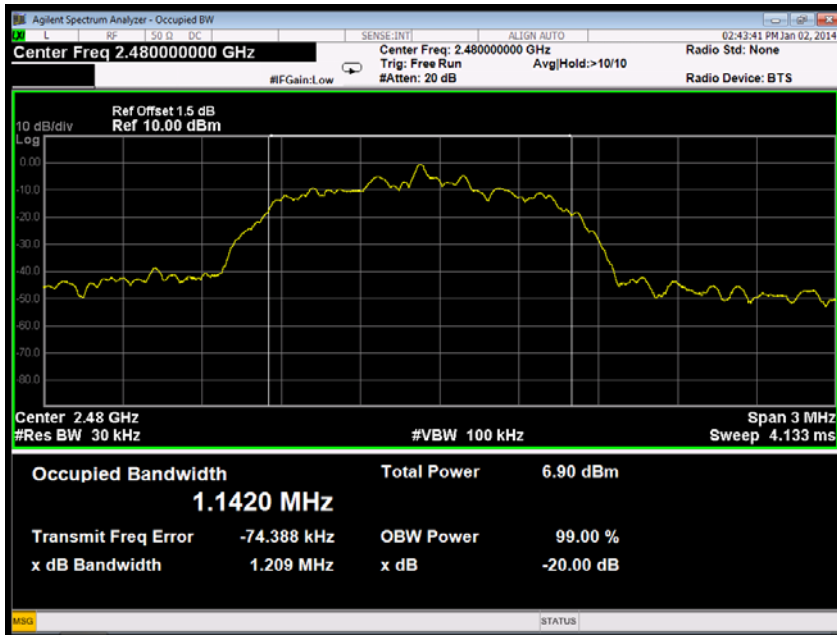



6.2 PEAK POWER

LIMIT

The maximum peak output power of the intentional radiator shall not exceed the following:

1. For frequency hopping systems operating in the 2400-2483.5 MHz band employing at least 75 non-overlapping hopping channels, and all frequency hopping systems in the 5725-5850 MHz band: 1 watt. For all other frequency hopping systems in the 2400-2483.5 MHz band: 0.125 watts.
2. Except as shown in paragraphs (b)(3) (i), (ii) and (iii) of this section, if transmitting antennas of directional gain greater than 6dBi are used the peak output power from the intentional radiator shall be reduced below the stated values in paragraphs (b)(1) or (b)(2) of this section, as appropriate, by the amount in dB that the directional gain of the antenna exceeds 6dBi.
3. The conducted output power limit specified in paragraph (b) of this section is based on the use of antennas with directional gains that do not exceed 6 dBi. Except as shown in paragraph (c) of this section, if transmitting antennas of directional gain greater than 6 dBi are used, the conducted output power from the intentional radiator shall be reduced below the stated values in paragraphs (b)(1), (b)(2), and (b)(3) of this section, as appropriate, by the amount in dB that the directional gain of the antenna exceeds 6 dBi.

MEASUREMENT EQUIPMENT USED

Name of Equipment	Manufacturer	Model	Serial Number	Last Calibration	Due Calibration
Power Meter	Anritsu	ML2495A	1204003	03/09/2013	03/08/2014
Power Sensor	Anritsu	MA2411B	1126150	03/09/2013	03/08/2014
Spectrum Analyzer	Agilent	E4446A	US44300399	03/09/2013	03/08/2014

Remark: Each piece of equipment is scheduled for calibration once a year.

Test Configuration

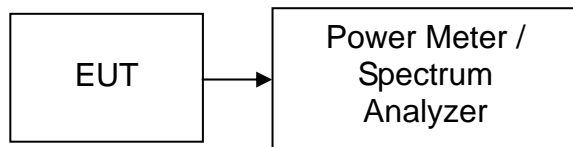

TEST PROCEDURE

The transmitter output is connected to the RF Power Meter. The RF Power Meter is set to the peak power detection.



TEST RESULTS

No non-compliance noted

Test Data

GFSK

Channel	Frequency (MHz)	Reading Power (dBm)	Factor (dB)	Output Power (dBm)	Output Power (W)	Limit (W)	Result
Low	2402	-1.62	3.50	1.88	0.00154	1	PASS
Mid	2441	-0.23	3.50	3.27	0.00212		PASS
High	2480	-0.27	3.50	3.23	0.00210		PASS

8DPSK

Channel	Frequency (MHz)	Reading Power (dBm)	Factor (dB)	Output Power (dBm)	Output Power (W)	Limit (W)	Result
Low	2402	-3.48	3.50	0.02	0.00100	1	PASS
Mid	2441	-1.68	3.50	1.82	0.00152		PASS
High	2480	-1.61	3.50	1.89	0.00155		PASS



6.3 PEAK POWER SPECTRAL DENSITY

LIMIT

1. For direct sequence systems, the peak power spectral density conducted from the intentional radiator to the antenna shall not be greater than 8dBm in any 3kHz band during any time interval of continuous transmission.
2. The direct sequence operating of the hybrid system, with the frequency hopping operation turned off, shall comply with the power density requirements of paragraph (d) of this section.

MEASUREMENT EQUIPMENT USED

Name of Equipment	Manufacturer	Model	Serial Number	Last Calibration	Due Calibration
Spectrum Analyzer	Agilent	N9010A	MY52221469	10/25/2013	10/24/2014

Remark: Each piece of equipment is scheduled for calibration once a year.

Test Configuration

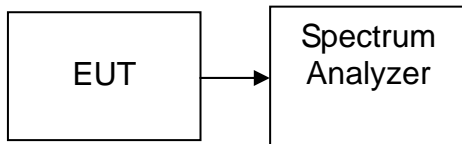

TEST PROCEDURE

1. Place the EUT on the table and set it in transmitting mode.
2. Remove the antenna from the EUT and then connect a low loss RF cable from the antenna port to the spectrum analyzer.
3. Set the spectrum analyzer as RBW = 3kHz, VBW = 10kHz, Span = 300kHz, Sweep=100s
4. Record the max. reading.
5. Repeat the above procedure until the measurements for all frequencies are completed.

TEST RESULTS

Not applicable. Since EUT is the Bluetooth device.



6.4 BAND EDGES MEASUREMENT

LIMIT

According to §15.247(c), in any 100 kHz bandwidth outside the frequency bands in which the spread spectrum intentional radiator is operating, the radio frequency power that is produced by the intentional radiator shall be at least 20dB below that in the 100kHz bandwidth within the band that contains the highest level of the desired power, In addition, radiated emissions which fall in the restricted bands, as defined in §15.205(a), must also comply with the radiated emission limits specified in 15.209(a).

MEASUREMENT EQUIPMENT USED

Radiated Emission Test Site 966(2)					
Name of Equipment	Manufacturer	Model Number	Serial Number	Last Calibration	Due Calibration
PSA Series Spectrum Analyzer	Agilent	E4446A	US44300399	03/09/2013	03/08/2014
EMI TEST RECEIVER	ROHDE&SCHWARZ	ESCI	100783	03/09/2013	03/08/2014
Amplifier	MITEQ	AM-1604-3000	1123808	03/18/2013	03/18/2014
High Noise Amplifier	Agilent	8449B	3008A01838	03/18/2013	03/18/2014
Board-Band Horn Antenna	Schwarzbeck	BBHA 9170	9170-497	06/21/2013	06/21/2014
Bilog Antenna	SCHAFFNER	CBL6143	5082	03/02/2013	03/01/2014
Horn Antenna	SCHWARZBECK	BBHA9120	D286	03/02/2013	03/01/2014
Loop Antenna	A、R、A	PLA-1030/B	1029	03/19/2013	03/18/2014
Turn Table	N/A	N/A	N/A	N.C.R	N.C.R
Controller	Sunol Sciences	SC104V	022310-1	N.C.R	N.C.R
Controller	CT	N/A	N/A	N.C.R	N.C.R
Temp. / Humidity Meter	Anymetre	JR913	N/A	03/04/2013	03/03/2014
Antenna Tower	SUNOL	TLT2	N/A	N.C.R	N.C.R
Test S/W	FARAD	LZ-RF / CCS-SZ-3A2			

Test Configuration

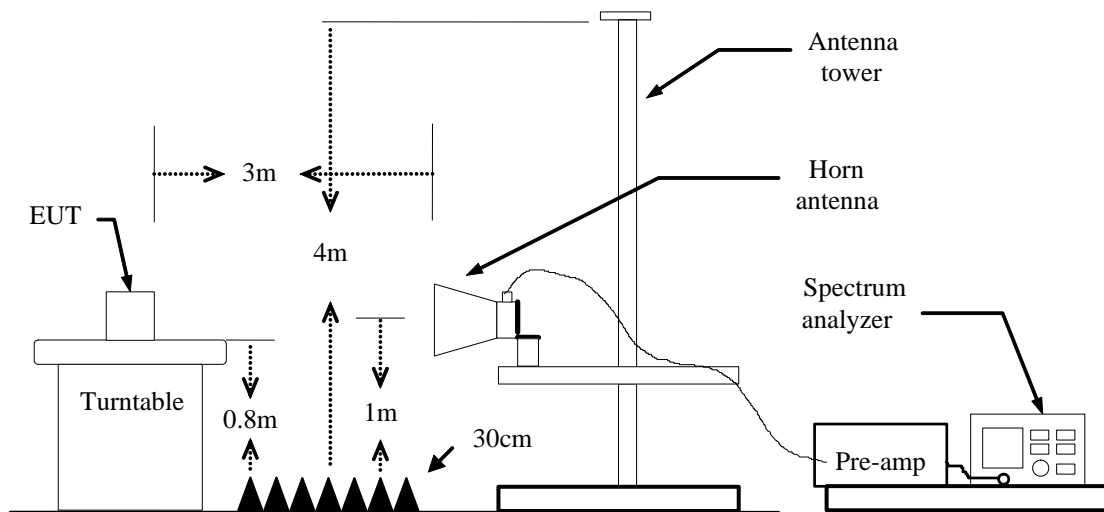



TEST PROCEDURE

1. The EUT is placed on a turntable, which is 0.8m above the ground plane.
2. The turntable shall be rotated for 360 degrees to determine the position of maximum emission level.
3. EUT is set 3m away from the receiving antenna, which is varied from 1m to 4m to find out the highest emission.
4. Set the spectrum analyzer in the following setting in order to capture the lower and upper band-edges of the emission:
 - (a) PEAK: RBW=VBW=1MHz / Sweep=AUTO
 - (b) AVERAGE: RBW=1MHz / VBW=2.2kHz / Sweep=AUTO
5. Repeat the procedures until all the PEAK and AVERAGE versus POLARIZATION are measured.

TEST RESULTS

Refer to attach spectrum analyzer data chart.



Test Data (GFSK)

Band Edges (CH-Low)

Detector mode: Peak

Polarity: Vertical

Agilent

R T

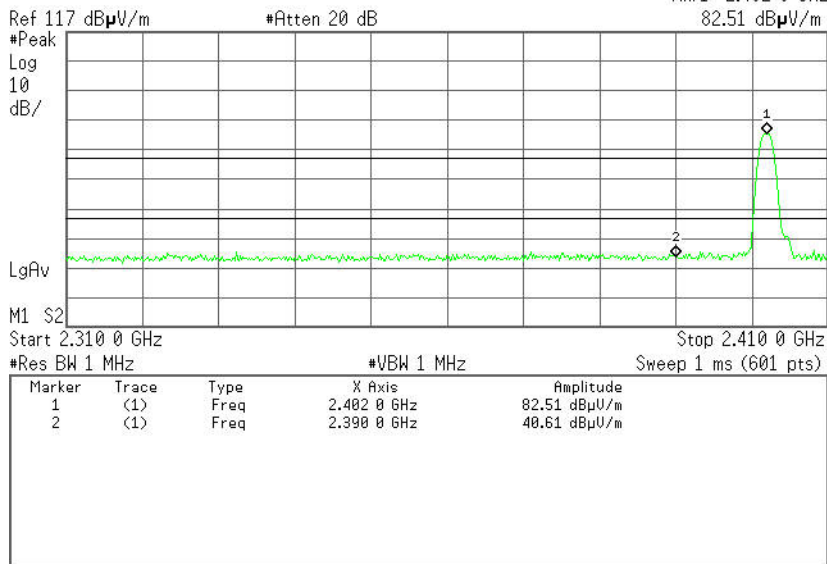

Detector mode: Average

Polarity: Vertical

Agilent

R T

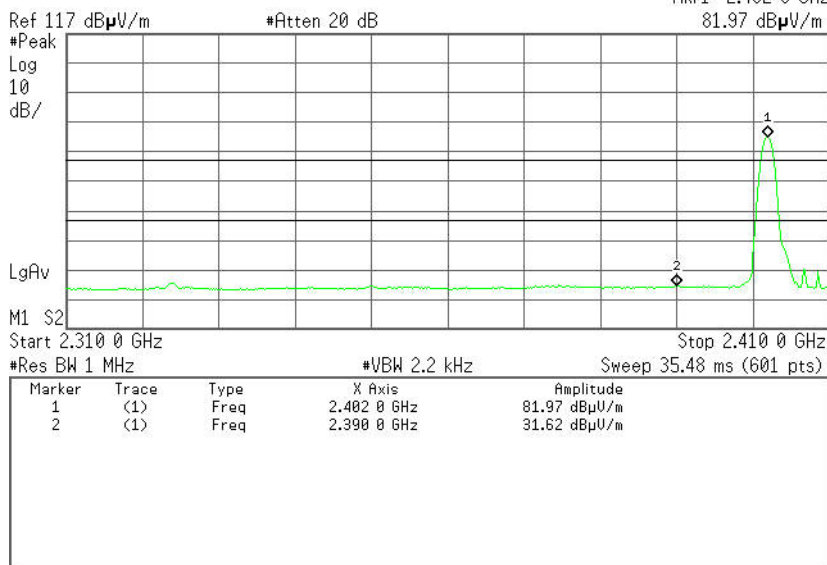



Detector mode: Peak

Polarity: Horizontal

Agilent

R T

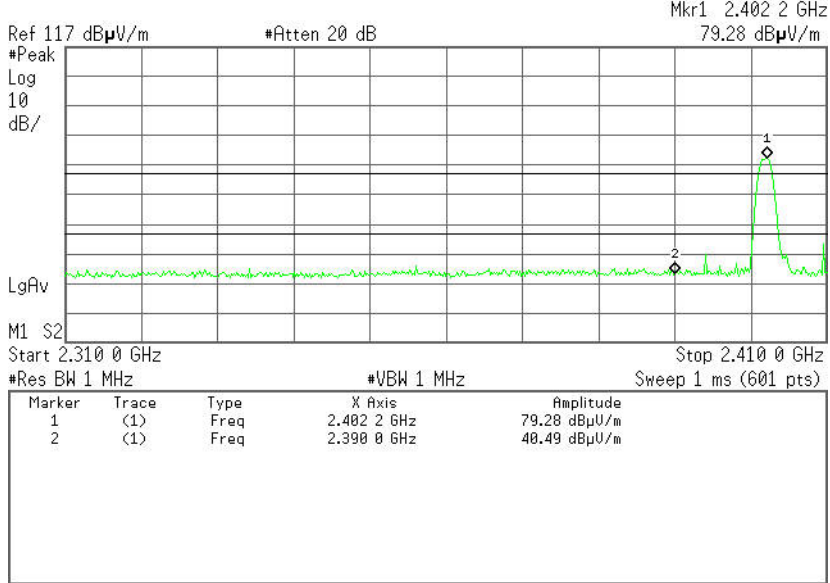

Detector mode: Average

Polarity: Horizontal

Agilent

R T

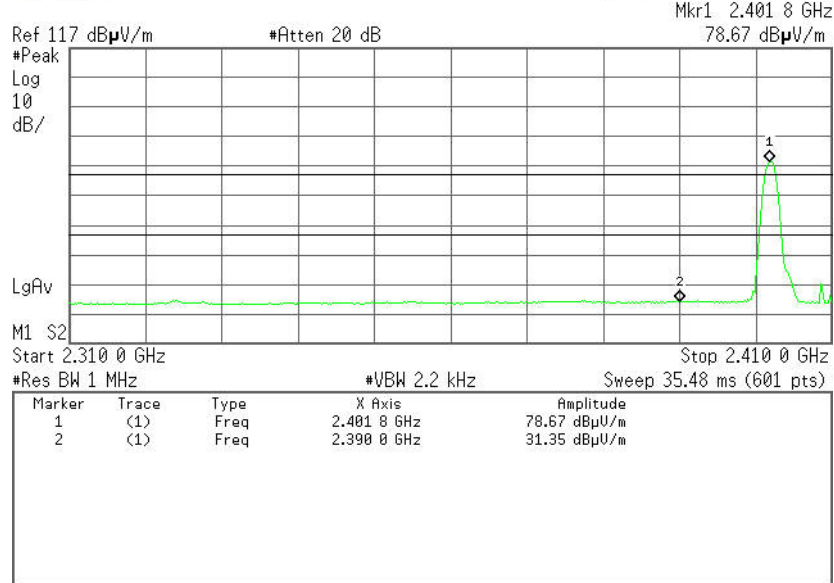



Band Edges (CH-High)

Detector mode: Peak

Polarity: Vertical

Agilent

R T

Mkr1 2.479 71 GHz
83.96 dBµV/m

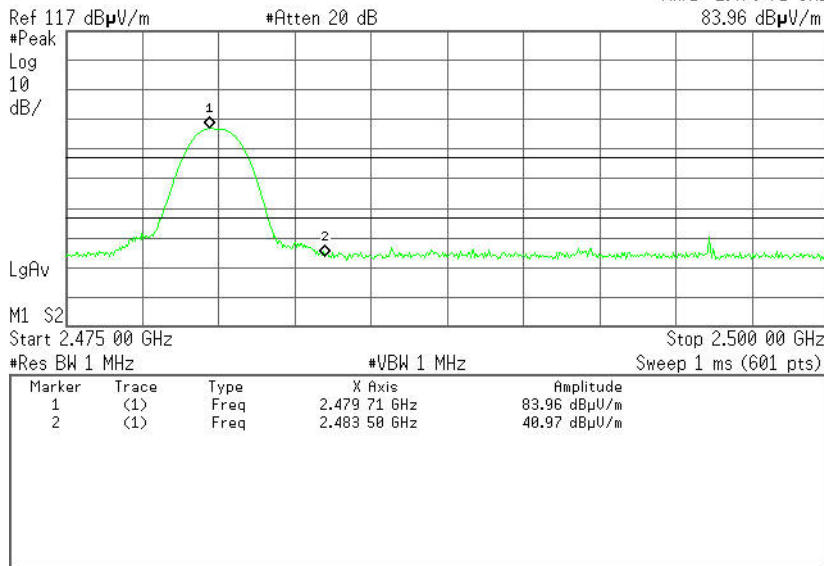

Detector mode: Average

Polarity: Vertical

Agilent

R T

Mkr1 2.479 92 GHz
83.43 dBµV/m

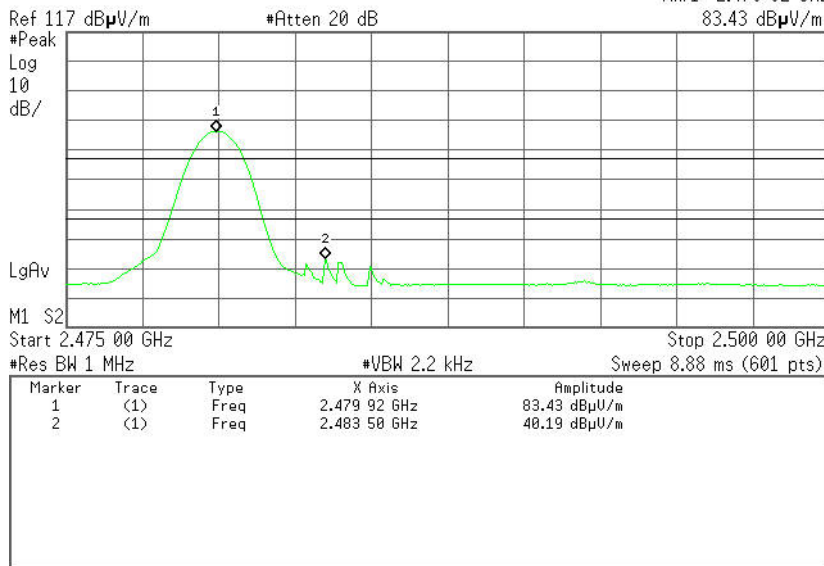



Detector mode: Peak

Polarity: Horizontal

Agilent

R T

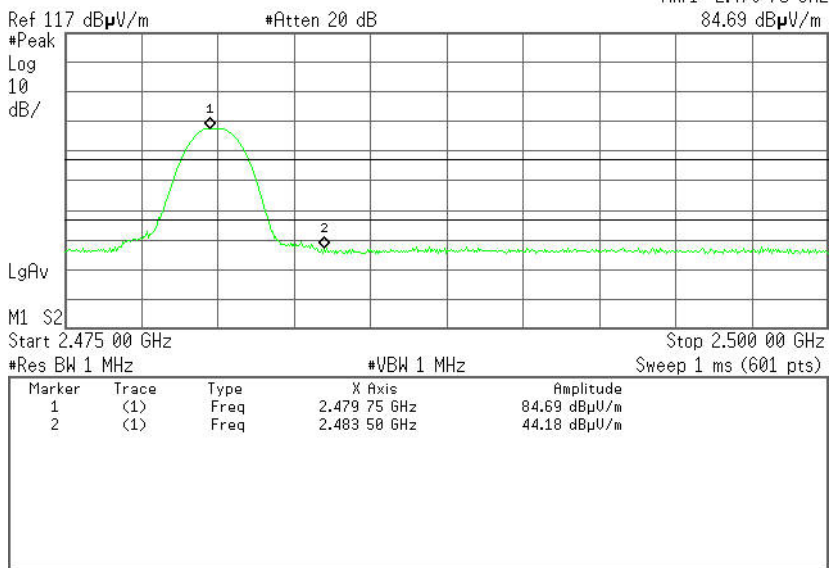

Detector mode: Average

Polarity: Horizontal

Agilent

R T

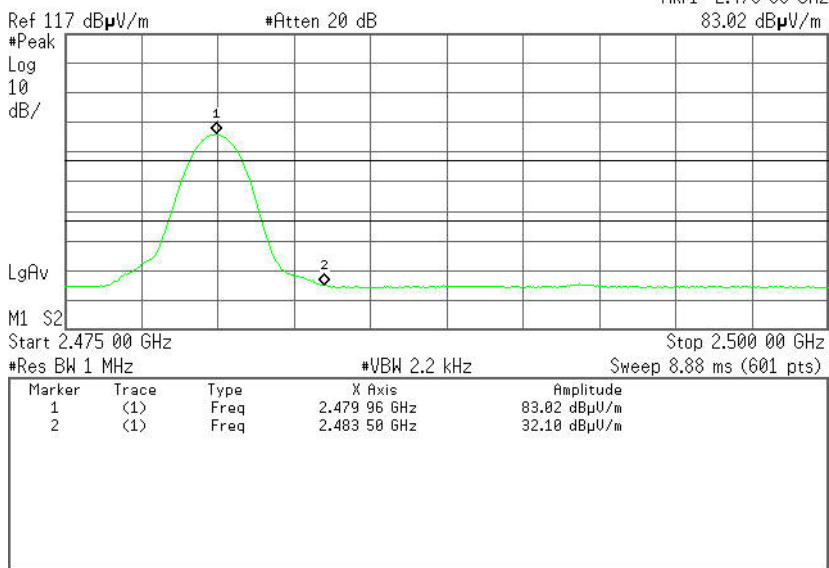



8DPSK

Band Edges (CH-Low)

Detector mode: Peak

Polarity: Vertical

Agilent

R T

Mkr1 2.401 8 GHz
79.50 dBµV/m

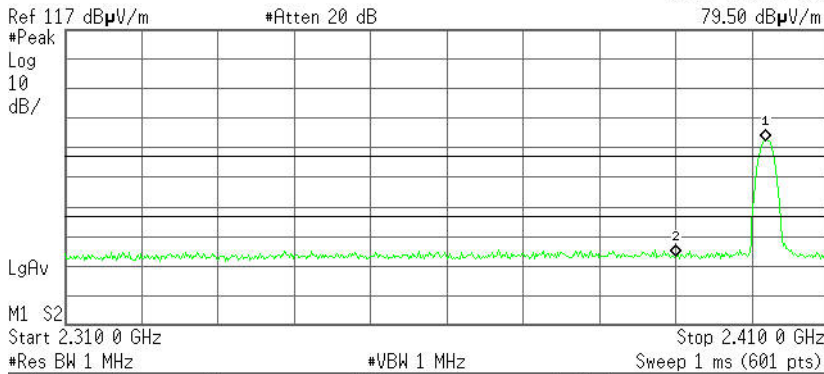

Marker	Trace	Type	X Axis	Amplitude
1	(1)	Freq	2.401 8 GHz	79.50 dBµV/m
2	(1)	Freq	2.390 0 GHz	40.55 dBµV/m

Detector mode: Average

Polarity: Vertical

Agilent

R T

Mkr1 2.402 0 GHz
76.22 dBµV/m

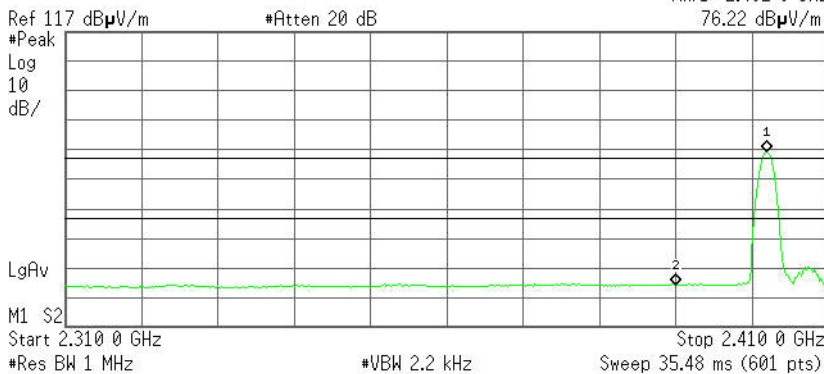

Marker	Trace	Type	X Axis	Amplitude
1	(1)	Freq	2.402 0 GHz	76.22 dBµV/m
2	(1)	Freq	2.390 0 GHz	31.33 dBµV/m



Detector mode: Peak

Polarity: Horizontal

Agilent

R T

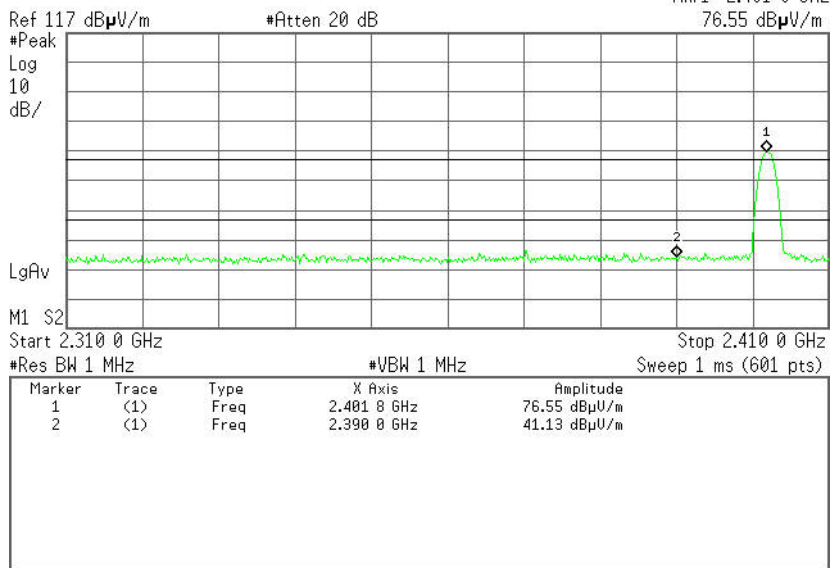

Detector mode: Average

Polarity: Horizontal

Agilent

R T

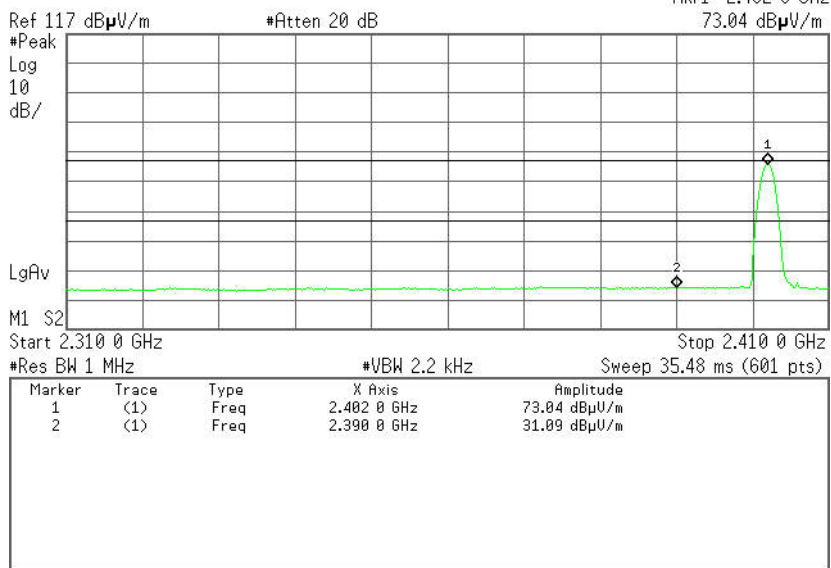



Band Edges (CH-High)

Detector mode: Peak

Polarity: Vertical

Agilent

R T

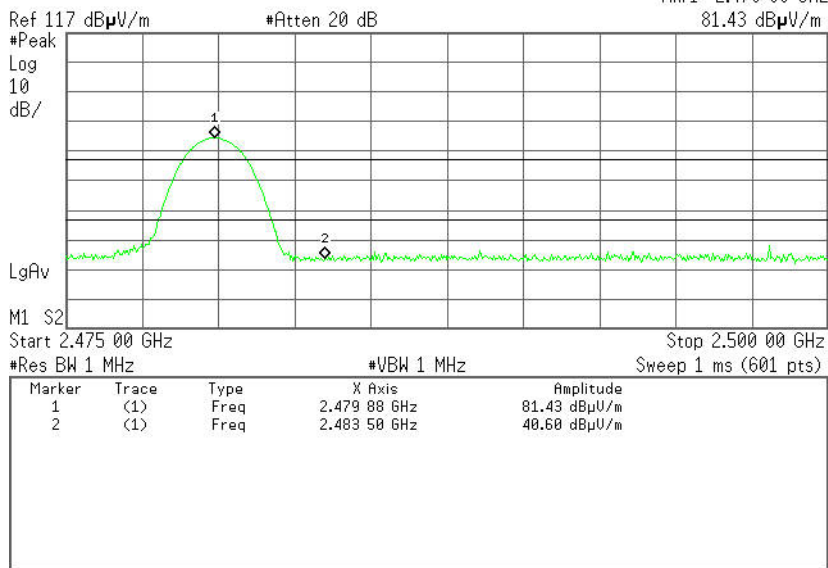

Detector mode: Average

Polarity: Vertical

Agilent

R T

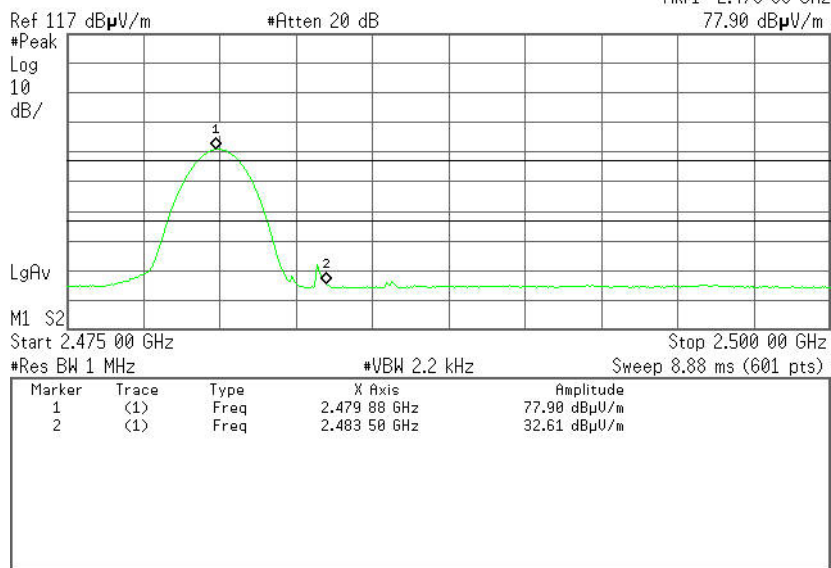



Detector mode: Peak

Polarity: Horizontal

Agilent

R T

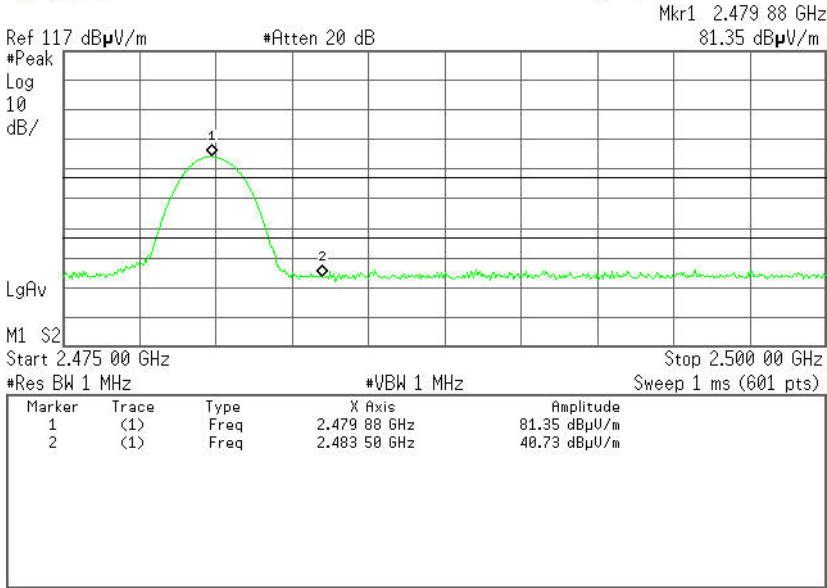

Detector mode: Average

Polarity: Horizontal

Agilent

R T

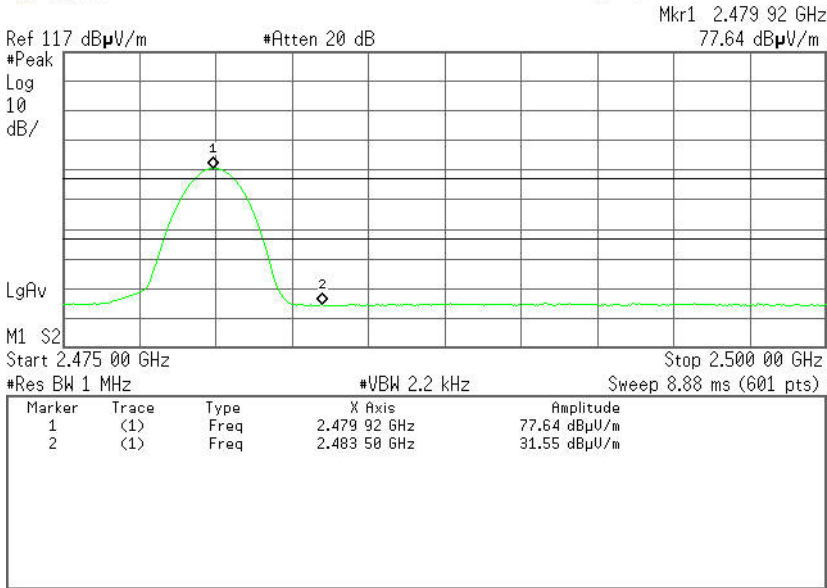



6.5 FREQUENCY SEPARATION

LIMIT

According to §15.247(a)(1), Frequency hopping systems shall have hopping channel carrier frequencies separated by a minimum of 25 kHz or the 20 dB bandwidth of the hopping channel, whichever is greater. Alternatively, frequency hopping systems operating in the 2400-2483.5 MHz band may have hopping channel carrier frequencies that are separated by 25 kHz or two-thirds of the 20 dB bandwidth of the hopping channel, whichever is greater, provided the systems operate with an output power no greater than 125 mW.

MEASUREMENT EQUIPMENT USED

Name of Equipment	Manufacturer	Model	Serial Number	Last Calibration	Due Calibration
Spectrum Analyzer	Agilent	N9010A	MY52221469	10/25/2013	10/24/2014

Remark: Each piece of equipment is scheduled for calibration once a year.

Test Configuration

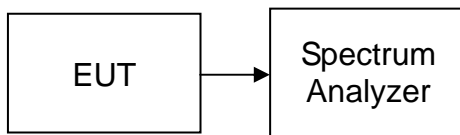

TEST PROCEDURE

1. Place the EUT on the table and set it in transmitting mode.
2. Remove the antenna from the EUT and then connect a low loss RF cable from the antenna port to the spectrum analyzer.
3. Set center frequency of spectrum analyzer = middle of hopping channel.
4. Set the spectrum analyzer as RBW=30kHz, VBW=30kHz, Adjust Span to 4 MHz, Sweep = auto.
5. Max hold. Mark 3 Peaks of hopping channel and record the 3 peaks frequency.

TEST RESULTS

No non-compliance noted

Test Data

GFSK

Channel Separation (MHz)	Two-thirds of the 20 dB Bandwidth (kHz)	Channel Separation Limit	Result
1.000	602.333	> Two-thirds of the 20 dB Bandwidth	Pass

8DPSK

Channel Separation (MHz)	Two-thirds of the 20 dB Bandwidth (kHz)	Channel Separation Limit	Result
1.000	806.000	> Two-thirds of the 20 dB Bandwidth	Pass



GFSK

Test Plot

Measurement of Channel Separation

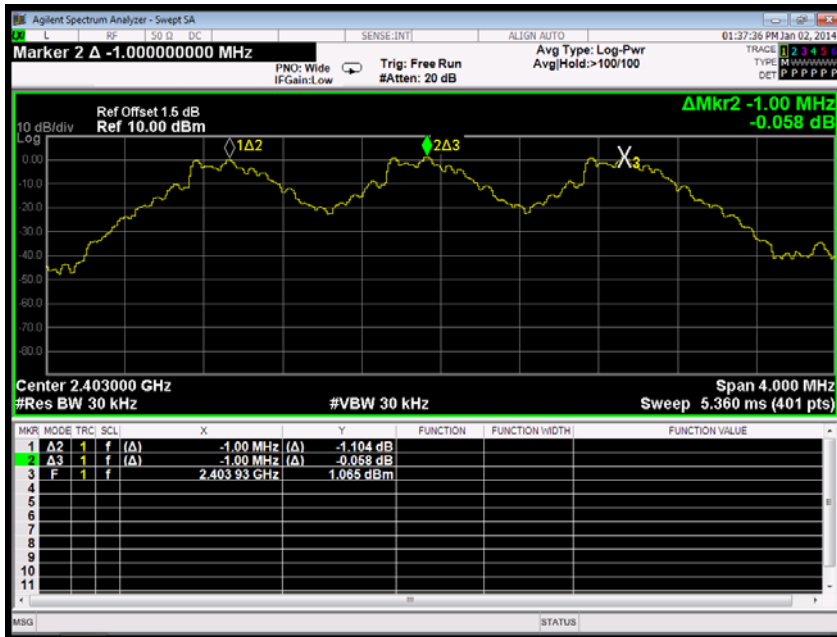

20 dB bandwidth(CH Low)

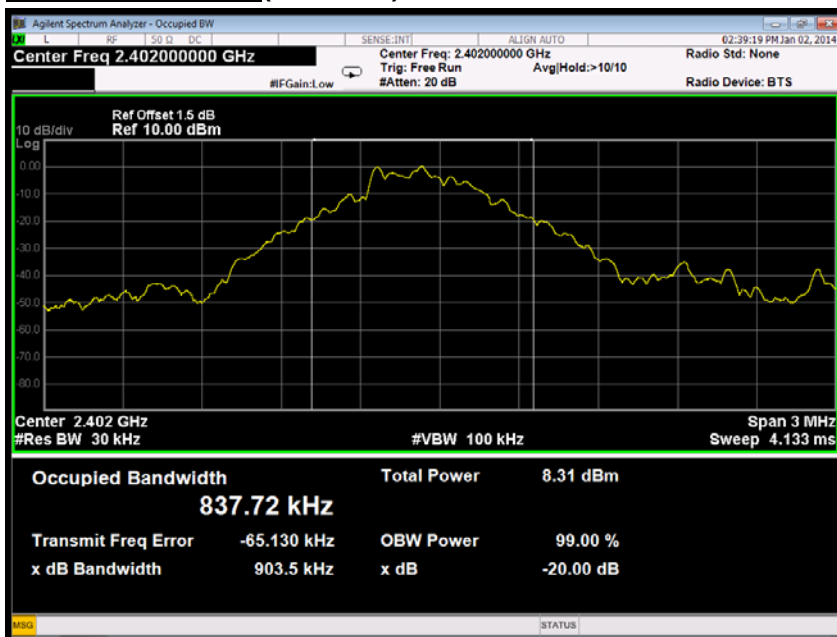



8DPSK

Test Plot

Measurement of Channel Separation



20 dB bandwidth(CH High)

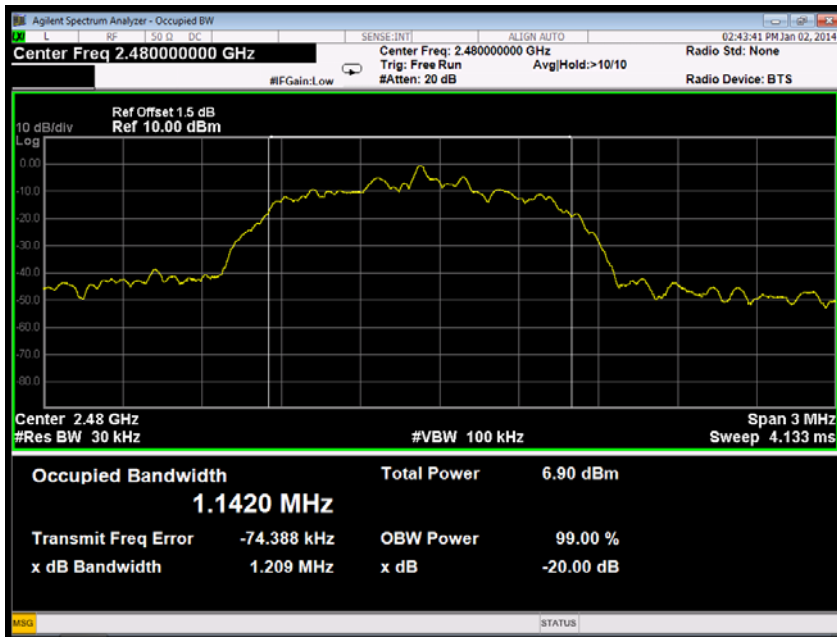



6.6 NUMBER OF HOPPING FREQUENCY

LIMIT

According to §15.247(a)(1)(ii), Frequency hopping systems operating in the 2400MHz-2483.5 MHz bands shall use at least 15 hopping frequencies.

MEASUREMENT EQUIPMENT USED

Name of Equipment	Manufacturer	Model	Serial Number	Last Calibration	Due Calibration
Spectrum Analyzer	Agilent	N9010A	MY52221469	10/25/2013	10/24/2014

Remark: Each piece of equipment is scheduled for calibration once a year.

Test Configuration

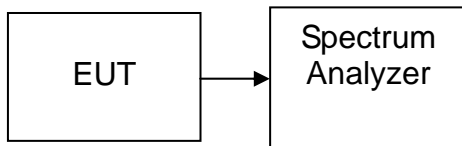

TEST PROCEDURE

1. Place the EUT on the table and set it in transmitting mode.
2. Remove the antenna from the EUT and then connect a low loss RF cable from the antenna port to the spectrum analyzer.
3. Set spectrum analyzer Start=2400MHz, Stop = 2441.5MHz, Sweep = 1ms and Start=2441.5MHz, Stop = 2483.5MHz, Sweep = 1ms.
4. Set the spectrum analyzer as RBW, VBW=300kHz,
5. Max hold, view and count how many channel in the band.

TEST RESULTS

No non-compliance noted

Test Data

Result (No. of CH)	Limit (No. of CH)	Result
79	>15	PASS



Test Plot (GFSK)

Channel Number

2.400 GHz – 2.4415 GHz

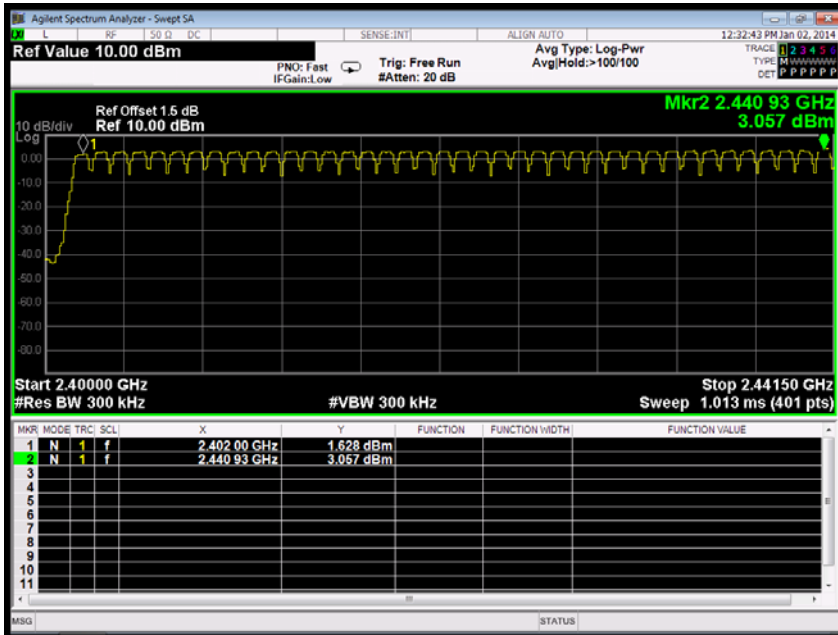

2.4415 GHz –2.4835 GHz

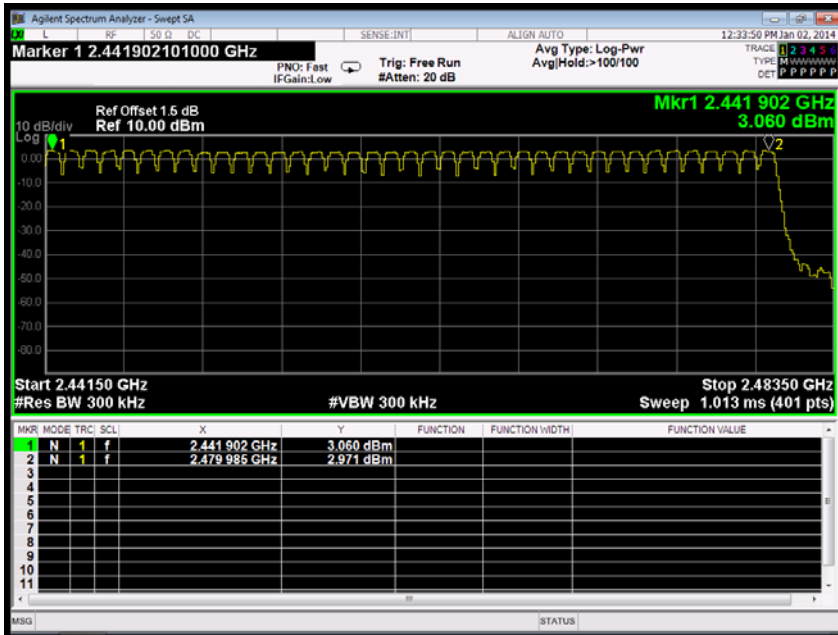



Test Plot (8DPSK)

Channel Number

2.400 GHz – 2.4415 GHz

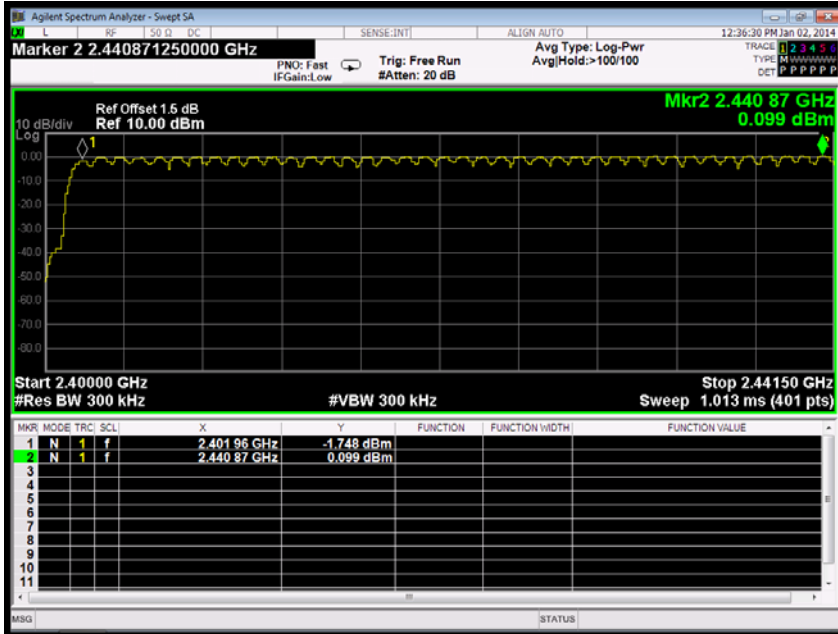

2.4415 GHz –2.4835 GHz

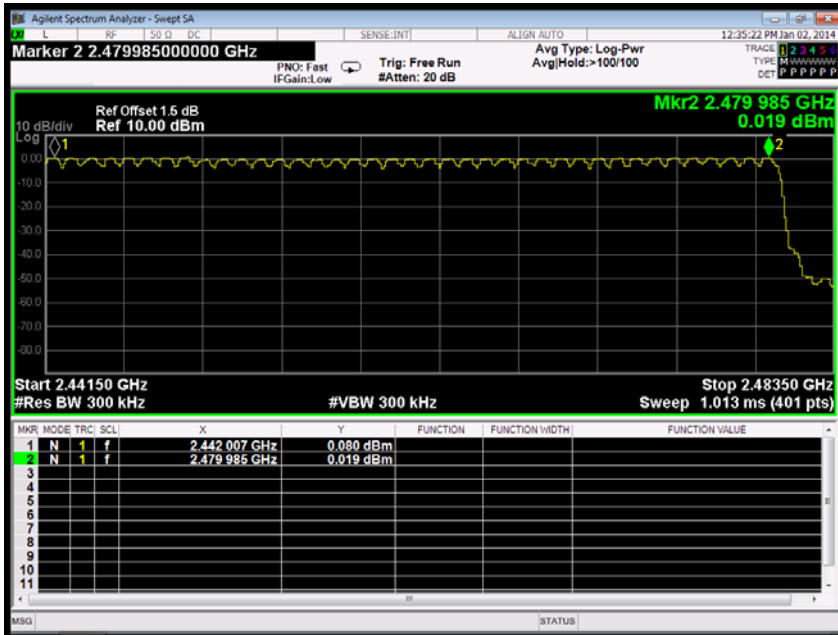



6.7 TIME OF OCCUPANCY (DWELL TIME)

LIMIT

According to §15.247(a)(1)(iii), Frequency hopping systems operating in the 2400MHz-2483.5 MHz bands. The average time of occupancy on any channels shall not greater than 0.4 s within a period 0.4 s multiplied by the number of hopping channels employed.

MEASUREMENT EQUIPMENT USED

Name of Equipment	Manufacturer	Model	Serial Number	Last Calibration	Due Calibration
Spectrum Analyzer	Agilent	N9010A	MY52221469	10/25/2013	10/24/2014

Remark: Each piece of equipment is scheduled for calibration once a year.

Test Configuration

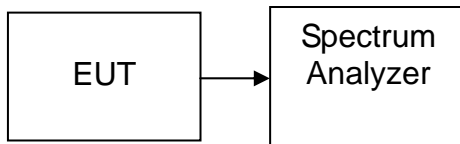

TEST PROCEDURE

1. Place the EUT on the table and set it in transmitting mode.
2. Remove the antenna from the EUT and then connect a low loss RF cable from the antenna port to the spectrum analyzer.
3. Set center frequency of spectrum analyzer = operating frequency.
4. Set the spectrum analyzer as RBW, VBW=1MHz, Span = 0Hz, Sweep = auto.
5. Repeat above procedures until all frequency measured were complete.



TEST RESULTS

No non-compliance noted

Test Data

GFSK

DH 1

CH Mid: $0.436 * (1600/2)/79 * 31.6 = 139.520(\text{ms})$

CH	Pulse Time (ms)	Total of Dwell (ms)	Period Time (s)	Limit (ms)	Result
Mid	0.436	139.520	31.60	400.00	PASS

DH 3

CH Mid: $1.700 * (1600/4)/79 * 31.6 = 272.000 (\text{ms})$

CH	Pulse Time (ms)	Total of Dwell (ms)	Period Time (s)	Limit (ms)	Result
Mid	1.700	272.000	31.60	400.00	PASS

DH 5

CH Mid: $2.950 * (1600/6)/79 * 31.6 = 314.667(\text{ms})$

CH	Pulse Time (ms)	Total of Dwell (ms)	Period Time (s)	Limit (ms)	Result
Mid	2.950	314.667	31.60	400.00	PASS



Test Data

8DPSK

DH 1

CH Mid: $0.436 * (1600/2)/79 * 31.6 = 139.520$ (ms)

CH	Pulse Time (ms)	Total of Dwell (ms)	Period Time (s)	Limit (ms)	Result
Mid	0.436	139.520	31.60	400.00	PASS

DH 3

CH Mid: $1.700 * (1600/4)/79 * 31.6 = 272.000$ (ms)

CH	Pulse Time (ms)	Total of Dwell (ms)	Period Time (s)	Limit (ms)	Result
Mid	1.700	272.000	31.60	400.00	PASS

DH 5

CH Mid: $2.960 * (1600/6)/79 * 31.6 = 315.733$ (ms)

CH	Pulse Time (ms)	Total of Dwell (ms)	Period Time (s)	Limit (ms)	Result
Mid	2.960	315.733	31.60	400.00	PASS



Test Plot

GFSK

DH 1

(CH Mid)

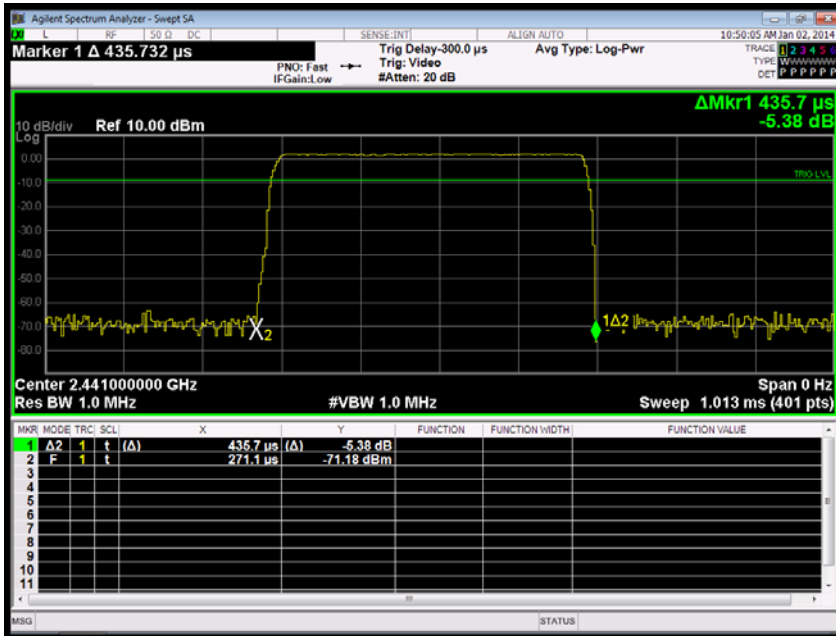

DH 3

(CH Mid)

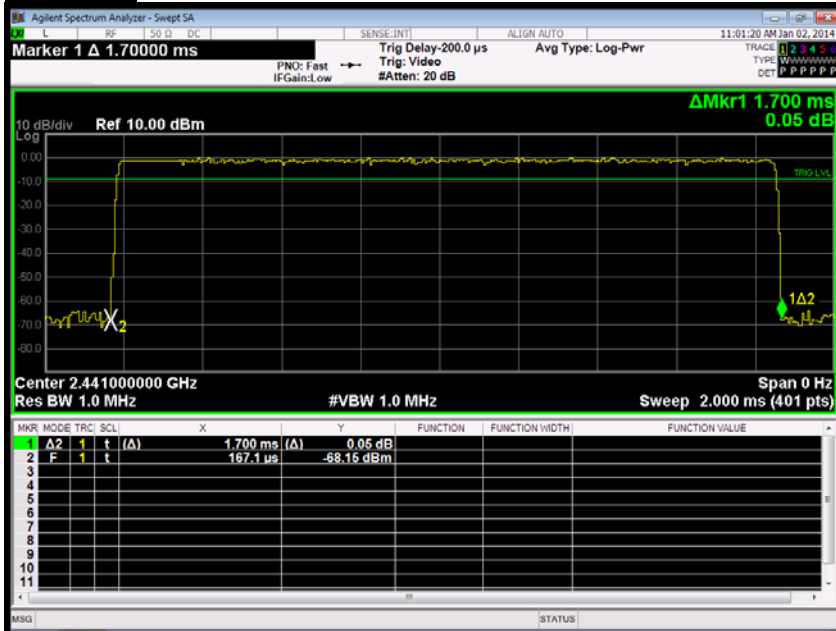



DH 5

(CH Mid)

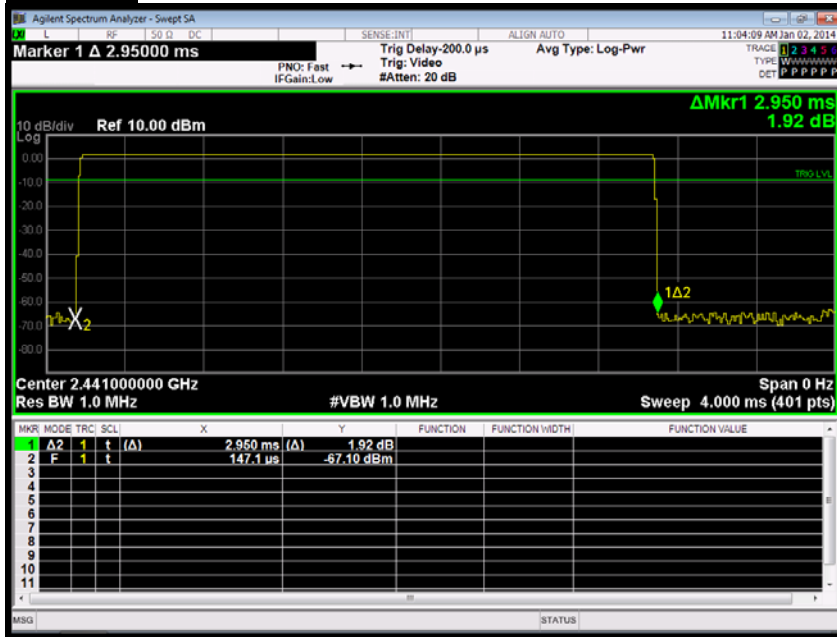



Test Plot
8DPSK

DH 1

(CH Mid)

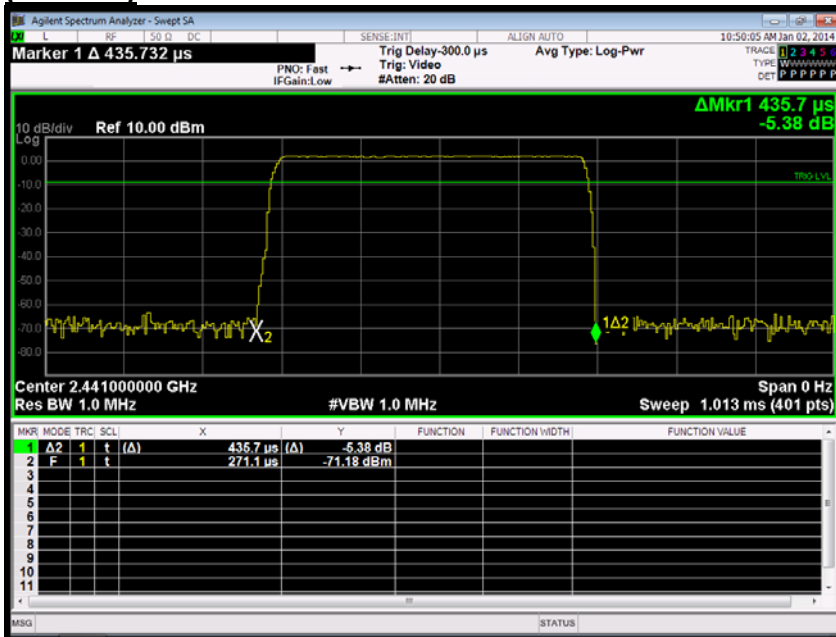

DH 3

(CH Mid)





DH 5

(CH Mid)

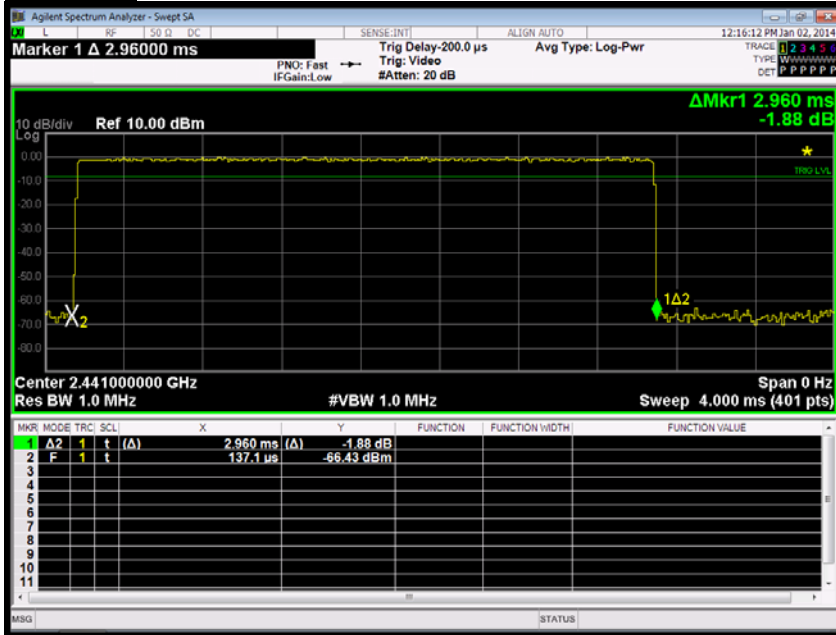



6.8 SPURIOUS EMISSIONS

6.8.1. CONDUCTED MEASUREMENT

LIMIT

In any 100 kHz bandwidth outside the frequency band in which the spread spectrum or digitally modulated intentional radiator is operating, the radio frequency power that is produced by the intentional radiator shall be at least 20 dB below that in the 100 kHz bandwidth within the band that contains the highest level of the desired power, based on either an RF conducted or a radiated measurement. Attenuation below the general limits specified in Section 15.209(a) is not required. In addition, radiated emissions which fall in the restricted bands, as defined in Section 15.205(a), must also comply with the radiated emission limits specified in Section 15.209(a) (see Section 15.205(c)).

MEASUREMENT EQUIPMENT USED

Name of Equipment	Manufacturer	Model	Serial Number	Last Calibration	Due Calibration
Spectrum Analyzer	Agilent	N9010A	MY52221469	10/25/2013	10/24/2014

Remark: Each piece of equipment is scheduled for calibration once a year.

Test Configuration

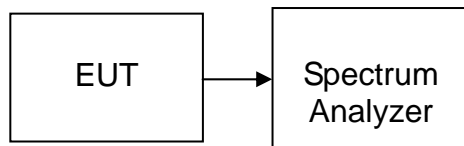

TEST PROCEDURE

Conducted RF measurements of the transmitter output were made to confirm that the EUT antenna port conducted emissions meet the specified limit and to identify any spurious signals that require further investigation or measurements on the radiated emissions site.

The transmitter output is connected to the spectrum analyzer. The resolution bandwidth is set to 100 kHz. The video bandwidth is set to 100 kHz.

Measurements are made over the 30MHz to 26GHz range with the transmitter set to the lowest, middle, and highest channels.

TEST RESULTS

No non-compliance noted



Test Plot (GFSK)

CH Low (30MHz ~26.5GHz)

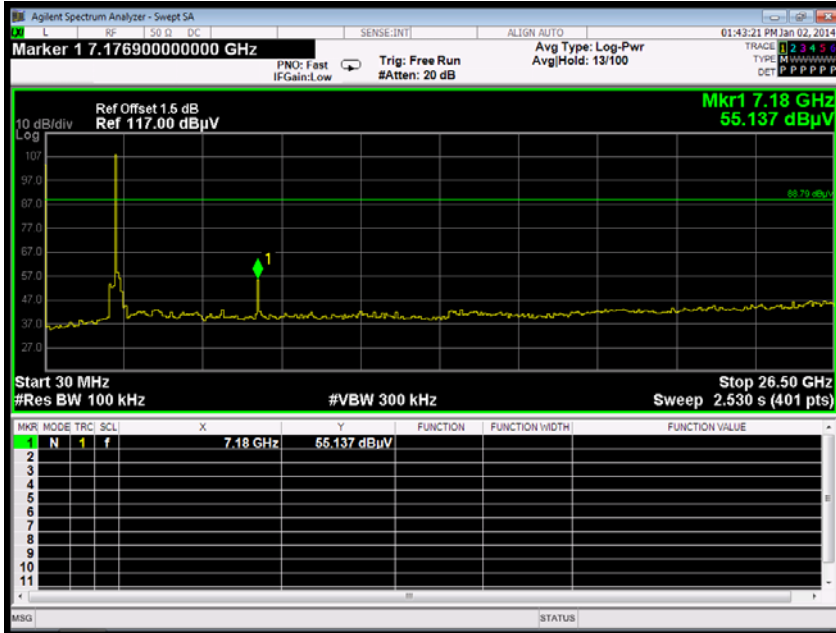

CH Low (2.31GHz ~2.41GHz)

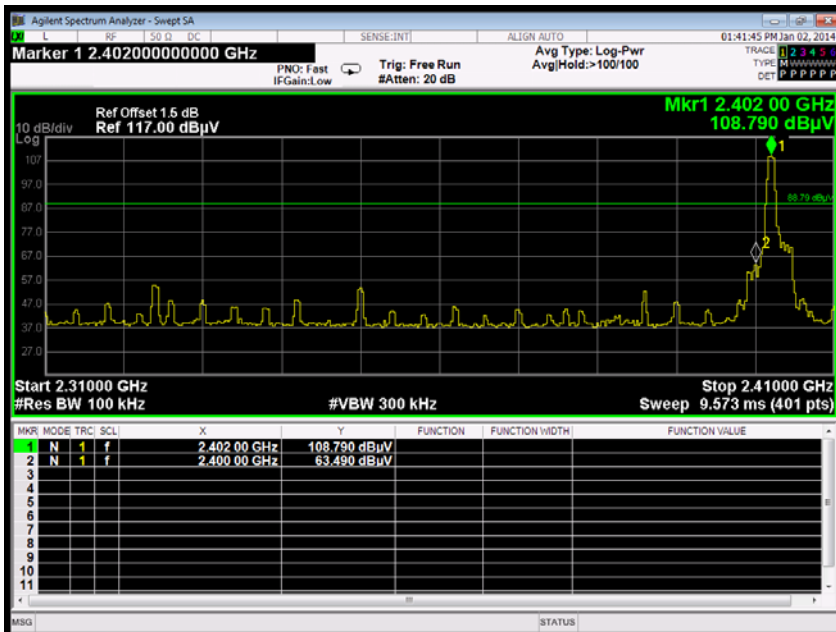



CH Mid (30MHz ~ 26.5GHz)

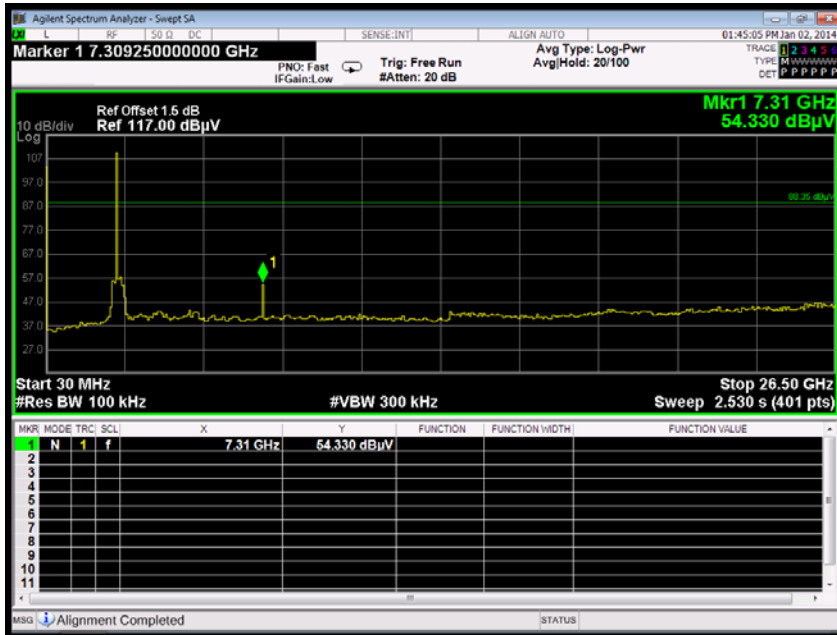



CH High (30MHz ~ 26.5GHz)

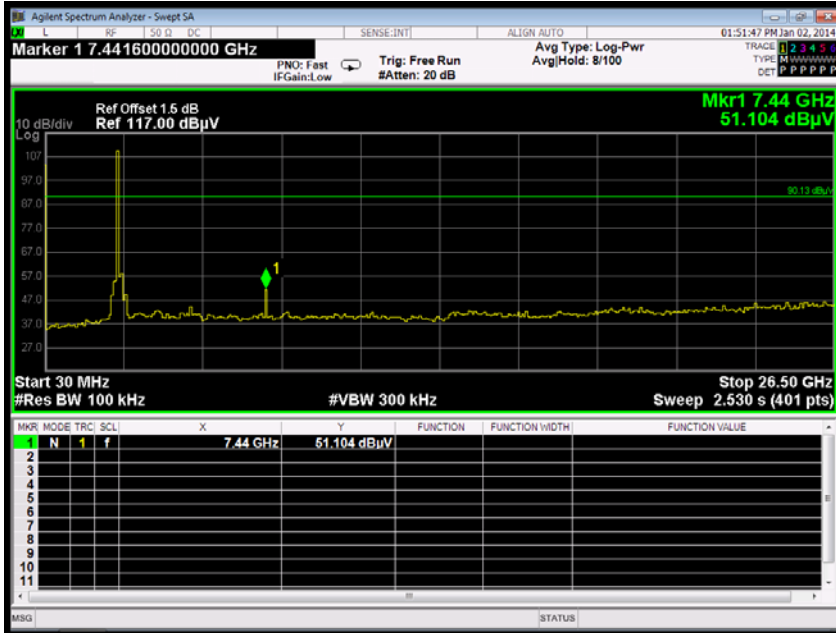

CH High (2.475GHz ~ 2.5GHz)

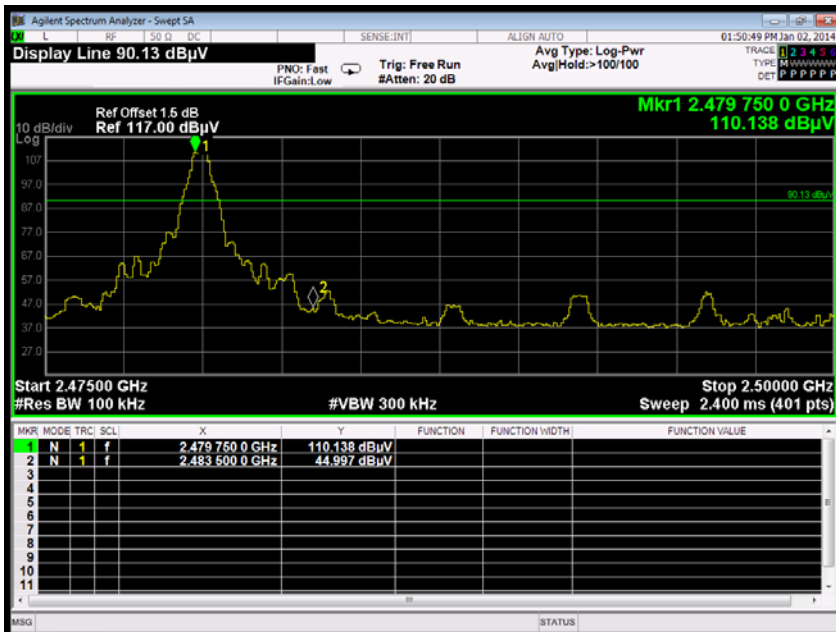



Test Plot (8DPSK)

CH Low (30MHz ~26.5GHz)

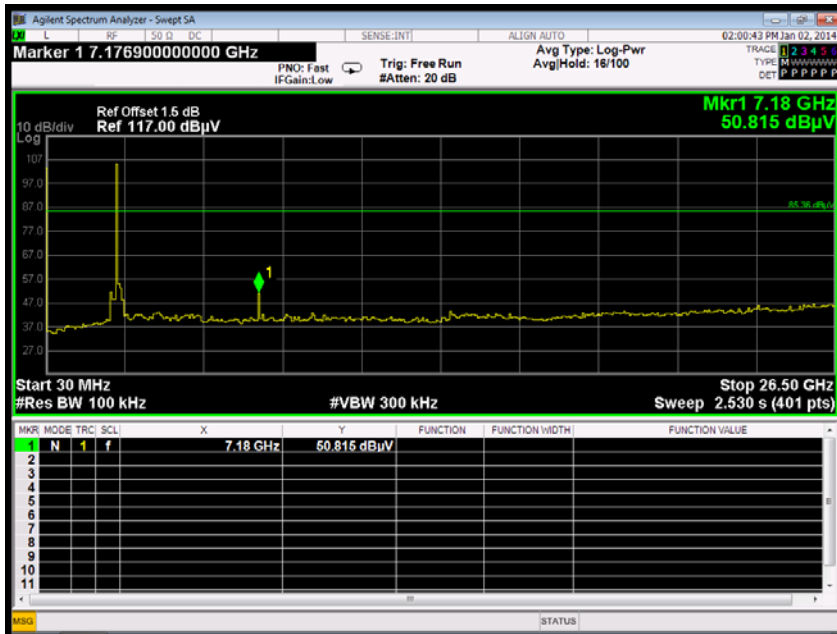

CH Low (2.31GHz ~2.41GHz)

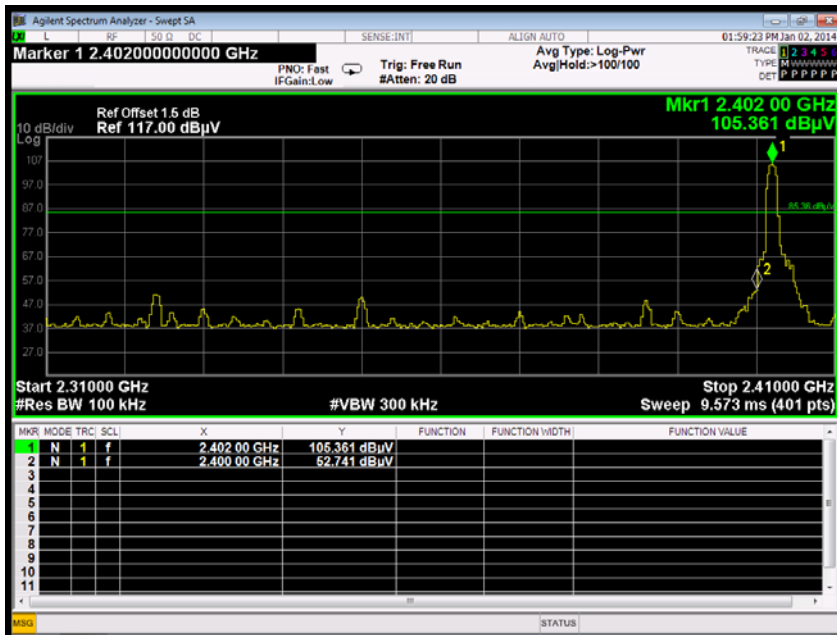



CH Mid (30MHz ~ 26.5GHz)

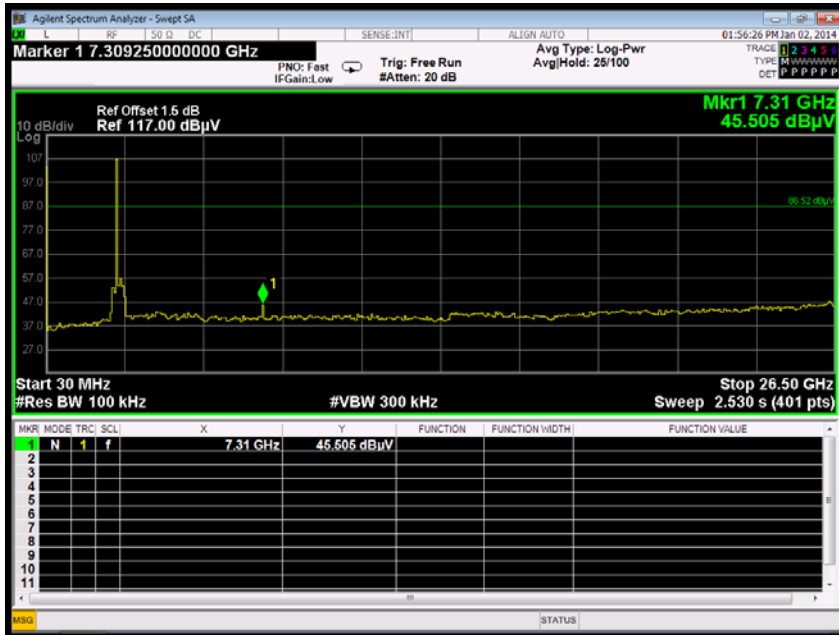



CH High (30MHz ~ 26.5GHz)

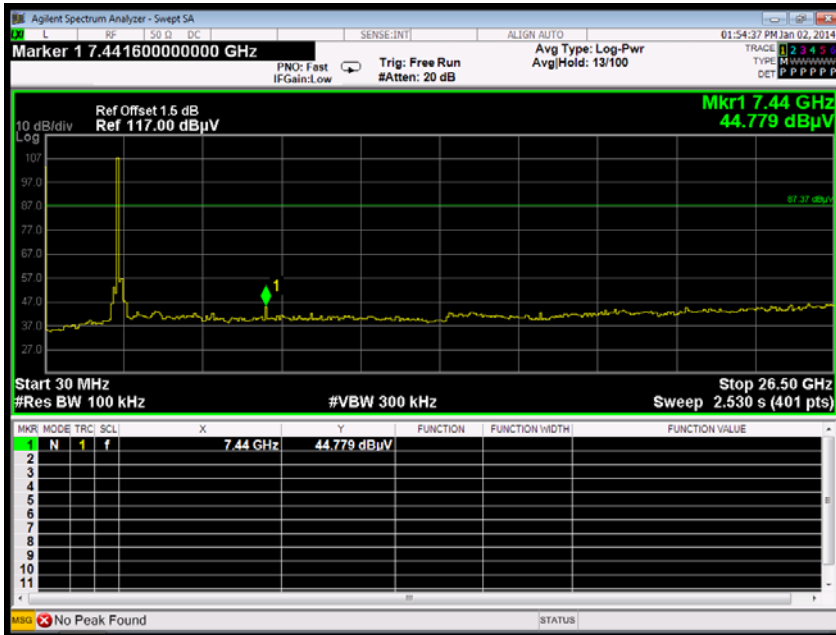

CH High (2.475GHz ~ 2.5GHz)





6.8.2. RADIATED EMISSIONS

LIMIT

1. Except as provided elsewhere in this Subpart, the emissions from an intentional radiator shall not exceed the field strength levels specified in the following table:

Frequency (MHz)	Field Strength (mV/m)	Measurement Distance (m)
0.009-0.490	2400/F(kHz)	300
0.490-1.705	24000/F(kHz)	30
1.705-30.0	30	30
30-88	100*	3
88-216	150*	3
216-960	200*	3
Above 960	500	3

Note: Except as provided in paragraph (g), fundamental emissions from intentional radiators operating under this Section shall not be located in the frequency bands 54-72 MHz, 76-88 MHz, 174-216 MHz or 470-806 MHz. However, operation within these frequency bands is permitted under other sections of this Part, e.g., Sections 15.231 and 15.241.

2. In the above emission table, the tighter limit applies at the band edges.

Frequency (Hz)	Field Strength (μ V/m at 3-meter)	Field Strength (dB μ V/m at 3-meter)
30-88	100	40
88-216	150	43.5
216-960	200	46
Above 960	500	54



MEASUREMENT EQUIPMENT USED

Radiated Emission Test Site 966(2)					
Name of Equipment	Manufacturer	Model Number	Serial Number	Last Calibration	Due Calibration
PSA Series Spectrum Analyzer	Agilent	E4446A	US44300399	03/09/2013	03/08/2014
EMI TEST RECEIVER	ROHDE&SCHWARZ	ESCI	100783	03/09/2013	03/08/2014
Amplifier	MITEQ	AM-1604-3000	1123808	03/18/2013	03/18/2014
High Noise Amplifier	Agilent	8449B	3008A01838	03/18/2013	03/18/2014
Board-Band Horn Antenna	Schwarzbeck	BBHA 9170	9170-497	06/21/2013	06/21/2014
Bilog Antenna	SCHAFFNER	CBL6143	5082	03/02/2013	03/01/2014
Horn Antenna	SCHWARZBECK	BBHA9120	D286	03/02/2013	03/01/2014
Loop Antenna	A、 R、 A	PLA-1030/B	1029	03/19/2013	03/18/2014
Turn Table	N/A	N/A	N/A	N.C.R	N.C.R
Controller	Sunol Sciences	SC104V	022310-1	N.C.R	N.C.R
Controller	CT	N/A	N/A	N.C.R	N.C.R
Temp. / Humidity Meter	Anymetre	JR913	N/A	03/04/2013	03/03/2014
Antenna Tower	SUNOL	TLT2	N/A	N.C.R	N.C.R
Test S/W	FARAD	LZ-RF / CCS-SZ-3A2			

Remark: Each piece of equipment is scheduled for calibration once a year.



TEST CONFIGURATION

Below 30MHz

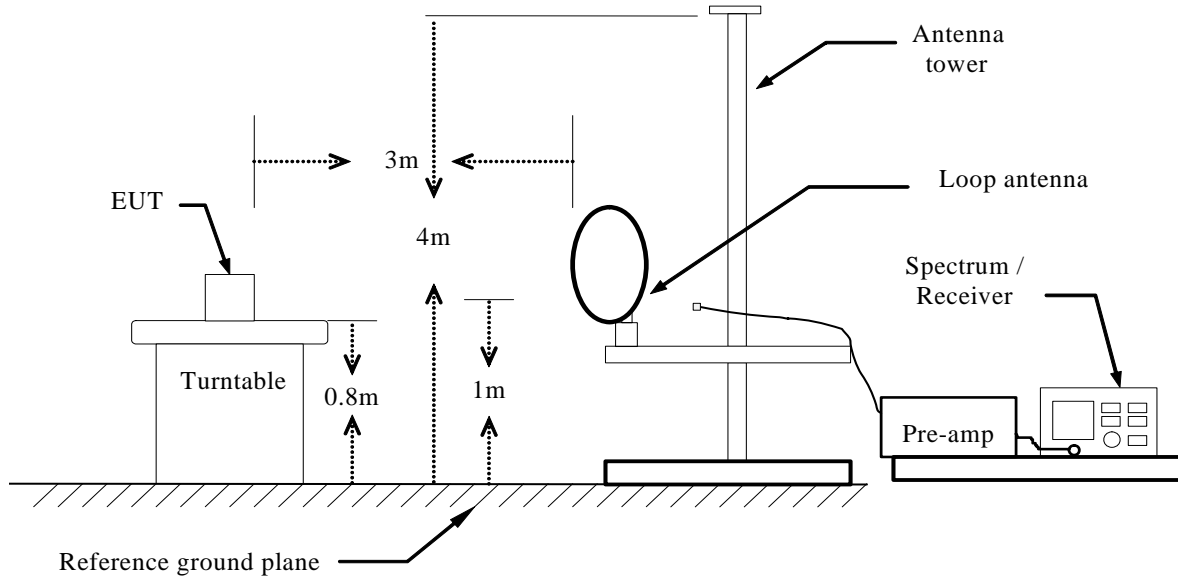

Below 1 GHz

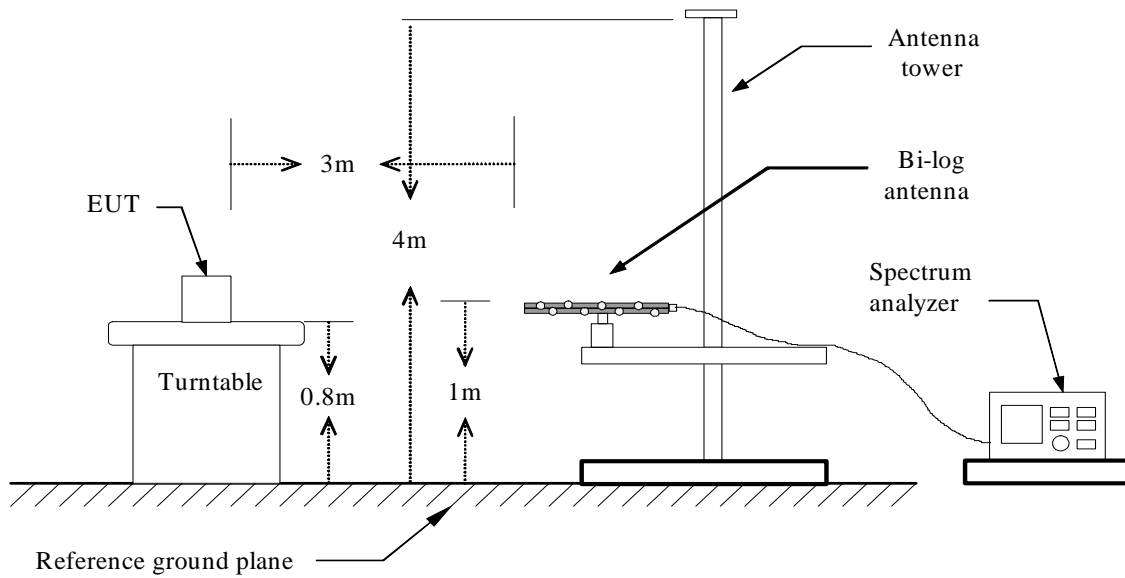



Above 1 GHz

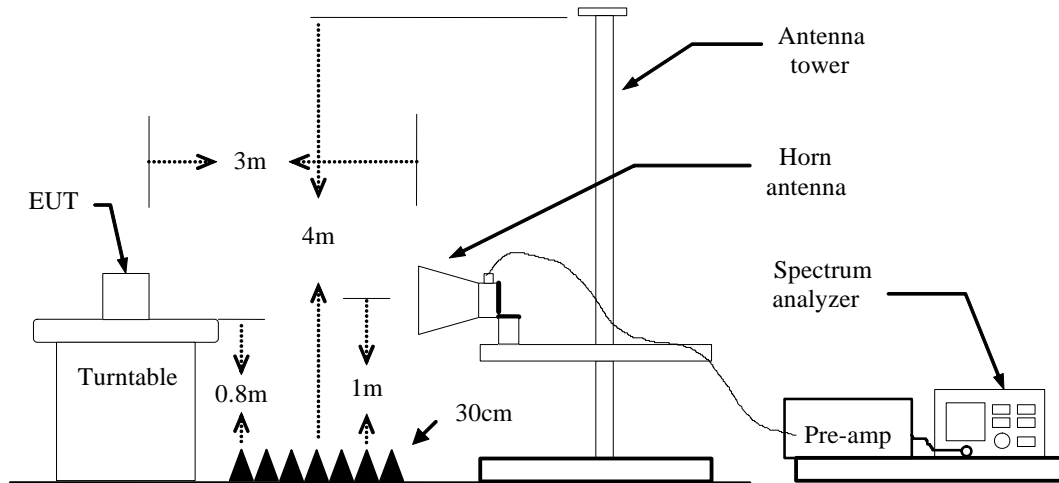

TEST PROCEDURE

1. The EUT is placed on a turntable, which is 0.8m above ground plane.
2. The turntable shall be rotated for 360 degrees to determine the position of maximum emission level.
3. EUT is set 3m away from the receiving antenna, which is varied from 1m to 4m to find out the highest emissions.
4. Maximum procedure was performed on the six highest emissions to ensure EUT compliance.
5. And also, each emission was to be maximized by changing the polarization of receiving antenna both horizontal and vertical.
6. Repeat above procedures until the measurements for all frequencies are complete.



TEST RESULTS

Below 1 GHz

Operation Mode: TX

Test Date: January 2, 2014

Temperature: 24°C

Tested by: Sun Guo

Humidity: 52% RH

Polarity: Ver. / Hor.

Frequency (MHz)	Reading (dBµV)	Correction Factor (dB/m)	Result (dBµV/m)	Limit (dBµV/m)	Margin (dB)	Antenna Pole (V/H)	Remark
34.8500	41.97	-13.13	28.84	40.00	-11.16	V	QP
144.7833	36.62	-19.12	17.50	43.50	-26.00	V	QP
246.6333	35.68	-17.43	18.25	46.00	-27.75	V	QP
351.7167	35.60	-16.69	18.91	46.00	-27.09	V	QP
479.4333	32.01	-14.40	17.61	46.00	-28.39	V	QP
594.2167	32.50	-12.76	19.74	46.00	-26.26	V	QP
123.7667	35.91	-20.21	15.70	43.50	-27.80	H	QP
170.6500	35.40	-18.68	16.72	43.50	-26.78	H	QP
319.3833	40.79	-17.59	23.20	46.00	-22.80	H	QP
351.7167	39.56	-16.69	22.87	46.00	-23.13	H	QP
505.3000	35.24	-14.36	20.88	46.00	-25.12	H	QP
560.2667	34.24	-13.67	20.57	46.00	-25.43	H	QP

****Remark:** No emission found between lowest internal used/generated frequency to 30MHz.

Notes:

1. Measuring frequencies from 9kHz to the 1GHz.
2. Radiated emissions measured in frequency range from 30MHz to 1GHz were made with an instrument using Peak/Quasi-peak detector mode.
3. Data of measurement within this frequency range shown " --- " in the table above means the reading of emissions are attenuated more than 20dB below the permissible limits or the field strength is too small to be measured.
4. The IF bandwidth of SPA between 30MHz to 1GHz was 120kHz.
5. Frequency (MHz) = Emission frequency in MHz
Reading (dBuV) = Receiver reading
Correction Factor(dB/m) = Antenna factor + Cable loss – Amplifier gain
Actual FS (dBuV/m) = Reading (dBuV) + Corr. Factor (dB/m)
Limit (dBuV/m) = Limit stated in standard
Margin(dB) = Measured (dBuV/m) – Limits (dBuV/m)
Antenna Pole(V/H) = Current carrying line of reading



Above 1 GHz

GFSK

Operation Mode: TX(CH Low)

Test Date: January 2, 2014

Temperature: 24°C

Tested by: Sun Guo

Humidity: 52% RH

Polarity: Ver. / Hor.

Frequency (MHz)	Reading (dBµV)	Correction Factor (dB/m)	Result (dBµV/m)	Limit (dBµV/m)	Margin (dB)	Antenna Pole (V/H)	Remark
1195.0000	51.90	-8.77	43.13	74.00	-30.87	V	peak
1600.0000	50.50	-8.68	41.82	74.00	-32.18	V	peak
3040.0000	46.34	-4.21	42.13	74.00	-31.87	V	peak
3895.0000	45.81	-2.51	43.30	74.00	-30.70	V	peak
4810.0000	48.52	0.46	48.98	74.00	-25.02	V	peak
5275.0000	44.29	1.54	45.83	74.00	-28.17	V	peak
1060.0000	54.35	-9.85	44.50	74.00	-29.50	H	peak
1540.0000	48.04	-8.43	39.61	74.00	-34.39	H	peak
3040.0000	46.10	-4.21	41.89	74.00	-32.11	H	peak
3850.0000	44.89	-2.50	42.39	74.00	-31.61	H	peak
4435.0000	44.80	-0.76	44.04	74.00	-29.96	H	peak
5290.0000	45.02	1.54	46.56	74.00	-27.44	H	peak

Notes:

1. Measuring frequencies from 1 GHz to the 10th harmonic of highest fundamental frequency.
2. Measurements above show only up to 6 maximum emissions noted, or would be lesser if no specific emissions from the EUT are recorded (ie: margin>20dB from the applicable limit) and considered that's already beyond the background noise floor.
3. Radiated emissions measured in frequency above 1000MHz were made with an instrument using Peak detector mode and average detector mode of the emission shown in Actual FS column.
4. Spectrum setting:
 - a. Peak Setting 1GHz - 26GHz, RBW = 1MHz, VBW = 1MHz, Sweep time = 200 ms.
 - b. AV Setting 1GH z- 26GHz, RBW = 1MHz, VBW = 10Hz, Sweep time = 200 ms.
5. Frequency (MHz) = Emission frequency in MHz
 Reading (dBµV/m) =Uncorrected Analyzer / Receiver Reading
 Correction Factor (dB) = Antenna factor + Cable loss – Amplifier gain
 Limit (dBµV/m) = Limit stated in standard
 Margin (dB) = Result (dBµV/m)- Limit (dBµV/m)
 Pk = Peak Reading
 AV. = Average Reading
 Remark = Mark Peak Reading or Average Reading



Operation Mode: TX(CH Mid)
Temperature: 24°C
Humidity: 52% RH

Test Date: January 2, 2014
Tested by: Sun Guo
Polarity: Ver. / Hor.

Table with 8 columns: Frequency (MHz), Reading (dBµV), Correction Factor (dB/m), Result (dBµV/m), Limit (dBµV/m), Margin (dB), Antenna Pole (V/H), Remark. It contains two sets of data rows for various frequencies.

Notes:

- 1. Measuring frequencies from 1 GHz to the 10th harmonic of highest fundamental frequency.
2. Measurements above show only up to 6 maximum emissions noted, or would be lesser if no specific emissions from the EUT are recorded...
3. Radiated emissions measured in frequency above 1000MHz were made with an instrument using Peak detector mode...
4. Spectrum setting:
a. Peak Setting 1GHz - 26GHz, RBW = 1MHz, VBW = 1MHz, Sweep time = 200 ms.
b. AV Setting 1GH z- 26GHz, RBW = 1MHz, VBW = 10Hz, Sweep time = 200 ms.
5. Frequency (MHz) = Emission frequency in MHz
Reading (dBµV/m) =Uncorrected Analyzer / Receiver Reading
Correction Factor (dB) = Antenna factor + Cable loss – Amplifier gain
Limit (dBµV/m) = Limit stated in standard
Margin (dB) = Result (dBµV/m)- Limit (dBµV/m)
Pk = Peak Reading
AV. = Average Reading
Remark = Mark Peak Reading or Average Reading



Operation Mode: TX(CH High)

Test Date: January 2, 2014

Temperature: 24 °C

Tested by: Sun Guo

Humidity: 52% RH

Polarity: Ver. / Hor.

Frequency (MHz)	Reading (dBµV)	Correction Factor (dB/m)	Result (dBµV/m)	Limit (dBµV/m)	Margin (dB)	Antenna Pole (V/H)	Remark
1195.0000	51.23	-8.77	42.46	74.00	-31.54	V	peak
1600.0000	50.03	-8.68	41.35	74.00	-32.65	V	peak
3295.0000	45.89	-4.05	41.84	74.00	-32.16	V	peak
3850.0000	45.60	-2.50	43.10	74.00	-30.90	V	peak
4960.0000	46.67	1.14	47.81	74.00	-26.19	V	peak
5560.0000	45.28	1.85	47.13	74.00	-26.87	V	peak
1075.0000	53.79	-9.73	44.06	74.00	-29.94	H	peak
1600.0000	48.25	-8.68	39.57	74.00	-34.43	H	peak
3370.0000	45.86	-4.01	41.85	74.00	-32.15	H	peak
3865.0000	44.96	-2.50	42.46	74.00	-31.54	H	peak
4525.0000	44.72	-0.59	44.13	74.00	-29.87	H	peak
5170.0000	44.33	1.52	45.85	74.00	-28.15	H	peak

Notes:

- Measuring frequencies from 1 GHz to the 10th harmonic of highest fundamental frequency.
- Measurements above show only up to 6 maximum emissions noted, or would be lesser if no specific emissions from the EUT are recorded (ie: margin>20dB from the applicable limit) and considered that's already beyond the background noise floor.
- Radiated emissions measured in frequency above 1000MHz were made with an instrument using Peak detector mode and average detector mode of the emission shown in Actual FS column.
- Spectrum setting:
 - Peak Setting 1GHz - 26GHz, RBW = 1MHz, VBW = 1MHz, Sweep time = 200 ms.
 - AV Setting 1GHz - 26GHz, RBW = 1MHz, VBW = 10Hz, Sweep time = 200 ms.
- Frequency (MHz) = Emission frequency in MHz

Reading (dBµV/m) =Uncorrected Analyzer / Receiver Reading

Correction Factor (dB) = Antenna factor + Cable loss – Amplifier gain

Limit (dBµV/m) = Limit stated in standard

Margin (dB) = Result (dBµV/m)- Limit (dBµV/m)

Pk = Peak Reading

AV. = Average Reading

Remark = Mark Peak Reading or Average Reading



8DPSK

Operation Mode: TX(CH Low)

Test Date: January 2, 2014

Temperature: 24°C

Tested by: Sun Guo

Humidity: 52% RH

Polarity: Ver. / Hor.

Frequency (MHz)	Reading (dBµV)	Correction Factor (dB/m)	Result (dBµV/m)	Limit (dBµV/m)	Margin (dB)	Antenna Pole (V/H)	Remark
1195.0000	51.78	-8.77	43.01	74.00	-30.99	V	peak
1600.0000	51.87	-8.68	43.19	74.00	-30.81	V	peak
2845.0000	47.39	-4.86	42.53	74.00	-31.47	V	peak
3295.0000	47.38	-4.05	43.33	74.00	-30.67	V	peak
4030.0000	46.10	-2.39	43.71	74.00	-30.29	V	peak
4810.0000	45.68	0.46	46.14	74.00	-27.86	V	peak
1060.0000	54.78	-9.85	44.93	74.00	-29.07	H	peak
1420.0000	47.65	-7.92	39.73	74.00	-34.27	H	peak
2950.0000	46.23	-4.44	41.79	74.00	-32.21	H	peak
3445.0000	46.20	-3.78	42.42	74.00	-31.58	H	peak
4135.0000	44.91	-1.89	43.02	74.00	-30.98	H	peak
4780.0000	44.02	0.32	44.34	74.00	-29.66	H	peak

Notes:

1. Measuring frequencies from 1 GHz to the 10th harmonic of highest fundamental frequency.
2. Measurements above show only up to 6 maximum emissions noted, or would be lesser if no specific emissions from the EUT are recorded (ie: margin>20dB from the applicable limit) and considered that's already beyond the background noise floor.
3. Radiated emissions measured in frequency above 1000MHz were made with an instrument using Peak detector mode and average detector mode of the emission shown in Actual FS column.
4. Spectrum setting:
 - a. Peak Setting 1GHz - 26GHz, RBW = 1MHz, VBW = 1MHz, Sweep time = 200 ms.
 - b. AV Setting 1GH z- 26GHz, RBW = 1MHz, VBW = 10Hz, Sweep time = 200 ms.
5. Frequency (MHz) = Emission frequency in MHz
 Reading (dBµV/m) =Uncorrected Analyzer / Receiver Reading
 Correction Factor (dB) = Antenna factor + Cable loss – Amplifier gain
 Limit (dBµV/m) = Limit stated in standard
 Margin (dB) = Result (dBµV/m)- Limit (dBµV/m)
 Pk = Peak Reading
 AV. = Average Reading
 Remark = Mark Peak Reading or Average Reading



Operation Mode: TX(CH Mid)
Temperature: 24°C
Humidity: 52% RH

Test Date: January 2, 2014
Tested by: Sun Guo
Polarity: Ver. / Hor.

Table with 8 columns: Frequency (MHz), Reading (dBµV), Correction Factor (dB/m), Result (dBµV/m), Limit (dBµV/m), Margin (dB), Antenna Pole (V/H), Remark. It contains two sets of data rows for various frequencies.

Notes:

- 1. Measuring frequencies from 1 GHz to the 10th harmonic of highest fundamental frequency.
2. Measurements above show only up to 6 maximum emissions noted, or would be lesser if no specific emissions from the EUT are recorded...
3. Radiated emissions measured in frequency above 1000MHz were made with an instrument using Peak detector mode and average detector mode...
4. Spectrum setting:
a. Peak Setting 1GHz - 26GHz, RBW = 1MHz, VBW = 1MHz, Sweep time = 200 ms.
b. AV Setting 1GHz - 26GHz, RBW = 1MHz, VBW = 10Hz, Sweep time = 200 ms.
5. Frequency (MHz) = Emission frequency in MHz
Reading (dBµV/m) = Uncorrected Analyzer / Receiver Reading
Correction Factor (dB) = Antenna factor + Cable loss - Amplifier gain
Limit (dBµV/m) = Limit stated in standard
Margin (dB) = Result (dBµV/m) - Limit (dBµV/m)
Pk = Peak Reading
AV = Average Reading
Remark = Mark Peak Reading or Average Reading



Operation Mode: TX(CH High)

Test Date: January 2, 2014

Temperature: 24 °C

Tested by: Sun Guo

Humidity: 52% RH

Polarity: Ver. / Hor.

Frequency (MHz)	Reading (dBµV)	Correction Factor (dB/m)	Result (dBµV/m)	Limit (dBµV/m)	Margin (dB)	Antenna Pole (V/H)	Remark
1195.0000	51.55	-8.77	42.78	74.00	-31.22	V	peak
1600.0000	49.75	-8.68	41.07	74.00	-32.93	V	peak
3040.0000	46.41	-4.21	42.20	74.00	-31.80	V	peak
3850.0000	45.45	-2.50	42.95	74.00	-31.05	V	peak
4075.0000	45.91	-2.17	43.74	74.00	-30.26	V	peak
5020.0000	43.68	1.34	45.02	74.00	-28.98	V	peak
1195.0000	51.83	-8.77	43.06	74.00	-30.94	H	peak
1465.0000	48.23	-8.11	40.12	74.00	-33.88	H	peak
3265.0000	45.79	-4.06	41.73	74.00	-32.27	H	peak
4105.0000	45.11	-2.03	43.08	74.00	-30.92	H	peak
4375.0000	44.71	-0.91	43.80	74.00	-30.20	H	peak
5170.0000	43.51	1.52	45.03	74.00	-28.97	H	peak

Notes:

1. Measuring frequencies from 1 GHz to the 10th harmonic of highest fundamental frequency.
2. Measurements above show only up to 6 maximum emissions noted, or would be lesser if no specific emissions from the EUT are recorded (ie: margin>20dB from the applicable limit) and considered that's already beyond the background noise floor.
3. Radiated emissions measured in frequency above 1000MHz were made with an instrument using Peak detector mode and average detector mode of the emission shown in Actual FS column.
4. Spectrum setting:
 - a. Peak Setting 1GHz - 26GHz, RBW = 1MHz, VBW = 1MHz, Sweep time = 200 ms.
 - b. AV Setting 1GH z- 26GHz, RBW = 1MHz, VBW = 10Hz, Sweep time = 200 ms.
5. Frequency (MHz) = Emission frequency in MHz
 Reading (dBµV/m) =Uncorrected Analyzer / Receiver Reading
 Correction Factor (dB) = Antenna factor + Cable loss – Amplifier gain
 Limit (dBµV/m) = Limit stated in standard
 Margin (dB) = Result (dBµV/m)- Limit (dBµV/m)
 Pk = Peak Reading
 AV. = Average Reading
 Remark = Mark Peak Reading or Average Reading



6.9 POWERLINE CONDUCTED EMISSIONS

LIMIT

For an intentional radiator which is designed to be connected to the public utility (AC) power line, the radio frequency voltage that is conducted back onto the AC power line on any frequency or frequencies within the band 150 kHz to 30 MHz shall not exceed 250 microvolts (The limit decreases linearly with the logarithm of the frequency in the range 0.15 MHz to 0.50 MHz). The limits at specific frequency range is listed as follows:

Frequency Range (MHz)	Limits (dBµV)	
	Quasi-peak	Average
0.15 to 0.50	66 to 56	56 to 46
0.50 to 5	56	46
5 to 30	60	50

Compliance with this provision shall be based on the measurement of the radio frequency voltage between each power line (LINE and NEUTRAL) and ground at the power terminals.

MEASUREMENT EQUIPMENT USED

Conducted Emission Test Site					
Name of Equipment	Manufacturer	Model Number	Serial Number	Last Calibration	Due Calibration
EMI TEST RECEIVER	ROHDE&SCHWARZ	ESCI	100783	03/09/2013	03/08/2014
LISN(EUT)	ROHDE&SCHWARZ	ENV216	101543-WX	04/20/2013	04/19/2014
LISN	EMCO	3825/2	8901-1459	03/09/2013	03/08/2014
Temp. / Humidity Meter	VICTOR	HTC-1	N/A	03/04/2013	03/03/2014
Test S/W	FARAD	EZ-EMC/ CCS-3A1-CE			

Remark: Each piece of equipment is scheduled for calibration once a year.



TEST CONFIGURATION

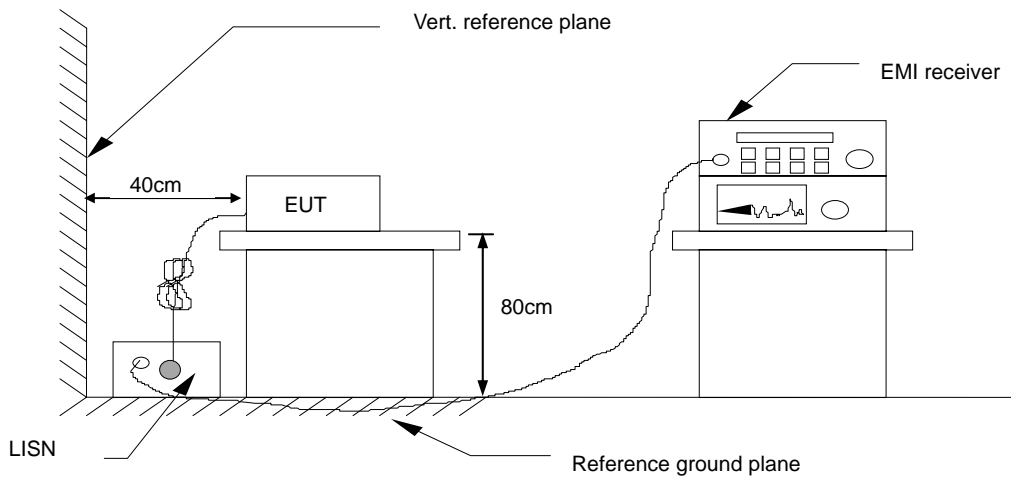

See test photographs attached in Appendix 1 for the actual connections between EUT and support equipment.

TEST PROCEDURE

1. The EUT was placed on a table, which is 0.8m above ground plane.
2. Maximum procedure was performed on the six highest emissions to ensure EUT compliance.
3. Repeat above procedures until all frequency measured were complete.

TEST RESULTS

The initial step in collecting conducted data is a spectrum analyzer peak scan of the measurement range. Significant peaks are then marked as shown on the following data page, and these signals are then quasi-peaked.

