



No. 1 Workshop, M-10, Middle section, Science & Technology Park, Shenzhen,
Guangdong, China 518057

Telephone: +86 (0) 755 2601 2053
Fax: +86 (0) 755 2671 0594
Email: sgs_internet_operations@sgs.com

Report No.: SZEMO09110651501
Page: 1 of 60

FCC REPORT

Application No: SZEMO091106515RF
Applicant: Sunitec Enterprise CO., Ltd
Product Name: Bluetooth Speakerphone
Operation Frequency: 2.402GHz to 2.480GHz
FCC ID: RA8-BC008
Standards: FCC CFR Title 47 Part 15 Subpart C Section 15.247: 2008
Date of Receipt: 20 November 2009
Date of Test: 26 November to 09 December 2009
Date of Issue: 10 December 2009

Test Result :	PASS *
----------------------	---------------

* In the configuration tested, the EUT complied with the standards specified above.

Authorized Signature:

Robinson Lo
Manager

The manufacturer should ensure that all products in series production are in conformity with the product sample detailed in this report. If the product in this report is used in any configuration other than that detailed in the report, the manufacturer must ensure the new system complies with all relevant standards. Any mention of SGS International Electrical Approvals or testing done by SGS International Electrical Approvals in connection with, distribution or use of the product described in this report must be approved by SGS International Electrical Approvals in writing. The report must not be used by the client to claim product certification, approval, or endorsement by NVLAP, NIST, or any agency of the federal government. All test results in this report can be traceable to National or International Standards.

"This document is issued by the Company subject to its General Conditions of Service printed overleaf, available on request or accessible at www.sgs.com/terms_and_conditions.htm and, for electronic format documents, subject to Terms and Conditions for Electronic Documents at www.sgs.com/terms_e-document.htm. Attention is drawn to the limitation of liability, indemnification and jurisdiction issues defined therein. Any holder of this document is advised that information contained hereon reflects the Company's findings at the time of its intervention only and within the limits of Client's instructions, if any. The Company's sole responsibility is to its Client and this document does not exonerate parties to a transaction from exercising all their rights and obligations under the transaction documents. This document cannot be reproduced except in full, without prior written approval of the Company. Any unauthorized alteration, forgery or falsification of the content or appearance of this document is unlawful and offenders may be prosecuted to the fullest extent of the law. Unless otherwise stated the results shown in this test report refer only to the sample(s) tested and such sample(s) are retained for 90 days only."



2 Contents

	Page
.....	1
2 CONTENTS	2
3 TEST SUMMARY	3
4 GENERAL INFORMATION	4
4.1 CLIENT INFORMATION	4
4.2 GENERAL DESCRIPTION OF E.U.T.	4
4.3 E.U.T OPERATION MODE.....	6
4.4 TEST FACILITY	7
4.5 TEST LOCATION	7
4.6 OTHER INFORMATION REQUESTED BY THE CUSTOMER.....	7
4.7 TEST INSTRUMENTS LIST	8
5 TEST RESULTS AND MEASUREMENT DATA	9
5.1 ANTENNA REQUIREMENT:	9
5.2 CONDUCTED EMISSIONS.....	10
5.3 CONDUCTED PEAK OUTPUT POWER	13
5.4 20dB OCCUPY BANDWIDTH.....	19
5.5 CARRIER FREQUENCIES SEPARATION	25
5.6 HOPPING CHANNEL NUMBER	32
5.7 DWELL TIME	34
5.8 BAND EDGE.....	37
5.9 RF ANTENNA CONDUCTED SPURIOUS EMISSIONS.....	41
5.10 PSEUDORANDOM FREQUENCY HOPPING SEQUENCE.....	51
5.11 RADIATED EMISSION.....	52
5.11.1 Radiated emission below 1GHz.....	54
5.11.2 Transmitter emission above 1GHz.....	55
5.11.3 Band Edge and Restricted band (Radiated measurement)	58-60

"This document is issued by the Company subject to its General Conditions of Service printed overleaf, available on request or accessible at www.sgs.com/terms_and_conditions.htm and, for electronic format documents, subject to Terms and Conditions for Electronic Documents at www.sgs.com/terms_e-document.htm. Attention is drawn to the limitation of liability, indemnification and jurisdiction issues defined therein. Any holder of this document is advised that information contained hereon reflects the Company's findings at the time of its intervention only and within the limits of Client's instructions, if any. The Company's sole responsibility is to its Client and this document does not exonerate parties to a transaction from exercising all their rights and obligations under the transaction documents. This document cannot be reproduced except in full, without prior written approval of the Company. Any unauthorized alteration, forgery or falsification of the content or appearance of this document is unlawful and offenders may be prosecuted to the fullest extent of the law. Unless otherwise stated the results shown in this test report refer only to the sample(s) tested and such sample(s) are retained for 90 days only."

3 Test Summary

Test Item	Section in CFR 47	Result
Antenna Requirement	15.203/15.247 (c)	Passed
Conducted Peak Output Power	15.247 (b)(1)	Passed
20dB Occupied Bandwidth	15.247 (a)(1)	Passed
Carrier Frequencies Separation	15.247 (a)(1)	Passed
Hopping Channel Number	15.247 (b)	Passed
Dwell Time	15.247 (a)(1)	Passed
Pseudo random Frequency Hopping Sequence	15.247(b)(4)&TCB Exclusion List (7 July 2002)	Passed
Radiated Emission	15.205/15.209	Passed
Band Edge	15.247(d)	Passed
RF Antenna Conducted spurious emissions	15.247(d)	Passed

Remark: Passed: The EUT complies with the essential requirements in the standard.

Failed: The EUT does not comply with the essential requirements in the standard.

4 General Information

4.1 Client Information

Applicant:	Sunitec Enterprise CO., Ltd
Address of Applicant:	No.2, Qilin Road 2, RunTang Ind, Dan-Keng Village Fu Min Community, Guan-Lan Town, Baoan District, Shenzhen Guangdong China
Manufacturer/ Factory:	Same as the applicant
Address of Manufacturer/ Factory:	Same as the applicant

4.2 General Description of E.U.T.

Product Name:	Bluetooth Speakerphone
Trade Name:	N/A
Item No.:	BC903, BC903B, BTCK-18, BTCK-28
Test Item:	BC903
Operation Frequency:	2402MHz~2480MHz
Channel numbers:	79
Channel separation:	1MHz
Modulation type:	GFSK, Pi/4QPSK, 8DPSK
Antenna Type:	Integral
Antenna gain:	0dBi (declare by manufacturer)
Power supply:	Input Voltage: DC 12-24V Output voltage: DC 5V 500mA

Operation Frequency each of channel							
Channel	Frequency	Channel	Frequency	Channel	Frequency	Channel	Frequency
1	2402MHz	21	2422MHz	41	2442MHz	61	2462MHz
2	2403MHz	22	2423MHz	42	2443MHz	62	2463MHz
3	2404MHz	23	2424MHz	43	2444MHz	63	2464MHz
4	2405MHz	24	2425MHz	44	2445MHz	64	2465MHz
5	2406MHz	25	2426MHz	45	2446MHz	65	2466MHz
6	2407MHz	26	2427MHz	46	2447MHz	66	2467MHz
7	2408MHz	27	2428MHz	47	2448MHz	67	2468MHz
8	2409MHz	28	2429MHz	48	2449MHz	68	2469MHz
9	2410MHz	29	2430MHz	49	2450MHz	69	2470MHz
10	2411MHz	30	2431MHz	50	2451MHz	70	2471MHz
11	2412MHz	31	2432MHz	51	2452MHz	71	2472MHz
12	2413MHz	32	2433MHz	52	2453MHz	72	2473MHz
13	2414MHz	33	2434MHz	53	2454MHz	73	2474MHz
14	2415MHz	34	2435MHz	54	2455MHz	74	2475MHz
15	2416MHz	35	2436MHz	55	2456MHz	75	2476MHz
16	2417MHz	36	2437MHz	56	2457MHz	76	2477MHz
17	2418MHz	37	2438MHz	57	2458MHz	77	2478MHz
18	2419MHz	38	2439MHz	58	2459MHz	78	2479MHz
19	2420MHz	39	2440MHz	59	2460MHz	79	2480MHz
20	2421MHz	40	2441MHz	60	2461MHz		

Note:

In section 15.31(m), regards to the operating frequency range over 10 MHz, the Lowest frequency, the middle frequency, and the highest frequency of channel were selected to perform the test, and the selected channel see below:

Channel	Frequency
The lowest channel	2402MHz
The middle channel	2441MHz
The Highest channel	2480MHz

This document is issued by the Company subject to its General Conditions of Service printed overleaf, available on request or accessible at www.sgs.com/terms_and_conditions.htm and, for electronic format documents, subject to Terms and Conditions for Electronic Documents at www.sgs.com/terms_e-document.htm. Attention is drawn to the limitation of liability, indemnification and jurisdiction issues defined therein. Any holder of this document is advised that information contained hereon reflects the Company's findings at the time of its intervention only and within the limits of Client's instructions, if any. The Company's sole responsibility is to its Client and this document does not exonerate parties to a transaction from exercising all their rights and obligations under the transaction documents. This document cannot be reproduced except in full, without prior written approval of the Company. Any unauthorized alteration, forgery or falsification of the content or appearance of this document is unlawful and offenders may be prosecuted to the fullest extent of the law. Unless otherwise stated the results shown in this test report refer only to the sample(s) tested and such sample(s) are retained for 90 days only.

4.3 E.U.T Operation mode

Operating Environment:	
Temperature:	24.0 °C
Humidity:	52 % RH
Atmospheric Pressure:	1008 mbar
Test mode:	
Normal operation mode:	Transmit information between the EUT with other Bluetooth device, the EUT is charged by PC.
Transmitting mode:	Keep the EUT in transmitting mode with modulation.

4.4 Test Facility

The test facility is recognized, certified, or accredited by the following organizations:

CNAS (No. CNAS L2929)

CNAS has accredited SGS-CSTC Standards Technical Services Co., Ltd. Shenzhen Branch EMC Lab to ISO/IEC 17025:2005 General Requirements for the Competence of Testing and Calibration Laboratories (CNAS-CL01 Accreditation Criteria for the Competence of Testing and Calibration Laboratories) for the competence in the field of testing.

VCCI

The 3m Semi-anechoic chamber and Shielded Room (7.5m x 4.0m x 3.0m) of SGS-CSTC Standards Technical Services Co., Ltd. have been registered in accordance with the Regulations for Voluntary Control Measures with Registration No.: R-2197 and C-2383 respectively.

Date of Registration: September 29, 2008. Valid until September 28, 2011.

FCC – Registration No.: 556682

SGS-CSTC Standards Technical Services Co., Ltd., Shenzhen EMC Laboratory has been registered and fully described in a report filed with the (FCC) Federal Communications Commission. The acceptance letter from the FCC is maintained in our files. Registration 556682, June 27, 2008.

Industry Canada (IC)

The 3m Semi-anechoic chamber of SGS-CSTC Standards Technical Services Co., Ltd. has been registered by Certification and Engineering Bureau of Industry Canada for radio equipment testing with Registration No.: 4620C-1.

4.5 Test Location

All tests were performed at:

SGS-CSTC Standards Technical Services Co., Ltd. Shenzhen Branch E&E Lab

No. 1 Workshop, M-10, Middle section, Science & Technology Park, Shenzhen, Guangdong, China 518057

Telephone: +86 (0) 755 2601 2053 Fax: +86 (0) 755 2671 0594

No tests were sub-contracted.

4.6 Other Information Requested by the Customer

None.

4.7 Test Instruments list

RE in Chamber						
Item	Test Equipment	Manufacturer	Model No.	Inventory No.	Cal.Date (dd-mm-yy)	Cal.Due date (dd-mm-yy)
1	3m Semi-Anechoic Chamber	ETS-LINDGREN	N/A	SEL0017	16-06-2009	15-06-2010
2	EMI Test Receiver	Rohde & Schwarz	ESIB26	SEL0023	12-12-2009	11-12-2010
3	EMI Test software	AUDIX	E3	SEL0050	N/A	N/A
4	Coaxial cable	SGS	N/A	SEL0028	18-06-2009	17-06-2010
6	BiConiLog Antenna (26-3000MHz)	ETS-LINDGREN	3142C	SEL0014	12-08-2009	11-08-2010
7	Double-ridged horn (1-18GHz)	ETS-LINDGREN	3117	SEL0005	12-08-2009	11-08-2010
8	Horn Antenna (18-26GHz)	ETS-LINDGREN	3160	SEL0076	12-08-2009	11-08-2010
9	Pre-amplifier (0.1-1300MHz)	Agilent Technologies	8447D	SEL0053	18-06-2009	17-06-2010
10	Pre-amplifier (1-18GHz)	Rohde & Schwarz	AFS42-00101 800-25-S-42	SEL0081	18-06-2009	17-06-2010
11	Pre-amplifier (18-26GHz)	Rohde & Schwarz	AFS33-18002 650-30-8P-44	SEL0080	18-06-2009	17-06-2010
12	Band filter	Amindeon	82346	SEL0094	18-06-2009	17-06-2010

Conducted Emission						
Item	Test Equipment	Manufacturer	Model No.	Inventory No.	Cal.Date (dd-mm-yy)	Cal.Due date (dd-mm-yy)
1	Shielding Room	ZhongYu Electron	GB-88	SEL0042	N/A	N/A
2	LISN	ETS-LINDGREN	3816/2	SEL0021	18-06-2009	17-06-2010
3	LISN	Schwarzbeck	NNBM 8125	SEL0119	28-07-2009	28-07-2010
4	EMI Test Receiver	Rohde & Schwarz	ESCI	SEL0022	18-06-2009	17-06-2010
5	Coaxial Cable	SGS	N/A	SEL0024	18-06-2009	17-06-2010

RF conducted						
Item	Test Equipment	Manufacturer	Model No.	Inventory No.	Cal.Date (dd-mm-yy)	Cal.Due date (dd-mm-yy)
1	Spectrum Analyzer	Rohde & Schwarz	10336/030	EMC0040	16-06-2009	15-06-2010
2	Coaxial cable	SGS	N/A	SEL0029	18-06-2009	17-06-2010

5 Test results and Measurement Data

5.1 Antenna requirement:

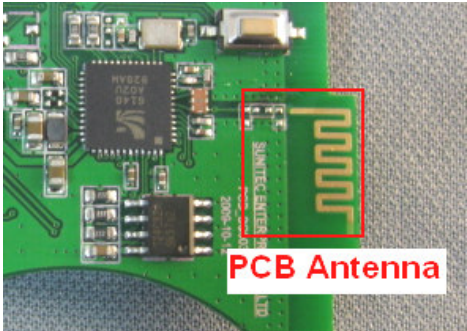
Standard requirement:	FCC Part15 C Section 15.203 /247(c)
<p>15.203 requirement: An intentional radiator shall be designed to ensure that no antenna other than that furnished by the responsible party shall be used with the device. The use of a permanently attached antenna or of an antenna that uses a unique coupling to the intentional radiator, the manufacturer may design the unit so that a broken antenna can be replaced by the user, but the use of a standard antenna jack or electrical connector is prohibited.</p> <p>15.247(c) (1)(i) requirement: (i) Systems operating in the 2400-2483.5 MHz band that is used exclusively for fixed. Point-to-point operations may employ transmitting antennas with directional gain greater than 6dBi provided the maximum conducted output power of the intentional radiator is reduced by 1 dB for every 3 dB that the directional gain of the antenna exceeds 6dBi.</p>	
E.U.T Antenna:	
<p>The antenna is integrated on the main PCB and no consideration of replacement. The best case gain of the antenna is 0dBi.</p> 	

5.2 Conducted Emissions

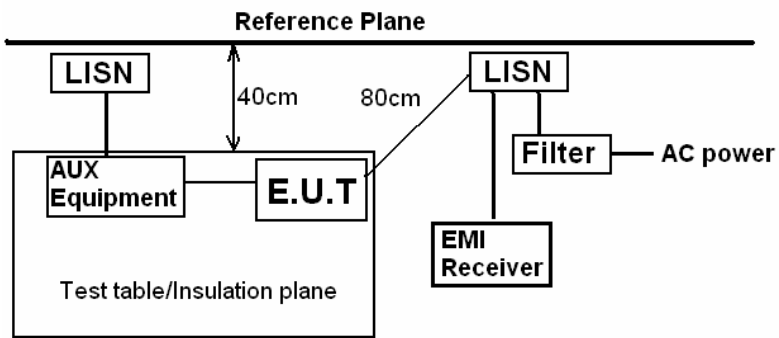
Test Requirement:	FCC Part15 C Section 15.207														
Test Method:	ANSI C63.4: 2003														
Test Frequency Range:	150KHz to 30MHz														
Class / Severity:	Class B														
Limit:	<table border="1"> <thead> <tr> <th rowspan="2">Frequency range (MHz)</th> <th colspan="2">Limit (dBuV)</th> </tr> <tr> <th>Quasi-peak</th> <th>Average</th> </tr> </thead> <tbody> <tr> <td>0.15-0.5</td> <td>66 to 56*</td> <td>56 to 46*</td> </tr> <tr> <td>0.5-5</td> <td>56</td> <td>46</td> </tr> <tr> <td>5-30</td> <td>60</td> <td>50</td> </tr> </tbody> </table> <p>* Decreases with the logarithm of the frequency.</p>	Frequency range (MHz)	Limit (dBuV)		Quasi-peak	Average	0.15-0.5	66 to 56*	56 to 46*	0.5-5	56	46	5-30	60	50
Frequency range (MHz)	Limit (dBuV)														
	Quasi-peak	Average													
0.15-0.5	66 to 56*	56 to 46*													
0.5-5	56	46													
5-30	60	50													
Test procedure	The E.U.T and simulators are connected to the main power through a line impedance stabilization network (L.I.S.N.). The provider a 50ohm/50uH coupling impedance for the measuring equipment. The peripheral devices are also connected to the main power through a LISN that provides a 50ohm/50uH coupling impedance with 50ohm termination. (Please refer to the block diagram of the test setup and photographs). Both sides of A.C. line are checked for maximum conducted interference. In order to find the maximum emission, the relative positions of equipment and all of the interface cables must be changed according to ANSI C63.4: 2003 on conducted measurement.														
Test setup:	 <p><i>Remark</i> <i>E.U.T: Equipment Under Test</i> <i>LISN: Line Impedance Stabilization Network</i> <i>Test table height=0.8m</i></p>														
Test Instruments:	Refer to section 4.7 for details														
Test mode:	Normal operation mode														
Test results:	Passed														

Measurement Data

An initial pre-scan was performed on the live and neutral lines with peak detector.

Quasi-Peak and Average measurement were performed at the frequencies with maximized peak emission were detected.

Live line:

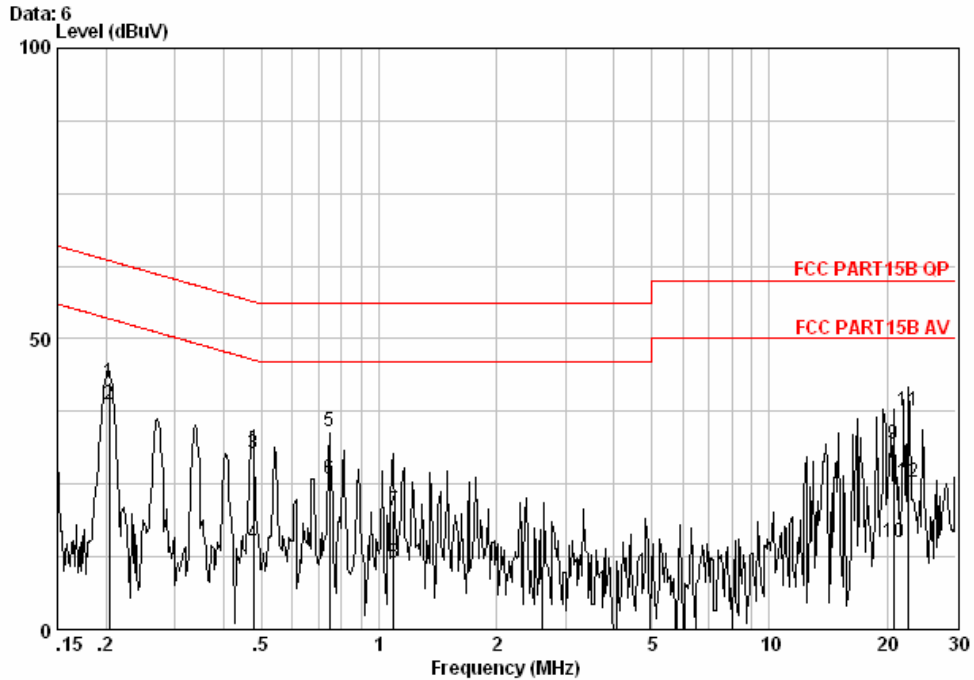

Site : Shielding Room
 Condition : FCC PART15B QP CE LINE
 EUT : BLUETOOTH SPEAKERPHONE
 Test No. : 651SRF
 Mode : Normal operation mode

	Freq	Cable Loss	LISN Factor	Read Level	Limit Level	Limit Line	Over Limit	Remark
	MHz	dB	dB	dBuV	dBuV	dBuV	dB	
1	0.20396	0.04	-0.04	42.40	42.40	63.45	-21.05	QP
2	0.20396	0.04	-0.04	38.70	38.70	53.45	-14.75	Average
3	0.47612	0.06	-0.04	30.20	30.22	56.41	-26.19	QP
4	0.47612	0.06	-0.04	14.70	14.72	46.41	-31.69	Average
5 @	0.74690	0.06	-0.05	34.10	34.12	46.00	-11.88	Average
6	0.74690	0.06	-0.05	25.90	25.92	56.00	-30.08	QP
7	1.088	0.08	-0.05	20.40	20.43	56.00	-35.57	QP
8	1.088	0.08	-0.05	11.50	11.53	46.00	-34.47	Average
9	20.814	0.27	-0.67	32.20	31.81	60.00	-28.19	QP
10	20.814	0.27	-0.67	15.30	14.91	50.00	-35.09	Average
11	22.660	0.28	-0.71	38.10	37.67	60.00	-22.33	QP
12	22.660	0.28	-0.71	25.90	25.47	50.00	-24.53	Average

Notes:

1. The following Quasi-Peak and Average measurements were performed on the EUT:
2. Final Test Level = Receiver Reading + LISN Factor + Cable Loss.

Neutral line:

Data: 5
Level (dBuV)

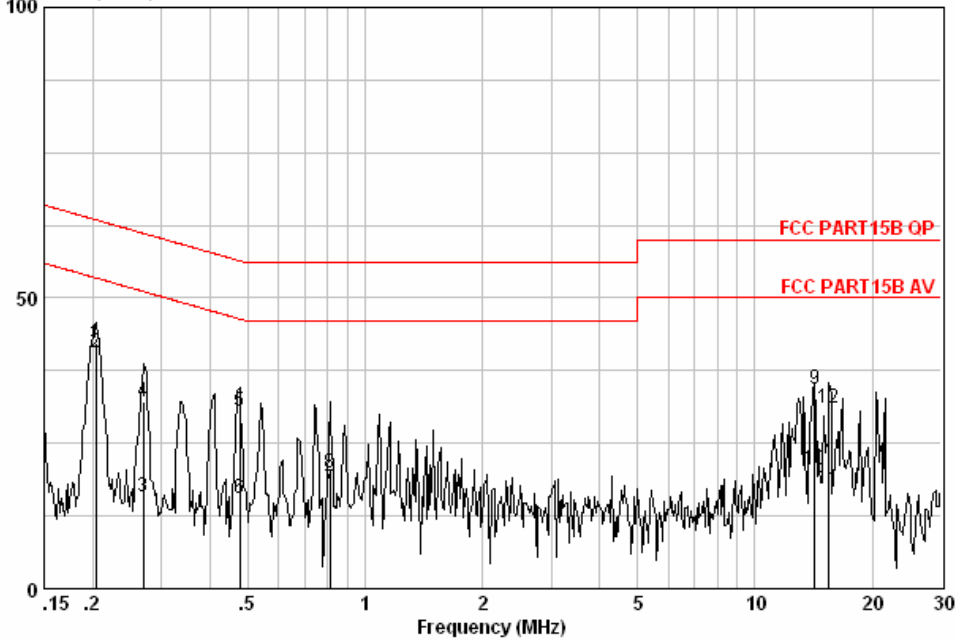

Site : Shielding Room
 Condition : FCC PART15B QP CE NEUTRAL
 EUT : BLUETOOTH SPEAKERPHONE
 Test No. : 6515RF
 Mode : Normal operation mode

	Freq	Cable Loss	LISN Factor	Read Level	Limit Level	Limit Line	Over Limit	Remark
	MHz	dB	dB	dBuV	dBuV	dBuV	dB	
1	0.20396	0.04	-0.04	42.10	42.10	63.45	-21.35	QP
2	0.20396	0.04	-0.04	40.50	40.50	53.45	-12.95	Average
3	0.27009	0.05	-0.04	15.90	15.91	51.12	-35.21	Average
4	0.27009	0.05	-0.04	32.10	32.11	61.12	-29.01	QP
5	0.47612	0.06	-0.04	30.50	30.52	56.41	-25.89	QP
6	0.47612	0.06	-0.04	15.60	15.62	46.41	-30.79	Average
7	0.81300	0.07	-0.04	17.20	17.23	46.00	-28.77	Average
8	0.81300	0.07	-0.04	20.00	20.03	56.00	-35.97	QP
9	14.210	0.25	-0.44	34.40	34.21	60.00	-25.79	QP
10	14.210	0.25	-0.44	20.70	20.51	50.00	-29.49	Average
11	15.470	0.25	-0.48	17.30	17.07	50.00	-32.93	Average
12	15.470	0.25	-0.48	31.20	30.97	60.00	-29.03	QP

Notes:

1. The following Quasi-Peak and Average measurements were performed on the EUT:
2. Final Test Level = Receiver Reading + LISN Factor + Cable Loss.

5.3 Conducted Peak Output Power

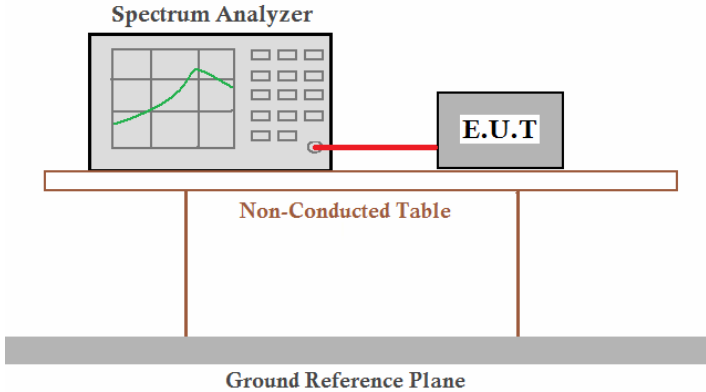
Test Requirement:	FCC Part15 C Section 15.247 (b)(1)
Test Method:	ANSI C63.4:2003 and KDB DA00-705
Limit:	30dBm
Test setup:	 <p><i>Remark: Offset the High-Frequency cable loss 1.5dB in the spectrum analyzer.</i></p>
Test Instruments:	Refer to section 4.7 for details
Test state:	Non-hopping transmitting with modulation.
Test results:	Passed

Measurement Data

GFSK mode			
Test channel	Peak Output Power (dBm)	Limit (dBm)	Result
Lowest	-0.10	30.00	Pass
Middle	-0.07	30.00	Pass
Highest	1.21	30.00	Pass
Pi/4QPSK mode			
Test channel	Peak Output Power (dBm)	Limit (dBm)	Result
Lowest	-0.37	30.00	Pass
Middle	-0.56	30.00	Pass
Highest	0.76	30.00	Pass
8DPSK mode			
Test channel	Peak Output Power (dBm)	Limit (dBm)	Result
Lowest	-0.16	30.00	Pass
Middle	-0.37	30.00	Pass
Highest	0.91	30.00	Pass

Test plot as follows:

Test mode:	GFSK	Test channel:	Lowest
------------	------	---------------	--------

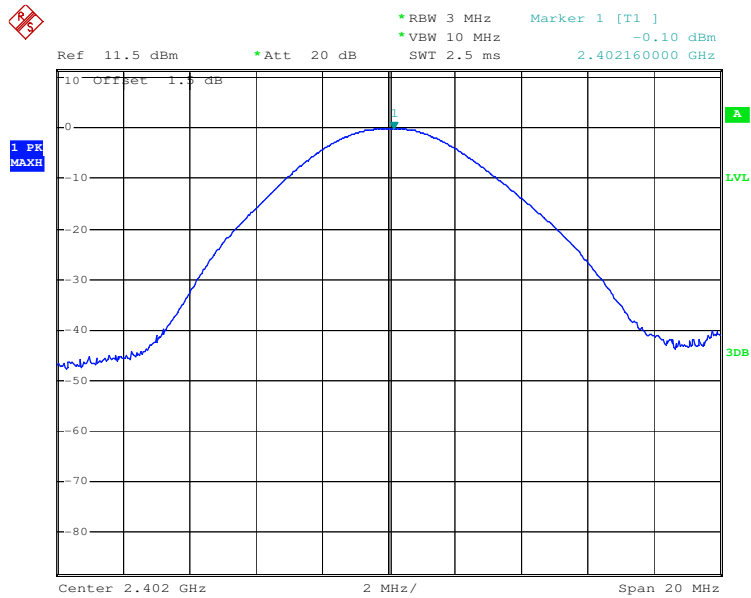

Date: 2.DEC.2009 09:59:34

Test mode:	GFSK	Test channel:	Middle
------------	------	---------------	--------

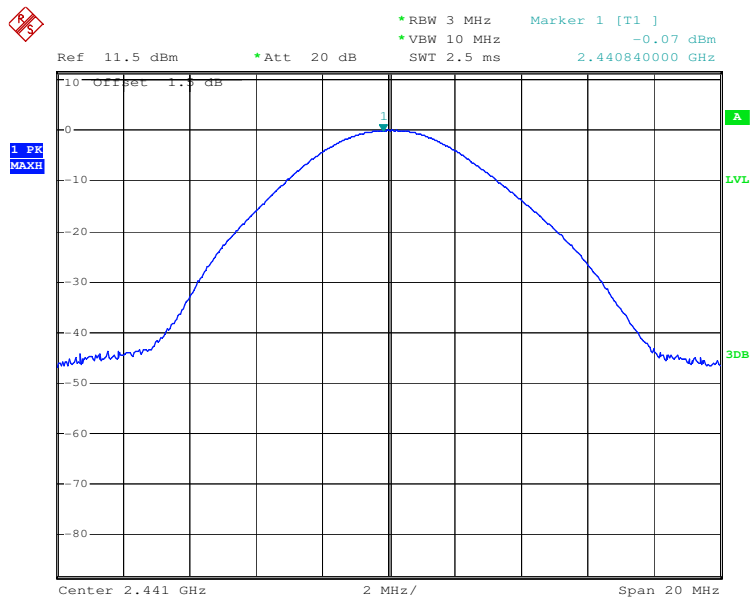

Date: 2.DEC.2009 09:21:06

"This document is issued by the Company subject to its General Conditions of Service printed overleaf, available on request or accessible at www.sgs.com/terms_and_conditions.htm and, for electronic format documents, subject to Terms and Conditions for Electronic Documents at www.sgs.com/terms_e-document.htm. Attention is drawn to the limitation of liability, indemnification and jurisdiction issues defined therein. Any holder of this document is advised that information contained hereon reflects the Company's findings at the time of its intervention only and within the limits of Client's instructions, if any. The Company's sole responsibility is to its Client and this document does not exonerate parties to a transaction from exercising all their rights and obligations under the transaction documents. This document cannot be reproduced except in full, without prior written approval of the Company. Any unauthorized alteration, forgery or falsification of the content or appearance of this document is unlawful and offenders may be prosecuted to the fullest extent of the law. Unless otherwise stated the results shown in this test report refer only to the sample(s) tested and such sample(s) are retained for 90 days only."



Test mode:	GFSK	Test channel:	Highest
------------	------	---------------	---------

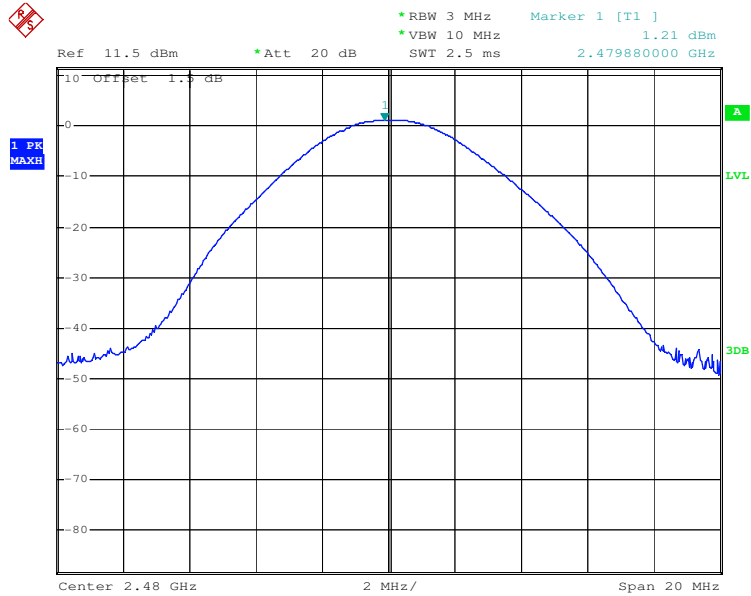

Date: 2.DEC.2009 10:32:13

Test mode:	Pi/4QPSK	Test channel:	Lowest
------------	----------	---------------	--------

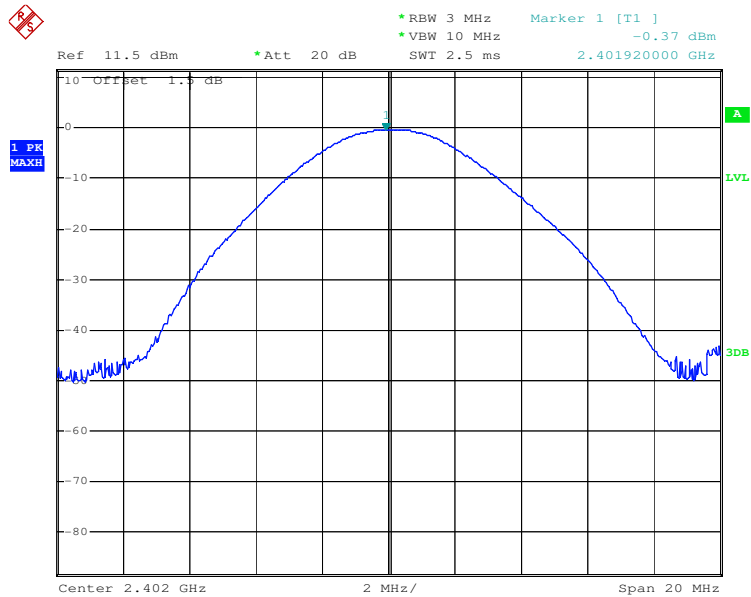

Date: 2.DEC.2009 10:12:29

"This document is issued by the Company subject to its General Conditions of Service printed overleaf, available on request or accessible at www.sgs.com/terms_and_conditions.htm and, for electronic format documents, subject to Terms and Conditions for Electronic Documents at www.sgs.com/terms_e-document.htm. Attention is drawn to the limitation of liability, indemnification and jurisdiction issues defined therein. Any holder of this document is advised that information contained hereon reflects the Company's findings at the time of its intervention only and within the limits of Client's instructions, if any. The Company's sole responsibility is to its Client and this document does not exonerate parties to a transaction from exercising all their rights and obligations under the transaction documents. This document cannot be reproduced except in full, without prior written approval of the Company. Any unauthorized alteration, forgery or falsification of the content or appearance of this document is unlawful and offenders may be prosecuted to the fullest extent of the law. Unless otherwise stated the results shown in this test report refer only to the sample(s) tested and such sample(s) are retained for 90 days only."



Test mode:	Pi/4QPSK	Test channel:	Middle
------------	----------	---------------	--------

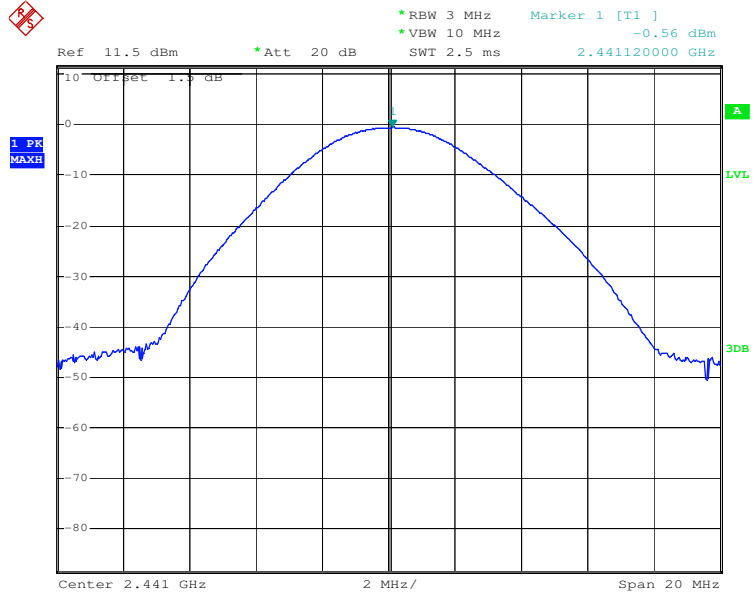

Date: 2.DEC.2009 09:37:15

Test mode:	Pi/4QPSK	Test channel:	Highest
------------	----------	---------------	---------

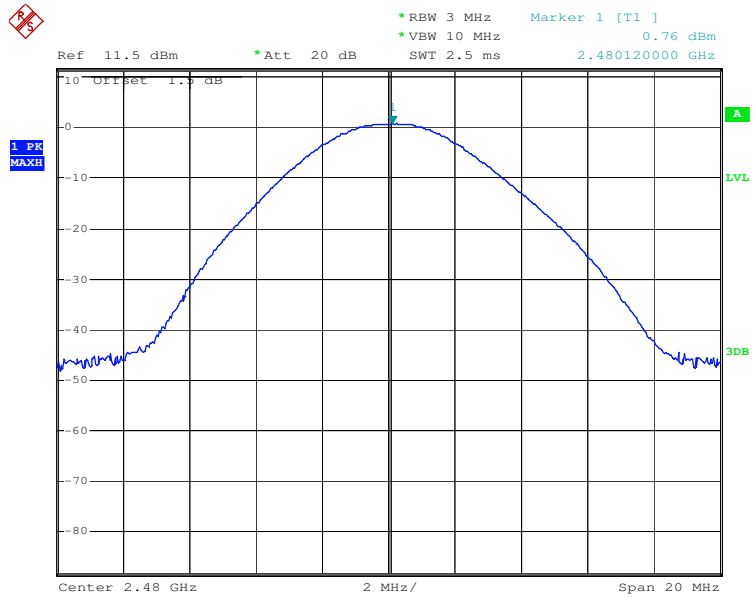

Date: 2.DEC.2009 10:44:47

"This document is issued by the Company subject to its General Conditions of Service printed overleaf, available on request or accessible at www.sgs.com/terms_and_conditions.htm and, for electronic format documents, subject to Terms and Conditions for Electronic Documents at www.sgs.com/terms_e-document.htm. Attention is drawn to the limitation of liability, indemnification and jurisdiction issues defined therein. Any holder of this document is advised that information contained hereon reflects the Company's findings at the time of its intervention only and within the limits of Client's instructions, if any. The Company's sole responsibility is to its Client and this document does not exonerate parties to a transaction from exercising all their rights and obligations under the transaction documents. This document cannot be reproduced except in full, without prior written approval of the Company. Any unauthorized alteration, forgery or falsification of the content or appearance of this document is unlawful and offenders may be prosecuted to the fullest extent of the law. Unless otherwise stated the results shown in this test report refer only to the sample(s) tested and such sample(s) are retained for 90 days only."



Test mode:	8DPSK	Test channel:	Lowest
------------	-------	---------------	--------

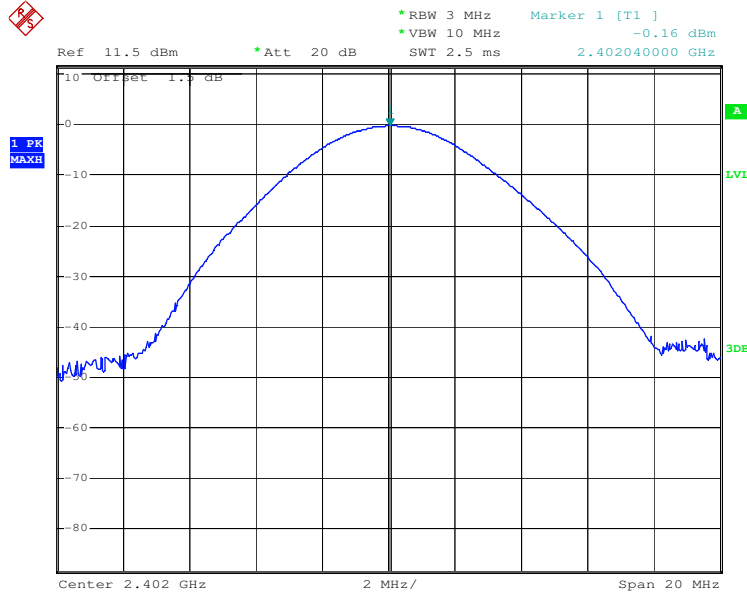

Date: 2.DEC.2009 10:17:02

Test mode:	8DPSK	Test channel:	Middle
------------	-------	---------------	--------

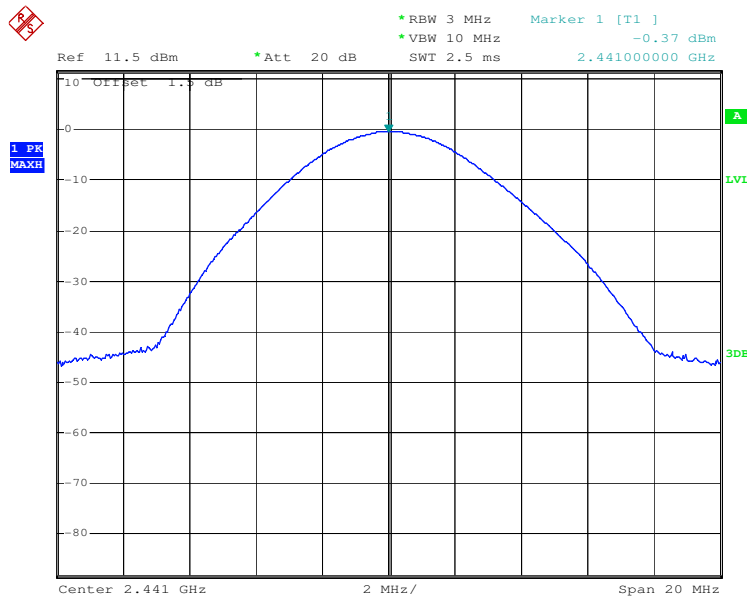

Date: 2.DEC.2009 09:51:26

"This document is issued by the Company subject to its General Conditions of Service printed overleaf, available on request or accessible at www.sgs.com/terms_and_conditions.htm and, for electronic format documents, subject to Terms and Conditions for Electronic Documents at www.sgs.com/terms_e-document.htm. Attention is drawn to the limitation of liability, indemnification and jurisdiction issues defined therein. Any holder of this document is advised that information contained hereon reflects the Company's findings at the time of its intervention only and within the limits of Client's instructions, if any. The Company's sole responsibility is to its Client and this document does not exonerate parties to a transaction from exercising all their rights and obligations under the transaction documents. This document cannot be reproduced except in full, without prior written approval of the Company. Any unauthorized alteration, forgery or falsification of the content or appearance of this document is unlawful and offenders may be prosecuted to the fullest extent of the law. Unless otherwise stated the results shown in this test report refer only to the sample(s) tested and such sample(s) are retained for 90 days only."



Test mode:	8DPSK	Test channel:	Highest
------------	-------	---------------	---------

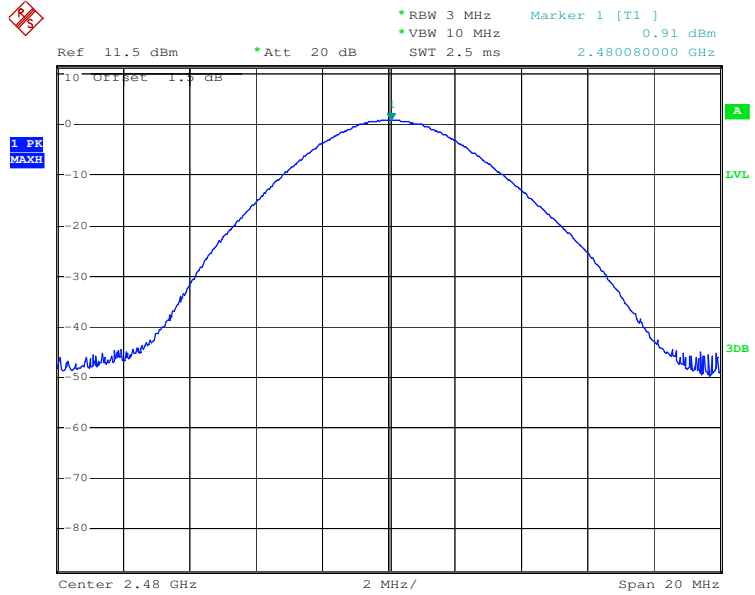

Date: 2.DEC.2009 10:55:50

"This document is issued by the Company subject to its General Conditions of Service printed overleaf, available on request or accessible at www.sgs.com/terms_and_conditions.htm and, for electronic format documents, subject to Terms and Conditions for Electronic Documents at www.sgs.com/terms_e-document.htm. Attention is drawn to the limitation of liability, indemnification and jurisdiction issues defined therein. Any holder of this document is advised that information contained hereon reflects the Company's findings at the time of its intervention only and within the limits of Client's instructions, if any. The Company's sole responsibility is to its Client and this document does not exonerate parties to a transaction from exercising all their rights and obligations under the transaction documents. This document cannot be reproduced except in full, without prior written approval of the Company. Any unauthorized alteration, forgery or falsification of the content or appearance of this document is unlawful and offenders may be prosecuted to the fullest extent of the law. Unless otherwise stated the results shown in this test report refer only to the sample(s) tested and such sample(s) are retained for 90 days only."

5.4 20dB Occupy Bandwidth

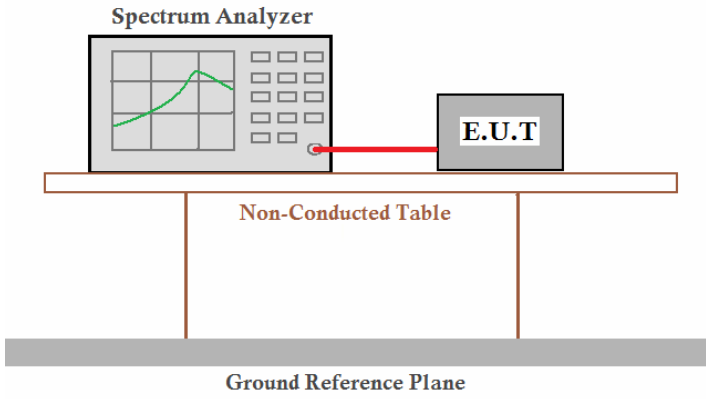
Test Requirement:	FCC Part15 C Section 15.247 (a)(1)
Test Method:	ANSI C63.4:2003 and KDB DA00-705
Test setup:	 <p style="text-align: center;"><i>Remark:</i> <i>Offset the High-Frequency cable loss 1.5dB in the spectrum analyzer</i></p>
Test Instruments:	Refer to section 4.7 for details
Test state:	Non-hopping transmitting with modulation.

Measurement Data

Test channel	20dB Occupy Bandwidth (KHz)		
	GFSK	Pi/4QPSK	8DPSK
Lowest	884	1268	1240
Middle	820	1260	1236
Highest	820	1264	1244



Test plot as follows:

Test mode:	GFSK	Test channel:	Lowest
------------	------	---------------	--------

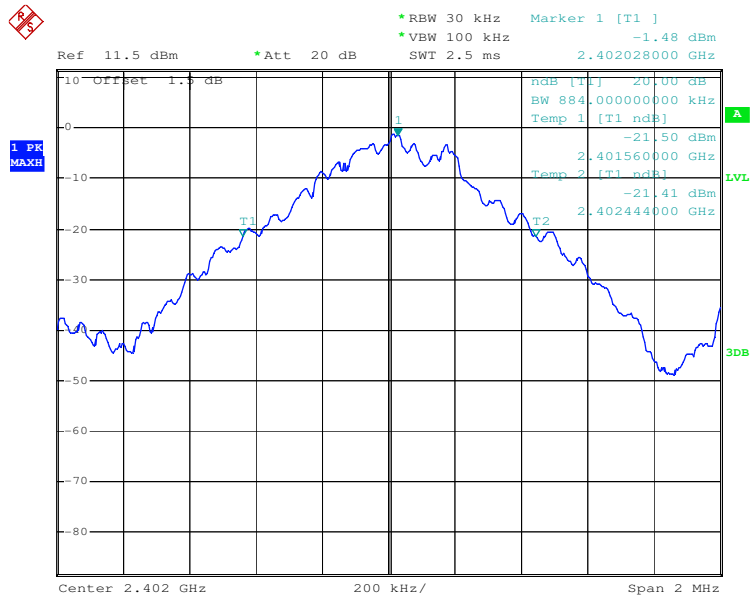

Date: 2.DEC.2009 10:00:05

Test mode:	GFSK	Test channel:	Middle
------------	------	---------------	--------

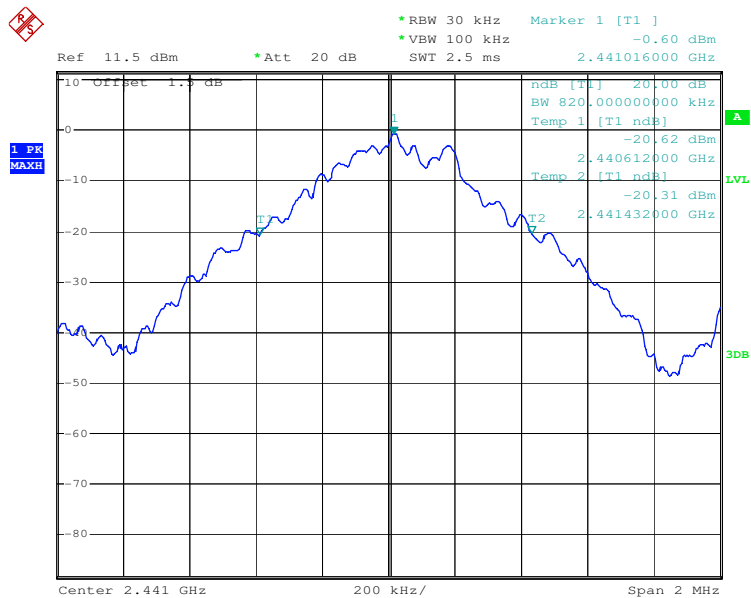

Date: 2.DEC.2009 09:22:09

"This document is issued by the Company subject to its General Conditions of Service printed overleaf, available on request or accessible at www.sgs.com/terms_and_conditions.htm and, for electronic format documents, subject to Terms and Conditions for Electronic Documents at www.sgs.com/terms_e-document.htm. Attention is drawn to the limitation of liability, indemnification and jurisdiction issues defined therein. Any holder of this document is advised that information contained hereon reflects the Company's findings at the time of its intervention only and within the limits of Client's instructions, if any. The Company's sole responsibility is to its Client and this document does not exonerate parties to a transaction from exercising all their rights and obligations under the transaction documents. This document cannot be reproduced except in full, without prior written approval of the Company. Any unauthorized alteration, forgery or falsification of the content or appearance of this document is unlawful and offenders may be prosecuted to the fullest extent of the law. Unless otherwise stated the results shown in this test report refer only to the sample(s) tested and such sample(s) are retained for 90 days only."



Test mode:	GFSK	Test channel:	Highest
------------	------	---------------	---------

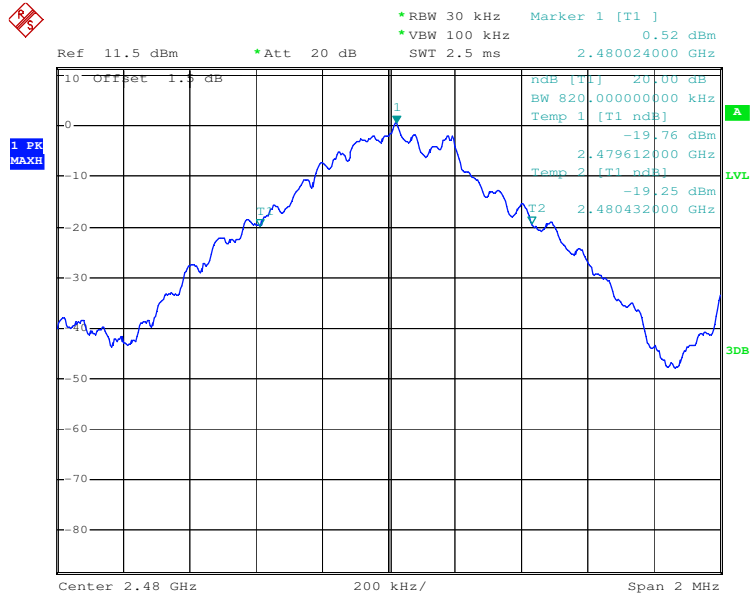

Date: 2.DEC.2009 10:31:18

Test mode:	Pi/4QPSK	Test channel:	Lowest
------------	----------	---------------	--------

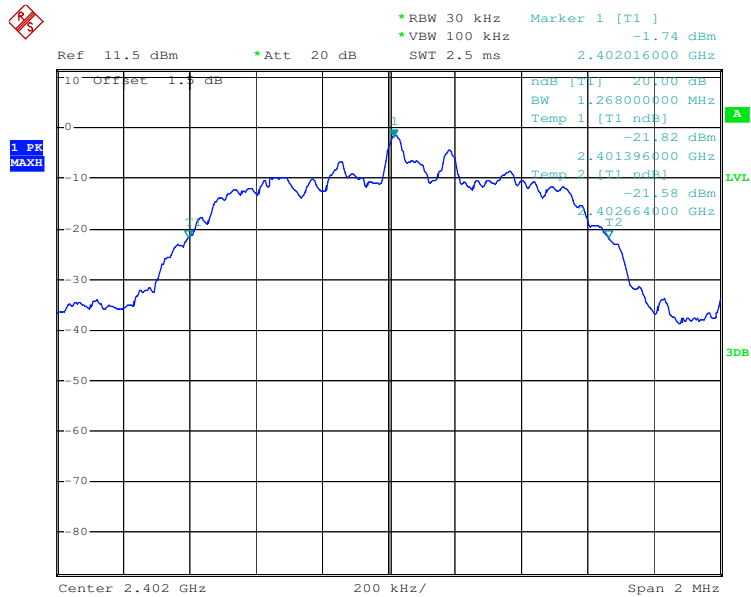

Date: 2.DEC.2009 10:11:43

"This document is issued by the Company subject to its General Conditions of Service printed overleaf, available on request or accessible at www.sgs.com/terms_and_conditions.htm and, for electronic format documents, subject to Terms and Conditions for Electronic Documents at www.sgs.com/terms_e-document.htm. Attention is drawn to the limitation of liability, indemnification and jurisdiction issues defined therein. Any holder of this document is advised that information contained hereon reflects the Company's findings at the time of its intervention only and within the limits of Client's instructions, if any. The Company's sole responsibility is to its Client and this document does not exonerate parties to a transaction from exercising all their rights and obligations under the transaction documents. This document cannot be reproduced except in full, without prior written approval of the Company. Any unauthorized alteration, forgery or falsification of the content or appearance of this document is unlawful and offenders may be prosecuted to the fullest extent of the law. Unless otherwise stated the results shown in this test report refer only to the sample(s) tested and such sample(s) are retained for 90 days only."



Test mode:	Pi/4QPSK	Test channel:	Middle
------------	----------	---------------	--------

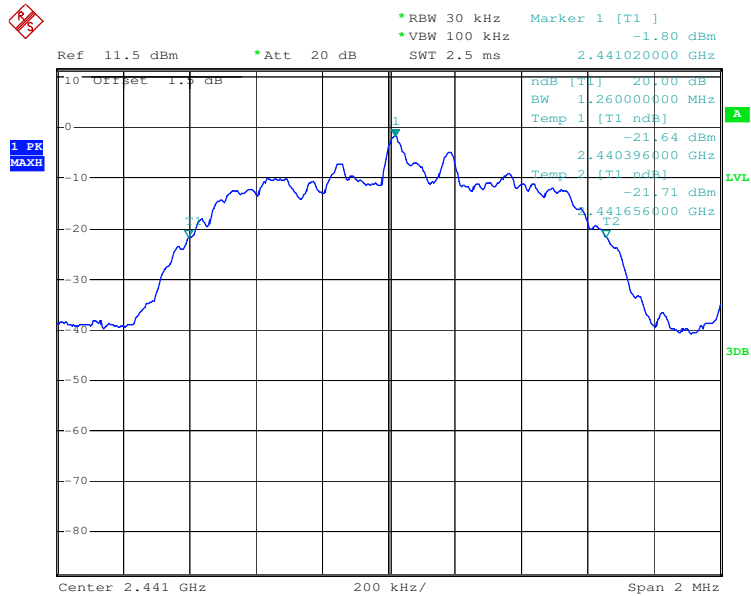

Date: 2.DEC.2009 09:38:11

Test mode:	Pi/4QPSK	Test channel:	Highest
------------	----------	---------------	---------

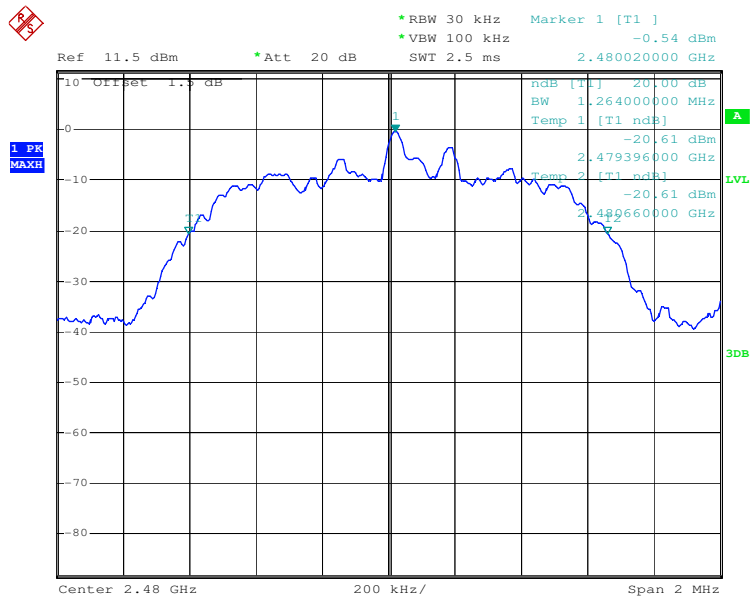

Date: 2.DEC.2009 10:41:03

"This document is issued by the Company subject to its General Conditions of Service printed overleaf, available on request or accessible at www.sgs.com/terms_and_conditions.htm and, for electronic format documents, subject to Terms and Conditions for Electronic Documents at www.sgs.com/terms_e-document.htm. Attention is drawn to the limitation of liability, indemnification and jurisdiction issues defined therein. Any holder of this document is advised that information contained hereon reflects the Company's findings at the time of its intervention only and within the limits of Client's instructions, if any. The Company's sole responsibility is to its Client and this document does not exonerate parties to a transaction from exercising all their rights and obligations under the transaction documents. This document cannot be reproduced except in full, without prior written approval of the Company. Any unauthorized alteration, forgery or falsification of the content or appearance of this document is unlawful and offenders may be prosecuted to the fullest extent of the law. Unless otherwise stated the results shown in this test report refer only to the sample(s) tested and such sample(s) are retained for 90 days only."



Test mode:	8DPSK	Test channel:	Lowest
------------	-------	---------------	--------

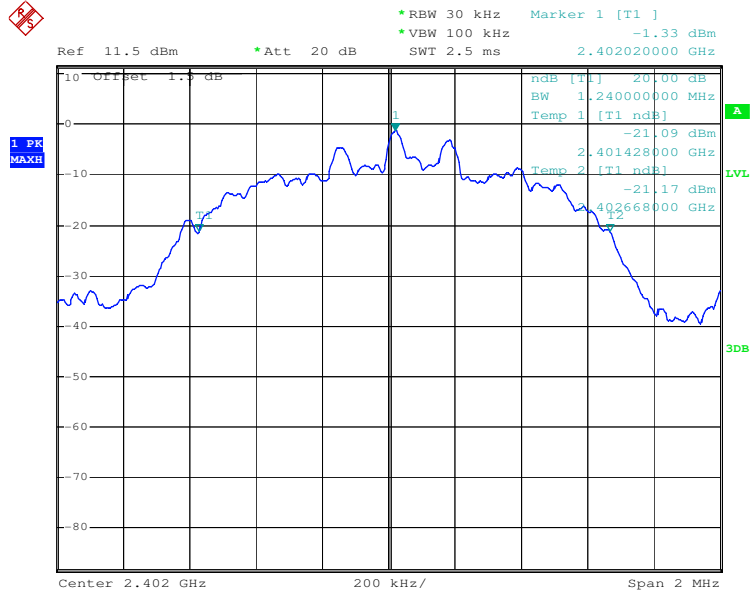

Date: 2.DEC.2009 10:15:39

Test mode:	8DPSK	Test channel:	Middle
------------	-------	---------------	--------

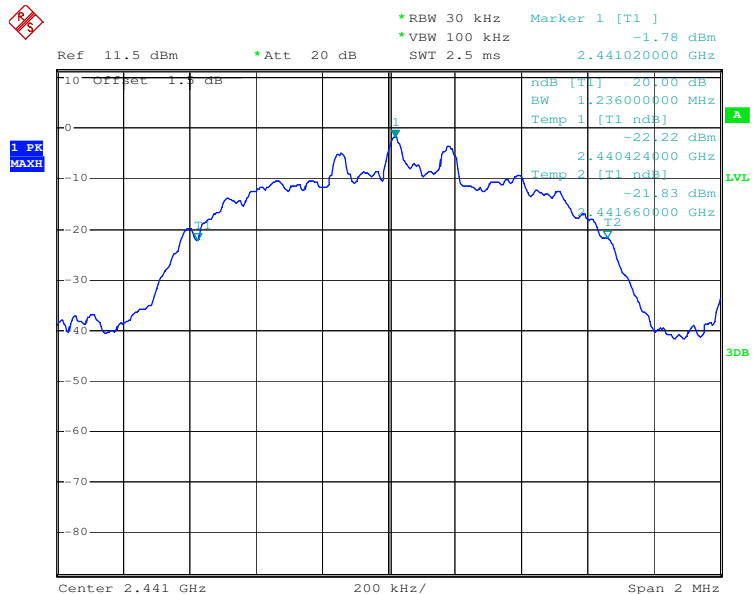

Date: 2.DEC.2009 09:51:55

"This document is issued by the Company subject to its General Conditions of Service printed overleaf, available on request or accessible at www.sgs.com/terms_and_conditions.htm and, for electronic format documents, subject to Terms and Conditions for Electronic Documents at www.sgs.com/terms_e-document.htm. Attention is drawn to the limitation of liability, indemnification and jurisdiction issues defined therein. Any holder of this document is advised that information contained hereon reflects the Company's findings at the time of its intervention only and within the limits of Client's instructions, if any. The Company's sole responsibility is to its Client and this document does not exonerate parties to a transaction from exercising all their rights and obligations under the transaction documents. This document cannot be reproduced except in full, without prior written approval of the Company. Any unauthorized alteration, forgery or falsification of the content or appearance of this document is unlawful and offenders may be prosecuted to the fullest extent of the law. Unless otherwise stated the results shown in this test report refer only to the sample(s) tested and such sample(s) are retained for 90 days only."



Test mode:	8DPSK	Test channel:	Highest
------------	-------	---------------	---------

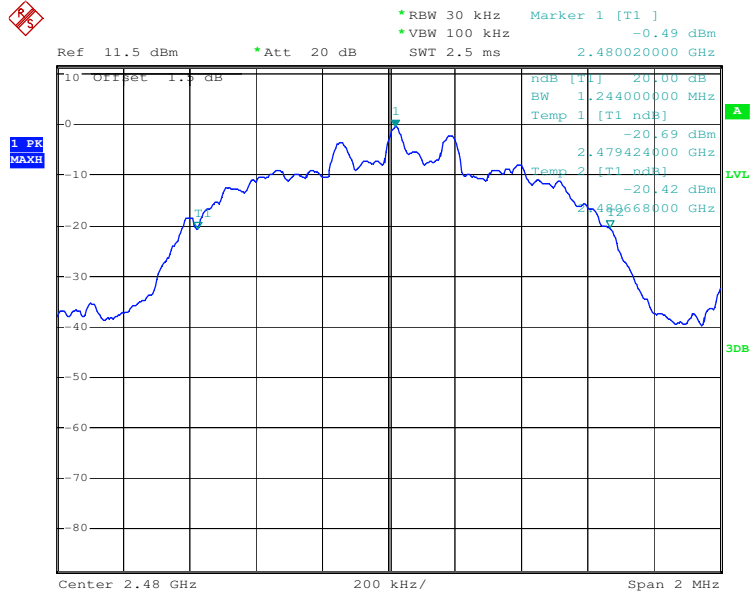

Date: 2.DEC.2009 10:54:04

5.5 Carrier Frequencies Separation

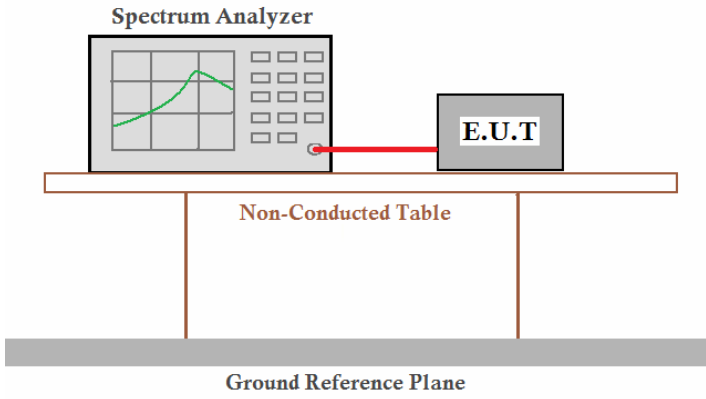
Test Requirement:	FCC Part15 C Section 15.247 (a)(1)
Test Method:	ANSI C63.4:2003 and KDB DA00-705
Test setup:	 <p><i>Remark: Offset the High-Frequency cable loss 1.5dB in the spectrum analyzer</i></p>
Test Instruments:	Refer to section 4.7 for details
Limit:	$\geq 0.025\text{MHz}$ or $2/3$ of the 20dB bandwidth (whichever is greater)
Test state:	Hopping transmitting with modulation.
Test results:	Passed

Measurement Data

GFSK mode			
Test channel	Carrier Frequencies Separation (KHz)	Limit (KHz)	Result
Lowest	1002	845.3	Pass
Middle	1002	845.3	Pass
Highest	1002	845.3	Pass
Pi/4QPSK mode			
Test channel	Carrier Frequencies Separation (KHz)	Limit (KHz)	Result
Lowest	1002	845.3	Pass
Middle	1002	845.3	Pass
Highest	1002	845.3	Pass
8DPSK mode			
Test channel	Carrier Frequencies Separation (KHz)	Limit (KHz)	Result
Lowest	1002	845.3	Pass
Middle	1002	845.3	Pass
Highest	1002	845.3	Pass

Note: According to section 5.3

Mode	20dB bandwidth (KHz) (worse case)	Limit (KHz) (Carrier Frequencies Separation)
GFSK	820	546.6
PI/4QPSK	1268	845.3
8DPSK	1244	829.3

This document is issued by the Company subject to its General Conditions of Service printed overleaf, available on request or accessible at www.sgs.com/terms_and_conditions.htm and, for electronic format documents, subject to Terms and Conditions for Electronic Documents at www.sgs.com/terms_e-document.htm. Attention is drawn to the limitation of liability, indemnification and jurisdiction issues defined therein. Any holder of this document is advised that information contained hereon reflects the Company's findings at the time of its intervention only and within the limits of Client's instructions, if any. The Company's sole responsibility is to its Client and this document does not exonerate parties to a transaction from exercising all their rights and obligations under the transaction documents. This document cannot be reproduced except in full, without prior written approval of the Company. Any unauthorized alteration, forgery or falsification of the content or appearance of this document is unlawful and offenders may be prosecuted to the fullest extent of the law. Unless otherwise stated the results shown in this test report refer only to the sample(s) tested and such sample(s) are retained for 90 days only.

Test plot as follows:

Test mode:	GFSK	Test channel:	Lowest
------------	------	---------------	--------

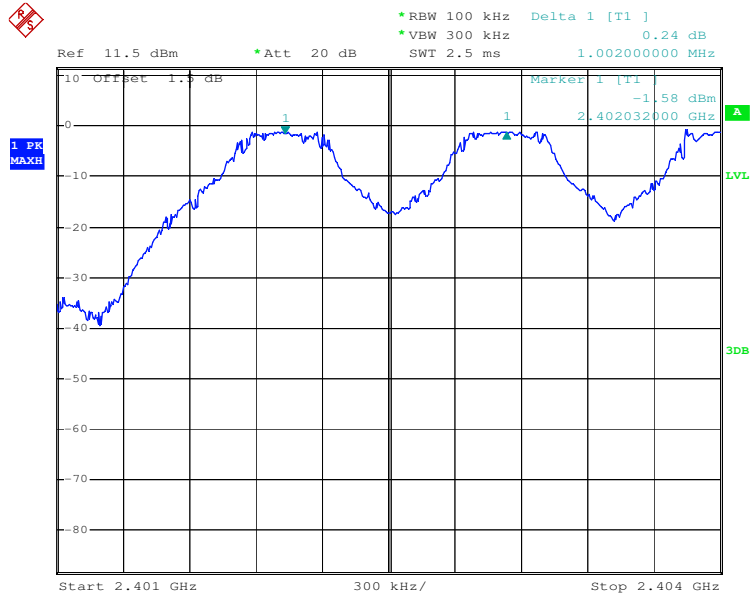

Date: 2.DEC.2009 10:08:04

Test mode:	GFSK	Test channel:	Middle
------------	------	---------------	--------

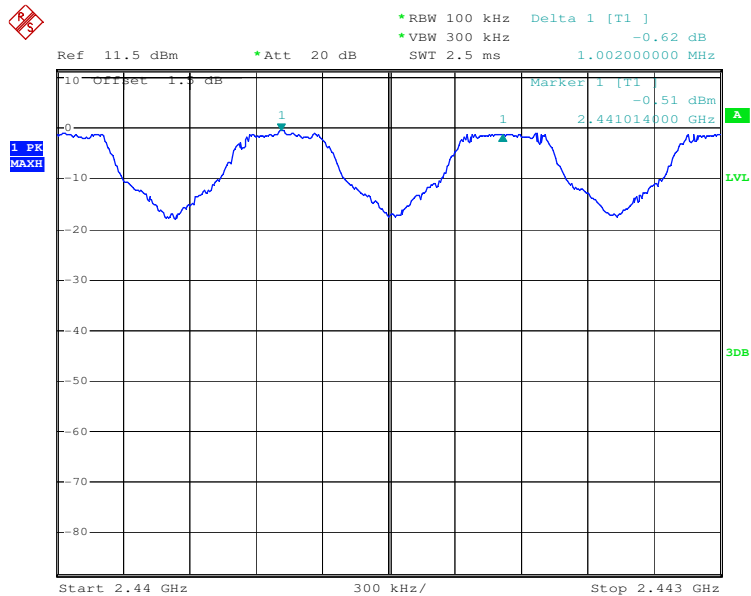

Date: 2.DEC.2009 09:30:17

"This document is issued by the Company subject to its General Conditions of Service printed overleaf, available on request or accessible at www.sgs.com/terms_and_conditions.htm and, for electronic format documents, subject to Terms and Conditions for Electronic Documents at www.sgs.com/terms_e-document.htm. Attention is drawn to the limitation of liability, indemnification and jurisdiction issues defined therein. Any holder of this document is advised that information contained hereon reflects the Company's findings at the time of its intervention only and within the limits of Client's instructions, if any. The Company's sole responsibility is to its Client and this document does not exonerate parties to a transaction from exercising all their rights and obligations under the transaction documents. This document cannot be reproduced except in full, without prior written approval of the Company. Any unauthorized alteration, forgery or falsification of the content or appearance of this document is unlawful and offenders may be prosecuted to the fullest extent of the law. Unless otherwise stated the results shown in this test report refer only to the sample(s) tested and such sample(s) are retained for 90 days only."



Test mode:	GFSK	Test channel:	Highest
------------	------	---------------	---------

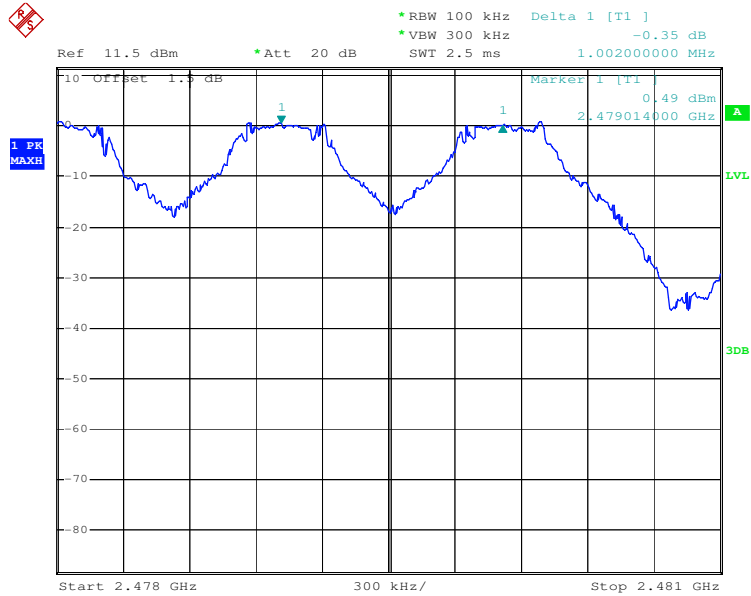

Date: 2.DEC.2009 10:39:11

Test mode:	PI/4QPSK	Test channel:	Lowest
------------	----------	---------------	--------

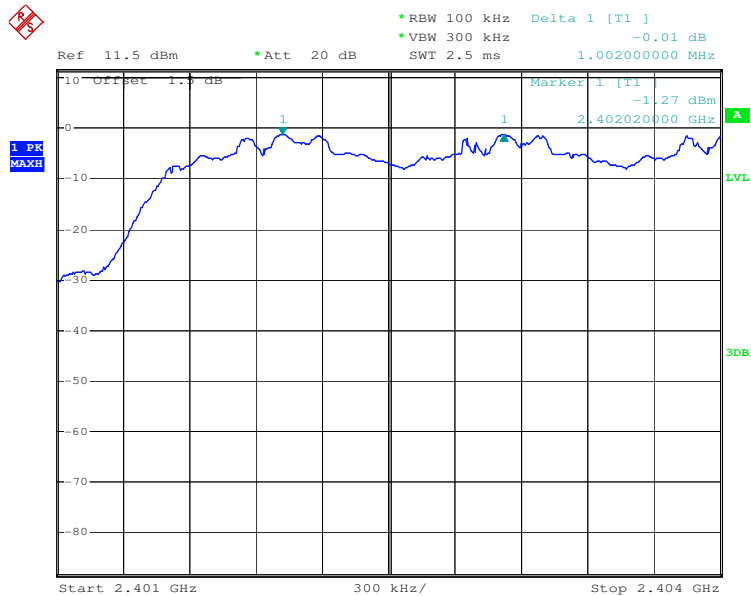

Date: 2.DEC.2009 10:09:27

"This document is issued by the Company subject to its General Conditions of Service printed overleaf, available on request or accessible at www.sgs.com/terms_and_conditions.htm and, for electronic format documents, subject to Terms and Conditions for Electronic Documents at www.sgs.com/terms_e-document.htm. Attention is drawn to the limitation of liability, indemnification and jurisdiction issues defined therein. Any holder of this document is advised that information contained hereon reflects the Company's findings at the time of its intervention only and within the limits of Client's instructions, if any. The Company's sole responsibility is to its Client and this document does not exonerate parties to a transaction from exercising all their rights and obligations under the transaction documents. This document cannot be reproduced except in full, without prior written approval of the Company. Any unauthorized alteration, forgery or falsification of the content or appearance of this document is unlawful and offenders may be prosecuted to the fullest extent of the law. Unless otherwise stated the results shown in this test report refer only to the sample(s) tested and such sample(s) are retained for 90 days only."

Test mode:	PI/4QPSK	Test channel:	Middle
------------	----------	---------------	--------

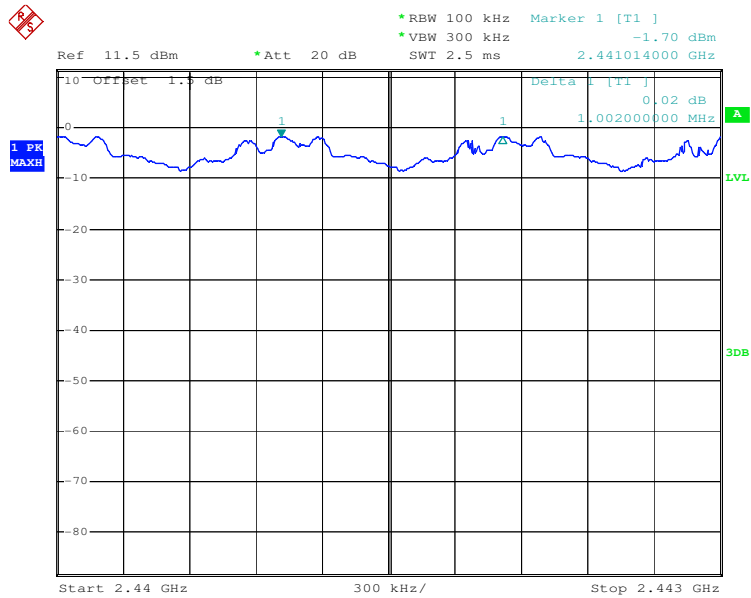

Date: 2.DEC.2009 09:43:29

Test mode:	PI/4QPSK	Test channel:	Highest
------------	----------	---------------	---------

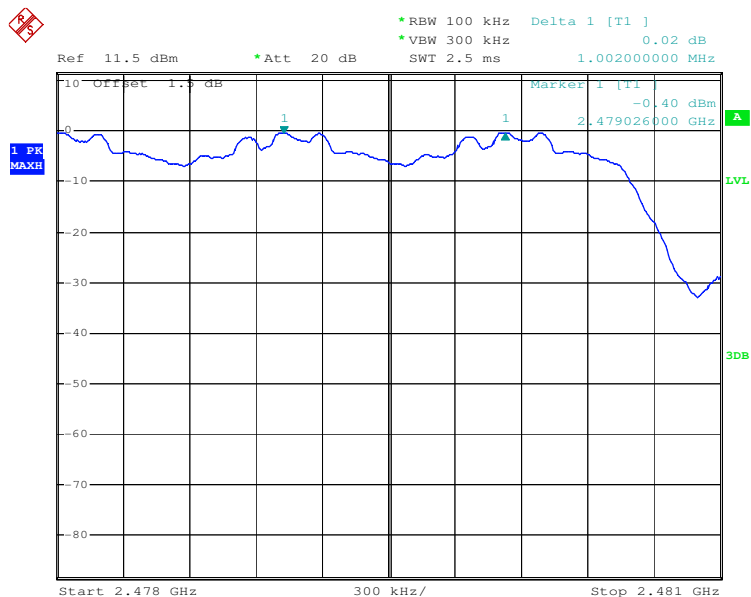

Date: 2.DEC.2009 10:50:24

"This document is issued by the Company subject to its General Conditions of Service printed overleaf, available on request or accessible at www.sgs.com/terms_and_conditions.htm and, for electronic format documents, subject to Terms and Conditions for Electronic Documents at www.sgs.com/terms_e-document.htm. Attention is drawn to the limitation of liability, indemnification and jurisdiction issues defined therein. Any holder of this document is advised that information contained hereon reflects the Company's findings at the time of its intervention only and within the limits of Client's instructions, if any. The Company's sole responsibility is to its Client and this document does not exonerate parties to a transaction from exercising all their rights and obligations under the transaction documents. This document cannot be reproduced except in full, without prior written approval of the Company. Any unauthorized alteration, forgery or falsification of the content or appearance of this document is unlawful and offenders may be prosecuted to the fullest extent of the law. Unless otherwise stated the results shown in this test report refer only to the sample(s) tested and such sample(s) are retained for 90 days only."



Test mode:	8DPSK	Test channel:	Lowest
------------	-------	---------------	--------

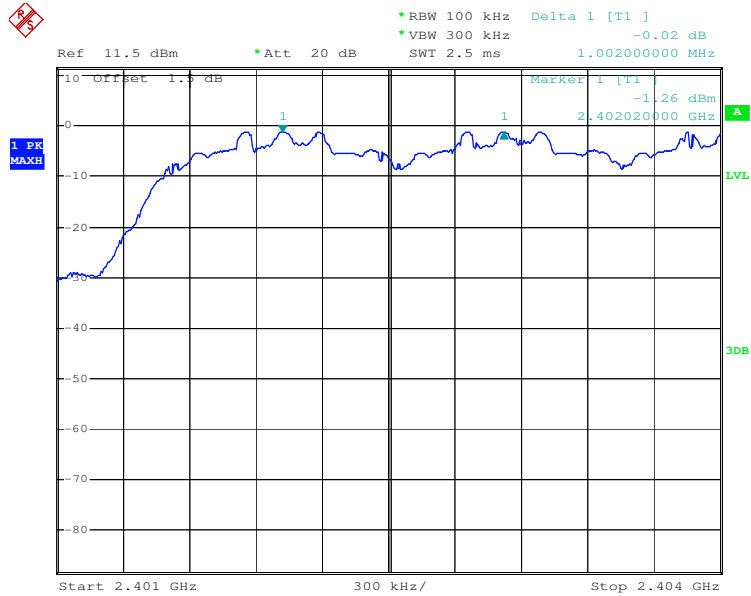

Date: 2.DEC.2009 10:22:33

Test mode:	8DPSK	Test channel:	Middle
------------	-------	---------------	--------

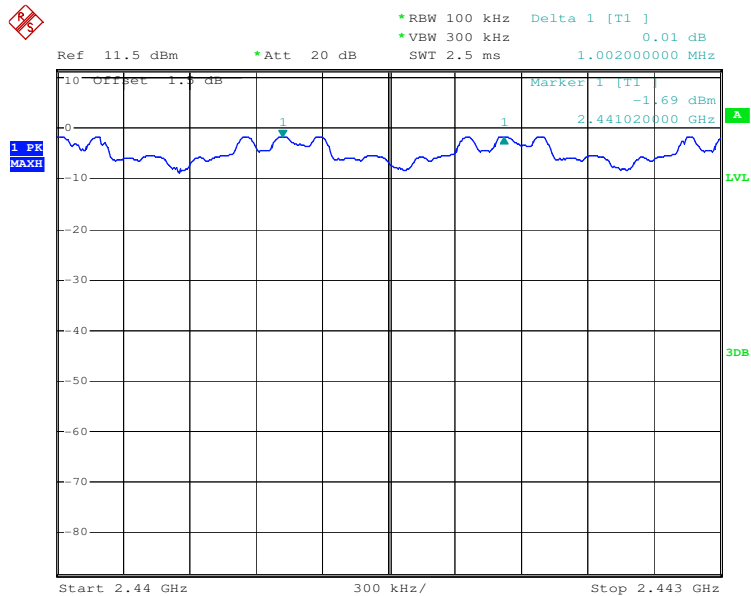

Date: 2.DEC.2009 09:56:50

"This document is issued by the Company subject to its General Conditions of Service printed overleaf, available on request or accessible at www.sgs.com/terms_and_conditions.htm and, for electronic format documents, subject to Terms and Conditions for Electronic Documents at www.sgs.com/terms_e-document.htm. Attention is drawn to the limitation of liability, indemnification and jurisdiction issues defined therein. Any holder of this document is advised that information contained hereon reflects the Company's findings at the time of its intervention only and within the limits of Client's instructions, if any. The Company's sole responsibility is to its Client and this document does not exonerate parties to a transaction from exercising all their rights and obligations under the transaction documents. This document cannot be reproduced except in full, without prior written approval of the Company. Any unauthorized alteration, forgery or falsification of the content or appearance of this document is unlawful and offenders may be prosecuted to the fullest extent of the law. Unless otherwise stated the results shown in this test report refer only to the sample(s) tested and such sample(s) are retained for 90 days only."



Test mode:	8DPSK	Test channel:	Highest
------------	-------	---------------	---------

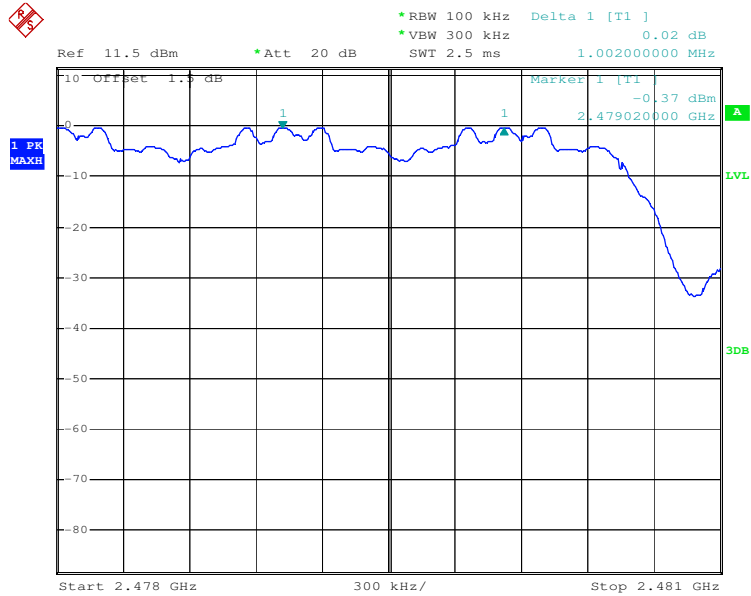

Date: 2.DEC.2009 11:12:55

"This document is issued by the Company subject to its General Conditions of Service printed overleaf, available on request or accessible at www.sgs.com/terms_and_conditions.htm and, for electronic format documents, subject to Terms and Conditions for Electronic Documents at www.sgs.com/terms_e-document.htm. Attention is drawn to the limitation of liability, indemnification and jurisdiction issues defined therein. Any holder of this document is advised that information contained hereon reflects the Company's findings at the time of its intervention only and within the limits of Client's instructions, if any. The Company's sole responsibility is to its Client and this document does not exonerate parties to a transaction from exercising all their rights and obligations under the transaction documents. This document cannot be reproduced except in full, without prior written approval of the Company. Any unauthorized alteration, forgery or falsification of the content or appearance of this document is unlawful and offenders may be prosecuted to the fullest extent of the law. Unless otherwise stated the results shown in this test report refer only to the sample(s) tested and such sample(s) are retained for 90 days only."

5.6 Hopping Channel Number

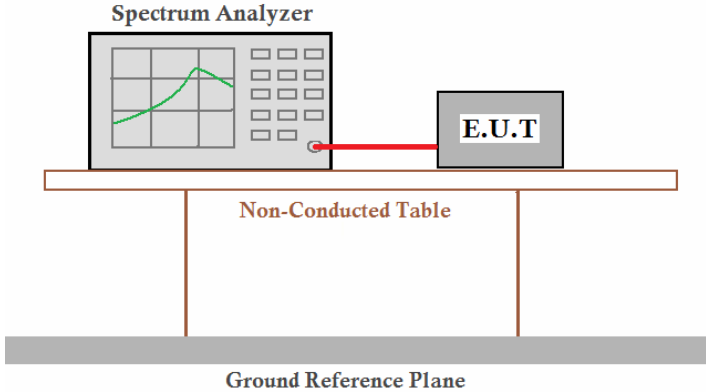
Test Requirement:	FCC Part15 C Section 15.247 (b)
Test Method:	ANSI C63.4:2003 and KDB DA00-705
Limit:	At least 75channels
Test setup:	 <p><i>Remark: Offset the High-Frequency cable loss 1.5dB in the spectrum analyzer</i></p>
Test Instruments:	Refer to section 4.7 for details
Test state:	Hopping transmitting with modulation.
Test results:	Passed

Measurement Data

Hopping channel numbers	Limit	Results
79	75	Pass

Test plot as follows

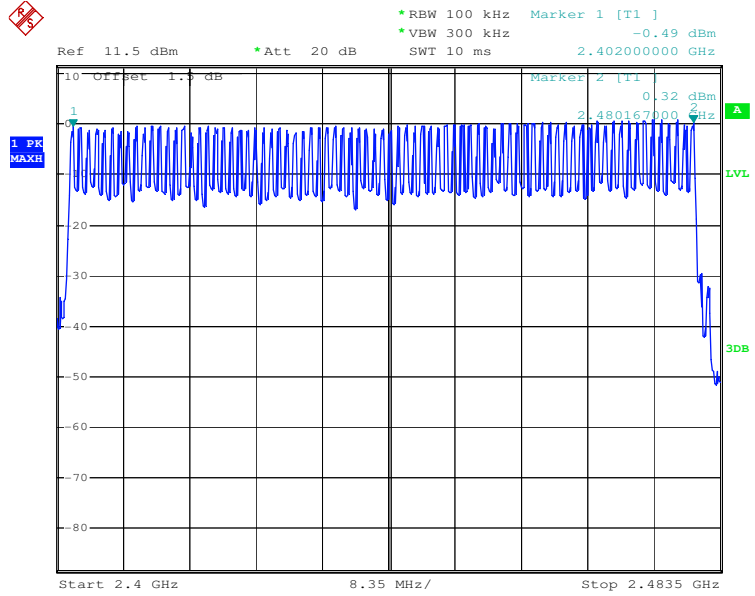

Date: 2.DEC.2009 11:22:17

5.7 Dwell Time

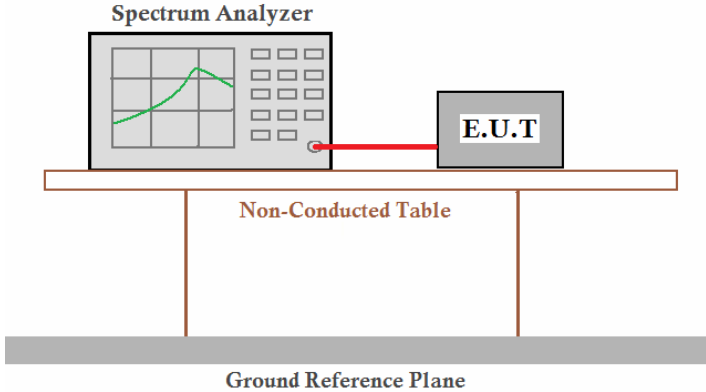
Test Requirement:	FCC Part15 C Section 15.247 (a)(1)
Test Method:	ANSI C63.4:2003 and KDB DA00-705
Limit:	<=0.4 Second
Test setup:	 <p><i>Remark: Offset the High-Frequency cable loss 1.5dB in the spectrum analyzer</i></p>
Test Instruments:	Refer to section 4.7 for details
Test state:	Hopping transmitting with modulation.
Test results:	Passed

Measurement Data

Mode	Packet	Dwell time (second)	Limit (second)
GFSK	DH1	0.1344	0.4
	DH3	0.2688	0.4
	DH5	0.3115	0.4
Pi/4QPSK	2-DH1	0.1344	0.4
	2-DH3	0.2688	0.4
	2-DH5	0.3115	0.4
8DPSK	3-DH1	0.1344	0.4
	3-DH3	0.2688	0.4
	3-DH5	0.3115	0.4

Test Result:

The test period: $T = 0.4 \text{ Second/Channel} \times 79 \text{ Channel} = 31.6 \text{ second}$

DH1, 2-DH1, 3-DH1: $\text{time slot} = 0.42(\text{ms}) \times (1600 / (2 \times 79)) \times 31.6 = 134.4 \text{ ms}$

DH3, 2-DH3, 3-DH3: $\text{time slot} = 1.68(\text{ms}) \times (1600 / (4 \times 79)) \times 31.6 = 268.8 \text{ ms}$

DH5, 2-DH5, 3-DH5: $\text{time slot} = 2.92(\text{ms}) \times (1600 / (6 \times 79)) \times 31.6 = 311.5 \text{ ms}$

This document is issued by the Company subject to its General Conditions of Service printed overleaf, available on request or accessible at www.sgs.com/terms_and_conditions.htm and, for electronic format documents, subject to Terms and Conditions for Electronic Documents at www.sgs.com/terms_e-document.htm. Attention is drawn to the limitation of liability, indemnification and jurisdiction issues defined therein. Any holder of this document is advised that information contained hereon reflects the Company's findings at the time of its intervention only and within the limits of Client's instructions, if any. The Company's sole responsibility is to its Client and this document does not exonerate parties to a transaction from exercising all their rights and obligations under the transaction documents. This document cannot be reproduced except in full, without prior written approval of the Company. Any unauthorized alteration, forgery or falsification of the content or appearance of this document is unlawful and offenders may be prosecuted to the fullest extent of the law. Unless otherwise stated the results shown in this test report refer only to the sample(s) tested and such sample(s) are retained for 90 days only.

Test plot as follows

Test mode:	GFSK, Pi/4QPSK, 8DPSK	Test Packet:	DH1, 2-DH1, 3-DH1
------------	-----------------------	--------------	-------------------

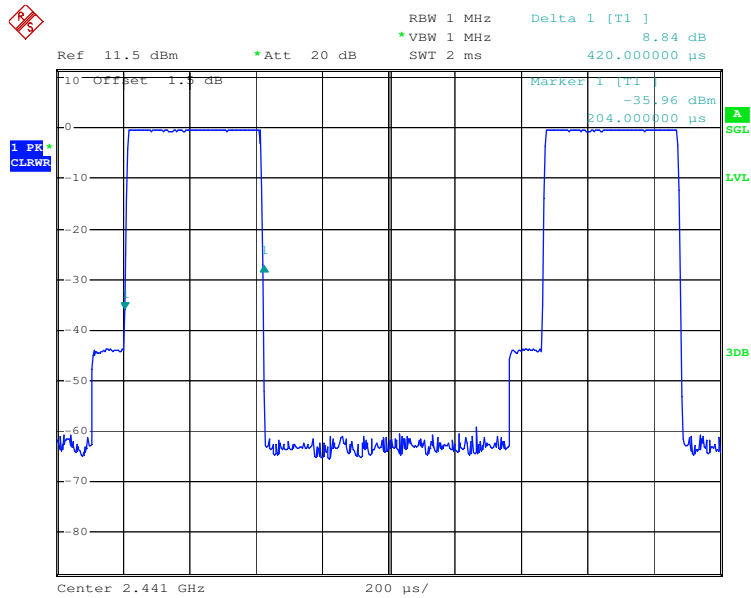

Date: 2.DEC.2009 09:34:44

Test mode:	GFSK, Pi/4QPSK, 8DPSK	Test Packet:	DH3, 2-DH3, 3-DH3
------------	-----------------------	--------------	-------------------

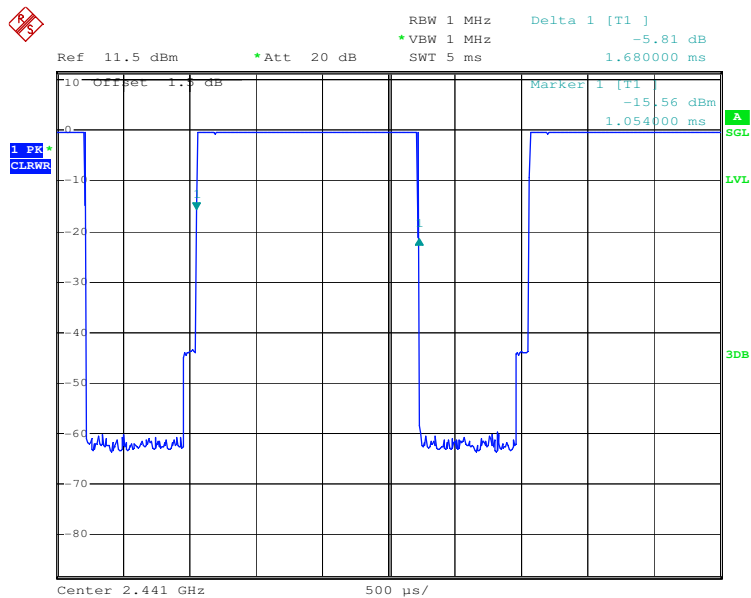

Date: 2.DEC.2009 09:35:25

"This document is issued by the Company subject to its General Conditions of Service printed overleaf, available on request or accessible at www.sgs.com/terms_and_conditions.htm and, for electronic format documents, subject to Terms and Conditions for Electronic Documents at www.sgs.com/terms_e-document.htm. Attention is drawn to the limitation of liability, indemnification and jurisdiction issues defined therein. Any holder of this document is advised that information contained hereon reflects the Company's findings at the time of its intervention only and within the limits of Client's instructions, if any. The Company's sole responsibility is to its Client and this document does not exonerate parties to a transaction from exercising all their rights and obligations under the transaction documents. This document cannot be reproduced except in full, without prior written approval of the Company. Any unauthorized alteration, forgery or falsification of the content or appearance of this document is unlawful and offenders may be prosecuted to the fullest extent of the law. Unless otherwise stated the results shown in this test report refer only to the sample(s) tested and such sample(s) are retained for 90 days only."



Test mode:	GFSK, Pi/4QPSK, 8DPSK	Test Packet:	DH5, 2-DH5, 3-DH5
------------	-----------------------	--------------	-------------------

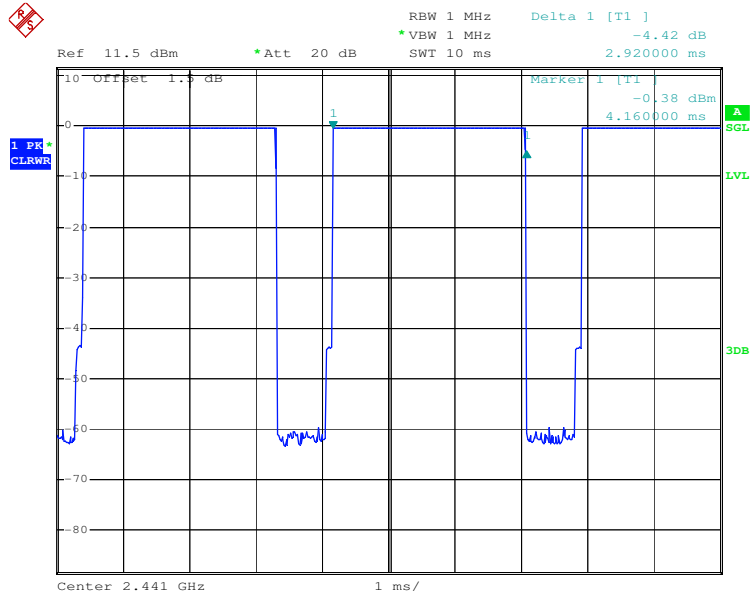

Date: 2.DEC.2009 09:33:48

"This document is issued by the Company subject to its General Conditions of Service printed overleaf, available on request or accessible at www.sgs.com/terms_and_conditions.htm and, for electronic format documents, subject to Terms and Conditions for Electronic Documents at www.sgs.com/terms_e-document.htm. Attention is drawn to the limitation of liability, indemnification and jurisdiction issues defined therein. Any holder of this document is advised that information contained hereon reflects the Company's findings at the time of its intervention only and within the limits of Client's instructions, if any. The Company's sole responsibility is to its Client and this document does not exonerate parties to a transaction from exercising all their rights and obligations under the transaction documents. This document cannot be reproduced except in full, without prior written approval of the Company. Any unauthorized alteration, forgery or falsification of the content or appearance of this document is unlawful and offenders may be prosecuted to the fullest extent of the law. Unless otherwise stated the results shown in this test report refer only to the sample(s) tested and such sample(s) are retained for 90 days only."

5.8 Band Edge

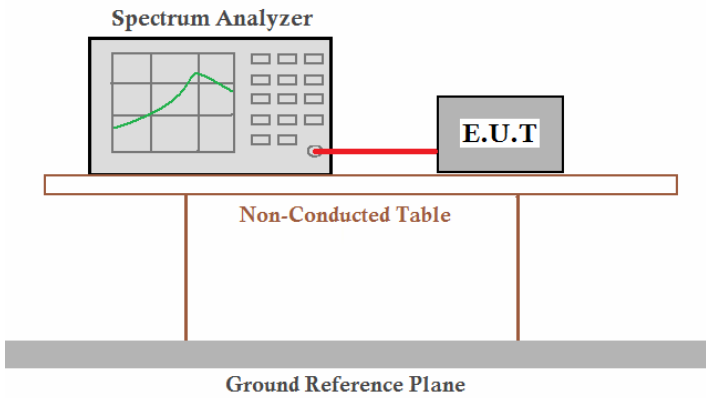
Test Requirement:	FCC Part15 C Section 15.247 (d)
Test Method:	ANSI C63.4:2003 and KDB DA00-705
Limit:	In any 100 kHz bandwidth outside the frequency band in which the spread spectrum intentional radiator is operating, the radio frequency power that is produced by the intentional radiator shall be at least 20 dB below that in the 100 kHz bandwidth within the band that contains the highest level of the desired power, based on either an RF conducted or a radiated measurement.
Test setup:	 <p style="text-align: center;"><i>Remark:</i> <i>Offset the High-Frequency cable loss 1.5dB in the spectrum analyzer.</i></p>
Test Instruments:	Refer to section 4.7 for details
Test state:	Hopping transmitting with modulation.
Test results:	Passed

Test plot as follows:

Test mode:	GFSK	Test channel:	Lowest
------------	------	---------------	--------

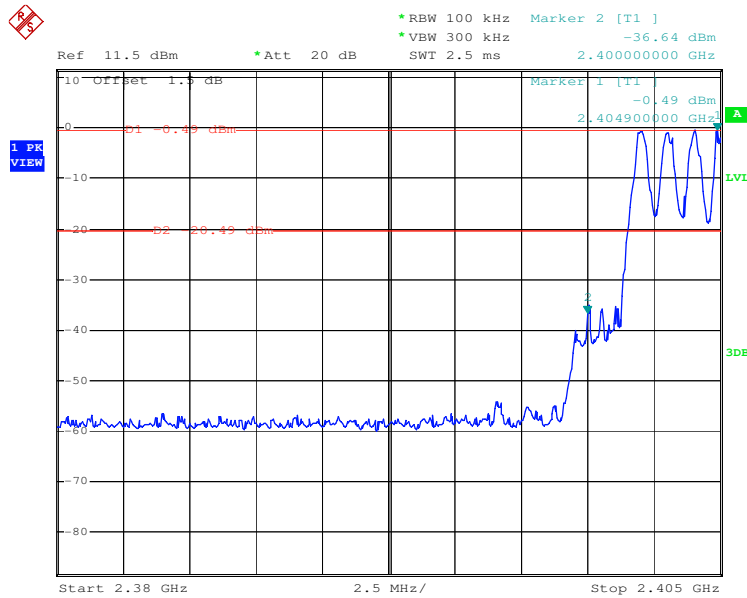

Date: 2.DEC.2009 10:05:46

Test mode:	GFSK	Test channel:	Highest
------------	------	---------------	---------

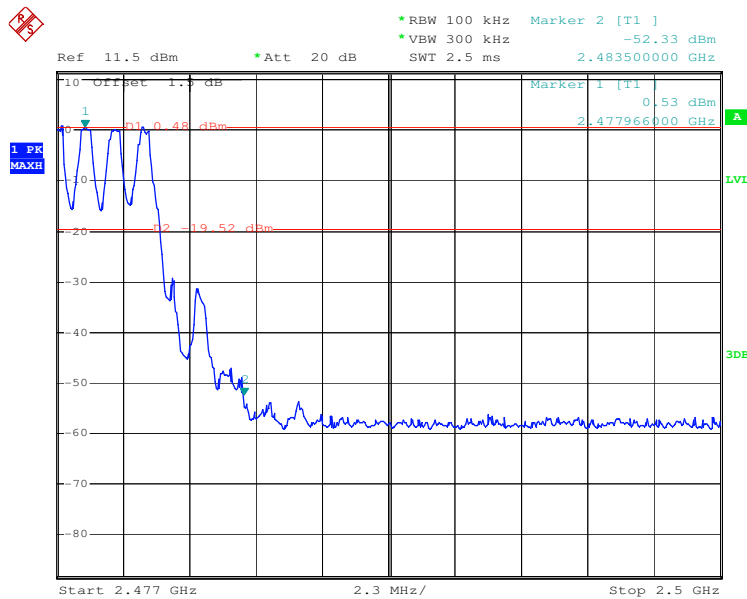

Date: 2.DEC.2009 10:37:23

"This document is issued by the Company subject to its General Conditions of Service printed overleaf, available on request or accessible at www.sgs.com/terms_and_conditions.htm and, for electronic format documents, subject to Terms and Conditions for Electronic Documents at www.sgs.com/terms_e-document.htm. Attention is drawn to the limitation of liability, indemnification and jurisdiction issues defined therein. Any holder of this document is advised that information contained hereon reflects the Company's findings at the time of its intervention only and within the limits of Client's instructions, if any. The Company's sole responsibility is to its Client and this document does not exonerate parties to a transaction from exercising all their rights and obligations under the transaction documents. This document cannot be reproduced except in full, without prior written approval of the Company. Any unauthorized alteration, forgery or falsification of the content or appearance of this document is unlawful and offenders may be prosecuted to the fullest extent of the law. Unless otherwise stated the results shown in this test report refer only to the sample(s) tested and such sample(s) are retained for 90 days only."

Test mode:	Pi/4QPSK	Test channel:	Lowest
------------	----------	---------------	--------

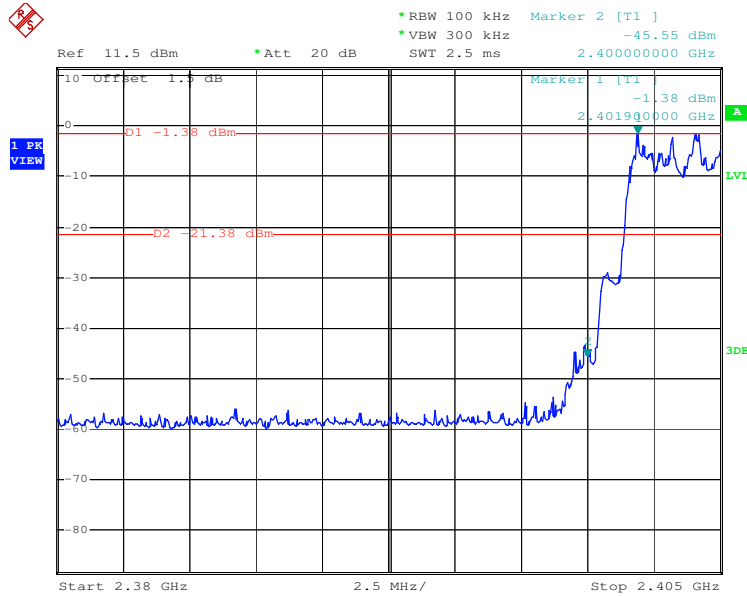

Date: 2.DEC.2009 10:10:58

Test mode:	Pi/4QPSK	Test channel:	Highest
------------	----------	---------------	---------

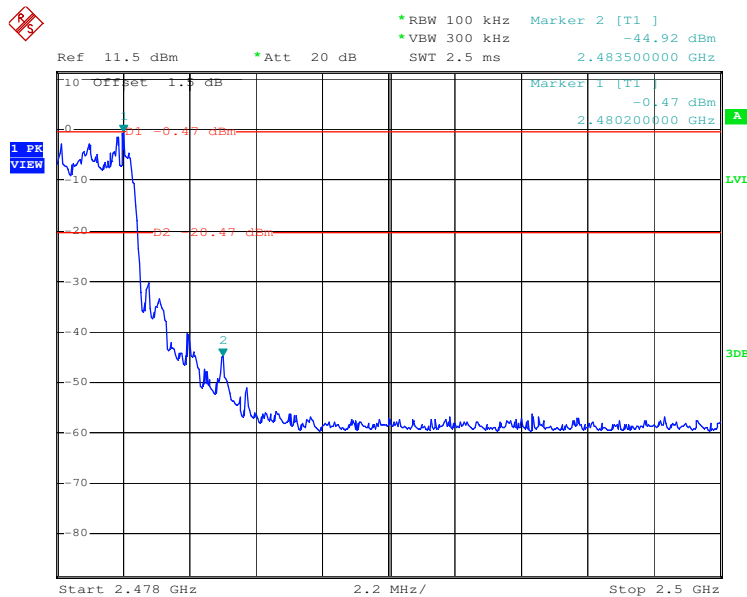

Date: 2.DEC.2009 10:46:34

"This document is issued by the Company subject to its General Conditions of Service printed overleaf, available on request or accessible at www.sgs.com/terms_and_conditions.htm and, for electronic format documents, subject to Terms and Conditions for Electronic Documents at www.sgs.com/terms_e-document.htm. Attention is drawn to the limitation of liability, indemnification and jurisdiction issues defined therein. Any holder of this document is advised that information contained hereon reflects the Company's findings at the time of its intervention only and within the limits of Client's instructions, if any. The Company's sole responsibility is to its Client and this document does not exonerate parties to a transaction from exercising all their rights and obligations under the transaction documents. This document cannot be reproduced except in full, without prior written approval of the Company. Any unauthorized alteration, forgery or falsification of the content or appearance of this document is unlawful and offenders may be prosecuted to the fullest extent of the law. Unless otherwise stated the results shown in this test report refer only to the sample(s) tested and such sample(s) are retained for 90 days only."



Test mode:	8DPSK	Test channel:	Lowest
------------	-------	---------------	--------

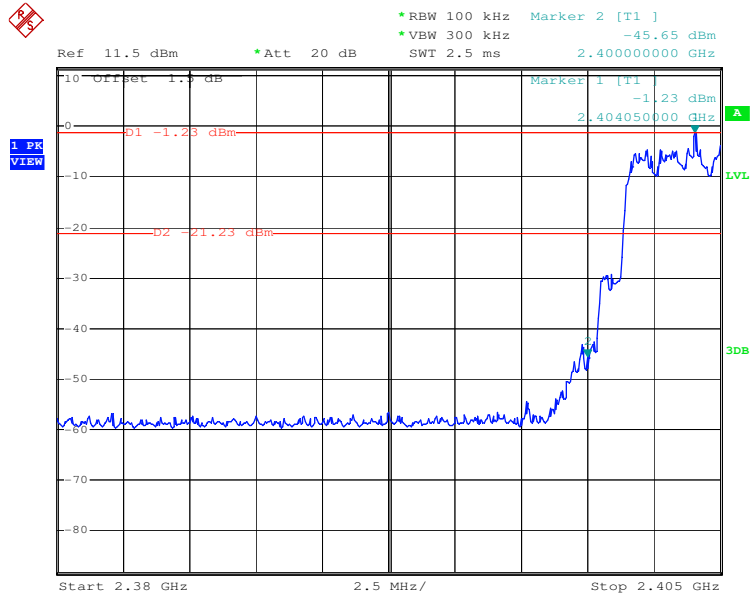

Date: 2.DEC.2009 10:21:09

Test mode:	8DPSK	Test channel:	Highest
------------	-------	---------------	---------

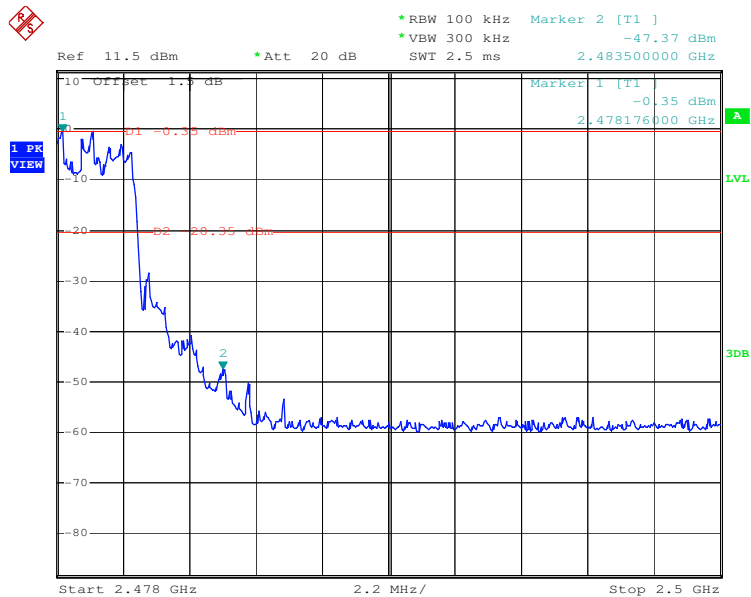

Date: 2.DEC.2009 11:11:23

"This document is issued by the Company subject to its General Conditions of Service printed overleaf, available on request or accessible at www.sgs.com/terms_and_conditions.htm and, for electronic format documents, subject to Terms and Conditions for Electronic Documents at www.sgs.com/terms_e-document.htm. Attention is drawn to the limitation of liability, indemnification and jurisdiction issues defined therein. Any holder of this document is advised that information contained hereon reflects the Company's findings at the time of its intervention only and within the limits of Client's instructions, if any. The Company's sole responsibility is to its Client and this document does not exonerate parties to a transaction from exercising all their rights and obligations under the transaction documents. This document cannot be reproduced except in full, without prior written approval of the Company. Any unauthorized alteration, forgery or falsification of the content or appearance of this document is unlawful and offenders may be prosecuted to the fullest extent of the law. Unless otherwise stated the results shown in this test report refer only to the sample(s) tested and such sample(s) are retained for 90 days only."

5.9 RF Antenna Conducted spurious emissions

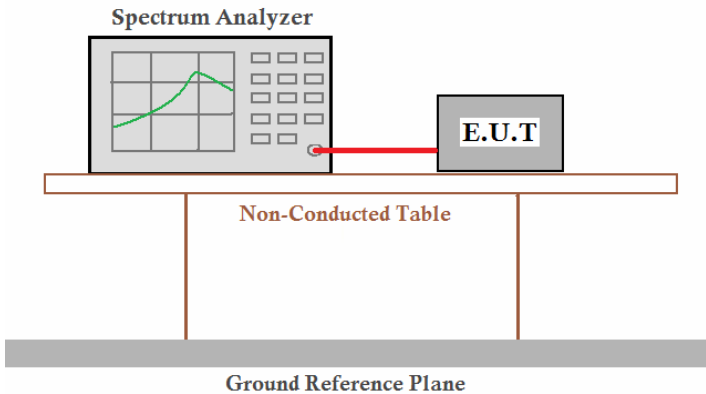
Test Requirement:	FCC Part15 C Section 15.247 (d)
Test Method:	ANSI C63.4:2003 and KDB DA00-705
Limit:	In any 100 kHz bandwidth outside the frequency band in which the spread spectrum intentional radiator is operating, the radio frequency power that is produced by the intentional radiator shall be at least 20 dB below that in the 100 kHz bandwidth within the band that contains the highest level of the desired power, based on either an RF conducted or a radiated measurement.
Test setup:	 <p><i>Remark:</i> Offset the High-Frequency cable loss 1.5dB in the spectrum analyzer.</p>
Test Instruments:	Refer to section 4.7 for details
Test results:	Passed



Test mode:	GFSK	Test channel:	Lowest
------------	------	---------------	--------

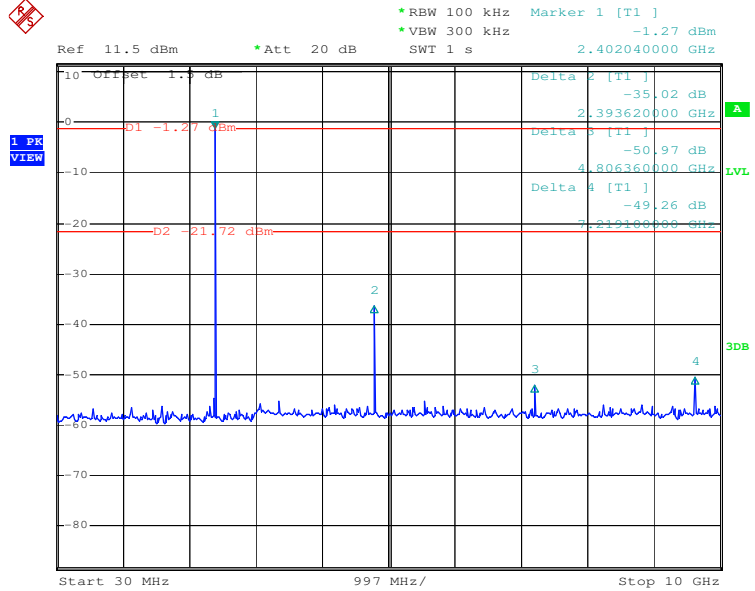

Date: 2.DEC.2009 10:03:20

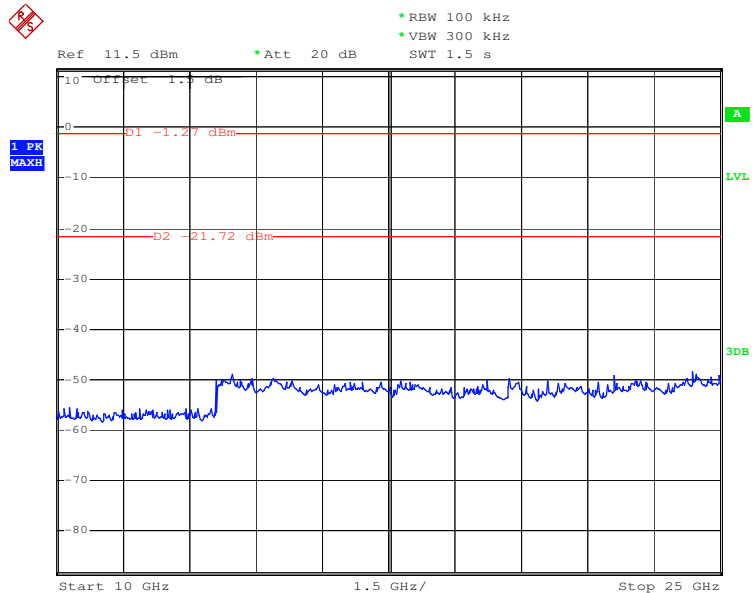

Date: 2.DEC.2009 10:03:57

"This document is issued by the Company subject to its General Conditions of Service printed overleaf, available on request or accessible at www.sgs.com/terms_and_conditions.htm and, for electronic format documents, subject to Terms and Conditions for Electronic Documents at www.sgs.com/terms_e-document.htm. Attention is drawn to the limitation of liability, indemnification and jurisdiction issues defined therein. Any holder of this document is advised that information contained hereon reflects the Company's findings at the time of its intervention only and within the limits of Client's instructions, if any. The Company's sole responsibility is to its Client and this document does not exonerate parties to a transaction from exercising all their rights and obligations under the transaction documents. This document cannot be reproduced except in full, without prior written approval of the Company. Any unauthorized alteration, forgery or falsification of the content or appearance of this document is unlawful and offenders may be prosecuted to the fullest extent of the law. Unless otherwise stated the results shown in this test report refer only to the sample(s) tested and such sample(s) are retained for 90 days only."



Test mode:	GFSK	Test channel:	Middle
------------	------	---------------	--------

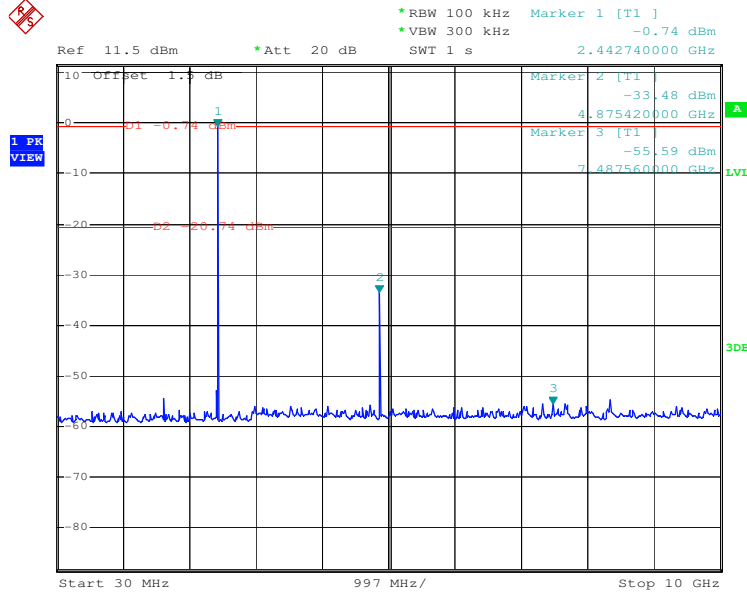

Date: 2.DEC.2009 09:24:51

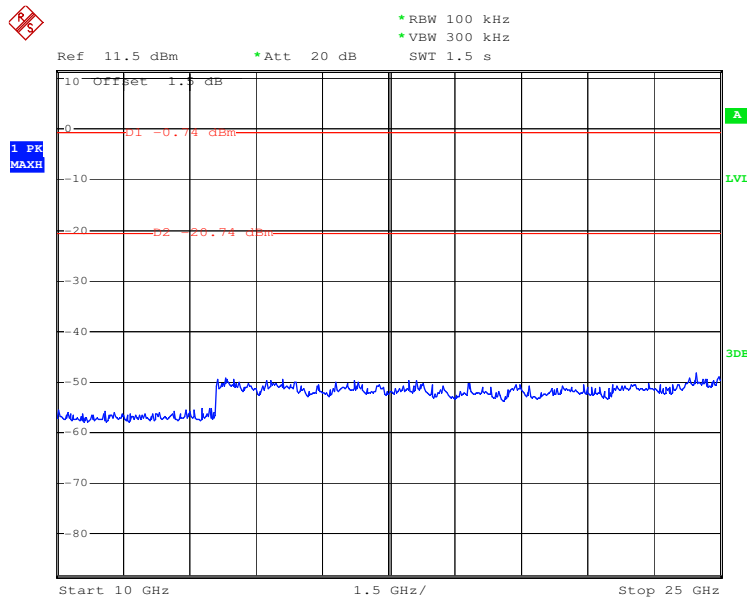

Date: 2.DEC.2009 09:26:07

"This document is issued by the Company subject to its General Conditions of Service printed overleaf, available on request or accessible at www.sgs.com/terms_and_conditions.htm and, for electronic format documents, subject to Terms and Conditions for Electronic Documents at www.sgs.com/terms_e-document.htm. Attention is drawn to the limitation of liability, indemnification and jurisdiction issues defined therein. Any holder of this document is advised that information contained hereon reflects the Company's findings at the time of its intervention only and within the limits of Client's instructions, if any. The Company's sole responsibility is to its Client and this document does not exonerate parties to a transaction from exercising all their rights and obligations under the transaction documents. This document cannot be reproduced except in full, without prior written approval of the Company. Any unauthorized alteration, forgery or falsification of the content or appearance of this document is unlawful and offenders may be prosecuted to the fullest extent of the law. Unless otherwise stated the results shown in this test report refer only to the sample(s) tested and such sample(s) are retained for 90 days only."

Test mode:	GFSK	Test channel:	Highest
------------	------	---------------	---------

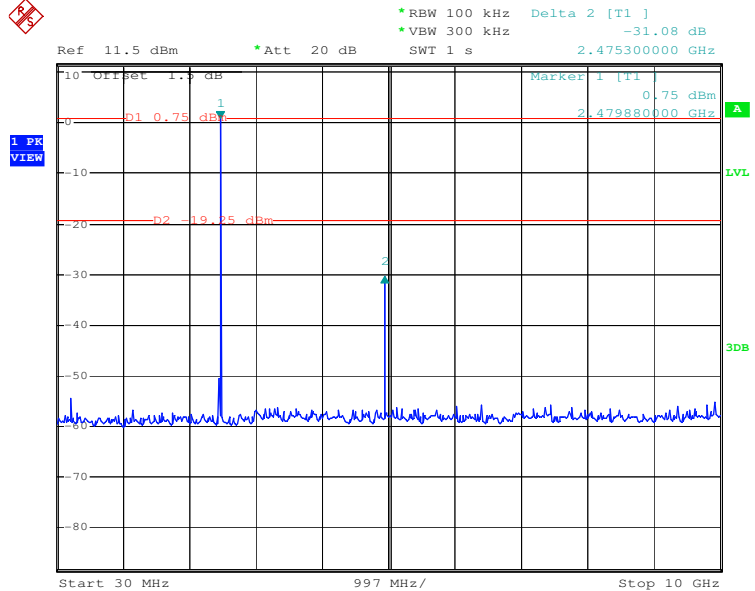

Date: 2.DEC.2009 10:33:10

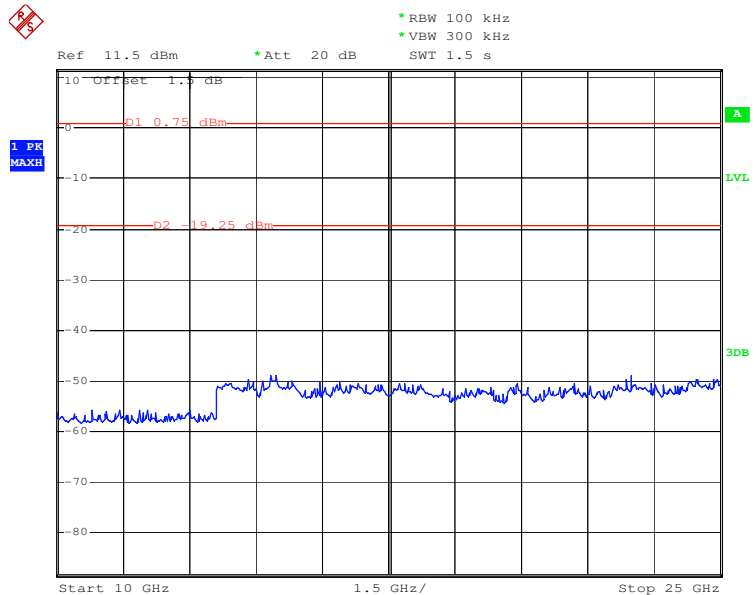

Date: 2.DEC.2009 10:33:40

Test mode:	Pi/4QPSK	Test channel:	Lowest
------------	----------	---------------	--------

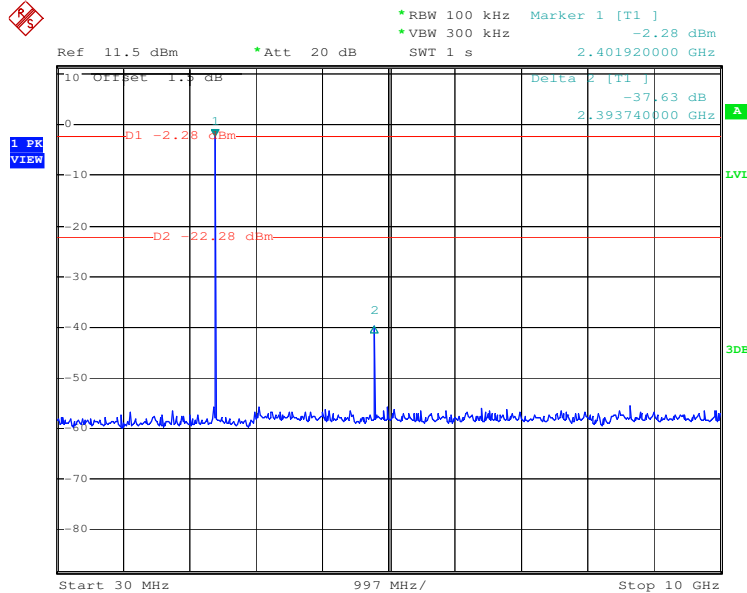

Date: 2.DEC.2009 10:13:39

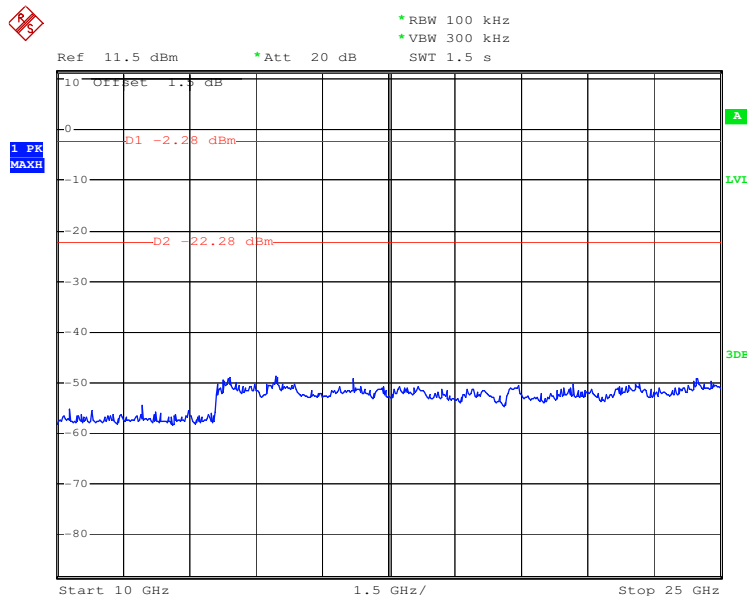

Date: 2.DEC.2009 10:14:09

Test mode:	Pi/4QPSK	Test channel:	Middle
------------	----------	---------------	--------

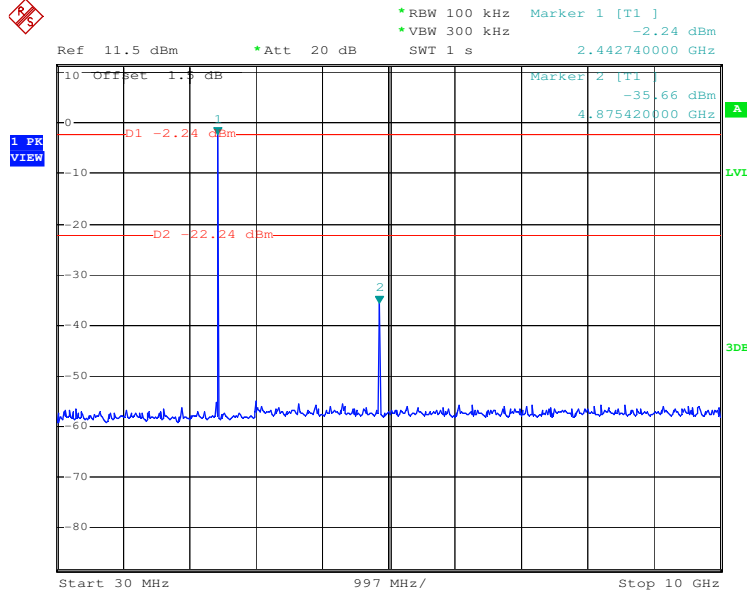

Date: 2.DEC.2009 09:40:15

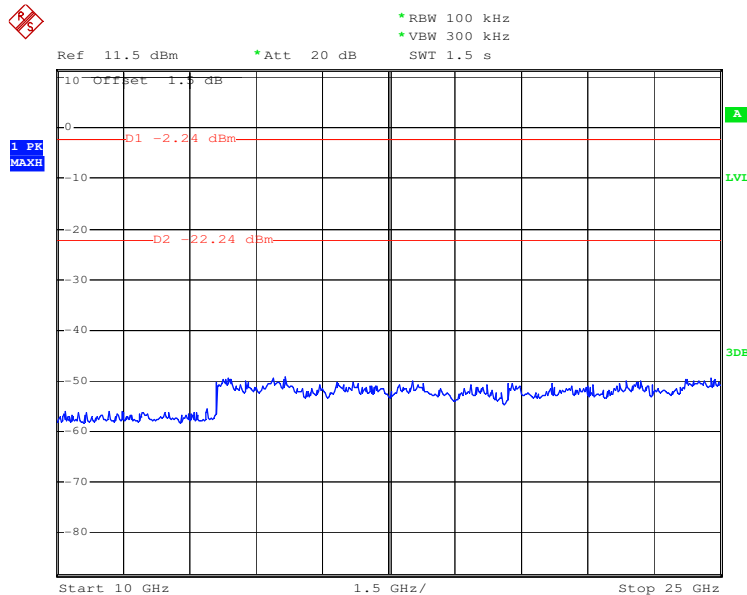

Date: 2.DEC.2009 09:40:47

Test mode:	Pi/4QPSK	Test channel:	Highest
------------	----------	---------------	---------

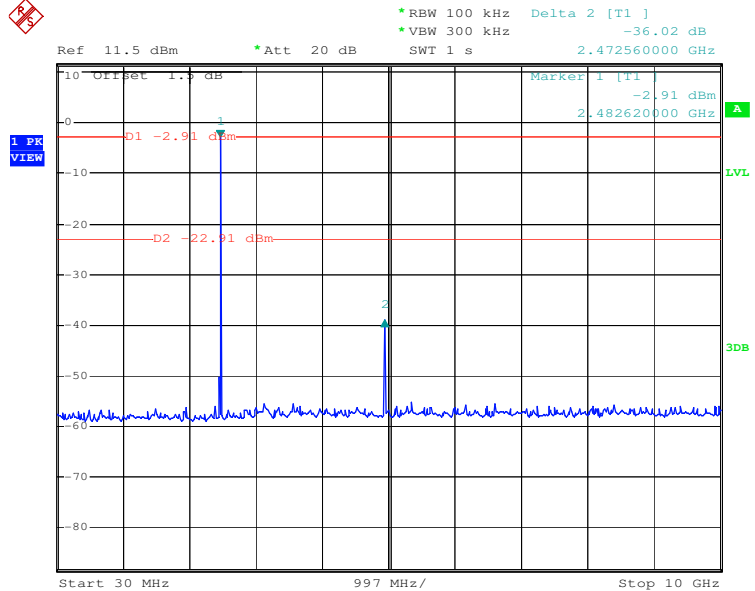

Date: 2.DEC.2009 10:43:06

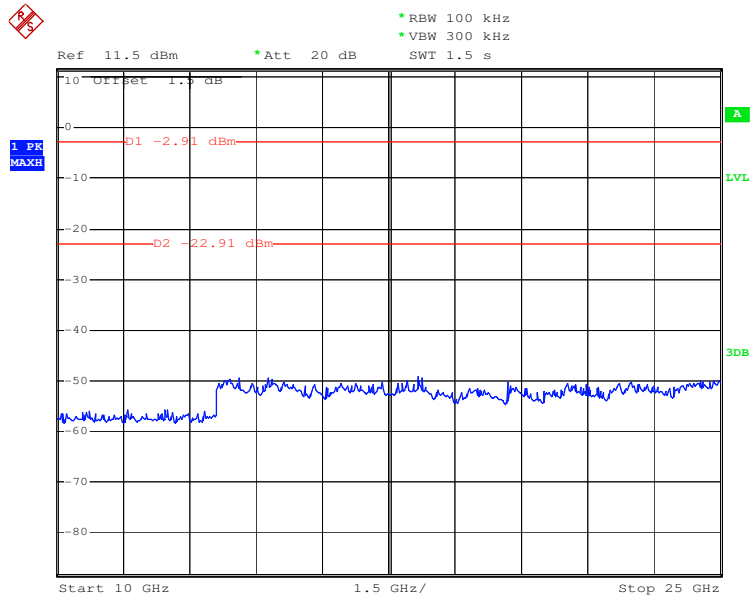

Date: 2.DEC.2009 10:43:33

"This document is issued by the Company subject to its General Conditions of Service printed overleaf, available on request or accessible at www.sgs.com/terms_and_conditions.htm and, for electronic format documents, subject to Terms and Conditions for Electronic Documents at www.sgs.com/terms_e-document.htm. Attention is drawn to the limitation of liability, indemnification and jurisdiction issues defined therein. Any holder of this document is advised that information contained hereon reflects the Company's findings at the time of its intervention only and within the limits of Client's instructions, if any. The Company's sole responsibility is to its Client and this document does not exonerate parties to a transaction from exercising all their rights and obligations under the transaction documents. This document cannot be reproduced except in full, without prior written approval of the Company. Any unauthorized alteration, forgery or falsification of the content or appearance of this document is unlawful and offenders may be prosecuted to the fullest extent of the law. Unless otherwise stated the results shown in this test report refer only to the sample(s) tested and such sample(s) are retained for 90 days only."

Test mode:	8DPSK	Test channel:	Lowest
------------	-------	---------------	--------

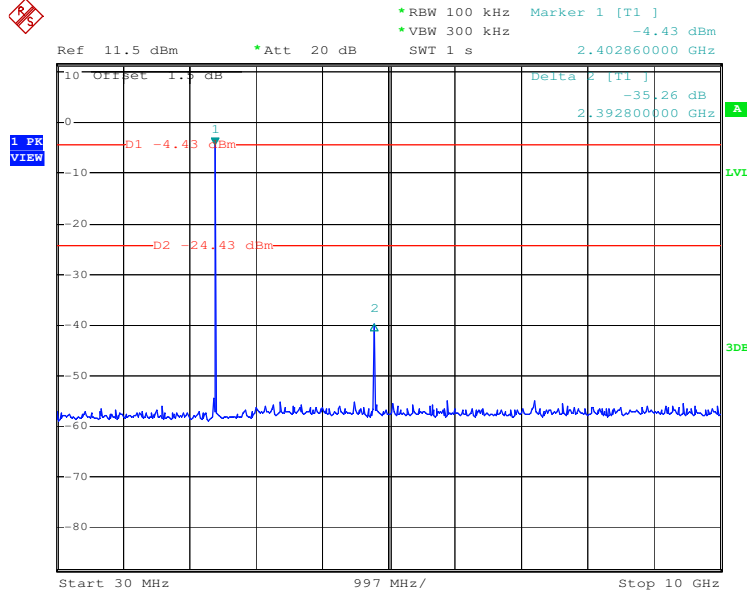

Date: 2.DEC.2009 10:19:02

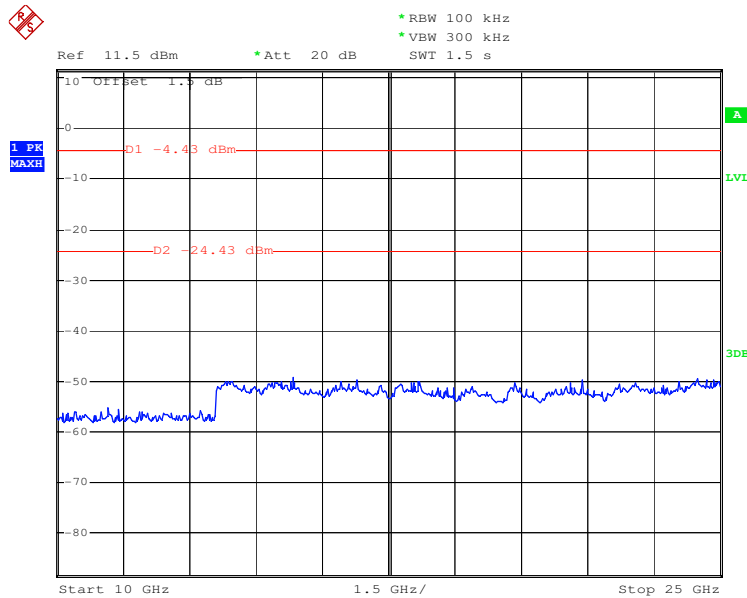

Date: 2.DEC.2009 10:19:34

Test mode:	8DPSK	Test channel:	Middle
------------	-------	---------------	--------

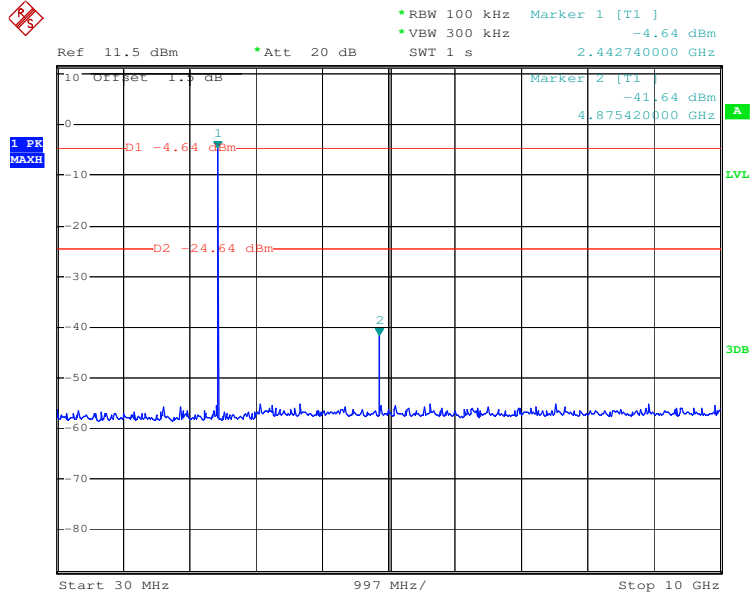

Date: 2.DEC.2009 09:54:10

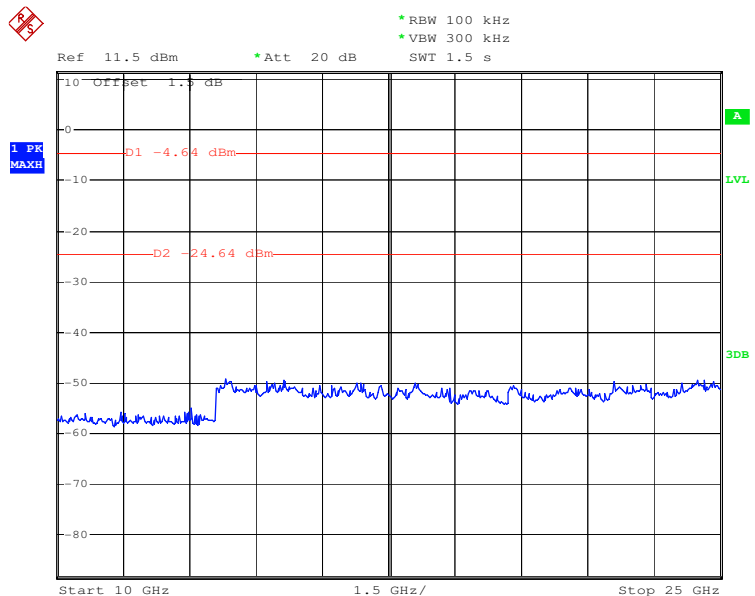

Date: 2.DEC.2009 09:54:51

"This document is issued by the Company subject to its General Conditions of Service printed overleaf, available on request or accessible at www.sgs.com/terms_and_conditions.htm and, for electronic format documents, subject to Terms and Conditions for Electronic Documents at www.sgs.com/terms_e-document.htm. Attention is drawn to the limitation of liability, indemnification and jurisdiction issues defined therein. Any holder of this document is advised that information contained hereon reflects the Company's findings at the time of its intervention only and within the limits of Client's instructions, if any. The Company's sole responsibility is to its Client and this document does not exonerate parties to a transaction from exercising all their rights and obligations under the transaction documents. This document cannot be reproduced except in full, without prior written approval of the Company. Any unauthorized alteration, forgery or falsification of the content or appearance of this document is unlawful and offenders may be prosecuted to the fullest extent of the law. Unless otherwise stated the results shown in this test report refer only to the sample(s) tested and such sample(s) are retained for 90 days only."

Test mode:	8DPSK	Test channel:	Highest
------------	-------	---------------	---------

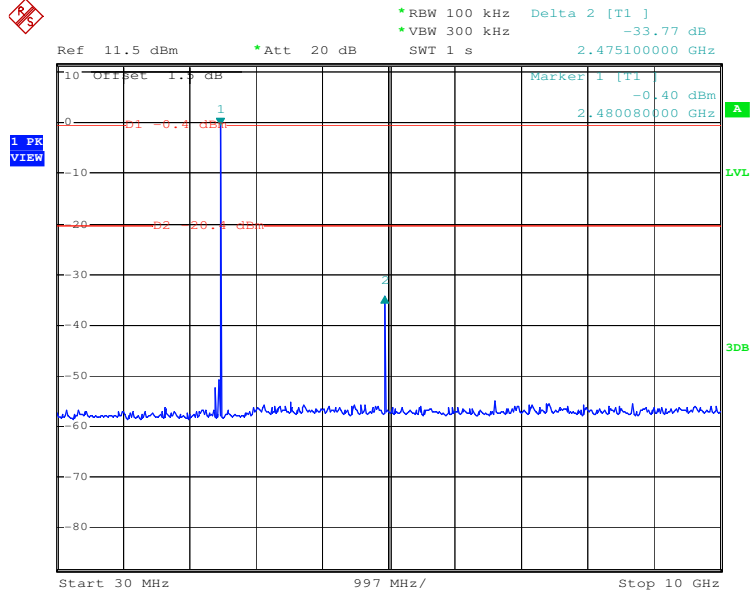

Date: 2.DEC.2009 11:07:14

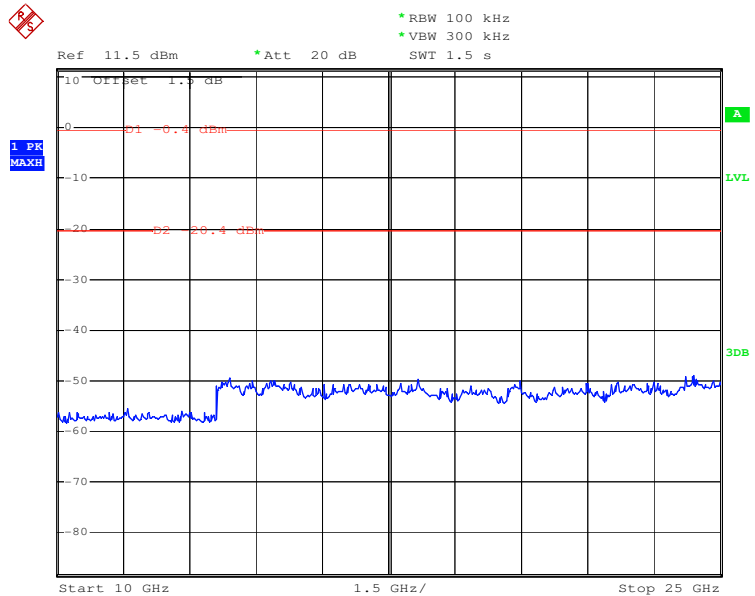

Date: 2.DEC.2009 11:09:50

5.10 Pseudorandom Frequency Hopping Sequence

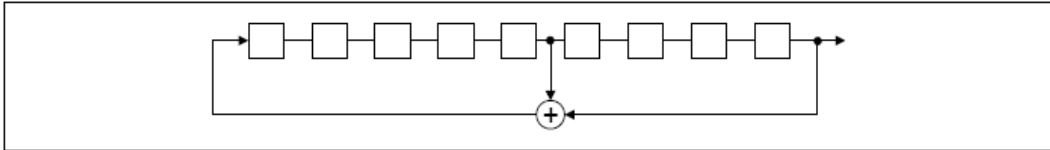
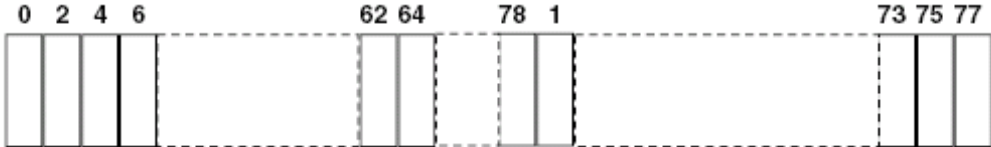
Test Requirement:	FCC Part15 C Section 15.247 (a)(1) requirement:
<p>Frequency hopping systems shall have hopping channel carrier frequencies separated by a minimum of 25 kHz or the 20 dB bandwidth of the hopping channel, whichever is greater.</p> <p>Alternatively. Frequency hopping systems operating in the 2400-2483.5 MHz band may have hopping channel carrier frequencies that are separated by 25 kHz or two-thirds of the 20 dB bandwidth of the hopping channel, whichever is greater, provided the systems operate with an output power no greater than 125 mW. The system shall hop to channel frequencies that are selected at the system hopping rate from a Pseudorandom ordered list of hopping frequencies. Each frequency must be used equally on the average by each transmitter. The system receivers shall have input bandwidths that match the hopping channel bandwidths of their corresponding transmitters and shall shift frequencies in synchronization with the transmitted signals.</p>	
EUT Pseudorandom Frequency Hopping Sequence	
<p>The pseudorandom sequence may be generated in a nine-stage shift register whose 5th and 9th stage outputs are added in a modulo-two addition stage. And the result is fed back to the input of the first stage. The sequence begins with the first ONE of 9 consecutive ONES; i.e. the shift register is initialized with nine ones.</p> <ul style="list-style-type: none"> • Number of shift register stages: 9 • Length of pseudo-random sequence: $2^9 - 1 = 511$ bits • Longest sequence of zeros: 8 (non-inverted signal) <div data-bbox="301 1041 1356 1189" style="text-align: center;">  </div> <p style="text-align: center;"><i>Linear Feedback Shift Register for Generation of the PRBS sequence</i></p> <p>An example of Pseudorandom Frequency Hopping Sequence as follow:</p> <div data-bbox="331 1294 1326 1442" style="text-align: center;">  </div> <p>Each frequency used equally on the average by each transmitter. The system receivers have input bandwidths that match the hopping channel bandwidths of their corresponding transmitters and shift frequencies in synchronization with the transmitted signals.</p>	

This document is issued by the Company subject to its General Conditions of Service printed overleaf, available on request or accessible at www.sgs.com/terms_and_conditions.htm and, for electronic format documents, subject to Terms and Conditions for Electronic Documents at www.sgs.com/terms_e-document.htm. Attention is drawn to the limitation of liability, indemnification and jurisdiction issues defined therein. Any holder of this document is advised that information contained hereon reflects the Company's findings at the time of its intervention only and within the limits of Client's instructions, if any. The Company's sole responsibility is to its Client and this document does not exonerate parties to a transaction from exercising all their rights and obligations under the transaction documents. This document cannot be reproduced except in full, without prior written approval of the Company. Any unauthorized alteration, forgery or falsification of the content or appearance of this document is unlawful and offenders may be prosecuted to the fullest extent of the law. Unless otherwise stated the results shown in this test report refer only to the sample(s) tested and such sample(s) are retained for 90 days only.

5.11 Radiated Emission

Test Requirement:	FCC Part15 C Section 15.209 , 15.205 and 15.247(d)																				
Test Method:	ANSI C63.4: 2003																				
Test Frequency Range:	30MHz to 25GHz																				
Test site:	Measurement Distance: 3m (Semi-Anechoic Chamber)																				
Receiver setup:	<table border="1"> <thead> <tr> <th>Frequency</th> <th>Detector</th> <th>RBW</th> <th>VBW</th> <th>Remark</th> </tr> </thead> <tbody> <tr> <td>30MHz-1GHz</td> <td>Quasi-peak</td> <td>100KHz</td> <td>300KHz</td> <td>Quasi-peak Value</td> </tr> <tr> <td rowspan="2">Above 1GHz</td> <td>Peak</td> <td>1MHz</td> <td>3MHz</td> <td>Peak Value</td> </tr> <tr> <td>Peak</td> <td>1MHz</td> <td>10Hz</td> <td>Average Value</td> </tr> </tbody> </table>	Frequency	Detector	RBW	VBW	Remark	30MHz-1GHz	Quasi-peak	100KHz	300KHz	Quasi-peak Value	Above 1GHz	Peak	1MHz	3MHz	Peak Value	Peak	1MHz	10Hz	Average Value	
Frequency	Detector	RBW	VBW	Remark																	
30MHz-1GHz	Quasi-peak	100KHz	300KHz	Quasi-peak Value																	
Above 1GHz	Peak	1MHz	3MHz	Peak Value																	
	Peak	1MHz	10Hz	Average Value																	
Limit:	<table border="1"> <thead> <tr> <th>Frequency</th> <th>Limit (dBuV/m @3m)</th> <th>Remark</th> </tr> </thead> <tbody> <tr> <td>30MHz-88MHz</td> <td>40.0</td> <td>Quasi-peak Value</td> </tr> <tr> <td>88MHz-216MHz</td> <td>43.5</td> <td>Quasi-peak Value</td> </tr> <tr> <td>216MHz-960MHz</td> <td>46.0</td> <td>Quasi-peak Value</td> </tr> <tr> <td>960MHz-1GHz</td> <td>54.0</td> <td>Quasi-peak Value</td> </tr> <tr> <td rowspan="2">Above 1GHz</td> <td>54.0</td> <td>Average Value</td> </tr> <tr> <td>74.0</td> <td>Peak Value</td> </tr> </tbody> </table>	Frequency	Limit (dBuV/m @3m)	Remark	30MHz-88MHz	40.0	Quasi-peak Value	88MHz-216MHz	43.5	Quasi-peak Value	216MHz-960MHz	46.0	Quasi-peak Value	960MHz-1GHz	54.0	Quasi-peak Value	Above 1GHz	54.0	Average Value	74.0	Peak Value
Frequency	Limit (dBuV/m @3m)	Remark																			
30MHz-88MHz	40.0	Quasi-peak Value																			
88MHz-216MHz	43.5	Quasi-peak Value																			
216MHz-960MHz	46.0	Quasi-peak Value																			
960MHz-1GHz	54.0	Quasi-peak Value																			
Above 1GHz	54.0	Average Value																			
	74.0	Peak Value																			
Test Procedure:	<ol style="list-style-type: none"> The EUT was placed on the top of a rotating table 0.8 meters above the ground at a 3 meter semi-anechoic chamber. The table was rotated 360 degrees to determine the position of the highest radiation. The EUT was set 3 meters away from the interference-receiving antenna, which was mounted on the top of a variable-height antenna tower. The antenna height is varied from one meter to four meters above the ground to determine the maximum value of the field strength. Both horizontal and vertical polarizations of the antenna are set to make the measurement. For each suspected emission, the EUT was arranged to its worst case and then the antenna was tuned to heights from 1 meter to 4 meters and the rotatable table was turned from 0 degrees to 360 degrees to find the maximum reading. The test-receiver system was set to Peak Detect Function and Specified Bandwidth with Maximum Hold Mode. If the emission level of the EUT in peak mode was 10dB lower than the limit specified, then testing could be stopped and the peak values of the EUT would be reported. Otherwise the emissions that did not have 10dB margin would be re-tested one by one using peak, quasi-peak or average method as specified and then reported in a data sheet. The radiation measurements are performed in X, Y, Z axis positioning. Only the worst case is shown in the report. 																				
Test mode:	Non-hopping transmitting with modulation. Pre-scan the EUT in GFSK, Pi/4QPSK and 8DPSK modes and find out the worst case is GFSK mode.																				
Test Instruments:	Refer to section 4.7 for details																				
Test results:	Passed																				

This document is issued by the Company subject to its General Conditions of Service printed overleaf, available on request or accessible at www.sgs.com/terms_and_conditions.htm and, for electronic format documents, subject to Terms and Conditions for Electronic Documents at www.sgs.com/terms_e-document.htm. Attention is drawn to the limitation of liability, indemnification and jurisdiction issues defined therein. Any holder of this document is advised that information contained hereon reflects the Company's findings at the time of its intervention only and within the limits of Client's instructions, if any. The Company's sole responsibility is to its Client and this document does not exonerate parties to a transaction from exercising all their rights and obligations under the transaction documents. This document cannot be reproduced except in full, without prior written approval of the Company. Any unauthorized alteration, forgery or falsification of the content or appearance of this document is unlawful and offenders may be prosecuted to the fullest extent of the law. Unless otherwise stated the results shown in this test report refer only to the sample(s) tested and such sample(s) are retained for 90 days only.

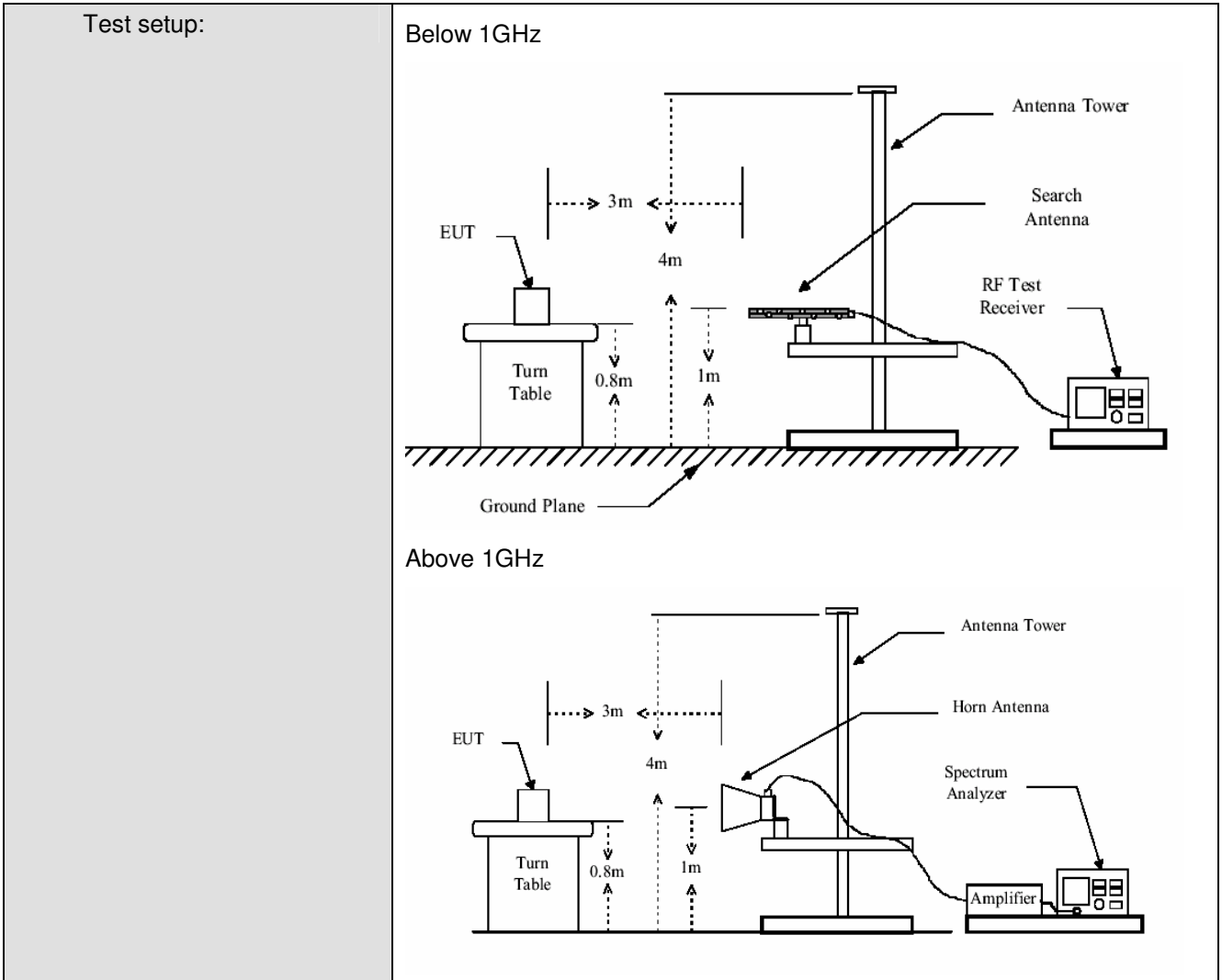

Note:

The field strength is calculated by adding the Antenna Factor, Cable Factor & Preamplifier. The basic equation with a sample calculation is as follows:

$$\text{Final Test Level} = \text{Receiver Reading} + \text{Antenna Factor} + \text{Cable Factor} - \text{Preamplifier Factor}$$



5.11.1 Radiated emission below 1GHz

Frequency (MHz)	Cable Loss (dB)	Antenna Factor (dB/m)	Preamp Factor (dB)	Read Level (dBuV)	Level (dBuV/m)	Limit Line (dBuV/m)	Over Limit (dB)	Polarization
57.228	0.80	7.40	28.07	56.50	36.63	40.00	-3.37	Vertical
131.850	1.28	7.78	27.59	51.40	32.87	43.50	-10.63	Vertical
194.900	1.39	10.15	27.18	49.37	33.73	43.50	-9.77	Vertical
291.900	1.87	13.53	26.75	49.25	37.90	46.00	-8.10	Vertical
428.670	2.32	16.46	27.50	43.66	34.94	46.00	-11.06	Vertical
874.870	3.51	23.00	26.55	31.81	31.77	46.00	-14.23	Vertical
57.228	0.80	7.52	28.07	56.00	36.25	40.00	-3.75	Horizontal
129.910	1.28	7.70	27.61	53.63	35.00	43.50	-8.50	Horizontal
194.900	1.39	10.15	27.18	49.86	34.22	43.50	-9.28	Horizontal
268.620	1.76	12.68	26.84	52.51	40.11	46.00	-5.89	Horizontal
288.020	1.85	13.40	26.76	54.43	42.92	46.00	-3.08	Horizontal
334.580	2.01	15.04	26.98	47.15	37.22	46.00	-8.78	Horizontal

Remark: the data above is tested with QP detector mode.

5.11.2 Transmitter emission above 1GHz

Test mode:	GFSK	Test channel:	Lowest	Remark:	Peak
------------	------	---------------	--------	---------	------

Frequency (MHz)	Cable Loss (dB)	Antenna Factor (dB/m)	Preamp Factor (dB)	Read Level (dBuV)	Level (dBuV/m)	Limit Line (dBuV/m)	Over Limit (dB)	Polarization
1630	5.11	27.52	39.15	52.24	45.72	74.00	-28.28	Vertical
4804	9.36	34.25	41.53	64.58	66.66	74.00	-7.34	Vertical
7206	13.38	37.23	40.98	46.87	56.50	74.00	-17.50	Vertical
9608	13.39	37.99	37.56	47.59	61.41	74.00	-12.59	Vertical
12010	16.45	39.10	39.09	46.01	62.47	74.00	-11.53	Vertical
14412	17.44	41.39	44.77	50.24	64.30	74.00	-9.70	Vertical
16814	18.96	42.14	39.54	44.12	65.68	74.00	-8.32	Vertical
1324	4.52	26.53	39.41	51.64	43.28	74.00	-30.72	Horizontal
4804	9.36	34.25	41.53	63.95	66.03	74.00	-7.97	Horizontal
7206	13.38	37.23	40.98	46.84	56.47	74.00	-17.53	Horizontal
9608	13.39	37.99	37.56	45.94	59.76	74.00	-14.24	Horizontal
12010	16.45	39.10	39.09	44.85	61.31	74.00	-12.69	Horizontal
14412	17.44	41.39	44.77	48.52	62.58	74.00	-11.42	Horizontal
16814	18.96	42.14	39.54	43.58	65.14	74.00	-8.86	Horizontal

Test mode:	GFSK	Test channel:	Lowest	Remark:	Average
------------	------	---------------	--------	---------	---------

Frequency (MHz)	Cable loss (dB)	Antenna factors (dB/m)	Preamp factor (dB)	Reading Level (dBμV)	Emission Level (dBμV/m)	Limit (dBμV/m)	Over limit (dB)	Polarization
1630	5.11	27.52	39.15	39.00	32.48	54.00	-21.52	Vertical
4804	9.36	34.25	41.53	47.95	50.03	54.00	-3.97	Vertical
7206	13.38	37.23	40.98	31.25	40.88	54.00	-13.12	Vertical
9608	13.39	37.99	37.56	29.51	43.33	54.00	-10.67	Vertical
12010	16.45	39.10	39.09	27.62	44.08	54.00	-9.92	Vertical
14412	17.44	41.39	44.77	32.79	46.85	54.00	-7.15	Vertical
16814	18.96	42.14	39.54	26.65	48.21	54.00	-5.79	Vertical
1324	4.52	26.53	39.41	31.52	23.16	54.00	-30.84	Horizontal
4804	9.36	34.25	41.53	46.78	48.86	54.00	-5.14	Horizontal
7206	13.38	37.23	40.98	26.57	36.20	54.00	-17.80	Horizontal
9608	13.39	37.99	37.56	29.02	42.84	54.00	-11.16	Horizontal
12010	16.45	39.10	39.09	27.95	44.41	54.00	-9.59	Horizontal
14412	17.44	41.39	44.77	32.65	46.71	54.00	-7.29	Horizontal
16814	18.96	42.14	39.54	27.20	48.76	54.00	-5.24	Horizontal

This document is issued by the Company subject to its General Conditions of Service printed overleaf, available on request or accessible at www.sgs.com/terms_and_conditions.htm and, for electronic format documents, subject to Terms and Conditions for Electronic Documents at www.sgs.com/terms_e-document.htm. Attention is drawn to the limitation of liability, indemnification and jurisdiction issues defined therein. Any holder of this document is advised that information contained hereon reflects the Company's findings at the time of its intervention only and within the limits of Client's instructions, if any. The Company's sole responsibility is to its Client and this document does not exonerate parties to a transaction from exercising all their rights and obligations under the transaction documents. This document cannot be reproduced except in full, without prior written approval of the Company. Any unauthorized alteration, forgery or falsification of the content or appearance of this document is unlawful and offenders may be prosecuted to the fullest extent of the law. Unless otherwise stated the results shown in this test report refer only to the sample(s) tested and such sample(s) are retained for 90 days only.



Test mode:	GFSK	Test channel:	Middle	Remark:	Peak
------------	------	---------------	--------	---------	------

Frequency (MHz)	Cable loss (dB)	Antenna factors (dB/m)	Preamp factor (dB)	Reading Level (dBμV)	Emission Level (dBμV/m)	Limit (dBμV/m)	Over limit (dB)	Polarization
1819	5.62	28.05	38.92	53.21	47.96	74.00	-26.04	Vertical
4882	10.57	34.35	40.33	61.77	66.36	74.00	-7.64	Vertical
7323	12.91	37.31	40.40	45.87	55.69	74.00	-18.31	Vertical
9764	13.89	38.03	37.94	47.52	61.50	74.00	-12.50	Vertical
12205	17.95	39.23	39.30	45.02	62.90	74.00	-11.10	Vertical
14646	17.18	41.27	45.96	51.67	64.16	74.00	-9.84	Vertical
17087	19.55	42.62	39.41	43.05	65.81	74.00	-8.19	Vertical
1576	5.03	27.36	39.07	52.69	46.01	74.00	-27.99	Horizontal
4882	10.57	34.35	40.33	62.01	66.60	74.00	-7.40	Horizontal
7323	12.91	37.31	40.40	47.95	57.77	74.00	-16.23	Horizontal
9764	13.89	38.03	37.94	45.76	59.74	74.00	-14.26	Horizontal
12205	17.95	39.23	39.30	43.85	61.73	74.00	-12.27	Horizontal
14646	17.18	41.27	45.96	49.99	62.48	74.00	-11.52	Horizontal
17087	19.55	42.62	39.41	41.89	64.65	74.00	-9.35	Horizontal

Test mode:	GFSK	Test channel:	Middle	Remark:	Average
------------	------	---------------	--------	---------	---------

Frequency (MHz)	Cable loss (dB)	Antenna factors (dB/m)	Preamp factor (dB)	Reading Level (dBμV)	Emission Level (dBμV/m)	Limit (dBμV/m)	Over limit (dB)	Polarization
1819	5.62	28.05	38.92	37.15	31.90	54.00	-22.10	Vertical
4882	10.57	34.35	40.33	45.32	49.91	54.00	-4.09	Vertical
7323	12.91	37.31	40.40	29.86	39.68	54.00	-14.32	Vertical
9764	13.89	38.03	37.94	29.75	43.73	54.00	-10.27	Vertical
12205	17.95	39.23	39.30	26.69	44.57	54.00	-9.43	Vertical
14646	17.18	41.27	45.96	34.15	46.64	54.00	-7.36	Vertical
17087	19.55	42.62	39.41	24.95	47.71	54.00	-6.29	Vertical
1576	5.03	27.36	39.07	39.37	32.69	54.00	-21.31	Horizontal
4882	10.57	34.35	40.33	45.68	50.27	54.00	-3.73	Horizontal
7323	12.91	37.31	40.40	29.15	38.97	54.00	-15.03	Horizontal
9764	13.89	38.03	37.94	29.53	43.51	54.00	-10.49	Horizontal
12205	17.95	39.23	39.30	27.06	44.94	54.00	-9.06	Horizontal
14646	17.18	41.27	45.96	32.94	45.43	54.00	-8.57	Horizontal
17087	19.55	42.62	39.41	25.89	48.65	54.00	-5.35	Horizontal

"This document is issued by the Company subject to its General Conditions of Service printed overleaf, available on request or accessible at www.sgs.com/terms_and_conditions.htm and, for electronic format documents, subject to Terms and Conditions for Electronic Documents at www.sgs.com/terms_e-document.htm. Attention is drawn to the limitation of liability, indemnification and jurisdiction issues defined therein. Any holder of this document is advised that information contained hereon reflects the Company's findings at the time of its intervention only and within the limits of Client's instructions, if any. The Company's sole responsibility is to its Client and this document does not exonerate parties to a transaction from exercising all their rights and obligations under the transaction documents. This document cannot be reproduced except in full, without prior written approval of the Company. Any unauthorized alteration, forgery or falsification of the content or appearance of this document is unlawful and offenders may be prosecuted to the fullest extent of the law. Unless otherwise stated the results shown in this test report refer only to the sample(s) tested and such sample(s) are retained for 90 days only."



SGS-CSTC Standards Technical Services Ltd.

Report No.: SZEMO09110651501

Page: 57 of 60

Test mode:	GFSK	Test channel:	Highest	Remark:	Peak
------------	------	---------------	---------	---------	------

Frequency (MHz)	Cable loss (dB)	Antenna factors (dB/m)	Preamp factor (dB)	Reading Level (dB μ V)	Emission Level (dB μ V/m)	Limit (dB μ V/m)	Over limit (dB)	Polarization
1990	5.36	28.47	38.81	52.24	47.26	74.00	-26.74	Vertical
4960	10.43	34.45	41.03	62.88	66.73	74.00	-7.27	Vertical
7440	12.72	37.37	40.01	49.65	59.73	74.00	-14.27	Vertical
9920	14.24	38.08	37.78	47.03	61.57	74.00	-12.43	Vertical
12400	17.55	39.34	39.48	45.34	62.75	74.00	-11.25	Vertical
14880	16.69	41.16	46.61	50.98	62.22	74.00	-11.78	Vertical
17360	19.75	42.92	39.62	43.75	66.80	74.00	-7.20	Vertical
1801	5.64	28.01	38.73	52.54	47.46	74.00	-26.54	Horizontal
4960	10.43	34.45	41.03	61.96	65.81	74.00	-8.19	Horizontal
7440	12.72	37.37	40.01	47.58	57.66	74.00	-16.34	Horizontal
9920	14.24	38.08	37.78	44.26	58.80	74.00	-15.20	Horizontal
12400	17.55	39.34	39.48	44.69	62.10	74.00	-11.90	Horizontal
14880	16.69	41.16	46.61	52.01	63.25	74.00	-10.75	Horizontal
17360	19.75	42.92	39.62	42.74	65.79	74.00	-8.21	Horizontal

Test mode:	GFSK	Test channel:	Highest	Remark:	Average
------------	------	---------------	---------	---------	---------

Frequency (MHz)	Cable loss (dB)	Antenna factors (dB/m)	Preamp factor (dB)	Reading Level (dB μ V)	Emission Level (dB μ V/m)	Limit (dB μ V/m)	Over limit (dB)	Polarization
1990	5.36	28.47	38.81	37.58	32.60	54.00	-21.40	Vertical
4960	10.43	34.45	41.03	45.92	49.77	54.00	-4.23	Vertical
7440	12.72	37.37	40.01	31.08	41.16	54.00	-12.84	Vertical
9920	14.24	38.08	37.78	28.19	42.73	54.00	-11.27	Vertical
12400	17.55	39.34	39.48	27.47	44.88	54.00	-9.12	Vertical
14880	16.69	41.16	46.61	35.46	46.70	54.00	-7.30	Vertical
17360	19.75	42.92	39.62	24.96	48.01	54.00	-5.99	Vertical
1801	5.64	28.01	38.73	38.12	33.04	54.00	-20.96	Horizontal
4960	10.43	34.45	41.03	46.03	49.88	54.00	-4.12	Horizontal
7440	12.72	37.37	40.01	29.74	39.82	54.00	-14.18	Horizontal
9920	14.24	38.08	37.78	27.58	42.12	54.00	-11.88	Horizontal
12400	17.55	39.34	39.48	27.09	44.50	54.00	-9.50	Horizontal
14880	16.69	41.16	46.61	34.90	46.14	54.00	-7.86	Horizontal
17360	19.75	42.92	39.62	25.19	48.24	54.00	-5.76	Horizontal

Remark: The disturbance above 18GHz was very low, and the above harmonics were the highest point could be found when testing, so only the above harmonics had been displayed.

"This document is issued by the Company subject to its General Conditions of Service printed overleaf, available on request or accessible at www.sgs.com/terms_and_conditions.htm and, for electronic format documents, subject to Terms and Conditions for Electronic Documents at www.sgs.com/terms_e-document.htm. Attention is drawn to the limitation of liability, indemnification and jurisdiction issues defined therein. Any holder of this document is advised that information contained hereon reflects the Company's findings at the time of its intervention only and within the limits of Client's instructions, if any. The Company's sole responsibility is to its Client and this document does not exonerate parties to a transaction from exercising all their rights and obligations under the transaction documents. This document cannot be reproduced except in full, without prior written approval of the Company. Any unauthorized alteration, forgery or falsification of the content or appearance of this document is unlawful and offenders may be prosecuted to the fullest extent of the law. Unless otherwise stated the results shown in this test report refer only to the sample(s) tested and such sample(s) are retained for 90 days only."



5.11.3 Band Edge and Restricted band (Radiated measurement)

Test mode:	GFSK	Test channel:	Lowest	Polarization:	Vertical
------------	------	---------------	--------	---------------	----------

Peak value:

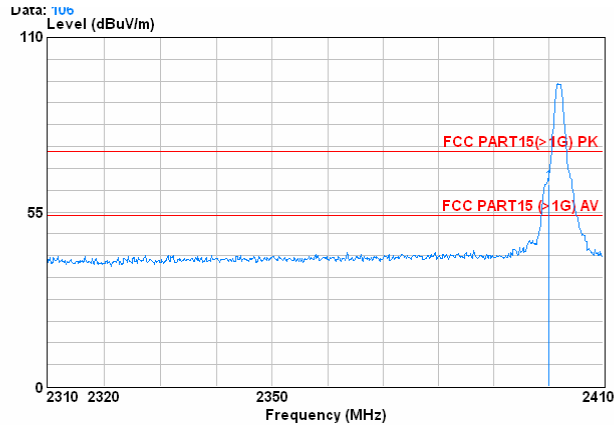

Condition : FCC PART15(>1G) PK 3m ANT3117(>1G) VERTICAL
 EUT : Bluetooth Speakerphone
 Job No. : 6515RF
 test channel : Lowest channel

	Freq	CableAntenna Loss	Preamp Factor	Preamp	Read Level	Level	Limit Line	Over Limit	Remark
	MHz	dB	dB/m	dB	dBuV	dBuV/m	dBuV/m	dB	
1 @	2400.000	6.34	30.03	38.87	66.15	63.65	74.00	-10.35	Peak

Average value:

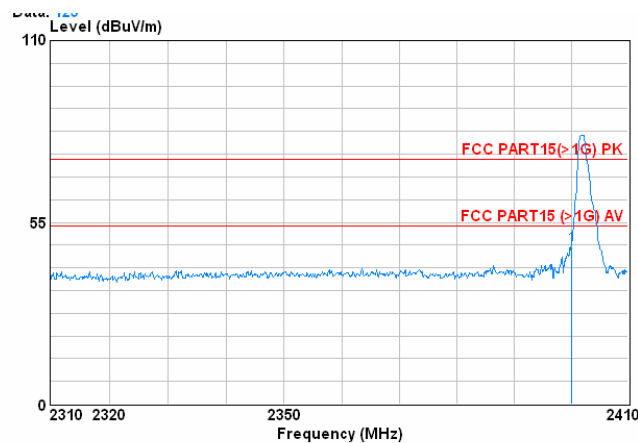

Condition : FCC PART15(>1G) PK 3m ANT3117(>1G) VERTICAL
 EUT : Bluetooth Speakerphone
 Job No. : 6515RF
 test channel : Lowest channel

	Freq	CableAntenna Loss	Preamp Factor	Preamp	Read Level	Level	Limit Line	Over Limit	Remark
	MHz	dB	dB/m	dB	dBuV	dBuV/m	dBuV/m	dB	
1 @	2400.000	6.34	30.03	38.87	50.15	47.65	54.00	-6.35	Average

"This document is issued by the Company subject to its General Conditions of Service printed overleaf, available on request or accessible at www.sgs.com/terms_and_conditions.htm and, for electronic format documents, subject to Terms and Conditions for Electronic Documents at www.sgs.com/terms_e-document.htm. Attention is drawn to the limitation of liability, indemnification and jurisdiction issues defined therein. Any holder of this document is advised that information contained hereon reflects the Company's findings at the time of its intervention only and within the limits of Client's instructions, if any. The Company's sole responsibility is to its Client and this document does not exonerate parties to a transaction from exercising all their rights and obligations under the transaction documents. This document cannot be reproduced except in full, without prior written approval of the Company. Any unauthorized alteration, forgery or falsification of the content or appearance of this document is unlawful and offenders may be prosecuted to the fullest extent of the law. Unless otherwise stated the results shown in this test report refer only to the sample(s) tested and such sample(s) are retained for 90 days only."



Test mode:	GFSK	Test channel:	Lowest	Polarization:	Horizontal
------------	------	---------------	--------	---------------	------------

Peak value:

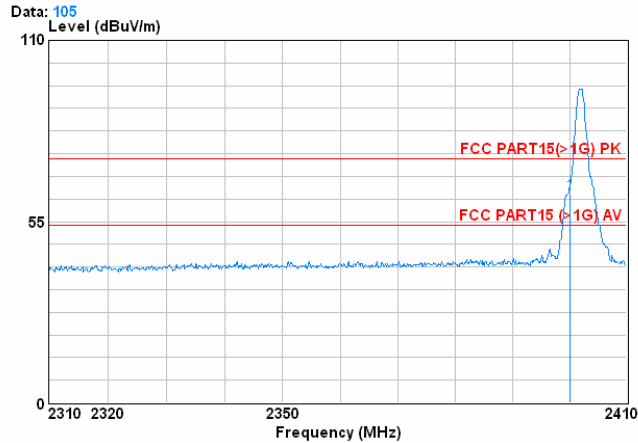

Condition : FCC PART15(>1G) PK 3m ANT3117(>1G) HORIZONTAL
 EUT : Bluetooth Speakerphone
 Job No. : 6515RF
 test channel : Lowest channel

	Freq	CableAntenna Loss	Preamp Factor	Preamp Factor	Read Level	Read Level	Limit Line	Over Limit	Remark
	MHz	dB	dB/m	dB	dBuV	dBuV/m	dBuV/m	dB	
1 @	2400.000	6.34	30.03	38.87	65.85	63.35	74.00	-10.65	Peak

Average value:

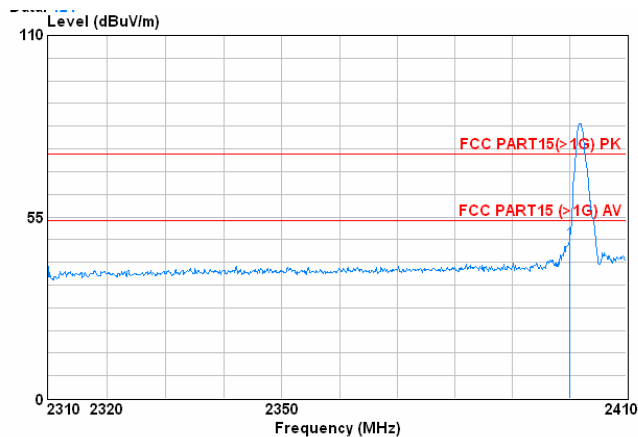

Condition : FCC PART15(>1G) PK 3m ANT3117(>1G) HORIZONTAL
 EUT : Bluetooth Speakerphone
 Job No. : 6515RF
 test channel : Lowest channel

	Freq	CableAntenna Loss	Preamp Factor	Preamp Factor	Read Level	Read Level	Limit Line	Over Limit	Remark
	MHz	dB	dB/m	dB	dBuV	dBuV/m	dBuV/m	dB	
1 @	2400.000	6.34	30.03	38.87	49.85	47.35	54.00	-6.65	Average

"This document is issued by the Company subject to its General Conditions of Service printed overleaf, available on request or accessible at www.sgs.com/terms_and_conditions.htm and, for electronic format documents, subject to Terms and Conditions for Electronic Documents at www.sgs.com/terms_e-document.htm. Attention is drawn to the limitation of liability, indemnification and jurisdiction issues defined therein. Any holder of this document is advised that information contained hereon reflects the Company's findings at the time of its intervention only and within the limits of Client's instructions, if any. The Company's sole responsibility is to its Client and this document does not exonerate parties to a transaction from exercising all their rights and obligations under the transaction documents. This document cannot be reproduced except in full, without prior written approval of the Company. Any unauthorized alteration, forgery or falsification of the content or appearance of this document is unlawful and offenders may be prosecuted to the fullest extent of the law. Unless otherwise stated the results shown in this test report refer only to the sample(s) tested and such sample(s) are retained for 90 days only."



Test mode:	GFSK	Test channel:	Highest	Polarization:	Vertical
------------	------	---------------	---------	---------------	----------

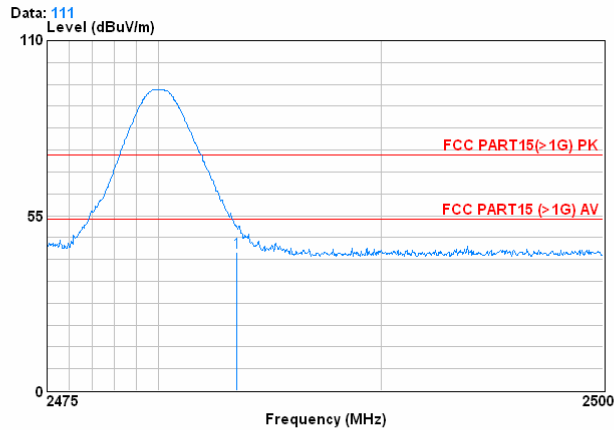

Condition : FCC PART15(>1G) PK 3m ANT3117(>1G) VERTICAL
 EUT : Bluetooth Speakerphone
 Job No. : 6515RF
 test channel : highest channel

	Freq	CableAntenna Loss Factor	Preamp Factor	Read Level	Limit Level	Over Limit	Remark
	MHz	dB	dB/m	dB	dBuV	dBuV/m	dB
1 @	2483.500	6.22	30.32	39.53	46.58	74.00	-30.41 Peak

Test mode:	GFSK	Test channel:	Highest	Polarization:	Horizontal
------------	------	---------------	---------	---------------	------------

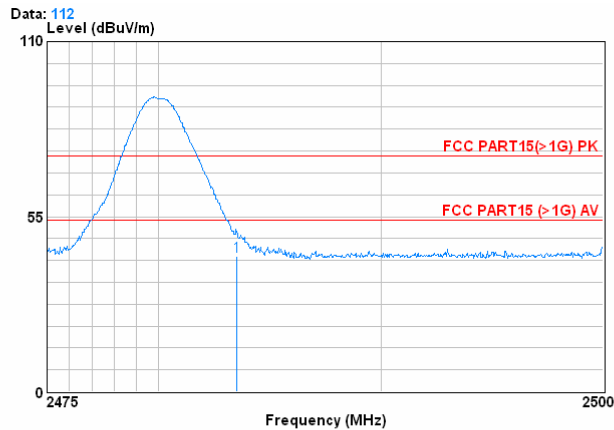

Condition : FCC PART15(>1G) PK 3m ANT3117(>1G) HORIZONTAL
 EUT : Bluetooth Speakerphone
 Job No. : 6515RF
 test channel : highest channel

	Freq	CableAntenna Loss Factor	Preamp Factor	Read Level	Limit Level	Over Limit	Remark
	MHz	dB	dB/m	dB	dBuV	dBuV/m	dB
1	2483.500	6.22	30.32	39.53	45.58	74.00	-31.41 Peak

"This document is issued by the Company subject to its General Conditions of Service printed overleaf, available on request or accessible at www.sgs.com/terms_and_conditions.htm and, for electronic format documents, subject to Terms and Conditions for Electronic Documents at www.sgs.com/terms_e-document.htm. Attention is drawn to the limitation of liability, indemnification and jurisdiction issues defined therein. Any holder of this document is advised that information contained hereon reflects the Company's findings at the time of its intervention only and within the limits of Client's instructions, if any. The Company's sole responsibility is to its Client and this document does not exonerate parties to a transaction from exercising all their rights and obligations under the transaction documents. This document cannot be reproduced except in full, without prior written approval of the Company. Any unauthorized alteration, forgery or falsification of the content or appearance of this document is unlawful and offenders may be prosecuted to the fullest extent of the law. Unless otherwise stated the results shown in this test report refer only to the sample(s) tested and such sample(s) are retained for 90 days only."