

FCC SAR Test Report

APPLICANT : Guangdong OPPO Mobile
Telecommunications Corp., Ltd.

EQUIPMENT : Mobile Phone

BRAND NAME : OPPO

MODEL NAME : CPH2603

FCC ID : R9C-OP23051

STANDARD : FCC 47 CFR Part 2 (2.1093)

We, Sporton International Inc. (Shenzhen), would like to declare that the tested sample has been evaluated in accordance with the test procedures given in 47 CFR Part 2.1093 and FCC KDB and has been in compliance with the applicable technical standards.

The test results in this report apply exclusively to the tested model / sample. Without written approval of Sporton International Inc. (Shenzhen), the test report shall not be reproduced except in full.



Approved by: Si Zhang

Sporton International Inc. (Shenzhen)
1/F, 2/F, Bldg 5, Shiling Industrial Zone, Xinwei Village, Xili, Nanshan, Shenzhen, 518055
People's Republic of China



Table of Contents

1. Statement of Compliance 4
2. Administration Data 5
3. Guidance Applied 5
4. Equipment Under Test (EUT) Information 6
4.1 General Information 6
4.2 General LTE SAR Test and Reporting Considerations 8
4.3 General 5G NR SAR Test and Reporting Considerations 12
5. RF Exposure Limits 14
5.1 Uncontrolled Environment 14
5.2 Controlled Environment 14
6. Specific Absorption Rate (SAR) 15
6.1 Introduction 15
6.2 SAR Definition 15
7. System Description and Setup 16
7.1 E-Field Probe 17
7.2 Data Acquisition Electronics (DAE) 17
7.3 Phantom 18
7.4 Device Holder 19
8. Measurement Procedures 20
8.1 Spatial Peak SAR Evaluation 20
8.2 Power Reference Measurement 21
8.3 Area Scan 21
8.4 Zoom Scan 22
8.5 Volume Scan Procedures 22
8.6 Power Drift Monitoring 22
9. Test Equipment List 23
10. System Verification 24
10.1 Tissue Simulating Liquids 24
10.2 Tissue Verification 24
10.3 System Performance Check Results 26
11. RF Exposure Positions 28
11.1 Ear and handset reference point 28
11.2 Definition of the cheek position 29
11.3 Definition of the tilt position 30
11.4 Body Worn Accessory 31
11.5 Product Specific 10g SAR Exposure 32
11.6 Wireless Router 32
12. Conducted RF Output Power (Unit: dBm) 33
13. Antenna Location 50
14. SAR Test Results 51
14.1 Head SAR 54
14.2 Hotspot SAR 74
14.3 Body Worn Accessory SAR 86
14.4 Product specific 10g SAR 98
14.5 Repeated SAR Measurement 100
14.6 TDD LTE Linearity Data Analysis 101
15. Simultaneous Transmission Analysis 103
15.1 Head Exposure Conditions 104
15.2 Hotspot Exposure Conditions 106
15.3 Body-Worn Accessory Exposure Conditions 107
15.4 Product specific 10g SAR Exposure Conditions 108
16. Uncertainty Assessment 109
17. References 110
Appendix A. Plots of System Performance Check
Appendix B. Plots of High SAR Measurement
Appendix C. DASy Calibration Certificate
Appendix D. Test Setup Photos
Appendix E. Conducted RF Output Power Table



Revision History

REPORT NO.	VERSION	DESCRIPTION	ISSUED DATE
FA3O3018B	Rev. 01	Initial issue of report.	Dec. 25, 2023

1. Statement of Compliance

The maximum results of Specific Absorption Rate (SAR) found during testing for **Guangdong OPPO Mobile Telecommunications Corp., Ltd., Mobile Phone, CPH2603**, are as follows.

Highest 1g SAR Summary						
Equipment Class	Frequency Band		Head (Separation 0mm)	Hotspot (Separation 10mm)	Body-worn (Separation 15mm)	Highest Simultaneous Transmission 1g SAR (W/kg)
			1g SAR (W/kg)			
Licensed	GSM	GSM850	0.97	0.76	0.46	1.57
		GSM1900	0.99	0.92	0.48	
	WCDMA	WCDMA II	1.06	0.62	0.49	
		WCDMA IV	1.15	0.60	0.47	
		WCDMA V	0.75	0.54	0.47	
	LTE	LTE Band 2	0.91	0.51	0.40	
		LTE Band 66/4	0.91	0.62	0.40	
		LTE Band 26/5	0.56	0.50	0.39	
		LTE Band 7	1.08	0.77	0.50	
		LTE Band 12/17	0.62	0.57	0.27	
		LTE Band 13	0.85	0.75	0.54	
		LTE Band 38	1.03	0.50	0.38	
		LTE Band 41	1.18	0.55	0.36	
	5G NR	FR1 n2	0.95	0.66	0.50	
		FR1 n26/n5	1.10	1.03	0.62	
		FR1 n7	1.05	0.74	0.40	
FR1 n66		1.04	0.67	0.49		
FR1 n38		1.18	0.65	0.41		
FR1 n41		1.15	0.87	0.60		
DTS	WLAN	2.4GHz WLAN	0.67	0.18	0.16	1.48
NII		5GHz WLAN	1.12	0.69	0.70	1.57
DSS	Bluetooth	2.4GHz Bluetooth	0.46	0.17	<0.10	1.57

Highest 10g SAR Summary				
Equipment Class	Frequency Band		Product Specific 10g SAR (W/kg) (Separation 0mm)	Highest Simultaneous Transmission 10g SAR (W/kg)
Licensed	LTE	LTE Band 7	1.88	2.69
	5G NR	FR1 n26/n5	1.40	
		FR1 n41	2.69	
NII	WLAN	5GHz WLAN	2.79	2.79
Date of Testing:			2023/11/11 ~ 2023/11/30	

Remark:

- This device supports LTE B4 / B5 / B17 and B66 / B26 / B12. Since the supported frequency span for LTE B4 / B5 / B17 falls completely within the supports frequency span for LTE B66 / B26 / B12, both LTE bands have the same target power, and both LTE bands share the same transmission path; therefore, SAR was only assessed for LTE B66 / B26 / B12.
- This device supports 5G NR n5 and n26. Since the supported frequency span for 5G NR n5 falls completely within the supports frequency span for n26, both 5G NR bands have the same target power, and both 5G NR bands share the same transmission path; therefore, SAR was only assessed for n26.
- This is a variant report for CPH2603. For the change note please refer to the CPH2603_Class II Permissive Change letter which is exhibited separately. According to the difference, added uplink duty cycle detection mechanism specification validation data referred to CPH2603_OpDes. All bands test results are leveraged from original report FA303018.

Declaration of Conformity:

The test results with all measurement uncertainty excluded are presented in accordance with the regulation limits or requirements declared by manufacturers.



Comments and Explanations:
The declared of product specification for EUT presented in the report are provided by the manufacturer, and the manufacturer takes all the responsibilities for the accuracy of product specification.

This device is in compliance with Specific Absorption Rate (SAR) for general population/uncontrolled exposure limits (1.6 W/kg for Partial-Body 1g SAR, 4.0 W/kg for Product Specific 10g SAR) specified in FCC 47 CFR part 2 (2.1093) and ANSI/IEEE C95.1-1992, and had been tested in accordance with the measurement methods and procedures specified in IEEE 1528-2013 and FCC KDB publications.

2. Administration Data

Sporton International Inc. (Shenzhen) is accredited to ISO/IEC 17025:2017 by American Association for Laboratory Accreditation with Certificate Number 5145.01.

Table with 4 columns: Test Firm, Test Site Location, Test Site No., and sub-columns for Sporton Site No., FCC Designation No., and FCC Test Firm Registration No.

Table with 2 columns: Applicant Company Name and Address.

Table with 2 columns: Manufacturer Company Name and Address.

3. Guidance Applied

The Specific Absorption Rate (SAR) testing specification, method, and procedure for this device is in accordance with the following standards:

- FCC 47 CFR Part 2 (2.1093)
• ANSI/IEEE C95.1-1992
• IEEE 1528-2013
• FCC KDB 865664 D01 SAR Measurement 100 MHz to 6 GHz v01r04
• FCC KDB 865664 D02 SAR Reporting v01r02
• FCC KDB 447498 D01 General RF Exposure Guidance v06
• FCC KDB 648474 D04 SAR Evaluation Considerations for Wireless Handsets v01r03
• FCC KDB 248227 D01 802.11 Wi-Fi SAR v02r02
• FCC KDB 941225 D01 3G SAR Procedures v03r01
• FCC KDB 941225 D05 SAR for LTE Devices v02r05
• FCC KDB 941225 D05A Rel.10 LTE SAR Test Guidance v01r02
• FCC KDB 941225 D06 Hotspot Mode SAR v02r01



4. Equipment Under Test (EUT) Information

4.1 General Information

Product Feature & Specification	
Equipment Name	Mobile Phone
Brand Name	OPPO
Model Name	CPH2603
FCC ID	R9C-OP23051
IMEI Code	Sample 1: IMEI 1: 860306070103999 IMEI 2: 860306070103981 Sample 2: IMEI 1: 860306070126891 IMEI 2: 860306070126883
Wireless Technology and Frequency Range	GSM850: 824 MHz ~ 849 MHz GSM1900: 1850 MHz ~ 1910 MHz WCDMA Band II: 1850 MHz ~ 1910 MHz WCDMA Band IV: 1710 MHz ~ 1755 MHz WCDMA Band V: 824 MHz ~ 849 MHz LTE Band 2: 1850 MHz ~ 1910 MHz LTE Band 4: 1710 MHz ~ 1755 MHz LTE Band 5: 824 MHz ~ 849 MHz LTE Band 7: 2500 MHz ~ 2570 MHz LTE Band 12: 699 MHz ~ 716 MHz LTE Band 13: 777 MHz ~ 787 MHz LTE Band 17: 704 MHz ~ 716 MHz LTE Band 26: 814 MHz ~ 849 MHz LTE Band 38: 2570 MHz ~ 2620 MHz LTE Band 41: 2496 MHz ~ 2690 MHz LTE Band 66: 1710 MHz ~ 1780 MHz 5G NR n2: 1850 MHz ~ 1910 MHz 5G NR n5: 824 MHz ~ 849 MHz 5G NR n7: 2500 MHz ~ 2570 MHz 5G NR n26: 814 MHz ~ 849 MHz 5G NR n66: 1710 MHz ~ 1780 MHz 5G NR n38: 2570 MHz ~ 2620 MHz 5G NR n41: 2496 MHz ~ 2690 MHz WLAN 2.4GHz Band: 2412 MHz ~ 2462 MHz WLAN 5.2GHz Band: 5180 MHz ~ 5240 MHz WLAN 5.3GHz Band: 5260 MHz ~ 5320 MHz WLAN 5.5GHz Band: 5500 MHz ~ 5700 MHz WLAN 5.8GHz Band: 5745 MHz ~ 5825 MHz Bluetooth: 2402 MHz ~ 2480 MHz NFC: 13.56 MHz
Mode	GSM/GPRS/EGPRS RMC/AMR 12.2Kbps HSDPA HSUPA DC-HSDPA HSPA+(16QAM uplink is supported) LTE: QPSK, 16QAM, 64QAM 5G NR : CP-OFDM / DFT-s-OFDM, QPSK, 16QAM, 64QAM, 256QAM WLAN 2.4GHz 802.11b/g/n HT20/HT40 WLAN 2.4GHz 802.11ac VHT20/VHT40 WLAN 2.4GHz 802.11ax HE20/HE40 WLAN 5GHz 802.11a/n HT20/HT40 WLAN 5GHz 802.11ac VHT20/VHT40/VHT80 WLAN 5GHz 802.11ax HE20/HE40/HE80 Bluetooth BR/EDR/LE NFC: ASK
HW Version	11
SW Version	ColorOS 14.0
GSM / (E)GPRS Transfer mode	Class B – EUT cannot support Packet Switched and Circuit Switched Network simultaneously but can automatically switch between Packet and Circuit Switched Network.



EUT Stage	Production Unit
-----------	-----------------

Remark:

- This device supports VoIP in GPRS, EGPRS, WCDMA and LTE (e.g. for 3rd-party VoIP), LTE supports VoLTE operation.
- This device 2.4GHz WLAN support hotspot operation and Bluetooth support tethering applications.
- This device 5.2GHz WLAN/5.8GHz WLAN support hotspot operation, and 5.2GHz WLAN/5.8GHz WLAN supports WiFi Direct (GC/GO), and 5.3GHz / 5.5GHz supports WiFi Direct (GC only).
- The 2.4GHz/5GHz WLAN can transmit in SISO and MIMO antenna mode.
- This device does not support DTM operation and support GRPS/EGRPS mode up to multi-slot class 12.
- For dual SIM card mobile has two SIM slots and supports dual SIM dual standby. The WWAN radio transmission will be enabled by either one SIM at a time (single active). After pre-scan two SIM cards power, we found test result of the SIM1 was the worse, so we chose SIM1 slot to perform all tests.
- The device implements receiver detect mechanism trigger reduced power for the power management for SAR compliance at different exposure conditions (head, hotspot, body, and extremity). It uses the receiver to indicate whether the user is making a call in head scenario or not. The selection between head and body power levels is based on the receiver detection mechanism. It can determine proximity to head or body and set the relevant power level for 2G&3G&4G and Wi-Fi antennas accordingly. The device will invoke corresponding work scenarios power level base on frequency bands/antennas, which can refer to appendix E and the detailed DSI descriptions of below table.

DSI	Trigger Conditions	Antenna No.	Exposure conditions	
DSI2	Receiver on	All Ant	Head Standalone	Head all Position
DSI6	Receiver on WWAN+ WLAN/BT Receiver on WWAN+WLAN 5GHz+BT Receiver on WWAN + WLAN2.4GHz+WLAN 5GHz	All Ant	Head Simultaneous	Head all Position
DSI1	Receiver off	All Ant	Body Worn/Extremity Standalone	Body Worn/Extremity all Position
DSI5	Receiver off WWAN+ WLAN/BT Receiver off WWAN+WLAN 5GHz+BT Receiver off WWAN + WLAN2.4GHz+WLAN 5GHz	All Ant	Hotspot Body-worn / Extremity Simultaneous	Hotspot/ Body Worn/Extremity all Position

- For WLAN when transmit, when transmit simultaneously together with WWAN/BT, the device power will be reduced power at head and extremity exposure conditions.
- This device supports HPUE for LTE Band 41 with class 2 level, HPUE power has been measured separately. For HPUE power is higher than power class 3 but with lower duty cycle, the maximum average power for class 2 and class 3 is almost the same, so we chose power class 3 full SAR testing and power class 2 verify the worst case of power class 3 SAR.
- 5G NR n41 supports HPUE, HPUE power and SAR testing performed separately.
- 5G NR n41 HUPE with higher power, 5G NR n41 HUPE SAR can represent power class 3 level SAR.
- For 5G NR test, using FTM (Factory Test Mode) to perform SAR with default 100% transmission.
- For 5G NR EN-DC mode, standalone SAR performed for 5G NR NSA band with the maximum power, EN-DC SAR summed EN-DC mode 5G NR standalone SAR and LTE standalone SAR, the result of EN-DC SAR is more conservatively.
- This device supports 5G NR FR1 bands as following table, including NSA mode and SA mode. NSA and SA mode performed SAR separately.

<5G NR>

Mode	Band	Duplex	SCS(KHz)	Bandwidths(BW)
NSA	n5	FDD	15	5, 10, 15, 20
	n7	FDD	15	5, 10, 15, 20, 25, 30, 40
	n66	FDD	15	5, 10, 15, 20, 30, 40
	n38	TDD	30	10, 15, 20, 30, 40
	n41	TDD	30	20, 30, 40, 50, 60, 70, 80, 90, 100
SA	n2	FDD	15	5, 10, 15, 20
	n5	FDD	15	5, 10, 15, 20
	n7	FDD	15	5, 10, 15, 20, 25, 30, 40
	n26	FDD	15	5, 10, 15, 20
	n66	FDD	15	5, 10, 15, 20, 30, 40
	n38	TDD	30	10, 15, 20, 30, 40
	n41	TDD	30	20, 30, 40, 50, 60, 70, 80, 90, 100



4.2 General LTE SAR Test and Reporting Considerations

Summarized necessary items addressed in KDB 941225 D05 v02r05																																																															
FCC ID	R9C-OP23051																																																														
Equipment Name	Mobile Phone																																																														
Operating Frequency Range of each LTE transmission band	LTE Band 2: 1850 MHz ~ 1910 MHz LTE Band 4: 1710 MHz ~ 1755 MHz LTE Band 5: 824 MHz ~ 849 MHz LTE Band 7: 2500 MHz ~ 2570 MHz LTE Band 12: 699 MHz ~ 716 MHz LTE Band 13: 777 MHz ~ 787 MHz LTE Band 17: 704 MHz ~ 716 MHz LTE Band 26: 814 MHz ~ 849 MHz LTE Band 38: 2570 MHz ~ 2620 MHz LTE Band 41: 2496 MHz ~ 2690 MHz LTE Band 66: 1710 MHz ~ 1780 MHz																																																														
Channel Bandwidth	LTE Band 2: 1.4MHz, 3MHz, 5MHz, 10MHz, 15MHz, 20MHz LTE Band 4: 1.4MHz, 3MHz, 5MHz, 10MHz, 15MHz, 20MHz LTE Band 5: 1.4MHz, 3MHz, 5MHz, 10MHz LTE Band 7: 5MHz, 10MHz, 15MHz, 20MHz LTE Band 12: 1.4MHz, 3MHz, 5MHz, 10MHz LTE Band 13: 5MHz, 10MHz LTE Band 17: 5MHz, 10MHz LTE Band 26: 1.4MHz, 3MHz, 5MHz, 10MHz, 15MHz LTE Band 38: 5MHz, 10MHz, 15MHz, 20MHz LTE Band 41: 5MHz, 10MHz, 15MHz, 20MHz LTE Band 66: 1.4MHz, 3MHz, 5MHz, 10MHz, 15MHz, 20MHz																																																														
uplink modulations used	QPSK / 16QAM / 64QAM																																																														
LTE Voice / Data requirements	Voice and Data																																																														
LTE Release Version	R15, Cat13																																																														
CA Support	Supported, Uplink and Downlink																																																														
LTE MPR permanently built-in by design	<p>Table 6.2.3-1: Maximum Power Reduction (MPR) for Power Class 1, 2 and 3</p> <table border="1"> <thead> <tr> <th rowspan="2">Modulation</th> <th colspan="6">Channel bandwidth / Transmission bandwidth (N_{RB})</th> <th rowspan="2">MPR (dB)</th> </tr> <tr> <th>1.4 MHz</th> <th>3.0 MHz</th> <th>5 MHz</th> <th>10 MHz</th> <th>15 MHz</th> <th>20 MHz</th> </tr> </thead> <tbody> <tr> <td>QPSK</td> <td>> 5</td> <td>> 4</td> <td>> 8</td> <td>> 12</td> <td>> 16</td> <td>> 18</td> <td>≤ 1</td> </tr> <tr> <td>16 QAM</td> <td>≤ 5</td> <td>≤ 4</td> <td>≤ 8</td> <td>≤ 12</td> <td>≤ 16</td> <td>≤ 18</td> <td>≤ 1</td> </tr> <tr> <td>16 QAM</td> <td>> 5</td> <td>> 4</td> <td>> 8</td> <td>> 12</td> <td>> 16</td> <td>> 18</td> <td>≤ 2</td> </tr> <tr> <td>64 QAM</td> <td>≤ 5</td> <td>≤ 4</td> <td>≤ 8</td> <td>≤ 12</td> <td>≤ 16</td> <td>≤ 18</td> <td>≤ 2</td> </tr> <tr> <td>64 QAM</td> <td>> 5</td> <td>> 4</td> <td>> 8</td> <td>> 12</td> <td>> 16</td> <td>> 18</td> <td>≤ 3</td> </tr> <tr> <td>256 QAM</td> <td colspan="6">≥ 1</td> <td>≤ 5</td> </tr> </tbody> </table>	Modulation	Channel bandwidth / Transmission bandwidth (N_{RB})						MPR (dB)	1.4 MHz	3.0 MHz	5 MHz	10 MHz	15 MHz	20 MHz	QPSK	> 5	> 4	> 8	> 12	> 16	> 18	≤ 1	16 QAM	≤ 5	≤ 4	≤ 8	≤ 12	≤ 16	≤ 18	≤ 1	16 QAM	> 5	> 4	> 8	> 12	> 16	> 18	≤ 2	64 QAM	≤ 5	≤ 4	≤ 8	≤ 12	≤ 16	≤ 18	≤ 2	64 QAM	> 5	> 4	> 8	> 12	> 16	> 18	≤ 3	256 QAM	≥ 1						≤ 5
Modulation	Channel bandwidth / Transmission bandwidth (N_{RB})						MPR (dB)																																																								
	1.4 MHz	3.0 MHz	5 MHz	10 MHz	15 MHz	20 MHz																																																									
QPSK	> 5	> 4	> 8	> 12	> 16	> 18	≤ 1																																																								
16 QAM	≤ 5	≤ 4	≤ 8	≤ 12	≤ 16	≤ 18	≤ 1																																																								
16 QAM	> 5	> 4	> 8	> 12	> 16	> 18	≤ 2																																																								
64 QAM	≤ 5	≤ 4	≤ 8	≤ 12	≤ 16	≤ 18	≤ 2																																																								
64 QAM	> 5	> 4	> 8	> 12	> 16	> 18	≤ 3																																																								
256 QAM	≥ 1						≤ 5																																																								
LTE A-MPR	In the base station simulator configuration, Network Setting value is set to NS_01 to disable A-MPR during SAR testing and the LTE SAR tests was transmitting on all TTI frames (Maximum TTI)																																																														
Spectrum plots for RB configuration	A properly configured base station simulator was used for the SAR and power measurement; therefore, spectrum plots for each RB allocation and offset configuration are not included in the SAR report.																																																														
Power reduction applied to satisfy SAR compliance	Yes, when operating in receiver detect mechanism, head/ body-worn /hotspot/extremity will trigger reduced power for some bands applied to satisfy SAR compliance, the detail please referred to section 13.																																																														
LTE Carrier Aggregation Combinations	Inter-Band and Intra-Band possible combinations and the detail power verification please referred to section 13.																																																														
LTE Carrier Aggregation Additional Information	1. This device supports LTE Carrier Aggregation (CA) in the uplink for intra-band with two component carriers in the uplink. SAR Measurements and conducted powers were evaluated per FCC Guidance. 2. This device supports maximum of 3 carriers in the downlink and 2 carriers in the uplink.																																																														



Transmission (H, M, L) channel numbers and frequencies in each LTE band												
LTE Band 2												
	Bandwidth 1.4 MHz		Bandwidth 3 MHz		Bandwidth 5 MHz		Bandwidth 10 MHz		Bandwidth 15 MHz		Bandwidth 20 MHz	
	Ch. #	Freq. (MHz)	Ch. #	Freq. (MHz)	Ch. #	Freq. (MHz)	Ch. #	Freq. (MHz)	Ch. #	Freq. (MHz)	Ch. #	Freq. (MHz)
L	18607	1850.7	18615	1851.5	18625	1852.5	18650	1855	18675	1857.5	18700	1860
M	18900	1880	18900	1880	18900	1880	18900	1880	18900	1880	18900	1880
H	19193	1909.3	19185	1908.5	19175	1907.5	19150	1905	19125	1902.5	19100	1900
LTE Band 4												
	Bandwidth 1.4 MHz		Bandwidth 3 MHz		Bandwidth 5 MHz		Bandwidth 10 MHz		Bandwidth 15 MHz		Bandwidth 20 MHz	
	Ch. #	Freq. (MHz)	Ch. #	Freq. (MHz)	Ch. #	Freq. (MHz)	Ch. #	Freq. (MHz)	Ch. #	Freq. (MHz)	Ch. #	Freq. (MHz)
L	19957	1710.7	19965	1711.5	19975	1712.5	20000	1715	20025	1717.5	20050	1720
M	20175	1732.5	20175	1732.5	20175	1732.5	20175	1732.5	20175	1732.5	20175	1732.5
H	20393	1754.3	20385	1753.5	20375	1752.5	20350	1750	20325	1747.5	20300	1745
LTE Band 5												
	Bandwidth 1.4 MHz		Bandwidth 3 MHz		Bandwidth 5 MHz		Bandwidth 10 MHz					
	Ch. #	Freq. (MHz)	Ch. #	Freq. (MHz)	Ch. #	Freq. (MHz)	Ch. #	Freq. (MHz)	Ch. #	Freq. (MHz)	Ch. #	Freq. (MHz)
L	20407	824.7	20415	825.5	20425	826.5	20450	829				
M	20525	836.5	20525	836.5	20525	836.5	20525	836.5	20525	836.5	20525	836.5
H	20643	848.3	20635	847.5	20625	846.5	20600	844				
LTE Band 7												
	Bandwidth 5 MHz		Bandwidth 10 MHz		Bandwidth 15 MHz		Bandwidth 20 MHz					
	Ch. #	Freq. (MHz)	Ch. #	Freq. (MHz)	Ch. #	Freq. (MHz)	Ch. #	Freq. (MHz)	Ch. #	Freq. (MHz)	Ch. #	Freq. (MHz)
L	20775	2502.5	20800	2505	20825	2507.5	20850	2510				
M	21100	2535	21100	2535	21100	2535	21100	2535	21100	2535	21100	2535
H	21425	2567.5	21400	2565	21375	2562.5	21350	2560				
LTE Band 12												
	Bandwidth 1.4 MHz		Bandwidth 3 MHz		Bandwidth 5 MHz		Bandwidth 10 MHz					
	Ch. #	Freq. (MHz)	Ch. #	Freq. (MHz)	Ch. #	Freq. (MHz)	Ch. #	Freq. (MHz)	Ch. #	Freq. (MHz)	Ch. #	Freq. (MHz)
L	23017	699.7	23025	700.5	23035	701.5	23060	704				
M	23095	707.5	23095	707.5	23095	707.5	23095	707.5	23095	707.5	23095	707.5
H	23173	715.3	23165	714.5	23155	713.5	23130	711				
LTE Band 13												
	Bandwidth 5 MHz				Bandwidth 10 MHz							
	Channel #		Freq.(MHz)		Channel #		Freq.(MHz)					
L	23205		779.5		23230		782					
M	23230		782		23230		782					
H	23255		784.5		23230		782					
LTE Band 17												
	Bandwidth 5 MHz				Bandwidth 10 MHz							
	Channel #		Freq.(MHz)		Channel #		Freq.(MHz)					
L	23755		706.5		23780		709					
M	23790		710		23790		710					
H	23825		713.5		23800		711					
LTE Band 26												
	Bandwidth 1.4 MHz		Bandwidth 3 MHz		Bandwidth 5 MHz		Bandwidth 10 MHz		Bandwidth 15 MHz			
	Ch. #	Freq. (MHz)	Ch. #	Freq. (MHz)	Ch. #	Freq. (MHz)	Ch. #	Freq. (MHz)	Ch. #	Freq. (MHz)	Ch. #	Freq. (MHz)
L	26697	814.7	26705	815.5	26715	816.5	26740	819	26765	821.5		
M	26865	831.5	26865	831.5	26865	831.5	26865	831.5	26865	831.5	26865	831.5
H	27033	848.3	27025	847.5	27015	846.5	26990	844	26965	841.5		
LTE Band 38												
	Bandwidth 5 MHz		Bandwidth 10 MHz		Bandwidth 15 MHz		Bandwidth 20 MHz					
	Ch. #	Freq. (MHz)	Ch. #	Freq. (MHz)	Ch. #	Freq. (MHz)	Ch. #	Freq. (MHz)	Ch. #	Freq. (MHz)	Ch. #	Freq. (MHz)
L	37775	2572.5	37800	2575	37825	2577.5	37850	2580				
M	38000	2595	38000	2595	38000	2595	38000	2595	38000	2595	38000	2595
H	38225	2617.5	38200	2615	38175	2612.5	38150	2610				
LTE Band 41												
	Bandwidth 5 MHz		Bandwidth 10 MHz		Bandwidth 15 MHz		Bandwidth 20 MHz					
	Ch. #	Freq. (MHz)	Ch. #	Freq. (MHz)	Ch. #	Freq. (MHz)	Ch. #	Freq. (MHz)	Ch. #	Freq. (MHz)	Ch. #	Freq. (MHz)
L	39675	2498.5	39700	2501	39725	2503.5	39750	2506				
LM	40148	2545.8	40160	2547	40173	2548.3	40185	2549.5				
M	40620	2593	40620	2593	40620	2593	40620	2593	40620	2593	40620	2593



HM	41093	2640.3	41080	2639	41068	2637.8	41055	2636.5				
H	41565	2687.5	41540	2685	41515	2682.5	41490	2680				
LTE Band 66												
	Bandwidth 1.4 MHz		Bandwidth 3 MHz		Bandwidth 5 MHz		Bandwidth 10 MHz		Bandwidth 15 MHz		Bandwidth 20 MHz	
	Ch. #	Freq. (MHz)	Ch. #	Freq. (MHz)	Ch. #	Freq. (MHz)	Ch. #	Freq. (MHz)	Ch. #	Freq. (MHz)	Ch. #	Freq. (MHz)
L	131979	1710.7	131987	1711.5	131997	1712.5	132022	1715	132047	1717.5	132072	1720
M	132322	1745	132322	1745	132322	1745	132322	1745	132322	1745	132322	1745
H	132665	1779.3	132657	1778.5	132647	1777.5	132622	1775	132597	1772.5	132572	1770



<For LTE Overlap Bands Description>

1) LTE Bands BW

Band	1.4 MHz	3 MHz	5 MHz	10 MHz	15 MHz	20 MHz
LTE Band 4	Yes	Yes	Yes	Yes	Yes	Yes
LTE Band 66	Yes	Yes	Yes	Yes	Yes	Yes
LTE Band 12	Yes	Yes	Yes	Yes		
LTE Band 17			Yes	Yes		
LTE Band 5	Yes	Yes	Yes	Yes		
LTE Band 26	Yes	Yes	Yes	Yes	Yes	

2) LTE Bands tune up:

Band	Antenna	DSI 1	DSI 2	DSI 5	DSI 6	Default Tune-up Limit
LTE Band 4	3	22.3	19.3	20.3	17.8	24.3
LTE Band 66	3	22.3	19.3	20.3	17.8	24.3
LTE Band 4_ENDC	3	19.3	16.3	17.3	14.8	24.3
LTE Band 66_ENDC	3	19.3	16.3	17.3	14.8	24.3
LTE Band 5	1	21.5	20	20	19	24.5
LTE Band 26	1	21.6	20.1	20.1	19.1	24.6
LTE Band 12	1	24.7	24.7	22.2	23.2	24.7
LTE Band 17	1	24.7	24.7	22.2	23.2	24.7
LTE Band 4	0	21.3	24.3	19.3	24.3	24.3
LTE Band 66	0	21.3	24.3	19.3	24.3	24.3
LTE Band 5	0	24.5	24.5	23.5	24.5	24.5
LTE Band 26	0	24.6	24.6	23.6	24.6	24.6
LTE Band 12	0	24.7	24.7	24.7	24.7	24.7
LTE Band 17	0	24.7	24.7	24.2	24.7	24.7
LTE Band 4	4	21.8	17.8	19.8	16.8	24.3
LTE Band 66	4	21.8	17.8	19.8	16.8	24.3
LTE Band 4_ENDC	4	18.8	14.8	16.8	13.8	24.3
LTE Band 66_ENDC	4	18.8	14.8	16.8	13.8	24.3



4.3 General 5G NR SAR Test and Reporting Considerations

5G NR Information	
Operating Frequency Range of each 5G NR transmission band	5G NR n2: 1850 MHz ~ 1910 MHz 5G NR n5: 824 MHz ~ 849 MHz 5G NR n7: 2500 MHz ~ 2570 MHz 5G NR n26: 814 MHz ~ 849 MHz 5G NR n66: 1710 MHz ~ 1780 MHz 5G NR n38: 2570 MHz ~ 2620 MHz 5G NR n41: 2496 MHz ~ 2690 MHz
Channel Bandwidth	The detail please refers to section 4.1 5G NR FR1 bands table.
SCS	FDD: SCS15KHz, TDD: SCS30KHz
uplink modulations used	DFT-s-OFDM: QPSK / 16QAM / 64QAM / 256QAM CP-OFDM: QPSK / 16QAM / 64QAM / 256QAM
A-MPR (Additional MPR) disabled for SAR Testing?	Yes
LTE Anchor Bands for n5	LTE B7/66
LTE Anchor Bands for n7	LTE B2/4/66
LTE Anchor Bands for n41	LTE B4/66
LTE Anchor Bands for n66	LTE B2/5/7/12
LTE Anchor Bands for n38	LTE B4/5/66

Transmission (H, M, L) channel numbers and frequencies in each 5G NR band

NR Band 2								
	Bandwidth 5MHz		Bandwidth 10MHz		Bandwidth 15MHz		Bandwidth 20MHz	
	Ch. #	Freq. (MHz)	Ch. #	Freq. (MHz)	Ch. #	Freq. (MHz)	Ch. #	Freq. (MHz)
L	370500	1852.5	371000	1855	371500	1857.5	372000	1860
M	376000	1880	376000	1880	376000	1880	376000	1880
H	381500	1907.5	381000	1905	380500	1902.5	380000	1900

NR Band 5								
	Bandwidth 5MHz		Bandwidth 10MHz		Bandwidth 15MHz		Bandwidth 20MHz	
	Ch. #	Freq. (MHz)	Ch. #	Freq. (MHz)	Ch. #	Freq. (MHz)	Ch. #	Freq. (MHz)
L	165300	826.5	165800	829	166300	831.5	166800	834
M	167300	836.5	167300	836.5	167300	836.5	167300	836.5
H	169300	846.5	168800	844	168300	841.5	167800	839

NR Band 7														
	Bandwidth 5MHz		Bandwidth 10MHz		Bandwidth 15MHz		Bandwidth 20MHz		Bandwidth 25MHz		Bandwidth 30MHz		Bandwidth 40MHz	
	Ch. #	Freq. (MHz)	Ch. #	Freq. (MHz)	Ch. #	Freq. (MHz)	Ch. #	Freq. (MHz)	Ch. #	Freq. (MHz)	Ch. #	Freq. (MHz)	Ch. #	Freq. (MHz)
L	500500	2502.5	501000	2505	501500	2507.5	502000	2510	502500	2512.5	503000	2515	504000	2520
M	507000	2535	507000	2535	507000	2535	507000	2535	507000	2535	507000	2535	507000	2535
H	513500	2567.5	513000	2565	512500	2562.5	512000	2560	511500	2557.5	511000	2555	510000	2550

NR Band 26								
	Bandwidth 5MHz		Bandwidth 10MHz		Bandwidth 15MHz		Bandwidth 20MHz	
	Ch. #	Freq. (MHz)	Ch. #	Freq. (MHz)	Ch. #	Freq. (MHz)	Ch. #	Freq. (MHz)
L	163300	816.5	163800	819	164300	821.5	164800	824
M	166300	831.5	166300	831.5	166300	831.5	166300	831.5
H	169300	846.5	168800	844	168300	841.5	167800	839

NR Band 66													
	Bandwidth 5MHz		Bandwidth 10MHz		Bandwidth 15MHz		Bandwidth 20MHz		Bandwidth 30MHz		Bandwidth 40MHz		
	Ch. #	Freq. (MHz)	Ch. #	Freq. (MHz)	Ch. #	Freq. (MHz)	Ch. #	Freq. (MHz)	Ch. #	Freq. (MHz)	Ch. #	Freq. (MHz)	
L	342500	1712.5	343000	1715	343500	1717.5	344000	1720	345000	1725	346000	1730	
M	349000	1745	349000	1745	349000	1745	349000	1745	349000	1745	349000	1745	
H	355500	1777.5	355000	1775	354500	1772.5	354000	1770	353000	1765	352000	1760	

NR Band 38										
	Bandwidth 10MHz		Bandwidth 15MHz		Bandwidth 20MHz		Bandwidth 30MHz		Bandwidth 40MHz	
	Ch. #	Freq. (MHz)	Ch. #	Freq. (MHz)	Ch. #	Freq. (MHz)	Ch. #	Freq. (MHz)	Ch. #	Freq. (MHz)
L	515004	2575.02	515502	2577.51	516000	2580	517002	2585.01	518004	2590.02
M	519000	2595	519000	2595	519000	2595	519000	2595	519000	2595
H	522996	2614.98	522498	2612.49	522000	2610	520998	2604.99	519996	2599.98



NR Band 41																		
Bandwidth 20MHz		Bandwidth 30MHz		Bandwidth 40MHz		Bandwidth 50MHz		Bandwidth 60MHz		Bandwidth 70MHz		Bandwidth 80MHz		Bandwidth 90MHz		Bandwidth 100MHz		
Ch. #	Freq. (MHz)	Ch. #	Freq. (MHz)	Ch. #	Freq. (MHz)	Ch. #	Freq. (MHz)	Ch. #	Freq. (MHz)	Ch. #	Freq. (MHz)	Ch. #	Freq. (MHz)	Ch. #	Freq. (MHz)	Ch. #	Freq. (MHz)	
L	501204	2506.02	502200	2511	503202	2516.01	504204	2521.02	505200	2526	500202	2501.01	507204	2536.02	508200	2541	509202	2546.01
M	518598	2592.99	518598	2592.99	518598	2592.99	518598	2592.99	518598	2592.99	518598	2592.99	518598	2592.99	518598	2592.99	518598	2592.99
H	535998	2679.99	534996	2674.98	534000	2670	532998	2664.99	531996	2659.98	537000	2685	529998	2649.99	528996	2644.98	528000	2640

<For NR Overlap Bands Description>

1) NR Bands BW

	Band	Duplex	SCS(KHz)	Bandwidths(BW)
NR	n5	FDD	15	5 10 15 20
	n26	FDD	15	5 10 15 20

2) NR Bands Tune up:

Band	Antenna	DSI 1	DSI 2	DSI 5	DSI 6	Default Tune-up Limit
n5	1	22.7	21.2	21.2	19.7	24.7
n26	1	22.7	21.2	21.2	19.7	24.7
n5	0	24.7	24.7	23.2	24.7	24.7
n26	0	24.7	24.7	23.2	24.7	24.7

5. RF Exposure Limits

5.1 Uncontrolled Environment

Uncontrolled Environments are defined as locations where there is the exposure of individuals who have no knowledge or control of their exposure. The general population/uncontrolled exposure limits are applicable to situations in which the general public may be exposed or in which persons who are exposed as a consequence of their employment may not be made fully aware of the potential for exposure or cannot exercise control over their exposure. Members of the general public would come under this category when exposure is not employment-related; for example, in the case of a wireless transmitter that exposes persons in its vicinity.

5.2 Controlled Environment

Controlled Environments are defined as locations where there is exposure that may be incurred by persons who are aware of the potential for exposure, (i.e. as a result of employment or occupation). In general, occupational/controlled exposure limits are applicable to situations in which persons are exposed as a consequence of their employment, who have been made fully aware of the potential for exposure and can exercise control over their exposure. The exposure category is also applicable when the exposure is of a transient nature due to incidental passage through a location where the exposure levels may be higher than the general population/uncontrolled limits, but the exposed person is fully aware of the potential for exposure and can exercise control over his or her exposure by leaving the area or by some other appropriate means.

Limits for Occupational/Controlled Exposure (W/kg)

Whole-Body	Partial-Body	Hands, Wrists, Feet and Ankles
0.4	8.0	20.0

Limits for General Population/Uncontrolled Exposure (W/kg)

Whole-Body	Partial-Body	Hands, Wrists, Feet and Ankles
0.08	1.6	4.0

Whole-Body SAR is averaged over the entire body, partial-body SAR is averaged over any 1gram of tissue defined as a tissue volume in the shape of a cube. SAR for hands, wrists, feet and ankles is averaged over any 10 grams of tissue defined as a tissue volume in the shape of a cube.

6. Specific Absorption Rate (SAR)

6.1 Introduction

SAR is related to the rate at which energy is absorbed per unit mass in an object exposed to a radio field. The SAR distribution in a biological body is complicated and is usually carried out by experimental techniques or numerical modeling. The standard recommends limits for two tiers of groups, occupational/controlled and general population/uncontrolled, based on a person's awareness and ability to exercise control over his or her exposure. In general, occupational/controlled exposure limits are higher than the limits for general population/uncontrolled.

6.2 SAR Definition

The SAR definition is the time derivative (rate) of the incremental energy (dW) absorbed by (dissipated in) an incremental mass (dm) contained in a volume element (dv) of a given density (ρ). The equation description is as below:

$$\text{SAR} = \frac{d}{dt} \left(\frac{dW}{dm} \right) = \frac{d}{dt} \left(\frac{dW}{\rho dv} \right)$$

SAR is expressed in units of Watts per kilogram (W/kg)

$$\text{SAR} = \frac{\sigma |E|^2}{\rho}$$

Where: σ is the conductivity of the tissue, ρ is the mass density of the tissue and E is the RMS electrical field strength.

7. System Description and Setup

The DASY5 system used for performing compliance tests consists of the following items:

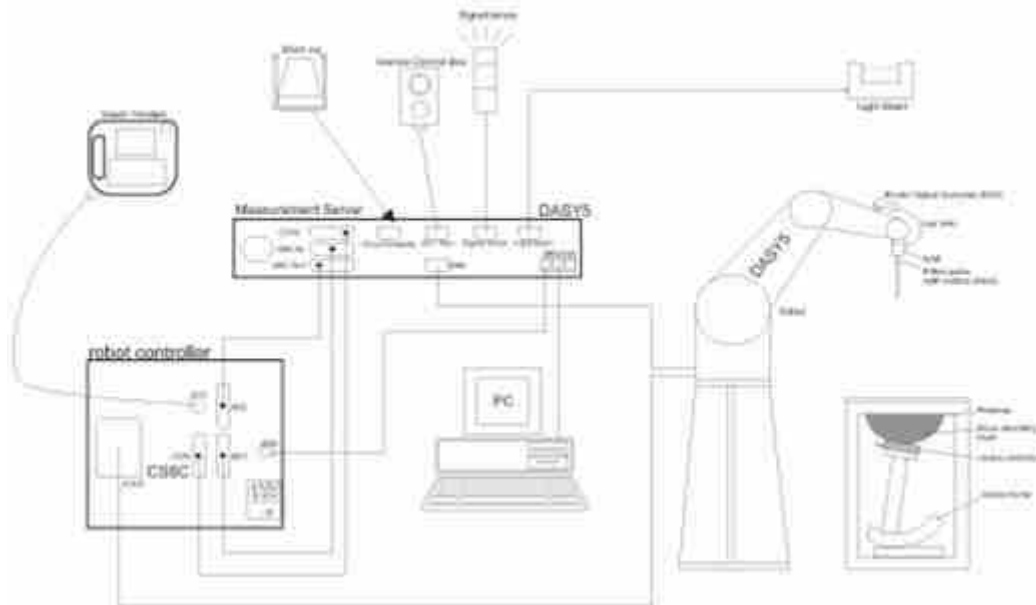

- A standard high precision 6-axis robot with controller, teach pendant and software. An arm extension for accommodating the data acquisition electronics (DAE).
- An isotropic Field probe optimized and calibrated for the targeted measurement.
- A data acquisition electronics (DAE) which performs the signal amplification, signal multiplexing, AD-conversion, offset measurements, mechanical surface detection, collision detection, etc. The unit is battery powered with standard or rechargeable batteries. The signal is optically transmitted to the EOC.
- The Electro-optical converter (EOC) performs the conversion from optical to electrical signals for the digital communication to the DAE. To use optical surface detection, a special version of the EOC is required. The EOC signal is transmitted to the measurement server.
- The function of the measurement server is to perform the time critical tasks such as signal filtering, control of the robot operation and fast movement interrupts.
- The Light Beam used is for probe alignment. This improves the (absolute) accuracy of the probe positioning.
- A computer running WinXP or Win7 and the DASY software.
- Remote control and teach pendant as well as additional circuitry for robot safety such as warning lamps, etc.
- The phantom, the device holder and other accessories according to the targeted measurement.

7.1 E-Field Probe

The SAR measurement is conducted with the dosimetric probe (manufactured by SPEAG).The probe is specially designed and calibrated for use in liquid with high permittivity. The dosimetric probe has special calibration in liquid at different frequency. This probe has a built in optical surface detection system to prevent from collision with phantom.

<EX3DV4 Probe>

Construction	Symmetric design with triangular core Built-in shielding against static charges PEEK enclosure material (resistant to organic solvents, e.g., DGBE)	
Frequency	10 MHz – >6 GHz Linearity: ±0.2 dB (30 MHz – 6 GHz)	
Directivity	±0.3 dB in TSL (rotation around probe axis) ±0.5 dB in TSL (rotation normal to probe axis)	
Dynamic Range	10 µW/g – >100 mW/g Linearity: ±0.2 dB (noise: typically <1 µW/g)	
Dimensions	Overall length: 337 mm (tip: 20 mm) Tip diameter: 2.5 mm (body: 12 mm) Typical distance from probe tip to dipole centers: 1 mm	

7.2 Data Acquisition Electronics (DAE)

The data acquisition electronics (DAE) consists of a highly sensitive electrometer-grade preamplifier with auto-zeroing, a channel and gain-switching multiplexer, a fast 16 bit AD-converter and a command decoder and control logic unit. Transmission to the measurement server is accomplished through an optical downlink for data and status information as well as an optical uplink for commands and the clock.

The input impedance of the DAE is 200 MOhm; the inputs are symmetrical and floating. Common mode rejection is above 80 dB.



Photo of DAE

7.3 Phantom

<SAM Twin Phantom>

Shell Thickness	2 ± 0.2 mm; Center ear point: 6 ± 0.2 mm	
Filling Volume	Approx. 25 liters	
Dimensions	Length: 1000 mm; Width: 500 mm; Height: adjustable feet	
Measurement Areas	Left Hand, Right Hand, Flat Phantom	

The bottom plate contains three pair of bolts for locking the device holder. The device holder positions are adjusted to the standard measurement positions in the three sections. A white cover is provided to tap the phantom during off-periods to prevent water evaporation and changes in the liquid parameters. On the phantom top, three reference markers are provided to identify the phantom position with respect to the robot.

<ELI Phantom>

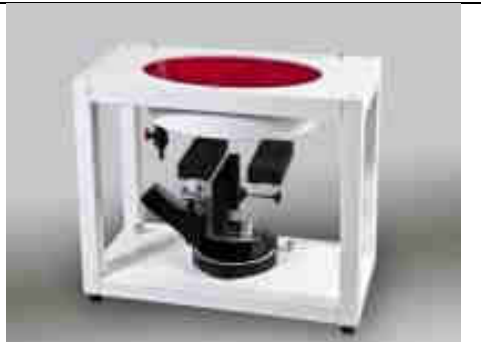
Shell Thickness	2 ± 0.2 mm (sagging: <1%)	
Filling Volume	Approx. 30 liters	
Dimensions	Major ellipse axis: 600 mm Minor axis: 400 mm	

The ELI phantom is intended for compliance testing of handheld and body-mounted wireless devices or for evaluating transmitters operating at low frequencies. ELI is fully compatible with standard and all known tissue simulating liquids.

7.4 Device Holder

<Mounting Device for Hand-Held Transmitter>

In combination with the Twin SAM V5.0/V5.0c or ELI phantoms, the Mounting Device for Hand-Held Transmitters enables rotation of the mounted transmitter device to specified spherical coordinates. At the heads, the rotation axis is at the ear opening. Transmitter devices can be easily and accurately positioned according to IEC 62209-1, IEEE 1528, FCC, or other specifications. The device holder can be locked for positioning at different phantom sections (left head, right head, flat). And upgrade kit to Mounting Device to enable easy mounting of wider devices like big smart-phones, e-books, small tablets, etc. It holds devices with width up to 140 mm.



Mounting Device for Hand-Held Transmitters

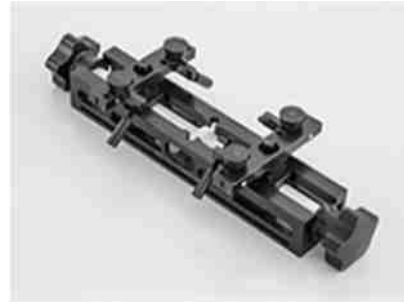

Mounting Device Adaptor for Wide-Phones

<Mounting Device for Laptops and other Body-Worn Transmitters>

The extension is lightweight and made of POM, acrylic glass and foam. It fits easily on the upper part of the mounting device in place of the phone positioned. The extension is fully compatible with the SAM Twin and ELI phantoms.



Mounting Device for Laptops

8. Measurement Procedures

The measurement procedures are as follows:

<Conducted power measurement>

- (a) For WWAN power measurement, use base station simulator to configure EUT WWAN transmission in conducted connection with RF cable, at maximum power in each supported wireless interface and frequency band.
- (b) Read the WWAN RF power level from the base station simulator.
- (c) For WLAN/BT power measurement, use engineering software to configure EUT WLAN/BT continuously transmission, at maximum RF power in each supported wireless interface and frequency band
- (d) Connect EUT RF port through RF cable to the power meter, and measure WLAN/BT output power

<SAR measurement>

- (a) Use base station simulator to configure EUT WWAN transmission in radiated connection, and engineering software to configure EUT WLAN/BT continuously transmission, at maximum RF power, in the highest power channel.
- (b) Place the EUT in the positions as Appendix D demonstrates.
- (c) Set scan area, grid size and other setting on the DASY software.
- (d) Measure SAR results for the highest power channel on each testing position.
- (e) Find out the largest SAR result on these testing positions of each band
- (f) Measure SAR results for other channels in worst SAR testing position if the reported SAR of highest power channel is larger than 0.8 W/kg

According to the test standard, the recommended procedure for assessing the peak spatial-average SAR value consists of the following steps:

- (a) Power reference measurement
- (b) Area scan
- (c) Zoom scan
- (d) Power drift measurement

8.1 Spatial Peak SAR Evaluation

The procedure for spatial peak SAR evaluation has been implemented according to the test standard. It can be conducted for 1g and 10g, as well as for user-specific masses. The DASY software includes all numerical procedures necessary to evaluate the spatial peak SAR value.

The base for the evaluation is a "cube" measurement. The measured volume must include the 1g and 10g cubes with the highest averaged SAR values. For that purpose, the center of the measured volume is aligned to the interpolated peak SAR value of a previously performed area scan.

The entire evaluation of the spatial peak values is performed within the post-processing engine (SEMCAD). The system always gives the maximum values for the 1g and 10g cubes. The algorithm to find the cube with highest averaged SAR is divided into the following stages:

- (a) Extraction of the measured data (grid and values) from the Zoom Scan
- (b) Calculation of the SAR value at every measurement point based on all stored data (A/D values and measurement parameters)
- (c) Generation of a high-resolution mesh within the measured volume
- (d) Interpolation of all measured values from the measurement grid to the high-resolution grid
- (e) Extrapolation of the entire 3-D field distribution to the phantom surface over the distance from sensor to surface
- (f) Calculation of the averaged SAR within masses of 1g and 10g

8.2 Power Reference Measurement

The Power Reference Measurement and Power Drift Measurements are for monitoring the power drift of the device under test in the batch process. The minimum distance of probe sensors to surface determines the closest measurement point to phantom surface. This distance cannot be smaller than the distance of sensor calibration points to probe tip as defined in the probe properties.

8.3 Area Scan

The area scan is used as a fast scan in two dimensions to find the area of high field values, before doing a fine measurement around the hot spot. The sophisticated interpolation routines implemented in DASY software can find the maximum found in the scanned area, within a range of the global maximum. The range (in dB0 is specified in the standards for compliance testing. For example, a 2 dB range is required in IEEE standard 1528 and IEC 62209 standards, whereby 3 dB is a requirement when compliance is assessed in accordance with the ARIB standard (Japan), if only one zoom scan follows the area scan, then only the absolute maximum will be taken as reference. For cases where multiple maximums are detected, the number of zoom scans has to be increased accordingly.

Area scan parameters extracted from FCC KDB 865664 D01v01r04 SAR measurement 100 MHz to 6 GHz.

	≤ 3 GHz	> 3 GHz
Maximum distance from closest measurement point (geometric center of probe sensors) to phantom surface	5 ± 1 mm	$\frac{1}{2} \cdot \delta \cdot \ln(2) \pm 0.5$ mm
Maximum probe angle from probe axis to phantom surface normal at the measurement location	$30^\circ \pm 1^\circ$	$20^\circ \pm 1^\circ$
Maximum area scan spatial resolution: Δx_{Area} , Δy_{Area}	≤ 2 GHz: ≤ 15 mm $2 - 3$ GHz: ≤ 12 mm	$3 - 4$ GHz: ≤ 12 mm $4 - 6$ GHz: ≤ 10 mm
	When the x or y dimension of the test device, in the measurement plane orientation, is smaller than the above, the measurement resolution must be \leq the corresponding x or y dimension of the test device with at least one measurement point on the test device.	

8.4 Zoom Scan

Zoom scans are used to assess the peak spatial SAR values within a cubic averaging volume containing 1 gram and 10 gram of simulated tissue. The zoom scan measures points (refer to table below) within a cube whose base faces are centered on the maxima found in a preceding area scan job within the same procedure. When the measurement is done, the zoom scan evaluates the averaged SAR for 1 gram and 10 gram and displays these values next to the job's label.

Zoom scan parameters extracted from FCC KDB 865664 D01v01r04 SAR measurement 100 MHz to 6 GHz.

		≤ 3 GHz	> 3 GHz	
Maximum zoom scan spatial resolution: Δx_{Zoom} , Δy_{Zoom}		≤ 2 GHz: ≤ 8 mm 2 – 3 GHz: ≤ 5 mm*	3 – 4 GHz: ≤ 5 mm* 4 – 6 GHz: ≤ 4 mm*	
Maximum zoom scan spatial resolution, normal to phantom surface	uniform grid: $\Delta z_{Zoom}(n)$	≤ 5 mm	3 – 4 GHz: ≤ 4 mm 4 – 5 GHz: ≤ 3 mm 5 – 6 GHz: ≤ 2 mm	
	graded grid	$\Delta z_{Zoom}(1)$: between 1 st two points closest to phantom surface	≤ 4 mm	3 – 4 GHz: ≤ 3 mm 4 – 5 GHz: ≤ 2.5 mm 5 – 6 GHz: ≤ 2 mm
		$\Delta z_{Zoom}(n>1)$: between subsequent points	$\leq 1.5 \cdot \Delta z_{Zoom}(n-1)$	
Minimum zoom scan volume	x, y, z	≥ 30 mm	3 – 4 GHz: ≥ 28 mm 4 – 5 GHz: ≥ 25 mm 5 – 6 GHz: ≥ 22 mm	
Note: δ is the penetration depth of a plane-wave at normal incidence to the tissue medium; see draft standard IEEE P1528-2011 for details. * When zoom scan is required and the <i>reported</i> SAR from the <i>area scan based 1-g SAR estimation</i> procedures of KDB 447498 is ≤ 1.4 W/kg, ≤ 8 mm, ≤ 7 mm and ≤ 5 mm zoom scan resolution may be applied, respectively, for 2 GHz to 3 GHz, 3 GHz to 4 GHz and 4 GHz to 6 GHz.				

8.5 Volume Scan Procedures

The volume scan is used to assess overlapping SAR distributions for antennas transmitting in different frequency bands. It is equivalent to an oversized zoom scan used in standalone measurements. The measurement volume will be used to enclose all the simultaneous transmitting antennas. For antennas transmitting simultaneously in different frequency bands, the volume scan is measured separately in each frequency band. In order to sum correctly to compute the 1g aggregate SAR, the EUT remain in the same test position for all measurements and all volume scan use the same spatial resolution and grid spacing. When all volume scan were completed, the software, SEMCAD postprocessor can combine and subsequently superpose these measurement data to calculating the multiband SAR.

8.6 Power Drift Monitoring

All SAR testing is under the EUT install full charged battery and transmit maximum output power. In DASy measurement software, the power reference measurement and power drift measurement procedures are used for monitoring the power drift of EUT during SAR test. Both these procedures measure the field at a specified reference position before and after the SAR testing. The software will calculate the field difference in dB. If the power drifts more than 5%, the SAR will be retested.



9. Test Equipment List

Manufacturer	Name of Equipment	Type/Model	Serial Number	Calibration	
				Last Cal.	Due Date
SPEAG	750MHz System Validation Kit	D750V3	1099	Dec. 15, 2021	Dec. 14, 2024
SPEAG	835MHz System Validation Kit	D835V2	4d162	Dec. 17, 2021	Dec. 16, 2024
SPEAG	1750MHz System Validation Kit	D1750V2	1137	Oct. 19, 2021	Oct. 17, 2024
SPEAG	1900MHz System Validation Kit	D1900V2	5d182	Dec. 20, 2021	Dec. 19, 2024
SPEAG	2450MHz System Validation Kit	D2450V2	1040	Apr. 25, 2023	Apr. 24, 2024
SPEAG	2600MHz System Validation Kit	D2600V2	1070	Dec. 20, 2021	Dec. 19, 2024
SPEAG	5000MHz System Validation Kit	D5GHzV2	1341	Dec. 13, 2021	Dec. 12, 2024
SPEAG	Data Acquisition Electronics	DAE4	1386	Jul. 17, 2023	Jul. 16, 2024
SPEAG	Dosimetric E-Field Probe	EX3DV4	7576	Aug. 23, 2023	Aug. 22, 2024
SPEAG	SAM Twin Phantom	QD 000 P40 CD	1671	NCR	NCR
SPEAG	Phone Positioner	N/A	N/A	NCR	NCR
Anritsu	Radio communication analyzer	MT8820C	6201300653	Jul. 05, 2023	Jul. 04, 2024
Anritsu	Radio communication analyzer	MT8821C	6262314715	Jul. 05, 2023	Jul. 04, 2024
Agilent	Wireless Communication Test Set	E5515C	MY50267224	Jul. 05, 2023	Jul. 04, 2024
Keysight	Network Analyzer	E5071C	MY46523671	Oct. 16, 2023	Oct. 15, 2024
Speag	Dielectric Assessment KIT	DAK-3.5	1071	Feb. 20, 2023	Feb. 19, 2024
Agilent	Signal Generator	N5181A	MY50145381	Dec. 27, 2022	Dec. 26, 2023
Anritsu	Power Sensor	MA2411B	1542004	Dec. 27, 2022	Dec. 26, 2023
Anritsu	Power Meter	ML2495A	1339473	Dec. 27, 2022	Dec. 26, 2023
R&S	Power Sensor	NRP50S	101254	Apr. 06, 2023	Apr. 05, 2024
R&S	Power Sensor	NRP8S	109228	Apr. 06, 2023	Apr. 05, 2024
R&S	CBT BLUETOOTH TESTER	CBT	100963	Dec. 27, 2022	Dec. 26, 2023
R&S	Spectrum Analyzer	FSP7	100818	Jul. 05, 2023	Jul. 04, 2024
TES	Hygrometer	1310	200505600	Jul. 08, 2023	Jul. 07, 2024
Anymetre	Thermo-Hygrometer	JR593	2015030904	Jul. 08, 2023	Jul. 07, 2024
SPEAG	Device Holder	N/A	N/A	N/A	N/A
AR	Amplifier	5S1G4	0333096		Note 1
Mini-Circuits	Amplifier	ZVE-3W-83+	599201528		Note 1
Mini-Circuits	Amplifier	ZVA-183W-S+	726202215		Note 1
ARRA	Power Divider	A3200-2	N/A		Note 1
ET Industries	Dual Directional Coupler	C-058-10	N/A		Note 1
Weinschel	Attenuator 1	3M-10	N/A		Note 1
Weinschel	Attenuator 2	3M-20	N/A		Note 1

Note:

1. Prior to system verification and validation, the path loss from the signal generator to the system check source and the power meter, which includes the amplifier, cable, attenuator and directional coupler, was measured by the network analyzer. The reading of the power meter was offset by the path loss difference between the path to the power meter and the path to the system check source to monitor the actual power level fed to the system check
2. Referring to KDB 865664 D01v01r04, the dipole calibration interval can be extended to 3 years with justification. The dipoles are also not physically damaged, or repaired during the interval.
3. The justification data of dipole can be found in appendix C. The return loss is < -20dB, within 20% of prior calibration, the impedance is within 5 ohm of prior calibration.

10. System Verification

10.1 Tissue Simulating Liquids

For the measurement of the field distribution inside the SAM phantom with DASY, the phantom must be filled with around 25 liters of homogeneous body tissue simulating liquid. For head SAR testing, the liquid height from the ear reference point (ERP) of the phantom to the liquid top surface is larger than 15 cm, which is shown in Fig. 11.1. For body SAR testing, the liquid height from the center of the flat phantom to the liquid top surface is larger than 15 cm, which is shown in Fig. 11.2.



Fig 11.1 Photo of Liquid Height for Head SAR



Fig 11.2 Photo of Liquid Height for Body SAR

10.2 Tissue Verification

The following tissue formulations are provided for reference only as some of the parameters have not been thoroughly verified. The composition of ingredients may be modified accordingly to achieve the desired target tissue parameters required for routine SAR evaluation.

Frequency (MHz)	Water (%)	Sugar (%)	Cellulose (%)	Salt (%)	Preventol (%)	DGBE (%)	Conductivity (σ)	Permittivity (ϵ_r)
For Head								
750	41.1	57.0	0.2	1.4	0.2	0	0.89	41.9
835	40.3	57.9	0.2	1.4	0.2	0	0.90	41.5
1800, 1900, 2000	55.2	0	0	0.3	0	44.5	1.40	40.0
2450	55.0	0	0	0	0	45.0	1.80	39.2
2600	54.8	0	0	0.1	0	45.1	1.96	39.0

Simulating Liquid for 5GHz, Manufactured by SPEAG

Ingredients	(% by weight)
Water	64~78%
Mineral oil	11~18%
Emulsifiers	9~15%
Additives and Salt	2~3%



<Tissue Dielectric Parameter Check Results>

Frequency (MHz)	Tissue Type	Liquid Temp. (°C)	Conductivity (σ)	Permittivity (ε _r)	Conductivity Target (σ)	Permittivity Target (ε _r)	Delta (σ) (%)	Delta (ε _r) (%)	Limit (%)	Date
750	Head	22.6	0.885	40.799	0.89	41.90	-0.56	-2.63	±5	2023/11/16
750	Head	22.3	0.887	40.873	0.89	41.90	-0.34	-2.45	±5	2023/11/17
835	Head	22.4	0.914	41.826	0.90	41.50	1.56	0.79	±5	2023/11/19
835	Head	22.6	0.911	42.404	0.90	41.50	1.22	2.18	±5	2023/11/27
1750	Head	22.5	1.356	38.633	1.37	40.10	-1.02	-3.66	±5	2023/11/14
1750	Head	22.6	1.350	39.254	1.37	40.10	-1.46	-2.11	±5	2023/11/26
1900	Head	22.5	1.449	40.009	1.40	40.00	3.50	0.02	±5	2023/11/16
1900	Head	22.5	1.453	39.107	1.40	40.00	3.79	-2.23	±5	2023/11/25
2450	Head	22.7	1.825	39.664	1.80	39.20	1.39	1.18	±5	2023/11/11
2450	Head	22.2	1.810	37.626	1.80	39.20	0.56	-4.02	±5	2023/11/28
2600	Head	22.4	2.056	37.589	1.96	39.00	4.90	-3.62	±5	2023/11/14
2600	Head	22.7	2.053	37.984	1.96	39.00	4.74	-2.61	±5	2023/11/29
5250	Head	22.2	4.673	35.938	4.71	35.95	-0.79	-0.03	±5	2023/11/20
5250	Head	22.3	4.764	36.965	4.71	35.95	1.15	2.82	±5	2023/11/27
5600	Head	22.3	5.080	35.374	5.07	35.50	0.20	-0.35	±5	2023/11/23
5600	Head	22.4	5.207	36.212	5.07	35.50	2.70	2.01	±5	2023/11/30
5750	Head	22.5	5.250	35.137	5.22	35.35	0.57	-0.60	±5	2023/11/24
5750	Head	22.8	5.382	35.934	5.22	35.35	3.10	1.65	±5	2023/11/29

10.3 System Performance Check Results

Comparing to the original SAR value provided by SPEAG, the verification data should be within its specification of 10 %. Below table shows the target SAR and measured SAR after normalized to 1W input power. The table below indicates the system performance check can meet the variation criterion and the plots can be referred to Appendix A of this report.

<1g SAR>

Date	Frequency (MHz)	Tissue Type	Input Power (mW)	Dipole S/N	Probe S/N	DAE S/N	Measured 1g SAR (W/kg)	Targeted 1g SAR (W/kg)	Normalized 1g SAR (W/kg)	Deviation (%)
2023/11/16	750	Head	250	1099	7576	1386	2.250	8.540	8.8	3.04
2023/11/17	750	Head	250	1099	7576	1386	2.190	8.540	8.76	2.58
2023/11/19	835	Head	250	4d162	7576	1386	2.530	9.640	10.12	4.98
2023/11/27	835	Head	250	4d162	7576	1386	2.440	9.640	9.76	1.24
2023/11/14	1750	Head	250	1137	7576	1386	9.140	36.500	36.56	0.16
2023/11/26	1750	Head	250	1137	7576	1386	9.510	36.500	38.04	4.22
2023/11/16	1900	Head	250	5d182	7576	1386	9.950	39.600	39.8	0.51
2023/11/25	1900	Head	250	5d182	7576	1386	10.500	39.600	42	6.06
2023/11/11	2450	Head	250	1040	7576	1386	12.900	52.700	51.6	-2.09
2023/11/28	2450	Head	250	1040	7576	1386	13.100	52.700	52.4	-0.57
2023/11/14	2600	Head	250	1070	7576	1386	14.400	56.200	57.6	2.49
2023/11/29	2600	Head	250	1070	7576	1386	13.700	56.200	54.8	-2.49
2023/11/20	5250	Head	100	1341	7576	1386	8.250	80.700	82.5	2.23
2023/11/27	5250	Head	100	1341	7576	1386	8.110	80.700	81.1	0.50
2023/11/23	5600	Head	100	1341	7576	1386	8.050	84.500	80.5	-4.73
2023/11/30	5600	Head	100	1341	7576	1386	8.150	84.500	81.5	-3.55
2023/11/24	5750	Head	100	1341	7576	1386	7.520	80.600	75.2	-6.70
2023/11/29	5750	Head	100	1341	7576	1386	7.790	80.600	77.9	-3.35

<10g SAR>

Date	Frequency (MHz)	Tissue Type	Input Power (mW)	Dipole S/N	Probe S/N	DAE S/N	Measured 10g SAR (W/kg)	Targeted 10g SAR (W/kg)	Normalized 10g SAR (W/kg)	Deviation (%)
2023/11/16	750	Head	250	1099	7576	1386	1.480	5.650	5.92	4.78
2023/11/17	750	Head	250	1099	7576	1386	1.460	5.650	5.84	3.36
2023/11/19	835	Head	250	4d162	7576	1386	1.640	6.260	6.56	4.79
2023/11/27	835	Head	250	4d162	7576	1386	1.590	6.260	6.36	1.60
2023/11/14	1750	Head	250	1137	7576	1386	5.060	19.200	20.24	5.42
2023/11/26	1750	Head	250	1137	7576	1386	5.070	19.200	20.28	5.63
2023/11/16	1900	Head	250	5d182	7576	1386	5.190	20.200	20.76	2.77
2023/11/25	1900	Head	250	5d182	7576	1386	5.330	20.200	21.32	5.54
2023/11/11	2450	Head	250	1040	7576	1386	5.990	24.600	23.96	-2.60
2023/11/28	2450	Head	250	1040	7576	1386	6.120	24.600	24.48	-0.49
2023/11/14	2600	Head	250	1070	7576	1386	6.580	24.600	26.32	6.99
2023/11/29	2600	Head	250	1070	7576	1386	5.960	24.600	23.84	-3.09
2023/11/20	5250	Head	100	1341	7576	1386	2.390	23.100	23.9	3.46
2023/11/27	5250	Head	100	1341	7576	1386	2.250	23.100	22.5	-2.60
2023/11/23	5600	Head	100	1341	7576	1386	2.280	24.000	22.8	-5.00
2023/11/30	5600	Head	100	1341	7576	1386	2.330	24.000	23.3	-2.92
2023/11/24	5750	Head	100	1341	7576	1386	2.120	22.700	21.2	-6.61
2023/11/29	5750	Head	100	1341	7576	1386	2.190	22.700	21.9	-3.52

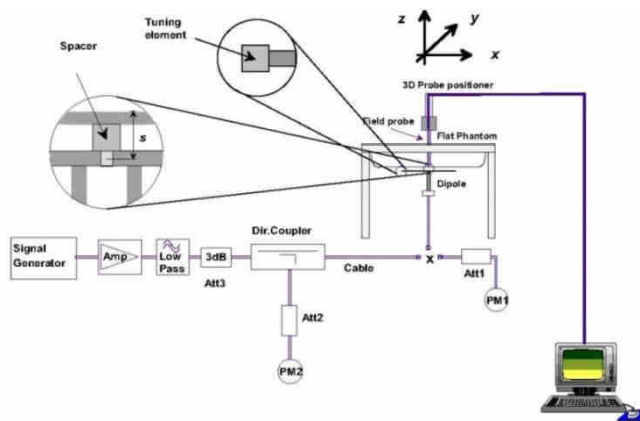

Fig 11.3.1 System Performance Check Setup



Fig 11.3.2 Setup Photo

11. RF Exposure Positions

11.1 Ear and handset reference point

Figure 12.1.1 shows the front, back, and side views of the SAM phantom. The center-of-mouth reference point is labeled “M,” the left ear reference point (ERP) is marked “LE,” and the right ERP is marked “RE.” Each ERP is 15 mm along the B-M (back-mouth) line behind the entrance-to-ear-canal (EEC) point, as shown in Figure 12.1.2 The Reference Plane is defined as passing through the two ear reference points and point M. The line N-F (neck-front), also called the reference pivoting line, is normal to the Reference Plane and perpendicular to both a line passing through RE and LE and the B-M line (see Figure 12.1.3). Both N-F and B-M lines should be marked on the exterior of the phantom shell to facilitate handset positioning. Posterior to the N-F line the ear shape is a flat surface with 6 mm thickness at each ERP, and forward of the N-F line the ear is truncated, as illustrated in Figure 12.1.2. The ear truncation is introduced to preclude the ear lobe from interfering with handset tilt, which could lead to unstable positioning at the cheek.

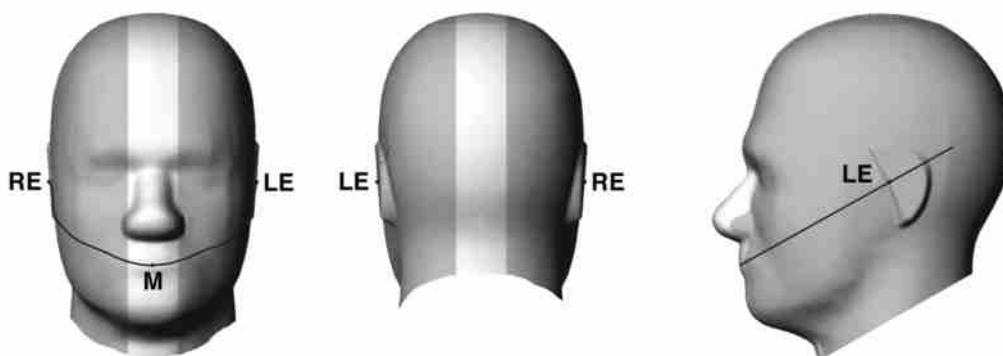

Fig 12.1.1 Front, back, and side views of SAM twin phantom

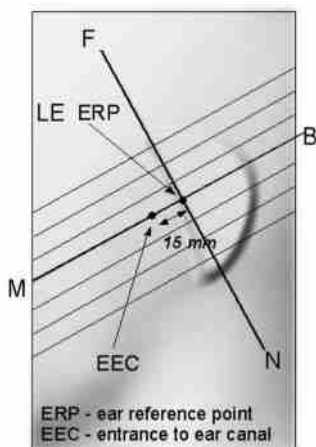

Fig 12.1.2 Close-up side view of phantom showing the ear region.

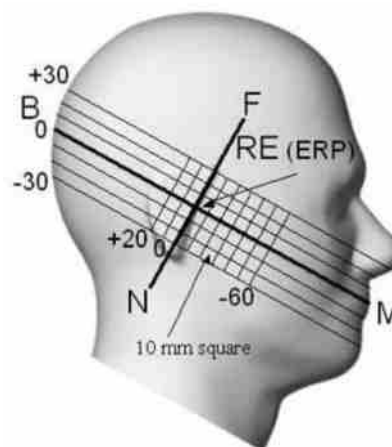

Fig 12.1.3 Side view of the phantom showing relevant markings and seven cross-sectional plane locations

11.2 Definition of the cheek position

1. Ready the handset for talk operation, if necessary. For example, for handsets with a cover piece (flip cover), open the cover. If the handset can transmit with the cover closed, both configurations must be tested.
2. Define two imaginary lines on the handset—the vertical centerline and the horizontal line. The vertical centerline passes through two points on the front side of the handset—the midpoint of the width w_t of the handset at the level of the acoustic output (point A in Figure 12.2.1 and Figure 12.2.2), and the midpoint of the width w_b of the bottom of the handset (point B). The horizontal line is perpendicular to the vertical centerline and passes through the center of the acoustic output (see Figure 12.2.1). The two lines intersect at point A. Note that for many handsets, point A coincides with the center of the acoustic output; however, the acoustic output may be located elsewhere on the horizontal line. Also note that the vertical centerline is not necessarily parallel to the front face of the handset (see Figure 12.2.2), especially for clamshell handsets, handsets with flip covers, and other irregularly-shaped handsets.
3. Position the handset close to the surface of the phantom such that point A is on the (virtual) extension of the line passing through points RE and LE on the phantom (see Figure 12.2.3), such that the plane defined by the vertical centerline and the horizontal line of the handset is approximately parallel to the sagittal plane of the phantom.
4. Translate the handset towards the phantom along the line passing through RE and LE until handset point A touches the pinna at the ERP.
5. While maintaining the handset in this plane, rotate it around the LE-RE line until the vertical centerline is in the plane normal to the plane containing B-M and N-F lines, i.e., the Reference Plane.
6. Rotate the handset around the vertical centerline until the handset (horizontal line) is parallel to the N-F line.
7. While maintaining the vertical centerline in the Reference Plane, keeping point A on the line passing through RE and LE, and maintaining the handset contact with the pinna, rotate the handset about the N-F line until any point on the handset is in contact with a phantom point below the pinna on the cheek. See Figure 12.2.3. The actual rotation angles should be documented in the test report.

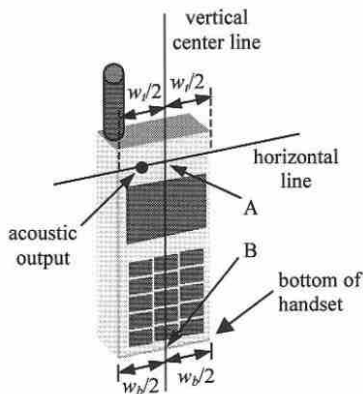

Fig 12.2.1 Handset vertical and horizontal reference lines—“fixed case”

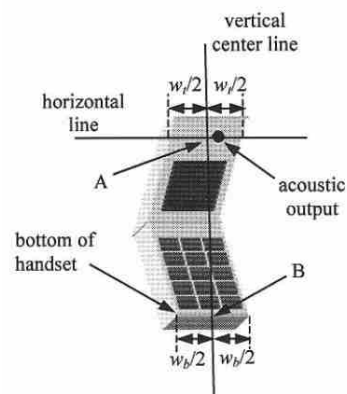

Fig 12.2.2 Handset vertical and horizontal reference lines—“clam-shell case”

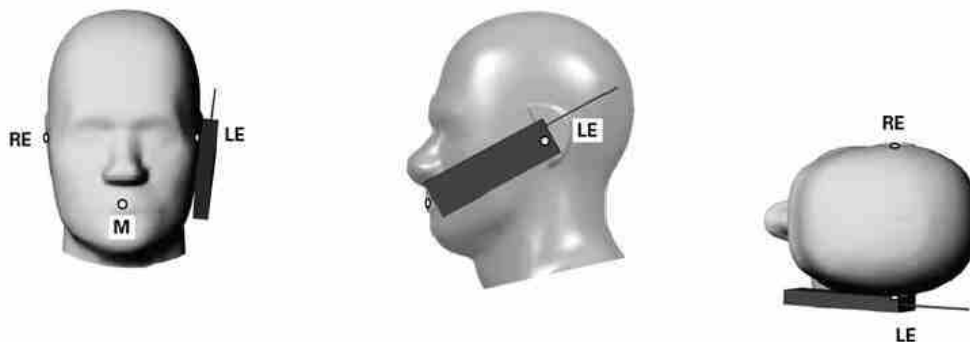

Fig 12.2.3 cheek or touch position. The reference points for the right ear (RE), left ear (LE), and mouth (M), which establish the Reference Plane for handset positioning, are indicated.

11.3 Definition of the tilt position

1. Ready the handset for talk operation, if necessary. For example, for handsets with a cover piece (flip cover), open the cover. If the handset can transmit with the cover closed, both configurations must be tested.
2. While maintaining the orientation of the handset, move the handset away from the pinna along the line passing through RE and LE far enough to allow a rotation of the handset away from the cheek by 15°.
3. Rotate the handset around the horizontal line by 15°.
4. While maintaining the orientation of the handset, move the handset towards the phantom on the line passing through RE and LE until any part of the handset touches the ear. The tilt position is obtained when the contact point is on the pinna. See Figure 12.3.1. If contact occurs at any location other than the pinna, e.g., the antenna at the back of the phantom head, the angle of the handset should be reduced. In this case, the tilt position is obtained if any point on the handset is in contact with the pinna and a second point

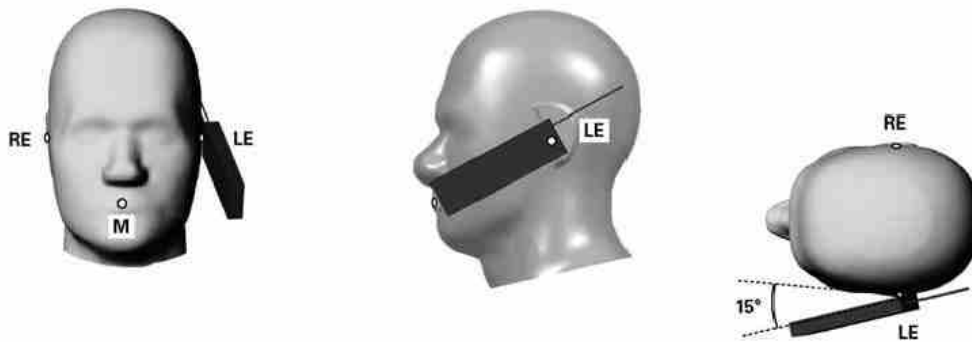

Fig 12.3.1 Tilt position. The reference points for the right ear (RE), left ear (LE), and mouth (M), which define the Reference Plane for handset positioning, are indicated.

11.4 Body Worn Accessory

Body-worn operating configurations are tested with the belt-clips and holsters attached to the device and positioned against a flat phantom in a normal use configuration (see Figure 11.4). Per KDB648474 D04v01r03, body-worn accessory exposure is typically related to voice mode operations when handsets are carried in body-worn accessories. The body-worn accessory procedures in FCC KDB 447498 D01v06 should be used to test for body-worn accessory SAR compliance, without a headset connected to it. This enables the test results for such configuration to be compatible with that required for hotspot mode when the body-worn accessory test separation distance is greater than or equal to that required for hotspot mode, when applicable. When the reported SAR for body-worn accessory, measured without a headset connected to the handset is $> 1.2 \text{ W/kg}$, the highest reported SAR configuration for that wireless mode and frequency band should be repeated for that body-worn accessory with a headset attached to the handset.

Accessories for body-worn operation configurations are divided into two categories: those that do not contain metallic components and those that do contain metallic components. When multiple accessories that do not contain metallic components are supplied with the device, the device is tested with only the accessory that dictates the closest spacing to the body. Then multiple accessories that contain metallic components are test with the device with each accessory. If multiple accessories share an identical metallic component (i.e. the same metallic belt-chip used with different holsters with no other metallic components) only the accessory that dictates the closest spacing to the body is tested.

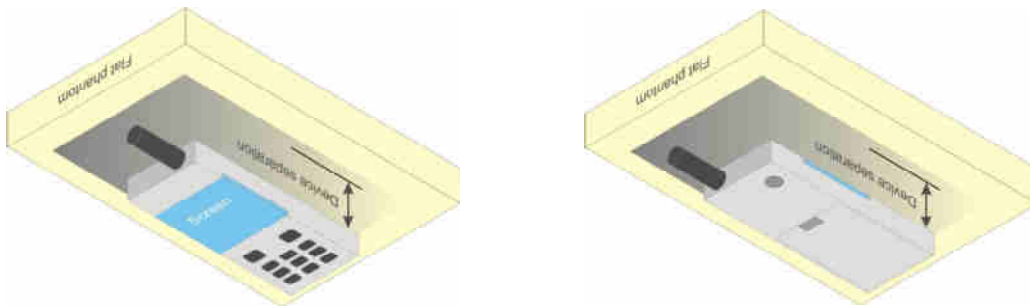

Fig 12.4 Body Worn Position

11.5 Product Specific 10g SAR Exposure

For smart phones with a display diagonal dimension > 15.0 cm or an overall diagonal dimension > 16.0 cm, that can provide similar mobile web access and multimedia support found in mini-tablets or UMPC mini-tablets and support voice calls next to the ear, According to KDB648474 D04v01r03, the following phablet procedures should be applied to evaluate SAR compliance for each applicable wireless modes and frequency band. Devices marketed as phablets, regardless of form factors and operating characteristics must be tested as a phablet to determine SAR compliance

1. The normally required head and body-worn accessory SAR test procedures for handsets, including hotspot mode, must be applied.
2. The UMPC mini-tablet procedures must also be applied to test the SAR of all surfaces and edges with an antenna located at ≤ 25 mm from that surface or edge, in direct contact with a flat phantom, for 10-g extremity SAR according to the body-equivalent tissue dielectric parameters in KDB 865664 to address interactive hand use exposure conditions.6 The UMPC mini-tablet 1-g SAR at 5 mm is not required. When hotspot mode applies, 10-g extremity SAR is required only for the surfaces and edges with hotspot mode 1-g reported SAR > 1.2 W/kg.

11.6 Wireless Router

Some battery-operated handsets have the capability to transmit and receive user through simultaneous transmission of WIFI simultaneously with a separate licensed transmitter. The FCC has provided guidance in FCC KDB Publication 941225 D06 v02r01 where SAR test considerations for handsets ($L \times W \geq 9$ cm x 5 cm) are based on a composite test separation distance of 10mm from the front, back and edges of the device containing transmitting antennas within 2.5cm of their edges, determined from general mixed use conditions for this type of devices. Since the hotspot SAR results may overlap with the body-worn accessory SAR requirements, the more conservative configurations can be considered, thus excluding some body-worn accessory SAR tests.

When the user enables the personal wireless router functions for the handset, actual operations include simultaneous transmission of both the WIFI transmitter and another licensed transmitter. Both transmitters often do not transmit at the same transmitting frequency and thus cannot be evaluated for SAR under actual use conditions due to the limitations of the SAR assessment probes. Therefore, SAR must be evaluated for each frequency transmission and mode separately and spatially summed with the WIFI transmitter according to FCC KDB Publication 447498 D01v06 publication procedures. The "Portable Hotspot" feature on the handset was NOT activated during SAR assessments, to ensure the SAR measurements were evaluated for a single transmission frequency RF signal at a time.

12. Conducted RF Output Power (Unit: dBm)

The detailed conducted power table can refer to Appendix E.

<GSM Conducted Power>

1. Per KDB 447498 D01, the maximum output power channel is used for SAR testing and for further SAR test reduction.
2. Per KDB 941225 D01v03r01, for SAR test reduction for GSM / GPRS / EDGE modes is determined by the source-based time-averaged output power including tune-up tolerance. The mode with highest specified time-averaged output power should be tested for SAR compliance in the applicable exposure conditions. For modes with the same specified maximum output power and tolerance, the higher number time-slot configuration should be tested.
3. Other configurations of GSM / GPRS / EDGE are considered as secondary modes. The 3G SAR test reduction procedure is applied, when the maximum output power and tune-up tolerance specified for production units in a secondary mode is $\leq \frac{1}{4}$ dB higher than the primary mode, SAR measurement is not required for the secondary mode.

<WCDMA Conducted Power>

1. The following tests were conducted according to the test requirements outlines in 3GPP TS 34.121 specification.
2. The procedures in KDB 941225 D01v03r01 are applied for 3GPP Rel. 6 HSPA to configure the device in the required sub-test mode(s) to determine SAR test exclusion.
3. For HSPA+ devices supporting 16 QAM in the uplink, power measurements procedure is according to the configurations in Table C.11.1.4 of 3GPP TS 34.121-1.
4. For DC-HSDPA, the device was configured according to the H-Set 12, Fixed Reference Channel (FRC) configuration in Table C.8.1.12 of 3GPP TS 34.121-1, with the primary and the secondary serving HS-DSCH Cell enabled during the power measurement.

A summary of these settings are illustrated below:

HSDPA Setup Configuration:

- a. The EUT was connected to Base Station Agilent E5515C referred to the Setup Configuration.
- b. The RF path losses were compensated into the measurements.
- c. A call was established between EUT and Base Station with following setting:
 - i. Set Gain Factors (β_c and β_d) and parameters were set according to each
 - ii. Specific sub-test in the following table, C10.1.4, quoted from the TS 34.121
 - iii. Set RMC 12.2Kbps + HSDPA mode.
 - iv. Set Cell Power = -86 dBm
 - v. Set HS-DSCH Configuration Type to FRC (H-set 1, QPSK)
 - vi. Select HSDPA Uplink Parameters
 - vii. Set Delta ACK, Delta NACK and Delta CQI = 8
 - viii. Set Ack-Nack Repetition Factor to 3
 - ix. Set CQI Feedback Cycle (k) to 4 ms
 - x. Set CQI Repetition Factor to 2
 - xi. Power Ctrl Mode = All Up bits
- d. The transmitted maximum output power was recorded.

Table C.10.1.4: β values for transmitter characteristics tests with HS-DPCCH

Sub-test	β_c	β_d	β_d (SF)	β_c/β_d	β_{HS} (Note 1, Note 2)	CM (dB) (Note 3)	MPR (dB) (Note 3)
1	2/15	15/15	64	2/15	4/15	0.0	0.0
2	12/15 (Note 4)	15/15 (Note 4)	64	12/15 (Note 4)	24/15	1.0	0.0
3	15/15	8/15	64	15/8	30/15	1.5	0.5
4	15/15	4/15	64	15/4	30/15	1.5	0.5

Note 1: $\Delta_{ACK}, \Delta_{NACK}$ and $\Delta_{CQI} = 30/15$ with $\beta_{HS} = 30/15 * \beta_c$.

Note 2: For the HS-DPCCH power mask requirement test in clause 5.2C, 5.7A, and the Error Vector Magnitude (EVM) with HS-DPCCH test in clause 5.13.1A, and HSDPA EVM with phase discontinuity in clause 5.13.1AA, Δ_{ACK} and $\Delta_{NACK} = 30/15$ with $\beta_{HS} = 30/15 * \beta_c$, and $\Delta_{CQI} = 24/15$ with $\beta_{HS} = 24/15 * \beta_c$.

Note 3: CM = 1 for $\beta_c/\beta_d = 12/15, \beta_{HS}/\beta_c = 24/15$. For all other combinations of DPDCCH, DPCCH and HS-DPCCH the MPR is based on the relative CM difference. This is applicable for only UEs that support HSDPA in release 6 and later releases.

Note 4: For subtest 2 the β_c/β_d ratio of 12/15 for the TFC during the measurement period (TF1, TF0) is achieved by setting the signalled gain factors for the reference TFC (TF1, TF1) to $\beta_c = 11/15$ and $\beta_d = 15/15$.

Setup Configuration

HSUPA Setup Configuration:

- a. The EUT was connected to Base Station Agilent E5515C referred to the Setup Configuration.
- b. The RF path losses were compensated into the measurements.
- c. A call was established between EUT and Base Station with following setting * :
 - i. Call Configs = 5.2B, 5.9B, 5.10B, and 5.13.2B with QPSK
 - ii. Set the Gain Factors (β_c and β_d) and parameters (AG Index) were set according to each specific sub-test in the following table, C11.1.3, quoted from the TS 34.121
 - iii. Set Cell Power = -86 dBm
 - iv. Set Channel Type = 12.2k + HSPA
 - v. Set UE Target Power
 - vi. Power Ctrl Mode= Alternating bits
 - vii. Set and observe the E-TFCI
 - viii. Confirm that E-TFCI is equal to the target E-TFCI of 75 for sub-test 1, and other subtest's E-TFCI
- d. The transmitted maximum output power was recorded.

Table C.11.1.3: β values for transmitter characteristics tests with HS-DPCCH and E-DCH

Sub-test	β_c	β_d	β_{sf} (SF)	β_c/β_d	β_{HS} (Note1)	β_{ec}	β_{ed} (Note 4) (Note 5)	β_{ed} (SF)	β_{ed} (Codes)	CM (dB) (Note 2)	MPR (dB) (Note 2) (Note 6)	AG Index (Note 5)	E-TFCI
1	11/15 (Note 3)	15/15 (Note 3)	64	11/15 (Note 3)	22/15	209/25	1309/225	4	1	1.0	0.0	20	75
2	6/15	15/15	64	6/15	12/15	12/15	94/75	4	1	3.0	2.0	12	67
3	15/15	9/15	64	15/9	30/15	30/15	β_{ed1} : 47/15 β_{ed2} : 47/15	4	2	2.0	1.0	15	92
4	2/15	15/15	64	2/15	4/15	2/15	56/75	4	1	3.0	2.0	17	71
5	15/15	0	-	-	5/15	5/15	47/15	4	1	1.0	0.0	12	67

Note 1: For sub-test 1 to 4, Δ_{ACK} , Δ_{NACK} and $\Delta_{CDI} = 30/15$ with $\beta_{HS} = 30/15 * \beta_c$. For sub-test 5, Δ_{ACK} , Δ_{NACK} and $\Delta_{CDI} = 5/15$ with $\beta_{HS} = 5/15 * \beta_c$.

Note 2: CM = 1 for $\beta_c/\beta_d = 12/15$, $\beta_{HS}/\beta_c = 24/15$. For all other combinations of DPDCH, DPCCH, HS-DPCCH, E-DPDCH and E-DPCCH the MPR is based on the relative CM difference.

Note 3: For subtest 1 the β_c/β_d ratio of 11/15 for the TFC during the measurement period (TF1, TF0) is achieved by setting the signalled gain factors for the reference TFC (TF1, TF0) to $\beta_c = 10/15$ and $\beta_d = 15/15$.

Note 4: In case of testing by UE using E-DPDCH Physical Layer category 1, Sub-test 3 is omitted according to TS25.306 Table 5.1g.

Note 5: β_{ed} can not be set directly; it is set by Absolute Grant Value.

Note 6: For subtests 2, 3 and 4, UE may perform E-DPDCH power scaling at max power which could results in slightly smaller MPR values.

Setup Configuration

DC-HSDPA 3GPP release 8 Setup Configuration:

- a. The EUT was connected to Base Station referred to the Setup Configuration below
- b. The RF path losses were compensated into the measurements.
- c. A call was established between EUT and Base Station with following setting:
 - i. Set RMC 12.2Kbps + HSDPA mode.
 - ii. Set Cell Power = -25 dBm
 - iii. Set HS-DSCH Configuration Type to FRC (H-set 12, QPSK)
 - iv. Select HSDPA Uplink Parameters
 - v. Set Gain Factors (β_c and β_d) and parameters were set according to each Specific sub-test in the following table, C10.1.4, quoted from the TS 34.121
 - a). Subtest 1: $\beta_c/\beta_d=2/15$
 - b). Subtest 2: $\beta_c/\beta_d=12/15$
 - c). Subtest 3: $\beta_c/\beta_d=15/8$
 - d). Subtest 4: $\beta_c/\beta_d=15/4$
 - vi. Set Delta ACK, Delta NACK and Delta CQI = 8
 - vii. Set Ack-Nack Repetition Factor to 3
 - viii. Set CQI Feedback Cycle (k) to 4 ms
 - ix. Set CQI Repetition Factor to 2
 - x. Power Ctrl Mode = All Up bits
- d. The transmitted maximum output power was recorded.

The following tests were conducted according to the test requirements outlines in 3GPP TS 34.121 specification. A summary of these settings are illustrated below:

C.8.1.12 Fixed Reference Channel Definition H-Set 12

Table C.8.1.12: Fixed Reference Channel H-Set 12

Parameter	Unit	Value
Nominal Avg. Inf. Bit Rate	kbps	60
Inter-TTI Distance	TTI's	1
Number of HARQ Processes	Processes	6
Information Bit Payload (N_{IP})	Bits	120
Number Code Blocks	Blocks	1
Binary Channel Bits Per TTI	Bits	960
Total Available SML's in UE	SML's	19200
Number of SML's per HARQ Proc.	SML's	3200
Coding Rate		0.15
Number of Physical Channel Codes	Codes	1
Modulation		QPSK
Note 1: The RMC is intended to be used for DC-HSDPA mode and both cells shall transmit with identical parameters as listed in the table. Note 2: Maximum number of transmission is limited to 1, i.e., retransmission is not allowed. The redundancy and constellation version 0 shall be used.		

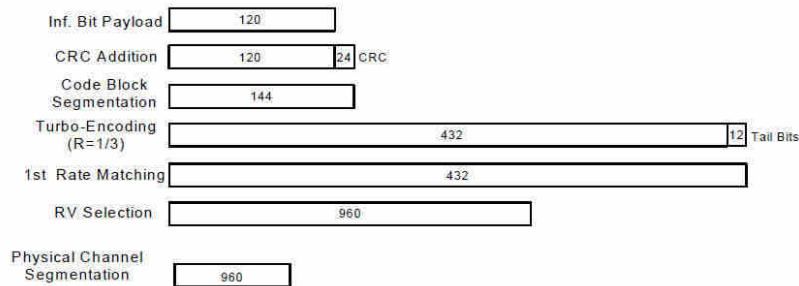

Figure C.8.19: Coding rate for Fixed reference Channel H-Set 12 (QPSK) Setup Configuration

HSPA+ 3GPP release 7 (uplink category 7) 16QAM, Setup Configuration:

1. The EUT was connected to Base Station Agilent E5515C referred to the Setup Configuration.
2. The RF path losses were compensated into the measurements.
3. A call was established between EUT and Base Station with following setting * :
 - i. Call Configs = 5.2E:HSPA+:UL with 16QAM
 - ii. Set the Gain Factors (β_c and β_d) and parameters (AG Index) were set according to each specific sub-test in the following table, C11.1.4, quoted from the TS 34.121-1 s5.2E
 - iii. Set Channel Parm
 - iv. Set Cell Power = -86 dBm
 - v. Set Channel Type = HSPA
 - vi. Set UE Target Power =21 dBm
 - vii. Power Ctrl Mode= All Up Bits
 - viii. Set Manual Uplink DPCH Bc/Bd = Manual
 - ix. Set Manual Uplink DPCH Bc and Bd=15,15(for 34.121-1 v8.10.0 table C11.1.4 sub-test 1)
 - x. Set HSPA Conn DL Channel Levels
 - xi. Set HS-SCCH Configs
 - xii. Set RB Test Mode Setup
 - xiii. Set Common HSUPA Parameters
 - xiv. Set Serving Grant
 - xv. Confirm that E-TFCI is equal to the target E-TFCI of 105 for sub-test 1, and other subtest's E-TFCI
4. The transmitted maximum output power was recorded.

Table C.11.1.4: β values for transmitter characteristics tests with HS-DPCCH and E-DCH with 16QAM

Sub-test	β_c (Note3)	β_d	β_{HS} (Note1)	β_{ec}	β_{ed} (2xSF2) (Note 4)	β_{ed} (2xSF4) (Note 4)	CM (dB) (Note 2)	MPR (dB) (Note 2)	AG Index (Note 4)	E-TFCI (Note 5)	E-TFCI (boost)
1	1	0	30/15	30/15	β_{ed1} : 30/15 β_{ed2} : 30/15	β_{ed3} : 24/15 β_{ed4} : 24/15	3.5	2.5	14	105	105

Note 1: $\Delta_{ACK}, \Delta_{NACK}$ and $\Delta_{CQI} = 30/15$ with $\beta_{in} = 30/15 * \beta_c$.

Note 2: CM = 3.5 and the MPR is based on the relative CM difference, MPR = MAX(CM-1,0).

Note 3: DPDCH is not configured, therefore the β_c is set to 1 and $\beta_d = 0$ by default.

Note 4: β_{ed} can not be set directly; it is set by Absolute Grant Value.

Note 5: All the sub-tests require the UE to transmit 2SF2+2SF4 16QAM EDCH and they apply for UE using E-DPDCH category 7. E-DCH TTI is set to 2ms TTI and E-DCH table index = 2. To support these E-DCH configurations DPDCH is not allocated. The UE is signaled to use the extrapolation algorithm.

Setup Configuration



<WCDMA Conducted Power>

General Note:

1. Per KDB 941225 D01v03r01, for SAR testing is measured using a 12.2 kbps RMC with TPC bits configured to all "1's".
2. Per KDB 941225 D01v03r01, RMC 12.2kbps setting is used to evaluate SAR. The maximum output power and tune-up tolerance specified for production units in HSDPA / HSUPA / DC-HSDPA / HSPA+ is $\leq \frac{1}{4}$ dB higher than RMC 12.2Kbps or when the highest reported SAR of the RMC12.2Kbps is scaled by the ratio of specified maximum output power and tune-up tolerance of HSDPA / HSUPA / DC-HSDPA / HSPA+ to RMC12.2Kbps and the adjusted SAR is ≤ 1.2 W/kg, SAR measurement is not required for HSDPA / HSUPA / DC-HSDPA / HSPA+, and according to the following RF output power, the output power results of the secondary modes (HSDPA / HSUPA / DC-HSDPA / HSPA+) are less than $\frac{1}{4}$ dB higher than the primary modes; therefore, SAR measurement is not required for HSDPA / HSUPA / DC-HSDPA / HSPA+.

<LTE Conducted Power>

General Note:

1. Anritsu MT8820C base station simulator was used to setup the connection with EUT; the frequency band, channel bandwidth, RB allocation configuration, modulation type are set in the base station simulator to configure EUT transmitting at maximum power and at different configurations which are requested to be reported to FCC, for conducted power measurement and SAR testing.
2. Per KDB 941225 D05v02r05, when a properly configured base station simulator is used for the SAR and power measurements, spectrum plots for each RB allocation and offset configuration is not required.
3. Per KDB 941225 D05v02r05, start with the largest channel bandwidth and measure SAR for QPSK with 1 RB allocation, using the RB offset and required test channel combination with the highest maximum output power for RB offsets at the upper edge, middle and lower edge of each required test channel.
4. Per KDB 941225 D05v02r05, 50% RB allocation for QPSK SAR testing follows 1RB QPSK allocation procedure.
5. Per KDB 941225 D05v02r05, for QPSK with 100% RB allocation, SAR is not required when the highest maximum output power for 100 % RB allocation is less than the highest maximum output power in 50% and 1 RB allocations and the highest reported SAR for 1 RB and 50% RB allocation are ≤ 0.8 W/kg. Otherwise, SAR is measured for the highest output power channel; and if the reported SAR is > 1.45 W/kg, the remaining required test channels must also be tested.
6. Per KDB 941225 D05v02r05, 16QAM/64QAM output power for each RB allocation configuration is $>$ not $\frac{1}{2}$ dB higher than the same configuration in QPSK and the reported SAR for the QPSK configuration is ≤ 1.45 W/kg; Per KDB 941225 D05v02r05, 16QAM/64QAM SAR testing is not required.
7. Per KDB 941225 D05v02r05, smaller bandwidth output power for each RB allocation configuration is $>$ not $\frac{1}{2}$ dB higher than the same configuration in the largest supported bandwidth, and the reported SAR for the largest supported bandwidth is ≤ 1.45 W/kg; Per KDB 941225 D05v02r05, smaller bandwidth SAR testing is not required.
8. For LTE B4 / B5 / B12 / B17 / B26 / B38 the maximum bandwidth does not support three non-overlapping channels, per KDB 941225 D05v02r05, when a device supports overlapping channel assignment in a channel bandwidth configuration, the middle channel of the group of overlapping channels should be selected for testing.
9. LTE B4 / B5 / B17 SAR test was covered by B66 / B26 / B12; according to April 2015 TCB workshop, SAR test for overlapping LTE bands can be reduced if
 - a. the maximum output power, including tolerance, for the smaller band is \leq the larger band to qualify for the SAR test exclusion
 - b. the channel bandwidth and other operating parameters for the smaller band are fully supported by the larger band
10. According to May 2017 TCB workshop, for 16QAM and 64QAM should be verified by checking the signal constellation with a call box to avoid incorrect maximum power levels due to MPR and other requirements associated with signal modulation, and the following figure is taken from the "Fundamental Measurement >> Modulation Analysis >> constellation" mode of the device connect to the MT8821C base station, therefore, the device 64QAM and 16QAM signal modulation are correct.

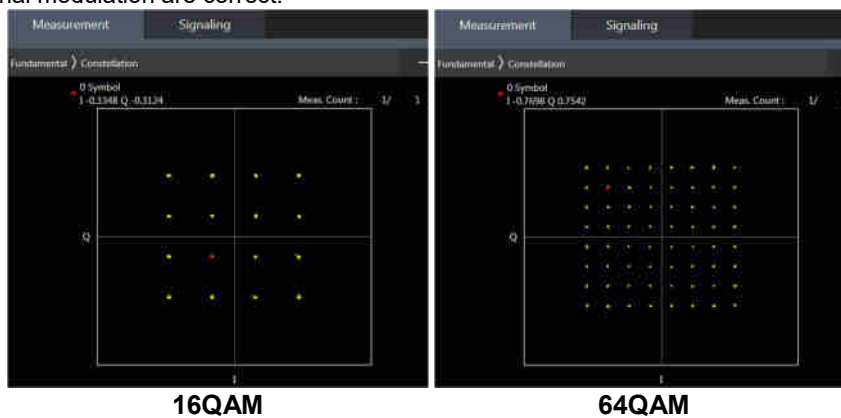

<TDD LTE SAR Measurement>

TDD LTE configuration setup for SAR measurement

SAR was tested with a fixed periodic duty factor according to the highest transmission duty factor implemented for the device and supported by 3GPP.

- a. 3GPP TS 36.211 section 4.2 for Type 2 Frame Structure and Table 4.2-2 for uplink-downlink configurations
- b. "special subframe S" contains both uplink and downlink transmissions, it has been taken into consideration to determine the transmission duty factor according to the worst case uplink and downlink cyclic prefix requirements for UpPTS
- c. Establishing connections with base station simulators ensure a consistent means for testing SAR and recommended for evaluating SAR. The Anritsu MT8820C (firmware: #22.52#004) was used for LTE output power measurements and SAR testing.

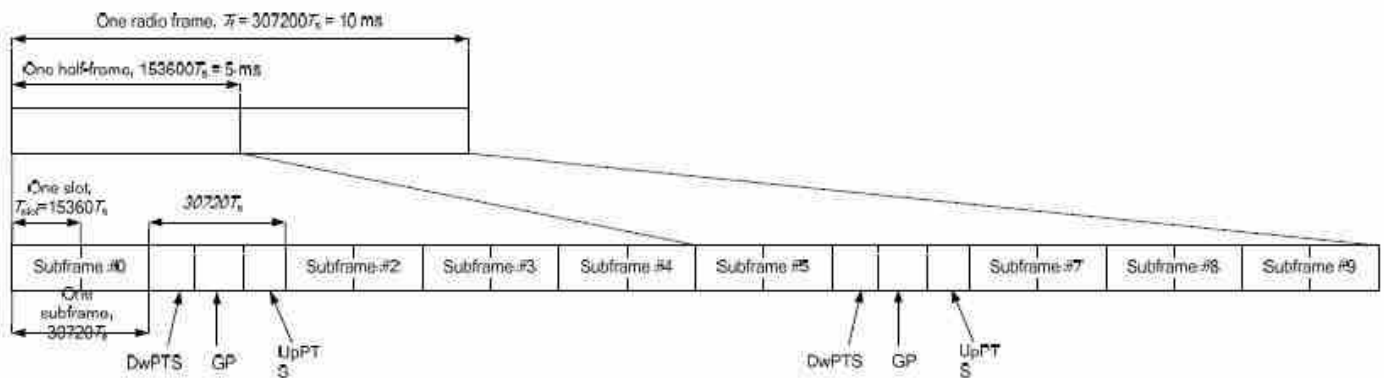

Figure 4.2-1: Frame structure type 2 (for 5 ms switch-point periodicity).

Table 4.2-2: Uplink-downlink configurations.

Uplink-downlink configuration	Downlink-to-Uplink Switch-point periodicity	Subframe number									
		0	1	2	3	4	5	6	7	8	9
0	5 ms	D	S	U	U	U	D	S	U	U	U
1	5 ms	D	S	U	U	D	D	S	U	U	D
2	5 ms	D	S	U	D	D	D	S	U	D	D
3	10 ms	D	S	U	U	U	D	D	D	D	D
4	10 ms	D	S	U	U	D	D	D	D	D	D
5	10 ms	D	S	U	D	D	D	D	D	D	D
6	5 ms	D	S	U	U	D	S	U	U	D	D

Table 4.2-1: Configuration of special subframe (lengths of DwPTS/GP/UpPTS).

Special subframe configuration	Normal cyclic prefix in downlink				Extended cyclic prefix in downlink		
	DwPTS	UpPTS		DwPTS	UpPTS		
		Normal cyclic prefix in uplink	Extended cyclic prefix in uplink		Normal cyclic prefix in uplink	Extended cyclic prefix in uplink	
0	6592 · Ts	2192 · Ts	2560 · Ts	7680 · Ts	2192 · Ts	2560 · Ts	
1	19760 · Ts			20480 · Ts			
2	21952 · Ts			23040 · Ts			
3	24144 · Ts			25600 · Ts			
4	26336 · Ts	4384 · Ts	5120 · Ts	7680 · Ts	4384 · Ts	5120 · Ts	
5	6592 · Ts			20480 · Ts			
6	19760 · Ts			23040 · Ts			
7	21952 · Ts			12800 · Ts			
8	24144 · Ts			-			-
9	13168 · Ts	-	-	-	-	-	

Special subframe (30720·T _s): Normal cyclic prefix in downlink (UpPTS)			
	Special subframe configuration	Normal cyclic prefix in uplink	Extended cyclic prefix in uplink
Uplink duty factor in one special subframe	0~4	7.13%	8.33%
	5~9	14.3%	16.7%

Special subframe(30720·T _s): Extended cyclic prefix in downlink (UpPTS)			
	Special subframe configuration	Normal cyclic prefix in uplink	Extended cyclic prefix in uplink
Uplink duty factor in one special subframe	0~3	7.13%	8.33%
	4~7	14.3%	16.7%

The highest duty factor is resulted from:

For LTE TDD Power class 2

- i. Uplink-downlink configuration: 1. In a half-frame consisted of 5 subframes, uplink operation is in 2 uplink subframes and 1 special subframe.
- ii. special subframe configuration: 5-9 for normal cyclic prefix in downlink, 4-7 for extended cyclic prefix in downlink
- iii. for special subframe with extended cyclic prefix in uplink, the total uplink duty factor in one half-frame is: $(2+0.167)/5 = 43.3\%$
- iv. for special subframe with normal cyclic prefix in uplink, the total uplink duty factor in one half-frame is: $(2+0.143)/5 = 42.9\%$
- v. For TDD LTE SAR measurement, the duty cycle 1:2.33 (42.9 %) was used perform testing and considering the theoretical duty cycle of 43.3% for extended cyclic prefix in the uplink, and the theoretical duty cycle of 42.9% for normal cyclic prefix in uplink, a scaling factor of extended cyclic prefix $43.3\%/42.9\% = 1.009$ is applied to scale-up the measured SAR result. The scaled TDD LTE SAR = measured SAR (W/kg)* Tune-up Scaling Factor* scaling factor for extended cyclic prefix.

For LTE TDD Power class 3

- i. Uplink-downlink configuration: 0. In a half-frame consisted of 5 subframes, uplink operation is in 3 uplink subframes and 1 special subframe.
- ii. special subframe configuration: 5-9 for normal cyclic prefix in downlink, 4-7 for extended cyclic prefix in downlink
- iii. for special subframe with extended cyclic prefix in uplink, the total uplink duty factor in one half-frame is: $(3+0.167)/5 = 63.3\%$
- iv. for special subframe with normal cyclic prefix in uplink, the total uplink duty factor in one half-frame is: $(3+0.143)/5 = 62.9\%$
- v. For TDD LTE SAR measurement, the duty cycle 1:1.59 (62.9 %) was used perform testing and considering the theoretical duty cycle of 63.3% for extended cyclic prefix in the uplink, and the theoretical duty cycle of 62.9% for normal cyclic prefix in uplink, a scaling factor of extended cyclic prefix $63.3\%/62.9\% = 1.006$ is applied to scale-up the measured SAR result. The scaled TDD LTE SAR = measured SAR (W/kg)* Tune-up Scaling Factor* scaling factor for extended cyclic prefix.

The device can adjust uplink/downlink configuration automatically according to the transmitting power class level, as followings:

LTE TDD Band	Power Class level	support uplink/downlink configuration
LTE Band 41	> 23	1,2,3,4,5
	=23	0,1,2,3,4,5,6
	< 23	0,1,2,3,4,5,6



<LTE Carrier Aggregation>

General Note:

1. This device supports Carrier Aggregation on downlink for inter and intra band. For the device supports bands and bandwidths and configurations are provided as follow table was according to 3GPP.
2. In applying the existing power measurement procedures of KDB 941225 D05A for DL CA SAR test exclusion, only the subset with the largest number of combinations of frequency bands and CCs in each row need combination, and for this device that all the configurations were choose to power measurement.
3. All permutations exist. No restrictions on Pcell & Scell combinations.
4. The gray color table is covered by other combinations and no need to verify power.

2CC Downlink Carrier Aggregation			3CC Downlink Carrier Aggregation		
Number	Combination	Covered by Measurement Superset	Number	Combination	Covered by Measurement Superset
1	2A-2A		1	2A-7A-7A	
2	2A-4A		2	2A-7A-66A	
3	2A-5A		3	2A-7C	
4	2A-7A	3CC-1	4	4A-4A-5A	
5	2A-12A		5	4A-7C	
6	2A-17A		6	12A-66A-66A	
7	2A-38A				
8	2A-66A	3CC-2			
9	4A-4A	3CC-4			
10	4A-5A	3CC-4			
11	4A-7A				
12	4A-12A				
13	4A-17A				
14	5A-7A				
15	5A-66A				
16	7A-7A	3CC-1			
17	7A-26A				
18	7A-66A	3CC-2			
19	12A-66A	3CC-6			
20	66A-66A	3CC-6			
21	7B				
22	2C				
23	7C	3CC-5			
24	38C				
25	41C				
26	41A-41A				

LTE Carrier Aggregation Conducted Power (Downlink)

- i. According to KDB941225 D05A v01r02, Uplink maximum output power measurement with downlink carrier aggregation active should be measured, using the highest output channel measured without downlink carrier aggregation, to confirm that uplink maximum output power with downlink carrier aggregation active remains within the specified tune-up tolerance limits and not more than ¼ dB higher than the maximum output measured without downlink carrier aggregation active.
- ii. Uplink maximum output power with downlink carrier aggregation active does not show more than ¼ dB higher than the maximum output power without downlink carrier aggregation active, therefore SAR evaluation with downlink carrier aggregation active can be excluded.
- iii. The device supports downlink three carrier aggregation. For power measurement were control and acknowledge data is sent on uplink channels that operate identical to specifications when downlink carrier aggregation is inactive.
- iv. Selected highest measured power when downlink carrier aggregation is inactive for conducted power comparison with downlink carrier aggregation is active, to confirm that when downlink carrier aggregation is active uplink maximum output power remains within the specified tune-up tolerance limits and not more than ¼ dB higher than the maximum output power measured when downlink carrier aggregation inactive.
- v. For inter-band CA, the SCC selected highest bandwidth and near the middle of its transmission band. For SCC DL RB size and offset will base on the PCC corresponding RB allocation.
- vi. For non-contiguous intra-band CA, the SCC selected to provide maximum separation from the PCC and must remain fully within the downlink transmission band.
- vii. For Intra-band, contiguous CA, the downlink channels selected to perform the uplink power measurement must satisfy 3GPP channel spacing (5.4.1A of 3GPP TS 36.521 or equivalent) and channel bandwidth (5.4.2A) requirements.

$$\text{Nominal channel spacing} = \left\lceil \frac{BW_{\text{Channel}(1)} + BW_{\text{Channel}(2)} - 0.1|BW_{\text{Channel}(1)} - BW_{\text{Channel}(2)}|}{0.6} \right\rceil 0.3 \text{ [MHz]}$$

LTE 4x4 MIMO (Downlink)

This device supports downlink 4x4 MIMO operations for LTE Band 4/7/38/41/66 only. Uplink transmission is limited to a single output stream. Power measurements were performed with downlink 4x4 MIMO active for the configuration with highest measured maximum conducted power with 4x4 downlink MIMO inactive measured among the channel bandwidth, modulation, and RB combinations in each frequency band.

Per FCC Guidance, SAR for downlink 4x4 MIMO was not needed since the maximum average output power in 4x4 downlink MIMO mode was not > 0.25 dB higher than the maximum output power with downlink 4x4 MIMO inactive. When carrier aggregation is applicable, power measurements were performed with the downlink carrier aggregation and 4x4 DL MIMO active for the configuration with highest measured maximum conducted power with downlink carrier aggregation inactive measured among the channel bandwidth, modulation, and RB combinations in each frequency band.

4X4 MIMO	Band
	LTE Band 4/7/38/41/66

LTE Carrier Aggregation Conducted Power (Uplink)

LTE Uplink CA	2CC Uplink Carrier Aggregation
Intra-band	Antenna Tx
CA_7C	Ant 0/3/4
CA_38B	Ant 0/3/4
CA_41C	Ant 0/3/4

<Intra-band>

General Note:

- i. The device supports intra-band uplink carrier aggregation for LTE B7/38/41 with a maximum of two uplink component carriers. For intra band contiguous carrier aggregation scenarios, 3GPP 36.101 table 6.2.2A-1 specifies that the aggregate maximum allowed output power is equivalent to the single carrier scenario. 3GPP 36.101 6.2.3A allows for several dB of MPR to be applied when not-contiguous RB allocation is implemented. The conducted power and MPR setting in this device are permanently implemented pre 3GPP requirement.
- ii. The device supports uplink carrier aggregation with a maximum of two uplink component carriers. For intra band contiguous carrier aggregation scenarios, 3GPP 36.101 table 6.2.2A-1 specifies that the aggregate maximum allowed output power is equivalent to the single carrier scenario. 3GPP 36.101 6.2.3A allows for several dB of MPR to be applied when not-contiguous RB allocation is implemented. The conducted power and MPR setting in this device are permanently implemented pre the 3GPP requirement.
- iii. According Nov. 2017 TCB workshop, the output power with uplink CA active was measured for the configuration with the highest reported SAR with single carrier for each exposure condition. The power was measured with wideband signal integration over both component carriers.
- iv. Additional SAR measurement for LTE UL CA with other DL CA combinations active were not required since the maximum output power for this configuration was not > 0.25dB higher than the maximum output power for UL CA active.

5G NR Output Power (Unit: dBm)

General Note:

1. 5G NR n5/n7 /n66 /n38 /n41 is NSA mode.
2. 5G NR n2/n5/n7 /n26 /n66 /n38/n41 is SA mode.
3. For 5G NR test procedure was following step similar FCC KDB 941225 D05:
 - a. For DFT-OFDM and CP-OFDM output power measurement reduction, according to 38.101 maximum power reduction for power class2 and 3, the CP-OFDM mode will not higher than DFT-OFDM mode, therefore, similar FCC KDB 941225 D05 procedure for other modulation output power for each RB allocation configuration is > not ½ dB higher than the same configuration in DFT-s QPSK and the reported SAR for the DFT-s QPSK configuration is ≤ 1.45 W/kg; CP-OFDM testing is not required.
 - b. For DFT-OFDM output power measurement reduction, according to 38.101 maximum power reduction for power class2 and 3, for 16QAM/64QAM/256QAM and smaller bandwidth output power will spot check largest channel bandwidth worst RB configuration to ensure the 16QAM/64QAM/256QAM and smaller bandwidth output power will not ½ dB higher than the same configuration in the largest supported bandwidth.
 - c. SAR testing start with the largest channel bandwidth and measure SAR for QPSK with 1 RB allocation, using the RB offset and required test channel combination with the highest maximum output power for RB offsets at the upper edge, middle and lower edge of each required test channel
 - d. 50% RB allocation for QPSK SAR testing follows 1RB QPSK allocation procedure
 - e. QPSK with 100% RB allocation, SAR is not required when the highest maximum output power for 100 % RB allocation is less than the highest maximum output power in 50% and 1 RB allocations and the highest reported SAR for 1 RB and 50% RB allocation are ≤ 0.8 W/kg. Otherwise, SAR is measured for the highest output power channel; and if the reported SAR is > 1.45 W/kg, the remaining required test channels must also be tested
 - f. PI/2 BPSK/16QAM/64QAM/256QAM output powers according to 3GPP MPR will not ½ dB higher than the same configuration in QPSK, also reported SAR for the QPSK configuration is less than 1.45 W/kg, PI/2 BPSK /16QAM/64QAM/256QAM SAR testing are not required.
 - g. Smaller bandwidth output power for each RB allocation configuration for this device will not ½ dB higher than the same configuration in the largest supported bandwidth, and the reported SAR for the largest supported bandwidth is ≤ 1.45 W/kg, smaller bandwidth SAR testing is not required for this device
4. For 5G NR test, using FTM (Factory Test Mode) to perform SAR with default 100% transmission.
5. 5G NR n41 supports HPUE, HPUE power and SAR testing performed separately.
6. 5G NR n41 HUPE with higher power, 5G NR n41 HUPE SAR can represent power class 3 level SAR.
7. NSA and SA mode should perform SAR separately. For the maximum power of NSA mode is the same as SA total power level, so SA SAR can represent NSA mode SAR.
8. 5G NR NSA mode, the power level is the same as 5G NR SA mode, so 5G NR NSA mode and SA mode power table only show one time.
9. 5G NR supports CP-OFDM and DFT-s-OFDM modulation, for DFT-s-OFDM power is higher than CP-OFDM, so only show DFT-s-OFDM power table and chose DFT-s-OFDM to perform SAR testing.
10. For DFT-s-OFDM and CP-OFDM output power measurement reduction, according to 38.101 maximum power reduction for the CP-OFDM mode will not higher than DFT-s-OFDM mode, therefore, CP-OFDM measurement is unnecessary.
11. For 5G NR EN-DC mode, standalone SAR performed for 5G NR NSA band with the maximum power, EN-DC SAR summed EN-DC mode 5G NR standalone SAR and LTE standalone SAR, the result of EN-DC SAR is more conservatively.

<3GPP 38.101 MPR for EN-DC>

Table 6.2.2-1 Maximum power reduction (MPR) for power class 3

Modulation		MPR (dB)		
		Edge RB allocations	Outer RB allocations	Inner RB allocations
DFT-s-OFDM	Pi/2 BPSK	$\leq 3.5^1$	$\leq 1.2^1$	$\leq 0.2^1$
		$\leq 0.5^2$	$\leq 0.5^2$	0 ²
	QPSK	≤ 1		0
	16 QAM	≤ 2		≤ 1
	64 QAM	≤ 2.5		
CP-OFDM	256 QAM	≤ 4.5		
	QPSK	≤ 3		≤ 1.5
	16 QAM	≤ 3		≤ 2
	64 QAM	≤ 3.5		
	256 QAM	≤ 6.5		

NOTE 1: Applicable for UE operating in TDD mode with Pi/2 BPSK modulation and UE indicates support for UE capability *powerBoosting-pi2BPSK* and if the IE *powerBoostPi2BPSK* is set to 1 and 40 % or less slots in radio frame are used for UL transmission for bands n40, n41, n77, n78 and n79. The reference power of 0 dB MPR is 26 dBm.

NOTE 2: Applicable for UE operating in FDD mode, or in TDD mode in bands other than n40, n41, n77, n78 and n79 with Pi/2 BPSK modulation and if the IE *powerBoostPi2BPSK* is set to 0 and if more than 40 % of slots in radio frame are used for UL transmission for bands n40, n41, n77, n78 and n79.

Table 6.2.2-2 Maximum power reduction (MPR) for power class 2

Modulation		MPR (dB)		
		Edge RB allocations	Outer RB allocations	Inner RB allocations
DFT-s-OFDM	Pi/2 BPSK	≤ 3.5	≤ 0.5	0
	QPSK	≤ 3.5	≤ 1	0
	16 QAM	≤ 3.5	≤ 2	≤ 1
	64 QAM	≤ 3.5	≤ 2.5	
	256 QAM	≤ 4.5		
CP-OFDM	QPSK	≤ 3.5	≤ 3	≤ 1.5
	16 QAM	≤ 3.5	≤ 3	≤ 2
	64 QAM	≤ 3.5		
	256 QAM	≤ 6.5		



<EN-DC combination>

ENDC	LTE TX	NR TX
DC_2A_n7A	ANT0	ANT4
	ANT3	
DC_4A_n7A	ANT3	ANT0
	ANT4	ANT3
		ANT4
DC_66A_n7A	ANT3	ANT0
	ANT4	ANT3
		ANT4
DC_2A_n66A	ANT0	ANT4
	ANT3	
DC_7A_n66A	ANT3	ANT0
	ANT4	ANT3
		ANT4
DC_5A_n66A	ANT0	ANT0
	ANT1	ANT3
		ANT4
DC_12A_n66A	ANT0	ANT0
	ANT1	ANT3
		ANT4
DC_4A_n38A	ANT3	ANT0
	ANT4	ANT3
		ANT4
DC_5A_n38A	ANT0	ANT0
	ANT1	ANT3
		ANT4
DC_66A_n38A	ANT3	ANT0
	ANT4	ANT3
		ANT4
DC_4A_n41A	ANT3	ANT0
	ANT4	ANT3
		ANT4
DC_66A_n41A	ANT3	ANT0
	ANT4	ANT3
		ANT4
DC_7A_n5A	ANT0	ANT0
	ANT3	ANT1
	ANT4	
DC_66A_n5A	ANT0	ANT0
	ANT3	ANT1
	ANT4	

**<WLAN Conducted Power>****General Note:**

1. The maximum output power specified for production units are determined for all applicable 802.11 transmission modes in each standalone and aggregated frequency band. Maximum output power is measured for the highest maximum output power configuration(s) in each frequency band according to the default power measurement procedures. For "Not required", SAR Test reduction was applied from KDB 248227 guidance, Sec. 2.1, b), 1) when the same maximum power is specified for multiple transmission modes in a frequency band, the largest channel bandwidth, lowest order modulation, lowest data rate and lowest order 802.11a/g/n/ac mode is used for SAR measurement, on the highest measured output power channel in the initial test configuration. Additional output power measurements were not necessary.
2. Per KDB 248227 D01v02r02, SAR test reduction is determined according to 802.11 transmission mode configurations and certain exposure conditions with multiple test positions. In the 2.4 GHz band, separate SAR procedures are applied to DSSS and OFDM configurations to simplify DSSS test requirements. For OFDM, in both 2.4 and 5 GHz bands, an initial test configuration must be determined for each standalone and aggregated frequency band, according to the transmission mode configuration with the highest maximum output power specified for production units to perform SAR measurements. If the same highest maximum output power applies to different combinations of channel bandwidths, modulations and data rates, additional procedures are applied to determine which test configurations require SAR measurement. When applicable, an initial test position may be applied to reduce the number of SAR measurements required for next to the ear, UMPC mini-tablet or hotspot mode configurations with multiple test positions.
3. For 2.4 GHz 802.11b DSSS, either the initial test position procedure for multiple exposure test positions or the DSSS procedure for fixed exposure position is applied; these are mutually exclusive. For 2.4 GHz and 5 GHz OFDM configurations, the initial test configuration is applied to measure SAR using either the initial test position procedure for multiple exposure test position configurations or the initial test configuration procedures for fixed exposure test conditions. Based on the reported SAR of the measured configurations and maximum output power of the transmission mode configurations that are not included in the initial test configuration, the subsequent test configuration and initial test position procedures are applied to determine if SAR measurements are required for the remaining OFDM transmission configurations. In general, the number of test channels that require SAR measurement is minimized based on maximum output power measured for the test sample(s).
4. For OFDM transmission configurations in the 2.4 GHz and 5 GHz bands, When the same maximum power is specified for multiple transmission modes in a frequency band, the largest channel bandwidth, lowest order modulation, lowest data rate and lowest order 802.11a/g/n/ac mode is used for SAR measurement, on the highest measured output power channel for each frequency band.
5. DSSS and OFDM configurations are considered separately according to the required SAR procedures. SAR is measured in the initial test position using the 802.11 transmission mode configuration required by the DSSS procedure or initial test configuration and subsequent test configuration(s) according to the OFDM procedures.18 The initial test position procedure is described in the following:
 - a. When the reported SAR of the initial test position is ≤ 0.4 W/kg, further SAR measurement is not required for the other test positions in that exposure configuration and 802.11 transmission mode combinations within the frequency band or aggregated band.
 - b. When the reported SAR of the test position is > 0.4 W/kg, SAR is repeated for the 802.11 transmission mode configuration tested in the initial test position to measure the subsequent next closet/smallest test separation distance and maximum coupling test position on the highest maximum output power channel, until the report SAR is ≤ 0.8 W/kg or all required test position are tested.
 - c. For all positions/configurations, when the reported SAR is > 0.8 W/kg, SAR is measured for these test positions/configurations on the subsequent next highest measured output power channel(s) until the reported SAR is ≤ 1.2 W/kg or all required channels are tested.
6. 802.11 ax supports both full tone size mode and partial tone size mode, after verification on partial tone size mode that partial size tone mode power will not be higher than full tone size mode, therefore, full tone mode power was chosen to be measured in this report.
7. When the same transmission mode configurations have the same maximum output power on the same channel for the 802.11 a/g/n/ac/ax modes, the channel in the lower order/sequence 802.11 mode (i.e. a, g, n ac then ax) is selected.
8. The 2.4GHz/5GHz/6GHz/BT WLAN can transmit in SISO/MIMO antenna mode.
9. When the single antenna RF power in MIMO mode is less than the single antenna RF power in SISO mode, SAR testing was performed on SISO mode, for MIMO SAR based on standalone SAR to be summed together as MIMO SAR; when the single antenna RF power in MIMO mode is larger than the single antenna RF power in SISO mode, SAR testing was performed on dual antenna.
10. For the conducted power measurement is MIMO chains transmitting simultaneously and measured the separately conducted power for both chains and then based on the conducted power of two antennas respectively to calculate sum of the power for MIMO mode.

<2.4GHz Bluetooth>

General Note:

1. For 2.4GHz Bluetooth SAR testing was selected 1Mbps, due to its highest average power.
2. The Bluetooth duty cycle are 76.35% as following figure, according to Oct. 2016 TCB workshop for Bluetooth SAR scaling need further consideration and the maximum duty cycle is 100%, therefore the actual duty cycle will be scaled up to100% for Bluetooth reported SAR calculation

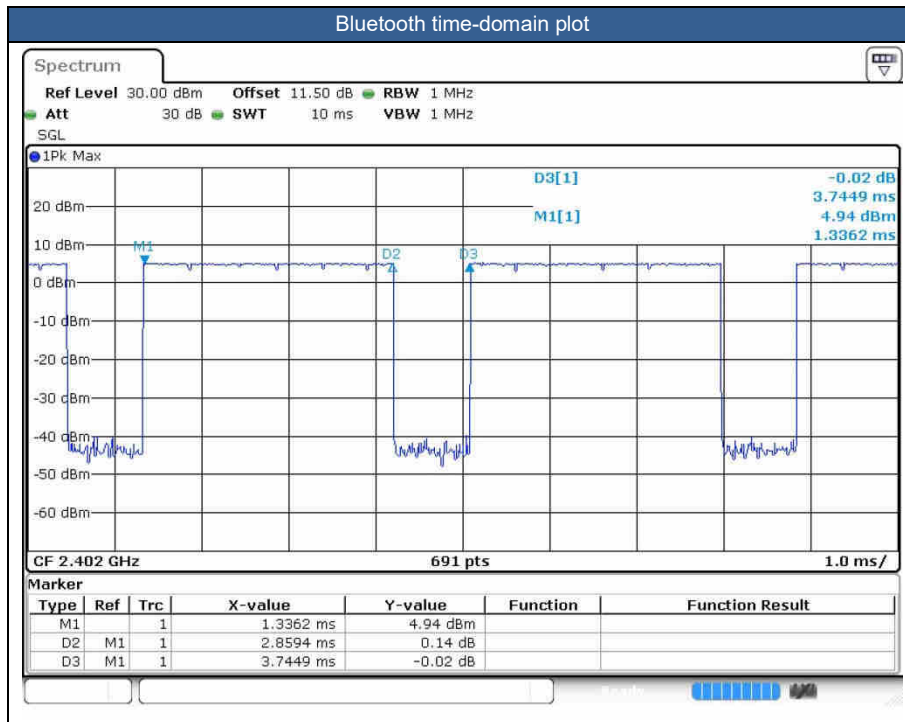



13. Antenna Location

The detailed antenna location information can refer to SAR Test Setup Photos.

14. SAR Test Results

General Note:

1. Per KDB 447498 D01v06, the reported SAR is the measured SAR value adjusted for maximum tune-up tolerance.
 - a. Tune-up scaling Factor = tune-up limit power (mW) / EUT RF power (mW), where tune-up limit is the maximum rated power among all production units.
 - b. For SAR testing of WLAN/Bluetooth signal with non-100% duty cycle, the measured SAR is scaled-up by the duty cycle scaling factor which is equal to "1/(duty cycle)"
 - c. For WWAN: Reported SAR(W/kg)= Measured SAR(W/kg)*Tune-up Scaling Factor
 - d. For BT/WLAN: Reported SAR(W/kg)= Measured SAR(W/kg)* Duty Cycle scaling factor * Tune-up scaling factor
 - e. For TDD LTE SAR measurement of power class 3, the duty cycle 1:1.59 (62.9 %) was used perform testing and considering the theoretical duty cycle of 63.3% for extended cyclic prefix in the uplink, and the theoretical duty cycle of 62.9% for normal cyclic prefix in uplink, a scaling factor of extended cyclic prefix 63.3%/62.9% = 1.006 is applied to scale-up the measured SAR result. The reported TDD LTE SAR (W/kg) = Measured SAR (W/kg)* Tune-up Scaling Factor* scaling factor for extended cyclic prefix.
 - f. For TDD LTE SAR measurement of power class 2, the duty cycle 1:2.33 (42.9 %) was used perform testing and considering the theoretical duty cycle of 43.3% for extended cyclic prefix in the uplink, and the theoretical duty cycle of 42.9% for normal cyclic prefix in uplink, a scaling factor of extended cyclic prefix 43.3%/42.9% = 1.009 is applied to scale-up the measured SAR result. The reported TDD LTE SAR (W/kg) = measured SAR (W/kg)* Tune-up Scaling Factor* scaling factor for extended cyclic prefix.
2. Per KDB 447498 D01v06, for each exposure position, testing of other required channels within the operating mode of a frequency band is not required when the *reported* 1-g or 10-g SAR for the mid-band or highest output power channel is:
 - ≤ 0.8 W/kg or 2.0 W/kg, for 1-g or 10-g respectively, when the transmission band is ≤ 100 MHz
 - ≤ 0.6 W/kg or 1.5 W/kg, for 1-g or 10-g respectively, when the transmission band is between 100 MHz and 200 MHz
 - ≤ 0.4 W/kg or 1.0 W/kg, for 1-g or 10-g respectively, when the transmission band is ≥ 200 MHz
3. Per KDB 865664 D01v01r04, for each frequency band, repeated SAR measurement is required when the measured SAR is ≥ 0.8W/kg. Per KDB 865664 D01v01r04, if the extremity repeated SAR is necessary, the same procedures should be adapted for measurements according to extremity and occupational exposure limits by applying a factor of 2.5 for extremity exposure and a factor of 5 for occupational exposure to the corresponding SAR thresholds.
4. The device implements receiver detect mechanism trigger reduced power for the power management for SAR compliance at different exposure conditions (head, hotspot, body, and extremity). It uses the receiver to indicate whether the user is making a call in head scenario or not. The selection between head and body power levels is based on the receiver detection mechanism. It can determine proximity to head or body and set the relevant power level for 2G&3G&4G and Wi-Fi antennas accordingly. The device will invoke corresponding work scenarios power level base on frequency bands/antennas, which can refer to appendix E.
5. For WLAN when transmit, when transmit simultaneously together with WWAN/BT, the device power will be reduced power at head and extremity exposure conditions.
6. This device supports HPUE for LTE Band 41 with class 2 level, HPUE power has been measured separately. For HPUE power is higher than power class 3 but with lower duty cycle, the maximum average power for class 2 and class 3 is almost the same, so we chose power class 3 full SAR testing and power class 2 verify the worst case of power class 3 SAR.
7. 5G NR n41 HUPE with higher power, 5G NR n41 HUPE SAR can represent power class 3 level SAR.
8. For 5G NR test, using FTM (Factory Test Mode) to perform SAR with default 100% transmission.
9. For 5G NR EN-DC mode, standalone SAR performed for 5G NR NSA band with the maximum power, EN-DC SAR summed EN-DC mode 5G NR standalone SAR and LTE standalone SAR, the result of EN-DC SAR is more conservatively.
10. Per KDB648474 D04v01r03, for smart phones with a display diagonal dimension > 15.0 cm or an overall diagonal dimension > 16.0 cm, when hotspot mode applies, 10-g extremity SAR is required only for the surfaces and edges with hotspot mode 1-g reported SAR > 1.2 W/kg, however, when power reduction applies to hotspot mode the measured SAR must be scaled to the maximum output power, including tolerance, allowed for phablet modes to compare with the 1.2 W/kg SAR test reduction threshold.
 - a. For this device SAR for WWAN/WLAN transmitter scaled to maximum output power mode for product specific 10g SAR is higher than 1.2W/kg of LTE Band 7, 5G NR n5 /n26/n41, therefore product specific 10g SAR is necessary.
 - b. WLAN 5.3/5.5GHz tested the product specific 10g SAR since it has no hotspot mode.
 - c. When 10-g product specific 10g SAR is considered, SAR thresholds is specified in the procedures for SAR test reduction and exclusion should be multiplied by 2.5.



11. According to Nov. 2017 TCB workshop, when the reported 1gSAR for UL CA configuration is <math><1.2\text{ W/kg}</math>, UL CA 1gSAR is not required for all required test channels (PCC based).
12. The following table “n/a” in the result means the SAR cube is too small to be detected.

UL duty cycle detection mechanism specification:

The device supports the UL duty cycle detection mechanism for LTE TDD & 5G NR (including FR1 SA and FR1 ENDC), the rest RAT will not apply. The main purpose is to distinguish duty cycle of UL symbol and apply the relevant power levels accordingly. The main purpose is to provide enhanced user experience while meeting the SAR compliance for transmission scheduling.

Note:

1. SAR is not required because the average output power is not higher than the Max UL duty cycle configuration.
2. For each band, the SAR evaluation uses the highest Time-average power configuration. Since the simulated base station cannot be configured with an accurate Max UL duty cycle, for the SAR test of LTE TDD & 5G NR bands, the highest Time-average power configuration is triggered by some test script to test 4G/5G bands to simulate extreme scenarios (Max UL duty cycle).
3. The detail results please referred to CPH2603_OpDes.

GSM Note:

1. Per KDB 941225 D01v03r01, for SAR test reduction for GSM / GPRS / EDGE modes is determined by the source-based time-averaged output power including tune-up tolerance. The mode with highest specified time-averaged output power should be tested for SAR compliance in the applicable exposure conditions. For modes with the same specified maximum output power and tolerance, the higher number time-slot configuration should be tested.
2. Other configurations of GSM / GPRS / EDGE are considered as secondary modes. The 3G SAR test reduction procedure is applied, when the maximum output power and tune-up tolerance specified for production units in a secondary mode is \leq ¼ dB higher than the primary mode, SAR measurement is not required for the secondary mode.

WCDMA Note:

1. Per KDB 941225 D01v03r01, for SAR testing is measured using a 12.2 kbps RMC with TPC bits configured to all “1’s”.
2. Per KDB 941225 D01v03r01, RMC 12.2kbps setting is used to evaluate SAR. The maximum output power and tune-up tolerance specified for production units in HSDPA / HSUPA / DC-HSDPA / HSPA+ is \leq ¼ dB higher than RMC 12.2Kbps or when the highest reported SAR of the RMC12.2Kbps is scaled by the ratio of specified maximum output power and tune-up tolerance of HSDPA / HSUPA / DC-HSDPA / HSPA+ to RMC12.2Kbps and the adjusted SAR is \leq 1.2 W/kg, SAR measurement is not required for HSDPA / HSUPA / DC-HSDPA / HSPA+ , and according to the following RF output power, the output power results of the secondary modes (HSDPA / HSUPA / DC-HSDPA / HSPA+) are less than ¼ dB higher than the primary modes; therefore, SAR measurement is not required for HSDPA / HSUPA / DC-HSDPA / HSPA+ .

LTE Note:

1. Per KDB 941225 D05v02r05, start with the largest channel bandwidth and measure SAR for QPSK with 1 RB allocation, using the RB offset and required test channel combination with the highest maximum output power for RB offsets at the upper edge, middle and lower edge of each required test channel.
2. Per KDB 941225 D05v02r05, 50% RB allocation for QPSK SAR testing follows 1RB QPSK allocation procedure.
3. Per KDB 941225 D05v02r05, for QPSK with 100% RB allocation, SAR is not required when the highest maximum output power for 100 % RB allocation is less than the highest maximum output power in 50% and 1 RB allocations and the highest reported SAR for 1 RB and 50% RB allocation are \leq 0.8 W/kg. Otherwise, SAR is measured for the highest output power channel; and if the reported SAR is $>$ 1.45 W/kg, the remaining required test channels must also be tested.
4. Per KDB 941225 D05v02r05, 16QAM/64QAM output power for each RB allocation configuration is $>$ not ½ dB higher than the same configuration in QPSK and the reported SAR for the QPSK configuration is \leq 1.45 W/kg; Per KDB 941225 D05v02r05, 16QAM/64QAM SAR testing is not required.
5. Per KDB 941225 D05v02r05, smaller bandwidth output power for each RB allocation configuration is $>$ not ½ dB higher than the same configuration in the largest supported bandwidth, and the reported SAR for the largest supported bandwidth is \leq 1.45 W/kg; Per KDB 941225 D05v02r05, smaller bandwidth SAR testing is not required.
6. For LTE B4 / B5 / B12 / B17 / B26 / B38 the maximum bandwidth does not support three non-overlapping channels, per KDB 941225 D05v02r05, when a device supports overlapping channel assignment in a channel bandwidth configuration, the middle channel of the group of overlapping channels should be selected for testing.
7. LTE B4 / B5 / B17 SAR test was covered by B66 / B26 / B12; according to April 2015 TCB workshop, SAR test for

overlapping LTE bands can be reduced if

- a. the maximum output power, including tolerance, for the smaller band is \leq the larger band to qualify for the SAR test exclusion
- b. the channel bandwidth and other operating parameters for the smaller band are fully supported by the larger band

5G NR Note:

1. For 5G NR test procedure was following step similar FCC KDB 941225 D05:
 - a. SAR testing start with the largest channel bandwidth and measure SAR for QPSK with 1 RB allocation, using the RB offset and required test channel combination with the highest maximum output power for RB offsets at the upper edge, middle and lower edge of each required test channel.
 - b. 50% RB allocation for QPSK SAR testing follows 1RB QPSK allocation procedure
 - c. QPSK with 100% RB allocation, SAR is not required when the highest maximum output power for 100 % RB allocation is less than the highest maximum output power in 50% and 1 RB allocations and the highest reported SAR for 1 RB and 50% RB allocation are ≤ 0.8 W/kg. Otherwise, SAR is measured for the highest output power channel; and if the reported SAR is > 1.45 W/kg, the remaining required test channels must also be tested.
 - d. PI/2 BPSK/16QAM/64QAM/256QAM output powers according to 3GPP MPR will not $\frac{1}{2}$ dB higher than the same configuration in QPSK, also reported SAR for the QPSK configuration is less than 1.45 W/kg, PI/2 BPSK /16QAM/64QAM/256QAM SAR testing are not required.
 - e. Smaller bandwidth output power for each RB allocation configuration for this device will not $\frac{1}{2}$ dB higher than the same configuration in the largest supported bandwidth, and the reported SAR for the largest supported bandwidth is ≤ 1.45 W/kg, smaller bandwidth SAR testing is not required for this device
 - f. For 5G FR1 n5/n7 /n38/n41/n66 the maximum bandwidth does not support three non-overlapping channels, when a device supports overlapping channel assignment in a channel bandwidth configuration, the middle channel of the group of overlapping channels should be selected for testing.

WLAN/Bluetooth Note:

1. Per KDB 248227 D01v02r02, for 2.4GHz 802.11g/n SAR testing is not required when the highest reported SAR for DSSS is adjusted by the ratio of OFDM to DSSS specified maximum output power and the adjusted SAR is ≤ 1.2 W/kg.
2. Per KDB 248227 D01v02r02, U-NII-1 SAR testing is not required when the U-NII-2A band highest reported SAR for a test configuration is ≤ 1.2 W/kg, SAR is not required for U-NII-1 band.
3. When the reported SAR of the test position is > 0.4 W/kg, SAR is repeated for the 802.11 transmission mode configuration tested in the initial test position to measure the subsequent next closet/smallest test separation distance and maximum coupling test position on the highest maximum output power channel, until the report SAR is ≤ 0.8 W/kg or all required test position are tested.
4. For all positions / configurations, when the reported SAR is > 0.8 W/kg, SAR is measured for these test positions / configurations on the subsequent next highest measured output power channel(s) until the reported SAR is ≤ 1.2 W/kg or all required channels are tested.
5. During SAR testing the WLAN transmission was verified using a spectrum analyzer.
6. The 2.4GHz/5GHz WLAN can transmit in SISO/MIMO antenna mode.
7. When the same transmission mode configurations have the same maximum output power on the same channel for the 802.11 a/g/n/ac/ax modes, the channel in the lower order/sequence 802.11 mode (i.e. a, g, n ac then ax) is selected.
8. When the single antenna RF power in MIMO mode is less than the single antenna RF power in SISO mode, SAR testing was performed on SISO mode, for MIMO SAR based on standalone SAR to be summed together as MIMO SAR; when the single antenna RF power in MIMO mode is larger than the single antenna RF power in SISO mode, SAR testing was performed on dual antenna.



14.1 Head SAR

Table with columns: Plot No., Band, BW (MHz), Modulation, RB Size, RB offset, Mode, Test Position, Gap (mm), Antenna, Power State, Ch., Freq. (MHz), Sample, Average Power (dBm), Tune-Up Limit (dBm), Tune-up Scaling Factor, Duty Cycle %, Duty Cycle Scaling Factor, Power Drift (dB), Measured 1g SAR (W/kg), Reported 1g SAR (W/kg). Rows include 750MHz and 835MHz sections with various LTE bands and modulation types.



FCC SAR Test Report

Report No. : FA303018B

Table with columns for FR1 n26, 20M, QPSK, 100, 0, DFT-15, Left Cheek, 0mm, Ant 1, DSI 2, 166300, 831.5, 1, 19.88, 21.20, 1.355, -0.06, 0.735, 0.996. Includes sub-sections for 1750MHz and LTE Band 66.



FCC SAR Test Report

Report No. : FA303018B

Table with columns for LTE Band, Modulation, Power, Frequency, Location, Orientation, Distance, Antenna, DSI, Power density, SAR, and other parameters. A specific row is highlighted in yellow.



Table with 22 columns: FR1 n41 PC2, 100M, QPSK, 135 69, DFT-30, Left Cheek, 0mm, Ant 3, DSI 2, 518598, 2592.99, 1, 14.87, 16.20, 1.358, -, -, 0.05, 0.457, 0.621. Rows contain detailed SAR test parameters and results.



<ENDC>

Table with columns: Plot No., Band, BW (MHz), Modulation, RB Size, RB offset, Mode, Test Position, Gap (mm), Antenna, Power State, Ch., Freq. (MHz), Sample, Average Power (dBm), Tune-Up Limit (dBm), Tune-up Scaling Factor, Duty Cycle %, Duty Cycle Scaling Factor, Power Drift (dB), Measured 1g SAR (W/kg), Reported 1g SAR (W/kg). Contains data for 750MHz and 835MHz bands.



FCC SAR Test Report

Report No. : FA303018B

Table with 21 columns: LTE Band, Modulation, Power, Frequency, Location, Antenna, DSI, Power Spectral Density, SAR values. Rows include configurations for Right/Left Cheek, Right/Left Tilted, and DSI 2/DSI 6.

2600MHz

Table with 21 columns: LTE Band, Modulation, Power, Frequency, Location, Antenna, DSI, Power Spectral Density, SAR values. Rows include configurations for Right/Left Cheek, Right/Left Tilted, and DSI 2/DSI 6.



FCC SAR Test Report

Report No. : FA303018B

Table with columns for antenna model, power, modulation, frequency, polarization, distance, location, antenna type, antenna gain, frequency band, power density, and SAR values. Rows include FR1 n38 and FR1 n41 PC2 configurations.



14.2 Hotspot SAR

Table with columns: Plot No., Band, BW (MHz), Modulation, RB Size, RB offset, Mode, Test Position, Gap (mm), Antenna, Power State, Ch., Freq. (MHz), Sample, Average Power (dBm), Tune-Up Limit (dBm), Tune-up Scaling Factor, Duty Cycle %, Duty Cycle Scaling Factor, Power Drift (dB), Measured 1g SAR (W/kg), Reported 1g SAR (W/kg). Rows are grouped by frequency bands: 750MHz, 835MHz, and 1500MHz.



FCC SAR Test Report

Report No. : FA303018B

Table with columns for LTE Band, Modulation, Power, etc. Includes rows for LTE Band 26, FR1 n26, and WCDMA IV, with specific values for SAR exposure and a highlighted peak of 1.032.



FCC SAR Test Report

Report No. : FA303018B

Table with columns for device, frequency, modulation, power, antenna, and SAR values. Includes rows for FR1 n66, GSM1900, WCDMA II, and LTE Band 2.



FCC SAR Test Report

Report No. : FA303018B

Table with columns: Band, Power, Modulation, Frequency, Power Density, SAR, and specific frequency values. Rows include LTE Bands 38, 38C, 41, and 41C, and FR1 n7.



FCC SAR Test Report

Report No. : FA303018B

	FR1 n41 PC2	100M	QPSK	135	69	DFT-30	Back	10mm	Ant 0	DSI 5	5185982592.99	1	18.21	20.20	1.581	-	-	0.16	0.334	0.528
	FR1 n41 PC2	100M	QPSK	135	69	DFT-30	Left Side	10mm	Ant 0	DSI 5	5185982592.99	1	18.21	20.20	1.581	-	-	-0.13	0.272	0.430
45	FR1 n41 PC2	100M	QPSK	135	69	DFT-30	Bottom Side	10mm	Ant 0	DSI 5	5185982592.99	1	18.21	20.20	1.581	-	-	0.07	0.549	0.868
	FR1 n41 PC2	100M	QPSK	135	69	DFT-30	Bottom Side	10mm	Ant 0	DSI 5	5185982592.99	2	18.21	20.20	1.581	-	-	0.03	0.521	0.824
	FR1 n41 PC2	100M	QPSK	270	0	DFT-30	Bottom Side	10mm	Ant 0	DSI 5	5185982592.99	1	18.20	20.20	1.585	-	-	0.03	0.398	0.631
	FR1 n41 PC2	100M	QPSK	1	137	DFT-30	Front	10mm	Ant 4	DSI 5	5185982592.99	1	16.95	18.70	1.496	-	-	0.02	0.083	0.124
	FR1 n41 PC2	100M	QPSK	1	137	DFT-30	Back	10mm	Ant 4	DSI 5	5185982592.99	1	16.95	18.70	1.496	-	-	-0.16	0.215	0.322
	FR1 n41 PC2	100M	QPSK	1	137	DFT-30	Left Side	10mm	Ant 4	DSI 5	5185982592.99	1	16.95	18.70	1.496	-	-	0.09	0.188	0.281
	FR1 n41 PC2	100M	QPSK	1	137	DFT-30	Top Side	10mm	Ant 4	DSI 5	5185982592.99	1	16.95	18.70	1.496	-	-	-0.09	0.064	0.096
	FR1 n41 PC2	100M	QPSK	135	69	DFT-30	Front	10mm	Ant 4	DSI 5	5185982592.99	1	16.92	18.70	1.507	-	-	-0.04	0.080	0.121
	FR1 n41 PC2	100M	QPSK	135	69	DFT-30	Back	10mm	Ant 4	DSI 5	5185982592.99	1	16.92	18.70	1.507	-	-	-0.14	0.209	0.315
	FR1 n41 PC2	100M	QPSK	135	69	DFT-30	Left Side	10mm	Ant 4	DSI 5	5185982592.99	1	16.92	18.70	1.507	-	-	-0.12	0.185	0.279
	FR1 n41 PC2	100M	QPSK	135	69	DFT-30	Top Side	10mm	Ant 4	DSI 5	5185982592.99	1	16.92	18.70	1.507	-	-	0.01	0.063	0.095



<ENDC>

Plot No.	Band	BW (MHz)	Modulation	RB Size	RB offset	Mode	Test Position	Gap (mm)	Antenna	Power State	Ch.	Freq. (MHz)	Sample	Average Power (dBm)	Tune-Up Limit (dBm)	Tune-up Scaling Factor	Power Drift (dB)	Measured 1g SAR (W/kg)	Reported 1g SAR (W/kg)
750MHz																			
	LTE Band 12	10M	QPSK	1	25	-	Front	10mm	Ant 1	DSI 5	23095	707.5	1	18.82	19.20	1.091	-0.02	0.098	0.107
	LTE Band 12	10M	QPSK	1	25	-	Back	10mm	Ant 1	DSI 5	23095	707.5	1	18.82	19.20	1.091	-0.09	0.162	0.177
	LTE Band 12	10M	QPSK	1	25	-	Left Side	10mm	Ant 1	DSI 5	23095	707.5	1	18.82	19.20	1.091	0.14	0.273	0.298
	LTE Band 12	10M	QPSK	25	12	-	Front	10mm	Ant 1	DSI 5	23095	707.5	1	18.75	19.20	1.109	0.19	0.096	0.106
	LTE Band 12	10M	QPSK	25	12	-	Back	10mm	Ant 1	DSI 5	23095	707.5	1	18.75	19.20	1.109	0.13	0.155	0.172
	LTE Band 12	10M	QPSK	25	12	-	Left Side	10mm	Ant 1	DSI 5	23095	707.5	1	18.75	19.20	1.109	0.07	0.242	0.268
	LTE Band 12	10M	QPSK	1	25	-	Front	10mm	Ant 0	DSI 5	23095	707.5	1	20.28	21.70	1.387	0.16	0.051	0.071
	LTE Band 12	10M	QPSK	1	25	-	Back	10mm	Ant 0	DSI 5	23095	707.5	1	20.28	21.70	1.387	-0.02	0.073	0.101
	LTE Band 12	10M	QPSK	1	25	-	Left Side	10mm	Ant 0	DSI 5	23095	707.5	1	20.28	21.70	1.387	-0.11	0.058	0.080
	LTE Band 12	10M	QPSK	1	25	-	Bottom Side	10mm	Ant 0	DSI 5	23095	707.5	1	20.28	21.70	1.387	0.08	0.042	0.058
	LTE Band 12	10M	QPSK	25	12	-	Front	10mm	Ant 0	DSI 5	23095	707.5	1	20.25	21.70	1.396	-0.01	0.046	0.064
	LTE Band 12	10M	QPSK	25	12	-	Back	10mm	Ant 0	DSI 5	23095	707.5	1	20.25	21.70	1.396	0.11	0.057	0.080
	LTE Band 12	10M	QPSK	25	12	-	Left Side	10mm	Ant 0	DSI 5	23095	707.5	1	20.25	21.70	1.396	-0.06	0.046	0.064
	LTE Band 12	10M	QPSK	25	12	-	Bottom Side	10mm	Ant 0	DSI 5	23095	707.5	1	20.25	21.70	1.396	0.19	0.030	0.042
835MHz																			
	LTE Band 5	10M	QPSK	1	25	-	Front	10mm	Ant 1	DSI 5	20525	836.5	1	16.72	17.00	1.067	0.12	0.157	0.167
	LTE Band 5	10M	QPSK	1	25	-	Back	10mm	Ant 1	DSI 5	20525	836.5	1	16.72	17.00	1.067	-0.11	0.225	0.240
46	LTE Band 5	10M	QPSK	1	25	-	Left Side	10mm	Ant 1	DSI 5	20525	836.5	1	16.72	17.00	1.067	-0.04	0.283	0.302
	LTE Band 5	10M	QPSK	25	12	-	Front	10mm	Ant 1	DSI 5	20525	836.5	1	16.66	17.00	1.081	-0.03	0.137	0.148
	LTE Band 5	10M	QPSK	25	12	-	Back	10mm	Ant 1	DSI 5	20525	836.5	1	16.66	17.00	1.081	0.02	0.211	0.228
	LTE Band 5	10M	QPSK	25	12	-	Left Side	10mm	Ant 1	DSI 5	20525	836.5	1	16.66	17.00	1.081	-0.12	0.225	0.243
	LTE Band 5	10M	QPSK	1	25	-	Front	10mm	Ant 0	DSI 5	20525	836.5	1	19.22	20.50	1.343	-0.12	0.081	0.109
	LTE Band 5	10M	QPSK	1	25	-	Back	10mm	Ant 0	DSI 5	20525	836.5	1	19.22	20.50	1.343	0.05	0.137	0.184
	LTE Band 5	10M	QPSK	1	25	-	Left Side	10mm	Ant 0	DSI 5	20525	836.5	1	19.22	20.50	1.343	0.15	0.059	0.079
	LTE Band 5	10M	QPSK	1	25	-	Bottom Side	10mm	Ant 0	DSI 5	20525	836.5	1	19.22	20.50	1.343	-0.19	0.097	0.130
	LTE Band 5	10M	QPSK	25	12	-	Front	10mm	Ant 0	DSI 5	20525	836.5	1	19.20	20.50	1.349	0.16	0.101	0.136
	LTE Band 5	10M	QPSK	25	12	-	Back	10mm	Ant 0	DSI 5	20525	836.5	1	19.20	20.50	1.349	-0.04	0.168	0.227
	LTE Band 5	10M	QPSK	25	12	-	Left Side	10mm	Ant 0	DSI 5	20525	836.5	1	19.20	20.50	1.349	-0.12	0.077	0.104
	LTE Band 5	10M	QPSK	25	12	-	Bottom Side	10mm	Ant 0	DSI 5	20525	836.5	1	19.20	20.50	1.349	0.17	0.120	0.162
	FR1 n5	20M	QPSK	1	53	DFT-15	Front	10mm	Ant 1	DSI 5	167300	836.5	1	16.42	17.70	1.343	-0.07	0.148	0.199
	FR1 n5	20M	QPSK	1	53	DFT-15	Back	10mm	Ant 1	DSI 5	167300	836.5	1	16.42	17.70	1.343	0.12	0.210	0.282
	FR1 n5	20M	QPSK	1	53	DFT-15	Left Side	10mm	Ant 1	DSI 5	167300	836.5	1	16.42	17.70	1.343	0.19	0.284	0.381
	FR1 n5	20M	QPSK	50	28	DFT-15	Front	10mm	Ant 1	DSI 5	167300	836.5	1	16.36	17.70	1.361	0.12	0.151	0.206
	FR1 n5	20M	QPSK	50	28	DFT-15	Back	10mm	Ant 1	DSI 5	167300	836.5	1	16.36	17.70	1.361	-0.08	0.212	0.289
47	FR1 n5	20M	QPSK	50	28	DFT-15	Left Side	10mm	Ant 1	DSI 5	167300	836.5	1	16.36	17.70	1.361	0.16	0.287	0.391
	FR1 n5	20M	QPSK	1	53	DFT-15	Front	10mm	Ant 0	DSI 5	167300	836.5	1	18.64	20.20	1.432	0.14	0.068	0.097
	FR1 n5	20M	QPSK	1	53	DFT-15	Back	10mm	Ant 0	DSI 5	167300	836.5	1	18.64	20.20	1.432	0.04	0.114	0.163
	FR1 n5	20M	QPSK	1	53	DFT-15	Left Side	10mm	Ant 0	DSI 5	167300	836.5	1	18.64	20.20	1.432	0.08	0.056	0.080
	FR1 n5	20M	QPSK	1	53	DFT-15	Bottom Side	10mm	Ant 0	DSI 5	167300	836.5	1	18.64	20.20	1.432	0.03	0.074	0.106
	FR1 n5	20M	QPSK	50	28	DFT-15	Front	10mm	Ant 0	DSI 5	167300	836.5	1	18.43	20.20	1.503	-0.16	0.056	0.084
	FR1 n5	20M	QPSK	50	28	DFT-15	Back	10mm	Ant 0	DSI 5	167300	836.5	1	18.43	20.20	1.503	0.16	0.104	0.156
	FR1 n5	20M	QPSK	50	28	DFT-15	Left Side	10mm	Ant 0	DSI 5	167300	836.5	1	18.43	20.20	1.503	0.13	0.047	0.071
	FR1 n5	20M	QPSK	50	28	DFT-15	Bottom Side	10mm	Ant 0	DSI 5	167300	836.5	1	18.43	20.20	1.503	0.06	0.069	0.104
1750MHz																			
	LTE Band 66	20M	QPSK	1	49	-	Front	10mm	Ant 3	DSI 5	132322	1745	1	16.78	17.30	1.127	0.16	0.086	0.097
	LTE Band 66	20M	QPSK	1	49	-	Back	10mm	Ant 3	DSI 5	132322	1745	1	16.78	17.30	1.127	0.07	0.156	0.176
	LTE Band 66	20M	QPSK	1	49	-	Left Side	10mm	Ant 3	DSI 5	132322	1745	1	16.78	17.30	1.127	-0.19	0.030	0.034
	LTE Band 66	20M	QPSK	1	49	-	Top Side	10mm	Ant 3	DSI 5	132322	1745	1	16.78	17.30	1.127	0.12	0.154	0.174
	LTE Band 66	20M	QPSK	50	24	-	Front	10mm	Ant 3	DSI 5	132322	1745	1	16.75	17.30	1.135	-0.18	0.088	0.100
	LTE Band 66	20M	QPSK	50	24	-	Back	10mm	Ant 3	DSI 5	132322	1745	1	16.75	17.30	1.135	0.19	0.158	0.179
	LTE Band 66	20M	QPSK	50	24	-	Left Side	10mm	Ant 3	DSI 5	132322	1745	1	16.75	17.30	1.135	-0.19	0.031	0.035
	LTE Band 66	20M	QPSK	50	24	-	Top Side	10mm	Ant 3	DSI 5	132322	1745	1	16.75	17.30	1.135	-0.05	0.156	0.177



FCC SAR Test Report

Report No. : FA303018B

Table with columns for LTE Band 66, FR1 n66, and 1900MHz. Each row contains 20 columns of test parameters including power, modulation, frequency, antenna, distance, and SAR values.



FCC SAR Test Report

Report No. : FA303018B

LTE Band 2	20M	QPSK	50	24	-	Bottom Side	10mm	Ant 0	DSI 5	18900	1880	1	14.95	15.80	1.216	-0.13	0.206	0.251	
2600MHz																			
LTE Band 7	20M	QPSK	1	49	-	Front	10mm	Ant 3	DSI 5	21100	2535	1	12.75	13.80	1.274	-0.05	0.050	0.064	
LTE Band 7	20M	QPSK	1	49	-	Back	10mm	Ant 3	DSI 5	21100	2535	1	12.75	13.80	1.274	0.11	0.088	0.112	
LTE Band 7	20M	QPSK	1	49	-	Left Side	10mm	Ant 3	DSI 5	21100	2535	1	12.75	13.80	1.274	0.13	0.019	0.024	
LTE Band 7	20M	QPSK	1	49	-	Top Side	10mm	Ant 3	DSI 5	21100	2535	1	12.75	13.80	1.274	-0.08	0.100	0.127	
LTE Band 7	20M	QPSK	50	24	-	Front	10mm	Ant 3	DSI 5	21100	2535	1	12.67	13.80	1.297	0.06	0.054	0.070	
LTE Band 7	20M	QPSK	50	24	-	Back	10mm	Ant 3	DSI 5	21100	2535	1	12.67	13.80	1.297	-0.19	0.090	0.117	
LTE Band 7	20M	QPSK	50	24	-	Left Side	10mm	Ant 3	DSI 5	21100	2535	1	12.67	13.80	1.297	0.02	0.019	0.025	
LTE Band 7	20M	QPSK	50	24	-	Top Side	10mm	Ant 3	DSI 5	21100	2535	1	12.67	13.80	1.297	-0.14	0.105	0.136	
LTE Band 7	20M	QPSK	1	49	-	Front	10mm	Ant 0	DSI 5	21100	2535	1	15.81	16.30	1.119	0.08	0.134	0.150	
LTE Band 7	20M	QPSK	1	49	-	Back	10mm	Ant 0	DSI 5	21100	2535	1	15.81	16.30	1.119	0.12	0.176	0.197	
LTE Band 7	20M	QPSK	1	49	-	Left Side	10mm	Ant 0	DSI 5	21100	2535	1	15.81	16.30	1.119	0.03	0.055	0.062	
LTE Band 7	20M	QPSK	1	49	-	Bottom Side	10mm	Ant 0	DSI 5	21100	2535	1	15.81	16.30	1.119	0.09	0.344	0.385	
LTE Band 7	20M	QPSK	50	24	-	Front	10mm	Ant 0	DSI 5	21100	2535	1	15.75	16.30	1.135	0.03	0.127	0.144	
LTE Band 7	20M	QPSK	50	24	-	Back	10mm	Ant 0	DSI 5	21100	2535	1	15.75	16.30	1.135	0.14	0.166	0.188	
LTE Band 7	20M	QPSK	50	24	-	Left Side	10mm	Ant 0	DSI 5	21100	2535	1	15.75	16.30	1.135	0.05	0.053	0.060	
LTE Band 7	20M	QPSK	50	24	-	Bottom Side	10mm	Ant 0	DSI 5	21100	2535	1	15.75	16.30	1.135	-0.08	0.277	0.314	
LTE Band 7	20M	QPSK	1	49	-	Front	10mm	Ant 4	DSI 5	21100	2535	1	14.29	15.30	1.262	0.01	0.033	0.042	
LTE Band 7	20M	QPSK	1	49	-	Back	10mm	Ant 4	DSI 5	21100	2535	1	14.29	15.30	1.262	-0.03	0.094	0.119	
LTE Band 7	20M	QPSK	1	49	-	Left Side	10mm	Ant 4	DSI 5	21100	2535	1	14.29	15.30	1.262	0.17	0.090	0.114	
LTE Band 7	20M	QPSK	1	49	-	Top Side	10mm	Ant 4	DSI 5	21100	2535	1	14.29	15.30	1.262	0.06	0.021	0.026	
LTE Band 7	20M	QPSK	50	24	-	Front	10mm	Ant 4	DSI 5	21100	2535	1	14.22	15.30	1.282	0.12	0.035	0.045	
LTE Band 7	20M	QPSK	50	24	-	Back	10mm	Ant 4	DSI 5	21100	2535	1	14.22	15.30	1.282	-0.19	0.095	0.122	
LTE Band 7	20M	QPSK	50	24	-	Left Side	10mm	Ant 4	DSI 5	21100	2535	1	14.22	15.30	1.282	0.18	0.094	0.121	
LTE Band 7	20M	QPSK	50	24	-	Top Side	10mm	Ant 4	DSI 5	21100	2535	1	14.22	15.30	1.282	-0.19	0.022	0.028	
FR1 n7	40M	QPSK	1	108	DFT-15	Front	10mm	Ant 3	DSI 5	507000	2535	1	12.49	13.20	1.178	-0.1	0.058	0.068	
FR1 n7	40M	QPSK	1	108	DFT-15	Back	10mm	Ant 3	DSI 5	507000	2535	1	12.49	13.20	1.178	-0.04	0.100	0.118	
FR1 n7	40M	QPSK	1	108	DFT-15	Left Side	10mm	Ant 3	DSI 5	507000	2535	1	12.49	13.20	1.178	0.16	0.023	0.027	
FR1 n7	40M	QPSK	1	108	DFT-15	Top Side	10mm	Ant 3	DSI 5	507000	2535	1	12.49	13.20	1.178	-0.04	0.114	0.134	
FR1 n7	40M	QPSK	108	54	DFT-15	Front	10mm	Ant 3	DSI 5	507000	2535	1	12.43	13.20	1.194	0.11	0.059	0.070	
FR1 n7	40M	QPSK	108	54	DFT-15	Back	10mm	Ant 3	DSI 5	507000	2535	1	12.43	13.20	1.194	-0.06	0.101	0.121	
FR1 n7	40M	QPSK	108	54	DFT-15	Left Side	10mm	Ant 3	DSI 5	507000	2535	1	12.43	13.20	1.194	0.03	0.023	0.027	
FR1 n7	40M	QPSK	108	54	DFT-15	Top Side	10mm	Ant 3	DSI 5	507000	2535	1	12.43	13.20	1.194	-0.13	0.113	0.135	
FR1 n7	40M	QPSK	1	108	DFT-15	Front	10mm	Ant 0	DSI 5	507000	2535	1	14.35	15.20	1.216	-0.01	0.117	0.142	
FR1 n7	40M	QPSK	1	108	DFT-15	Back	10mm	Ant 0	DSI 5	507000	2535	1	14.35	15.20	1.216	0.05	0.159	0.193	
FR1 n7	40M	QPSK	1	108	DFT-15	Left Side	10mm	Ant 0	DSI 5	507000	2535	1	14.35	15.20	1.216	-0.09	0.060	0.073	
FR1 n7	40M	QPSK	1	108	DFT-15	Bottom Side	10mm	Ant 0	DSI 5	507000	2535	1	14.35	15.20	1.216	0.11	0.319	0.388	
FR1 n7	40M	QPSK	108	54	DFT-15	Front	10mm	Ant 0	DSI 5	507000	2535	1	14.27	15.20	1.239	-0.07	0.116	0.144	
FR1 n7	40M	QPSK	108	54	DFT-15	Back	10mm	Ant 0	DSI 5	507000	2535	1	14.27	15.20	1.239	0.17	0.158	0.196	
FR1 n7	40M	QPSK	108	54	DFT-15	Left Side	10mm	Ant 0	DSI 5	507000	2535	1	14.27	15.20	1.239	-0.03	0.057	0.071	
FR1 n7	40M	QPSK	108	54	DFT-15	Bottom Side	10mm	Ant 0	DSI 5	507000	2535	1	14.27	15.20	1.239	0.03	0.298	0.369	
FR1 n7	40M	QPSK	1	108	DFT-15	Front	10mm	Ant 4	DSI 5	507000	2535	1	13.55	14.70	1.303	-0.09	0.035	0.046	
FR1 n7	40M	QPSK	1	108	DFT-15	Back	10mm	Ant 4	DSI 5	507000	2535	1	13.55	14.70	1.303	0.14	0.099	0.129	
FR1 n7	40M	QPSK	1	108	DFT-15	Left Side	10mm	Ant 4	DSI 5	507000	2535	1	13.55	14.70	1.303	0.19	0.096	0.125	
FR1 n7	40M	QPSK	1	108	DFT-15	Top Side	10mm	Ant 4	DSI 5	507000	2535	1	13.55	14.70	1.303	-0.08	0.025	0.033	
FR1 n7	40M	QPSK	108	54	DFT-15	Front	10mm	Ant 4	DSI 5	507000	2535	1	13.46	14.70	1.330	-0.16	0.037	0.049	
FR1 n7	40M	QPSK	108	54	DFT-15	Back	10mm	Ant 4	DSI 5	507000	2535	1	13.46	14.70	1.330	-0.01	0.101	0.134	
FR1 n7	40M	QPSK	108	54	DFT-15	Left Side	10mm	Ant 4	DSI 5	507000	2535	1	13.46	14.70	1.330	-0.11	0.100	0.133	
FR1 n7	40M	QPSK	108	54	DFT-15	Top Side	10mm	Ant 4	DSI 5	507000	2535	1	13.46	14.70	1.330	0.01	0.028	0.037	
FR1 n38	40M	QPSK	1	53	DFT-30	Front	10mm	Ant 3	DSI 5	519000	2595	1	12.75	14.20	1.396	0.11	0.065	0.091	
FR1 n38	40M	QPSK	1	53	DFT-30	Back	10mm	Ant 3	DSI 5	519000	2595	1	12.75	14.20	1.396	0.09	0.111	0.155	
FR1 n38	40M	QPSK	1	53	DFT-30	Left Side	10mm	Ant 3	DSI 5	519000	2595	1	12.75	14.20	1.396	0.16	0.025	0.035	
FR1 n38	40M	QPSK	1	53	DFT-30	Top Side	10mm	Ant 3	DSI 5	519000	2595	1	12.75	14.20	1.396	-0.06	0.133	0.186	
FR1 n38	40M	QPSK	50	28	DFT-30	Front	10mm	Ant 3	DSI 5	519000	2595	1	12.70	14.20	1.413	0.13	0.061	0.086	
FR1 n38	40M	QPSK	50	28	DFT-30	Back	10mm	Ant 3	DSI 5	519000	2595	1	12.70	14.20	1.413	0.15	0.109	0.154	



Table with 20 columns: Model, Power, Modulation, Frequency, Bandwidth, Modulation, Frequency, Bandwidth, Modulation, Frequency, Bandwidth, Modulation, Frequency, Bandwidth, Modulation, Frequency, Bandwidth, Modulation, Frequency, Bandwidth. Rows include FR1 n38 and FR1 n41 PC2 configurations.



Plot No.	Band	Mode	Test Position	Gap (mm)	Antenna	Power State	Ch.	Freq. (MHz)	Sample	Average Power (dBm)	Tune-Up Limit (dBm)	Tune-up Scaling Factor	Duty Cycle %	Duty Cycle Scaling Factor	Power Drift (dB)	Measured 1g SAR (W/kg)	Reported 1g SAR (W/kg)	
BT/WIFI																		
	Bluetooth	DH5 1Mbps	Front	10mm	Ant 7	Full	39	2441	1	14.30	15.00	1.175	76.35	1.310	-0.04	0.057	0.087	
	Bluetooth	DH5 1Mbps	Back	10mm	Ant 7	Full	39	2441	1	14.30	15.00	1.175	76.35	1.310	0	0.065	0.100	
	Bluetooth	DH5 1Mbps	Right Side	10mm	Ant 7	Full	39	2441	1	14.30	15.00	1.175	76.35	1.310	0.1	0.017	0.026	
48	Bluetooth	DH5 1Mbps	Top Side	10mm	Ant 7	Full	39	2441	1	14.30	15.00	1.175	76.35	1.310	-0.12	0.110	0.169	
	WLAN2.4GHz	802.11b 1Mbps	Front	10mm	Ant 7	Full	6	2437	1	13.95	14.50	1.135	100	1.000	0.04	0.068	0.077	
	WLAN2.4GHz	802.11b 1Mbps	Back	10mm	Ant 7	Full	6	2437	1	13.95	14.50	1.135	100	1.000	0.04	0.130	0.148	
	WLAN2.4GHz	802.11b 1Mbps	Right Side	10mm	Ant 7	Full	6	2437	1	13.95	14.50	1.135	100	1.000	-0.11	0.062	0.070	
	WLAN2.4GHz	802.11b 1Mbps	Top Side	10mm	Ant 7	Full	6	2437	1	13.95	14.50	1.135	100	1.000	-0.08	0.145	0.165	
	WLAN2.4GHz	802.11b 1Mbps	Front	10mm	Ant 8	Full	6	2437	1	13.91	14.50	1.146	100	1.000	-0.12	0.116	0.133	
	WLAN2.4GHz	802.11b 1Mbps	Back	10mm	Ant 8	Full	6	2437	1	13.91	14.50	1.146	100	1.000	0.07	0.121	0.139	
49	WLAN2.4GHz	802.11b 1Mbps	Right Side	10mm	Ant 8	Full	6	2437	1	13.91	14.50	1.146	100	1.000	-0.05	0.159	0.182	
	WLAN2.4GHz	802.11b 1Mbps	Top Side	10mm	Ant 8	Full	6	2437	1	13.91	14.50	1.146	100	1.000	-	n/a	n/a	
	WLAN5.2GHz	802.11n-HT40 MCS0	Front	10mm	Ant 8+6	Full	46	5230	1	16.11	17.00	1.227	87.66	1.141	0.04	0.161	0.225	
	WLAN5.2GHz	802.11n-HT40 MCS0	Back	10mm	Ant 8+6	Full	46	5230	1	16.11	17.00	1.227	87.66	1.141	0.03	0.310	0.434	
50	WLAN5.2GHz	802.11n-HT40 MCS0	Right Side	10mm	Ant 8+6	Full	46	5230	1	16.11	17.00	1.227	87.66	1.141	-0.03	0.492	0.689	
	WLAN5.2GHz	802.11n-HT40 MCS0	Right Side	10mm	Ant 8+6	Full	46	5230	2	16.11	17.00	1.227	87.66	1.141	-0.03	0.467	0.654	
	WLAN5.2GHz	802.11n-HT40 MCS0	Top Side	10mm	Ant 8+6	Full	46	5230	1	16.11	17.00	1.227	87.66	1.141	-0.07	0.316	0.443	
	WLAN5.8GHz	802.11ac-VHT80 MCS0	Front	10mm	Ant 8+6	Full	155	5775	1	12.55	13.50	1.245	87.28	1.146	-0.01	0.071	0.101	
51	WLAN5.8GHz	802.11ac-VHT80 MCS0	Back	10mm	Ant 8+6	Full	155	5775	1	12.55	13.50	1.245	87.28	1.146	-0.02	0.249	0.355	
	WLAN5.8GHz	802.11ac-VHT80 MCS0	Right Side	10mm	Ant 8+6	Full	155	5775	1	12.55	13.50	1.245	87.28	1.146	0.1	0.122	0.174	
	WLAN5.8GHz	802.11ac-VHT80 MCS0	Top Side	10mm	Ant 8+6	Full	155	5775	1	12.55	13.50	1.245	87.28	1.146	0.01	0.211	0.301	



14.3 Body Worn Accessory SAR

Table with columns: Plot No., Band, BW (MHz), Modulation, RB Size, RB offset, Mode, Test Position, Gap (mm), Antenna, Power State, Ch., Freq. (MHz), Sample, Average Power (dBm), Tune-Up Limit (dBm), Tune-up Scaling Factor, Duty Cycle %, Duty Cycle Scaling Factor, Power Drift (dB), Measured 1g SAR (W/kg), Reported 1g SAR (W/kg). Rows are grouped by frequency bands: 750MHz, 835MHz, and 1500MHz.



FCC SAR Test Report

Report No. : FA303018B

	LTE Band 26	15M	QPSK	1	37	-	Front	15mm	Ant 0	DSI 1	26865	831.5	1	23.27	24.60	1.358	-	-	0.04	0.163	0.221
	LTE Band 26	15M	QPSK	1	37	-	Back	15mm	Ant 0	DSI 1	26865	831.5	1	23.27	24.60	1.358	-	-	0.01	0.196	0.266
	LTE Band 26	15M	QPSK	36	20	-	Front	15mm	Ant 0	DSI 1	26865	831.5	1	22.28	23.60	1.355	-	-	-0.07	0.124	0.168
	LTE Band 26	15M	QPSK	36	20	-	Back	15mm	Ant 0	DSI 1	26865	831.5	1	22.28	23.60	1.355	-	-	-0.16	0.148	0.201
	LTE Band 26	15M	QPSK	1	37	-	Front	15mm	Ant 0	DSI 5	26865	831.5	1	22.28	23.60	1.355	-	-	0.16	0.119	0.161
	LTE Band 26	15M	QPSK	1	37	-	Back	15mm	Ant 0	DSI 5	26865	831.5	1	22.28	23.60	1.355	-	-	-0.17	0.141	0.191
	LTE Band 26	15M	QPSK	36	20	-	Front	15mm	Ant 0	DSI 5	26865	831.5	1	22.16	23.60	1.393	-	-	-0.08	0.112	0.156
	LTE Band 26	15M	QPSK	36	20	-	Back	15mm	Ant 0	DSI 5	26865	831.5	1	22.16	23.60	1.393	-	-	0.08	0.135	0.188
	FR1 n26	20M	QPSK	1	53	DFT-15	Front	15mm	Ant 1	DSI 1	166300	831.5	1	21.45	22.70	1.334	-	-	0.01	0.298	0.397
57	FR1 n26	20M	QPSK	1	53	DFT-15	Back	15mm	Ant 1	DSI 1	166300	831.5	1	21.45	22.70	1.334	-	-	0.15	0.461	0.615
	FR1 n26	20M	QPSK	1	53	DFT-15	Back	15mm	Ant 1	DSI 1	166300	831.5	2	21.45	22.70	1.334	-	-	0.15	0.454	0.605
	FR1 n26	20M	QPSK	50	28	DFT-15	Front	15mm	Ant 1	DSI 1	166300	831.5	1	21.42	22.70	1.343	-	-	-0.14	0.290	0.389
	FR1 n26	20M	QPSK	50	28	DFT-15	Back	15mm	Ant 1	DSI 1	166300	831.5	1	21.42	22.70	1.343	-	-	-0.13	0.419	0.563
	FR1 n26	20M	QPSK	1	53	DFT-15	Front	15mm	Ant 1	DSI 5	166300	831.5	1	19.94	21.20	1.337	-	-	-0.09	0.207	0.277
	FR1 n26	20M	QPSK	1	53	DFT-15	Back	15mm	Ant 1	DSI 5	166300	831.5	1	19.94	21.20	1.337	-	-	0.05	0.326	0.436
	FR1 n26	20M	QPSK	50	28	DFT-15	Front	15mm	Ant 1	DSI 5	166300	831.5	1	19.93	21.20	1.340	-	-	0.02	0.205	0.275
	FR1 n26	20M	QPSK	50	28	DFT-15	Back	15mm	Ant 1	DSI 5	166300	831.5	1	19.93	21.20	1.340	-	-	0	0.297	0.398
	FR1 n26	20M	QPSK	1	53	DFT-15	Front	15mm	Ant 0	DSI 1	166300	831.5	1	23.40	24.70	1.349	-	-	-0.09	0.137	0.185
	FR1 n26	20M	QPSK	1	53	DFT-15	Back	15mm	Ant 0	DSI 1	166300	831.5	1	23.40	24.70	1.349	-	-	-0.07	0.172	0.232
	FR1 n26	20M	QPSK	50	28	DFT-15	Front	15mm	Ant 0	DSI 1	166300	831.5	1	23.39	24.70	1.352	-	-	0.07	0.135	0.183
	FR1 n26	20M	QPSK	50	28	DFT-15	Back	15mm	Ant 0	DSI 1	166300	831.5	1	23.39	24.70	1.352	-	-	-0.05	0.170	0.230
	FR1 n26	20M	QPSK	1	53	DFT-15	Front	15mm	Ant 0	DSI 5	166300	831.5	1	21.96	23.20	1.330	-	-	-0.09	0.097	0.129
	FR1 n26	20M	QPSK	1	53	DFT-15	Back	15mm	Ant 0	DSI 5	166300	831.5	1	21.96	23.20	1.330	-	-	-0.04	0.122	0.162
	FR1 n26	20M	QPSK	50	28	DFT-15	Front	15mm	Ant 0	DSI 5	166300	831.5	1	21.89	23.20	1.352	-	-	0.07	0.095	0.128
	FR1 n26	20M	QPSK	50	28	DFT-15	Back	15mm	Ant 0	DSI 5	166300	831.5	1	21.89	23.20	1.352	-	-	-0.18	0.119	0.161
1750MHz																					
	WCDMA IV	-	-	-	-	RMC 12.2Kbps	Front	15mm	Ant 3	DSI 1	1413	1732.6	1	22.77	23.30	1.130	-	-	0.01	0.182	0.206
	WCDMA IV	-	-	-	-	RMC 12.2Kbps	Back	15mm	Ant 3	DSI 1	1413	1732.6	1	22.77	23.30	1.130	-	-	-0.06	0.302	0.341
	WCDMA IV	-	-	-	-	RMC 12.2Kbps	Front	15mm	Ant 3	DSI 5	1413	1732.6	1	20.72	21.30	1.143	-	-	-0.03	0.115	0.131
	WCDMA IV	-	-	-	-	RMC 12.2Kbps	Back	15mm	Ant 3	DSI 5	1413	1732.6	1	20.72	21.30	1.143	-	-	-0.16	0.201	0.230
	WCDMA IV	-	-	-	-	RMC 12.2Kbps	Front	15mm	Ant 0	DSI 1	1413	1732.6	1	20.64	21.80	1.306	-	-	-0.07	0.221	0.289
58	WCDMA IV	-	-	-	-	RMC 12.2Kbps	Back	15mm	Ant 0	DSI 1	1413	1732.6	1	20.64	21.80	1.306	-	-	-0.11	0.358	0.468
	WCDMA IV	-	-	-	-	RMC 12.2Kbps	Front	15mm	Ant 0	DSI 5	1413	1732.6	1	18.73	19.80	1.279	-	-	-0.07	0.139	0.178
	WCDMA IV	-	-	-	-	RMC 12.2Kbps	Back	15mm	Ant 0	DSI 5	1413	1732.6	1	18.73	19.80	1.279	-	-	-0.06	0.226	0.289
	LTE Band 66	20M	QPSK	1	49	-	Front	15mm	Ant 3	DSI 1	132322	1745	1	21.86	22.30	1.107	-	-	0.06	0.134	0.148
	LTE Band 66	20M	QPSK	1	49	-	Back	15mm	Ant 3	DSI 1	132322	1745	1	21.86	22.30	1.107	-	-	-0.08	0.218	0.241
	LTE Band 66	20M	QPSK	50	24	-	Front	15mm	Ant 3	DSI 1	132322	1745	1	21.75	22.30	1.135	-	-	0.16	0.138	0.157
	LTE Band 66	20M	QPSK	50	24	-	Back	15mm	Ant 3	DSI 1	132322	1745	1	21.75	22.30	1.135	-	-	0.17	0.220	0.250
	LTE Band 66	20M	QPSK	1	49	-	Front	15mm	Ant 3	DSI 5	132322	1745	1	19.91	20.30	1.094	-	-	-0.03	0.085	0.093
	LTE Band 66	20M	QPSK	1	49	-	Back	15mm	Ant 3	DSI 5	132322	1745	1	19.91	20.30	1.094	-	-	0.07	0.135	0.148
	LTE Band 66	20M	QPSK	50	24	-	Front	15mm	Ant 3	DSI 5	132322	1745	1	18.89	20.30	1.384	-	-	0.01	0.089	0.123
	LTE Band 66	20M	QPSK	50	24	-	Back	15mm	Ant 3	DSI 5	132322	1745	1	18.89	20.30	1.384	-	-	0.08	0.138	0.191
	LTE Band 66	20M	QPSK	1	49	-	Front	15mm	Ant 0	DSI 1	132322	1745	1	20.25	21.30	1.274	-	-	0.11	0.195	0.248
	LTE Band 66	20M	QPSK	1	49	-	Back	15mm	Ant 0	DSI 1	132322	1745	1	20.25	21.30	1.274	-	-	0.14	0.314	0.400
	LTE Band 66	20M	QPSK	50	24	-	Front	15mm	Ant 0	DSI 1	132322	1745	1	20.24	21.30	1.276	-	-	0.02	0.199	0.254
59	LTE Band 66	20M	QPSK	50	24	-	Back	15mm	Ant 0	DSI 1	132322	1745	1	20.24	21.30	1.276	-	-	-0.13	0.315	0.402
	LTE Band 66	20M	QPSK	1	49	-	Front	15mm	Ant 0	DSI 5	132322	1745	1	18.29	19.30	1.262	-	-	-0.19	0.123	0.155
	LTE Band 66	20M	QPSK	1	49	-	Back	15mm	Ant 0	DSI 5	132322	1745	1	18.29	19.30	1.262	-	-	-0.11	0.198	0.250
	LTE Band 66	20M	QPSK	50	24	-	Front	15mm	Ant 0	DSI 5	132322	1745	1	18.28	19.30	1.265	-	-	0.11	0.126	0.159
	LTE Band 66	20M	QPSK	50	24	-	Back	15mm	Ant 0	DSI 5	132322	1745	1	18.28	19.30	1.265	-	-	-0.02	0.199	0.252
	LTE Band 66	20M	QPSK	1	49	-	Front	15mm	Ant 4	DSI 1	132322	1745	1	21.37	21.80	1.104	-	-	-0.01	0.104	0.115
	LTE Band 66	20M	QPSK	1	49	-	Back	15mm	Ant 4	DSI 1	132322	1745	1	21.37	21.80	1.104	-	-	-0.14	0.188	0.208
	LTE Band 66	20M	QPSK	50	24	-	Front	15mm	Ant 4	DSI 1	132322	1745	1	21.30	21.80	1.122	-	-	0.01	0.111	0.125
	LTE Band 66	20M	QPSK	50	24	-	Back	15mm	Ant 4	DSI 1	132322	1745	1	21.30	21.80	1.122	-	-	-0.16	0.190	0.213
	LTE Band 66	20M	QPSK	1	49	-	Front	15mm	Ant 4	DSI 5	132322	1745	1	19.61	19.80	1.045	-	-	0.04	0.066	0.069
	LTE Band 66	20M	QPSK	1	49	-	Back	15mm	Ant 4	DSI 5	132322	1745	1	19.61	19.80	1.045	-	-	-0.03	0.119	0.124



	LTE Band 66	20M	QPSK	50	24	-	Front	15mm	Ant 4	DSI 5	132322	1745	1	19.59	19.80	1.050	-	-	-0.04	0.070	0.073
	LTE Band 66	20M	QPSK	50	24	-	Back	15mm	Ant 4	DSI 5	132322	1745	1	19.59	19.80	1.050	-	-	-0.07	0.120	0.126
	FR1 n66	40M	QPSK	1	108	DFT-15	Front	15mm	Ant 3	DSI 1	349000	1745	1	21.82	23.20	1.374	-	-	-0.1	0.200	0.275
	FR1 n66	40M	QPSK	1	108	DFT-15	Back	15mm	Ant 3	DSI 1	349000	1745	1	21.82	23.20	1.374	-	-	-0.09	0.348	0.478
	FR1 n66	40M	QPSK	108	54	DFT-15	Front	15mm	Ant 3	DSI 1	349000	1745	1	21.81	23.20	1.377	-	-	0.01	0.222	0.306
60	FR1 n66	40M	QPSK	108	54	DFT-15	Back	15mm	Ant 3	DSI 1	349000	1745	1	21.81	23.20	1.377	-	-	-0.11	0.358	0.493
	FR1 n66	40M	QPSK	1	108	DFT-15	Front	15mm	Ant 3	DSI 5	349000	1745	1	19.99	21.20	1.321	-	-	0.06	0.135	0.178
	FR1 n66	40M	QPSK	1	108	DFT-15	Back	15mm	Ant 3	DSI 5	349000	1745	1	19.99	21.20	1.321	-	-	0.06	0.224	0.296
	FR1 n66	40M	QPSK	108	54	DFT-15	Front	15mm	Ant 3	DSI 5	349000	1745	1	19.95	21.20	1.334	-	-	0.01	0.140	0.187
	FR1 n66	40M	QPSK	108	54	DFT-15	Back	15mm	Ant 3	DSI 5	349000	1745	1	19.95	21.20	1.334	-	-	-0.19	0.226	0.301
	FR1 n66	40M	QPSK	1	108	DFT-15	Front	15mm	Ant 0	DSI 1	349000	1745	1	20.87	21.70	1.211	-	-	0.16	0.251	0.304
	FR1 n66	40M	QPSK	1	108	DFT-15	Back	15mm	Ant 0	DSI 1	349000	1745	1	20.87	21.70	1.211	-	-	-0.16	0.378	0.458
	FR1 n66	40M	QPSK	108	54	DFT-15	Front	15mm	Ant 0	DSI 1	349000	1745	1	20.79	21.70	1.233	-	-	-0.02	0.257	0.317
	FR1 n66	40M	QPSK	108	54	DFT-15	Back	15mm	Ant 0	DSI 1	349000	1745	1	20.79	21.70	1.233	-	-	-0.17	0.388	0.478
	FR1 n66	40M	QPSK	1	108	DFT-15	Front	15mm	Ant 0	DSI 5	349000	1745	1	18.86	19.70	1.213	-	-	0.12	0.185	0.224
	FR1 n66	40M	QPSK	1	108	DFT-15	Back	15mm	Ant 0	DSI 5	349000	1745	1	18.86	19.70	1.213	-	-	0.17	0.269	0.326
	FR1 n66	40M	QPSK	108	54	DFT-15	Front	15mm	Ant 0	DSI 5	349000	1745	1	18.85	19.70	1.216	-	-	0.15	0.192	0.234
	FR1 n66	40M	QPSK	108	54	DFT-15	Back	15mm	Ant 0	DSI 5	349000	1745	1	18.85	19.70	1.216	-	-	0.13	0.275	0.334
	FR1 n66	40M	QPSK	1	108	DFT-15	Front	15mm	Ant 4	DSI 1	349000	1745	1	20.91	22.20	1.346	-	-	0.08	0.114	0.153
	FR1 n66	40M	QPSK	1	108	DFT-15	Back	15mm	Ant 4	DSI 1	349000	1745	1	20.91	22.20	1.346	-	-	-0.07	0.229	0.308
	FR1 n66	40M	QPSK	108	54	DFT-15	Front	15mm	Ant 4	DSI 1	349000	1745	1	20.88	22.20	1.355	-	-	-0.02	0.117	0.159
	FR1 n66	40M	QPSK	108	54	DFT-15	Back	15mm	Ant 4	DSI 1	349000	1745	1	20.88	22.20	1.355	-	-	-0.09	0.230	0.312
	FR1 n66	40M	QPSK	1	108	DFT-15	Front	15mm	Ant 4	DSI 5	349000	1745	1	19.06	20.20	1.300	-	-	-0.07	0.072	0.094
	FR1 n66	40M	QPSK	1	108	DFT-15	Back	15mm	Ant 4	DSI 5	349000	1745	1	19.06	20.20	1.300	-	-	0.08	0.144	0.187
	FR1 n66	40M	QPSK	108	54	DFT-15	Front	15mm	Ant 4	DSI 5	349000	1745	1	19.04	20.20	1.306	-	-	0.14	0.074	0.097
	FR1 n66	40M	QPSK	108	54	DFT-15	Back	15mm	Ant 4	DSI 5	349000	1745	1	19.04	20.20	1.306	-	-	0.18	0.145	0.189
1900MHz																					
	GSM1900	-	-	-	-	GPRS (4 Tx slots)	Front	15mm	Ant 3	DSI 1	661	1880	1	24.40	24.80	1.096	-	-	-0.02	0.122	0.134
	GSM1900	-	-	-	-	GPRS (4 Tx slots)	Back	15mm	Ant 3	DSI 1	661	1880	1	24.40	24.80	1.096	-	-	0.17	0.237	0.260
	GSM1900	-	-	-	-	GPRS (4 Tx slots)	Front	15mm	Ant 3	DSI 5	661	1880	1	23.10	24.30	1.318	-	-	0	0.095	0.125
	GSM1900	-	-	-	-	GPRS (4 Tx slots)	Back	15mm	Ant 3	DSI 5	661	1880	1	23.10	24.30	1.318	-	-	0.12	0.192	0.253
	GSM1900	-	-	-	-	GPRS (4 Tx slots)	Front	15mm	Ant 0	DSI 1	661	1880	1	23.29	24.80	1.416	-	-	0.17	0.224	0.317
61	GSM1900	-	-	-	-	GPRS (4 Tx slots)	Back	15mm	Ant 0	DSI 1	661	1880	1	23.29	24.80	1.416	-	-	-0.04	0.337	0.477
	GSM1900	-	-	-	-	GPRS (4 Tx slots)	Front	15mm	Ant 0	DSI 5	661	1880	1	22.74	24.30	1.432	-	-	-0.02	0.200	0.286
	GSM1900	-	-	-	-	GPRS (4 Tx slots)	Back	15mm	Ant 0	DSI 5	661	1880	1	22.74	24.30	1.432	-	-	-0.07	0.300	0.430
	WCDMA II	-	-	-	-	RMC 12.2Kbps	Front	15mm	Ant 3	DSI 1	9400	1880	1	20.31	20.90	1.146	-	-	0.15	0.135	0.155
	WCDMA II	-	-	-	-	RMC 12.2Kbps	Back	15mm	Ant 3	DSI 1	9400	1880	1	20.31	20.90	1.146	-	-	0.13	0.250	0.286
	WCDMA II	-	-	-	-	RMC 12.2Kbps	Front	15mm	Ant 3	DSI 5	9400	1880	1	18.24	18.90	1.164	-	-	0.11	0.085	0.099
	WCDMA II	-	-	-	-	RMC 12.2Kbps	Back	15mm	Ant 3	DSI 5	9400	1880	1	18.24	18.90	1.164	-	-	0.12	0.158	0.184
	WCDMA II	-	-	-	-	RMC 12.2Kbps	Front	15mm	Ant 0	DSI 1	9400	1880	1	20.31	21.40	1.285	-	-	0.08	0.233	0.299
62	WCDMA II	-	-	-	-	RMC 12.2Kbps	Back	15mm	Ant 0	DSI 1	9400	1880	1	20.31	21.40	1.285	-	-	0.04	0.378	0.486
	WCDMA II	-	-	-	-	RMC 12.2Kbps	Front	15mm	Ant 0	DSI 5	9400	1880	1	18.28	19.40	1.294	-	-	0.05	0.147	0.190
	WCDMA II	-	-	-	-	RMC 12.2Kbps	Back	15mm	Ant 0	DSI 5	9400	1880	1	18.28	19.40	1.294	-	-	0.1	0.239	0.309
	LTE Band 2	20M	QPSK	1	49	-	Front	15mm	Ant 3	DSI 1	18900	1880	1	19.79	20.30	1.125	-	-	0.14	0.121	0.136
	LTE Band 2	20M	QPSK	1	49	-	Back	15mm	Ant 3	DSI 1	18900	1880	1	19.79	20.30	1.125	-	-	0.14	0.238	0.268
	LTE Band 2	20M	QPSK	50	24	-	Front	15mm	Ant 3	DSI 1	18900	1880	1	19.78	20.30	1.127	-	-	-0.19	0.125	0.141
	LTE Band 2	20M	QPSK	50	24	-	Back	15mm	Ant 3	DSI 1	18900	1880	1	19.78	20.30	1.127	-	-	0.01	0.242	0.273
	LTE Band 2	20M	QPSK	1	49	-	Front	15mm	Ant 3	DSI 5	18900	1880	1	17.72	18.30	1.143	-	-	-0.04	0.076	0.087
	LTE Band 2	20M	QPSK	1	49	-	Back	15mm	Ant 3	DSI 5	18900	1880	1	17.72	18.30	1.143	-	-	0.02	0.150	0.171
	LTE Band 2	20M	QPSK	50	24	-	Front	15mm	Ant 3	DSI 5	18900	1880	1	17.65	18.30	1.161	-	-	0.14	0.079	0.092
	LTE Band 2	20M	QPSK	50	24	-	Back	15mm	Ant 3	DSI 5	18900	1880	1	17.65	18.30	1.161	-	-	0.11	0.153	0.178
	LTE Band 2	20M	QPSK	1	49	-	Front	15mm	Ant 0	DSI 1	18900	1880	1	20.08	20.80	1.180	-	-	0.01	0.193	0.228
	LTE Band 2	20M	QPSK	1	49	-	Back	15mm	Ant 0	DSI 1	18900	1880	1	20.08	20.80	1.180	-	-	0.11	0.333	0.393
	LTE Band 2	20M	QPSK	50	24	-	Front	15mm	Ant 0	DSI 1	18900	1880	1	20.04	20.80	1.191	-	-	-0.19	0.192	0.229



63	LTE Band 2	20M	QPSK	50	24	-	Back	15mm	Ant 0	DSI 1	18900	1880	1	20.04	20.80	1.191	-	-	0.02	0.334	0.398
	LTE Band 2	20M	QPSK	1	49	-	Front	15mm	Ant 0	DSI 5	18900	1880	1	18.02	18.80	1.197	-	-	0.03	0.118	0.141
	LTE Band 2	20M	QPSK	1	49	-	Back	15mm	Ant 0	DSI 5	18900	1880	1	18.02	18.80	1.197	-	-	0.17	0.210	0.251
	LTE Band 2	20M	QPSK	50	24	-	Front	15mm	Ant 0	DSI 5	18900	1880	1	17.99	18.80	1.205	-	-	-0.05	0.121	0.146
	LTE Band 2	20M	QPSK	50	24	-	Back	15mm	Ant 0	DSI 5	18900	1880	1	17.99	18.80	1.205	-	-	0.03	0.211	0.254
	FR1 n2	20M	QPSK	1	53	DFT-15	Front	15mm	Ant 3	DSI 1	376000	1880	1	19.94	20.70	1.191	-	-	0.15	0.146	0.174
	FR1 n2	20M	QPSK	1	53	DFT-15	Back	15mm	Ant 3	DSI 1	376000	1880	1	19.94	20.70	1.191	-	-	0.15	0.278	0.331
	FR1 n2	20M	QPSK	50	28	DFT-15	Front	15mm	Ant 3	DSI 1	376000	1880	1	19.82	20.70	1.225	-	-	0.02	0.149	0.182
	FR1 n2	20M	QPSK	50	28	DFT-15	Back	15mm	Ant 3	DSI 1	376000	1880	1	19.82	20.70	1.225	-	-	-0.03	0.282	0.345
	FR1 n2	20M	QPSK	1	53	DFT-15	Front	15mm	Ant 3	DSI 5	376000	1880	1	18.01	18.70	1.172	-	-	0.15	0.092	0.108
	FR1 n2	20M	QPSK	1	53	DFT-15	Back	15mm	Ant 3	DSI 5	376000	1880	1	18.01	18.70	1.172	-	-	0.08	0.175	0.205
	FR1 n2	20M	QPSK	50	28	DFT-15	Front	15mm	Ant 3	DSI 5	376000	1880	1	17.96	18.70	1.186	-	-	-0.03	0.094	0.111
	FR1 n2	20M	QPSK	50	28	DFT-15	Back	15mm	Ant 3	DSI 5	376000	1880	1	17.96	18.70	1.186	-	-	0.03	0.178	0.211
	FR1 n2	20M	QPSK	1	53	DFT-15	Front	15mm	Ant 0	DSI 1	376000	1880	1	19.84	21.20	1.368	-	-	0.01	0.202	0.276
	FR1 n2	20M	QPSK	1	53	DFT-15	Back	15mm	Ant 0	DSI 1	376000	1880	1	19.84	21.20	1.368	-	-	-0.03	0.344	0.470
	FR1 n2	20M	QPSK	50	28	DFT-15	Front	15mm	Ant 0	DSI 1	376000	1880	1	19.78	21.20	1.387	-	-	0.16	0.213	0.295
64	FR1 n2	20M	QPSK	50	28	DFT-15	Back	15mm	Ant 0	DSI 1	376000	1880	1	19.78	21.20	1.387	-	-	0.17	0.359	0.498
	FR1 n2	20M	QPSK	50	28	DFT-15	Back	15mm	Ant 0	DSI 1	376000	1880	2	19.78	21.20	1.387	-	-	0.05	0.353	0.490
	FR1 n2	20M	QPSK	1	53	DFT-15	Front	15mm	Ant 0	DSI 5	376000	1880	1	17.56	19.20	1.459	-	-	0.17	0.127	0.185
	FR1 n2	20M	QPSK	1	53	DFT-15	Back	15mm	Ant 0	DSI 5	376000	1880	1	17.56	19.20	1.459	-	-	-0.04	0.217	0.317
	FR1 n2	20M	QPSK	50	28	DFT-15	Front	15mm	Ant 0	DSI 5	376000	1880	1	17.54	19.20	1.466	-	-	0.06	0.134	0.196
	FR1 n2	20M	QPSK	50	28	DFT-15	Back	15mm	Ant 0	DSI 5	376000	1880	1	17.54	19.20	1.466	-	-	-0.18	0.227	0.333
2600MHz																					
	LTE Band 7	20M	QPSK	1	49	-	Front	15mm	Ant 3	DSI 1	21100	2535	1	17.78	18.80	1.265	-	-	-0.03	0.105	0.133
	LTE Band 7	20M	QPSK	1	49	-	Back	15mm	Ant 3	DSI 1	21100	2535	1	17.78	18.80	1.265	-	-	0.02	0.165	0.209
	LTE Band 7	20M	QPSK	50	24	-	Front	15mm	Ant 3	DSI 1	21100	2535	1	17.72	18.80	1.282	-	-	-0.11	0.107	0.137
	LTE Band 7	20M	QPSK	50	24	-	Back	15mm	Ant 3	DSI 1	21100	2535	1	17.72	18.80	1.282	-	-	0.04	0.175	0.224
	LTE Band 7C	20M	QPSK	50	24	-	Back	15mm	Ant 3	DSI 1	21100+	2535+	1	17.68	18.10	1.102	-	-	0.02	0.148	0.163
	LTE Band 7C	20M	QPSK	50	24	-	Back	15mm	Ant 3	DSI 1	21100+	2535+	1	17.68	18.10	1.102	-	-	0.02	0.148	0.163
	LTE Band 7	20M	QPSK	1	49	-	Front	15mm	Ant 3	DSI 5	21100	2535	1	15.70	16.80	1.288	-	-	-0.14	0.066	0.085
	LTE Band 7	20M	QPSK	1	49	-	Back	15mm	Ant 3	DSI 5	21100	2535	1	15.70	16.80	1.288	-	-	0.17	0.104	0.134
	LTE Band 7	20M	QPSK	50	24	-	Front	15mm	Ant 3	DSI 5	21100	2535	1	15.67	16.80	1.297	-	-	0.16	0.068	0.088
	LTE Band 7	20M	QPSK	50	24	-	Back	15mm	Ant 3	DSI 5	21100	2535	1	15.67	16.80	1.297	-	-	0.15	0.106	0.138
	LTE Band 7C	20M	QPSK	50	24	-	Back	15mm	Ant 3	DSI 5	21100+	2535+	1	15.65	16.10	1.109	-	-	-0.11	0.090	0.099
	LTE Band 7C	20M	QPSK	50	24	-	Back	15mm	Ant 3	DSI 5	21100+	2535+	1	15.65	16.10	1.109	-	-	-0.11	0.090	0.099
	LTE Band 7	20M	QPSK	1	49	-	Front	15mm	Ant 0	DSI 1	21100	2535	1	20.84	21.30	1.112	-	-	0.06	0.226	0.251
	LTE Band 7	20M	QPSK	1	49	-	Back	15mm	Ant 0	DSI 1	21100	2535	1	20.84	21.30	1.112	-	-	-0.14	0.385	0.428
	LTE Band 7	20M	QPSK	50	24	-	Front	15mm	Ant 0	DSI 1	21100	2535	1	20.84	21.30	1.112	-	-	-0.06	0.238	0.265
65	LTE Band 7	20M	QPSK	50	24	-	Back	15mm	Ant 0	DSI 1	21100	2535	1	20.84	21.30	1.112	-	-	0.09	0.449	0.499
	LTE Band 7C	20M	QPSK	50	24	-	Back	15mm	Ant 0	DSI 1	21100+	2535+	1	20.56	20.60	1.009	-	-	0.09	0.380	0.383
	LTE Band 7C	20M	QPSK	50	24	-	Back	15mm	Ant 0	DSI 1	21100+	2535+	1	20.56	20.60	1.009	-	-	0.09	0.380	0.383
	LTE Band 7	20M	QPSK	1	49	-	Front	15mm	Ant 0	DSI 5	21100	2535	1	18.78	19.30	1.127	-	-	0.04	0.153	0.172
	LTE Band 7	20M	QPSK	1	49	-	Back	15mm	Ant 0	DSI 5	21100	2535	1	18.78	19.30	1.127	-	-	-0.1	0.297	0.335
	LTE Band 7C	20M	QPSK	1	49	-	Back	15mm	Ant 0	DSI 5	21100+	2535+	1	18.52	18.60	1.019	-	-	0.12	0.246	0.251
	LTE Band 7C	20M	QPSK	1	49	-	Back	15mm	Ant 0	DSI 5	21100+	2535+	1	18.52	18.60	1.019	-	-	0.12	0.246	0.251
	LTE Band 7	20M	QPSK	50	24	-	Front	15mm	Ant 0	DSI 5	21100	2535	1	18.74	19.30	1.138	-	-	0.02	0.150	0.171
	LTE Band 7	20M	QPSK	50	24	-	Back	15mm	Ant 0	DSI 5	21100	2535	1	18.74	19.30	1.138	-	-	-0.14	0.291	0.331
	LTE Band 7	20M	QPSK	1	49	-	Front	15mm	Ant 4	DSI 1	21100	2535	1	19.13	20.30	1.309	-	-	0.03	0.057	0.075
	LTE Band 7	20M	QPSK	1	49	-	Back	15mm	Ant 4	DSI 1	21100	2535	1	19.13	20.30	1.309	-	-	-0.08	0.153	0.200
	LTE Band 7C	20M	QPSK	1	49	-	Back	15mm	Ant 4	DSI 1	21100+	2535+	1	19.12	19.60	1.117	-	-	0.02	0.140	0.156
	LTE Band 7C	20M	QPSK	1	49	-	Back	15mm	Ant 4	DSI 1	21100+	2535+	1	19.12	19.60	1.117	-	-	0.02	0.140	0.156
	LTE Band 7	20M	QPSK	50	24	-	Front	15mm	Ant 4	DSI 1	21100	2535	1	19.13	20.30	1.309	-	-	0.02	0.049	0.064
	LTE Band 7	20M	QPSK	50	24	-	Back	15mm	Ant 4	DSI 1	21100	2535	1	19.13	20.30	1.309	-	-	-0.01	0.146	0.191
	LTE Band 7	20M	QPSK	1	49	-	Front	15mm	Ant 4	DSI 5	21100	2535	1	17.09	18.30	1.321	-	-	0.14	0.031	0.041
	LTE Band 7	20M	QPSK	1	49	-	Back	15mm	Ant 4	DSI 5	21100	2535	1	17.09	18.30	1.321	-	-	0.03	0.090	0.119
	LTE Band 7	20M	QPSK	50	24	-	Front	15mm	Ant 4	DSI 5	21100	2535	1	17.08	18.30	1.324	-	-	-0.12	0.036	0.048
	LTE Band 7	20M	QPSK	50	24	-	Back	15mm	Ant 4	DSI 5	21100	2535	1	17.08	18.30	1.324	-	-	0.08	0.095	0.126
	LTE Band 7C	20M	QPSK	50	24	-	Back	15mm	Ant 4	DSI 5	21100+	2535+	1	17.05	17.60	1.135	-	-	-0.06	0.080	0.091
	LTE Band 7C	20M	QPSK	50	24	-	Back	15mm	Ant 4	DSI 5	21100+	2535+	1	17.05	17.60	1.135	-	-	-0.06	0.080	0.091
	LTE Band 38	20M	QPSK	1	49	-	Front	15mm	Ant 3	DSI 1	38000	2595	1	20.29	21.40	1.291	62.9	1.006	0.15	0.120	0.156
	LTE Band 38	20M	QPSK	1	49	-	Back	15mm	Ant 3	DSI 1	38000	2595	1	20.29	21.40	1.291	62.9	1.			



FCC SAR Test Report

Report No. : FA303018B

	LTE Band 38	20M	QPSK	50	24	-	Front	15mm	Ant 3	DSI 1	38000	2595	1	20.27	21.40	1.297	62.9	1.006	0.15	0.124	0.162
	LTE Band 38	20M	QPSK	50	24	-	Back	15mm	Ant 3	DSI 1	38000	2595	1	20.27	21.40	1.297	62.9	1.006	0.07	0.181	0.236
	LTE Band 38C	20M	QPSK	50	24	-	Back	15mm	Ant 3	DSI 1	37901+38099	2585.1+2604.9	1	20.25	20.60	1.084	62.9	1.006	0.07	0.153	0.167
	LTE Band 38	20M	QPSK	1	49	-	Front	15mm	Ant 3	DSI 5	38000	2595	1	18.29	19.40	1.291	62.9	1.006	0.02	0.076	0.099
	LTE Band 38	20M	QPSK	1	49	-	Back	15mm	Ant 3	DSI 5	38000	2595	1	18.29	19.40	1.291	62.9	1.006	-0.12	0.110	0.143
	LTE Band 38	20M	QPSK	50	24	-	Front	15mm	Ant 3	DSI 5	38000	2595	1	18.24	19.40	1.306	62.9	1.006	-0.05	0.078	0.102
	LTE Band 38	20M	QPSK	50	24	-	Back	15mm	Ant 3	DSI 5	38000	2595	1	18.24	19.40	1.306	62.9	1.006	0	0.114	0.150
	LTE Band 38C	20M	QPSK	50	24	-	Back	15mm	Ant 3	DSI 5	37901+38099	2585.1+2604.9	1	18.19	18.60	1.099	62.9	1.006	0.1	0.096	0.107
	LTE Band 38	20M	QPSK	1	49	-	Front	15mm	Ant 0	DSI 1	38000	2595	1	24.08	24.40	1.076	62.9	1.006	0.11	0.105	0.114
66	LTE Band 38	20M	QPSK	1	49	-	Back	15mm	Ant 0	DSI 1	38000	2595	1	24.08	24.40	1.076	62.9	1.006	-0.15	0.347	0.376
	LTE Band 38C	20M	QPSK	1	49	-	Back	15mm	Ant 0	DSI 1	37901+38099	2585.1+2604.9	1	23.51	23.60	1.021	62.9	1.006	-0.15	0.293	0.301
	LTE Band 38	20M	QPSK	50	24	-	Front	15mm	Ant 0	DSI 1	38000	2595	1	23.07	23.40	1.079	62.9	1.006	0.05	0.102	0.111
	LTE Band 38	20M	QPSK	50	24	-	Back	15mm	Ant 0	DSI 1	38000	2595	1	23.07	23.40	1.079	62.9	1.006	0.13	0.311	0.338
	LTE Band 38	20M	QPSK	1	49	-	Front	15mm	Ant 0	DSI 5	38000	2595	1	22.05	22.40	1.084	62.9	1.006	-0.13	0.083	0.091
	LTE Band 38	20M	QPSK	1	49	-	Back	15mm	Ant 0	DSI 5	38000	2595	1	22.05	22.40	1.084	62.9	1.006	-0.05	0.276	0.301
	LTE Band 38C	20M	QPSK	1	49	-	Back	15mm	Ant 0	DSI 5	37901+38099	2585.1+2604.9	1	21.49	21.60	1.026	62.9	1.006	-0.11	0.233	0.241
	LTE Band 38	20M	QPSK	50	24	-	Front	15mm	Ant 0	DSI 5	38000	2595	1	21.79	22.40	1.151	62.9	1.006	-0.06	0.078	0.090
	LTE Band 38	20M	QPSK	50	24	-	Back	15mm	Ant 0	DSI 5	38000	2595	1	21.79	22.40	1.151	62.9	1.006	-0.15	0.247	0.286
	LTE Band 38	20M	QPSK	1	49	-	Front	15mm	Ant 4	DSI 1	38000	2595	1	21.19	22.40	1.321	62.9	1.006	-0.16	0.056	0.074
	LTE Band 38	20M	QPSK	1	49	-	Back	15mm	Ant 4	DSI 1	38000	2595	1	21.19	22.40	1.321	62.9	1.006	0.13	0.141	0.187
	LTE Band 38	20M	QPSK	50	24	-	Front	15mm	Ant 4	DSI 1	38000	2595	1	20.99	22.40	1.384	62.9	1.006	0	0.057	0.079
	LTE Band 38	20M	QPSK	50	24	-	Back	15mm	Ant 4	DSI 1	38000	2595	1	20.99	22.40	1.384	62.9	1.006	0.13	0.144	0.200
	LTE Band 38C	20M	QPSK	50	24	-	Back	15mm	Ant 4	DSI 1	37901+38099	2585.1+2604.9	1	20.75	21.60	1.216	62.9	1.006	0.13	0.122	0.149
	LTE Band 38	20M	QPSK	1	49	-	Front	15mm	Ant 4	DSI 5	38000	2595	1	18.97	20.40	1.390	62.9	1.006	0.06	0.035	0.049
	LTE Band 38	20M	QPSK	1	49	-	Back	15mm	Ant 4	DSI 5	38000	2595	1	18.97	20.40	1.390	62.9	1.006	0.01	0.089	0.124
	LTE Band 38	20M	QPSK	50	24	-	Front	15mm	Ant 4	DSI 5	38000	2595	1	18.85	20.40	1.429	62.9	1.006	-0.01	0.036	0.052
	LTE Band 38	20M	QPSK	50	24	-	Back	15mm	Ant 4	DSI 5	38000	2595	1	18.85	20.40	1.429	62.9	1.006	0.04	0.091	0.131
	LTE Band 38C	20M	QPSK	50	24	-	Back	15mm	Ant 4	DSI 5	37901+38099	2585.1+2604.9	1	18.76	19.60	1.213	62.9	1.006	0.08	0.077	0.094
	LTE Band 41	20M	QPSK	1	49	-	Front	15mm	Ant 3	DSI 1	40620	2593	1	19.05	19.80	1.189	62.9	1.006	-0.1	0.083	0.099
	LTE Band 41	20M	QPSK	1	49	-	Back	15mm	Ant 3	DSI 1	40620	2593	1	19.05	19.80	1.189	62.9	1.006	0.06	0.124	0.148
	LTE Band 41	20M	QPSK	50	24	-	Front	15mm	Ant 3	DSI 1	40620	2593	1	19.02	19.80	1.197	62.9	1.006	-0.11	0.087	0.105
	LTE Band 41	20M	QPSK	50	24	-	Back	15mm	Ant 3	DSI 1	40620	2593	1	19.02	19.80	1.197	62.9	1.006	-0.04	0.126	0.152
	LTE Band 41C	20M	QPSK	50	24	-	Back	15mm	Ant 3	DSI 1	40620+40422	2593+2573.2	1	18.72	19.30	1.143	62.9	1.006	0.06	0.107	0.123
	LTE Band 41 PC2	20M	QPSK	50	24	-	Back	15mm	Ant 3	DSI 1	40620	2593	1	21.91	22.80	1.227	42.9	1.009	0.17	0.167	0.207
	LTE Band 41	20M	QPSK	1	49	-	Front	15mm	Ant 3	DSI 5	40620	2593	1	17.07	17.80	1.183	62.9	1.006	0.11	0.052	0.062
	LTE Band 41	20M	QPSK	1	49	-	Back	15mm	Ant 3	DSI 5	40620	2593	1	17.07	17.80	1.183	62.9	1.006	0.15	0.075	0.089
	LTE Band 41	20M	QPSK	50	24	-	Front	15mm	Ant 3	DSI 5	40620	2593	1	16.96	17.80	1.213	62.9	1.006	0.05	0.055	0.067
	LTE Band 41	20M	QPSK	50	24	-	Back	15mm	Ant 3	DSI 5	40620	2593	1	16.96	17.80	1.213	62.9	1.006	-0.06	0.077	0.094
	LTE Band 41C	20M	QPSK	50	24	-	Back	15mm	Ant 3	DSI 5	40620+40422	2593+2573.2	1	16.86	17.30	1.107	62.9	1.006	0.18	0.065	0.072
	LTE Band 41 PC2	20M	QPSK	50	24	-	Back	15mm	Ant 3	DSI 5	40620	2593	1	19.87	20.80	1.239	42.9	1.009	0.08	0.105	0.131
	LTE Band 41	20M	QPSK	1	49	-	Front	15mm	Ant 0	DSI 1	40620	2593	1	22.62	22.80	1.042	62.9	1.006	-0.01	0.154	0.161
	LTE Band 41	20M	QPSK	1	49	-	Back	15mm	Ant 0	DSI 1	40620	2593	1	22.62	22.80	1.042	62.9	1.006	-0.16	0.234	0.245
	LTE Band 41C	20M	QPSK	1	49	-	Back	15mm	Ant 0	DSI 1	40620+40422	2593+2573.2	1	22.17	22.30	1.030	62.9	1.006	-0.16	0.146	0.152
67	LTE Band 41 PC2	20M	QPSK	1	49	-	Back	15mm	Ant 0	DSI 1	40620	2593	1	25.63	25.80	1.040	42.9	1.009	0.08	0.341	0.358
	LTE Band 41	20M	QPSK	50	24	-	Front	15mm	Ant 0	DSI 1	40620	2593	1	21.65	21.80	1.035	62.9	1.006	-0.14	0.120	0.125
	LTE Band 41	20M	QPSK	50	24	-	Back	15mm	Ant 0	DSI 1	40620	2593	1	21.65	21.80	1.035	62.9	1.006	0.08	0.218	0.227
	LTE Band 41	20M	QPSK	1	49	-	Front	15mm	Ant 0	DSI 5	40620	2593	1	20.59	20.80	1.050	62.9	1.006	-0.05	0.097	0.102
	LTE Band 41	20M	QPSK	1	49	-	Back	15mm	Ant 0	DSI 5	40620	2593	1	20.59	20.80	1.050	62.9	1.006	0	0.142	0.150
	LTE Band 41C	20M	QPSK	1	49	-	Back	15mm	Ant 0	DSI 5	40620+40422	2593+2573.2	1	20.11	20.30	1.045	62.9	1.006	0.1	0.092	0.097
	LTE Band 41 PC2	20M	QPSK	1	49	-	Back	15mm	Ant 0	DSI 5	40620	2593	1	23.71	23.80	1.021	42.9	1.009	0.12	0.215	0.221
	LTE Band 41	20M	QPSK	50	24	-	Front	15mm	Ant 0	DSI 5	40620	2593	1	20.50	20.80	1.072	62.9	1.006	-0.04	0.076	0.082
	LTE Band 41	20M	QPSK	50	24	-	Back	15mm	Ant 0	DSI 5	40620	2593	1	20.50	20.80	1.072	62.9	1.006	-0.13	0.097	0.105
	LTE Band 41	20M	QPSK	1	49	-	Front	15mm	Ant 4	DSI 1	40620	2593	1	19.97	20.80	1.211	62.9	1.006	-0.12	0.040	0.049
	LTE Band 41	20M	QPSK	1	49	-	Back	15mm	Ant 4	DSI 1	40620	2593	1	19.97	20.80	1.211	62.9	1.006	0.05	0.100	0.122



	LTE Band 41	20M	QPSK	50	24	-	Front	15mm	Ant 4	DSI 1	40620	2593	1	19.95	20.80	1.216	62.9	1.006	0.07	0.043	0.053
	LTE Band 41	20M	QPSK	50	24	-	Back	15mm	Ant 4	DSI 1	40620	2593	1	19.95	20.80	1.216	62.9	1.006	0.19	0.119	0.146
	LTE Band 41C	20M	QPSK	50	24	-	Back	15mm	Ant 4	DSI 1	40620+ 40422	2593+ 2573.2	1	19.22	20.30	1.282	62.9	1.006	0.19	0.085	0.110
	LTE Band 41 PC2	20M	QPSK	50	24	-	Back	15mm	Ant 4	DSI 1	40620	2593	1	22.53	23.80	1.340	42.9	1.009	-0.18	0.140	0.189
	LTE Band 41	20M	QPSK	1	49	-	Front	15mm	Ant 4	DSI 5	40620	2593	1	18.14	18.80	1.164	62.9	1.006	-0.1	0.027	0.032
	LTE Band 41	20M	QPSK	1	49	-	Back	15mm	Ant 4	DSI 5	40620	2593	1	18.14	18.80	1.164	62.9	1.006	0.12	0.078	0.091
	LTE Band 41C	20M	QPSK	1	49	-	Back	15mm	Ant 4	DSI 5	40620+ 40422	2593+ 2573.2	1	17.34	18.30	1.247	62.9	1.006	0.01	0.053	0.067
	LTE Band 41 PC2	20M	QPSK	1	49	-	Back	15mm	Ant 4	DSI 5	40620	2593	1	20.60	21.80	1.318	42.9	1.009	0.08	0.088	0.117
	LTE Band 41	20M	QPSK	50	24	-	Front	15mm	Ant 4	DSI 5	40620	2593	1	18.11	18.80	1.172	62.9	1.006	0.13	0.020	0.024
	LTE Band 41	20M	QPSK	50	24	-	Back	15mm	Ant 4	DSI 5	40620	2593	1	18.11	18.80	1.172	62.9	1.006	0.16	0.068	0.080
	FR1 n7	40M	QPSK	1	108	DFT-15	Front	15mm	Ant 3	DSI 1	507000	2535	1	17.42	18.20	1.197	-	-	-0.19	0.106	0.127
	FR1 n7	40M	QPSK	1	108	DFT-15	Back	15mm	Ant 3	DSI 1	507000	2535	1	17.42	18.20	1.197	-	-	-0.17	0.179	0.214
	FR1 n7	40M	QPSK	108	54	DFT-15	Front	15mm	Ant 3	DSI 1	507000	2535	1	17.40	18.20	1.202	-	-	0.03	0.102	0.123
	FR1 n7	40M	QPSK	108	54	DFT-15	Back	15mm	Ant 3	DSI 1	507000	2535	1	17.40	18.20	1.202	-	-	0.15	0.175	0.210
	FR1 n7	40M	QPSK	1	108	DFT-15	Front	15mm	Ant 3	DSI 5	507000	2535	1	15.65	16.20	1.135	-	-	-0.06	0.067	0.076
	FR1 n7	40M	QPSK	1	108	DFT-15	Back	15mm	Ant 3	DSI 5	507000	2535	1	15.65	16.20	1.135	-	-	0.1	0.115	0.131
	FR1 n7	40M	QPSK	108	54	DFT-15	Front	15mm	Ant 3	DSI 5	507000	2535	1	15.63	16.20	1.140	-	-	-0.02	0.065	0.074
	FR1 n7	40M	QPSK	108	54	DFT-15	Back	15mm	Ant 3	DSI 5	507000	2535	1	15.63	16.20	1.140	-	-	-0.12	0.112	0.128
	FR1 n7	40M	QPSK	1	108	DFT-15	Front	15mm	Ant 0	DSI 1	507000	2535	1	19.54	20.20	1.164	-	-	-0.14	0.224	0.261
68	FR1 n7	40M	QPSK	1	108	DFT-15	Back	15mm	Ant 0	DSI 1	507000	2535	1	19.54	20.20	1.164	-	-	-0.01	0.345	0.402
	FR1 n7	40M	QPSK	108	54	DFT-15	Front	15mm	Ant 0	DSI 1	507000	2535	1	19.51	20.20	1.172	-	-	-0.07	0.214	0.251
	FR1 n7	40M	QPSK	108	54	DFT-15	Back	15mm	Ant 0	DSI 1	507000	2535	1	19.51	20.20	1.172	-	-	0.09	0.315	0.369
	FR1 n7	40M	QPSK	1	108	DFT-15	Front	15mm	Ant 0	DSI 5	507000	2535	1	17.57	18.20	1.156	-	-	0	0.141	0.163
	FR1 n7	40M	QPSK	1	108	DFT-15	Back	15mm	Ant 0	DSI 5	507000	2535	1	17.57	18.20	1.156	-	-	0.07	0.218	0.252
	FR1 n7	40M	QPSK	108	54	DFT-15	Front	15mm	Ant 0	DSI 5	507000	2535	1	17.56	18.20	1.159	-	-	0.06	0.135	0.156
	FR1 n7	40M	QPSK	108	54	DFT-15	Back	15mm	Ant 0	DSI 5	507000	2535	1	17.56	18.20	1.159	-	-	0.18	0.199	0.231
	FR1 n7	40M	QPSK	1	108	DFT-15	Front	15mm	Ant 4	DSI 1	507000	2535	1	18.66	19.70	1.271	-	-	-0.08	0.060	0.076
	FR1 n7	40M	QPSK	1	108	DFT-15	Back	15mm	Ant 4	DSI 1	507000	2535	1	18.66	19.70	1.271	-	-	-0.19	0.157	0.199
	FR1 n7	40M	QPSK	108	54	DFT-15	Front	15mm	Ant 4	DSI 1	507000	2535	1	18.62	19.70	1.282	-	-	0.15	0.055	0.071
	FR1 n7	40M	QPSK	108	54	DFT-15	Back	15mm	Ant 4	DSI 1	507000	2535	1	18.62	19.70	1.282	-	-	0.16	0.154	0.197
	FR1 n7	40M	QPSK	1	108	DFT-15	Front	15mm	Ant 4	DSI 5	507000	2535	1	16.66	17.70	1.271	-	-	0.16	0.038	0.048
	FR1 n7	40M	QPSK	1	108	DFT-15	Back	15mm	Ant 4	DSI 5	507000	2535	1	16.66	17.70	1.271	-	-	-0.06	0.099	0.126
	FR1 n7	40M	QPSK	108	54	DFT-15	Front	15mm	Ant 4	DSI 5	507000	2535	1	16.63	17.70	1.279	-	-	-0.15	0.037	0.047
	FR1 n7	40M	QPSK	108	54	DFT-15	Back	15mm	Ant 4	DSI 5	507000	2535	1	16.63	17.70	1.279	-	-	0	0.098	0.125
	FR1 n38	40M	QPSK	1	53	DFT-30	Front	15mm	Ant 3	DSI 1	519000	2595	1	17.64	19.20	1.432	-	-	0	0.125	0.179
	FR1 n38	40M	QPSK	1	53	DFT-30	Back	15mm	Ant 3	DSI 1	519000	2595	1	17.64	19.20	1.432	-	-	0.16	0.178	0.255
	FR1 n38	40M	QPSK	50	28	DFT-30	Front	15mm	Ant 3	DSI 1	519000	2595	1	17.61	19.20	1.442	-	-	0.18	0.120	0.173
	FR1 n38	40M	QPSK	50	28	DFT-30	Back	15mm	Ant 3	DSI 1	519000	2595	1	17.61	19.20	1.442	-	-	0.13	0.174	0.251
	FR1 n38	40M	QPSK	1	53	DFT-30	Front	15mm	Ant 3	DSI 5	519000	2595	1	15.64	17.20	1.432	-	-	-0.1	0.078	0.112
	FR1 n38	40M	QPSK	1	53	DFT-30	Back	15mm	Ant 3	DSI 5	519000	2595	1	15.64	17.20	1.432	-	-	-0.02	0.115	0.165
	FR1 n38	40M	QPSK	50	28	DFT-30	Front	15mm	Ant 3	DSI 5	519000	2595	1	15.59	17.20	1.449	-	-	-0.14	0.076	0.110
	FR1 n38	40M	QPSK	50	28	DFT-30	Back	15mm	Ant 3	DSI 5	519000	2595	1	15.59	17.20	1.449	-	-	0.15	0.110	0.159
	FR1 n38	40M	QPSK	1	53	DFT-30	Front	15mm	Ant 0	DSI 1	519000	2595	1	20.15	21.70	1.429	-	-	-0.16	0.093	0.133
	FR1 n38	40M	QPSK	1	53	DFT-30	Back	15mm	Ant 0	DSI 1	519000	2595	1	20.15	21.70	1.429	-	-	-0.11	0.235	0.336
	FR1 n38	40M	QPSK	50	28	DFT-30	Front	15mm	Ant 0	DSI 1	519000	2595	1	20.07	21.70	1.455	-	-	-0.18	0.098	0.143
69	FR1 n38	40M	QPSK	50	28	DFT-30	Back	15mm	Ant 0	DSI 1	519000	2595	1	20.07	21.70	1.455	-	-	0.18	0.284	0.413
	FR1 n38	40M	QPSK	1	53	DFT-30	Front	15mm	Ant 0	DSI 5	519000	2595	1	18.12	19.70	1.439	-	-	0.04	0.059	0.085
	FR1 n38	40M	QPSK	1	53	DFT-30	Back	15mm	Ant 0	DSI 5	519000	2595	1	18.12	19.70	1.439	-	-	-0.18	0.175	0.252
	FR1 n38	40M	QPSK	50	28	DFT-30	Front	15mm	Ant 0	DSI 5	519000	2595	1	18.08	19.70	1.452	-	-	0.19	0.062	0.090
	FR1 n38	40M	QPSK	50	28	DFT-30	Back	15mm	Ant 0	DSI 5	519000	2595	1	18.08	19.70	1.452	-	-	0.17	0.179	0.260
	FR1 n38	40M	QPSK	1	53	DFT-30	Front	15mm	Ant 4	DSI 1	519000	2595	1	17.93	19.70	1.503	-	-	-0.08	0.046	0.069
	FR1 n38	40M	QPSK	1	53	DFT-30	Back	15mm	Ant 4	DSI 1	519000	2595	1	17.93	19.70	1.503	-	-	0.14	0.241	0.362
	FR1 n38	40M	QPSK	50	28	DFT-30	Front	15mm	Ant 4	DSI 1	519000	2595	1	17.87	19.70	1.524	-	-	-0.16	0.045	0.069
	FR1 n38	40M	QPSK	50	28	DFT-30	Back	15mm	Ant 4	DSI 1	519000	2595	1	17.87	19.70	1.524	-	-	-0.02	0.235	0.358
	FR1 n38	40M	QPSK	1	53	DFT-30	Front	15mm	Ant 4	DSI 5	519000	2595	1	15.94	17.70	1.500	-	-	-0.19	0.029	0.043



FCC SAR Test Report

Report No. : FA303018B

Table with 22 columns: Device ID, Power, Modulation, Frequency, Bandwidth, Modulation, Distance, Antenna, Antenna, DSI, Power, Power, Power, Power, Power, Power, Power, Power, Power, Power, Power, Power. Row 70 is highlighted in yellow.



<ENDC>

Plot No.	Band	BW (MHz)	Modulation	RB Size	RB offset	Mode	Test Position	Gap (mm)	Antenna	Power State	Ch.	Freq. (MHz)	Power Setting	Sample	Average Power (dBm)	Tune-Up Limit (dBm)	Tune-up Scaling Factor	Power Drift (dB)	Measured 1g SAR (W/kg)	Reported 1g SAR (W/kg)
750MHz																				
	LTE Band 12	10M	QPSK	1	25	-	Front	15mm	Ant 1	DSI 1	23095	707.5	19.5	1	20.98	21.20	1.052	-0.15	0.074	0.078
	LTE Band 12	10M	QPSK	1	25	-	Back	15mm	Ant 1	DSI 1	23095	707.5	19.5	1	20.98	21.20	1.052	-0.13	0.109	0.115
	LTE Band 12	10M	QPSK	25	12	-	Front	15mm	Ant 1	DSI 1	23095	707.5	19.5	1	20.96	21.20	1.057	0.14	0.075	0.079
	LTE Band 12	10M	QPSK	25	12	-	Back	15mm	Ant 1	DSI 1	23095	707.5	19.5	1	20.96	21.20	1.057	0.02	0.113	0.119
	LTE Band 12	10M	QPSK	1	25	-	Front	15mm	Ant 1	DSI 5	23095	707.5	17.5	1	18.82	19.20	1.091	0.03	0.052	0.057
	LTE Band 12	10M	QPSK	1	25	-	Back	15mm	Ant 1	DSI 5	23095	707.5	17.5	1	18.82	19.20	1.091	-0.03	0.077	0.084
	LTE Band 12	10M	QPSK	25	12	-	Front	15mm	Ant 1	DSI 5	23095	707.5	17.5	1	18.75	19.20	1.109	-0.09	0.054	0.060
	LTE Band 12	10M	QPSK	25	12	-	Back	15mm	Ant 1	DSI 5	23095	707.5	17.5	1	18.75	19.20	1.109	0.1	0.080	0.089
	LTE Band 12	10M	QPSK	1	25	-	Front	15mm	Ant 0	DSI 1	23095	707.5	22	1	22.28	23.70	1.387	0.12	0.085	0.118
	LTE Band 12	10M	QPSK	1	25	-	Back	15mm	Ant 0	DSI 1	23095	707.5	22	1	22.28	23.70	1.387	-0.07	0.113	0.157
	LTE Band 12	10M	QPSK	25	12	-	Front	15mm	Ant 0	DSI 1	23095	707.5	22	1	22.22	23.70	1.406	-0.03	0.081	0.114
	LTE Band 12	10M	QPSK	25	12	-	Back	15mm	Ant 0	DSI 1	23095	707.5	22	1	22.22	23.70	1.406	0.01	0.103	0.145
	LTE Band 12	10M	QPSK	1	25	-	Front	15mm	Ant 0	DSI 5	23095	707.5	20	1	20.28	21.70	1.387	0.07	0.054	0.075
	LTE Band 12	10M	QPSK	1	25	-	Back	15mm	Ant 0	DSI 5	23095	707.5	20	1	20.28	21.70	1.387	-0.18	0.071	0.098
	LTE Band 12	10M	QPSK	25	12	-	Front	15mm	Ant 0	DSI 5	23095	707.5	20	1	20.25	21.70	1.396	0.18	0.051	0.071
	LTE Band 12	10M	QPSK	25	12	-	Back	15mm	Ant 0	DSI 5	23095	707.5	20	1	20.25	21.70	1.396	-0.01	0.065	0.091
835MHz																				
	LTE Band 5	10M	QPSK	1	25	-	Front	15mm	Ant 1	DSI 1	20525	836.5	17	1	18.28	18.50	1.052	-0.04	0.121	0.127
71	LTE Band 5	10M	QPSK	1	25	-	Back	15mm	Ant 1	DSI 1	20525	836.5	17	1	18.28	18.50	1.052	-0.03	0.189	0.199
	LTE Band 5	10M	QPSK	25	12	-	Front	15mm	Ant 1	DSI 1	20525	836.5	17	1	18.25	18.50	1.059	0.05	0.108	0.114
	LTE Band 5	10M	QPSK	25	12	-	Back	15mm	Ant 1	DSI 1	20525	836.5	17	1	18.25	18.50	1.059	0.13	0.175	0.185
	LTE Band 5	10M	QPSK	1	25	-	Front	15mm	Ant 1	DSI 5	20525	836.5	15.5	1	16.72	17.00	1.067	0.03	0.086	0.091
	LTE Band 5	10M	QPSK	1	25	-	Back	15mm	Ant 1	DSI 5	20525	836.5	15.5	1	16.72	17.00	1.067	0.08	0.134	0.143
	LTE Band 5	10M	QPSK	25	12	-	Front	15mm	Ant 1	DSI 5	20525	836.5	15.5	1	16.66	17.00	1.081	-0.12	0.077	0.083
	LTE Band 5	10M	QPSK	25	12	-	Back	15mm	Ant 1	DSI 5	20525	836.5	15.5	1	16.66	17.00	1.081	-0.18	0.124	0.134
	LTE Band 5	10M	QPSK	1	25	-	Front	15mm	Ant 0	DSI 1	20525	836.5	21	1	21.27	22.50	1.327	0.05	0.101	0.134
	LTE Band 5	10M	QPSK	1	25	-	Back	15mm	Ant 0	DSI 1	20525	836.5	21	1	21.27	22.50	1.327	0.06	0.121	0.161
	LTE Band 5	10M	QPSK	25	12	-	Front	15mm	Ant 0	DSI 1	20525	836.5	21	1	21.20	22.50	1.349	0.16	0.076	0.103
	LTE Band 5	10M	QPSK	25	12	-	Back	15mm	Ant 0	DSI 1	20525	836.5	21	1	21.20	22.50	1.349	0.15	0.091	0.123
	LTE Band 5	10M	QPSK	1	25	-	Front	15mm	Ant 0	DSI 5	20525	836.5	19	1	19.22	20.50	1.343	-0.1	0.072	0.096
	LTE Band 5	10M	QPSK	1	25	-	Back	15mm	Ant 0	DSI 5	20525	836.5	19	1	19.22	20.50	1.343	-0.15	0.086	0.115
	LTE Band 5	10M	QPSK	25	12	-	Front	15mm	Ant 0	DSI 5	20525	836.5	19	1	19.20	20.50	1.349	0.02	0.054	0.073
	LTE Band 5	10M	QPSK	25	12	-	Back	15mm	Ant 0	DSI 5	20525	836.5	19	1	19.20	20.50	1.349	-0.09	0.064	0.087
	FR1 n5	20M	QPSK	1	53	DFT-15	Front	15mm	Ant 1	DSI 1	167300	836.5	17	1	18.42	19.70	1.343	-0.13	0.151	0.203
72	FR1 n5	20M	QPSK	1	53	DFT-15	Back	15mm	Ant 1	DSI 1	167300	836.5	17	1	18.42	19.70	1.343	-0.11	0.223	0.299
	FR1 n5	20M	QPSK	50	28	DFT-15	Front	15mm	Ant 1	DSI 1	167300	836.5	17	1	18.37	19.70	1.358	0	0.142	0.193
	FR1 n5	20M	QPSK	50	28	DFT-15	Back	15mm	Ant 1	DSI 1	167300	836.5	17	1	18.37	19.70	1.358	-0.14	0.205	0.278
	FR1 n5	20M	QPSK	1	53	DFT-15	Front	15mm	Ant 1	DSI 5	167300	836.5	15	1	16.42	17.70	1.343	0.03	0.110	0.148
	FR1 n5	20M	QPSK	1	53	DFT-15	Back	15mm	Ant 1	DSI 5	167300	836.5	15	1	16.42	17.70	1.343	0.17	0.160	0.215
	FR1 n5	20M	QPSK	50	28	DFT-15	Front	15mm	Ant 1	DSI 5	167300	836.5	15	1	16.36	17.70	1.361	0	0.100	0.136
	FR1 n5	20M	QPSK	50	28	DFT-15	Back	15mm	Ant 1	DSI 5	167300	836.5	15	1	16.36	17.70	1.361	-0.08	0.145	0.197
	FR1 n5	20M	QPSK	1	53	DFT-15	Front	15mm	Ant 0	DSI 1	167300	836.5	20.5	1	20.77	22.20	1.390	-0.01	0.079	0.110
	FR1 n5	20M	QPSK	1	53	DFT-15	Back	15mm	Ant 0	DSI 1	167300	836.5	20.5	1	20.77	22.20	1.390	-0.12	0.097	0.135
	FR1 n5	20M	QPSK	50	28	DFT-15	Front	15mm	Ant 0	DSI 1	167300	836.5	20.5	1	20.75	22.20	1.396	-0.06	0.077	0.108
	FR1 n5	20M	QPSK	50	28	DFT-15	Back	15mm	Ant 0	DSI 1	167300	836.5	20.5	1	20.75	22.20	1.396	-0.08	0.096	0.134
	FR1 n5	20M	QPSK	1	53	DFT-15	Front	15mm	Ant 0	DSI 5	167300	836.5	18.5	1	18.64	20.20	1.432	-0.03	0.049	0.070
	FR1 n5	20M	QPSK	1	53	DFT-15	Back	15mm	Ant 0	DSI 5	167300	836.5	18.5	1	18.64	20.20	1.432	0.08	0.061	0.087
	FR1 n5	20M	QPSK	50	28	DFT-15	Front	15mm	Ant 0	DSI 5	167300	836.5	18.5	1	18.43	20.20	1.503	0.03	0.049	0.074
	FR1 n5	20M	QPSK	50	28	DFT-15	Back	15mm	Ant 0	DSI 5	167300	836.5	18.5	1	18.43	20.20	1.503	0.06	0.061	0.092
1750MHz																				
	LTE Band 66	20M	QPSK	1	49	-	Front	15mm	Ant 3	DSI 1	132322	1745	18	1	18.72	19.30	1.143	0.11	0.067	0.077
	LTE Band 66	20M	QPSK	1	49	-	Back	15mm	Ant 3	DSI 1	132322	1745	18	1	18.72	19.30	1.143	0.13	0.107	0.122



FCC SAR Test Report

Report No. : FA303018B

LTE Band 66	20M	QPSK	50	24	-	Front	15mm	Ant 3	DSI 1	132322	1745	18	1	18.68	19.30	1.153	0.08	0.069	0.080
LTE Band 66	20M	QPSK	50	24	-	Back	15mm	Ant 3	DSI 1	132322	1745	18	1	18.68	19.30	1.153	0.07	0.109	0.126
LTE Band 66	20M	QPSK	1	49	-	Front	15mm	Ant 3	DSI 5	132322	1745	16	1	16.78	17.30	1.127	-0.16	0.043	0.048
LTE Band 66	20M	QPSK	1	49	-	Back	15mm	Ant 3	DSI 5	132322	1745	16	1	16.78	17.30	1.127	0.03	0.068	0.077
LTE Band 66	20M	QPSK	50	24	-	Front	15mm	Ant 3	DSI 5	132322	1745	16	1	16.75	17.30	1.135	-0.14	0.045	0.051
LTE Band 66	20M	QPSK	50	24	-	Back	15mm	Ant 3	DSI 5	132322	1745	16	1	16.75	17.30	1.135	-0.05	0.069	0.078
LTE Band 66	20M	QPSK	1	49	-	Front	15mm	Ant 0	DSI 1	132322	1745	17	1	17.17	18.30	1.297	0.08	0.098	0.126
LTE Band 66	20M	QPSK	1	49	-	Back	15mm	Ant 0	DSI 1	132322	1745	17	1	17.17	18.30	1.297	0.1	0.157	0.204
LTE Band 66	20M	QPSK	50	24	-	Front	15mm	Ant 0	DSI 1	132322	1745	17	1	17.16	18.30	1.300	0	0.100	0.129
LTE Band 66	20M	QPSK	50	24	-	Back	15mm	Ant 0	DSI 1	132322	1745	17	1	17.16	18.30	1.300	-0.11	0.158	0.205
LTE Band 66	20M	QPSK	1	49	-	Front	15mm	Ant 0	DSI 5	132322	1745	15	1	15.16	16.30	1.300	-0.1	0.062	0.081
LTE Band 66	20M	QPSK	1	49	-	Back	15mm	Ant 0	DSI 5	132322	1745	15	1	15.16	16.30	1.300	0.07	0.100	0.130
LTE Band 66	20M	QPSK	50	24	-	Front	15mm	Ant 0	DSI 5	132322	1745	15	1	15.11	16.30	1.315	0.12	0.063	0.083
LTE Band 66	20M	QPSK	50	24	-	Back	15mm	Ant 0	DSI 5	132322	1745	15	1	15.11	16.30	1.315	0.14	0.100	0.132
LTE Band 66	20M	QPSK	1	49	-	Front	15mm	Ant 4	DSI 1	132322	1745	17.5	1	18.22	18.80	1.143	0.02	0.056	0.064
LTE Band 66	20M	QPSK	1	49	-	Back	15mm	Ant 4	DSI 1	132322	1745	17.5	1	18.22	18.80	1.143	-0.05	0.094	0.107
LTE Band 66	20M	QPSK	50	24	-	Front	15mm	Ant 4	DSI 1	132322	1745	17.5	1	18.15	18.80	1.161	-0.03	0.060	0.070
LTE Band 66	20M	QPSK	50	24	-	Back	15mm	Ant 4	DSI 1	132322	1745	17.5	1	18.15	18.80	1.161	-0.15	0.095	0.110
LTE Band 66	20M	QPSK	1	49	-	Front	15mm	Ant 4	DSI 5	132322	1745	15.5	1	16.59	16.80	1.050	0.15	0.035	0.037
LTE Band 66	20M	QPSK	1	49	-	Back	15mm	Ant 4	DSI 5	132322	1745	15.5	1	16.59	16.80	1.050	0.18	0.060	0.063
LTE Band 66	20M	QPSK	50	24	-	Front	15mm	Ant 4	DSI 5	132322	1745	15.5	1	16.56	16.80	1.057	0.11	0.037	0.039
LTE Band 66	20M	QPSK	50	24	-	Back	15mm	Ant 4	DSI 5	132322	1745	15.5	1	16.56	16.80	1.057	0.03	0.060	0.063
FR1 n66	40M	QPSK	1	108	DFT-15	Front	15mm	Ant 3	DSI 1	349000	1745	18.5	1	18.75	20.20	1.396	-0.15	0.100	0.140
FR1 n66	40M	QPSK	1	108	DFT-15	Back	15mm	Ant 3	DSI 1	349000	1745	18.5	1	18.75	20.20	1.396	-0.07	0.174	0.243
FR1 n66	40M	QPSK	108	54	DFT-15	Front	15mm	Ant 3	DSI 1	349000	1745	18.5	1	18.67	20.20	1.422	-0.09	0.111	0.158
FR1 n66	40M	QPSK	108	54	DFT-15	Back	15mm	Ant 3	DSI 1	349000	1745	18.5	1	18.67	20.20	1.422	-0.03	0.179	0.255
FR1 n66	40M	QPSK	1	108	DFT-15	Front	15mm	Ant 3	DSI 5	349000	1745	16.5	1	16.74	18.20	1.400	0.01	0.068	0.095
FR1 n66	40M	QPSK	1	108	DFT-15	Back	15mm	Ant 3	DSI 5	349000	1745	16.5	1	16.74	18.20	1.400	-0.09	0.112	0.157
FR1 n66	40M	QPSK	108	54	DFT-15	Front	15mm	Ant 3	DSI 5	349000	1745	16.5	1	16.70	18.20	1.413	0.1	0.070	0.099
FR1 n66	40M	QPSK	108	54	DFT-15	Back	15mm	Ant 3	DSI 5	349000	1745	16.5	1	16.70	18.20	1.413	0.18	0.113	0.160
FR1 n66	40M	QPSK	1	108	DFT-15	Front	15mm	Ant 0	DSI 1	349000	1745	18	1	17.54	18.70	1.306	-0.16	0.126	0.165
FR1 n66	40M	QPSK	1	108	DFT-15	Back	15mm	Ant 0	DSI 1	349000	1745	18	1	17.54	18.70	1.306	0.04	0.189	0.247
FR1 n66	40M	QPSK	108	54	DFT-15	Front	15mm	Ant 0	DSI 1	349000	1745	18	1	17.43	18.70	1.340	-0.05	0.129	0.173
FR1 n66	40M	QPSK	108	54	DFT-15	Back	15mm	Ant 0	DSI 1	349000	1745	18	1	17.43	18.70	1.340	-0.09	0.194	0.260
FR1 n66	40M	QPSK	1	108	DFT-15	Front	15mm	Ant 0	DSI 5	349000	1745	16	1	15.62	16.70	1.282	-0.12	0.093	0.119
FR1 n66	40M	QPSK	1	108	DFT-15	Back	15mm	Ant 0	DSI 5	349000	1745	16	1	15.62	16.70	1.282	-0.06	0.135	0.173
FR1 n66	40M	QPSK	108	54	DFT-15	Front	15mm	Ant 0	DSI 5	349000	1745	16	1	15.56	16.70	1.300	0.15	0.096	0.125
FR1 n66	40M	QPSK	108	54	DFT-15	Back	15mm	Ant 0	DSI 5	349000	1745	16	1	15.56	16.70	1.300	0.12	0.138	0.179
FR1 n66	40M	QPSK	1	108	DFT-15	Front	15mm	Ant 4	DSI 1	349000	1745	17.5	1	17.90	19.20	1.349	0.12	0.057	0.077
FR1 n66	40M	QPSK	1	108	DFT-15	Back	15mm	Ant 4	DSI 1	349000	1745	17.5	1	17.90	19.20	1.349	0.13	0.115	0.155
FR1 n66	40M	QPSK	108	54	DFT-15	Front	15mm	Ant 4	DSI 1	349000	1745	17.5	1	17.85	19.20	1.365	-0.05	0.059	0.081
FR1 n66	40M	QPSK	108	54	DFT-15	Back	15mm	Ant 4	DSI 1	349000	1745	17.5	1	17.85	19.20	1.365	0.07	0.115	0.157
FR1 n66	40M	QPSK	1	108	DFT-15	Front	15mm	Ant 4	DSI 5	349000	1745	15.5	1	15.92	17.20	1.343	0.09	0.036	0.048
FR1 n66	40M	QPSK	1	108	DFT-15	Back	15mm	Ant 4	DSI 5	349000	1745	15.5	1	15.92	17.20	1.343	0.02	0.072	0.097
FR1 n66	40M	QPSK	108	54	DFT-15	Front	15mm	Ant 4	DSI 5	349000	1745	15.5	1	15.88	17.20	1.355	0.01	0.037	0.050
FR1 n66	40M	QPSK	108	54	DFT-15	Back	15mm	Ant 4	DSI 5	349000	1745	15.5	1	15.88	17.20	1.355	-0.07	0.073	0.099
1900MHz																			
LTE Band 2	20M	QPSK	1	49	-	Front	15mm	Ant 3	DSI 1	18900	1880	17.5	1	16.79	17.30	1.125	-0.18	0.061	0.069
LTE Band 2	20M	QPSK	1	49	-	Back	15mm	Ant 3	DSI 1	18900	1880	17.5	1	16.79	17.30	1.125	-0.09	0.119	0.134
LTE Band 2	20M	QPSK	50	24	-	Front	15mm	Ant 3	DSI 1	18900	1880	17.5	1	16.78	17.30	1.127	0.15	0.063	0.071
LTE Band 2	20M	QPSK	50	24	-	Back	15mm	Ant 3	DSI 1	18900	1880	17.5	1	16.78	17.30	1.127	0.07	0.121	0.136
LTE Band 2	20M	QPSK	1	49	-	Front	15mm	Ant 3	DSI 5	18900	1880	15.5	1	14.72	15.30	1.143	0	0.038	0.043
LTE Band 2	20M	QPSK	1	49	-	Back	15mm	Ant 3	DSI 5	18900	1880	15.5	1	14.72	15.30	1.143	-0.02	0.075	0.086
LTE Band 2	20M	QPSK	50	24	-	Front	15mm	Ant 3	DSI 5	18900	1880	15.5	1	14.65	15.30	1.161	-0.08	0.040	0.046
LTE Band 2	20M	QPSK	50	24	-	Back	15mm	Ant 3	DSI 5	18900	1880	15.5	1	14.65	15.30	1.161	-0.1	0.077	0.089
LTE Band 2	20M	QPSK	1	49	-	Front	15mm	Ant 0	DSI 1	18900	1880	18	1	16.99	17.80	1.205	0.13	0.096	0.116



FCC SAR Test Report

Report No. : FA303018B

LTE Band 2	20M	QPSK	1	49	-	Back	15mm	Ant 0	DSI 1	18900	1880	18	1	16.99	17.80	1.205	-0.18	0.167	0.201
LTE Band 2	20M	QPSK	50	24	-	Front	15mm	Ant 0	DSI 1	18900	1880	18	1	16.98	17.80	1.208	-0.08	0.097	0.117
LTE Band 2	20M	QPSK	50	24	-	Back	15mm	Ant 0	DSI 1	18900	1880	18	1	16.98	17.80	1.208	0.14	0.167	0.202
LTE Band 2	20M	QPSK	1	49	-	Front	15mm	Ant 0	DSI 5	18900	1880	16	1	15.02	15.80	1.197	-0.09	0.061	0.073
LTE Band 2	20M	QPSK	1	49	-	Back	15mm	Ant 0	DSI 5	18900	1880	16	1	15.02	15.80	1.197	-0.05	0.105	0.126
LTE Band 2	20M	QPSK	50	24	-	Front	15mm	Ant 0	DSI 5	18900	1880	16	1	14.95	15.80	1.216	-0.14	0.061	0.074
LTE Band 2	20M	QPSK	50	24	-	Back	15mm	Ant 0	DSI 5	18900	1880	16	1	14.95	15.80	1.216	-0.05	0.106	0.129
2600MHz																			
LTE Band 7	20M	QPSK	1	49	-	Front	15mm	Ant 3	DSI 1	21100	2535	14.5	1	14.78	15.80	1.265	-0.03	0.054	0.068
LTE Band 7	20M	QPSK	1	49	-	Back	15mm	Ant 3	DSI 1	21100	2535	14.5	1	14.78	15.80	1.265	-0.09	0.083	0.105
LTE Band 7	20M	QPSK	50	24	-	Front	15mm	Ant 3	DSI 1	21100	2535	14.5	1	14.75	15.80	1.274	0.14	0.053	0.067
LTE Band 7	20M	QPSK	50	24	-	Back	15mm	Ant 3	DSI 1	21100	2535	14.5	1	14.75	15.80	1.274	-0.15	0.082	0.104
LTE Band 7	20M	QPSK	1	49	-	Front	15mm	Ant 3	DSI 5	21100	2535	12.5	1	12.75	13.80	1.274	-0.03	0.031	0.039
LTE Band 7	20M	QPSK	1	49	-	Back	15mm	Ant 3	DSI 5	21100	2535	12.5	1	12.75	13.80	1.274	-0.03	0.052	0.066
LTE Band 7	20M	QPSK	50	24	-	Front	15mm	Ant 3	DSI 5	21100	2535	12.5	1	12.67	13.80	1.297	0.02	0.033	0.043
LTE Band 7	20M	QPSK	50	24	-	Back	15mm	Ant 3	DSI 5	21100	2535	12.5	1	12.67	13.80	1.297	-0.15	0.052	0.067
LTE Band 7	20M	QPSK	1	49	-	Front	15mm	Ant 0	DSI 1	21100	2535	18	1	17.84	18.30	1.112	0.03	0.113	0.126
LTE Band 7	20M	QPSK	1	49	-	Back	15mm	Ant 0	DSI 1	21100	2535	18	1	17.84	18.30	1.112	-0.13	0.193	0.215
LTE Band 7	20M	QPSK	50	24	-	Front	15mm	Ant 0	DSI 1	21100	2535	18	1	17.78	18.30	1.127	-0.04	0.119	0.134
LTE Band 7	20M	QPSK	50	24	-	Back	15mm	Ant 0	DSI 1	21100	2535	18	1	17.78	18.30	1.127	0.09	0.225	0.254
LTE Band 7	20M	QPSK	1	49	-	Front	15mm	Ant 0	DSI 5	21100	2535	16	1	15.81	16.30	1.119	0	0.072	0.081
LTE Band 7	20M	QPSK	1	49	-	Back	15mm	Ant 0	DSI 5	21100	2535	16	1	15.81	16.30	1.119	0.01	0.122	0.137
LTE Band 7	20M	QPSK	50	24	-	Front	15mm	Ant 0	DSI 5	21100	2535	16	1	15.75	16.30	1.135	-0.17	0.075	0.085
LTE Band 7	20M	QPSK	50	24	-	Back	15mm	Ant 0	DSI 5	21100	2535	16	1	15.75	16.30	1.135	0.12	0.142	0.161
LTE Band 7	20M	QPSK	1	49	-	Front	15mm	Ant 4	DSI 1	21100	2535	17	1	16.13	17.30	1.309	-0.09	0.025	0.033
LTE Band 7	20M	QPSK	1	49	-	Back	15mm	Ant 4	DSI 1	21100	2535	17	1	16.13	17.30	1.309	0.15	0.072	0.094
LTE Band 7	20M	QPSK	50	24	-	Front	15mm	Ant 4	DSI 1	21100	2535	17	1	16.08	17.30	1.324	-0.11	0.029	0.038
LTE Band 7	20M	QPSK	50	24	-	Back	15mm	Ant 4	DSI 1	21100	2535	17	1	16.08	17.30	1.324	0.17	0.075	0.099
LTE Band 7	20M	QPSK	1	49	-	Front	15mm	Ant 4	DSI 5	21100	2535	15	1	14.29	15.30	1.262	0.17	0.016	0.020
LTE Band 7	20M	QPSK	1	49	-	Back	15mm	Ant 4	DSI 5	21100	2535	15	1	14.29	15.30	1.262	-0.09	0.045	0.057
LTE Band 7	20M	QPSK	50	24	-	Front	15mm	Ant 4	DSI 5	21100	2535	15	1	14.22	15.30	1.282	-0.05	0.018	0.023
LTE Band 7	20M	QPSK	50	24	-	Back	15mm	Ant 4	DSI 5	21100	2535	15	1	14.22	15.30	1.282	0.06	0.045	0.058
FR1 n7	40M	QPSK	1	108	DFT-15	Front	15mm	Ant 3	DSI 1	507000	2535	14.5	1	14.29	15.20	1.233	-0.01	0.053	0.065
FR1 n7	40M	QPSK	1	108	DFT-15	Back	15mm	Ant 3	DSI 1	507000	2535	14.5	1	14.29	15.20	1.233	-0.08	0.090	0.111
FR1 n7	40M	QPSK	108	54	DFT-15	Front	15mm	Ant 3	DSI 1	507000	2535	14.5	1	14.25	15.20	1.245	-0.06	0.053	0.066
FR1 n7	40M	QPSK	108	54	DFT-15	Back	15mm	Ant 3	DSI 1	507000	2535	14.5	1	14.25	15.20	1.245	0.08	0.092	0.114
FR1 n7	40M	QPSK	1	108	DFT-15	Front	15mm	Ant 3	DSI 5	507000	2535	12.5	1	12.49	13.20	1.178	-0.02	0.034	0.040
FR1 n7	40M	QPSK	1	108	DFT-15	Back	15mm	Ant 3	DSI 5	507000	2535	12.5	1	12.49	13.20	1.178	0.04	0.058	0.068
FR1 n7	40M	QPSK	108	54	DFT-15	Front	15mm	Ant 3	DSI 5	507000	2535	12.5	1	12.43	13.20	1.194	0.04	0.032	0.038
FR1 n7	40M	QPSK	108	54	DFT-15	Back	15mm	Ant 3	DSI 5	507000	2535	12.5	1	12.43	13.20	1.194	0.17	0.056	0.067
FR1 n7	40M	QPSK	1	108	DFT-15	Front	15mm	Ant 0	DSI 1	507000	2535	16.5	1	16.45	17.20	1.189	-0.06	0.112	0.133
FR1 n7	40M	QPSK	1	108	DFT-15	Back	15mm	Ant 0	DSI 1	507000	2535	16.5	1	16.45	17.20	1.189	-0.1	0.173	0.206
FR1 n7	40M	QPSK	108	54	DFT-15	Front	15mm	Ant 0	DSI 1	507000	2535	16.5	1	16.42	17.20	1.197	-0.17	0.107	0.128
FR1 n7	40M	QPSK	108	54	DFT-15	Back	15mm	Ant 0	DSI 1	507000	2535	16.5	1	16.42	17.20	1.197	-0.09	0.158	0.189
FR1 n7	40M	QPSK	1	108	DFT-15	Front	15mm	Ant 0	DSI 5	507000	2535	14.5	1	14.35	15.20	1.216	0.05	0.071	0.086
FR1 n7	40M	QPSK	1	108	DFT-15	Back	15mm	Ant 0	DSI 5	507000	2535	14.5	1	14.35	15.20	1.216	-0.1	0.109	0.133
FR1 n7	40M	QPSK	108	54	DFT-15	Front	15mm	Ant 0	DSI 5	507000	2535	14.5	1	14.27	15.20	1.239	0.12	0.068	0.084
FR1 n7	40M	QPSK	108	54	DFT-15	Back	15mm	Ant 0	DSI 5	507000	2535	14.5	1	14.27	15.20	1.239	-0.15	0.100	0.124
FR1 n7	40M	QPSK	1	108	DFT-15	Front	15mm	Ant 4	DSI 1	507000	2535	16	1	15.54	16.70	1.306	0.12	0.030	0.039
FR1 n7	40M	QPSK	1	108	DFT-15	Back	15mm	Ant 4	DSI 1	507000	2535	16	1	15.54	16.70	1.306	-0.17	0.079	0.103
FR1 n7	40M	QPSK	108	54	DFT-15	Front	15mm	Ant 4	DSI 1	507000	2535	16	1	15.52	16.70	1.312	0.09	0.030	0.039
FR1 n7	40M	QPSK	108	54	DFT-15	Back	15mm	Ant 4	DSI 1	507000	2535	16	1	15.52	16.70	1.312	0.07	0.078	0.102
FR1 n7	40M	QPSK	1	108	DFT-15	Front	15mm	Ant 4	DSI 5	507000	2535	14	1	13.55	14.70	1.303	-0.01	0.019	0.025
FR1 n7	40M	QPSK	1	108	DFT-15	Back	15mm	Ant 4	DSI 5	507000	2535	14	1	13.55	14.70	1.303	-0.03	0.050	0.065
FR1 n7	40M	QPSK	108	54	DFT-15	Front	15mm	Ant 4	DSI 5	507000	2535	14	1	13.46	14.70	1.330	0.06	0.019	0.025
FR1 n7	40M	QPSK	108	54	DFT-15	Back	15mm	Ant 4	DSI 5	507000	2535	14	1	13.46	14.70	1.330	-0.13	0.049	0.065



FR1 n38	40M	QPSK	1	53	DFT-30	Front	15mm	Ant 3	DSI 1	519000	2595	14	1	14.74	16.20	1.400	-0.04	0.060	0.084
FR1 n38	40M	QPSK	1	53	DFT-30	Back	15mm	Ant 3	DSI 1	519000	2595	14	1	14.74	16.20	1.400	-0.11	0.087	0.122
FR1 n38	40M	QPSK	50	28	DFT-30	Front	15mm	Ant 3	DSI 1	519000	2595	14	1	14.64	16.20	1.432	0.02	0.060	0.086
FR1 n38	40M	QPSK	50	28	DFT-30	Back	15mm	Ant 3	DSI 1	519000	2595	14	1	14.64	16.20	1.432	0.1	0.087	0.125
FR1 n38	40M	QPSK	1	53	DFT-30	Front	15mm	Ant 3	DSI 5	519000	2595	12	1	12.75	14.20	1.396	0.18	0.038	0.053
FR1 n38	40M	QPSK	1	53	DFT-30	Back	15mm	Ant 3	DSI 5	519000	2595	12	1	12.75	14.20	1.396	0.03	0.055	0.077
FR1 n38	40M	QPSK	50	28	DFT-30	Front	15mm	Ant 3	DSI 5	519000	2595	12	1	12.70	14.20	1.413	0.15	0.038	0.054
FR1 n38	40M	QPSK	50	28	DFT-30	Back	15mm	Ant 3	DSI 5	519000	2595	12	1	12.70	14.20	1.413	0.05	0.055	0.078
FR1 n38	40M	QPSK	1	53	DFT-15	Front	15mm	Ant 0	DSI 1	519000	2595	16.5	1	17.11	18.70	1.442	0.13	0.047	0.068
FR1 n38	40M	QPSK	1	53	DFT-15	Back	15mm	Ant 0	DSI 1	519000	2595	16.5	1	17.11	18.70	1.442	0.11	0.134	0.193
FR1 n38	40M	QPSK	50	28	DFT-15	Front	15mm	Ant 0	DSI 1	519000	2595	16.5	1	17.05	18.70	1.462	0.05	0.049	0.072
FR1 n38	40M	QPSK	50	28	DFT-15	Back	15mm	Ant 0	DSI 1	519000	2595	16.5	1	17.05	18.70	1.462	-0.04	0.142	0.208
FR1 n38	40M	QPSK	1	53	DFT-15	Front	15mm	Ant 0	DSI 5	519000	2595	14.5	1	15.10	16.70	1.445	0.06	0.030	0.043
FR1 n38	40M	QPSK	1	53	DFT-15	Back	15mm	Ant 0	DSI 5	519000	2595	14.5	1	15.10	16.70	1.445	-0.1	0.083	0.120
FR1 n38	40M	QPSK	50	28	DFT-15	Front	15mm	Ant 0	DSI 5	519000	2595	14.5	1	15.01	16.70	1.476	-0.03	0.031	0.046
FR1 n38	40M	QPSK	50	28	DFT-15	Back	15mm	Ant 0	DSI 5	519000	2595	14.5	1	15.01	16.70	1.476	0.16	0.090	0.133
FR1 n38	40M	QPSK	1	53	DFT-15	Front	15mm	Ant 4	DSI 1	519000	2595	14.5	1	15.00	16.70	1.479	-0.11	0.023	0.034
FR1 n38	40M	QPSK	1	53	DFT-15	Back	15mm	Ant 4	DSI 1	519000	2595	14.5	1	15.00	16.70	1.479	-0.02	0.121	0.179
FR1 n38	40M	QPSK	50	28	DFT-15	Front	15mm	Ant 4	DSI 1	519000	2595	14.5	1	14.94	16.70	1.500	0.03	0.023	0.034
FR1 n38	40M	QPSK	50	28	DFT-15	Back	15mm	Ant 4	DSI 1	519000	2595	14.5	1	14.94	16.70	1.500	-0.11	0.093	0.139
FR1 n38	40M	QPSK	1	53	DFT-15	Front	15mm	Ant 4	DSI 5	519000	2595	12.5	1	13.05	14.70	1.462	-0.01	0.015	0.022
FR1 n38	40M	QPSK	1	53	DFT-15	Back	15mm	Ant 4	DSI 5	519000	2595	12.5	1	13.05	14.70	1.462	-0.01	0.076	0.111
FR1 n38	40M	QPSK	50	28	DFT-15	Front	15mm	Ant 4	DSI 5	519000	2595	12.5	1	13.00	14.70	1.479	-0.03	0.014	0.021
FR1 n38	40M	QPSK	50	28	DFT-15	Back	15mm	Ant 4	DSI 5	519000	2595	12.5	1	13.00	14.70	1.479	-0.08	0.054	0.080
FR1 n41 PC2	100M	QPSK	1	137	DFT-30	Front	15mm	Ant 3	DSI 1	518598	2592.99	16.5	1	15.28	16.70	1.387	0.16	0.065	0.090
FR1 n41 PC2	100M	QPSK	1	137	DFT-30	Back	15mm	Ant 3	DSI 1	518598	2592.99	16.5	1	15.28	16.70	1.387	0.11	0.098	0.136
FR1 n41 PC2	100M	QPSK	135	69	DFT-30	Front	15mm	Ant 3	DSI 1	518598	2592.99	16.5	1	15.26	16.70	1.393	-0.14	0.067	0.093
FR1 n41 PC2	100M	QPSK	135	69	DFT-30	Back	15mm	Ant 3	DSI 1	518598	2592.99	16.5	1	15.26	16.70	1.393	0.05	0.099	0.138
FR1 n41 PC2	100M	QPSK	1	137	DFT-30	Front	15mm	Ant 3	DSI 5	518598	2592.99	14.5	1	13.11	14.70	1.442	0.14	0.041	0.059
FR1 n41 PC2	100M	QPSK	1	137	DFT-30	Back	15mm	Ant 3	DSI 5	518598	2592.99	14.5	1	13.11	14.70	1.442	-0.16	0.062	0.089
FR1 n41 PC2	100M	QPSK	135	69	DFT-30	Front	15mm	Ant 3	DSI 5	518598	2592.99	14.5	1	13.07	14.70	1.455	-0.04	0.042	0.061
FR1 n41 PC2	100M	QPSK	135	69	DFT-30	Back	15mm	Ant 3	DSI 5	518598	2592.99	14.5	1	13.07	14.70	1.455	0.05	0.062	0.090
FR1 n41 PC2	100M	QPSK	1	137	DFT-30	Front	15mm	Ant 0	DSI 1	518598	2592.99	20.5	1	18.92	20.70	1.507	0.06	0.125	0.188
FR1 n41 PC2	100M	QPSK	1	137	DFT-30	Back	15mm	Ant 0	DSI 1	518598	2592.99	20.5	1	18.92	20.70	1.507	0.11	0.164	0.247
FR1 n41 PC2	100M	QPSK	135	69	DFT-30	Front	15mm	Ant 0	DSI 1	518598	2592.99	20.5	1	18.84	20.70	1.535	-0.01	0.128	0.196
FR1 n41 PC2	100M	QPSK	135	69	DFT-30	Back	15mm	Ant 0	DSI 1	518598	2592.99	20.5	1	18.84	20.70	1.535	-0.15	0.192	0.295
FR1 n41 PC2	100M	QPSK	1	137	DFT-30	Front	15mm	Ant 0	DSI 5	518598	2592.99	18.5	1	16.88	18.70	1.521	-0.09	0.056	0.085
FR1 n41 PC2	100M	QPSK	1	137	DFT-30	Back	15mm	Ant 0	DSI 5	518598	2592.99	18.5	1	16.88	18.70	1.521	-0.15	0.074	0.113
FR1 n41 PC2	100M	QPSK	135	69	DFT-30	Front	15mm	Ant 0	DSI 5	518598	2592.99	18.5	1	16.82	18.70	1.542	-0.06	0.057	0.088
FR1 n41 PC2	100M	QPSK	135	69	DFT-30	Back	15mm	Ant 0	DSI 5	518598	2592.99	18.5	1	16.82	18.70	1.542	-0.05	0.086	0.133
FR1 n41 PC2	100M	QPSK	1	137	DFT-30	Front	15mm	Ant 4	DSI 1	518598	2592.99	17.5	1	15.87	17.70	1.524	0.02	0.034	0.052
FR1 n41 PC2	100M	QPSK	1	137	DFT-30	Back	15mm	Ant 4	DSI 1	518598	2592.99	17.5	1	15.87	17.70	1.524	-0.17	0.083	0.126
FR1 n41 PC2	100M	QPSK	135	69	DFT-30	Front	15mm	Ant 4	DSI 1	518598	2592.99	17.5	1	15.85	17.70	1.531	0.16	0.035	0.054
FR1 n41 PC2	100M	QPSK	135	69	DFT-30	Back	15mm	Ant 4	DSI 1	518598	2592.99	17.5	1	15.85	17.70	1.531	-0.03	0.086	0.132
FR1 n41 PC2	100M	QPSK	1	137	DFT-30	Front	15mm	Ant 4	DSI 5	518598	2592.99	15.5	1	13.85	15.70	1.531	-0.04	0.021	0.032
FR1 n41 PC2	100M	QPSK	1	137	DFT-30	Back	15mm	Ant 4	DSI 5	518598	2592.99	15.5	1	13.85	15.70	1.531	-0.16	0.052	0.080
FR1 n41 PC2	100M	QPSK	135	69	DFT-30	Front	15mm	Ant 4	DSI 5	518598	2592.99	15.5	1	13.77	15.70	1.560	0.18	0.022	0.034
FR1 n41 PC2	100M	QPSK	135	69	DFT-30	Back	15mm	Ant 4	DSI 5	518598	2592.99	15.5	1	13.77	15.70	1.560	0.11	0.054	0.084



Plot No.	Band	Mode	Test Position	Gap (mm)	Antenna	Power State	Ch.	Freq. (MHz)	Sample	Average Power (dBm)	Tune-Up Limit (dBm)	Tune-up Scaling Factor	Duty Cycle %	Duty Cycle Scaling Factor	Power Drift (dB)	Measured 1g SAR (W/kg)	Reported 1g SAR (W/kg)	
BT/WIFI																		
	Bluetooth	DH5 1Mbps	Front	15mm	Ant 7	Full	39	2441	1	14.30	15.00	1.175	76.35	1.310	-0.06	0.042	0.065	
73	Bluetooth	DH5 1Mbps	Back	15mm	Ant 7	Full	39	2441	1	14.30	15.00	1.175	76.35	1.310	0.12	0.044	0.068	
	WLAN2.4GHz	802.11b 1Mbps	Front	15mm	Ant 7	Full	11	2462	1	14.90	15.00	1.023	100	1.000	0.01	0.065	0.067	
	WLAN2.4GHz	802.11b 1Mbps	Back	15mm	Ant 7	Full	11	2462	1	14.90	15.00	1.023	100	1.000	0.05	0.087	0.089	
	WLAN2.4GHz	802.11b 1Mbps	Front	15mm	Ant 8	Full	6	2437	1	14.80	15.00	1.047	100	1.000	0.15	0.072	0.075	
74	WLAN2.4GHz	802.11b 1Mbps	Back	15mm	Ant 8	Full	6	2437	1	14.80	15.00	1.047	100	1.000	-0.07	0.154	0.161	
	WLAN5.3GHz	802.11n-HT40 MCS0	Front	15mm	Ant 8+6	Full	54	5270	1	18.65	19.50	1.216	87.66	1.141	0.09	0.168	0.233	
75	WLAN5.3GHz	802.11n-HT40 MCS0	Back	15mm	Ant 8+6	Full	54	5270	1	18.65	19.50	1.216	87.66	1.141	-0.01	0.507	0.704	
	WLAN5.3GHz	802.11n-HT40 MCS0	Back	15mm	Ant 8+6	Full	54	5270	2	18.65	19.50	1.216	87.66	1.141	-0.01	0.491	0.681	
	WLAN5.5GHz	802.11ac-VHT80 MCS0	Front	15mm	Ant 8+6	Full	122	5610	1	16.58	17.50	1.236	87.28	1.146	0.12	0.065	0.092	
76	WLAN5.5GHz	802.11ac-VHT80 MCS0	Back	15mm	Ant 8+6	Full	122	5610	1	16.58	17.50	1.236	87.28	1.146	-0.15	0.287	0.407	
	WLAN5.8GHz	802.11ac-VHT80 MCS0	Front	15mm	Ant 8+6	Full	155	5775	1	16.11	17.00	1.227	87.28	1.146	-0.11	0.092	0.129	
77	WLAN5.8GHz	802.11ac-VHT80 MCS0	Back	15mm	Ant 8+6	Full	155	5775	1	16.11	17.00	1.227	87.28	1.146	-0.18	0.345	0.485	



14.4 Product specific 10g SAR

Plot No.	Band	BW (MHz)	Modulation	RB Size	RB offset	Mode	Test Position	Gap (mm)	Antenna	Power State	Ch.	Freq. (MHz)	Sample	Average Power (dBm)	Tune-Up Limit (dBm)	Tune-up Scaling Factor	Power Drift (dB)	Measured 10g SAR (W/kg)	Reported 10g SAR (W/kg)
835MHz																			
	FR1 n26	20M	QPSK	1	53	DFT-15	Left Side	0mm	Ant 1	DSI 1	166300	831.5	1	21.45	22.70	1.334	-0.19	0.947	1.262
78	FR1 n26	20M	QPSK	50	28	DFT-15	Left Side	0mm	Ant 1	DSI 1	166300	831.5	1	21.42	22.70	1.343	-0.08	1.040	1.396
	FR1 n26	20M	QPSK	50	28	DFT-15	Left Side	0mm	Ant 1	DSI 1	166300	831.5	2	21.42	22.70	1.343	-0.08	0.839	1.127
	FR1 n26	20M	QPSK	1	53	DFT-15	Left Side	0mm	Ant 1	DSI 5	166300	831.5	1	19.94	21.20	1.337	-0.16	0.670	0.896
	FR1 n26	20M	QPSK	50	28	DFT-15	Left Side	0mm	Ant 1	DSI 5	166300	831.5	1	19.93	21.20	1.340	-0.01	0.736	0.987
2600MHz																			
	LTE Band 7	20M	QPSK	1	49	-	Bottom Side	0mm	Ant 0	DSI 1	21100	2535	1	20.84	21.30	1.112	-0.18	1.560	1.734
79	LTE Band 7	20M	QPSK	50	24	-	Bottom Side	0mm	Ant 0	DSI 1	21100	2535	1	20.84	21.30	1.112	0.16	1.690	1.879
	LTE Band 7C	20M	QPSK	50	24	-	Bottom Side	0mm	Ant 0	DSI 1	21100+20902	2535+2515.2	1	20.56	20.60	1.009	-0.02	1.460	1.474
	LTE Band 7	20M	QPSK	1	49	-	Bottom Side	0mm	Ant 0	DSI 5	21100	2535	1	18.78	19.30	1.127	-0.15	0.959	1.081
	LTE Band 7C	20M	QPSK	1	49	-	Bottom Side	0mm	Ant 0	DSI 5	21100+20902	2535+2515.2	1	18.52	18.60	1.019	-0.03	0.948	0.966
	LTE Band 7	20M	QPSK	50	24	-	Bottom Side	0mm	Ant 0	DSI 5	21100	2535	1	18.74	19.30	1.138	-0.16	0.966	1.099
	FR1 n41 PC2	100M	QPSK	1	137	DFT-30	Bottom Side	0mm	Ant 0	DSI 1	518598	2592.99	1	20.32	22.20	1.542	0.16	1.480	2.282
80	FR1 n41 PC2	100M	QPSK	135	69	DFT-30	Bottom Side	0mm	Ant 0	DSI 1	518598	2592.99	1	20.23	22.20	1.574	0.15	1.710	2.692
	FR1 n41 PC2	100M	QPSK	135	69	DFT-30	Bottom Side	0mm	Ant 0	DSI 1	518598	2592.99	2	20.23	22.20	1.574	0.15	1.470	2.314
	FR1 n41 PC2	100M	QPSK	270	0	DFT-30	Bottom Side	0mm	Ant 0	DSI 1	518598	2592.99	1	20.20	22.20	1.585	0.16	1.330	2.108
	FR1 n41 PC2	100M	QPSK	1	137	DFT-30	Bottom Side	0mm	Ant 0	DSI 5	518598	2592.99	1	18.33	20.20	1.538	-0.01	0.934	1.437
	FR1 n41 PC2	100M	QPSK	135	69	DFT-30	Bottom Side	0mm	Ant 0	DSI 5	518598	2592.99	1	18.21	20.20	1.581	0.18	0.943	1.491

Plot No.	Band	Mode	Test Position	Gap (mm)	Antenna	Power State	Ch.	Freq. (MHz)	Sample	Average Power (dBm)	Tune-Up Limit (dBm)	Tune-up Scaling Factor	Duty Cycle %	Duty Cycle Scaling Factor	Power Drift (dB)	Measured 10g SAR (W/kg)	Reported 10g SAR (W/kg)
BT/WIFI																	
81	WLAN5.3GHz	802.11n-HT40 MCS0	Front	0mm	Ant 8+6	5G+BT	54	5270	1	18.65	19.50	1.216	87.66	1.141	0.1	1.000	1.388
	WLAN5.3GHz	802.11n-HT40 MCS0	Back	0mm	Ant 8+6	5G+BT	54	5270	1	18.65	19.50	1.216	87.66	1.141	-0.12	0.832	1.155
	WLAN5.3GHz	802.11n-HT40 MCS0	Right Side	0mm	Ant 8+6	5G+BT	54	5270	1	18.65	19.50	1.216	87.66	1.141	-0.07	2.010	2.789
	WLAN5.3GHz	802.11n-HT40 MCS0	Right Side	0mm	Ant 8+6	5G+BT	54	5270	2	18.65	19.50	1.216	87.66	1.141	-0.07	1.910	2.650
	WLAN5.3GHz	802.11n-HT40 MCS0	Top Side	0mm	Ant 8+6	5G+BT	54	5270	1	18.65	19.50	1.216	87.66	1.141	0.14	1.490	2.068
	WLAN5.3GHz	802.11n-HT40 MCS0	Right Side	0mm	Ant 8+6	5G+BT	62	5310	1	10.14	11.50	1.368	87.66	1.141	-0.09	0.241	0.376
	WLAN5.3GHz	802.11n-HT40 MCS0	Front	0mm	Ant 8+6	5G+WWAN	54	5270	1	16.13	17.00	1.222	87.66	1.141	0.01	0.447	0.623
	WLAN5.3GHz	802.11n-HT40 MCS0	Back	0mm	Ant 8+6	5G+WWAN	54	5270	1	16.13	17.00	1.222	87.66	1.141	0.07	0.372	0.519
	WLAN5.3GHz	802.11n-HT40 MCS0	Right Side	0mm	Ant 8+6	5G+WWAN	54	5270	1	16.13	17.00	1.222	87.66	1.141	-0.03	0.889	1.239
	WLAN5.3GHz	802.11n-HT40 MCS0	Top Side	0mm	Ant 8+6	5G+WWAN	54	5270	1	16.13	17.00	1.222	87.66	1.141	-0.03	0.666	0.928
	WLAN5.3GHz	802.11n-HT40 MCS0	Front	0mm	Ant 8+6	5G+WWAN+BT	54	5270	1	12.54	13.50	1.247	87.66	1.141	0.06	0.198	0.281
	WLAN5.3GHz	802.11n-HT40 MCS0	Back	0mm	Ant 8+6	5G+WWAN+BT	54	5270	1	12.54	13.50	1.247	87.66	1.141	-0.02	0.165	0.234
	WLAN5.3GHz	802.11n-HT40 MCS0	Right Side	0mm	Ant 8+6	5G+WWAN+BT	54	5270	1	12.54	13.50	1.247	87.66	1.141	-0.03	0.396	0.564
	WLAN5.3GHz	802.11n-HT40 MCS0	Top Side	0mm	Ant 8+6	5G+WWAN+BT	54	5270	1	12.54	13.50	1.247	87.66	1.141	-0.14	0.294	0.418
	WLAN5.3GHz	802.11n-HT40 MCS0	Front	0mm	Ant 8+6	2.4G+5G+WWAN	54	5270	1	15.12	16.00	1.225	87.66	1.141	0.01	0.354	0.495
WLAN5.3GHz	802.11n-HT40 MCS0	Back	0mm	Ant 8+6	2.4G+5G+WWAN	54	5270	1	15.12	16.00	1.225	87.66	1.141	0.02	0.296	0.414	
WLAN5.3GHz	802.11n-HT40 MCS0	Right Side	0mm	Ant 8+6	2.4G+5G+WWAN	54	5270	1	15.12	16.00	1.225	87.66	1.141	-0.01	0.714	0.998	
WLAN5.3GHz	802.11n-HT40 MCS0	Top Side	0mm	Ant 8+6	2.4G+5G+WWAN	54	5270	1	15.12	16.00	1.225	87.66	1.141	-0.01	0.528	0.738	
82	WLAN5.5GHz	802.11ac-VHT80 MCS0	Front	0mm	Ant 8+6	5G+BT	122	5610	1	16.58	17.50	1.236	87.28	1.146	0.12	0.316	0.448
	WLAN5.5GHz	802.11ac-VHT80 MCS0	Back	0mm	Ant 8+6	5G+BT	122	5610	1	16.58	17.50	1.236	87.28	1.146	-0.02	0.349	0.494
	WLAN5.5GHz	802.11ac-VHT80 MCS0	Right Side	0mm	Ant 8+6	5G+BT	122	5610	1	16.58	17.50	1.236	87.28	1.146	-0.05	0.825	1.169
	WLAN5.5GHz	802.11ac-VHT80 MCS0	Top Side	0mm	Ant 8+6	5G+BT	122	5610	1	16.58	17.50	1.236	87.28	1.146	0.07	0.592	0.839
	WLAN5.5GHz	802.11ac-VHT80 MCS0	Front	0mm	Ant 8+6	5G+WWAN	122	5610	1	13.09	14.00	1.233	87.28	1.146	-0.11	0.147	0.208
	WLAN5.5GHz	802.11ac-VHT80 MCS0	Back	0mm	Ant 8+6	5G+WWAN	122	5610	1	13.09	14.00	1.233	87.28	1.146	0.02	0.161	0.228
	WLAN5.5GHz	802.11ac-VHT80 MCS0	Right Side	0mm	Ant 8+6	5G+WWAN	122	5610	1	13.09	14.00	1.233	87.28	1.146	-0.14	0.352	0.497
	WLAN5.5GHz	802.11ac-VHT80 MCS0	Top Side	0mm	Ant 8+6	5G+WWAN	122	5610	1	13.09	14.00	1.233	87.28	1.146	0.02	0.282	0.399
	WLAN5.5GHz	802.11ac-VHT80 MCS0	Front	0mm	Ant 8+6	5G+WWAN+BT	122	5610	1	12.08	13.00	1.236	87.28	1.146	0.03	0.118	0.167
	WLAN5.5GHz	802.11ac-VHT80 MCS0	Back	0mm	Ant 8+6	5G+WWAN+BT	122	5610	1	12.08	13.00	1.236	87.28	1.146	0.15	0.143	0.203
	WLAN5.5GHz	802.11ac-VHT80 MCS0	Right Side	0mm	Ant 8+6	5G+WWAN+BT	122	5610	1	12.08	13.00	1.236	87.28	1.146	0.12	0.298	0.422
	WLAN5.5GHz	802.11ac-VHT80 MCS0	Top Side	0mm	Ant 8+6	5G+WWAN+BT	122	5610	1	12.08	13.00	1.236	87.28	1.146	-0.07	0.229	0.324
	WLAN5.5GHz	802.11ac-VHT80 MCS0	Front	0mm	Ant 8+6	2.4G+5G+WWAN	122	5610	1	12.59	13.50	1.233	87.28	1.146	0.02	0.121	0.171
	WLAN5.5GHz	802.11ac-VHT80 MCS0	Back	0mm	Ant 8+6	2.4G+5G+WWAN	122	5610	1	12.59	13.50	1.233	87.28	1.146	0.07	0.125	0.177
	WLAN5.5GHz	802.11ac-VHT80 MCS0	Right Side	0mm	Ant 8+6	2.4G+5G+WWAN	122	5610	1	12.59	13.50	1.233	87.28	1.146	-0.12	0.285	0.403
WLAN5.5GHz	802.11ac-VHT80 MCS0	Top Side	0mm	Ant 8+6	2.4G+5G+WWAN	122	5610	1	12.59	13.50	1.233	87.28	1.146	-0.18	0.245	0.346	



14.5 Repeated SAR Measurement

<1g>

Plot No.	Band	BW (MHz)	Modulation	RB Size	RB offset	Mode	Test Position	Gap (mm)	Antenna	Power State	Ch.	Freq. (MHz)	Sample	Average Power (dBm)	Tune-Up Limit (dBm)	Tune-up Scaling Factor	Duty Cycle %	Duty Cycle Scaling Factor	Power Drift (dB)	Measured 1g SAR (W/kg)	Ratio	Reported 1g SAR (W/kg)
1st	LTE Band 13	10M	QPSK	1	25	-	Left Cheek	0mm	Ant 1	DSI 2	23230	782	1	21.29	21.50	1.050	-	-	-0.15	0.811	1	0.851
2nd	LTE Band 13	10M	QPSK	1	25	-	Left Cheek	0mm	Ant 1	DSI 2	23230	782	1	21.29	21.50	1.050	-	-	0.03	0.785	1.033	0.824
1st	FR1 n26	20M	QPSK	50	28	DFT-15	Left Cheek	0mm	Ant 1	DSI 2	166300	831.5	1	19.93	21.20	1.340	-	-	0.09	0.818	1	1.096
2nd	FR1 n26	20M	QPSK	50	28	DFT-15	Left Cheek	0mm	Ant 1	DSI 2	166300	831.5	1	19.93	21.20	1.340	-	-	0.03	0.795	1.029	1.065
1st	WCDMA IV	-	-	-	-	RMC 12.2Kbps	Right Cheek	0mm	Ant 3	DSI 2	1312	1712.4	1	19.24	19.80	1.138	-	-	-0.04	1.010	1	1.149
2nd	WCDMA IV	-	-	-	-	RMC 12.2Kbps	Right Cheek	0mm	Ant 3	DSI 2	1312	1712.4	1	19.24	19.80	1.138	-	-	0.11	0.988	1.022	1.124
1st	GSM1900	-	-	-	-	GPRS (4 Tx slots)	Right Cheek	0mm	Ant 3	DSI 2	810	1909.8	1	21.56	21.80	1.057	-	-	0.18	0.933	1	0.986
2nd	GSM1900	-	-	-	-	GPRS (4 Tx slots)	Right Cheek	0mm	Ant 3	DSI 2	810	1909.8	1	21.56	21.80	1.057	-	-	0.03	0.911	0.911	0.963
1st	LTE Band 41 PC2	20M	QPSK	50	24	-	Right Tilted	0mm	Ant 3	DSI 2	41490	2680	1	19.90	20.80	1.230	42.9	1.009	-0.03	0.952	1	1.182
2nd	LTE Band 41 PC2	20M	QPSK	50	24	-	Right Tilted	0mm	Ant 3	DSI 2	41490	2680	1	19.90	20.80	1.230	42.9	1.009	0.01	0.934	1.019	1.159
1st	WLAN5.3GHz	-	-	-	-	802.11n-HT40 MCS0	Left Cheek	0mm	Ant 8+6	5G&2.4G+5G&5G+BT	54	5270	1	16.91	17.50	1.146	87.66	1.141	-0.07	0.848	1	1.108
2nd	WLAN5.3GHz	-	-	-	-	802.11n-HT40 MCS0	Left Cheek	0mm	Ant 8+6	5G&2.4G+5G&5G+BT	54	5270	1	16.91	17.50	1.146	87.66	1.141	0.03	0.812	1.044	1.061
1st	WLAN5.5GHz	-	-	-	-	802.11ac-VHT80 MCS0	Left Cheek	0mm	Ant 8+6	5G&2.4G+5G&5G+BT	122	5610	1	17.38	18.00	1.153	87.28	1.146	0.05	0.845	1	1.117
2nd	WLAN5.5GHz	-	-	-	-	802.11ac-VHT80 MCS0	Left Cheek	0mm	Ant 8+6	5G&2.4G+5G&5G+BT	122	5610	1	17.38	18.00	1.153	87.28	1.146	0.02	0.811	1.042	1.072

<10g>

Plot No.	Band	Mode	Test Position	Gap (mm)	Antenna	Power State	Ch.	Freq. (MHz)	Sample	Average Power (dBm)	Tune-Up Limit (dBm)	Tune-up Scaling Factor	Duty Cycle %	Duty Cycle Scaling Factor	Power Drift (dB)	Measured 10g SAR (W/kg)	Ratio	Reported 10g SAR (W/kg)
1st	WLAN5.3GHz	802.11n-HT40 MCS0	Right Side	0mm	Ant 8+6	5G+BT	54	5270	1	18.65	19.50	1.216	87.66	1.141	-0.07	2.010	1	2.789
2nd	WLAN5.3GHz	802.11n-HT40 MCS0	Right Side	0mm	Ant 8+6	5G+BT	54	5270	1	18.65	19.50	1.216	87.66	1.141	0.03	1.970	1.020	2.734

General Note:

- Per KDB 865664 D01v01r04, for each frequency band, repeated SAR measurement is required only when the measured SAR is $\geq 0.8W/kg$.
- Per KDB 865664 D01v01r04, if the ratio among the repeated measurement is ≤ 1.2 and the measured SAR $< 1.45W/kg$, only one repeated measurement is required.
- Per KDB 865664 D01v01r04, if the extremity repeated SAR is necessary, the same procedures should be adapted for measurements according to extremity and occupational exposure limits by applying a factor of 2.5 for extremity exposure and a factor of 5 for occupational exposure to the corresponding SAR thresholds.
- The ratio is the difference in percentage between original and repeated *measured SAR*.
- All measurement SAR result is scaled-up to account for tune-up tolerance and is compliant.



14.6 TDD LTE Linearity Data Analysis

General Note:

This device support Power Class 2 and Power Class 3 operations for LTE Band 41. The highest available duty cycle for Power Class 2 operation is 43.3% using UL-DL configuration 1. Per FCC Guidance based on the device behavior, all SAR tests were performed using Power Class 3. Power Class 2 is tested using the highest SAR test configuration in Power Class 3 for each LTE configuration and exposure condition combination, according to the highest time averaged power for all applicable uplink-downlink configurations in Power Class 2. When the reported SAR vs. output power is linearly scaled with < 10% discrepancy between power classes and all reported SAR are < 1.4 W/kg for 1g and < 3.5 W/kg for 10g, Separate SAR testing for Power Class 2 is not required.

LTE Band 41(HPUE)-Linearity Data for DSI2-ANT3			LTE Band 41(HPUE)-Linearity Data for DSI2&6-ANT0		
	LTE Band 41 (Power Class 3)	LTE Band 41 (Power Class 2)		LTE Band 41 (Power Class 3)	LTE Band 41 (Power Class 2)
Maximum Tune up Power (dBm)	17.80	20.80	Maximum Tune up Power (dBm)	22.80	25.80
Reported 1g SAR (W/kg)	0.961	1.182	Reported 1g SAR (W/kg)	0.043	0.059
Duty Cycle	63.30%	43.30%	Duty Cycle	63.30%	43.30%
Frame Averaged (mW)	38.14	52.06	Frame Averaged (mW)	120.62	164.62
Linearity SAR (W/kg)	1.312		Linearity SAR (W/kg)	0.059	
% deviation from expected linearity		-9.88%	% deviation from expected linearity		0.53%

LTE Band 41(HPUE)-Linearity Data for DSI6-ANT3		
	LTE Band 41 (Power Class 3)	LTE Band 41 (Power Class 2)
Maximum Tune up Power (dBm)	16.30	19.30
Reported 1g SAR (W/kg)	0.734	0.907
Duty Cycle	63.30%	43.30%
Frame Averaged (mW)	27.00	36.85
Linearity SAR (W/kg)	1.002	
% deviation from expected linearity		-9.46%

LTE Band 41(HPUE)-Linearity Data for DSI1-ANT3			LTE Band 41(HPUE)-Linearity Data for DSI1-ANT0		
	LTE Band 41 (Power Class 3)	LTE Band 41 (Power Class 2)		LTE Band 41 (Power Class 3)	LTE Band 41 (Power Class 2)
Maximum Tune up Power (dBm)	19.80	22.80	Maximum Tune up Power (dBm)	22.80	25.80
Reported 1g SAR (W/kg)	0.152	0.207	Reported 1g SAR (W/kg)	0.245	0.358
Duty Cycle	63.30%	43.30%	Duty Cycle	63.30%	43.30%
Frame Averaged (mW)	60.45	82.51	Frame Averaged (mW)	120.62	164.62
Linearity SAR (W/kg)	0.207		Linearity SAR (W/kg)	0.334	
% deviation from expected linearity		-0.22%	% deviation from expected linearity		7.06%

Body Worn

Body Worn

LTE Band 41(HPUE)-Linearity Data for DSI5-ANT3			LTE Band 41(HPUE)-Linearity Data for DSI5-ANT0		
	LTE Band 41 (Power Class 3)	LTE Band 41 (Power Class 2)		LTE Band 41 (Power Class 3)	LTE Band 41 (Power Class 2)
Maximum Tune up Power (dBm)	17.80	20.80	Maximum Tune up Power (dBm)	20.80	23.80
Reported 1g SAR (W/kg)	0.094	0.131	Reported 1g SAR (W/kg)	0.150	0.221
Duty Cycle	63.30%	43.30%	Duty Cycle	63.30%	43.30%
Frame Averaged (mW)	38.14	52.06	Frame Averaged (mW)	76.10	103.87
Linearity SAR (W/kg)	0.128		Linearity SAR (W/kg)	0.205	
% deviation from expected linearity		2.11%	% deviation from expected linearity		7.95%

Hotspot

Hotspot

LTE Band 41(HPUE)-Linearity Data for DSI5-ANT3			LTE Band 41(HPUE)-Linearity Data for DSI5-ANT0		
	LTE Band 41 (Power Class 3)	LTE Band 41 (Power Class 2)		LTE Band 41 (Power Class 3)	LTE Band 41 (Power Class 2)
Maximum Tune up Power (dBm)	17.80	20.80	Maximum Tune up Power (dBm)	20.80	23.80
Reported 1g SAR (W/kg)	0.225	0.316	Reported 1g SAR (W/kg)	0.400	0.550
Duty Cycle	63.30%	43.30%	Duty Cycle	63.30%	43.30%



Frame Averaged (mW)	38.14	52.06	Frame Averaged (mW)	76.10	103.87
Linearity SAR (W/kg)	0.307		Linearity SAR (W/kg)	0.546	
% deviation from expected linearity		2.90%	% deviation from expected linearity		0.74%

LTE Band 41(HPUE)-Linearity Data for DSI2-ANT4		
	LTE Band 41 (Power Class 3)	LTE Band 41 (Power Class 2)
Maximum Tune up Power (dBm)	21.80	24.80
Reported 1g SAR (W/kg)	0.596	0.891
Duty Cycle	63.30%	43.30%
Frame Averaged (mW)	95.81	130.76
Linearity SAR (W/kg)	0.813	
% deviation from expected linearity		9.53%

LTE Band 41(HPUE)-Linearity Data for DSI6-ANT4		
	LTE Band 41 (Power Class 3)	LTE Band 41 (Power Class 2)
Maximum Tune up Power (dBm)	20.80	23.80
Reported 1g SAR (W/kg)	0.518	0.693
Duty Cycle	63.30%	43.30%
Frame Averaged (mW)	76.10	103.87
Linearity SAR (W/kg)	0.707	
% deviation from expected linearity		-1.98%

LTE Band 41(HPUE)-Linearity Data for DSI1-ANT4		
	LTE Band 41 (Power Class 3)	LTE Band 41 (Power Class 2)
Maximum Tune up Power (dBm)	20.80	23.80
Reported 1g SAR (W/kg)	0.146	0.189
Duty Cycle	63.30%	43.30%
Frame Averaged (mW)	76.10	103.87
Linearity SAR (W/kg)	0.199	
% deviation from expected linearity		-5.15%

Body Worn

LTE Band 41(HPUE)-Linearity Data for DSI5-ANT4		
	LTE Band 41 (Power Class 3)	LTE Band 41 (Power Class 2)
Maximum Tune up Power (dBm)	18.80	21.80
Reported 1g SAR (W/kg)	0.091	0.117
Duty Cycle	63.30%	43.30%
Frame Averaged (mW)	48.02	65.54
Linearity SAR (W/kg)	0.124	
% deviation from expected linearity		-5.80%

Hotspot

LTE Band 41(HPUE)-Linearity Data for DSI5-ANT4		
	LTE Band 41 (Power Class 3)	LTE Band 41 (Power Class 2)
Maximum Tune up Power (dBm)	18.80	21.80
Reported 1g SAR (W/kg)	0.174	0.235
Duty Cycle	63.30%	43.30%
Frame Averaged (mW)	48.02	65.54
Linearity SAR (W/kg)	0.237	
% deviation from expected linearity		-1.05%

15. Simultaneous Transmission Analysis

No.	Simultaneous Transmission Configurations	Portable Handset			
		Head	Body-worn	Hotspot	Product specific 10g SAR
1.	WWAN + WLAN2.4GHz	Yes	Yes	Yes	Yes
2.	WWAN + WLAN5GHz	Yes	Yes	Yes	Yes
3.	WWAN + Bluetooth	Yes	Yes	Yes	Yes
4.	WLAN 5GHz + Bluetooth	Yes	Yes	Yes	Yes
5.	WWAN + WLAN 5GHz + Bluetooth	Yes	Yes	Yes	Yes
6.	WLAN2.4GHz + WLAN5GHz	Yes	Yes	Yes	Yes
7.	WWAN + WLAN2.4GHz + WLAN5GHz	Yes	Yes	Yes	Yes
8.	WWAN + WLAN2.4GHz+NFC				Yes
9.	WWAN + WLAN5GHz+NFC				Yes
10.	WWAN + Bluetooth+NFC				Yes
11.	WLAN 5GHz + Bluetooth+NFC				Yes
12.	WWAN + WLAN 5GHz + Bluetooth+NFC				Yes
13.	WLAN2.4GHz + WLAN5GHz+NFC				Yes
14.	WWAN + WLAN2.4GHz + WLAN5GHz+NFC				Yes

General Note:

- This device supports VoIP in GPRS, EGPRS, WCDMA, LTE and 5GNR (e.g. for 3rd-party VoIP), LTE supports VoLTE operation.
- WWAN above includes 5G NR bands and EN-DC combination.
- The 2.4GHz/5GHz WLAN can transmit in SISO and MIMO antenna mode and MIMO SAR can represent SISO SAR.
- EUT will choose each GSM, WCDMA, LTE and 5GNR according to the network signal condition; therefore, they will not operate simultaneously at any moment.
- For 5GNR EN-DC mode, standalone SAR performed for 5GNR NSA band with the maximum power, EN-DC SAR summed EN-DC mode 5GNR standalone SAR and LTE standalone SAR, the result of EN-DC SAR is more conservatively.
- This device 2.4GHz WLAN support hotspot operation and Bluetooth support tethering applications.
- This device 5.2GHz WLAN/5.8GHz WLAN support hotspot operation, and 5.2GHz WLAN/5.8GHz WLAN supports WLAN Direct (GC/GO), and 5.3GHz / 5.5GHz supports WLAN Direct (GC only).
- The worst case 5 GHz WLAN SAR for each configuration was used for SAR summation.
- According to the EUT characteristic, WLAN 2.4GHz and Bluetooth cannot transmit simultaneously.
- According to the EUT characteristic, WLAN 5GHz and Bluetooth can transmit simultaneously.
- According to the EUT characteristic, WLAN 5GHz chain 1 and WLAN 2.4GHz chain 0 can transmit simultaneously.
- NFC can transmit simultaneously with other Radios in extremity exposure condition.
- When stand-alone SAR is not required for a transmitter or antenna, its SAR is considered zero in the SAR summing process to assess Multi-band transmission SAR compliance.
- The maximum SAR summation is calculated based on the same configuration and test position.
- For standalone WWAN, always choose the highest SAR among the selected WWAN bands within the selected antenna for each exposure position to perform simultaneous transmission analysis with WLAN/BT. This is the worst co-located analysis and can represent each band.
- When EN-DC SAR co-located with WLAN/Bluetooth, chose the worst SAR among the selected LTE bands within the selected antenna per each test position and also the worst SAR of the selected 5GNR Bands within the selected antenna to do co-located with WLAN/Bluetooth. This is the worst co-located analysis and can represent each LTE bands and each 5GNR bands.
- Per KDB 447498 D01v06, simultaneous transmission SAR is compliant if,
 - 1g Scalar SAR summation < 1.6W/kg and 10g Scalar SAR summation < 4.0W/kg.
 - $SPLSR = (SAR1 + SAR2)^{1.5} / (\min. \text{separation distance, mm})$, and the peak separation distance is determined from the square root of $[(x1-x2)^2 + (y1-y2)^2 + (z1-z2)^2]$, where (x1, y1, z1) and (x2, y2, z2) are the coordinates of the extrapolated peak SAR locations in the zoom scan.
 - If $SPLSR \leq 0.04$ for 1g SAR and $SPLSR \leq 0.10$ for 10g SAR, simultaneously transmission SAR measurement is not necessary.
 - Simultaneously transmission SAR measurement, and the reported multi-band 1g SAR < 1.6W/kg and 10g SAR < 4.0W/kg.

15.1 Head Exposure Conditions

Exposure Position	10	17	10+17
	WLAN5GHz Ant 8+6	Bluetooth Ant 7	Summed
	1g SAR (W/kg)	1g SAR (W/kg)	1g SAR (W/kg)
Right Cheek	0.759	0.263	1.02
Right Tilted	0.983	0.312	1.30
Left Cheek	1.117	0.457	1.57
Left Tilted	0.901	0.429	1.33

Exposure Position	5	10	5+10
	WLAN2.4GHz Ant 7	WLAN5GHz Ant 8+6	Summed
	1g SAR (W/kg)	1g SAR (W/kg)	1g SAR (W/kg)
Right Cheek	0.165	0.759	0.92
Right Tilted	0.195	0.983	1.18
Left Cheek	0.358	1.117	1.48
Left Tilted	0.228	0.901	1.13

WWAN Band	Exposure Position	1	5	6	10	1+5+6	1+10
		WWAN	WLAN2.4GHz Ant 7	WLAN2.4GHz Ant 8	WLAN5GHz Ant 8+6	Summed	Summed
		1g SAR (W/kg)	1g SAR (W/kg)	1g SAR (W/kg)	1g SAR (W/kg)	1g SAR (W/kg)	1g SAR (W/kg)
All Bands	Right Cheek	0.848	0.148	0.198	0.260	1.19	1.11
	Right Tilted	0.975	0.176	0.027	0.393	1.18	1.37
	Left Cheek	0.772	0.323	0.193	0.536	1.29	1.31
	Left Tilted	0.510	0.205	0.044	0.380	0.76	0.89

WWAN Band	Exposure Position	1	10	17	1+10+17
		WWAN	WLAN5GHz Ant 8+6	Bluetooth Ant 7	Summed
		1g SAR (W/kg)	1g SAR (W/kg)	1g SAR (W/kg)	1g SAR (W/kg)
All Bands	Right Cheek	0.848	0.164	0.263	1.28
	Right Tilted	0.975	0.196	0.312	1.48
	Left Cheek	0.772	0.282	0.457	1.51
	Left Tilted	0.510	0.200	0.429	1.14

WWAN Band	Exposure Position	1	5	10	1+5+10
		WWAN	WLAN2.4GHz Ant 7	WLAN5GHz Ant 8+6	Summed
		1g SAR (W/kg)	1g SAR (W/kg)	1g SAR (W/kg)	1g SAR (W/kg)
All Bands	Right Cheek	0.848	0.066	0.229	1.14
	Right Tilted	0.975	0.078	0.317	1.37
	Left Cheek	0.772	0.144	0.398	1.31
	Left Tilted	0.510	0.091	0.282	0.88



<ENDC>

WWAN Band	FR1 Band	Exposure Position	1	2	1+2
			WWAN	FR1	Summed
			1g SAR (W/kg)	1g SAR (W/kg)	1g SAR (W/kg)
LTE Bands	NR Bands	Right Cheek	0.475	0.777	1.25
		Right Tilted	0.536	0.881	1.42
		Left Cheek	0.319	0.555	0.87
		Left Tilted	0.319	0.523	0.84

WWAN Band	FR1 Band	Exposure Position	1	2	5	6	10	1+2+5+6	1+2+10
			WWAN	FR1	WLAN2.4GHz Ant 7	WLAN2.4GHz Ant 8	WLAN5GHz Ant 8+6	Summed	Summed
			1g SAR (W/kg)	1g SAR (W/kg)	1g SAR (W/kg)	1g SAR (W/kg)	1g SAR (W/kg)	1g SAR (W/kg)	1g SAR (W/kg)
LTE Bands	NR Bands	Right Cheek	0.397	0.549	0.148	0.198	0.260	1.29	1.21
		Right Tilted	0.440	0.620	0.176	0.027	0.393	1.26	1.45
		Left Cheek	0.257	0.555	0.323	0.193	0.536	1.33	1.35
		Left Tilted	0.257	0.370	0.205	0.044	0.380	0.88	1.01

WWAN Band	FR1 Band	Exposure Position	1	2	10	17	1+2+10+17
			WWAN	FR1	WLAN5GHz Ant 8+6	Bluetooth Ant 7	Summed
			1g SAR (W/kg)	1g SAR (W/kg)	1g SAR (W/kg)	1g SAR (W/kg)	1g SAR (W/kg)
LTE Bands	NR Bands	Right Cheek	0.397	0.549	0.164	0.263	1.37
		Right Tilted	0.440	0.620	0.196	0.312	1.57
		Left Cheek	0.257	0.555	0.282	0.457	1.55
		Left Tilted	0.257	0.370	0.200	0.429	1.26

WWAN Band	FR1 Band	Exposure Position	1	2	5	10	1+2+5+10
			WWAN	FR1	WLAN2.4GHz Ant 7	WLAN5GHz Ant 8+6	Summed
			1g SAR (W/kg)	1g SAR (W/kg)	1g SAR (W/kg)	1g SAR (W/kg)	1g SAR (W/kg)
LTE Bands	NR Bands	Right Cheek	0.397	0.549	0.066	0.229	1.24
		Right Tilted	0.440	0.620	0.078	0.317	1.46
		Left Cheek	0.257	0.555	0.144	0.398	1.35
		Left Tilted	0.257	0.370	0.091	0.282	1.00

15.2 Hotspot Exposure Conditions

WWAN Band	Exposure Position	1	5	6	10	17	1+5+6	1+5+10	1+10+17
		WWAN	WLAN2.4GHz Ant 7	WLAN2.4GHz Ant 8	WLAN5GHz Ant 8+6	Bluetooth Ant 7	Summed	Summed	Summed
		1g SAR (W/kg)	1g SAR (W/kg)	1g SAR (W/kg)	1g SAR (W/kg)	1g SAR (W/kg)	1g SAR (W/kg)	1g SAR (W/kg)	1g SAR (W/kg)
All Bands	Front	0.573	0.077	0.133	0.225	0.087	0.78	0.88	0.89
	Back	0.915	0.148	0.139	0.434	0.100	1.20	1.50	1.45
	Left side	1.032					1.03	1.03	1.03
	Right side		0.070	0.182	0.689	0.026	0.25	0.76	0.72
	Top side	0.637	0.165		0.443	0.169	0.80	1.25	1.25
	Bottom side	0.868					0.87	0.87	0.87

<ENDC>

WWAN Band	FR1 Band	Exposure Position	1	2	5	6	10	17	1+2+5+6	1+2+5+10	1+2+10+17
			WWAN	FR1	WLAN2.4GHz Ant 7	WLAN2.4GHz Ant 8	WLAN5GHz Ant 8+6	Bluetooth Ant 7	Summed	Summed	Summed
			1g SAR (W/kg)	1g SAR (W/kg)	1g SAR (W/kg)	1g SAR (W/kg)	1g SAR (W/kg)	1g SAR (W/kg)	1g SAR (W/kg)	1g SAR (W/kg)	1g SAR (W/kg)
LTE Bands	NR Bands	Front	0.179	0.222	0.077	0.133	0.225	0.087	0.61	0.70	0.71
		Back	0.321	0.356	0.148	0.139	0.434	0.100	0.96	1.26	1.21
		Left side	0.302	0.391					0.69	0.69	0.69
		Right side			0.070	0.182	0.689	0.026	0.25	0.76	0.72
		Top side	0.187	0.339	0.165		0.443	0.169	0.69	1.13	1.14
		Bottom side	0.385	0.424					0.81	0.81	0.81

15.3 Body-Worn Accessory Exposure Conditions

WWAN Band	Exposure Position	1	5	6	10	17	1+5+6	1+5+10	1+10+17
		WWAN	WLAN2.4GHz Ant 7	WLAN2.4GHz Ant 8	WLAN5GHz Ant 8+6	Bluetooth Ant 7	Summed	Summed	Summed
		1g SAR (W/kg)	1g SAR (W/kg)	1g SAR (W/kg)	1g SAR (W/kg)	1g SAR (W/kg)	1g SAR (W/kg)	1g SAR (W/kg)	1g SAR (W/kg)
All Bands	Front	0.286	0.067	0.075	0.233	0.065	0.43	0.59	0.58
	Back	0.436	0.089	0.161	0.704	0.068	0.69	1.23	1.21

<ENDC>

WWAN Band	FR1 Band	Exposure Position	1	2	1+2
			WWAN	FR1	Summed
			1g SAR (W/kg)	1g SAR (W/kg)	1g SAR (W/kg)
LTE Bands	NR Bands	Front	0.134	0.203	0.34
		Back	0.254	0.299	0.55

WWAN Band	FR1 Band	Exposure Position	1	2	5	6	10	17	1+2+5+6	1+2+5+10	1+2+10+17
			WWAN	FR1	WLAN2.4GHz Ant 7	WLAN2.4GHz Ant 8	WLAN5GHz Ant 8+6	Bluetooth Ant 7	Summed	Summed	Summed
			1g SAR (W/kg)	1g SAR (W/kg)	1g SAR (W/kg)	1g SAR (W/kg)	1g SAR (W/kg)	1g SAR (W/kg)	1g SAR (W/kg)	1g SAR (W/kg)	1g SAR (W/kg)
LTE Bands	NR Bands	Front	0.096	0.148	0.067	0.075	0.233	0.065	0.39	0.54	0.54
		Back	0.161	0.215	0.089	0.161	0.704	0.068	0.63	1.17	1.15

15.4 Product specific 10g SAR Exposure Conditions

Remark:

1. For WLAN2.4G/Bluetooth Product specific 10g stand-alone SAR is not required for a transmitter or antenna, due to 1g hotspot SAR is <1.2W/kg.
2. The unit of SAR evaluation is W/kg.

(b) WWAN Band	Exposure Position	1	10	19	1+10+19
		WWAN	WLAN5GHz Ant 8+6	NFC	Summed
		10g SAR (W/kg)	10g SAR (W/kg)	10g SAR (W/kg)	1g SAR (W/kg)
All Bands	Front		0.623		0.62
	Back		0.519	0.010	0.53
	Left side	0.987			0.99
	Right side		1.239		1.24
	Top side		0.928		0.93
	Bottom side	1.491			1.49

WWAN Band	Exposure Position	1	10	19	1+10+19
		WWAN	WLAN5GHz Ant 8+6	NFC	Summed
		10g SAR (W/kg)	10g SAR (W/kg)	10g SAR (W/kg)	1g SAR (W/kg)
All Bands	Front		0.281		0.28
	Back		0.234	0.010	0.24
	Left side	0.987			0.99
	Right side		0.564		0.56
	Top side		0.418		0.42
	Bottom side	1.491			1.49

WWAN Band	Exposure Position	1	10	19	1+10+19
		WWAN	WLAN5GHz Ant 8+6	NFC	Summed
		10g SAR (W/kg)	10g SAR (W/kg)	10g SAR (W/kg)	1g SAR (W/kg)
All Bands	Front		0.495		0.50
	Back		0.414	0.010	0.42
	Left side	0.987			0.99
	Right side		0.998		1.00
	Top side		0.738		0.74
	Bottom side	1.491			1.49

Test Engineer : Hank Huang, Kevin Xu, David Dai, Bin He



16. Uncertainty Assessment

Per KDB 865664 D01 SAR measurement 100MHz to 6GHz, when the highest measured 1-g SAR within a frequency band is < 1.5 W/kg and the measured 10-g SAR within a frequency band is < 3.75 W/kg. The expanded SAR measurement uncertainty must be $\leq 30\%$, for a confidence interval of $k = 2$. If these conditions are met, extensive SAR measurement uncertainty analysis described in IEEE Std 1528-2013 is not required in SAR reports submitted for equipment approval. For this device, the highest measured 1-g SAR is less 1.5W/kg and highest measured 10-g SAR is less 3.75W/kg. Therefore, the measurement uncertainty table is not required in this report.

17. References

- [1] FCC 47 CFR Part 2 "Frequency Allocations and Radio Treaty Matters; General Rules and Regulations"
- [2] ANSI/IEEE Std. C95.1-1992, "IEEE Standard for Safety Levels with Respect to Human Exposure to Radio Frequency Electromagnetic Fields, 3 kHz to 300 GHz", September 1992
- [3] IEEE Std. 1528-2013, "IEEE Recommended Practice for Determining the Peak Spatial-Average Specific Absorption Rate (SAR) in the Human Head from Wireless Communications Devices: Measurement Techniques", Sep 2013
- [4] SPEAG DASY System Handbook
- [5] FCC KDB 865664 D01 v01r04, "SAR Measurement Requirements for 100 MHz to 6 GHz", Aug 2015.
- [6] FCC KDB 865664 D02 v01r02, "RF Exposure Compliance Reporting and Documentation Considerations" Oct 2015.
- [7] FCC KDB 648474 D04 v01r03, "SAR Evaluation Considerations for Wireless Handsets", Oct 2015.
- [8] FCC KDB 248227 D01 v02r02, "SAR Guidance for IEEE 802.11 (WiFi) Transmitters", Oct 2015.
- [9] FCC KDB 941225 D01 v03r01, "3G SAR MEAUREMENT PROCEDURES", Oct 2015
- [10] FCC KDB 941225 D05 v02r05, "SAR Evaluation Considerations for LTE Devices", Dec 2015
- [11] FCC KDB 941225 D05A v01r02, "Rel. 10 LTE SAR Test Guidance and KDB Inquiries", Oct 2015
- [12] FCC KDB 941225 D06 v02r01, "SAR Evaluation Procedures for Portable Devices with Wireless Router Capabilities", Oct 2015.
- [13] FCC KDB 447498 D01 v06, "Mobile and Portable Device RF Exposure Procedures and Equipment Authorization Policies", Oct 2015

-----THE END-----