



FCC RF Test Report

APPLICANT : Guangdong OPPO Mobile Telecommunications Corp., Ltd.
EQUIPMENT : Mobile Phone
BRAND NAME : OPPO
MODEL NAME : CPH2603
FCC ID : R9C-OP23051
STANDARD : 47 CFR Part 2, 22, 24, 27
CLASSIFICATION : PCS Licensed Transmitter Held to Ear (PCE)
TEST DATE(S) : Nov. 20, 2023 ~ Dec. 08, 2023

We, Sporton International Inc. (ShenZhen), would like to declare that the tested sample has been evaluated in accordance with the procedures given in ANSI C63.26-2015 and shown compliance with the applicable technical standards.

The test results in this report apply exclusively to the tested model / sample. Without written approval of Sporton International Inc. (ShenZhen), the test report shall not be reproduced except in full.

Jason Jia



Approved by: Jason Jia

Sporton International Inc. (ShenZhen)

1/F, 2/F, Bldg 5, Shiling Industrial Zone, Xinwei Village, Xili, Nanshan, Shenzhen, 518055

People's Republic of China



TABLE OF CONTENTS

REVISION HISTORY...3
SUMMARY OF TEST RESULT...4
1 GENERAL DESCRIPTION...5
1.1 Applicant...5
1.2 Manufacturer...5
1.3 Product Feature of Equipment Under Test...5
1.4 Product Specification of Equipment Under Test...5
1.5 Modification of EUT...6
1.6 Maximum ERP/EIRP and Emission Designator...7
1.7 Testing Location...9
1.8 Test Software...9
1.9 Applicable Standards...9
2 TEST CONFIGURATION OF EQUIPMENT UNDER TEST...10
2.1 Test Mode...10
2.2 Connection Diagram of Test System...12
2.3 Support Unit used in test configuration and system...12
2.4 Measurement Results Explanation Example...13
2.5 Frequency List of Low/Middle/High Channels...13
3 CONDUCTED TEST ITEMS...17
3.1 Measuring Instruments...17
3.2 Test Setup...17
3.3 Test Result of Conducted Test...17
3.4 Conducted Output Power and ERP/EIRP...18
3.5 Peak-to-Average Ratio...19
3.6 Occupied Bandwidth...20
3.7 Conducted Band Edge...21
3.8 Conducted Spurious Emission...23
3.9 Frequency Stability...24
4 RADIATED TEST ITEMS...25
4.1 Measuring Instruments...25
4.2 Test Setup...25
4.3 Test Result of Radiated Test...26
4.4 Radiated Spurious Emission...27
5 LIST OF MEASURING EQUIPMENT...28
6 MEASUREMENT UNCERTAINTY...29
APPENDIX A. TEST RESULTS OF CONDUCTED TEST
APPENDIX B. TEST RESULTS OF RADIATED TEST
APPENDIX C. TEST SETUP PHOTOGRAPHS



SUMMARY OF TEST RESULT

Report Section	FCC Rule	Description	Limit	Result	Remark
3.4	§2.1046	Conducted Output Power	Reporting Only	PASS	-
	§22.913(a)(5)	Effective Radiated Power (5G NR n5, n26)	ERP < 7 Watt		
	§24.232(c) §27.50(h)(2)	Equivalent Isotropic Radiated Power (5G NR n2) (5G NR n7, n41, n38)	EIRP < 2Watt		
	§27.50(d)(4)	Equivalent Isotropic Radiated Power (5G NR n66)	EIRP < 1Watt		
3.5	§24.232(d) §27.50(j)(4)	Peak-to-Average Ratio	<13 dB	PASS	-
3.6	§2.1049	Occupied Bandwidth	Reporting Only	PASS	-
3.7	§2.1051 §22.917(a) §24.238(a) §27.53(h)	Conducted Band Edge Measurement (5G NR n5, n26) (5G NR n2) (5G NR n66)	< 43+10log ₁₀ (P[Watts])	PASS	-
	§27.53(m)(4)	Conducted Band Edge Measurement (5G NR n7, n41, n38)	§27.53(m)(4)		
3.8	§2.1051 §22.917(a) §24.238(a) §27.53(h)	Conducted Spurious Emission (5G NR n5, n26) (5G NR n2) (5G NR n66)	< 43+10log ₁₀ (P[Watts])	PASS	-
	§2.1051 §27.53(m)(4)	Conducted Spurious Emission (5G NR n7, n41, n38)	< 55+10log ₁₀ (P[Watts])		
3.9	§2.1055 §22.355	Frequency Stability Temperature & Voltage	< 2.5 ppm for Part 22	PASS	-
	§24.235 §27.54		Within Authorized Band		
4.4	§2.1053 §22.917(a) §24.238(a) §27.53(h)	Radiated Spurious Emission (5G NR n5, n26) (5G NR n2) (5G NR n66)	< 43+10log ₁₀ (P[Watts])	PASS	Under limit 23.23 dB at 7591.77 MHz
	§2.1053 §27.53(m)(4)	Radiated Spurious Emission (5G NR n7, n41, n38)	< 55+10log ₁₀ (P[Watts])		

Conformity Assessment Condition:

- The test results (PASS/FAIL) with all measurement uncertainty excluded are presented against the regulation limits or in accordance with the requirements stipulated by the applicant/manufacturer who shall bear all the risks of non-compliance that may potentially occur if measurement uncertainty is taken into account.
- The measurement uncertainty please refer to each test result in the section "Measurement Uncertainty"

Disclaimer:

The product specifications of the EUT presented in the test report that may affect the test assessments are declared by the manufacturer who shall take full responsibility for the authenticity.



1 General Description

1.1 Applicant

Guangdong OPPO Mobile Telecommunications Corp., Ltd.

NO.18 Haibin Road, Wusha Village, Chang'an Town, Dongguan City, Guangdong, China

1.2 Manufacturer

Guangdong OPPO Mobile Telecommunications Corp., Ltd.

NO.18 Haibin Road, Wusha Village, Chang'an Town, Dongguan City, Guangdong, China

1.3 Product Feature of Equipment Under Test

Product Feature	
Equipment	Mobile Phone
Brand Name	OPPO
Model Name	CPH2603
FCC ID	R9C-OP23051
IMEI Code	Conducted : 860306070113238 Radiation : 860306070102116/860306070102108
HW Version	11
SW Version	ColorOS 14.0
EUT Stage	Production Unit

1.4 Product Specification of Equipment Under Test

Standards-related Product Specification	
Tx Frequency	5G NR n2 : 1850 MHz ~ 1910 MHz 5G NR n5 : 824 MHz ~ 849 MHz 5G NR n7 : 2500 MHz ~ 2570 MHz 5G NR n26 : 814 MHz ~ 849 MHz 5G NR n38 : 2570 MHz ~ 2620 MHz 5G NR n41 : 2496 MHz ~ 2690 MHz 5G NR n66 : 1710 MHz ~ 1780 MHz
Rx Frequency	5G NR n2 : 1930 MHz ~ 1990 MHz 5G NR n5 : 869 MHz ~ 894 MHz 5G NR n7 : 2620 MHz ~ 2690 MHz 5G NR n26 : 859 MHz ~ 894 MHz 5G NR n38: 2570 MHz ~ 2620 MHz 5G NR n41 : 2496 MHz ~ 2690 MHz 5G NR n66 : 2110 MHz~ 2200 MHz
Bandwidth	n2, n5, n26: 5MHz / 10MHz / 15MHz / 20MHz n7: 5MHz / 10MHz / 15MHz / 20MHz / 25MHz / 30MHz / 40MHz n38: 10MHz / 15MHz / 20MHz / 30MHz / 40MHz n41 : 20MHz / 30MHz / 40MHz / 50MHz / 60MHz / 70MHz / 80MHz / 90MHz / 100MHz n66: 5MHz / 10MHz / 15MHz / 20MHz / 30MHz / 40MHz



SCS	15kHz for n2, n5, n7, n26, n66 30kHz for n38, n41
Antenna Gain	<p><Ant. 0> n2: -1.2 dBi n5: -4.8 dBi n7: -0.7 dBi n26: -4.8 dBi n38: -0.7 dBi n41: -0.7 dBi n66: -1.4 dBi</p> <p><Ant. 1> n5: -3.7 dBi n26: -3.7 dBi</p> <p><Ant. 3> n2: -0.8 dBi n7: -0.4 dBi n38: -0.4 dBi n41: -0.4 dBi n66: -1.3 dBi</p> <p><Ant. 4> n7: -0.5 dBi n38: -0.5 dBi n41: -0.5 dBi n66: -1.1 dBi</p>
Type of Modulation	CP-OFDM: QPSK / 16QAM / 64QAM / 256QAM DFT-s-OFDM: QPSK / 16QAM / 64QAM / 256QAM

Remark:

1. The maximum ERP/EIRP is calculated from max output power and max antenna gain, only the maximum ERP/EIRP are shown in the report: 5G NR n2/n7/n66 for Ant. 3, n5/n26 for Ant. 1, and n38/n41 for Ant. 0.
2. All the supported ENDC combinations are verified conducted power, only the ENDC combination with highest power are shown in the report.
3. 5G NR n2/n26 support SA mode, n5/n7/n38/n41/n66 support SA & NSA mode. According to the maximum power between SA and NSA mode, SA covers NSA mode for n5/n7/n66 and NSA covers SA mode for n38/n41.
4. The device supports HPUE mode for 5G NR n41.
5. The EN-DC mode combination could be referred to the product spec.

1.5 Modification of EUT

No modifications are made to the EUT during all test items.



1.6 Maximum ERP/EIRP and Emission Designator

5G NR n2 SA		QPSK		16QAM / 64QAM / 256QAM	
BW (MHz)	Frequency Range (MHz)	Maximum EIRP(W)	Emission Designator (99%OBW)	Maximum EIRP(W)	Emission Designator (99%OBW)
5	1852.5 ~ 1907.5	0.1459	4M46G7D	0.1180	4M47W7D
10	1855.0 ~ 1905.0	0.1419	9M27G7D	0.1135	9M31W7D
15	1857.5 ~ 1902.5	0.1459	14M1G7D	0.1146	14M1W7D
20	1860.0 ~ 1900.0	0.1535	18M9G7D	0.1227	18M9W7D

5G NR n5 SA		QPSK		16QAM / 64QAM / 256QAM	
BW (MHz)	Frequency Range (MHz)	Maximum ERP(W)	Emission Designator (99%OBW)	Maximum ERP(W)	Emission Designator (99%OBW)
5	826.5 ~ 846.5	0.0750	4M46G7D	0.0604	4M47W7D
10	829.0 ~ 844.0	0.0724	9M27G7D	0.0578	9M28W7D
15	831.5 ~ 841.5	0.0755	14M1G7D	0.0596	14M1W7D
20	834.0 ~ 839.0	0.0759	18M9G7D	0.0603	19M0W7D

5G NR n26 SA		QPSK		16QAM / 64QAM / 256QAM	
BW (MHz)	Frequency Range (MHz)	Maximum ERP(W)	Emission Designator (99%OBW)	Maximum ERP(W)	Emission Designator (99%OBW)
5	826.5 ~ 846.5	0.0746	4M46G7D	0.0587	4M47W7D
10	829.0 ~ 844.0	0.0738	9M27G7D	0.0583	9M28W7D
15	831.5 ~ 841.5	0.0755	14M1G7D	0.0589	14M1W7D
20	834.0 ~ 839.0	0.0762	18M9G7D	0.0604	19M0W7D

5G NR n66 SA		QPSK		16QAM / 64QAM / 256QAM	
BW (MHz)	Frequency Range (MHz)	Maximum EIRP(W)	Emission Designator (99%OBW)	Maximum EIRP(W)	Emission Designator (99%OBW)
5	1712.5 ~ 1777.5	0.1592	4M46G7D	0.1265	4M47W7D
10	1715.0 ~ 1775.0	0.1528	9M29G7D	0.1216	9M30W7D
15	1717.5 ~ 1772.5	0.1538	14M1G7D	0.1250	14M1W7D
20	1720.0 ~ 1770.0	0.1531	18M9G7D	0.1247	18M9W7D
30	1725.0 ~ 1765.0	0.1517	28M6G7D	0.1222	28M6W7D
40	1730.0 ~ 1760.0	0.1807	38M5G7D	0.1365	38M5W7D



5G NR n7 SA		QPSK		16QAM / 64QAM / 256QAM	
BW (MHz)	Frequency Range (MHz)	Maximum EIRP(W)	Emission Designator (99%OBW)	Maximum EIRP(W)	Emission Designator (99%OBW)
5	2502.5 ~ 2567.5	0.1991	4M46G7D	0.1710	4M47W7D
10	2505.0 ~ 2565.0	0.2028	9M27G7D	0.1679	9M30W7D
15	2507.5 ~ 2562.5	0.2118	14M1G7D	0.1718	14M1W7D
20	2510.0 ~ 2560.0	0.2109	18M9G7D	0.1714	18M9W7D
25	2512.5 ~ 2557.5	0.2104	23M7G7D	0.1726	23M8W7D
30	2515.0 ~ 2555.0	0.2032	28M5G7D	0.1683	28M6W7D
40	2520.0 ~ 2550.0	0.2128	38M5G7D	0.1694	38M6W7D

EN DC_4A-n38A		QPSK		16QAM / 64QAM / 256QAM	
BW (MHz)	Frequency Range (MHz)	Maximum EIRP(W)	Emission Designator (99%OBW)	Maximum EIRP(W)	Emission Designator (99%OBW)
10	2575.0 ~ 2615.0	0.2421	8M59G7D	0.2104	8M56W7D
15	2577.5 ~ 2612.5	0.2377	13M6G7D	0.2023	13M6W7D
20	2580.0 ~ 2610.0	0.2339	18M2G7D	0.2014	18M3W7D
30	2585.0 ~ 2605.0	0.2323	27M8G7D	0.1972	27M8W7D
40	2590.0 ~ 2600.0	0.2559	37M8G7D	0.2056	37M9W7D

EN DC_4A-n41A		QPSK		16QAM / 64QAM / 256QAM	
BW (MHz)	Frequency Range (MHz)	Maximum EIRP(W)	Emission Designator (99%OBW)	Maximum EIRP(W)	Emission Designator (99%OBW)
20	2506.02 ~ 2679.99	0.3076	18M2G7D	0.2618	18M3W7D
30	2511.00 ~ 2674.98	0.3055	27M8G7D	0.2704	27M8W7D
40	2516.01 ~ 2670.00	0.2917	37M8G7D	0.2443	37M9W7D
50	2521.02 ~ 2664.99	0.3076	47M5G7D	0.2570	47M5W7D
60	2526.00 ~ 2659.98	0.3013	57M9G7D	0.2506	57M8W7D
70	2531.01 ~ 2655.00	0.2917	67M5G7D	0.2399	67M5W7D
80	2536.02 ~ 2649.99	0.2812	77M5G7D	0.2323	77M4W7D
90	2541.00 ~ 2644.98	0.2716	87M4G7D	0.2234	87M6W7D
100	2546.01 ~ 2640.00	0.3170	97M1G7D	0.2559	97M3W7D

Note:

1. 5G NR n26 overlaps the entire frequency range of 5G NR n5. Therefore, the test results provided in this report covers 5G NR n5 and the portion of 5G NR n26 subject to Part 22.
2. 5G NR n41 overlaps the entire frequency range of 5G NR n38. Therefore, the test results provided in this report covers 5G NR n41 as well as 5G NR n38, and 5G NR n38 additional test BW 10/15MHz.
3. All modulations have been tested, only the worst test results of PSK & QAM are shown in the report.



1.7 Testing Location

Sporton International Inc. (ShenZhen) is accredited to ISO/IEC 17025:2017 by American Association for Laboratory Accreditation with Certificate Number 5145.01.

Test Firm	Sporton International Inc. (ShenZhen)		
Test Site Location	1/F, 2/F, Bldg 5, Shiling Industrial Zone, Xinwei Village, Xili, Nanshan, Shenzhen, 518055 People's Republic of China TEL: +86-755-86379589 FAX: +86-755-86379595		
Test Site No.	Sporton Site No.	FCC Designation No.	FCC Test Firm Registration No.
	TH01-SZ	CN1256	421272

Test Firm	Sporton International Inc. (ShenZhen)		
Test Site Location	101, 1st Floor, Block B, Building 1, No. 2, Tengfeng 4th Road, Fenghuang Community, Fuyong Street, Baoan District, Shenzhen City, Guangdong Province 518103 People's Republic of China TEL: +86-755-86066985		
Test Site No.	Sporton Site No.	FCC Designation No.	FCC Test Firm Registration No.
	03CH01-SZ	CN1256	421272

1.8 Test Software

Item	Site	Manufacture	Name	Version
1.	03CH01-SZ	AUDIX	E3	6.2009-8-24

1.9 Applicable Standards

According to the specifications of the manufacturer, the EUT must comply with the requirements of the following standards:

- 47 CFR Part 2, 22, 24, 27
- ANSI C63.26-2015
- FCC KDB 971168 D01 Power Meas License Digital Systems v03r01
- FCC KDB 412172 D01 Determining ERP and EIRP v01r01

Remark:

All test items were verified and recorded according to the standards and without any deviation during the test.



2 Test Configuration of Equipment Under Test

2.1 Test Mode

Antenna port conducted and radiated test items are performed according to KDB 971168 D01 Power Meas License Digital Systems v03r01 with maximum output power.

For radiated measurement, pre-scanned in three orthogonal panels, X, Y, Z. The worst cases (X/Y/Z plane) were recorded in this report.

The device is investigated from 30MHz to 10 times of fundamental signal for radiated spurious emission test under different RB size/offset and modulations in exploratory test. Subsequently, only the worst case emissions are reported.

Orthogonal Planes of EUT	X Plane	Y Plane	Z Plane
			

Test Items	5G NR	Bandwidth (MHz)													Modulation			RB #		Test Channel				
		5	10	15	20	25	30	40	50	60	70	80	90	100	PI/2 BPSK	QPSK	16 QAM	64 QAM	256 QAM	1	Full	L	M	H
Max. Output Power	n2	v	v	v	v	-	-	-	-	-	-	-	-	-	-	v	v	v	v	v	v	v	v	v
	n5	v	v	v	v	-	-	-	-	-	-	-	-	-	-	v	v	v	v	v	v	v	v	v
	n7	v	v	v	v	v	v	v	-	-	-	-	-	-	-	v	v	v	v	v	v	v	v	v
	n26	v	v	v	v	-	-	-	-	-	-	-	-	-	-	v	v	v	v	v	v	v	v	v
	n38	-	v	v	v	-	v	v	-	-	-	-	-	-	-	v	v	v	v	v	v	v	v	v
	n41	-	-	-	v	-	v	v	v	v	v	v	v	v	-	v	v	v	v	v	v	v	v	v
	n66	v	v	v	v	-	v	v	-	-	-	-	-	-	-	v	v	v	v	v	v	v	v	v
Peak-to-Average Ratio	n2				v	-	-	-	-	-	-	-	-	-	v					v	v		v	
	n7				v										v					v	v		v	
	n26				v	-	-	-	-	-	-	-	-	-	v					v	v		v	
	n38	-	v			-									-	v					v	v		v
	n41	-	-	-	v	-									-	v					v	v		v
	n66				v	-									-	v					v	v		v
26dB and 99% Bandwidth	n2	v	v	v	v	-	-	-	-	-	-	-	-	-	v	v	v	v		v		v		
	n7	v	v	v	v	v	v	v	-	-	-	-	-	-	v	v	v	v		v		v		
	n26	v	v	v	v	-	-	-	-	-	-	-	-	-	v	v	v	v		v		v		
	n38	-	v	v		-									-	v	v	v	v		v		v	
	n41	-	-	-	v	-	v	v	v	v	v	v	v	v	-	v	v	v	v		v		v	
	n66	v	v	v	v	-	v	v	-	-	-	-	-	-	-	v	v	v	v		v		v	



Test Items	5G NR	Bandwidth (MHz)													Modulation					RB #		Test Channel		
		5	10	15	20	25	30	40	50	60	70	80	90	100	PI/2 BPSK	QPSK	16 QAM	64 QAM	256 QAM	1	Full	L	M	H
Conducted Band Edge	n2	v	v		v	-	-	-	-	-	-	-	-	-	v				v	v	v		v	
	n7	v			v			v	-	-	-	-	-	-	v				v	v	v		v	
	n26	v	v		v	-	-	-	-	-	-	-	-	-	v				v	v	v		v	
	n38	-	v	v		-			-	-	-	-	-	-	v				v	v	v		v	
	n41	-	-	-	v	-			v					v	-	v			v	v	v		v	
	n66	v			v	-		v	-	-	-	-	-	-	v				v	v	v		v	
Conducted Spurious Emission	n2	v	v		v	-	-	-	-	-	-	-	-	-	v				v		v	v	v	
	n7	v			v			v	-	-	-	-	-	-	v				v		v	v	v	
	n26	v	v		v	-	-	-	-	-	-	-	-	-	v				v		v	v	v	
	n38	-	v	v		-			-	-	-	-	-	-	v				v		v	v	v	
	n41	-	-	-	v	-			v					v	-	v			v		v	v	v	
	n66	v			v	-		v	-	-	-	-	-	-	v				v		v	v	v	
Frequency Stability	n2				v	-	-	-	-	-	-	-	-	-	v					v		v		
	n7				v			-	-	-	-	-	-	-	v					v		v		
	n26				v	-	-	-	-	-	-	-	-	-	v					v		v		
	n38	-	v			-			-	-	-	-	-	-	v					v		v		
	n41	-	-	-	v	-			v						-	v				v		v		
	n66				v	-			-	-	-	-	-	-	v					v		v		
E.R.P / E.I.R.P	n2	v	v	v	v	-	-	-	-	-	-	-	-	-	v	v	v	v	v	v	v	v	v	
	n5	v	v	v	v	-	-	-	-	-	-	-	-	-	v	v	v	v	v	v	v	v	v	
	n7	v	v	v	v	v	v	v	-	-	-	-	-	-	v	v	v	v	v	v	v	v	v	
	n26	v	v	v	v	-	-	-	-	-	-	-	-	-	v	v	v	v	v	v	v	v	v	
	n38	-	v	v	v	-	v	v	-	-	-	-	-	-	v	v	v	v	v	v	v	v	v	
	n41	-	-	-	v	-	v	v	v	v	v	v	v	v	-	v	v	v	v	v	v	v	v	
	n66	v	v	v	v	-	v	v	-	-	-	-	-	-	v	v	v	v	v	v	v	v	v	
Radiated Spurious Emission	n2	Worst Case																				v		
	n5	Worst Case																				v		
	n7	Worst Case																				v		
	n26	Worst Case																				v		
	n41	Worst Case																				v		
	n66	Worst Case																				v		
Note	1. The mark "v" means that this configuration is chosen for testing 2. The mark "-" means that this bandwidth is not supported. 3. The device is investigated from 30MHz to 10 times of fundamental signal for radiated spurious emission test under different RB size/offset and modulations in exploratory test. Subsequently, only the worst case emissions are reported. 4. Frequency Stability : Normal Voltage = 3.91V ; Low Voltage =3.60V. ; High Voltage =4.50V																							

2.2 Connection Diagram of Test System

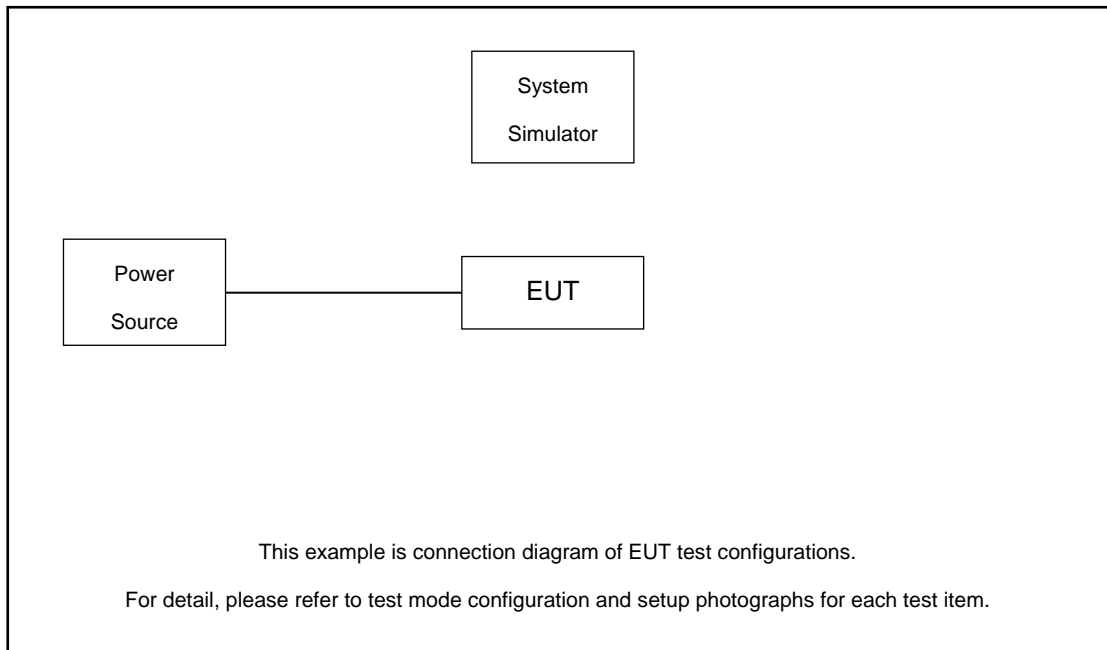

The EUT has been configuration operated in a manner tended to maximize its emission characteristics in a typical application.

2.3 Support Unit used in test configuration and system

Item	Equipment	Trade Name	Model No.	FCC ID	Data Cable	Power Cord
1.	DC Power Supply	GW	GPS-3030D	N/A	N/A	Unshielded, 1.8 m
2.	LTE Base Station	Anritsu	MT8821C	N/A	N/A	Unshielded, 1.8 m
3.	NR Base Station	Anritsu	MT8000A	N/A	N/A	Unshielded, 1.8 m



2.4 Measurement Results Explanation Example

For all conducted test items:

The offset level is set in the spectrum analyzer to compensate the RF cable loss between EUT conducted output port and spectrum analyzer. With the offset compensation, the spectrum analyzer reading level is exactly the EUT RF output level.

The spectrum analyzer offset is derived from RF cable loss.

$$\text{Offset} = \text{RF cable loss.}$$

Following shows an offset computation example with cable loss 8.0 dB.

Example :

$$\begin{aligned} \text{Offset(dB)} &= \text{RF cable loss(dB)}. \\ &= 8.0 \text{ (dB)} \end{aligned}$$

2.5 Frequency List of Low/Middle/High Channels

5G NR n2 Channel and Frequency List				
BW [MHz]	Channel/Frequency(MHz)	Lowest	Middle	Highest
20	Channel	372000	376000	380000
	Frequency	1860	1880	1900
15	Channel	371500	376000	380500
	Frequency	1857.5	1880	1902.5
10	Channel	371000	376000	381000
	Frequency	1855	1880	1905
5	Channel	370500	376000	381500
	Frequency	1852.5	1880	1907.5

5G NR n5 Channel and Frequency List				
BW [MHz]	Channel/Frequency(MHz)	Lowest	Middle	Highest
20	Channel	166800	167300	167800
	Frequency	834	836.5	839
15	Channel	166300	167300	168300
	Frequency	831.5	836.5	841.5
10	Channel	165800	167300	168800
	Frequency	829	836.5	844
5	Channel	165300	167300	169300
	Frequency	826.5	836.5	846.5



5G NR n7 Channel and Frequency List				
BW [MHz]	Channel/Frequency(MHz)	Lowest	Middle	Highest
40	Channel	504000	507000	510000
	Frequency	2520	2535	2550
30	Channel	503000	507000	511000
	Frequency	2515	2535	2555
25	Channel	502500	507000	511500
	Frequency	2512.5	2535	2557.5
20	Channel	502000	507000	512000
	Frequency	2510	2535	2560
15	Channel	501500	507000	512500
	Frequency	2507.5	2535	2562.5
10	Channel	501000	507000	513000
	Frequency	2505	2535	2565
5	Channel	500500	507000	513500
	Frequency	2502.5	2535	2567.5

5G NR n26 Channel and Frequency List				
BW [MHz]	Channel/Frequency(MHz)	Lowest	Middle	Highest
20	Channel	166800	167300	167800
	Frequency	834	836.5	839
15	Channel	166300	167300	168300
	Frequency	831.5	836.5	841.5
10	Channel	165800	167300	168800
	Frequency	829	836.5	844
5	Channel	165300	167300	169300
	Frequency	826.5	836.5	846.5



5G NR n38 Channel and Frequency List				
BW [MHz]	Channel/Frequency(MHz)	Lowest	Middle	Highest
40	Channel	518000	519000	520000
	Frequency	2590	2595	2600
30	Channel	517000	519000	521000
	Frequency	2585	2595	2605
20	Channel	516000	519000	522000
	Frequency	2580	2595	2610
15	Channel	515500	519000	522500
	Frequency	2577.5	2595	2612.5
10	Channel	515000	519000	523000
	Frequency	2575	2595	2615

5G NR n41 Channel and Frequency List				
BW [MHz]	Channel/Frequency(MHz)	Lowest	Middle	Highest
100	Channel	509202	518598	528000
	Frequency	2546.01	2592.99	2640
90	Channel	508200	518598	528996
	Frequency	2541	2592.99	2644.98
80	Channel	507204	518598	529998
	Frequency	2536.02	2592.99	2649.99
70	Channel	506202	518598	531000
	Frequency	2531.01	2592.99	2655
60	Channel	505200	518598	531996
	Frequency	2526	2592.99	2659.98
50	Channel	504204	518598	532998
	Frequency	2521.02	2592.99	2664.99
40	Channel	503202	518598	534000
	Frequency	2516.01	2592.99	2670
30	Channel	502200	518598	534996
	Frequency	2511	2592.99	2674.98
20	Channel	501204	518598	535998
	Frequency	2506.02	2592.99	2679.99



5G NR n66 Channel and Frequency List				
BW [MHz]	Channel/Frequency(MHz)	Lowest	Middle	Highest
40	Channel	346000	349000	352000
	Frequency	1730	1745	1760
30	Channel	345000	349000	353000
	Frequency	1725	1745	1765
20	Channel	344000	349000	354000
	Frequency	1720	1745	1770
15	Channel	343500	349000	354500
	Frequency	1717.5	1745	1772.5
10	Channel	343000	349000	355000
	Frequency	1715	1745	1775
5	Channel	342500	349000	355500
	Frequency	1712.5	1745	1777.5

3 Conducted Test Items

3.1 Measuring Instruments

See list of measuring instruments of this test report.

3.2 Test Setup

3.2.1 Conducted Output Power

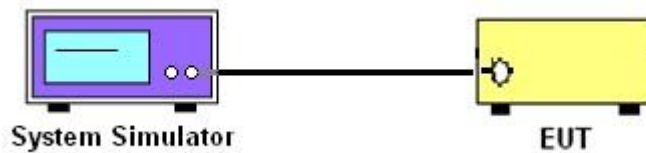

3.2.2 Peak-to-Average Ratio, Occupied Bandwidth ,Conducted Band-Edge and Conducted Spurious Emission

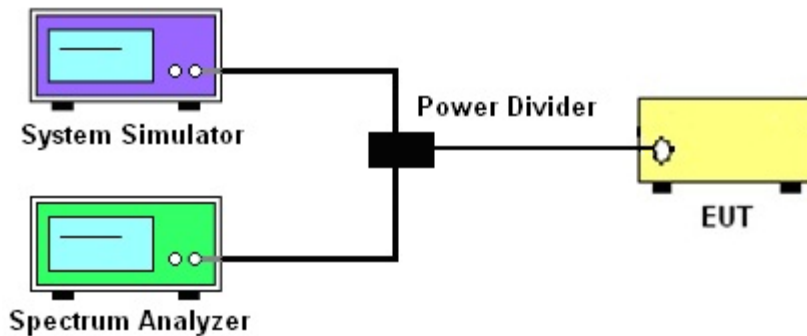

3.2.3 Frequency Stability

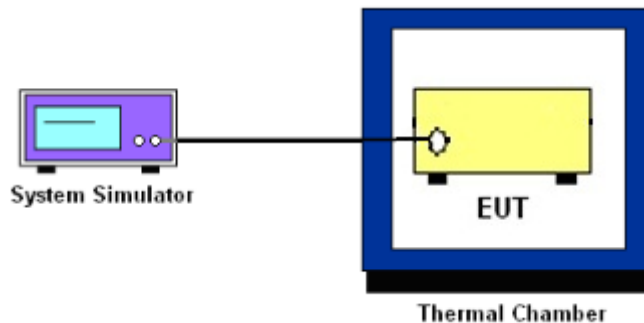

3.3 Test Result of Conducted Test

Please refer to Appendix A.



3.4 Conducted Output Power and ERP/EIRP

3.4.1 Description of the Conducted Output Power Measurement and ERP/EIRP Measurement

A system simulator was used to establish communication with the EUT. Its parameters were set to force the EUT transmitting at maximum output power. The measured power in the radio frequency on the transmitter output terminals shall be reported.

The ERP of mobile transmitters must not exceed 7 Watts for 5G NR n5, n26.

The EIRP of mobile transmitters must not exceed 2 Watts for 5G NR n2, n7, n38, n41.

The EIRP of mobile transmitters must not exceed 1 Watts for 5G NR n66.

According to KDB 412172 D01 Power Approach,

$EIRP = P_T + G_T - L_C$, $ERP = EIRP - 2.15$, where

P_T = transmitter output power in dBm

G_T = gain of the transmitting antenna in dBi

L_C = signal attenuation in the connecting cable between the transmitter and antenna in dB

3.4.2 Test Procedures

1. The testing follows ANSI C63.26 Section 5.2
2. The transmitter output port was connected to the system simulator.
3. Set EUT at maximum power through the system simulator.
4. Select lowest, middle, and highest channels for each band and different modulation.
5. Measure and record the power level from the system simulator.



3.5 Peak-to-Average Ratio

3.5.1 Description of the PAR Measurement

Power Complementary Cumulative Distribution Function (CCDF) curves provide a means for characterizing the power peaks of a digitally modulated signal on a statistical basis. A CCDF curve depicts the probability of the peak signal amplitude exceeding the average power level. Most contemporary measurement instrumentation include the capability to produce CCDF curves for an input signal provided that the instrument's resolution bandwidth can be set wide enough to accommodate the entire input signal bandwidth. In measuring transmissions in this band using an average power technique, the peak-to-average ratio (PAR) of the transmission may not exceed 13 dB.

3.5.2 Test Procedures

1. The testing follows ANSI C63.26 Section 5.2.3.4 (CCDF).
2. The EUT was connected to spectrum and system simulator via a power divider.
3. Set the CCDF (Complementary Cumulative Distribution Function) option in spectrum analyzer.
4. The highest RF powers were measured and recorded the maximum PAPR level associated with a probability of 0.1 %.
5. Record the deviation as Peak to Average Ratio.



3.6 Occupied Bandwidth

3.6.1 Description of Occupied Bandwidth Measurement

The occupied bandwidth is the width of a frequency band such that, below the lower and above the upper frequency limits, the mean powers emitted are each equal to a specified percentage 0.5% of the total mean transmitted power.

The 26 dB emission bandwidth is defined as the frequency range between two points, one above and one below the carrier frequency, at which the spectral density of the emission is attenuated 26 dB below the maximum in-band spectral density of the modulated signal. Spectral density (power per unit bandwidth) is to be measured with a detector of resolution bandwidth equal to approximately 1.0% of the emission bandwidth.

3.6.2 Test Procedures

1. The testing follows ANSI C63.26 Section 5.4
2. The EUT was connected to spectrum analyzer and system simulator via a power divider.
3. The spectrum analyzer center frequency is set to the nominal EUT channel center frequency. The span range for the spectrum analyzer shall be between two and five times the anticipated OBW.
4. The nominal resolution bandwidth (RBW) shall be in the range of 1 to 5 % of the anticipated OBW, and the VBW shall be at least 3 times the RBW.
5. Set the detection mode to peak, and the trace mode to max hold.
6. Determine the reference value: Set the EUT to transmit a modulated signal. Allow the trace to stabilize. Set the spectrum analyzer marker to the highest level of the displayed trace. (this is the reference value)
7. Determine the “-26 dB down amplitude” as equal to (Reference Value – X).
8. Place two markers, one at the lowest and the other at the highest frequency of the envelope of the spectral display such that each marker is at or slightly below the “-X dB down amplitude” determined in step 6. If a marker is below this “-X dB down amplitude” value it shall be placed as close as possible to this value. The OBW is the positive frequency difference between the two markers.
9. Use the 99 % power bandwidth function of the spectrum analyzer and report the measured bandwidth.



3.7 Conducted Band Edge

3.7.1 Description of Conducted Band Edge Measurement

22.917(a)

For operations in the 824 – 849 MHz band, the FCC limit is $43 + 10\log_{10}(P[\text{Watts}])$ dB below the transmitter power $P(\text{Watts})$ in a 100kHz bandwidth. However, in the 1MHz bands immediately outside and adjacent to the licensee's frequency block, a resolution bandwidth of at least one percent of the emission bandwidth of the fundamental emission of the transmitter may be employed.

24.238 (a)

For operations in the 1850-1910 and 1930-1990 MHz band, the FCC limit is $43 + 10\log_{10}(P[\text{Watts}])$ dB below the transmitter power $P(\text{Watts})$ in a 1MHz bandwidth. However, in the 1 MHz bands immediately outside and adjacent to the frequency block a resolution bandwidth of at least one percent of the emission bandwidth of the fundamental emission of the transmitter may be employed.

27.53 (h)

For operations in the 1710 – 1755 MHz band, the FCC limit is $43 + 10\log_{10}(P[\text{Watts}])$ dB below the transmitter power $P(\text{Watts})$ in a 1 MHz bandwidth. However, in the 1MHz bands immediately outside and adjacent to the licensee's frequency block, a resolution bandwidth of at least one percent of the emission bandwidth of the fundamental emission of the transmitter may be employed.

27.53(m)(4)

For mobile digital stations, the attenuation factor shall be not less than $40 + 10 \log (P)$ dB on all frequencies between the channel edge and 5 megahertz from the channel edge, $43 + 10 \log (P)$ dB on all frequencies between 5 megahertz and X megahertz from the channel edge, and $55 + 10 \log (P)$ dB on all frequencies more than X megahertz from the channel edge, where X is the greater of 6 megahertz or the actual emission bandwidth as defined in paragraph (m)(6) of this section. In addition, the attenuation factor shall not be less that $43 + 10 \log (P)$ dB on all frequencies between 2490.5 MHz and 2496 MHz and $55 + 10 \log (P)$ dB at or below 2490.5 MHz. Mobile Satellite Service licensees operating on frequencies below 2495 MHz may also submit a documented interference complaint against BRS licensees operating on channel BRS Channel 1 on the same terms and conditions as adjacent channel BRS or EBS licensees.



3.7.2 Test Procedures

1. The testing follows ANSI C63.26 section 5.7
2. The EUT was connected to spectrum analyzer and system simulator via a power divider.
3. The band edges of low and high channels for the highest RF powers were measured.
4. Set RBW \geq 1% EBW in the 1MHz band immediately outside and adjacent to the band edge.
5. Beyond the 1 MHz band from the band edge, RBW=1MHz was used or a narrower RBW was used (generally limited to no less than 1% of the OBW) and the measured power was integrated over the full required measurement bandwidth.
6. Set spectrum analyzer with RMS detector.
7. The RF fundamental frequency should be excluded against the limit line in the operating frequency band.
8. Checked that all the results comply with the emission limit line.

Example:

The limit line is derived from $43 + 10\log(P)$ dB below the transmitter power P(Watts)

$$= P(W) - [43 + 10\log(P)] \text{ (dB)}$$

$$= [30 + 10\log(P)] \text{ (dBm)} - [43 + 10\log(P)] \text{ (dB)} = -13\text{dBm}.$$

9. When using the integration method, the starting frequency of the integration shall be centered at one-half of the RBW away from the band edge.

3.8 Conducted Spurious Emission

3.8.1 Description of Conducted Spurious Emission Measurement

The power of any emission outside of the authorized operating frequency ranges must be lower than the transmitter power (P) by a factor of at least $43 + 10 \log (P)$ dB.

For 5G NR n7/n38/n41:

The power of any emission outside of the authorized operating frequency ranges must be lower than the transmitter power (P) by a factor of at least $55 + 10 \log (P)$ dB.

It is measured by means of a calibrated spectrum analyzer and scanned from 30 MHz up to a frequency including its 10th harmonic.

3.8.2 Test Procedures

1. The testing follows ANSI C63.26 section 5.7
2. The EUT was connected to spectrum analyzer and system simulator via a power divider.
3. The RF output of EUT was connected to the spectrum analyzer by RF cable and attenuator. The path loss was compensated to the results for each measurement.
4. The middle channel for the highest RF power within the transmitting frequency was measured.
5. The conducted spurious emission for the whole frequency range was taken.
6. Make the measurement with the spectrum analyzer's RBW = 1MHz, VBW = 3MHz.
7. Set spectrum analyzer with RMS detector.
8. Taking the record of maximum spurious emission.
9. The RF fundamental frequency should be excluded against the limit line in the operating frequency band.
10. The limit line is derived from $43 + 10\log(P)$ dB below the transmitter power P(Watts)
 $= P(W) - [43 + 10\log(P)]$ (dB)
 $= [30 + 10\log(P)]$ (dBm) - $[43 + 10\log(P)]$ (dB)
 $= -13$ dBm.
11. For 5G NR n7/n38/n41
The limit line is derived from $55 + 10\log(P)$ dB below the transmitter power P(Watts)
 $= P(W) - [55 + 10\log(P)]$ (dB)
 $= [30 + 10\log(P)]$ (dBm) - $[55 + 10\log(P)]$ (dB)
 $= -25$ dBm.



3.9 Frequency Stability

3.9.1 Description of Frequency Stability Measurement

The frequency stability shall be measured by variation of ambient temperature and variation of primary supply voltage to ensure that the fundamental emission stays within the authorized frequency block. The frequency stability of the transmitter shall be maintained within $\pm 0.00025\%$ ($\pm 2.5\text{ppm}$) of the center frequency.

3.9.2 Test Procedures for Temperature Variation

1. The testing follows ANSI C63.26 section 5.6.4
2. The EUT was set up in the thermal chamber and connected with the system simulator.
3. With power OFF, the temperature was decreased to -30°C and the EUT was stabilized before testing. Power was applied and the maximum change in frequency was recorded within one minute.
4. With power OFF, the temperature was raised in 10°C step up to 50°C . The EUT was stabilized at each step for at least half an hour. Power was applied and the maximum frequency change was recorded within one minute.

3.9.3 Test Procedures for Voltage Variation

1. The testing follows ANSI C63.26 section 5.6.5
2. The EUT was placed in a temperature chamber at $20\pm 5^{\circ}\text{C}$ and connected with the system simulator.
3. The power supply voltage to the EUT was varied from 85% to 115% of the nominal value for other than hand carried battery equipment.
4. For hand carried, battery powered equipment, reduce the primary ac or dc supply voltage to the battery operating end point, which shall be specified by the manufacturer.
5. The variation in frequency was measured for the worst case.

4 Radiated Test Items

4.1 Measuring Instruments

See list of measuring instruments of this test report.

4.2 Test Setup

4.2.1 For radiated test below 30MHz

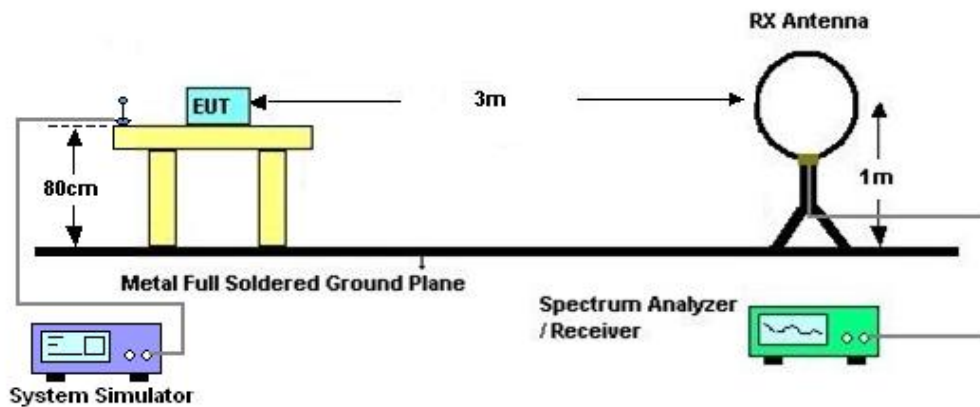

4.2.2 For radiated test from 30MHz to 1GHz

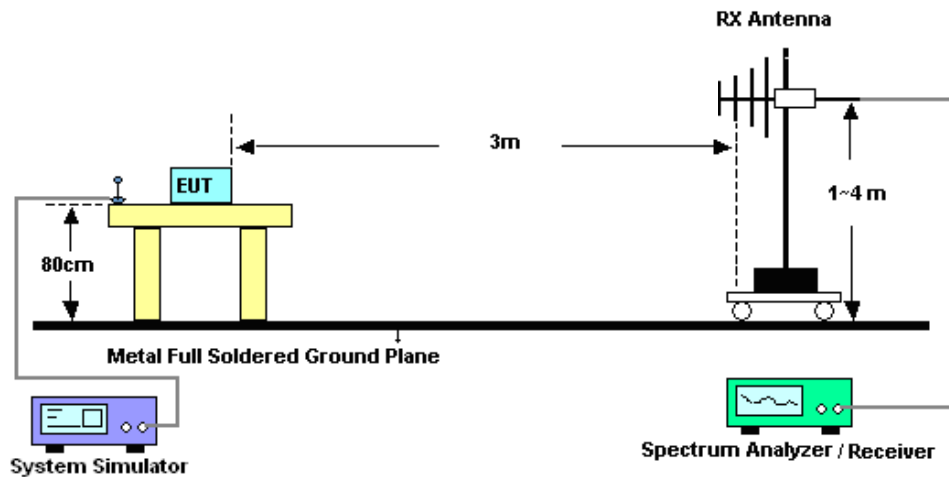

4.2.3 For radiated test above 1GHz

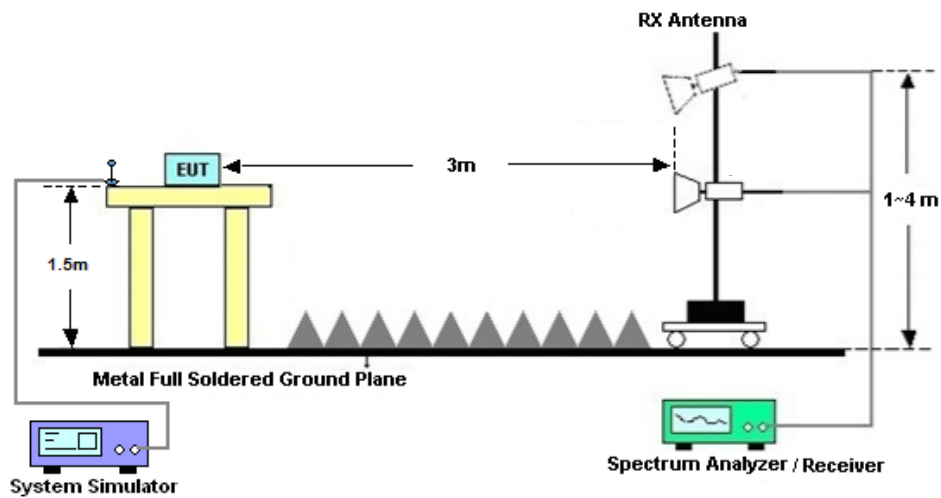

4.3 Test Result of Radiated Test

The low frequency, which started from 9 kHz to 30MHz, was pre-scanned and the result which was 20dB lower than the limit line was not reported.

Please refer to Appendix B.



4.4 Radiated Spurious Emission

4.4.1 Description of Radiated Spurious Emission

The radiated spurious emission was measured by substitution method according to ANSI C63.26. The power of any emission outside of the authorized operating frequency ranges must be attenuated below the transmitter power (P) by a factor of at least $43 + 10 \log (P)$ dB.

For 5G NR n7/n38/n41

The power of any emission outside of the authorized operating frequency ranges must be attenuated below the transmitter power (P) by a factor of at least $55 + 10 \log (P)$ dB.

The spectrum is scanned from 30 MHz up to a frequency including its 10th harmonic.

4.4.2 Test Procedures

1. The testing follows ANSI C63.26 Section 5.5
2. The EUT was placed on a turntable with 0.8 meter height for frequency below 1GHz and 1.5 meter height for frequency above 1GHz respectively above ground.
3. The EUT was set 3 meters from the receiving antenna mounted on the antenna tower.
4. The table was rotated 360 degrees to determine the position of the highest spurious emission.
5. The height of the receiving antenna is varied between 1m to 4m to search the maximum spurious emission for both horizontal and vertical polarizations.
6. During the measurement, the system simulator parameters were set to force the EUT transmitting at maximum output power.
7. Make the measurement with the spectrum analyzer's RBW = 1MHz, VBW = 3MHz, taking the record of maximum spurious emission.
8. A horn antenna was substituted in place of the EUT and was driven by a signal generator.
9. Tune the output power of signal generator to the same emission level with EUT maximum spurious emission.
10. $EIRP (dBm) = S.G. Power - Tx Cable Loss + Tx Antenna Gain$
11. $ERP (dBm) = EIRP - 2.15$
12. The RF fundamental frequency should be excluded against the limit line in the operating frequency band.

The limit line is derived from $43 + 10\log(P)$ dB below the transmitter power P(Watts)
 $= P(W) - [43 + 10\log(P)] (dB)$
 $= [30 + 10\log(P)] (dBm) - [43 + 10\log(P)] (dB)$
 $= -13dBm.$

13. For 5G NR n7/n38/n41:

The limit line is derived from $55 + 10\log(P)$ dB below the transmitter power P(Watts)The limit line is derived from $55 + 10\log(P)$ dB below the transmitter power P(Watts)



5 List of Measuring Equipment

Instrument	Manufacturer	Model No.	Serial No.	Characteristics	Calibration Date	Test Date	Due Date	Remark
Spectrum Analyzer	R&S	FSV40	101078	10Hz~40GHz	Apr. 06, 2023	Nov. 20, 2023 Nov. 22, 2023	Apr. 05, 2024	Conducted (TH01-SZ)
DC Power Supply	TTI	PL330P	290070	Max 32V , 3A	Oct. 16, 2023	Nov. 20, 2023 Nov. 22, 2023	Oct. 15, 2024	Conducted (TH01-SZ)
Power Divider	TOJOIN	PS-2SM-04 265	60.06.020.007 7	0.4GHz~26.5GHz	Dec. 25, 2022	Nov. 20, 2023 Nov. 22, 2023	Dec. 24, 2023	Conducted (TH01-SZ)
Thermal Chamber	Ten Billion Hongzhangroup	LP-150U	H2014081803	-40~+150°C	Jul. 05, 2023	Nov. 20, 2023 Nov. 22, 2023	Jul. 04, 2024	Conducted (TH01-SZ)
EMI Test Receiver&SA	Agilent	N9038A	MY52260185	20Hz~26.5GHz	Dec. 26, 2022	Dec. 08, 2023	Dec. 25, 2023	Radiation (03CH01-SZ)
EXA Spectrum Analyzer	KEYSIGHT	N9010A	MY55150213	10Hz~44GHz	Jul. 07, 2023	Dec. 08, 2023	Jul. 06, 2024	Radiation (03CH01-SZ)
Loop Antenna	R&S	HFH2-Z2	100354	9kHz~30MHz	Jul. 28, 2022	Dec. 08, 2023	Jul. 27, 2024	Radiation (03CH01-SZ)
Bilog Antenna	TeseQ	CBL6112D	35407	30MHz-2GHz	Oct. 24, 2023	Dec. 08, 2023	Oct. 23, 2025	Radiation (03CH01-SZ)
Double Ridge Horn Antenna	ETS-Lindgren	3117	00119436	1GHz~18GHz	Jul. 08, 2023	Dec. 08, 2023	Jul. 07, 2024	Radiation (03CH01-SZ)
SHF-EHF Horn	com-power	AH-840	101071	18GHz-40GHz	Apr. 08, 2023	Dec. 08, 2023	Apr. 07, 2024	Radiation (03CH01-SZ)
LF Amplifier	Burgeon	BPA-530	102209	0.01~3000Mhz	Apr. 04, 2023	Dec. 08, 2023	Apr. 03, 2024	Radiation (03CH01-SZ)
HF Amplifier	MITEQ	AMF-7D-00 101800-30-1 0P-R	1943528	1GHz~18GHz	Oct. 18, 2023	Dec. 08, 2023	Oct. 17, 2024	Radiation (03CH01-SZ)
HF Amplifier	KEYSIGHT	83017A	MY53270105	0.5GHz~26.5Ghz	Oct. 18, 2023	Dec. 08, 2023	Oct. 17, 2024	Radiation (03CH01-SZ)
HF Amplifier	MITEQ	TTA1840-35 -HG	1871923	18GHz~40GHz	Jul. 07, 2023	Dec. 08, 2023	Jul. 06, 2024	Radiation (03CH01-SZ)
AC Power Source	Chroma	61601	616010001985	N/A	Oct. 18, 2023	Dec. 08, 2023	Oct. 17, 2024	Radiation (03CH01-SZ)
Turn Table	EM	EM1000	N/A	0~360 degree	NCR	Dec. 08, 2023	NCR	Radiation (03CH01-SZ)
Antenna Mast	EM	EM1000	N/A	1 m~4 m	NCR	Dec. 08, 2023	NCR	Radiation (03CH01-SZ)

NCR: No Calibration Required



6 Measurement Uncertainty

The measurement uncertainties shown below were calculated in accordance with the requirements of ANSI 63.26-2015. All the measurement uncertainty value were shown with a coverage K=2 to indicate 95% level of confidence. The measurement data show herein meets or exceeds the CISPR measurement uncertainty values specified in CISPR 16-4-2 and can be compared directly to specified limit to determine compliance.

Uncertainty of Conducted Measurement

Test Item	Uncertainty
Conducted Spurious Emission & Bandedge	±1.34 dB
Occupied Channel Bandwidth	±0.012 MHz
Conducted Power	±1.34 dB
Peak to Average Ratio	±1.34 dB
Frequency Stability	±1.3 Hz

Uncertainty of Radiated Emission Measurement (9 KHz ~ 30 MHz)

Measuring Uncertainty for a Level of Confidence of 95% (U = 2Uc(y))	2.48dB
---	--------

Uncertainty of Radiated Emission Measurement (30 MHz ~ 1000 MHz)

Measuring Uncertainty for a Level of Confidence of 95% (U = 2Uc(y))	3.53dB
---	--------

Uncertainty of Radiated Emission Measurement (1 GHz ~ 40 GHz)

Measuring Uncertainty for a Level of Confidence of 95% (U = 2Uc(y))	4.02dB
---	--------

----- THE END -----



Appendix A. Test Results of Conducted Test

Test Engineer :	Jung Guo	Temperature :	22~23°C
		Relative Humidity :	40~42%

FR1 N2(ANT3)

Transmitter Conducted Output Power And EIRP, (G_T - L_C)=-0.8dB

NR Band	SCS (kHz)	Bandwidth (MHz)	Arfcn	Freq (MHz)	Modulation	RB	Conducted Power(dBm)	EIRP (dBm)	EIRP (W)
2	15	5	370500	1852.5	DFT-s-OFDM QPSK	1@1	22.31	21.51	0.1416
2	15	5	370500	1852.5	DFT-s-OFDM 16 QAM	1@1	21.38	20.58	0.1143
2	15	5	376000	1880.0	DFT-s-OFDM QPSK	1@1	22.39	21.59	0.1442
2	15	5	376000	1880.0	DFT-s-OFDM 16 QAM	1@1	21.45	20.65	0.1161
2	15	5	381500	1907.5	DFT-s-OFDM QPSK	1@1	22.44	21.64	0.1459
2	15	5	381500	1907.5	DFT-s-OFDM 16 QAM	1@1	21.52	20.72	0.1180
2	15	10	371000	1855.0	DFT-s-OFDM QPSK	1@1	22.2	21.4	0.1380
2	15	10	371000	1855.0	DFT-s-OFDM 16 QAM	1@1	21.23	20.43	0.1104
2	15	10	376000	1880.0	DFT-s-OFDM QPSK	1@1	22.25	21.45	0.1396
2	15	10	376000	1880.0	DFT-s-OFDM 16 QAM	1@1	21.29	20.49	0.1119
2	15	10	381000	1905.0	DFT-s-OFDM QPSK	1@1	22.32	21.52	0.1419
2	15	10	381000	1905.0	DFT-s-OFDM 16 QAM	1@1	21.35	20.55	0.1135
2	15	15	371500	1857.5	DFT-s-OFDM QPSK	1@1	22.34	21.54	0.1426
2	15	15	371500	1857.5	DFT-s-OFDM 16 QAM	1@1	21.35	20.55	0.1135
2	15	15	376000	1880.0	DFT-s-OFDM QPSK	1@1	22.3	21.5	0.1413
2	15	15	376000	1880.0	DFT-s-OFDM 16 QAM	1@1	21.34	20.54	0.1132
2	15	15	380500	1902.5	DFT-s-OFDM QPSK	1@1	22.44	21.64	0.1459
2	15	15	380500	1902.5	DFT-s-OFDM 16 QAM	1@1	21.39	20.59	0.1146
2	15	20	372000	1860.0	DFT-s-OFDM QPSK	50@25	22.54	21.74	0.1493
2	15	20	372000	1860.0	DFT-s-OFDM QPSK	1@1	22.34	21.54	0.1426
2	15	20	372000	1860.0	DFT-s-OFDM QPSK	1@104	22.38	21.58	0.1439
2	15	20	372000	1860.0	DFT-s-OFDM 16 QAM	50@25	21.59	20.79	0.1199
2	15	20	372000	1860.0	DFT-s-OFDM 16 QAM	1@1	21.38	20.58	0.1143
2	15	20	372000	1860.0	DFT-s-OFDM 16 QAM	1@104	21.35	20.55	0.1135
2	15	20	372000	1860.0	DFT-s-OFDM 64 QAM	50@25	19.99	19.19	0.0830
2	15	20	372000	1860.0	DFT-s-OFDM 64 QAM	1@1	19.89	19.09	0.0811
2	15	20	372000	1860.0	DFT-s-OFDM 64 QAM	1@104	19.89	19.09	0.0811
2	15	20	372000	1860.0	DFT-s-OFDM 256 QAM	50@25	18.17	17.37	0.0546
2	15	20	372000	1860.0	DFT-s-OFDM 256 QAM	1@1	17.97	17.17	0.0521

2	15	20	372000	1860.0	DFT-s-OFDM 256 QAM	1@104	18.01	17.21	0.0526
2	15	20	372000	1860.0	CP-OFDM QPSK	53@26	21.01	20.21	0.1050
2	15	20	372000	1860.0	CP-OFDM QPSK	1@1	20.71	19.91	0.0979
2	15	20	372000	1860.0	CP-OFDM QPSK	1@104	20.79	19.99	0.0998
2	15	20	376000	1880.0	DFT-s-OFDM QPSK	50@25	22.55	21.75	0.1496
2	15	20	376000	1880.0	DFT-s-OFDM QPSK	1@1	22.27	21.47	0.1403
2	15	20	376000	1880.0	DFT-s-OFDM QPSK	1@104	22.46	21.66	0.1466
2	15	20	376000	1880.0	DFT-s-OFDM 16 QAM	50@25	21.58	20.78	0.1197
2	15	20	376000	1880.0	DFT-s-OFDM 16 QAM	1@1	21.34	20.54	0.1132
2	15	20	376000	1880.0	DFT-s-OFDM 16 QAM	1@104	21.4	20.6	0.1148
2	15	20	376000	1880.0	DFT-s-OFDM 64 QAM	50@25	19.97	19.17	0.0826
2	15	20	376000	1880.0	DFT-s-OFDM 64 QAM	1@1	19.85	19.05	0.0804
2	15	20	376000	1880.0	DFT-s-OFDM 64 QAM	1@104	19.99	19.19	0.0830
2	15	20	376000	1880.0	DFT-s-OFDM 256 QAM	50@25	18.12	17.32	0.0540
2	15	20	376000	1880.0	DFT-s-OFDM 256 QAM	1@1	17.85	17.05	0.0507
2	15	20	376000	1880.0	DFT-s-OFDM 256 QAM	1@104	18	17.2	0.0525
2	15	20	376000	1880.0	CP-OFDM QPSK	53@26	21.06	20.26	0.1062
2	15	20	376000	1880.0	CP-OFDM QPSK	1@1	20.75	19.95	0.0989
2	15	20	376000	1880.0	CP-OFDM QPSK	1@104	20.83	20.03	0.1007
2	15	20	380000	1900.0	DFT-s-OFDM QPSK	50@25	22.66	21.86	0.1535
2	15	20	380000	1900.0	DFT-s-OFDM QPSK	1@1	22.45	21.65	0.1462
2	15	20	380000	1900.0	DFT-s-OFDM QPSK	1@104	22.39	21.59	0.1442
2	15	20	380000	1900.0	DFT-s-OFDM 16 QAM	50@25	21.69	20.89	0.1227
2	15	20	380000	1900.0	DFT-s-OFDM 16 QAM	1@1	21.46	20.66	0.1164
2	15	20	380000	1900.0	DFT-s-OFDM 16 QAM	1@104	21.41	20.61	0.1151
2	15	20	380000	1900.0	DFT-s-OFDM 64 QAM	50@25	20.11	19.31	0.0853
2	15	20	380000	1900.0	DFT-s-OFDM 64 QAM	1@1	20.01	19.21	0.0834
2	15	20	380000	1900.0	DFT-s-OFDM 64 QAM	1@104	19.95	19.15	0.0822
2	15	20	380000	1900.0	DFT-s-OFDM 256 QAM	50@25	18.26	17.46	0.0557
2	15	20	380000	1900.0	DFT-s-OFDM 256 QAM	1@1	18.12	17.32	0.0540
2	15	20	380000	1900.0	DFT-s-OFDM 256 QAM	1@104	18.09	17.29	0.0536
2	15	20	380000	1900.0	CP-OFDM QPSK	53@26	21.09	20.29	0.1069
2	15	20	380000	1900.0	CP-OFDM QPSK	1@1	20.89	20.09	0.1021
2	15	20	380000	1900.0	CP-OFDM QPSK	1@104	20.78	19.98	0.0995

Frequency Stability

NR Band	SCS (kHz)	Bandwidth (MHz)	Arfcn	Freq (MHz)	Modulation	RB	Deviation (ppm)	Verdict	Environment
2	15	20	376000	1880.0	DFT-s-OFDM QPSK	100@0	0.0065	PASS	NV
2	15	20	376000	1880.0	DFT-s-OFDM QPSK	100@0	0.0059	PASS	LV
2	15	20	376000	1880.0	DFT-s-OFDM QPSK	100@0	0.0068	PASS	HV
2	15	20	376000	1880.0	DFT-s-OFDM QPSK	100@0	0.0066	PASS	-30°C
2	15	20	376000	1880.0	DFT-s-OFDM QPSK	100@0	0.0037	PASS	-20°C
2	15	20	376000	1880.0	DFT-s-OFDM QPSK	100@0	0.0029	PASS	-10°C
2	15	20	376000	1880.0	DFT-s-OFDM QPSK	100@0	0.0068	PASS	0°C
2	15	20	376000	1880.0	DFT-s-OFDM QPSK	100@0	0.0036	PASS	10°C
2	15	20	376000	1880.0	DFT-s-OFDM QPSK	100@0	0.0065	PASS	20°C
2	15	20	376000	1880.0	DFT-s-OFDM QPSK	100@0	0.0045	PASS	30°C
2	15	20	376000	1880.0	DFT-s-OFDM QPSK	100@0	0.0049	PASS	40°C
2	15	20	376000	1880.0	DFT-s-OFDM QPSK	100@0	0.0058	PASS	50°C

Peak to Average Ratio

NR Band	SCS (kHz)	Bandwidth (MHz)	Arfcn	Freq (MHz)	Modulation	RB	Result (dB)	Limit (dB)	Verdict
2	15	20	376000	1880.0	DFT-s-OFDM QPSK	100@0	5.65	13	PASS
2	15	20	376000	1880.0	DFT-s-OFDM QPSK	1@0	5.46	13	PASS

N2(20M)_DFT-s-OFDM_QPSK_Outer_Full_Mid_CH



N2(20M)_DFT-s-OFDM_QPSK_Edge_1RB_Left_Mid_CH



Occupied Bandwidth

NR Band	SCS (kHz)	Bandwidth (MHz)	Arfcn	Freq (MHz)	Modulation	RB	OBW (MHz)	26dB BW (MHz)
2	15	5	376000	1880.0	CP-OFDM QPSK	25@0	4.4617	4.915
2	15	5	376000	1880.0	CP-OFDM 16 QAM	25@0	4.463	4.815
2	15	5	376000	1880.0	CP-OFDM 64 QAM	25@0	4.4628	4.867
2	15	5	376000	1880.0	CP-OFDM 256 QAM	25@0	4.4691	4.833
2	15	10	376000	1880.0	CP-OFDM QPSK	52@0	9.2735	9.928
2	15	10	376000	1880.0	CP-OFDM 16 QAM	52@0	9.29	9.839
2	15	10	376000	1880.0	CP-OFDM 64 QAM	52@0	9.306	9.837
2	15	10	376000	1880.0	CP-OFDM 256 QAM	52@0	9.2769	9.773
2	15	15	376000	1880.0	CP-OFDM QPSK	79@0	14.117	14.72
2	15	15	376000	1880.0	CP-OFDM 16 QAM	79@0	14.085	14.77
2	15	15	376000	1880.0	CP-OFDM 64 QAM	79@0	14.086	14.77
2	15	15	376000	1880.0	CP-OFDM 256 QAM	79@0	14.072	14.74
2	15	20	376000	1880.0	CP-OFDM QPSK	106@0	18.881	19.73
2	15	20	376000	1880.0	CP-OFDM 16 QAM	106@0	18.907	19.84
2	15	20	376000	1880.0	CP-OFDM 64 QAM	106@0	18.94	19.68
2	15	20	376000	1880.0	CP-OFDM 256 QAM	106@0	18.944	19.75

N2(5M)_CP-OFDM_QPSK_Outer_Full_Mid_CH

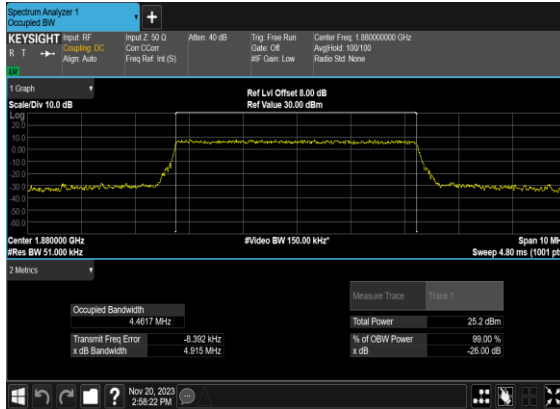

N2(5M)_CP-OFDM_16 QAM_Outer_Full_Mid_CH

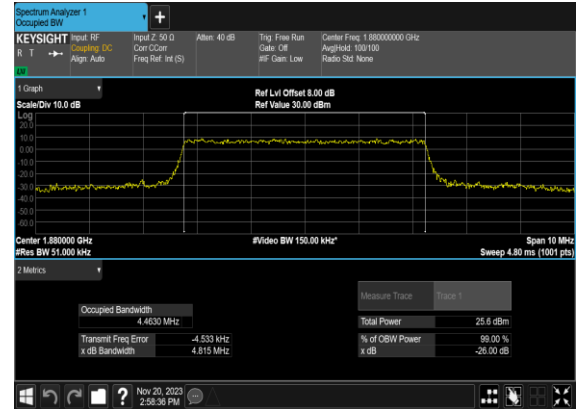

N2(5M)_CP-OFDM_64 QAM_Outer_Full_Mid_CH

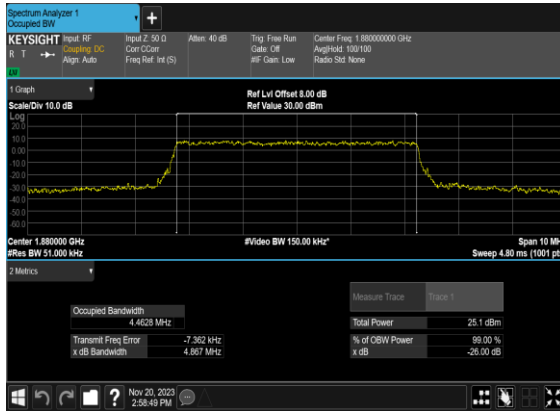

N2(5M)_CP-OFDM_256 QAM_Outer_Full_Mid_CH

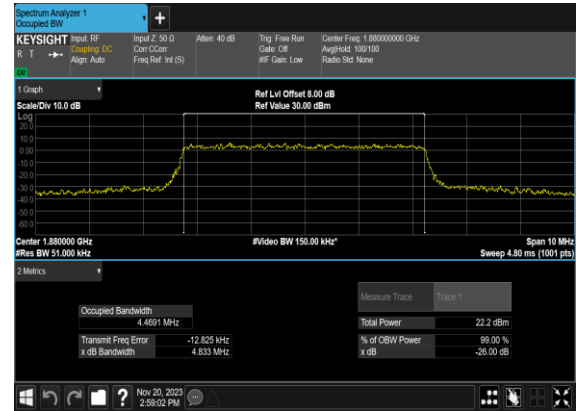

N2(10M)_CP-OFDM_QPSK_Outer_Full_Mid_CH

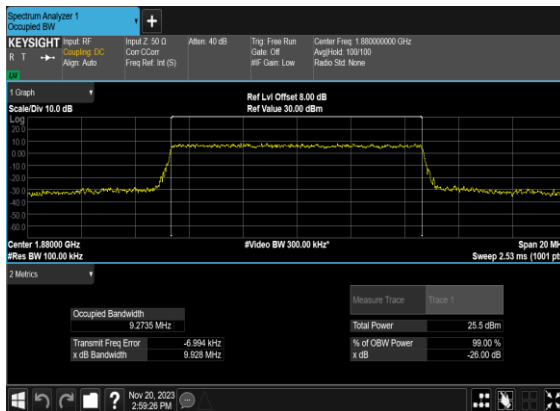

N2(10M)_CP-OFDM_16 QAM_Outer_Full_Mid_CH

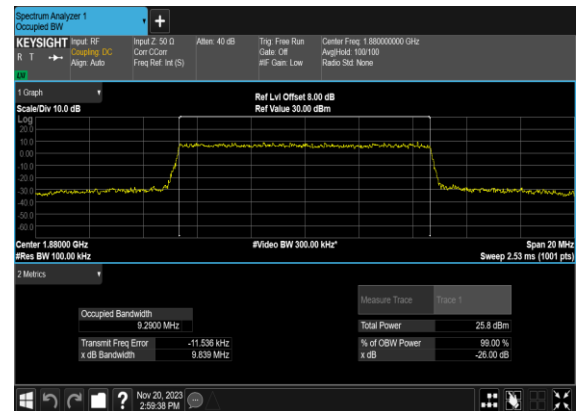

N2(10M)_CP-OFDM_64 QAM_Outer_Full_Mid_CH

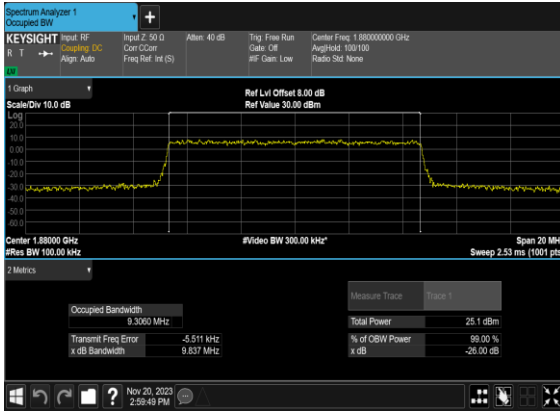

N2(10M)_CP-OFDM_256 QAM_Outer_Full_Mid_CH

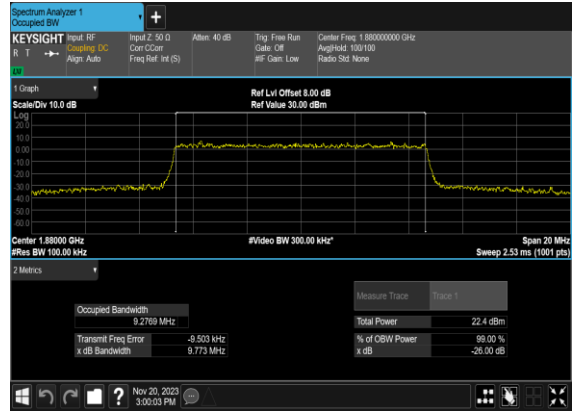

N2(15M)_CP- OFDM_QPSK_Outer_Full_Mid_CH

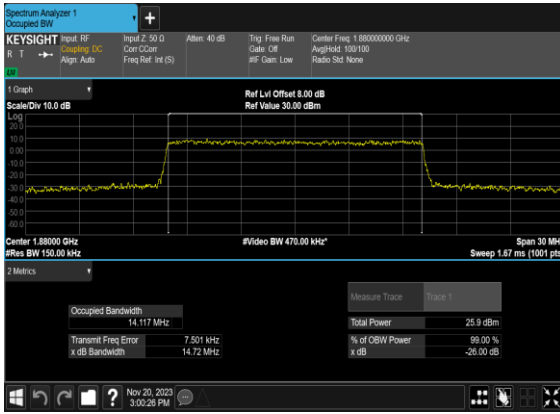

N2(15M)_CP-OFDM_16 QAM_Outer_Full_Mid_CH

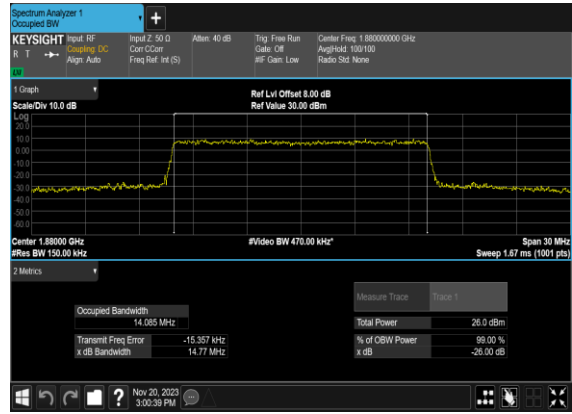

N2(15M)_CP-OFDM_64 QAM_Outer_Full_Mid_CH

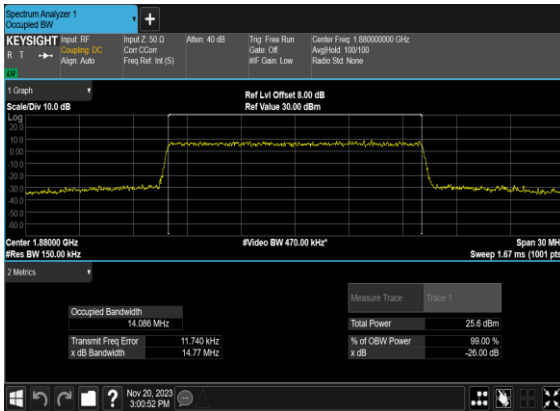

N2(15M)_CP-OFDM_256 QAM_Outer_Full_Mid_CH

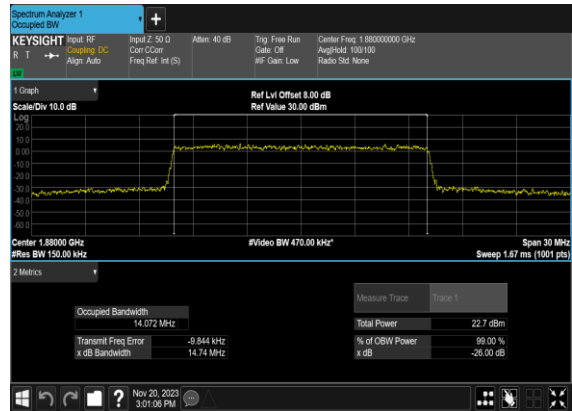

N2(20M)_CP-OFDM_QPSK_Outer_Full_Mid_CH

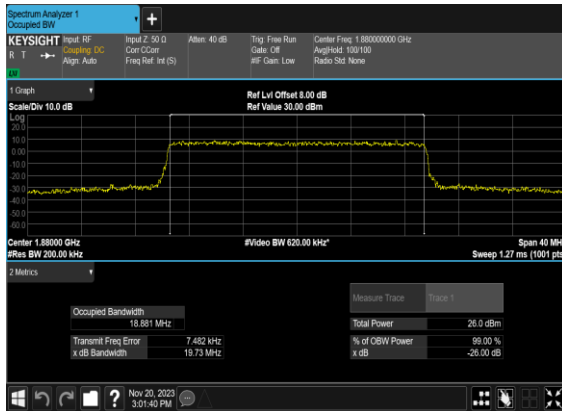

N2(20M)_CP-OFDM_16QAM_Outer_Full_Mid_CH

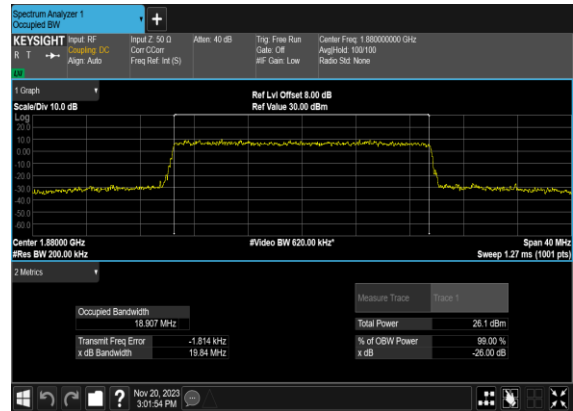

N2(20M)_CP-OFDM_64QAM_Outer_Full_Mid_CH



N2(20M)_CP-OFDM_256QAM_Outer_Full_Mid_CH

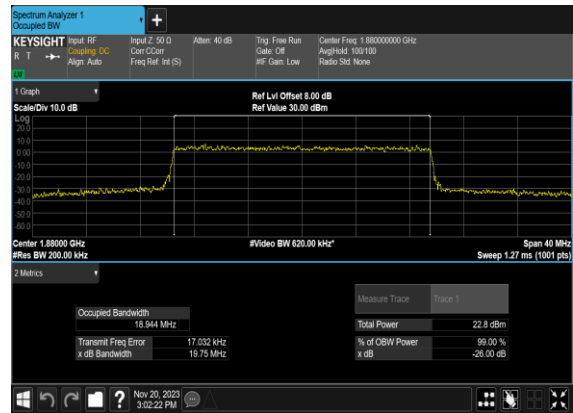

Conducted Spurious Emissions

NR Band	SCS (kHz)	Bandwidth (MHz)	Arfcn	Freq (MHz)	Modulation	RB	Result	Verdict
2	15	5	370500	1852.5	DFT-s-OFDM QPSK	1@0	see graph	---
2	15	5	370500	1852.5	DFT-s-OFDM QPSK	1@0	see graph	PASS
2	15	5	376000	1880.0	DFT-s-OFDM QPSK	1@0	see graph	---
2	15	5	376000	1880.0	DFT-s-OFDM QPSK	1@0	see graph	PASS
2	15	5	381500	1907.5	DFT-s-OFDM QPSK	1@0	see graph	---
2	15	5	381500	1907.5	DFT-s-OFDM QPSK	1@0	see graph	PASS
2	15	10	371000	1855.0	DFT-s-OFDM QPSK	1@0	see graph	---
2	15	10	371000	1855.0	DFT-s-OFDM QPSK	1@0	see graph	PASS
2	15	10	376000	1880.0	DFT-s-OFDM QPSK	1@0	see graph	---
2	15	10	376000	1880.0	DFT-s-OFDM QPSK	1@0	see graph	PASS
2	15	10	381000	1905.0	DFT-s-OFDM QPSK	1@0	see graph	---
2	15	10	381000	1905.0	DFT-s-OFDM QPSK	1@0	see graph	PASS
2	15	20	372000	1860.0	DFT-s-OFDM QPSK	1@0	see graph	---
2	15	20	372000	1860.0	DFT-s-OFDM QPSK	1@0	see graph	PASS
2	15	20	376000	1880.0	DFT-s-OFDM QPSK	1@0	see graph	---
2	15	20	376000	1880.0	DFT-s-OFDM QPSK	1@0	see graph	PASS
2	15	20	380000	1900.0	DFT-s-OFDM QPSK	1@0	see graph	---
2	15	20	380000	1900.0	DFT-s-OFDM QPSK	1@0	see graph	PASS

N2(5M)_DFT-s-OFDM_QPSK_Edge_1RB_Left_Low_CH



N2(5M)_DFT-s-OFDM_QPSK_Edge_1RB_Left_Mid_CH



N2(5M)_DFT-s-OFDM_QPSK_Edge_1RB_Left_High_CH

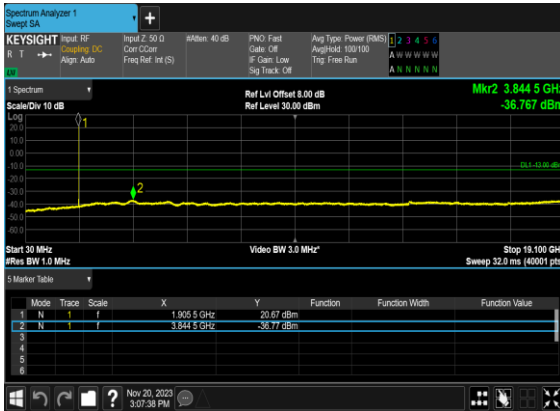

N2(10M)_DFT-s-OFDM_QPSK_Edge_1RB_Left_Low_CH



N2(10M)_DFT-s-OFDM_QPSK_Edge_1RB_Left_Mid_CH

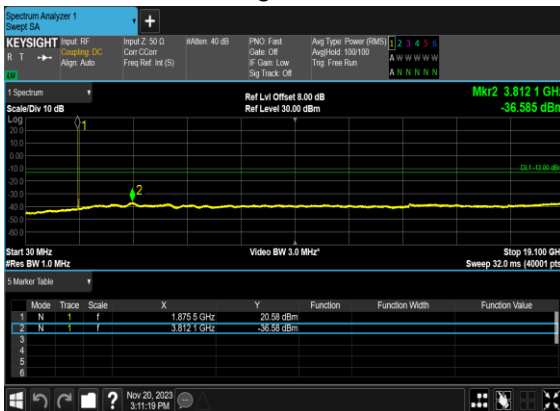

N2(10M)_DFT-s-OFDM_QPSK_Edge_1RB_Left_High_CH

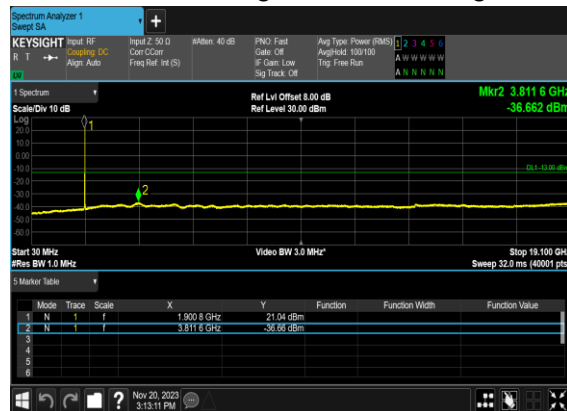

N2(20M)_DFT-s-OFDM_QPSK_Edge_1RB_Left_Low_CH

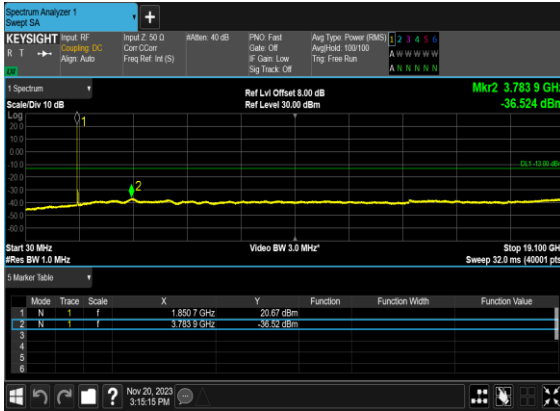

N2(20M)_DFT-s-OFDM_QPSK_Edge_1RB_Left_Mid_CH

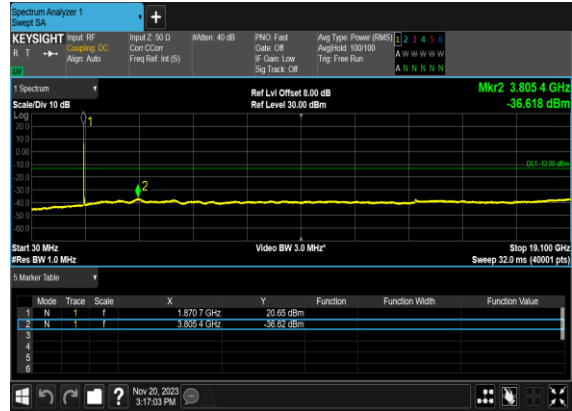

N2(20M)_DFT-s-OFDM_QPSK_Edge_1RB_Left_High_CH

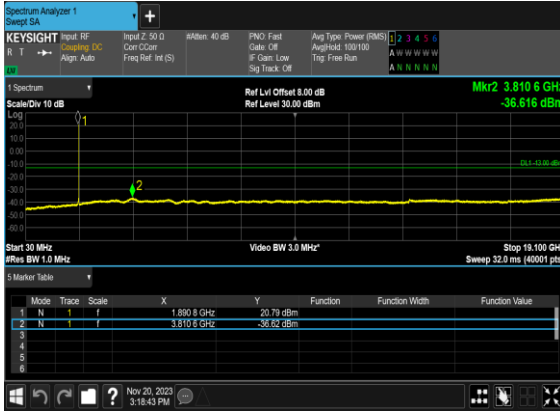

Conducted Band Edge

NR Band	SCS (kHz)	Bandwidth (MHz)	Arfcn	Freq (MHz)	Modulation	RB	Result	Verdict
2	15	5	370500	1852.5	DFT-s-OFDM QPSK	1@0	see graph	PASS
2	15	5	370500	1852.5	DFT-s-OFDM QPSK	25@0	see graph	PASS
2	15	5	381500	1907.5	DFT-s-OFDM QPSK	1@24	see graph	PASS
2	15	5	381500	1907.5	DFT-s-OFDM QPSK	25@0	see graph	PASS
2	15	10	371000	1855.0	DFT-s-OFDM QPSK	1@0	see graph	PASS
2	15	10	371000	1855.0	DFT-s-OFDM QPSK	50@0	see graph	PASS
2	15	10	381000	1905.0	DFT-s-OFDM QPSK	1@51	see graph	PASS
2	15	10	381000	1905.0	DFT-s-OFDM QPSK	50@0	see graph	PASS
2	15	20	372000	1860.0	DFT-s-OFDM QPSK	1@0	see graph	PASS
2	15	20	372000	1860.0	DFT-s-OFDM QPSK	100@0	see graph	PASS
2	15	20	380000	1900.0	DFT-s-OFDM QPSK	1@105	see graph	PASS
2	15	20	380000	1900.0	DFT-s-OFDM QPSK	100@0	see graph	PASS

N2(5M)_DFT-s-OFDM_QPSK_Edge_1RB_Left_Low_CH

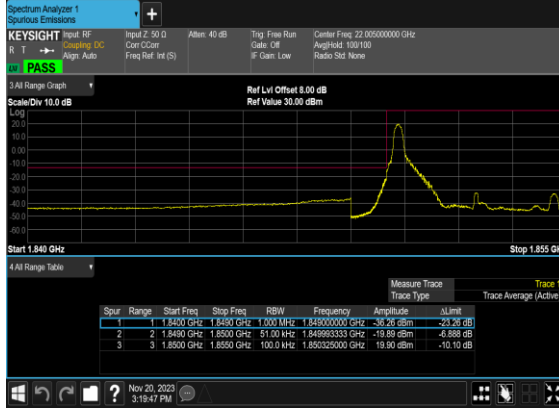

N2(5M)_DFT-s-OFDM_QPSK_Outer_Full_Low_CH

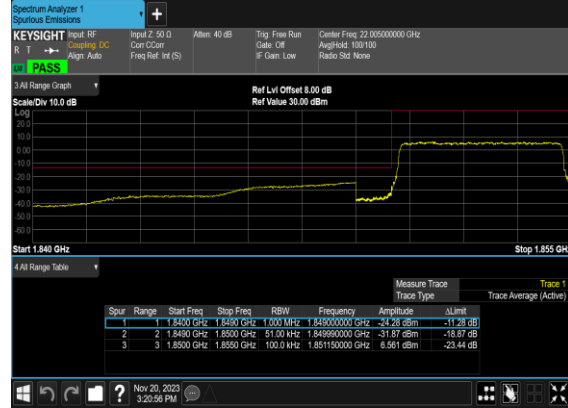

N2(5M)_DFT-s-OFDM_QPSK_Edge_1RB_Right_High_CH

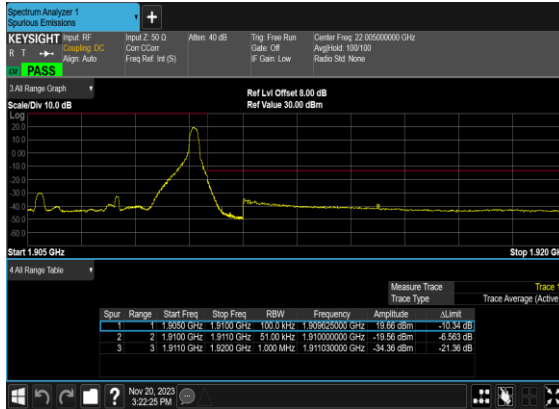

N2(5M)_DFT-s-OFDM_QPSK_Outer_Full_High_CH

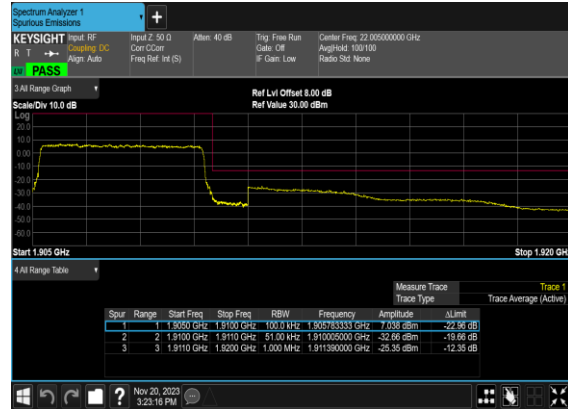

N2(10M)_DFT-s-OFDM_QPSK_Edge_1RB_Left_Low_CH

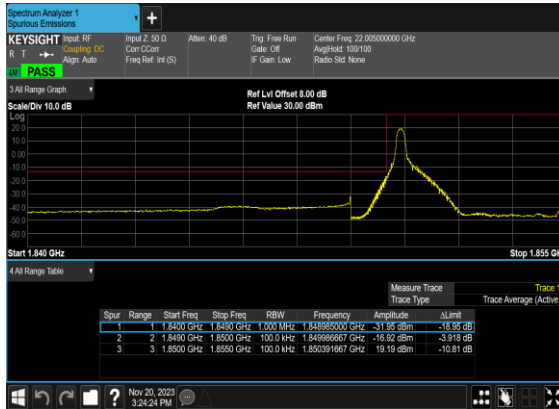

N2(10M)_DFT-s-OFDM_QPSK_Outer_Full_Low_CH

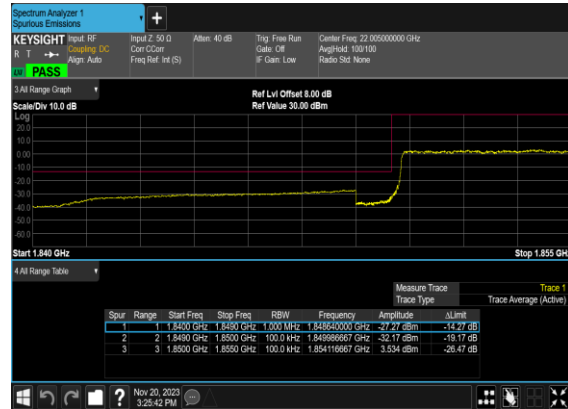

N2(10M)_DFT-s-OFDM_QPSK_Edge_1RB_Right_High_CH

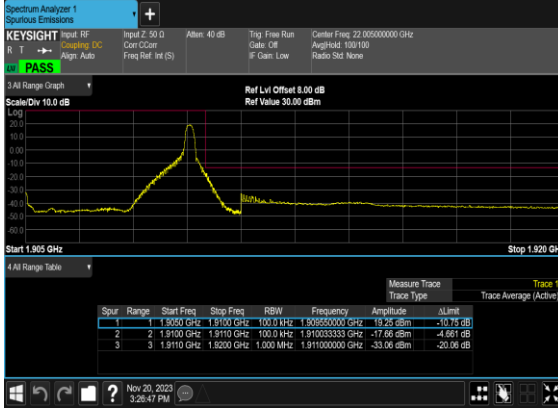

N2(10M)_DFT-s-OFDM_QPSK_Outer_Full_High_CH



N2(20M)_DFT-s-OFDM_QPSK_Edge_1RB_Left_Low_CH



N2(20M)_DFT-s-OFDM_QPSK_Outer_Full_Low_CH

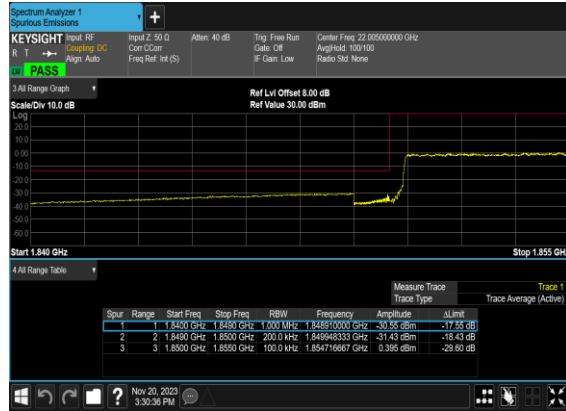

N2(20M)_DFT-s-OFDM_QPSK_Edge_1RB_Right_High_CH

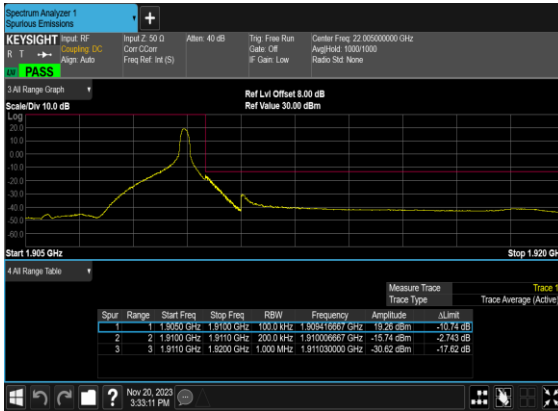

N2(20M)_DFT-s-OFDM_QPSK_Edge_1RB_Right_High_CH_CHP_P ASS

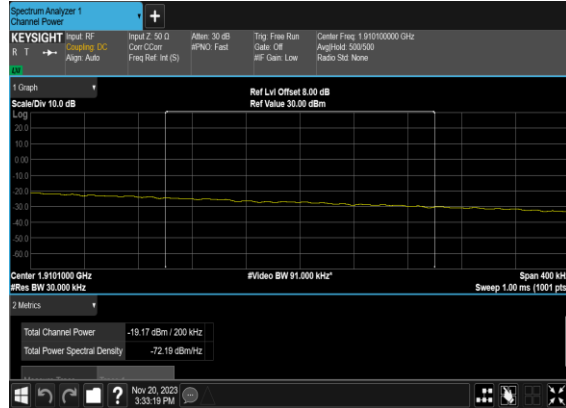

N2(20M)_DFT-s-OFDM_QPSK_Outer_Full_High_CH

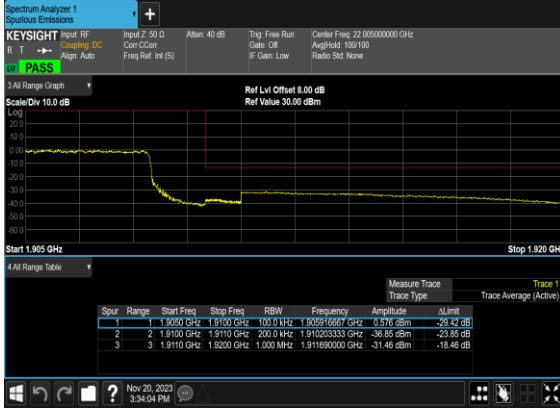

FR1 N5(ANT1)

Transmitter Conducted Output Power And ERP, (G_T - L_C)=-3.7dB

NR Band	SCS (kHz)	Bandwidth (MHz)	Arfcn	Freq (MHz)	Modulation	RB	Conducted Power(dBm)	ERP(dBm)	ERP(W)
5	15	5	165300	826.5	DFT-s-OFDM QPSK	1@1	24.6	18.75	0.0750
5	15	5	165300	826.5	DFT-s-OFDM 16 QAM	1@1	23.66	17.81	0.0604
5	15	5	167300	836.5	DFT-s-OFDM QPSK	1@1	24.51	18.66	0.0735
5	15	5	167300	836.5	DFT-s-OFDM 16 QAM	1@1	23.55	17.7	0.0589
5	15	5	169300	846.5	DFT-s-OFDM QPSK	1@1	24.3	18.45	0.0700
5	15	5	169300	846.5	DFT-s-OFDM 16 QAM	1@1	23.27	17.42	0.0552
5	15	10	165800	829.0	DFT-s-OFDM QPSK	1@1	24.45	18.6	0.0724
5	15	10	165800	829.0	DFT-s-OFDM 16 QAM	1@1	23.47	17.62	0.0578
5	15	10	167300	836.5	DFT-s-OFDM QPSK	1@1	24.34	18.49	0.0706
5	15	10	167300	836.5	DFT-s-OFDM 16 QAM	1@1	23.38	17.53	0.0566
5	15	10	168800	844.0	DFT-s-OFDM QPSK	1@1	24.1	18.25	0.0668
5	15	10	168800	844.0	DFT-s-OFDM 16 QAM	1@1	23.1	17.25	0.0531
5	15	15	166300	831.5	DFT-s-OFDM QPSK	1@1	24.63	18.78	0.0755
5	15	15	166300	831.5	DFT-s-OFDM 16 QAM	1@1	23.6	17.75	0.0596
5	15	15	167300	836.5	DFT-s-OFDM QPSK	1@1	24.53	18.68	0.0738
5	15	15	167300	836.5	DFT-s-OFDM 16 QAM	1@1	23.54	17.69	0.0587
5	15	15	168300	841.5	DFT-s-OFDM QPSK	1@1	24.39	18.54	0.0714
5	15	15	168300	841.5	DFT-s-OFDM 16 QAM	1@1	23.45	17.6	0.0575
5	15	20	166800	834.0	DFT-s-OFDM QPSK	50@25	24.54	18.69	0.0740
5	15	20	166800	834.0	DFT-s-OFDM QPSK	1@1	24.65	18.8	0.0759
5	15	20	166800	834.0	DFT-s-OFDM QPSK	1@104	24.19	18.34	0.0682
5	15	20	166800	834.0	DFT-s-OFDM 16 QAM	50@25	23.65	17.8	0.0603
5	15	20	166800	834.0	DFT-s-OFDM 16 QAM	1@1	23.55	17.7	0.0589
5	15	20	166800	834.0	DFT-s-OFDM 16 QAM	1@104	23.18	17.33	0.0541
5	15	20	166800	834.0	DFT-s-OFDM 64 QAM	50@25	22.03	16.18	0.0415
5	15	20	166800	834.0	DFT-s-OFDM 64 QAM	1@1	22.18	16.33	0.0430
5	15	20	166800	834.0	DFT-s-OFDM 64 QAM	1@104	21.76	15.91	0.0390
5	15	20	166800	834.0	DFT-s-OFDM 256 QAM	50@25	20.04	14.19	0.0262
5	15	20	166800	834.0	DFT-s-OFDM 256 QAM	1@1	20.09	14.24	0.0265

5	15	20	166800	834.0	DFT-s-OFDM 256 QAM	1@104	19.71	13.86	0.0243
5	15	20	166800	834.0	CP-OFDM QPSK	53@26	23.01	17.16	0.0520
5	15	20	166800	834.0	CP-OFDM QPSK	1@1	23.04	17.19	0.0524
5	15	20	166800	834.0	CP-OFDM QPSK	1@104	22.62	16.77	0.0475
5	15	20	167300	836.5	DFT-s-OFDM QPSK	50@25	24.49	18.64	0.0731
5	15	20	167300	836.5	DFT-s-OFDM QPSK	1@1	24.53	18.68	0.0738
5	15	20	167300	836.5	DFT-s-OFDM QPSK	1@104	24.18	18.33	0.0681
5	15	20	167300	836.5	DFT-s-OFDM 16 QAM	50@25	23.57	17.72	0.0592
5	15	20	167300	836.5	DFT-s-OFDM 16 QAM	1@1	23.6	17.75	0.0596
5	15	20	167300	836.5	DFT-s-OFDM 16 QAM	1@104	23.18	17.33	0.0541
5	15	20	167300	836.5	DFT-s-OFDM 64 QAM	50@25	21.97	16.12	0.0409
5	15	20	167300	836.5	DFT-s-OFDM 64 QAM	1@1	22.12	16.27	0.0424
5	15	20	167300	836.5	DFT-s-OFDM 64 QAM	1@104	21.79	15.94	0.0393
5	15	20	167300	836.5	DFT-s-OFDM 256 QAM	50@25	19.99	14.14	0.0259
5	15	20	167300	836.5	DFT-s-OFDM 256 QAM	1@1	20.08	14.23	0.0265
5	15	20	167300	836.5	DFT-s-OFDM 256 QAM	1@104	19.73	13.88	0.0244
5	15	20	167300	836.5	CP-OFDM QPSK	53@26	22.98	17.13	0.0516
5	15	20	167300	836.5	CP-OFDM QPSK	1@1	22.99	17.14	0.0518
5	15	20	167300	836.5	CP-OFDM QPSK	1@104	22.61	16.76	0.0474
5	15	20	167800	839.0	DFT-s-OFDM QPSK	50@25	24.5	18.65	0.0733
5	15	20	167800	839.0	DFT-s-OFDM QPSK	1@1	24.51	18.66	0.0735
5	15	20	167800	839.0	DFT-s-OFDM QPSK	1@104	24.21	18.36	0.0685
5	15	20	167800	839.0	DFT-s-OFDM 16 QAM	50@25	23.55	17.7	0.0589
5	15	20	167800	839.0	DFT-s-OFDM 16 QAM	1@1	23.54	17.69	0.0587
5	15	20	167800	839.0	DFT-s-OFDM 16 QAM	1@104	23.27	17.42	0.0552
5	15	20	167800	839.0	DFT-s-OFDM 64 QAM	50@25	21.98	16.13	0.0410
5	15	20	167800	839.0	DFT-s-OFDM 64 QAM	1@1	22.1	16.25	0.0422
5	15	20	167800	839.0	DFT-s-OFDM 64 QAM	1@104	21.87	16.02	0.0400
5	15	20	167800	839.0	DFT-s-OFDM 256 QAM	50@25	19.94	14.09	0.0256
5	15	20	167800	839.0	DFT-s-OFDM 256 QAM	1@1	20	14.15	0.0260
5	15	20	167800	839.0	DFT-s-OFDM 256 QAM	1@104	19.8	13.95	0.0248
5	15	20	167800	839.0	CP-OFDM QPSK	53@26	22.92	17.07	0.0509
5	15	20	167800	839.0	CP-OFDM QPSK	1@1	22.94	17.09	0.0512
5	15	20	167800	839.0	CP-OFDM QPSK	1@104	22.67	16.82	0.0481

FR1 N7(ANT3)

Transmitter Conducted Output Power And EIRP, (G_T - L_C)=-0.4dB

NR Band	SCS (kHz)	Bandwidth (MHz)	Arfcn	Freq (MHz)	Modulation	RB	Conducted Power(dBm)	EIRP (dBm)	EIRP (W)
7	15	5	500500	2535.0	DFT-s-OFDM QPSK	1@1	23.35	22.95	0.1972
7	15	5	500500	2502.5	DFT-s-OFDM 16 QAM	1@1	22.73	22.33	0.1710
7	15	5	507000	2535.0	DFT-s-OFDM QPSK	1@1	23.39	22.99	0.1991
7	15	5	507000	2535.0	DFT-s-OFDM 16 QAM	1@1	22.46	22.06	0.1607
7	15	5	513500	2567.5	DFT-s-OFDM QPSK	1@1	23.13	22.73	0.1875
7	15	5	513500	2567.5	DFT-s-OFDM 16 QAM	1@1	22.23	21.83	0.1524
7	15	10	501000	2505.0	DFT-s-OFDM QPSK	1@1	23.47	23.07	0.2028
7	15	10	501000	2505.0	DFT-s-OFDM 16 QAM	1@1	22.65	22.25	0.1679
7	15	10	507000	2535.0	DFT-s-OFDM QPSK	1@1	23.18	22.78	0.1897
7	15	10	507000	2535.0	DFT-s-OFDM 16 QAM	1@1	22.27	21.87	0.1538
7	15	10	513000	2565.0	DFT-s-OFDM QPSK	1@1	23.08	22.68	0.1854
7	15	10	513000	2565.0	DFT-s-OFDM 16 QAM	1@1	22.15	21.75	0.1496
7	15	15	501500	2507.5	DFT-s-OFDM QPSK	1@1	23.66	23.26	0.2118
7	15	15	501500	2507.5	DFT-s-OFDM 16 QAM	1@1	22.75	22.35	0.1718
7	15	15	507000	2535.0	DFT-s-OFDM QPSK	1@1	23.34	22.94	0.1968
7	15	15	507000	2535.0	DFT-s-OFDM 16 QAM	1@1	22.41	22.01	0.1589
7	15	15	512500	2562.5	DFT-s-OFDM QPSK	1@1	23.29	22.89	0.1945
7	15	15	512500	2562.5	DFT-s-OFDM 16 QAM	1@1	22.34	21.94	0.1563
7	15	20	502000	2510.0	DFT-s-OFDM QPSK	1@1	23.64	23.24	0.2109
7	15	20	502000	2510.0	DFT-s-OFDM 16 QAM	1@1	22.74	22.34	0.1714
7	15	20	507000	2535.0	DFT-s-OFDM QPSK	1@1	23.3	22.9	0.1950
7	15	20	507000	2535.0	DFT-s-OFDM 16 QAM	1@1	22.41	22.01	0.1589
7	15	20	512000	2560.0	DFT-s-OFDM QPSK	1@1	23.35	22.95	0.1972
7	15	20	512000	2560.0	DFT-s-OFDM 16 QAM	1@1	22.48	22.08	0.1614
7	15	25	502500	2512.5	DFT-s-OFDM QPSK	1@1	23.63	23.23	0.2104
7	15	25	502500	2512.5	DFT-s-OFDM 16 QAM	1@1	22.77	22.37	0.1726
7	15	25	507000	2535.0	DFT-s-OFDM QPSK	1@1	23.3	22.9	0.1950
7	15	25	507000	2535.0	DFT-s-OFDM 16 QAM	1@1	22.42	22.02	0.1592
7	15	25	511500	2557.5	DFT-s-OFDM QPSK	1@1	23.27	22.87	0.1936

7	15	25	511500	2557.5	DFT-s-OFDM 16 QAM	1@1	22.39	21.99	0.1581
7	15	30	503000	2515.0	DFT-s-OFDM QPSK	1@1	23.48	23.08	0.2032
7	15	30	503000	2515.0	DFT-s-OFDM 16 QAM	1@1	22.66	22.26	0.1683
7	15	30	507000	2535.0	DFT-s-OFDM QPSK	1@1	23.28	22.88	0.1941
7	15	30	507000	2535.0	DFT-s-OFDM 16 QAM	1@1	22.41	22.01	0.1589
7	15	30	511000	2555.0	DFT-s-OFDM QPSK	1@1	23.19	22.79	0.1901
7	15	30	511000	2555.0	DFT-s-OFDM 16 QAM	1@1	22.36	21.96	0.1570
7	15	40	504000	2520.0	DFT-s-OFDM QPSK	108@54	23.68	23.28	0.2128
7	15	40	504000	2520.0	DFT-s-OFDM QPSK	1@1	23.21	22.81	0.1910
7	15	40	504000	2520.0	DFT-s-OFDM QPSK	1@214	22.92	22.52	0.1786
7	15	40	504000	2520.0	DFT-s-OFDM 16 QAM	108@54	22.69	22.29	0.1694
7	15	40	504000	2520.0	DFT-s-OFDM 16 QAM	1@1	22.27	21.87	0.1538
7	15	40	504000	2520.0	DFT-s-OFDM 16 QAM	1@214	21.95	21.55	0.1429
7	15	40	504000	2520.0	DFT-s-OFDM 64 QAM	108@54	21.18	20.78	0.1197
7	15	40	504000	2520.0	DFT-s-OFDM 64 QAM	1@1	20.87	20.47	0.1114
7	15	40	504000	2520.0	DFT-s-OFDM 64 QAM	1@214	20.61	20.21	0.1050
7	15	40	504000	2520.0	DFT-s-OFDM 256 QAM	108@54	19.15	18.75	0.0750
7	15	40	504000	2520.0	DFT-s-OFDM 256 QAM	1@1	18.81	18.41	0.0693
7	15	40	504000	2520.0	DFT-s-OFDM 256 QAM	1@214	18.55	18.15	0.0653
7	15	40	504000	2520.0	CP-OFDM QPSK	108@54	22.18	21.78	0.1507
7	15	40	504000	2520.0	CP-OFDM QPSK	1@1	21.66	21.26	0.1337
7	15	40	504000	2520.0	CP-OFDM QPSK	1@214	21.35	20.95	0.1245
7	15	40	507000	2535.0	DFT-s-OFDM QPSK	108@54	23.6	23.2	0.2089
7	15	40	507000	2535.0	DFT-s-OFDM QPSK	1@1	23.16	22.76	0.1888
7	15	40	507000	2535.0	DFT-s-OFDM QPSK	1@214	22.93	22.53	0.1791
7	15	40	507000	2535.0	DFT-s-OFDM 16 QAM	108@54	22.56	22.16	0.1644
7	15	40	507000	2535.0	DFT-s-OFDM 16 QAM	1@1	22.24	21.84	0.1528
7	15	40	507000	2535.0	DFT-s-OFDM 16 QAM	1@214	21.98	21.58	0.1439
7	15	40	507000	2535.0	DFT-s-OFDM 64 QAM	108@54	21.09	20.69	0.1172
7	15	40	507000	2535.0	DFT-s-OFDM 64 QAM	1@1	20.81	20.41	0.1099
7	15	40	507000	2535.0	DFT-s-OFDM 64 QAM	1@214	20.5	20.1	0.1023
7	15	40	507000	2535.0	DFT-s-OFDM 256 QAM	108@54	19.04	18.64	0.0731
7	15	40	507000	2535.0	DFT-s-OFDM 256 QAM	1@1	18.74	18.34	0.0682
7	15	40	507000	2535.0	DFT-s-OFDM 256 QAM	1@214	18.49	18.09	0.0644
7	15	40	507000	2535.0	CP-OFDM QPSK	108@54	22.09	21.69	0.1476

7	15	40	507000	2535.0	CP-OFDM QPSK	1@1	21.64	21.24	0.1330
7	15	40	507000	2535.0	CP-OFDM QPSK	1@214	21.31	20.91	0.1233
7	15	40	510000	2550.0	DFT-s-OFDM QPSK	108@54	23.59	23.19	0.2084
7	15	40	510000	2550.0	DFT-s-OFDM QPSK	1@1	22.94	22.54	0.1795
7	15	40	510000	2550.0	DFT-s-OFDM QPSK	1@214	22.63	22.23	0.1671
7	15	40	510000	2550.0	DFT-s-OFDM 16 QAM	108@54	22.56	22.16	0.1644
7	15	40	510000	2550.0	DFT-s-OFDM 16 QAM	1@1	22.09	21.69	0.1476
7	15	40	510000	2550.0	DFT-s-OFDM 16 QAM	1@214	21.73	21.33	0.1358
7	15	40	510000	2550.0	DFT-s-OFDM 64 QAM	108@54	21.08	20.68	0.1169
7	15	40	510000	2550.0	DFT-s-OFDM 64 QAM	1@1	20.59	20.19	0.1045
7	15	40	510000	2550.0	DFT-s-OFDM 64 QAM	1@214	20.17	19.77	0.0948
7	15	40	510000	2550.0	DFT-s-OFDM 256 QAM	108@54	19.02	18.62	0.0728
7	15	40	510000	2550.0	DFT-s-OFDM 256 QAM	1@1	18.55	18.15	0.0653
7	15	40	510000	2550.0	DFT-s-OFDM 256 QAM	1@214	18.16	17.76	0.0597
7	15	40	510000	2550.0	CP-OFDM QPSK	108@54	22.04	21.64	0.1459
7	15	40	510000	2550.0	CP-OFDM QPSK	1@1	21.45	21.05	0.1274
7	15	40	510000	2550.0	CP-OFDM QPSK	1@214	21.09	20.69	0.1172

Frequency Stability

NR Band	SCS (kHz)	Bandwidth (MHz)	Arfcn	Freq (MHz)	Modulation	RB	Deviation (ppm)	Verdict	Environment
7	15	20	507000	2535.0	DFT-s-OFDM QPSK	100@0	0.0021	PASS	NV
7	15	20	507000	2535.0	DFT-s-OFDM QPSK	100@0	0.0025	PASS	LV
7	15	20	507000	2535.0	DFT-s-OFDM QPSK	100@0	0.0051	PASS	HV
7	15	20	507000	2535.0	DFT-s-OFDM QPSK	100@0	0.0045	PASS	-30°C
7	15	20	507000	2535.0	DFT-s-OFDM QPSK	100@0	0.0035	PASS	-20°C
7	15	20	507000	2535.0	DFT-s-OFDM QPSK	100@0	0.0053	PASS	-10°C
7	15	20	507000	2535.0	DFT-s-OFDM QPSK	100@0	0.0043	PASS	0°C
7	15	20	507000	2535.0	DFT-s-OFDM QPSK	100@0	0.0041	PASS	10°C
7	15	20	507000	2535.0	DFT-s-OFDM QPSK	100@0	0.0021	PASS	20°C
7	15	20	507000	2535.0	DFT-s-OFDM QPSK	100@0	0.0064	PASS	30°C
7	15	20	507000	2535.0	DFT-s-OFDM QPSK	100@0	0.0056	PASS	40°C
7	15	20	507000	2535.0	DFT-s-OFDM QPSK	100@0	0.0036	PASS	50°C

Peak to Average Ratio

NR Band	SCS (kHz)	Bandwidth (MHz)	Arfcn	Freq (MHz)	Modulation	RB	Result (dB)	Limit (dB)	Verdict
7	15	20	507000	2535.0	DFT-s-OFDM QPSK	100@0	5.1	13	PASS
7	15	20	507000	2535.0	DFT-s-OFDM QPSK	1@0	4.49	13	PASS

N7(20M)_DFT-s-OFDM_QPSK_Outer_Full_Mid_CH



N7(20M)_DFT-s-OFDM_QPSK_Edge_1RB_Left_Mid_CH



Occupied Bandwidth

NR Band	SCS (kHz)	Bandwidth (MHz)	Arfcn	Freq (MHz)	Modulation	RB	OBW (MHz)	26dB BW (MHz)
7	15	5	507000	2535.0	CP-OFDM QPSK	25@0	4.4635	4.803
7	15	5	507000	2535.0	CP-OFDM 16 QAM	25@0	4.4725	4.858
7	15	5	507000	2535.0	CP-OFDM 64 QAM	25@0	4.4635	4.832
7	15	5	507000	2535.0	CP-OFDM 256 QAM	25@0	4.4719	4.839
7	15	10	507000	2535.0	CP-OFDM QPSK	52@0	9.2744	9.822
7	15	10	507000	2535.0	CP-OFDM 16 QAM	52@0	9.2965	9.8
7	15	10	507000	2535.0	CP-OFDM 64 QAM	52@0	9.3018	9.833
7	15	10	507000	2535.0	CP-OFDM 256 QAM	52@0	9.2742	9.758
7	15	15	507000	2535.0	CP-OFDM QPSK	79@0	14.111	14.73
7	15	15	507000	2535.0	CP-OFDM 16 QAM	79@0	14.085	14.68
7	15	15	507000	2535.0	CP-OFDM 64 QAM	79@0	14.088	14.84
7	15	15	507000	2535.0	CP-OFDM 256 QAM	79@0	14.072	14.73
7	15	20	507000	2535.0	CP-OFDM QPSK	106@0	18.889	19.71
7	15	20	507000	2535.0	CP-OFDM 16 QAM	106@0	18.904	19.77
7	15	20	507000	2535.0	CP-OFDM 64 QAM	106@0	18.923	19.67
7	15	20	507000	2535.0	CP-OFDM 256 QAM	106@0	18.903	19.71
7	15	25	507000	2535.0	CP-OFDM QPSK	133@0	23.699	24.63
7	15	25	507000	2535.0	CP-OFDM 16 QAM	133@0	23.723	24.64
7	15	25	507000	2535.0	CP-OFDM 64 QAM	133@0	23.805	24.66
7	15	25	507000	2535.0	CP-OFDM 256 QAM	133@0	23.698	24.65
7	15	30	507000	2535.0	CP-OFDM QPSK	160@0	28.545	29.59
7	15	30	507000	2535.0	CP-OFDM 16 QAM	160@0	28.516	29.6
7	15	30	507000	2535.0	CP-OFDM 64 QAM	160@0	28.545	29.66
7	15	30	507000	2535.0	CP-OFDM 256 QAM	160@0	28.554	29.57
7	15	40	507000	2535.0	CP-OFDM QPSK	216@0	38.51	39.9
7	15	40	507000	2535.0	CP-OFDM 16 QAM	216@0	38.591	40.03
7	15	40	507000	2535.0	CP-OFDM 64 QAM	216@0	38.575	40.09
7	15	40	507000	2535.0	CP-OFDM 256 QAM	216@0	38.503	39.87

N7(5M)_CP-OFDM_QPSK_Outer_Full_Mid_CH

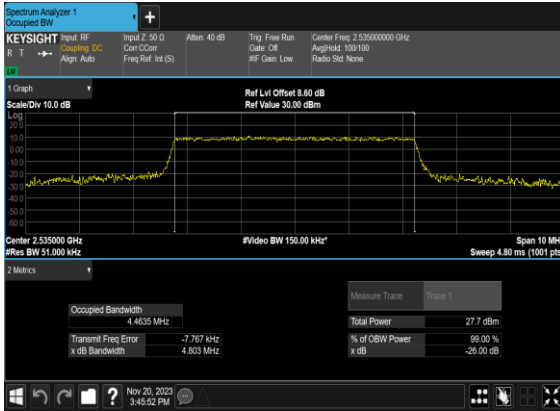

N7(5M)_CP-OFDM_16QAM_Outer_Full_Mid_CH

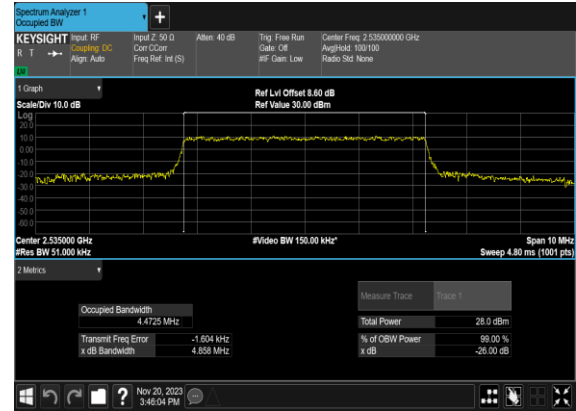

N7(5M)_CP-OFDM_64QAM_Outer_Full_Mid_CH



N7(5M)_CP-OFDM_256QAM_Outer_Full_Mid_CH

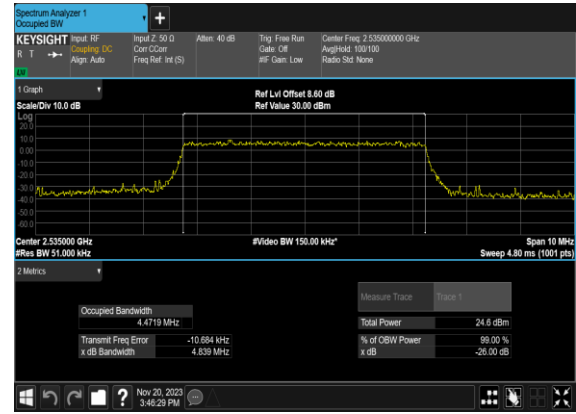

N7(10M)_CP-OFDM_QPSK_Outer_Full_Mid_CH

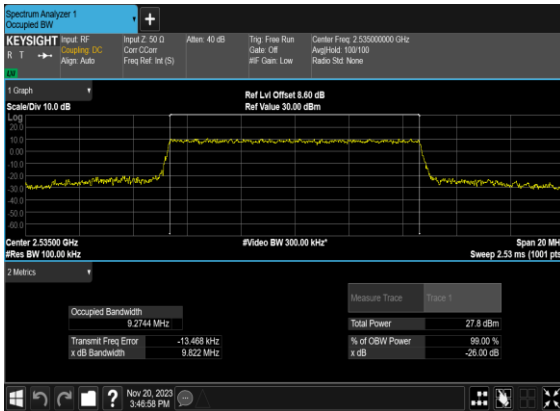

N7(10M)_CP-OFDM_16QAM_Outer_Full_Mid_CH

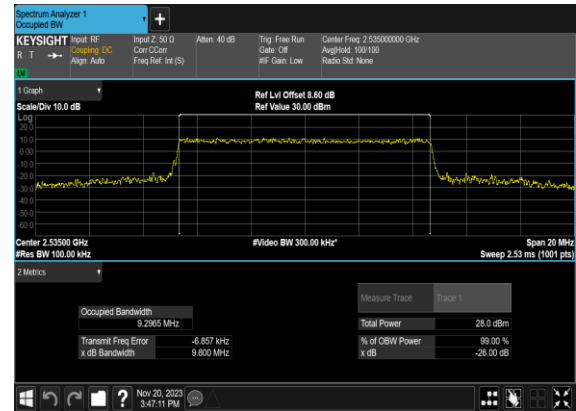

N7(10M)_CP-OFDM_64 QAM_Outer_Full_Mid_CH

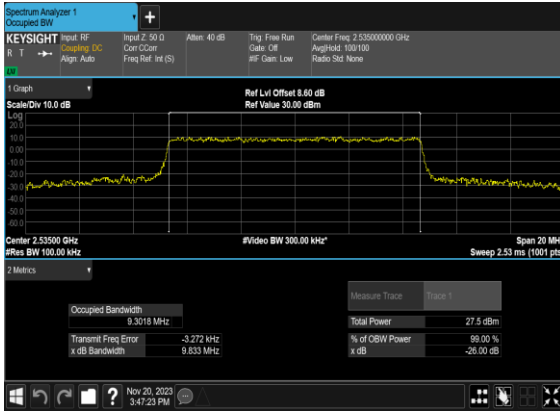

N7(10M)_CP-OFDM_256 QAM_Outer_Full_Mid_CH

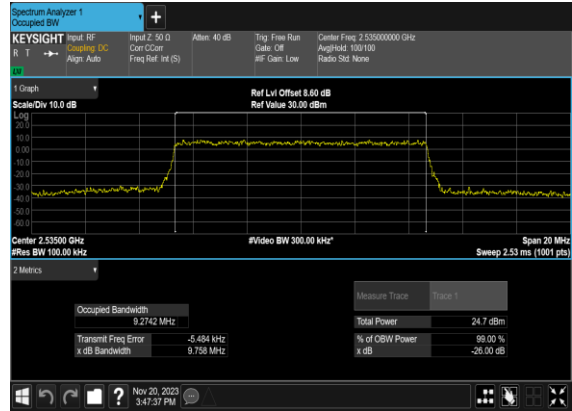

N7(15M)_CP- OFDM_QPSK_Outer_Full_Mid_CH



N7(15M)_CP-OFDM_16 QAM_Outer_Full_Mid_CH



N7(15M)_CP-OFDM_64 QAM_Outer_Full_Mid_CH

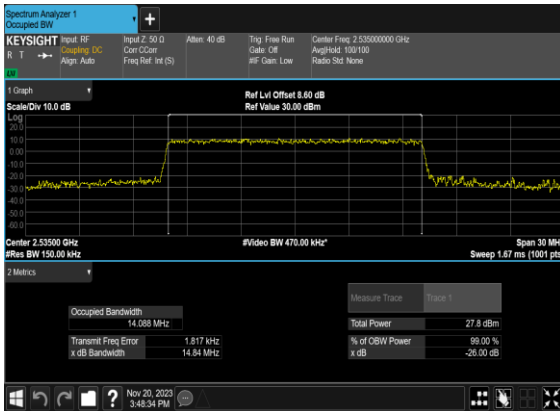

N7(15M)_CP-OFDM_256 QAM_Outer_Full_Mid_CH

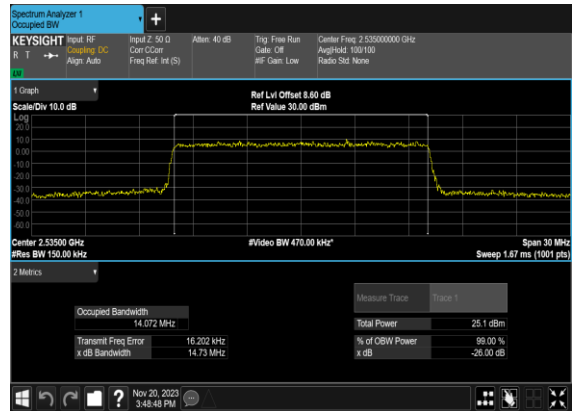

N7(20M)_CP-OFDM_QPSK_Outer_Full_Mid_CH

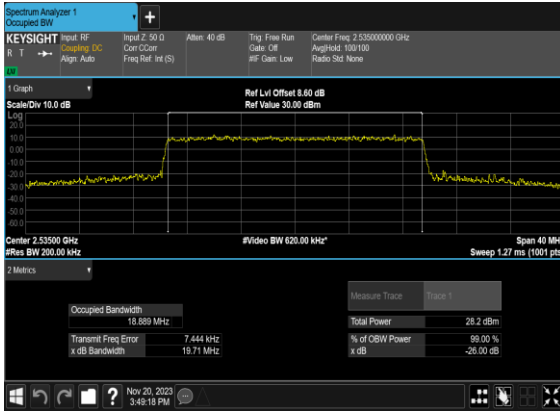

N7(20M)_CP-OFDM_16QAM_Outer_Full_Mid_CH

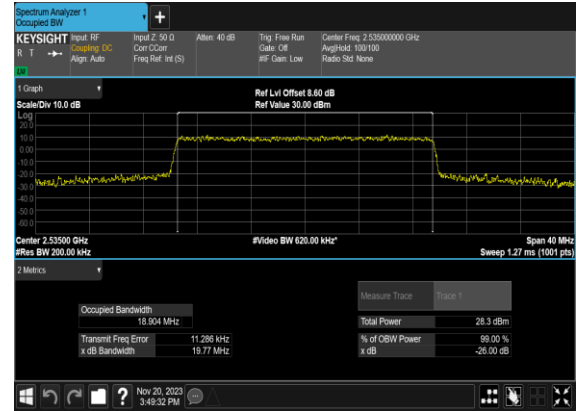

N7(20M)_CP-OFDM_64QAM_Outer_Full_Mid_CH

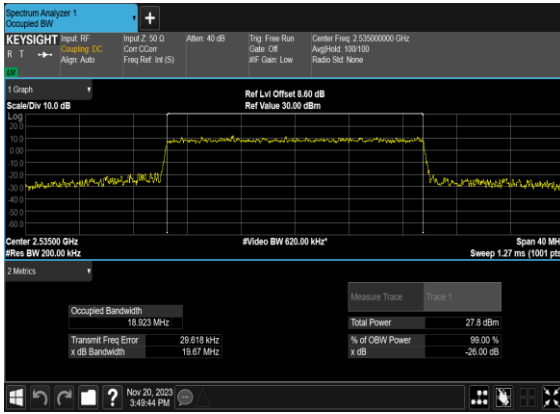

N7(20M)_CP-OFDM_256QAM_Outer_Full_Mid_CH



N7(25M)_CP-OFDM_QPSK_Outer_Full_Mid_CH

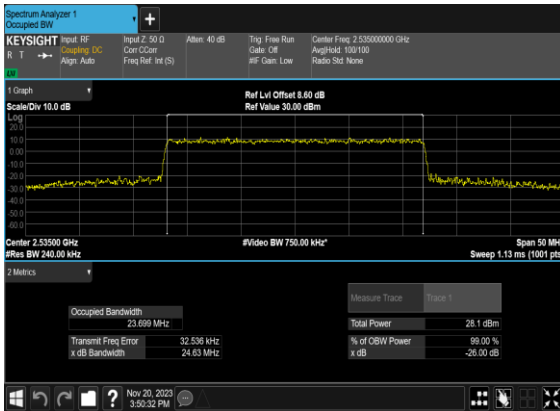

N7(25M)_CP-OFDM_16QAM_Outer_Full_Mid_CH

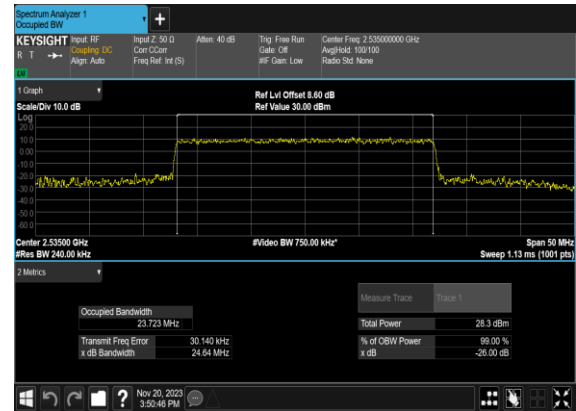

N7(25M)_CP-OFDM_64 QAM_Outer_Full_Mid_CH

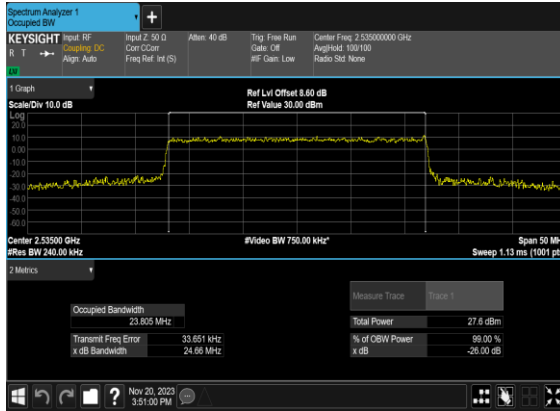

N7(25M)_CP-OFDM_256 QAM_Outer_Full_Mid_CH

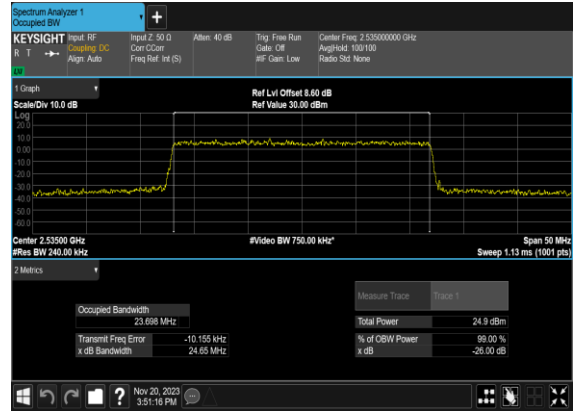

N7(30M)_CP- OFDM_QPSK_Outer_Full_Mid_CH

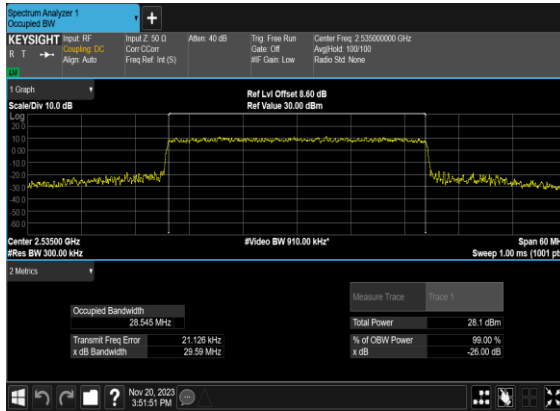

N7(30M)_CP-OFDM_16 QAM_Outer_Full_Mid_CH

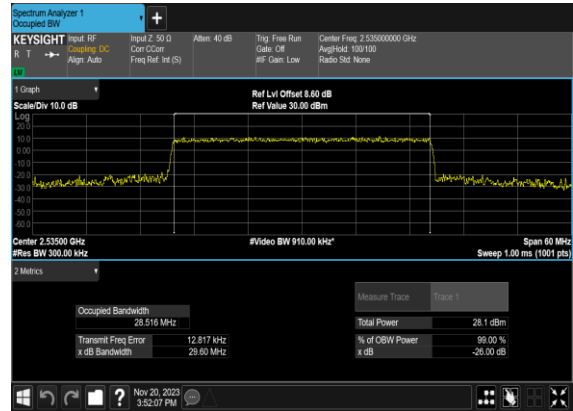

N7(30M)_CP-OFDM_64 QAM_Outer_Full_Mid_CH

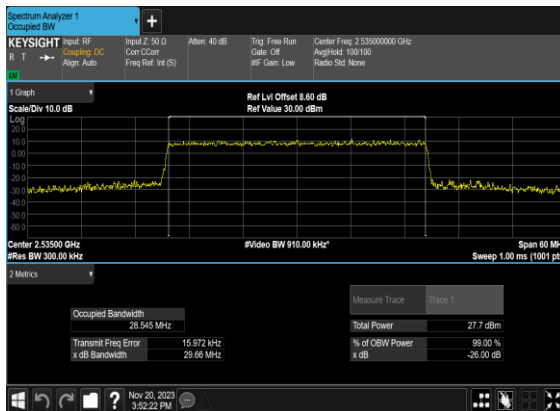

N7(30M)_CP-OFDM_256 QAM_Outer_Full_Mid_CH

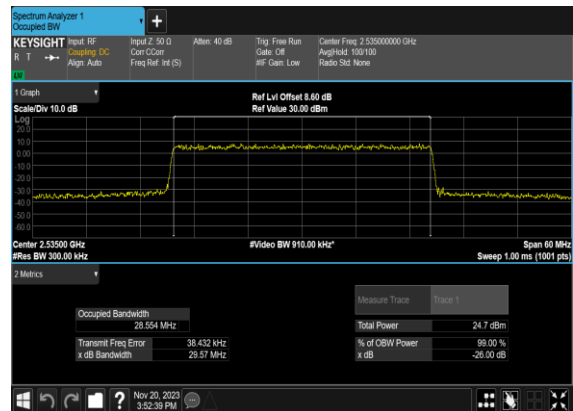

N7(40M)_CP-OFDM_QPSK_Outer_Full_Mid_CH

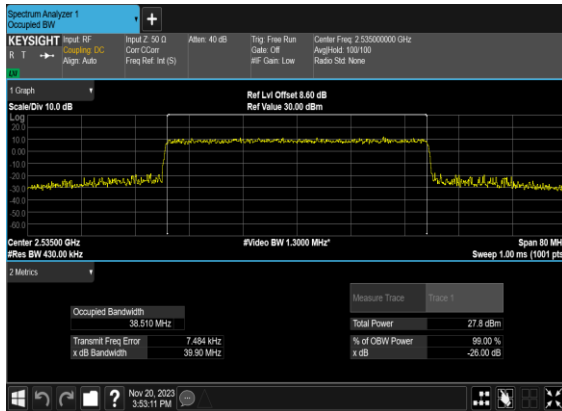

N7(40M)_CP-OFDM_16QAM_Outer_Full_Mid_CH

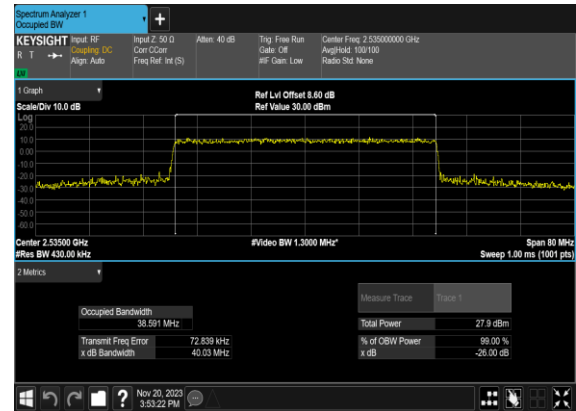

N7(40M)_CP-OFDM_64QAM_Outer_Full_Mid_CH

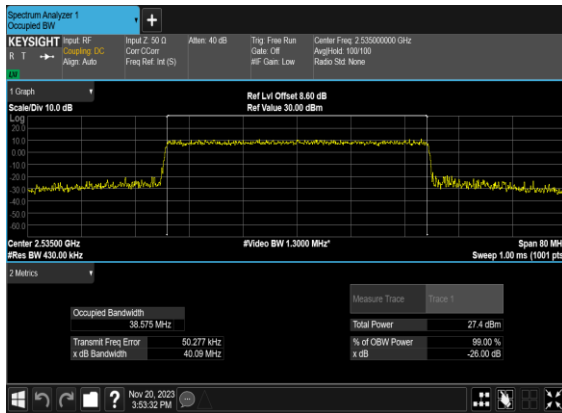

N7(40M)_CP-OFDM_256QAM_Outer_Full_Mid_CH

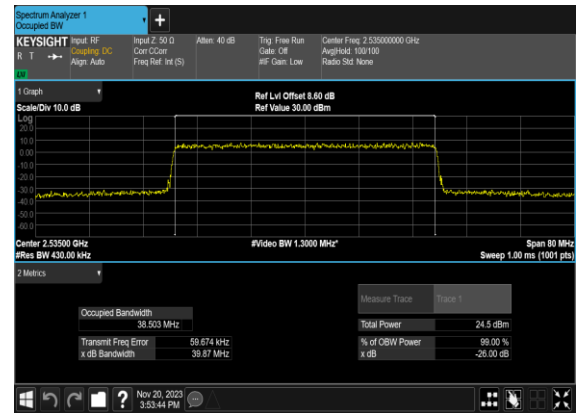

Conducted Spurious Emissions

NR Band	SCS (kHz)	Bandwidth (MHz)	Arfcn	Freq (MHz)	Modulation	RB	Result	Verdict
7	15	5	500500	2502.5	DFT-s-OFDM QPSK	1@0	see graph	---
7	15	5	500500	2502.5	DFT-s-OFDM QPSK	1@0	see graph	PASS
7	15	5	500500	2502.5	DFT-s-OFDM QPSK	1@0	see graph	PASS
7	15	5	507000	2535.0	DFT-s-OFDM QPSK	1@0	see graph	---
7	15	5	507000	2535.0	DFT-s-OFDM QPSK	1@0	see graph	PASS
7	15	5	507000	2535.0	DFT-s-OFDM QPSK	1@0	see graph	PASS
7	15	5	513500	2567.5	DFT-s-OFDM QPSK	1@0	see graph	---
7	15	5	513500	2567.5	DFT-s-OFDM QPSK	1@0	see graph	PASS
7	15	5	513500	2567.5	DFT-s-OFDM QPSK	1@0	see graph	PASS
7	15	20	502000	2510.0	DFT-s-OFDM QPSK	1@0	see graph	---
7	15	20	502000	2510.0	DFT-s-OFDM QPSK	1@0	see graph	PASS
7	15	20	502000	2510.0	DFT-s-OFDM QPSK	1@0	see graph	PASS
7	15	20	507000	2535.0	DFT-s-OFDM QPSK	1@0	see graph	---
7	15	20	507000	2535.0	DFT-s-OFDM QPSK	1@0	see graph	PASS
7	15	20	507000	2535.0	DFT-s-OFDM QPSK	1@0	see graph	PASS
7	15	20	512000	2560.0	DFT-s-OFDM QPSK	1@0	see graph	---
7	15	20	512000	2560.0	DFT-s-OFDM QPSK	1@0	see graph	PASS
7	15	20	512000	2560.0	DFT-s-OFDM QPSK	1@0	see graph	PASS
7	15	40	504000	2520.0	DFT-s-OFDM QPSK	1@0	see graph	---
7	15	40	504000	2520.0	DFT-s-OFDM QPSK	1@0	see graph	PASS
7	15	40	504000	2520.0	DFT-s-OFDM QPSK	1@0	see graph	PASS
7	15	40	507000	2535.0	DFT-s-OFDM QPSK	1@0	see graph	---
7	15	40	507000	2535.0	DFT-s-OFDM QPSK	1@0	see graph	PASS
7	15	40	507000	2535.0	DFT-s-OFDM QPSK	1@0	see graph	PASS
7	15	40	510000	2550.0	DFT-s-OFDM QPSK	1@0	see graph	---
7	15	40	510000	2550.0	DFT-s-OFDM QPSK	1@0	see graph	PASS
7	15	40	510000	2550.0	DFT-s-OFDM QPSK	1@0	see graph	PASS

N7(5M)_DFT-s-OFDM_QPSK_Edge_1RB_Left_Low_CH

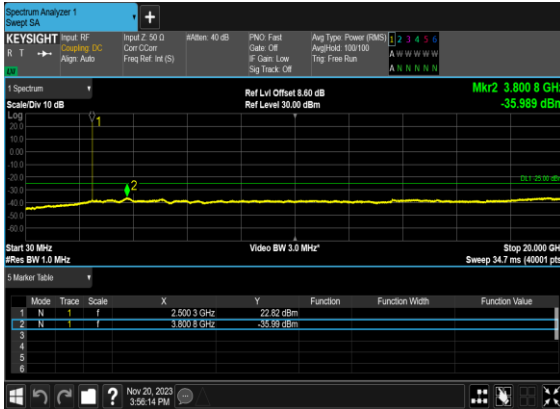

N7(5M)_DFT-s-OFDM_QPSK_Edge_1RB_Left_Low_CH

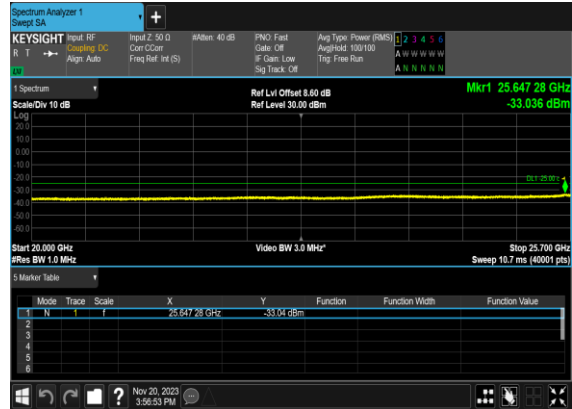

N7(5M)_DFT-s-OFDM_QPSK_Edge_1RB_Left_Mid_CH

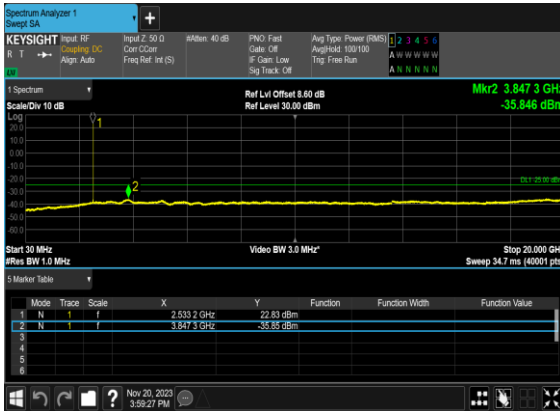

N7(5M)_DFT-s-OFDM_QPSK_Edge_1RB_Left_Mid_CH

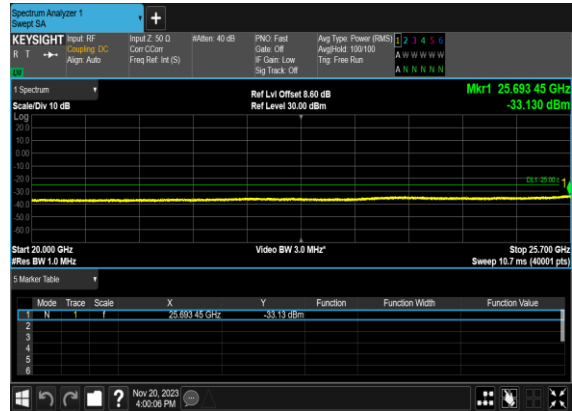

N7(5M)_DFT-s-OFDM_QPSK_Edge_1RB_Left_High_CH

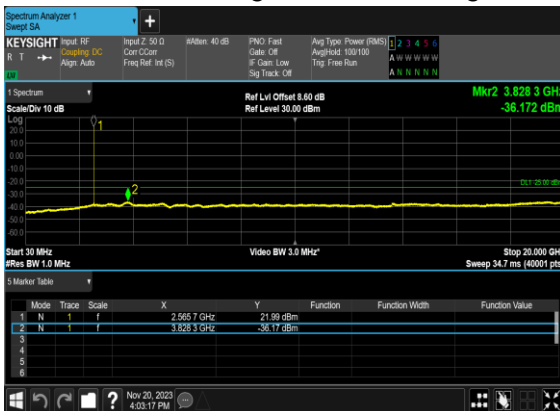

N7(5M)_DFT-s-OFDM_QPSK_Edge_1RB_Left_High_CH

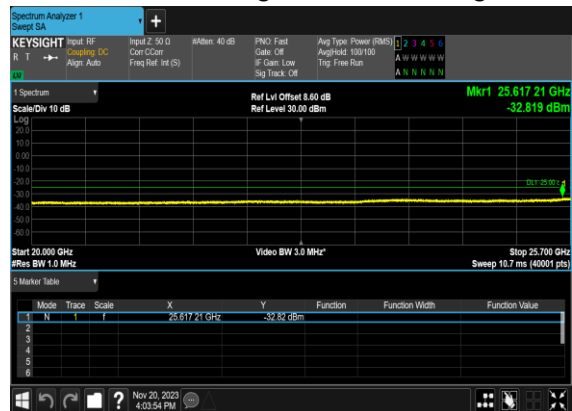

N7(20M)_DFT-s-OFDM_QPSK_Edge_1RB_Left_Low_CH

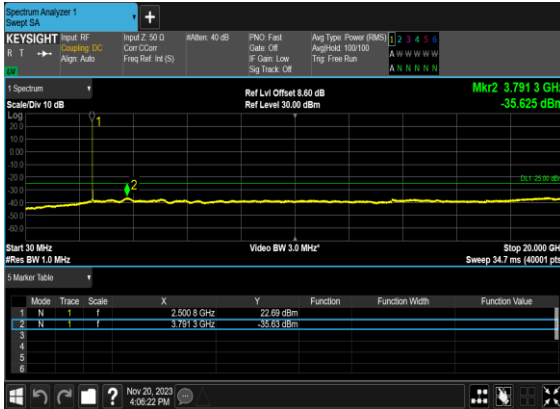

N7(20M)_DFT-s-OFDM_QPSK_Edge_1RB_Left_Low_CH

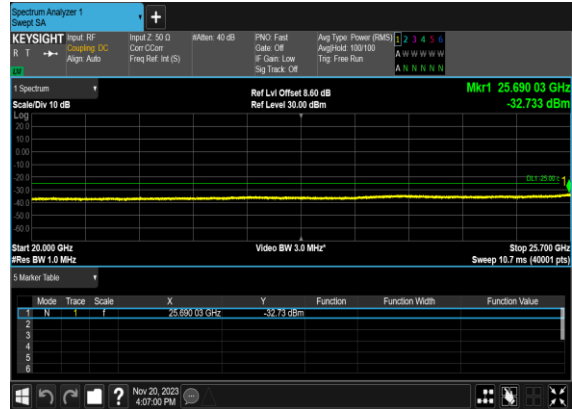

N7(20M)_DFT-s-OFDM_QPSK_Edge_1RB_Left_Mid_CH

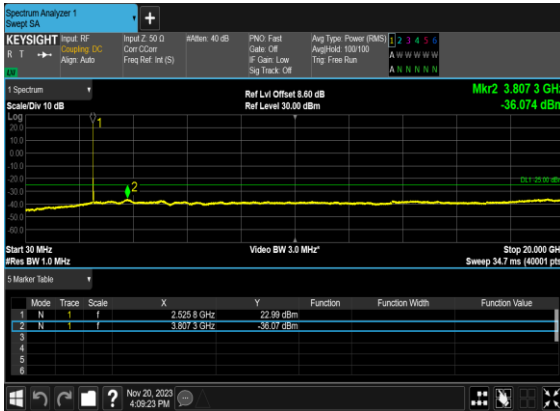

N7(20M)_DFT-s-OFDM_QPSK_Edge_1RB_Left_Mid_CH

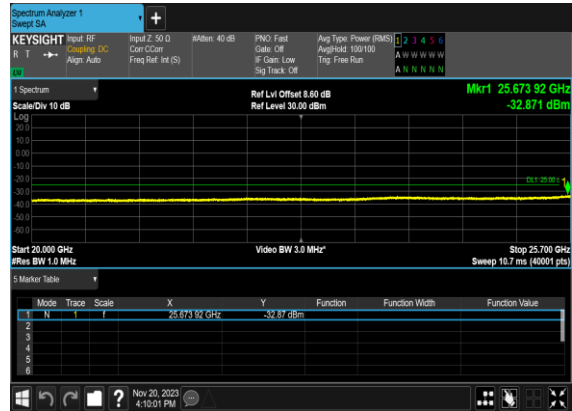

N7(20M)_DFT-s-OFDM_QPSK_Edge_1RB_Left_High_CH

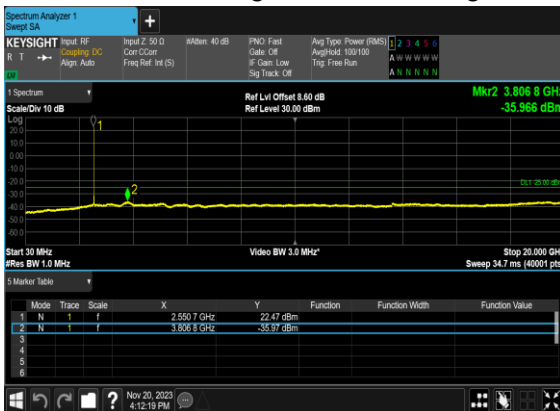

N7(20M)_DFT-s-OFDM_QPSK_Edge_1RB_Left_High_CH

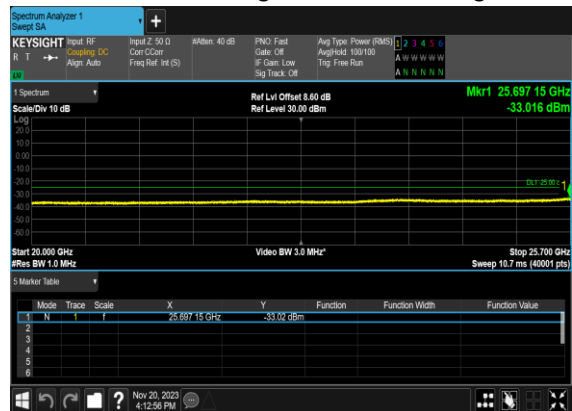

N7(40M)_DFT-s-OFDM_QPSK_Edge_1RB_Left_Low_CH

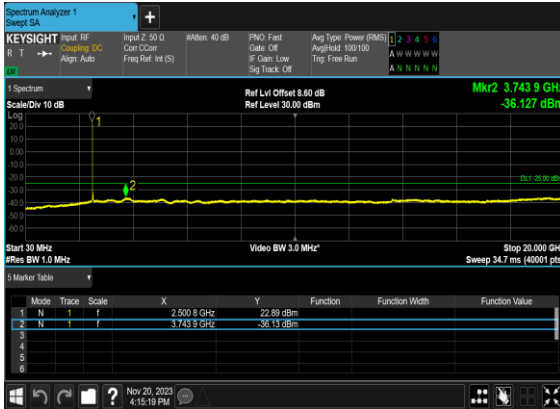

N7(40M)_DFT-s-OFDM_QPSK_Edge_1RB_Left_Low_CH

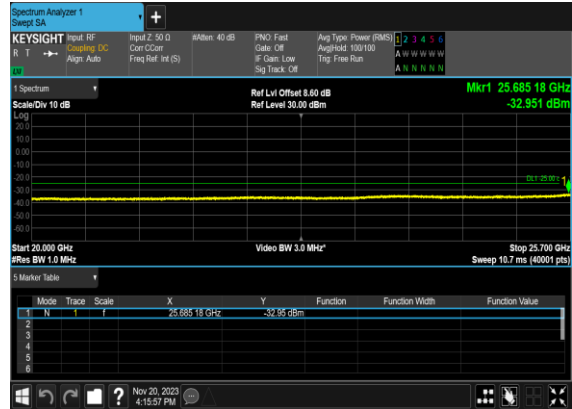

N7(40M)_DFT-s-OFDM_QPSK_Edge_1RB_Left_Mid_CH

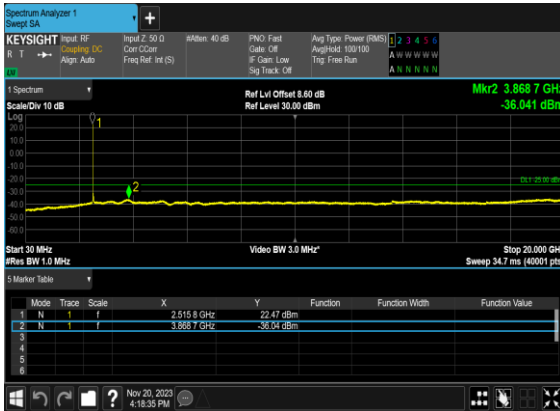

N7(40M)_DFT-s-OFDM_QPSK_Edge_1RB_Left_Mid_CH

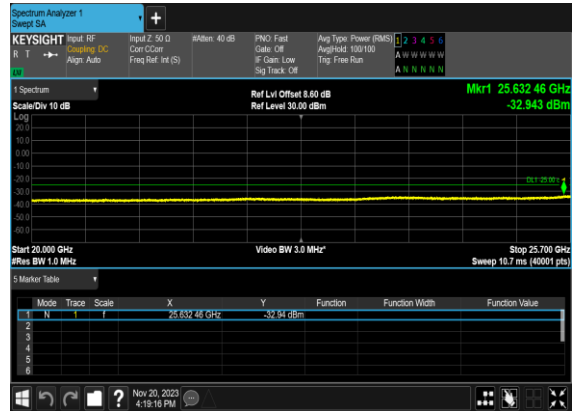

N7(40M)_DFT-s-OFDM_QPSK_Edge_1RB_Left_High_CH

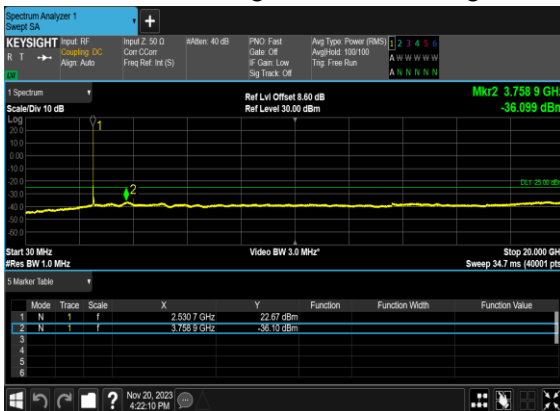

N7(40M)_DFT-s-OFDM_QPSK_Edge_1RB_Left_High_CH

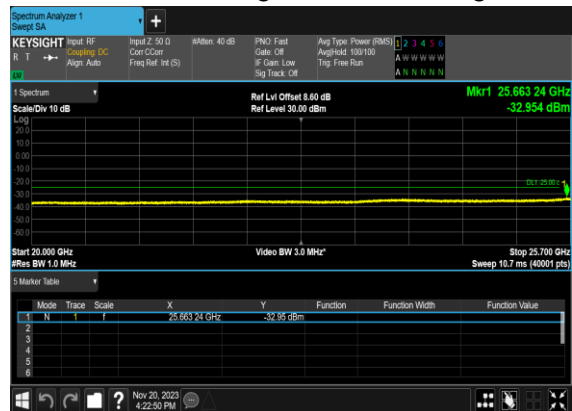

Conducted Band Edge

NR Band	SCS (kHz)	Bandwidth (MHz)	Arfcn	Freq (MHz)	Modulation	RB	Result	Verdict
7	15	5	500500	2502.5	DFT-s-OFDM QPSK	1@0	see graph	PASS
7	15	5	500500	2502.5	DFT-s-OFDM QPSK	25@0	see graph	PASS
7	15	5	513500	2567.5	DFT-s-OFDM QPSK	1@24	see graph	PASS
7	15	5	513500	2567.5	DFT-s-OFDM QPSK	25@0	see graph	PASS
7	15	20	502000	2510.0	DFT-s-OFDM QPSK	1@0	see graph	PASS
7	15	20	502000	2510.0	DFT-s-OFDM QPSK	100@0	see graph	PASS
7	15	20	512000	2560.0	DFT-s-OFDM QPSK	1@105	see graph	PASS
7	15	20	512000	2560.0	DFT-s-OFDM QPSK	100@0	see graph	PASS
7	15	40	504000	2520.0	DFT-s-OFDM QPSK	1@0	see graph	PASS
7	15	40	504000	2520.0	DFT-s-OFDM QPSK	216@0	see graph	PASS
7	15	40	510000	2550.0	DFT-s-OFDM QPSK	1@215	see graph	PASS
7	15	40	510000	2550.0	DFT-s-OFDM QPSK	216@0	see graph	PASS

N7(5M)_DFT-s-OFDM_QPSK_Edge_1RB_Left_Low_CH

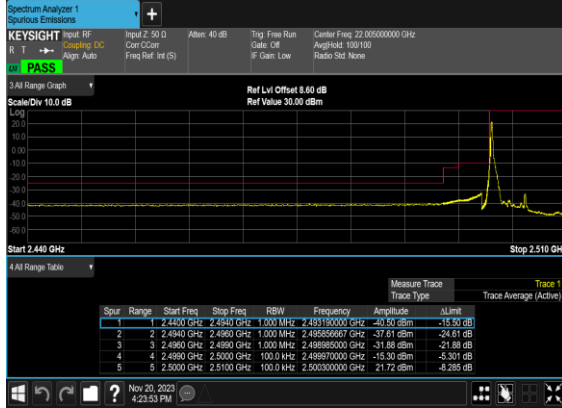

N7(5M)_DFT-s-OFDM_QPSK_Outer_Full_Low_CH

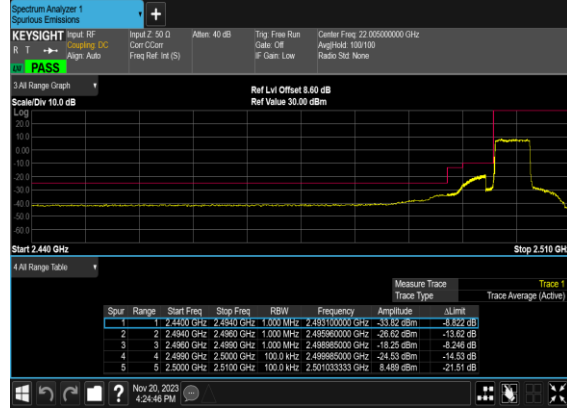

N7(5M)_DFT-s-OFDM_QPSK_Edge_1RB_Right_High_CH

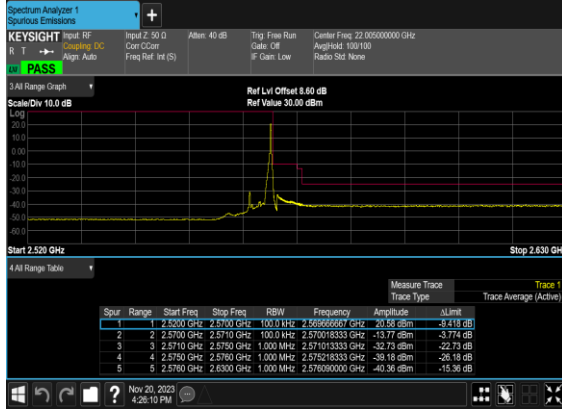

N7(5M)_DFT-s-OFDM_QPSK_Outer_Full_High_CH

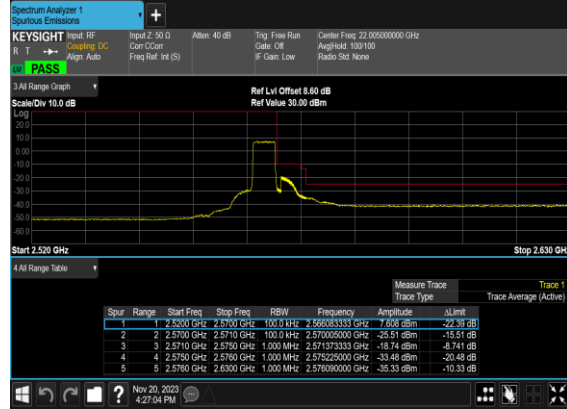

N7(20M)_DFT-s-OFDM_QPSK_Edge_1RB_Left_Low_CH

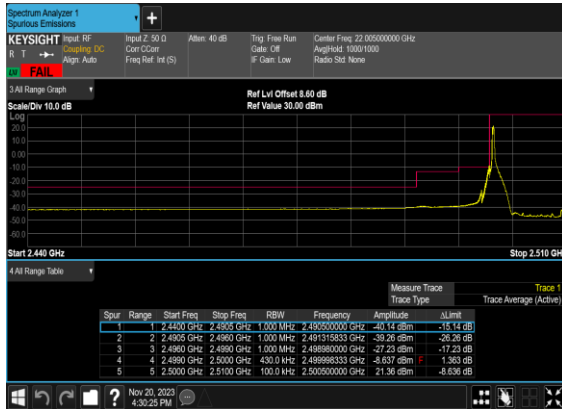

N7(20M)_DFT-s-OFDM_QPSK_Edge_1RB_Left_Low_CH_CHP_PASS

