

FCC Certification Test Report

Report No.: FD140925C24B

Test Model: OPPO N5206

FCC ID: R9C-N5206

Received Date: Oct. 28, 2014

Test Date: Nov. 10, 2014 ~ Nov. 12, 2014

Issued Date: Nov. 14, 2014

Applicant: GUANGDONG OPPO MOBILE TELECOMMUNICATIONS CORP.,LTD

Address: NO.18 HAIBIN ROAD, WUSHA, CHANG'AN, DONGGUAN, GUANGDONG, CHINA

Issued By: Bureau Veritas Consumer Products Services (H.K.) Ltd., Taoyuan Branch

Lab Address: No. 19, Hwa Ya 2nd Rd, Wen Hwa Tsuen, Kwei Shan Hsiang, Taoyuan Hsien 333, Taiwan, R.O.C.



This report is for your exclusive use. Any copying or replication of this report to or for any other person or entity, or use of our name or trademark, is permitted only with our prior written permission. This report sets forth our findings solely with respect to the test samples identified herein. The results set forth in this report are not indicative or representative of the quality or characteristics of the lot from which a test sample was taken or any similar or identical product unless specifically and expressly noted. Our report includes all of the tests requested by you and the results thereof based upon the information that you provided to us. You have 60 days from date of issuance of this report to notify us of any material error or omission caused by our negligence, provided, however, that such notice shall be in writing and shall specifically address the issue you wish to raise. A failure to raise such issue within the prescribed time shall constitute your unqualified acceptance of the completeness of this report, the tests conducted and the correctness of the report contents. Unless specific mention, the uncertainty of measurement has been explicitly taken into account to declare the compliance or non-compliance to the specification. The report must not be used by the client to claim product certification, approval, or endorsement by NVLAP, NIST, or any agency of the federal government. The report must not be used by the client to claim product certification, approval, or endorsement by TAF or any government agencies.

Table of Contents

Release Control Record	3
1 Certificate of Conformity	4
2 Summary of Test Results	5
2.1 Measurement Uncertainty	5
2.2 Modification Record	5
3 General Information	6
3.1 Features of EUT	6
3.2 General Description of EUT	6
3.3 Operating Modes of EUT and Determination of Worst Case Operating Mode	7
3.4 Test Program Used and Operation Descriptions	7
3.5 Primary Clock Frequencies of Internal Source	7
3.6 Miscellaneous	8
4 Configuration and Connections with EUT	9
4.1 Connection Diagram of EUT and Peripheral Devices	9
4.2 Configuration of Peripheral Devices and Cable Connections	9
5 Conducted Emissions at Mains Ports	10
5.1 Limits	10
5.2 Test Instruments	10
5.3 Test Arrangement	11
5.4 Test Results	12
6 Radiated Emissions up to 1 GHz	14
6.1 Limits	14
6.2 Test Instruments	15
6.3 Test Arrangement	16
6.4 Test Results	17
7 Radiated Emissions above 1 GHz	19
7.1 Limits	19
7.2 Test Instruments	20
7.3 Test Arrangement	21
7.4 Test Results	22
8 Pictures of Test Arrangements	26
8.1 Conducted Emissions at Mains Ports	26
8.2 Radiated Emissions up to 1 GHz	27
8.3 Radiated Emissions above 1 GHz	28
Appendix – Information on the Testing Laboratories	29



A D T

Release Control Record

Issue No.	Description	Date Issued
FD140925C24B	Original Release	Nov. 14, 2014

1 Certificate of Conformity

Product: Mobile Phone

Brand: OPPO

Test Model: OPPO N5206

Sample Status: Identical Prototype

Applicant: GUANGDONG OPPO MOBILE TELECOMMUNICATIONS CORP.,LTD

Test Date: Nov. 10, 2014 ~ Nov. 12, 2014

Standards: 47 CFR FCC Part 15, Subpart B, Class B
ICES-003:2012 Issue 5, Class B
ANSI C63.4:2009

The above equipment has been tested by **Bureau Veritas Consumer Products Services (H.K.) Ltd., Taoyuan Branch**, and found compliance with the requirement of the above standards. The test record, data evaluation & Equipment Under Test (EUT) configurations represented herein are true and accurate accounts of the measurements of the sample's EMC characteristics under the conditions specified in this report.

Prepared by : Ivonne Wu , **Date:** Nov. 14, 2014
Ivonne Wu / Supervisor

Approved by : Carl Chen , **Date:** Nov. 14, 2014
Carl Chen / Project Engineer

2 Summary of Test Results

47 CFR FCC Part 15, Subpart B / ICES-003:2012 Issue 5, Class B

ANSI C63.4:2009

FCC Clause	ICES-003 Clause	Test Item	Result/Remarks	Verdict
15.107	6.1	AC Power Line Conducted Emissions	Minimum passing Class B margin is -6.85 dB at 0.15000 MHz	Pass
15.109	6.2.1	Radiated Emissions up to 1 GHz	Minimum passing Class B margin is -3.16 dB at 193.45 MHz	Pass
	6.2.2	Radiated Emissions above 1 GHz	Minimum passing Class B margin is -19.37 dB at 4843.85 MHz	Pass

Note: There is no deviation to the applied test methods and requirements covered by the scope of this report.

2.1 Measurement Uncertainty

Where relevant, the following measurement uncertainty levels have been estimated for tests performed on the EUT:

The listed uncertainties are the worst case uncertainty for the entire range of measurement. Please note that the uncertainty values are provided for informational purposes only and are not used in determining the PASS/FAIL results.

Measurement	Frequency	Expanded Uncertainty (k=2) (\pm)
Conducted Emissions at mains ports	150kHz ~ 30MHz	2.44 dB
Radiated Emissions up to 1 GHz	30MHz ~ 1GHz	4.70 dB
Radiated Emissions above 1 GHz	Above 1GHz	2.26 dB

2.2 Modification Record

There were no modifications required for compliance.

3 General Information

3.1 Features of EUT

The tests reported herein were performed according to the method specified by GUANGDONG OPPO MOBILE TELECOMMUNICATIONS CORP.,LTD, for detailed feature description, please refer to the manufacturer's specifications or user's manual.

3.2 General Description of EUT

Product	Mobile Phone
Brand	OPPO
Test Model	OPPO N5206
Status of EUT	Identical Prototype
Operating Software	Android 4.3
Power Supply Rating	3.8Vdc (Battery) 5Vdc (Adapter or host equipment)
Accessory Device	Refer to Note as below
Data Cable Supplied	1m shielded cable w/o core

Note:

1. The EUT contains following accessory devices.

Product	Brand	Model	Description
Adapter	Salcomp	AK955	I/P: 100-240Vac, 50/60Hz, 700mA O/P: 5Vdc, 5000mA
Battery	OPPO	BLP581	3.8Vdc, 3000mAh
Earphone	OPPO	MH124	1.1m non-shielded cable
USB Cable	LUXSHARE-ICT	RDN1403282	1m shielded cable w/o core
LCD Panel	JDI	LPM055A081A TENTATIVE	--
Photo Camera	SUNNY	P16V01C	--

3.3 Operating Modes of EUT and Determination of Worst Case Operating Mode

Test modes are presented in the report as below.

Mode	Test Condition
1	GSM 850 Idle + BT Idle + WLAN (2.4G) Idle + NFC On + GPS Rx & GLONASS + USB Cable + Earphone + Adapter + SIM 1
2	WCDMA 1900 Idle + BT Idle + WLAN (5G) Idle + NFC On + Camera + USB Cable + Earphone + Adapter + SIM 1
3	LTE Band 4 Idle + BT Idle + WLAN (2.4G) Idle + NFC On + MPEG4 + USB Cable + Earphone + USB Link + SIM 1
4	GSM 850 Idle + BT Idle + WLAN (5G) Idle + NFC On + Camera + USB Cable + Earphone + Adapter + SIM 2

Remark:

1. For conducted emission test, test mode 2 was the worst case and only this mode was presented in the report.
2. For radiated emission test, test mode 2 was the worst case and only this mode was presented in the report.

3.4 Test Program Used and Operation Descriptions

- a. The EUT linked with Bluetooth earphone in idle mode.
- b. The NFC function was turned on.
- c. The EUT played camera and sent audio signal to the earphone.
- d. The EUT communicated data with the Universal Radio Communication Tester and Wireless AP, which acted as communication partners.
- e. Set WWAN/WLAN function in idle mode.

3.5 Primary Clock Frequencies of Internal Source

The highest frequency generated or used within the EUT or on which the EUT operates or tunes is 5000 MHz, provided by GUANGDONG OPPO MOBILE TELECOMMUNICATIONS CORP.,LTD, for detailed internal source, please refer to the manufacturer's specifications.

3.6 Miscellaneous

Labelling Requirements for Part 15 Devices:

➤ Verification

The specific labelling requirements for a device subject to the Verification procedure are contained in Section 15.19(a). These labelling requirements are:

If the device is subject only to Verification, include a label bearing a unique identifier (Section 2.954) and one of three compliance statements specified in Section 15.19(a). If the labeling area for the device is so small, and/or it is not practical to place the compliance statement on the device, then the statement can be placed in the user manual or product packaging (Section 15.19(a)(5)). However, the device must still be labelled with the unique identifier (Verification). Generally, devices smaller than the palm of the hand are considered too small for the compliance statement.

➤ Certification

If the device is subject to Certification: (1) Section 2.925 contains information on identification of the equipment; (2) include a label bearing an FCC Identifier (FCC ID) (Section 2.926) and (3) include the appropriate compliance statement in Section 15.19(a). If the device is considered too small and therefore it is impractical (smaller than the palm of the hand) to display the compliance statement, then the statement may be placed in the user manual or product packaging. However, the device must still be labelled with the FCC ID. If the device is unquestionably too small for the FCC ID to be readable (smaller than 4-6 points), the FCC ID may be placed in the user manual. However, it must be determined that the device itself is too small – the label area allocated to the FCC ID may not be reduced because of over crowded identification of other product and regulatory information.

An electronic display of the FCC ID (see 9. Electronic Labelling below) may be used for Certification of Section 15.212 modular transmitters and software defined radios (Section 2.944).

➤ Declaration of Conformity (DoC):

The labelling requirements for a device subject to the DoC procedure are specified in Section 15.19(b). The label should include the FCC logo along with the Trade Name and Model Number, which satisfies the unique identifier requirement of Section 2.1074 if it represents the identical equipment tested for DoC compliance. For personal computers assembled from authorized components, the following additional text must also be included: “Assembled from tested components,” “Complete system not tested.” When the device is so small and/or when it is not practical to place the required additional text on the device, the text may be placed in the user manual or pamphlet supplied to the user. However, the FCC logo, Trade Name, and Model Number must still be displayed on the device (Section 15.19(b)(3)).



Part 15 Declaration of Conformity (DoC) Label Examples

Equipment certified as software defined radio may use a means that readily displays the FCC ID on an electronic display screen, instead of labelling the device (Section 2.925 (e)).

Further information may refer to FCC KDB:784748 D01 Labelling Part 15 &18 Guidelines

Labelling Requirements for ICES-003 Devices:

➤ Industry Canada ICES-003 Compliance Label:

CAN ICES-3 ()/NMB-3(*)*

* Insert either “A” or “B” but not both to identify the applicable Class of ITE.

4 Configuration and Connections with EUT

4.1 Connection Diagram of EUT and Peripheral Devices

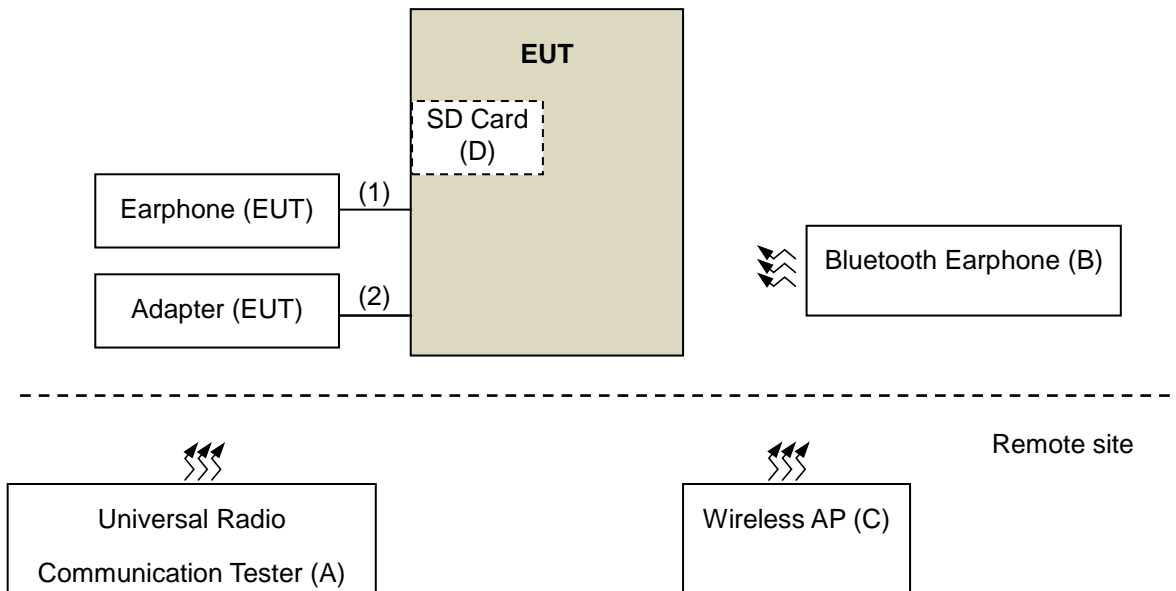

4.2 Configuration of Peripheral Devices and Cable Connections

ID	Product	Brand	Model No.	Serial No.	FCC ID	Remarks
A.	Universal Radio Communication Tester	R&S	CMU200	122554	N/A	--
B.	BLUETOOTH EARPHONE	ELECOM	LBT-MPHS400	N/A	N/A	--
C.	Wireless N Dual band Router	D-LINK	DIR-815	PVK21B5000399	KA21R815A1	--
D.	SD Card	Transcend	N/A	N/A	N/A	--

Note:

1. All power cords of the above support units are non-shielded (1.8m).
2. Items E-F acted as communication partners to transfer data.

ID	Descriptions	Qty.	Length (m)	Shielding (Yes/No)	Cores (Qty.)	Remarks
1.	Earphone Cable	1	1.1	N	0	Accessory of the EUT
2.	USB Cable	1	1	Y	0	Accessory of the EUT

Note: The core(s) is(are) originally attached to the cable(s).

5 Conducted Emissions at Mains Ports

5.1 Limits

Frequency (MHz)	Class A (dBuV)		Class B (dBuV)	
	Quasi-peak	Average	Quasi-peak	Average
0.15 - 0.5	79	66	66 - 56	56 - 46
0.50 - 5.0	73	60	56	46
5.0 - 30.0	73	60	60	50

Notes: 1. The lower limit shall apply at the transition frequencies.
 2. The limit decreases linearly with the logarithm of the frequency in the range of 0.15 to 0.50 MHz.

5.2 Test Instruments

DESCRIPTION & MANUFACTURER	MODEL NO.	SERIAL NO.	DATE OF CALIBRATION	DUE DATE OF CALIBRATION
Test Receiver ROHDE & SCHWARZ	ESCI	100612	Sep. 30, 2014	Sep. 29, 2015
RF signal cable Woken	5D-FB	Cable-HYC01-01	Dec. 27, 2013	Dec. 26, 2014
LISN ROHDE & SCHWARZ (EUT)	ESH3-Z5	835239/001	Feb. 13, 2014	Feb. 12, 2015
LISN ROHDE & SCHWARZ (Peripheral)	ESH3-Z5	100311	Jul. 21, 2014	Jul. 20, 2015
Software ADT	BV ADT_Cond_ V7.3.7.3	NA	NA	NA

NOTE: 1. The calibration interval of the above test instruments is 12 months and the calibrations are traceable to NML/ROC and NIST/USA.
 2. The test was performed in HwaYa Shielded Room 1.
 3. The VCCI Site Registration No. is C-2040.

5.3 Test Arrangement

- a. The EUT was placed 0.4 meters from the conducting wall of the shielded room with EUT being connected to the power mains through a line impedance stabilization network (LISN). Other support units were connected to the power mains through another LISN. The two LISNs provide 50 Ohm/ 50uH of coupling impedance for the measuring instrument.
- b. Both lines of the power mains connected to the EUT were checked for maximum conducted interference.
- c. The test results of conducted emissions at mains ports are recorded of six worst margins for quasi-peak (mandatory) [and average (if necessary)] values against the limits at frequencies of interest unless the margin is 20 dB or greater.

Note: The resolution bandwidth and video bandwidth of test receiver is 9kHz for quasi-peak detection (QP) and average detection (AV) at frequency 0.15MHz-30MHz.

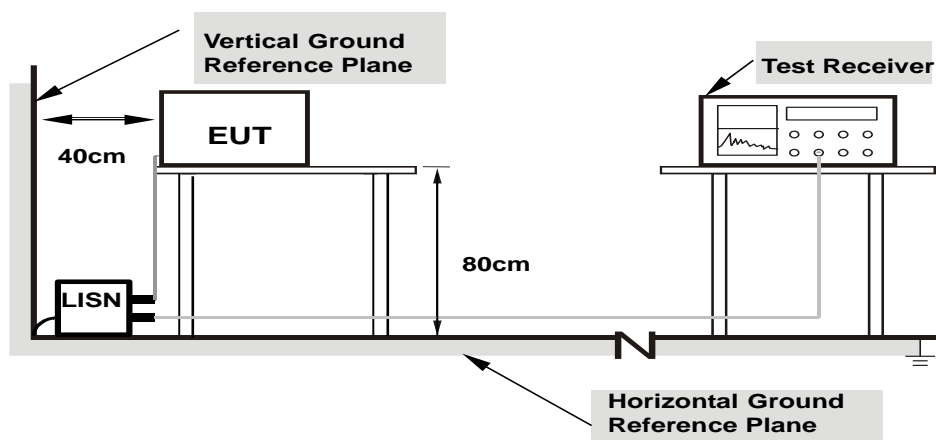

- Note:**
- 1. Support units were connected to second LISN.
 - 2. Both of LISNs (AMN) are 80 cm from EUT and at least 80 cm from other units and other metal planes

5.4 Test Results

Frequency Range	150kHz ~ 30MHz	Detector Function & Resolution Bandwidth	Quasi-Peak (QP) / Average (AV), 9kHz
Input Power	120Vac, 60Hz	Environmental Conditions	22°C, 61%RH
Tested by	Mick Chou	Test Date	2014/11/10
Test Mode	Mode 2		

Phase Of Power : Line (L)										
No	Frequency (MHz)	Correction Factor (dB)	Reading Value (dBuV)		Emission Level (dBuV)		Limit (dBuV)		Margin (dB)	
			Q.P.	AV.	Q.P.	AV.	Q.P.	AV.	Q.P.	AV.
1	0.15000	0.11	59.04	39.92	59.15	40.03	66.00	56.00	-6.85	-15.97
2	0.28685	0.10	48.36	36.94	48.46	37.04	60.62	50.62	-12.16	-13.58
3	0.42782	0.11	41.21	32.90	41.32	33.01	57.29	47.29	-15.97	-14.28
4	0.58010	0.14	40.41	28.94	40.55	29.08	56.00	46.00	-15.45	-16.92
5	0.97892	0.21	39.20	26.83	39.41	27.04	56.00	46.00	-16.59	-18.96
6	3.91142	0.26	32.92	22.62	33.18	22.88	56.00	46.00	-22.82	-23.12

Remarks:

1. Q.P. and AV. are abbreviations of quasi-peak and average individually.
2. The emission levels of other frequencies were very low against the limit.
3. Margin value = Emission level – Limit value
4. Correction factor = Insertion loss + Cable loss
5. Emission Level = Correction Factor + Reading Value

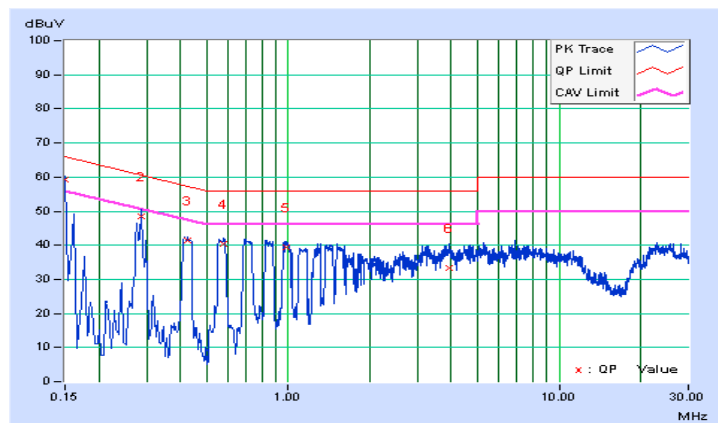

Frequency Range	150kHz ~ 30MHz	Detector Function & Resolution Bandwidth	Quasi-Peak (QP) / Average (AV), 9kHz
Input Power	120Vac, 60Hz	Environmental Conditions	22°C, 61%RH
Tested by	Mick Chou	Test Date	2014/11/10
Test Mode	Mode 2		

Phase Of Power : Neutral (N)										
No	Frequency (MHz)	Correction Factor (dB)	Reading Value (dBuV)		Emission Level (dBuV)		Limit (dBuV)		Margin (dB)	
			Q.P.	AV.	Q.P.	AV.	Q.P.	AV.	Q.P.	AV.
1	0.15000	0.05	56.93	37.43	56.98	37.48	66.00	56.00	-9.02	-18.52
2	0.27512	0.12	47.70	33.49	47.82	33.61	60.96	50.96	-13.14	-17.35
3	0.42334	0.17	40.00	31.56	40.17	31.73	57.38	47.38	-17.21	-15.65
4	0.58384	0.19	38.99	24.73	39.18	24.92	56.00	46.00	-16.82	-21.08
5	0.83325	0.21	39.63	27.32	39.84	27.53	56.00	46.00	-16.16	-18.47
6	4.29851	0.27	36.16	26.63	36.43	26.90	56.00	46.00	-19.57	-19.10

Remarks:

1. Q.P. and AV. are abbreviations of quasi-peak and average individually.
2. The emission levels of other frequencies were very low against the limit.
3. Margin value = Emission level – Limit value
4. Correction factor = Insertion loss + Cable loss
5. Emission Level = Correction Factor + Reading Value

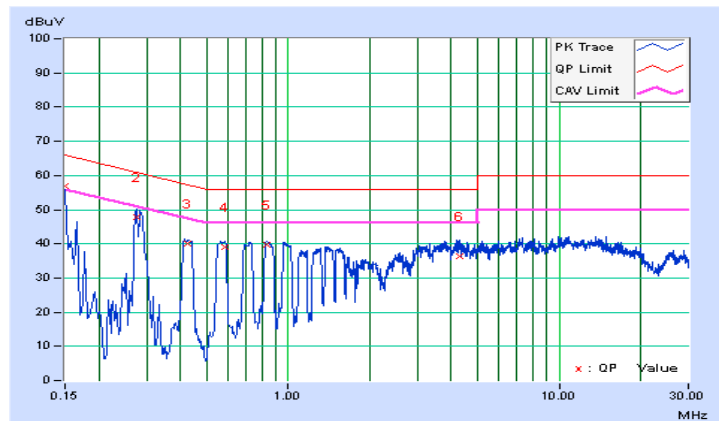

6 Radiated Emissions up to 1 GHz

6.1 Limits

Emissions radiated outside of the specified bands, shall be according to the general radiated limits as following:

Radiated Emissions Limits at 10 meters (dB μ V/m)				
Frequencies (MHz)	FCC 15B / ICES-003, Class A	FCC 15B / ICES-003, Class B	CISPR 22, Class A	CISPR 22, Class B
30-88	39	29.5	40	30
88-216	43.5	33.1		
216-230	46.4	35.6		
230-960				
960-1000	49.5	43.5	47	37

Radiated Emissions Limits at 3 meters (dB μ V/m)				
Frequencies (MHz)	FCC 15B / ICES-003, Class A	FCC 15B / ICES-003, Class B	CISPR 22, Class A	CISPR 22, Class B
30-88	49.5	40	50.5	40.5
88-216	54	43.5		
216-230	56.9	46		
230-960				
960-1000	60	54	57.5	47.5

- Notes:
1. The lower limit shall apply at the transition frequencies.
 2. Emission level (dB μ V/m) = 20 log Emission level (uV/m).
 3. QP detector shall be applied if not specified.



6.2 Test Instruments

DESCRIPTION & MANUFACTURER	MODEL NO.	SERIAL NO.	DATE OF CALIBRATION	DUE DATE OF CALIBRATION
Test Receiver ROHDE & SCHWARZ (V)	ESR-7	101240	Sep. 29, 2014	Sep. 28, 2015
Test Receiver ROHDE & SCHWARZ (H)	ESR-7	101264	Nov. 29, 2013	Nov. 28, 2014
BILOG Antenna SCHWARZBECK (V)	VULB9168	9168-148	Feb. 25, 2014	Feb. 24, 2015
BILOG Antenna SCHWARZBECK (H)	VULB9168	9168-149	Feb. 25, 2014	Feb. 24, 2015
Preamplifier Agilent (V)	8447D	2944A10636	Oct. 18, 2014	Oct. 17, 2015
Preamplifier Agilent (H)	8447D	2944A10637	Oct. 18, 2014	Oct. 17, 2015
Preamplifier Agilent	8449B	3008A01959	Oct. 18, 2014	Oct. 17, 2015
RF signal cable Woken (V)	8D-FB	Cable-CH(H)-01	Oct. 25, 2014	Oct. 24, 2015
RF signal cable Woken (H)	8D-FB	Cable-CH(V)-01	Oct. 25, 2014	Oct. 24, 2015
Software BV ADT	BV ADT_Radiated_ V 8.7.07	NA	NA	NA
Antenna Tower (V)	MFA-440	9707	NA	NA
Antenna Tower (H)	MFA-440	970705	NA	NA
Turn Table	DS430	50303	NA	NA
Controller (V)	MF7802	074	NA	NA
Controller (H)	MF7802	08093	NA	NA

NOTE: 1. The calibration interval of the above test instruments is 12 months and the calibrations are traceable to NML/ROC and NIST/USA.

2. The test was performed in HwaYa Chamber 1.
3. The FCC Site Registration No. is 477732.
4. The IC Site Registration No. is IC 7450F-1.
5. The VCCI Site Registration No. is R-1893, G-113.

6.3 Test Arrangement

- The EUT was placed on the top of a rotating table 0.8 meters above the ground at an accredited test facility. The table was rotated 360 degrees to determine the position of the highest radiation.
- The EUT was set 10 meters away from the interference-receiving antenna, which was mounted on the top of a variable-height antenna tower.
- The antenna is a broadband antenna, and its height is varied from one meter to four meters above the ground to determine the maximum value of the field strength. Both horizontal and vertical polarizations of the antenna are set to make the measurement.
- For each suspected emission, the EUT was arranged to its worst case and then the antenna was tuned to heights from 1 meter to 4 meters and the rotatable table was turned from 0 degrees to 360 degrees to find the maximum reading.
- The test-receiver system was set to quasi-peak detect function and specified bandwidth with maximum hold mode when the test frequency is below 1 GHz.

Note: The resolution bandwidth and video bandwidth of test receiver/spectrum analyzer is 120kHz for quasi-peak detection (QP) at frequency below 1GHz.

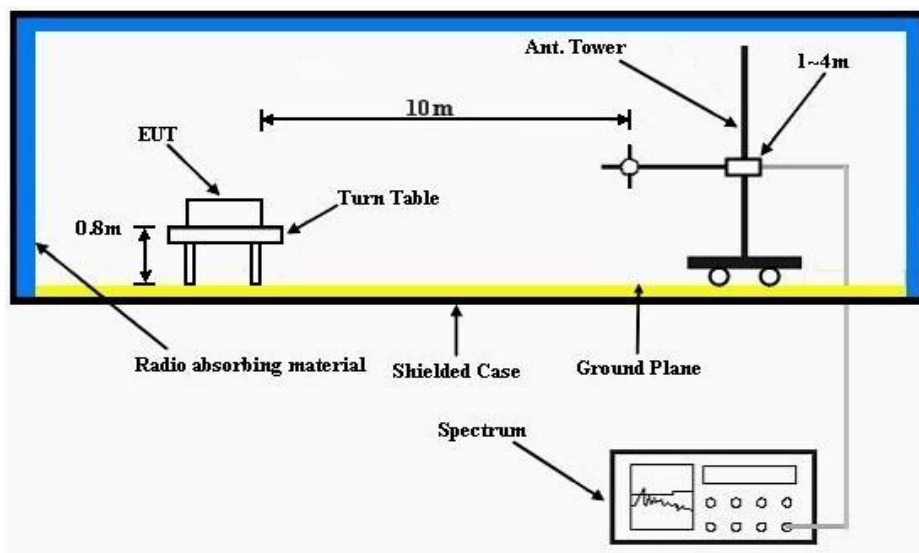

6.4 Test Results

Frequency Range	30MHz ~ 1GHz	Detector Function & Resolution Bandwidth	Quasi-Peak (QP), 120kHz
Input Power	120Vac, 60Hz	Environmental Conditions	24°C, 67%RH
Tested by	Scott Yang	Test Date	2014/11/11
Test Mode	Mode 2		

Antenna Polarity & Test Distance : Horizontal at 10 m								
No	Frequency (MHz)	Emission Level (dBuV/m)	Limit (dBuV/m)	Margin (dB)	Antenna Height (m)	Table Angle (Degree)	Raw Value (dBuV)	Correction Factor (dB/m)
1	42.27	17.13 QP	30.00	-12.87	2.00 H	323	31.81	-14.68
2	93.10	18.25 QP	30.00	-11.75	3.50 H	125	37.81	-19.56
3	159.31	21.79 QP	30.00	-8.21	4.00 H	291	35.43	-13.64
4	189.43	22.75 QP	30.00	-7.25	3.50 H	332	38.69	-15.94
5	205.92	20.31 QP	30.00	-9.69	4.00 H	325	36.65	-16.34
6	288.86	19.75 QP	37.00	-17.25	3.00 H	101	31.81	-12.06

Remarks:

1. Emission Level(dBuV/m) = Raw Value(dBuV) + Correction Factor(dB/m)
2. Correction Factor(dB/m) = Antenna Factor (dB/m) + Cable Factor (dB) – Pre-Amplifier Factor (dB)
3. The other emission levels were very low against the limit.
4. Margin value = Emission level – Limit value

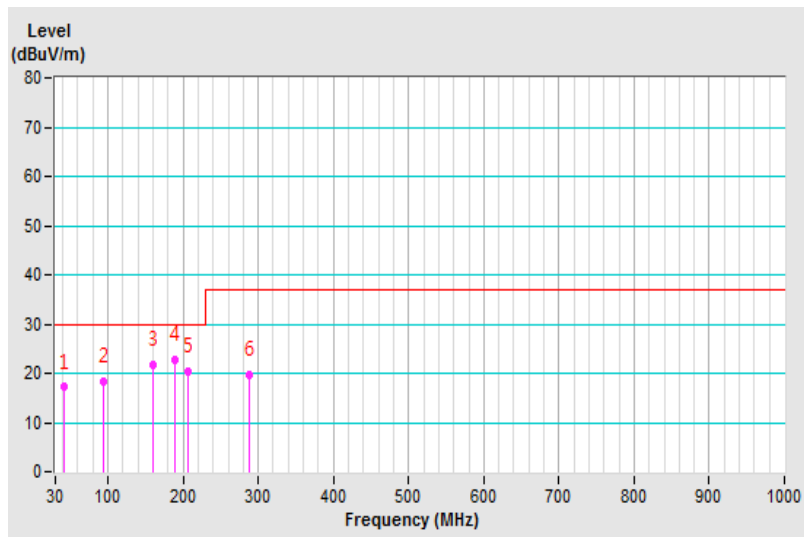

Frequency Range	30MHz ~ 1GHz	Detector Function & Resolution Bandwidth	Quasi-Peak (QP), 120kHz
Input Power	120Vac, 60Hz	Environmental Conditions	24°C, 67%RH
Tested by	Scott Yang	Test Date	2014/11/11
Test Mode	Mode 2		

Antenna Polarity & Test Distance : Vertical at 10 m								
No	Frequency (MHz)	Emission Level (dBuV/m)	Limit (dBuV/m)	Margin (dB)	Antenna Height (m)	Table Angle (Degree)	Raw Value (dBuV)	Correction Factor (dB/m)
1	43.10	21.57 QP	30.00	-8.43	3.00 V	355	35.86	-14.29
2	65.02	26.58 QP	30.00	-3.42	2.50 V	97	41.65	-15.07
3	163.82	22.39 QP	30.00	-7.61	1.00 V	251	35.72	-13.33
4	193.45	26.84 QP	30.00	-3.16	1.00 V	124	42.60	-15.76
5	242.97	20.60 QP	37.00	-16.40	1.00 V	19	34.23	-13.63
6	292.83	20.75 QP	37.00	-16.25	1.50 V	289	31.98	-11.23

Remarks:

1. Emission Level(dBuV/m) = Raw Value(dBuV) + Correction Factor(dB/m)
2. Correction Factor(dB/m) = Antenna Factor (dB/m) + Cable Factor (dB) – Pre-Amplifier Factor (dB)
3. The other emission levels were very low against the limit.
4. Margin value = Emission level – Limit value

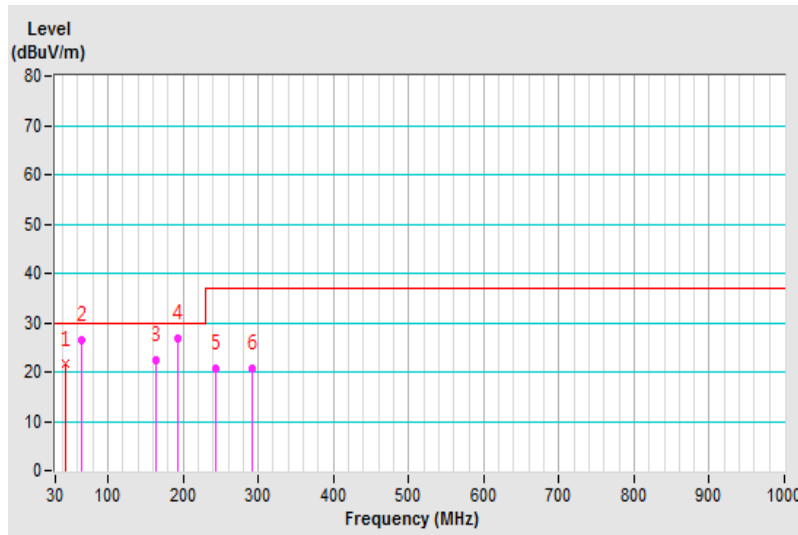

7 Radiated Emissions above 1 GHz

7.1 Limits

Emissions radiated outside of the specified bands, shall be according to the general radiated limits as following:

Radiated Emissions Limits at 10 meters (dBµV/m)				
Frequencies (MHz)	FCC 15B / ICES-003, Class A	FCC 15B / ICES-003, Class B	CISPR 22, Class A	CISPR 22, Class B
1000-3000	Avg: 49.5	Avg: 43.5	Not defined	Not defined
Above 3000	Peak: 69.5	Peak: 63.5	Not defined	Not defined

Radiated Emissions Limits at 3 meters (dBµV/m)				
Frequencies (MHz)	FCC 15B / ICES-003, Class A	FCC 15B / ICES-003, Class B	CISPR 22, Class A	CISPR 22, Class B
1000-3000	Avg: 60	Avg: 54	Avg: 56 Peak: 76	Avg: 50 Peak: 70
Above 3000	Peak: 80	Peak: 74	Avg: 60 Peak: 80	Avg: 54 Peak: 74

- Notes:
1. The lower limit shall apply at the transition frequencies.
 2. Emission level (dBµV/m) = 20 log Emission level (uV/m).
 3. As shown in 15.35(b), for frequencies above 1000MHz, the field strength limits are based on average detector, however, the peak field strength of any emission shall not exceed the maximum permitted average limits, specified above by more than 20dB under any condition of modulation.

Radiated Emissions Limits at 1.5 meters (dBµV/m)		
Frequencies (MHz)	FCC 15B / ICES-003, Class A	FCC 15B / ICES-003, Class B
Above 18000	Avg: 66 Peak: 86	Avg: 60 Peak: 80

Note: Limit@1.5m = Limit@3m + 20log(3/1.5)

Frequency Range (For unintentional radiators)

Highest frequency generated or used in the device or on which the device operates or tunes (MHz)	Upper frequency of measurement range (MHz)
Below 1.705	30
1.705-108	1000
108-500	2000
500-1000	5000
Above 1000	5th harmonic of the highest frequency or 40GHz, whichever is lower



7.2 Test Instruments

DESCRIPTION & MANUFACTURER	MODEL NO.	SERIAL NO.	DATE OF CALIBRATION	DUE DATE OF CALIBRATION
Test Receiver ROHDE & SCHWARZ	ESCI	100424	Oct. 06, 2014	Oct. 05, 2015
Spectrum Analyzer Agilent	E4446A	MY44360124	Feb. 12, 2014	Feb. 11, 2015
BILOG Antenna SCHWARZBECK	VULB9168	9168-157	Feb. 26, 2014	Feb. 25, 2015
RF signal cable Woken	8D-FB	NA	Mar. 21, 2014	Mar. 20, 2015
HORN Antenna SCHWARZBECK	BBHA 9120 D	9120D-404	Jan. 05, 2014	Jan. 04, 2015
Preamplifier Agilent (Above 1GHz)	8449B	3008A01959	Oct. 18, 2014	Oct. 17, 2015
RF signal cable HUBER+SUHNER	SUCOFLEX 104	MWX322+MWX2211308S0295	Nov. 06, 2014	Nov. 05, 2015
Software BV ADT	BV ADT_Radiated_ V7.6.15.9.4	NA	NA	NA
Antenna Tower BV ADT	AT100	AT93021702	NA	NA
Turn Table BV ADT	TT100	TT93021702	NA	NA
Controller BV ADT	SC100	SC93021702	NA	NA
HORN Antenna SCHWARZBECK	BBHA 9170	BBHA9170243	Jan. 09, 2014	Jan. 08, 2015
RF signal cable HUBER+SUHNER	SUCOFLEX 102	38218/2+37433/2	Oct. 25, 2014	Oct. 24, 2015
Fix tool for Boresight antenna tower	BAF-01	2	NA	NA
26GHz ~ 40GHz Amplifier	EMC26400	815221	Oct. 18, 2014	Oct. 17, 2015

- NOTE:**
1. The calibration interval of the above test instruments is 12 months and the calibrations are traceable to NML/ROC and NIST/USA.
 2. The test was performed in HwaYa Chamber 2.
 3. The horn antenna and HP preamplifier (model: 8449B) are used only for the measurement of emission frequency above 1GHz if tested.
 4. The FCC Site Registration No. is 686814.
 5. The IC Site Registration No. is IC 7450F-2.
 6. The VCCI Site Registration No. is G-18.

7.3 Test Arrangement

- The EUT was placed on the top of a rotating table 0.8 meters above the ground at an accredited chamber room. The table was rotated 360 degrees to determine the position of the highest radiation.
- For frequency range 1GHz ~ 18GHz, the EUT was set 3 meters away from the interference-receiving antenna, which was mounted on the top of a variable-height antenna tower.
- For frequency range 18GHz ~ 40GHz, the EUT was set 1.5 meters away from the interference-receiving antenna, which was mounted on the top of a variable-height antenna tower.
- The height of antenna can be varied from one meter to four meters, the height of adjustment depends on the EUT height and the antenna 3dB beamwidth both, to detect the maximum value of the field strength. Both horizontal and vertical polarizations of the antenna are set to make the measurement.
- For each suspected emission, the EUT was arranged to its worst case and then the antenna was tuned to heights and the rotatable table was turned from 0 degrees to 360 degrees to find the maximum reading.
- The spectrum analyzer system was set to peak and average detect function and specified bandwidth with maximum hold mode when the test frequency is above 1 GHz.

Note: The resolution bandwidth of test receiver/spectrum analyzer is 1MHz and video bandwidth is 3MHz for Peak detection (PK) at frequency above 1GHz. The resolution bandwidth of test receiver/spectrum analyzer is 1 MHz for Average detection (AV) at frequency above 1GHz.

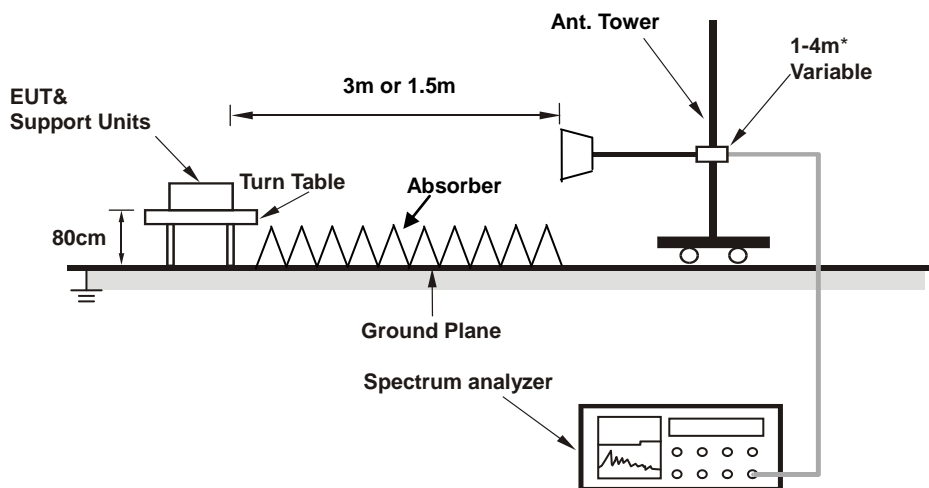

7.4 Test Results

Frequency Range	1GHz ~ 18GHz	Detector Function & Resolution Bandwidth	Peak (PK) / Average (AV), 1MHz
Input Power	120Vac, 60Hz	Environmental Conditions	23°C, 65%RH
Tested by	Felix Chen	Test Date	2014/11/10
Test Mode	Mode 2		

Antenna Polarity & Test Distance : Horizontal at 3 m								
No	Frequency (MHz)	Emission Level (dBuV/m)	Limit (dBuV/m)	Margin (dB)	Antenna Height (m)	Table Angle (Degree)	Raw Value (dBuV)	Correction Factor (dB/m)
1	1902.82	36.58 PK	74.00	-37.42	1.10 H	277	43.54	-6.96
2	1902.82	23.15 AV	54.00	-30.85	1.10 H	277	30.11	-6.96
3	2095.10	37.52 PK	74.00	-36.48	1.28 H	354	43.82	-6.30
4	2095.10	23.66 AV	54.00	-30.34	1.28 H	354	29.96	-6.30
5	4826.44	51.23 PK	74.00	-22.77	1.03 H	124	49.54	1.69
6	4826.44	31.18 AV	54.00	-22.82	1.03 H	124	29.49	1.69

Remarks:

1. Emission Level(dBuV/m) = Raw Value(dBuV) + Correction Factor(dB/m)
2. Correction Factor(dB/m) = Antenna Factor (dB/m) + Cable Factor (dB) – Pre-Amplifier Factor (dB)
3. The other emission levels were very low against the limit.
4. Margin value = Emission level – Limit value

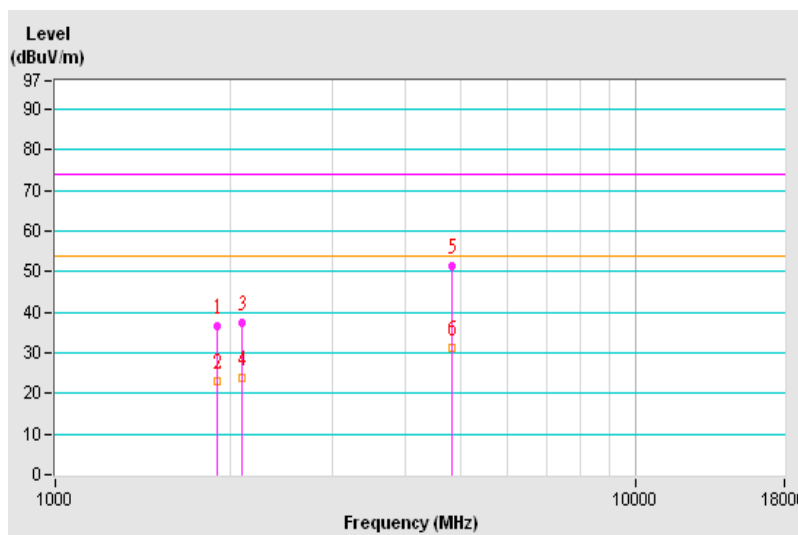

Frequency Range	1GHz ~ 18GHz	Detector Function & Resolution Bandwidth	Peak (PK) / Average (AV), 1MHz
Input Power	120Vac, 60Hz	Environmental Conditions	23°C, 65%RH
Tested by	Felix Chen	Test Date	2014/11/10
Test Mode	Mode 2		

Antenna Polarity & Test Distance : Vertical at 3 m								
No	Frequency (MHz)	Emission Level (dBuV/m)	Limit (dBuV/m)	Margin (dB)	Antenna Height (m)	Table Angle (Degree)	Raw Value (dBuV)	Correction Factor (dB/m)
1	2189.11	37.77 PK	74.00	-36.23	1.47 V	309	43.77	-6.00
2	2189.11	23.59 AV	54.00	-30.41	1.47 V	309	29.59	-6.00
3	2918.57	38.69 PK	74.00	-35.31	1.22 V	113	42.45	-3.76
4	2918.57	23.92 AV	54.00	-30.08	1.22 V	113	27.68	-3.76
5	4843.85	54.63 PK	74.00	-19.37	1.58 V	97	52.86	1.77
6	4843.85	30.38 AV	54.00	-23.62	1.58 V	97	28.61	1.77

Remarks:

1. Emission Level(dBuV/m) = Raw Value(dBuV) + Correction Factor(dB/m)
2. Correction Factor(dB/m) = Antenna Factor (dB/m) + Cable Factor (dB) - Pre-Amplifier Factor (dB)
3. The other emission levels were very low against the limit.
4. Margin value = Emission level - Limit value

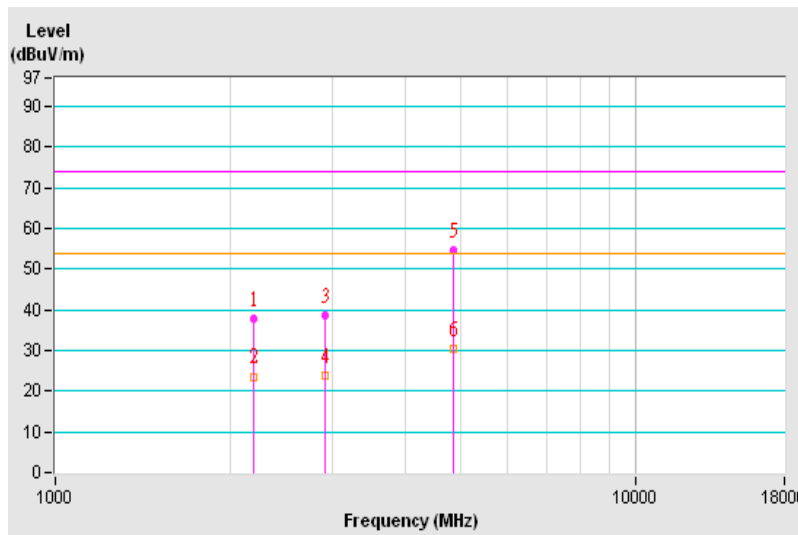

Frequency Range	18GHz ~ 40GHz	Detector Function & Resolution Bandwidth	Peak (PK) / Average (AV), 1MHz
Input Power	120Vac, 60Hz	Environmental Conditions	23°C, 65%RH
Tested by	Felix Chen	Test Date	2014/11/12
Test Mode	Mode 2		

Antenna Polarity & Test Distance : Horizontal at 1.5 m								
No	Frequency (MHz)	Emission Level (dBuV/m)	Limit (dBuV/m)	Margin (dB)	Antenna Height (m)	Table Angle (Degree)	Raw Value (dBuV)	Correction Factor (dB/m)
1	20132.34	48.68 PK	80.00	-31.32	1.00 H	167	55.93	-7.25
2	20132.34	35.71 AV	60.00	-24.29	1.00 H	167	42.96	-7.25

Remarks:

1. Emission Level(dBuV/m) = Raw Value(dBuV) + Correction Factor(dB/m)
2. Correction Factor(dB/m) = Antenna Factor (dB/m) + Cable Factor (dB) – Pre-Amplifier Factor (dB)
3. The other emission levels were very low against the limit.
4. Margin value = Emission level – Limit value

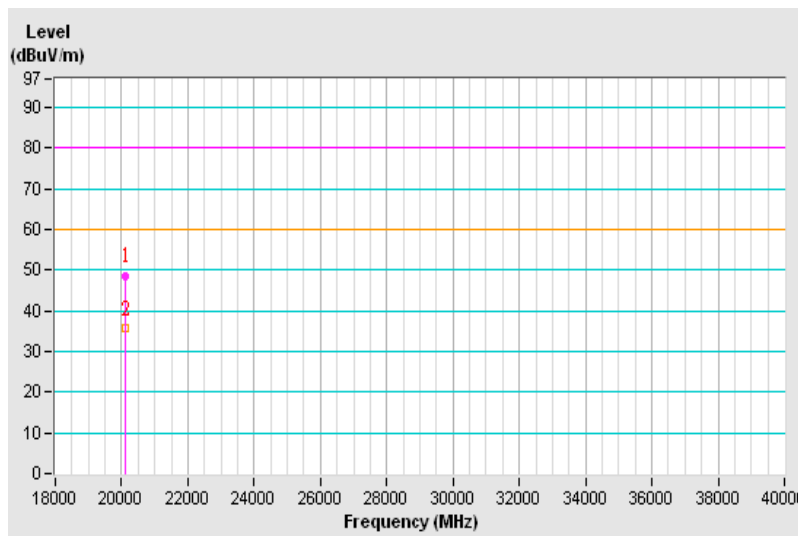

Frequency Range	18GHz ~ 40GHz	Detector Function & Resolution Bandwidth	Peak (PK) / Average (AV), 1MHz
Input Power	120Vac, 60Hz	Environmental Conditions	23°C, 65%RH
Tested by	Felix Chen	Test Date	2014/11/12
Test Mode	Mode 2		

Antenna Polarity & Test Distance : Vertical at 1.5 m								
No	Frequency (MHz)	Emission Level (dBuV/m)	Limit (dBuV/m)	Margin (dB)	Antenna Height (m)	Table Angle (Degree)	Raw Value (dBuV)	Correction Factor (dB/m)
1	21323.43	49.70 PK	80.00	-30.30	1.00 V	133	55.21	-5.51
2	21323.43	36.85 AV	60.00	-23.15	1.00 V	133	42.36	-5.51

Remarks:

1. Emission Level(dBuV/m) = Raw Value(dBuV) + Correction Factor(dB/m)
2. Correction Factor(dB/m) = Antenna Factor (dB/m) + Cable Factor (dB) – Pre-Amplifier Factor (dB)
3. The other emission levels were very low against the limit.
4. Margin value = Emission level – Limit value

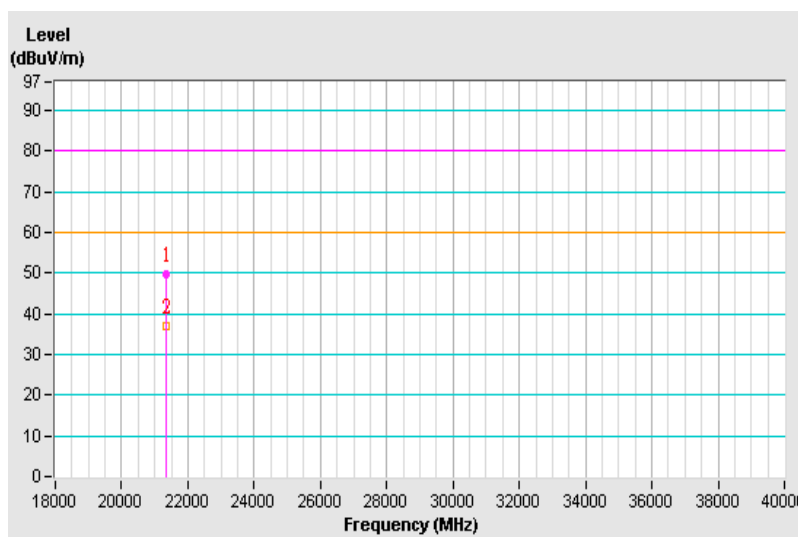

8 Pictures of Test Arrangements

8.1 Conducted Emissions at Mains Ports



8.2 Radiated Emissions up to 1 GHz

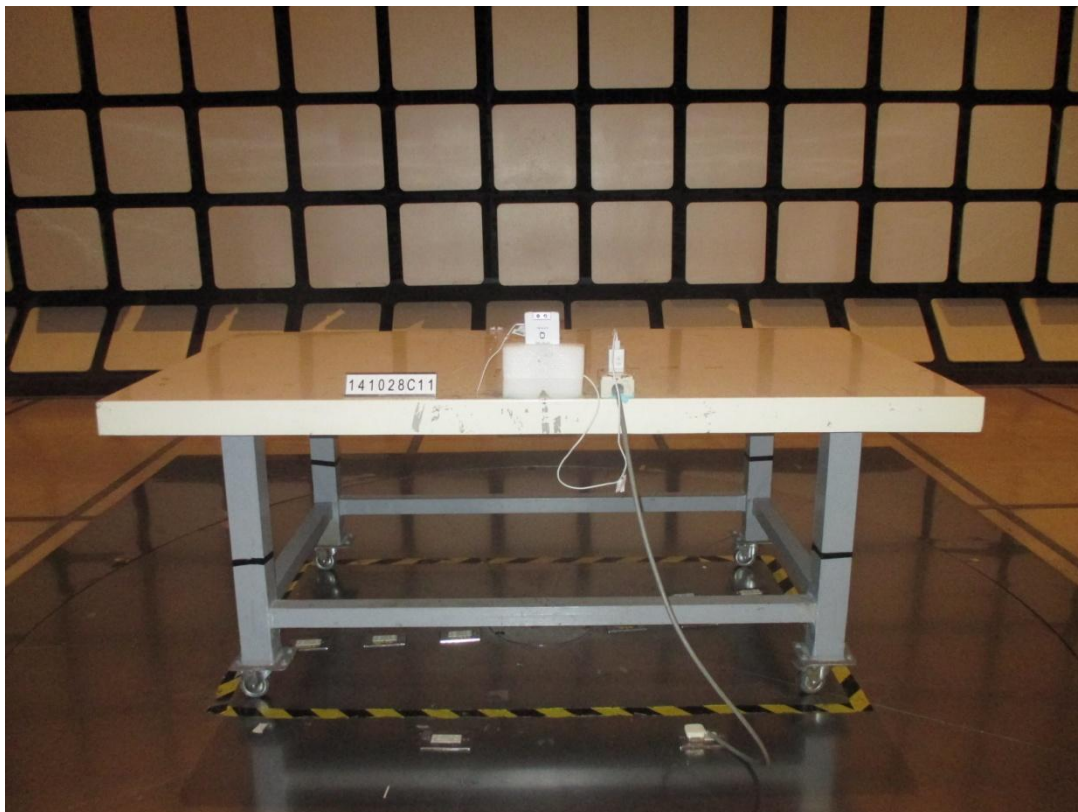

8.3 Radiated Emissions above 1 GHz

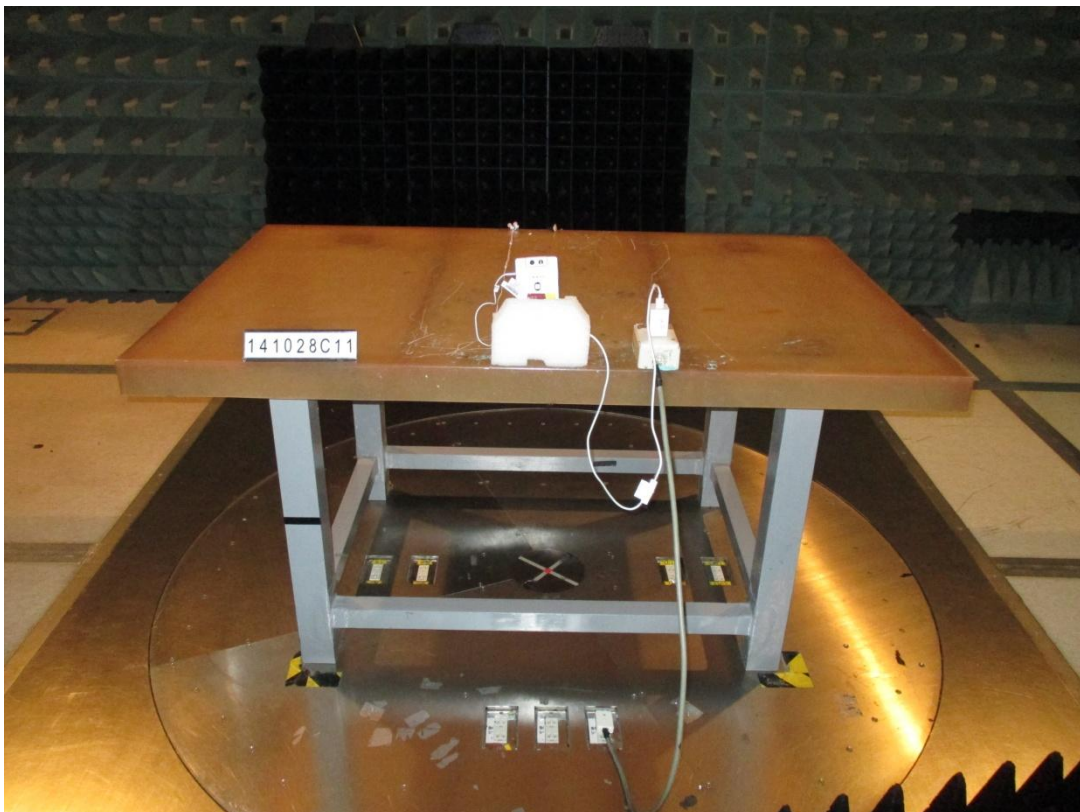
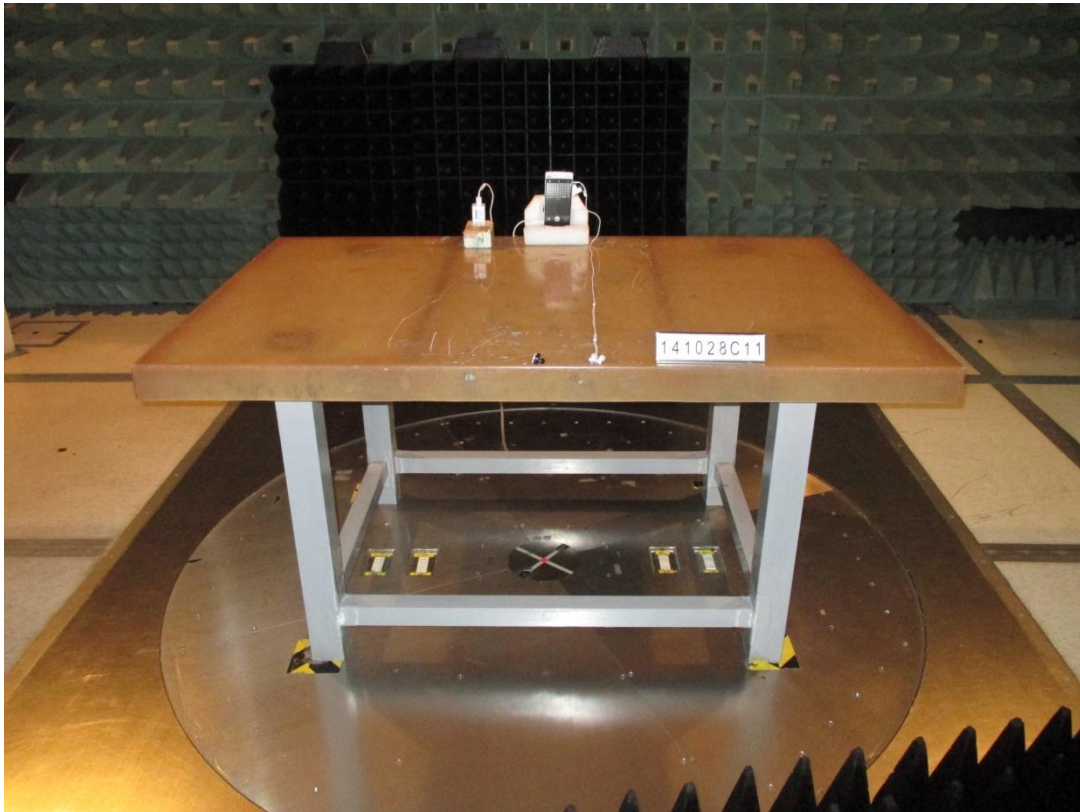

Appendix – Information on the Testing Laboratories

We, Bureau Veritas Consumer Products Services (H.K.) Ltd., Taoyuan Branch, were founded in 1988 to provide our best service in EMC, Radio, Telecom and Safety consultation. Our laboratories are accredited and approved according to ISO/IEC 17025.

If you have any comments, please feel free to contact us at the following:

Linko EMC/RF Lab

Tel: 886-2-26052180

Fax: 886-2-26051924

Hsin Chu EMC/RF/Telecom Lab

Tel: 886-3-5935343

Fax: 886-3-5935342

Hwa Ya EMC/RF/Safety Lab

Tel: 886-3-3183232

Fax: 886-3-3270892

Email: service.adt@tw.bureauveritas.com

Web Site: www.bureauveritas-adt.com

The address and road map of all our labs can be found in our web site also.

--- END ---