



# FCC TEST REPORT (NFC)

**REPORT NO.:** RF140925C24A-5  
**MODEL NO.:** OPPO N5206  
**FCC ID:** R9C-N5206  
**RECEIVED:** Oct. 01, 2014  
**TESTED:** Oct. 01, 2014 ~ Nov. 11, 2014  
**ISSUED:** Nov. 14, 2014

**APPLICANT:** GUANGDONG OPPO MOBILE  
TELECOMMUNICATIONS CORP.,LTD

**ADDRESS:** NO.18 HAIBIN ROAD, WUSHA, CHANG'AN,  
DONGGUAN, GUANGDONG, CHINA

**ISSUED BY:** Bureau Veritas Consumer Products Services (H.K.)  
Ltd., Taoyuan Branch

**LAB ADDRESS:** No. 47-2, 14th Ling, Chia Pau Vil., Lin Kou Dist., New  
Taipei City, Taiwan, R.O.C.

**TEST LOCATION:** No. 19, Hwa Ya 2nd Rd, Wen Hwa Tsuen, Kwei Shan  
Hsiang, Taoyuan Hsien 333, Taiwan, R.O.C.

This report should not be used by the client to claim  
product certification, approval, or endorsement by  
TAF or any government agencies.



This report is for your exclusive use. Any copying or replication of this report to or for any other person or entity, or use of our name or trademark, is permitted only with our prior written permission. This report sets forth our findings solely with respect to the test samples identified herein. The results set forth in this report are not indicative or representative of the quality or characteristics of the lot from which a test sample was taken or any similar or identical product unless specifically and expressly noted. Our report includes all of the tests requested by you and the results thereof based upon the information that you provided to us. You have 60 days from date of issuance of this report to notify us of any material error or omission caused by our negligence, provided, however, that such notice shall be in writing and shall specifically address the issue you wish to raise. A failure to raise such issue within the prescribed time shall constitute your unqualified acceptance of the completeness of this report, the tests conducted and the correctness of the report contents. Unless specific mention, the uncertainty of measurement has been explicitly taken into account to declare the compliance or non-compliance to the specification.



# Table of Contents

|   |    |
|---|----|
| RELEASE CONTROL RECORD.....   | 3  |
| 1. CERTIFICATION .....  | 4  |
| 2. SUMMARY OF TEST RESULTS.....   | 5  |
| 2.1 MEASUREMENT UNCERTAINTY .....   | 5  |
| 3. GENERAL INFORMATION .....  | 6  |
| 3.1 GENERAL DESCRIPTION OF EUT.....   | 6  |
| 3.2 DESCRIPTION OF TEST MODES.....  | 7  |
| 3.2.1 TEST MODE APPLICABILITY AND TESTED CHANNEL DETAIL .....                                 | 7  |
| 3.3 DESCRIPTION OF SUPPORT UNITS .....  | 8  |
| 3.3.1 CONFIGURATION OF SYSTEM UNDER TEST.....   | 8  |
| 3.4 GENERAL DESCRIPTION OF APPLIED STANDARDS .....  | 9  |
| 4. TEST TYPES AND RESULTS.....  | 10 |
| 4.1 RADIATED EMISSION MEASUREMENT .....   | 10 |
| 4.1.1 LIMITS OF RADIATED EMISSION MEASUREMENT .....   | 10 |
| 4.1.2 TEST INSTRUMENTS .....  | 11 |
| 4.1.3 TEST PROCEDURES.....  | 12 |
| 4.1.4 DEVIATION FROM TEST STANDARD .....  | 12 |
| 4.1.5 TEST SETUP .....  | 13 |
| 4.1.6 EUT OPERATING CONDITIONS.....   | 13 |
| 4.1.7 TEST RESULTS .....  | 14 |
| 4.2 CONDUCTED EMISSION MEASUREMENT .....  | 20 |
| 4.2.1 LIMITS OF CONDUCTED EMISSION MEASUREMENT .....  | 20 |
| 4.2.2 TEST INSTRUMENTS .....  | 20 |
| 4.2.3 TEST PROCEDURES.....  | 21 |
| 4.2.4 DEVIATION FROM TEST STANDARD .....  | 21 |
| 4.2.5 TEST SETUP .....  | 21 |
| 4.2.6 EUT OPERATING CONDITIONS.....   | 21 |
| 4.2.7 TEST RESULTS .....  | 22 |
| 4.3 FREQUENCY STABILITY .....   | 24 |
| 4.3.1 LIMITS OF FREQUENCY STABILITY MEASUREMENT .....   | 24 |
| 4.3.2 TEST INSTRUMENTS .....  | 24 |
| 4.3.3 TEST PROCEDURE .....  | 24 |
| 4.3.4 DEVIATION FROM TEST STANDARD .....  | 24 |
| 4.3.5 TEST SETUP .....  | 25 |
| 4.3.6 EUT OPERATING CONDITION .....   | 25 |
| 4.3.7 TEST RESULTS .....  | 26 |
| 4.4 20dB BANDWIDTH.....   | 27 |
| 4.4.1 LIMITS OF 20dB BANDWIDTH MEASUREMENT .....  | 27 |
| 4.4.2 TEST INSTRUMENTS .....  | 27 |
| 4.4.3 TEST PROCEDURE .....  | 27 |
| 4.4.4 DEVIATION FROM TEST STANDARD .....  | 27 |
| 4.4.5 TEST SETUP .....  | 27 |
| 4.4.6 EUT OPERATING CONDITION .....   | 27 |
| 4.4.7 TEST RESULTS .....  | 28 |
| 5. PHOTOGRAPHS OF THE TEST CONFIGURATION .....  | 29 |
| 6. INFORMATION ON THE TESTING LABORATORIES .....  | 30 |
| 7. APPENDIX A - MODIFICATIONS RECORDERS FOR ENGINEERING CHANGES TO THE EUT<br>BY THE LAB..... | 31 |



## RELEASE CONTROL RECORD

| ISSUE NO.      | REASON FOR CHANGE | DATE ISSUED   |
|----------------|-------------------|---------------|
| RF140925C24A-5 | Original release  | Nov. 14, 2014 |

## 1. CERTIFICATION

**PRODUCT:** Mobile Phone  
**MODEL:** OPPO N5206  
**BRAND:** OPPO  
**APPLICANT:** GUANGDONG OPPO MOBILE  
TELECOMMUNICATIONS CORP.,LTD  
**TESTED:** Oct. 01, 2014 ~ Nov. 11, 2014  
**TEST SAMPLE:** Identical Prototype  
**STANDARDS:** **FCC Part 15, Subpart C (Section 15.225)**  
**FCC Part 15, Subpart C (Section 15.215)**  
ANSI C63.10-2009

The above equipment (model: OPPO N5206) has been tested by **Bureau Veritas Consumer Products Services (H.K.) Ltd., Taoyuan Branch**. The test record, data evaluation & Equipment Under Test (EUT) configurations represented herein are true and accurate accounts of the measurements of the sample's EMC characteristics under the conditions specified in this report.

**PREPARED BY :** Ivonne Wu , **DATE :** Nov. 14, 2014  
Ivonne Wu / Supervisor

**APPROVED BY :** Sam Chen , **DATE :** Nov. 14, 2014  
Sam Chen / Senior Project Engineer

## 2. SUMMARY OF TEST RESULTS

The EUT has been tested according to the following specifications:

| APPLIED STANDARD: FCC PART 15, SUBPART C (SECTION 15.225, 15.215) |   |        |  |
|---|---|--------|--|
| STANDARD SECTION  | TEST TYPE AND LIMIT   | RESULT | REMARK   |
| 15.207  | Conducted emission test   | PASS   | Meet the requirement of limit. Minimum passing margin is -2.92dB at 13.55859MHz. |
| 15.225 (a)  | The field strength of any emissions within the band 13.553-13.567 MHz               | PASS   | Meet the requirement of limit. Minimum passing margin is -69.96dB at 13.559MHz.  |
| 15.225 (d)  | The field strength of any emissions appearing outside of the 13.110-14.010 MHz band | PASS   | Meet the requirement of limit. Minimum passing margin is -3dB at 30.54MHz.       |
| 15.225 (e)  | The frequency tolerance   | PASS   | Meet the requirement of limit.   |
| 15.215 (c)  | 20dB Bandwidth  | PASS   | Meet the requirement of limit.   |

### 2.1 MEASUREMENT UNCERTAINTY

Where relevant, the following measurement uncertainty levels have been estimated for tests performed on the EUT as specified in CISPR 16-4-2:

| MEASUREMENT        | FREQUENCY       | UNCERTAINTY |
|--------------------|-----------------|-------------|
| Conducted Emission | 150kHz ~ 30MHz  | 2.44 dB     |
| Radiated emissions | 30MHz ~ 200MHz  | 3.34 dB     |
|                    | 200MHz ~1000MHz | 3.35 dB     |

This uncertainty represents an expanded uncertainty expressed at approximately the 95% confidence level using a coverage factor of k=2.



A D T

### 3. GENERAL INFORMATION

#### 3.1 GENERAL DESCRIPTION OF EUT

|                            |   |
|----------------------------|---|
| <b>EUT</b>                 | Mobile Phone  |
| <b>MODEL NO.</b>           | OPPO N5206  |
| <b>POWER SUPPLY</b>        | 5.0Vdc (adapter or host equipment)<br>3.8Vdc (Li-ion battery) |
| <b>MODULATION TYPE</b>     | ASK   |
| <b>OPERATING FREQUENCY</b> | 13.56MHz  |
| <b>ANTENNA TYPE</b>        | Loop Antenna  |
| <b>DATA CABLE</b>          | Refer to Note   |
| <b>I/O PORTS</b>           | Refer to user's manual  |
| <b>ACCESSORY DEVICES</b>   | Refer to Note   |

**NOTE:**

1. The EUT contains following accessory devices.

| ITEM         | BRAND        | MODEL                    | SPECIFICATION                               |
|--------------|--------------|--------------------------|---|
| Adapter      | Salcomp      | AK955                    | I/P: 100-240Vac, 700mA<br>O/P: 5Vdc, 5000mA |
| Battery      | OPPO         | BLP581                   | 3.8Vdc, 3000mAh                             |
| Earphone     | OPPO         | MH124                    | 1.1m non-shielded cable                     |
| USB Cable    | LUXSHARE-ICT | RDN1403282               | 1m shielded cable                           |
| LCD Panel    | JDI          | LPM055A081A<br>TENTATIVE | --  |
| Photo Camera | SUNNY        | P16V01C                  | --  |

2. The above EUT information is declared by the manufacturer and for more detailed features description, please refer to the manufacturer's specifications or User's Manual.

## 3.2 DESCRIPTION OF TEST MODES

### 3.2.1 TEST MODE APPLICABILITY AND TESTED CHANNEL DETAIL

| EUT CONFIGURE MODE | APPLICABLE TO |     |    |    | DESCRIPTION |
|--------------------|---------------|-----|----|----|-------------|
|                    | RE            | PLC | FS | BW |             |
| -                  | √             | √   | √  | √  | -           |

Where **RE:** Radiated Emission                      **PLC:** Power Line Conducted Emission  
**FS:** Frequency Stability                              **BW:** 20dB Bandwidth

**NOTE:**

The EUT had been pre-tested on the positioned of each 3 axis. The worst case was found when positioned on **Y-plane**.

**RADIATED EMISSION TEST:**

- Pre-Scan has been conducted to determine the worst-case mode from all possible combinations between available modulations antenna ports (if EUT with antenna diversity architecture).
- Following channel(s) was (were) selected for the final test as listed below.

| EUT CONFIGURE MODE | AVAILABLE CHANNEL | TESTED CHANNEL | MODULATION TYPE |
|--------------------|-------------------|----------------|-----------------|
| -                  | 1                 | 1              | ASK             |

**POWER LINE CONDUCTED EMISSION TEST:**

- Pre-Scan has been conducted to determine the worst-case mode from all possible combinations between available modulations antenna ports (if EUT with antenna diversity architecture).
- Following channel(s) was (were) selected for the final test as listed below.

| EUT CONFIGURE MODE | AVAILABLE CHANNEL | TESTED CHANNEL | MODULATION TYPE |
|--------------------|-------------------|----------------|-----------------|
| -                  | 1                 | 1              | ASK             |

**FREQUENCY STABILITY:**

- Pre-Scan has been conducted to determine the worst-case mode from all possible combinations between available modulations and antenna ports (if EUT with antenna diversity architecture).
- Following channel(s) was (were) selected for the final test as listed below.

| EUT CONFIGURE MODE | AVAILABLE CHANNEL | TESTED CHANNEL | MODULATION TYPE |
|--------------------|-------------------|----------------|-----------------|
| -                  | 1                 | 1              | ASK             |

**20dB BANDWIDTH:**

- Pre-Scan has been conducted to determine the worst-case mode from all possible combinations between available modulations, antenna ports (if EUT with antenna diversity architecture).
- Following channel(s) was (were) selected for the final test as listed below.

| EUT CONFIGURE MODE | AVAILABLE CHANNEL | TESTED CHANNEL | MODULATION TYPE |
|--------------------|-------------------|----------------|-----------------|
| -                  | 1                 | 1              | ASK             |

**TEST CONDITION:**

| APPLICABLE TO | ENVIRONMENTAL CONDITIONS | INPUT POWER  | TESTED BY  |
|---------------|--------------------------|--------------|------------|
| RE            | 25deg. C, 65%RH          | 120Vac, 60Hz | Toby Tien  |
| FS            | 25deg. C, 65%RH          | 120Vac, 60Hz | Howard Kao |
| PLC           | 25deg. C, 65%RH          | 120Vac, 60Hz | Gavin Wu   |
| BW            | 25deg. C, 65%RH          | 120Vac, 60Hz | Howard Kao |

**3.3 DESCRIPTION OF SUPPORT UNITS**

The EUT has been tested as an independent unit together with other necessary accessories or support units.

**3.3.1 CONFIGURATION OF SYSTEM UNDER TEST**

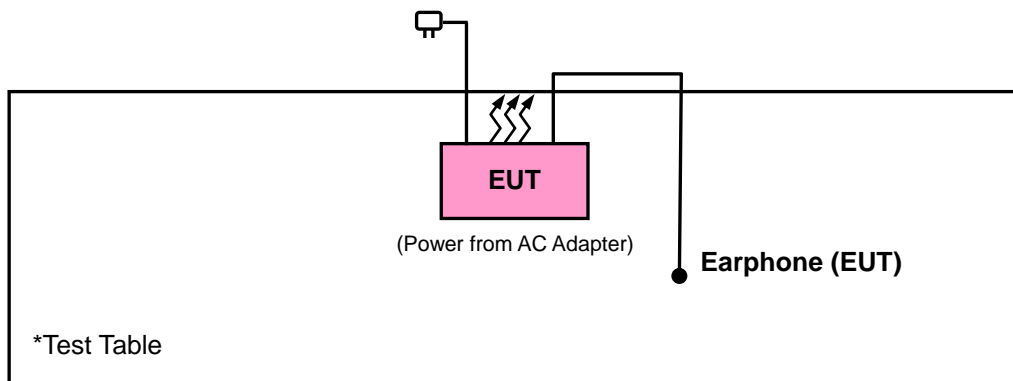



### 3.4 GENERAL DESCRIPTION OF APPLIED STANDARDS

The EUT is a RFID Product. According to the specifications of the manufacturer, it must comply with the requirements of the following standards:

**FCC Part 15, Subpart C (15.225)**

**FCC Part 15, Subpart C (15.215)**

**ANSI C63.10-2009**

All test items have been performed and recorded as per the above standards.

**NOTE:** The EUT has been verified to comply with the requirements of FCC Part 15, Subpart B, Class B. The test report has been issued separately.

## 4. TEST TYPES AND RESULTS

### 4.1 RADIATED EMISSION MEASUREMENT

#### 4.1.1 LIMITS OF RADIATED EMISSION MEASUREMENT

The field strength of any emissions within the band 13.553-13.567 MHz shall not exceed 15,848 microvolts/meter at 30 meters.

The field strength of any emissions appearing outside of the 13.110-14.010 MHz band shall not exceed the general radiated emission limits in § 15.209.

| FREQUENCIES (MHz) | FIELD STRENGTH (microvolts/meter) | MEASUREMENT DISTANCE (meters) |
|-------------------|-----------------------------------|-------------------------------|
| 0.009 ~ 0.490     | 2400/F(kHz)                       | 300                           |
| 0.490 ~ 1.705     | 24000/F(kHz)                      | 30                            |
| 1.705 ~ 30.0      | 30                                | 30                            |
| 30 ~ 88           | 100                               | 3                             |
| 88 ~ 216          | 150                               | 3                             |
| 216 ~ 960         | 200                               | 3                             |
| Above 960         | 500                               | 3                             |

**NOTE:**

1. The lower limit shall apply at the transition frequencies.
2. Emission level (dBuV/m) = 20 log Emission level (uV/m).
3. As shown in 15.35(b), for frequencies above 1000MHz, the field strength limits are based on average detector, however, the peak field strength of any emission shall not exceed the maximum permitted average limits, specified above by more than 20dB under any condition of modulation.



**4.1.2 TEST INSTRUMENTS**

**Test Date: Oct. 01, 2014 ~ Oct. 28, 2014**

| DESCRIPTION & MANUFACTURER                     | MODEL NO.      | SERIAL NO.                      | DATE OF CALIBRATION | DUE DATE OF CALIBRATION |
|--|----------------|---------------------------------|---------------------|-------------------------|
| Test Receiver<br>AGILENT                       | N9038A         | MY51210203                      | Jan. 17, 2014       | Jan. 16, 2015           |
| Spectrum Analyzer<br>ROHDE & SCHWARZ           | FSU43          | 101261                          | Dec. 21, 2013       | Dec. 20, 2014           |
| BILOG Antenna<br>SCHWARZBECK                   | VULB9168       | 9168-472                        | Feb. 27, 2014       | Feb. 26, 2015           |
| HORN Antenna<br>SCHWARZBECK                    | BBHA 9120 D    | 9120D-969                       | Feb. 19, 2014       | Feb. 18, 2015           |
| HORN Antenna<br>SCHWARZBECK                    | BBHA 9170      | 9170-480                        | Dec. 18, 2013       | Dec. 17, 2014           |
| Loop Antenna                                   | HFH2-Z2        | 100070                          | Mar. 06, 2014       | Mar. 05, 2016           |
| Preamplifier<br>EMCI                           | EMC 012645     | 980115                          | Dec. 26, 2013       | Dec. 25, 2014           |
| Preamplifier<br>EMCI                           | EMC 184045     | 980116                          | Jan. 13, 2014       | Jan. 12, 2015           |
| Preamplifier<br>EMCI                           | EMC 330H       | 980112                          | Dec. 27, 2013       | Dec. 26, 2014           |
| RF signal cable<br>HUBER+SUHNNER               | SUCOFLEX 104   | Cable-RF2-02(254<br>644+251640) | Aug. 22, 2014       | Aug. 21, 2015           |
| RF signal cable<br>HUBER+SUHNNER               | SUCOFLEX 104   | Cable-RF2-03(246<br>272/4)      | Aug. 22, 2014       | Aug. 21, 2015           |
| RF signal cable<br>Worken                      | RG-213         | NA                              | Nov. 07, 2013       | Nov. 06, 2014           |
| Software<br>BV ADT                             | E3<br>6.120103 | NA                              | NA                  | NA                      |
| Antenna Tower<br>MF                            | MFA-440H       | NA                              | NA                  | NA                      |
| Turn Table<br>MF                               | MFT-201SS      | NA                              | NA                  | NA                      |
| Antenna Tower & Turn<br>Table Controller<br>MF | MF-7802        | NA                              | NA                  | NA                      |

- NOTE:** 1. The calibration interval of the above test instruments is 12 months and the calibrations are traceable to NML/ROC and NIST/USA.
2. The calibration interval of the loop antenna is 24 months and the calibrations are traceable to NML/ROC and NIST/USA.
3. The test was performed in HwaYa Chamber 10.
4. The FCC Site Registration No. is 690701.



A D T

5. The IC Site Registration No. is IC 7450F-10.

#### 4.1.3 TEST PROCEDURES

- a. The EUT was placed on the top of a rotating table 0.8 meters above the ground at a 3 meter semi-anechoic chamber. The table was rotated 360 degrees to determine the position of the highest radiation.
- b. The EUT was set 3 meters away from the interference-receiving antenna, which was mounted on the top of a variable-height antenna tower.
- c. The antenna is a broadband antenna, and its height is varied from one meter to four meters above the ground to determine the maximum value of the field strength. Both horizontal and vertical polarizations of the antenna are set to make the measurement.
- d. For each suspected emission, the EUT was arranged to its worst case and then the antenna was tuned to heights from 1 meter to 4 meters and the rotatable table was turned from 0 degrees to 360 degrees to find the maximum reading.
- e. The test-receiver system was set to Peak Detect Function and Specified Bandwidth with Maximum Hold Mode.
- f. If the emission level of the EUT in peak mode was lower than the limit specified, then testing could be stopped and the peak values of the EUT would be reported. Otherwise the emissions would be re-tested one by one using peak, quasi-peak or average method as specified and then reported in a data sheet.

#### NOTE:

1. The resolution bandwidth and video bandwidth of test receiver/spectrum analyzer is 120kHz for Quasi-peak detection at frequency below 1GHz.
2. The resolution bandwidth of test receiver/spectrum analyzer is 1MHz and video bandwidth is 3MHz for Peak detection at frequency above 1GHz.
3. All modes of operation were investigated and the worst-case emissions are reported.

#### 4.1.4 DEVIATION FROM TEST STANDARD

No deviation.

#### 4.1.5 TEST SETUP

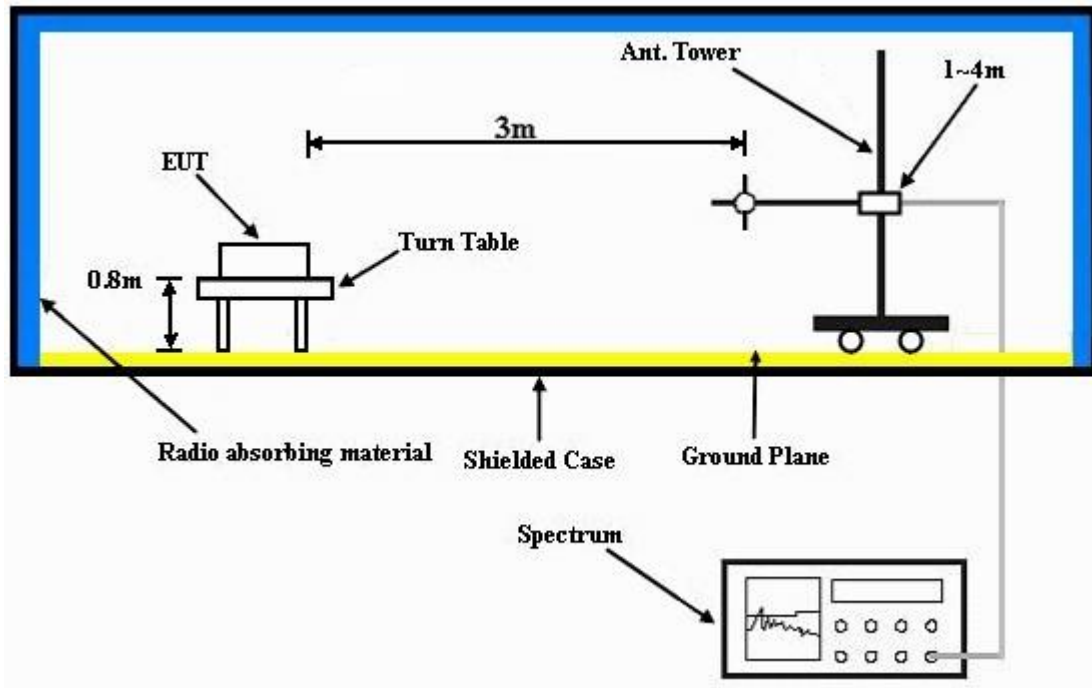

For the actual test configuration, please refer to the attached file (Test Setup Photo).

#### 4.1.6 EUT OPERATING CONDITIONS

Set the EUT under transmission condition continuously at specific channel frequency.



A D T

4.1.7 TEST RESULTS

| EUT TEST CONDITION       |                 | MEASUREMENT DETAIL |                    |
|--------------------------|-----------------|--------------------|--------------------|
| CHANNEL                  | Channel 1       | FREQUENCY RANGE    | 13.553 ~ 13.567MHz |
| INPUT POWER              | 120Vac, 60Hz    | DETECTOR FUNCTION  | Peak (PK)          |
| ENVIRONMENTAL CONDITIONS | 25deg. C, 65%RH | TESTED BY          | Toby Tien          |

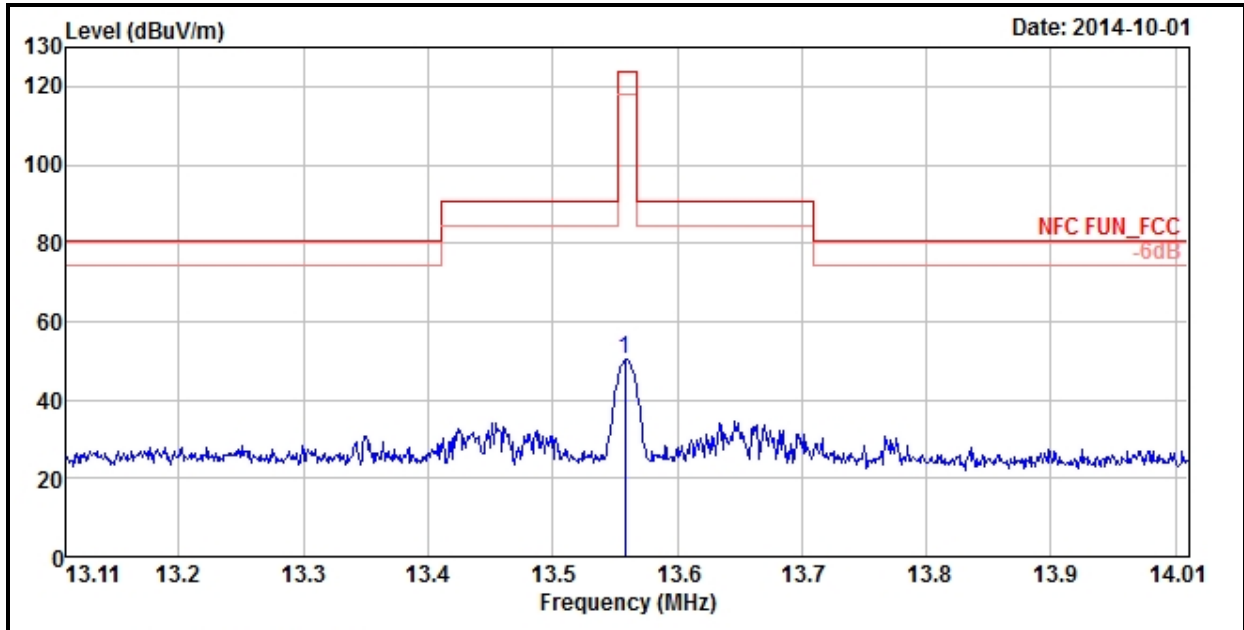

| ANTENNA POLARITY & TEST DISTANCE: LOOP ANTENNA OPEN AT 3M |                         |                   |                |             |                       |                 |                    |                     |                      |        |
|---|-------------------------|-------------------|----------------|-------------|-----------------------|-----------------|--------------------|---------------------|----------------------|--------|
| FREQ. (MHz)   | EMISSION LEVEL (dBuV/m) | READ LEVEL (dBuV) | LIMIT (dBuV/m) | MARGIN (dB) | ANTENNA FACTOR (dB/m) | CABLE LOSS (dB) | PREAMP FACTOR (dB) | ANTENNA HEIGHT (cm) | TABLE ANGLE (Degree) | REMARK |
| 13.559  | 54.04                   | 57.42             | 124            | -69.96      | 37.67                 | 0.31            | 41.36              | 100                 | 0                    | Peak   |

- REMARKS:**
1. Emission level(dBuV/m)= Read Level (dBuV) + Correction Factor (dB/m)
  2. Correction Factor (dB/m) = Antenna Factor + Cable Loss (dB) – Preamp Factor (dB)
  3. The other emission levels were very low against the limit.
  4. Margin value = Emission level – Limit value.
  5. Above limits have been translated by the formula

The measured field strength was extrapolated to distance 30 meters, using the formula that the limit of field strength varies as the inverse distance square (40dB per decade of distance)

Example:

$$\begin{aligned}
 13.56\text{MHz} &= 15848\mu\text{V/m} && 30\text{m} \\
 &= 84\text{dBuV/m} && 30\text{m} \\
 &= 84+20\log(30/3)^2 && 3\text{m} \\
 &= 124\text{dBuV/m}
 \end{aligned}$$



A D T

| EUT TEST CONDITION       |                 | MEASUREMENT DETAIL |                    |
|--------------------------|-----------------|--------------------|--------------------|
| CHANNEL                  | Channel 1       | FREQUENCY RANGE    | 13.553 ~ 13.567MHz |
| INPUT POWER              | 120Vac, 60Hz    | DETECTOR FUNCTION  | Peak (PK)          |
| ENVIRONMENTAL CONDITIONS | 25deg. C, 65%RH | TESTED BY          | Toby Tien          |

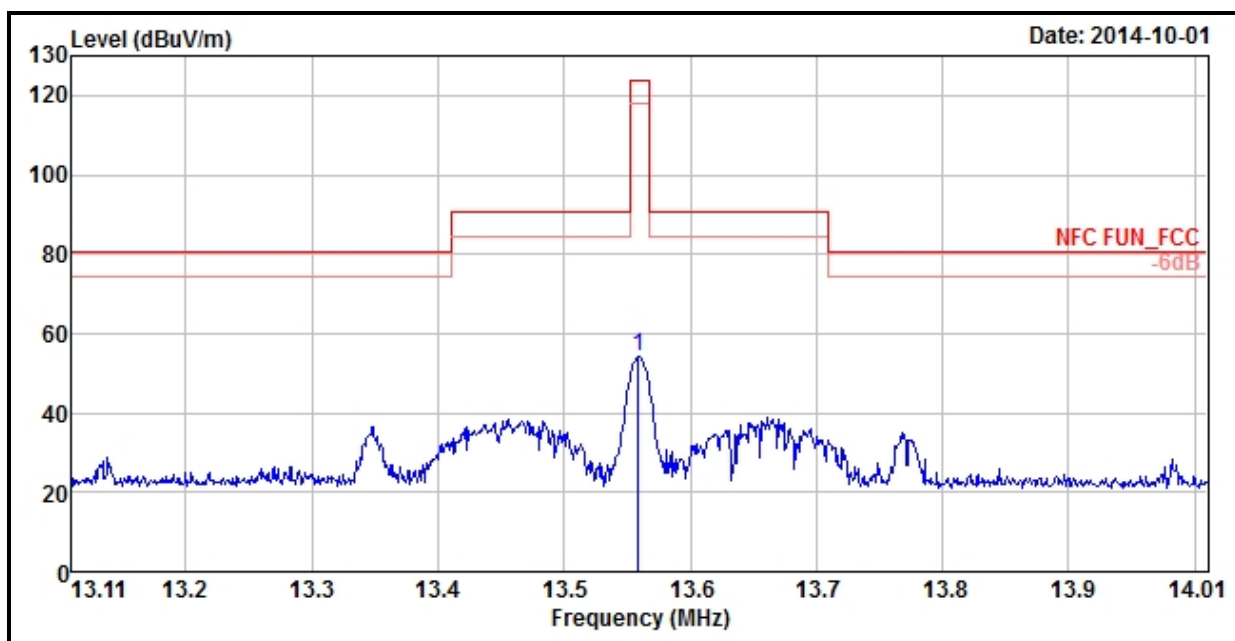

| ANTENNA POLARITY & TEST DISTANCE: LOOP ANTENNA CLOSE AT 3M |                         |                   |                |             |                       |                 |                    |                     |                      |        |
|--|-------------------------|-------------------|----------------|-------------|-----------------------|-----------------|--------------------|---------------------|----------------------|--------|
| FREQ. (MHz)  | EMISSION LEVEL (dBuV/m) | READ LEVEL (dBuV) | LIMIT (dBuV/m) | MARGIN (dB) | ANTENNA FACTOR (dB/m) | CABLE LOSS (dB) | PREAMP FACTOR (dB) | ANTENNA HEIGHT (cm) | TABLE ANGLE (Degree) | REMARK |
| 13.558   | 50.42                   | 53.8              | 124            | -73.58      | 37.67                 | 0.31            | 41.36              | 100                 | 360                  | Peak   |

- REMARKS:**
1. Emission level(dBuV/m)= Read Level (dBuV) + Correction Factor (dB/m)
  2. Correction Factor (dB/m) = Antenna Factor + Cable Loss (dB) – Preamp Factor (dB)
  3. The other emission levels were very low against the limit.
  4. Margin value = Emission level – Limit value.
  5. Above limits have been translated by the formula

The measured field strength was extrapolated to distance 30 meters, using the formula that the limit of field strength varies as the inverse distance square (40dB per decade of distance)

Example:

$$\begin{aligned}
 13.56\text{MHz} &= 15848\mu\text{V/m} && 30\text{m} \\
 &= 84\text{dBuV/m} && 30\text{m} \\
 &= 84+20\log(30/3)^2 && 3\text{m} \\
 &= 124\text{dBuV/m}
 \end{aligned}$$



A D T

| EUT TEST CONDITION       |                 | MEASUREMENT DETAIL |             |
|--------------------------|-----------------|--------------------|-------------|
| CHANNEL                  | Channel 1       | FREQUENCY RANGE    | Below 30MHz |
| INPUT POWER              | 120Vac, 60Hz    | DETECTOR FUNCTION  | Peak (PK)   |
| ENVIRONMENTAL CONDITIONS | 25deg. C, 65%RH | TESTED BY          | Toby Tien   |

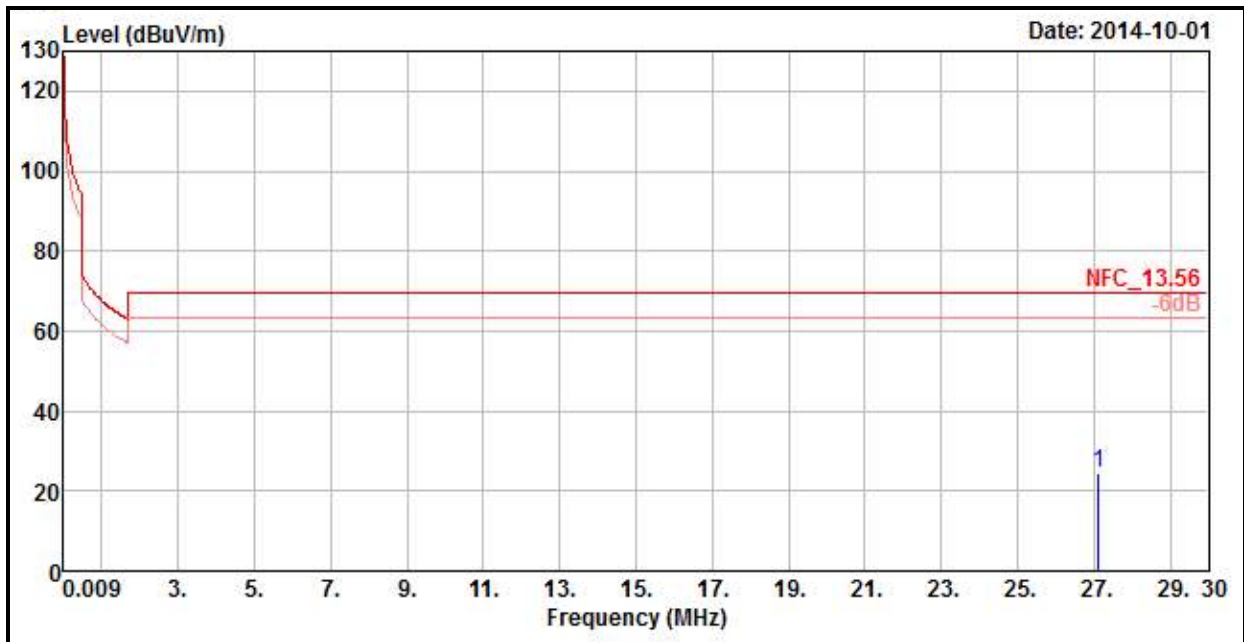

| ANTENNA POLARITY & TEST DISTANCE: LOOP ANTENNA OPEN AT 3M |                         |                   |                |             |                       |                 |                    |                     |                      |        |
|---|-------------------------|-------------------|----------------|-------------|-----------------------|-----------------|--------------------|---------------------|----------------------|--------|
| FREQ. (MHz)   | EMISSION LEVEL (dBuV/m) | READ LEVEL (dBuV) | LIMIT (dBuV/m) | MARGIN (dB) | ANTENNA FACTOR (dB/m) | CABLE LOSS (dB) | PREAMP FACTOR (dB) | ANTENNA HEIGHT (cm) | TABLE ANGLE (Degree) | REMARK |
| 27.12   | 24.63                   | 30.03             | 69.54          | -44.91      | 35.55                 | 0.38            | 41.33              | 100                 | 360                  | Peak   |

**REMARKS:**

1. Emission level(dBuV/m)= Read Level (dBuV) + Correction Factor (dB/m)
2. Correction Factor (dB/m) = Antenna Factor + Cable Loss (dB) – Preamp Factor (dB)
3. The other emission levels were very low against the limit.
4. Margin value = Emission level – Limit value.





A D T

| EUT TEST CONDITION       |                 | MEASUREMENT DETAIL |             |
|--------------------------|-----------------|--------------------|-------------|
| CHANNEL                  | Channel 1       | FREQUENCY RANGE    | Below 30MHz |
| INPUT POWER              | 120Vac, 60Hz    | DETECTOR FUNCTION  | Peak (PK)   |
| ENVIRONMENTAL CONDITIONS | 25deg. C, 65%RH | TESTED BY          | Toby Tien   |

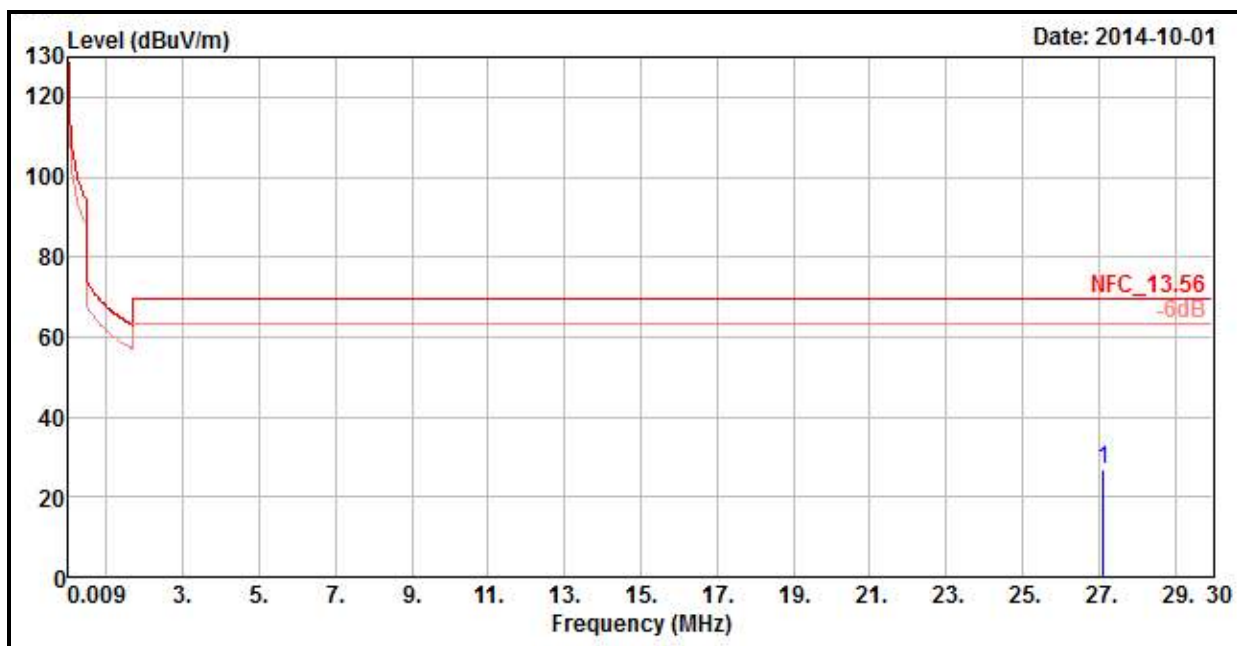

| ANTENNA POLARITY & TEST DISTANCE: LOOP ANTENNA CLOSE AT 3M |                         |                   |                |             |                       |                 |                    |                     |                      |        |
|--|-------------------------|-------------------|----------------|-------------|-----------------------|-----------------|--------------------|---------------------|----------------------|--------|
| FREQ. (MHz)  | EMISSION LEVEL (dBuV/m) | READ LEVEL (dBuV) | LIMIT (dBuV/m) | MARGIN (dB) | ANTENNA FACTOR (dB/m) | CABLE LOSS (dB) | PREAMP FACTOR (dB) | ANTENNA HEIGHT (cm) | TABLE ANGLE (Degree) | REMARK |
| 27.12  | 26.92                   | 32.32             | 69.54          | -42.62      | 35.55                 | 0.38            | 41.33              | 100                 | 0                    | Peak   |

- REMARKS:**
1. Emission level(dBuV/m)= Read Level (dBuV) + Correction Factor (dB/m)
  2. Correction Factor (dB/m) = Antenna Factor + Cable Loss (dB) – Preamp Factor (dB)
  3. The other emission levels were very low against the limit.
  4. Margin value = Emission level – Limit value.



A D T

| EUT TEST CONDITION       |                 | MEASUREMENT DETAIL |                              |
|--------------------------|-----------------|--------------------|------------------------------|
| CHANNEL                  | Channel 1       | FREQUENCY RANGE    | 30MHz ~ 1GHz                 |
| INPUT POWER              | 120Vac, 60 Hz   | DETECTOR FUNCTION  | Peak (PK)<br>Quasi-peak (QP) |
| ENVIRONMENTAL CONDITIONS | 25deg. C, 65%RH | TESTED BY          | Toby Tien                    |

### HORIZONTAL

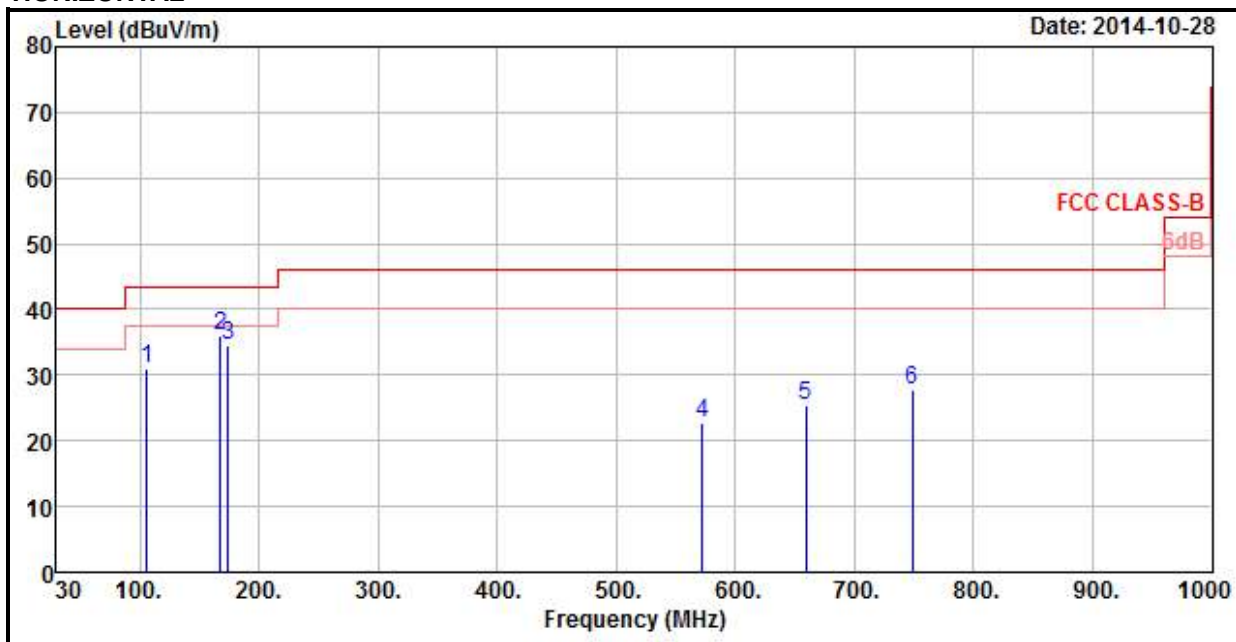

### VERTICAL

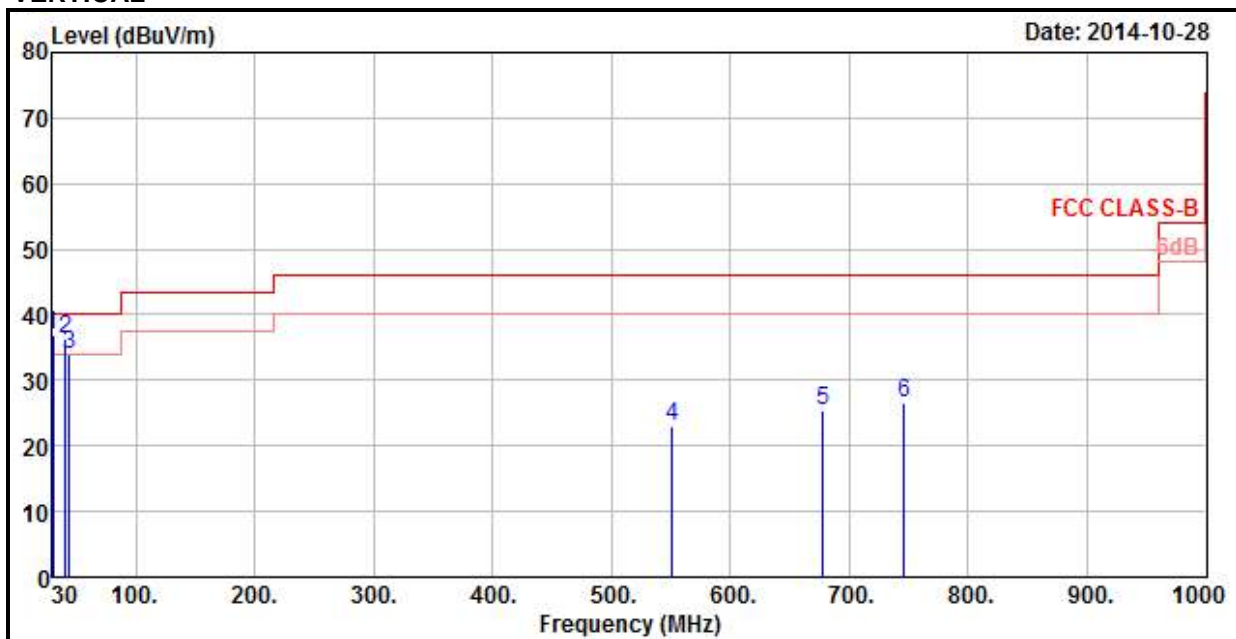



A D T

| ANTENNA POLARITY & TEST DISTANCE: HORIZONTAL AT 3 M |                         |                   |                |             |                       |                 |                    |                     |                      |        |
|---|-------------------------|-------------------|----------------|-------------|-----------------------|-----------------|--------------------|---------------------|----------------------|--------|
| FREQ. (MHz)   | EMISSION LEVEL (dBuV/m) | READ LEVEL (dBuV) | LIMIT (dBuV/m) | MARGIN (dB) | ANTENNA FACTOR (dB/m) | CABLE LOSS (dB) | PREAMP FACTOR (dB) | ANTENNA HEIGHT (cm) | TABLE ANGLE (Degree) | REMARK |
| 105.87  | 30.88                   | 52.05             | 43.5           | -12.62      | 9.62                  | 1.1             | 31.89              | 102                 | 152                  | Peak   |
| 167.97  | 35.99                   | 54.36             | 43.5           | -7.51       | 11.96                 | 1.43            | 31.76              | 113                 | 162                  | Peak   |
| 173.91  | 34.41                   | 53.34             | 43.5           | -9.09       | 11.38                 | 1.46            | 31.77              | 125                 | 185                  | Peak   |
| 572.3   | 22.75                   | 32.86             | 46             | -23.25      | 18.97                 | 3.01            | 32.09              | 100                 | 25                   | Peak   |
| 659.1   | 25.38                   | 33.72             | 46             | -20.62      | 20.33                 | 3.28            | 31.95              | 100                 | 119                  | Peak   |
| 748.7   | 27.67                   | 33.92             | 46             | -18.33      | 21.5                  | 3.57            | 31.32              | 109                 | 104                  | Peak   |
| ANTENNA POLARITY & TEST DISTANCE: VERTICAL AT 3 M   |                         |                   |                |             |                       |                 |                    |                     |                      |        |
| FREQ. (MHz)   | EMISSION LEVEL (dBuV/m) | READ LEVEL (dBuV) | LIMIT (dBuV/m) | MARGIN (dB) | ANTENNA FACTOR (dB/m) | CABLE LOSS (dB) | PREAMP FACTOR (dB) | ANTENNA HEIGHT (cm) | TABLE ANGLE (Degree) | REMARK |
| 30.54   | 37                      | 55.41             | 40             | -3          | 12.14                 | 0.57            | 31.12              | 108                 | 112                  | Peak   |
| 40.8  | 36.36                   | 53.16             | 40             | -3.64       | 13.55                 | 0.67            | 31.02              | 119                 | 201                  | Peak   |
| 43.77   | 33.94                   | 50.75             | 40             | -6.06       | 13.59                 | 0.71            | 31.11              | 117                 | 128                  | Peak   |
| 551.3   | 22.96                   | 33.49             | 46             | -23.04      | 18.48                 | 2.95            | 31.96              | 132                 | 156                  | Peak   |
| 678   | 25.33                   | 33.26             | 46             | -20.67      | 20.55                 | 3.35            | 31.83              | 110                 | 83                   | Peak   |
| 745.9   | 26.52                   | 32.87             | 46             | -19.48      | 21.46                 | 3.56            | 31.37              | 109                 | 171                  | Peak   |

**REMARKS:**

1. Emission Level = Read Level + Antenna Factor + Cable Loss - Preamp Factor

Margin value = Emission level – Limit value.

## 4.2 CONDUCTED EMISSION MEASUREMENT

### 4.2.1 LIMITS OF CONDUCTED EMISSION MEASUREMENT

| FREQUENCY OF EMISSION (MHz) | CONDUCTED LIMIT (dB $\mu$ V) |          |
|-----------------------------|------------------------------|----------|
|                             | Quasi-peak                   | Average  |
| 0.15 ~ 0.5                  | 66 to 56                     | 56 to 46 |
| 0.5 ~ 5                     | 56                           | 46       |
| 5 ~ 30                      | 60                           | 50       |

**NOTE:**

1. The lower limit shall apply at the transition frequencies.
2. The limit decreases in line with the logarithm of the frequency in the range of 0.15 to 0.50 MHz.
3. All emanations from a class A/B digital device or system, including any network of conductors and apparatus connected thereto, shall not exceed the level of field strengths specified above.

### 4.2.2 TEST INSTRUMENTS

| DESCRIPTION & MANUFACTURER              | MODEL NO.                | SERIAL NO.     | DATE OF CALIBRATION | DUE DATE OF CALIBRATION |
|---|--------------------------|----------------|---------------------|-------------------------|
| Test Receiver<br>ROHDE & SCHWARZ        | ESCS30                   | 100288         | Apr. 24, 2014       | Apr. 23, 2015           |
| RF signal cable<br>Woken                | 5D-FB                    | Cable-HYCO2-01 | Dec. 27, 2013       | Dec. 26, 2014           |
| LISN<br>ROHDE & SCHWARZ<br>(EUT)        | ESH2-Z5                  | 100100         | Dec. 23, 2013       | Dec. 22, 2014           |
| LISN<br>ROHDE & SCHWARZ<br>(Peripheral) | ESH3-Z5                  | 100312         | Jul. 10, 2014       | Jul. 09, 2015           |
| Software<br>ADT                         | BV ADT_Cond_<br>V7.3.7.3 | NA             | NA                  | NA                      |

**NOTE:**

1. The calibration interval of the above test instruments is 12 months and the calibrations are traceable to NML/ROC and NIST/USA.
2. The test was performed in HwaYa Shielded Room 2.
3. The VCCI Site Registration No. is C-2047.

#### 4.2.3 TEST PROCEDURES

- The EUT was placed 0.4 meters from the conducting wall of the shielded room with EUT being connected to the power mains through a line impedance stabilization network (LISN). Other support units were connected to the power mains through another LISN. The two LISNs provide 50 ohm/ 50uH of coupling impedance for the measuring instrument.
- Both lines of the power mains connected to the EUT were checked for maximum conducted interference.
- The frequency range from 150kHz to 30MHz was searched. Emission levels under (Limit - 20dB) was not recorded.

**NOTE:** All modes of operation were investigated and the worst-case emissions are reported.

#### 4.2.4 DEVIATION FROM TEST STANDARD

No deviation.

#### 4.2.5 TEST SETUP

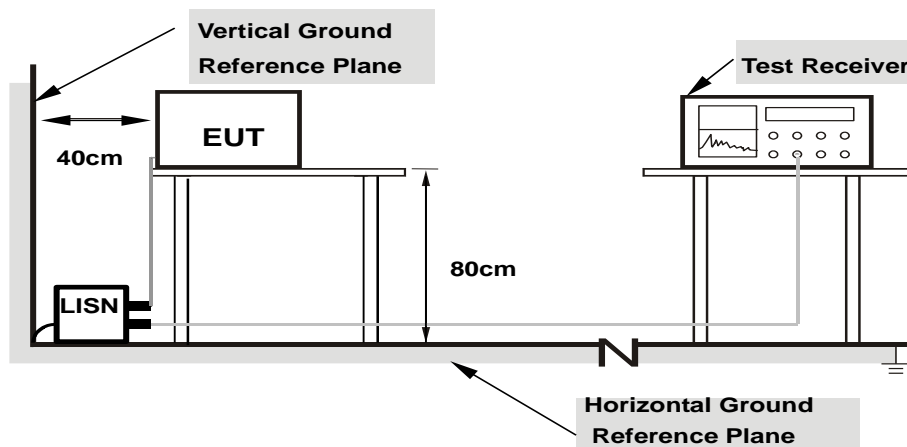

- Note:**
- Support units were connected to second LISN.
  - Both of LISNs (AMN) are 80 cm from EUT and at least 80 from other units and other metal planes

For the actual test configuration, please refer to the attached file (Test Setup Photo).

#### 4.2.6 EUT OPERATING CONDITIONS

Same as item 4.1.6.

### 4.2.7 TEST RESULTS

|              |        |                      |      |
|--------------|--------|----------------------|------|
| <b>PHASE</b> | Line 1 | <b>6dB BANDWIDTH</b> | 9kHz |
|--------------|--------|----------------------|------|

| No | Freq.<br>[MHz] | Corr.<br>Factor<br>(dB) | Reading Value |       | Emission Level |       | Limit     |       | Margin |        |
|----|----------------|-------------------------|---------------|-------|----------------|-------|-----------|-------|--------|--------|
|    |                |                         | [dB (uV)]     |       | [dB (uV)]      |       | [dB (uV)] |       | (dB)   |        |
|    |                |                         | Q.P.          | AV.   | Q.P.           | AV.   | Q.P.      | AV.   | Q.P.   | AV.    |
| 1  | 0.15000        | 0.26                    | 54.15         | 33.47 | 54.41          | 33.73 | 66.00     | 56.00 | -11.59 | -22.27 |
| 2  | 0.27891        | 0.29                    | 46.23         | 33.05 | 46.52          | 33.34 | 60.85     | 50.85 | -14.33 | -17.51 |
| 3  | 2.87891        | 0.39                    | 36.30         | 26.85 | 36.69          | 27.24 | 56.00     | 46.00 | -19.31 | -18.76 |
| 4  | 4.19141        | 0.43                    | 38.53         | 30.69 | 38.96          | 31.12 | 56.00     | 46.00 | -17.04 | -14.88 |
| 5  | 5.54297        | 0.45                    | 35.52         | 28.35 | 35.97          | 28.80 | 60.00     | 50.00 | -24.03 | -21.20 |
| 6  | 13.55859       | 0.52                    | 45.01         | 44.88 | 45.53          | 45.40 | 60.00     | 50.00 | -14.47 | -4.60  |

#### REMARKS:

1. Q.P. and AV. are abbreviations of quasi-peak and average individually.
2. The emission levels of other frequencies were very low against the limit.
3. Margin value = Emission level - Limit value
4. Correction factor = Insertion loss + Cable loss
5. Emission Level = Correction Factor + Reading Value

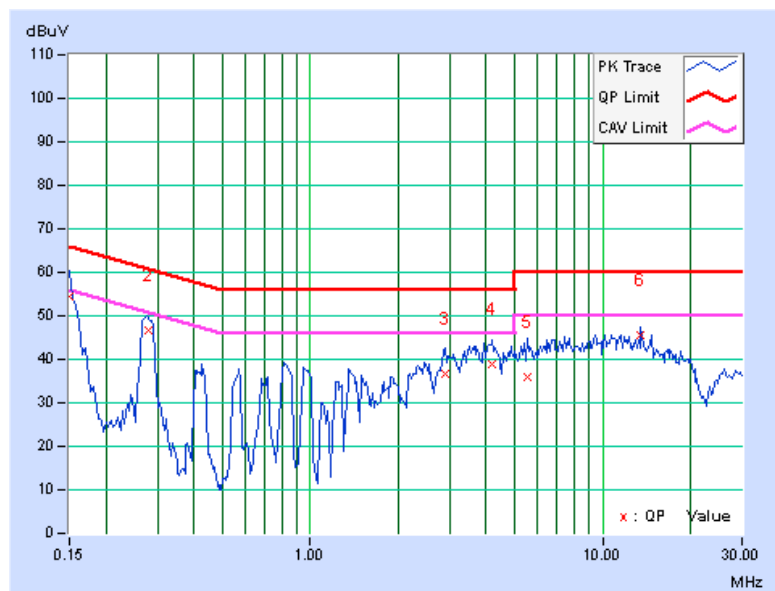

|       |        |               |      |
|-------|--------|---------------|------|
| PHASE | Line 2 | 6dB BANDWIDTH | 9kHz |
|-------|--------|---------------|------|

| No | Freq.<br>[MHz] | Corr.<br>Factor<br>(dB) | Reading Value |       | Emission Level |       | Limit     |       | Margin |        |
|----|----------------|-------------------------|---------------|-------|----------------|-------|-----------|-------|--------|--------|
|    |                |                         | [dB (uV)]     |       | [dB (uV)]      |       | [dB (uV)] |       | (dB)   |        |
|    |                |                         | Q.P.          | AV.   | Q.P.           | AV.   | Q.P.      | AV.   | Q.P.   | AV.    |
| 1  | 0.15000        | 0.26                    | 54.47         | 34.14 | 54.73          | 34.40 | 66.00     | 56.00 | -11.27 | -21.60 |
| 2  | 0.27500        | 0.29                    | 49.77         | 38.49 | 50.06          | 38.78 | 60.97     | 50.97 | -10.91 | -12.19 |
| 3  | 0.40781        | 0.30                    | 40.58         | 31.08 | 40.88          | 31.38 | 57.69     | 47.69 | -16.81 | -16.31 |
| 4  | 0.71250        | 0.32                    | 37.88         | 28.36 | 38.20          | 28.68 | 56.00     | 46.00 | -17.80 | -17.32 |
| 5  | 0.97813        | 0.34                    | 40.21         | 28.40 | 40.55          | 28.74 | 56.00     | 46.00 | -15.45 | -17.26 |
| 6  | 13.55859       | 0.55                    | 47.99         | 46.53 | 48.54          | 47.08 | 60.00     | 50.00 | -11.46 | -2.92  |

**REMARKS:**

1. Q.P. and AV. are abbreviations of quasi-peak and average individually.
2. The emission levels of other frequencies were very low against the limit.
3. Margin value = Emission level - Limit value
4. Correction factor = Insertion loss + Cable loss
5. Emission Level = Correction Factor + Reading Value

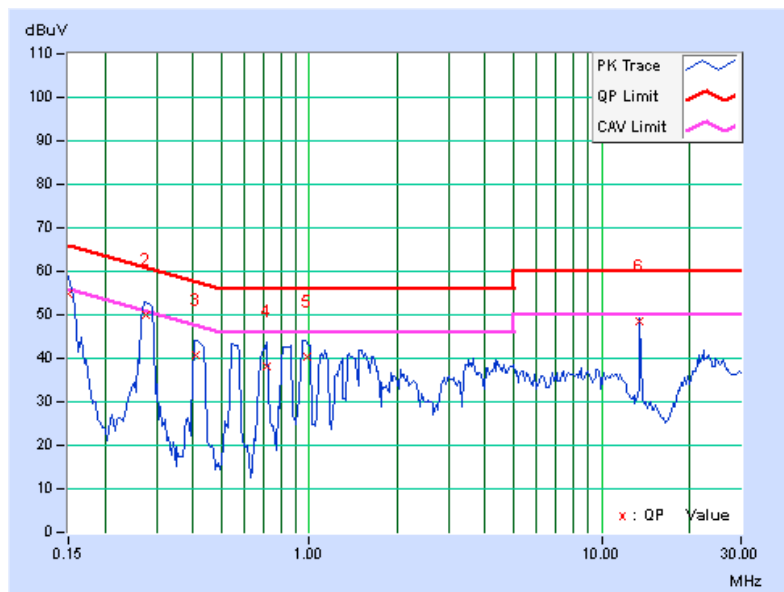

### 4.3 FREQUENCY STABILITY

#### 4.3.1 LIMITS OF FREQUENCY STABILITY MEASUREMENT

The frequency tolerance of the carrier signal shall be maintained within +/- 0.01% of the operating frequency over a temperature variation of -20 degrees to 50 degrees C at normal supply voltage, and for a variation in the primary supply voltage from 85% to 115% of the rated supply voltage at a temperature of 20 degrees C.

#### 4.3.2 TEST INSTRUMENTS

| DESCRIPTION & MANUFACTURER     | MODEL NO.        | SERIAL NO.  | DATE OF CALIBRATION | DUE DATE OF CALIBRATION |
|--------------------------------|------------------|-------------|---------------------|-------------------------|
| R&S SPECTRUM ANALYZER          | FSU43            | 101261      | Dec. 21, 2013       | Dec. 20, 2014           |
| Temperature & Humidity Chamber | GTH-120-40-CP-AR | MAA1306-019 | Sep. 01, 2014       | Aug. 31, 2015           |

**NOTE:** The calibration interval of the above test instruments is 12 months and the calibrations are traceable to NML/ROC and NIST/USA.

#### 4.3.3 TEST PROCEDURE

- a. The EUT was placed inside the environmental test chamber and powered by nominal DC voltage.
- b. Turn the EUT on and couple its output to a spectrum analyzer.
- c. Turn the EUT off and set the chamber to the highest temperature specified.
- d. Allow sufficient time (approximately 30 min) for the temperature of the chamber to stabilize, turn the EUT on and measure the operating frequency after 2, 5, and 10 minutes.
- e. Repeat step 2 and 3 with the temperature chamber set to the lowest temperature.
- f. The test chamber was allowed to stabilize at +20 degree C for a minimum of 30 minutes. The supply voltage was then adjusted on the EUT from 85% to 115% range and the frequency record.

#### 4.3.4 DEVIATION FROM TEST STANDARD

No deviation.



### 4.3.5 TEST SETUP

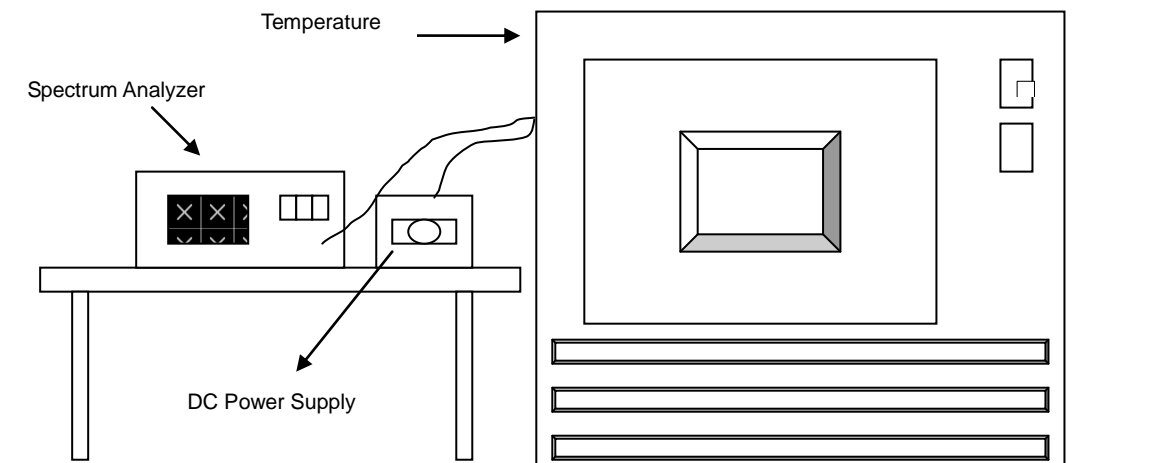

### 4.3.6 EUT OPERATING CONDITION

Same as item 4.1.6.



**4.3.7 TEST RESULTS**

| FREQUENCY STABILITY VERSUS TEMP. |                    |                    |                 |                    |                 |                    |                 |                    |                 |
|----------------------------------|--------------------|--------------------|-----------------|--------------------|-----------------|--------------------|-----------------|--------------------|-----------------|
| TEMP. (°C)                       | POWER SUPPLY (Vdc) | 0 MINUTE           |                 | 2 MINUTE           |                 | 5 MINUTE           |                 | 10 MINUTE          |                 |
|                                  |                    | Measured Frequency | Frequency Drift | Measured Frequency | Frequency Drift | Measured Frequency | Frequency Drift | Measured Frequency | Frequency Drift |
|                                  |                    | (MHz)              | %               | (MHz)              | %               | (MHz)              | %               | (MHz)              | %               |
| 50                               | 3.8                | 13.560008          | 0.00006         | 13.560004          | 0.00003         | 13.560006          | 0.00004         | 13.559997          | -0.00002        |
| 40                               | 3.8                | 13.560027          | 0.00020         | 13.560049          | 0.00036         | 13.560028          | 0.00021         | 13.560005          | 0.00037         |
| 30                               | 3.8                | 13.560018          | 0.00013         | 13.560024          | 0.00018         | 13.560024          | 0.00018         | 13.560031          | 0.00023         |
| 20                               | 3.8                | 13.560066          | 0.00049         | 13.560072          | 0.00053         | 13.560054          | 0.00040         | 13.560068          | 0.00050         |
| 10                               | 3.8                | 13.560018          | 0.00013         | 13.560001          | 0.00007         | 13.560014          | 0.00010         | 13.560031          | 0.00023         |
| 0                                | 3.8                | 13.560025          | 0.00018         | 13.560017          | 0.00013         | 13.560017          | 0.00013         | 13.560028          | 0.00021         |
| -10                              | 3.8                | 13.560004          | 0.00003         | 13.560001          | 0.00007         | 13.560019          | 0.00014         | 13.560016          | 0.00012         |
| -20                              | 3.8                | 13.560042          | 0.00031         | 13.560025          | 0.00018         | 13.560037          | 0.00027         | 13.560034          | 0.00025         |

| FREQUENCY STABILITY VERSUS VOLTAGE |                    |                    |                 |                    |                 |                    |                 |                    |                 |
|------------------------------------|--------------------|--------------------|-----------------|--------------------|-----------------|--------------------|-----------------|--------------------|-----------------|
| TEMP. (°C)                         | POWER SUPPLY (Vdc) | 0 MINUTE           |                 | 2 MINUTE           |                 | 5 MINUTE           |                 | 10 MINUTE          |                 |
|                                    |                    | Measured Frequency | Frequency Drift | Measured Frequency | Frequency Drift | Measured Frequency | Frequency Drift | Measured Frequency | Frequency Drift |
|                                    |                    | (MHz)              | %               | (MHz)              | %               | (MHz)              | %               | (MHz)              | %               |
| 20                                 | 4.35               | 13.560063          | 0.00046         | 13.560007          | 0.00052         | 13.560051          | 0.00038         | 13.560066          | 0.00049         |
|                                    | 3.8                | 13.560066          | 0.00049         | 13.560072          | 0.00053         | 13.560054          | 0.00040         | 13.560068          | 0.00050         |
|                                    | 3.6                | 13.560064          | 0.00047         | 13.560073          | 0.00054         | 13.560056          | 0.00041         | 13.560068          | 0.00050         |

## **4.4 20dB BANDWIDTH**

### **4.4.1 LIMITS OF 20dB BANDWIDTH MEASUREMENT**

The 20dB bandwidth shall be specified in operating frequency band.

### **4.4.2 TEST INSTRUMENTS**

Same as item 4.1.2.

### **4.4.3 TEST PROCEDURE**

The bandwidth of the fundamental frequency was measured by spectrum analyzer with 1kHz RBW and 3kHz VBW. The 20dB bandwidth is defined as the total spectrum the power of which is higher than peak power minus 20dB.

### **4.4.4 DEVIATION FROM TEST STANDARD**

No deviation.

### **4.4.5 TEST SETUP**

Same as item 4.1.5.

### **4.4.6 EUT OPERATING CONDITION**

Same as item 4.1.6.



A D T

### 4.4.7 TEST RESULTS

| 20dBc point (Low) | 20dBc point (High) | Operating frequency band (MHz) | PASS/FAIL |
|-------------------|--------------------|--------------------------------|-----------|
| 13.557980769 MHz  | 13.560544872 MHz   | 13.553~13.567                  | PASS      |

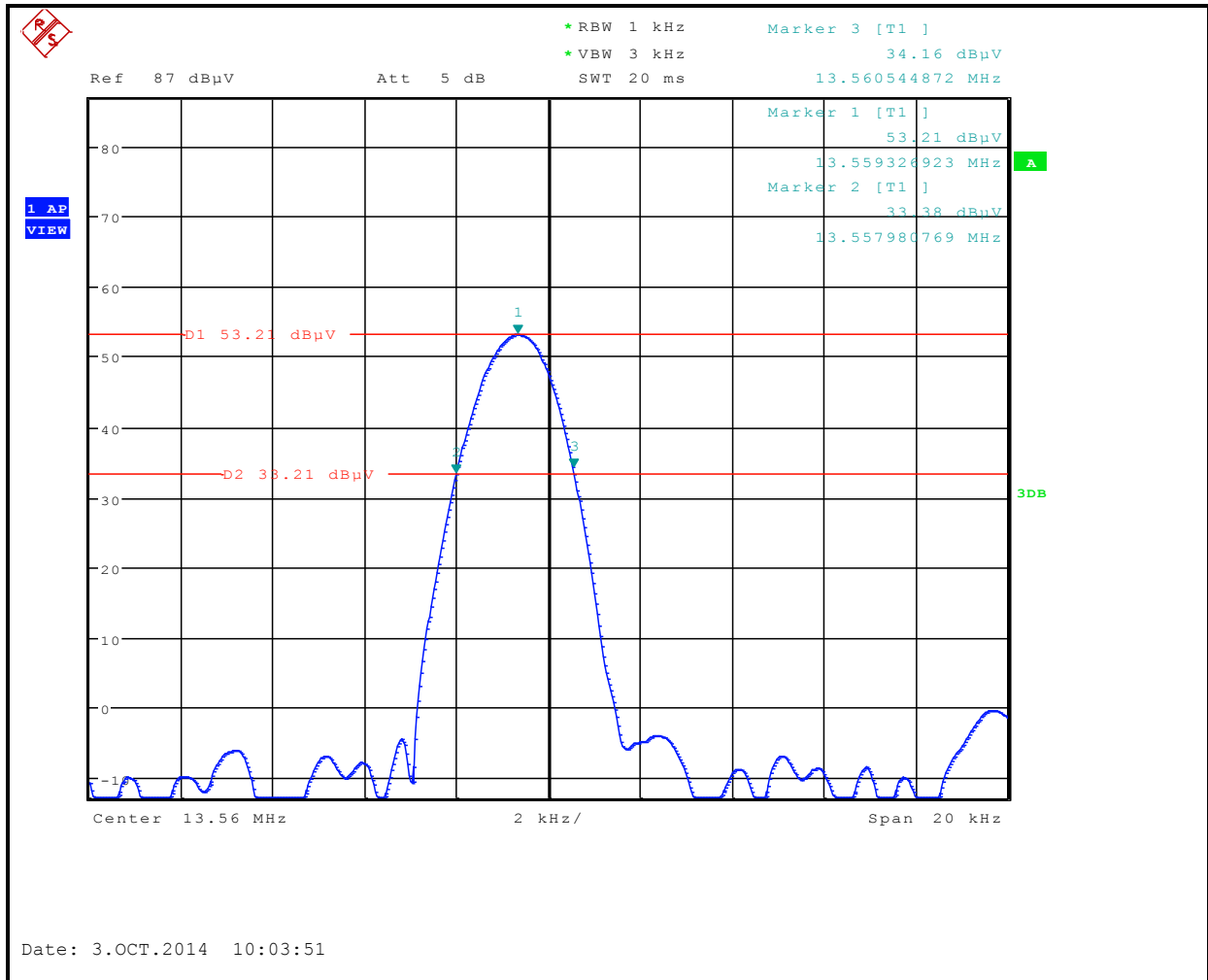

## 5. PHOTOGRAPHS OF THE TEST CONFIGURATION

Please refer to the attached file (Test Setup Photo).

## 6. INFORMATION ON THE TESTING LABORATORIES

We, Bureau Veritas Consumer Products Services (H.K.) Ltd., Taoyuan Branch, were founded in 1988 to provide our best service in EMC, Radio, Telecom and Safety consultation. Our laboratories are accredited and approved according to ISO/IEC 17025.

If you have any comments, please feel free to contact us at the following:

**Linko EMC/RF Lab:**

Tel: 886-2-26052180

Fax: 886-2-26051924

**Hsin Chu EMC/RF/Telecom Lab:**

Tel: 886-3-5935343

Fax: 886-3-5935342

**Hwa Ya EMC/RF/Safety Lab:**

Tel: 886-3-3183232

Fax: 886-3-3270892

**Email:** [service.adt@tw.bureauveritas.com](mailto:service.adt@tw.bureauveritas.com)

**Web Site:** [www.bureauveritas-adt.com](http://www.bureauveritas-adt.com)

The address and road map of all our labs can be found in our web site also.

## **7. APPENDIX A - MODIFICATIONS RECORDERS FOR ENGINEERING CHANGES TO THE EUT BY THE LAB**

No any modifications are made to the EUT by the lab during the test.

--- END ---