



TEST REPORT

No.I22N01710-NFC

for

Guangdong OPPO Mobile Telecommunications Corp., Ltd.

Mobile Phone

Model Name: CPH2483

with

Hardware Version: 11

Software Version: ColorOS V13.0

FCC ID: R9C-CPH2483

Issued Date: 2022-10-25

Designation Number: CN1210

Note:

The test results in this test report relate only to the devices specified in this report. This report shall not be reproduced except in full without the written approval of SAICT.

Test Laboratory:

SAICT, Shenzhen Academy of Information and Communications Technology

Building G, Shenzhen International Innovation Center, No.1006 Shennan Road, Futian District, Shenzhen, Guangdong, P. R. China 518000.

Tel:+86(0)755-33322000, Fax:+86(0)755-33322001

Email: yewu@caict.ac.cn www.saict.ac.cn

©Copyright. All rights reserved by SAICT.

CONTENTS

1. SUMMARY OF TEST REPORT	3
1.1. TEST ITEMS	3
1.2. TEST STANDARDS	3
1.3. TEST RESULT	3
1.4. TESTING LOCATION	3
1.5. PROJECT DATA	3
1.6. SIGNATURE	3
2. CLIENT INFORMATION	4
2.1. APPLICANT INFORMATION	4
2.2. MANUFACTURER INFORMATION	4
3. EQUIPMENT UNDER TEST (EUT) AND ANCILLARY EQUIPMENT (AE)	5
3.1. ABOUT EUT	5
3.2. INTERNAL IDENTIFICATION OF EUT USED DURING THE TEST	5
3.3. INTERNAL IDENTIFICATION OF AE USED DURING THE TEST	5
3.4. GENERAL DESCRIPTION	6
3.5. EUT SET-UPS	6
4. REFERENCE DOCUMENTS	7
4.1. DOCUMENTS SUPPLIED BY APPLICANT	7
4.2. REFERENCE DOCUMENTS FOR TESTING	7
5. TEST RESULTS	8
5.1. TESTING ENVIRONMENT	8
5.2. TEST RESULTS	8
5.3. STATEMENTS	8
6. TEST EQUIPMENTS UTILIZED	9
7. LABORATORY ENVIRONMENT	10
ANNEX A: MEASUREMENT RESULTS	11
A.1. ELECTRIC FIELD STRENGTH OF FUNDAMENTAL AND OUTSIDE THE ALLOCATED BANDS	11
A.2. ELECTRIC FIELD RADIATED EMISSIONS (<30MHz)	13
A.3. ELECTRIC FIELD RADIATED EMISSIONS (\geq 30MHz).....	15
A.4. FREQUENCY TOLERANCE	17
A.5. 20dB BANDWIDTH	19
A.6. CONDUCTED EMISSION	21



1. Summary of Test Report

1.1. Test Items

Description	Mobile Phone
Model Name	CPH2483
Applicant's name	Guangdong OPPO Mobile Telecommunications Corp., Ltd.
Manufacturer's Name	Guangdong OPPO Mobile Telecommunications Corp., Ltd.

1.2. Test Standards

FCC Part15-2021; ANSI C63.10-2013; ANSI C63.4-2014.

1.3. Test Result

Pass

Please refer to "5.2. Test Results"

1.4. Testing Location

Address: Building G, Shenzhen International Innovation Center, No.1006 Shennan Road, Futian District, Shenzhen, Guangdong, P. R. China

1.5. Project data

Testing Start Date:	2022-10-07
Testing End Date:	2022-10-25

1.6. Signature

Lin Zechuang
(Prepared this test report)

An Ran
(Reviewed this test report)

Zhang Bojun
(Approved this test report)



2. Client Information

2.1. Applicant Information

Company Name: Guangdong OPPO Mobile Telecommunications Corp., Ltd.
Address: NO.18 Haibin Road, Wusha Village, Chang'an Town, Dongguan City,
Guangdong, China
Contact Person Mei XiLi
E-Mail (86)76986076999
Telephone: meixili@oppo.com
Fax: /

2.2. Manufacturer Information

Company Name: Guangdong OPPO Mobile Telecommunications Corp., Ltd.
Address: NO.18 Haibin Road, Wusha Village, Chang'an Town, Dongguan City,
Guangdong, China
Contact Person Mei XiLi
E-Mail (86)76986076999
Telephone: meixili@oppo.com
Fax: /



3. Equipment Under Test (EUT) and Ancillary Equipment (AE)

3.1. About EUT

Description	Mobile Phone
Model Name	CPH2483
Frequency	13.56MHz
Equipment type	Near Field Communication (NFC)
Antenna type	Integrated antenna
Power Supply	3.87V DC by Battery
FCC ID	R9C-CPH2483
Condition of EUT as received	No abnormality in appearance

Note: Components list, please refer to documents of the manufacturer; it is also included in the original test record of Shenzhen Academy of Information and Communications Technology.

3.2. Internal Identification of EUT used during the test

EUT ID*	IMEI	HW Version	SW Version	Receive Date
UT03aa	869062060030632	11	ColorOS V13.0	2022-09-08
	869062060030624			
UT09aa	869062060033933	11	ColorOS V13.0	2022-09-13
	869062060033925			
UT10aa	869062060031390	11	ColorOS V13.0	2022-09-13
	869062060031382			

*EUT ID: is used to identify the test sample in the lab internally.

UT03aa is used for conduction test, UT09aa is used for radiation test, and UT10aa is used for AC Power line Conducted Emission test.

3.3. Internal Identification of AE used during the test

AE ID*	Description	AE ID*
AE1	Power Supply	/
AE2	NFC Card	/
AE3	Battery	/
AE4	Charger	Ab01a,Ab02a
AE5	USB Cable	Ca01a,Ca02a

AE1/AE2

/

AE3

Model	BLP923
Manufacturer	Chongqing Cosmx Battery Co., Ltd.
Capacity	4880mAh
Nominal Voltage	3.87 V

AE4



Model VCB3HDUH
Manufacturer SHENZHEN HUNTKEY ELECTRIC CO., LTD.
Specification American Standard Charger
AE5
Model DL150
Manufacturer /

*AE ID and AE Label: is used to identify the test sample in the lab internally.

3.4. **General Description**

Equipment under Test (EUT) is a model of Mobile Phone with FPC+ferrite antenna and battery. It consists of normal options: Lithium Battery, Charger and USB Cable. Manual and specifications of the EUT were provided to fulfil the test. Samples undergoing test were selected by the client.

3.5. **EUT Set-ups**

EUT Set-up No.	Combination of EUT and AE	Remarks
Set. NFC01	EUT+AE1+AE2	NFC RF, TX test
Set. NFC02	EUT+AE1	NFC RF, RX test

CE_test.apk is installed in the EUT which helps to control the NFC signal transmitting.

The Transmit State of NFC: the NFC function is on. The EUT will transmit the NFC data and command continuously during the test.

The Transmit State without modulation: The EUT will transmit the CW signal at the operating frequency.



4. Reference Documents

4.1. Documents supplied by applicant

EUT feature information is supplied by the applicant or manufacturer, which is the basis of testing.

4.2. Reference Documents for testing

The following documents listed in this section are referred for testing.

Reference	Title	Version
FCC Part 15	FCC CFR 47,Part 15,Subpart C	2021
ANSI C63.10	American National Standard of Procedures for Compliance Testing of Unlicensed Wireless Devices	2013
ANSI C63.4	American National Standard for Methods of Measurement of Radio-Noise Emissions from Low-Voltage Electrical and Electronic Equipment in the Range of 9 kHz to 40 GHz.	2014

5. Test Results

5.1. Testing Environment

Normal Temperature: 15~35°C

Relative Humidity: 20~75%

5.2. Test Results

No	Test Cases	Sub-clause of Part 15C	Section in This Report	Verdict
1	Electric Field Strength of Fundamental Emissions	CFR 47 § 15.225(a)	A.1	P
2	Electric Field Strength of Outside the Allocated Bands	CFR 47 § 15.225(b) CFR 47 § 15.225(c)		P
3	Electric Field Radiated Emissions	CFR 47 § 15.209	A.2	P
		CFR 47 § 15.225(d)	A.3	P
4	Frequency Tolerance	CFR 47 § 15.225(e)	A.4	P
5	20dB Bandwidth	CFR 47 § 15.215(c)	A.5	P
6	Conducted Emissions	CFR 47 § 15.207	A.6	P

The measurement is carried out according to ANSI C63.10 and ANSI C63.4.
See **ANNEX A** for details.

5.3. Statements

The test cases listed in Section 5.2 of this report for the EUT specified in Section 3 were performed by SAICT according to the reference documents in Section 4.

The EUT meets all applicable requirements of the regulations and standards in Section 4.2.

This report only deals with the NFC function among the features described in section 3.

Disclaimer:

A. After confirmation with the customer, the sample information provided by the customer may affect the validity of the measurement results in this report, and the impact and consequences arising therefrom shall be borne by the customer.

B. The samples in this report are provided by the customer, and the test results are only applicable to the samples received.

6. Test Equipments Utilized

Conducted test system

No.	Equipment	Model	Serial Number	Manufacturer	Calibration Due date	Calibration Period
1	Vector Signal Analyzer	FSV40	100903	Rohde & Schwarz	2022-12-29	1 year
2	DC Power Supply	NGSM	5425	Rohde & Schwarz	2022-11-07	1 year

Climate chamber

No.	Equipment	Model	Serial Number	Manufacturer	Calibration Due date	Calibration Period
1	Climate chamber	SU-242	93008165	ESPEC	2023-03-13	1 year

Radiated emission test system

No.	Equipment	Model	Serial Number	Manufacturer	Calibration Due date	Calibration Period
1	Test Receiver	ESR7	101676	Rohde & Schwarz	2022-11-24	1 year
2	BiLog Antenna	3142E	0224831	ETS-Lindgren	2024-05-27	3 years
3	Anechoic Chamber	FACT3-2.0	1285	ETS-Lindgren	2023-05-29	2 years
4	Loop Antenna	HLA6120	35779	TESEQ	2025-05-12	3 years
5	Test Receiver	ESCI	100702	Rohde & Schwarz	2023-01-12	1 year
6	LISN	ENV216	102067	Rohde & Schwarz	2023-07-14	1 year

Test software

No.	Equipment	Manufacturer	Version
1	JS1120-3	Tonscend	3.2
2	EMC32	Rohde & Schwarz	10.50.40

7. Laboratory Environment

Shielded room

Temperature	Min. = 15 °C, Max. = 35 °C
Relative humidity	Min. = 20 %, Max. = 75 %
Shielding effectiveness	0.014MHz-1MHz> 60 dB; 1MHz-18000MHz>90 dB
Electrical insulation	> 2M Ω
Ground system resistance	< 4 Ω

Anechoic chamber

Temperature	Min. = 15 °C, Max. = 35 °C
Relative humidity	Min. = 20 %, Max. = 75 %
Shielding effectiveness	0.014MHz-1MHz> 60 dB; 1MHz-18000MHz>90 dB
Electrical insulation	> 2M Ω
Ground system resistance	< 4 Ω
Normalised site attenuation (NSA)	< \pm 4 dB, 3 m distance, from 30 to 1000 MHz
Voltage Standing Wave Ratio (VSWR)	\leq 6 dB, from 1 to 18 GHz, 3m distance
Uniformity of field strength	Between 0 and 6 dB, from 80 to 6000 MHz

ANNEX A: MEASUREMENT RESULTS

A.1. Electric Field Strength of Fundamental and Outside the Allocated bands

A.1.1. Reference

See CFR 47 § 15.225

A.1.2. Measurement Methods

The transmitter carrier output levels (E-Field) from the EUT are measured in a semi-anechoic chamber. The EUT is placed on a non-conductive stand of 80cm high, and at a measurement distance of 3m from the receiving antenna. The center of the receiving loop antenna is 1.0 meter above the ground. The E-field is measured with a shielded loop antenna connected to a measurement receiver. Detected E-field was maximized by rotating the EUT through 360° and adjusting the receiving antenna polarizations. The maximization processes were repeated with the EUT positioned respectively in its three orthogonal axes. The measurements were performed with the peak detector and if required, the quasi-peak detector.

The measurement bandwidth is:

Frequency of Emission (MHz)	RBW/VBW
12.56-14.56	10/30 kHz

The E-field measured at 3m is calculated as:

$$E\text{-field (dB}\mu\text{V/m)} = Rx \text{ (dB}\mu\text{V)} + \text{Cable Loss (dB)} + AF@3m \text{ (dB/m)}$$

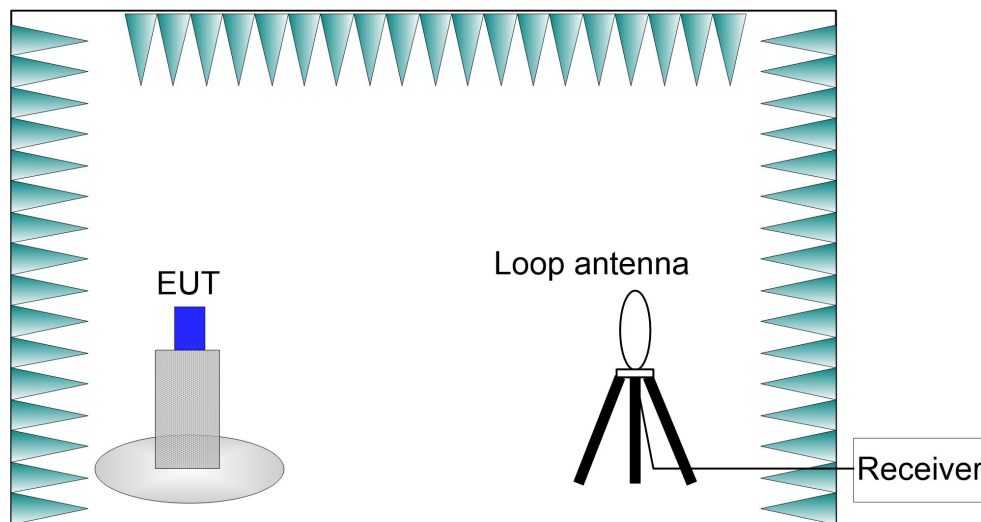

A.1.3. EUT Operating Mode and Test Conditions

The measurement of EUT is carried out under the transmit state of NFC (See 3.5).

The EUT is powered by a travel adapter.

During the measurements, the ambient temperature of the electromagnetic anechoic chamber is in the range of 15 ~ 25°C.

A.1.4. Limits

Frequency Range (MHz)	E-field Strength Limit @ 30 m ($\mu\text{V}/\text{m}$)	E-field Strength Limit @ 3 m ($\text{dB}\mu\text{V}/\text{m}$)
13.560 \pm 0.007	+15,848	124
13.410 to 13.553 13.567 to 13.710	+334	90
13.110 to 13.410 13.710 to 14.010	+106	81

Note: Where the limits have been defined at one distance, and a signal level measured at another, the limits have been extrapolated using the following formula:
 Extrapolation (dB) = 40 * \log_{10} (Measurement Distance / Specification Distance)

A.1.5. Measurement Results

Measurement results of normal conditions see Figure A-1 for different set-ups of EUT. The result displayed take into account applicable antenna factors and cable losses.

Conclusions: PASS.

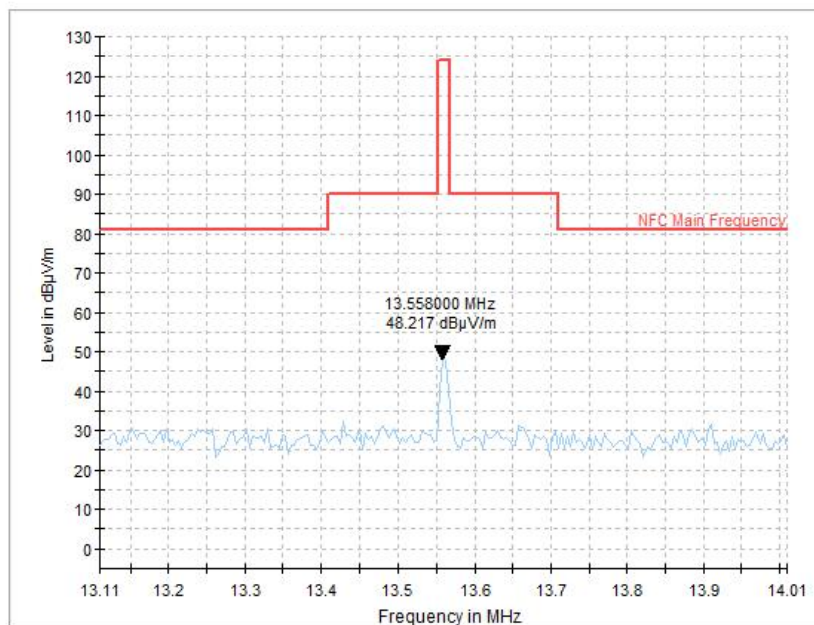

Figure A-1 Electric Field Strength

A.1.6. Measurement Uncertainty

Measurement uncertainty: $U = 1.79$ dB, $k=2$.

A.2. Electric Field Radiated Emissions (<30MHz)

A.2.1. Reference

See CFR 47 § 15.209

See CFR 47 § 15.225(d)

A.2.2. Measurement Methods

The transmitter carrier output levels (E-Field) from the EUT are measured in a semi-anechoic chamber. The EUT is placed on a non-conductive stand of 80cm high, and at a measurement distance of 3m from the receiving antenna. The center of the receiving loop antenna is 1.0 meter above the ground. The E-field is measured with a shielded loop antenna connected to a measurement receiver. Detected E-field was maximized by rotating the EUT through 360° and adjusting the receiving antenna polarizations. The maximization processes were repeated with the EUT positioned respectively in its three orthogonal axes. The measurements were performed with the peak detector and if required, the quasi-peak detector.

The measurement bandwidth is:

Frequency of Emission (MHz)	RBW/VBW
0.009-0.15	100/300 Hz
0.15-30	10/30 kHz

The E-field measured at 3m is calculated as:

$$\text{E-field (dB}\mu\text{V/m)} = \text{Rx (dB}\mu\text{V)} + \text{Cable Loss (dB)} + \text{AF@3m (dB/m)}$$

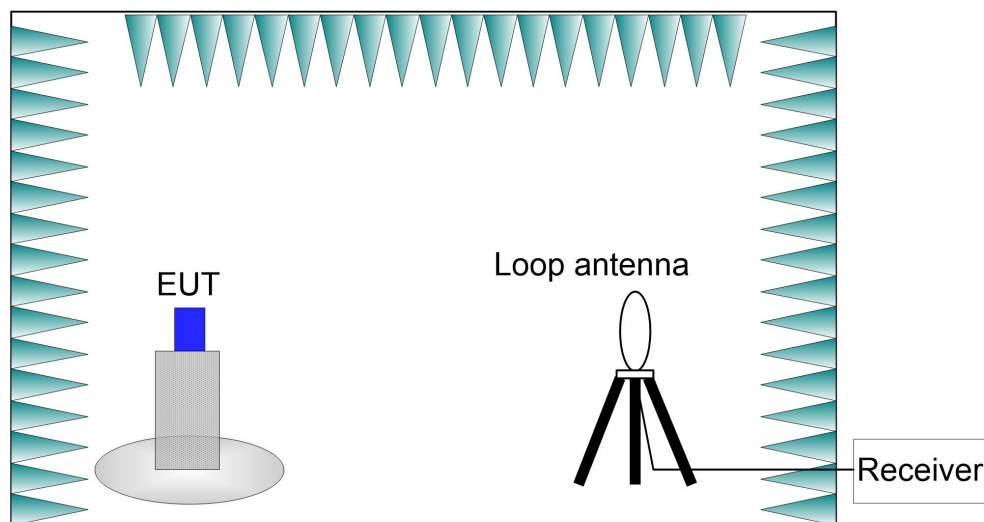

A.2.3. EUT Operating Mode and Test Conditions

The measurement of EUT is carried out under the transmit state of NFC (See 3.5).

The EUT is powered by a travel adapter.

During the measurements, the ambient temperature of the electromagnetic anechoic chamber is in the range of 15 ~ 25°C.

A.2.4. Limits

Frequency Range (MHz)	E-field Strength Limit @ 30m (μV/m)	E-field Strength Limit @ 3m (dBμV/m)
0.009-0.490	2400/F(kHz)	129-94
0.490-1.705	24000/F(kHz)	74-63
1.705-30	30	70

Note: Where the limits have been defined at one distance, and a signal level measured at another, the limits have been extrapolated using the following formula:
 Extrapolation (dB) = 40 * log₁₀(Measurement Distance / Specification Distance)

A.2.5. Measurement Results

Measurement results of normal conditions see Figure A-2 for different set-ups of EUT. The result displayed take into account applicable antenna factors and cable losses.

Conclusions: PASS.

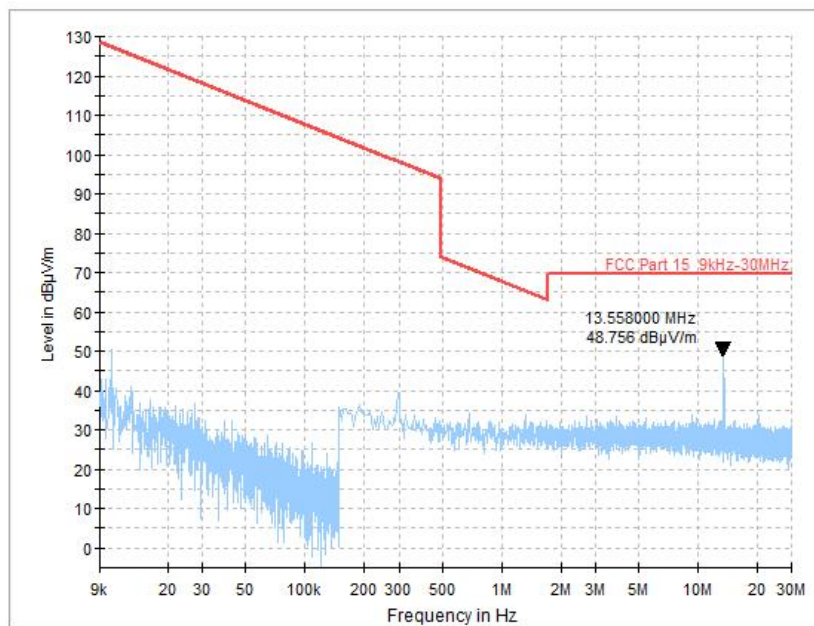

Figure A-2 Transmit State (9kHz-30MHz)

A.2.6. Measurement Uncertainty

Measurement uncertainty: $U = 1.79 \text{ dB}$, $k=2$.

A.3. Electric Field Radiated Emissions ($\geq 30\text{MHz}$)

A.3.1. Reference

See CFR 47 § 15.209

See CFR 47 § 15.225(d)

A.3.2. Measurement Methods

The electric field radiated emissions from the EUT are measured in a semi-anechoic chamber. The EUT is placed on a non-conductive stand of 80cm high, and at a measurement distance of 3m from the receiving antenna. The receiving antennas connected to a measurement receiver comply with the standard requirements. In order to search for maximum field strength emitted from the EUT, the receiving antenna can be moved between the height of 1.0 m to 4.0 m. Detected E-field was maximized at each frequency by rotating the EUT through 360° and adjusting the receiving antenna positions for both vertical and horizontal antenna polarizations. The maximization processes were repeated with the EUT positioned respectively in its three orthogonal axes. The measurements were performed with the peak detector and if required, the quasi-peak detector.

The measurement bandwidth is:

Frequency of Emission (MHz)	RBW/VBW
30-1000	120kHz

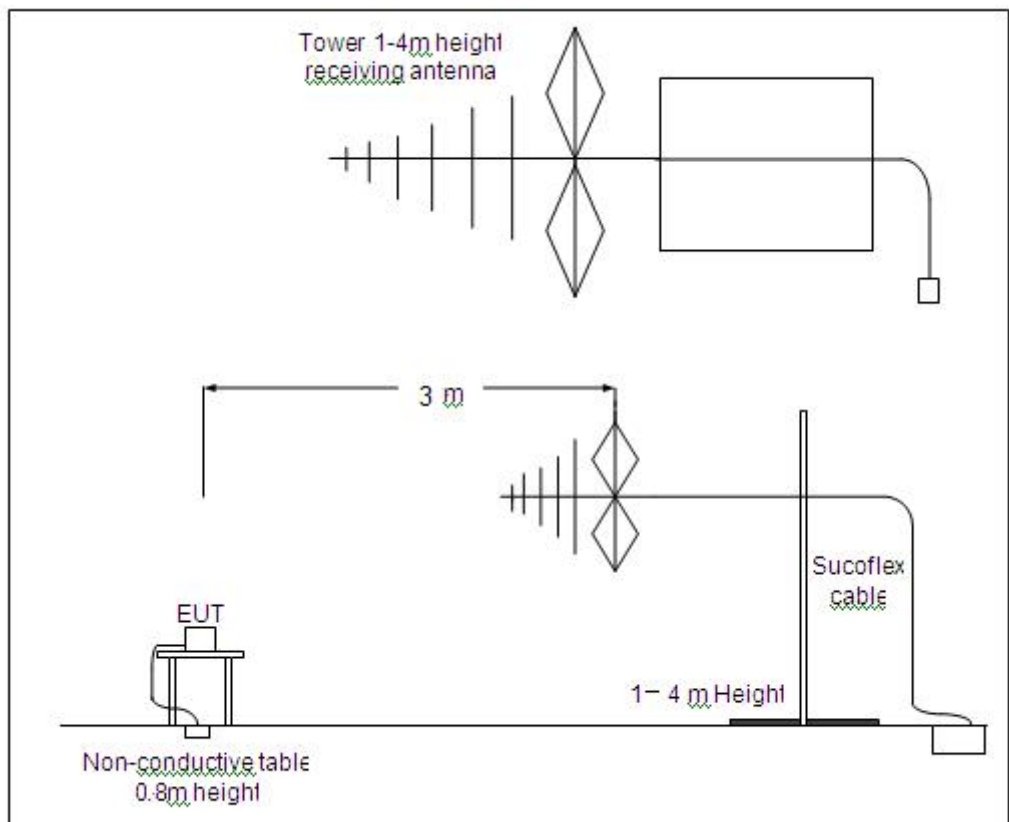

A.3.3. EUT Operating Mode and Test Conditions

The measurement of EUT is carried out under the transmit state of NFC (See 3.5).

EUT had been connected to a travel adapter.

During the measurements, the ambient temperature of the electromagnetic anechoic chamber is in the range of 15 ~ 25°C.

A.3.4. Limits

Frequency Range (MHz)	E-field Strength Limit @ 3m (µV/m)	E-field Strength Limit @ 3m (dBµV/m)	E-field Strength Limit @ 10m (dBµV/m)
30-88	100	40	30
88-216	150	43.5	33.5
216-960	200	46	36
960-1000	500	54	44

A.3.5. Measurement Results

Measurement results of normal conditions see Figure A-3 for different set-ups of EUT. The result displayed take into account applicable antenna factors and cable losses.

Conclusions: PASS.

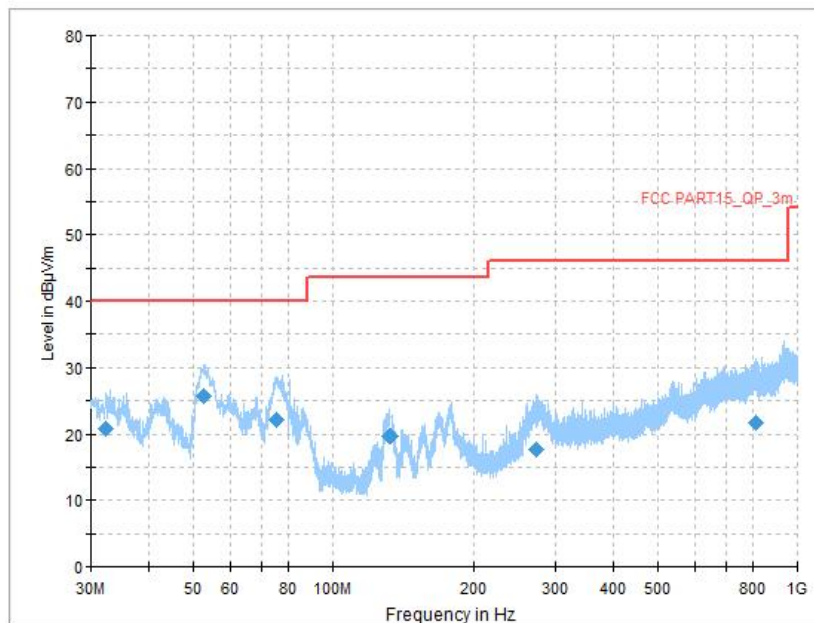

Figure A-3 Transmit State (30MHz-1GHz)

A.3.6. Measurement Uncertainty

Measurement uncertainty: $U = 4.86$ dB, $k=2$

A.4. Frequency Tolerance

A.4.1. Reference

See CFR 47 § 15.225(e)

A.4.2. Measurement Methods

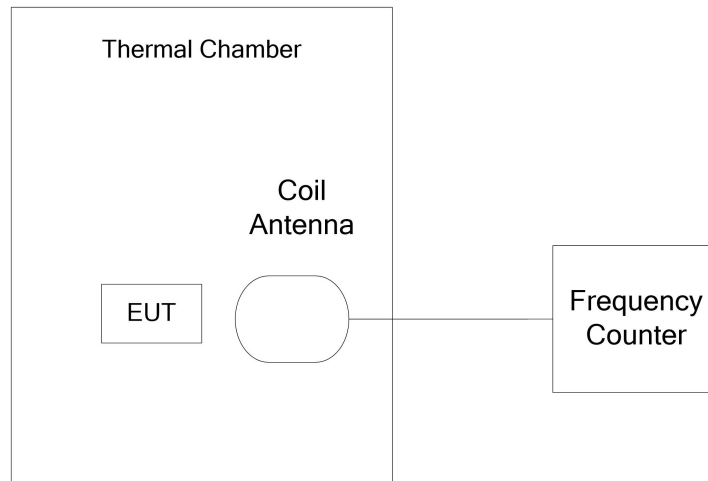

The transmitter output signal was picked up by coil antenna connected to the frequency counter. The center frequency was measured with 30Hz RBW and 1kHz span. During the test, the EUT was placed in a thermal chamber until thermal balance and lasting appropriate time.

A.4.3. EUT Operating Mode and Test Conditions

The measurement of EUT is carried out under the transmit state of without modulation (See 3.5). EUT had been not connected to a travel adapter.
Operation Temperature: T min, T nom, and T max with V nom.
Operation Voltage: V min and V max with T nom.

A.4.4. Test Layouts

See A.4.2.

A.4.5. Limits

The frequency tolerance of the carrier signal shall be maintained within +/- 0.01% of the operating frequency.

A.4.6. Measurement Results

Measurement results see Table A-1 for different test conditions.

Conclusions: PASS.

**Table A-1: Frequency Stability VS Temperature and Voltage**

Temperature	Voltage	Frequency Error (MHz)			
		Startup	2 Min Later	5 Min Later	10 Min Later
T min	V nom	13.559938	13.559940	13.559942	13.559945
T max	V nom	13.559942	13.559949	13.559948	13.559948
T nom	V nom	13.559940	13.559940	13.559940	13.559941
T nom	V min	13.559939	13.559939	13.559936	13.559938
T nom	V max	13.559940	13.559940	13.559945	13.559946

Temperature	Voltage	Frequency Error (%)			
		Startup	2 Min Later	5 Min Later	10 Min Later
T min	V nom	0.00	0.00	0.00	0.00
T max	V nom	0.00	0.00	0.00	0.00
T nom	V nom	0.00	0.00	0.00	0.00
T nom	V min	0.00	0.00	0.00	0.00
T nom	V max	0.00	0.00	0.00	0.00

Note: T min= -20°C, T max= 50°C, T nom ≈20°C, V min=3.29V, V max=4.45V, V nom=3.87V

A.4.7. Measurement Uncertainty

Measurement uncertainty: $U = 77$ Hz, $k=2$

A.5. 20dB Bandwidth

A.5.1. Reference

See CFR 47 § 15.215(c)

A.5.2. Measurement Methods

The transmitter output signal was picked up by coil antenna to the spectrum analyzer.

The transmitter output signal was picked up by coil antenna connected to the spectrum analyzer.

The bandwidth of the center frequency was measured with 100Hz RBW, 300Hz VBW and 10kHz span.

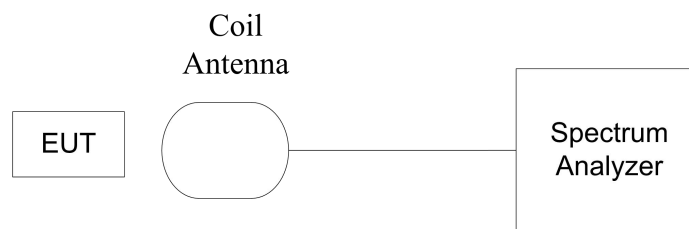

A.5.3. EUT Operating Mode and Test Conditions

The measurement of EUT is carried out under the transmit state of NFC and without modulation (See 3.5).

EUT had been not connected to a travel adapter.

During the measurements, the ambient temperature is in the range of 15 ~ 25°C.

A.5.4. Test Layouts

See A.5.2.

A.5.5. Limits

The 20dB bandwidth shall be less than 80% of the permitted frequency band. For 13.56 MHz NFC, the permitted frequency band is 14 kHz, so the limit is 11.2 kHz.

A.5.6. Measurement Results

Measurement results see Figure A-4.

Conclusions: PASS.

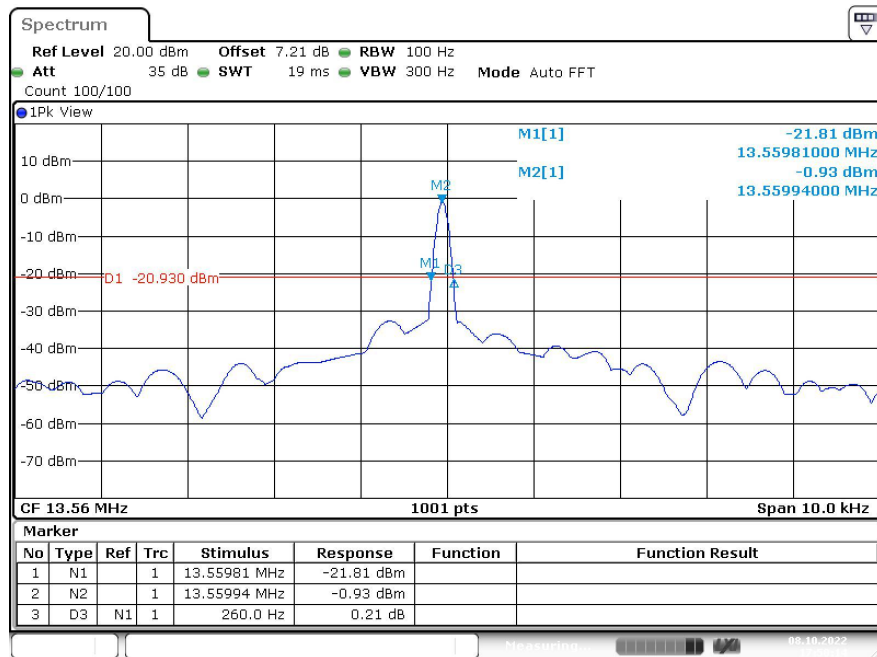

Figure A-4 20dB Bandwidth

A.5.7. Measurement Uncertainty

Measurement uncertainty: $U = 77 \text{ Hz}$, $k=2$

A.6. Conducted emission

A.6.1. Reference

See CFR 47 § 15.207

A.6.2. Measurement Methods

The conducted emissions from the AC port of the EUT are measured in a shielding room. The EUT is connected to a Line Impedance Stabilization Network (LISN). An overview sweep with peak detection was performed. The measurements were performed with a quasi-peak detector and if required, an average detector.

The conducted emission measurements were made with the following detector of the test receiver: Quasi-Peak / Average Detector.

The measurement bandwidth is:

Frequency of Emission (MHz)	RBW/VBW
0.15-30	9kHz

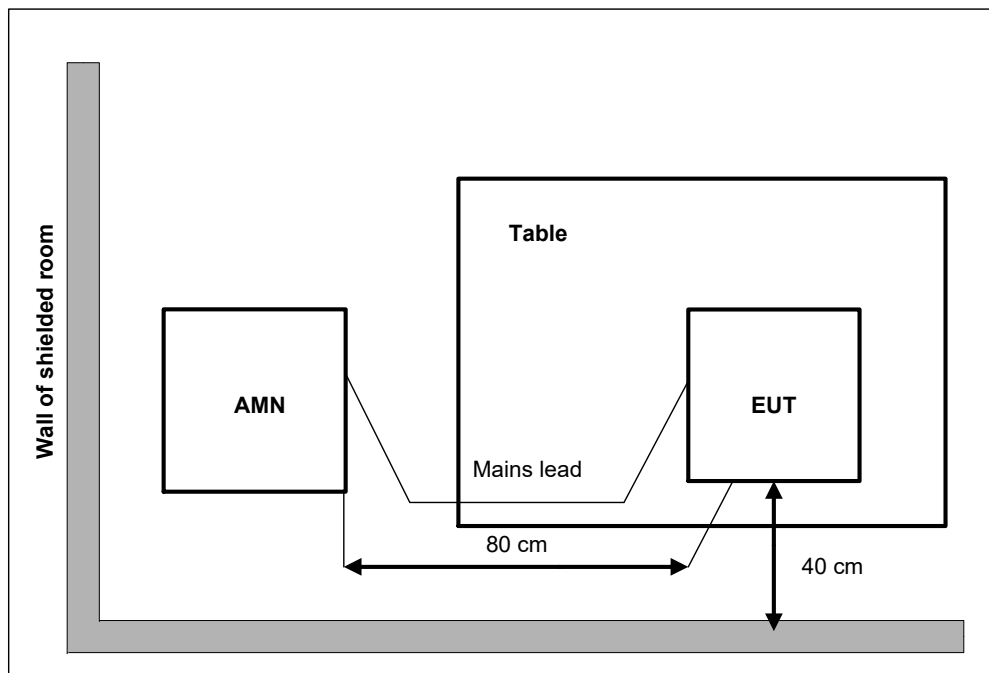

A.6.3. EUT Operating Mode and Test Conditions

The measurement of EUT is carried out under the transmit state of NFC (See 3.5).

The EUT is powered by a travel adapter.

During the measurements, the ambient temperature is in the range of 15 ~ 25°C.

**A.6.4. Limits**

Frequency range(MHz)	Quasi-peak Limit (dB μ V)	Average Limit (dB μ V)
0.15 to 0.5	66 to 56	56 to 46
0.5 to 5	56	46
5 to 30	60	50

A.6.5. Measurement Results

Measurement results see Figure A-5 and Figure A-6.

Conclusions: PASS.

Note: The measurement result at 13.56MHz is the fundamental emission of NFC signal.

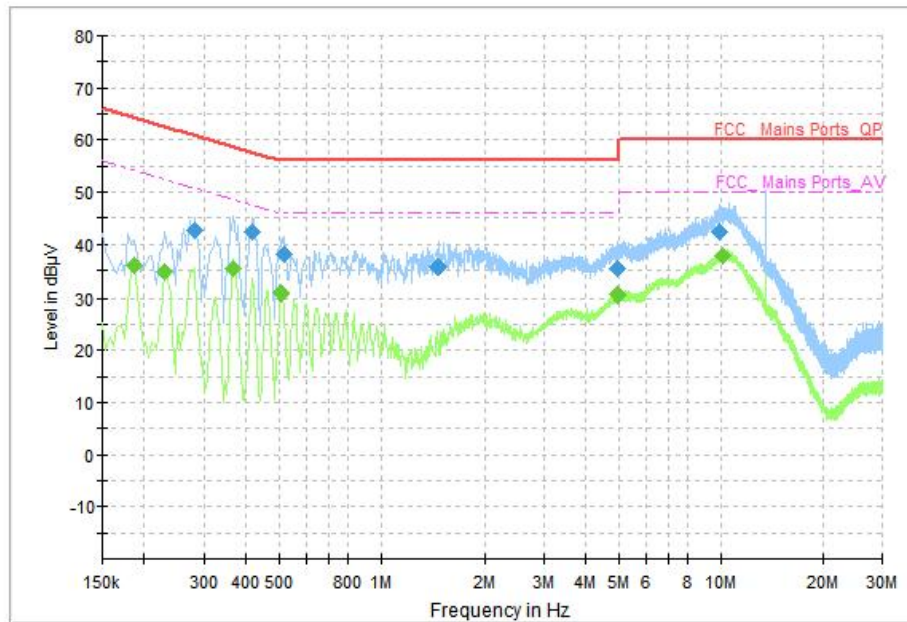

Figure A-5 Conducted Emission (Traffic)

Measurement Results: Quasi Peak

Frequency (MHz)	QuasiPeak (dBµV)	Limit (dBµV)	Margin (dB)	Line	Filter	Corr. (dB)
0.282000	42.68	60.76	18.07	N	ON	10
0.418000	42.27	57.49	15.22	N	ON	10
0.518000	38.25	56.00	17.75	N	ON	10
1.466000	35.79	56.00	20.21	N	ON	10
4.934000	35.24	56.00	20.76	L1	ON	10
9.914000	42.36	60.00	17.64	L1	ON	10

Measurement Results: Average

Frequency (MHz)	Average (dBµV)	Limit (dBµV)	Margin (dB)	Line	Filter	Corr. (dB)
0.186000	35.95	54.21	18.26	N	ON	10
0.230000	34.71	52.45	17.74	N	ON	10
0.366000	35.33	48.59	13.26	N	ON	10
0.506000	30.62	46.00	15.38	N	ON	10
4.974000	30.40	46.00	15.60	L1	ON	10
10.142000	37.81	50.00	12.19	L1	ON	10

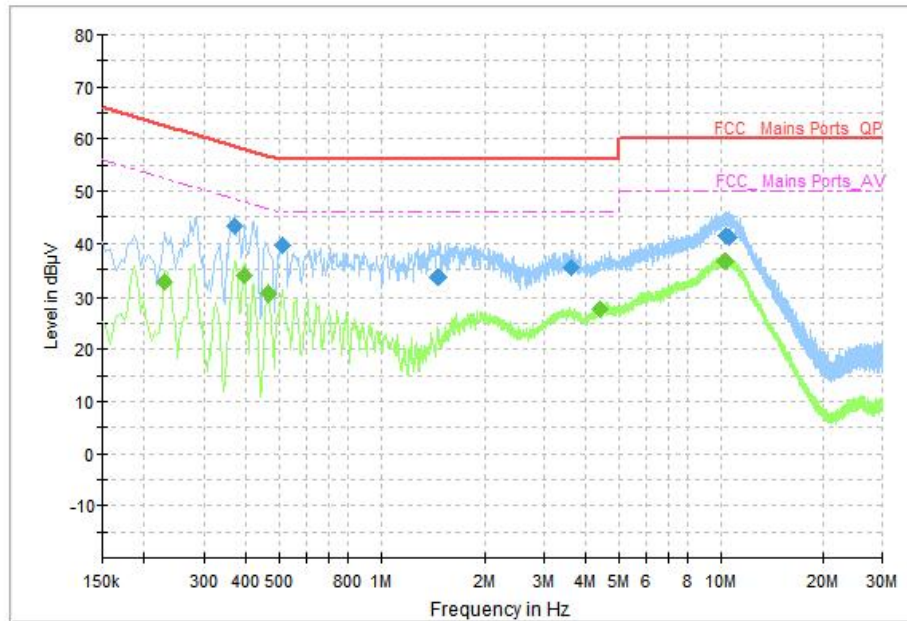

Figure A-6 Conducted Emission (Idle)

Measurement Results: Quasi Peak

Frequency (MHz)	QuasiPeak (dBµV)	Limit (dBµV)	Margin (dB)	Line	Filter	Corr. (dB)
0.370000	43.37	58.50	15.13	N	ON	10
0.510000	39.74	56.00	16.26	N	ON	10
1.466000	33.61	56.00	22.39	N	ON	10
3.614000	35.50	56.00	20.50	N	ON	10
10.382000	41.39	60.00	18.61	L1	ON	10
10.610000	41.27	60.00	18.73	L1	ON	10

Measurement Results: Average

Frequency (MHz)	Average (dBµV)	Limit (dBµV)	Margin (dB)	Line	Filter	Corr. (dB)
0.230000	32.69	52.45	19.76	N	ON	10
0.394000	33.76	47.98	14.22	L1	ON	10
0.466000	30.57	46.59	16.01	N	ON	10
4.386000	27.62	46.00	18.38	L1	ON	10
10.254000	36.54	50.00	13.46	L1	ON	10
10.402000	36.67	50.00	13.33	L1	ON	10

A.6.6. Measurement Uncertainty

 Measurement uncertainty: $U = 2.62$ dB, $k=2$
*****END OF REPORT*****