



TEST REPORT

No.I22N02158-WLAN 5GHz

for

Guangdong OPPO Mobile Telecommunications Corp., Ltd.

Mobile Phone

Model Name: CPH2437

with

Hardware Version: 11

Software Version: ColorOS 13.0

FCC ID: R9C-CPH2437

Issued Date: 2022-12-02

Designation Number: CN1210

Note:

The test results in this test report relate only to the devices specified in this report. This report shall not be reproduced except in full without the written approval of SAICT.

Test Laboratory:

SAICT, Shenzhen Academy of Information and Communications Technology

Building G, Shenzhen International Innovation Center, No.1006 Shennan Road, Futian District, Shenzhen, Guangdong, P. R. China 518000.

Tel:+86(0)755-33322000, Fax:+86(0)755-33322001

Email: yewu@caict.ac.cn. www.saict.ac.cn

©Copyright. All rights reserved by SAICT.



REPORT HISTORY

Report Number	Revision	Description	Issue Date
I22N02158-WLAN 5GHz	Rev.0	1st edition	2022-12-02

Note: the latest revision of the test report supersedes all previous versions.



CONTENTS

CONTENTS	3
1. SUMMARY OF TEST REPORT	4
1.1. TEST ITEMS	4
1.2. TEST STANDARDS	4
1.3. TEST RESULT	4
1.4. TESTING LOCATION	4
1.5. PROJECT DATA	4
1.6. SIGNATURE	4
2. CLIENT INFORMATION	5
2.1. APPLICANT INFORMATION	5
2.2. MANUFACTURER INFORMATION	5
3. EQUIPMENT UNDER TEST (EUT) AND ANCILLARY EQUIPMENT (AE)	6
3.1. ABOUT EUT	6
3.2. INTERNAL IDENTIFICATION OF EUT	6
3.3. INTERNAL IDENTIFICATION OF AE	7
3.4. GENERAL DESCRIPTION	7
4. REFERENCE DOCUMENTS	8
4.1. DOCUMENTS SUPPLIED BY APPLICANT	8
4.2. REFERENCE DOCUMENTS FOR TESTING	8
5. TEST RESULTS	9
5.1. TESTING ENVIRONMENT	9
5.2. TEST RESULTS	9
5.3. STATEMENTS	9
6. TEST EQUIPMENTS UTILIZED	10
7. LABORATORY ENVIRONMENT	11
8. MEASUREMENT UNCERTAINTY	12
ANNEX A: DETAILED TEST RESULTS	13
A.1. MEASUREMENT METHOD	13
A.2. MAXIMUM OUTPUT POWER	16
A.3. PEAK POWER SPECTRAL DENSITY (CONDUCTED)	21
A.4. OCCUPIED 26dB BANDWIDTH (CONDUCTED)	23
A.5. OCCUPIED 6dB BANDWIDTH (CONDUCTED)	38
A.6. 99% OCCUPIED BANDWIDTH (CONDUCTED)	42
A.7. DYNAMIC FREQUENCY SELECTION	57
A.8. BAND EDGES COMPLIANCE	61
A.9. TRANSMITTER SPURIOUS EMISSION	84
A.10. RADIATED SPURIOUS EMISSIONS < 30MHZ	122
A.11. AC POWER LINE CONDUCTED EMISSION	124
A.12. POWER CONTROL	127



1. Summary of Test Report

1.1. Test Items

Description	Mobile Phone
Model Name	CPH2437
Applicant's name	Guangdong OPPO Mobile Telecommunications Corp., Ltd.
Manufacturer's Name	Guangdong OPPO Mobile Telecommunications Corp., Ltd.

1.2. Test Standards

FCC Part15-2021; FCC 06-96-2006; ANSI C63.10-2013; KDB789033-V02r01; KDB 905462-D02; KDB 662911-V02r01.

1.3. Test Result

Pass

Please refer to "5.2. Test Results"

1.4. Testing Location

Address: Building G, Shenzhen International Innovation Center, No.1006 Shennan Road, Futian District, Shenzhen, Guangdong, P. R. China 51800

1.5. Project data

Testing Start Date:	2022-10-21
Testing End Date:	2022-11-30

1.6. Signature

Lin Zechuang
(Prepared this test report)

An Ran
(Reviewed this test report)

Zhang Bojun
(Approved this test report)



2. Client Information

2.1. Applicant Information

Company Name: Guangdong OPPO Mobile Telecommunications Corp., Ltd.
Address: NO.18 Haibin Road, Wusha Village, Chang'an Town, Dongguan City,
Guangdong, China
Contact Person Mei XiLi
E-Mail (86)76986076999
Telephone: meixili@oppo.com
Fax: /

2.2. Manufacturer Information

Company Name: Guangdong OPPO Mobile Telecommunications Corp., Ltd.
Address: NO.18 Haibin Road, Wusha Village, Chang'an Town, Dongguan City,
Guangdong, China
Contact Person Mei XiLi
E-Mail (86)76986076999
Telephone: meixili@oppo.com
Fax: /



3. Equipment Under Test (EUT) and Ancillary Equipment (AE)

3.1. About EUT

Description	Mobile Phone
Model Name	CPH2437
RF Protocol	IEEE 802.11a/n-HT20/n-HT40/ac-VHT20/ac-VHT40/ac-VHT80/ ac-VHT160/ax-HE20/ax-HE40/ax-HE80/ax-HE160
WLAN Frequency Range	ISM Bands: 5150MHz~5250MHz; 5250MHz~5350MHz; 5470MHz~5725MHz; 5725MHz~5850MHz.
Type of modulation	OFDM/OFDMA
Antenna Type	Integrated antenna
Antenna Gain	5150MHz~5350MHz: SISO: ANT9: 1.38dBi; ANT13: -0.81dBi; Directional Gain: 3.36dBi (see Note1) 5470MHz~5725MHz: SISO: ANT9: 1.19dBi; ANT13: -0.32dBi; Directional Gain: 3.48dBi (see Note1) 5725MHz~5850MHz: SISO: ANT9: -0.26dBi; ANT13: -0.69dBi; Directional Gain: 2.54dBi (see Note1)
Power Supply	3.89V DC by Battery
FCC ID	R9C-CPH2437
Device Type (DFS)	Client without radar detection(only support client mode)
Condition of EUT as received	No abnormality in appearance

Note1: Directional gain(correlated) = 10log [(10^{G1/20} + 10^{G2/20} + ... + 10^{GN/20})² /NANT]dBi.

For 5150MHz~5350MHz: Directional gain=10log [(10^{1.38/20} + 10^{-0.81/20})² /2]dBi=3.36dBi;

For 5470MHz~5725MHz: Directional gain=10log [(10^{1.19/20} + 10^{-0.32/20})² /2]dBi=3.48dBi;

For 5725MHz~5850MHz: Directional gain=10log [(10^{-0.26/20} + 10^{-0.69/20})² /2]dBi=2.54dBi.

Note2: Components list, please refer to documents of the manufacturer; it is also included in the original test record of Shenzhen Academy of Information and Communications Technology.

3.2. Internal Identification of EUT used during the test

EUT ID*	SN or IMEI	HW Version	SW Version	Date of Receipt
UT06aa	869315060027713	11	ColorOS 13.0	2022-10-18
	869315060027705			
UT10aa	869315060020270	11	ColorOS 13.0	2022-10-19
	869315060020262			
UT11aa	869315060020734	11	ColorOS 13.0	2022-10-19
	869315060020726			

*EUT ID: is used to identify the test sample in the lab internally.

UT06aa is used for conduction test, UT10aa is used for radiation test, and UT11aa is used for AC Power line Conducted Emission test.



3.3. Internal Identification of AE used during the test

AE No.	Description	AE ID*
AE1	Battery	/
AE2	Charger	/
AE3	USB Cable	/

AE1-1

Model	BLP971
Manufacturer	Dongguan NVT Techonology Co., Ltd.
Capacity	3110mAh
Nominal Voltage	3.89 V

AE1-2

Model	BLP969
Manufacturer	Dongguan NVT Techonology Co., Ltd.
Capacity	1190mAh
Nominal Voltage	3.89 V

AE2

Model	VCB7CAUH
Manufacturer	Jiangsu ChenYang Electronics Co.,. Ltd.
Specification	American Standard Charger

AE3

Model	DL152
Manufacturer	/

*AE ID and AE Label: is used to identify the test sample in the lab internally.

3.4. General Description

The Equipment under Test (EUT) is a model of Smart Phone with PIFA antenna and battery. It consists of normal options: Lithium Battery, Charger and USB Cable. Manual and specifications of the EUT were provided to fulfil the test. Samples undergoing test were selected by the client.



4. REFERENCE DOCUMENTS

4.1. Documents supplied by applicant

EUT feature information is supplied by the applicant or manufacturer, which is the basis of testing.

4.2. Reference Documents for testing

The following documents listed in this section are referred for testing.

Reference	Title	Version
FCC Part15	FCC CFR 47,Part 15,Subpart C FCC CFR 47,Part 15,Subpart E	2021
FCC 06-96	Revision of Parts 2 and 15 of the Commission’s Rules to Permit Unlicensed National Information Infrastructure (U-NII) devices in the 5 GHz band	2006
ANSI C63.10	American National Standard of Procedures for Compliance Testing of Unlicensed Wireless Devices	2013
KDB 789033	GUIDELINES FOR COMPLIANCE TESTING OF UNLICENSED NATIONAL INFORMATION INFRASTRUCTURE (U-NII) DEVICES PART 15, SUBPART E	V02r01
KDB 905462	Compliance Measurement Procedures for Unlicensed-national Information Infrastructure Devices Operating in the 5250-5350 MHz and 5470-5725 MHz Bands Incorporating Dynamic Frequency Selection	D02
KDB 662911	Emissions Testing of Transmitters with Multiple Outputs in the Same Band (e.g., MIMO, Smart Antenna, etc)	V02r01



5. Test Results

5.1. Testing Environment

Normal Temperature: 15~35°C

Relative Humidity: 20~75%

5.2. Test Results

No.	Test cases	Sub-clause of Part15E	Verdict
0	Maximum Output Power	15.407(a)	P
1	Power Spectral Density	15.407(a)	P
2	Occupied 26dB Bandwidth	15.403(i)	/
3	Occupied 6dB Bandwidth	15.407(e)	P
4	99% Occupied Bandwidth	15.403	/
5	Dynamic Frequency Selection	15.407 (h)	P
6	Band edge compliance	15.209	P
7	Radiated Spurious Emissions	15.209	P
8	AC Power line Conducted	15.207	P
9	Transmit Power Control	15.407	NA

See **ANNEX A** for details.

Note: According to the definition of the application description, the device will automatically discontinue transmission in case of either absence of information to transmit or operational failure.

5.3. Statements

SAICT has evaluated the test cases requested by the applicant/manufacture as listed in section 5.2 of this report, for the EUT specified in section 3, according to the standards or reference documents listed in section 4.2

Disclaimer:

A. After confirmation with the customer, the sample information provided by the customer may affect the validity of the measurement results in this report, and the impact and consequences arising therefrom shall be borne by the customer.

B. The samples in this report are provided by the customer, and the test results are only applicable to the samples received.

**6. Test Equipments Utilized****Conducted test system**

No.	Equipment	Model	Serial Number	Manufacturer	Calibration Due date	Calibration Period
1	Vector Signal Analyzer	FSV40	100903	Rohde & Schwarz	2022-12-29	1 year
2	Power Sensor	U2021XA	MY55430013	Keysight	2022-12-29	1 year
3	Data Acquisition	U2531A	TW55443507	Keysight	/	/
4	RF Control Unit	JS0806-2	21C8060398	Tonscend	2023-05-08	1 year
5	Vector Signal General	SMU200A	104096	Rohde & Schwarz	2022-12-29	1 year
6	Shielding Room	S81	CT000986-1344	ETS-Lindgren	2026-09-12	5 years
No.	Equipment	Model	FCC ID	Manufacturer	Calibration Due date	Calibration Period
7	Master AP	RT-AX86U	MSQ-RTAXI600	ASUS	/	/

Radiated test system

No.	Equipment	Model	Serial Number	Manufacturer	Calibration Due date	Calibration Period
1	Test Receiver	ESR7	101676	Rohde & Schwarz	2023-11-23	1 year
2	BiLog Antenna	3142E	0224831	ETS-Lindgren	2024-05-27	3 years
3	Horn Antenna	3117	00066577	ETS-Lindgren	2025-04-17	3 years
4	Horn Antenna	QSH-SL-1 8-26-S-20	17013	Q-par	2023-01-06	3 years
5	Horn Antenna	QSH-SL-1 8-40-K-SG	15979	Q-par	2023-01-06	3 years
6	Anechoic Chamber	FACT3-2.0	1285	ETS-Lindgren	2023-05-29	2 years
7	Spectrum Analyzer	FSV40	101192	Rohde & Schwarz	2023-01-12	1 year
8	Loop Antenna	HLA6120	35779	TESEQ	2025-05-10	3 years
9	Test Receiver	ESCI	100702	Rohde & Schwarz	2023-01-12	1 year
10	LISN	ENV216	102067	Rohde & Schwarz	2023-07-14	1 year

Test software

No.	Equipment	Manufacturer	Version
1	JS1120-3	Tonscend	3.2
2	EMC32	Rohde & Schwarz	10.50.40

EUT is engineering software provided by the customer to control the transmitting signal.
The EUT was programmed to be in continuously transmitting mode.



7. Laboratory Environment

Shielded room

Temperature	Min. = 15 °C, Max. = 35 °C
Relative humidity	Min. = 20 %, Max. = 75 %
Shielding effectiveness	0.014MHz-1MHz> 60 dB; 1MHz-18000MHz>90 dB
Electrical insulation	> 2MΩ
Ground system resistance	< 4 Ω

Anechoic chamber

Temperature	Min. = 15 °C, Max. = 35 °C
Relative humidity	Min. = 20 %, Max. = 75 %
Shielding effectiveness	0.014MHz-1MHz> 60 dB; 1MHz-18000MHz>90 dB
Electrical insulation	> 2MΩ
Ground system resistance	< 4 Ω
Normalised site attenuation (NSA)	<±4 dB, 3 m distance, from 30 to 1000 MHz
Voltage Standing Wave Ratio (VSWR)	≤ 6 dB, from 1 to 18 GHz, 3m distance
Uniformity of field strength	Between 0 and 6 dB, from 80 to 6000 MHz



8. Measurement Uncertainty

Test Name	Uncertainty ($k=2$)	
1. Maximum output Power	1.36dB	
2. Peak Power Spectral Density	1.36dB	
3. Occupied 26dB Bandwidth	4.56kHz	
4. Occupied 6dB Bandwidth	4.56kHz	
5. 99% Occupied Bandwidth	4.56kHz	
6. Band Edges Compliance	4.68dB	
7. Transmitter Spurious Emission - Radiated	9kHz≤f<30MHz	1.79dB
	30MHz≤f<1GHz	4.86dB
	1GHz≤f<18GHz	4.82dB
	18GHz≤f≤40GHz	2.90dB
8. AC Power line Conducted Emission	150kHz≤f≤30MHz	2.62dB

ANNEX A: Detailed Test Results

A.1. Measurement Method

1) Conducted Measurements

- 1). Connect the EUT to the test system correctly.
- 2). Set the EUT to the required work mode.
- 3). Set the EUT to the required channel.
- 4). Set the spectrum analyzer to start measurement.
- 5). Record the values.

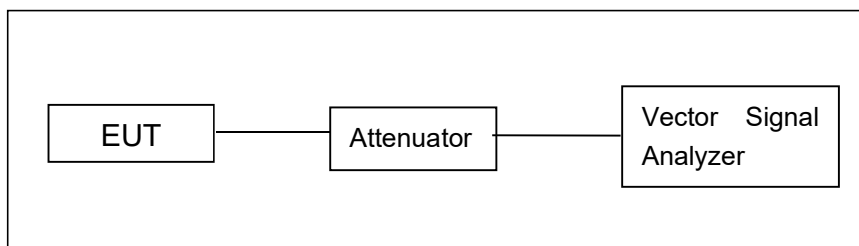

6). The below figure shows the DFS setup, where the EUT is a WLAN device operating in slave mode, without Radar Interference Detection function. This setup also contains a device operating in master mode. The radar test signals are injected into the master device. The EUT (slave device) is associated with the master device. WLAN traffic is generated by streaming the mpeg file from the master to the slave in full monitor video mode using the media player.

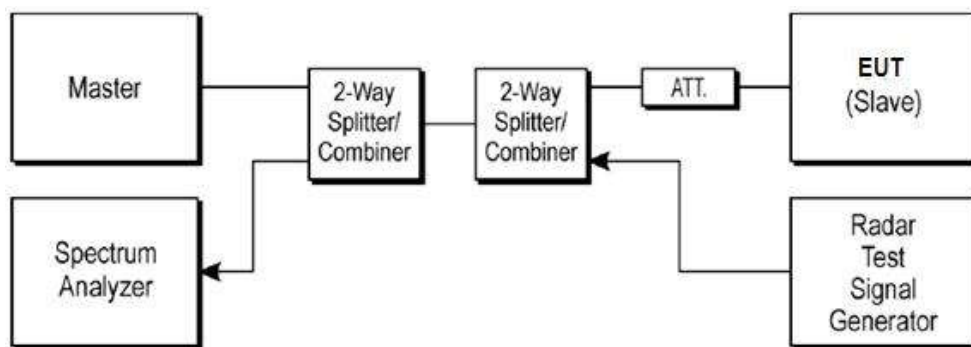

2) Radiated Emission Measurements

Test setup:

9kHz-30MHz:

The EUT are measured in a anechoic chamber. The EUT is placed on a non-conductive stand of 80cm high, and at a measurement distance of 3m from the receiving antenna. The center of the receiving loop antenna is 1.0 meter above the ground. The test setup refers to figure below.

Detected emissions were maximized at each frequency by rotating the EUT and adjusting the receiver antenna polarization.

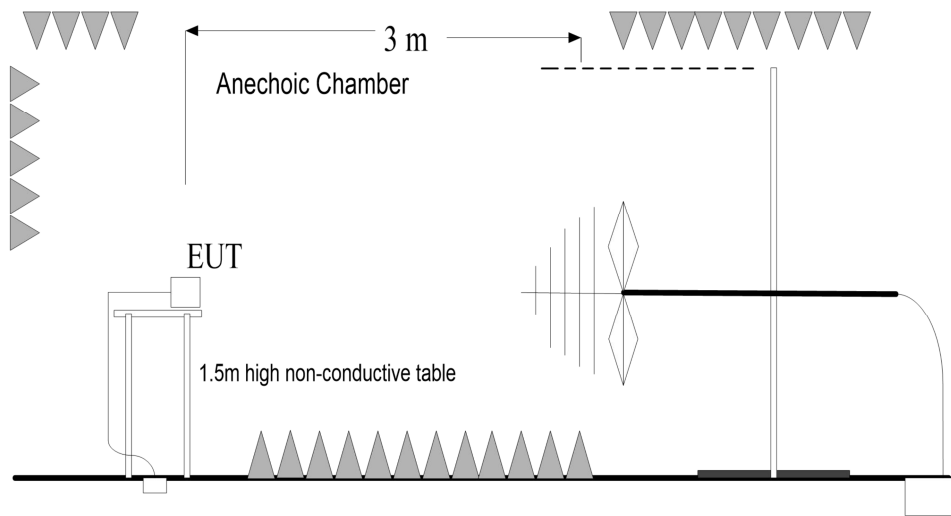

30MHz-40GHz:

The EUT are measured in a anechoic chamber. The EUT is placed on a non-conductive stand of 80cm high, and at a measurement distance of 3m from the receiving antenna. The center of the receiving antenna is 1.0 meter to 4.0 meter above the ground. The test setup refers to figure below. Detected emissions were maximized at each frequency by rotating the EUT and adjusting the receiver antenna polarization.

30MHz-1GHz:

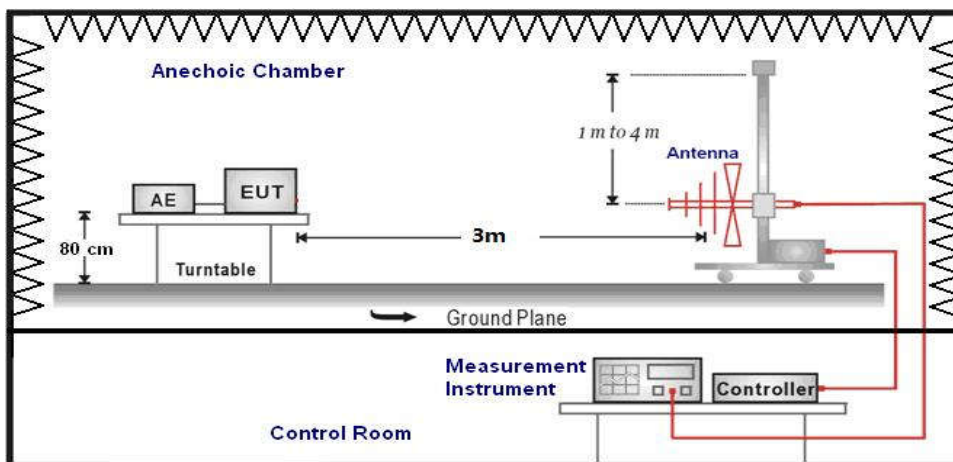

1GHz-3GHz:

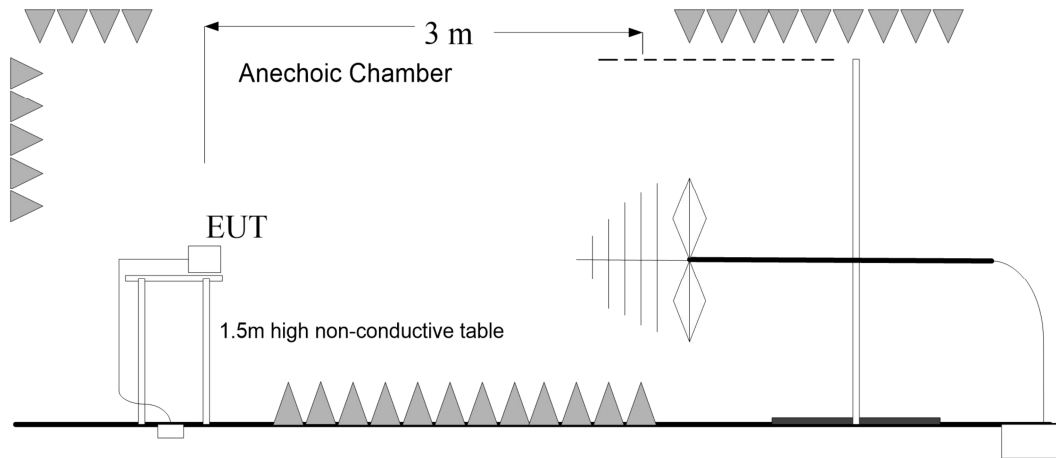

3GHz-40GHz:

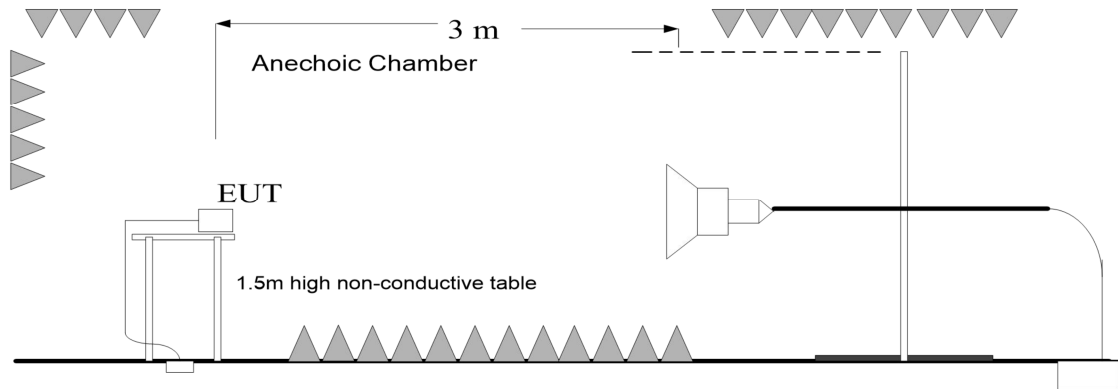

3) AC Power line Conducted Emission Measurement

For WLAN, the EUT is working under test mode. The EUT is commanded to operate at maximum transmitting power.

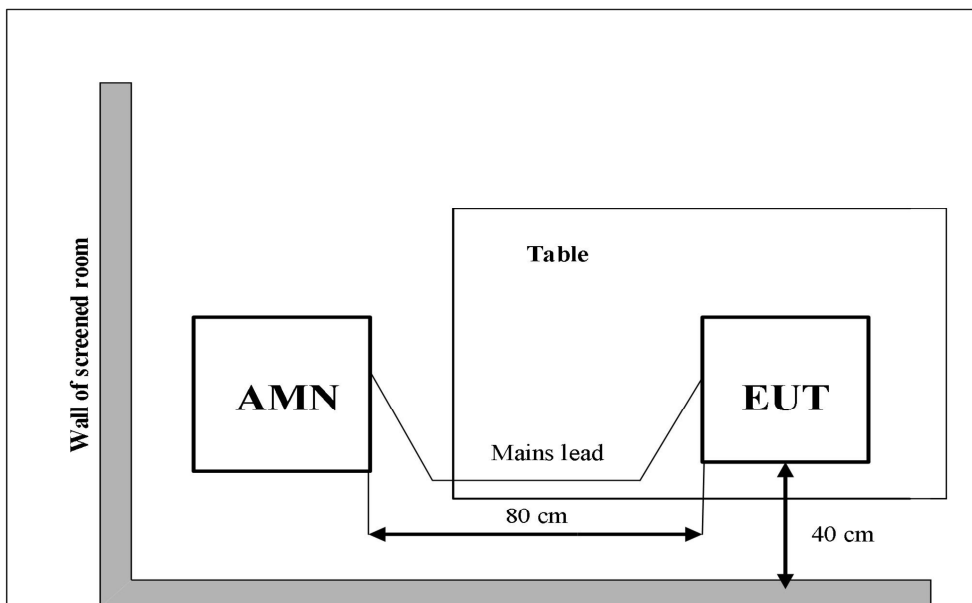



A.2. Maximum output Power

Measurement Limit and Method:

Standard	Frequency (MHz)	Limit (dBm)
FCC CRF Part 15.407(a)	5150MHz~5250MHz	24
	5250MHz~5350MHz	24 or 11+10logB
	5470MHz~5725MHz	24 or 11+10logB
	5725MHz~5850MHz	30

Limit use the less value, and B is the 26dB bandwidth.

Measurement of method: See ANSI C63.10-2013-Clause 12.3.3.2.

Method PM-G is a measurement using a gated RF average power meter.

Measurements may be performed using a wideband gated RF power meter provided that the gate parameters are adjusted such that the power is measured only when the EUT is transmitting at its maximum power control level. Because the measurement is made only during the ON time of the transmitter, no duty cycle correction factor is required.

Measurement Results:

SISO:

Mode	Frequency (MHz)	RF output power (dBm)		Conclusion
		Antenna 9	Antenna 13	
802.11a	5180MHz(CH36)	13.37	13.41	P
	5200MHz(CH40)	13.34	13.47	P
	5240MHz(CH48)	13.45	13.72	P
	5260MHz(CH52)	14.32	14.69	P
	5280MHz(CH56)	14.38	14.76	P
	5320MHz(CH64)	14.40	14.68	P
	5500MHz(CH100)	14.87	15.04	P
	5580MHz(CH116)	14.86	14.97	P
	5700MHz(CH140)	14.98	15.14	P
	5745MHz(CH149)	16.40	16.41	P
	5785MHz(CH157)	16.35	16.38	P
802.11n-HT20	5825MHz(CH165)	16.41	16.48	P
	5180MHz(CH36)	13.31	13.35	P
	5200MHz(CH40)	13.28	13.42	P
	5240MHz(CH48)	13.38	13.61	P
	5260MHz(CH52)	14.26	14.61	P
	5280MHz(CH56)	14.31	14.63	P
	5320MHz(CH64)	14.35	14.57	P
	5500MHz(CH100)	14.84	15.01	P
	5580MHz(CH116)	14.86	14.91	P
5700MHz(CH140)	14.91	15.12	P	
5745MHz(CH149)	16.32	16.38	P	



	5785MHz(CH157)	16.27	16.31	P
	5825MHz(CH165)	16.36	16.44	P
802.11ac-VHT20	5180MHz(CH36)	13.27	13.32	P
	5200MHz(CH40)	13.26	13.37	P
	5240MHz(CH48)	13.32	13.57	P
	5260MHz(CH52)	14.23	14.54	P
	5280MHz(CH56)	14.27	14.59	P
	5320MHz(CH64)	14.28	14.61	P
	5500MHz(CH100)	14.77	14.98	P
	5580MHz(CH116)	14.81	14.94	P
	5700MHz(CH140)	14.86	15.08	P
	5745MHz(CH149)	16.35	16.30	P
	5785MHz(CH157)	16.29	16.29	P
	5825MHz(CH165)	16.33	16.46	P
802.11ax-HE20	5180MHz(CH36)	13.22	13.24	P
	5200MHz(CH40)	13.24	13.29	P
	5240MHz(CH48)	13.33	13.50	P
	5260MHz(CH52)	14.19	14.45	P
	5280MHz(CH56)	14.24	14.51	P
	5320MHz(CH64)	14.25	14.47	P
	5500MHz(CH100)	14.71	14.91	P
	5580MHz(CH116)	14.79	14.89	P
	5700MHz(CH140)	14.82	15.01	P
	5745MHz(CH149)	16.24	16.29	P
	5785MHz(CH157)	16.25	16.27	P
	5825MHz(CH165)	16.35	16.41	P
802.11n-HT40	5190MHz(CH38)	13.09	13.24	P
	5230MHz(CH46)	13.14	13.45	P
	5270MHz(CH54)	14.09	14.52	P
	5310MHz(CH62)	14.21	14.54	P
	5510MHz(CH102)	14.52	14.71	P
	5550MHz(CH110)	14.60	14.85	P
	5670MHz(CH134)	14.72	14.84	P
	5755MHz(CH151)	16.17	16.18	P
	5795MHz(CH159)	16.22	16.21	P
802.11ac-VHT40	5190MHz(CH38)	13.04	13.19	P
	5230MHz(CH46)	13.08	13.31	P
	5270MHz(CH54)	14.11	14.54	P
	5310MHz(CH62)	14.17	14.48	P
	5510MHz(CH102)	14.51	14.64	P
	5550MHz(CH110)	14.57	14.82	P
	5670MHz(CH134)	14.68	14.82	P
	5755MHz(CH151)	16.18	16.23	P



	5795MHz(CH159)	16.26	16.29	P
802.11ax-HE40	5190MHz(CH38)	13.17	13.31	P
	5230MHz(CH46)	13.20	13.46	P
	5270MHz(CH54)	14.14	14.59	P
	5310MHz(CH62)	14.25	14.62	P
	5510MHz(CH102)	14.69	14.79	P
	5550MHz(CH110)	14.68	14.88	P
	5670MHz(CH134)	14.78	14.86	P
	5755MHz(CH151)	16.23	16.31	P
	5795MHz(CH159)	16.32	16.36	P
802.11ac-VHT80	5210MHz(CH42)	13.01	13.28	P
	5290MHz(CH58)	14.08	14.47	P
	5530MHz(CH106)	14.51	14.85	P
	5610MHz(CH122)	14.68	14.82	P
	5775MHz(CH155)	16.08	16.17	P
802.11ax-HE80	5210MHz(CH42)	13.11	13.36	P
	5290MHz(CH58)	14.17	14.51	P
	5530MHz(CH106)	14.74	14.94	P
	5610MHz(CH122)	14.73	14.95	P
	5775MHz(CH155)	16.21	16.34	P
802.11ac-VHT160	5250MHz(CH50)	12.98	13.05	P
	5570MHz(CH114)	14.35	14.53	P
802.11ax-HE 160	5250MHz(CH50)	13.04	13.15	P
	5570MHz(CH114)	14.54	14.81	P

MIMO:

Mode	Frequency (MHz)	RF output power (dBm)	Conclusion
802.11n-HT20	5180MHz(CH36)	16.37	P
	5200MHz(CH40)	16.37	P
	5240MHz(CH48)	16.48	P
	5260MHz(CH52)	17.45	P
	5280MHz(CH56)	17.48	P
	5320MHz(CH64)	17.50	P
	5500MHz(CH100)	17.94	P
	5580MHz(CH116)	17.95	P
	5700MHz(CH140)	17.98	P
	5745MHz(CH149)	19.39	P
	5785MHz(CH157)	19.36	P
	5825MHz(CH165)	19.47	P
802.11ac-VHT20	5180MHz(CH36)	16.32	P
	5200MHz(CH40)	16.29	P
	5240MHz(CH48)	16.34	P
	5260MHz(CH52)	17.40	P



	5280MHz(CH56)	17.42	P
	5320MHz(CH64)	17.44	P
	5500MHz(CH100)	17.92	P
	5580MHz(CH116)	17.89	P
	5700MHz(CH140)	17.94	P
	5745MHz(CH149)	19.35	P
	5785MHz(CH157)	19.31	P
	5825MHz(CH165)	19.44	P
802.11ax-HE20	5180MHz(CH36)	16.28	P
	5200MHz(CH40)	16.24	P
	5240MHz(CH48)	16.41	P
	5260MHz(CH52)	17.34	P
	5280MHz(CH56)	17.40	P
	5320MHz(CH64)	17.41	P
	5500MHz(CH100)	17.84	P
	5580MHz(CH116)	17.87	P
	5700MHz(CH140)	17.86	P
	5745MHz(CH149)	19.32	P
	5785MHz(CH157)	19.30	P
5825MHz(CH165)	19.41	P	
802.11n-HT40	5190MHz(CH38)	16.17	P
	5230MHz(CH46)	16.31	P
	5270MHz(CH54)	17.31	P
	5310MHz(CH62)	17.38	P
	5510MHz(CH102)	17.70	P
	5550MHz(CH110)	17.74	P
	5670MHz(CH134)	17.81	P
	5755MHz(CH151)	19.13	P
5795MHz(CH159)	19.25	P	
802.11ac-VHT40	5190MHz(CH38)	16.12	P
	5230MHz(CH46)	16.24	P
	5270MHz(CH54)	17.31	P
	5310MHz(CH62)	17.33	P
	5510MHz(CH102)	17.64	P
	5550MHz(CH110)	17.77	P
	5670MHz(CH134)	17.79	P
	5755MHz(CH151)	19.22	P
5795MHz(CH159)	19.26	P	
802.11ax-HE40	5190MHz(CH38)	16.26	P
	5230MHz(CH46)	16.37	P
	5270MHz(CH54)	17.39	P
	5310MHz(CH62)	17.44	P
	5510MHz(CH102)	17.80	P



	5550MHz(CH110)	17.84	P
	5670MHz(CH134)	17.88	P
	5755MHz(CH151)	19.27	P
	5795MHz(CH159)	19.32	P
802.11ac-VHT80	5210MHz(CH42)	16.14	P
	5290MHz(CH58)	17.29	P
	5530MHz(CH106)	17.72	P
	5610MHz(CH122)	17.81	P
	5775MHz(CH155)	19.14	P
802.11ax-HE80	5210MHz(CH42)	16.23	P
	5290MHz(CH58)	17.35	P
	5530MHz(CH106)	17.82	P
	5610MHz(CH122)	17.87	P
	5775MHz(CH155)	19.27	P
802.11ac-VHT160	5250MHz(CH50)	16.06	P
	5570MHz(CH114)	17.48	P
802.11ax-HE160	5250MHz(CH50)	16.22	P
	5570MHz(CH114)	17.68	P

Note:

The data rate 1Mbps (11b mode), 6Mbps (11g mode), MCS0 (11n mode), MCS0 (VHT mode) and MCS0 (11ax mode) are selected as the Worst-Case. 11ax-HE20(RU242), 11ax-HE40(RU484), 11ax-HE80(RU996) and 11ax-HE160(RU996-67) are the type with maximum outpower level. 802.11a(n), 11ax-HE40, 11ax-HE80 and 11ax-HE160 are selected as the worst-case (SISO (Antenna 13) and MIMO). The following cases and test graphs are mostly performed with this condition.

The EUT was programmed to be in continuously transmitting mode and the transmit duty cycle is not less than 98%.

Conclusion: PASS



A.3. Peak Power Spectral Density (conducted)

Measurement of method: See KDB 789033 D02 v02r01, Section F.

Measurement Limit:

Standard	Frequency (MHz)	Limit
FCC CRF Part 15.407(a)	5150MHz~5250MHz	11dBm/MHz
	5250MHz~5350MHz	11dBm/MHz
	5470MHz~5725MHz	11dBm/MHz
	5725MHz~5850MHz	30dBm/500kHz

The PPSD measurement method SA-1 is made according to KDB 789033.

Measurement Results:

SISO:

Mode	Frequency (MHz)	Power Spectral Density(dBm/MHz)	Conclusion
802.11a	5180MHz(CH36)	1.90	P
	5200MHz(CH40)	1.53	P
	5240MHz(CH48)	2.21	P
	5260MHz(CH52)	2.41	P
	5280MHz(CH56)	2.82	P
	5320MHz(CH64)	2.47	P
	5500MHz(CH100)	3.33	P
	5580MHz(CH116)	3.57	P
	5700MHz(CH140)	3.06	P
802.11ax-HE40	5190MHz(CH38)	-1.04	P
	5230MHz(CH46)	-0.90	P
	5270MHz(CH54)	-0.33	P
	5310MHz(CH62)	0.03	P
	5510MHz(CH102)	0.87	P
	5550MHz(CH110)	0.21	P
	5670MHz(CH134)	0.38	P
802.11ax-HE80	5210MHz(CH42)	-5.32	P
	5290MHz(CH58)	-3.69	P
	5530MHz(CH106)	-3.33	P
	5610MHz(CH122)	-3.80	P
802.11ax-HE160	5250MHz(CH50)	-4.18	P
	5570MHz(CH114)	-3.25	P
Mode	Frequency (MHz)	Power Spectral Density (dBm/500kHz)	Conclusion
802.11a	5745MHz(CH149)	1.58	P
	5785MHz(CH157)	1.82	P
	5825MHz(CH165)	2.42	P
802.11ax-HE40	5755MHz(CH151)	-1.52	P
	5795MHz(CH159)	-0.97	P



802.11ax-HE80	5775MHz(CH155)	-5.21	P
---------------	----------------	-------	---

MIMO:

Mode	Frequency (MHz)	Power Spectral Density(dBm/MHz)	Conclusion
802.11n-HT20	5180MHz(CH36)	4.88	P
	5200MHz(CH40)	4.28	P
	5240MHz(CH48)	5.16	P
	5260MHz(CH52)	5.96	P
	5280MHz(CH56)	5.44	P
	5320MHz(CH64)	5.37	P
	5500MHz(CH100)	6.42	P
	5580MHz(CH116)	6.32	P
	5700MHz(CH140)	6.22	P
802.11ax-HE40	5190MHz(CH38)	2.46	P
	5230MHz(CH46)	2.17	P
	5270MHz(CH54)	2.96	P
	5310MHz(CH62)	3.34	P
	5510MHz(CH102)	3.78	P
	5550MHz(CH110)	3.22	P
	5670MHz(CH134)	3.84	P
802.11ax-HE80	5210MHz(CH42)	-2.13	P
	5290MHz(CH58)	-0.81	P
	5530MHz(CH106)	-0.92	P
	5610MHz(CH122)	-0.37	P
802.11ax-HE160	5250MHz(CH50)	-1.81	P
	5570MHz(CH114)	-0.95	P
Mode	Channel	Power Spectral Density (dBm/500kHz)	Conclusion
802.11n-HT20	5745MHz(CH149)	4.60	P
	5785MHz(CH157)	5.48	P
	5825MHz(CH165)	5.43	P
802.11ax-HE40	5755MHz(CH151)	1.56	P
	5795MHz(CH159)	1.40	P
802.11ax-HE80	5775MHz(CH155)	-0.56	P

Conclusion: PASS



A.4. Occupied 26dB Bandwidth (conducted)

Measurement of method: See KDB 789033 D02 v02r01, Section C.1.

Measurement Limit:

Standard	Limit (MHz)
FCC 47 CFR Part 15.403 (i)	/

The measurement is made according to KDB 789033

Measurement Result:

Mode	Frequency (MHz)	Occupied 26dB Bandwidth(MHz)		Conclusion
		Fig.	Value	
802.11a	5180MHz(CH36)	Fig.1	19.96	/
	5200MHz(CH40)	Fig.2	19.60	/
	5240MHz(CH48)	Fig.3	19.72	/
	5260MHz(CH52)	Fig.4	19.60	/
	5280MHz(CH56)	Fig.5	19.76	/
	5320MHz(CH64)	Fig.6	19.68	/
	5500MHz(CH100)	Fig.7	19.80	/
	5580MHz(CH116)	Fig.8	19.68	/
	5700MHz(CH140)	Fig.9	19.36	/
	5745MHz(CH149)	Fig.10	23.88	/
	5785MHz(CH157)	Fig.11	23.24	/
5825MHz(CH165)	Fig.12	23.24	/	
802.11ax-HE40	5190MHz(CH38)	Fig.13	41.20	/
	5230MHz(CH46)	Fig.14	41.28	/
	5270MHz(CH54)	Fig.15	41.60	/
	5310MHz(CH62)	Fig.16	41.12	/
	5510MHz(CH102)	Fig.17	41.04	/
	5550MHz(CH110)	Fig.18	40.72	/
	5670MHz(CH134)	Fig.19	41.20	/
	5755MHz(CH151)	Fig.20	41.04	/
5795MHz(CH159)	Fig.21	41.04	/	
802.11ax-HE80	5210MHz(CH42)	Fig.22	81.28	/
	5290MHz(CH58)	Fig.23	81.60	/
	5530MHz(CH106)	Fig.24	81.44	/
	5610MHz(CH122)	Fig.25	81.28	/
	5775MHz(CH155)	Fig.26	81.12	/
802.11ax-HE160	5250MHz(CH50)	Fig.27	162.56	/
	5570MHz(CH114)	Fig.28	162.56	/

See below for test graphs.

Conclusion: PASS

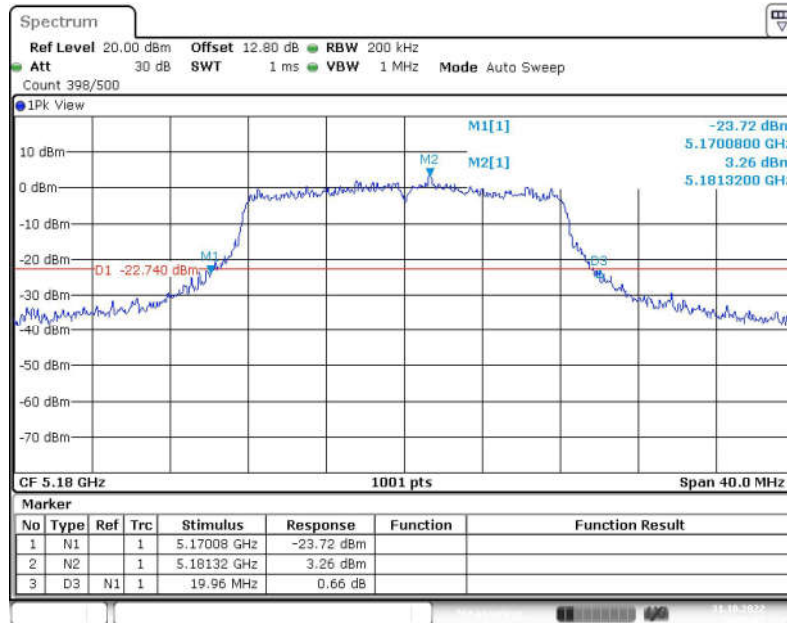

Fig. 1 Occupied 26dB Bandwidth (802.11a, 5180MHz)

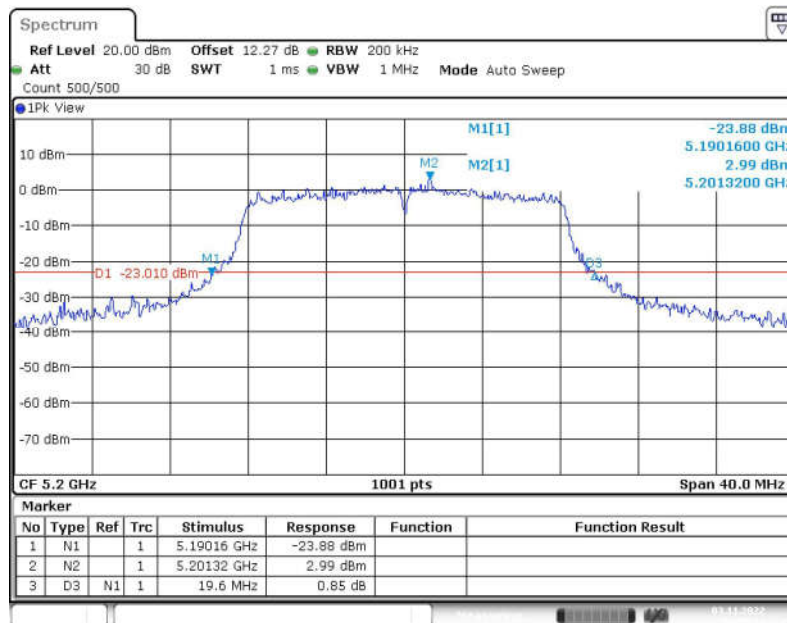

Fig. 2 Occupied 26dB Bandwidth (802.11a, 5200MHz)

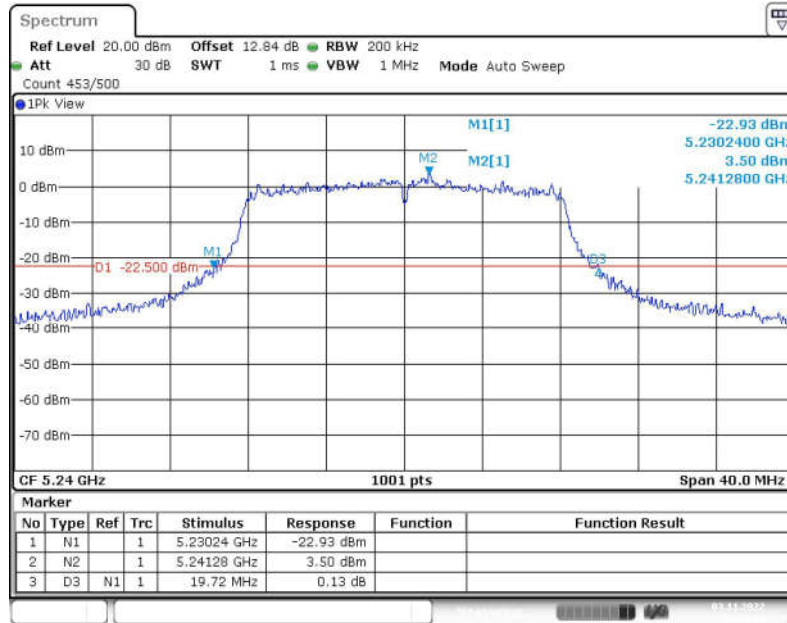

Fig. 3 Occupied 26dB Bandwidth (802.11a, 5240MHz)

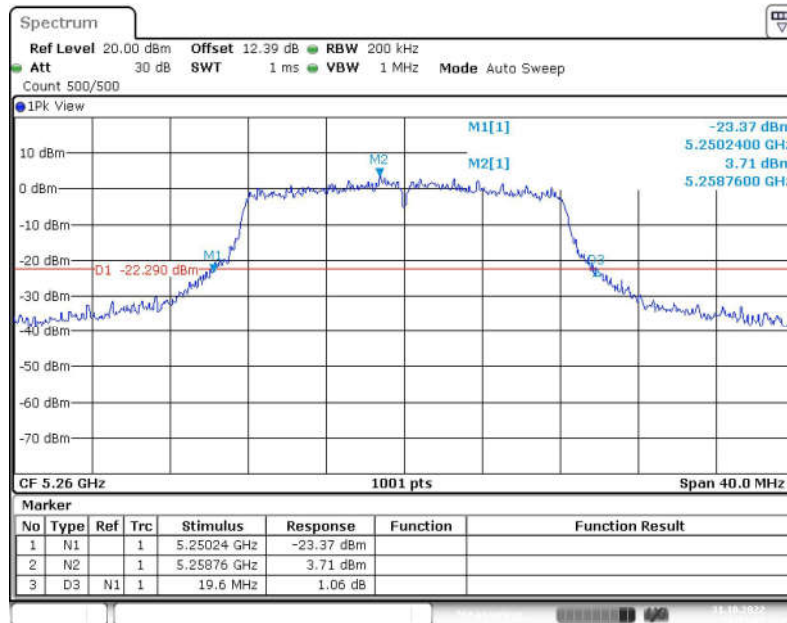

Fig. 4 Occupied 26dB Bandwidth (802.11a, 5260MHz)

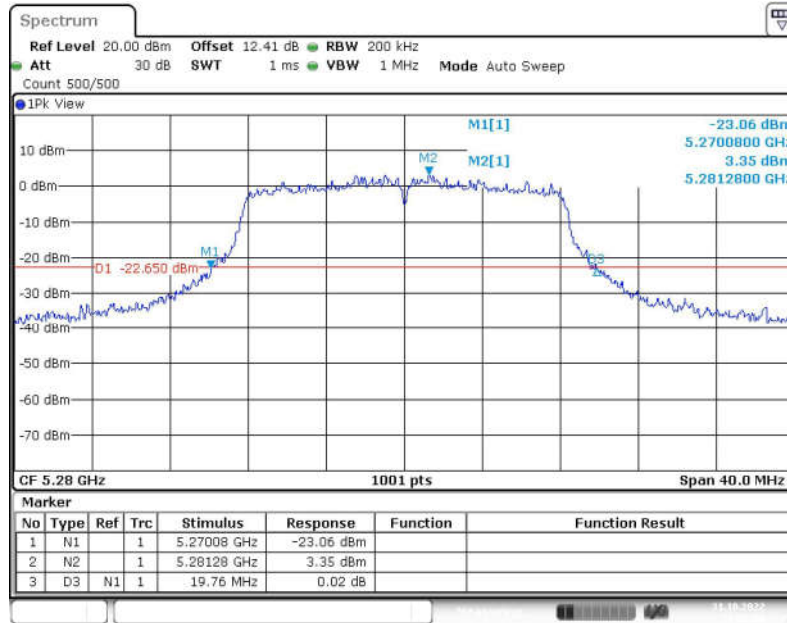

Fig. 5 Occupied 26dB Bandwidth (802.11a, 5280MHz)

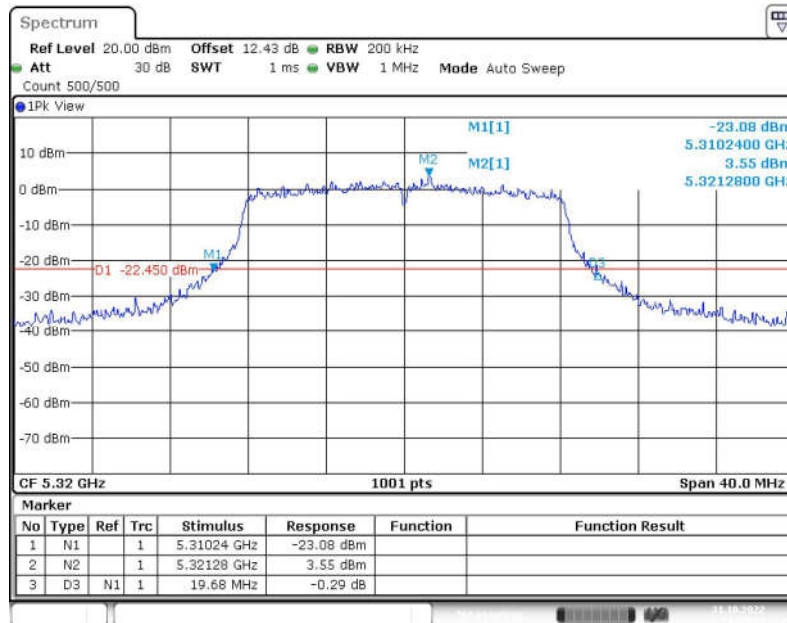

Fig. 6 Occupied 26dB Bandwidth (802.11a, 5320MHz)

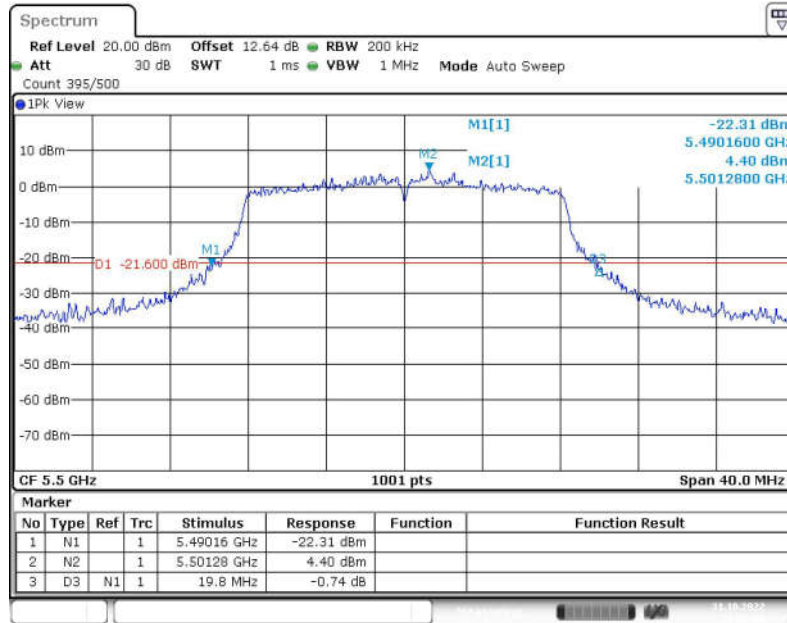

Fig. 7 Occupied 26dB Bandwidth (802.11a, 5500MHz)

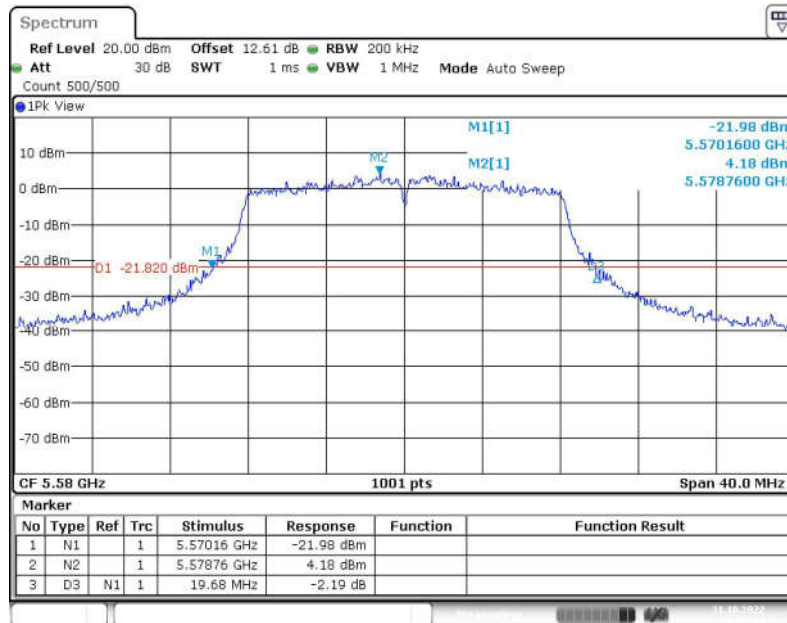

Fig. 8 Occupied 26dB Bandwidth (802.11a, 5580MHz)

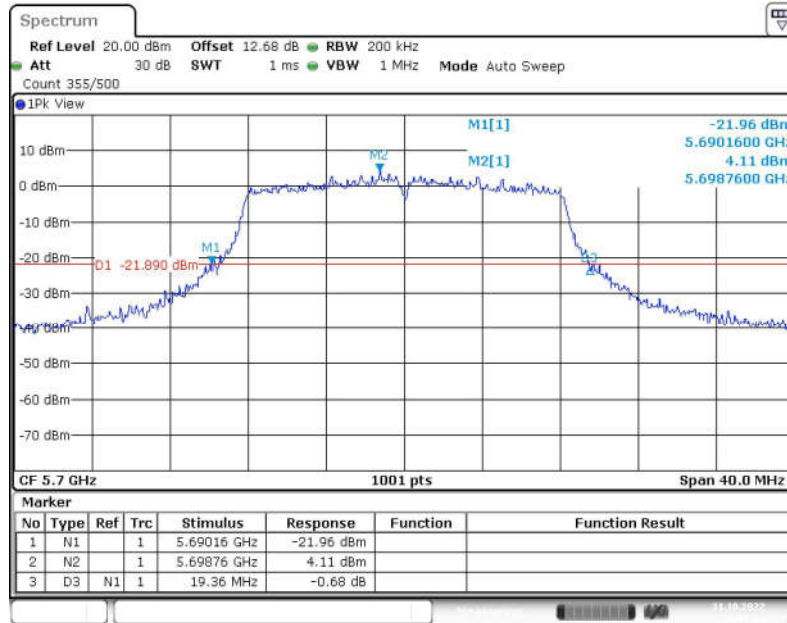

Fig. 9 Occupied 26dB Bandwidth (802.11a, 5700MHz)

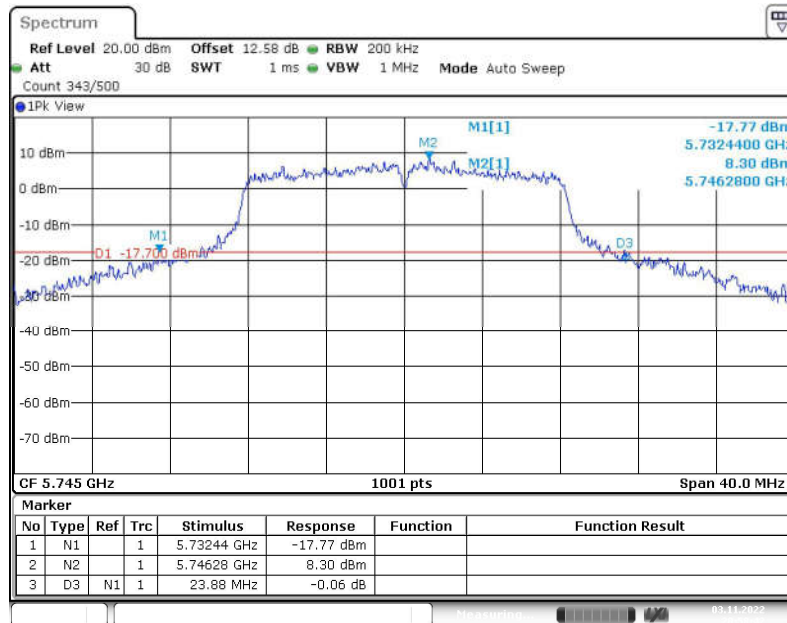

Fig. 10 Occupied 26dB Bandwidth (802.11a, 5745MHz)

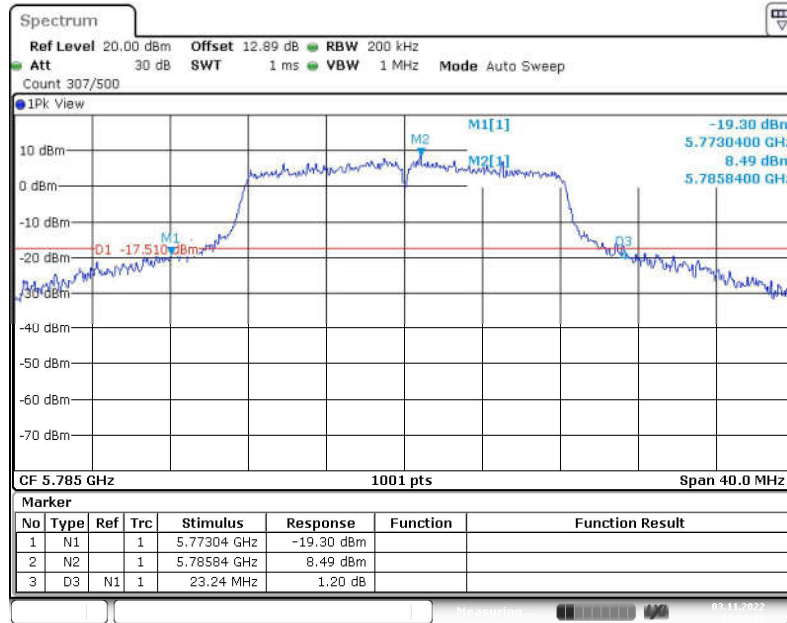

Fig. 11 Occupied 26dB Bandwidth (802.11a, 5785MHz)

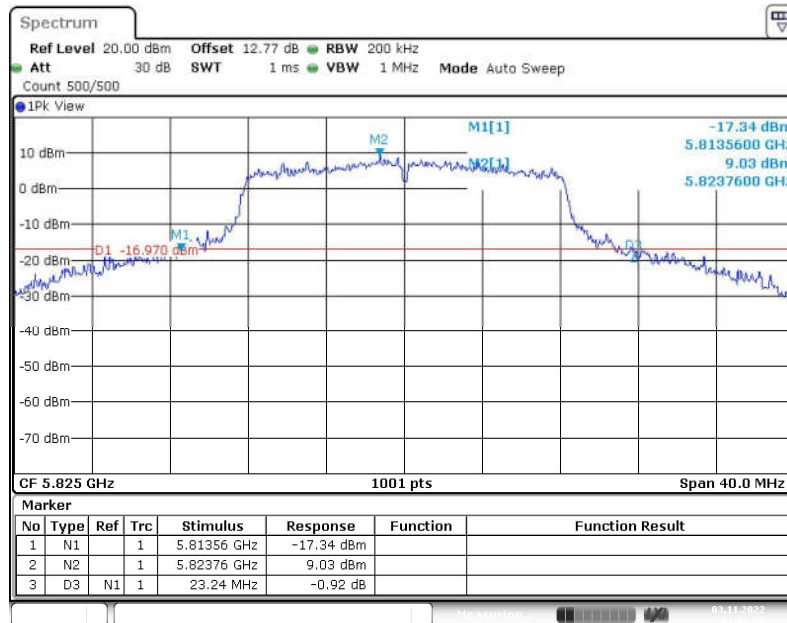

Fig. 12 Occupied 26dB Bandwidth (802.11a, 5825MHz)

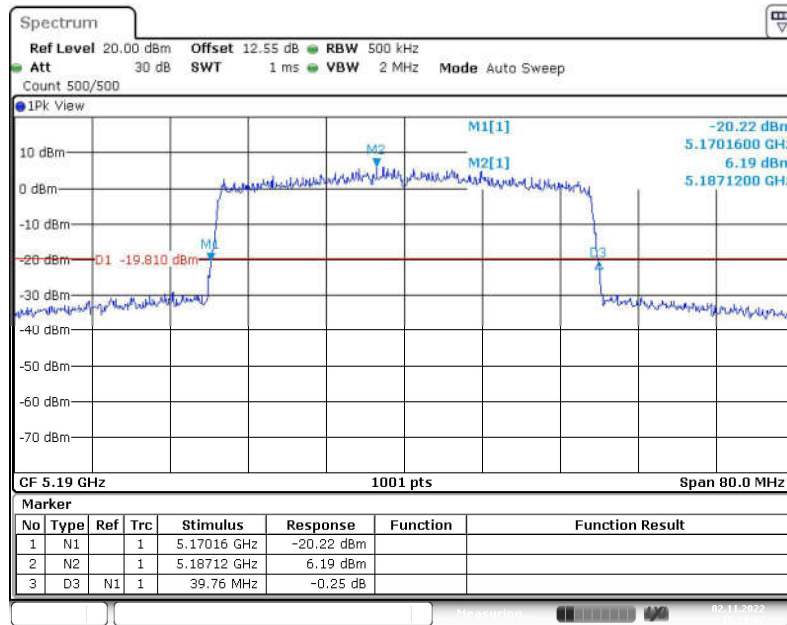

Fig. 13 Occupied 26dB Bandwidth (802.11ax-HE40, 5190MHz)

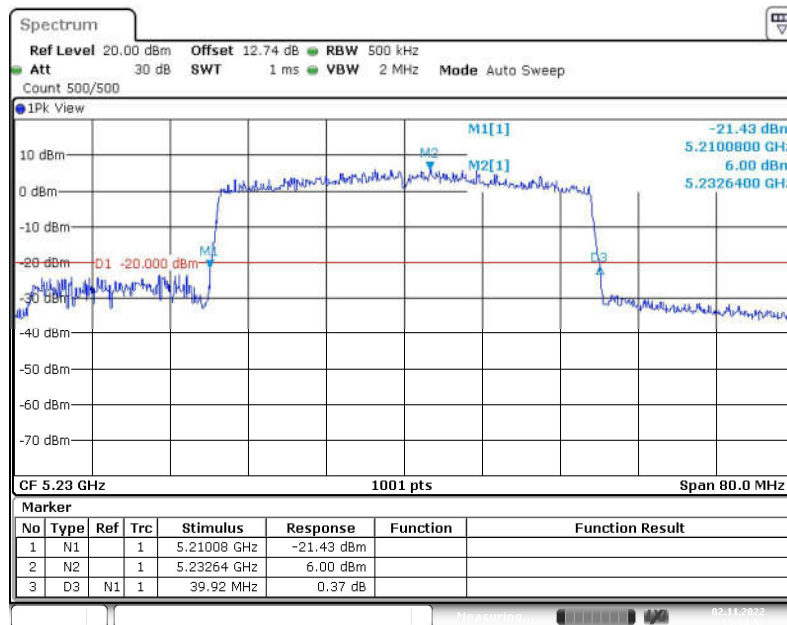

Fig. 14 Occupied 26dB Bandwidth (802.11ax-HE40, 5230MHz)

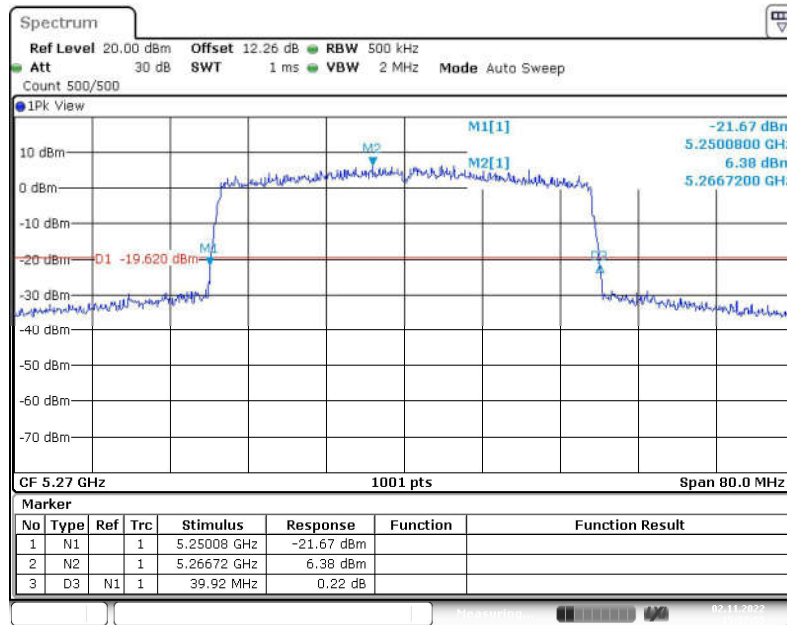

Fig. 15 Occupied 26dB Bandwidth (802.11ax-HE40, 5270MHz)

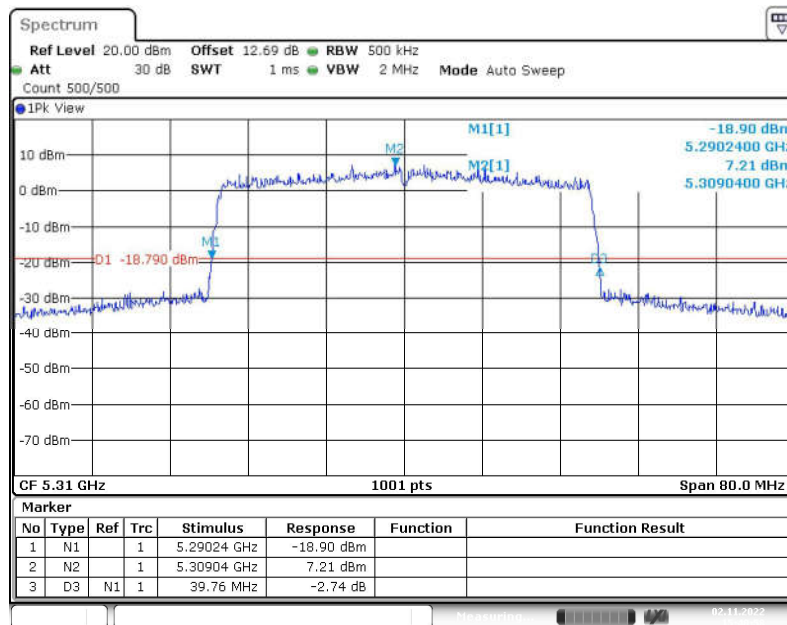

Fig. 16 Occupied 26dB Bandwidth (802.11ax-HE40, 5310MHz)

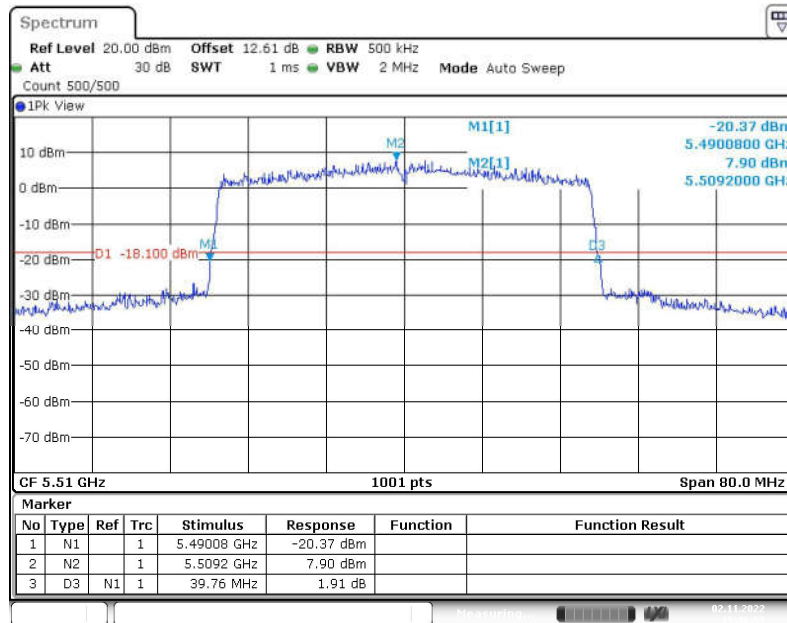

Fig. 17 Occupied 26dB Bandwidth (802.11ax-HE40, 5510MHz)

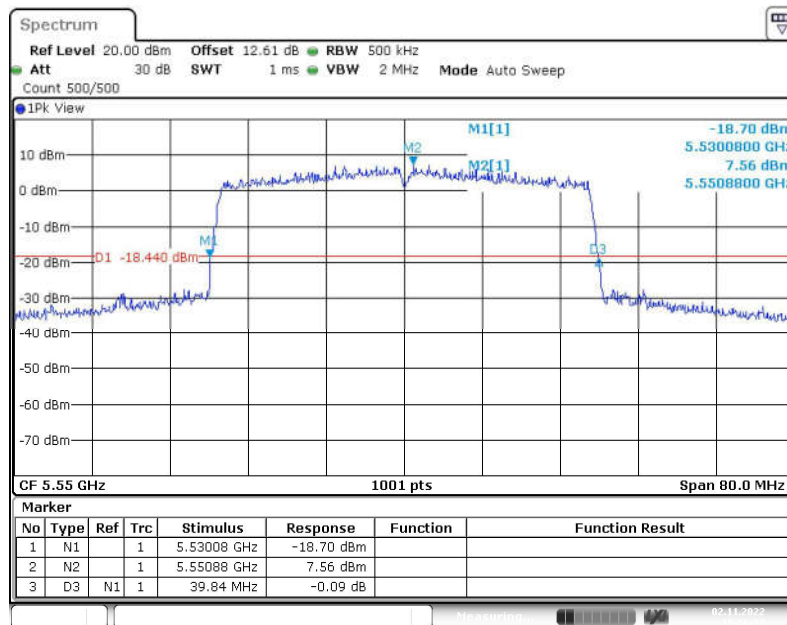

Fig. 18 Occupied 26dB Bandwidth (802.11ax-HE40, 5550MHz)

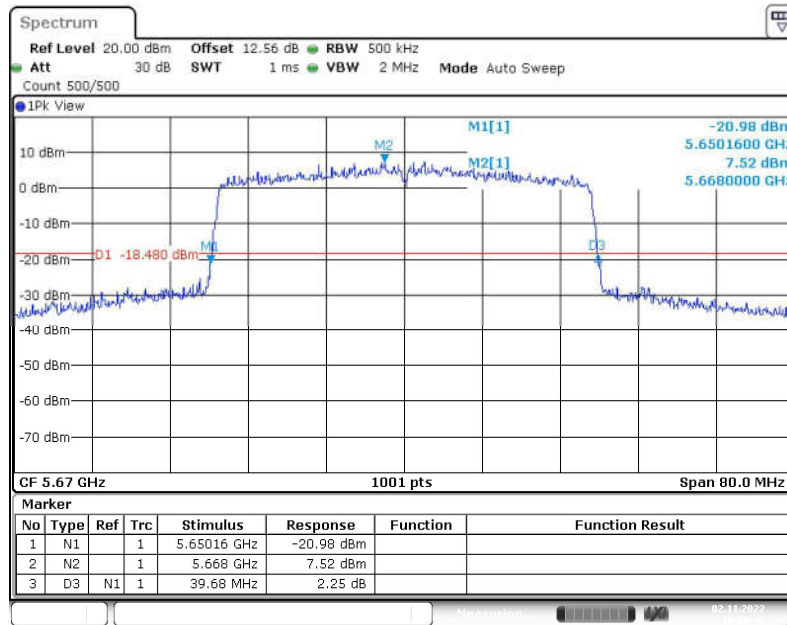

Fig. 19 Occupied 26dB Bandwidth (802.11ax-HE40, 5670MHz)

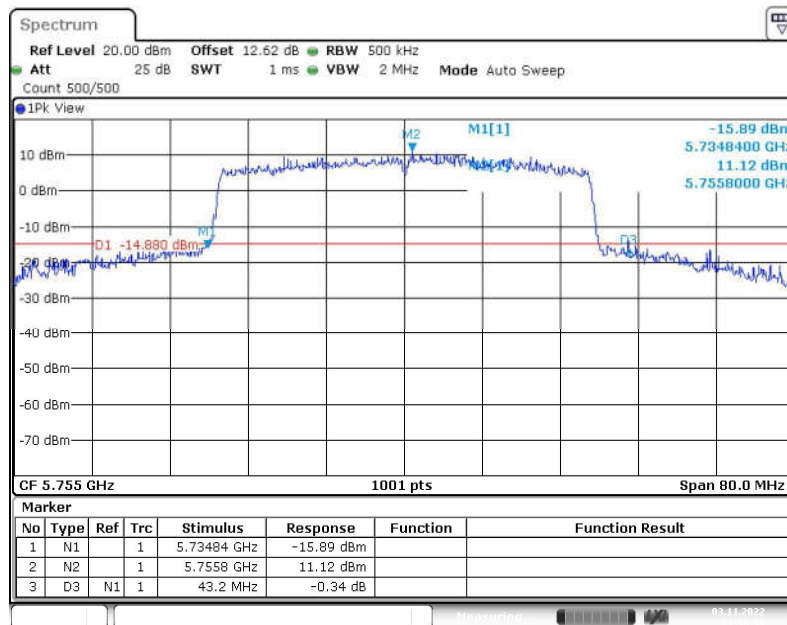

Fig. 20 Occupied 26dB Bandwidth (802.11ax-HE40, 5755MHz)

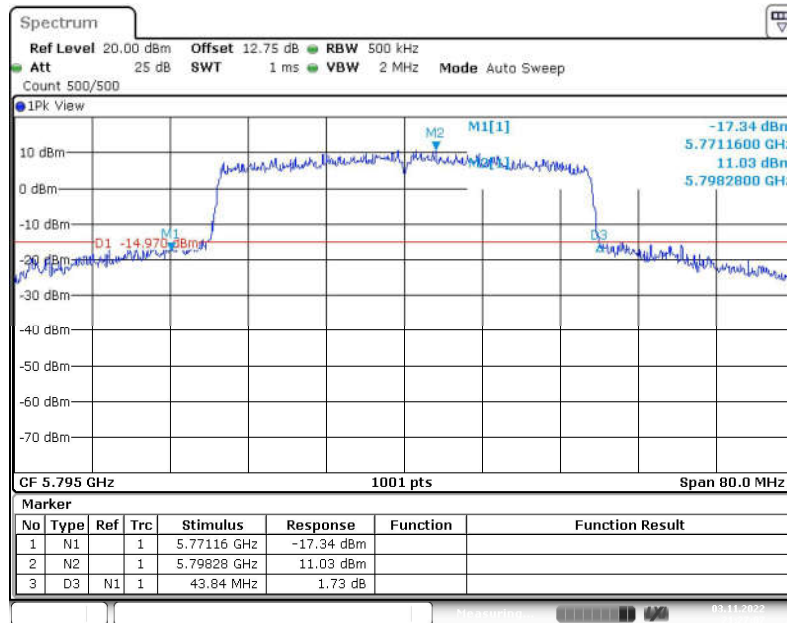

Fig. 21 Occupied 26dB Bandwidth (802.11ax-HE40, 5795MHz)

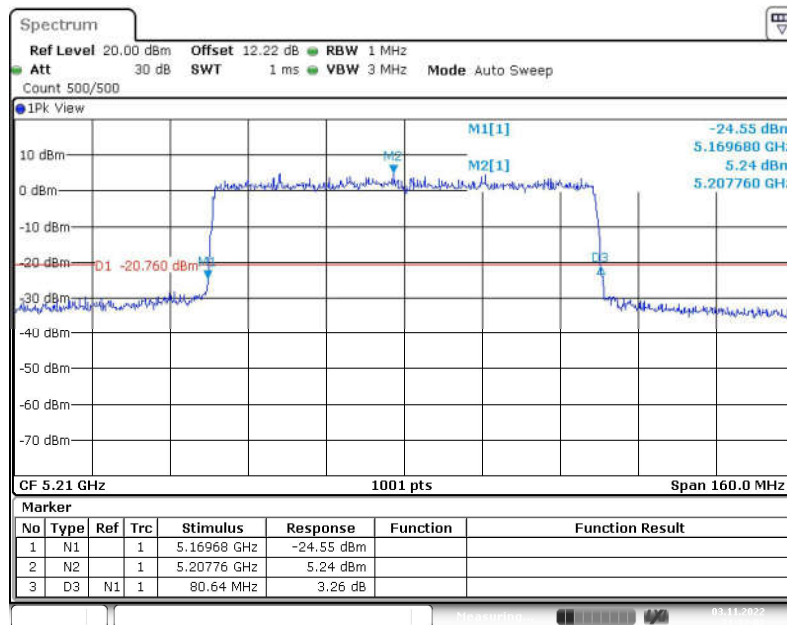

Fig. 22 Occupied 26dB Bandwidth (802.11ax-HE80, 5210MHz)

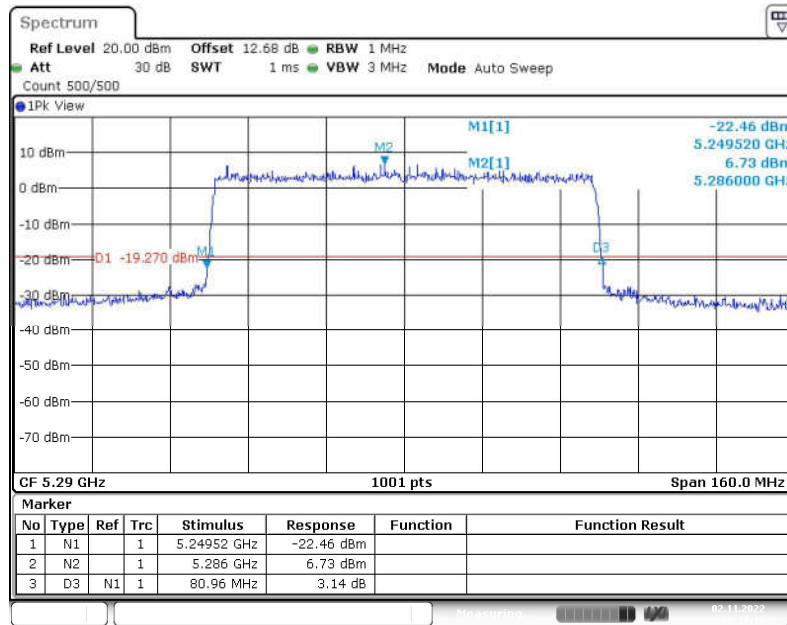

Fig. 23 Occupied 26dB Bandwidth (802.11ax-HE80, 5290MHz)

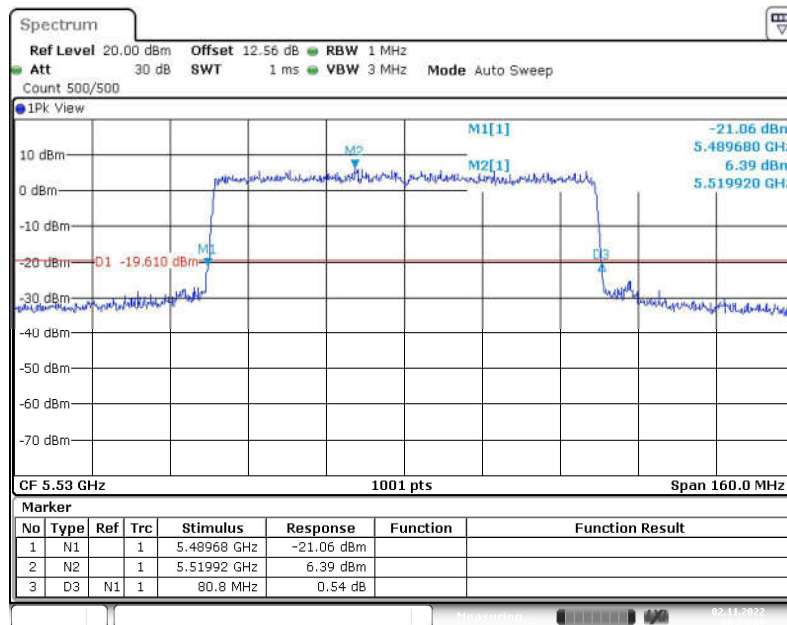

Fig. 24 Occupied 26dB Bandwidth (802.11ax-HE80, 5530MHz)

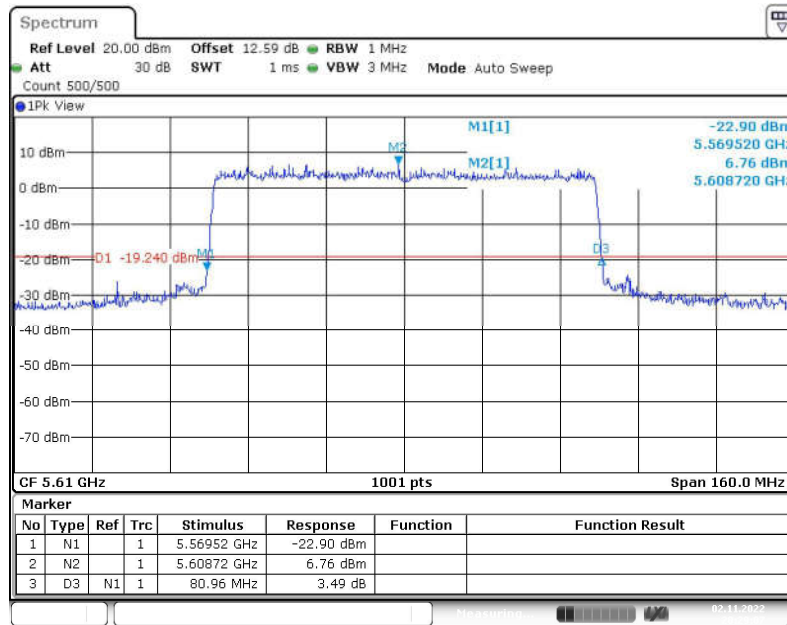

Fig. 25 Occupied 26dB Bandwidth (802.11ax-HE80, 5610MHz)

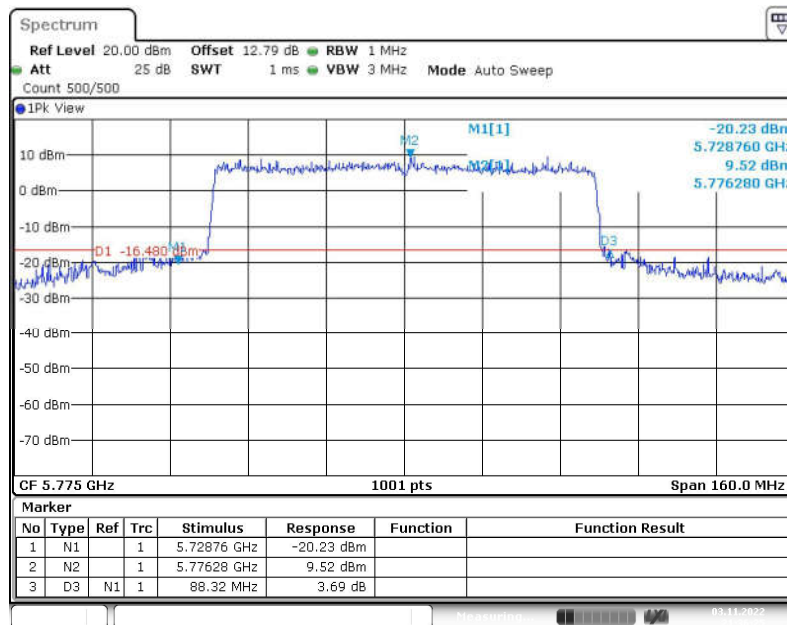

Fig. 26 Occupied 26dB Bandwidth (802.11ax-HE80, 5775MHz)

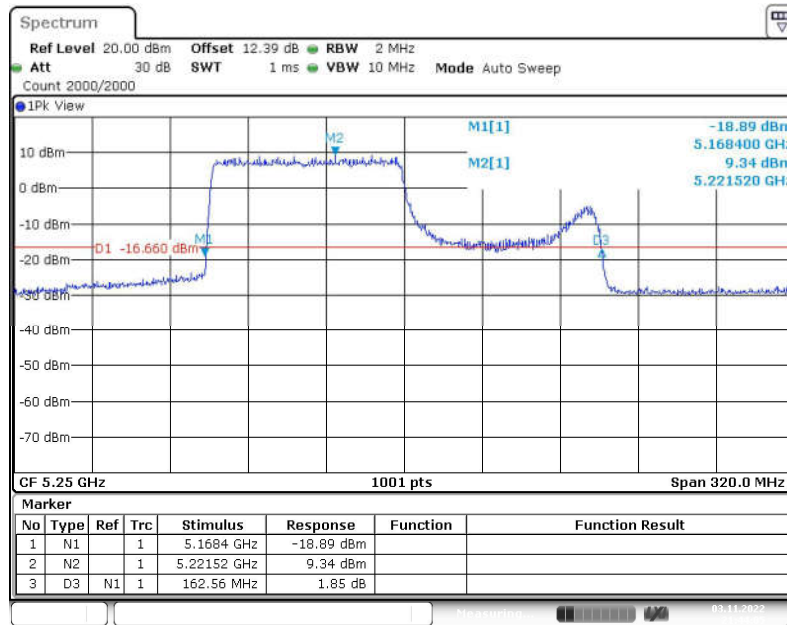

Fig. 27 Occupied 26dB Bandwidth (802.11ax-HE160, 5250MHz)

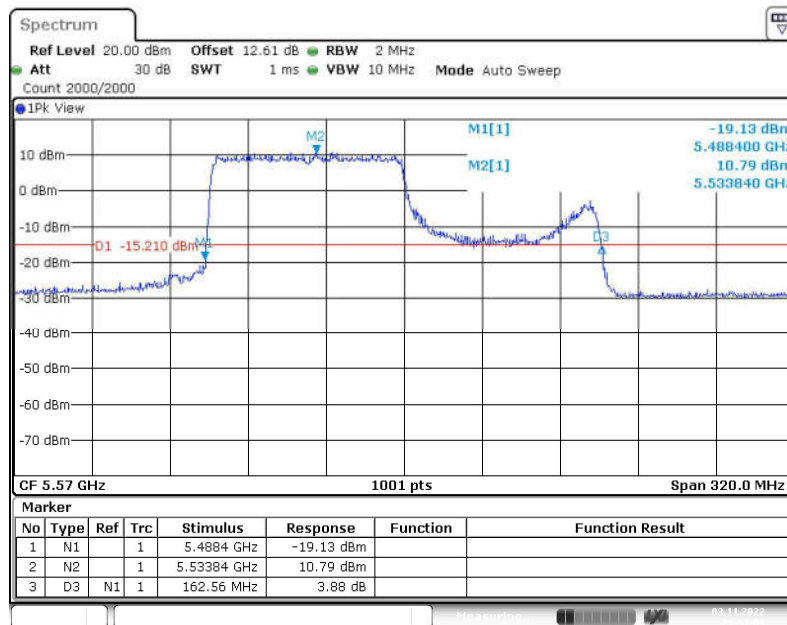

Fig. 28 Occupied 26dB Bandwidth (802.11ax-HE160, 5570MHz)



A.5. Occupied 6dB Bandwidth (conducted)

Measurement of method: See KDB 789033 D02 v02r01, Section C.2.

Measurement Limit:

Standard	Limit (MHz)
FCC 47 CFR Part 15.407 (e)	≥ 0.5

The measurement is made according to KDB 789033.

Measurement Result:

Mode	Frequency (MHz)	Occupied 6dB Bandwidth(MHz)		Conclusion
		Fig.	Value	
802.11a	5745MHz(CH149)	Fig.29	15.16	P
	5785MHz(CH157)	Fig.30	15.12	P
	5825MHz(CH165)	Fig.31	15.68	P
802.11ax-HE40	5755MHz(CH151)	Fig.32	35.84	P
	5795MHz(CH159)	Fig.33	35.84	P
802.11ax-HE80	5775MHz(CH155)	Fig.34	77.76	P

See below for test graphs.

Conclusion: PASS

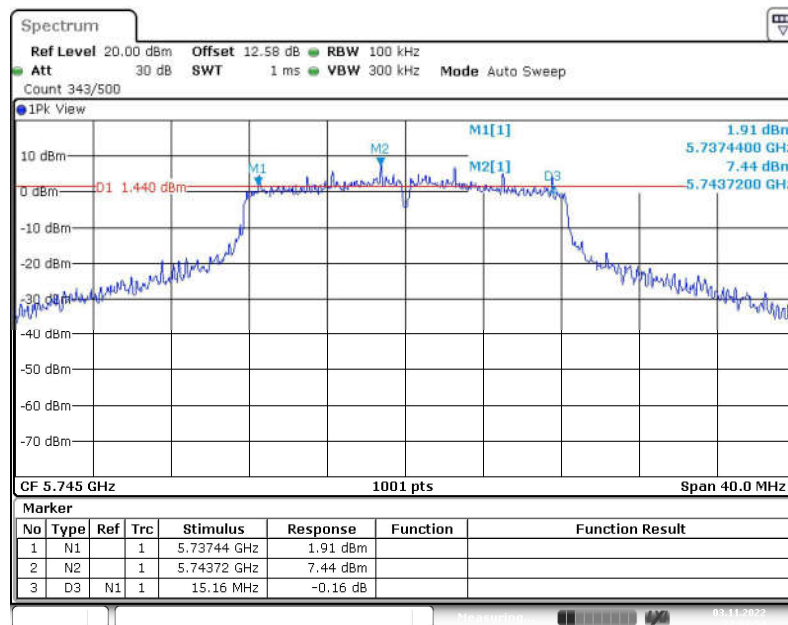

Fig. 29 Occupied 6dB Bandwidth (802.11a, 5745MHz)

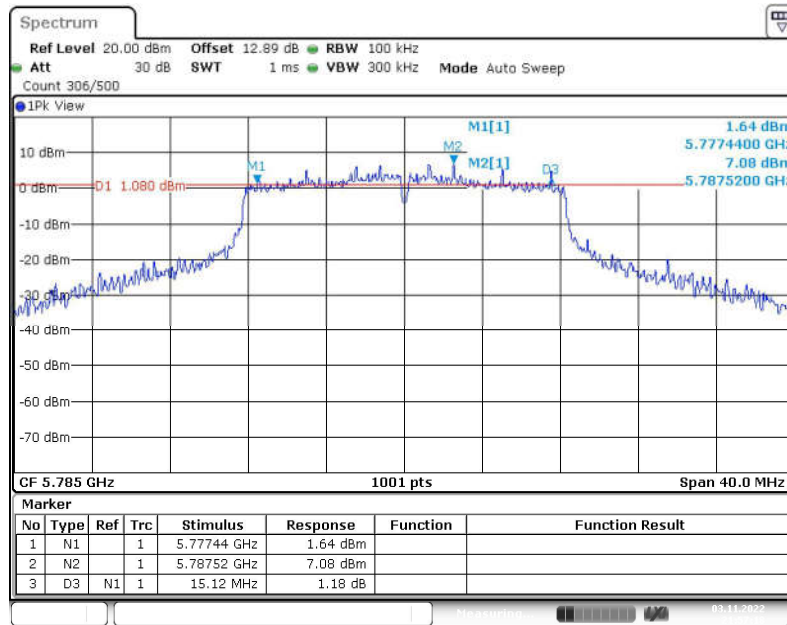

Fig. 30 Occupied 6dB Bandwidth (802.11a, 5785MHz)

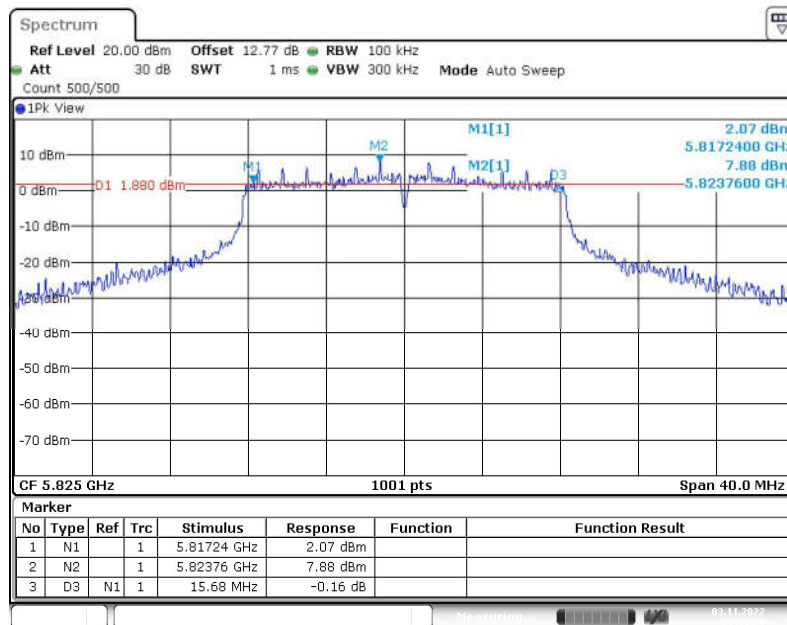

Fig. 31 Occupied 6dB Bandwidth (802.11a, 5825MHz)

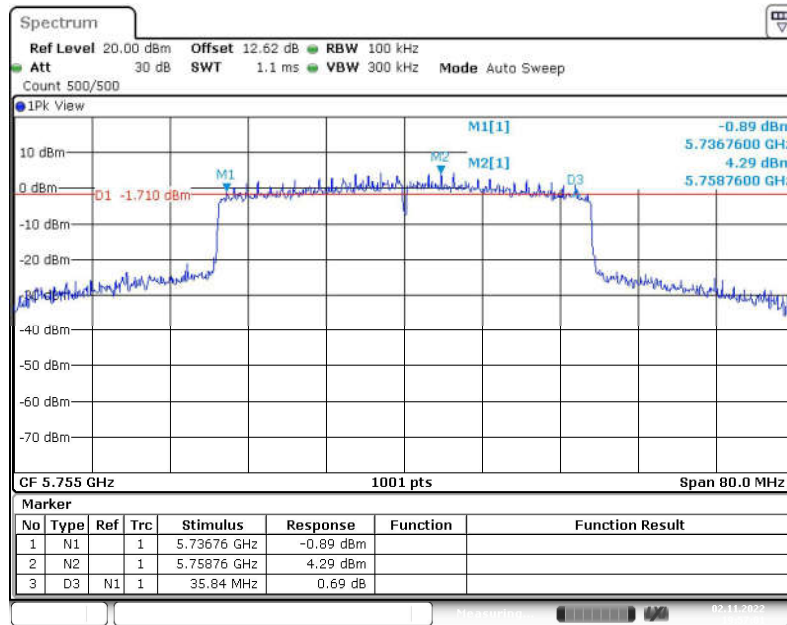

Fig. 32 Occupied 6dB Bandwidth (802.11ax-HE40, 5755MHz)

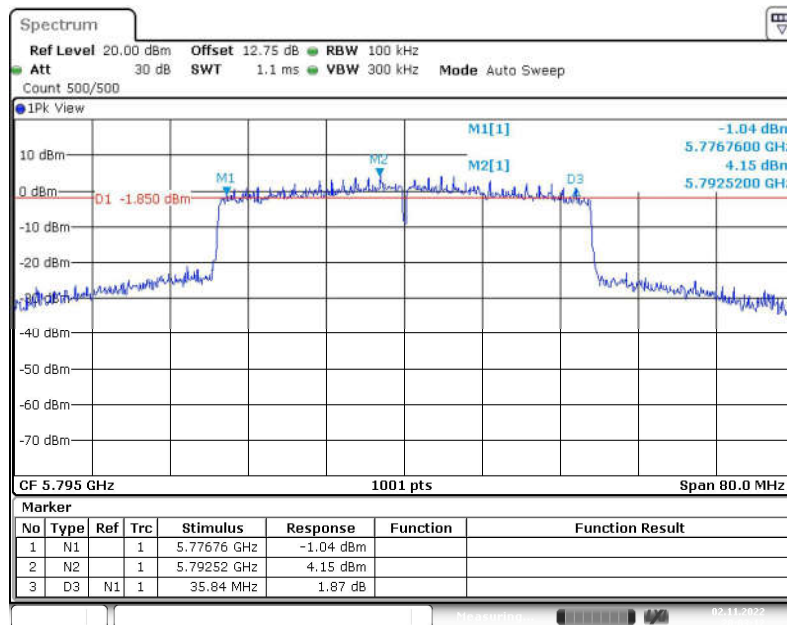

Fig. 33 Occupied 6dB Bandwidth (802.11ax-HE40, 5795MHz)

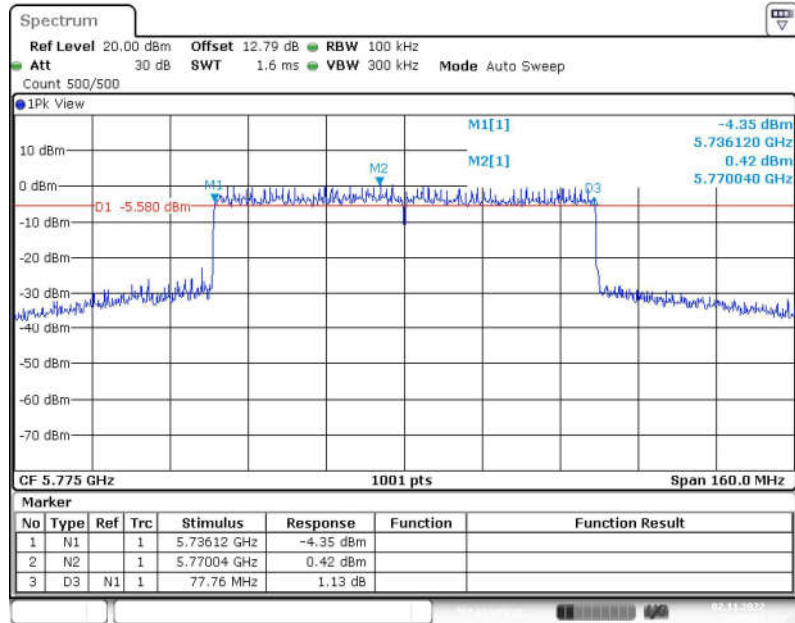

Fig. 34 Occupied 6dB Bandwidth (802.11ax-HE80, 5775MHz)



A.6. 99% Occupied Bandwidth (conducted)

Measurement of method: See KDB 789033 D02 v02r01, Section D.

Measurement Limit:

Standard	Limit (MHz)
FCC 47 CFR Part 15.403	/

The measurement is made according to KDB 789033.

Measurement Result:

Mode	Frequency (MHz)	99% Occupied Bandwidth(MHz)		Conclusion
		Fig.	Value	
802.11a	5180MHz(CH36)	Fig.35	17.10	/
	5200MHz(CH40)	Fig.36	17.10	/
	5240MHz(CH48)	Fig.37	17.10	/
	5260MHz(CH52)	Fig.38	17.06	/
	5280MHz(CH56)	Fig.39	17.02	/
	5320MHz(CH64)	Fig.40	17.10	/
	5500MHz(CH100)	Fig.41	17.06	/
	5580MHz(CH116)	Fig.42	17.06	/
	5700MHz(CH140)	Fig.43	17.02	/
	5745MHz(CH149)	Fig.44	17.50	/
	5785MHz(CH157)	Fig.45	17.42	/
5825MHz(CH165)	Fig.46	17.54	/	
802.11ax-HE40	5190MHz(CH38)	Fig.47	37.64	/
	5230MHz(CH46)	Fig.48	37.72	/
	5270MHz(CH54)	Fig.49	37.80	/
	5310MHz(CH62)	Fig.50	37.72	/
	5510MHz(CH102)	Fig.51	37.64	/
	5550MHz(CH110)	Fig.52	37.72	/
	5670MHz(CH134)	Fig.53	37.72	/
	5755MHz(CH151)	Fig.54	37.96	/
5795MHz(CH159)	Fig.55	37.96	/	
802.11ax-HE80	5210MHz(CH42)	Fig.56	77.84	/
	5290MHz(CH58)	Fig.57	77.84	/
	5530MHz(CH106)	Fig.58	77.68	/
	5610MHz(CH122)	Fig.59	77.84	/
	5775MHz(CH155)	Fig.60	78.00	/
802.11ax-HE160	5250MHz(CH50)	Fig.61	153.39	/
	5570MHz(CH114)	Fig.62	153.28	/

See below for test graphs.

Conclusion: PASS

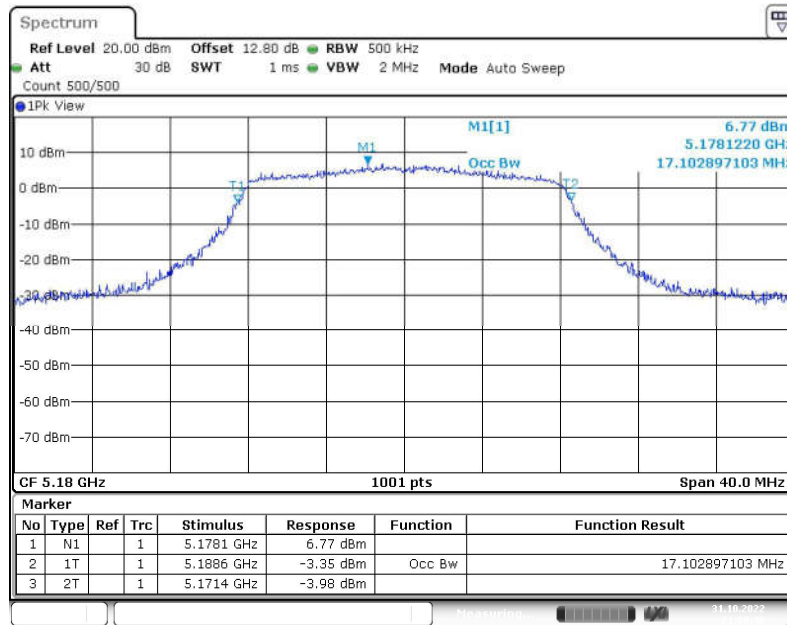

Fig. 35 99% Occupied Bandwidth (802.11a, 5180MHz)

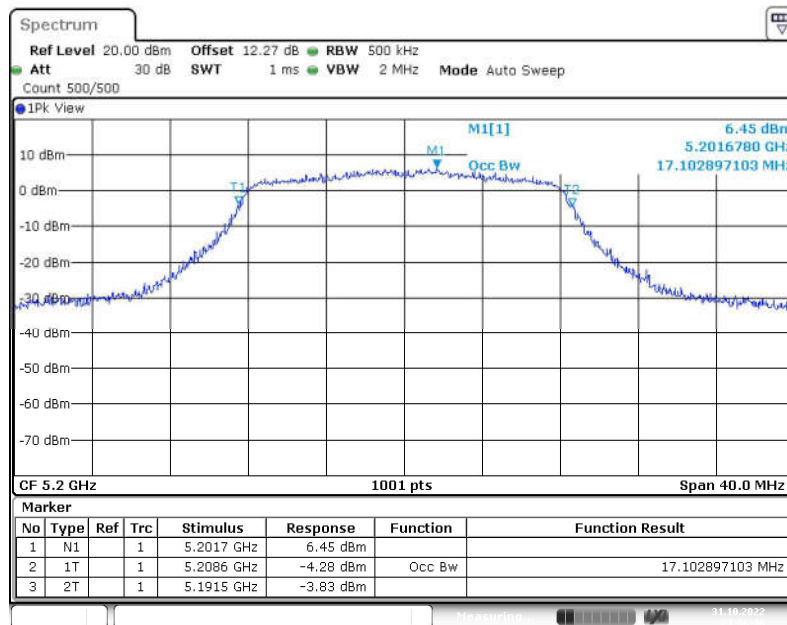

Fig. 36 99% Occupied Bandwidth (802.11a, 5200MHz)

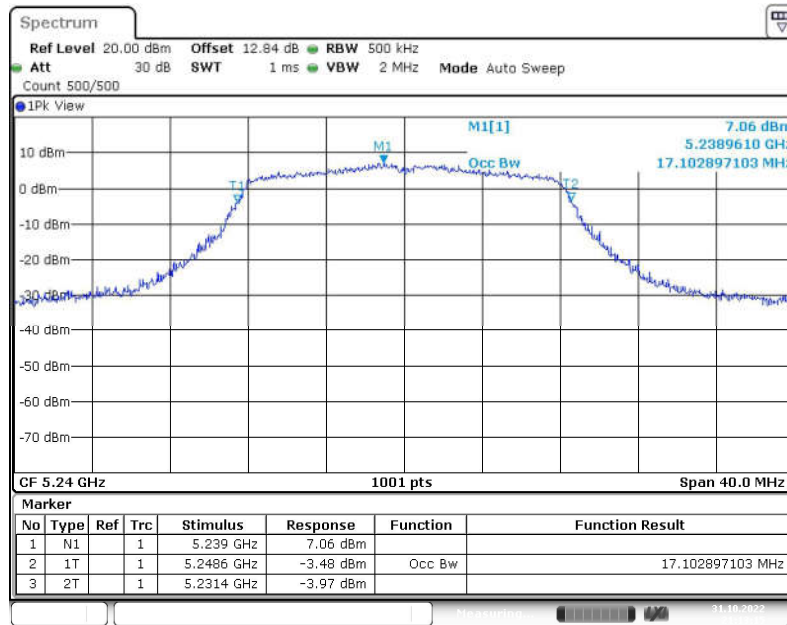

Fig. 37 99% Occupied Bandwidth (802.11a, 5240MHz)

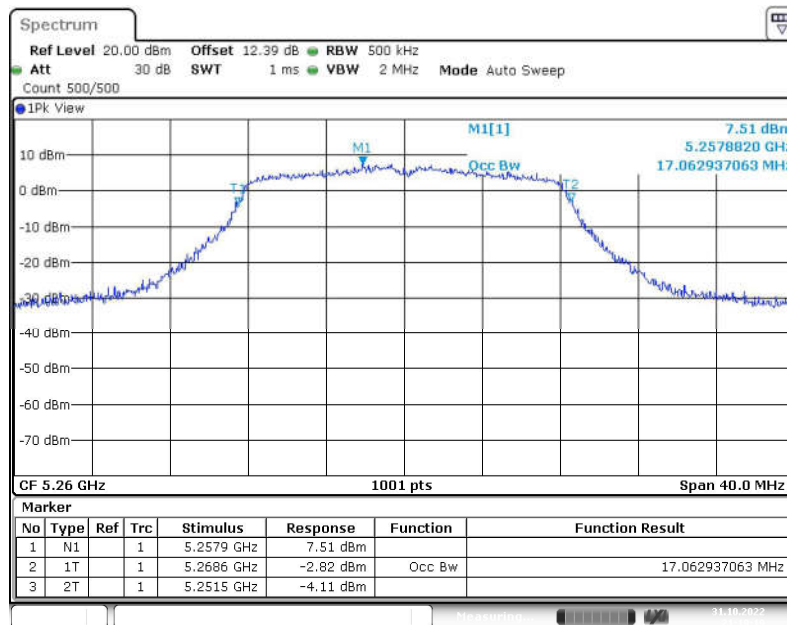

Fig. 38 99% Occupied Bandwidth (802.11a, 5260MHz)

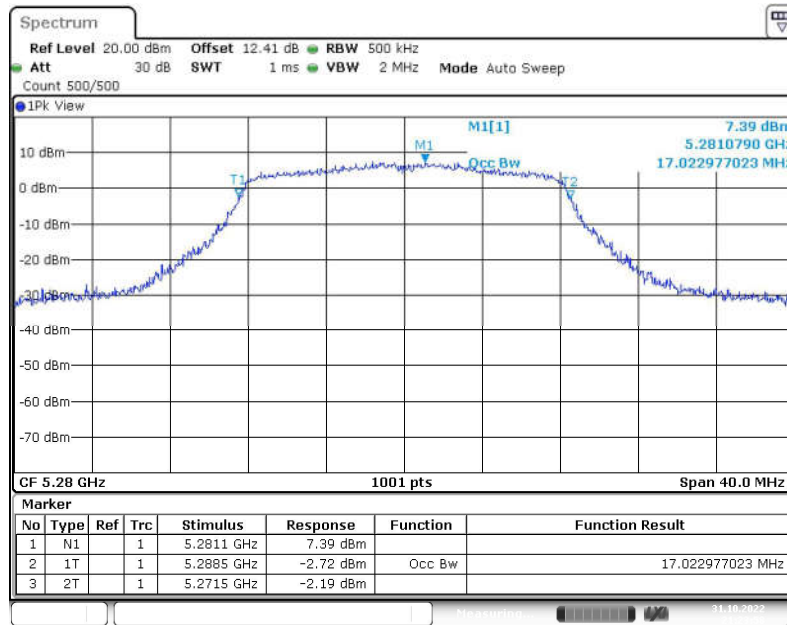

Fig. 39 99% Occupied Bandwidth (802.11a, 5280MHz)

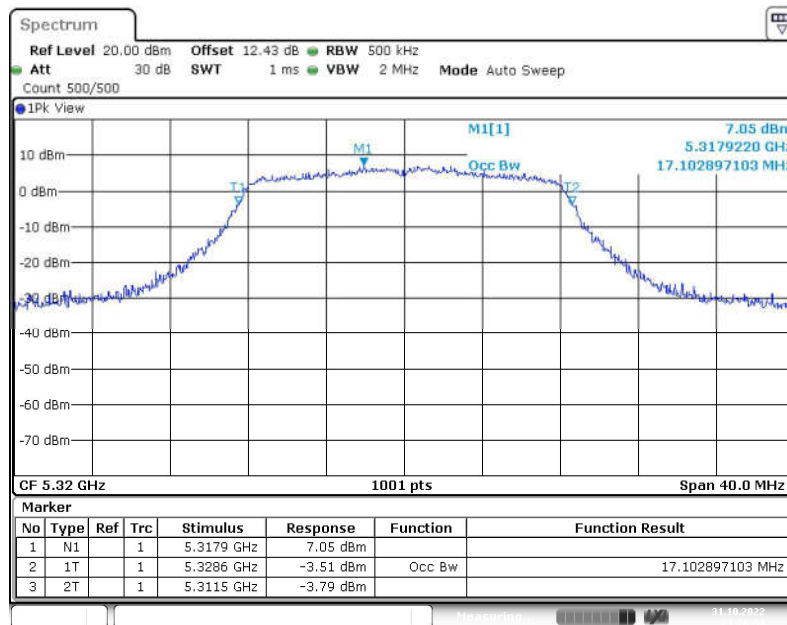

Fig. 40 99% Occupied Bandwidth (802.11a, 5320MHz)

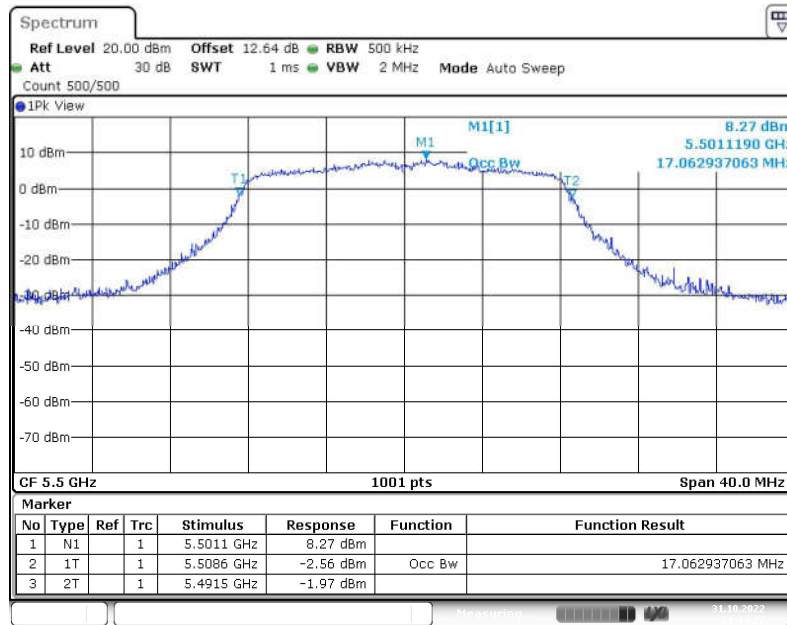

Fig. 41 99% Occupied Bandwidth (802.11a, 5500MHz)

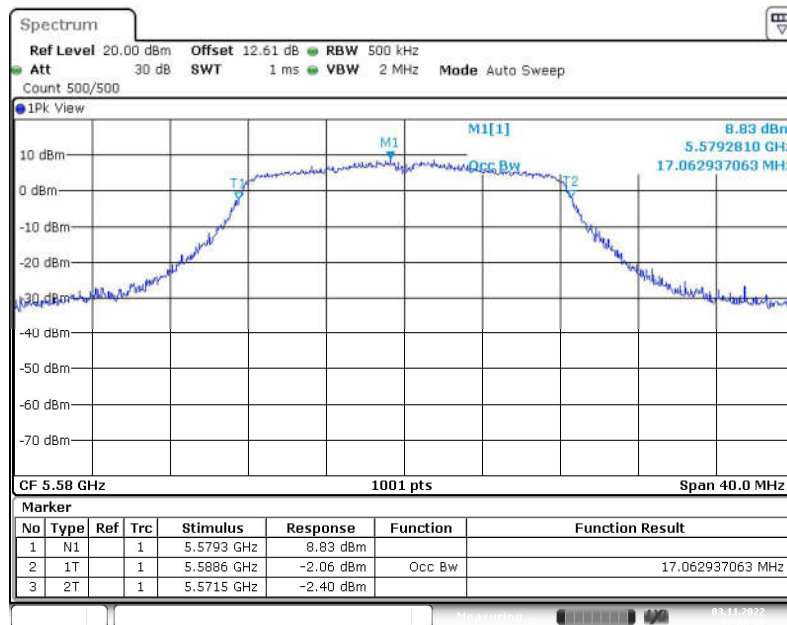

Fig. 42 99% Occupied Bandwidth (802.11a, 5580MHz)

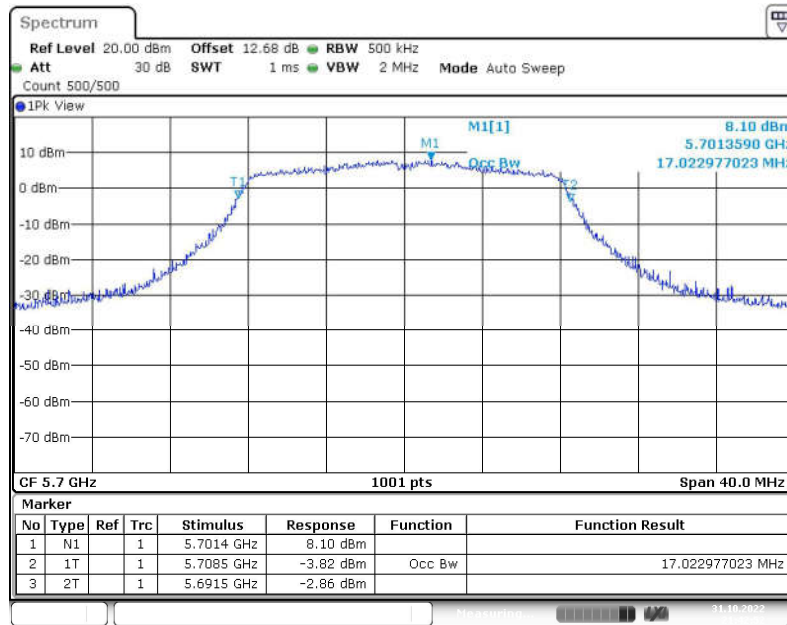

Fig. 43 99% Occupied Bandwidth (802.11a, 5700MHz)

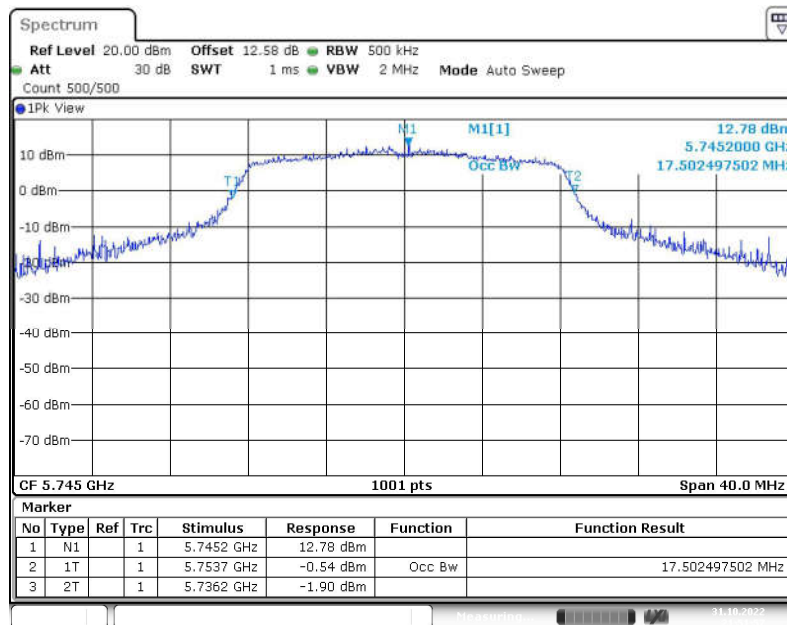

Fig. 44 99% Occupied Bandwidth (802.11a, 5745MHz)

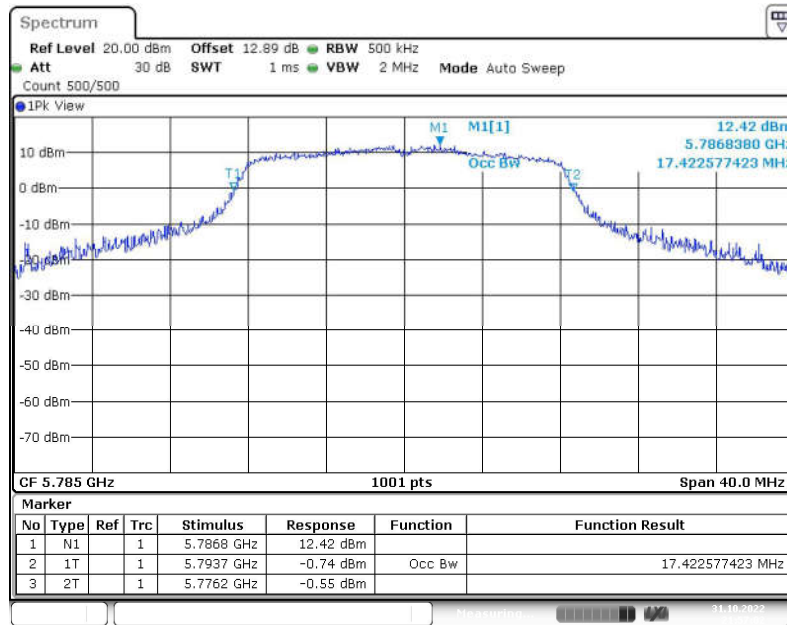

Fig. 45 99% Occupied Bandwidth (802.11a, 5785MHz)

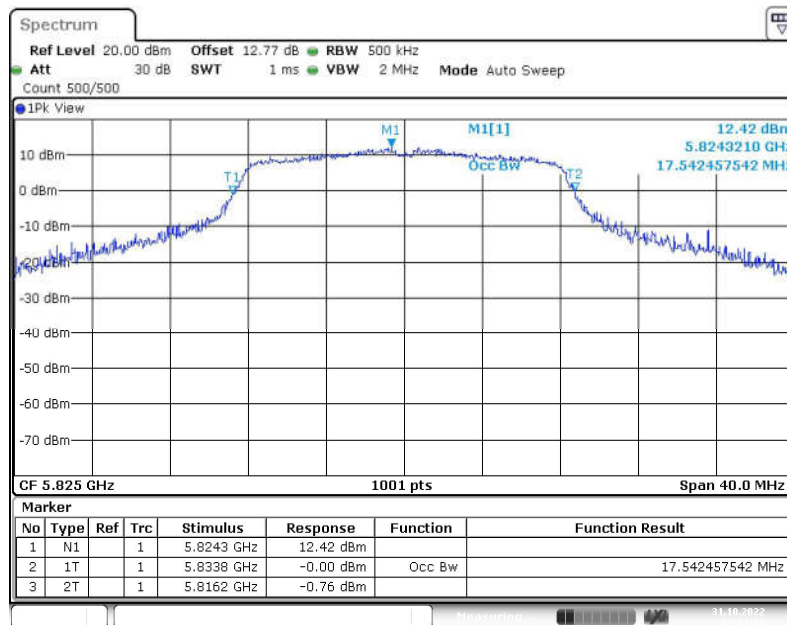

Fig. 46 99% Occupied Bandwidth (802.11a, 5825MHz)

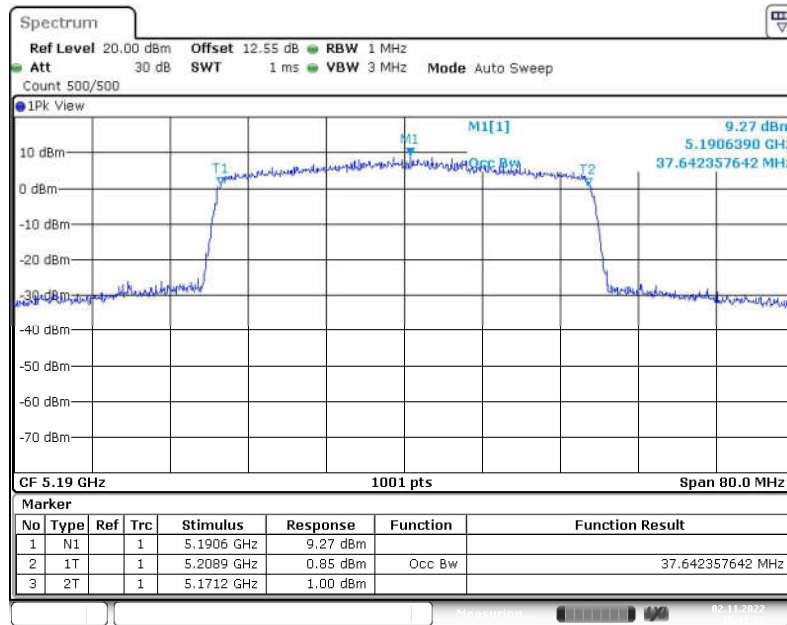

Fig. 47 99% Occupied Bandwidth (802.11ax-HE40, 5190MHz)

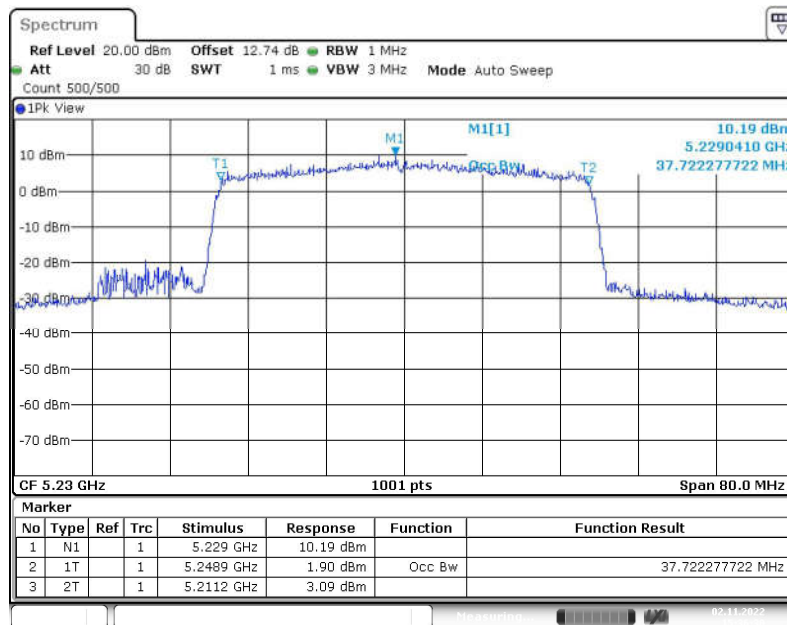

Fig. 48 99% Occupied Bandwidth (802.11ax-HE40, 5230MHz)

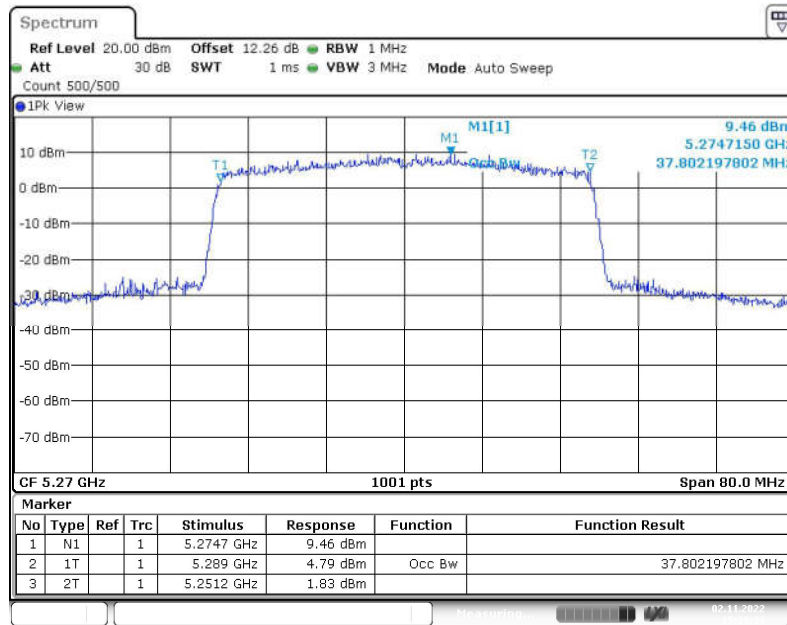

Fig. 49 99% Occupied Bandwidth (802.11ax-HE40, 5270MHz)

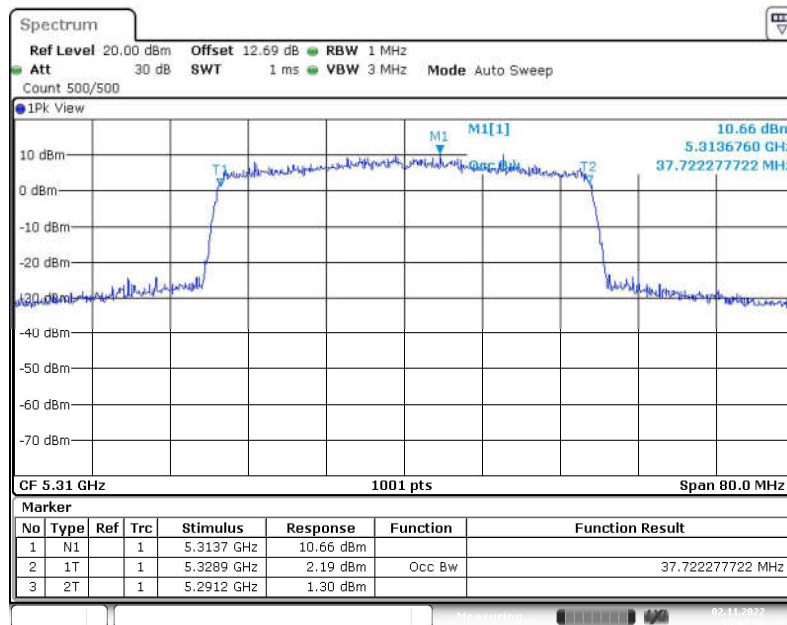

Fig. 50 99% Occupied Bandwidth (802.11ax-HE40, 5310MHz)

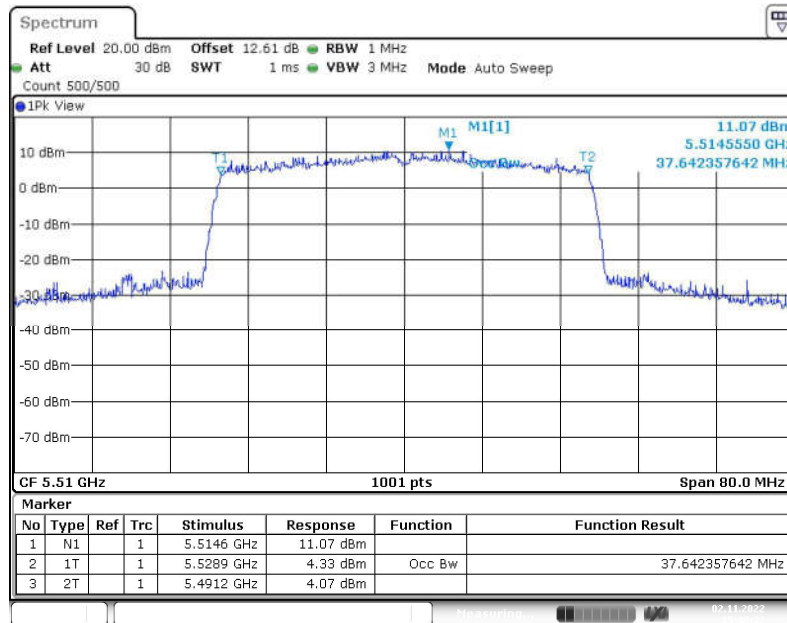

Fig. 51 99% Occupied Bandwidth (802.11ax-HE40, 5510MHz)

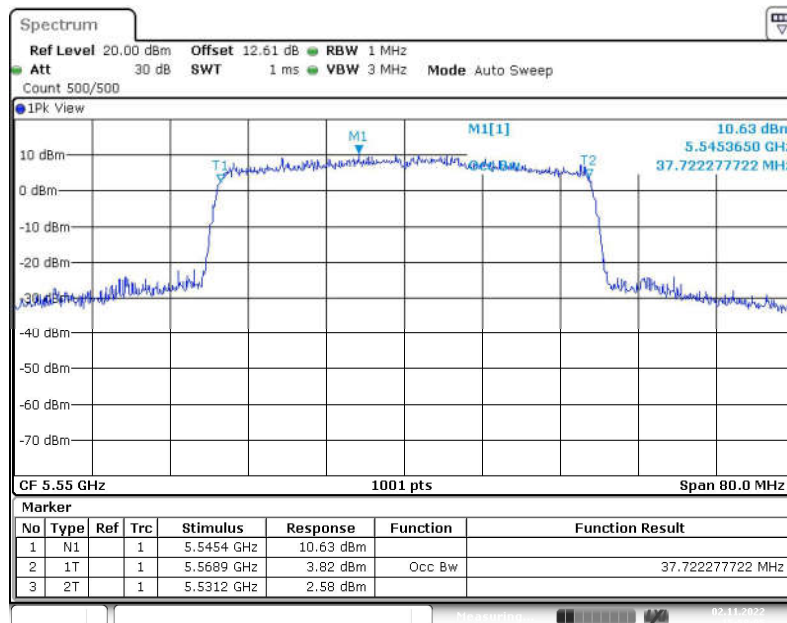

Fig. 52 99% Occupied Bandwidth (802.11ax-HE40, 5550MHz)

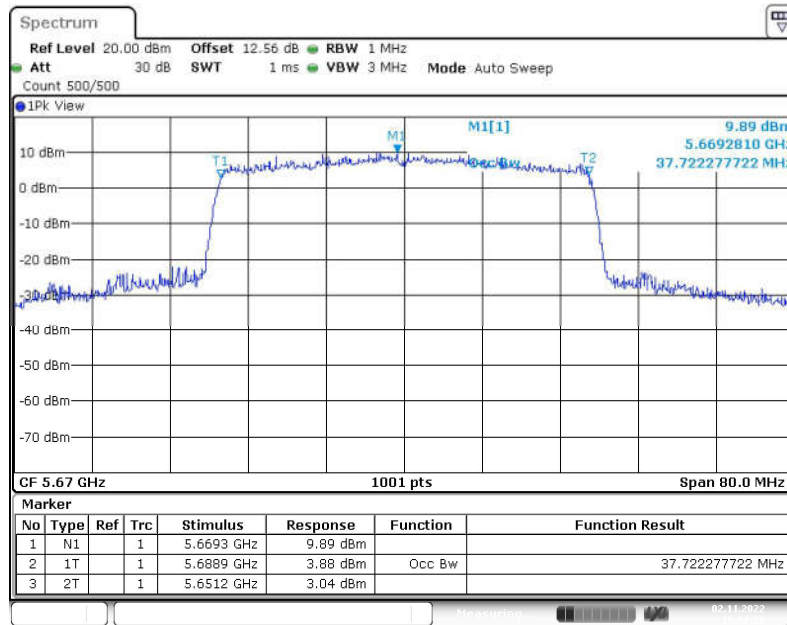

Fig. 53 99% Occupied Bandwidth (802.11ax-HE40, 5670MHz)

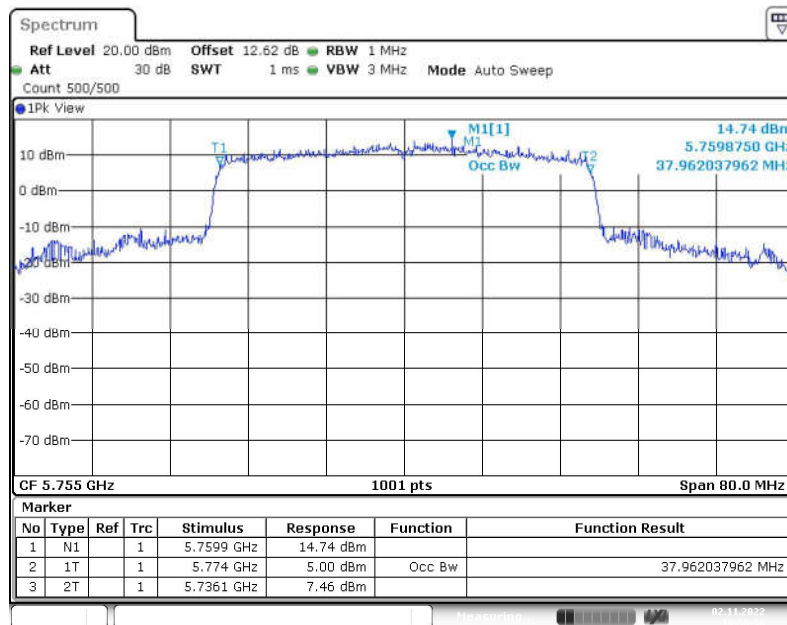

Fig. 54 99% Occupied Bandwidth (802.11ax-HE40, 5755MHz)

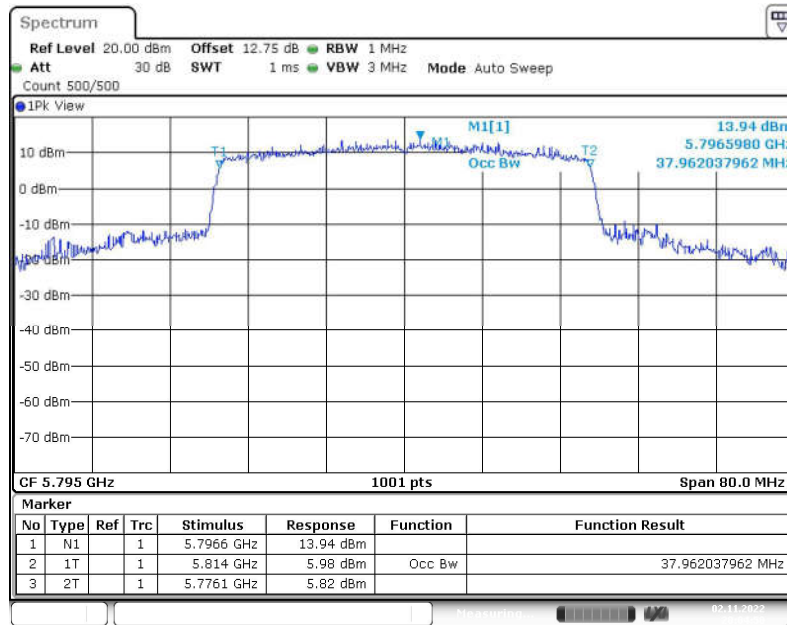

Fig. 55 99% Occupied Bandwidth (802.11ax-HE40, 5795MHz)

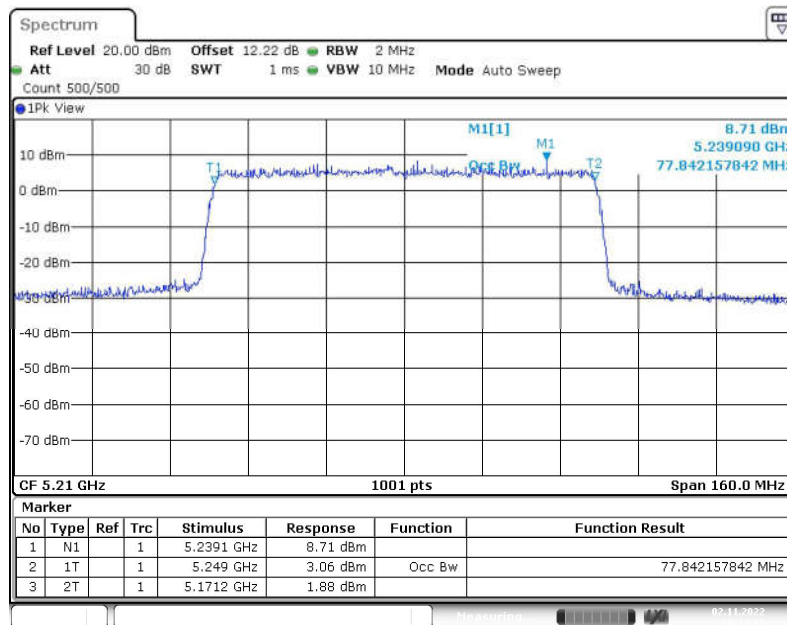

Fig. 56 99% Occupied Bandwidth (802.11ax-HE80, 5210MHz)

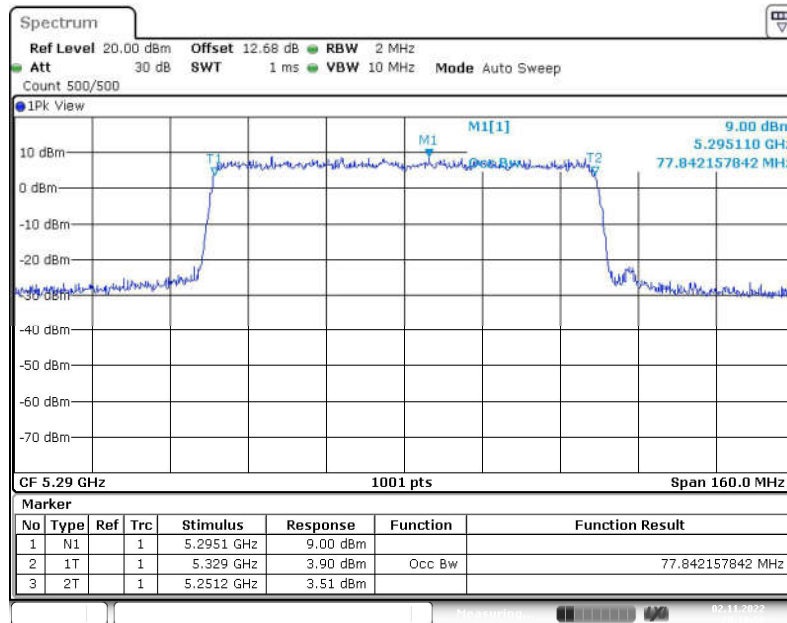

Fig. 57 99% Occupied Bandwidth (802.11ax-HE80, 5290MHz)

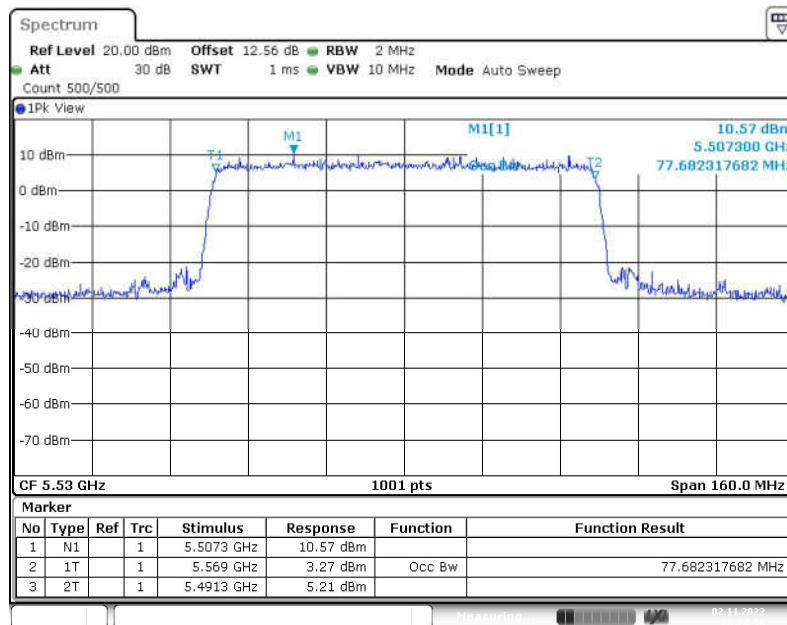

Fig. 58 99% Occupied Bandwidth (802.11ax-HE80, 5530MHz)

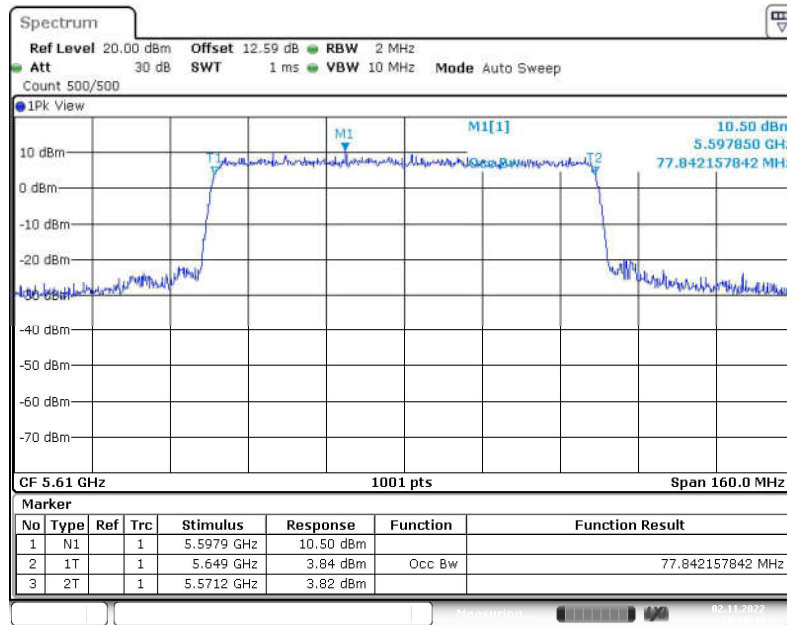

Fig. 59 99% Occupied Bandwidth (802.11ax-HE80, 5610MHz)

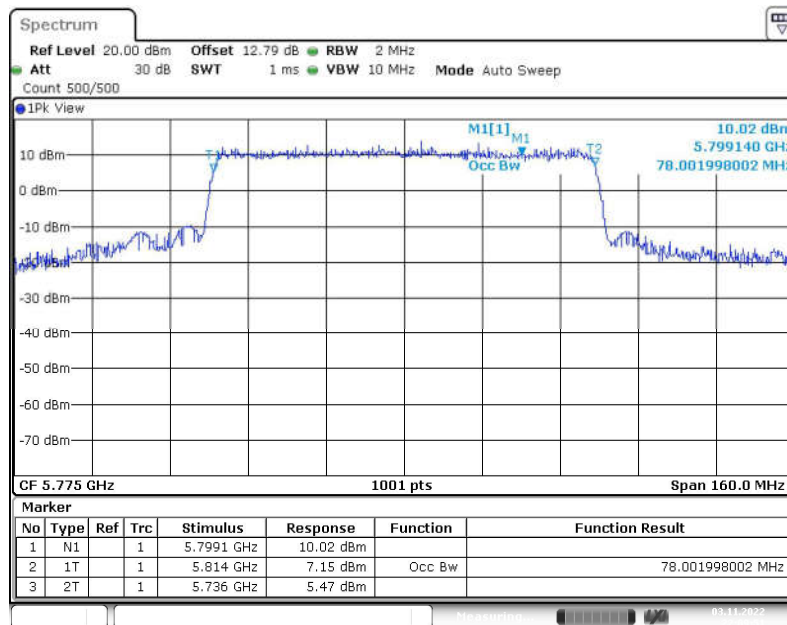

Fig. 60 99% Occupied Bandwidth (802.11ax-HE80, 5775MHz)