

FCC Radio Test Report

FCC ID: R9C-CPH2365

This report concerns: Original Grant

Project No. : 2108C136
Equipment : Mobile Phone
Brand Name : OPPO
Test Model : CPH2365
Series Model : N/A
Applicant : Guangdong OPPO Mobile Telecommunications Corp., Ltd.
Address : NO.18 Haibin Road, Wusha Village, Chang'an Town, Dongguan City, Guangdong, China
Manufacturer : Guangdong OPPO Mobile Telecommunications Corp., Ltd.
Address : NO.18 Haibin Road, Wusha Village, Chang'an Town, Dongguan City, Guangdong, China
Factory : Guangdong OPPO Mobile Telecommunications Corp., Ltd.
Address : NO.18 Haibin Road, Wusha Village, Chang'an Town, Dongguan City, Guangdong, Chin
Date of Receipt : Dec. 23, 2020
Date of Test : Dec. 24, 2020 ~ Aug. 24, 2021
Issued Date : Aug. 30, 2021
Report Version : R00
Test Sample : Engineering Sample No.: DG20201225140 for conducted, DG2020122314 for radiated.
Standard(s) : 47 CFR FCC Part 24 Subpart E
47 CFR FCC Part 2
ANSI/TIA/EIA-603-E-2016
FCC KDB 971168 D01 Power Meas License Digital Systems v03r01

The above equipment has been tested and found compliance with the requirement of the relative standards by BTL Inc.

Vegeta Li

Prepared by : Vegeta Li

Steven Lu

Approved by : Steven Lu



TESTING CERT #5123.02

Add: No. 3 Jinshagang 1st Rd. Shixia, Dalang Town, Dongguan City, Guangdong, People's Republic of China

Tel: +86-769-8318-3000

Web: www.newbtl.com

Declaration

BTL represents to the client that testing is done in accordance with standard procedures as applicable and that test instruments used has been calibrated with standards traceable to international standard(s) and/or national standard(s).

BTL's reports apply only to the specific samples tested under conditions. It is manufacture's responsibility to ensure that additional production units of this model are manufactured with the identical electrical and mechanical components. **BTL** shall have no liability for any declarations, inferences or generalizations drawn by the client or others from **BTL** issued reports.

The report must not be used by the client to claim product certification, approval, or endorsement by NIST, A2LA, or any agency of the U.S. Government.

This report is the confidential property of the client. As a mutual protection to the clients, the public and ourselves, the test report shall not be reproduced, except in full, without our written approval.

BTL's laboratory quality assurance procedures are in compliance with the **ISO/IEC 17025** requirements, and accredited by the conformity assessment authorities listed in this test report.

BTL is not responsible for the sampling stage, so the results only apply to the sample as received.

The information, data and test plan are provided by manufacturer which may affect the validity of results, so it is manufacturer's responsibility to ensure that the apparatus meets the essential requirements of applied standards and in all the possible configurations as representative of its intended use.

Limitation

For the use of the authority's logo is limited unless the Test Standard(s)/Scope(s)/Item(s) mentioned in this test report is (are) included in the conformity assessment authorities acceptance respective.

Please note that the measurement uncertainty is provided for informational purpose only and is not use in determining the Pass/Fail results.

Table of Contents	Page
REPORT ISSUED HISTORY	5
1 . SUMMARY OF TEST RESULTS	6
1.1 TEST FACILITY	7
1.2 MEASUREMENT UNCERTAINTY	7
1.3 TEST ENVIRONMENT CONDITIONS	7
2 . GENERAL INFORMATION	8
2.1 GENERAL DESCRIPTION OF EUT	8
2.2 DESCRIPTION OF TEST MODES	11
2.3 BLOCK DIAGRAM SHOWING THE CONFIGURATION OF SYSTEM TESTED	13
2.4 DESCRIPTION OF SUPPORT UNITS	13
3 . TEST RESULT	14
3.1 OUTPUT POWER MEASUREMENT	14
3.1.1 LIMIT	14
3.1.2 TEST PROCEDURE	14
3.1.3 TEST SETUP LAYOUT	14
3.1.4 TEST DEVIATION	14
3.1.5 TEST RESULTS	14
3.2 OCCUPIED BANDWIDTH MEASUREMENT	15
3.2.1 TEST PROCEDURE	15
3.2.2 TEST SETUP LAYOUT	15
3.2.3 TEST DEVIATION	15
3.2.4 TEST RESULTS	15
3.3 CONDUCTED SPURIOUS EMISSIONS MEASUREMENT	16
3.3.1 LIMIT	16
3.3.2 TEST PROCEDURES	16
3.3.3 TEST SETUP LAYOUT	16
3.3.4 TEST DEVIATION	16
3.3.5 TEST RESULTS	16
3.4 RADIATED SPURIOUS EMISSIONS MEASUREMENT	17
3.4.1 LIMIT	17
3.4.2 TEST PROCEDURES	17
3.4.3 TEST SETUP LAYOUT	18
3.4.4 TEST DEVIATION	19
3.4.5 TEST RESULTS (9KHZ TO 30MHZ)	19
3.4.6 TEST RESULTS (30MHZ TO 1000MHZ)	19
3.4.7 TEST RESULTS (ABOVE 1000MHZ)	19
3.5 BAND EDGE MEASUREMENT	20
3.5.1 LIMIT	20
3.5.2 TEST PROCEDURES	20

Table of Contents	Page
3.5.3 TEST SETUP LAYOUT	20
3.5.4 TEST DEVIATION	20
3.5.5 TEST RESULTS	20
3.6 PEAK TO AVERAGE RATIO MEASUREMENT	21
3.6.1 LIMIT	21
3.6.2 TEST PROCEDURES	21
3.6.3 TEST SETUP LAYOUT	21
3.6.4 TEST DEVIATION	21
3.6.5 TEST RESULTS	21
3.7 FREQUENCY STABILITY MEASUREMENT	22
3.7.1 LIMIT	22
3.7.2 TEST PROCEDURES	22
3.7.3 TEST SETUP LAYOUT	22
3.7.4 TEST DEVIATION	22
3.7.5 TEST RESULTS	22
4. LIST OF MEASUREMENT EQUIPMENTS	23
APPENDIX A - OUTPUT POWER	25
APPENDIX B - OCCUPIED BANDWIDTH	34
APPENDIX C - CONDUCTED SPURIOUS EMISSIONS	58
APPENDIX D - RADIATED SPURIOUS EMISSIONS (9KHZ TO 30MHZ)	64
APPENDIX E - RADIATED SPURIOUS EMISSIONS (30MHZ TO 1000MHZ)	69
APPENDIX F - RADIATED SPURIOUS EMISSIONS (ABOVE 1000MHZ)	90
APPENDIX G - BAND EDGE	111
APPENDIX H - PEAK TO AVERAGE RATIO	120
APPENDIX I - FREQUENCY STABILITY	137

REPORT ISSUED HISTORY

Report Version	Description	Issued Date
R00	Original Issue.	Aug. 30, 2021

1. SUMMARY OF TEST RESULTS

Test procedures according to the technical standard(s):

FCC Part 24 Subpart E & Part 2			
Standard(s) Section	Test Item	Judgment	Remark
2.1046 24.232(c)	Equivalent Isotropic Radiated Power	PASS	-----
2.1049	Occupied Bandwidth	PASS	-----
2.1051 24.238(a)	Conducted Spurious Emissions	PASS	-----
2.1053 24.238(a)	Radiated Spurious Emissions	PASS	-----
24.238(a)	Band Edge Measurements	PASS	-----
24.232(d)	Peak To Average Ratio	PASS	-----
2.1055 24.235	Frequency Stability	PASS	-----

Note:

(1) "N/A" denotes test is not applicable in this test report.

1.1 TEST FACILITY

The test facilities used to collect the test data in this report is at the location of No. 3 Jinshagang 1st Rd. Shixia, Dalang Town, Dongguan City, Guangdong, People's Republic of China.

BTL's Test Firm Registration Number for FCC: 357015

BTL's Designation Number for FCC: CN1240

1.2 MEASUREMENT UNCERTAINTY

ISO/IEC 17025 requires that an estimate of the measurement uncertainties associated with the emissions test results be included in the report. The measurement uncertainties given below are based on a 95% confidence level (based on a coverage factor (k=2))

The BTL measurement uncertainty as below table:

A. Radiated Measurement:

Test Site	Method	Measurement Frequency Range	Ant. H / V	U,(dB)
DG-CB03 (3m)	CISPR	9KHz ~ 30MHz	-	2.36
		30MHz ~ 200MHz	V	4.36
		30MHz ~ 200MHz	H	3.32
		200MHz ~ 1,000MHz	V	4.08
		200MHz ~ 1,000MHz	H	3.96

Test Site	Method	Measurement Frequency Range	U,(dB)
DG-CB03 (3m)	CISPR	1GHz ~ 6GHz	3.80
		6GHz ~ 18GHz	4.82

B. Other Measurement:

Parameter	Uncertainty
Spectrum Bandwidth	±3.8 %
Maximum Output Power	±0.95 dB
Power Spectral Density	±0.86 dB
Frequency Stability	±0.16 dB
Temperature	±0.08 °C
Time	±0.58 %
Supply voltages	±0.3 %

Note: Unless specifically mentioned, the uncertainty of measurement has not been taken into account to declare the compliance or non-compliance to the specification.

1.3 TEST ENVIRONMENT CONDITIONS

Test Item	Temperature	Humidity	Test Voltage	Tested By
Output Power & ERP	21.6°C	43%	DC 3.87V	Tate Liu
Occupied Bandwidth	21.6°C	43%	DC 3.87V	Tate Liu
Conducted Spurious Emissions	21.6°C	43%	DC 3.87V	Tate Liu
Radiated Spurious Emissions	26°C	52%	AC 120V/60Hz	Hayden Chen
Band Edge	22.4°C	45%	DC 3.87V	Tate Liu
Peak to Average Ratio	22.4°C	45%	DC 3.87V	Tate Liu
Frequency Stability	Normal & Extreme	45%	Normal & Extreme	Tate Liu

2. GENERAL INFORMATION

2.1 GENERAL DESCRIPTION OF EUT

Equipment	Mobile Phone								
Brand Name	OPPO								
Test Model	CPH2365								
Series Model	N/A								
Model Difference(s)	N/A								
Hardware Version	11								
Software Version	ColorOS V11.1								
Power Source	1. DC Voltage supplied from AC adapter. Model: VCB3HAUH 2. Supplied from Li-ion Polymer battery. 1# Manufacturer / Model: Sunwoda / BLP851 2# Manufacturer / Model: TWS / BLP851 3. Supplied from USB port.								
Power Rating	1. I/P: 100-240V~ 50/60Hz 1.2A O/P: 5V---2A or 5-11V---3A MAX 2. 3.87Vdc, 4880mAh 3. DC 5V								
IEMI No.	Radiated	864213050020910							
	Conducted	864213050021272							
Modulation Type	GSM		GMSK						
	EDGE/GPRS		GMSK, 8PSK						
	WCDMA/HSDPA/HSUPA		UL: QPSK DL: QPSK, 16QAM						
	LTE		UL: QPSK, 16QAM, 64QAM DL: QPSK, 16QAM, 64QAM						
Max. EIRP	GSM 1900 / GPRS 1900		GMSK	29.57	dBm				
	EDGE 1900		8PSK	24.42	dBm				
	WCDMA Band II		QPSK	22.40	dBm				
	HSDPA Band II		QPSK	21.17	dBm				
	HSUPA Band II		QPSK	21.27	dBm				
	LTE	Channel Bandwidth (MHz)	QPSK (dBm)	16QAM (dBm)	64QAM (dBm)				
						1.4	22.32	21.64	20.47
	Band 2								
						3	22.36	21.70	20.30
						5	22.58	21.84	20.56
						10	22.44	21.78	20.39
15						22.51	21.83	20.79	
20	22.38	21.88	20.77						

Note:

1. For a more detailed features description, please refer to the manufacturer's specifications or the user's manual.

2. Channel List:

PCS 1900				
Test Frequency ID	UARFCN	Frequency of Uplink (MHz)	UARFCN	Frequency of Downlink (MHz)
Low Range	512	1850.2	528	1930.2
Mid Range	661	1880	677	1960
High Range	810	1909.8	826	1989.8

WCDMA Band II				
Test Frequency ID	UARFCN	Frequency of Uplink (MHz)	UARFCN	Frequency of Downlink (MHz)
Low Range	9262	1852.4	9662	1932.4
Mid Range	9400	1880.0	9800	1960.0
High Range	9538	1907.6	9938	1987.6

LTE Band 2					
Test Frequency ID	Bandwidth (MHz)	N _{UL}	Frequency of Uplink (MHz)	N _{DL}	Frequency of Downlink (MHz)
Low Range	1.4	18607	1850.7	607	1930.7
	3	18615	1851.5	615	1931.5
	5	18625	1852.5	625	1932.5
	10	18650	1855	650	1935
	15	18675	1857.5	675	1937.5
	20	18700	1860	700	1940
Mid Range	1.4/3/5/10/15/20	18900	1880	900	1960
High Range	1.4	19193	1909.3	1193	1989.3
	3	19185	1908.5	1185	1988.5
	5	19175	1907.5	1175	1987.5
	10	19150	1905	1150	1985
	15	19125	1902.5	1125	1982.5
	20	19100	1900	1100	1980

3. Table for Filed Antenna:

Main Antenna

Brand	Model Name	Antenna Type	Connector	Gain (dBi)	Note
N/A	N/A	PIFA	N/A	-0.68	PCS 1900
N/A	N/A	PIFA	N/A	-1.1	WCDMA Band II
N/A	N/A	PIFA	N/A	-1.1	LTE Band 2

Second Antenna

Brand	Model Name	Antenna Type	Connector	Gain (dBi)	Note
N/A	N/A	PIFA	N/A	-1.45	PCS 1900
N/A	N/A	PIFA	N/A	-1.5	WCDMA Band II
N/A	N/A	PIFA	N/A	-1.5	LTE Band 2

Note: The antenna gain is provided by the manufacturer.

2.2 DESCRIPTION OF TEST MODES

Following mode(s) is (were) found to be the worst case(s) and selected for the final test.

GSM MODE			
Test Item	Available Channel	Tested Channel	Mode
Output Power & EIRP	512 to 810	512, 661, 810	GSM, GPRS, EDGE
Occupied Bandwidth	512 to 810	512, 661, 810	GSM, EDGE
Conducted Spurious Emissions	512 to 810	661	GSM, EDGE
Radiated Spurious Emissions	512 to 810	661	GSM
Band Edge	512 to 810	512, 810	GSM, EDGE
Peak to Average Ratio	512 to 810	512, 661, 810	GSM, EDGE
Frequency Stability	512 to 810	661	GSM

WCDMA BAND II MODE			
Test Item	Available Channel	Tested Channel	Mode
Output Power & EIRP	9262 to 9538	9262, 9400, 9538	WCDMA, HSDPA, HSUPA
Occupied Bandwidth	9262 to 9538	9262, 9400, 9538	WCDMA, HSDPA, HSUPA
Conducted Spurious Emissions	9262 to 9538	9400	WCDMA
Radiated Spurious Emissions	9262 to 9538	9400	WCDMA
Band Edge	9262 to 9538	9262, 9538	WCDMA, HSDPA, HSUPA
Peak to Average Ratio	9262 to 9538	9262, 9400, 9538	WCDMA, HSDPA, HSUPA
Frequency Stability	9262 to 9538	9400	WCDMA

LTE BAND 2 MODE					
Test Item	Available Channel	Tested Channel	Channel Bandwidth	Modulation	Mode
Output Power & EIRP	18607 to 19193	18607, 18900, 19193	1.4MHz	QPSK, 16QAM, 64QAM	1RB/3RB/6RB
	18615 to 19185	18615, 18900, 19185	3MHz	QPSK, 16QAM, 64QAM	1RB/8RB/15RB
	18625 to 19175	18625, 18900, 19175	5MHz	QPSK, 16QAM, 64QAM	1RB/12RB/25RB
	18650 to 19150	18650, 18900, 19150	10MHz	QPSK, 16QAM, 64QAM	1RB/25RB/50RB
	18675 to 19125	18675, 18900, 19125	15MHz	QPSK, 16QAM, 64QAM	1RB/36RB/75RB
	18700 to 19100	18700, 18900, 19100	20MHz	QPSK, 16QAM, 64QAM	1RB/50RB/100RB
Occupied Bandwidth	18607 to 19193	18607, 18900, 19193	1.4MHz	QPSK, 16QAM, 64QAM	6RB
	18615 to 19185	18615, 18900, 19185	3MHz	QPSK, 16QAM, 64QAM	15RB
	18625 to 19175	18625, 18900, 19175	5MHz	QPSK, 16QAM, 64QAM	25RB
	18650 to 19150	18650, 18900, 19150	10MHz	QPSK, 16QAM, 64QAM	50RB
	18675 to 19125	18675, 18900, 19125	15MHz	QPSK, 16QAM, 64QAM	75 RB
	18700 to 19100	18700, 18900, 19100	20MHz	QPSK, 16QAM, 64QAM	100RB
Conducted Spurious Emissions	18607 to 19193	18900	1.4 MHz	QPSK	1RB
	18625 to 19175	18900	5MHz	QPSK	1RB
	18700 to 19100	18900	20MHz	QPSK	1RB
Radiated Spurious Emissions	18607 to 19193	18900	1.4 MHz	QPSK	1RB
	18625 to 19175	18900	5MHz	QPSK	1RB
	18700 to 19100	18900	20MHz	QPSK	1RB
Band Edge	18607 to 19193	18607, 19193	1.4MHz	QPSK	1RB/6RB
	18615 to 19185	18615, 19185	3MHz	QPSK	1RB/15RB
	18625 to 19175	18625, 19175	5MHz	QPSK	1RB/25RB
	18650 to 19150	18650, 19150	10MHz	QPSK	1RB/50RB
	18675 to 19125	18675, 19125	15MHz	QPSK	1RB/75RB
	18700 to 19100	18700, 19100	20MHz	QPSK	1RB/100RB
Peak To Average Ratio	18607 to 19193	18607, 18900, 19193	1.4MHz	QPSK, 16QAM, 64QAM	1RB
	18615 to 19185	18615, 18900, 19185	3MHz	QPSK, 16QAM, 64QAM	1RB
	18625 to 19175	18625, 18900, 19175	5MHz	QPSK, 16QAM, 64QAM	1RB
	18650 to 19150	18650, 18900, 19150	10MHz	QPSK, 16QAM, 64QAM	1RB
	18675 to 19125	18675, 18900, 19125	15MHz	QPSK, 16QAM, 64QAM	1RB
	18700 to 19100	18700, 18900, 19100	20MHz	QPSK, 16QAM, 64QAM	1RB
Frequency Stability	18607 to 19193	18900	1.4MHz	QPSK	1RB
	18615 to 19185	18900	3MHz	QPSK	1RB
	18625 to 19175	18900	5MHz	QPSK	1RB
	18650 to 19150	18900	10MHz	QPSK	1RB
	18675 to 19125	18900	15MHz	QPSK	1RB
	18700 to 19100	18900	20MHz	QPSK	1RB

2.3 BLOCKDIGRAMSHOWINGTHECONFIGURATIONOFSYSTEMTESTED

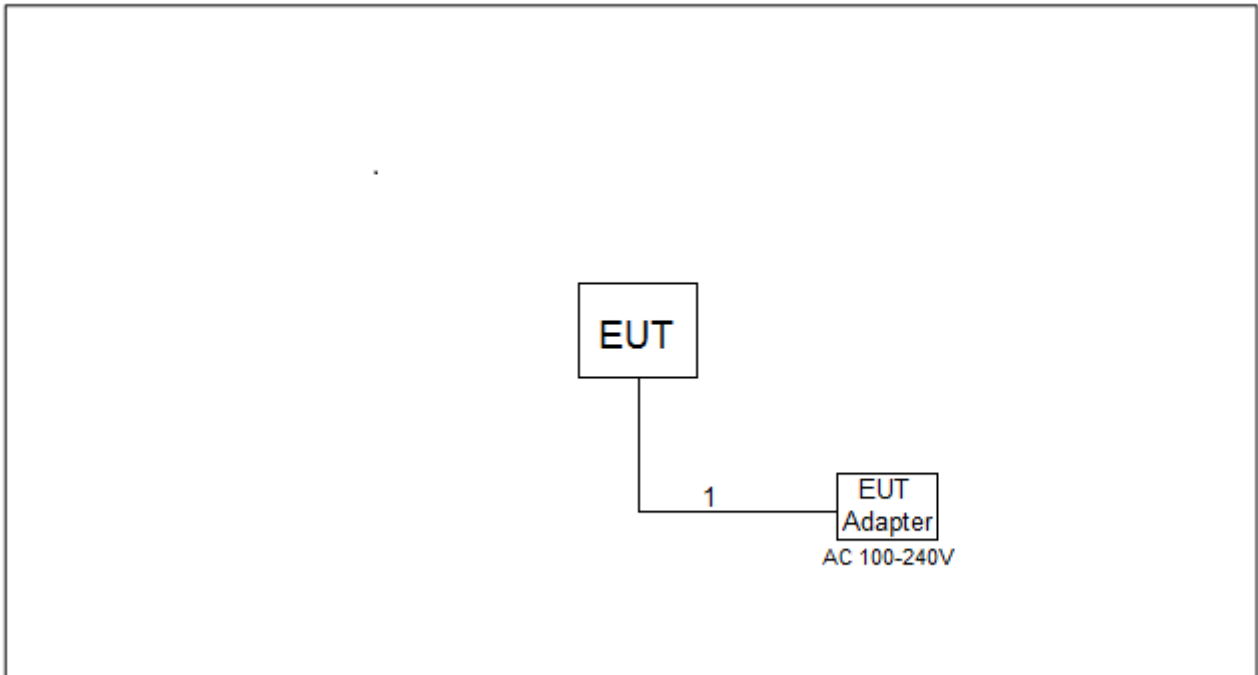

2.4 DESCRIPTION OF SUPPORT UNITS

The EUT has been tested as an independent unit together with other necessary accessories or support units. The following support units or accessories were used to form a representative test configuration during the tests.

Item	Equipment	Mfr/Brand	Model/Type No.	Series No.
-	-	-	-	-

Item	Cable Type	Shielded Type	Ferrite Core	Length
1	USB Cable	NO	NO	1m

3. TEST RESULT

3.1 OUTPUT POWER MEASUREMENT

3.1.1 LIMIT

Mobile / Portable station are limited to 2 watts e.i.r.p.

3.1.2 TEST PROCEDURE

The testing follows FCC KDB 971168 v03r01 Section 5.

EIRP:

$EIRP = \text{Output Power} + \text{Antenan gain}$

Output Power:

The EUT was set up for the maximum power with GSM, GPRS, EDGE, WCDMA and LTE link data modulation and link up with simulator. Set the EUT to transmit under low, middle and high channel and record the power level shown on simulator.

3.1.3 TEST SETUP LAYOUT

Output Power Measurement

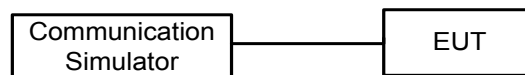

3.1.4 TEST DEVIATION

No deviation

3.1.5 TEST RESULTS

Please refer to the APPENDIX A.

3.2 OCCUPIED BANDWIDTH MEASUREMENT

3.2.1 TEST PROCEDURE

The testing follows FCC KDB 971168 v03r01 Section 4.

1. The EUT makes a call to the communication simulator. All measurements were done at low, middle and high operational frequency range. The communication simulator station system controlled a EUT to export maximum output power under transmission mode and specific channel frequency. Use OBW measurement function of Spectrum analyzer to measure 99 % occupied bandwidth and 26dB bandwidth.
2. The EUT was connected to spectrum analyzer and system simulator via a power divider.
3. $RBW=(1\% \sim 5\%)*EBW$
 $VBW \geq 3* RBW$
4. Set spectrum analyzer with Peak detector.

3.2.2 TEST SETUP LAYOUT

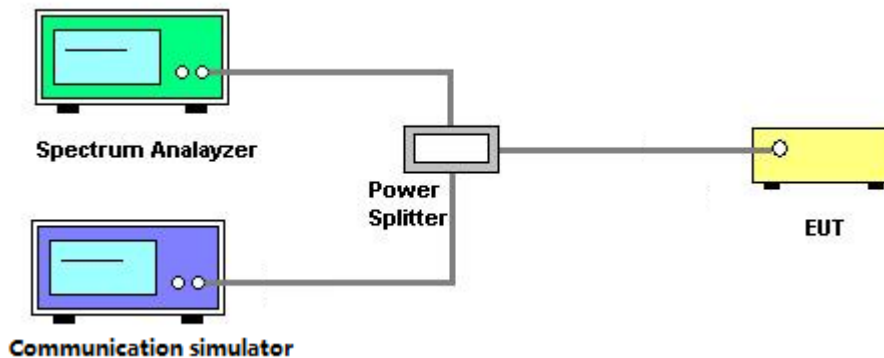

3.2.3 TEST DEVIATION

No deviation

3.2.4 TEST RESULTS

Please refer to the APPENDIX B.

3.3 CONDUCTED SPURIOUS EMISSIONS MEASUREMENT

3.3.1 LIMIT

The power of any emission outside of the authorized operating frequency ranges must be attenuated below the transmitting power (P) by a factor of at least $43 + 10 \log(P)$ dB. The emission limit equal to -13dBm.

3.3.2 TEST PROCEDURES

The testing follows FCC KDB 971168 v03r01 Section 6.

1. The EUT was connected to spectrum analyzer and system simulator via a power divider.
2. The band edges of low and high channels for the highest RF powers were measured. Set RBW $\geq 1\%$ EBW in the 1MHz band immediately outside and adjacent to the band edge.
3. Set spectrum analyzer with Peak detector.
4. The RF fundamental frequency should be excluded against the limit line in the operating frequency band.

3.3.3 TEST SETUP LAYOUT

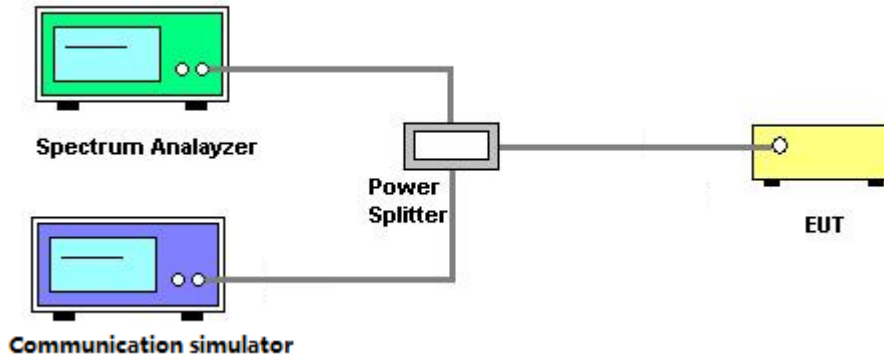

3.3.4 TEST DEVIATION

No deviation

3.3.5 TEST RESULTS

Please refer to the APPENDIX C.

3.4 RADIATED SPURIOUS EMISSIONS MEASUREMENT

3.4.1 LIMIT

The power of any emission outside of the authorized operating frequency ranges must be attenuated below the transmitting power (P) by a factor of at least $43 + 10 \log(P)$ dB. The emission limit equal to -13dBm.

3.4.2 TEST PROCEDURES

The testing follows FCC KDB 971168 v03r01 Section 6.2.

1. In the semi-anechoic chamber, EUT placed on the 0.8m height of Turn Table, rotated the table around 360 degrees to search the maximum radiation power and receiver antenna shall be rotated vertical and horizontal polarization and moved height from 1m to 4m to find the maximum polar radiated power. The "Read Value" is the spectrum reading the maximum power value.
2. The substitution horn antenna is substituted for EUT at the same position and signals generator export the CW signal to the substitution antenna via a TX cable. Rotated the Turn Table and moved receiving antenna to find the maximum radiation power. Adjust output power level of S.G to get a Value of spectrum reading equal to "Read Value " of step a. Record the power level of S.G
3. $EIRP = \text{Output power level of S.G} - \text{TX cable loss} + \text{Antenna gain of substitution horn.}$
4. ERP can be calculated form $EIRP$ by subtracting the gain of dipole, $ERP = EIPR - 2.15\text{dBi.}$
5. The resolution bandwidth and video bandwidth of test receiver/spectrum analyzer is 1MHz/3MHz.

3.4.3 TEST SETUP LAYOUT

Below 30MHz

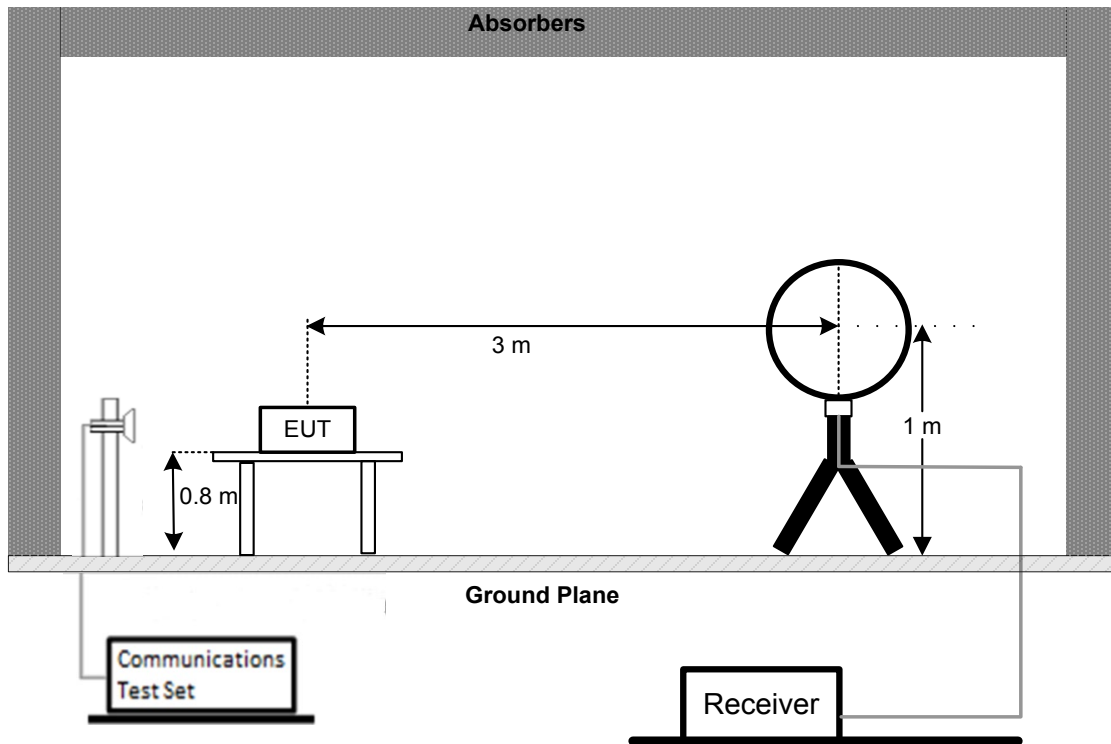

30MHz to 1000MHz

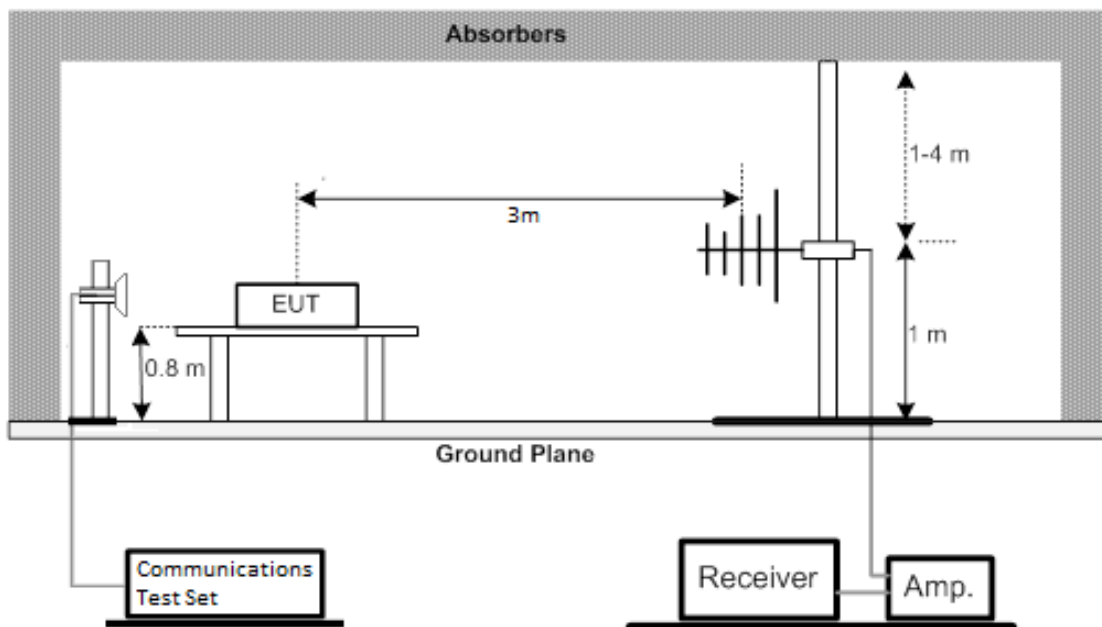

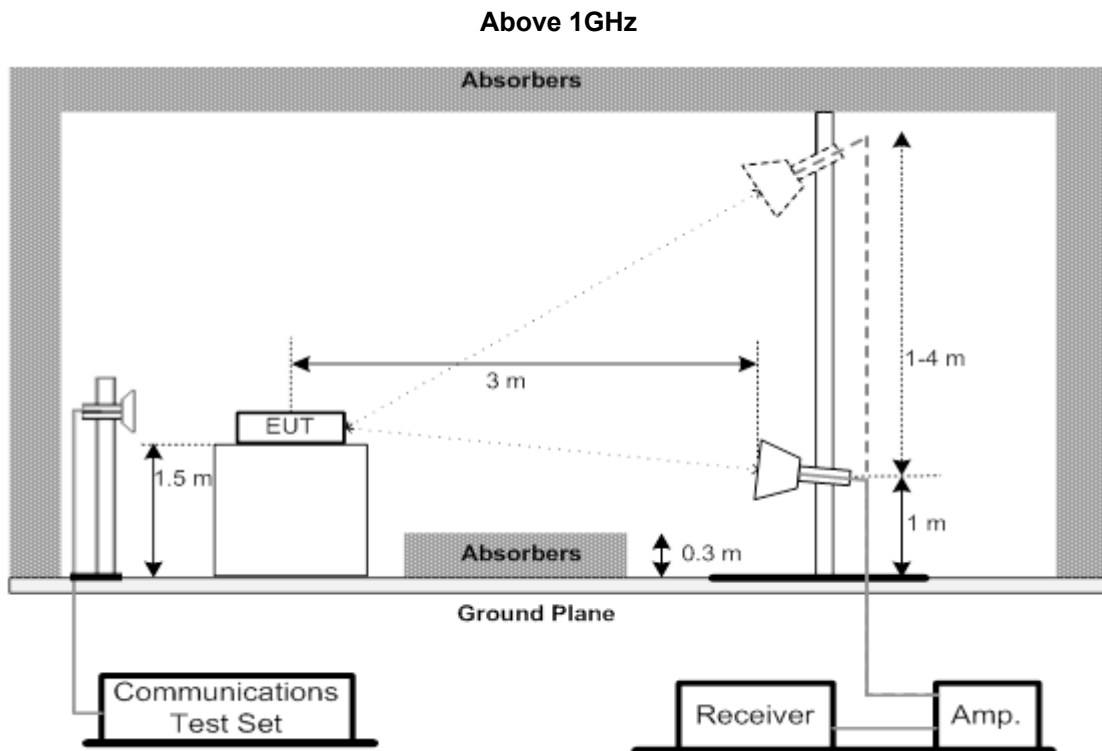

3.4.4 TEST DEVIATION

No deviation

3.4.5 TEST RESULTS (9KHZ TO 30MHZ)

Please refer to the APPENDIX D.

3.4.6 TEST RESULTS (30MHZ TO 1000MHZ)

Please refer to the APPENDIX E.

3.4.7 TEST RESULTS (ABOVE 1000MHZ)

Please refer to the APPENDIX F.

3.5 BAND EDGE MEASUREMENT

3.5.1 LIMIT

A Power of any emission outside of the authorized operating frequency ranges must be attenuated below the transmitting power (P) by a factor of at least $43 + 10 \log(P)$ dB. In the 1 MHz bands immediately outside and adjacent to the frequency block a resolution bandwidth of at least one percent of the emission bandwidth of the fundamental emission of the transmitter may be employed.

3.5.2 TEST PROCEDURES

The testing follows FCC KDB 971168 v03r01 Section 6.

1. All measurements were done at low and high operational frequency range.
2. Record the max trace plot into the test report.

3.5.3 TEST SETUP LAYOUT

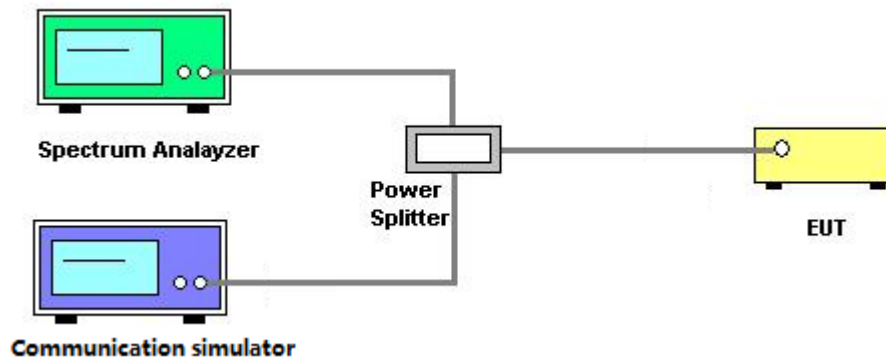

3.5.4 TEST DEVIATION

No deviation

3.5.5 TEST RESULTS

Please refer to the APPENDIX G.

3.6 PEAK TO AVERAGE RATIO MEASUREMENT

3.6.1 LIMIT

In measuring transmissions in this band using an average power technique, the peak to-average ratio (PAR) of the transmission may not exceed 13 dB.

3.6.2 TEST PROCEDURES

The testing follows FCC KDB 971168 v03r01 Section 5.7.

1. Set resolution/measurement bandwidth \geq signal's occupied bandwidth;
2. Set the number of counts to a value that stabilizes the measured CCDF curve;
3. Record the maximum PAPR level associated with a probability of 0.1%.

3.6.3 TEST SETUP LAYOUT

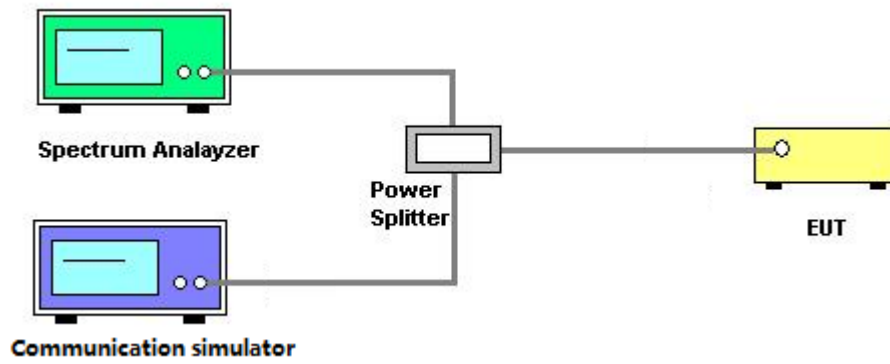

3.6.4 TEST DEVIATION

No deviation

3.6.5 TEST RESULTS

Please refer to the APPENDIX H.

3.7 FREQUENCY STABILITY MEASUREMENT

3.7.1 LIMIT

± 1.5 ppm is for base and fixed station. ± 2.5 ppm is for mobile station.

3.7.2 TEST PROCEDURES

The testing follows FCC KDB 971168 v03r01 Section 9.

1. Device is placed at the oven room. The oven room could control the temperatures and humidity. Power warm up is at least 15 min and power applied should perform before recording frequency error.
2. EUT is connected the external power supply to control the DC input power. The test voltage range is from minimum to maximum working voltage. Each step shall be record the frequency error rate.
3. The temperature range step is 10 degrees in this test items. All temperature levels shall be hold the $\pm 0.5^{\circ}\text{C}$ during the measurement testing. The each temperature step shall be at least 0.5 hours, consider the EUT could be test under the stability condition.
4. The frequency error was recorded frequency error from the communication simulator.

3.7.3 TEST SETUP LAYOUT

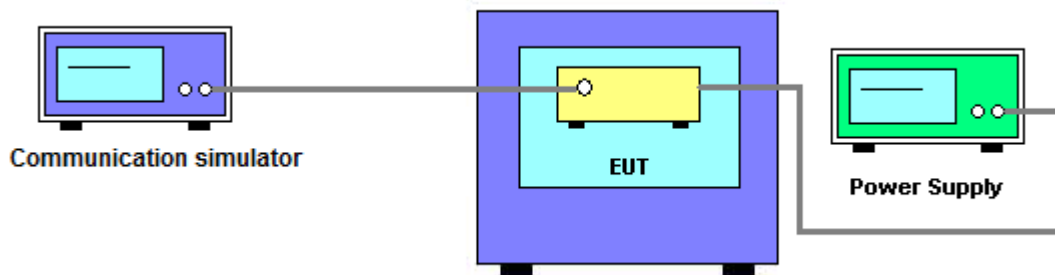

3.7.4 TEST DEVIATION

No deviation

3.7.5 TEST RESULTS

Please refer to the APPENDIX I.

4. LIST OF MEASUREMENT EQUIPMENTS

Radiated Spurious Emission Measurement					
Item	Kind of Equipment	Manufacturer	Type No.	Serial No.	Calibrated until
1	Antenna	Schwarzbeck	VULB9160	9160-3231	Apr. 14, 2022
2	Amplifier	Agilent	8449B	3008A02334	Feb. 27, 2022
3	High Pass Filter	Wairwright Instruments Gmbh	WHK 1.5/15G-10ST	11	Feb. 27, 2022
4	Band Reject Filter	Wairwright Instruments Gmbh	WRCG 1710/1785-1690/1805-60/ 12SS	38	Feb. 27, 2022
5	Band Reject Filter	Wairwright Instruments Gmbh	WRCG 824/849-810/863-60/9SS	7	Feb. 27, 2022
6	Band Reject Filter	Wairwright Instruments Gmbh	WRCG 880/915-860/935-60/9SS	14	Feb. 27, 2022
7	Band Reject Filter	Wairwright Instruments Gmbh	WRCG 1850/1910-1830/1930-60/ 10SS	17	Feb. 27, 2022
8	High Pass Filter	Wairwright Instruments Gmbh	WHK3.1/18G-10SS	24	Feb. 27, 2022
9	Wireless Communication Test SET	Agilent	E5515C	MY48364183	Feb. 28, 2022
10	Microwave Preamplifier With Adaptor	EMC INSTRUMENT	EMC2654045	980039 & HA01	Feb. 28, 2022
11	Receiver	Agilent	N9038A	MY52130039	Mar. 19, 2022
12	wideband radio communication tester	R&S	CMW500	152372	Feb. 27, 2022
13	High pass filter	KANGMAIWEI	ZHPF-M3-12.75G-3869	B2015073763	Feb. 07, 2022
14	High pass filter	KANGMAIWEI	ZHPF-M1000-4000-1	B2015073762	Feb. 07, 2022
15	High pass filter	KANGMAIWEI	ZHPF-M6-186-1727	B2015073764	Feb. 07, 2022
16	Cable	emci	LMR-400(30MHz-1GHz) (8m+5m)	N/A	May 20, 2022
17	Cable	mitron	B10-01-01-12M	18072744	Oct. 16, 2021
18	Controller	ETS-Lindgren	2090	N/A	N/A
19	Measurement Software	Farad	EZ-EMC Ver.NB-03A1-01	N/A	N/A
20	Loop Antenna	EM	EM-6876-1	230	Oct. 16, 2021
21	Double Ridged Guide Antenna	ETS	3115	75846	Mar. 17, 2022
22	Broad-Band Horn Antenna	Schwarzbeck	BBHA 9170	9170319	Jun. 30, 2022

Conducted Measurement					
Item	Kind of Equipment	Manufacturer	Type No.	Serial No.	Calibrated until
1	Wireless Communication Test SET	Agilent	E5515C	MY48364183	Feb. 28, 2022
2	EXA Spectrum Analyzer	Agilent	N9010A	MY50520044	Feb. 28, 2022
3	POWER SPLITTER	Mini-Circuits	ZFRSC-123-S+	331000910-1	Feb. 27, 2022
4	wideband radio communication tester	R&S	CMW500	152372	Feb. 27, 2022

Frequency Stability Measurement					
Item	Kind of Equipment	Manufacturer	Type No.	Serial No.	Calibrated until
1	Wireless Communication Test SET	Agilent	E5515C	MY48364183	Feb. 28, 2022
2*	Multi-output DC Power Supply	GW Instek	GPC-3030DN	EK880675	Jul. 25, 2023
3	POWER SPLITTER	Mini-Circuits	ZFRSC-123-S+	331000910-1	Feb. 27, 2022
4	wideband radio communication tester	R&S	CMW500	152372	Feb. 27, 2022
5	Const Temp, & Humidity Chamber	Bell	BTH-50C	20170306001	Feb. 27, 2022

Remark: "N/A" denotes no model name, serial no. or calibration specified.

"*" calibration period of equipment list is three year.

Except * item, all calibration period of equipment list is one year.

APPENDIX A - OUTPUT POWER

Output Power (dBm):

PCS1900		512CH	661CH	810CH
		1850.2MHz	1880MHz	1909.8MHz
GSM (CS)		29.76	30.25	30.22
GPRS/EDGE (GMSK)	1 Tx Slot	29.82	30.13	30.17
	2 Tx Slot	25.89	25.96	25.97
	3 Tx Slot	25.19	25.26	25.23
	4 Tx Slot	24.01	24.17	24.06
EDGE (8PSK)	1 Tx Slot	24.57	25.02	25.10
	2 Tx Slot	23.58	23.91	23.52
	3 Tx Slot	22.73	22.43	22.85
	4 Tx Slot	20.75	20.60	20.38

Modulation	Band	WCDMA Band II		
	Tx Channel	9262CH	9400CH	9538CH
	Frequency	1852.4MHz	1880MHz	1907.6MHz
QPSK	RMC 12.2K	23.37	23.5	23.38
	RMC 64K	23.38	23.5	23.37
	RMC 144K	23.38	23.5	23.37
	RMC 384K	23.36	23.49	23.36
	HSDPA Subtest-1	22.16	22.26	22.11
	HSDPA Subtest-2	22.19	22.27	22.02
	HSDPA Subtest-3	21.66	21.78	21.67
	HSDPA Subtest-4	21.68	21.77	21.51
	HSUPA Subtest-1	21.69	21.83	21.74
	HSUPA Subtest-2	20.2	20.32	20.32
	HSUPA Subtest-3	21.19	21.32	21.22
	HSUPA Subtest-4	20.2	20.33	20.33
	HSUPA Subtest-5	22.19	22.37	22.27

LTE Band / BW	Modulation	RB Size	RB Offset	Low CH	Mid CH	High CH
				18607CH	18900CH	19193CH
				1850.7MHz	1880MHz	1909.3MHz
2 / 1.4M	QPSK	1	0	23.24	23.37	23.28
		1	2	23.27	23.39	23.32
		1	5	23.22	23.42	23.24
		3	0	23.23	23.34	23.27
		3	1	23.31	23.36	23.29
		3	2	23.27	23.42	23.25
	16QAM	6	0	22.18	22.28	22.23
		1	0	22.30	22.72	22.23
		1	2	22.27	22.71	22.25
		1	5	22.23	22.74	22.24
		3	0	22.17	22.47	22.40
		3	1	22.21	22.49	22.47
	64QAM	3	2	22.18	22.51	22.40
		6	0	21.31	21.21	21.40
		1	0	21.13	21.48	21.14
		1	2	21.20	21.57	21.22
		1	5	21.16	21.51	21.09
		3	0	20.90	21.45	21.14
		3	1	20.94	21.46	21.20
		3	2	20.87	21.48	21.16
		6	0	20.51	20.54	20.81

LTE Band / BW	Modulation	RB Size	RB Offset	Low CH	Mid CH	High CH
				18615CH	18900CH	19185CH
				1851.5MHz	1880MHz	1908.5MHz
2 / 3M	QPSK	1	0	23.14	23.46	23.41
		1	7	23.24	23.42	23.38
		1	14	23.12	23.42	23.32
		8	0	21.73	21.89	21.82
		8	4	21.74	21.87	21.83
		8	7	21.70	21.91	21.77
		15	0	21.76	21.87	21.82
	16QAM	1	0	22.11	22.80	22.33
		1	7	22.13	22.75	22.30
		1	14	22.01	22.75	22.23
		8	0	20.81	20.98	20.85
		8	4	20.78	20.96	20.86
		8	7	20.77	20.95	20.81
	64QAM	15	0	20.75	20.84	20.74
		1	0	21.32	21.27	21.37
		1	7	21.28	21.33	21.40
		1	14	21.22	21.24	21.26
		8	0	20.02	20.19	20.06
		8	4	20.06	20.19	20.07
		8	7	20.00	20.20	20.03
		15	0	19.97	20.16	20.13

LTE Band / BW	Modulation	RB Size	RB Offset	Low CH	Mid CH	High CH
				18625CH	18900CH	19175CH
				1852.5MHz	1880MHz	1907.5MHz
2 / 5M	QPSK	1	0	23.40	23.68	23.52
		1	13	23.27	23.57	23.36
		1	24	23.28	23.50	23.34
		12	0	21.78	21.96	21.90
		12	6	21.75	21.90	21.89
		12	11	21.70	21.96	21.85
		25	0	21.77	21.92	21.89
	16QAM	1	0	22.50	22.93	22.56
		1	13	22.39	22.94	22.39
		1	24	22.43	22.86	22.32
		12	0	20.86	21.06	20.97
		12	6	20.81	21.02	20.92
		12	11	20.76	21.04	20.85
		25	0	20.75	20.93	20.80
	64QAM	1	0	21.05	21.66	21.56
		1	13	20.95	21.56	21.43
		1	24	20.95	21.50	21.37
		12	0	20.08	20.16	20.19
		12	6	20.05	20.10	20.18
		12	11	19.97	20.11	20.14
		25	0	19.99	20.08	20.14

LTE Band / BW	Modulation	RB Size	RB Offset	Low CH	Mid CH	High CH
				18650CH	18900CH	19150CH
				1855MHz	1880MHz	1905MHz
2 / 10M	QPSK	1	0	23.29	23.54	23.54
		1	25	23.19	23.39	23.39
		1	49	23.37	23.53	23.45
		25	0	21.73	21.94	21.80
		25	13	21.76	21.81	21.86
		25	25	21.79	21.88	21.81
		50	0	21.76	21.86	21.90
	16QAM	1	0	22.30	22.88	22.43
		1	25	22.19	22.71	22.31
		1	49	22.34	22.83	22.31
		25	0	20.73	20.94	20.89
		25	13	20.74	20.87	20.92
		25	25	20.80	20.91	20.83
		50	0	20.72	20.86	20.86
	64QAM	1	0	21.43	21.39	21.44
		1	25	21.32	21.26	21.32
		1	49	21.49	21.41	21.36
		25	0	20.01	20.24	20.11
		25	13	20.03	20.13	20.15
		25	25	20.03	20.17	20.12
		50	0	20.03	20.15	20.17

LTE Band / BW	Modulation	RB Size	RB Offset	Low CH	Mid CH	High CH
				18675CH	18900CH	19125CH
				1857.5MHz	1880MHz	1902.5MHz
2 / 15M	QPSK	1	0	23.25	23.50	23.61
		1	38	23.03	23.42	23.29
		1	74	23.25	23.58	23.37
		36	0	21.69	21.87	21.84
		36	18	21.69	21.88	21.86
		36	39	21.65	21.93	21.82
		75	0	21.64	21.96	21.83
	16QAM	1	0	22.23	22.93	22.92
		1	38	22.05	22.75	22.71
		1	74	22.24	22.93	22.69
		36	0	20.64	20.87	20.85
		36	18	20.64	20.90	20.80
		36	39	20.63	20.94	20.74
		75	0	20.63	20.91	20.83
	64QAM	1	0	21.39	21.44	21.89
		1	38	21.19	21.27	21.69
		1	74	21.36	21.42	21.82
		36	0	19.91	20.16	20.16
		36	18	19.95	20.19	20.14
		36	39	19.93	20.21	20.11
		75	0	19.91	20.17	20.18

LTE Band / BW	Modulation	RB Size	RB Offset	Low CH	Mid CH	High CH
				18700CH	18900CH	19100CH
				1860MHz	1880MHz	1900MHz
2 / 20M	QPSK	1	0	23.36	23.30	23.48
		1	50	23.22	23.19	23.24
		1	99	23.03	23.04	22.99
		50	0	21.63	21.90	21.98
		50	25	21.71	21.87	21.91
		50	50	21.55	21.77	21.70
		100	0	21.67	21.80	21.88
	16QAM	1	0	22.69	22.84	22.98
		1	50	22.73	22.75	22.82
		1	99	22.56	22.55	22.55
		50	0	20.66	20.85	21.03
		50	25	20.72	20.82	20.95
		50	50	20.57	20.76	20.73
		100	0	20.67	20.78	20.91
	64QAM	1	0	21.22	21.51	21.87
		1	50	21.17	21.39	21.74
		1	99	20.99	21.24	21.46
		50	0	19.91	20.22	20.31
		50	25	19.98	20.22	20.23
		50	50	19.85	20.12	19.98
		100	0	19.95	20.09	20.13

EIRP (dBm):

PCS1900		512CH	661CH	810CH
		1850.2MHz	1880MHz	1909.8MHz
GSM (CS)		29.08	29.57	29.54
GPRS/EDGE (GMSK)	1 Tx Slot	29.14	29.45	29.49
	2 Tx Slot	25.21	25.28	25.29
	3 Tx Slot	24.51	24.58	24.55
	4 Tx Slot	23.33	23.49	23.38
EDGE (8PSK)	1 Tx Slot	23.89	24.34	24.42
	2 Tx Slot	22.90	23.23	22.84
	3 Tx Slot	22.05	21.75	22.17
	4 Tx Slot	20.07	19.92	19.70

Modulation	Band	WCDMA Band II		
	Tx Channel	9262CH	9400CH	9538CH
	Frequency	1852.4MHz	1880MHz	1907.6MHz
QPSK	RMC 12.2K	22.27	22.40	22.28
	RMC 64K	22.28	22.40	22.27
	RMC 144K	22.28	22.40	22.27
	RMC 384K	22.26	22.39	22.26
	HSDPA Subtest-1	21.06	21.16	21.01
	HSDPA Subtest-2	21.09	21.17	20.92
	HSDPA Subtest-3	20.56	20.68	20.57
	HSDPA Subtest-4	20.58	20.67	20.41
	HSUPA Subtest-1	20.59	20.73	20.64
	HSUPA Subtest-2	19.10	19.22	19.22
	HSUPA Subtest-3	20.09	20.22	20.12
	HSUPA Subtest-4	19.10	19.23	19.23
	HSUPA Subtest-5	21.09	21.27	21.17

LTE Band / BW	Modulation	RB Size	RB Offset	Low CH	Mid CH	High CH
				18607CH	18900CH	19193CH
				1850.7MHz	1880MHz	1909.3MHz
2 / 1.4M	QPSK	1	0	22.14	22.27	22.18
		1	2	22.17	22.29	22.22
		1	5	22.12	22.32	22.14
		3	0	22.13	22.24	22.17
		3	1	22.21	22.26	22.19
		3	2	22.17	22.32	22.15
	16QAM	6	0	21.08	21.18	21.13
		1	0	21.20	21.62	21.13
		1	2	21.17	21.61	21.15
		1	5	21.13	21.64	21.14
		3	0	21.07	21.37	21.30
		3	1	21.11	21.39	21.37
	64QAM	3	2	21.08	21.41	21.30
		6	0	20.21	20.11	20.30
		1	0	20.03	20.38	20.04
		1	2	20.10	20.47	20.12
		1	5	20.06	20.41	19.99
		3	0	19.80	20.35	20.04
		3	1	19.84	20.36	20.10
		3	2	19.77	20.38	20.06
		6	0	19.41	19.44	19.71

LTE Band / BW	Modulation	RB Size	RB Offset	Low CH	Mid CH	High CH
				18615CH	18900CH	19185CH
				1851.5MHz	1880MHz	1908.5MHz
2 / 3M	QPSK	1	0	22.04	22.36	22.31
		1	7	22.14	22.32	22.28
		1	14	22.02	22.32	22.22
		8	0	20.63	20.79	20.72
		8	4	20.64	20.77	20.73
		8	7	20.60	20.81	20.67
		15	0	20.66	20.77	20.72
	16QAM	1	0	21.01	21.70	21.23
		1	7	21.03	21.65	21.20
		1	14	20.91	21.65	21.13
		8	0	19.71	19.88	19.75
		8	4	19.68	19.86	19.76
		8	7	19.67	19.85	19.71
	64QAM	15	0	19.65	19.74	19.64
		1	0	20.22	20.17	20.27
		1	7	20.18	20.23	20.30
		1	14	20.12	20.14	20.16
		8	0	18.92	19.09	18.96
		8	4	18.96	19.09	18.97
		8	7	18.90	19.10	18.93
		15	0	18.87	19.06	19.03

LTE Band / BW	Modulation	RB Size	RB Offset	Low CH	Mid CH	High CH
				18625CH	18900CH	19175CH
				1852.5MHz	1880MHz	1907.5MHz
2 / 5M	QPSK	1	0	22.30	22.58	22.42
		1	13	22.17	22.47	22.26
		1	24	22.18	22.40	22.24
		12	0	20.68	20.86	20.80
		12	6	20.65	20.80	20.79
		12	11	20.60	20.86	20.75
		25	0	20.67	20.82	20.79
	16QAM	1	0	21.40	21.83	21.46
		1	13	21.29	21.84	21.29
		1	24	21.33	21.76	21.22
		12	0	19.76	19.96	19.87
		12	6	19.71	19.92	19.82
		12	11	19.66	19.94	19.75
		25	0	19.65	19.83	19.70
	64QAM	1	0	19.95	20.56	20.46
		1	13	19.85	20.46	20.33
		1	24	19.85	20.40	20.27
		12	0	18.98	19.06	19.09
		12	6	18.95	19.00	19.08
		12	11	18.87	19.01	19.04
		25	0	18.89	18.98	19.04

LTE Band / BW	Modulation	RB Size	RB Offset	Low CH	Mid CH	High CH
				18650CH	18900CH	19150CH
				1855MHz	1880MHz	1905MHz
2 / 10M	QPSK	1	0	22.19	22.44	22.44
		1	25	22.09	22.29	22.29
		1	49	22.27	22.43	22.35
		25	0	20.63	20.84	20.70
		25	13	20.66	20.71	20.76
		25	25	20.69	20.78	20.71
		50	0	20.66	20.76	20.80
	16QAM	1	0	21.20	21.78	21.33
		1	25	21.09	21.61	21.21
		1	49	21.24	21.73	21.21
		25	0	19.63	19.84	19.79
		25	13	19.64	19.77	19.82
		25	25	19.70	19.81	19.73
		50	0	19.62	19.76	19.76
	64QAM	1	0	20.33	20.29	20.34
		1	25	20.22	20.16	20.22
		1	49	20.39	20.31	20.26
		25	0	18.91	19.14	19.01
		25	13	18.93	19.03	19.05
		25	25	18.93	19.07	19.02
		50	0	18.93	19.05	19.07

LTE Band / BW	Modulation	RB Size	RB Offset	Low CH	Mid CH	High CH
				18675CH	18900CH	19125CH
				1857.5MHz	1880MHz	1902.5MHz
2 / 15M	QPSK	1	0	22.15	22.40	22.51
		1	38	21.93	22.32	22.19
		1	74	22.15	22.48	22.27
		36	0	20.59	20.77	20.74
		36	18	20.59	20.78	20.76
		36	39	20.55	20.83	20.72
		75	0	20.54	20.86	20.73
	16QAM	1	0	21.13	21.83	21.82
		1	38	20.95	21.65	21.61
		1	74	21.14	21.83	21.59
		36	0	19.54	19.77	19.75
		36	18	19.54	19.80	19.70
		36	39	19.53	19.84	19.64
		75	0	19.53	19.81	19.73
	64QAM	1	0	20.29	20.34	20.79
		1	38	20.09	20.17	20.59
		1	74	20.26	20.32	20.72
		36	0	18.81	19.06	19.06
		36	18	18.85	19.09	19.04
		36	39	18.83	19.11	19.01
		75	0	18.81	19.07	19.08

LTE Band / BW	Modulation	RB Size	RB Offset	Low CH	Mid CH	High CH
				18700CH	18900CH	19100CH
				1860MHz	1880MHz	1900MHz
2 / 20M	QPSK	1	0	22.26	22.20	22.38
		1	50	22.12	22.09	22.14
		1	99	21.93	21.94	21.89
		50	0	20.53	20.80	20.88
		50	25	20.61	20.77	20.81
		50	50	20.45	20.67	20.60
		100	0	20.57	20.70	20.78
	16QAM	1	0	21.59	21.74	21.88
		1	50	21.63	21.65	21.72
		1	99	21.46	21.45	21.45
		50	0	19.56	19.75	19.93
		50	25	19.62	19.72	19.85
		50	50	19.47	19.66	19.63
		100	0	19.57	19.68	19.81
	64QAM	1	0	20.12	20.41	20.77
		1	50	20.07	20.29	20.64
		1	99	19.89	20.14	20.36
		50	0	18.81	19.12	19.21
		50	25	18.88	19.12	19.13
		50	50	18.75	19.02	18.88
		100	0	18.85	18.99	19.03

APPENDIX B - OCCUPIED BANDWIDTH

PCS1900					
GSM			EDGE		
CS			8PSK		
Channel	Frequency (MHz)	99% Occupied Bandwidth (MHz)	Channel	Frequency (MHz)	99% Occupied Bandwidth (MHz)
512	1850.2	0.2429	512	1850.2	0.3182
661	1880	0.2426	661	1880	0.3144
810	1909.8	0.2419	810	1909.8	0.3113
Channel	Frequency (MHz)	26dB Bandwidth (MHz)	Channel	Frequency (MHz)	26dB Bandwidth (MHz)
512	1850.2	0.2464	512	1850.2	0.3185
661	1880	0.2441	661	1880	0.3170
810	1909.8	0.2473	810	1909.8	0.3210

Spectrum Plot

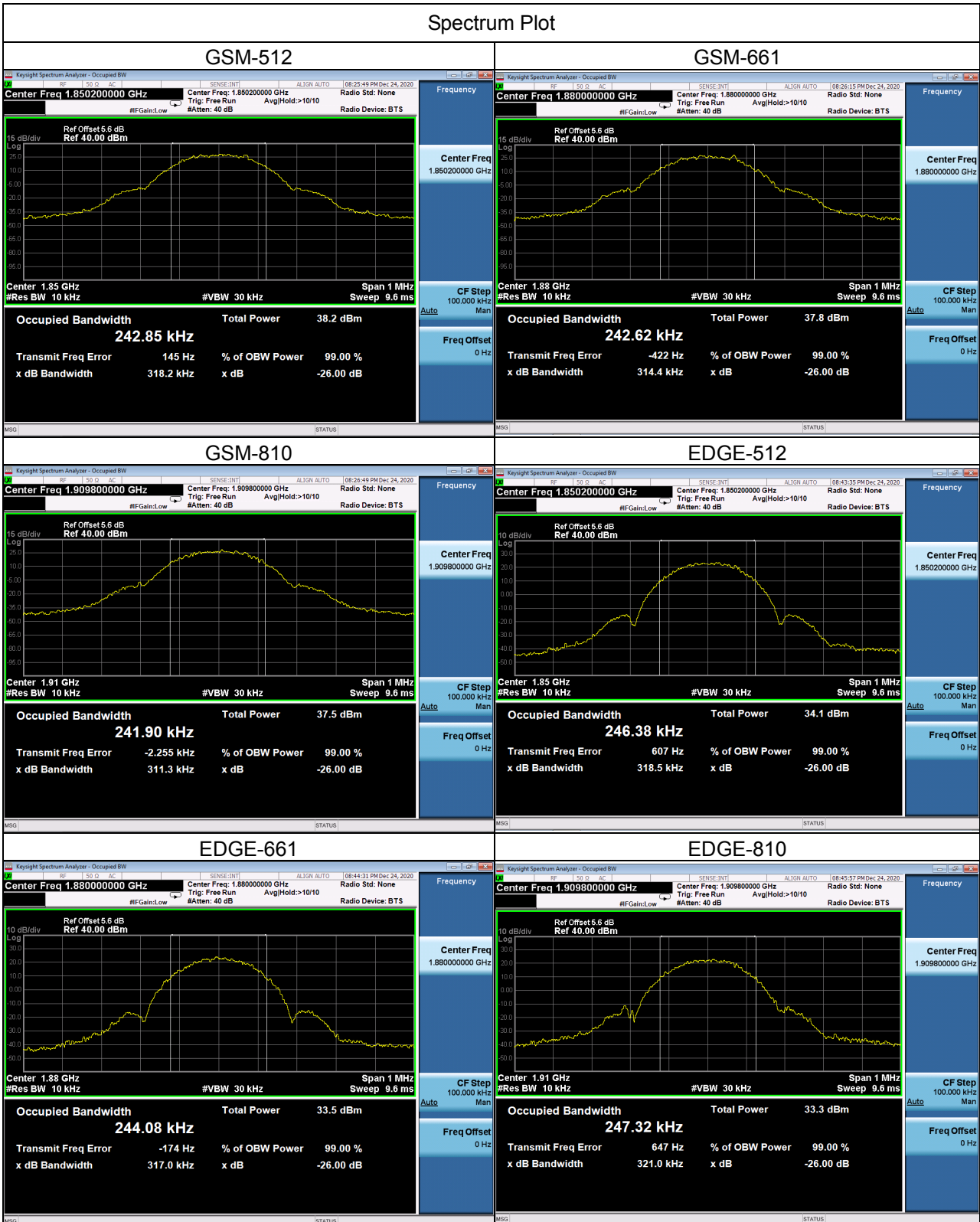

WCDMA Band II_WCDMA					
QPSK					
Channel	Frequency (MHz)	99% Occupied Bandwidth (MHz)	Channel	Frequency (MHz)	26dB Bandwidth (MHz)
9262	1852.4	4.1546	9262	1852.4	4.742
9400	1880	4.1514	9400	1880	4.746
9538	1907.6	4.1510	9538	1907.6	4.745



WCDMA Band II _HSDPA					
QPSK					
Channel	Frequency (MHz)	99% Occupied Bandwidth (MHz)	Channel	Frequency (MHz)	26dB Bandwidth (MHz)
9262	1852.4	4.1458	9262	1852.4	4.730
9400	1880	4.1523	9400	1880	4.741
9538	1907.6	4.1449	9538	1907.6	4.731



WCDMA Band II _HSUPA					
QPSK					
Channel	Frequency (MHz)	99% Occupied Bandwidth (MHz)	Channel	Frequency (MHz)	26dB Bandwidth (MHz)
9262	1852.4	4.1450	9262	1852.4	4.711
9400	1880	4.1623	9400	1880	4.737
9538	1907.6	4.1566	9538	1907.6	4.725



LTE Band 2_1.4M					
QPSK					
Channel	Frequency (MHz)	99% Occupied Bandwidth (MHz)	Channel	Frequency (MHz)	26dB Bandwidth (MHz)
18607	1850.7	1.0896	18607	1850.7	1.317
18900	1880	1.0999	18900	1880	1.307
19193	1909.3	1.0871	19193	1909.3	1.291
16QAM					
Channel	Frequency (MHz)	99% Occupied Bandwidth (MHz)	Channel	Frequency (MHz)	26dB Bandwidth (MHz)
18607	1850.7	1.0893	18607	1850.7	1.292
18900	1880	1.0940	18900	1880	1.286
19193	1909.3	1.0937	19193	1909.3	1.314
64QAM					
Channel	Frequency (MHz)	99% Occupied Bandwidth (MHz)	Channel	Frequency (MHz)	26dB Bandwidth (MHz)
18607	1850.7	1.0879	18607	1850.7	1.267
18900	1880	1.0856	18900	1880	1.252
19193	1909.3	1.0868	19193	1909.3	1.284

Spectrum Plot

QPSK-18607

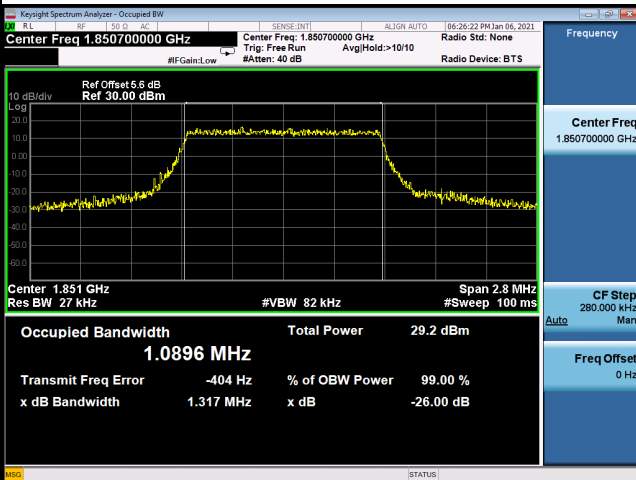

QPSK-18900

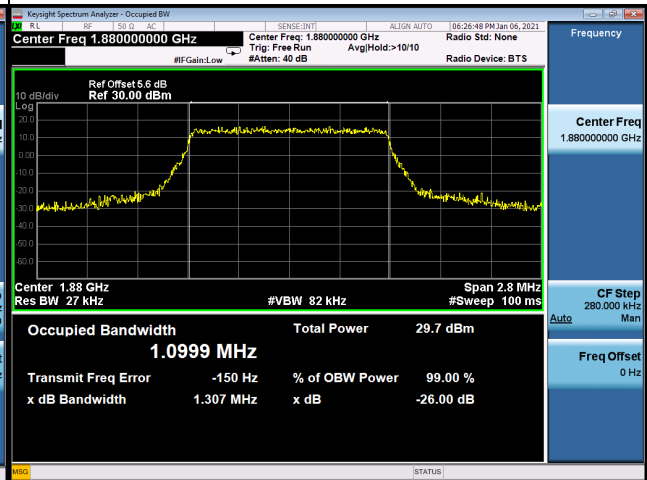

QPSK-19193

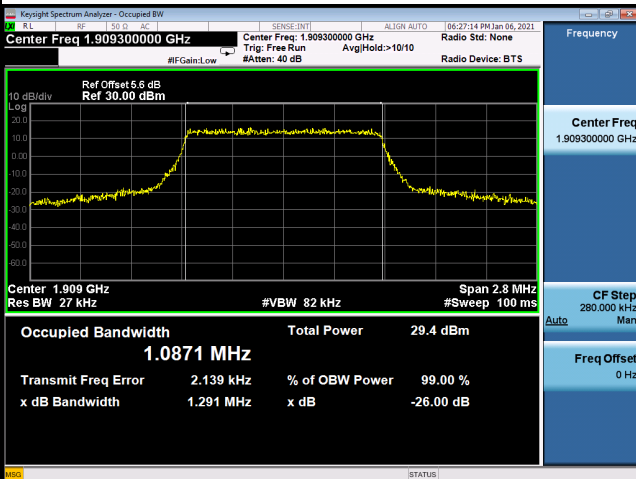

16QAM-18607

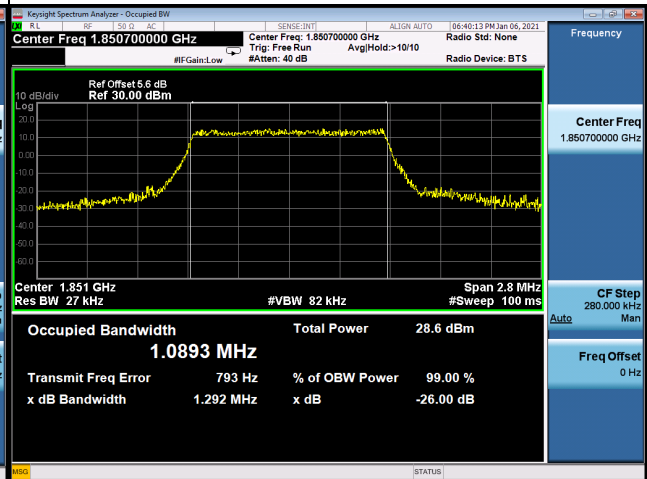

16QAM-18900

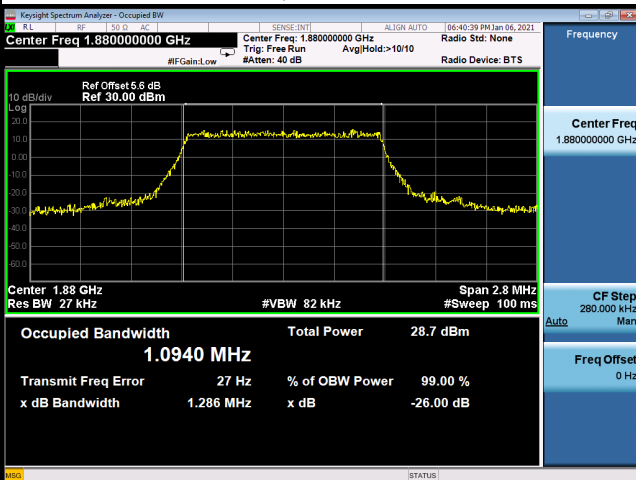

16QAM-19193

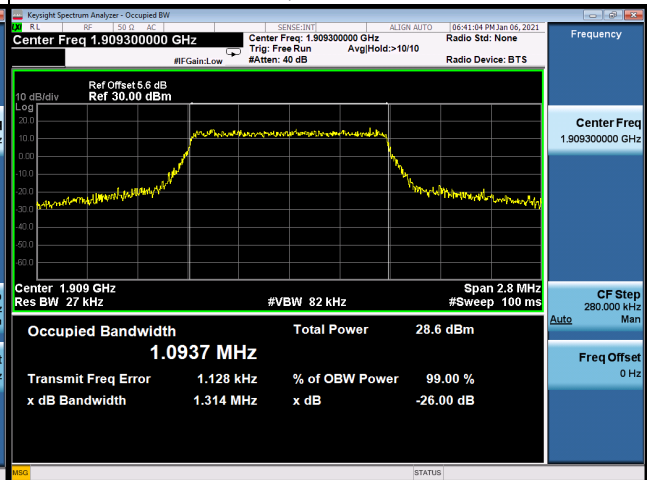

Spectrum Plot

64QAM-18607



64QAM-18900



64QAM-19193



LTE Band 2_3M					
QPSK					
Channel	Frequency (MHz)	99% Occupied Bandwidth (MHz)	Channel	Frequency (MHz)	26dB Bandwidth (MHz)
18615	1851.5	2.6989	18615	1851.5	3.003
18900	1880	2.7000	18900	1880	2.992
19185	1908.5	2.6997	19185	1908.5	2.986
16QAM					
Channel	Frequency (MHz)	99% Occupied Bandwidth (MHz)	Channel	Frequency (MHz)	26dB Bandwidth (MHz)
18615	1851.5	2.7046	18615	1851.5	3.009
18900	1880	2.6946	18900	1880	2.999
19185	1908.5	2.6939	19185	1908.5	2.989
64QAM					
Channel	Frequency (MHz)	99% Occupied Bandwidth (MHz)	Channel	Frequency (MHz)	26dB Bandwidth (MHz)
18615	1851.5	2.7074	18615	1851.5	2.991
18900	1880	2.7005	18900	1880	2.970
19185	1908.5	2.6995	19185	1908.5	2.960

Spectrum Plot

QPSK-18615

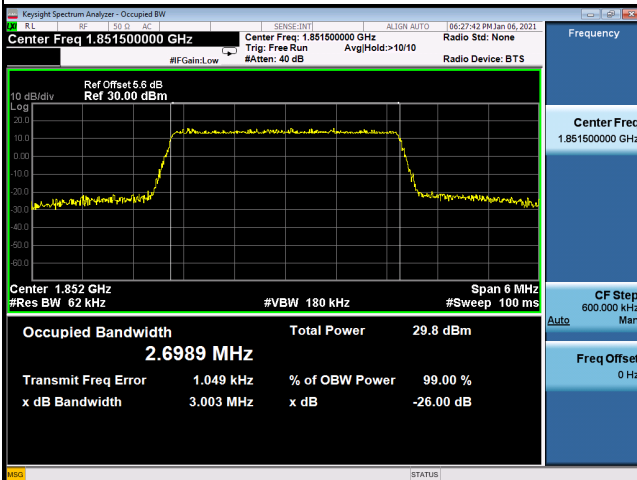

QPSK-18900

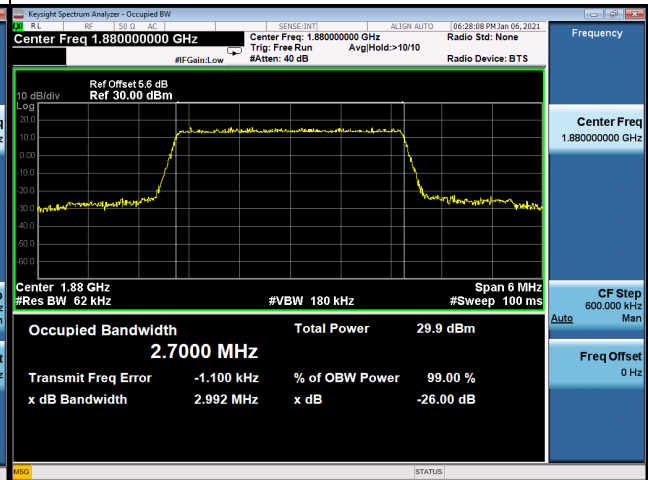

QPSK-19185

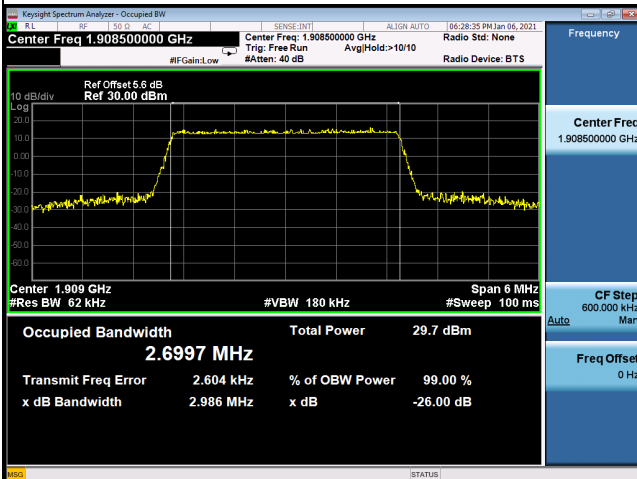

16QAM-18615

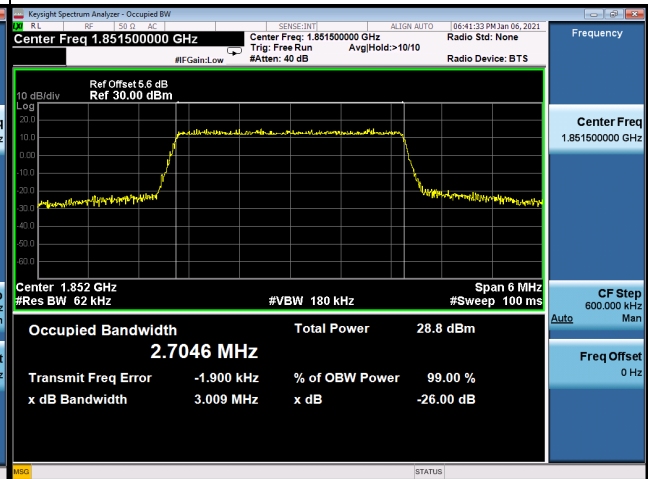

16QAM-18900

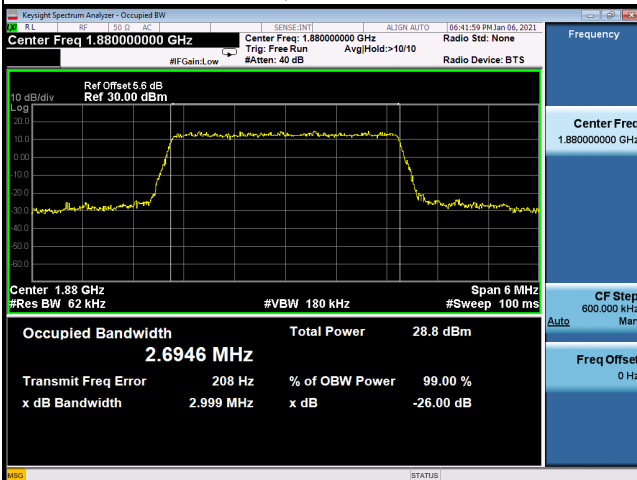

16QAM-19185

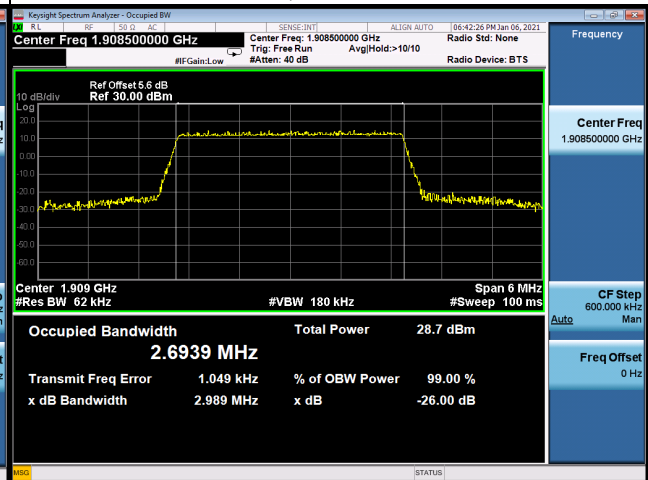

Spectrum Plot

64QAM-18615

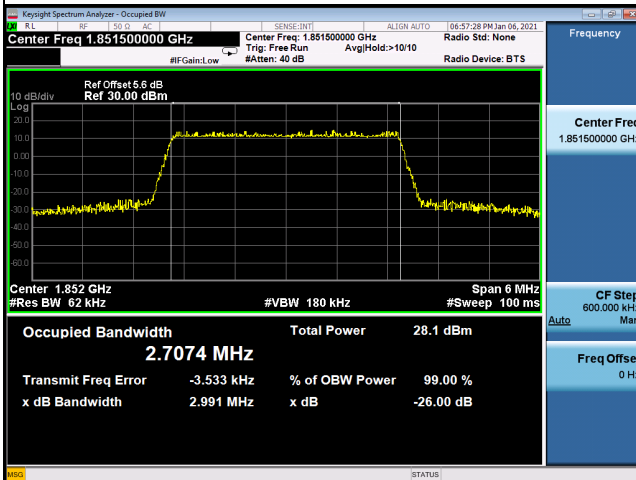

64QAM-18900

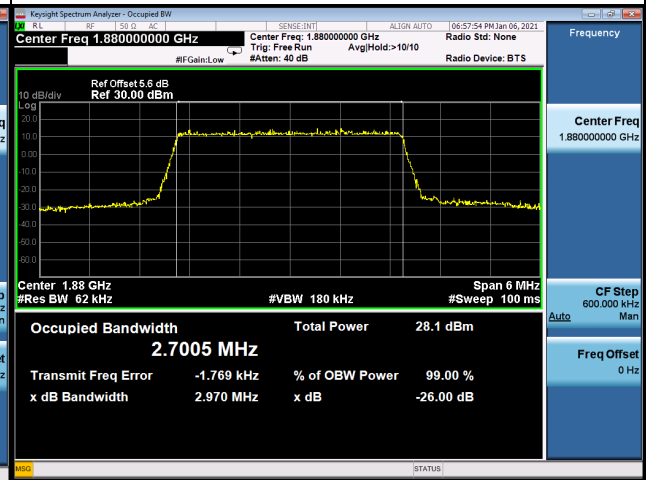

64QAM-19185

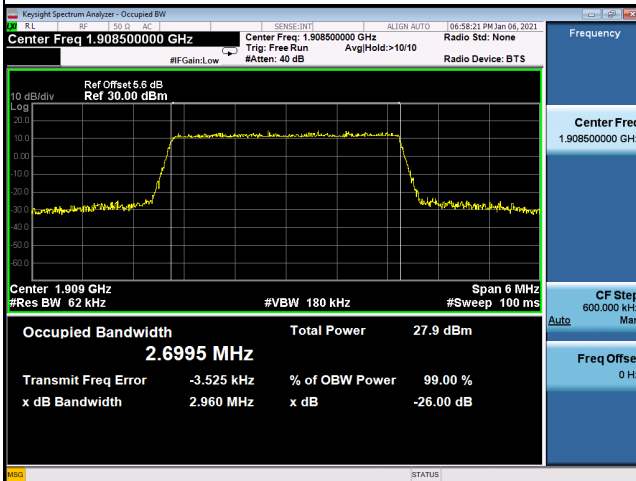

LTE Band 2_5M					
QPSK					
Channel	Frequency (MHz)	99% Occupied Bandwidth (MHz)	Channel	Frequency (MHz)	26dB Bandwidth (MHz)
18625	1852.5	4.5055	18625	1852.5	4.998
18900	1880	4.5055	18900	1880	4.970
19175	1907.5	4.5069	19175	1907.5	4.971
16QAM					
Channel	Frequency (MHz)	99% Occupied Bandwidth (MHz)	Channel	Frequency (MHz)	26dB Bandwidth (MHz)
18625	1852.5	4.5084	18625	1852.5	5.022
18900	1880	4.4999	18900	1880	4.985
19175	1907.5	4.4921	19175	1907.5	4.941
64QAM					
Channel	Frequency (MHz)	99% Occupied Bandwidth (MHz)	Channel	Frequency (MHz)	26dB Bandwidth (MHz)
18625	1852.5	4.5124	18625	1852.5	4.968
18900	1880	4.5039	18900	1880	4.986
19175	1907.5	4.5034	19175	1907.5	4.984

Spectrum Plot

QPSK-18625

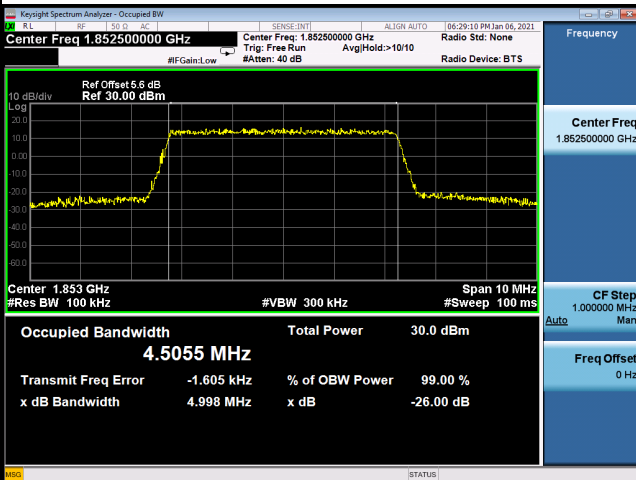

QPSK-18900

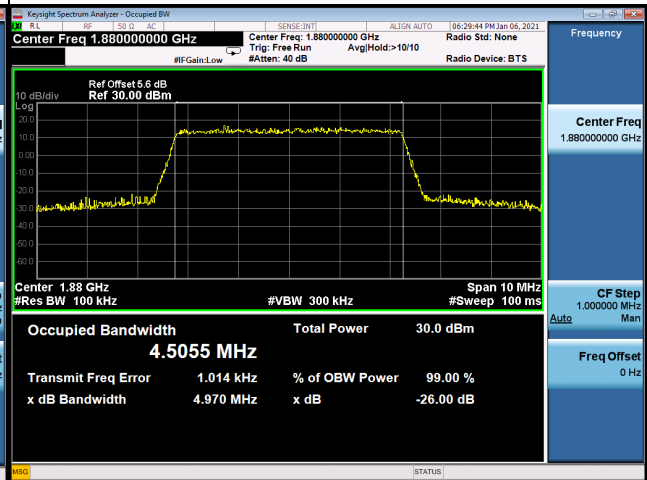

QPSK-19175

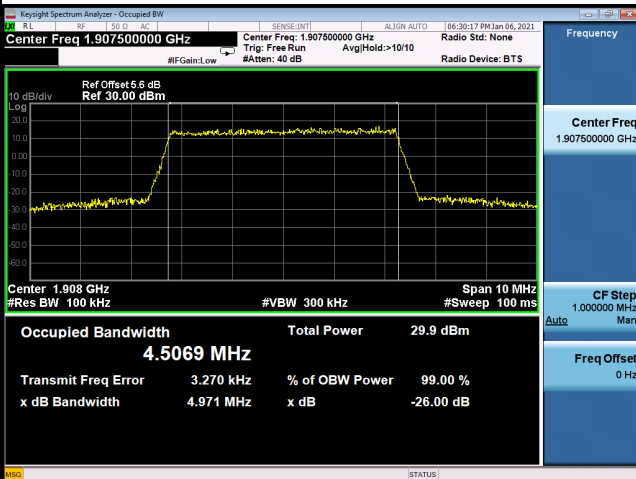

16QAM-18625

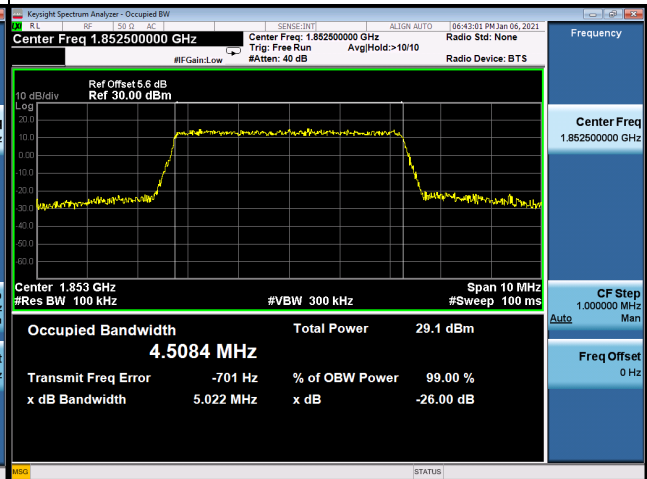

16QAM-18900

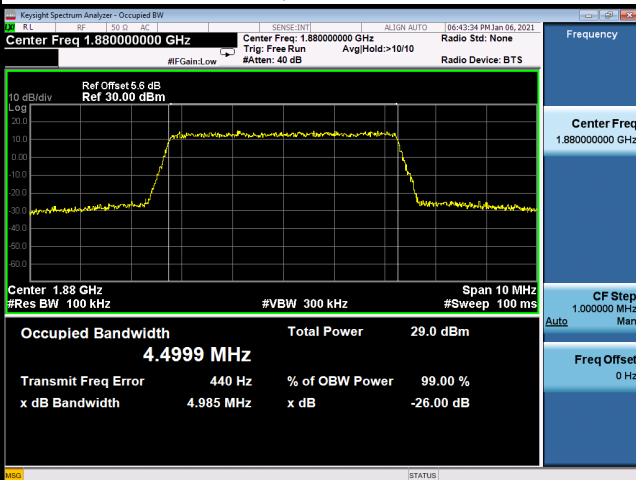

16QAM-19175

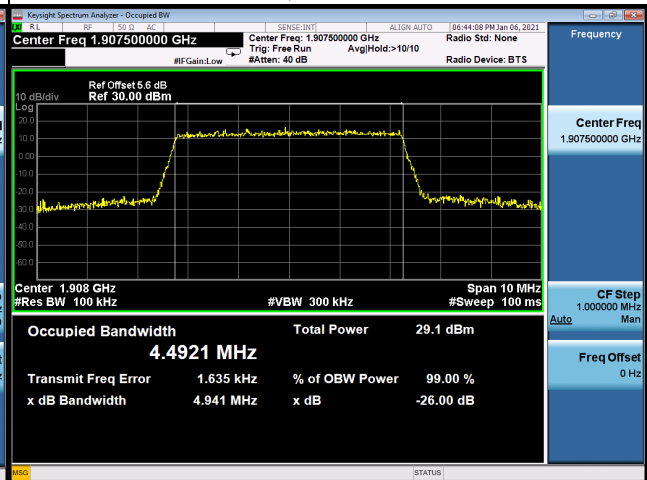

Spectrum Plot

64QAM-18625

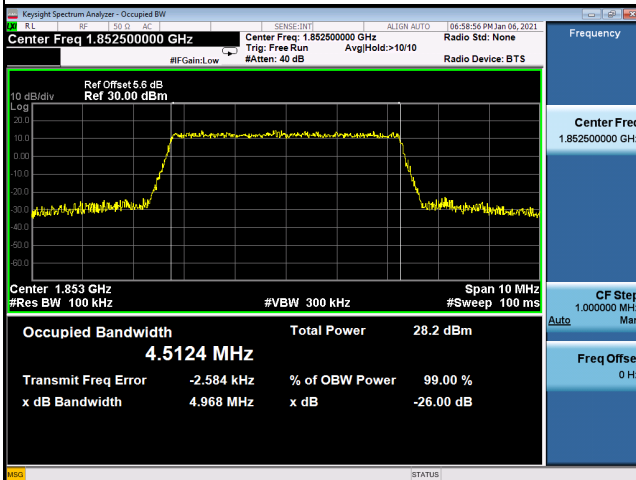

64QAM-18900

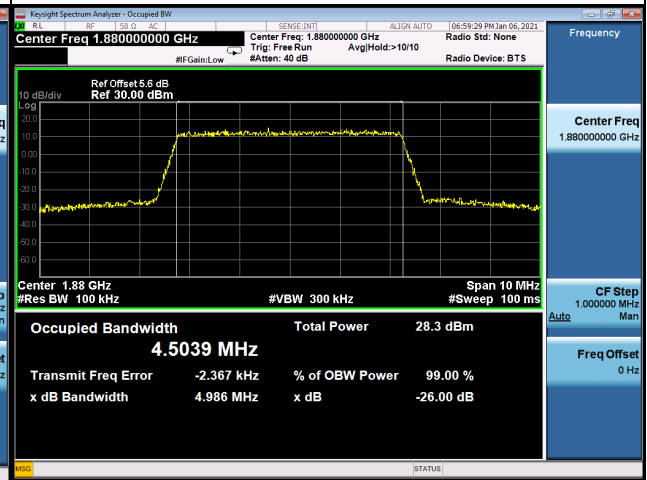

64QAM-19175

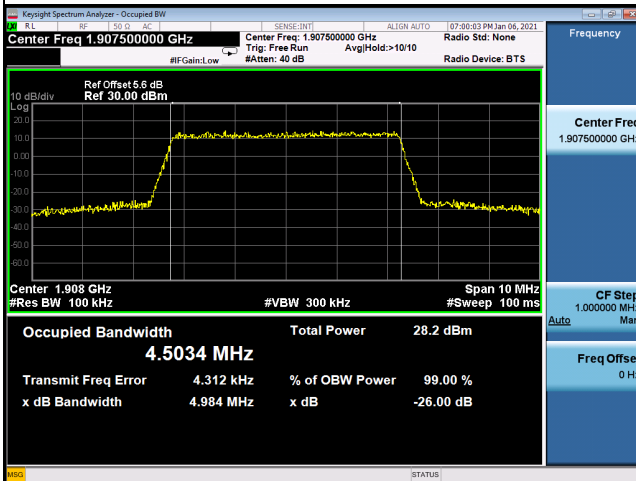

LTE Band 2_10M					
QPSK					
Channel	Frequency (MHz)	99% Occupied Bandwidth (MHz)	Channel	Frequency (MHz)	26dB Bandwidth (MHz)
18650	1855	8.9668	18650	1855	9.928
18900	1880	8.9680	18900	1880	9.782
19150	1905	8.9874	19150	1905	9.957
16QAM					
Channel	Frequency (MHz)	99% Occupied Bandwidth (MHz)	Channel	Frequency (MHz)	26dB Bandwidth (MHz)
18650	1855	8.9756	18650	1855	9.895
18900	1880	8.9614	18900	1880	9.838
19150	1905	9.0111	19150	1905	9.868
64QAM					
Channel	Frequency (MHz)	99% Occupied Bandwidth (MHz)	Channel	Frequency (MHz)	26dB Bandwidth (MHz)
18650	1855	8.9565	18650	1855	9.818
18900	1880	8.9565	18900	1880	9.917
19150	1905	8.9658	19150	1905	9.873

Spectrum Plot

QPSK-18650

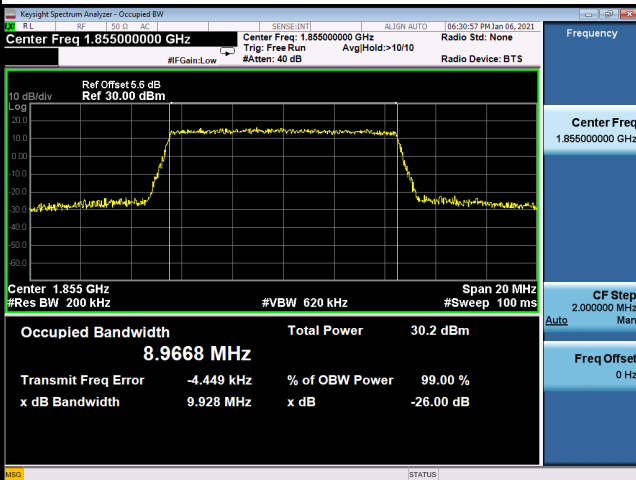

QPSK-18900

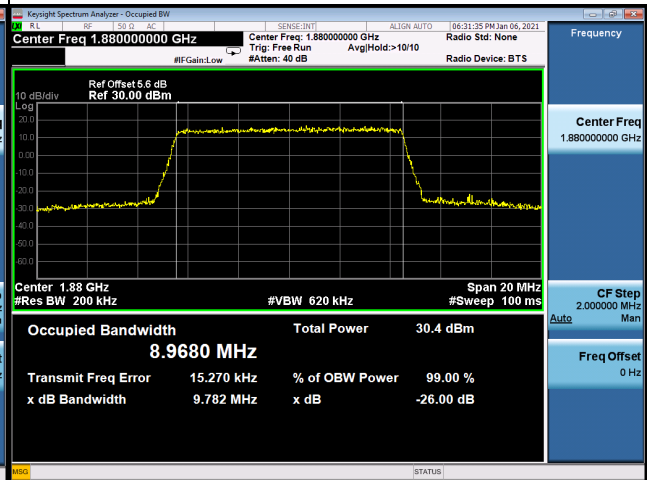

QPSK-19150

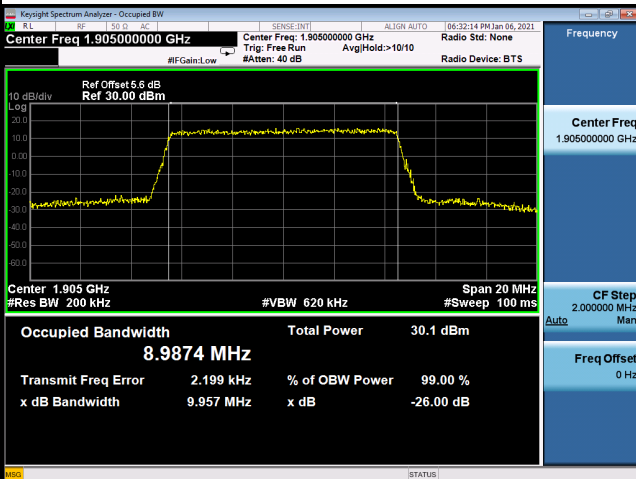

16QAM-18650

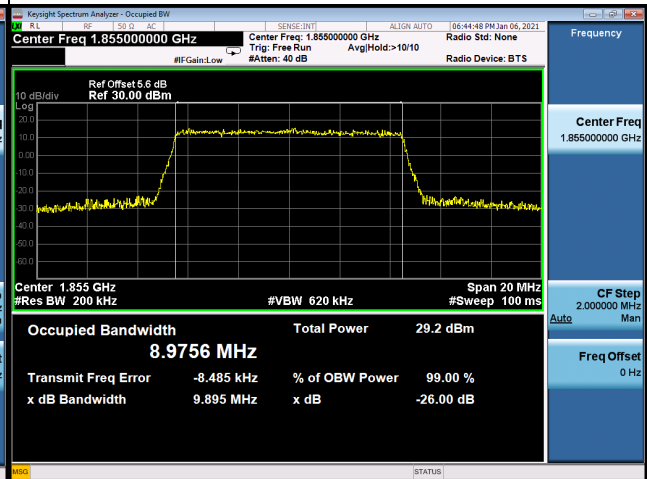

16QAM-18900

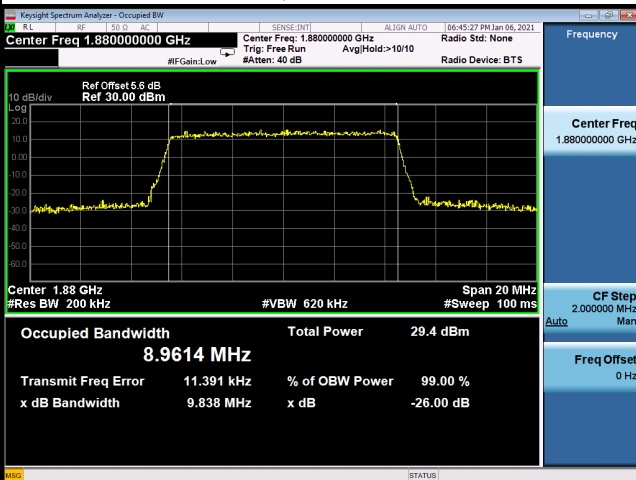

16QAM-19150

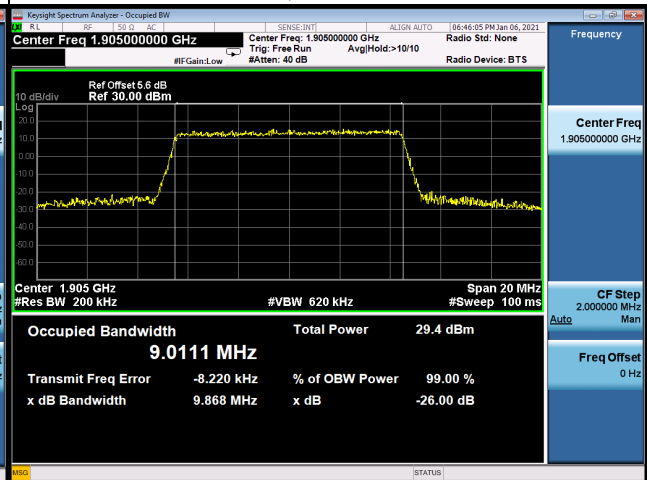

Spectrum Plot

64QAM-18650

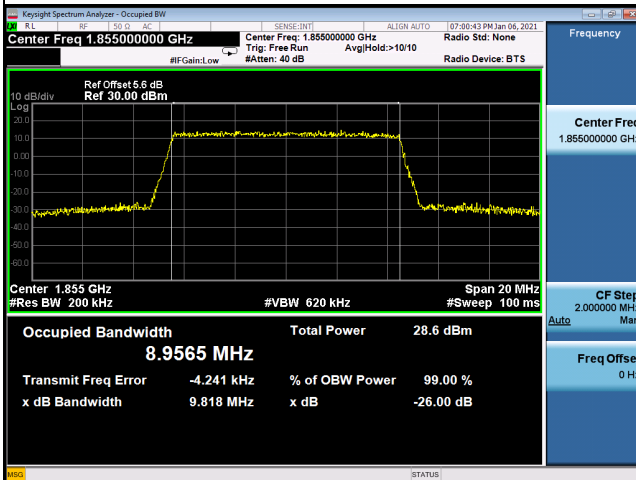

64QAM-18900

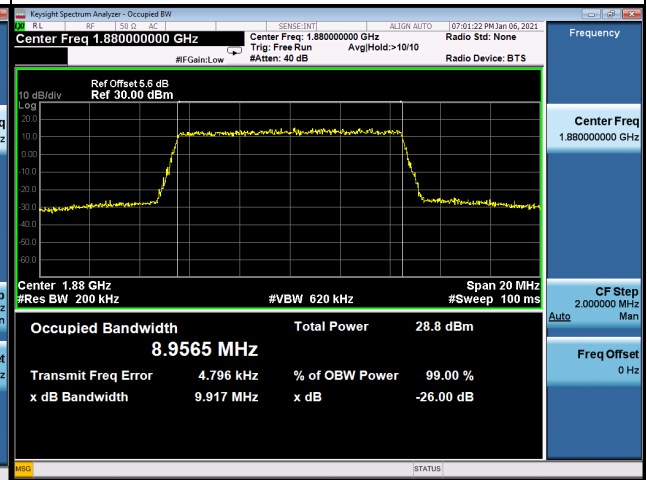

64QAM-19150

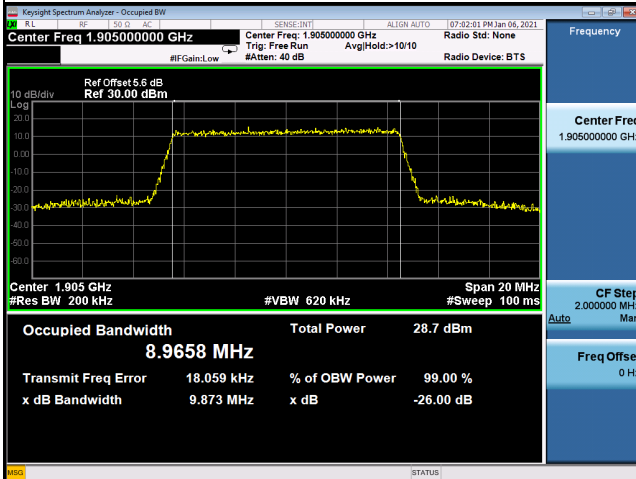

LTE Band 2_15M					
QPSK					
Channel	Frequency (MHz)	99% Occupied Bandwidth (MHz)	Channel	Frequency (MHz)	26dB Bandwidth (MHz)
18675	1857.5	13.440	18675	1857.5	14.68
18900	1880	13.454	18900	1880	14.54
19125	1902.5	13.476	19125	1902.5	14.84
16QAM					
Channel	Frequency (MHz)	99% Occupied Bandwidth (MHz)	Channel	Frequency (MHz)	26dB Bandwidth (MHz)
18675	1857.5	13.450	18675	1857.5	14.60
18900	1880	13.443	18900	1880	14.67
19125	1902.5	13.480	19125	1902.5	14.76
64QAM					
Channel	Frequency (MHz)	99% Occupied Bandwidth (MHz)	Channel	Frequency (MHz)	26dB Bandwidth (MHz)
18675	1857.5	13.439	18675	1857.5	14.63
18900	1880	13.457	18900	1880	14.69
19125	1902.5	13.498	19125	1902.5	14.77

Spectrum Plot

QPSK-18675

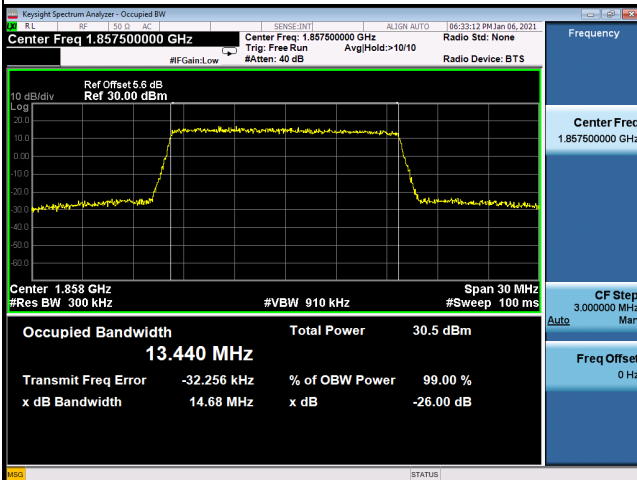

QPSK-18900

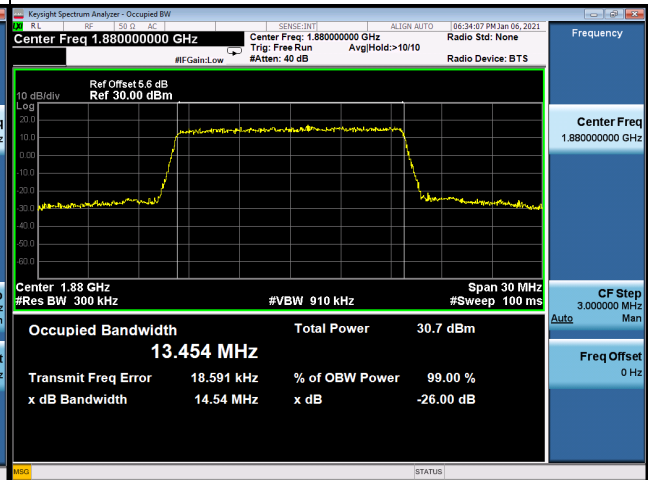

QPSK-19125

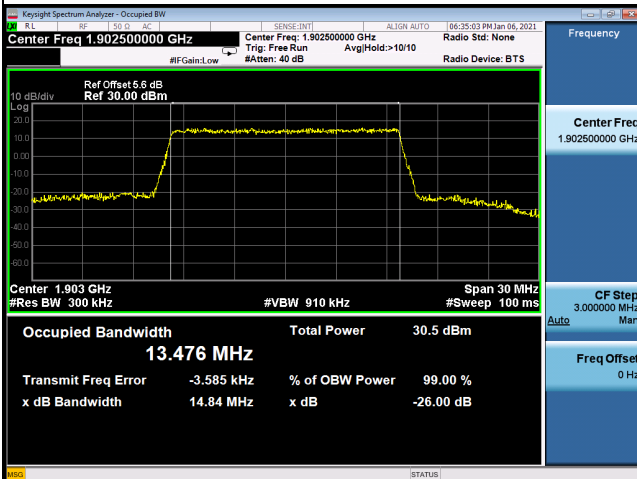

16QAM-18675

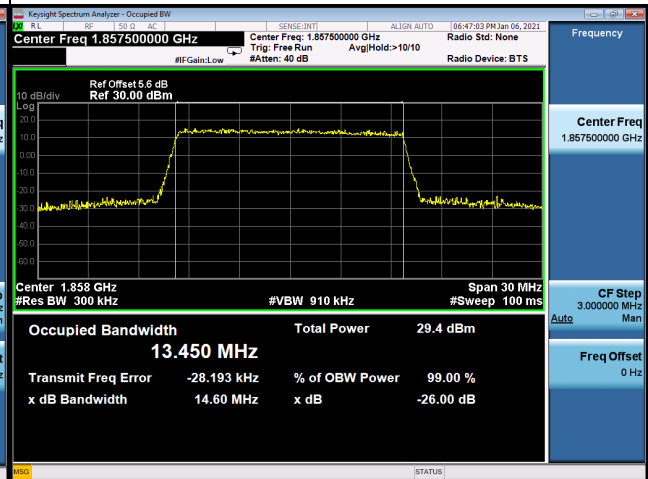

16QAM-18900

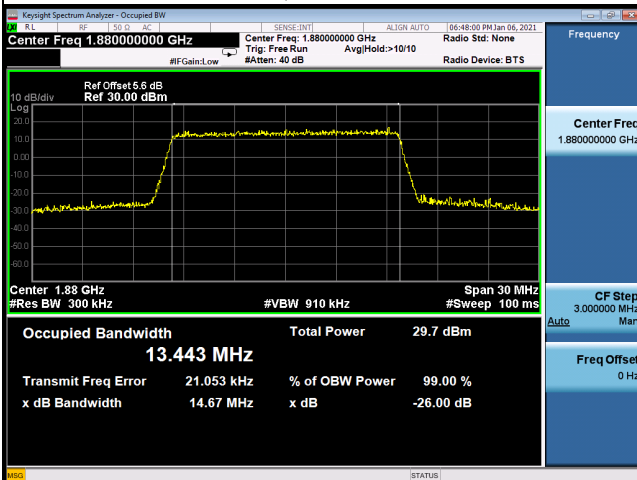

16QAM-19125

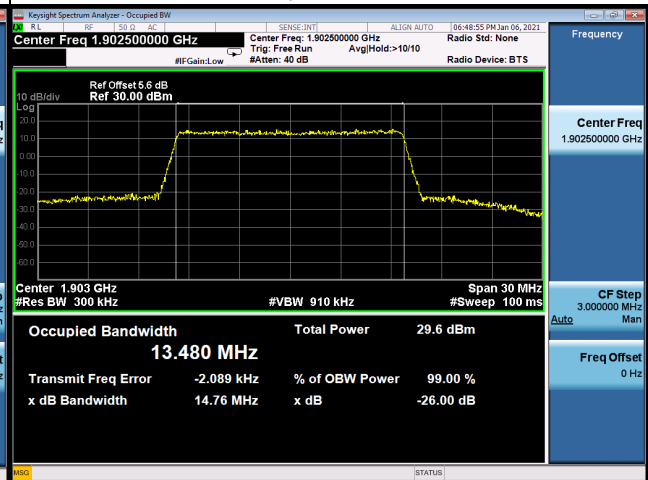

Spectrum Plot

64QAM-18675

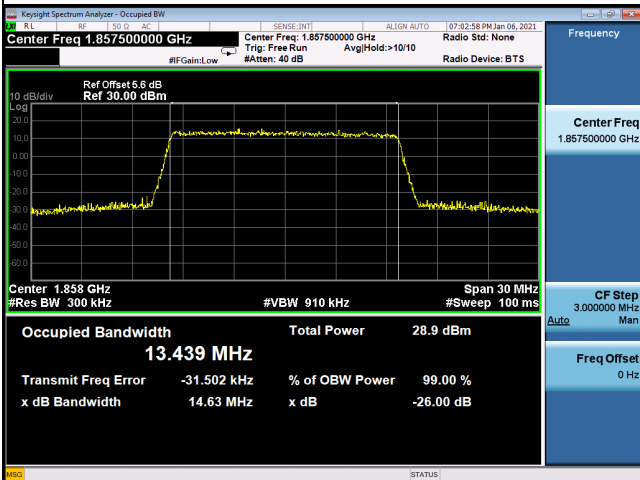

64QAM-18900

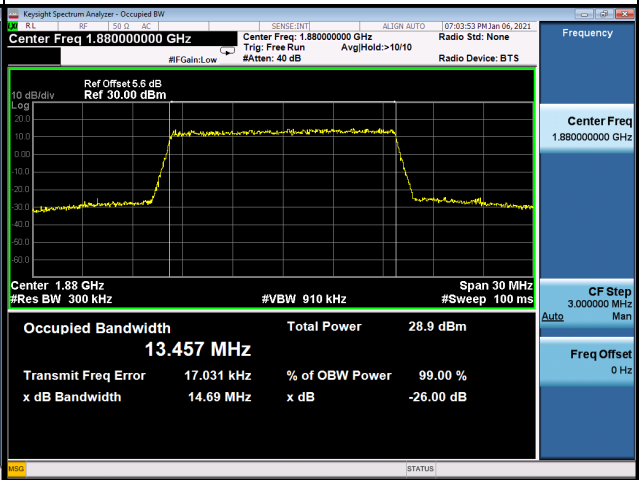

64QAM-19125

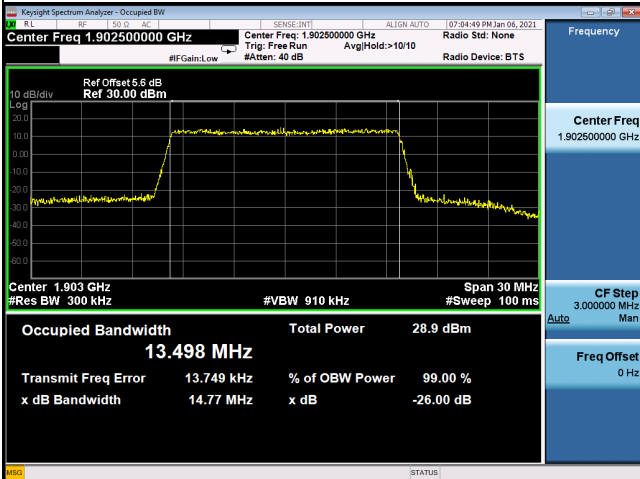

LTE Band 2_20M					
QPSK					
Channel	Frequency (MHz)	99% Occupied Bandwidth (MHz)	Channel	Frequency (MHz)	26dB Bandwidth (MHz)
18700	1860	17.912	18700	1860	19.43
18900	1880	17.907	18900	1880	19.41
19100	1900	17.989	19100	1900	19.51
16QAM					
Channel	Frequency (MHz)	99% Occupied Bandwidth (MHz)	Channel	Frequency (MHz)	26dB Bandwidth (MHz)
18700	1860	17.903	18700	1860	19.37
18900	1880	17.924	18900	1880	19.50
19100	1900	17.971	19100	1900	19.56
64QAM					
Channel	Frequency (MHz)	99% Occupied Bandwidth (MHz)	Channel	Frequency (MHz)	26dB Bandwidth (MHz)
18700	1860	17.914	18700	1860	19.48
18900	1880	17.932	18900	1880	19.49
19100	1900	17.998	19100	1900	19.66

Spectrum Plot

QPSK-18700

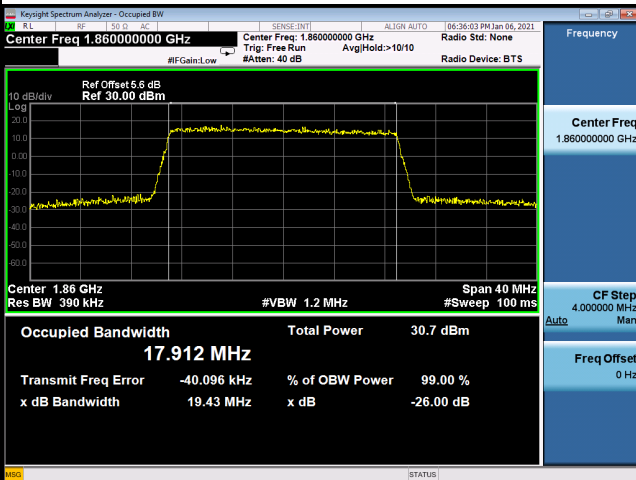

QPSK-18900

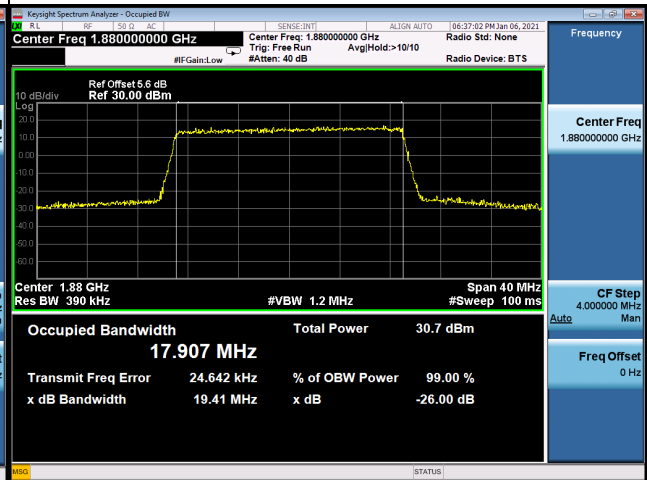

QPSK-19100

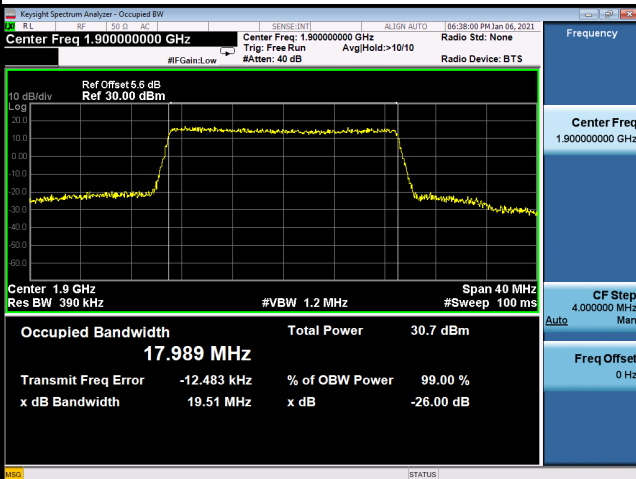

16QAM-18700

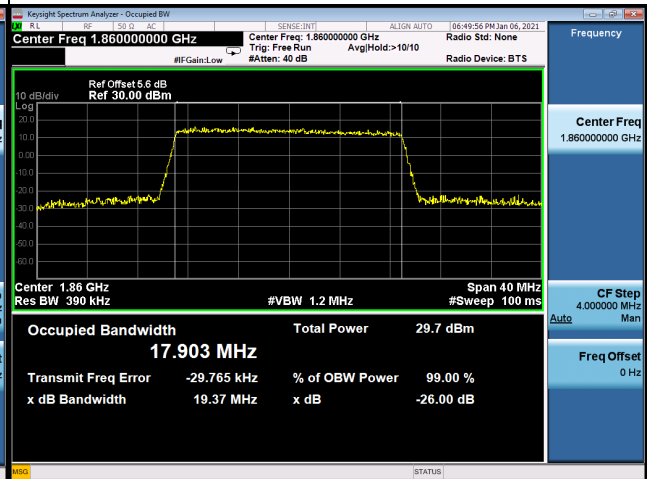

16QAM-18900

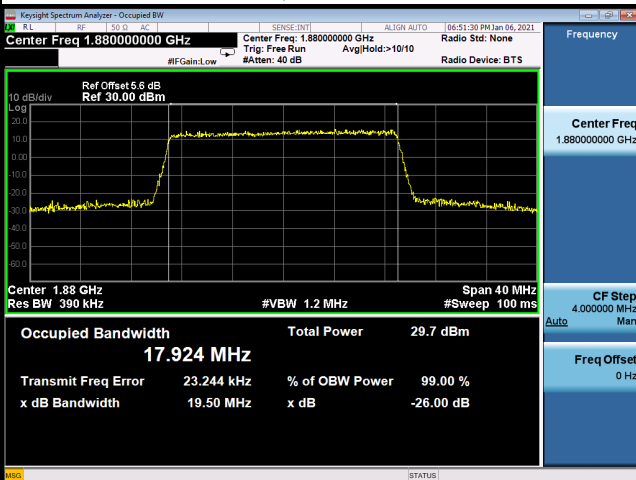

16QAM-19100

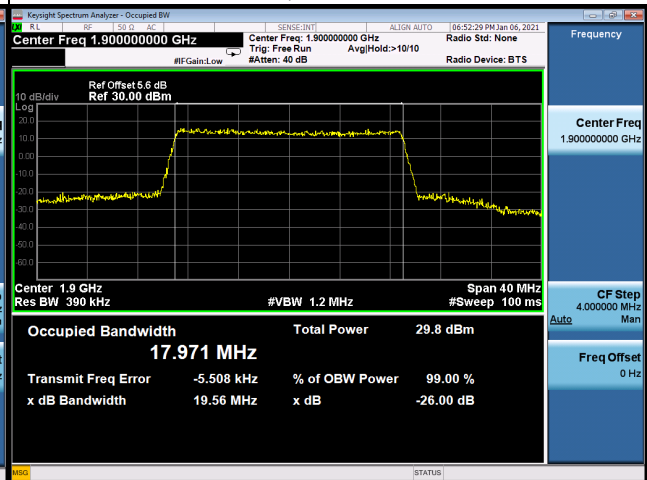

Spectrum Plot

64QAM-18700

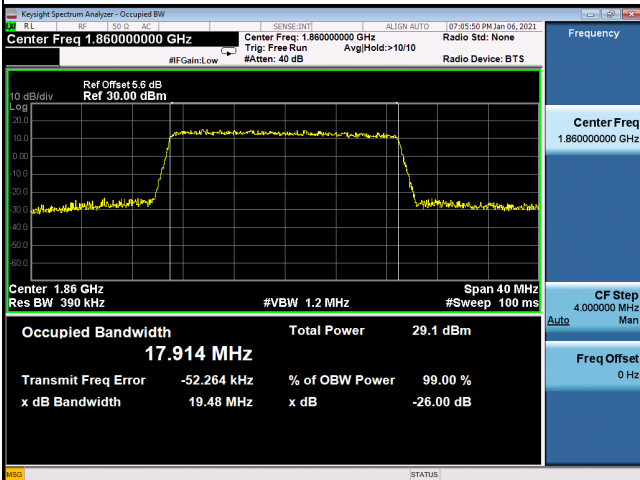

64QAM-18900

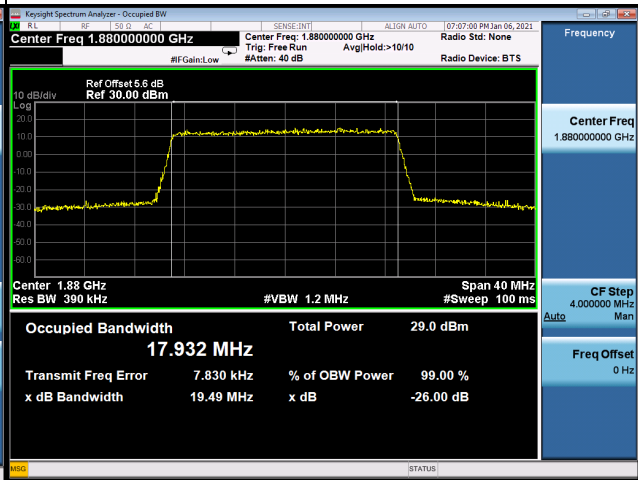

64QAM-19100

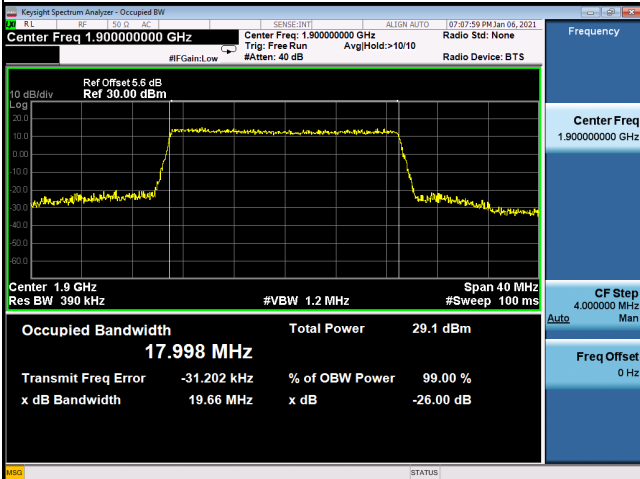

APPENDIX C - CONDUCTED SPURIOUS EMISSIONS