



TEST REPORT

No. I21N04025-RLAN

for

Guangdong OPPO Mobile Telecommunications Corp., Ltd.

Mobile Phone

Model Name: CPH2363

with

Hardware Version: 11

Software Version: ColorOS V12.1

FCC ID: R9C-CPH2363

Issued Date: 2022-01-17

Designation Number: CN1210

Note:

The test results in this test report relate only to the devices specified in this report. This report shall not be reproduced except in full without the written approval of SAICT.

Test Laboratory:

SAICT, Shenzhen Academy of Information and Communications Technology

Building G, Shenzhen International Innovation Center, No.1006 Shennan Road, Futian District, Shenzhen, Guangdong, P. R. China 518000.

Tel:+86(0)755-33322000, Fax:+86(0)755-33322001

Email: yewu@caict.ac.cn www.saict.ac.cn

©Copyright. All rights reserved by SAICT.



CONTENTS

CONTENTS	2
1. SUMMARY OF TEST REPORT.....	3
1.1. TEST ITEMS.....	3
1.2. TEST STANDARDS	3
1.3. TEST RESULT	3
1.4. TESTING LOCATION	3
1.5. PROJECT DATA	3
1.6. SIGNATURE	3
2. CLIENT INFORMATION.....	4
2.1. APPLICANT INFORMATION	4
2.2. MANUFACTURER INFORMATION	4
3. EQUIPMENT UNDER TEST (EUT) AND ANCILLARY EQUIPMENT (AE)	5
3.1. ABOUT EUT	5
3.2. INTERNAL IDENTIFICATION OF EUT	5
3.3. INTERNAL IDENTIFICATION OF AE.....	5
3.4. GENERAL DESCRIPTION.....	6
4. REFERENCE DOCUMENTS	7
4.1. DOCUMENTS SUPPLIED BY APPLICANT	7
4.2. REFERENCE DOCUMENTS FOR TESTING	7
5. TEST RESULTS	8
5.1. TESTING ENVIRONMENT.....	8
5.2. TEST RESULTS	8
5.3. STATEMENTS.....	8
6. TEST EQUIPMENTS UTILIZED	9
7. LABORATORY ENVIRONMENT	10
8. MEASUREMENT UNCERTAINTY	11
ANNEX A: DETAILED TEST RESULTS.....	12
A.1. MEASUREMENT METHOD	12
A.2. MAXIMUM OUTPUT POWER	14
A.3. PEAK POWER SPECTRAL DENSITY (CONDUCTED).....	16
A.4. OCCUPIED 26dB BANDWIDTH (CONDUCTED).....	17
A.5. OCCUPIED 6dB BANDWIDTH (CONDUCTED).....	31
A.6. 99% OCCUPIED BANDWIDTH (CONDUCTED)	35
A.7. DYNAMIC FREQUENCY SELECTION.....	49
A.8. BAND EDGES COMPLIANCE	53
A.9. TRANSMITTER SPURIOUS EMISSION	63
A.10. RADIATED SPURIOUS EMISSIONS < 30MHZ.....	81
A.11. AC POWER LINE CONDUCTED EMISSION.....	83
A.12. POWER CONTROL	86



1. Summary of Test Report

1.1. Test Items

Product Name	Mobile Phone
Model Name	CPH2363
Applicant's name	Guangdong OPPO Mobile Telecommunications Corp., Ltd.
Manufacturer's Name	Guangdong OPPO Mobile Telecommunications Corp., Ltd.

1.2. Test Standards

FCC Part15-2019; FCC 06-96-2006; ANSI C63.10-2013; KDB789033-V02r01; KDB 905462-D02

1.3. Test Result

Pass

Please refer to "5.2. Test Results"

1.4. Testing Location

Address: Building G, Shenzhen International Innovation Center, No.1006 Shennan Road,
Futian District, Shenzhen, Guangdong, P. R. China

1.5. Project data

Testing Start Date:	2021-12-23
Testing End Date:	2022-01-16

1.6. Signature

Lin Zechuang
(Prepared this test report)

An Ran
(Reviewed this test report)

Zhang Bojun
(Approved this test report)



2. Client Information

2.1. Applicant Information

Company Name: Guangdong OPPO Mobile Telecommunications Corp., Ltd.
Address: NO.18 Haibin Road, Wusha Village, Chang'an Town, Dongguan City,
Guangdong, China
Contact Person Mei XiLi
E-Mail meixili@oppo.com
Telephone: (86)76986076999
Fax: /

2.2. Manufacturer Information

Company Name: Guangdong OPPO Mobile Telecommunications Corp., Ltd.
Address: NO.18 Haibin Road, Wusha Village, Chang'an Town, Dongguan City,
Guangdong, China
Contact Person Mei XiLi
E-Mail meixili@oppo.com
Telephone: (86)76986076999
Fax: /



3. Equipment Under Test (EUT) and Ancillary Equipment (AE)

3.1. About EUT

Product Name	Mobile Phone
Model Name	CPH2363
RLAN Frequency Range	ISM Bands: 5150MHz~5250MHz; 5250MHz~5350MHz; 5470MHz~5725MHz; 5725MHz~5850MHz.
RLAN Protocol	IEEE 802.11a/n-HT20/n-HT40/ac-VHT20/ac-VHT40/ac-VHT80
Type of modulation	OFDM
Antenna Type	Integrated antenna
Antenna Gain	1.10dBi
Power Supply	3.87V DC by Battery
FCC ID	R9C-CPH2363
Device Type (DFS)	Client without radar detection(only support client mode)
Condition of EUT as received	No abnormality in appearance

Note: Components list, please refer to documents of the manufacturer; it is also included in the original test record of Shenzhen Academy of Information and Communications Technology.

3.2. Internal Identification of EUT

EUT ID*	IMEI	HW Version	SW Version	Receive Date
UT16aa	861150050032979	11	ColorOS V12.1	2021-12-23
UT02aa	861150050027433	11	ColorOS V12.1	2021-12-23
UT03aa	861150050027656	11	ColorOS V12.1	2021-12-23

*EUT ID: is used to identify the test sample in the lab internally.

UT16aa is used for conduction test, UT02aa is used for radiation test, and UT03aa is used for AC Power line Conducted Emission test.

3.3. Internal Identification of AE

AE ID*	Description	AE ID*
AE1	Battery	/
AE2	Charger	/
AE3	USB Cable	/
AE4	Headset	/

AE1

Model	BLP907
Manufacturer	Sunwoda Electronic Co., Ltd.
Capacity	4385mAh
Nominal Voltage	3.87V

AE2



Model	VCB3HDUH
Manufacturer	Shenzhen Huntkey Electric Co., Ltd.
Specification	American Standard Charger
AE3	
Model	DL143
Manufacturer	/
AE4	
Model	MH157
Manufacturer	/

*AE ID: is used to identify the test sample in the lab internally.

3.4. General Description

The Equipment under Test (EUT) is a model of Mobile Phone with PIFA antenna and battery.

It consists of normal options: Lithium Battery, Charger, USB Cable and Headset.

Manual and specifications of the EUT were provided to fulfil the test.

Samples undergoing test were selected by the client.



4. REFERENCE DOCUMENTS

4.1. Documents supplied by applicant

EUT feature information is supplied by the applicant or manufacturer, which is the basis of testing.

4.2. Reference Documents for testing

The following documents listed in this section are referred for testing.

Reference	Title	Version
FCC Part15	FCC CFR 47,Part 15,Subpart C FCC CFR 47,Part 15,Subpart E	2019
FCC 06-96	Revision of Parts 2 and 15 of the Commission's Rules to Permit Unlicensed National Information Infrastructure (U-NII) devices in the 5 GHz band	2006
ANSI C63.10	American National Standard of Procedures for Compliance Testing of Unlicensed Wireless Devices	2013
KDB 789033	GUIDELINES FOR COMPLIANCE TESTING OF UNLICENSED NATIONAL INFORMATION INFRASTRUCTURE (U-NII) DEVICES PART 15, SUBPART E	V02r01
KDB 905462	Compliance Measurement Procedures for Unlicensed-national Information Infrastructure Devices Operating in the 5250-5350 MHz and 5470-5725 MHz Bands Incorporating Dynamic Frequency Selection	D02



5. Test Results

5.1. Testing Environment

Normal Temperature: 15~35°C

Relative Humidity: 20~75%

5.2. Test Results

No.	Test cases	Sub-clause of Part15E	Verdict
0	Maximum Output Power	15.407(a)	P
1	Power Spectral Density	15.407(a)	P
2	Occupied 26dB Bandwidth	15.403(i)	/
3	Occupied 6dB Bandwidth	15.407(e)	P
4	99% Occupied Bandwidth	15.403	/
5	Dynamic Frequency Selection	15.407 (h)	P
6	Band edge compliance	15.209	P
7	Radiated Spurious Emissions	15.209	P
8	AC Power line Conducted	15.207	P
9	Transmit Power Control	15.407	NA

See **ANNEX A** for details.

Note: According to the definition of the application description, the device will automatically discontinue transmission in case of either absence of information to transmit or operational failure.

5.3. Statements

SAICT has evaluated the test cases requested by the applicant/manufacture as listed in section 5.2 of this report, for the EUT specified in section 3, according to the standards or reference documents listed in section 4.2

Disclaimer:

A. After confirmation with the customer, the sample information provided by the customer may affect the validity of the measurement results in this report, and the impact and consequences arising therefrom shall be borne by the customer.

B. The samples in this report are provided by the customer, and the test results are only applicable to the samples received.

6. Test Equipments Utilized

Conducted test system

No.	Equipment	Model	Serial Number	Manufacturer	Calibration Due date	Calibration Period
1	Vector Signal Analyzer	FSV40	100903	Rohde & Schwarz	2022-12-29	1 year
2	Power Sensor	U2021XA	MY55430013	Keysight	2022-12-29	1 year
3	Data Acquisition	U2531A	TW55443507	Keysight	/	/
4	RF Control Unit	JS0806-2	21C8060398	Tonscend	2022-05-09	1 year
5	Vector Signal General	SMU200A	104096	Rohde & Schwarz	2022-12-29	1 year
6	Shielding Room	S81	/	ETS-Lindgren	2022-11-14	3 years
7	Test Receiver	ESCI	100702	Rohde & Schwarz	2023-01-12	1 year
8	LISN	ENV216	102067	Rohde & Schwarz	2022-07-15	1 year
No.	Equipment	Model	FCC ID	Manufacturer	Calibration Due date	Calibration Period
9	Master AP	RT-AX86U	MSQ-RTAXI600	ASUS	/	/

Radiated test system

No.	Equipment	Model	Serial Number	Manufacturer	Calibration Due date	Calibration Period
1	Loop Antenna	HLA6120	35779	TESEQ	2022-04-25	3 years
2	BiLog Antenna	3142E	0224831	ETS-Lindgren	2024-05-27	3 years
3	Horn Antenna	3117	00066577	ETS-Lindgren	2022-04-02	3 years
4	Horn Antenna	QSH-SL-18 -26-S-20	17013	Q-par	2023-01-06	3 years
5	Horn Antenna	QSH-SL-18 -40-K-SG	15979	Q-par	2023-01-06	3 years
6	Test Receiver	ESR7	101676	Rohde & Schwarz	2022-11-24	1 year
7	Spectrum Analyser	FSV40	101192	Rohde & Schwarz	2023-01-12	1 year
8	Chamber	FACT3-2.0	1285	ETS-Lindgren	2023-05-29	2 years

Test software

No.	Equipment	Manufacturer	Version
1	JS1120-3	Tonscend	2.6
2	EMC32	Rohde & Schwarz	10.50.40

EUT is engineering software provided by the customer to control the transmitting signal. The EUT was programmed to be in continuously transmitting mode.

Anechoic chamber

Fully anechoic chamber by ETS-Lindgren

7. Laboratory Environment

Semi-anechoic chamber

Temperature	Min. = 15 °C, Max. = 35 °C
Relative humidity	Min. = 20 %, Max. = 75 %
Shielding effectiveness	0.014MHz-1MHz> 60 dB; 1MHz-18000MHz>90 dB
Electrical insulation	> 2M Ω
Ground system resistance	< 4 Ω
Normalised site attenuation (NSA)	< \pm 4 dB, 3 m distance, from 30 to 1000 MHz

Shielded room

Temperature	Min. = 15 °C, Max. = 35 °C
Relative humidity	Min. = 20 %, Max. = 75 %
Shielding effectiveness	0.014MHz-1MHz> 60 dB; 1MHz-1000MHz>90 dB
Electrical insulation	> 2M Ω
Ground system resistance	< 4 Ω

Fully-anechoic chamber

Temperature	Min. = 15 °C, Max. = 35 °C
Relative humidity	Min. = 20 %, Max. = 75 %
Shielding effectiveness	0.014MHz-1MHz> 60 dB; 1MHz-18000MHz>90 dB
Electrical insulation	> 2M Ω
Ground system resistance	< 4 Ω
Voltage Standing Wave Ratio (VSWR)	\leq 6 dB, from 1 to 18 GHz, 3 m distance
Uniformity of field strength	Between 0 and 6 dB, from 80 to 6000 MHz

**8. Measurement Uncertainty**

Test Name	Uncertainty ($k=2$)	
1. Maximum output Power	1.32dB	
2. Peak Power Spectral Density	2.32dB	
3. Occupied 26dB Bandwidth	66Hz	
4. Occupied 6dB Bandwidth	66Hz	
5. 99% Occupied Bandwidth	66Hz	
6. Band Edges Compliance	4.68dB	
7. Transmitter Spurious Emission - Radiated	$9\text{kHz} \leq f < 30\text{MHz}$	1.79dB
	$30\text{MHz} \leq f < 1\text{GHz}$	4.86dB
	$1\text{GHz} \leq f < 18\text{GHz}$	4.82dB
	$18\text{GHz} \leq f \leq 40\text{GHz}$	2.90dB
8. AC Power line Conducted Emission	$150\text{kHz} \leq f \leq 30\text{MHz}$	2.62dB

ANNEX A: Detailed Test Results

A.1. Measurement Method

Conducted Measurements

- 1). Connect the EUT to the test system correctly.
- 2). Set the EUT to the required work mode.
- 3). Set the EUT to the required channel.
- 4). Set the spectrum analyzer to start measurement.
- 5). Record the values.

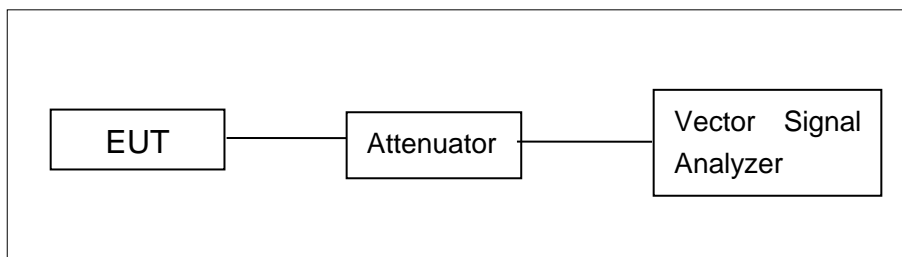

6). The below figure shows the DFS setup, where the EUT is a RLAN device operating in slave mode, without Radar Interference Detection function. This setup also contains a device operating in master mode. The radar test signals are injected into the master device. The EUT (slave device) is associated with the master device. WLAN traffic is generated by streaming the mpeg file from the master to the slave in full monitor video mode using the media player.

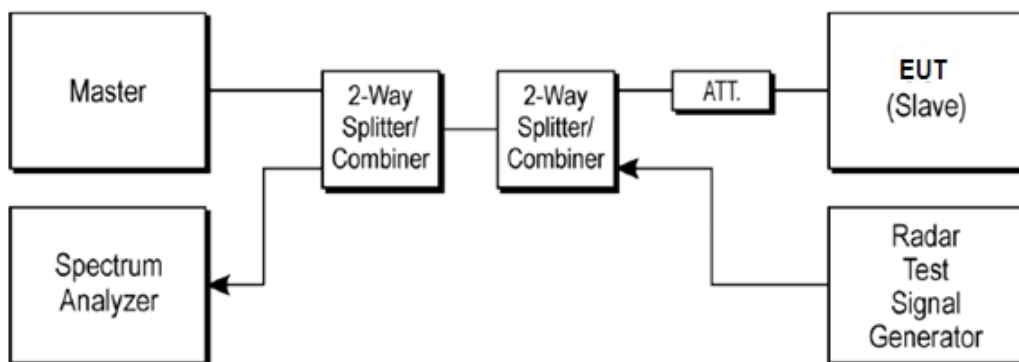

Radiated Emission Measurements

In the case of radiated emission, the used settings are as follows:

Sweep frequency from 30 MHz to 1 GHz, RBW = 100 KHz, VBW = 300 KHz;

Sweep frequency from 1 GHz to 26 GHz, RBW = 1 MHz, VBW = 10 Hz;

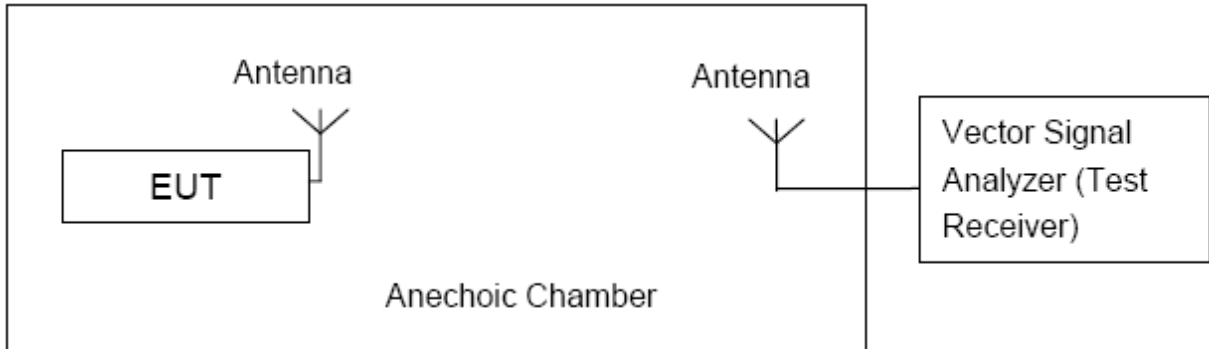

The measurement is made according to KDB 789033.

The radiated emission test is performed in semi-anechoic chamber. The distance from the EUT to the reference point of measurement antenna is 3m. The test is carried out on both vertical and horizontal polarization and only maximization result of both polarizations is kept. During the test, the turntable is rotated 360° and the measurement antenna is moved from 1m to 4m to get the maximization result.

A.2. Maximum output Power

Measurement Limit and Method:

Standard	Frequency (MHz)	Limit (dBm)
FCC CRF Part 15.407(a)	5150MHz~5250MHz	24
	5250MHz~5350MHz	24 or 11+10logB
	5470MHz~5725MHz	24 or 11+10logB
	5725MHz~5850MHz	30

Limit use the less value, and B is the 26dB bandwidth.

Measurement of method: See ANSI C63.10-2013-Clause 12.3.3.2

Method PM-G is a measurement using a gated RF average power meter.

Measurements may be performed using a wideband gated RF power meter provided that the gate parameters are adjusted such that the power is measured only when the EUT is transmitting at its maximum power control level. Because the measurement is made only during the ON time of the transmitter, no duty cycle correction factor is required.

Measurement Results:

Mode	Channel	RF output power (dBm)	Conclusion
802.11a	5180MHz (Ch36)	17.41	P
	5200MHz (Ch40)	17.39	P
	5240MHz (Ch48)	17.32	P
	5260MHz (Ch52)	17.31	P
	5280MHz (Ch56)	17.23	P
	5320MHz (Ch64)	17.17	P
	5500MHz (Ch100)	17.58	P
	5580MHz (Ch116)	17.82	P
	5700MHz (Ch140)	12.05	P
	5745MHz (CH149)	18.13	P
	5785MHz (CH157)	17.90	P
	5825MHz (CH165)	17.69	P
802.11n-HT20	5180MHz (Ch36)	17.27	P
	5200MHz (Ch40)	17.20	P
	5240MHz (Ch48)	17.12	P
	5260MHz (Ch52)	17.12	P
	5280MHz (Ch56)	17.05	P
	5320MHz (Ch64)	17.06	P
	5500MHz (Ch100)	17.40	P
	5580MHz (Ch116)	17.75	P
	5700MHz (Ch140)	11.91	P
	5745MHz (CH149)	17.98	P
	5785MHz (CH157)	17.72	P
	5825MHz (CH165)	17.49	P



802.11ac-VHT20	5180MHz (Ch36)	17.20	P
	5200MHz (Ch40)	17.18	P
	5240MHz (Ch48)	17.10	P
	5260MHz (Ch52)	17.09	P
	5280MHz (Ch56)	17.04	P
	5320MHz (Ch64)	17.08	P
	5500MHz (Ch100)	17.39	P
	5580MHz (Ch116)	17.64	P
	5700MHz (Ch140)	11.88	P
	5745MHz (CH149)	17.93	P
	5785MHz (CH157)	17.68	P
	5825MHz (CH165)	17.50	P
802.11n-HT40	5190MHz (Ch38)	12.28	P
	5230MHz (Ch46)	16.35	P
	5270MHz (Ch54)	16.26	P
	5310MHz (Ch62)	13.21	P
	5510MHz (Ch102)	13.56	P
	5550MHz (Ch110)	16.84	P
	5670MHz (Ch134)	17.05	P
	5755MHz (CH151)	17.18	P
	5795MHz (CH159)	16.98	P
802.11ac-VHT40	5190MHz (Ch38)	12.29	P
	5230MHz (Ch46)	17.21	P
	5270MHz (Ch54)	17.13	P
	5310MHz (Ch62)	13.24	P
	5510MHz (Ch102)	13.57	P
	5550MHz (Ch110)	17.85	P
	5670MHz (Ch134)	18.01	P
	5755MHz (CH151)	18.11	P
	5795MHz (CH159)	17.90	P
802.11ac-VHT80	5210MHz (Ch42)	10.11	P
	5290MHz (Ch58)	10.12	P
	5530MHz (Ch106)	9.48	P
	5610MHz (Ch122)	16.82	P
	5775MHz (CH155)	16.84	P

Note:

The data rate 6Mbps (11a mode), MCS0 (11n mode) and MCS0 (11ac mode) are selected as the worst case. 802.11a, 802.11ac-VHT40 and 802.11ac-VHT80 are selected as the worst-case. The following cases and test graphs are mostly performed with this condition.

The EUT was programmed to be in continuously transmitting mode and the transmit duty cycle is not less than 98%.

Conclusion: PASS

A.3. Peak Power Spectral Density (conducted)

Measurement of method: See KDB 789033 D02 v02r01, Section F.

Measurement Limit:

Standard	Frequency (MHz)	Limit
FCC CRF Part 15.407(a)	5150MHz~5250MHz	11dBm/MHz
	5250MHz~5350MHz	11dBm/MHz
	5470MHz~5725MHz	11dBm/MHz
	5725MHz~5850MHz	30dBm/500kHz

The PPSD measurement method SA-1 is made according to KDB 789033.

Measurement Results:

Mode	Channel	Power Spectral Density(dBm/MHz)	Conclusion
802.11a	5180MHz (Ch36)	6.07	P
	5200MHz (Ch40)	5.33	P
	5240MHz (Ch48)	5.62	P
	5260MHz (Ch52)	5.69	P
	5280MHz (Ch56)	5.61	P
	5320MHz (Ch64)	5.62	P
	5500MHz (Ch100)	5.73	P
	5580MHz (Ch116)	6.17	P
	5700MHz (Ch140)	0.04	P
802.11ac-VHT40	5190MHz (Ch38)	-1.69	P
	5230MHz (Ch46)	2.94	P
	5270MHz (Ch54)	2.30	P
	5310MHz (Ch62)	-1.37	P
	5510MHz (Ch102)	-0.89	P
	5550MHz (Ch110)	2.96	P
	5670MHz (Ch134)	3.14	P
802.11ac-VHT80	5210MHz (Ch42)	-7.14	P
	5290MHz (Ch58)	-8.10	P
	5530MHz (Ch106)	-9.11	P
	5610MHz (Ch122)	-0.87	P
Mode	Channel	Power Spectral Density (dBm/500kHz)	Conclusion
802.11a	5745MHz (CH149)	3.68	P
	5785MHz (CH157)	3.93	P
	5825MHz (CH165)	3.67	P
802.11ac-VHT40	5755MHz (CH151)	0.46	P
	5795MHz (CH159)	0.44	P
802.11ac-VHT80	5775MHz (CH155)	-3.42	P

Conclusion: PASS



A.4. Occupied 26dB Bandwidth (conducted)

Measurement of method: See KDB 789033 D02 v02r01, Section C.1.

Measurement Limit:

Standard	Limit (MHz)
FCC 47 CFR Part 15.403 (i)	/

The measurement is made according to KDB 789033

Measurement Result:

Mode	Channel	Occupied 26dB Bandwidth(MHz)		Conclusion
802.11a	5180MHz(Ch36)	Fig.1	21.68	/
	5200MHz(Ch40)	Fig.2	21.88	/
	5240MHz(Ch48)	Fig.3	21.88	/
	5260MHz(Ch52)	Fig.4	21.68	/
	5280MHz(Ch56)	Fig.5	22.60	/
	5320MHz(Ch64)	Fig.6	22.52	/
	5500MHz(Ch100)	Fig.7	22.20	/
	5580MHz(Ch116)	Fig.8	21.96	/
	5700MHz(Ch140)	Fig.9	22.68	/
	5745MHz(Ch149)	Fig.10	22.40	/
	5785MHz(Ch157)	Fig.11	21.36	/
802.11ac-VHT40	5825MHz(Ch165)	Fig.12	21.44	/
	5190MHz(Ch38)	Fig.13	41.92	/
	5230MHz(Ch46)	Fig.14	41.12	/
	5270MHz(Ch54)	Fig.15	41.68	/
	5310MHz(Ch62)	Fig.16	41.92	/
	5510MHz(Ch102)	Fig.17	41.60	/
	5550MHz(Ch110)	Fig.18	41.12	/
	5670MHz(Ch134)	Fig.19	41.60	/
802.11ac-VHT80	5755MHz(Ch151)	Fig.20	41.76	/
	5795MHz(Ch159)	Fig.21	41.52	/
	5210MHz(Ch42)	Fig.22	84.48	/
	5290MHz(Ch58)	Fig.23	85.60	/
	5530MHz(Ch106)	Fig.24	84.32	/
	5610MHz(Ch122)	Fig.25	84.16	/
	5775MHz(Ch155)	Fig.26	83.84	/

See below for test graphs.

Conclusion: PASS

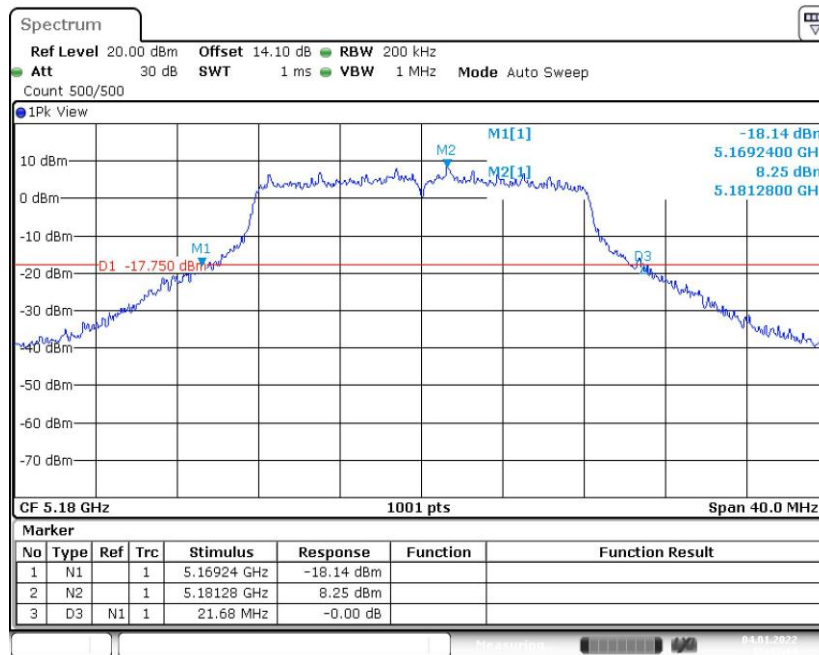

Fig. 1 Occupied 26dB Bandwidth (802.11a, 5180MHz)

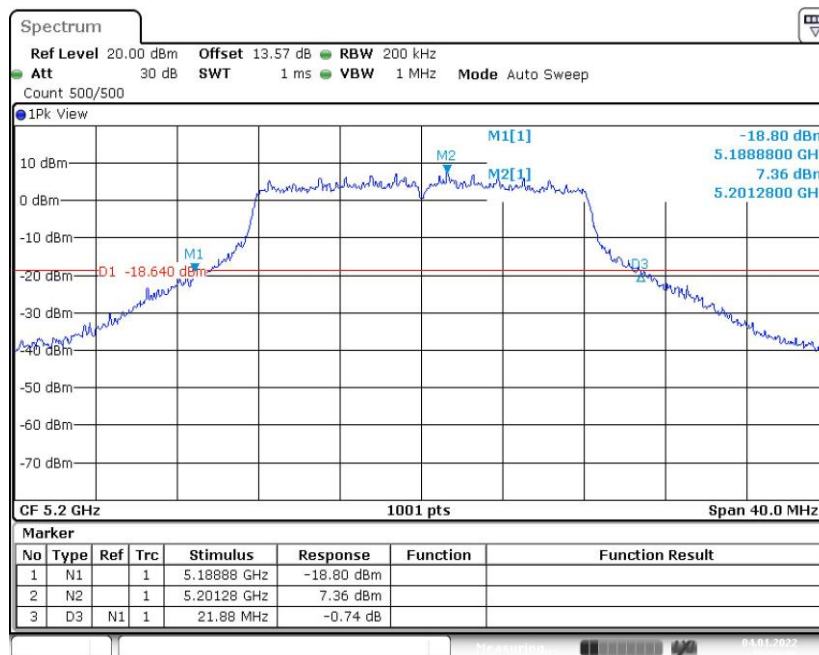

Fig. 2 Occupied 26dB Bandwidth (802.11a, 5200MHz)

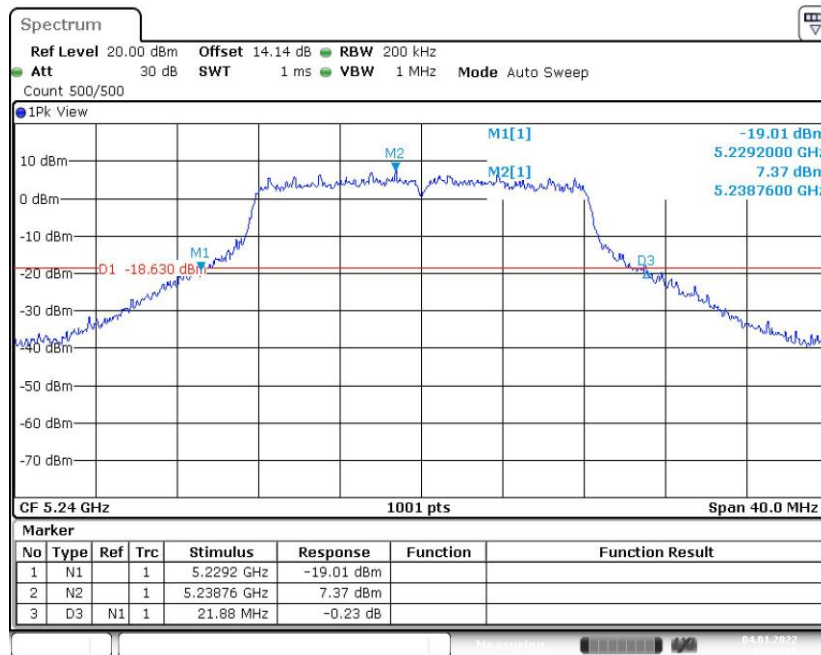

Fig. 3 Occupied 26dB Bandwidth (802.11a, 5240MHz)



Fig. 4 Occupied 26dB Bandwidth (802.11a, 5260MHz)

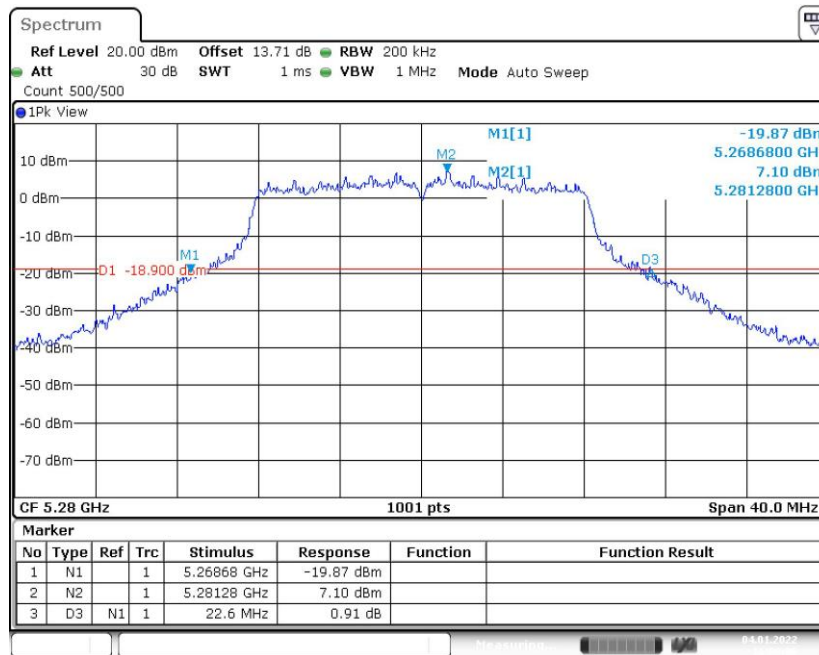

Fig. 5 Occupied 26dB Bandwidth (802.11a, 5280MHz)

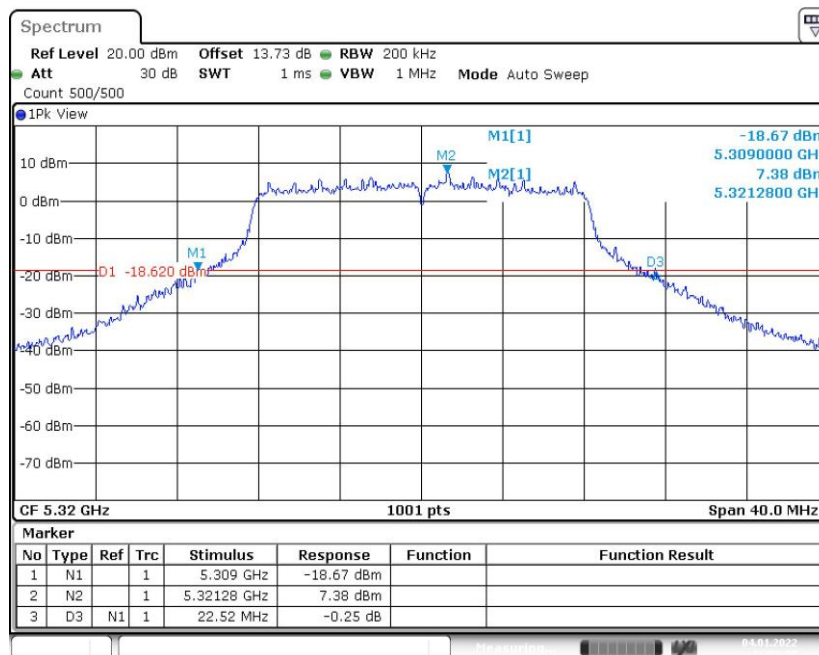

Fig. 6 Occupied 26dB Bandwidth (802.11a, 5320MHz)

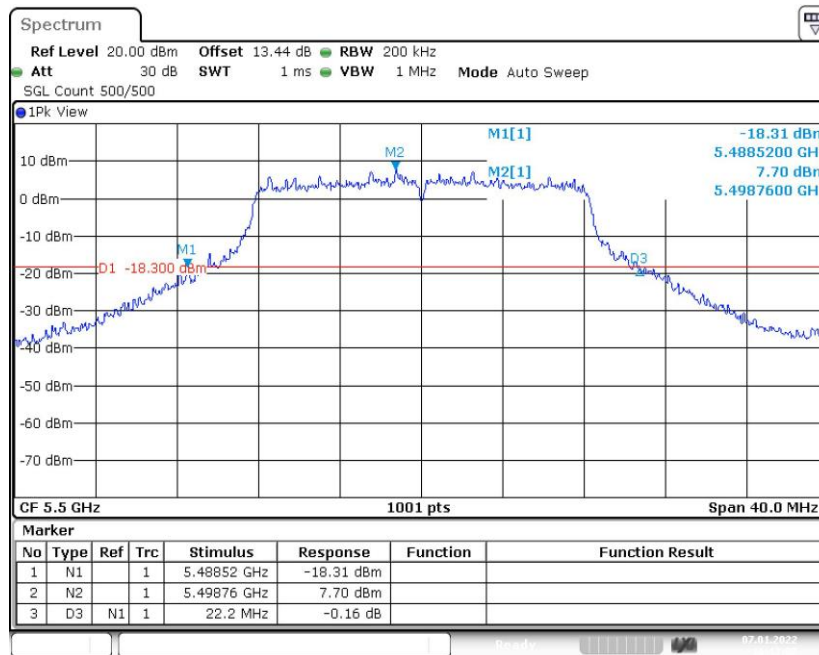

Fig. 7 Occupied 26dB Bandwidth (802.11a, 5500MHz)

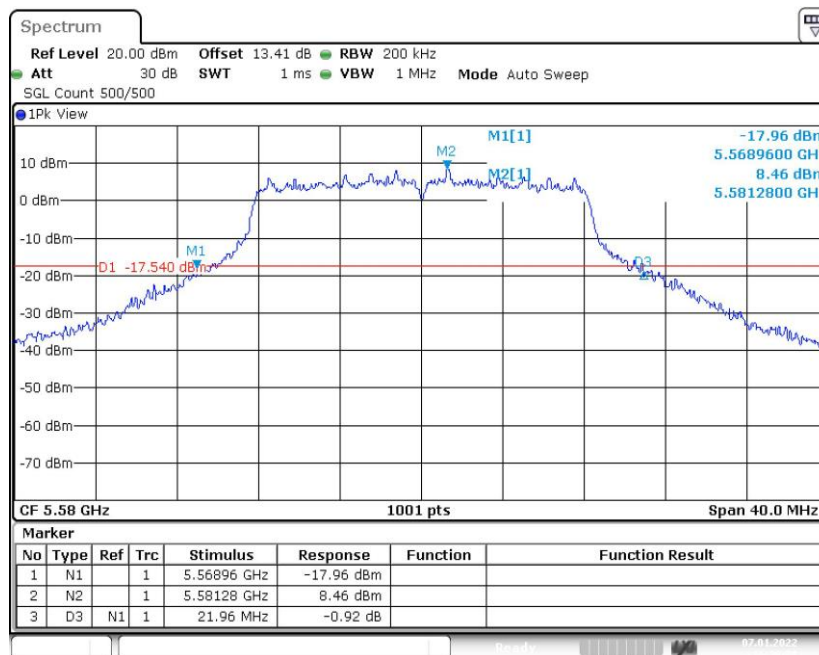

Fig. 8 Occupied 26dB Bandwidth (802.11a, 5580MHz)

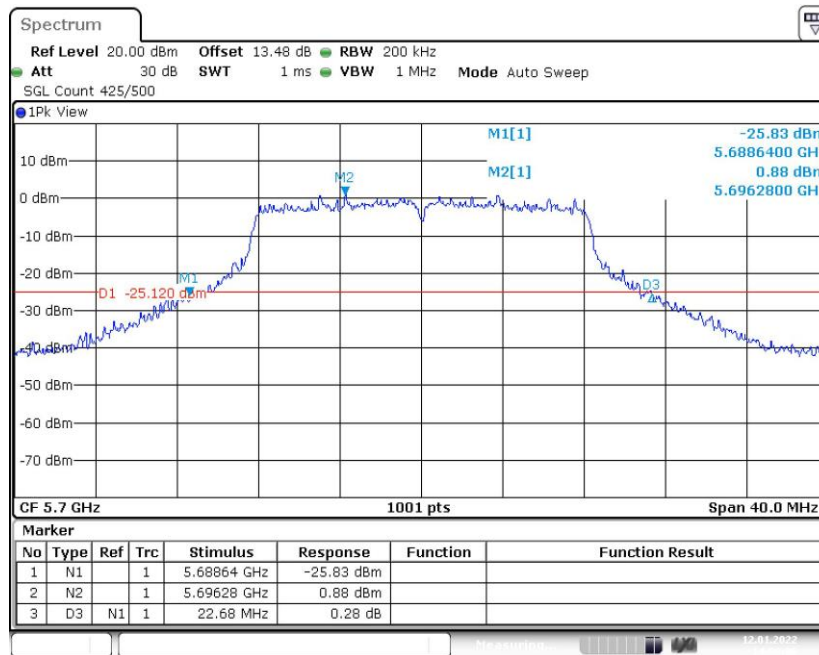

Fig. 9 Occupied 26dB Bandwidth (802.11a, 5700MHz)

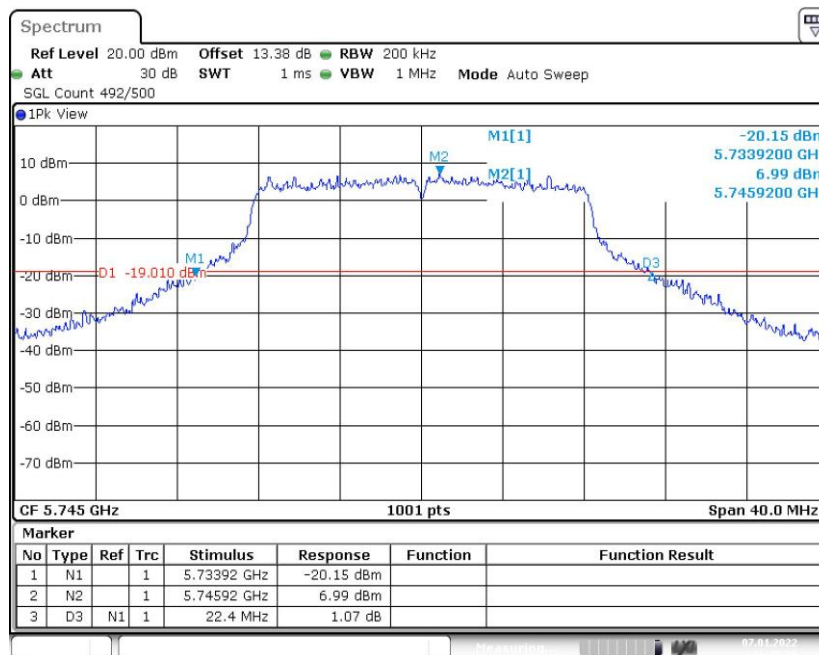

Fig. 10 Occupied 26dB Bandwidth (802.11a, 5745MHz)

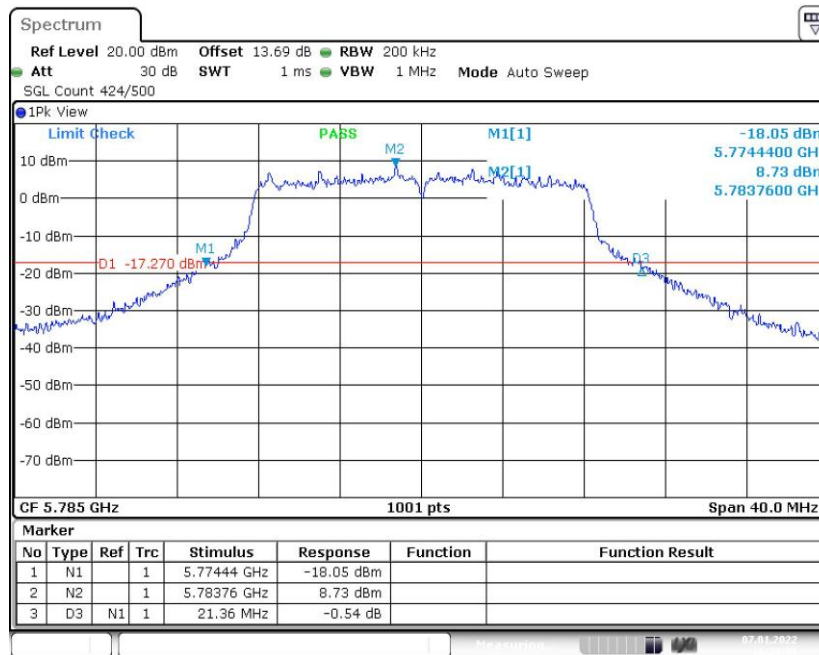

Fig. 11 Occupied 26dB Bandwidth (802.11a, 5785MHz)

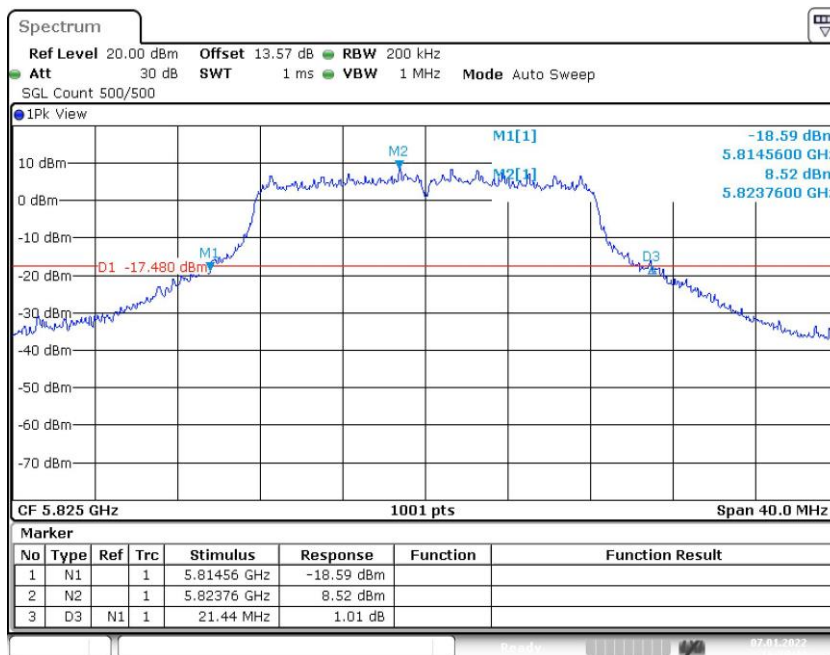

Fig. 12 Occupied 26dB Bandwidth (802.11a, 5825MHz)

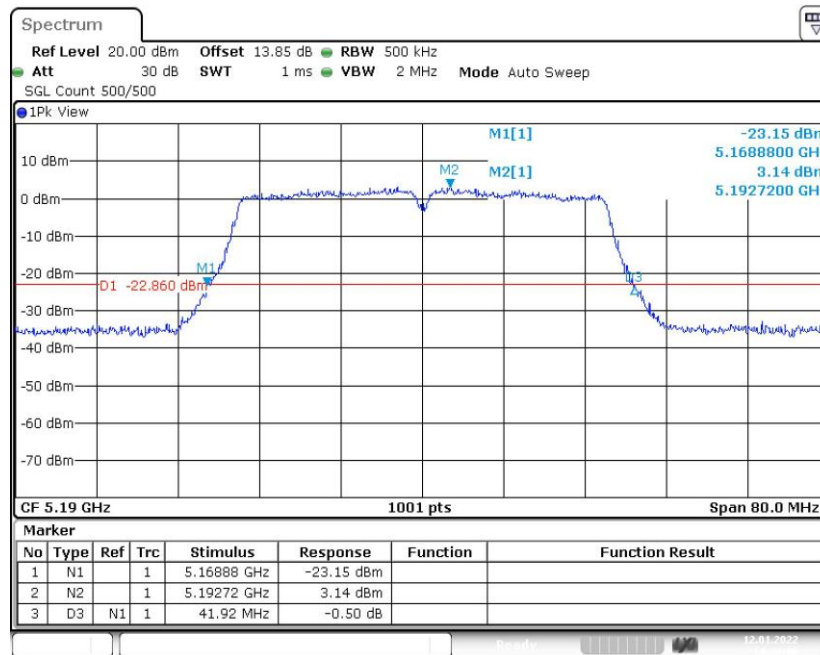

Fig. 13 Occupied 26dB Bandwidth (802.11ac-VHT40, 5190MHz)

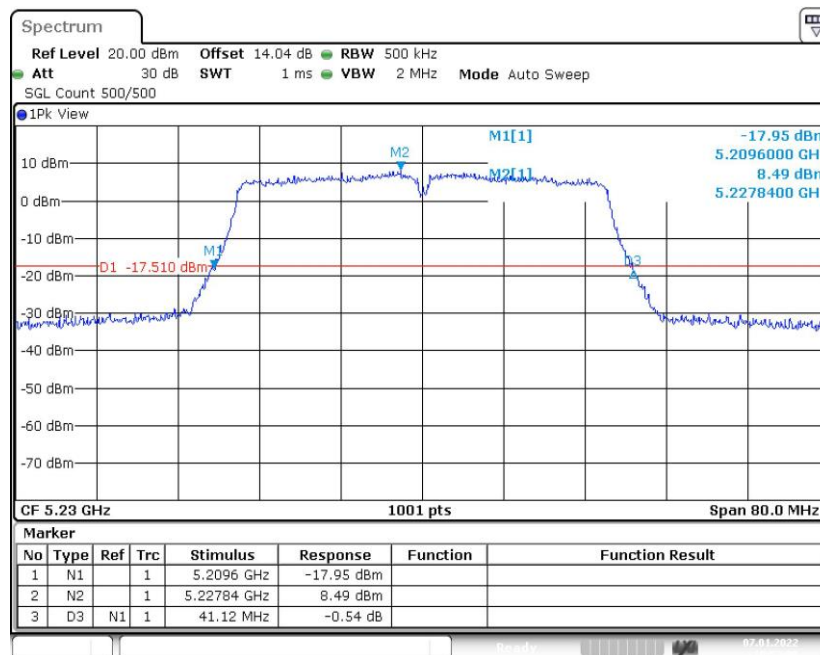

Fig. 14 Occupied 26dB Bandwidth (802.11ac-VHT40, 5230MHz)

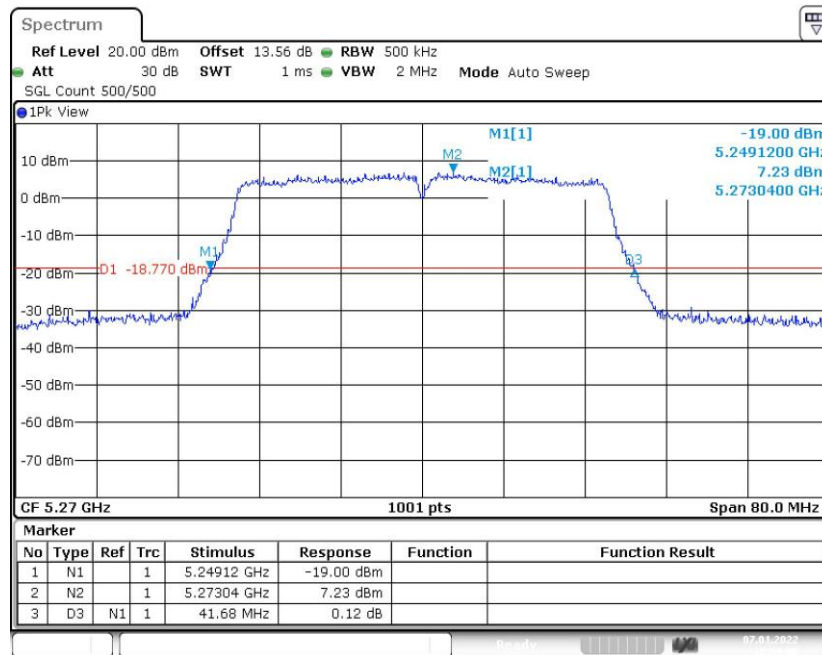

Fig. 15 Occupied 26dB Bandwidth (802.11ac-VHT40, 5270MHz)

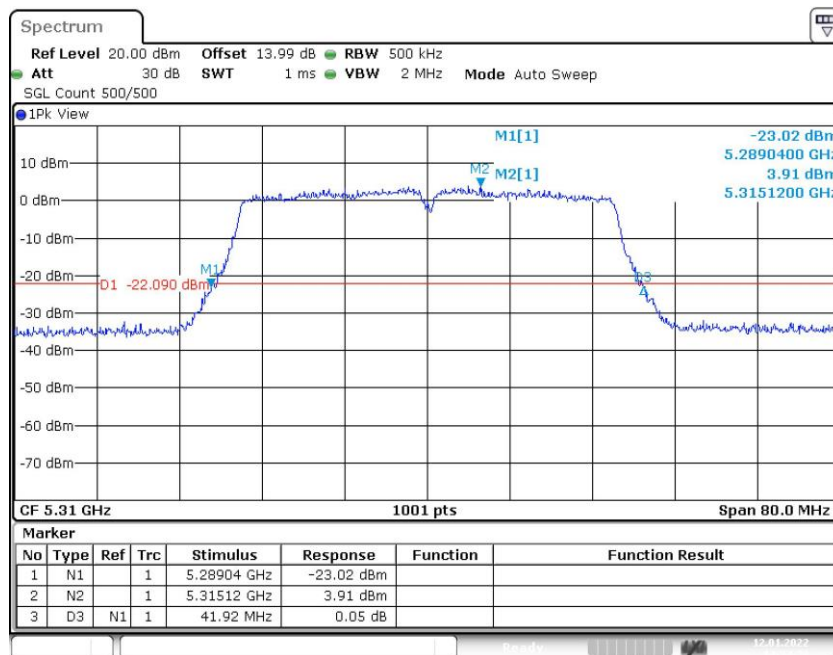

Fig. 16 Occupied 26dB Bandwidth (802.11ac-VHT40, 5310MHz)

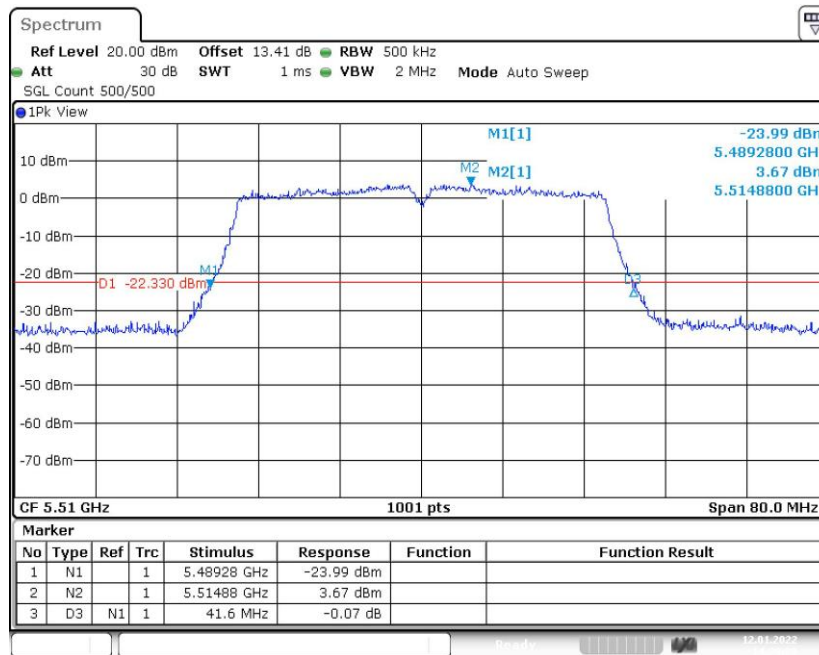

Fig. 17 Occupied 26dB Bandwidth (802.11ac-VHT40, 5510MHz)

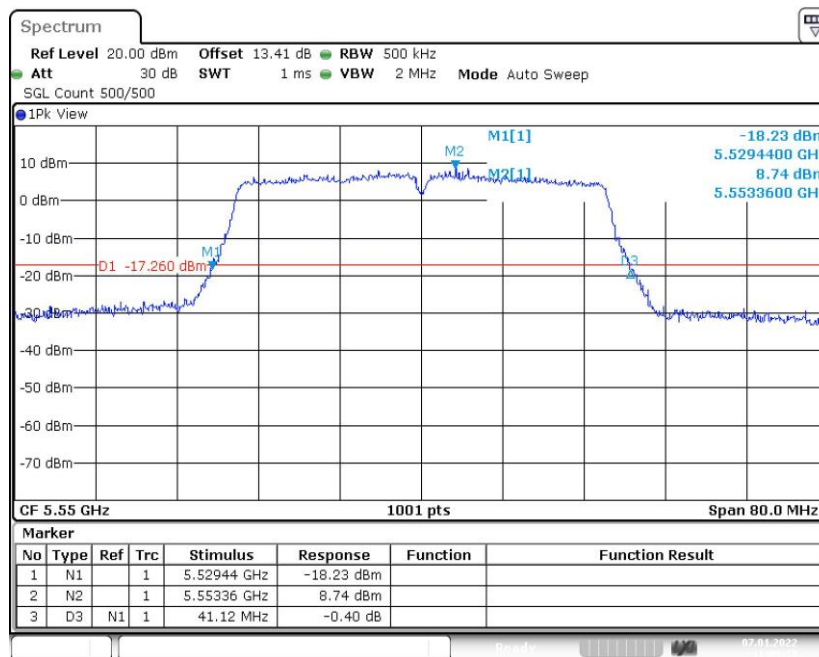

Fig. 18 Occupied 26dB Bandwidth (802.11ac-VHT40, 5550MHz)

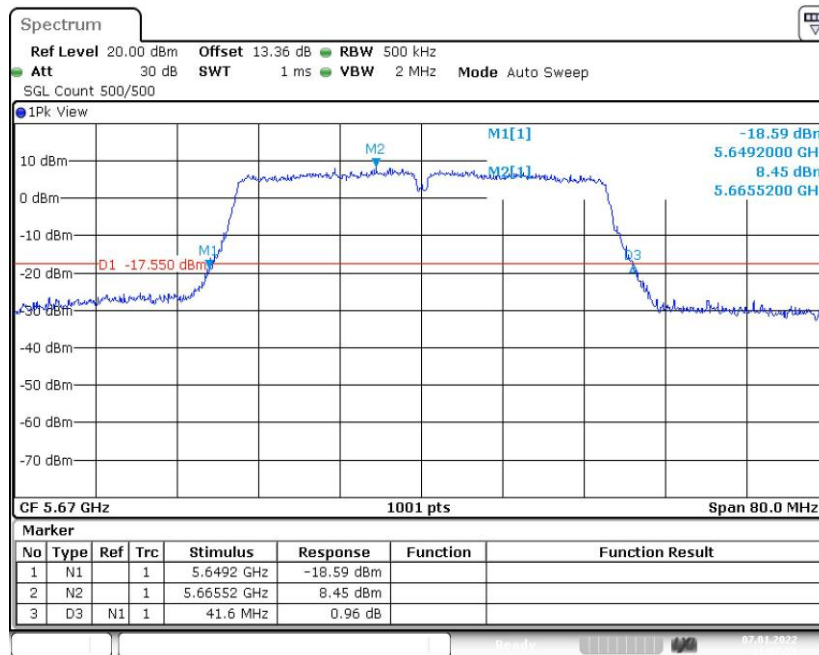

Fig. 19 Occupied 26dB Bandwidth (802.11ac-VHT40, 5670MHz)

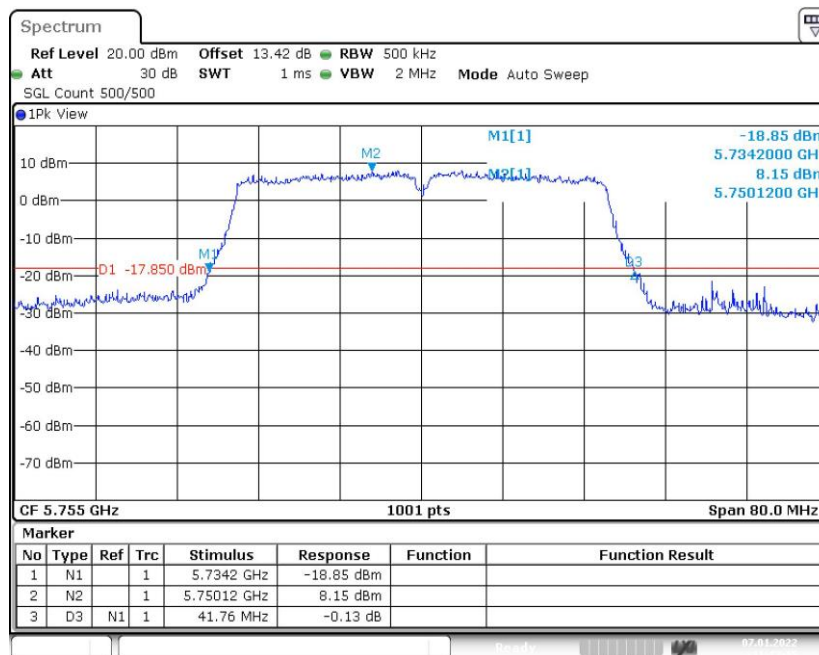

Fig. 20 Occupied 26dB Bandwidth (802.11ac-VHT40, 5755MHz)

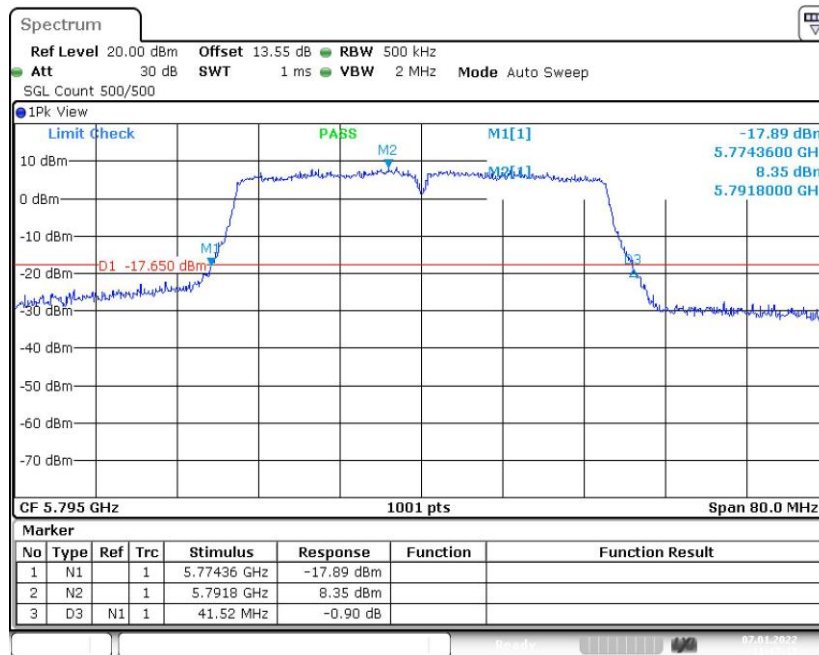

Fig. 21 Occupied 26dB Bandwidth (802.11ac-VHT40, 5795MHz)

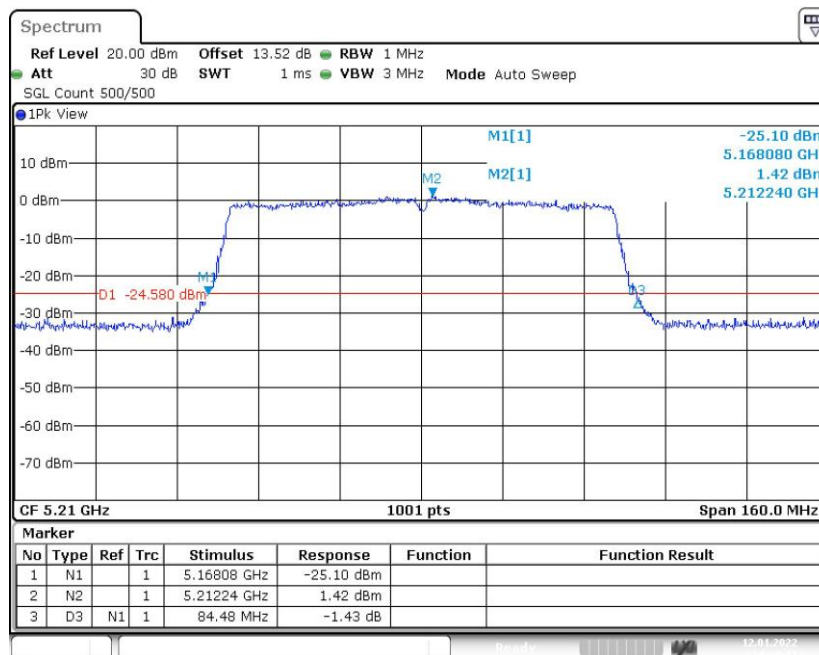

Fig. 22 Occupied 26dB Bandwidth (802.11ac-VHT80, 5210MHz)

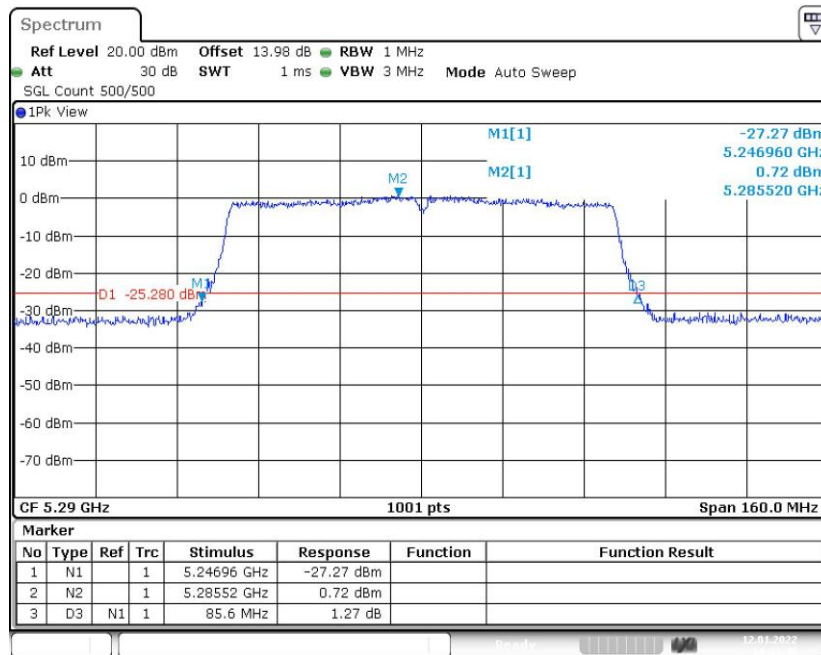

Fig. 23 Occupied 26dB Bandwidth (802.11ac-VHT80, 5290MHz)

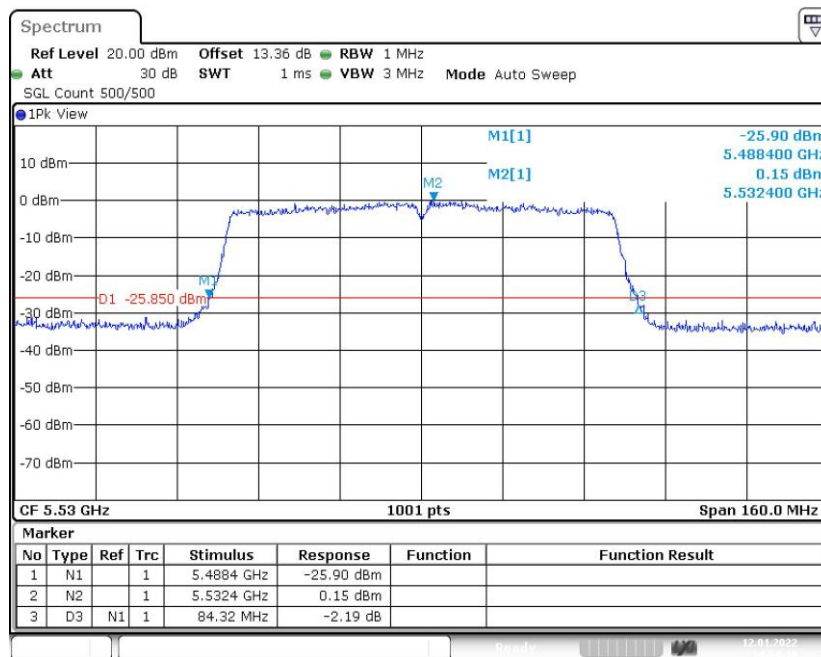

Fig. 24 Occupied 26dB Bandwidth (802.11ac-VHT80, 5530MHz)

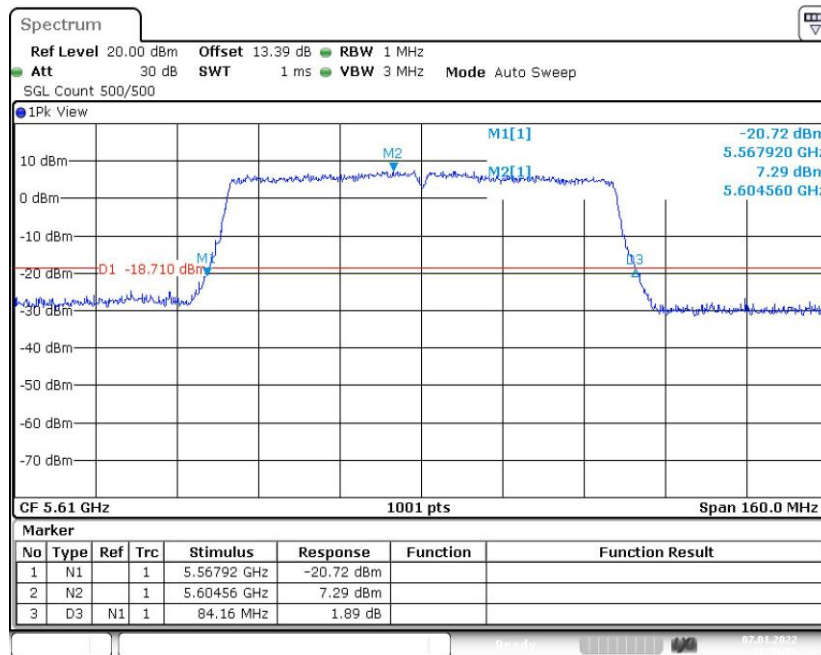

Fig. 25 Occupied 26dB Bandwidth (802.11ac-VHT80, 5610MHz)

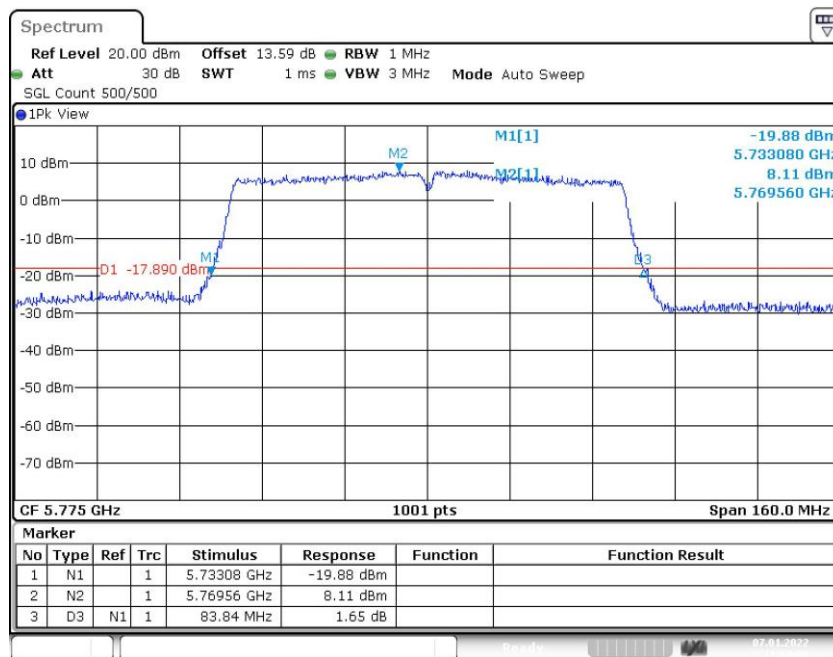

Fig. 26 Occupied 26dB Bandwidth (802.11ac-VHT80, 5775MHz)

A.5. Occupied 6dB Bandwidth (conducted)

Measurement of method: See KDB 789033 D02 v02r01, Section C.2.

Measurement Limit:

Standard	Limit (MHz)
FCC 47 CFR Part 15.407 (e)	≥ 0.5

The measurement is made according to KDB 789033

Measurement Result:

Mode	Channel	Occupied 6dB Bandwidth(MHz)		Conclusion
802.11a	5745MHz(Ch149)	Fig.27	15.88	P
	5785MHz(Ch157)	Fig.28	16.28	P
	5825MHz(Ch165)	Fig.29	15.12	P
802.11ac-VHT40	5755MHz(Ch151)	Fig.30	35.36	P
	5795MHz(Ch159)	Fig.31	35.52	P
802.11ac-VHT80	5775MHz(Ch155)	Fig.32	75.20	P

See below for test graphs.

Conclusion: PASS

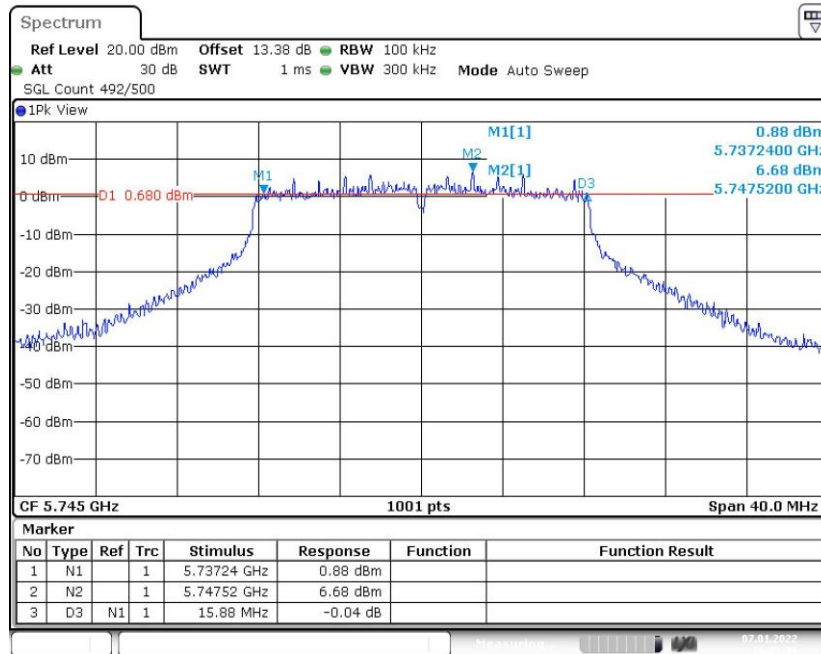

Fig. 27 Occupied 6dB Bandwidth (802.11a, 5745MHz)

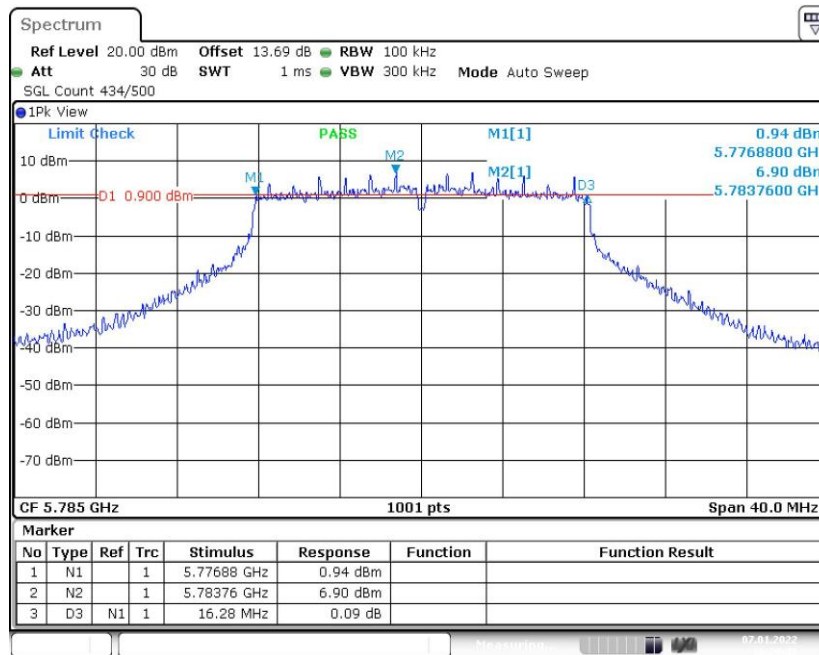

Fig. 28 Occupied 6dB Bandwidth (802.11a, 5785MHz)

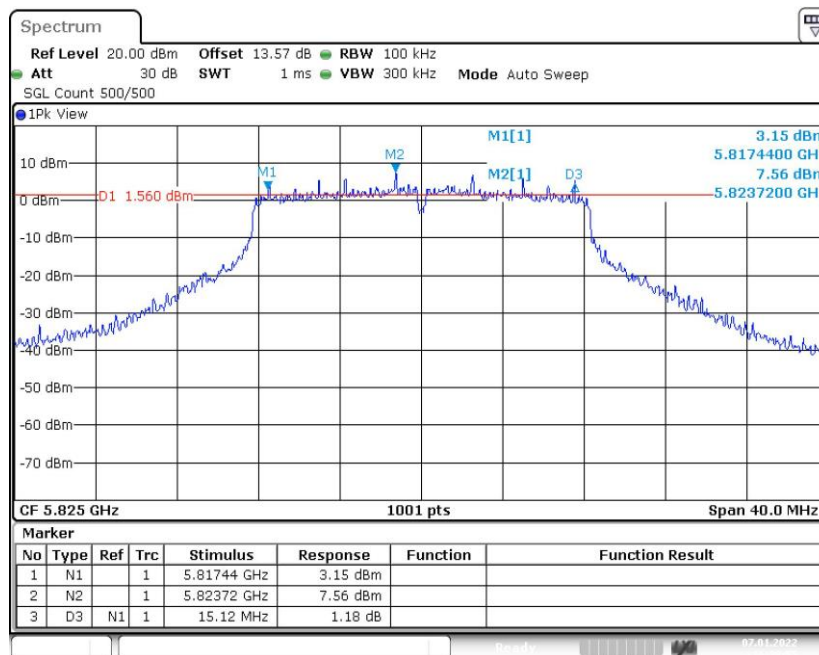

Fig. 29 Occupied 6dB Bandwidth (802.11a, 5825MHz)

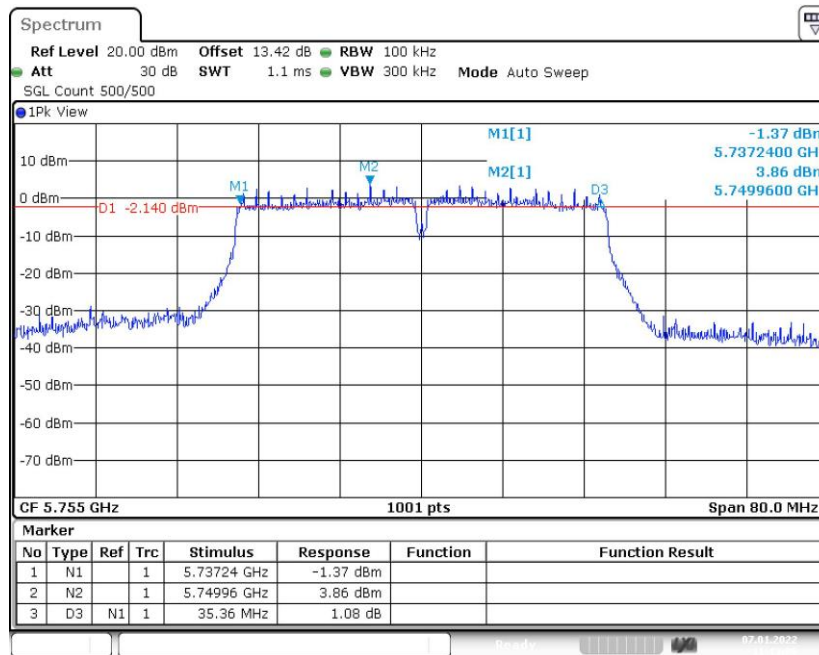

Fig. 30 Occupied 6dB Bandwidth (802.11ac-VHT40, 5755MHz)

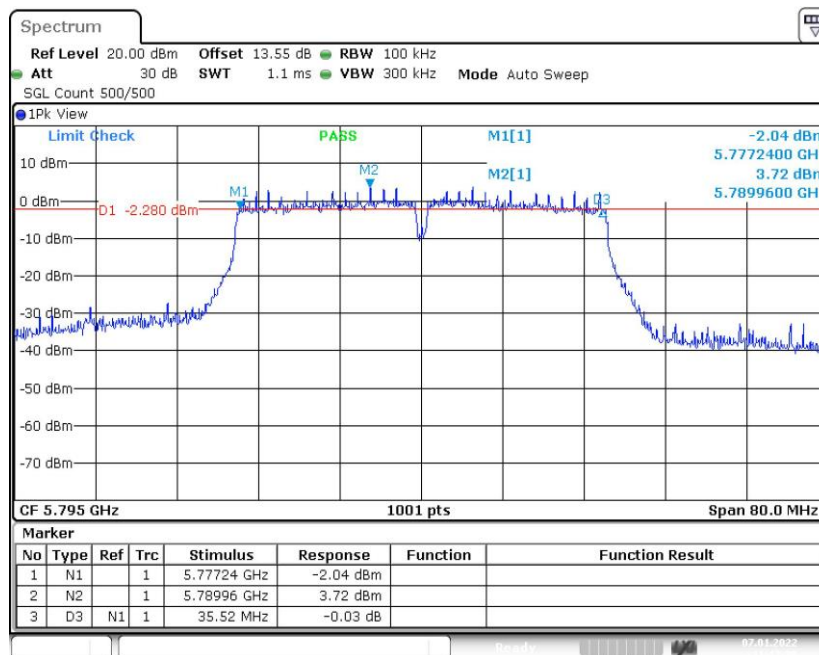

Fig. 31 Occupied 6dB Bandwidth (802.11ac-VHT40, 5795MHz)

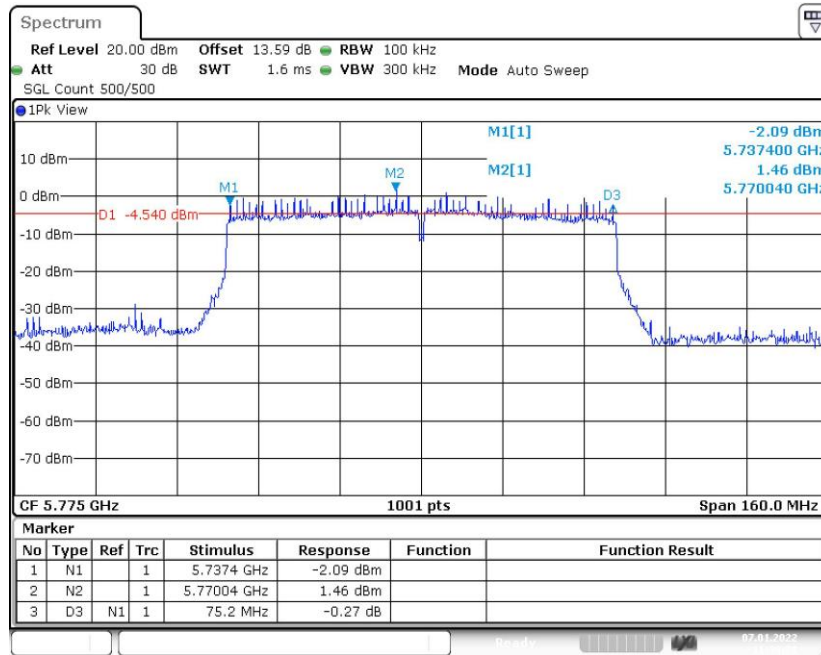

Fig. 32 Occupied 6dB Bandwidth (802.11ac-VHT80, 5775MHz)



A.6. 99% Occupied Bandwidth (conducted)

Measurement of method: See KDB 789033 D02 v02r01, Section D.

Measurement Limit:

Standard	Limit (MHz)
FCC 47 CFR Part 15.403	/

The measurement is made according to KDB 789033

Measurement Result:

Mode	Channel	99% Occupied Bandwidth(MHz)		Conclusion
802.11a	5180MHz(Ch36)	Fig.33	17.18	/
	5200MHz(Ch40)	Fig.34	17.30	/
	5240MHz(Ch48)	Fig.35	17.26	/
	5260MHz(Ch52)	Fig.36	17.26	/
	5280MHz(Ch56)	Fig.37	17.26	/
	5320MHz(Ch64)	Fig.38	17.30	/
	5500MHz(Ch100)	Fig.39	17.26	/
	5580MHz(Ch116)	Fig.40	17.26	/
	5700MHz(Ch140)	Fig.41	17.26	/
	5745MHz(Ch149)	Fig.42	17.22	/
	5785MHz(Ch157)	Fig.43	17.22	/
5825MHz(Ch165)	Fig.44	17.22	/	
802.11ac-VHT40	5190MHz(Ch38)	Fig.45	36.68	/
	5230MHz(Ch46)	Fig.46	36.68	/
	5270MHz(Ch54)	Fig.47	36.68	/
	5310MHz(Ch62)	Fig.48	36.52	/
	5510MHz(Ch102)	Fig.49	36.60	/
	5550MHz(Ch110)	Fig.50	36.60	/
	5670MHz(Ch134)	Fig.51	36.68	/
	5755MHz(Ch151)	Fig.52	36.68	/
5795MHz(Ch159)	Fig.53	36.60	/	
802.11ac-VHT80	5210MHz(Ch42)	Fig.54	76.24	/
	5290MHz(Ch58)	Fig.55	76.24	/
	5530MHz(Ch106)	Fig.56	76.08	/
	5610MHz(Ch122)	Fig.57	76.08	/
	5775MHz(Ch155)	Fig.58	76.08	/

See below for test graphs.

Conclusion: PASS

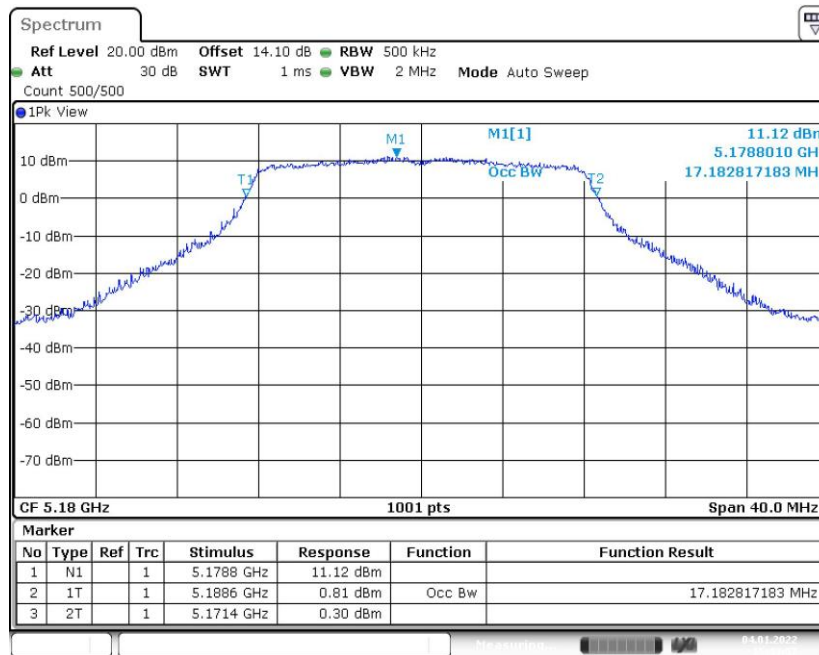

Fig. 33 99% Occupied Bandwidth (802.11a, 5180MHz)

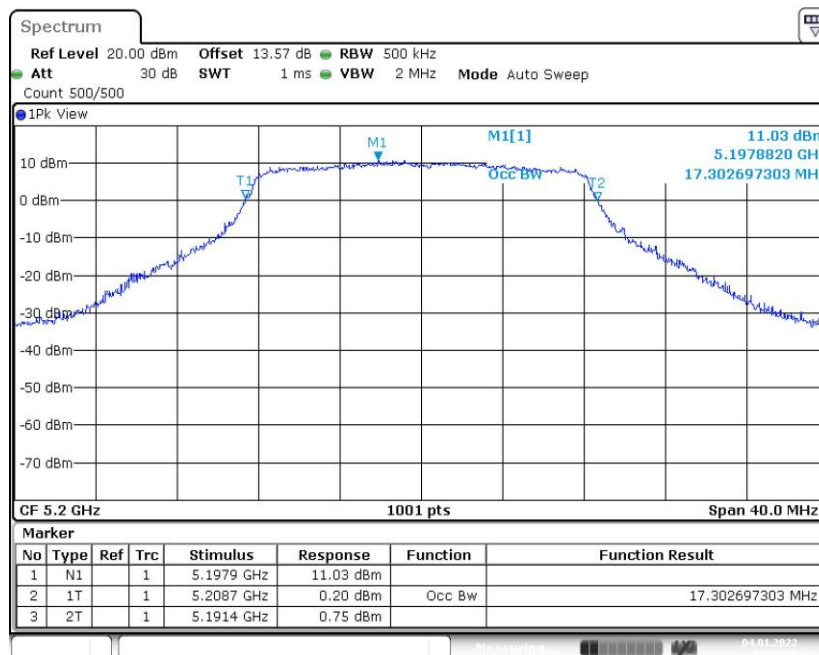

Fig. 34 99% Occupied Bandwidth (802.11a, 5200MHz)

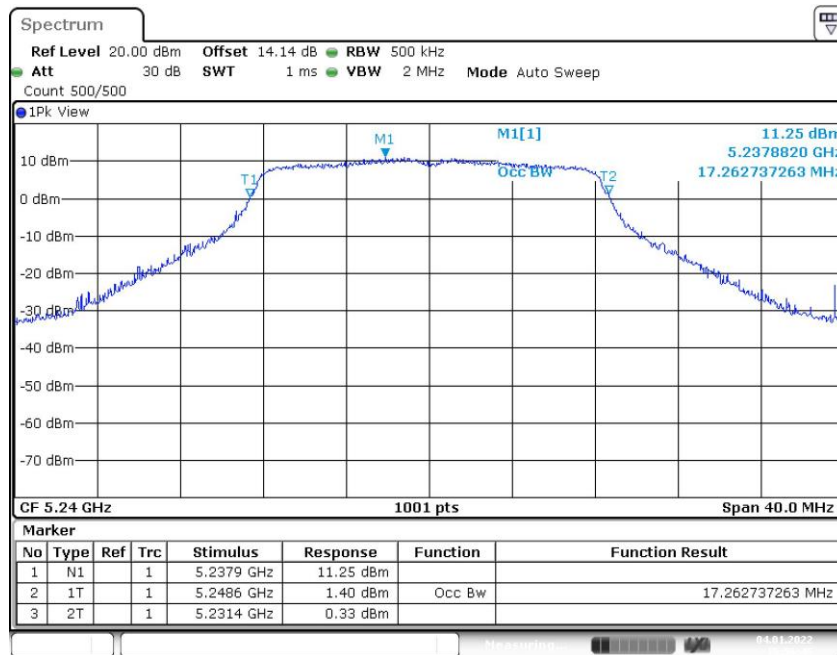

Fig. 35 99% Occupied Bandwidth (802.11a, 5240MHz)

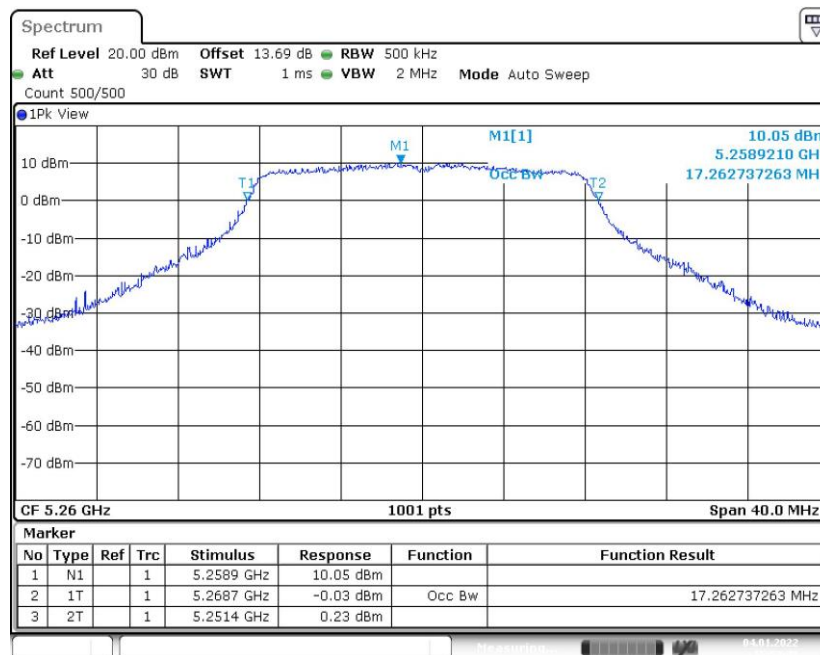

Fig. 36 99% Occupied Bandwidth (802.11a, 5260MHz)

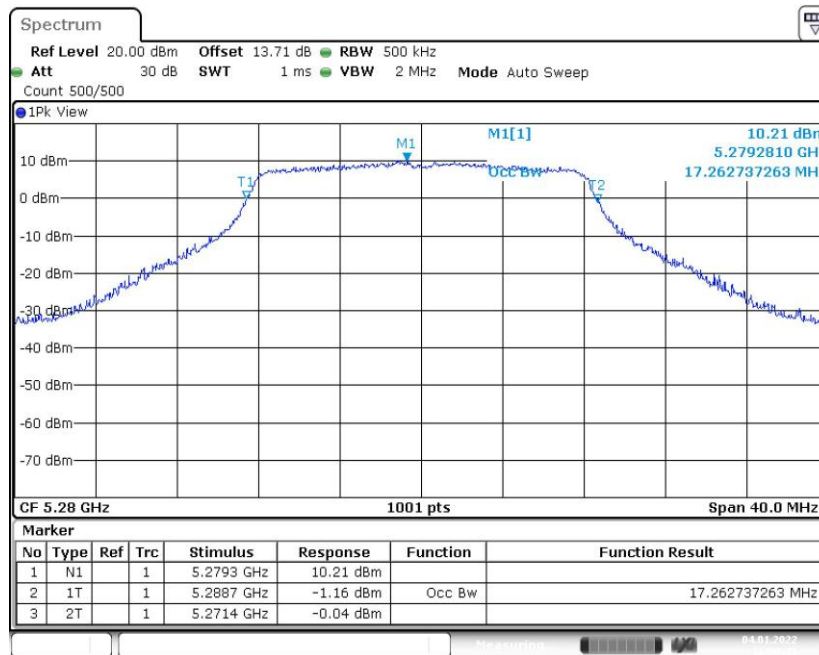

Fig. 37 99% Occupied Bandwidth (802.11a, 5280MHz)

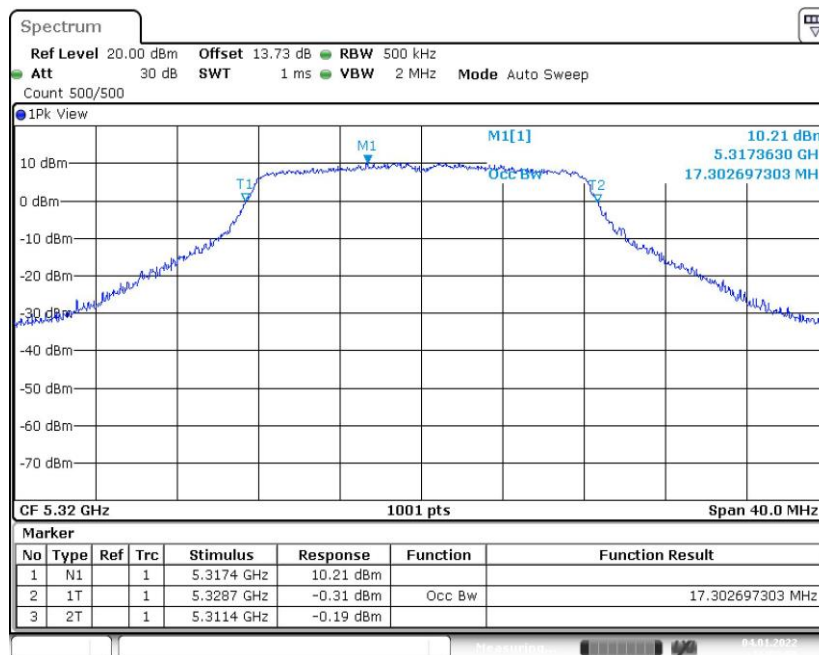

Fig. 38 99% Occupied Bandwidth (802.11a, 5320MHz)

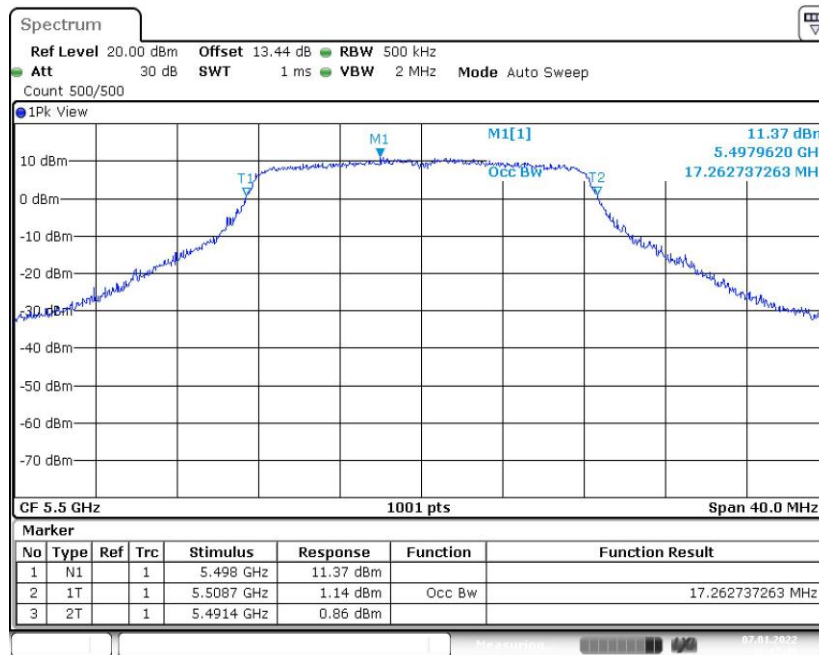

Fig. 39 99% Occupied Bandwidth (802.11a, 5500MHz)

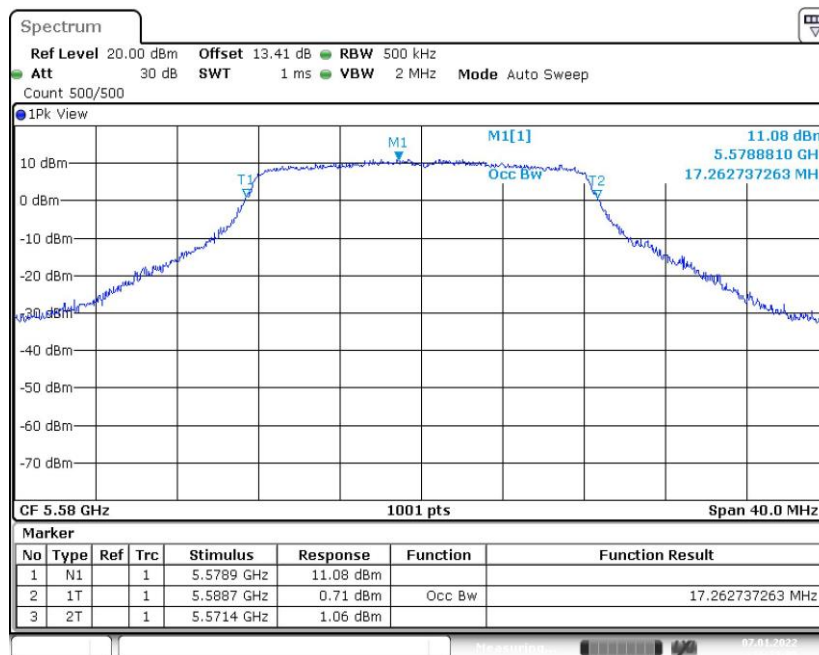

Fig. 40 99% Occupied Bandwidth (802.11a, 5580MHz)

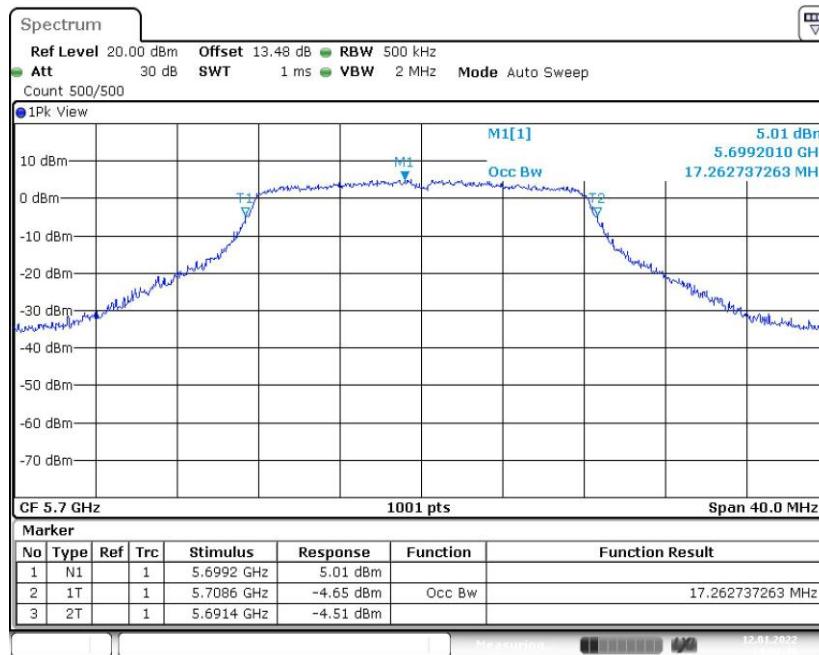

Fig. 41 99% Occupied Bandwidth (802.11a, 5700MHz)

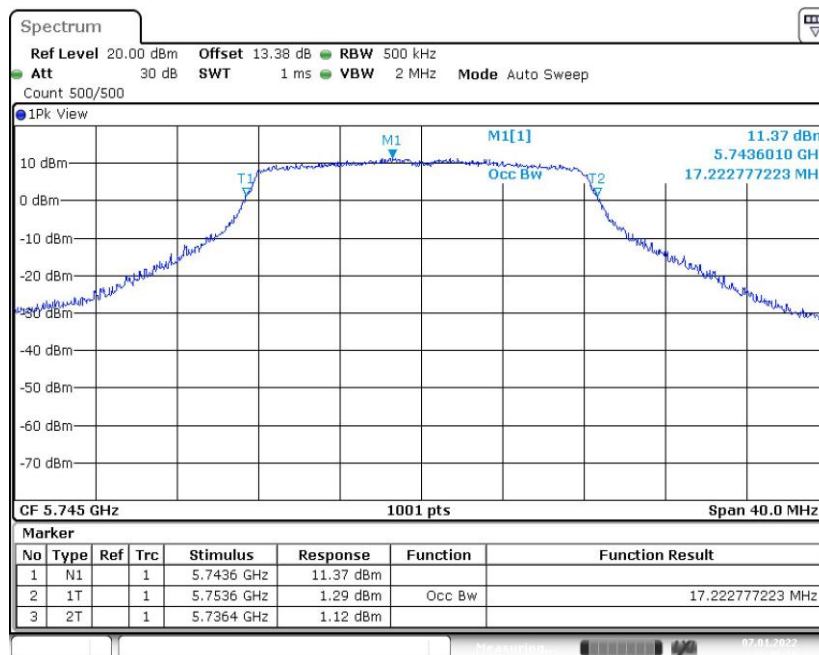

Fig. 42 99% Occupied Bandwidth (802.11a, 5745MHz)

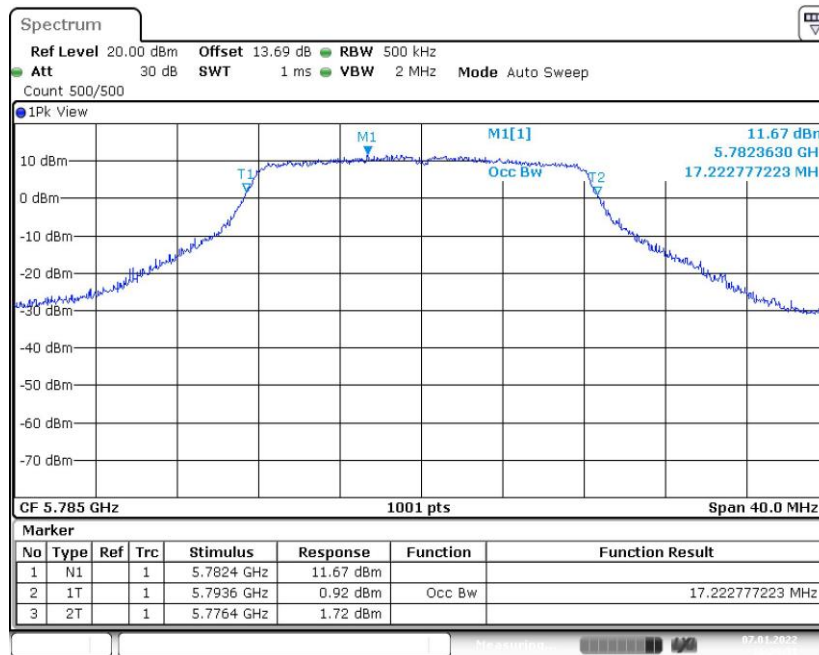

Fig. 43 99% Occupied Bandwidth (802.11a, 5785MHz)

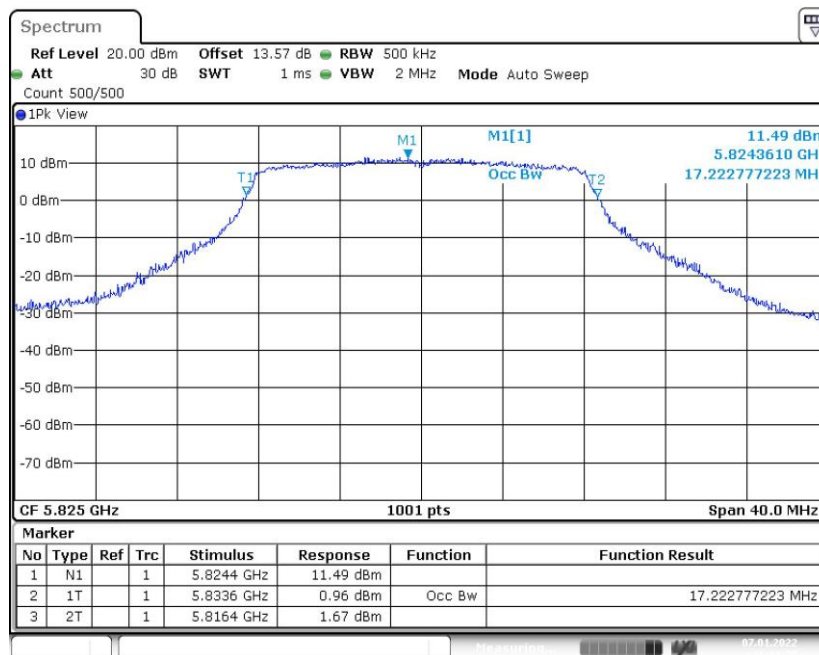

Fig. 44 99% Occupied Bandwidth (802.11a, 5825MHz)

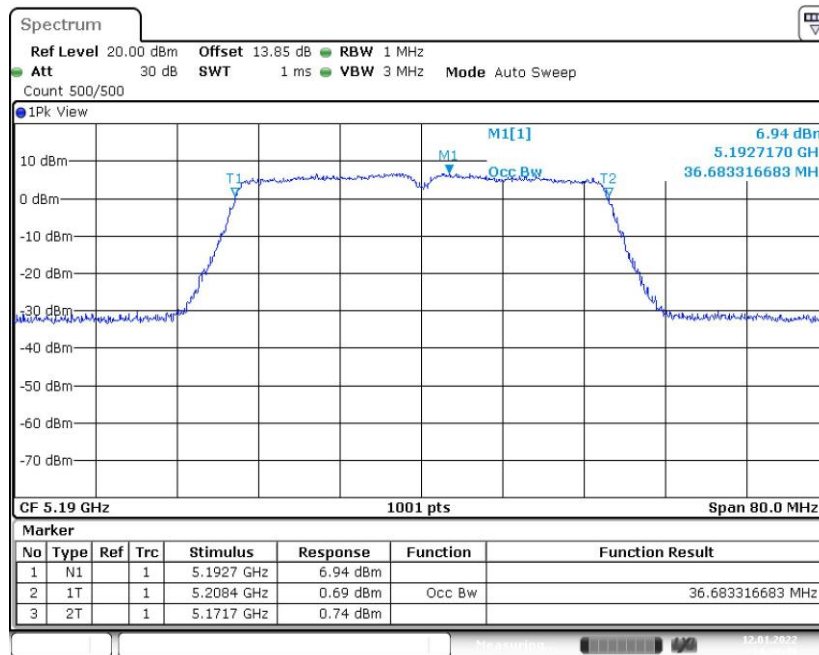

Fig. 45 99% Occupied Bandwidth (802.11ac-VHT40, 5190MHz)

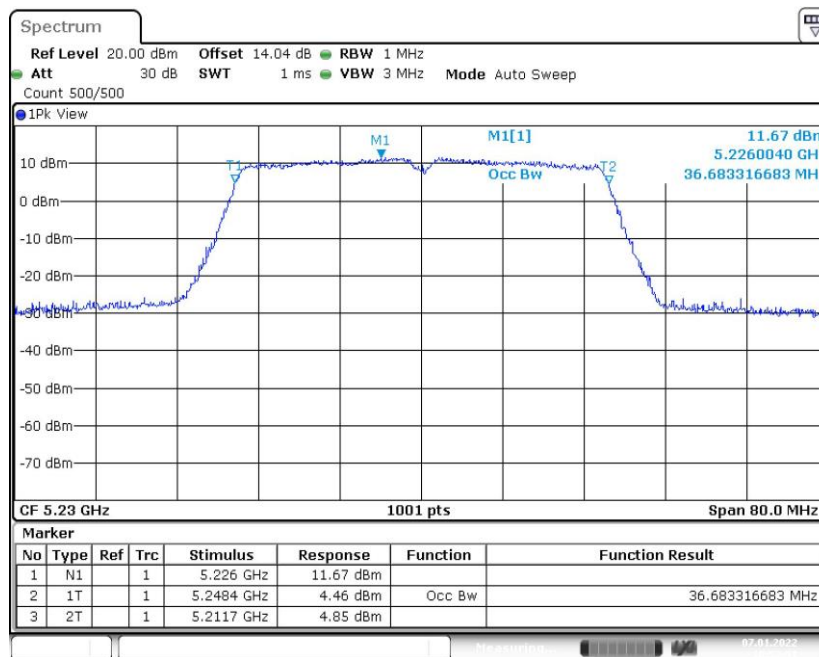

Fig. 46 99% Occupied Bandwidth (802.11ac-VHT40, 5230MHz)

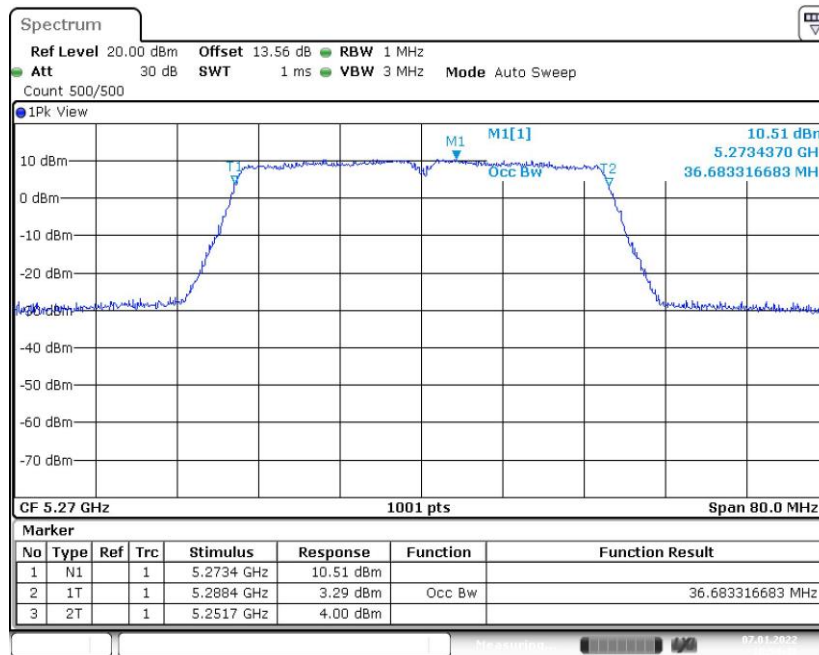

Fig. 47 99% Occupied Bandwidth (802.11ac-VHT40, 5270MHz)

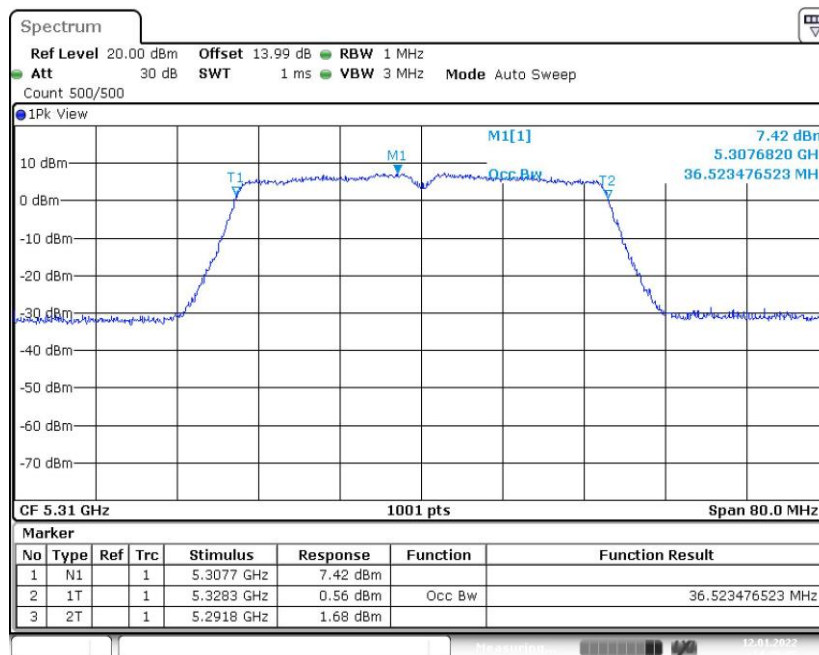

Fig. 48 99% Occupied Bandwidth (802.11ac-VHT40, 5310MHz)